

Thank you for choosing the vehicle from GAC Motor Co., Ltd. (GAC Motor for short) . To better enjoy the driving pleasure provided by your vehicle, please carefully read this User's Manual. The use instructions on the car provided in this Manual will allow you to fully understand its operations and important notes. The proper use of the car will improve driving safety and increase service life.

The on-board Warranty Manual describes the warranty services provided by GAC MOTOR which you can enjoy, as well as regular maintenance of your GA4 vehicle. Read this Manual thoroughly so you can understand your rights and responsibilities.

Please keep this Manual in your car for your reference.

Your dealer is dedicated to your satisfaction and will be pleased to answer any questions and concerns.

If you have any advice or comments, welcome to call GAC MOTOR customer service hotline: +86-400-158-9999. Thank you for your support and great kindness to GAC MOTOR. Wish you a happy driving!

## Reading Instructions

---

Your safety, and the safety of passengers, are very important. Therefore, operating this car safely is an important responsibility.

To help you be familiar with relevant safety notes, we have provided operating steps and other instructions on signboards of the car and in this manual. These instructions alert you to warn potential hazards that could hurt you or passengers.

Of course, it is not practical or possible to list all the hazards associated with operating or maintaining your car. You must use your own good judgment.

You will find these important safety instructions in a variety of forms, including:

- Safety Signboards— Attached to the car.
- Safety Information— Words preceded by a safety warning symbol and one of the three signal words: "Warning", "Caution" or "Hint".

Meanings are as follows:

 Warning Instruction for important or possible personal injury.

 Caution Instruction for important or possible vehicle damage.

 Hint Instruction for potential risks that will not cause injury or damage.

- Some paragraphs in this Manual are inapplicable to all the models, and corresponding caption texts are labeled with "\*" for reference.
- Unless otherwise specially stated, vehicle directions (front, rear, left, right) herein are based on the vehicle's driving direction.

---

1. Important Safety Precautions .....	1	3.5.1 Carbon Monoxide .....	40
2. Pictorial References .....	2	3.6 Safety Labels .....	41
2.1 Exterior .....	2	4. Operating System and Equipment .....	42
2.2 Interior .....	6	4.1 Cab .....	42
3. Safety Operating Instructions .....	12	4.1.1 Instrument Cluster .....	42
3.1 Safety Driving .....	12	4.1.2 Indicator Light .....	58
3.1.1 General Instructions .....	12	4.1.3 Steering Wheel .....	62
3.1.2 Correct Sitting Position of Occupants .....	13	4.2 Start and Stop Vehicle .....	65
3.2 Seat Belt .....	15	4.2.1 Smart Key .....	65
3.2.1 Why Wear Seat Belts .....	15	4.2.2 Emergency Mechanical Key* .....	73
3.2.2 Seat Belt .....	17	4.2.3 Central Locking System .....	74
3.3 SRS System .....	21	4.2.4 Door .....	79
3.3.1 SRS Indicator .....	22	4.2.5 Trunk Lid .....	80
3.3.2 Front Seat Frontal Airbag .....	23	4.2.6 Electric Windows .....	81
3.3.3 Front Seat Side Airbag* .....	25	4.2.7 Electric Sunroof* .....	85
3.3.4 Cases When Airbags Could Deploy .....	27	4.2.8 Engine Hood .....	89
3.3.5 Cases When Airbags Could Not Deploy .....	28	4.2.9 Basic Operations of Anti-Theft on Vehicle Body .....	91
3.4 Safety Rules for Children .....	30	4.3 Lights and Visual Field .....	93
3.4.1 General Instructions .....	30	4.3.1 Exterior Lights .....	93
3.4.2 Child Safety Seat .....	32	4.3.2 Interior Lights .....	100
3.4.3 Information about Child Safety Seat .....	34	4.3.3 Windshield Wiper .....	103
3.4.4 Install a Child Seat Properly .....	36	4.3.4 Windshields .....	106
3.5 Dangerous Exhaust Gases .....	40	4.3.5 Rear-View Mirror .....	107

## Contents

---

4.3.6 Sun Visor .....	111	4.6.10 Pre-maintenance Inspection .....	163
4.4 Seats and Storage Devices .....	112	4.7 Audio System (AVN)* .....	165
4.4.1 Importance of Adjusting Seats Properly.....	112	4.7.1 Control Panel .....	165
4.4.2 Headrest .....	113	4.7.2 Control Buttons on the Steering Wheel.....	167
4.4.3 Front Seats .....	115	4.7.3 Basic Operations.....	169
4.4.4 Rear Seats.....	117	4.7.4 Radio.....	173
4.4.5 Storage Devices .....	118	4.7.5 USB Play.....	177
4.4.6 Cigarette Lighter/Power Outlet .....	124	4.7.6 iPod Play .....	184
4.4.7 Trunk .....	125	4.7.7 Bluetooth.....	185
4.4.8 Accessories and Modifications .....	127	4.7.8 System Setting.....	191
4.5 A/C System .....	129	4.7.9 Car Setting.....	197
4.5.1 General Instructions.....	129	4.7.10 Supported Formats .....	201
4.5.2 Control Panel.....	130	4.7.11 Precautions for Use of USB .....	205
4.5.3 Air Outlets.....	139	4.7.12 Precautions for Product Use .....	207
4.6 Audio System (Radio)* .....	140	4.7.13 Guide on Elimination of Common Faults.....	208
4.6.1 Control Panel.....	140	5. Driving Directions .....	209
4.6.2 Control Buttons on the Steering Wheel* .....	143	5.1 Starting and Driving.....	209
4.6.3 Basic Operations .....	144	5.1.1 Ignition Switch* .....	209
4.6.4 Radio .....	149	5.1.2 Start Switch* .....	210
4.6.5 USB Play .....	154	5.1.3 Engine Start.....	212
4.6.6 iPod Play .....	158	5.1.4 Engine Shutdown.....	214
4.6.7 Precautions.....	159	5.1.5 Gear and Driving Instructions .....	216
4.6.8 Supported Formats .....	161	5.1.6 Electronic Parking Brake (EPB) System*.....	225
4.6.9 Characteristics and Specifications .....	162	5.1.7 Mechanical Parking Brake System*.....	231

<ul style="list-style-type: none"> <li>5.2 Service Electronic Brake System .....232               <ul style="list-style-type: none"> <li>5.2.1 Anti-Lock Braking System (ABS) .....232</li> <li>5.2.2 Electronic Brakeforce Distribution System (EBD) .....235</li> <li>5.2.3 Electronic Stability Program (ESP)* .....236</li> <li>5.2.4 Traction Control System (TCS)* .....239</li> <li>5.2.5 Hydraulic Brake Assist (HBA)* .....240</li> <li>5.2.6 Hill Hold Control (HHC)* .....241</li> </ul> </li> <li>5.3 Driver Assistance System .....242               <ul style="list-style-type: none"> <li>5.3.1 Cruise Control System* .....242</li> <li>5.3.2 Tire Pressure Monitoring System* .....245</li> </ul> </li> <li>5.4 Reversing Assist System.....247               <ul style="list-style-type: none"> <li>5.4.1 Reversing Radar System .....247</li> <li>5.4.2 Reversing Rear-view System* .....250</li> <li>5.4.3 Panorama Parking System* .....253</li> </ul> </li> <li>5.5 Electric Power Steering (EPS) System .....256</li> <li>5.6 Driving Skills .....257               <ul style="list-style-type: none"> <li>5.6.1 Safety Check for Driving .....257</li> <li>5.6.2 Driving during Running-in Period .....258</li> <li>5.6.3 Important Tips for Driving under Different Conditions .....260</li> <li>5.6.4 Efficient Use of the Car .....262</li> <li>5.6.5 Fire Prevention.....263</li> </ul> </li> <li>6. Usage and Maintenance .....264</li> </ul>	<ul style="list-style-type: none"> <li>6.1 Maintenance Instructions .....264</li> <li>6.2 Interior Maintenance .....265</li> <li>6.3 Exterior Maintenance .....267</li> <li>6.4 Checking and Adding Fluids .....272               <ul style="list-style-type: none"> <li>6.4.1 Fuel Oil.....272</li> <li>6.4.2 Engine Oil .....274</li> <li>6.4.3 Coolant.....279</li> <li>6.4.4 Windshield Washing Liquid and Wiper Blade...283</li> <li>6.4.5 Brake Fluid.....285</li> <li>6.4.6 Battery.....288</li> </ul> </li> <li>6.5 A/C Filter.....291</li> <li>6.6 Replacing Bulbs.....294</li> <li>6.7 Wheels.....312</li> <li>6.8 Tire Chain .....319</li> <li>6.9 Maintenance Instructions for Car Body Anti-Theft .....320</li> <li>7. Technical Data.....321               <ul style="list-style-type: none"> <li>7.1 Vehicle Identification Numbers .....321</li> <li>7.2 Vehicle Parameters .....323</li> <li>7.3 Vehicle Parameters .....324</li> <li>7.4 Vehicle Parameters .....328</li> </ul> </li> <li>8. Handling of Accident.....332               <ul style="list-style-type: none"> <li>8.1 Vehicle Tools and Spare Tire .....332</li> <li>8.2 Usage of Warning Triangle.....334</li> </ul> </li> </ul>
--	--

## Contents

---

8.3 Usage of Reflective Vest .....	335
8.4 Replacing the Flat Tire.....	336
8.5 Fuse.....	340
8.5.1 Fuses in the Instrument Panel Fuse Box .....	342
8.5.2 Fuse in Engine Compartment Fuse Box .....	345
8.6 Emergency Start .....	348
8.7 Emergency Towing .....	350
9. Environmental Protection Information .....	355
9.1 Environmental Protection Information No. ....	355
9.2 Environmental Protection Information .....	357

## 1. Important Safety Precautions

---

The following safety precautions describe the safety features and correct use of the vehicle. We think all of them are very important.

### ◆ **Be sure to wear the seat belt**

In all types of crashes, seat belts are protective devices that perform best. Air bags are designed to enhance safety provided by seat belts rather than take the place of seat belts. Thus even if the car is equipped with air bags, make sure that you and other occupants always correctly wear seat belts.

### ◆ **Protect all children**

Children 12 years old and under must never ride in the front seat. They shall be correctly restrained in the second-row seats. For infants and babies, child safety seats shall be used. For older children, both child safety seats and three-point seat belts shall be used.

### ◆ **Note that air bag may cause danger**

Air bags can save lives. However, deployment of air bags could result in serious or fatal injury to the occupant too close to them or improperly restrained. Air bags present greatest threats to infants, babies, and short adults. Therefore, be sure to observe all instructions and warnings contained in this Manual.

### ◆ **Never drive after drinking alcohol**

Never drive after drinking alcohol. Even drinking a little alcohol can suppress capability of dealing with changing situations, besides, it takes longer time for doing so. Never drive after drinking alcohol. Do not let your friends drive after drinking alcohol either.

### ◆ **Observe road traffic safety regulations and be polite while driving.**

### ◆ **Pay due attention to driving safety**

Making calls or doing other things while driving could cause you to pay no attention to road conditions, other vehicles and pedestrians. This could result in accidents. Keep in mind that avoid distraction while driving.

### ◆ **Control the vehicle speed**

Vehicle speed being too fast is one of the main causes for injury and death in crashes. Generally, the faster the vehicle speed, the greater the risk. Nonetheless, sometimes accidents with relatively slow vehicle speeds can also lead to serious injury or death. Regardless of the highest speed permitted by the regulation, never drive faster than the permission by actual road conditions for safety purpose.

### ◆ **Keep the vehicle at a safe status**

Tire burst or mechanical fault can be very dangerous. To reduce possibility of these problems, check tire pressures and conditions from time to time, and have the vehicle serviced periodically according to the Warranty Manual.

## 2. Pictorial References

---

### 2.1 Exterior

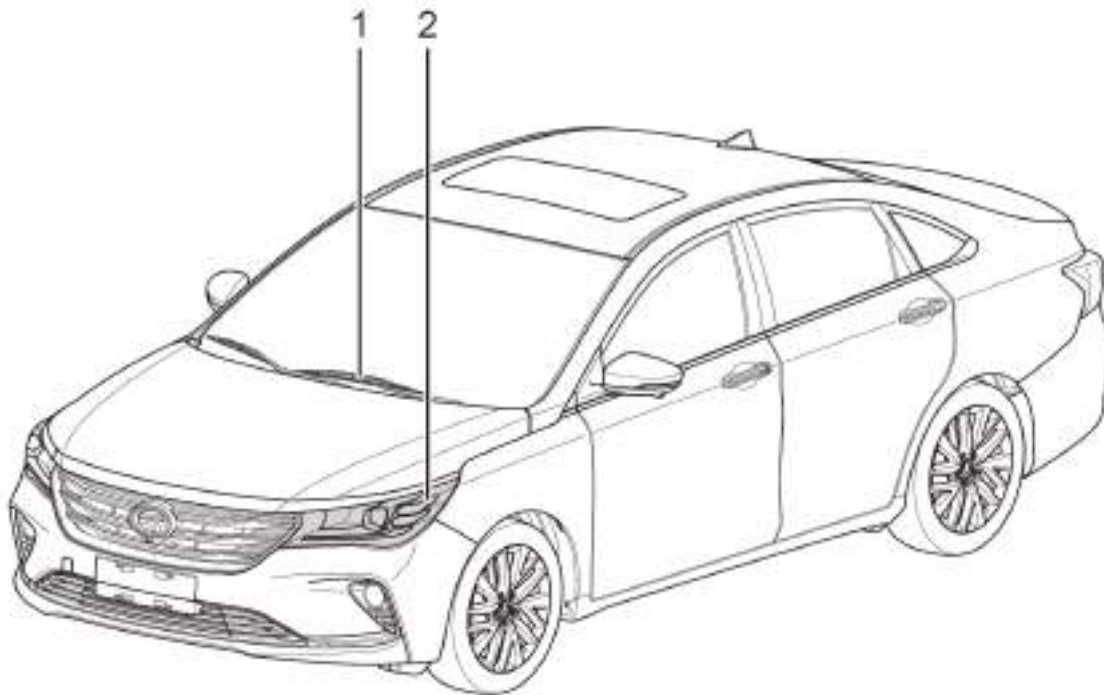

1. Replace front windshield wiper =>Refer to Page 346
2. The front combination light consists of:
  - Low Beam
  - High beam
  - Front position light
  - Daytime Running Light\*
  - Front turn signal light
  - Turn on the light =>Refer to Page 94
  - Replace the bulb =>Refer to Page 356
  - Front combination light bulb specifications =>Refer to Page 392



## 2. Pictorial References

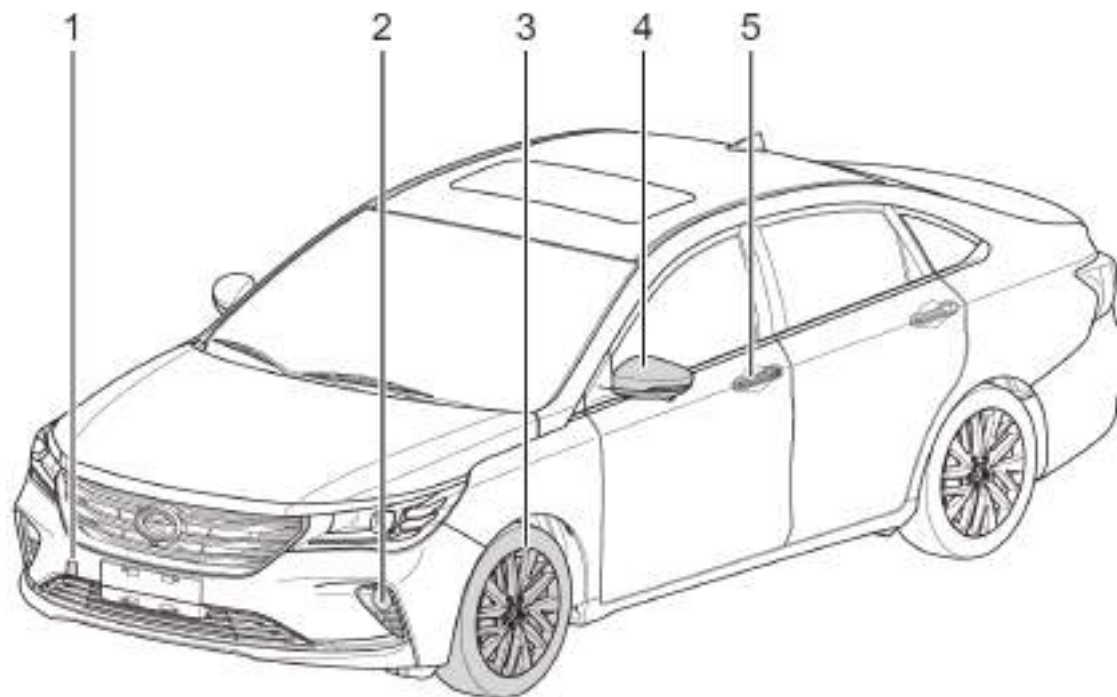

1. Front towing =>Refer to Page 412
2. Front fog light\* =>Refer to Page 98  
Bulb specifications\* =>Refer to Page 392  
Replace the bulb\* =>Refer to Page 356
3. Wheels =>Refer to Page 374
4. Exterior rear-view mirror =>Refer to Page 109
  - Rear-view mirror side turn signal =>Refer to Page 94  
Bulb specifications =>Refer to Page 390  
Replace the bulb =>Refer to Page 356
  - Guest greeting light\* =>Refer to Page 100  
Bulb specifications\* =>Refer to Page 392
5. Keyless entry\* =>Refer to Page 69
  - Vehicle door lock hole =>Refer to Page 78

## 2. Pictorial References

---

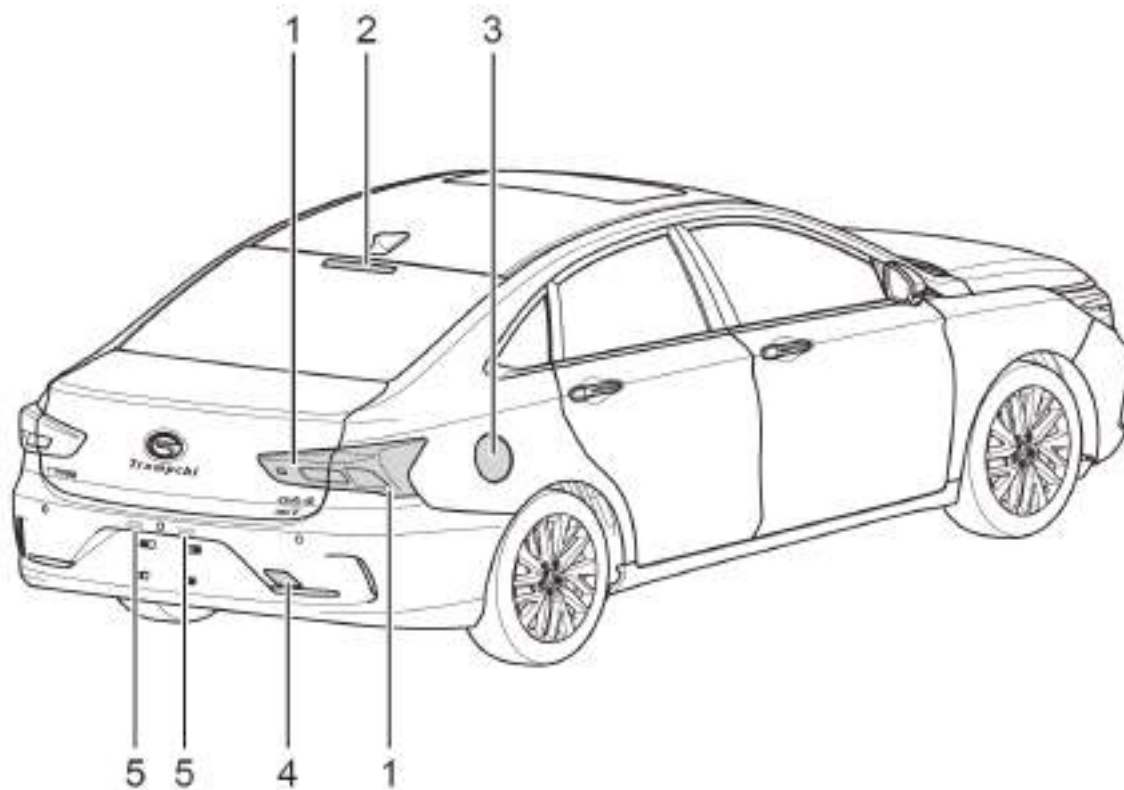

1. The rear combination light consists of:
  - Rear position light
  - Brake Light
  - Rear turn signal light
  - Reversing light
  - Rear fog light (left only)
  - Replace the bulb =>Refer to Page 356
  - Rear combination light specifications =>Refer to Page 392
  - Trunk lid release button\* =>Refer to Page 81
2. High brake light
  - Bulb specifications =>Refer to Page 392
  - Replace the bulb =>Refer to Page 356
3. Fuel tank lid =>Refer to Page 334
4. Rear towing =>Refer to Page 413
5. Number plate light
  - Bulb specifications =>Refer to Page 392
  - Replace the bulb =>Refer to Page 356

## 2. Pictorial References

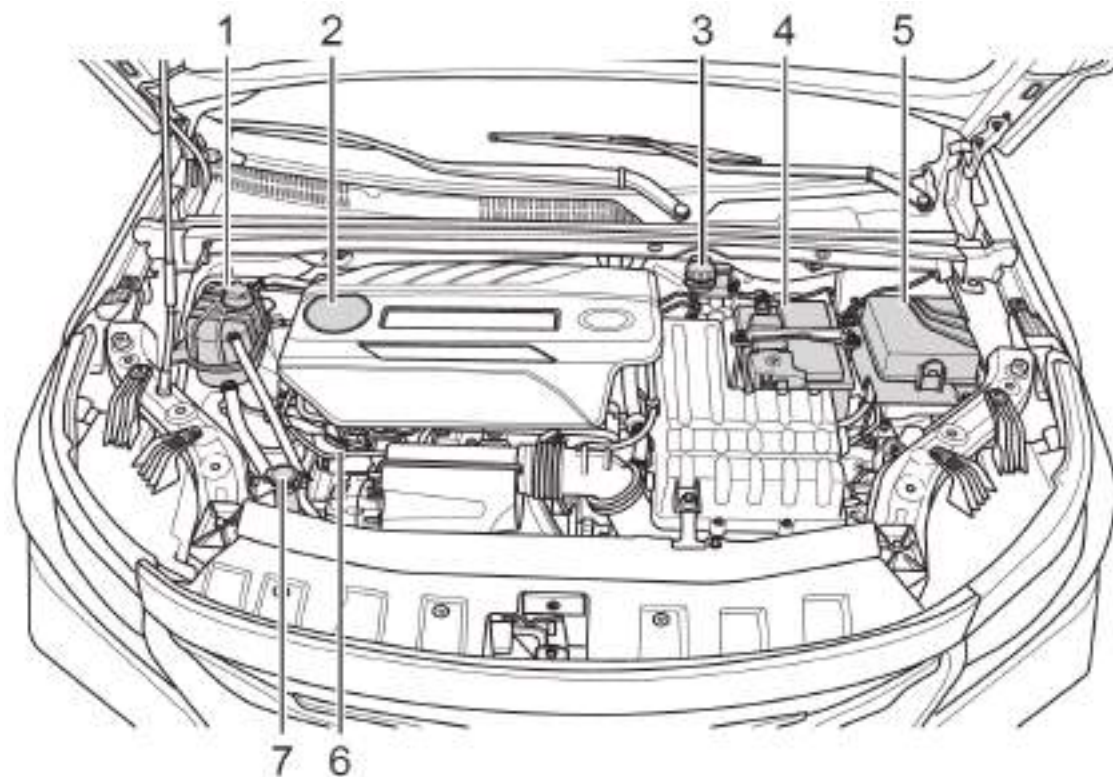

FER

1. Coolant expansion tank =>Refer to Page 341
2. Engine oil filler cap =>Refer to Page 338
3. Brake fluid tank =>Refer to Page 347
4. Battery =>Refer to Page 350
5. Front engine compartment fuse box =>Refer to Page 402
6. Engine oil dipstick =>Refer to Page 337
7. Windshield washing liquid storage tank =>Refer to Page 345

## 2. Pictorial References

---

### 2.2 Interior

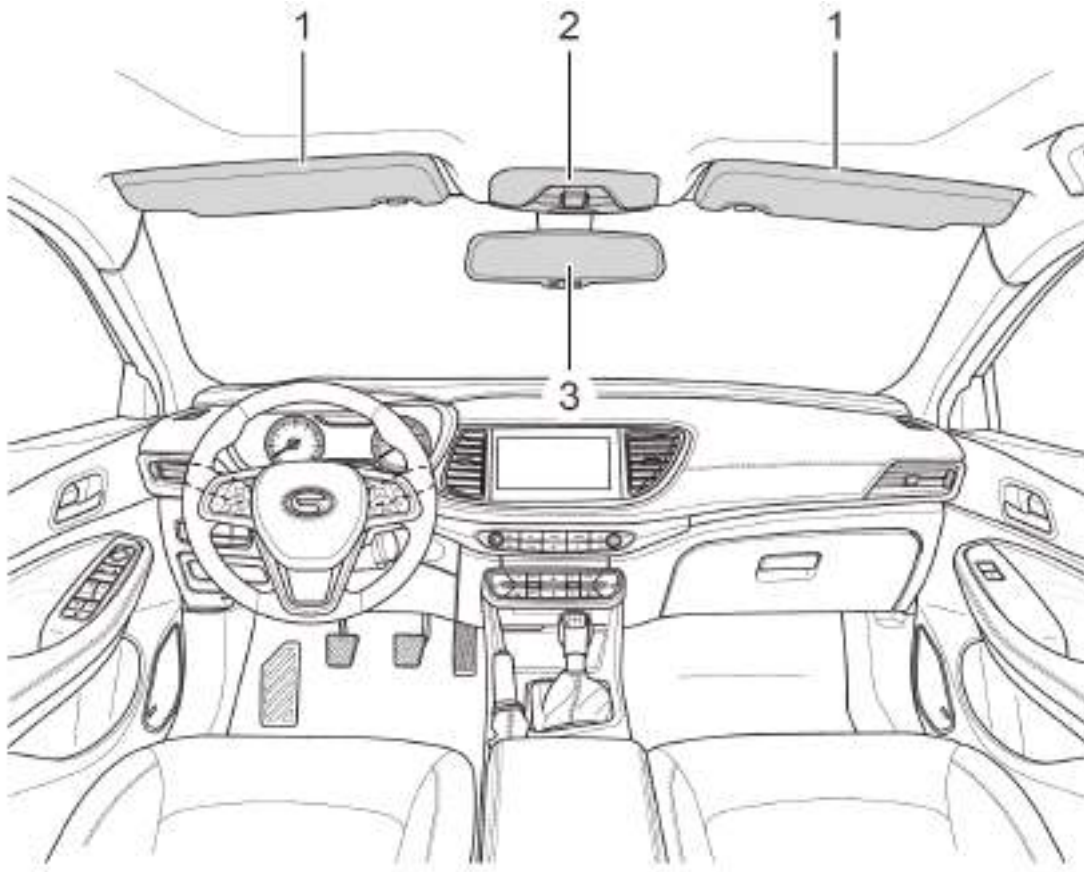

1. Sun visor => Refer to Page 112
2. Front roof lights =>Refer to Page 101
  - Electric sunroof switch\* =>Refer to Page 86
  - Glasses case => Refer to Page 123
3. Automatic anti-glare interior rear-view mirror\* => Refer to Page 108
  - Manual anti-glare interior rear-view mirror\* => Refer to Page 109

## 2. Pictorial References

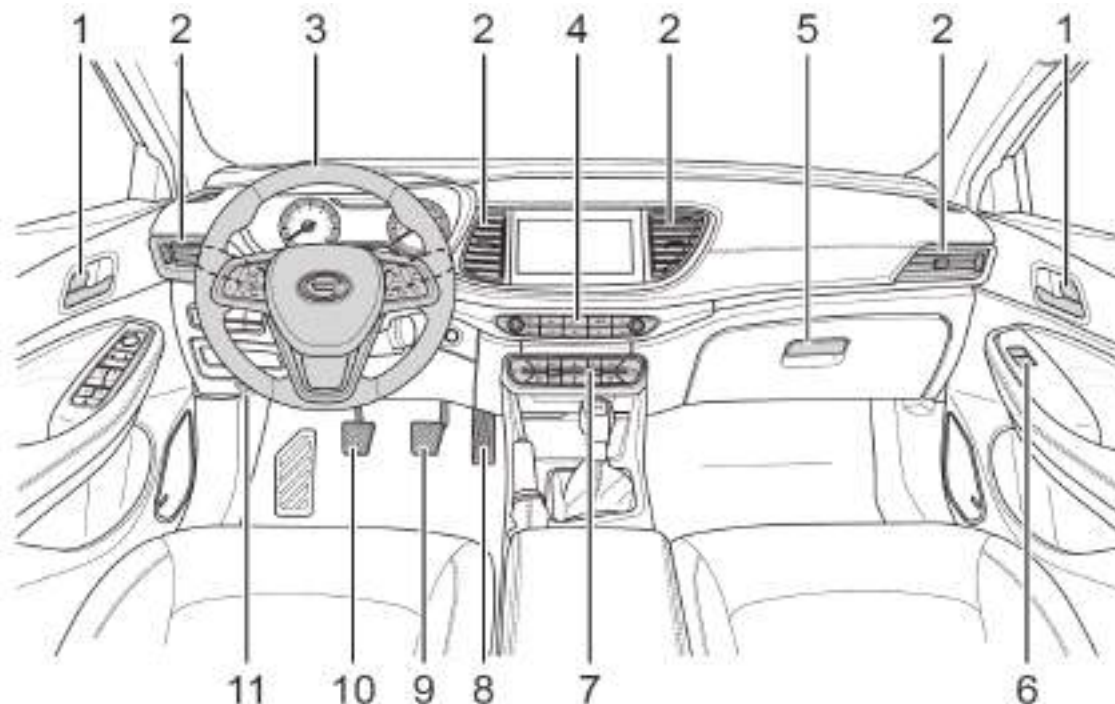

1. Door latch and door inner handle =>Refer to Page 76
2. Air outlets =>Refer to Page 145
3. Steering wheel => Refer to Page 63
4. Control panel of audio system:
  - Audio System (AVN)\* => Refer to Page 171
  - Audio System (Radio)\* => Refer to Page 146
5. Handle of glove box =>Refer to Page 123
6. Passenger side electric window button =>Refer to Page 83
7. Control panel of air conditioning system =>Refer to Page 136
  - Hazard warning light switch => Refer to Page 99
8. Accelerator pedal
9. Brake pedal
10. Clutch pedal
11. Engine hood open handle => Refer to Page 90

## 2. Pictorial References

---

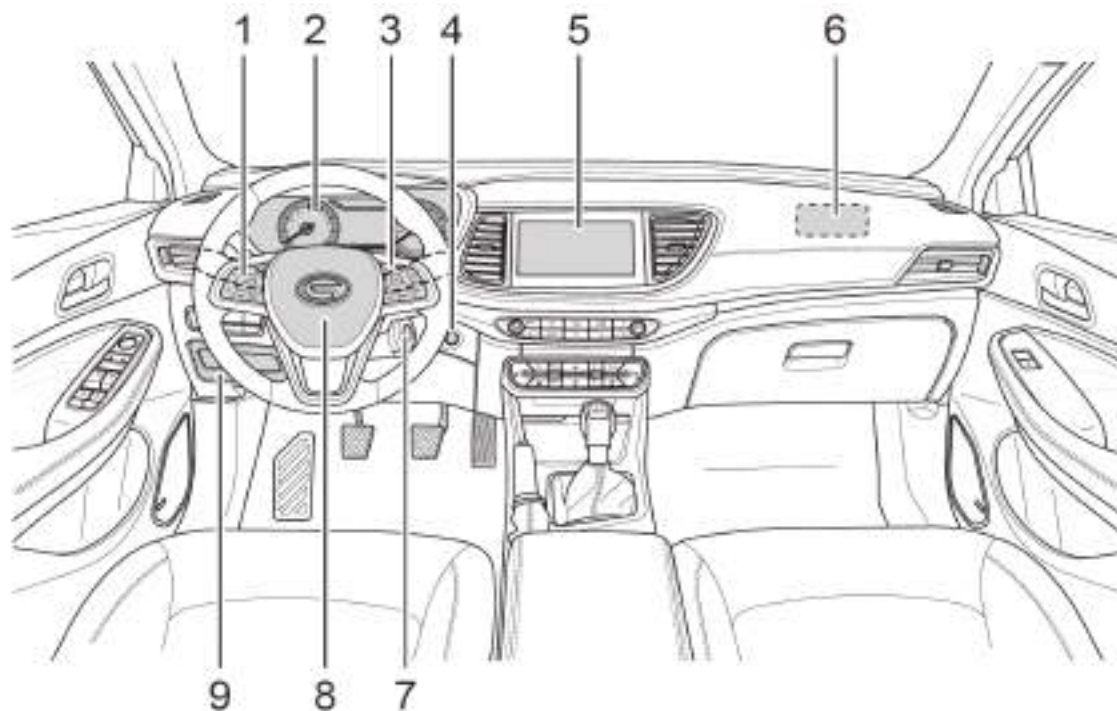

1. Steering wheel button (left) =>Refer to Page 64
2. Instrument Cluster => Refer to Page 43
  - Indicator light =>Refer to Page 59
3. Steering wheel button (right) =>Refer to Page 64
4. Start switch \*=>Refer to Page 272
5. Audio system display screen
  - Audio System (AVN)\* => Refer to Page 171
  - Audio System (Radio)\* => Refer to Page 146
6. Front passenger front airbag => Refer to Page 23
7. Ignition Switch\* => Refer to Page 271
8. Driver front airbag =>Refer to Page 23
  - Horn button on steering wheel =>Refer to Page 65
9. Storage shelf for lower panel in the cab =>Refer to Page 121
  - Instrument panel fuse box => Refer to Page 402



## 2. Pictorial References

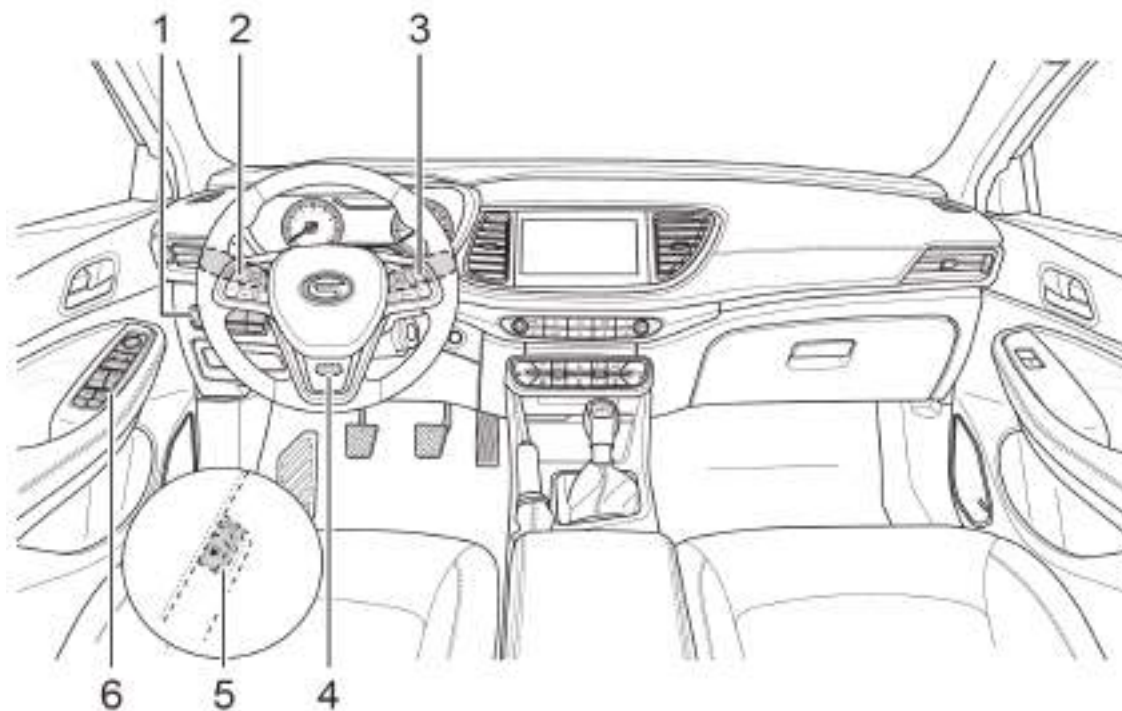

1. Left instrument switch group:
  - ESP OFF button\*=>Refer to Page 298
  - Headlight height manual adjustment knob=> Refer to Page 98
  - Panorama parking system button\*=> Refer to Page 315
2. Light combination switch =>Refer to Page 94
3. Wiper combination switch =>Refer to Page 104
4. Steering wheel locking handle => Refer to Page 63
5. Handle of fuel tank cap=> Refer to Page 334
  - Trunk lid release handle => Refer to Page 81
6. Electric window button on the driver's side => Refer to Page 82
  - Central locking button =>Refer to Page 77
  - Exterior rear-view mirror adjusting button => Refer to Page 109

## 2. Pictorial References

---

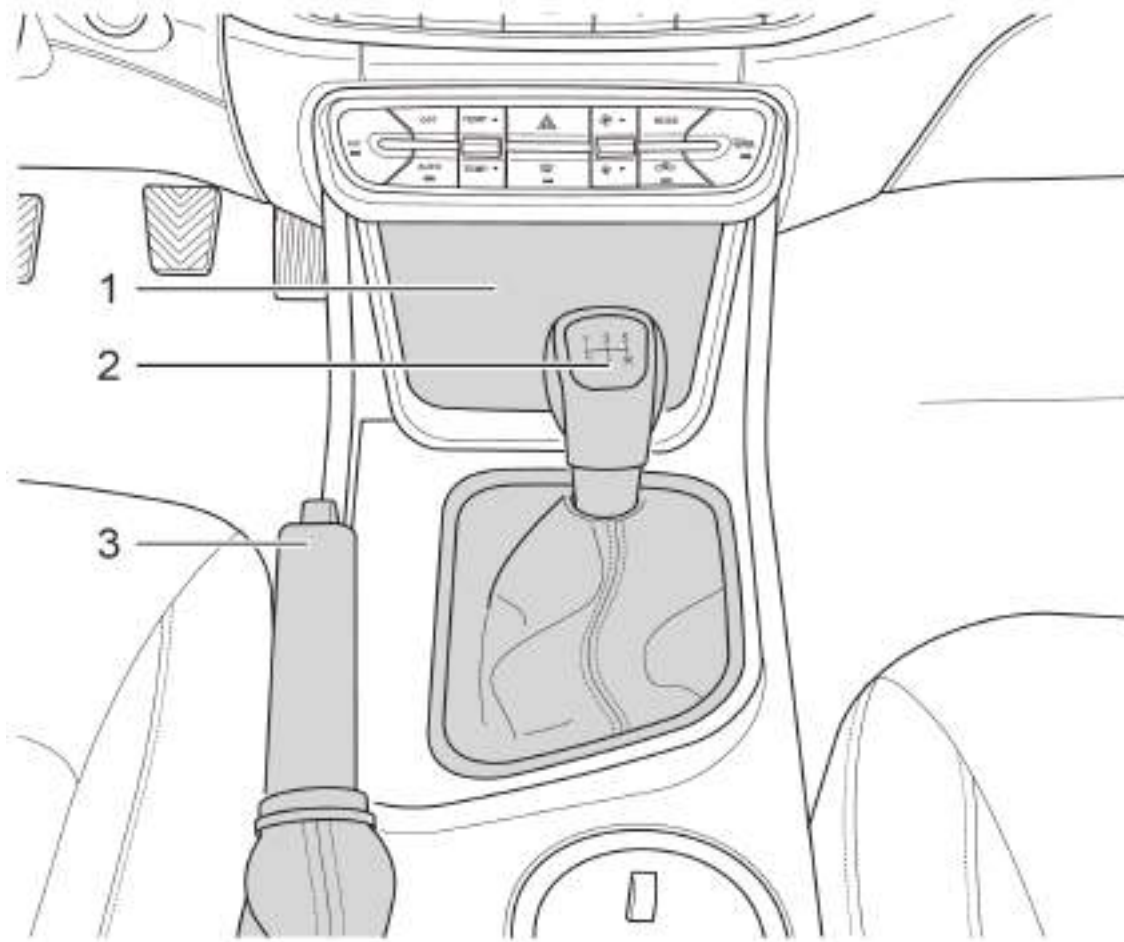

1. Cigarette lighter/power outlet =>Refer to Page 127
  - Jack socket for USB => Refer to Page 124
  - Mobile phone wireless charging button and area\* => Refer to Page 128
2. Manual transmission shift lever\* => Refer to Page 284
3. Mechanical parking brake handle\* => Refer to Page 293



## 2. Pictorial References

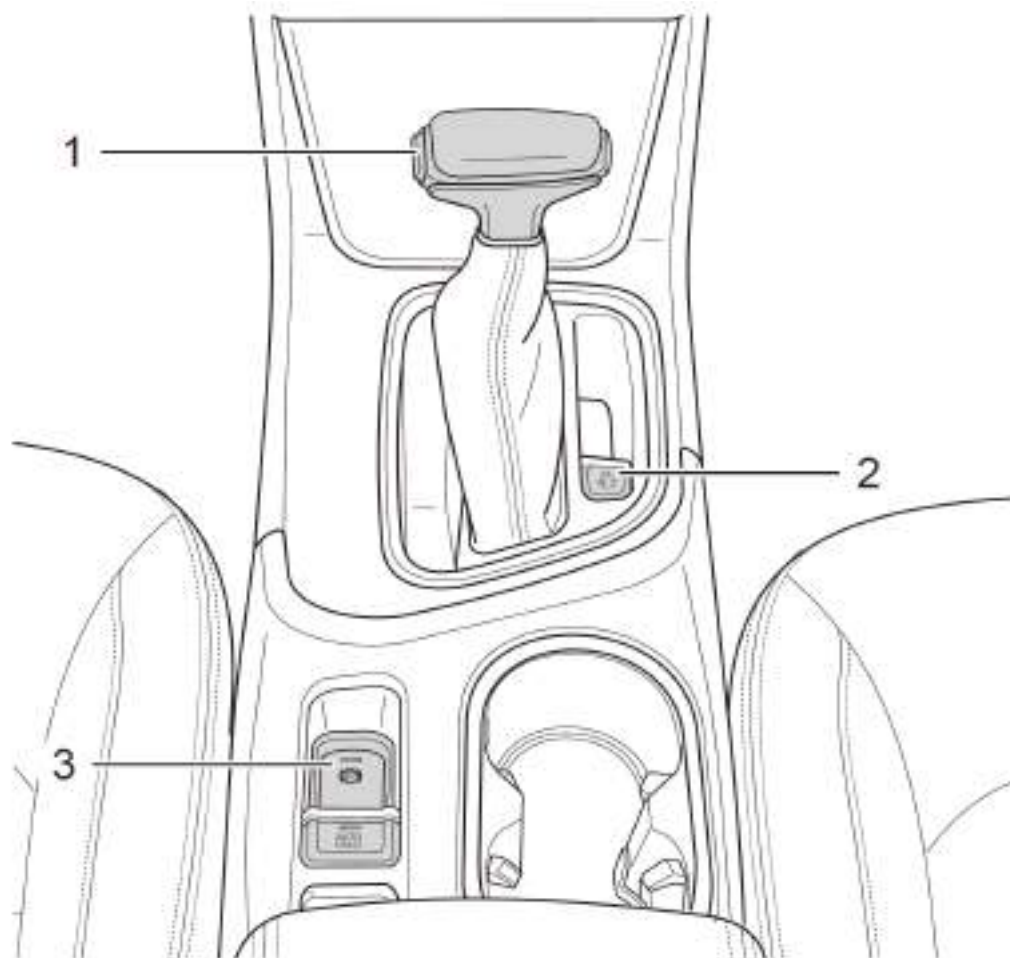

1. Transmission shift lever\* => Refer to Page 278
2. Driving mode button\* => Refer to Page 281
3. EPB system button\*=> Refer to Page 287

### 3. Safety Operating Instructions

---

#### 3.1 Safety Driving

##### 3.1.1 General Instructions

This section describes important information, operating essentials, recommendations and safety precautions for safety driving. For your safety and the safety of your passengers, please read it carefully and observe the relevant regulations.

#### Warning

**Keep this User's Manual in your car. Please make sure the Manual stays with the vehicle if you lend or sell it to the next owner. It is an integral part of the vehicle.**

#### **You should do the following inspections before driving your vehicle:**

- Make sure that all car lights are under normal working condition.
- Ensure sufficient fuel level.
- Ensure sufficient coolant level.
- Ensure sufficient brake fluid level.
- Ensure normal engine oil level.
- Ensure sufficient windshield washer fluid level.
- Make sure that tire pressure is under normal condition.
- Make sure all windows are clean and unobstructed.
- Make sure that no items obstruct the pedal movement in the footwell.
- Adjust the seats, headrest and rear view mirrors according to height and body type.
- Make sure the child is protected with suitable child seat and properly worn the seat belt.
- Wear your seat belt correctly. Check that your passengers have fastened their seat belts.

#### Warning

**Please observe the following precautions when installing the driver's foot mat. Otherwise, the foot mat may slide during driving and hinder the driver's operation of the pedal, which may cause accident.**

- Never use two or more foot mats simultaneously.
- Never bottom up the foot mat or place it back to front.

#### Caution

- Do not let yourself be distracted from driving because of external factors.
- Do not drive your vehicle when your reaction capacity weakens. Medicines, alcohol, drugs and other will impair your reaction capacity.
- Follow the traffic laws and speed limits strictly.

#### 3.1.2 Correct Sitting Position of Occupants

##### Correct Sitting Position of the Driver



Correct driving position has a direct influence on driving safety and fatigue.

For the safety of yourself and the passengers, to reduce the risk of accidental injuries and deaths, the driver is recommended to do the following operation:

- Sit upright and make sure the back contacts with the seat back as much as possible.
- Adjust the driver's seat forward or backward, so that you can effectively operate all pedals with legs bent slightly.

- Adjust the steering wheel until it faces your chest to ensure that the distance between steering wheel and your chest is not less than 25cm.
- Adjust the seat backrest to proper position, so that your back can fully contact with the seat backrest.
- Lock the headrest and make its center flush with the upper part of the ear.
- Wear the seat belt correctly. => Refer to Page 18

#### **⚠ Warning**

- Carefully adjust the seat to ensure the seat causes no injuries of other passengers when moving the seat.
- Your hands should always hold the steering wheel outside edge (at the 9 o'clock and 3 o'clock positions) to ensure you can see all instruments and indicator lights on the instrument cluster.
- Never adjust the driver's seat during driving. Otherwise, the car may be out of control.
- Never stretch the fingers or other body parts under the seat. Otherwise, they may be pinched by the seat.
- Never place any objects under the front seats. Otherwise, these objects may be jammed between the seat and guide rail, hindering from locking the seat and causing an accident.

### 3. Safety Operating Instructions

---

#### Correct Sitting Position of Front Passenger

To ensure the safety of front passenger and reduce the risk of accidental injury and death, front passenger should do the following operations:

- The front passenger should adjust the seat as far as possible, leave suitable distance between his/her chest and the instrument panel, so as to get the most safety protection when airbag is triggered.
- Adjust the headrest properly.
- Adjust the seat backrest to proper position, so that your back can fully contact with the seat backrest.
- Wear the seat belt correctly. => Refer to Page 18
- Keep feet in the footwell in front of the front seat.

#### Warning

- **If the front passenger sits too close to the instrument panel, he/ she cannot get effective protection from airbags.**
- **While driving, do not allow the front passenger to put his/her feet on the instrument panel, outside the window or on the seat. But always keep his/her feet in the footwell. Otherwise, he/she can be injured easily during emergency braking or in a crash.**
- **While driving, do not recline the backrest too far. Wear the seat belt correctly and keep correct sitting position to avoid injury caused by emergency braking.**

#### Correct Sitting Position of Rear Passengers

To ensure the safety of rear seat passengers and reduce the risk of accidental injuries and deaths, rear seat passengers should do the following matters:

- Adjust the headrest properly.
- Sit upright and make sure the back contacts with seat back as much as possible.
- Keep feet in the footwell in front of the rear seat.
- Wear the seat belt correctly. => Refer to Page 18
- Whenever an infant or child rides in your car, be sure to use suitable child safety seat to protect the infant or child in accordance with the relevant provisions. => Refer to Page 33

#### Warning

**Sitting improperly or wearing the seat belts improperly can increase the chance of injury during an accident.**

#### 3.2 Seat Belts

##### 3.2.1 Why Wear Seat Belts

###### Protection from Seat Belts



In case of crash, correctly wearing seat belts can restrict the driver and passengers at proper positions, reducing inertia of forward motion, to prevent loss of control of motion and being ejected out of the vehicle, allow the driver and passengers to get effective protection from the airbags, and minimize injury due to impact.

The seat belts can absorb most of the kinetic energy resulting from a collision. In addition, the crumple zones and other passive safety systems can absorb the energy at the same time to reduce the risk of injury further together with the seat belts.

###### Consequences Arising from not Wearing Seat Belts

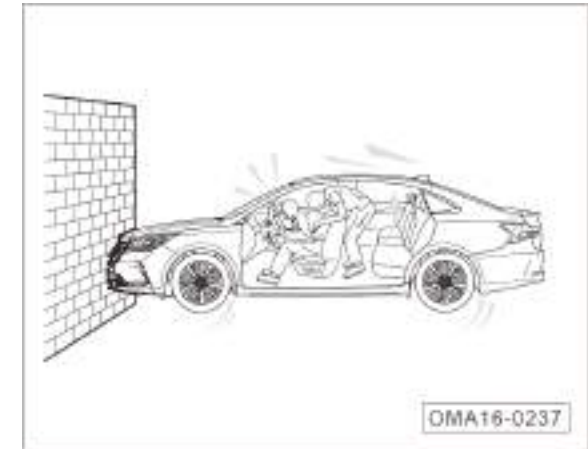

After a collision, the occupants not wearing the seat belts still move forward due to inertia at the speed before the collision, but the vehicle does not. Thus the occupants would be seriously injured.

### 3. Safety Operating Instructions



Even if the car is at low speed, the force exerted on human body, when a collision occurs, is big, and the passenger cannot control his own body by hands. The unrestrained passengers will be thrown forward and injured once colliding with other objects in the car.



The rear seat passengers must wear the seat belts properly as well. Otherwise, the passengers can be thrown forward during a crash. The rear seat passengers not wearing the seat belts can be injured and endanger other occupants.

#### Warning

**Airbags do not replace your seat belts. Whether the airbag is equipped or not, it is essential to make sure you and your passengers always wear seat belts properly.**

#### 3.2.2 Seat Belt

##### Seat Belt Indicator Light

##### Driver seat belt indicator light

If the driver has not worn the seat belt with the Start or Ignition switch at the "ON" position, the driver seat belt telltale on the instrument cluster illuminates and text appears to remind the driver to wear the seat belt.

##### Front passenger seat belt indicator light\*

If the front passenger has not yet worn the seat belt with the Start or Ignition switch at the "ON" position, the front passenger seat belt telltale on the instrument cluster illuminates and text appears to remind the front passenger to wear the seat belt.

#### Caution

Before starting driving, check the front seat and make sure there is no heavy on the seat to prevent the system from mistaking that there is occupant on it and giving a false alarm.

When the Start switch or ignition switch is at "ON" position and the vehicle speed is less than 20km/h, if the driver or front passenger does not fasten his/her seat belt\*, the corresponding indicator light on the instrument cluster will flash about 6 seconds and then stay on.

#### Caution

When the seat belt device fails, the indicator light will also flash about 6s and then stay on. Please go to your GAC MOTOR dealer for maintenance.

When the Start or Ignition switch is at "ON" position and the vehicle speed is not lower than 20km/h, if the driver or the front passenger does not fasten the seat belt\*, the corresponding indicator light on the instrument cluster will flash about 20 seconds and then stay on, and the beeper also sounds until the seat belt is fastened.

#### Caution

When the seat belt device fails, the indicator light will also flash about 20s and then stay on, and the beeper also sounds. Please go to your GAC MOTOR dealer for maintenance.



### 3. Safety Operating Instructions

#### Seat Belt Pretensioner Equipment





The configuration of seat belt pretensioner equipment may vary with different vehicle models.

- The seat belt restrains the driver and passengers to sit in a suitable position, preventing the body over tilting forward before the collision.
- The seat belt pretensioners will be activated by the electronic control unit in the event of a severe collision, and then the pretensioner will drive the seatbelt webbing tighten by immediate pulling back.

- In the event of collision, the driver's body will move forward then the seat belt pretensioners activate, to make the restraining force to the body at a certain range, preventing a further injury towards the driver; at the same time, the seat belt pretensioners activate in conjunction with the airbag to provide an optimal protection.

#### **i** Hint

- When being initiated, the pretensioner equipment releases little harmless smoke and generates sound, which is normal.
- After collision, initiated pretensioner equipment cannot be reused, and the airbag indicator light  is continuously on. Please contact GAC MOTOR dealer for replacement. 

#### Wear Front Seat Belts

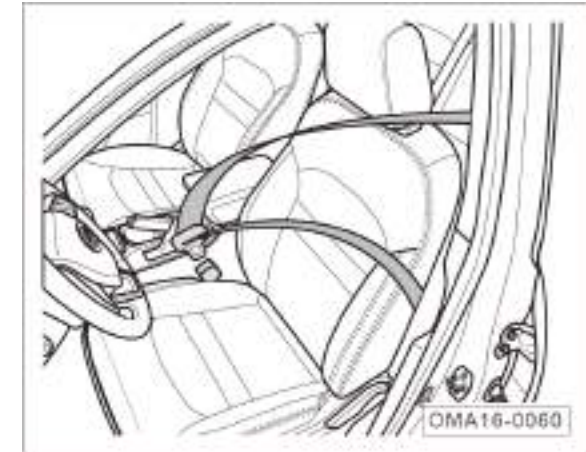

- Properly adjust the front seat. => Refer to Page 116
- Properly adjust the headrest. => Refer to Page 114
- Gradually draw the seat belt out at constant speed, and draw it over your shoulder and hip. Insert the latch plate into the corresponding buckle until you hear a click.
- Then, pull the shoulder part of the belt upward parallel to your upper body. Strain the hip part of the belt and make sure that the latch plate is locked securely.



#### Wear Rear Seat Belts



- Properly adjust the headrest. => Refer to Page 114
- Gradually draw the seat belt out at constant speed, and draw it over your shoulder and hip. Insert the latch plate into the corresponding buckle until you hear a click.
- Then, pull the shoulder part of the belt upward parallel to your upper body. Strain the hip part of the belt and make sure that the latch plate is locked securely.

#### Unbuckle the Seat Belt



- When the red PRESS button near the buckle is pushed, the latch plate pops up automatically.
- Hold the latch plate and return the seat belt to allow the retractor to retract the belt.

#### Adjust Seat Belt Height

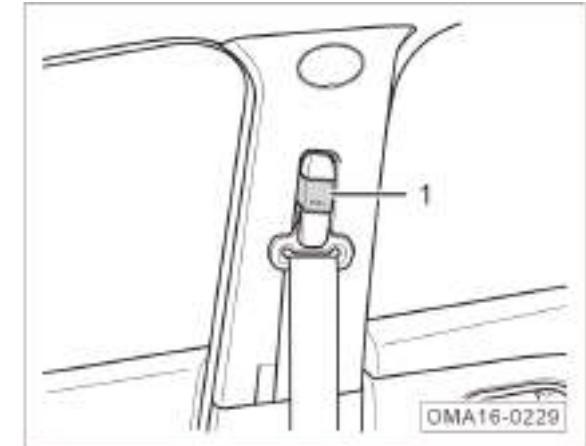

- Pull the belt guide part ① outward and move it upward/downward to adjust the seat belt to the desired height.
- Release the seat belt guide part.
- After the completion of adjustment, tug on the belt to make sure the guide part is securely locked.

### 3. Safety Operating Instructions

---

#### A Pregnant Woman Must Wear Seat Belt Correctly



Please follow doctors' orders and wear the seat belt correctly.

- Adjust the front seat and its headrest to the desired position.
- Hold the latch plate and pull the shoulder part of the belt to go across your shoulder slowly, and position the waist part of the belt as low as possible across your hips, not across your abdomen.
- Insert the latch plate into the corresponding buckle until you hear a click.
- Pull up the shoulder part of the belt parallel to your upper body, and tug on the hip part of the belt to make sure that the latch plate is locked securely.

#### **⚠ Warning**

To reduce injury risk of the occupants in case of emergency braking or accident, please observe the following precautions:

- Be sure you and your passengers wear seat belts properly before driving.
- Never share the seat belt. Two people (including children) should never use the same seat belt.
- Never excessively incline the front seat backrest for comfort.
- Never put the shoulder part of the seat belt below or behind the arm.
- Be sure to insert the latch plate into its own buckle. Never insert it into other buckles.
- Do not unfasten the seat belt until the vehicle is completely stationary.

#### 3.3 SRS System

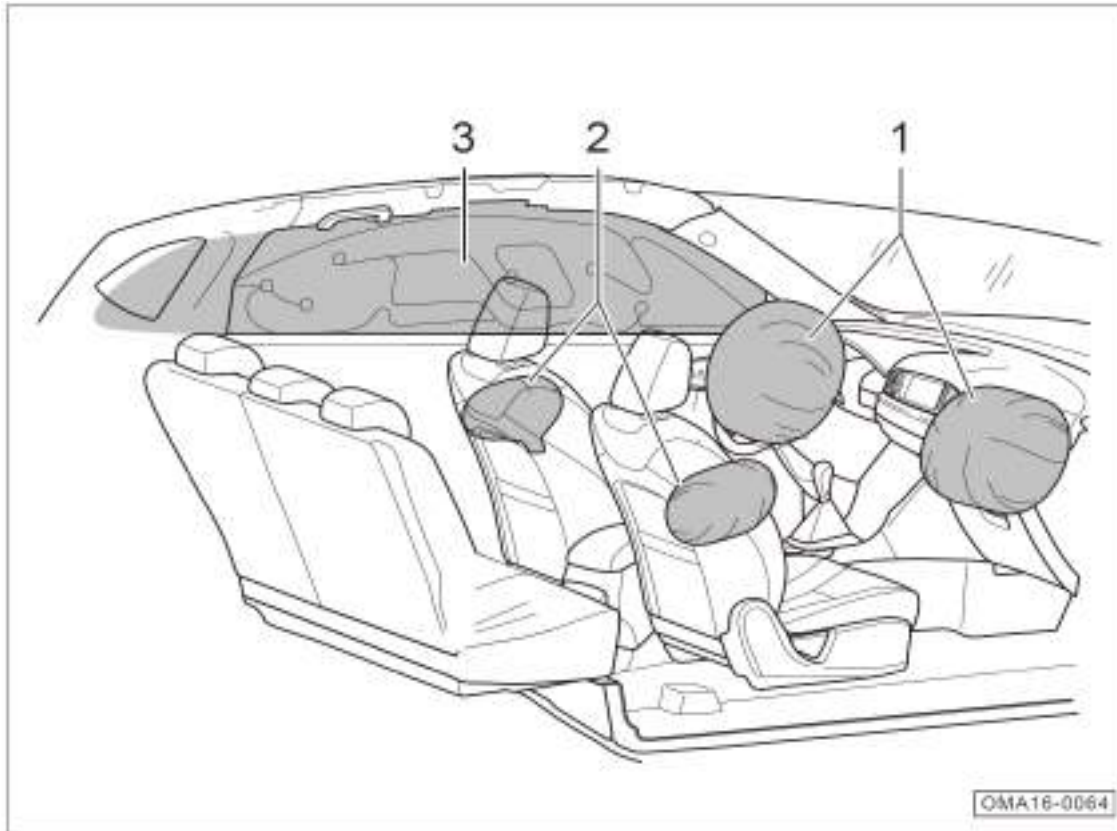

Depending on the configuration, the SRS system consists of the following airbags:

1. Front seat frontal airbag
2. Front seat side airbag
3. Side curtain airbag\*

### 3. Safety Operating Instructions

---

#### 3.3.1 SRS Indicator

The airbag is monitored by electric monitoring system located in airbag control unit. Switch the Start or Ignition switch to the "ON" position, the indicator light illuminates for a few seconds then extinguishes after self-checking.

The SRS indicator light  indicates a fault developing in the system in one of the following conditions:

1. After the Start or Ignition switch is switched to "ON" position, the indicator light does not illuminate.
2. After the Start or Ignition switch is switched to "ON" position, the indicator light stays illuminated.
3. After the Start or Ignition switch is switched to "ON" position, the indicator light illuminates again after turning off.
4. When the vehicle is running, the indicator light will be illuminated or flash.

#### Warning

- **Do not repair, adjust or modify any airbags by yourself without authorization.**
- **An airbag inflates only once. If the airbag ever inflates during a crash, it must be replaced by a GAC MOTOR dealer.**
- **If the SRS system fails, go to your authorized GAC MOTOR dealer immediately to have the system checked/repared. Otherwise, the control unit system may not trigger the airbags or trigger the airbags abnormally during a collision.**

#### 3.3.2 Front Seat Frontal Airbag



The driver's frontal airbag is installed in the center of the steering wheel (dotted dash area), and the mark of airbag is shown by the arrow "SRSAIRBAG".

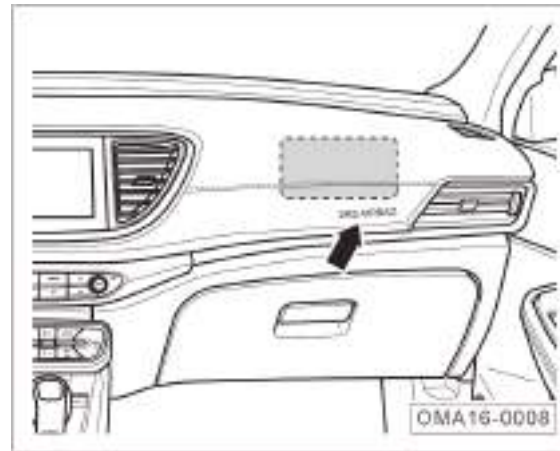

The front passenger frontal airbag is installed inside the dashboard (dotted dash area), and the mark of airbag is shown by the arrow "SRSAIRBAG".

When the vehicle has a severe frontal collision and the trigger condition is reached, the frontal airbag inflates immediately in conjunction with the seat belt to provide additional protection to the head and chest of front passengers.

The system may activate the airbag at other positions when some type of collision occurs.

#### **i** Hint

When the airbags inflate, you may see what looks like smoke. This is a normal phenomenon.

### 3. Safety Operating Instructions

---

The frontal airbags may not be triggered in one of the following conditions:

- Start or Ignition switch is at the “ACC” or “OFF” position;
- Minor frontal collision;
- Side collision;
- Rear collision;
- Rollover;
- Other special conditions.

#### **i Hint**

“Minor” is based on the feeling of the vehicle controller, regardless of the extent of damage to the vehicle.

#### 3.3.3 Front Seat Side Airbag\*

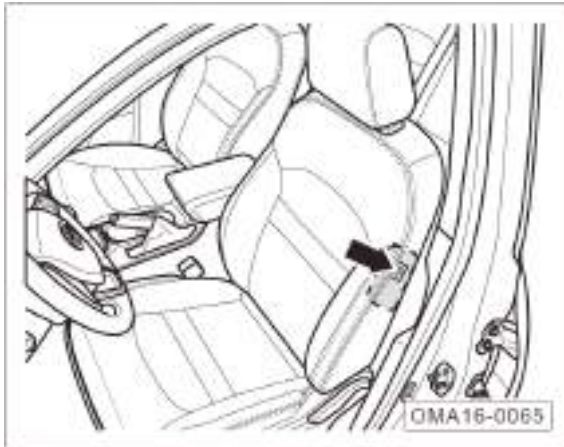

The front side airbag is installed inside the driver's seat and front passenger's seat back against the door (dotted dash area), the mark of the airbag is shown by the arrow "AIRBAG".

When the vehicle has a severe side collision and the trigger condition is reached, the side airbag inflates immediately in conjunction with the seat belt to provide additional protection to the upper body of front occupants.

The system may activate the airbag at other positions when some type of collision occurs.

#### **i** Hint

When the airbags inflate, you may see what looks like smoke. This is a normal phenomenon.

The side airbags may not be triggered in one of the following conditions:

- Start or Ignition switch is at the "ACC" or "OFF" position;
- Frontal collision;
- Minor side collision;
- Rear collision;
- Other special conditions.

#### **i** Hint

"Minor" is based on the feeling of the vehicle controller, regardless of the extent of damage to the vehicle.

### 3. Safety Operating Instructions

---



#### Warning

- Please notice the warnings on the door side. Do not lean on the door side, where installed with side airbag during driving.
- Never cover the side airbag with seat cover or other objects so that the side airbag fails in case of an accident.



### 3. Safety Operating Instructions

---

#### 3.3.4 Cases When Airbags Could Deploy

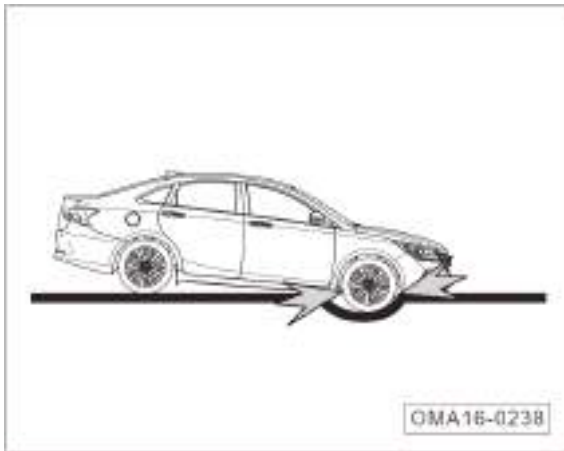

- The vehicle front collides with the ground when the vehicle wheels are attempting to pass over a deep trough.

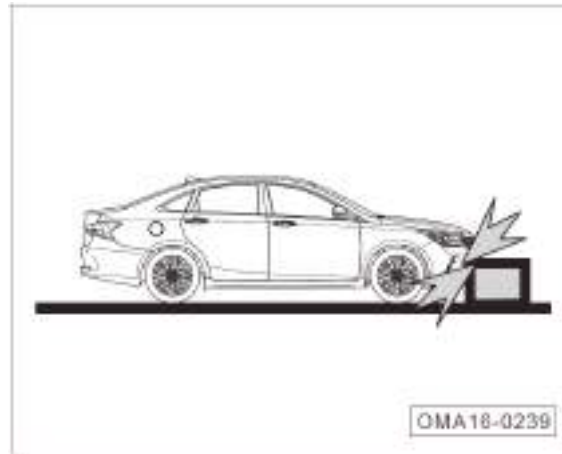

- The vehicle collides with an obstacle or street curb, etc.

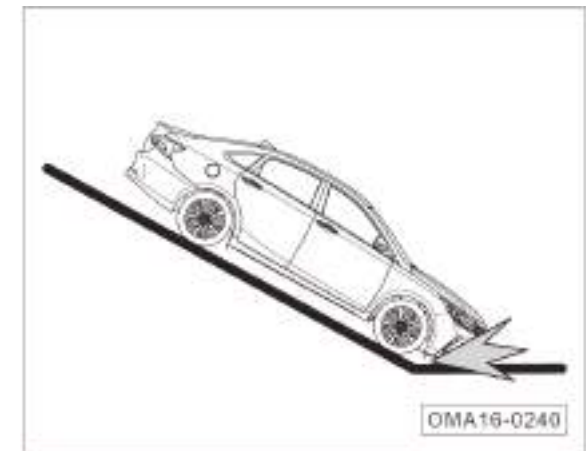

- The vehicle front collides with the ground when the vehicle is travelling down a steep slope.

#### 3.3.5 Cases When Airbags Could Not Deploy

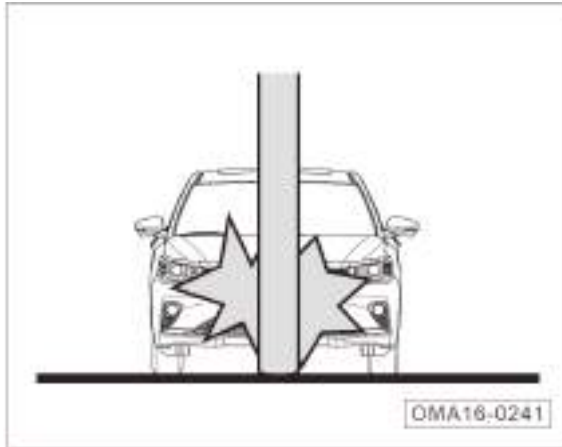

- The vehicle collides with a concrete structure, pillar, tree, or other vimineous object.

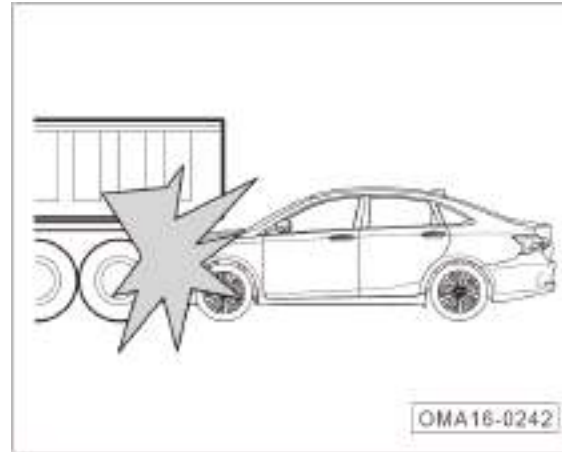

- The vehicle collides with the tail of a large truck.

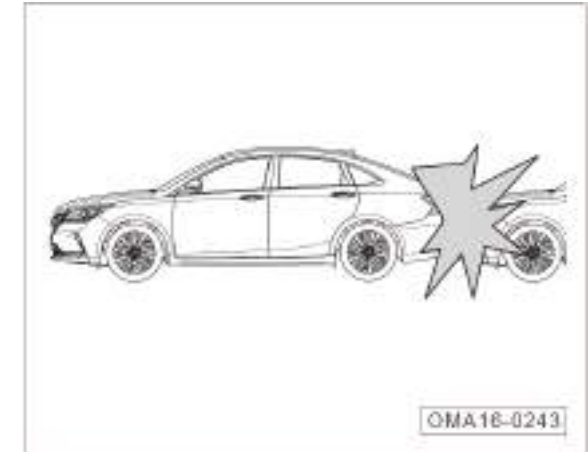

- Another vehicle collides with your vehicle from behind.

### 3. Safety Operating Instructions

---

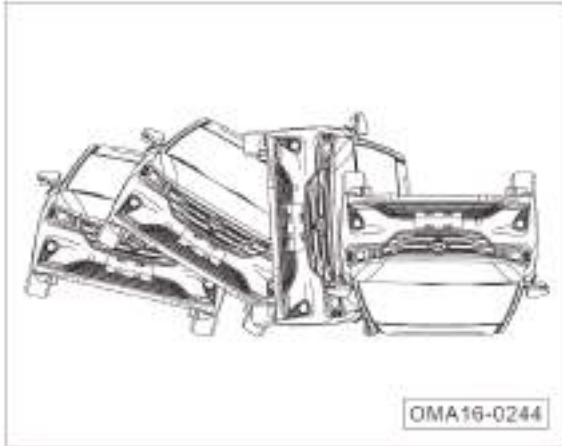

- The vehicle laterally rolls over.

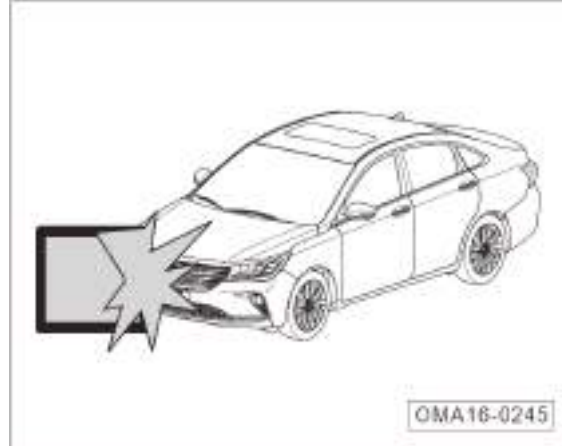

- The corner of the vehicle collides with the wall or another vehicle.

#### 3.4 Safety Rules for Children

##### 3.4.1 General Instructions

Before installing the child safety seat in the second row, adjust the front seat to the desired position according to the child seat size and the child's body type. This will help keep the child restrained in the second row from striking the interior sharp objects of the car during a crash or emergency braking. Moreover, this will also prevent the child from being injured due to the airbags working. Never hold an infant or child on your lap!

Be sure to install the child seats correctly in accordance with the manufacturer's Instructions. Keep the child seat instructions together with the vehicle documents in your car so you can refer to it at any time.



The safety signboards are on the sun visors. They warn you of the front airbag's potential hazards. Read these signboards carefully and follow their instructions.

#### Warning

**Do not use a child restraint system against the driving direction on a seat protected by a frontal airbag (activated)!**

**Even if the child is seated in the child seat, never let her/his head or any body part lean on the door area (the deployment area of the side airbag or side airbag curtain) as it is risky when the side airbag or the side airbag curtain inflates, and the impact may cause serious injury, even death of the child.**

### 3. Safety Operating Instructions

---

#### Warning

- Don't let the child stand or kneel on the seat.
- Don't let the child operate any equipment that may clamp their body part, such as electric window and sunroof.
- Never leave the child in the car alone.
- Never leave the child or pet in the enclosed car exposed to sunlight.
- The seat belt may be unsuitable for any infant. The shoulder part of seat belt is too close to the infant's face or neck. In case of an accident, this may cause serious or even death of the infant.

3.4.2 Child Safety Seat

Child Seat Classification (For Reference Only):

a. Group 0/0+ child safety seats:

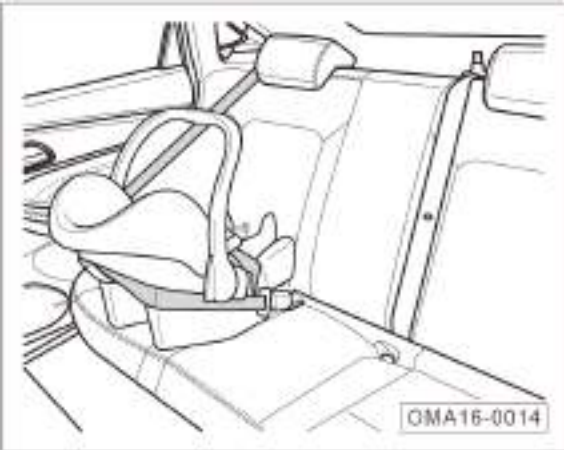

For infants or babies less than 13kg.

b. Group I child safety seats:



For infants or babies within 9kg~18kg;

c. Group II child safety seats:

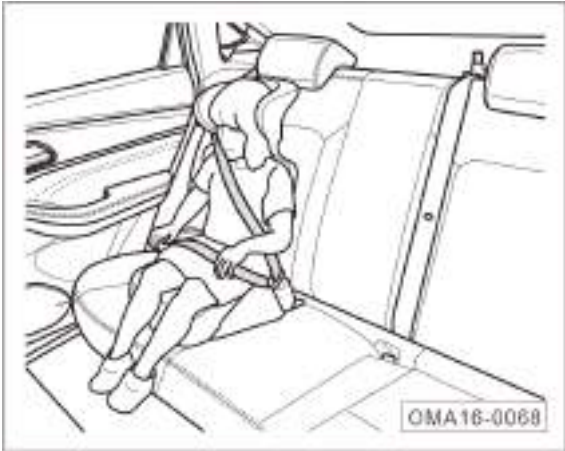

For children within 15kg~25kg;

### 3. Safety Operating Instructions

---

d. Group III child safety seats:



For children within 22kg~36kg;

#### 3.4.3 Information about Child Safety Seat

##### Child safety seat anchoring point:

Mass group	Position to fix the system		
	Front passenger seat	Second-row seats on both sides	Second-row central seat
Group 0: <10kg	X	U	X
Group 0+: <13kg	X	U	X
Group I: 9~18kg	X	U/UF	X
Group II: 15~25kg	X	UF	X
Group III: 22~36kg	X	UF	X

Note: Meanings of the letters in the table:

U= Permitting use of "General" child safety seats in this mass group

UF= Permitting use of "General" front-facing child safety seats in this mass group

X= Not applicable for use of child safety seats



### 3. Safety Operating Instructions

#### ISOFIX child safety seats anchoring points

Mass group	Size	Anchoring module	Position to fix the system		
			Front passenger seat	Second-row seats on both sides	Second-row central seat
Portable infant bed	F	ISO/L1	X	X	X
Group 0: <10kg	G	ISO/L2	X	X	X
Group 0+: <13kg	E	ISO/R1	X	IL	X
	E	ISO/R1	X	IL	X
	D	ISO/R2	X	IL	X
	C	ISO/R3	X	IL	X
Group I: 9~18kg	D	ISO/R2	X	IL	X
	C	ISO/R3	X	IL	X
	B	ISO/F2	X	IUF	X
	B1	ISO/F2X	X	IL	X
	A	ISO/F3	X	IUF	X
Group II: 15~25kg	—	—	X	—	X
Group III: 22~36kg	—	—	X	—	X

Note: Meanings of the letters in the table:

IUF—General type ISOFIX child safety seats, front-facing and fixed using upward tensioning straps.

IL—Special type ISOFIX child restraint systems, which may be those used for special vehicles, or restricted, or semi-general.

X= Not applicable for use of child safety seats.

Dimension ranges may be specified for some child safety seats. Find the dimension range from the manufacturer's instructions, packaging, or child safety seats. For how to correctly install the child safety seats, refer to their use instructions.

#### 3.4.4 Install a Child Seat Properly

Child seat generally has three types of installations, i.e. three-point seat belt, ISOFIX system, and LATCH system. The installation of three-point seat belt is that using its own seat belts to tighten the child seat, as shown in the figure "Child Seat Classifications". Installation of ISOFIX and LATCH system is that using the child seat fixing device to fasten and lock with the remaining anchor points in the car.

#### **i** Hint

Method for installing a certain kind of child safety seats is introduced here only for reference purpose. When installing child safety seats, be sure to refer to their use instructions and observe the installation instructions provided by the manufacturer.

#### Installing the Child Safety Seat Using the Three-Point Seat Belt



1. Place the child safety seat on the rear seat.
2. According to the installation instructions provided by the manufacturer, pass the seat belt through the child safety seat, and push the latch plate into buckle until it clicks.



3. Push downward the tongue. Pass the shoulder part of seat belt through the narrow gap on the side of child safety seat.

### 3. Safety Operating Instructions

---



4. Hold the shoulder part of seat belt near the buckle, and pull it upward so that the lap part of seat belt is no longer loose. Press the safety seat using your own weight and push it in the seat.

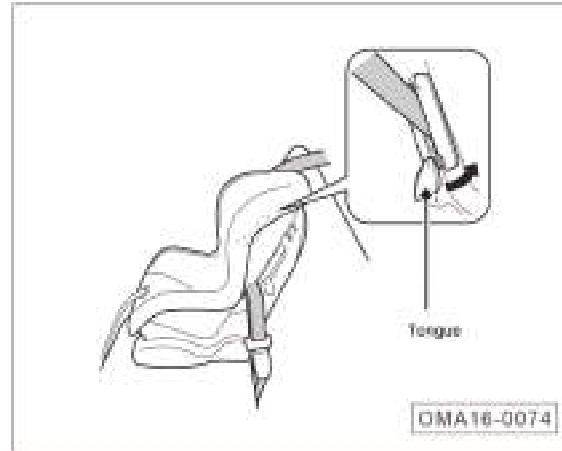

5. Place the seat belt correctly and push upward the tongue. Ensure that the seat belt is not twisted. While pushing upward the tongue, pull upward the upper shoulder part of seat belt so that the seat belt is no longer loose.



6. Shake the child safety seat forward and backward, leftward and rightward to ensure it is securely anchored.
7. Ensure that all unused seat belts within reach of children are locked.

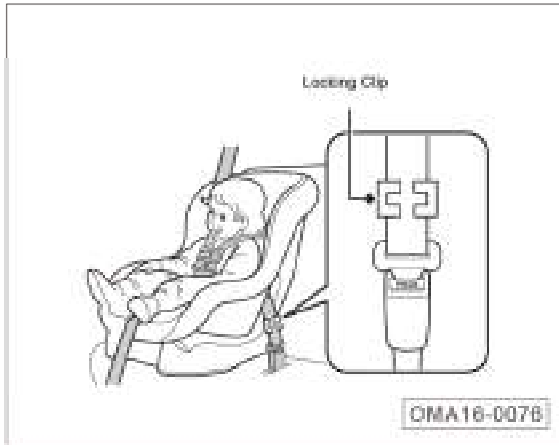

If the child safety seat has no means for fixing the seat belt, install a locking clip to the seat belt.

- With steps 1 and 2 completed, pull upward the shoulder part of seat belt so that the lap part of seat belt is no longer loose.
- Tightly hold the seat belt near the latch plate. Hold together the two parts of seat belt so that they cannot slide out of the latch plate. Release the seat belt from the buckle.

Install the locking clip as shown in the figure. With the clip as close to the latch plate as possible, insert the latch plate in the buckle. Perform steps 6 and 7.

#### Install the ISOFIX System or LATCH System

The installing methods for both ISOFIX system and LATCH system are similar, LATCH system has one more anchor point than ISOFIX system, but the lower anchor point for both systems can be interchangeable. The two sides of seats in second row for this car are equipped with LATCH system. Therefore, both LATCH and ISOFIX child seat can be installed.

#### ⚠ Warning

**Do not connect any other things like fastening belt, hard or sharp objects or other things other than child seat items to the anchoring device. Otherwise, it may endanger the child's life when accident occurs.**



- The lower anchor points ① at both sides of the rear seats are hidden inside the gaps between the backrest and cushion, you may see it by breaking off with hands.

### 3. Safety Operating Instructions

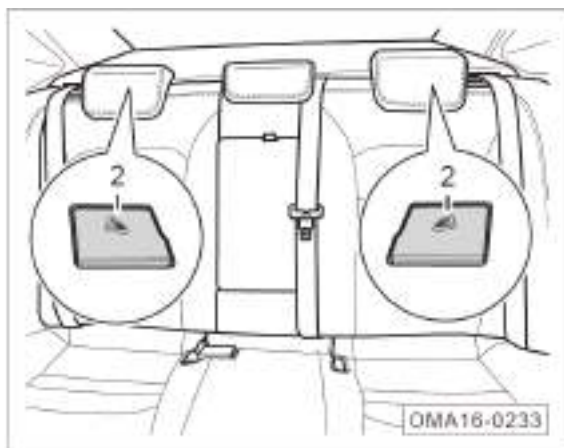

- The upper anchor points ② at both sides of the rear seats are just behind the backrests, you may see it by opening the trim covers.

Be sure to remove/install the child safety seats in accordance with the manufacturer's Instructions. The installation instructions for LATCH system child seat are mainly introduced as follows:



1. Place the child safety seat on the seat. Find the lower anchor point ①. Insert the lower guide slot (see the arrows) into the lower anchor point ① until it clicks.

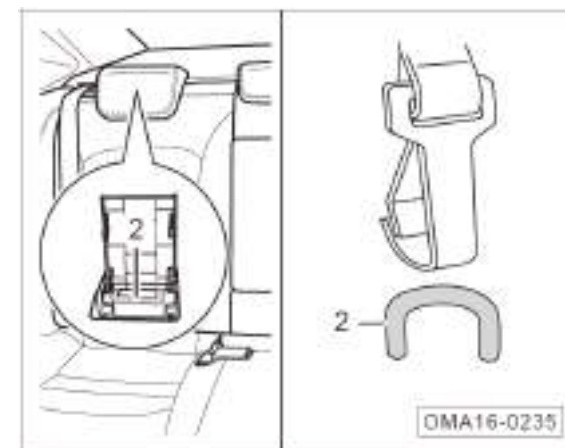

2. Raise the headrest to the upmost position. Pass the anchoring strap through the headrest support and open the upper anchoring trim cover to engage the upper anchor point ②. Ensure that the anchoring strap is not twisted.
3. Tighten the anchoring strap, shake the child safety seat on all sides to make sure it is securely anchored.
4. Ensure that all unused seat belts within reach of children are locked.

### 3.5 Dangerous Exhaust Gases

#### 3.5.1 Carbon Monoxide

Exhaust gases from the engine of this car contain carbon monoxide, a colorless odorless very toxic gas. As long as you can correctly maintain and use the car, carbon monoxide will not enter the interior of car.

Please go to your GAC MOTOR dealer to check whether the exhaust system is normal under the following circumstances:

- Abnormal noise coming out of exhaust system
- Abnormal color of exhaust gases coming out of exhaust system

Driving with the trunk open can cause exhaust gases entering the car resulting in danger. If you have to drive with the trunk open, open all windows and turn on the air conditioning system.

1. Select the external air circulation mode.
2. Select the  mode.
3. Set the fan speed to maximum.

If you sit in the car with the engine running, operate the air conditioning system in the same manner.

#### Warning

- **Inhaling carbon monoxide can cause unconsciousness, even death.**
- **Do not run the engine in confined areas for a long time, which will result in high content of carbon monoxide in the exhaust gas.**
- **Running the engine in confined areas (such as garage) can cause rapid buildup of carbon monoxide. Never run the engine for a long time with the garage door closed. Even if the garage door is open, drive away immediately.**

### 3. Safety Operating Instructions

#### 3.6 Safety Labels

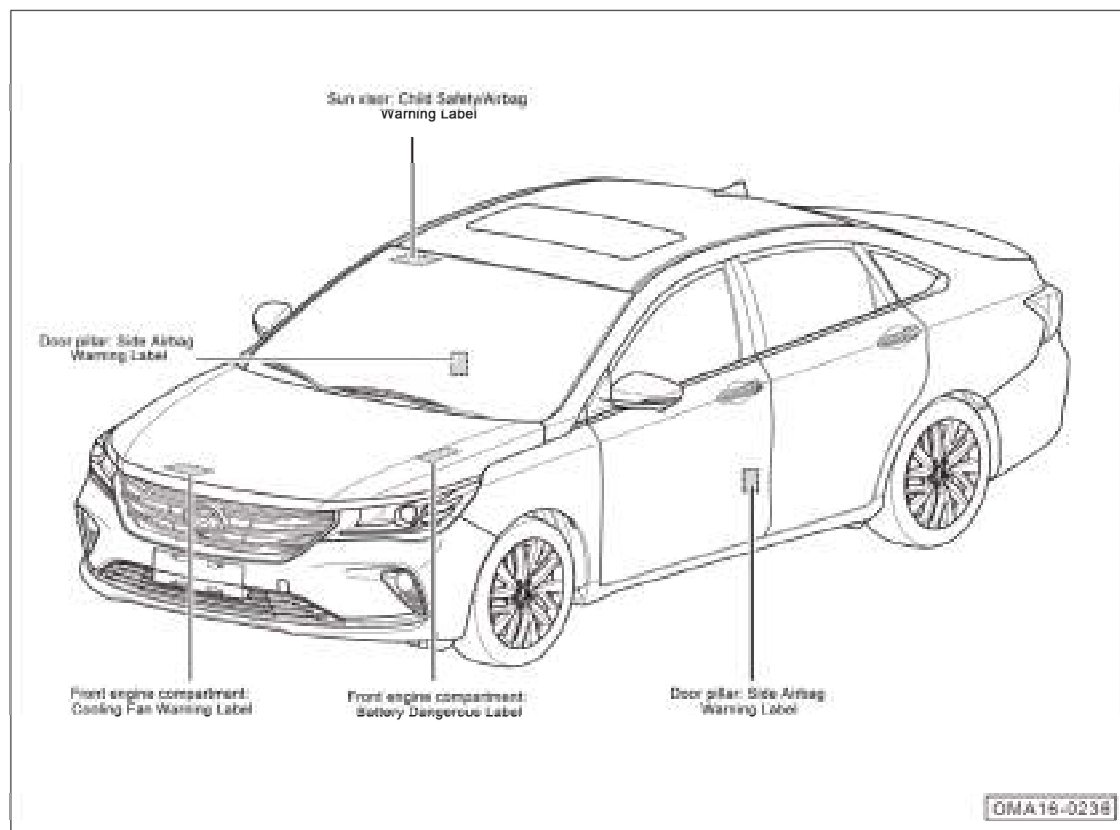

Shown in the figure are examples of the locations of labels. These labels are intended to indicate potential risks that could cause serious injury even death. Read these labels carefully.

If any label comes off or becomes illegible, contact a GAC MOTOR dealer for replacement.

#### **i** Hint

Note that actual locations and quantities of labels may be different from those shown in the figure.

### 4.1 Cab

#### 4.1.1 Instrument Cluster

##### TFT Instrument Cluster\*

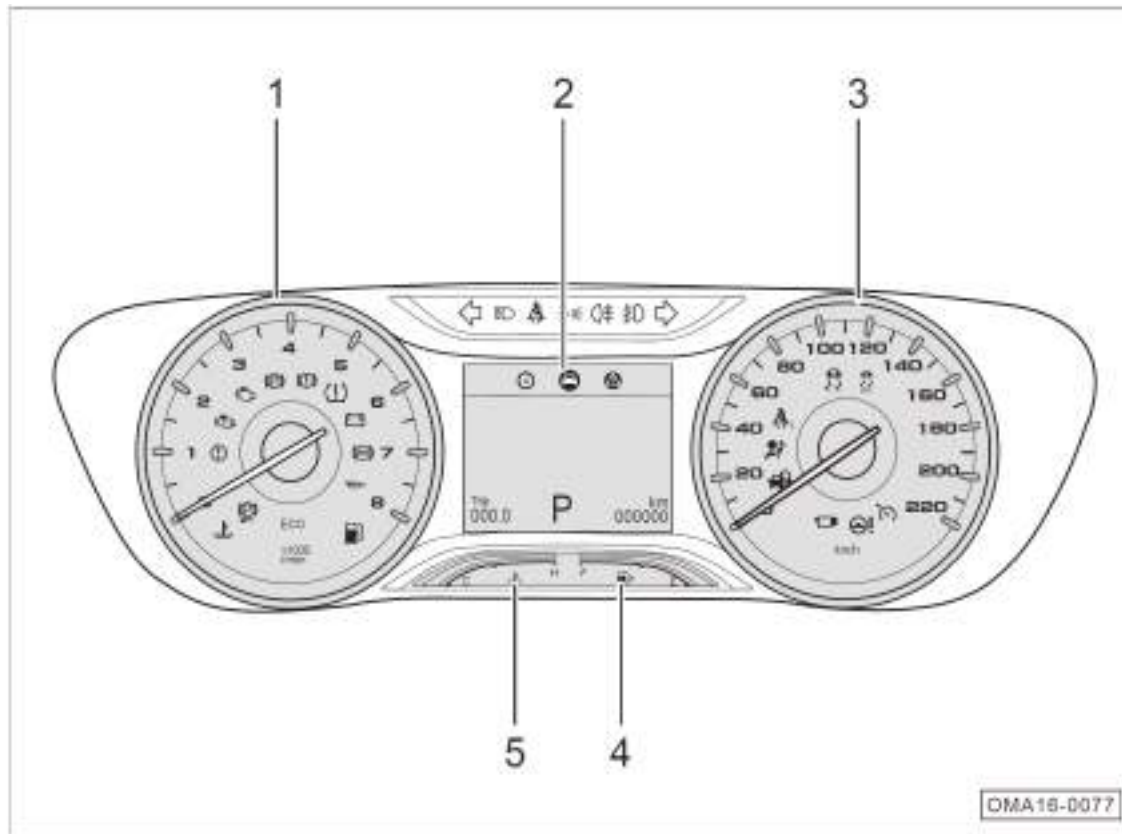

1. Engine tachometer
2. Instrument cluster display
  - Included information: door opening indication, gear\*, mileage, travel, menu setting, graphic & text alarm information
3. Speedometer
4. Fuel gauge
5. Engine coolant temperature gauge



## 4. Operating System and Equipment

### 4.1.1.1 TN Display Instrument Cluster\*

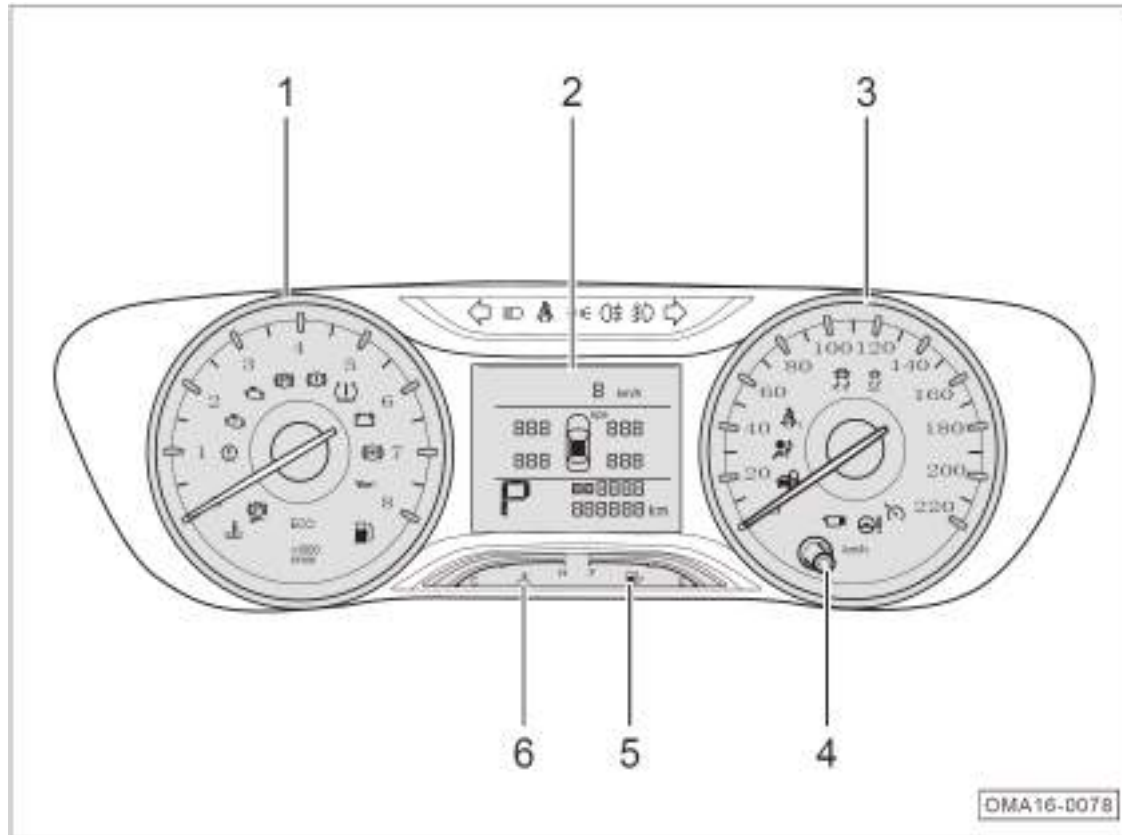

1. Engine tachometer
2. Instrument cluster display
  - Included information: door opening indication, gear\*, mileage and travel information
3. Speedometer
4. Backlight brightness adjustment/short-mileage adjusting rod
5. Fuel gauge
6. Engine coolant temperature gauge

### Engine tachometer

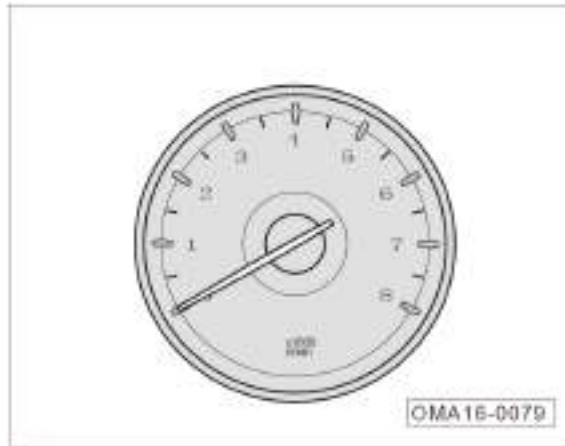

The engine tachometer is used to indicate the current engine speed, in x1,000 r/min, minimum scale 500 r/min, ranging from 0 r/min to 8,000 r/min.

#### **i** Hint

- The red warning area (7,000 r/min ~ 8,000 r/min) on the speed dial means the heavy-duty area of the car. Do not let the car operate in this area. Doing so can cause fuel cut-off due to engine self-protection.
- Damage to the engine probably occurs if the tachometer reading is in the red zone while the running-in period of the car does not expire.
- Even if the running-in period has expired, damage to the engine probably occurs if the tachometer reading is in the red zone.

### Instrument Cluster Display (TFT)\*

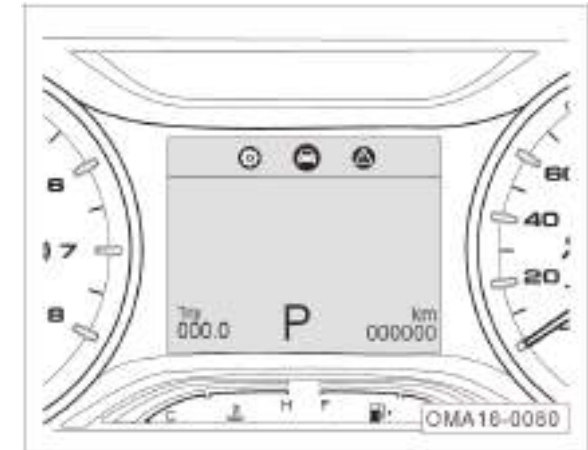

Displayed information includes: door opening indication information => [Refer to Page 46](#), gear information => [Refer to Page 46](#), mileage information => [Refer to Page 46](#), travel information => [Refer to Page 46](#), menu setting information => [Refer to Page 49](#), and graphic & text alarm information => [Refer to Page 53](#).

## 4. Operating System and Equipment

### Door opening indication information

- Display icon hint information when any door, engine hood or trunk lid is open. 

### Gear Information\*

- The “P” location is used to indicate current gear, for example, display P, R, N, D based on received signal.

### Mileage information

#### **Short-mileage Trip**

- Display range from 0km to 999.9km. When a short-mileage trip exceeds 999.9km, it will be reset and then continue to accumulate.
- Short-mileage Trip, may be reset by the total mileage in the settings of menu on display.  
=>Refer to Page 50

#### **Total mileage**

- Display range: 0 km~999999 km.

### Travel Information

Press ◀/▶ button on the right side of the steering wheel to enter the travel information interface when the Start or Ignition switch is at "ON" position; and then press ▲/▼ button to switch between the following travel information interfaces:

1. Outside temperature
2. Endurance mileage
3. Battery voltage
4. Instantaneous fuel consumption
5. Short-term memory
6. Long-term memory
7. Tire pressure\*
8. Tire temperature\*

#### 1. Outside temperature

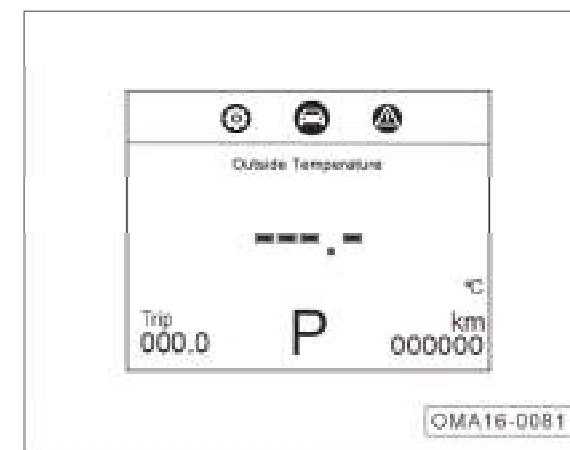

Indicate current ambient temperature outside the car

#### **Hint**

- Displayed based on outside temperature signal from the air conditioning system, expressed in °C / °F. =>Refer to page 51.
- “--.” is shown when no valid value is received.

2. Endurance mileage

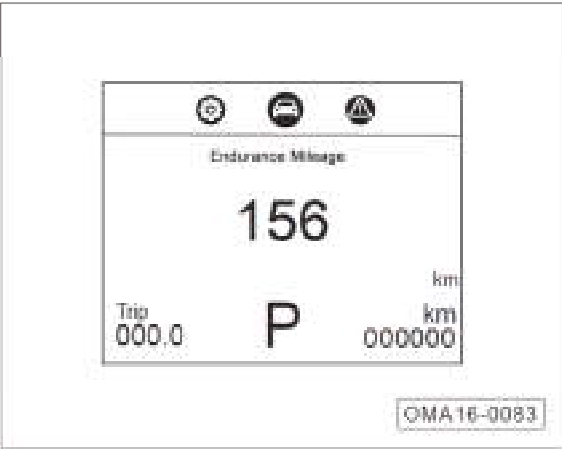

Indicate approximately distance that can be covered by remaining fuel in the fuel tank. "Low" is displayed in the case of too little fuel herein. In this case, fuel should be refilled timely.

**i Hint**

The parameter is shown for reference only and cannot be preset, which varies with the remaining fuel volume in the fuel tank.

3. Battery voltage

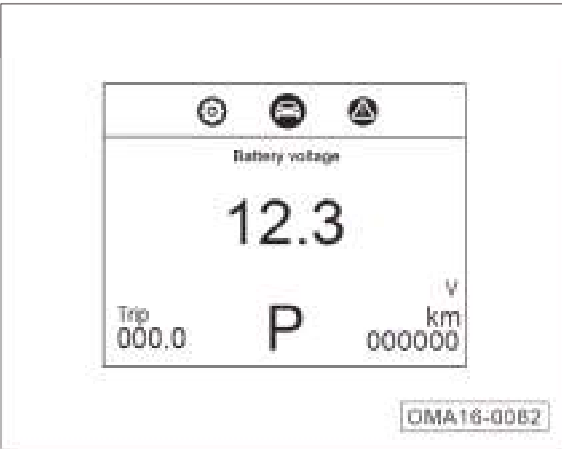

Indicate current battery voltage. This parameter cannot be preset.

**i Hint**

"--." is shown when no valid value is received.

4. Instantaneous fuel consumption

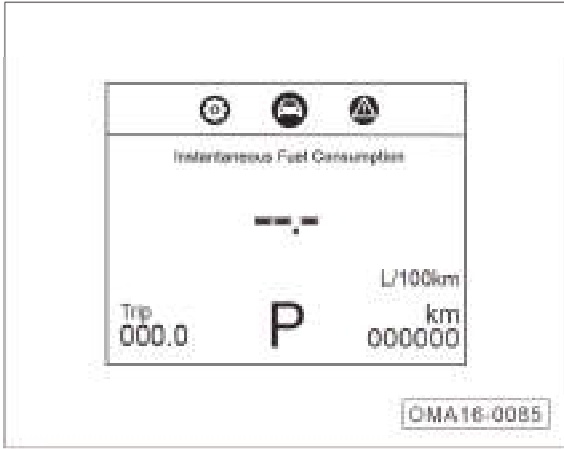

Indicate fuel consumption in the past 1s. This parameter cannot be preset.

**i Hint**

"--." is shown when no valid value is received.

## 4. Operating System and Equipment

### 5. Short-term memory

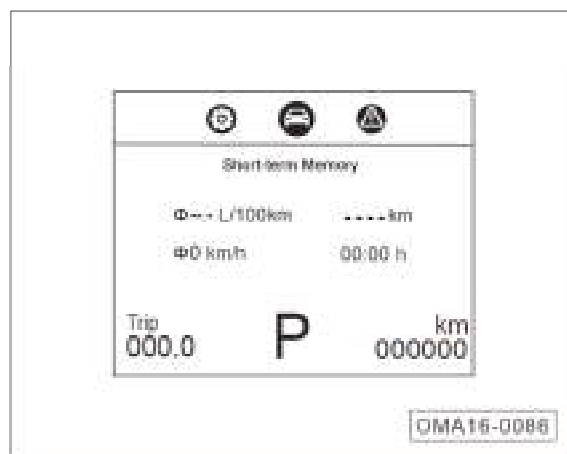

Indicate the one-time travel information, including the average fuel consumption (unit: L/100km), driving mileage (unit: km), average vehicle speed (unit: km/h), driving time (unit: h).

This parameter cannot be preset. It resets when a certain period elapses since the Start or Ignition switch is turned off. But the data is permanently saved in the memory.

### 6. Long-term memory

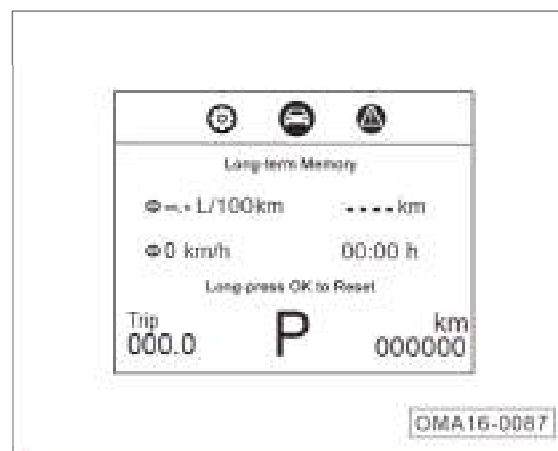

Indicate the travel information since reset last time: average fuel consumption (unit: L/100km), driving mileage (unit: km), average vehicle speed (unit: km/h), driving time (unit: h).

This parameter can be preset. It resets by long pressing the OK button.

### 7. Tire pressure\*

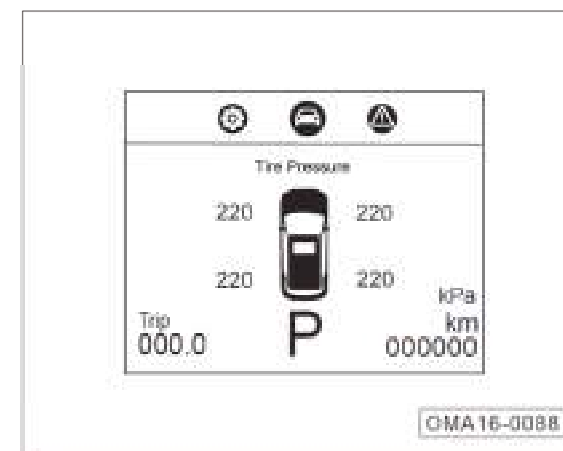

The displayed values are the corresponding pressure of the four tires.

#### **i Hint**

Indication of tire pressure is dependent upon vehicle model/ configuration. In case of no such configuration, no tire pressure data is displayed.

### 8. Tire temperature\*

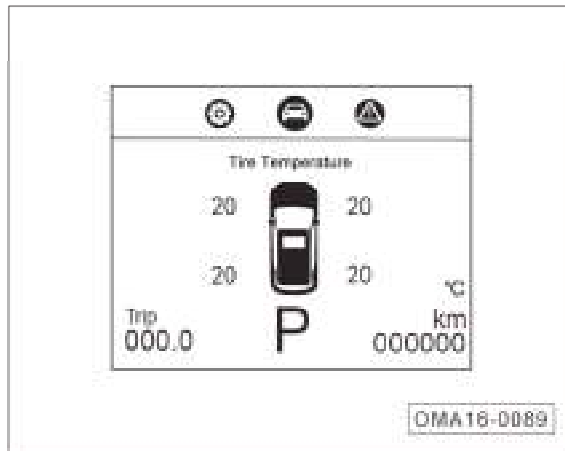

Indicate the tire temperature corresponding to four wheels of the car.

#### **i** Hint

Indication of tire temperature is dependent upon vehicle model/ configuration. In case of no such configuration, no tire temperature data is displayed.

### Menu setting

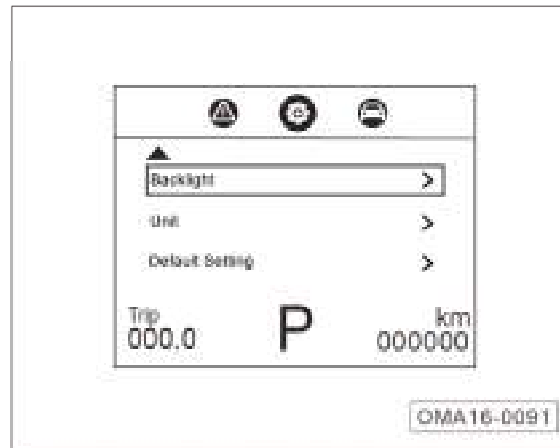
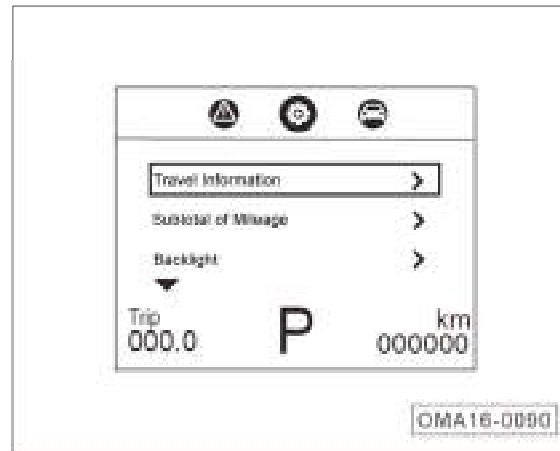

When the Start switch or ignition switch is at "ON" position and the vehicle speed is zero, press ◀/▶ button on the right side of the steering wheel to enter the menu setting interface, including:

1. Travel information
2. Subtotal of mileage
3. Backlight
4. Unit
5. Default setting
6. Return

And then press ▲ /▼ button to move the cursor and press the OK to enter the menu at the lower level.

Select "RETURN" and press the OK button to return to the travel information interface.

## 4. Operating System and Equipment

### 1. Travel Information Setting

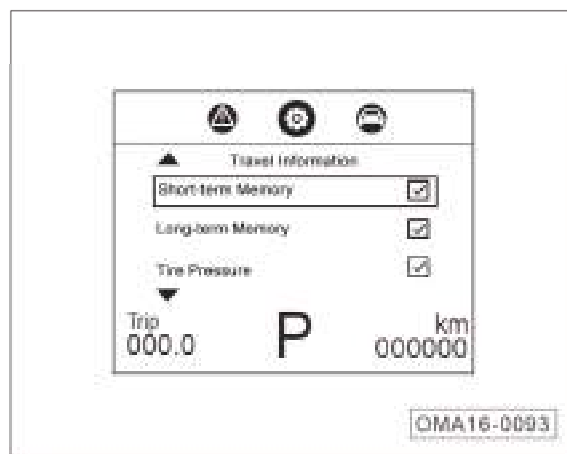
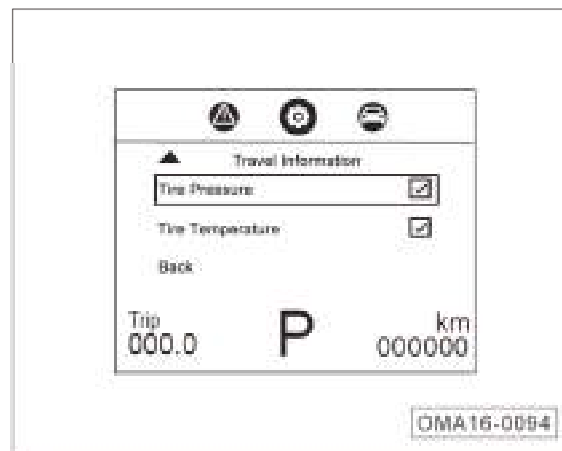
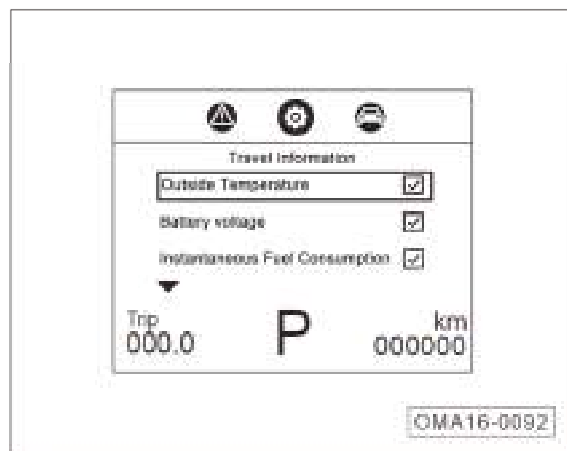

- Move the cursor by pressing ▲ / ▼ button and select or cancel by press the OK button.
- Multi-selections are available; the selected items display alternately in the travel information interface by pressing ▲ / ▼ button while unselected ones will not be displayed.
- Select "RETURN" and press the OK button to return to the previous menu.

### 2. Subtotal Mileage Setting

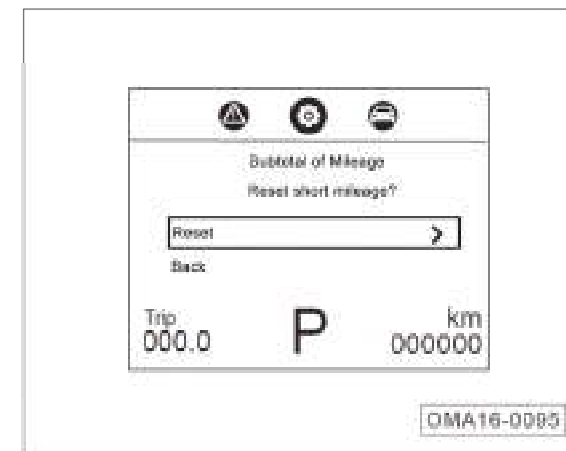

Short-mileage can be reset.

- Select "Reset" and press the OK button to reset the short-mileage trip.
- Select "RETURN" and press OK to return to the previous menu.

3. Backlight Setting

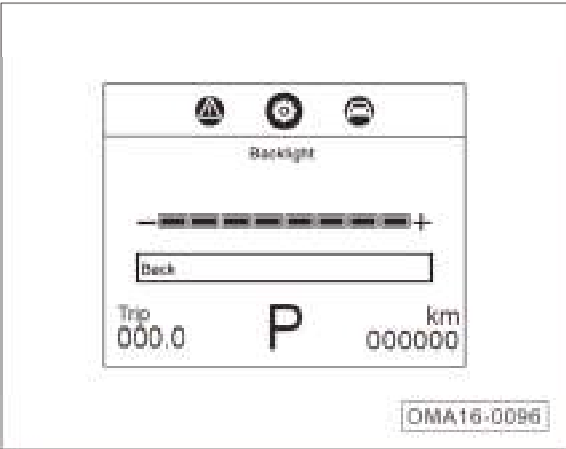

- The backlight grade in the car can be adjusted.
- The backlight cannot be adjusted before the position light is switched on.
- When the position light is switched on, press ▲ to increase and press ▼ to decrease the backlight.
- Press OK button to return to the previous menu.

4. Setting of Unit

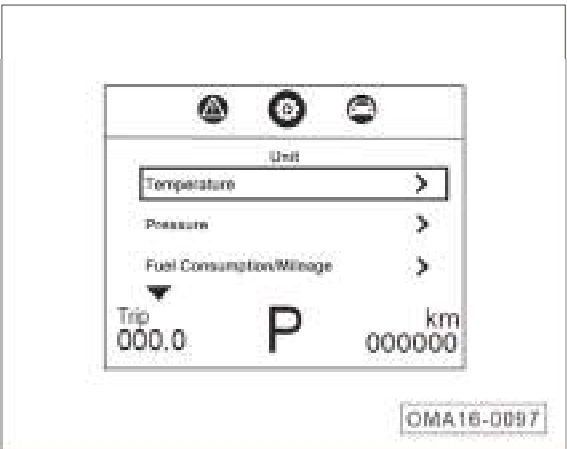

- The units of temperature, pressure, fuel consumption/mileage can be set.
- Move the cursor by pressing ▲ / ▼ button and select or cancel by press the OK button.
- Select "RETURN" and press OK to return to the previous menu.

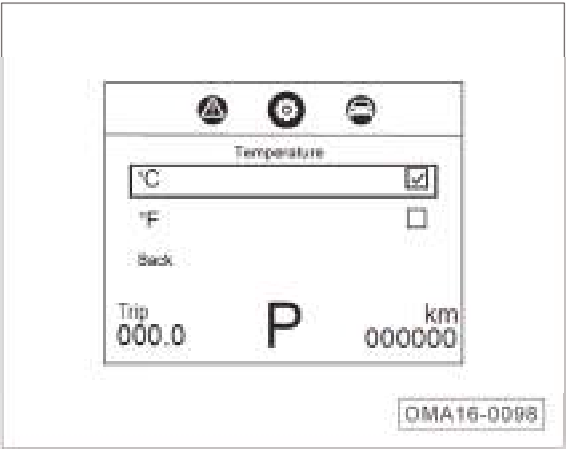

- The Figure shows the unit setting of temperature.



## 4. Operating System and Equipment

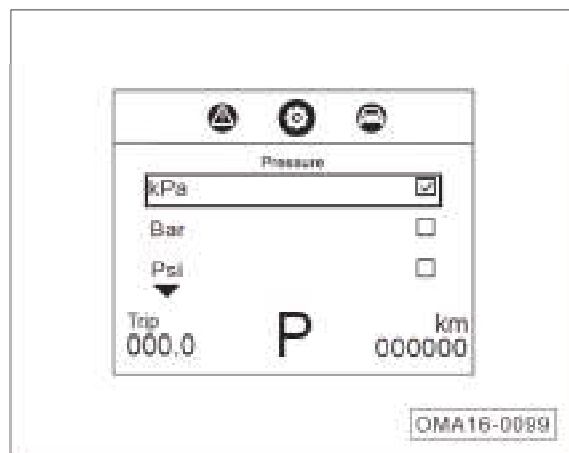

- The Figure shows the unit setting of pressure.

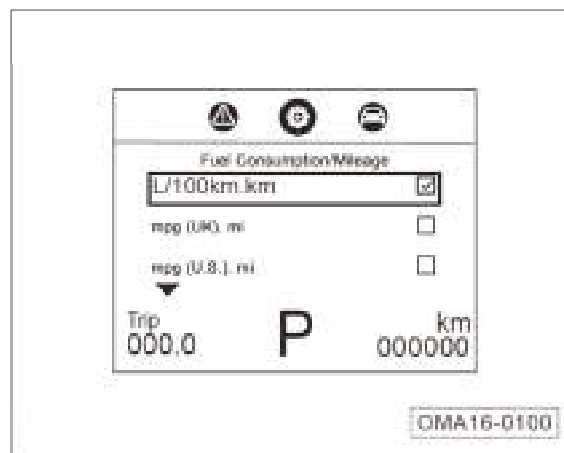

- The Figure shows the unit setting of fuel consumption/mileage.

## 5. Default setting

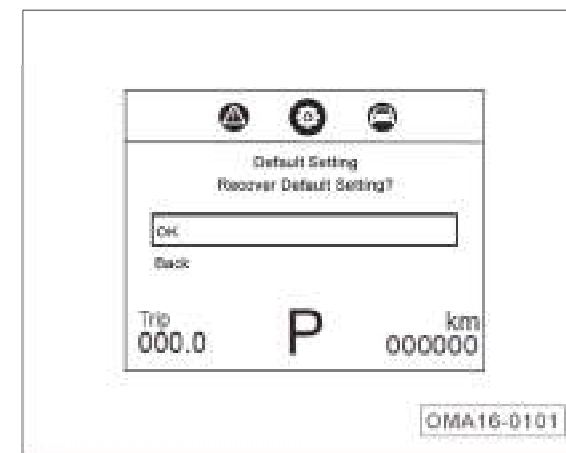

Default settings can be recovered.

- Select "Confirm" and press the OK button to recover default settings.
- Select "RETURN" and press OK to return to the previous menu.

### Graphic & Text Alarm Information\*

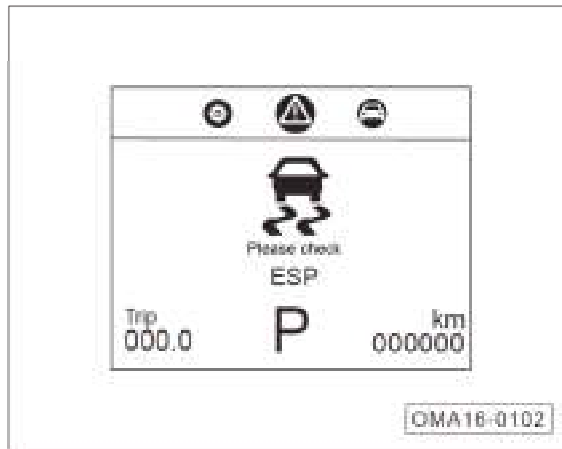

When the Start switch or ignition switch is at "ON" position, press ◀/▶ button on the right side of the steering wheel to enter the graphic & text alarm information interface to check abnormal alarm prompt information of the car.

- In case of any abnormality, the instrument cluster prioritizes the display of graphic & text alarm information which can be checked by press the OK button.
- In the case of multiple graphic & text alarm information, all the information can be checked by continuously press the OK button.
- If the car is in good condition, the display shows "The car is in good condition".

### Instrument Cluster Display (TN Display)\*

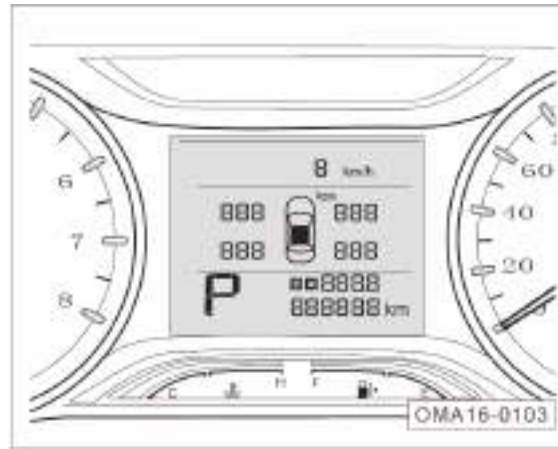

Displayed information includes: door opening indication information => Refer to Page 54, gear information => Refer to Page 54, mileage information => Refer to Page 54 and travel information => Refer to Page 54.

### Door opening indication information

- Display icon hint information when any door, engine hood or trunk lid is open. 

### Gear Information\*

- The "P" location is used to indicate current gear, for example, display P, R, N, D based on received signal.

### Mileage information

888888 km **Total mileage**

- Display range: 0 km~999999 km.

## 4. Operating System and Equipment

### Short-mileage Trip

- Display range from 0km to 999.9km. When a short-mileage trip exceeds 999.9km, it will be reset and then continue to accumulate.



- Short press the short-mileage adjusting rod (see the arrow) to switch between short-mileage A/B.
- Long press the short-mileage adjusting rod (see the arrow) to reset short-mileage A/B.

### Travel Information\*

When the Start switch or Ignition switch is at "ON" position and the vehicle speed is zero, press DISP button on the right side of the steering wheel continuously to enter the travel information interface, including:

1. Battery voltage
2. Endurance mileage
3. Average fuel consumption
4. Instantaneous fuel consumption
5. Average speed
6. Travel time
7. Tire temperature\*
8. Tire pressure\*

### 1. Battery voltage

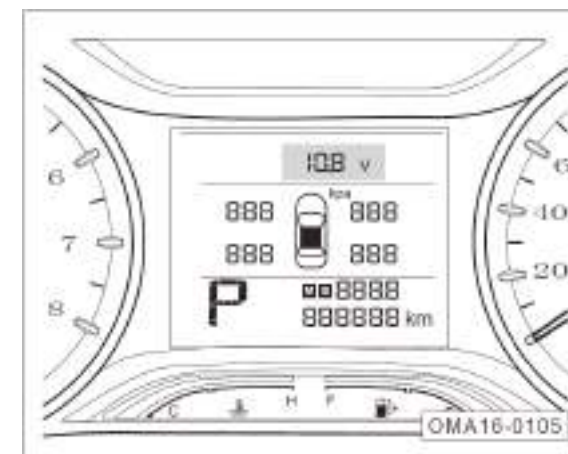

Indicate current battery voltage. This parameter cannot be preset.

2. Endurance mileage



Indicate approximately distance that can be covered by remaining fuel in the fuel tank. “Low” is displayed in the case of too little fuel herein. In this case, fuel should be refilled timely.

**i Hint**

The parameter is shown for reference only and cannot be preset, which varies with the remaining fuel volume in the fuel tank.

3. Average fuel consumption

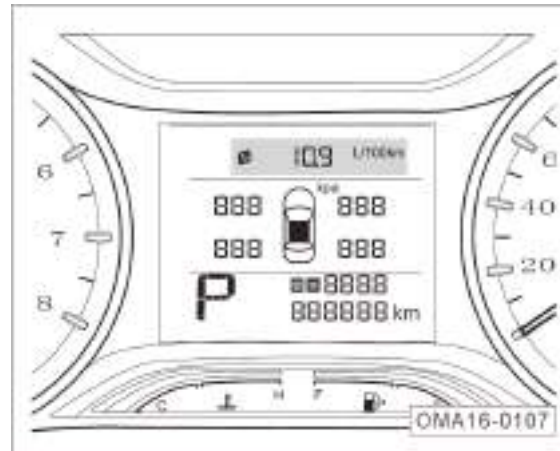

Indicate average fuel consumption in the past. This parameter can be reset by pressing DISP button on the right side of the steering wheel continuously.

**i Hint**

“--.” is shown when no valid value is received.

4. Instantaneous fuel consumption

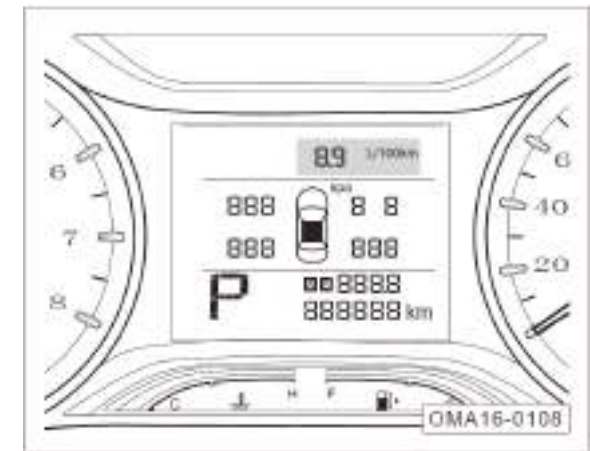

Indicate fuel consumption in the past 1s. This parameter cannot be preset.

**i Hint**

“--.” is shown when no valid value is received.

## 4. Operating System and Equipment

### 5. Average speed

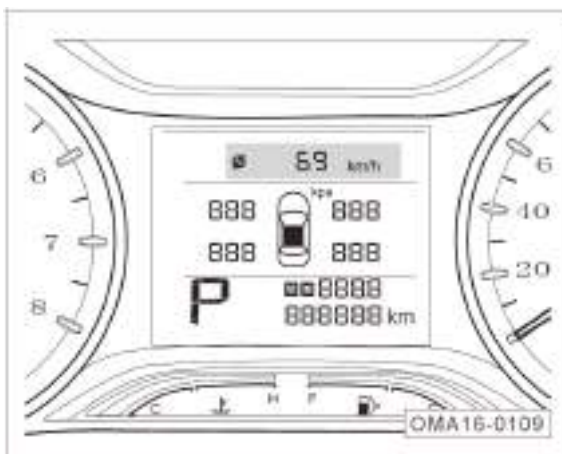

Indicate average speed in the past. This parameter can be reset by pressing DISP button on the right side of the steering wheel continuously.

### 6. Travel time

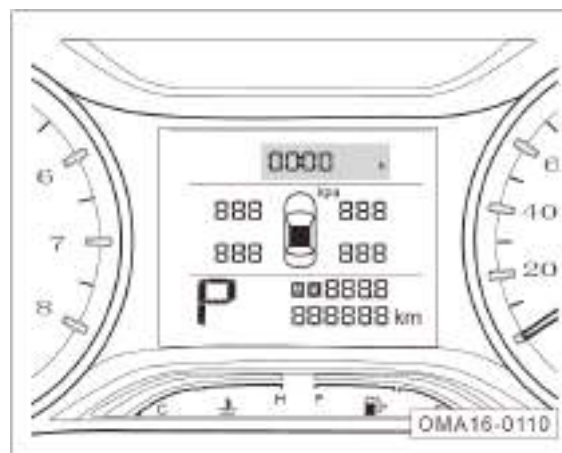

Indicate travel time. This parameter can be reset by pressing DISP button on the right side of the steering wheel continuously.

### 7. Tire pressure\*

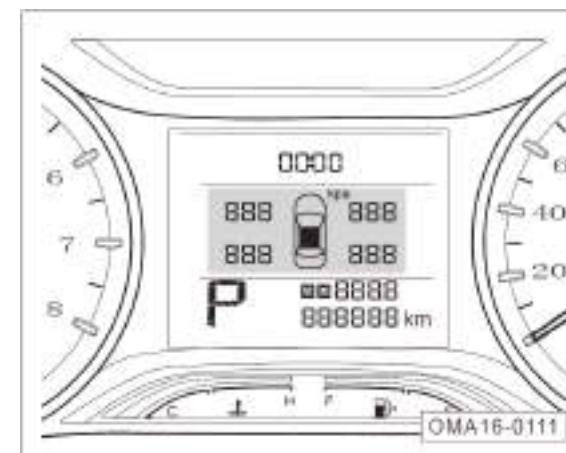

The displayed values are the corresponding pressure of the four tires.

#### **i** Hint

Indication of tire pressure is dependent upon vehicle model/ configuration. In case of no such configuration, no tire pressure data is displayed.

8. Tire temperature\*



Indicate the tire temperature corresponding to four wheels of the car.

**i Hint**

Indication of tire temperature is dependent upon vehicle model/ configuration. In case of no such configuration, no tire temperature data is displayed.

Backlight Brightness Adjustment\*

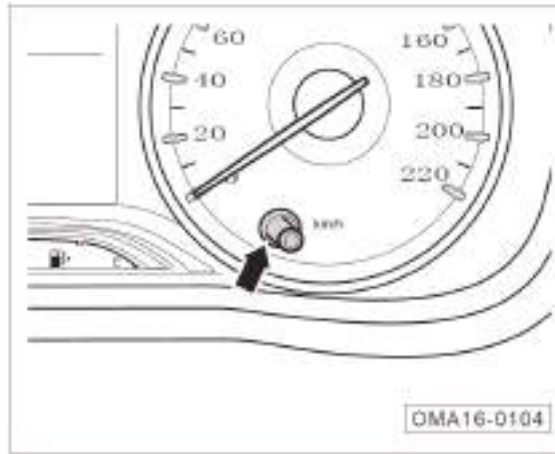

- When the position light is switched on, anticlockwise rotate the backlight brightness adjusting rod to decrease the backlight and clockwise rotate it to increase the backlight.

Speedometer



Speedometer is used for indicating the current vehicle speed, in km/h, minimum scale of 10km/h, ranging from 0km/h to 220km/h.

**Caution**

- 200km/h ~ 220km/h represents the heavy-load range. To protect your car, avoid prolonged driving in this range.
- Strictly abide by traffic rules. Do not overspeed at will.

## 4. Operating System and Equipment

### Fuel gauge

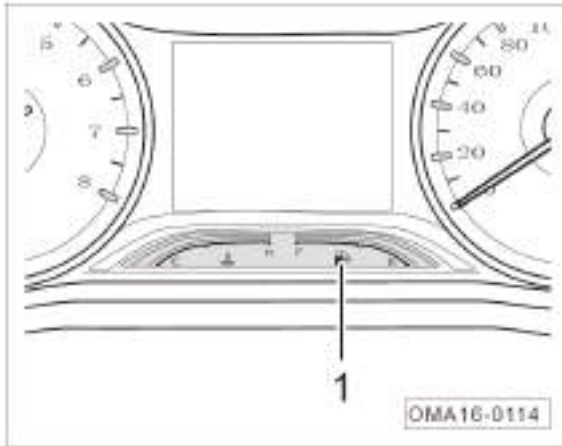

Fuel gauge ① is used to indicate the current fuel remaining in the tank.

- There is a total of 8 major sections, indicating the range of E~F, in which, "E" represents the fuel tank is empty, and "F" represents the fuel tank is full. An appropriate number of sections are illuminated depending on the residual fuel.
- It indicates insufficient fuel in the fuel tank when only the first bar or no bar is on and the low level yellow indicator light (  ) in the instrument cluster flickers. In this case, the fuel should be refilled as soon as possible.

### Engine coolant temperature gauge

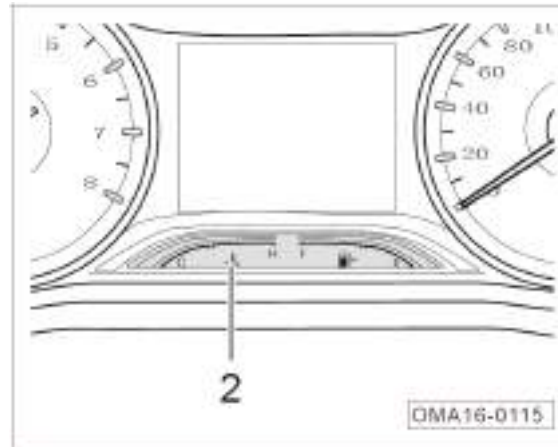

Engine coolant temperature gauge ② (i.e., water temperature gauge) used for indicating the current engine coolant temperature.

- There is a total of 8 major sections, indicating the range of C ~ H, in which, "C" represents low temperature and "H" indicates high temperature. An appropriate number of sections are illuminated depending on the temperature.
- When the engine coolant temperature is  $>50^{\circ}\text{C}$ , the temperature gauge lights up gradually from the first major section.
- After the engine starts and works for some time, 3~4 major sections are lit.

- When the 8th major section is lit, it indicates that the current engine coolant temperature is too high. Meanwhile, the high coolant temperature red indicator light  in the instrument cluster is lit and the buzzer alarms to alert the driver. And now the engine load shall be reduced (for example: do not run the engine at a high speed for a long time, or not long drive at steep road), park the car timely and check the coolant level. => Refer to Page 342

#### Hint

- If the engine coolant temperature is too high, do not continue driving even if the coolant level is normal, unless the temperature reaches the normal range. If the temperature remains high, please have your car checked and repaired at GAC MOTOR dealer as soon as possible.
- If additional part is installed at air inlet, it may reduce cooling effect of coolant. The engine overheats easily at high ambient temperature and when the engine running under high load.

4.1.2 Indicator Light

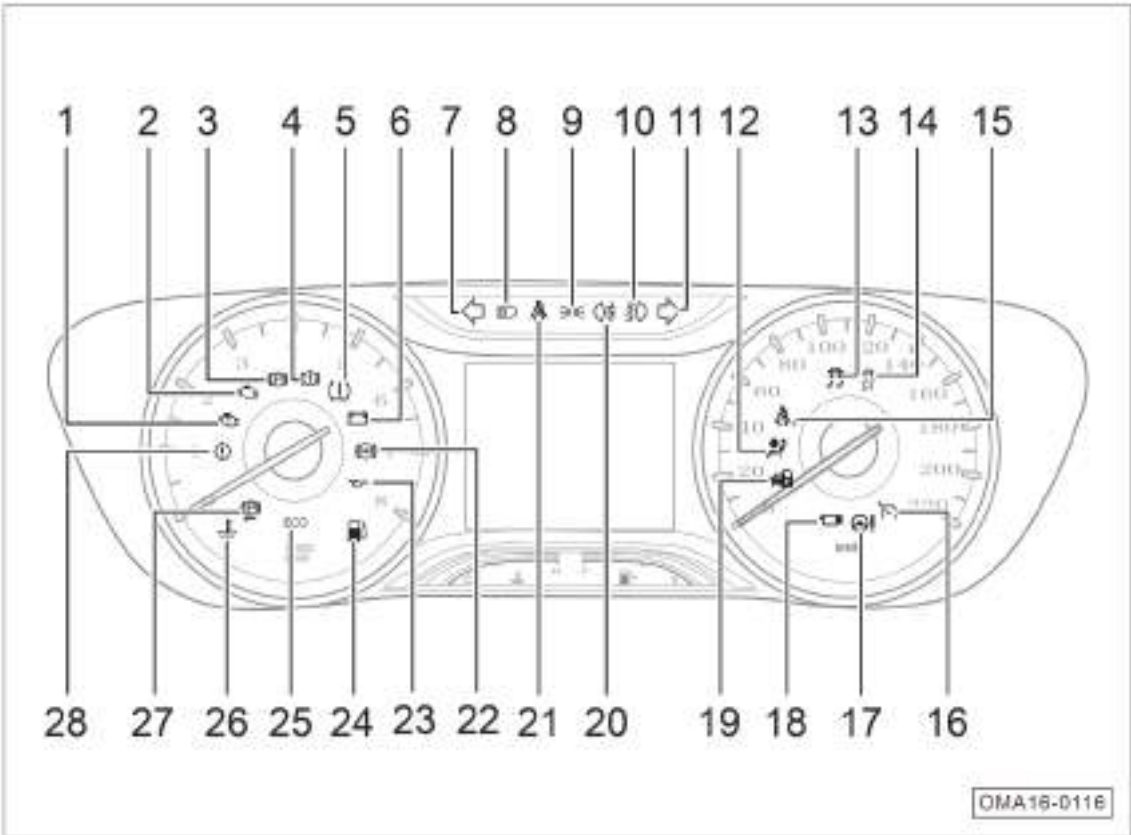









**Caution**

If any indicator light or warning light in the instrument cluster illuminates after car starting or during driving, it indicates relevant system or function may work or failure occurs. You should read through the indications of each indicator light, warning light carefully; please have your car checked and repaired at the GAC MOTOR dealer timely when failure occurred.













## 4. Operating System and Equipment







### 4.1.2.1 Indicator Light

S/N	Icon	Name	Color	Function
1		Engine malfunction indicator light	Yellow	With the Start or Ignition switch at "ON" position, the indicator light illuminates for a few seconds and then extinguishes after self-checking of the system if the engine is not started and there is no fault. After the engine starting, if the indicator light is lit, it indicates that there is a fault in the engine system.
2		Emission failure indicator light	Yellow	With the Start or Ignition switch at "ON" position, the indicator light is lit when the engine is not started and is off after the engine is started. After the engine starting, if the indicator is still on, it indicates that there is a fault in the exhaust system.
3		EPB status indicator light*	Red	If the indicator light is lit (red), it indicates that the EPB is applied. If the indicator light (red) flashes, it indicates that the EPB is partly engaged or failed.
			Green	If the indicator light is lit (green), it indicates that electronic automatic parking is activated.
4		Parking brake and brake system indicator light	Red	If the indicator light is lit, it indicates that the hand brake is set, the brake fluid level is too low or there is a fault in the electric brakeforce distribution (EBD) system.
5		Tire pressure monitoring system (TPMS) indicator light*	Yellow	If the indicator light is lit, it indicates that there is a fault in TPMS.
6		Charging system warning light	Red	With the Start or Ignition switch at "ON" position, the warning light is lit when the engine is not started and is off after the engine is started. After the engine starting, if the warning light is lit, it indicates that there is a fault in the charging system.
			Green	
7		Left turn signal and hazard warning indicator light	Green	When the left turn signal indicator light flashes alone, it indicates that the left turn light is turned on. When the hazard warning indicator light switch is pressed, the left/right turn signal indicator lights will flash together with all the outside turn signal lights.
			Blue	
8		High beam indicator light	Blue	If the indicator light is lit, it indicates that high beams are turned on.
9		Position light indicator light	Green	If the indicator light is lit, it indicates that the position lights, instrument panel light, number plate lights, etc. are turned on.

## 4. Operating System and Equipment

S/N	Icon	Name	Color	Function
10		Front fog light indicator light	Green	If the indicator light is lit, it indicates that front fog lights are turned on.
11		Right turn signal and hazard warning indicator light	Green	When right turn signal indicator light flashes alone, it indicates that the right turn lights are turned on.
				When the hazard warning indicator light switch is pressed, the left/right turn signal indicator lights will flash together with all the outside turn signal lights.
12		Supplemental restraint system (SRS) indicator light	Red	If the indicator light is lit, it indicates that there is a fault in the SRS system.
13		Electronic stability program (ESP) indicator light*	Yellow	If the indicator is lit, it indicates that there is a fault in the ESP system or HHC system.
				If the indicator light flashes, it indicates the ESP is working.
14		Electronic Stability Program Off (ESP OFF) indicator light.*	Yellow	If the indicator light is lit, it indicates that the ESP system is turned off.
15		Front passenger seat belt indicator light*	Red	If the indicator light is lit, it indicates that the front passenger seat belt is not fastened or there is a fault in the belt system.
16		Cruise control indicator light*	White	If the indicator light is lit (white), it indicates that the adaptive cruise system is making preparation.
			Green	If the indicator light is lit (green), it indicates that the adaptive cruise system is enabled.
17		Electronic Power Steering (EPS) indicator light	Yellow	If the indicator light is lit, it indicates that there is a fault in the EPS system.
18		Panorama parking system indicator light*	Yellow	If the indicator light is lit, it indicates that there is a fault in the panorama parking system.
19		Immobilizer lock system indicator light	Red	If the indicator light is lit, it indicates that the engine immobilizer system or the car anti-theft system is enabled.
20		Rear fog light indicator light	Yellow	If the indicator light is lit, it indicates that rear fog lights are turned on.

#### 4. Operating System and Equipment

S/N	Icon	Name	Color	Function
21		Driver seat belt indicator light	Red	If the indicator light is lit, it indicates that the seat belt is not fastened or there is a fault in the belt system.
22		Anti-lock brake system (ABS) indicator light	Yellow	If the indicator light is lit, it indicates that there is a fault in ABS.
23		Low engine oil pressure warning light	Red	With the Start or Ignition switch at "ON" position, the warning light is lit when the engine is not started and is off after the engine is started. After the engine starting, if the warning light is still on, it indicates that the engine oil pressure is low.
24		Low fuel indicator light	Yellow	If the indicator light flashes (yellow), it indicates that less fuel remains in the tank. If the indicator light is lit (yellow), it indicates a possible fault with the fuel pump.
25	ECO	ECO mode indicator light*	Green	If the indicator light is lit, it indicates that ECO mode is activated.
26		High engine coolant temperature indicator light	Red	If the indicator light is lit (red), it indicates that the engine coolant temperature is too high.
27		EPB malfunction indicator light*	Yellow	If the indicator light is lit, it indicates that there is a fault in the EPB system. If the indicator light flashes, it indicates that the EPB system is in maintenance mode.
28		Transmission malfunction indicator light	Yellow	If the indicator light is lit, it indicates that there is a fault in the automatic transmission. If the indicator light flickers, it indicates that the oil temperature of the automatic transmission is high.

### 4.1.3 Steering Wheel

#### Steering Wheel Position Adjustment

The driver is allowed to adjust the height of and the distance to steering wheel according to own body size.



- Adjust the driver's seat to a proper position.

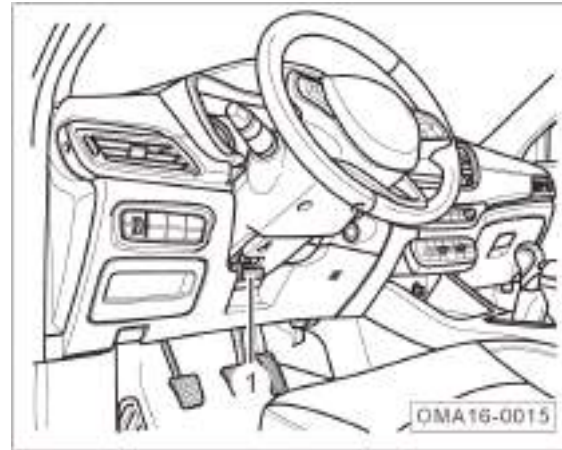

- Pull up the locking handle ① to unlock the steering wheel.
- Move the steering wheel upward or downward to adjust it to a proper position. The steering wheel shall face the driver's front chest, and the position of the steering wheel shall ensure that the driver can see all instrument clusters and indicators on the instrument panel.
- Push the locking handle downward to lock the steering wheel.
- Move the steering wheel upward and downward to ensure that it is securely locked.

#### ⚠ Warning

- After adjusting the steering wheel, remember to push the locking handle downward to lock the steering wheel to prevent automatic displacement of steering wheel during driving.
- To avoid traffic accident, it is not allowed to adjust the steering wheel unless the vehicle is stopped.
- The steering wheel shall not just face the driver's face. Otherwise, effective protection by driver's frontal airbag cannot be achieved during a crash. After adjustment, the steering wheel shall face the driver's front chest.

## 4. Operating System and Equipment

### Steering Wheel Button (Left)

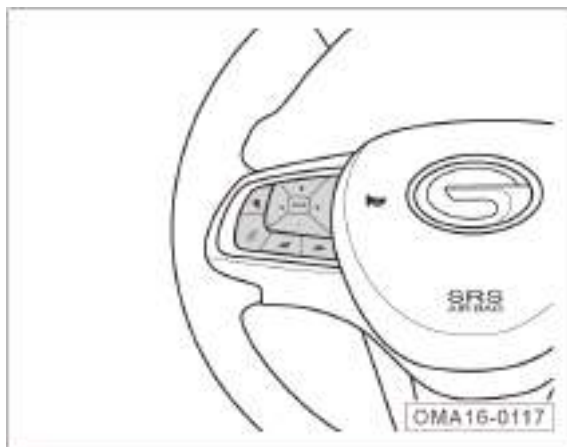

The buttons at left of the steering wheel are for audio system control. For its function and operation:

- Audio system (radio)  
=> Refer to Page 149
- Audio system (AVN)  
=> Refer to Page 173

### Steering Wheel Button (Right)

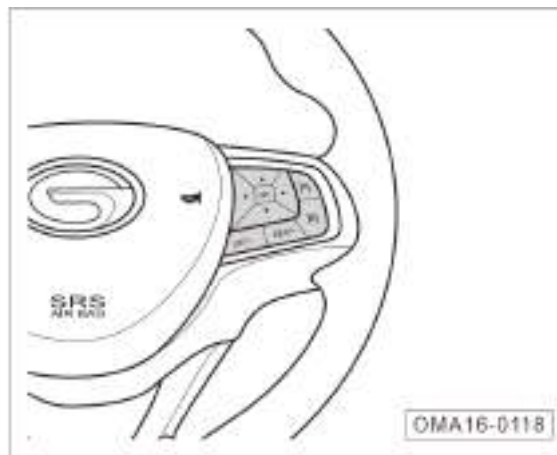

Type 1: the buttons at right of the steering wheel include the instrument cluster display control button and constant speed cruise control button.

1. Instrument cluster display screen control button\*
  - OK: select/confirm
  - Short press: Select current menu item.
  - Long press: Reset the current data in travel information memorizer.
  - ◀/▶: Left/ right

- Switch the display interfaces of instrument cluster one by one.
  - ▲/▼: Previous/ next
  - At the travel information interface, short press this button to switch to the previous or next travel information interface.
  - At the menu setting interface, short press the previous/next to move the selection cursor or to adjust numerical values.
2. Cruise control button\* => Refer to Page 304

### Horn Button on Steering Wheel

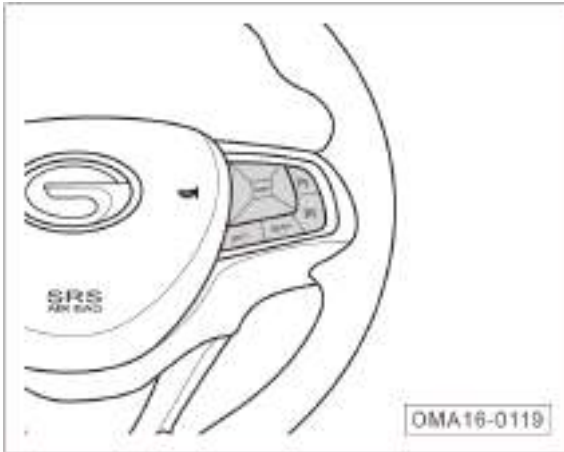

Type 2: the buttons at right of the steering wheel include the instrument cluster display control button and constant speed cruise control button.

1. Instrument cluster display screen control button\*
  - DISP: Short press the button continuously to switch the travel information orderly; Long press to reset the current data in travel information memorizer.
2. Cruise control button\* => [Refer to Page 304](#)



- Press the  horn button on the steering wheel, the horn sounds. Release the button, the horn stops sounding.

#### Warning

**Do not press the  horn button for a long time, otherwise it will be easily damaged.**

## 4. Operating System and Equipment

### 4.2 Start and Stop Vehicle

#### 4.2.1 Smart Key

##### Caution

There is an electric loop inside the smart key to trigger the immobilizer system. If this loop is damaged, it may fail to start the engine. Thus:

- The smart key shall be protected from direct sunlight, high temperature and high humidity.
- Dropping the smart key from a high place or crushed with a heavy thing shall be avoided.
- Contacting the smart key with fluids shall be avoided. Use a piece of soft cloth to dry it immediately when got wet.

#### Smart Remote Key\*



Two smart keys (containing emergency mechanical key) and key bar code are attached with the vehicle. If need to re-customize the key, inform the GAC MOTOR Dealer of the key bar code. If the key bar code is lost, inform the GAC MOTOR Dealer of the vehicle VIN.

#### Remote key\*

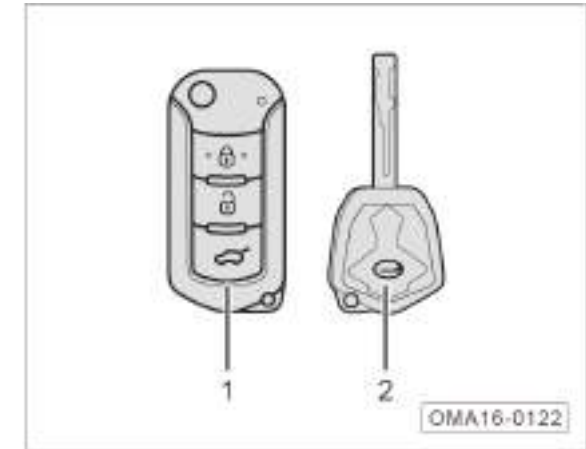

One smart key ① (containing emergency mechanical key), one emergency key ② and key bar code are attached with the vehicle. If need to re-customize the key, inform the GAC MOTOR Dealer of the key bar code. If the key bar code is lost, inform the GAC MOTOR Dealer of the vehicle VIN.

### Low Signal Intensity of Smart Key

To lock/unlock the door or unlock the trunk lid, the vehicle will emit wireless electric wave to locate the smart key. In following cases, it may be impossible or difficult to lock/unlock the door or unlock the trunk lid:

- The equipment nearby is emitting strong wireless electric wave.
- The smart key is carried together with telecommunication equipment, laptop, mobile phone or wireless signal transmitter.
- The smart key is contacted with covered by any metallic objects.

#### Caution

When leaving the vehicle, do not leave the smart key in the vehicle. Please take it with you at all times.

### Operation of Buttons

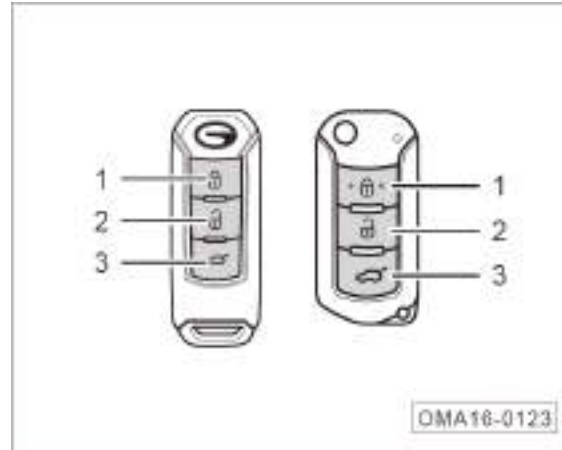

1. Lock button
2. Unlock button
3. Trunk lid unlock button

#### Hint

The standard remote control distance is 30m, and the longest remote control distance is 80m.

When the Start or Ignition switch is at "ACC" or "ON" position, the operation of any button on the smart key is not available.

If the locking or unlocking function fails, quickly press the corresponding button for 3 times in a short time to recover such function. If failed to be recovered, the key shall be inspected and repaired at the GAC Motor Dealer.

If the lock or unlock button is pressed successively, the vehicle will successively execute 6 times of locking or unlocking, which will resulted to protection mode to protect the lock from damage.



## 4. Operating System and Equipment

The wireless remote function of the smart key is able to lock/unlock all doors, lift/down window at driver side\*, open/close sunroof\* and unlock the trunk lid.

The intelligent sensing function of smart key is able to achieve PEPS to operate the Start switch to start or shut down the engine\*.

### Hint

There is transceiver chip inside the smart key. This chip is equipped with electronic code that will be sent to the vehicle. The smart key can be used to operate the vehicle only when the chip electronic code is consistent with the registered vehicle ID code.



### 1. Lock Button Operation

- Short pressing this button once within the effective range, all doors will be locked; pressing this button and hold for 2s, the window at driver side will close automatically; pressing this button and hold for 3s, the sunroof will close automatically\*. If this button is released while the window or sunroof is closing automatically, the closing will be stopped.
- Pressing this button twice continuously within 0.5s, the vehicle locating function can be activated, and the turn signal light will flash quickly for 3 times.

### Hint

When the door is locked, the turn signal will flash once.

### Caution

In case one door is not closed and the  lock button is pressed, the four doors will be locked and then be unlocked immediately. In case the engine hood or trunk lid is not closed and the  lock button is pressed, then system will alarm.

### 2. Unlocking Button Operation

- Short pressing this button once within the effective range, all doors will be unlocked; pressing this button and hold for 2s, the window at driver side will open automatically; pressing this button and hold for 3s, the sunroof will open automatically\*. If this button is released while the window or sunroof is opening automatically, the opening will be stopped.

#### Hint

When the door is unlocked, the turn signal will flash twice.

#### Caution

After pressing the  unlocking button to unlock the door, the system will lock the door again if it is not opened within 30s.

### 3. Trunk Lid Unlock Button Operation

- Within effective range, the trunk lid can be unlocked by long pressing this button ( $\geq 2s$ ).

#### Caution

Once the vehicle speed exceeds 1.5km/ h, it is forbidden to unlock the trunk lid.

### Keyless Entry\*

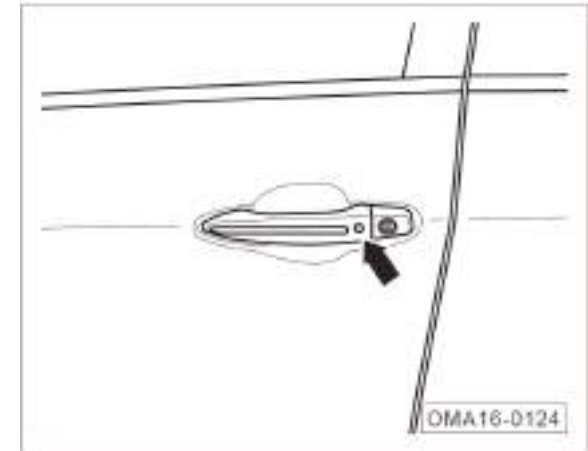

- When the Start switch is at "OFF" position and the doors are locked, if the user with smart key approaches to the door and presses the button on the handle of front door, all doors will be unlocked.
- When the start switch is at "OFF" position, if the user presses the button on the handle of front door with smart key after closing all doors, all doors will be locked.

## 4. Operating System and Equipment

### Caution

- After locking vehicle doors using keyless entry function, it takes 3 seconds before the keyless entry function can be activated to unlock doors.
- Snow or ice on the vehicle door handle should be removed as soon as possible, which affects the keyless entry function.

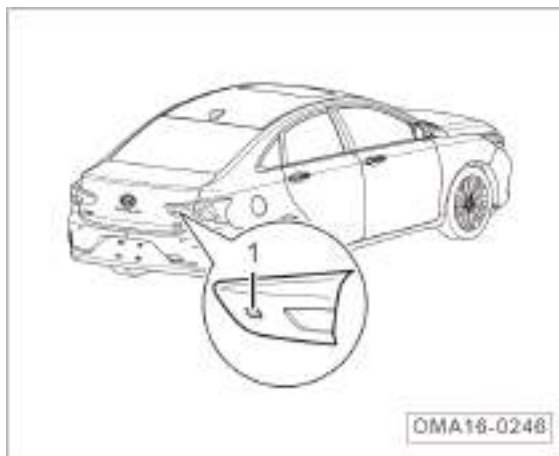

- When the Start switch is at "OFF" position and the doors are closed, if the user with smart key approaches to the trunk lid, pressing the release button ① of the trunk lid may unlock and open the trunk lid.
- If the vehicle is unlocked and stationary, then you may open the trunk lid by pressing the release button ① of the trunk lid without carrying the smart key.

### Caution

Once the vehicle speed exceeds 1.5km/ h, it is forbidden to unlock the trunk lid.

### Immobilizer System



The vehicle is provided with the immobilizer function to prevent the vehicle from being stolen. If an improperly-coded key (or other tool) is used to start the engine, the fuel system will not work and the vehicle cannot be started normally.

#### Caution

If matched smart key is used, the immobilizer system will be deactivated automatically.

### "Sound" and "Light" Alarm Switching

The "light" alarm indicates the vehicle warns the driver only with light, while the "sound and flash" alarm mode indicates the vehicle warns the driver both with light and horn sound.

When the start switch or ignition switch is at "OFF/LOCK" position, press the  button and  button at the same time for 2s, the "sound" alarm mode and "sound and flash" alarm mode can be switched. If the switching is successful, the left and right turn signals will flash at the same time for 3 times.

### Battery Replacement

The smart key is equipped with wireless transmitter and battery while the vehicle is equipped with wireless receiver. If the battery power of the smart key is adequate, it is able to work within the effective range. If there are obstacles between the smart key and vehicle, the battery power is inadequate, or the key is used in severe weather, its effective operation range will be minimized.

#### Hint

Every pressing of the button on smart key will lead once flash of its indicator light. Such operation will consume the battery power.

If the indicator light does not flash when the button is pressed, or if the button has to be pressed several times to lock or unlock the door, the battery may be run out or nearly run out. Replace the battery as soon as possible.

## 4. Operating System and Equipment

### ⚠ Caution

- The smart key will consume battery power when receiving wireless electric waves, so do not place the smart key on or near any television set, computer or other electric devices.
- Be sure to use a new battery with the same rated voltage and size for replacement.
- Using of improper battery may damage the smart key.
- The disposal of used battery must meet relevant environmental protection laws and regulations.

### i Hint

Do not replace the battery unless you have the required skill, otherwise the key may be easily damaged.

Please go to your GAC MOTOR dealer for replacement.

### Steps to Replace Battery

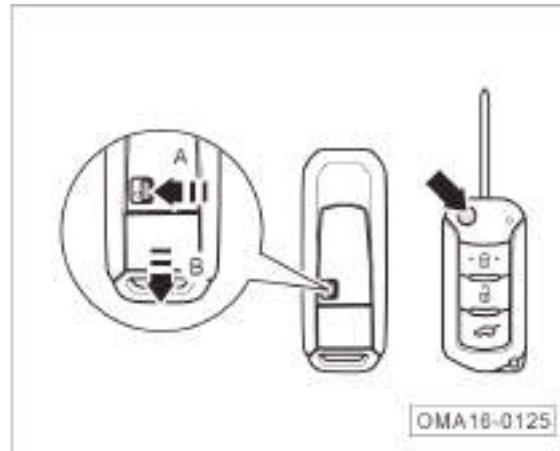

- Key for model with start switch: Move the switch in the direction of arrow A and pull out the emergency mechanical key in direction of arrow B.
- Key for model with ignition switch: Press the button indicated by the arrow, the mechanical key will get out.

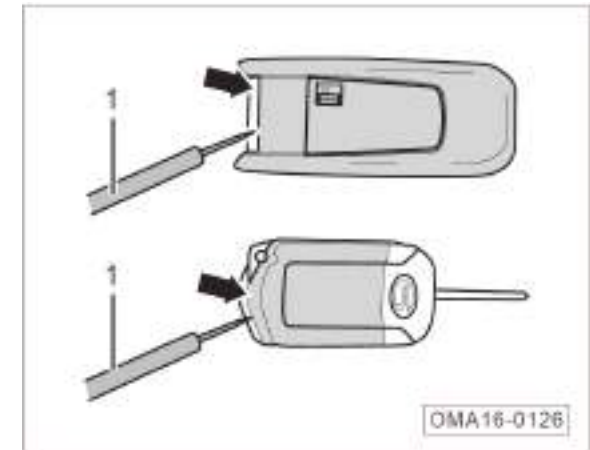

- Use a mini straight screwdriver ① to prise out the remote key housing at the position of the arrow.

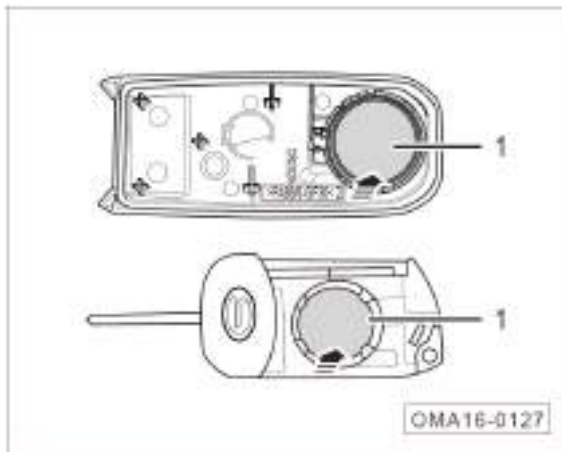

- Use your finger to press the battery in the direction of arrow and take out the remote key battery ①.
- Install the smart key in the reverse order.

## 4. Operating System and Equipment

### 4.2.2 Emergency Mechanical Key\*

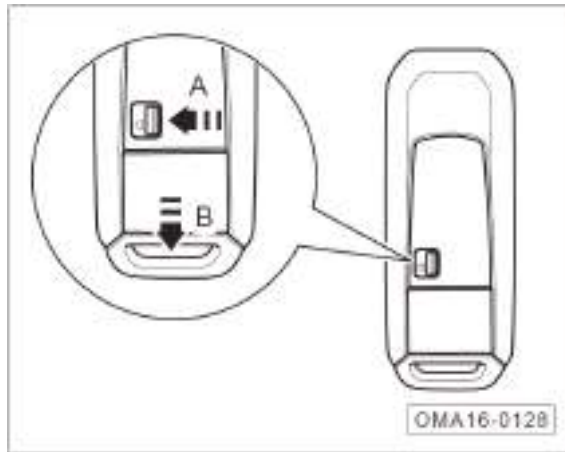

- Move the switch in the direction of arrow A and pull out the emergency mechanical key in direction of arrow B.



- Insert the emergency mechanical key into the lock hole of door at driver side to lock all doors or unlock the door at driver side. => Refer to Page 78

#### **i** Hint

The emergency mechanical key can only be used to lock all doors or unlock the door at driver side, while it cannot be used to start the engine.

### 4.2.3 Central Locking System

The central locking system can be operated in following two methods to lock or unlock all doors:

1. Press the lock or unlock button on the smart key to operate the central locking system.
2. Use the central locking button to operate the central locking system.

#### Hint



If the anti-theft function of the smart key is activated, the central locking button can only be used to lock doors, but cannot be used to unlock doors.

### Door Unlocking

Within the effective range, short press the  button on smart key once to unlock all doors.

Within approximately 1.0m to vehicle door with smart key, all doors can be unlocked directly through PEPS function\*. => [Refer to Page 69](#)

#### Hint

For current models, it is defaulted to unlock all doors by pressing the  button on smart key. Through the "Car Setting" under the audio system, it can be set to unlock all doors or only the left front door by pressing  button on remote key. => [Refer to Page 204](#)

### Auto-Unlock Function

If the vehicle stops with the doors locked, the door at driver side can be unlocked automatically when the start switch is turn to "OFF/LOCK" position

#### Hint

The "automatic unlocking" function is optional, which can be activated or deactivated via the "Car Setting" under the audio system\*. => [Refer to Page 204](#)



## 4. Operating System and Equipment

### Locking Function of Vehicle Speed

Under the precondition that all doors are closed:

- The central locking system will automatically lock all doors if the vehicle speed exceeds 20km/h.
- The central locking system will automatically lock all doors if the vehicle speed is at 5km/h to 20km/h for more than 30s.

#### **i** Hint

The "vehicle speed locking" function is optional, which can be activated or deactivated via the "Car Setting" under the audio system\*. => [Refer to Page 204](#)

After speed locking, all doors can be unlocked by pressing the central locking button.

### Collision unlocking function

If the vehicle is collided during driving, four doors can be unlocked at the same time when the Start or Ignition switch is at "ON" position. Four doors can be unlocked again 3s after first unlocking operation.

### Door Lock Latch and Inner Handle

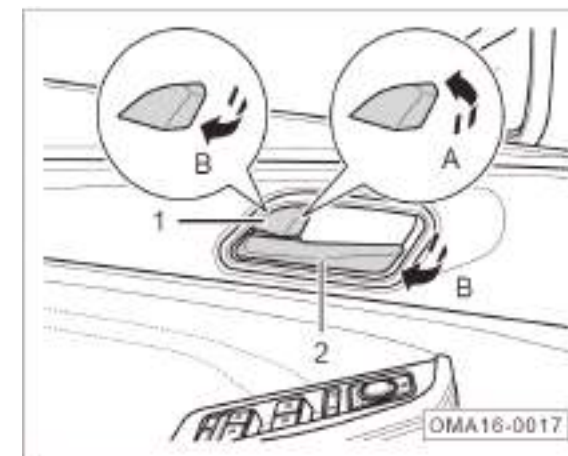

Each door has a lock latch ① and an inner handle ②.

- Pushing the door latch ① inward in direction of arrow A, corresponding door can be locked.
- Pulling the door latch ① outward in direction of arrow B, corresponding door can be unlocked. Then, pull the inner handle ② in direction of arrow B to open corresponding door.

### Hint

The door lock latch can only lock or unlock the corresponding door.

If the rear door lock latch is unlocked and the rear door cannot be opened by inner handle, a possible cause is that the child safety lock is activated =>Please refer to Page 78. In such case, the rear door can be opened from outside. Do not rudely pull the inner handle, otherwise it may be damaged

### Caution

When the door latch is locked, do not forcibly pull the inner handle.

### Central Locking Button

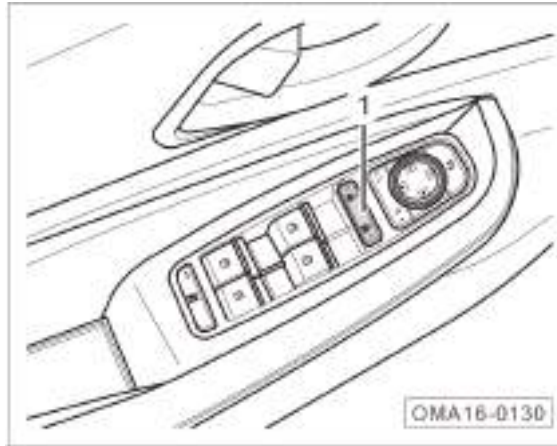

The central locking button ① at the driver side can lock and unlock the doors inside the vehicle.

#### Door locking:

- Press the  end of the central locking button ① to lock all the doors.

#### Door unlocking:

- Press the  end of the central locking button ① to unlock all the doors.

### Warning

**Never leave the child or the disabled in the vehicle alone. If emergency occurs with the doors locked, it is hard for the child or disabled to leave the vehicle by self. In the event of accidents, locked doors will certainly increase the difficulty of rescue.**

## 4. Operating System and Equipment

### Door Lock Hole

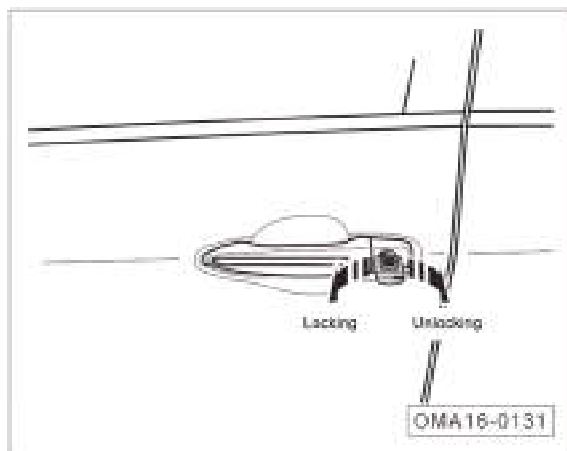

- Take out the emergency mechanical key\*; => [Refer to Page 74](#)
- Insert the emergency mechanical key into the lock hole of door at driver side;
- Rotate the key anticlockwise, and all doors can be locked;
- Rotate the key clockwise, and only the door at driver side can be unlocked.

### ⚠ Warning



To protect the door lock motor, if the door is successively locked and unlocked for 6 times, the body protection system will enter door lock motor protection status (one more unlocking can be executed). In such case, the door lock can be operated 5s later.

### Child Safety Lock

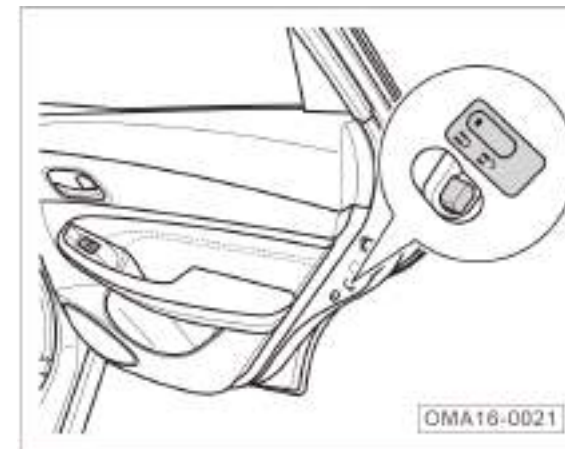

The child safety lock can prevent the child from opening the rear door unintentionally, which is able to reduce the accident risk. After the child safety lock is activated, the door only can be opened from outside.



### Locking Child Safety Lock:

- Open the door that needs to lock the child safety lock.
- Turn the child safety lock from  to  as shown in the picture to activate the child safety lock.

### Unlocking child safety lock:

- Open the door whose child safety lock needs to be unlocked.
- Turn the child safety lock from  to  as shown in the picture to unlock the child safety lock.

#### Hint

When the child safety lock is activated, the rear door cannot be opened by inner handle. In such case, the rear door can be opened from outside. Do not rudely pull the inner handle, otherwise it may be damaged.

#### Warning

**Never leave the child or the disabled alone in the vehicle. Once the lock button is pressed, the door will be locked immediately. When an emergency occurs, it is hard for the child or the disabled to leave the vehicle by self. In the event of accidents, locked doors will certainly increase the difficulty of rescue.**

## 4. Operating System and Equipment

### 4.2.4 Door

#### Close the Door

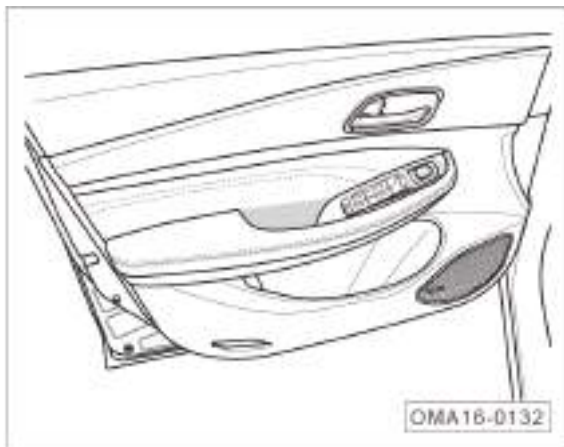

- Pull inward the handle from inside.
- Push the door directly from outside.

#### **i** Hint

- If the door is insecurely closed, for example when the applied force is insufficient, open and close the door again.
- An alert will appear on the instrument cluster display if any door is insecurely closed; When the vehicle speed exceeds 5km/h, you will hear a warning beep.

#### **⚠** Warning

- **Before driving off, check that all doors are closed. Insecurely closed doors may be opened suddenly during travel, causing injury or accident.**
- **The doors can only be opened or closed when the car is stationary.**
- **To avoid pinch, hands must be away from the door edge while the door is closed.**

### 4.2.5 Trunk Lid

#### Open the Trunk lid

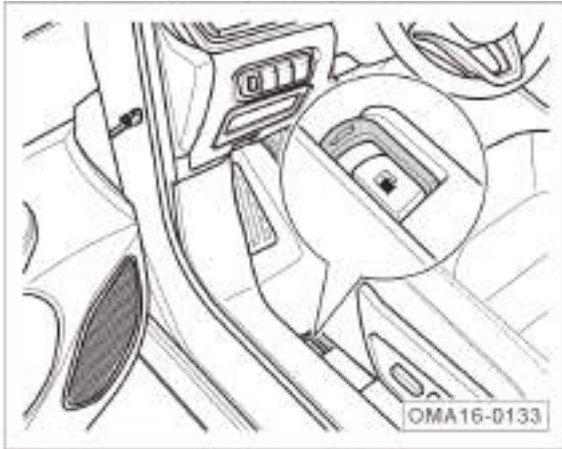

- When the car is stationary, pull the trunk lid release handle to open the trunk lid.

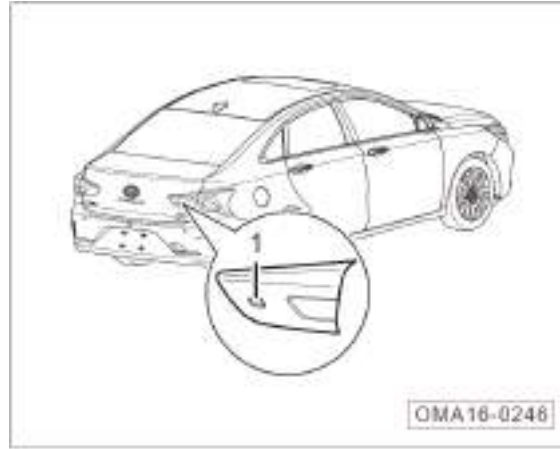

In the effective range, press the  button on the smart key for approximately 2 seconds to unlock the trunk lid.

For models with keyless entry function\*, carry the smart key with you, and press the trunk lid release button ① in the area approximately 1.0 meter from the trunk lid to open the trunk lid; or press the  button on the smart key to unlock the car and then the trunk lid release button ① to open the trunk lid.

#### Close the Trunk Lid



- Lower the trunk lid down to the rear bumper cover, and then press it down to close it.
- Check whether the trunk lid is locked securely.

#### Hint

An alert will appear on the instrument cluster display if the trunk lid is insecurely closed; When the vehicle speed exceeds 5km/h, you will hear a warning beep.

## 4. Operating System and Equipment

### 4.2.6 Electric Windows

With the Start or Ignition switch at "ON" position, the electric windows can be operated. Within 40 seconds after the Start or Ignition switch is turned to "ACC" or "FF/ LOCK" from "ON", the electric windows can be operated. However if the driver side door is opened within this 40 seconds, the electric windows cannot be operated since the door opening instant.

#### Electric Window Button on the Driver's Side

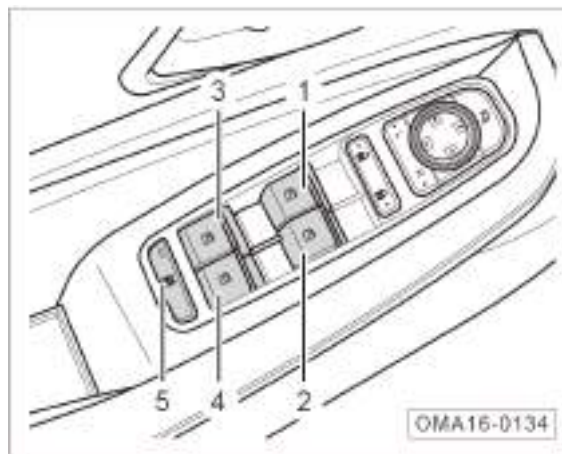

1. Front left electric window button
2. Front right electric window button
3. Rear left electric window button
4. Rear right electric window button
5. Passenger window lock button

- When button ① is pulled up lightly, the electric window moves up. It stops moving if it has reached the highest position or the button is released.
- Lightly press button ①, the electric window moves down. It stops moving if it has reached the lowest position or the button is released.
- When Button ① is heavily pressed, the electric window moves down all the way to the lowest position.

#### **i** Hint

To interrupt the window movement during the automatic lowering process, pull up Button ① again.

- Buttons ②, ③ and ④ are operated in the same manner as Button ① and are used to operate respective window.

For models equipped with automatic lifting function for the driver side window:

- When Button ① is heavily pulled up, the electric window moves up all the way to the highest position.

### **i** Hint

To interrupt the window movement during the automatic lifting process, press Button ① again.

- If the passenger window lock button ⑤ is activated, the button indicator is on. Buttons ①, ②, ③ and ④ can be operated effectively while the passenger side electric window button cannot be operated. To unlock, press the button again. Then, the button indicator is off.

### **⚠** Caution

- Even if you leave your car for a short time, be sure to lock all the doors and windows, unless your car is attended.
- Attention should be paid when closing windows; otherwise serious injury may be caused.

### Passenger Side Electric Window Button

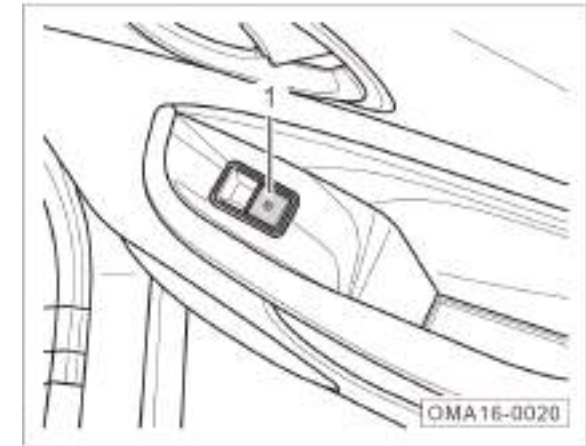

Electric window button ① is provided on each passenger side door:

- When button ① is pulled up lightly, the electric window moves up. It stops moving if it has reached the highest position or the button is released.
- Lightly press button ①, the electric window moves down. It stops moving if it has reached the lowest position or the button is released.
- When Button ① is heavily pressed, the electric window moves down all the way to the lowest position.



### Hint

If the passenger window locking button is activated (the button indicator is on), button ① for each electric window cannot be used for operation of respective window.

### Anti-Pinch Function\*

The driver side electric window is equipped with anti-pinch function. If the window encounters an obstacle when it moves up in the anti-pinch area (4~200mm), it stops there and moves down immediately. If the above situation occurs, check out the reason before closing the window again.

If the anti-pinch function has been activated for quite a few times in a short period, the initialization data of anti-pinch is automatically erased to protect the window movement system. In this case, check carefully for obstacle again. Remove the obstacle if any. Perform the initialization learning to recover the anti-pinch function.

### Caution

- In spite of the anti-pinch function, it is necessary to check for obstacle before closing windows. In some cases (for example, thin or flexible obstacles), anti-pinch function may not be triggered.
- Do not install any accessories within window movement range. Otherwise, anti-pinch function could be affected or accidentally triggered thus the windows cannot be closed normally.

### Anti-Pinch Initialization\*

Initialization must be performed again if the driver side electric window cannot move up automatically due to anti-pinch function failure, or if initialization data of anti-pinch has been automatically erased due to the anti-pinch function being activated for quite a few times in a short period.

When the electric window button on the driver's side is pulled up, the window moves up step by step until it is closed completely. Then continue to pull up and hold the button for 2 to 3 seconds. The initialization is thus completed.

#### **i** Hint

During initialization learning, the window has no anti-pinch function, so do not use any part of the body or other articles to obstruct the window movement. Otherwise, injury may be caused and the initialization affected.

#### **i** Hint

If the electric window system fails, contact your authorized GAC MOTOR dealer to have it checked and repaired.

## 4. Operating System and Equipment

### 4.2.7 Electric Sunroof\*

With the Start or Ignition switch at "ON" position, the electric sunroof can be operated. Within 40 seconds after the Start or Ignition switch is turned to "ACC" or "FF/ LOCK" from "ON", the electric windows can be operated. However if the driver side door is opened within this 40 seconds, the electric sunroof cannot be operated since the door opening instant.

#### **i Hint**

With the Start switch or Ignition switch at "OFF/LOCK", the instrument cluster will display "Sunroof Not Closed" and the buzzer will sound to alert the driver if the door on the driver's side is opened but the electric sunroof is not closed. In this case, please check whether the sunroof is closed timely.

### Open and Close the Sunroof Visor

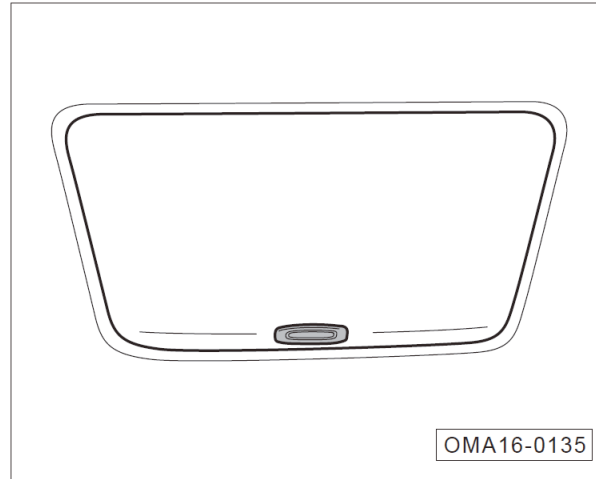

Hold the groove:

- Pull backward to open the sunroof visor;
- Pull forward to open the sunroof visor.

#### **i Hint**

When the electric sunroof slides to open, the sunroof visor will be opened together with the electric sunroof.

#### **Caution**

- To avoid damage to the sunroof visor due to possible effect of air flow generated during car driving on the sunroof visor, the sunroof visor can be closed only when the electric sunroof is completely closed.
- Close the electric sunroof before closing the sunroof visor. If the sunroof visor is closed but the sunroof is not, rainwater can enter the vehicle when it rains.

### Open and Close the Electric Sunroof

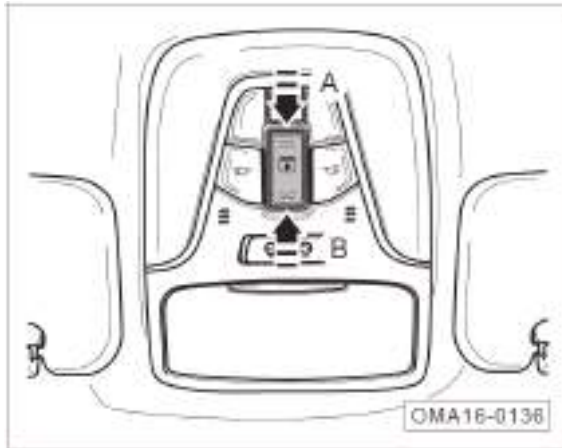

The electric sunroof is of sliding type. Tilting and sliding can be performed for the completely closed sunroof.

- To slightly open the sunroof, briefly press end A. The sunroof will move a short distance and then stop.
- To slightly close the sunroof, briefly press end B. The sunroof will move a short distance and then stop.
- Press and hold end A for a short time, the sunroof will automatically open completely.

- Press and hold end B for a short time, the sunroof will automatically open completely.
- If you want some fresh air, press end B when the sunroof is closed and the sunroof will automatically move to the tilt position; if you want to close it, press end A until the sunroof is fully closed.

#### Caution

Before leaving the car or when the car is at unattended state, fully close the sunroof. If not, rain or foreign matters may enter the car.

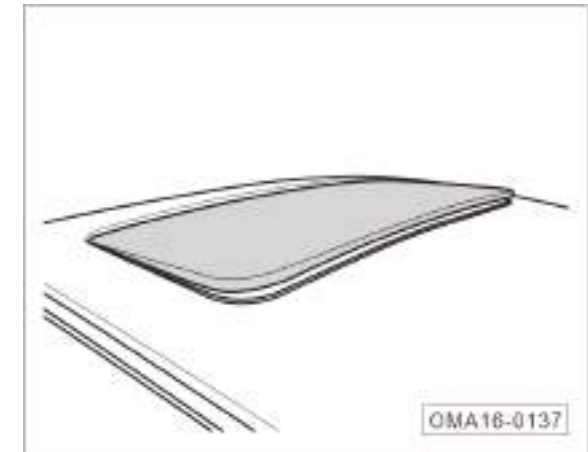

- The figure shows the rear end of electric sunroof tilting.

## 4. Operating System and Equipment



- The figure shows that the electric sunroof slides to fully open position.

### Sunroof Anti-pinch Function

When the sunroof slides to close or is closed downward from tilting, the anti-pinch function will be activated. The purpose of the anti-pinch function is to prevent the sunroof from pinching big items when it is closed:

- When the sunroof slides to close, if the anti-pinch function is triggered, the sunroof will move a certain distance along the open direction and then stop.
- When the sunroof is closed from tilting, if the anti-pinch function is triggered, the sunroof will move along the tilt direction until the maximum tilt position.

### Caution

Do not try to operate the electric sunroof in low temperature (below  $-20^{\circ}\text{C}$ ). In such environment, the anti-pinch function may not be activated, resulting in accidents. Also, low temperature can damage the sunroof motor.

### Warning

- **Be sure to close the electric sunroof with extra care. To avoid serious injury, make sure that nobody stays within the area of closing movement.**
- **The anti-pinch function cannot prevent the electric sunroof from pinching human fingers or other items in small size.**
- **The electric sunroof stops sensing obstacle when it is almost closed. At this time, there is no anti-pinch function.**
- **Do not attempt to activate the anti-pinch function by hand or your body part. Doing so can cause serious injury to your body easily.**

### Sunroof Manual Initialization and Adaptive Learning

In some cases (sudden out of power of battery or prolonged use of vehicle), you may need to manually initialize the electric sunroof and perform its adaptive learning.

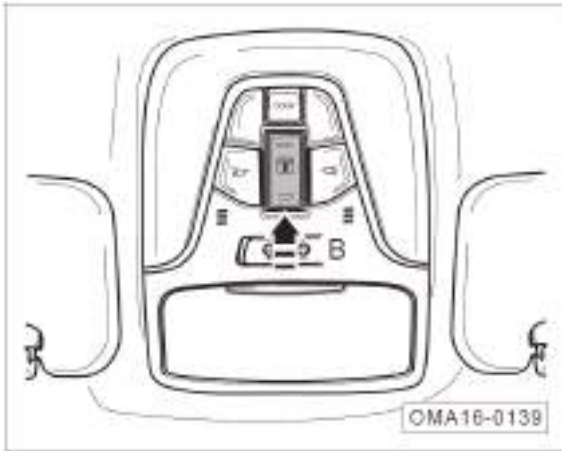

- When the sunroof is closed, press end B and release it until the sunroof moves to the fully tilting position.
- Press end B for over 10 seconds to initialize the sunroof. After two clicks, the initialization is completed.

- After the initialization, press and hold end B and stop movement of the sunroof after the movement “tilting position → OFF position → sliding open → OFF position” to finish adaptive learning of the sunroof.

#### Caution

If the electric sunroof system fails, contact your authorized GAC MOTOR dealer to have it checked and repaired.

## 4. Operating System and Equipment

### 4.2.8 Engine Hood

#### Open and Close the Engine Hood

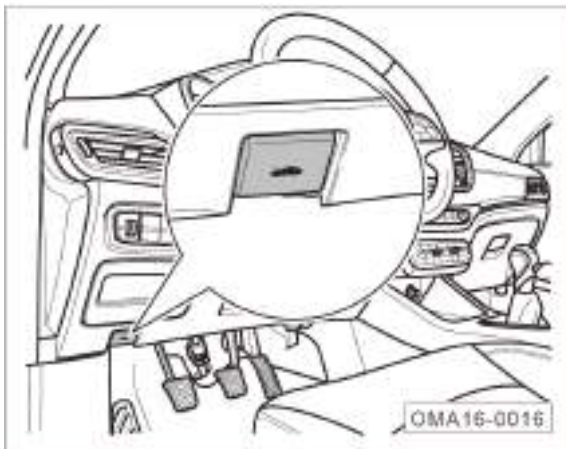

- Park your car properly and apply the parking brake.
- Pull the hood release handle that is located below the instrument panel on the driver side, the hood is unlocked and slightly springs up.

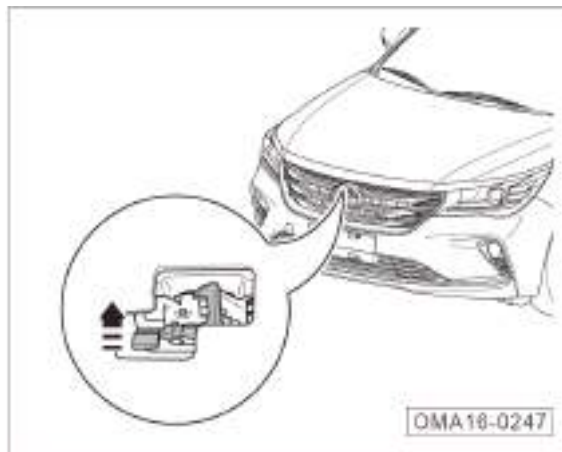

- Push upward the lockup mechanism in direction of the arrow to fully unlock the engine hood.

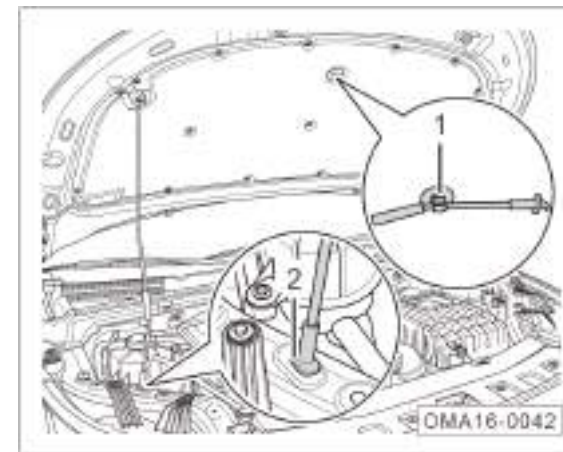

- Uplift the hood to the limit position, remove the stay bar from the support ①, and fix the stay bar at the fixing hole ② to support the hood at the limit position.
- To close the hood, remove the stay bar from the fixing hole ② and place it at the support ①; drop the hood to the position near the fenders, and push heavily its front end downward using both hands.

- After the engine hood is closed, inspect whether the buckle is locked firmly.

### Hint

- Lubricate the moving part of the lockup mechanism of the engine hood properly to help open or close the engine hood.
- An alert will appear on the instrument cluster display if the engine hood is insecurely closed; When the vehicle speed exceeds 5km/h, you will hear a warning beep.

### Warning

**Engine compartment is a hazard area where improper operation may cause serious injuries or deaths.**



- **If you see vapor or coolant overflowing from the engine compartment, do not open the hood. Doing so can seriously scald you.**
- **When the engine is hot, do not touch it. Doing so can seriously scald you.**
- **Never open the coolant expansion tank cover when the engine is in hot condition. At this moment, the cooling system is at high temperature and pressure condition.**
- **During the startup or running of the engine, do not touch the drive belt, alternator, radiator fan and other rotating components, the high-voltage ignition system and high-temperature exhaust system.**





## 4. Operating System and Equipment

### 4.2.9 Basic Operations of Anti-Theft on Vehicle Body

#### Anti-Theft on Vehicle Body-Unlock:

With the Start switch or Ignition switch at “OFF/LOCK” position and the car locked, if the user carries the smart key to approach the front door and presses once the button in the handle of the front door or the unlock button on the smart key, the anti-theft system unlocks the door and the indicator lights  and  in the instrument panel and the turn signals flash twice.

#### Anti-Theft on Vehicle Body - Lock:

With the Start switch or Ignition switch at “OFF/LOCK” position and four doors, engine hood and trunk lid closed, if the smart key is not in the car, after pressing once the button in the handle of the front door or the lock button on the smart key, the anti-theft system locks the door and the indicator lights  and  in the instrument panel and the turn signals flash once.

1. If the engine hood or the trunk lid is not securely closed, when the  button on the smart key is pressed, the alarm starts: left and right turn signals flash and the anti-theft horn gives short beep.

#### Hint

During an alarm, if the unclosed door is closed, the car will enter anti-theft state; or if  on the smart key is pressed, the alarm stops and the car is unlocked.

2. If any door is not closed, after  on the smart key is pressed, the four doors will be locked and then immediately unlocked without any alarm.

#### Activate the Anti - Theft on vehicle body:

1. With the Start switch or Ignition switch at “OFF/LOCK” position and the car locked, if any door, engine hood, or trunk lid is unlocked forcibly or using an illegal key, the anti-theft system will trigger the horn beep and flashing of turn signals for about 28 seconds.
2. When the car is locked at anti-theft status by smart key, the immobilizer system will trigger horn sound and both turn signal lights will flicker for alarm within several seconds after the door on the driver's side is opened with the mechanical key.

#### Hint

Before the alarm is triggered or during an alarm, if  on the smart key is pressed or the Start or Ignition switch is switched to “ON” position, the alarm stops and the car is unlocked.

### **Anti-Theft on Engine:**

With the Start or Ignition switch at "OFF/LOCK", car body immobilizer system released and the smart key inside the car, if the Start or Ignition switch is switched to "ON" position and the engine immobilizer system passes validation, the system will releases the engine anti-theft. If it fails the validation, the immobilizer system prevents from starting the engine and triggers anti-theft alarm.

## 4. Operating System and Equipment

### 4.3 Lights and Visual Field

#### 4.3.1 Exterior Lights

##### Light Combination Switch

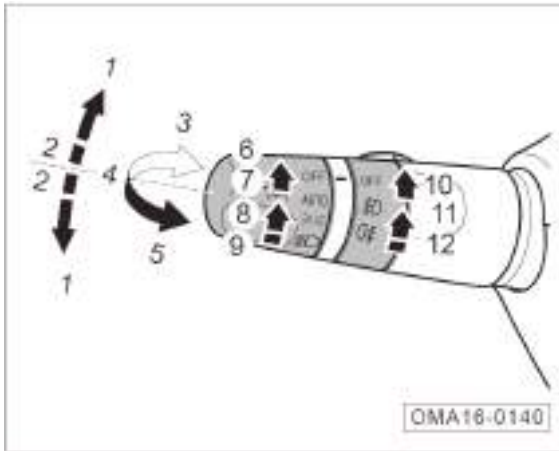

1. Turn signal light
2. Lane change flashlight
3. Headlight high beam
4. Headlight low beam
5. High beam flashing
6. OFF light off

7. AUTO light \*
8. Position light (manual open)
9. Low beam (manual open)
10. OFF fog light off
11. Front fog light\*
12. Rear fog light

##### Hint

After driving in rainy days or washing the car, frosting/fogging may occur on inner side of the light due to difference of temperature inside and outside the light. This is similar to fogging on window in rainy days and has not impact on the service life of the light. The fog can be eliminated by turning on the light. If a great quantity of water droplets or water are found inside the light, please contact your authorized GAC MOTOR dealer to have it checked and repaired.





##### Turn signal light

- By pushing the light combination switch lever up or down to position ①, the right or left turn signal is turned on and or in the instrument cluster flashes.



##### Caution

If any turn signal on the front end or rear end fails, flashing frequency of or in the instrument cluster will be doubled. Please go to your GAC MOTOR dealer timely for repair.

### Lane change flashlight

- Switch the Start or Ignition switch to “ON” position.
- By pushing quickly (within 0.1~0.7s) the light combination switch lever up or down to position ②, and then releasing it to let it return to the original position, the corresponding turn signal flashes three times, and the  or  in the instrument cluster also flashes three times.
- By pushing the light combination switch lever up or down to position ② and keeping it at this position, the corresponding turn signal and also the  or  in the instrument cluster flash continuously. If the lever is released to let it return to the original position, the flashing stops.

### Headlight High Beam

- Switch the Start or Ignition switch to “ON” position.
- Turn the light switch to  position to start the headlight low beam.
- By pushing forward (forward direction of the car) the light combination switch lever to position ③, the headlight high beams are turned on and  in the instrument cluster flashes.
- By pulling back (backward direction of the car) the light combination switch lever to position ④, the headlight high beams are turned off,  in the instrument cluster is off, but headlight low beams are still on.
- By turning the light switch to OFF position, all lights are turned off.

### Warning

**Headlight high beams may dazzle the drivers of other cars nearby and result in accidents. Please use them properly.**

## 4. Operating System and Equipment

### Headlight Low Beam

- Switch the Start or Ignition switch to “ON” position.
- When the light combination switch lever is at position ④, turn the light switch to  position to turn on headlight low beams.
- By turning the light switch to OFF position, all lights are turned off.

### High Beam Flashing

- Switch the Start or Ignition switch to “ON” position.
- Pull back (backward direction of the car) the light combination switch lever to position ⑤ to turn on headlight high beams.
- Release the light combination switch lever to let it return to position ④ to turn off the high beams.

#### Hint

Even if no light is turned on, high beams remain on and  in the instrument cluster remains on if the light combination switch lever is pulled back (backward direction of the car).

### AUTO (Auto Lighting)\*

- Switch the Start or Ignition switch to “ON” position.
- Turn the light switch to AUTO position to enable the auto lighting function.

#### Hint

- With auto lighting function enabled, lights of the car will be turned on or off depending on the environmental light. When the ambient lighting outside the car dims gradually, the position lights are turned on firstly, and then the low beams. When the ambient lighting outside the car brightens gradually, the low beams are turned off firstly, and then the position lights. When entering or exiting a tunnel or garage or other dark environment, the position lights and low beams will be automatically turned on or off at the same time.
- You can adjust auto lighting sensitivity via the "Car Settings" under audio system => Refer to [Page 205](#). The higher the sensitivity, the brighter the lights.

### Caution

- If the instrument cluster display prompts "The sensor fails, please control the lighting manually", and for the sake of safety, the system will keep low beams turned on. In this case, you can choose to control the lighting manually, and go to the authorized GAC MOTOR dealer timely to have your car checked and repaired.
- Auto lighting may fail in heavily foggy or misty weather. Manually turn on the lights then.

### Headlight not Off Warning

After the Start or Ignition switch is switched to "OFF/LOCK" position, if the headlights are on when the door on driver side is opened, the system will raise the alarm of buzzing. Meanwhile, the message "Light Not Off" appears on the instrument cluster display.

### Headlight Lag Off Function (Follow Me Home)

Within 10 minutes after the Start or Ignition switch is switched to "OFF/LOCK" position, if the light switch is rotated from OFF position to another position and then back to OFF position within 2 seconds, headlight lag off function is activated.

After this function is activated, the low beams will be on for 30 seconds. If any door(including four doors, engine hood, and trunk lid) is opened within 30 seconds, the time will be reset and the low beams will remain on for 30 seconds. If all doors are closed during this period, the time will also be reset and the low beams will be on for 30 seconds. If any door is opened during this period, the time will then be reset, the low beams will be on for 30 seconds, and so on.

### Hint

You can set the function of "Follow Me Home" via the "Car Setting" on audio system\* => Refer to [Page 205](#).



## 4. Operating System and Equipment

### Manually Adjust Headlight Height



Manually adjust the range of headlights (low beams) at positions 0, 1, 2 or 3 considering the vehicle posture variation due to occupant and luggage weight.

### Position Light

- By turning the light switch to  position to turn on position lights, the position lights, instrument panel lighting lamp, number plate lights are turned on and  in the instrument cluster is on accordingly.
- If you forget to turn off the position lights, after the Start or Ignition switch is at "OFF" position and the car is locked for 15 minutes, these lights will go out automatically to save battery power.

### Warning

**Do not turn on the position lights only when driving the car at night or in poor visibility, otherwise, it can cause accidents easily. Turn on low beams when driving at night or in poor visibility environments.**







### Daytime Running Light\*

- With the engine started, the daytime running lights can be automatically turned on. When the position lights are turned on or the engine stops work, the daytime running lights will be automatically turned off.





### Hint

"Daytime running light" function is optional, and can be activated or deactivated via "Car Setting" under the audio system\*. => Refer to Page 205

### Fog Lights

- Switch the Start or Ignition switch to “ON” position.
- Turn the light switch to  or  position.
- Turn the fog light switch from OFF to  position to turn on the front fog lights.\*
- Turn the fog light switch from  position to  position, and release it to let it return to  position, in order to turn on rear fog lights. Repeat the process to realize changeover between the mode of only front fog lights\* on and the mode of both front fog lights \* and rear fog lights on.
- Turn the fog light switch to OFF position to turn off front fog lights\* and rear fog lights.



### Hint

- For certain models not equipped with front fog lights, when the light switch is turned to  or  position, rear fog lights are turned on if the fog light switch is turned to  position.
- When the front and rear fog lights are on, all the lights can be turned off by turning the light switch to "OFF" position; in this case, the front fog lights \* can be turned on again by turning the light switch to  or  position while the rear fog lights can be turned on again by using the fog light switch.

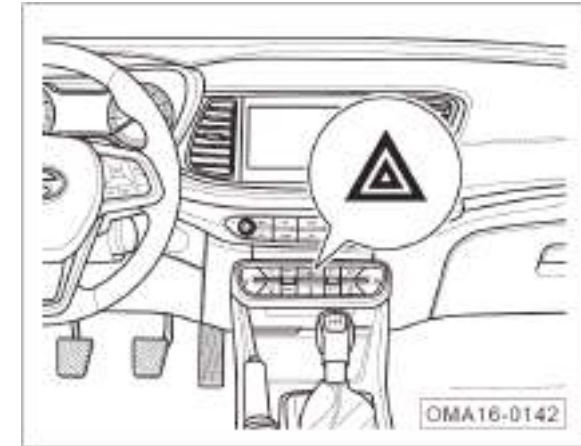
### Hazard Warning Indicator Light



With the Start or Ignition switch at any position, if  switch is pressed, the red background light of the switch is on, i.e. the hazard warning indicator light turned on. After the switch is pressed again, the light is turned off.

After the hazard warning indicator light is turned on, all the turn signals flash at the same time, together with the  and  in the instrument cluster.



## 4. Operating System and Equipment

In case of emergency, use the hazard warning indicator light to attract the attention of other people on the road, so as to reduce the risk of accidents. Turn it on in one of the following conditions:

- Vehicle breakdown due to any fault.
- At the end of traffic flow during traffic jam.
- Towing another vehicle or being towed.



### Hint

- The hazard warning indicator light will consume battery. Turn them off if permitted.
- Follow the relevant laws and regulations when using the hazard warning indicator light.
- If the hazard warning indicator light fails in emergency, other warning means must be taken to attract attention of other people on the road provided that these means are safe and comply with relevant traffic regulations.

### Collision Warning Light

In case of collision, left and right turn signals flash.

#### Lighting for Getting on the Car

- By pressing  on the smart key when you get close to the car, the position lights will be on for 25 seconds as auxiliary lighting so that you can see clearly obstacles if any. If  on the smart key is pressed again, the position lights will be on for another 25 seconds.– If the Start or Ignition switch is switched to “ON” position after getting on the car, the position lights go out.

#### Lighting for Locating the Car

- If  on the smart key is pressed twice successively within 0.5s, the position lights will be on for 8s and left and right turn signals will flash 3 times so that the car can be located easily.

### Guest greeting light \*

- When the Start switch is at “OFF” or “ACC” position, the guest greeting light will be on if the door is unlocked or opened.
- The guest greeting light is turned off if the Start switch is switched to “ON” position or after a while (about 25 seconds when the door is closed and about 15 minutes when the door is open).

### Auxiliary Turning Lighting\*

- With the Start or Ignition switch at “ON” position and headlight low beams turned on, if the turn signals are turned on, the corresponding front fog light will be turned on automatically to supplement the light in the headlamp lighting area.
- When the turn signals are turned off, the front fog light will be turned off automatically.

### Hint

The front fog light can only be turned on via the auxiliary turning lighting function when it is off.

### 4.3.2 Interior Lights

#### Auto On Function of Roof Lights



– If "DOOR" button is pressed when the function of automatic turning on of roof lights is disabled, this function is enabled; if the "DOOR" button is pressed again, this function is disabled.

#### Lag Off Function of Interior Lights

In the case that the Auto On function of roof lights is enabled:

- With the Start or Ignition switch at "OFF/LOCK" position, the roof light automatically turns on when any door is opened and turns off about 25s after the door is closed.
- With the Start or Ignition switch at "OFF/LOCK" position, the roof light automatically turns on and then turns off about 25s later when the door is unlocked by smart key.
- When the Start or Ignition switch is switched from "ON" to "OFF/LOCK", the roof light automatically turns on and then turns off about 25s later.

#### **i** Hint

With the Start or Ignition switch at "OFF/LOCK", the doors closed and roof lights on, the roof lights will automatically turn off if locking with smart key or switching the Start or Ignition switch to "ON".

## 4. Operating System and Equipment

---

### Front Roof Light

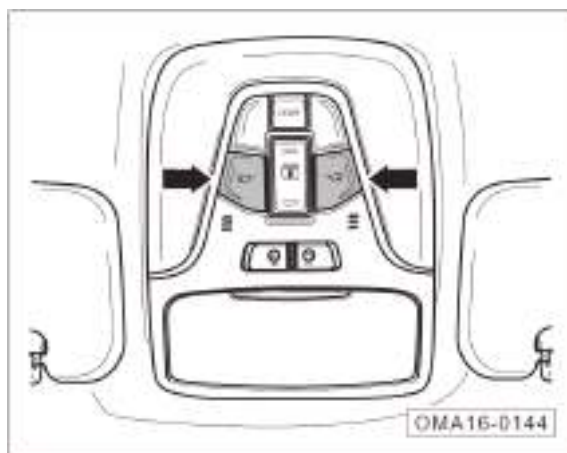

- When the roof lights are off, by pressing the switch (see the arrows) on the left or right side of the front roof light, the corresponding roof light goes on, and by pressing the switch again, it goes out.

### Rear Roof Light\*



- When the roof lights are off, by pressing the switch (see the arrows) on the left or right side of the rear roof light, the corresponding roof light goes on, and by pressing the switch again, it goes out.

### Glove box light

- By opening the glove box, the glove box light turns on automatically.
- By closing the glove box, the glove box light goes out automatically.

### Trunk Light

- By opening the trunk lid, the trunk light turns on automatically.
- By closing the trunk lid, the trunk light goes out automatically.

### **Courtesy Light\***

- When the door is opened, the courtesy lights go on automatically.
- When the door is closed, the courtesy lights go off automatically.

### **Atmosphere Light\***

- When the position lights are on, the atmosphere lights go on automatically.
- When the position lights are off, the atmosphere lights go off automatically.

### **Vanity Mirror Light\***

- The vanity mirror light automatically turns on when the vanity mirror cover is opened.
- The vanity mirror light automatically turns off when the vanity mirror cover is closed.

## 4. Operating System and Equipment

### 4.3.3 Windscreen Wiper

#### Automatic Wiper Combination Switch\*

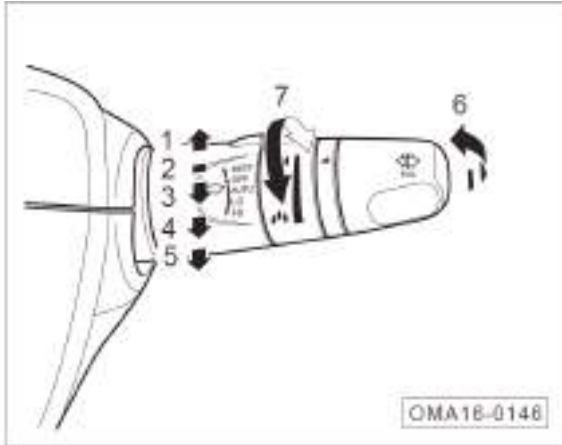

1. MIST: Continuous Wiping
2. OFF: Wiping Off
3. AUTO: Automatic Wiping
4. LO: Low-speed Wiping
5. HI: High-speed Wiping
6. Turning on front windshield washer system
7. Adjusting automatic wiper sensitivity

#### Manual Wiper Combination Switch\*

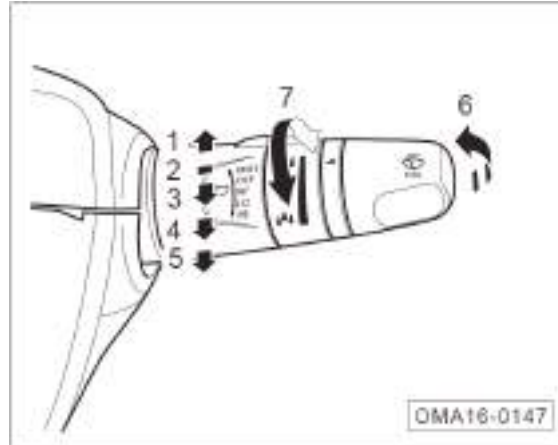

1. MIST: Continuous Wiping
2. OFF: Wiping Off
3. INT: Intermittent Wiping
4. LO: Low-speed Wiping
5. HI: High-speed Wiping
6. Turning on front windshield washer system
7. Adjusting wiping frequency

#### MIST: Continuous Wiping

- If the wiper combination switch lever is shifted to limit position ① MIST position, the front wipers will work continuously.
- If the lever is released to let it return to OFF position ②, the front wipers will stop work.

#### OFF: Wiping Off

- If the wiper combination switch lever is shifted to limit position ② OFF position, the front wipers will stop wiping.

### AUTO: Automatic Wiping\*

- If the wiper combination switch lever is pushed to ③ AUTO position, the front wipers will work automatically, and the wiper system will adjust the wiping speed based on the current rainfall and real-time vehicle speed.
- The wiper sensitivity can be adjusted by turning up/down the knob ⑦. The sensitivity increases from up to down.

### Caution

- Worn or dirty wiper blades will affect the visibility adversely and reduce driving safety.
- When the instrument cluster display prompts "The sensor fails, please control the wipers manually", for the sake of safety, the wipers will keep operating at a low speed. In this case, you can choose to control the wipers manually based on actual situation, and go to the authorized GAC MOTOR dealer timely to have your car checked and repaired.
- Before auto wiping in winter, make sure the wiper blades are not frozen.

### INT: Intermittent Wiping\*

- If the wiper combination switch lever is pushed to ③ INT position, the front wipers will work intermittently at a certain frequency.
- The wiping frequency can be adjusted via ⑦. The time interval between wiping increases from up to down when the knob ⑦ is turned up/down.

### LO: Low-Speed Wiping

- If the wiper combination switch lever is pushed to ④ LO position, the front wipers will work at a low speed.

### HI: High-Speed Wiping

- If the wiper combination switch lever is pushed to ⑤ HI position, the front wipers will work at a high speed.

## 4. Operating System and Equipment

---

### Turning on Front Windshield Washer System

- If the wiper combination switch lever is pulled back (backward direction of the car) to position ⑥, the front windshield washer system is started; the washer jets water and a little later the front wipers begin to work.
- If the wiper combination switch lever is released to let it return to the original position, the front windshield washer system is off and the front wipers continue to work for about 4s.
- After a pause of 6 seconds, the front wipers operate once to remove residual water stains on the glass.

### Maintenance of Front Wiper\*

- Within 10 seconds after the Start or Ignition switch from "ON" position switched to "OFF" position, if the wiper combination switch lever is pushed to MIST and then pulled back rapidly, the front wipers will move to the highest positions and then stop.

#### **i** Hint

The "Maintenance of Front Wiper" function can be enabled or disabled via "Car Setting" under the audio system. => [Refer to Page 204](#)

### 4.3.4 Windshields

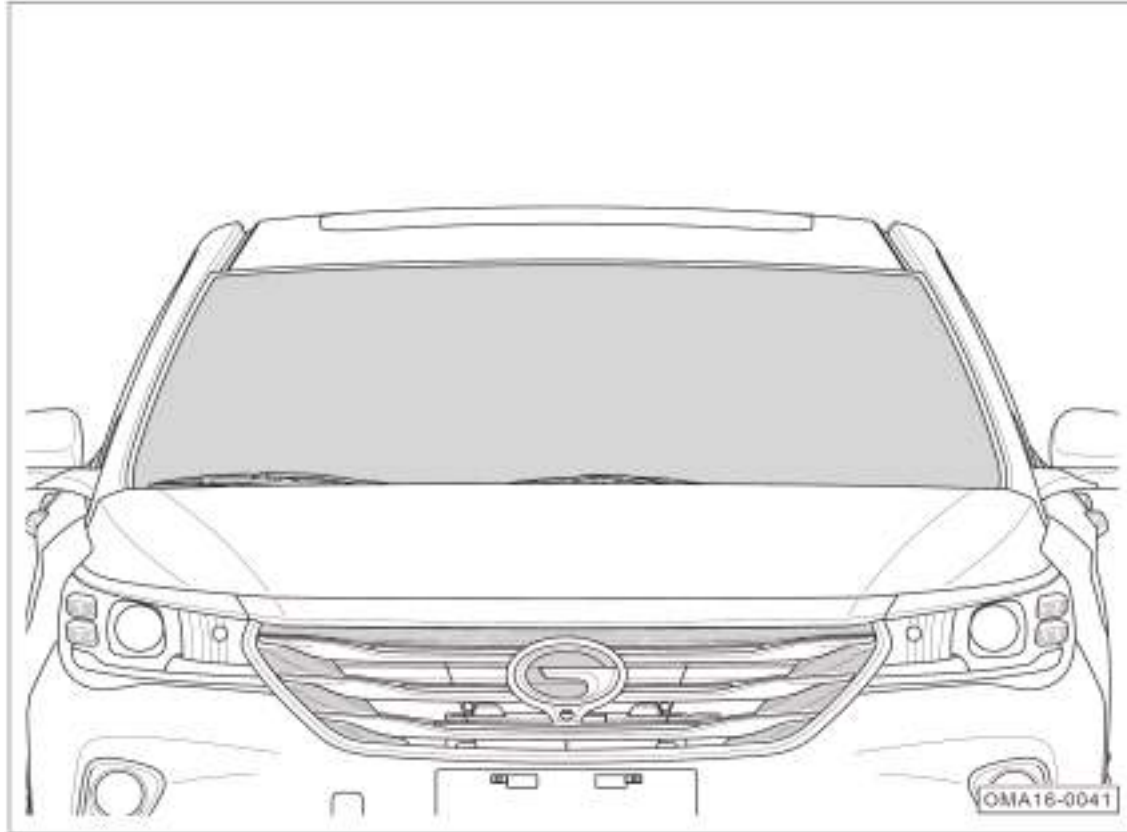

#### Windshield

The front windshield, of green, insulated, laminated and anti-scattered glass, can effectively reduce the risk of injury during a crash.

#### Warning

- Always keep the windshield clean.
- Stick certificates to the windshield in accordance with local traffic regulations. Do not apply irrelevant stickers or attach articles to the front windshield. They may obstruct driver's view and could result in accident.



## 4. Operating System and Equipment

### 4.3.5 Rear-View Mirror

#### Interior Rear-View Mirror

Not seeing the rear situation clearly through the interior rear-view mirror is extremely dangerous to driving!

The interior rear-view mirror has the automatic anti-glare function. During nighttime driving:

- For models equipped with automatic anti-glare interior rear-view mirror, the light sensor in the interior rear-view mirror can monitor light rays behind and ahead of the car to reduce the intensity of reflection of light rays coming from behind the car and provide excellent rear view.
- For models equipped with manual anti-glare interior rear-view mirror, the interior rear-view mirror can be adjusted to reduce the intensity of reflection of light rays coming from behind the car and provide excellent rear view.

#### Automatic Anti-Glare Interior Rear-view Mirror\*



- When the Start switch or ignition switch is at "ON" position, automatic anti-glare function is enabled automatically, and switch light goes on. Press the switch (see the arrow) to disable the auto anti-glare function.
- Press the switch again to enable this function again.

#### **i** Hint

If the temperature in the car is low, it could take a little longer time for the anti-glare rear-view mirror to respond to intense light rays.

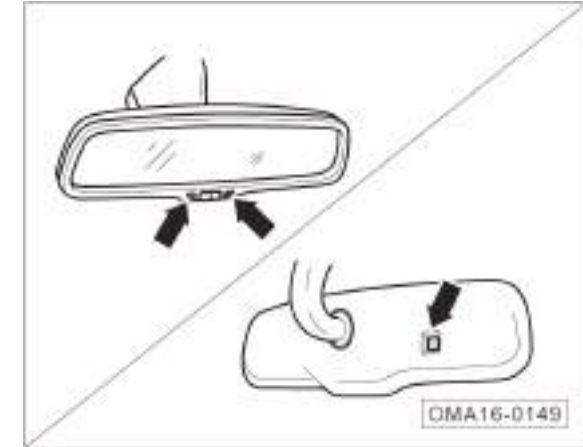

#### **Caution**

To ensure the anti-glare rear-view mirror sensor functioning normally, do not cover it (see the arrows) with finger or cloth.

### Manual Anti-Glare Interior Rearview Mirror\*

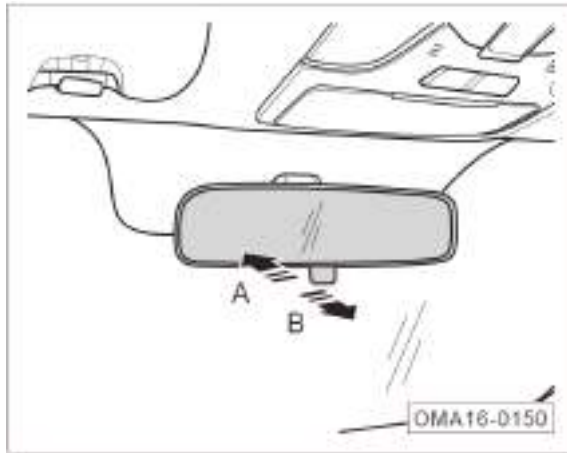

- Move the interior rear-view mirror adjustment handle in the direction of Arrow A to bias reflection of light rays coming from behind the car and achieve anti-glare effect.
- Move the interior rear-view mirror adjustment handle in the direction of Arrow B to back to the normal rear view angle.

### Exterior Rear-View Mirror

The exterior rear-view mirror system has the following functions:

- Power Adjustment
- Power folding-up\*
- Automatic folding-up\*
- Defogging/defrosting\*

#### **⚠ Warning**

**The exterior rear-view mirrors with curved surface (convex and spherical) are able to expand view, but compared with the real objects, their reflected images are smaller and further. Do not judge the distance from the rear vehicle based on its reflected image when changing a lane. Doing so can cause accidents due to misjudgment.**

### Power Adjustment

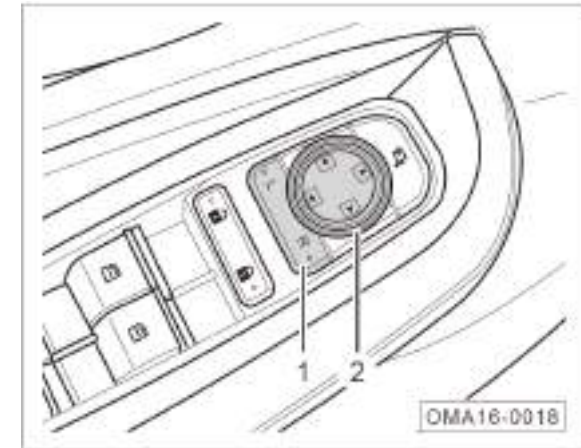

- Press L or R on the exterior rear-view mirror selection button ① (select left or right exterior rear-view mirror).
- Press the exterior rear-view mirror adjusting button ② up, down, leftward, and rightward so that the selected mirror provides a good rear view.
- After the rear-view mirrors are adjusted, return the exterior rear-view mirror selection button ①.

## 4. Operating System and Equipment

### **i** Hint

If power adjustment of exterior rear-view mirrors fails, you can gently push the outer edge of the mirror for adjustment.

### Power Folding-Up\*

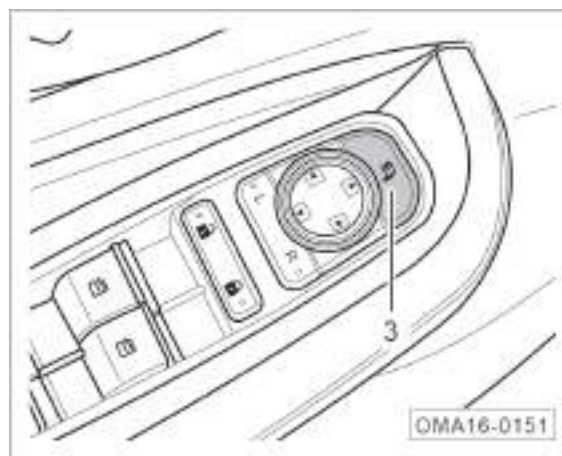

- When the exterior rear-view mirror power folding-up button ③ is pressed, the exterior rear-view mirror folds up.
- When the exterior rear-view mirror power folding-up button ③ is pressed again, the exterior rear-view mirror unfolds.

### Automatic Folding-Up\*

- If the car is locked from outside, the exterior rear-view mirrors can be folded up automatically.
- If the car is unlocked from outside, the exterior rear-view mirrors can be unfolded automatically.

### **i** Hint

- “Automatic folding-up” function can be enabled or disabled via the “Car Setting” under the audio system => [Refer to Page 204](#).

### Caution

- As the folding-up is performed by a motor, do not manually fold up the exterior rear-view mirrors unless you have to do so.
- Special attention should be paid not to make your fingers injured by the rear-view mirror or its base when folding an exterior rear-view mirror.
- If manual folding-up is required in emergency, the exterior rear-view mirror must be unfolded also manually rather than turning the exterior rear-view mirror adjustment knob. In case of manual unfolding, a click can be heard when the mirror reaches the locked position.

### Defogging/Defrosting Function\*

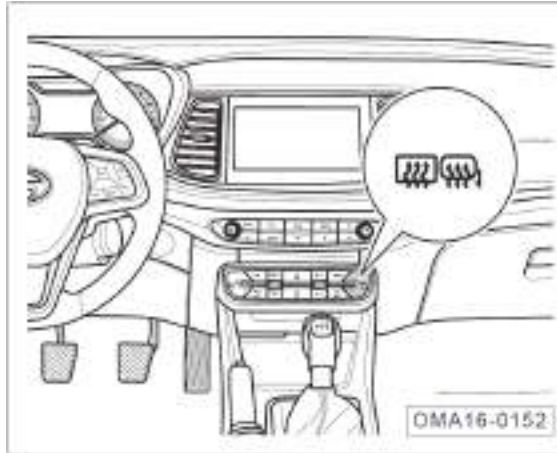

- When  button is pressed, the indicator light of the button is on and the heating function is enabled to remove fog or frost from exterior rear-view mirrors and rear windshield.
- This function will be disabled automatically about 15 minutes later or it can be disabled manually by pressing the button again during heating. When the heating function is disabled, the indicator light goes out.

### Caution

- If defogging/defrosting is necessary after the function is automatically disabled, press the button again.
- Do not have the defogging/defrosting function operating for a long time. This could cause overheating or damage to the heater.
- To save battery power, press the button to disable the defogging/defrosting function when it is unnecessary.

## 4. Operating System and Equipment

### 4.3.6 Sun Visor



- Pull down the sun visor on the driver side or the front passenger side in the direction of arrow A to block sunshine coming in through the front windshield.
- To use the vanity mirror, pull down the sun visor, and then open the vanity mirror cover in the direction of arrow B. The vanity mirror light goes on automatically at the same time.



- Draw out the sun visor on the driver side or the front passenger side from the movable support on one side in the direction of arrow A to block sunshine coming in through the side windows after it is pulled down.

#### **i** Hint

The vanity mirror light above the sun visor will automatically go out when the Start or Ignition switch is switched to “OFF/ LOCK” position, or the car is locked, or several minutes after the door is opened/closed\*.

### 4.4 Seats and Storage Devices

#### 4.4.1 Importance of Adjusting Seats Properly

To maximize the protection from the seat belts and airbags, adjust the seats properly.

Driver's seat or front passenger's seat can be adjusted according to the body shape.

Before the car moves off, seats shall be adjusted properly, so that the driver or passenger can:

- Operate all control mechanisms on the instrument panel in an accurate, effective and safe manner;
- Have a correct sitting posture and do not get fatigued easily.
- Be fully protected by seat belts and airbags.

#### Warning

**Incorrect sitting posture will cause serious injury.**

- **Any passenger should sit upright and well back in the seat.**
- **Be sure you and your passengers wear the seat belts properly.**
- **Make sure the child is restrained in the child safety seat properly.**
- **All the headrests must be adjusted properly according to the height of the driver and passengers, and the seat belts are well worn all the time to get the best protection.**
- **During traveling, the front passenger should place the feet in the footwell. Never put the feet on the instrument panel/seat or stretching out of the window. Incorrect sitting posture will cause serious injury when the airbags is triggered.**

## 4. Operating System and Equipment

### 4.4.2 Headrest

#### Adjusting Headrests Properly

Adjusting the headrests properly is of great importance to protect the driver and passengers and reduce the risk of injury.

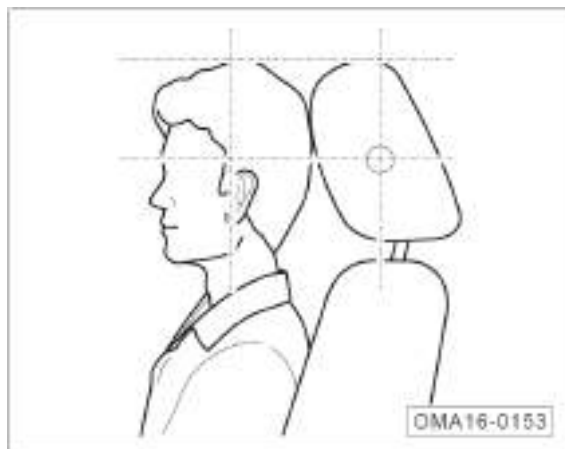

- Adjust the headrest so that the central back of your head rests against the center of the headrest and the top of the headrest is at the same height as your head (or try your best to keep them at the same height).

Failure to do so as shown in the figure can cause serious injury during an accident.

#### ⚠ Warning

**To reduce the risk of injuries and deaths during accidents, be sure to observe the following matters:**

- The headrests must always be in their mounting positions. Driving with the headrests removed or improperly installed can cause serious injury during a crash.
- All the drivers and passengers must adjust their headrests to correct positions according to their own body types. The top of the headrests must be even with the top of their heads as far as possible but not lower than their eyes. The central back of their heads should rest against the headrests as far as possible.
- Improperly-adjusted headrests will increase the risk of injury during a crash or emergency braking.
- **While driving, do not adjust the headrests.**

#### 👁 Caution

Passengers of smaller size should adjust their headrests as low as possible. Taller persons should adjust their headrests as high as possible.

### Adjusting Front Seat Headrests



- Press and hold the button in the direction of Arrow A and press the headrest down to the desired position.
- Lift up the headrest directly to the desired position.
- Make sure that the headrest is in place and positioned properly after adjustment.

### Adjusting Rear Seat Headrests

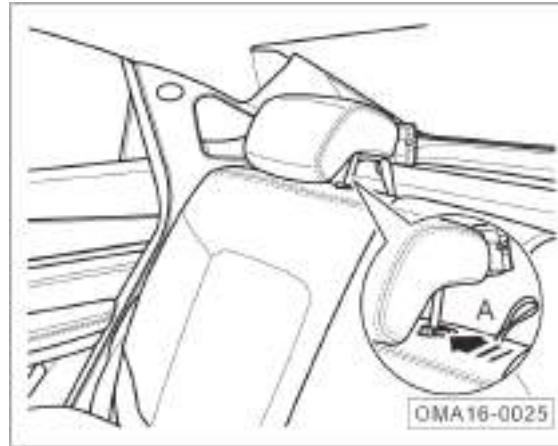

- Press and hold the button in the direction of Arrow A and press the headrest down to the desired position.
- Lift up the headrest directly to the desired position.
- Make sure that the headrest is in place and positioned properly after adjustment.

### ⚠ Warning

- During driving, never remove the headrest, or it will lead to serious injury of occupants when an accident occurs.
- After the headrest is installed, you must adjust the headrest according to your shape, to obtain optimal protection.
- Please carefully read and follow relevant warnings and instructions.



## 4. Operating System and Equipment

### 4.4.3 Front Seats

#### Warning

- Be sure to adjust the seats with care. Negligence or improper operation can cause personal injury.
- Never adjust the front seats while traveling. To adjust the seat, you need to deviate from your correct sitting posture. Therefore, front seats must be adjusted when the car is stationary.
- During traveling, the seat backrests must not be tilted too much. If so, the seat belts cannot fit over the passengers' bodies and people are likely to be badly injured in any accident. The seat belt can provide full protection only when the backrest is correct.
- After the Start or Ignition switch is switched to "OFF" position, the electric adjusting mechanism of front seats in some models still works. Never leave a child alone in the car to prevent her/him from improper operation of electrical device and causing accidents.

#### 6-Way Electric Adjustment of Driver's Seat\*



#### Forward/Backward adjustment of seat:

- Move the switch in the direction of arrow ① or ② to slide the seat forward or backward.

#### Up/Down adjustment of seat:

- Move the switch in the direction of arrow ③ or ④ to raise or lower the seat.

#### Forward/Backward adjustment of backrest:

- Move the switch in the direction of arrow ⑤ or ⑥ to tilt the backrest forward or backward.

#### Hint

When measuring the depth of seat cushion, adjust the seat to the middle of the sliding rail and adjust the seat backrest to serviceable condition (25°).

### Manual 6-Way Electric Adjustment of Driver's Seat\*



#### Forward/Backward adjustment of seat:

- Pull up the adjusting handle in the direction of arrow ① to slide the seat forward or backward. Release the handle, and slide slightly the seat forward or backward until the seat lockup mechanism is engaged.

#### Up/Down adjustment of seat:

- Pull up or push down repeatedly the adjusting handle in the direction of arrow ②- from the original position to gradually raise or lower the seat.

#### Forward/Backward adjustment of backrest:

- Pull up the adjusting handle in the direction of arrow ③- to adjust the backrest to proper position and then release the handle.

#### **i** Hint

When measuring the depth of seat cushion, adjust the seat to the middle of the sliding rail and adjust the seat backrest to serviceable condition (25°).

### 4-Way Manually Adjustable Front Passenger Seat



#### Forward/Backward adjustment of seat:

- Pull up the adjusting handle in the direction of arrow ① to slide the seat forward or backward. Release the handle, and slide slightly the seat forward or backward until the seat lockup mechanism is engaged.

#### Forward/Backward adjustment of backrest:

- Pull up the adjusting handle in the direction of arrow ② to adjust the backrest to proper position and then release the handle.

## 4. Operating System and Equipment

### 4.4.4 Rear Seats

#### Putting Down Rear Seat Backrests

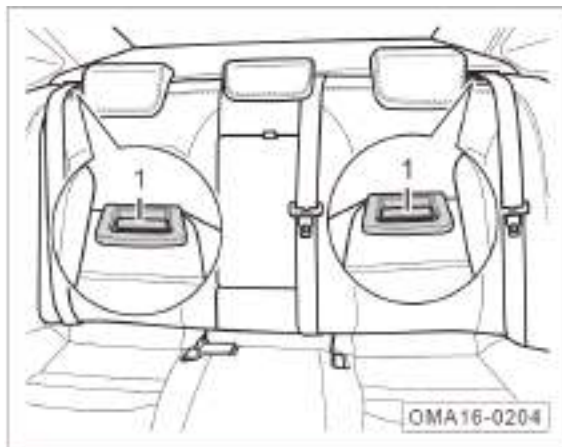

- Pull up the rear seat backrest switches ① to put down rear seat backrests.
- To restore the seat backrests to upright position, push the seat backrests till they are locked in place. Before driving, be sure that the seat backrests are locked in place.

#### **i** Hint

The left and right rear seat backrests can be put down separately. If only one side is put down, the passenger can also sit on the other side.

#### Central Armrest between Rear Seats\*

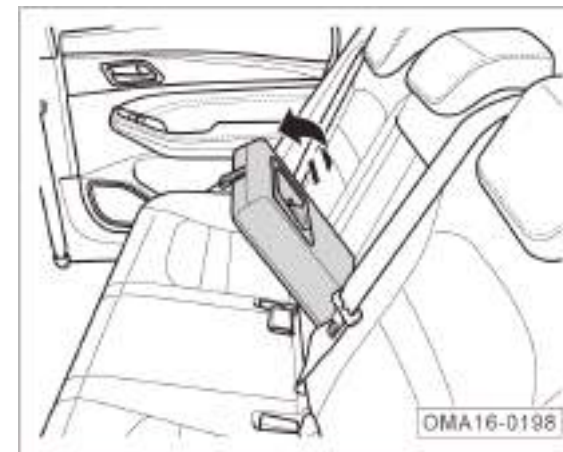

- Open the central armrest between rear seats in the direction of the arrow.

### 4.4.5 Storage Devices

#### Storage Sink in Door Interior Trim Panel

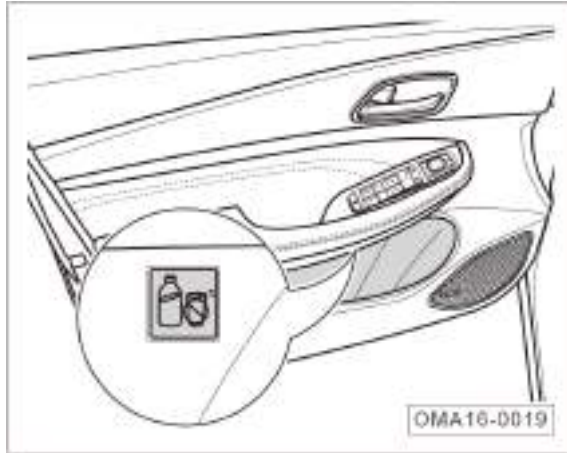

- There is a storage sink under each door interior trim panel.

#### Caution

Such articles as beverage bottles, maps and manuals may be placed in the storage sink, but such thermosensitive articles as chocolate or drugs may not be placed, or they are apt to go bad or be damaged.

#### Storage Shelf for Lower Panel in the Cab



- Small articles may be placed in the storage shelf.

#### Storage Sink under Dashboard\*



- There is a storage sink under the dashboard.

#### Hint

Small articles may be placed in the storage sink. Certain models are equipped with mobile phone wireless charging function, so the area may be taken as the charging area. No article are allowed to be placed in the area during charging. To place any articles, please disable the mobile phone wireless charging function.

## 4. Operating System and Equipment

### Cup Holders

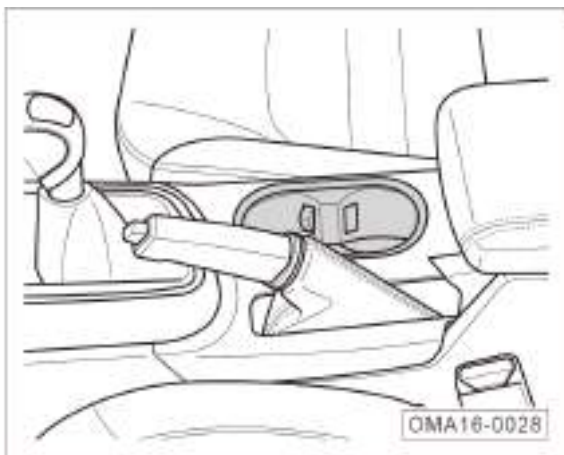

#### Front Cup Holders

- Front cup holders are provided in front of the armrest box.



#### Rear Cup Holders\*

- After the central armrest between rear seats is opened, you can use the rear cup holders.

#### **i** Hint

Cup holders may be used for holding such articles as beverage bottles and movable ash trays.

#### **⚠** Warning

**Never place any hot beverage bottle in cup holders to avoid scalding due to splashing during traveling.**

Glasses Case

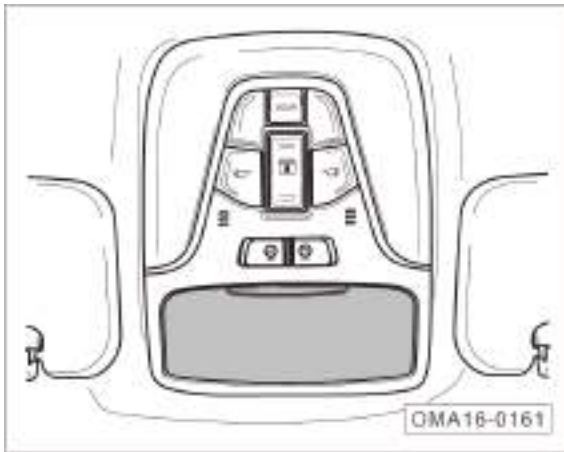

- Press the glasses case to open it gradually.



- Push back the glasses case in the direction of the arrow until it clicks to close it.

**i** Hint

Small articles such as sunglasses may be placed in the glasses case.

Glove Box

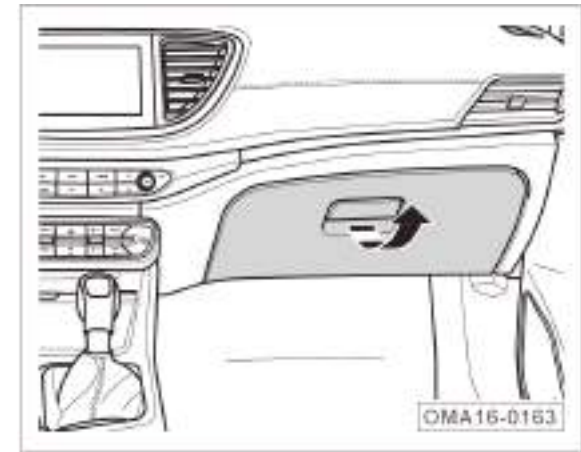

- Pull the opening handle in direction of the arrow to open the glove box.
- Push back the glove box until it clicks to close it.

## 4. Operating System and Equipment

### **i** Hint

Relatively large articles such as beverage bottles and bags may be placed in the glove box.

### **⚠** Warning

**Always keep the glove box closed while driving! Otherwise, items inside the glove box may be thrown out, injuring your passenger in a crash or emergency braking.**

### Central Armrest Box



- To open the central armrest box, raise the box cover.

### USB Interface



- The USB interface ① is located in front of the auxiliary dashboard and can be used after the cover is opened.

### Pocket on Back of Front Seat



- Such articles as books and foldable umbrella may be placed in the pocket.

### Reflective Vest

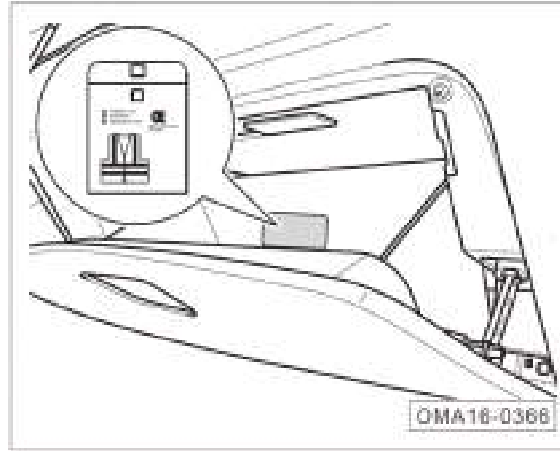

- Take the reflective vest out of the glove box if the car should be parked due to any car accident or other faults.



- Wear the reflective vest.



## 4. Operating System and Equipment

---

### **i** Hint

- During accident handling, wear the reflective vest as required irrespective of the lighting conditions to draw attention of the passerby or other drivers.
- After using the reflective vest, return it to the glove box properly, or wash it when necessary as per the notes on the collar to ensure reflecting performance.

### Microwave Window

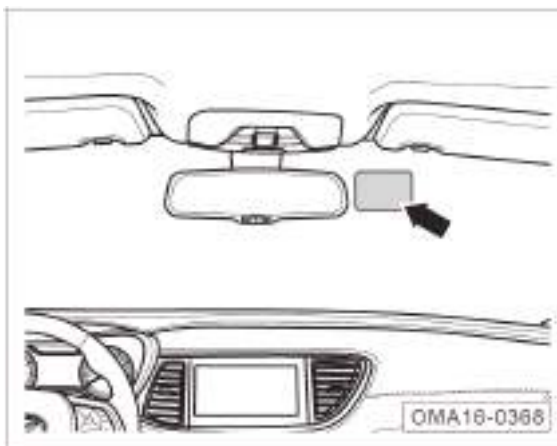

- The microwave window is on the right side of the front windshield corresponding to the interior rear-view mirror.

### **i** Hint

The microwave window can be used for installing ETC card.

### 4.4.6 Cigarette Lighter/Power Outlet

#### Central Console Cigarette Lighter/Power Outlet



- With the Start or Ignition switch at "ON" or "ACC" position, when the cigarette lighter is pressed down, you can pull it out after it pops up automatically.
- You can use the power outlet after pulling out the cigarette lighter.

#### Rear-Seat USB Power Interface



- A USB power interface is provided behind the central armrest box for direct connection of USB wire.

#### Warning

- Improper use of power outlet can cause fire. Do not leave a child alone in the car.
- To prevent fire hazards, never use power outlet when nobody is in the car.

#### Caution

- To avoid damage to the electrical system, do not connect any generating equipment to the power outlet.
- Use only electrical equipment in line with the national electromagnetic compatibility norms.
- To avoid damage to electrical equipment connected to power outlet due to voltage fluctuation, be sure to turn off the electrical equipment when the Start switch is turned on/off.

### 4.4.7 Trunk

To ensure operation stability of the car, items shall be distributed in the trunk as even as possible, and heavy items shall be placed in the front portion of the trunk as far as possible.

#### Warning

The scattered belongings or other items in the car may cause serious injury!

- Heavy items in the trunk must be secured with anchoring straps. Bear in mind: Carrying heavy items may cause the change of the car's gravity center, thereby changing the operation stability of the car.
- While traveling, the items scattered in the trunk may slide suddenly, resulting in change in the operation stability of the car.

#### Trunk Capacity

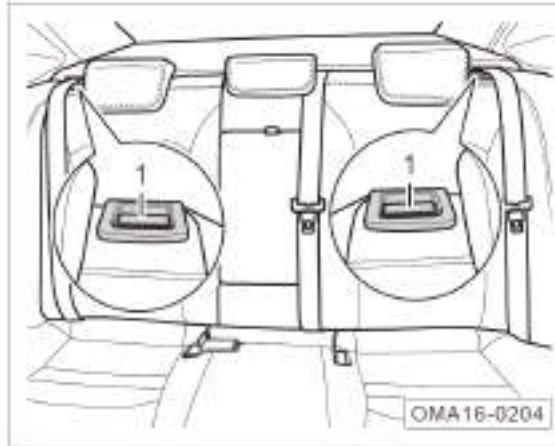

- By pulling up the rear seat backrest switches ①, rear seat backrests can be put down to increase the trunk capacity.

#### Caution

Ensure that any liquid container in the trunk is securely sealed to prevent leakage. Do not place the container on the folded seat backrests as much as possible to prevent liquid leakage wetting the seats.

#### Trunk Devices

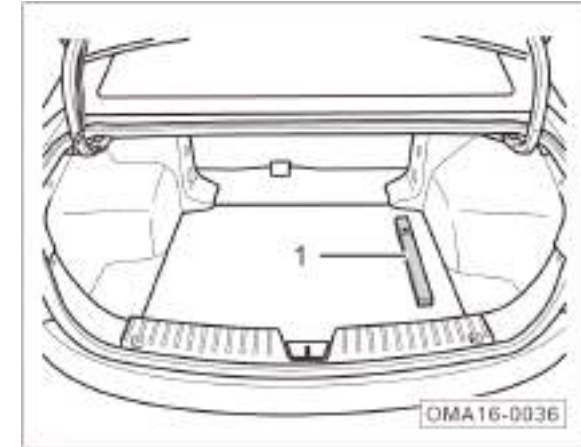

- Open the trunk lid, you can see the warning triangle ①.

## 4. Operating System and Equipment

---

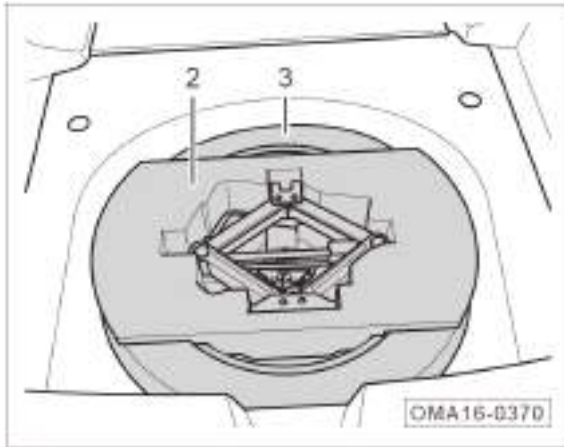

- Raise the trunk carpet, you can see vehicle tools ② and spare tire ③.

### 4.4.8 Accessories and Modifications

The data labels and signboards attached to the fuel tank lid, engine hood lock rack and other vehicle components of the car, when delivered, contain important data and information on car operation. Do not remove or damage such labels and signboards. Always keep the data and information on the labels and signboards clear and readable.

This car is designed with the latest safety technique to ensure excellent active safety and passive safety. Therefore, to maintain the car's excellent features, before installing accessories or replacing components, be sure to consult GAC MOTOR dealer.

We recommend you always use the accessories and components which have been designed and approved for your car. We are not responsible for any component not manufactured by us.

#### Warning

**Improper accessories or modifications may affect your car's operation stability and other performance, and may lead to severe injury or death.**

If car phone, alarm device, two-way radio equipment, and low-power audio system need to be installed, they should not interfere with your car's computer control system, such as Anti-lock Brake System (ABS).

#### Before installing any accessory:

1. Make sure that the accessory does not dim any light, or affect normal operation or performance of the car.
2. Do not install accessories on the B pillar or across the rear windows for cars equipped with side curtain airbags. Accessories installed in these areas may interfere with normal operation of side curtain airbags.

## 4. Operating System and Equipment

---

### Modifying Your Car

Removing components from your car, or replacing components with non-GAC MOTOR model components could seriously affect your car's operation stability and reliability. For example:

- Installing larger or smaller wheels and tires can interfere with normal operation of ABS and other systems.
- Modifying the steering wheel or any other safety facility may lead to system failure.

#### Warning

- **Improper accessories or modifications can easily cause faults and accidents. We recommend you always use the approved accessories and components with strictly-verified adaptability, reliability and safety by GAC MOTOR.**
- **Improper maintenance or modifications can weaken the protection from airbags, and cause system failure and fatal accidents. Do not install or connect the beverage cup holder, phone holder and other accessories onto the cover of airbag assembly or in the range of action of airbags.**
- **Improper operation or modifications (modification of the engine, brake system, steering system, wheels, tires or other components) can affect the function of the SRS system, resulting in serious injury or death.**

#### Warning

- **Do not install wheels and tires not approved by GAC MOTOR.**
- **Modifying the front part of the car and the engine compartment can deteriorate pedestrian protection performance of the car and violates the road regulations.**

### 4.5 A/C System

#### 4.5.1 General Instructions

The A/C filter can remove the pollen and dust brought in from the inlet of the A/C system.

The A/C filter must be cleaned or replaced regularly in accordance with the regulations in "Regular Maintenance Schedule" in the Warranty Manual.

Shorten the replacement interval of the A/C filter if you often drive in the urban area with heavy smoke caused by factories and diesel-powered cars. If the air flow from the A/C air outlet is not smooth as usual, the A/C filter may be blocked. Clean or replace the A/C filter as soon as possible.

#### Warning

- **Activate the interior air circulation mode as needed. Deactivate it when there is no need.**
- **Blurred windows easily increase the risk of accidents and casualties. For the sake of safety, all the windows must be free of ice, snow and fog to ensure clear vision.**
- **Turbid air in the car will make the driver fatigued, depressed and distracted, resulting in accidents and casualties easily.**

#### Caution

The expertise and special tools are essential to the diagnosis and repair of A/C system. Therefore, if your A/C system fails or is suspected to fail, go to the authorized GAC MOTOR dealer to have it checked and repaired.

#### Hint

- **When the outside temperature and humidity are high, moisture in the air will condense on the evaporator of the refrigeration system, resulting in water droplets dripping from the evaporator to form water under the car. This is normal, and there is no need to worry.**
- **The air inlet in front of the front windshield should be unblocked, and not clogged by snow, ice and leaves to ensure normal heating and cooling and prevent the front windshield from fogging up.**
- **All the windows and the sunroof must be closed for the A/C system to play a maximum effect. If the car has been exposed to the burning sun and it is very hot in the car, you should open the windows for a short time to dissipate the heat and accelerate cooling.**

## 4. Operating System and Equipment

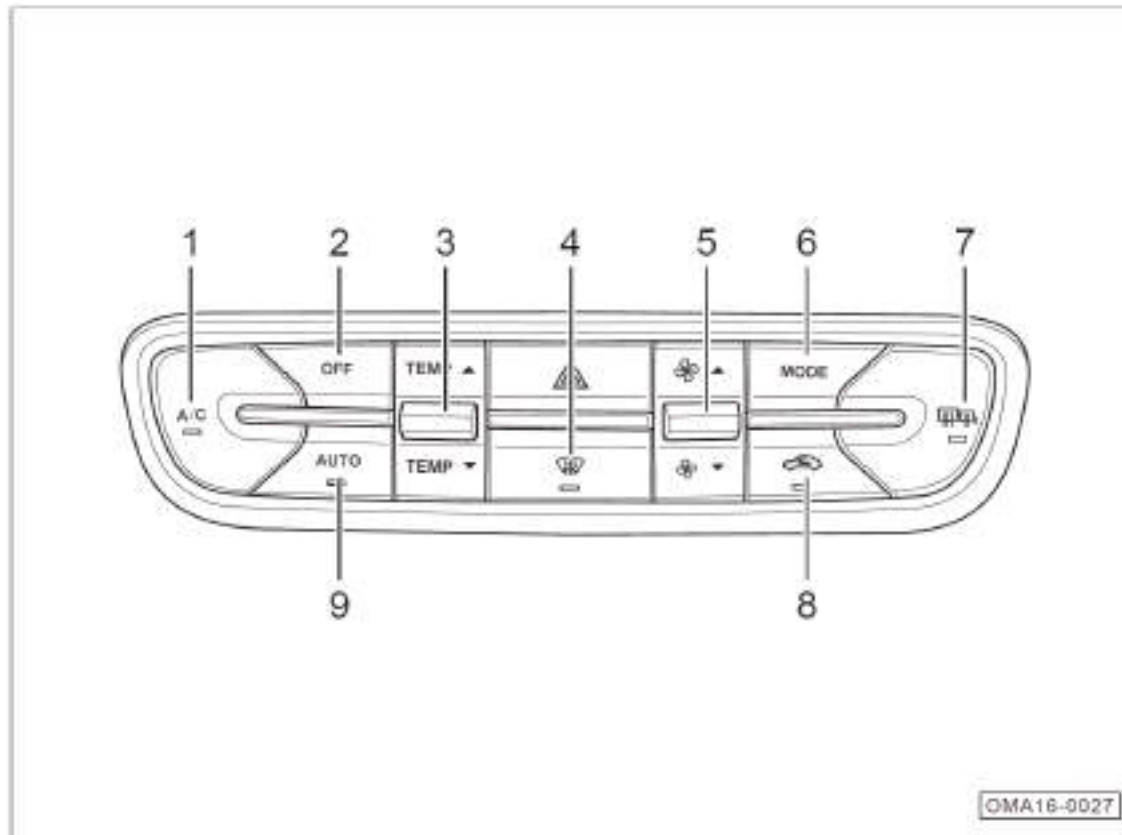

### 4.5.2 Control Panel

#### Full Auto A/C System\*



1. A/C button
  - Turn on/off the A/C refrigeration system.
2. OFF button
  - Turn off A/C system.
3. Temperature adjustment switch
  - Adjust the temperature in the car: Pull up the switch to increase the temperature and pull it down to decrease the temperature.
4.  Front windshield defrosting/defogging button
  - Remove the surface of the front windshield snow, frost or fog with the air flow from A/C system.



5. Air speed control switch
  - Control the blower speed: Pull up the switch to increase the speed and the air volume and pull it down to decrease the speed and the air volume.
6. Air vent mode button
  - Select the air vent mode: The symbol of the air vent mode is shown on the display of the audio system.
7.  Rear windshield and exterior rear-view mirror\* defogging/defrosting button
  - Heat electrically the rear windshield and exterior rear-view mirrors\* to remove the surface snow, frost or fog.
8.  Air circulation button
  - Choose the air intake mode of A/C: Interior or Exterior circulation.
9. AUTO A/C button
  - The temperature, air speed, air vent mode and air circulation mode are automatically adjusted in this mode.

### Hint

- A/C system of certain models can be controlled through the audio system as well. => Refer to Page 206
- When any button on the A/C control panel (except rear windshield and exterior rear-view mirror\* defogging/defrosting button) is pressed, the audio system (AVN) display will automatically pop up the A/C setting interface and the user can also click corresponding soft keys for setting.



## 4. Operating System and Equipment

### 4.5.2.1 Control Panel

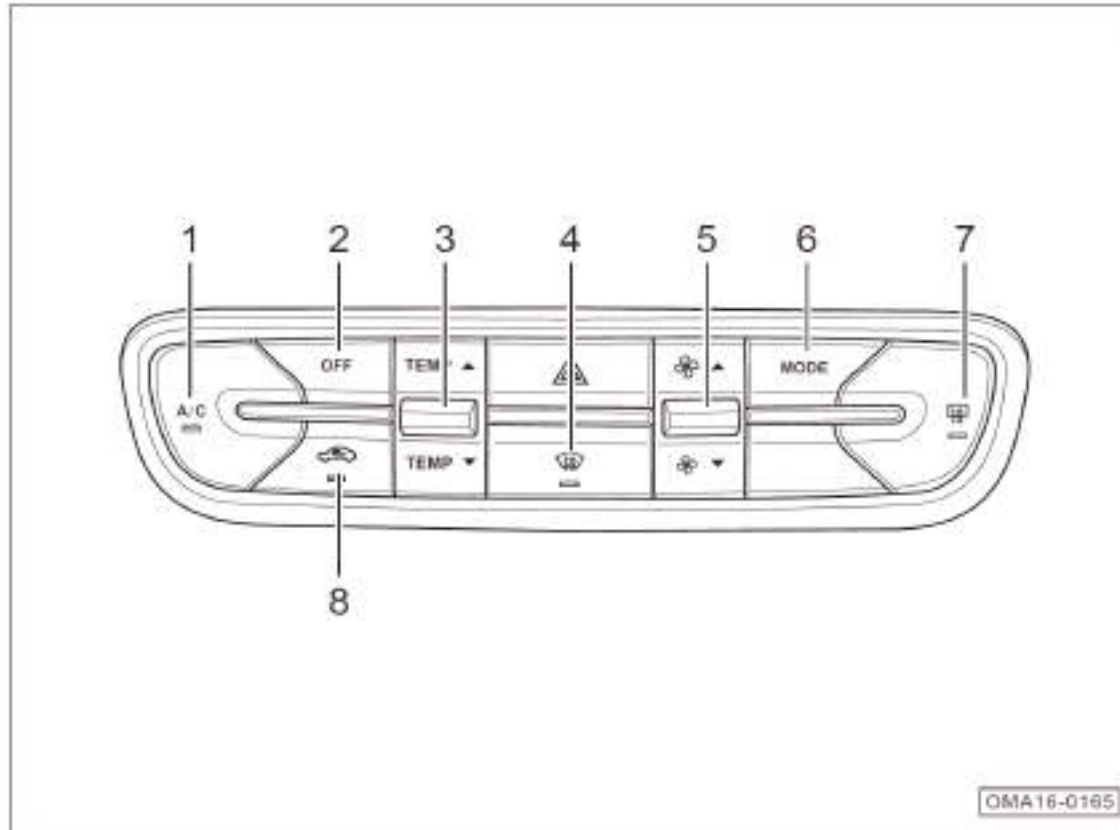
#### Manual Electric Control A/C System\*



1. A/C button
  - Turn on/off the A/C refrigeration system.
2. OFF button
  - Turn off A/C system.
3. Temperature adjustment switch
  - Adjust the temperature in the car: Pull up the switch to increase the temperature and pull it down to decrease the temperature.
4.  Front windshield defrosting/defogging button
  - Remove the surface of the front windshield snow, frost or fog with the air flow from A/C system.

5. Air speed control switch
  - Control the blower speed: Pull up the switch to increase the speed and the air volume and pull it down to decrease the speed and the air volume.
6. Air vent mode button
  - Select the air vent mode: The symbol of the air vent mode is shown on the display of the audio system.
7.  Rear windshield defrosting/defogging button
  - Heat electrically the rear windshield to remove the surface snow, frost or fog.
8.  Air circulation button
  - Choose the air intake mode of A/C: Interior or Exterior circulation.

### Hint

- A/C system of certain models can be controlled through the audio system as well. => Refer to Page 206
- When any button on the A/C control panel (except rear windshield defogging/defrosting button) is pressed, the audio system (AVN) display will automatically pop up the A/C setting interface and the user can also click corresponding soft keys for setting.

### A/C Button

Press A/C button to light on the button light. The A/C system will enable the refrigeration function. When the refrigeration function is enabled:

- This means refrigeration/dehumidification is needed, but the compressor is not necessary to run.
- When the temperature outside is lower than 0°C, if the refrigeration function of A/C is on, the button light will be on, but the air condition compressor may not work.



Press A/C button again to light off the button light. The A/C system will disable the refrigeration function.

## 4. Operating System and Equipment

---

### A/C Off

Press button to turn off A/C system. After A/C system is off, the compressor and the blower are turned off and the air speed at the air outlet is 0.

After A/C system is off, , MODE and air speed control switch can be operated effectively without turning on A/C system; while the temperature adjustment switch is unavailable. If AUTO\*, A/C or  is pressed, the A/C system will be turned on.

### Temperature Setting

Set the temperature in the car by pulling up and down the temperature adjustment switch. When the interior temperature is set:

- The adjusted temperature value is shown on the display. The temperature is adjustable within 18.5°C~31.5°C.
- Adjust the temperature at a step of 0.5°C.
- When the set temperature is lower than 18.5°C, LO is shown on the display; when the set temperature is higher than 31.5°C, HI is shown on the display.

Temperature setting will not change the operation mode of the A/C system.

In AUTO mode, when entering LO/HI mode, the system will keep operating in a large air supply state.

In AUTO mode, in order to obtain the most ideal interior temperature, we recommend that the set temperature is 25.0°C. If necessary, you can adjust the temperature by yourself\*.

### Hint

The temperature value on the display is the target value of the set temperature, instead of the measured value of the interior temperature.

### Front Windshield Defrosting

Press  button to light on the button light and enable the front windshield defrosting function. The system will perform the following settings automatically:

- Increase the air speed at the air outlet.
- Turn on the A/C system.
- Enter front windshield blowing mode.
- Enter exterior circulation mode.

Press  button again to light off the button light, disable the front windshield defrosting function, and return to the state before the defrosting action; or press AUTO button to directly enter the AUTO control state to disable the front windshield defrosting function\*.

### Caution

When the lowest temperature is set, enabling the defrosting function may cause fog on the outside of the windscreen to affect the driver's vision. When the defrosting function is enabled, the temperature is suggested to be set at hot or warm position.

When the defrosting function is enabled at an ambient temperature of higher than 0 °C , if the compressor (A/C) is turned off manually, it may cause fog on the front windshield to affect the driver's vision, and even lead to traffic accidents.

### Air Speed Setting

The air speed can either be controlled manually or automatically\*.

Operate the air speed control switch to control the air speed at the air outlet manually. In manual control mode, the air speed scale is within 1~7. The corresponding air speed scale will be shown on the display:

- Pull up the air speed control switch to increase the blower speed and the air speed at the air outlet by one scale.
- Pull down the air speed control switch to decrease the blower speed and the air speed at the air outlet by one scale.

In AUTO mode, the system will control the air speed at the air outlet automatically. The air speed at the air outlet is not limited to 7-scale regulation in manual state, but there are only 7-scale indicating bar on the display, so the number of the indicating bars shown is the proximate one. To achieve the target value of the interior temperature, the air speed will be adjusted automatically\*.

In AUTO mode, if the air speed control switch is operated, the system will be switched to Manual mode from AUTO mode and the "AUTO" identification will disappear\*.

## 4. Operating System and Equipment

### Air Vent Mode

The air vent mode can be controlled manually or automatically\*.

Press MODE button continuously to control the outlet air mode at the air outlet manually. The circulation switching sequences of the outlet air mode are listed as follows:

 Face blowing mode: Air is blown out from the air outlet of the instrument panel.

 Face and foot blowing mode: Air is blown out from the air outlets of the instrument panel and the footwell.

 Foot blowing mode: Air is blown out from the air outlet of the footwell.

 Foot and front windshield blowing mode: Air is blown out from the defrosting air outlet of the front windshield and the air outlet of the footwell.

In "AUTO" mode, the system will control the air vent mode automatically. The basic factor affecting the air vent mode is the air vent temperature\*.

- When the outlet air temperature is hotter, the air flow will be blown towards the feet.
- When the outlet air temperature is cooler, the air flow will be blown towards the face.

In AUTO mode, if the MODE button is pressed, the system will be switched to Manual mode from AUTO mode and the "AUTO" identification will disappear\*.

#### Hint

- To ensure that A/C system can effectively control all the air vent modes automatically, please open all the air outlets.
- When the AUTO mode is enabled in winter, the system will control the air vent mode automatically and the air vent mode will be switched over from the front windshield blowing mode.

### Rear Windshield Defrosting

Press  button to light on the button light and enable the rear windshield defrosting function to heat the rear windshield and the exterior rear-view mirrors\* electrically.

During the rear windshield defrosting, press  the button again to light off the button light and disable the rear windshield defrosting function. If the rear windshield defrosting function is not off, this function will be off automatically after continuous working for 15 minutes.

#### Hint

If the engine is not started, prolonged rear windshield defrosting function may cause low battery voltage, leading to start failure of the car.

### AUTO Mode\*



When AUTO button is pressed, the button light is on, the A/C system enters full automatic operation mode, and the following items are controlled automatically as per the set value:

- Air vent temperature
- Air speed at the air outlet
- Air vent mode
- Air circulation mode
- Working conditions of A/C
- Working conditions of anion purifier\*

Press the AUTO button again to light off the button light. A/C system exits full automatic operation mode.

### Air Circulation

Press  button to make air circulation mode switch between interior circulation and exterior circulation.

- Interior air circulation: By pressing  button, the button light goes on and the system enters interior air circulation mode. In this mode:
  - The outside air can be prevented from entering the car to make the interior air circulate.
  - The exhaust of other vehicles or other dirty air can be prevented from entering the car.
  - In AUTO control mode in summer, interior air circulation mode will be selected to strengthen the refrigeration effect\*.
- Exterior air circulation: Press  button to light off the button light. Air circulation enters exterior air circulation mode. When this mode is available:
  - The outside air will be introduced into the car to keep fresh interior air.

### Caution

- Prolonged interior air circulation will cause accumulation of carbon dioxide in the car, and it is not conducive to keep the driver awake.
- Using the interior air circulation mode in cold or rainy weather is easy to cause fogging of window, to affect the driver's vision.

## 4. Operating System and Equipment

---

### Sunlight Sensor\*



The full automatic A/C control system can measure the interior and exterior sunlight intensity. Pay attention to not cover the sunlight sensor located in the center of the dashboard during driving.

#### Caution

Due to different environment areas and vehicle conditions, the ambient temperature shown may be different from the actual value.



### 4.5.3 Air Outlets

#### Side Air Outlets of Instrument Panel



- Move the flap ① at the air outlet leftward, rightward, upward and downward to adjust the air direction.
- Turn the knob ② near the air outlet upward and downward to adjust the air volume. The lower-most position is the off position.

#### Central Air Outlets of Instrument Panel

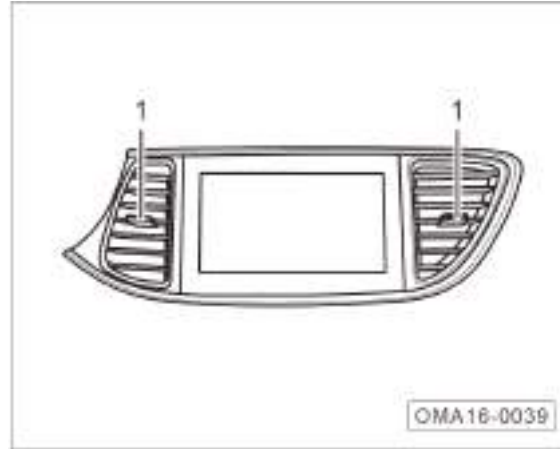

- Move the flap ① at the air outlet leftward, rightward, upward and downward to adjust the air direction.

#### Rear Air Outlets of Central Armrest Box\*

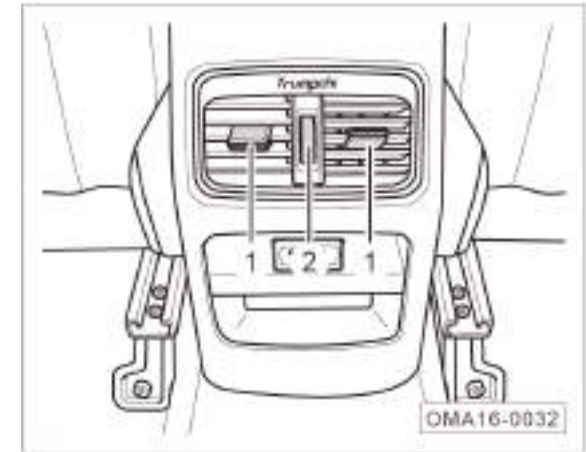

- Move the flap ① at the air outlet leftward, rightward, upward and downward to adjust the air direction.
- Turn the knob ② near the air outlet upward and downward to adjust the air volume. The lower-most position is the off position.

## 4. Operating System and Equipment

### 4.6 Audio System (Radio)\*

#### 4.6.1 Control Panel

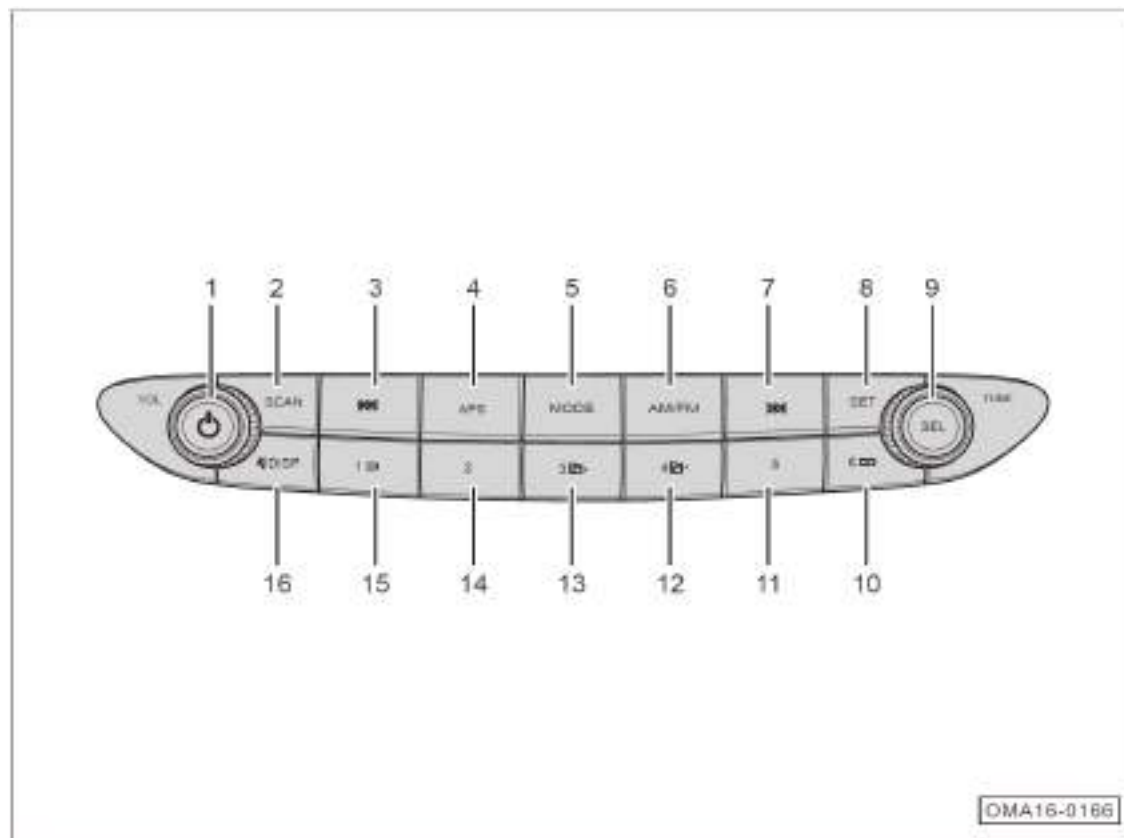

1. Power Button/Volume Adjustment Knob
  - Short press to power on under power-off state; short press to power off under power-on state, at the same time, turn off all the sound sources and display the clock interface.
  - Turn the knob clockwise to turn up the volume; and counter-clockwise to down the volume.
2. SCAN button
  - Short press to search the effective stations towards HF automatically under the radio interface. Each station will be played for 10 seconds.
  - Short press to scan the whole disk and Long press to scan the folder under USB interface; Each music will be played for 10 seconds.

3. Station frequency adjustment/Previous button
  - Short press to search the effective stations towards LF automatically under the radio interface.
  - Long press to search the effective stations towards LF manually under the radio interface.
  - Short press to jump to the previous under the music play interface.
  - Long press for REW under the music play interface.
4. Automatic saved station/Preset saved station scan button
  - Short press to search the saved stations. Each preset station will be played for 10 seconds.
  - Long press to search and save the effective stations automatically.
5. Audio Source Switching Button
  - Short press to switch radio and USB play.
6. AM/FM Radio Button
  - Short press to switch to radio mode in other sound source states.
7. Station frequency adjustment/Next button
  - Short press to switch the radio band in radio state: FM1 → FM2 → FM3 → AM1 → AM2.
  - Short press to search the effective stations towards HF automatically under the radio interface.
  - Long press to search the effective stations towards HF manually under the radio interface.
  - Short press to jump to the next under the music play interface.
8. Setting menu button
  - Long press for FF under the music play interface.
  - Short press to enter the setting interface.
9. Station frequency adjustment/SEL option button
  - Leftward and rightward rotation for manual adjustment of station frequency under the radio interface.
  - Leftward and rightward rotation for selection or adjustment under the setting interface. Short press to confirm the selection.
10. Preset Station 6/Random play button
  - Play the preset Station 6 under the radio interface.
  - Short press for random play of all the files and long press for random play in the folder under USB music play interface.
11. Preset Station 5
  - Play the preset Station 5 under the radio interface.
12. Preset Station 4/Next folder button
  - Play the preset Station 4 under the radio interface.
  - Short press to enter the next folder under USB play interface.
13. Preset Station 3/Previous folder button
  - Play the preset Station 3 under the radio interface.
  - Short press to enter the previous folder under USB play interface.
14. Preset Station 2
  - Play the preset Station 2 under the radio interface.
15. Preset Station 1/Loop play button
  - Play the preset Station 1 under the radio interface.

## 4. Operating System and Equipment

---

- Short press for file loop play and long press for folder random play under USB music play interface.
16. Mute Button
- Short press to mute, and short press again to unmute.

### Hint

The interface or function of audio system introduced in the *User's Manual* may differ due to different vehicle configurations, i.e. it is for reference only. Please refer to the actual car you buy.

### 4.6.2 Control Buttons on the Steering Wheel\*

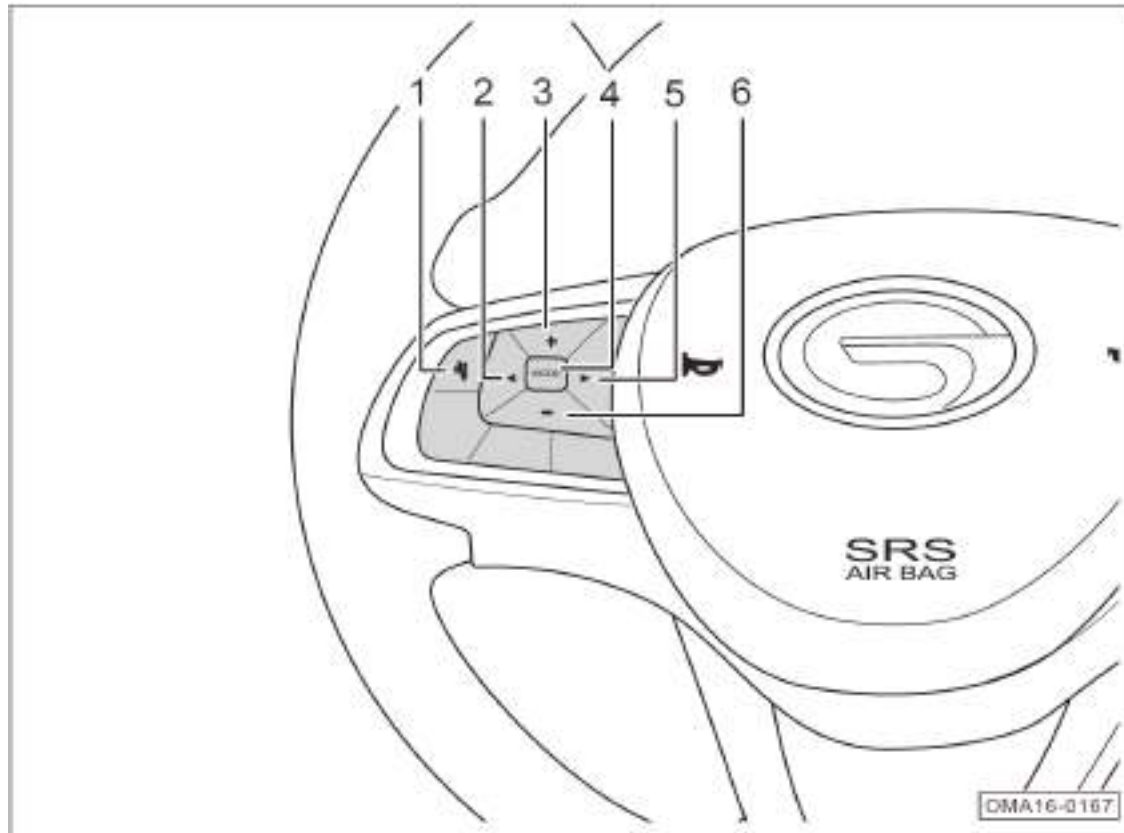

1. Mute Button
  - Short press this button to mute the media source.
  - After muting, press again to unmute.
2. Backward Button
  - In radio mode, search the station towards LF automatically. If an effective station is met, auto search stops and the station starts playing.
  - Change the track into the previous one in media source play.
3. Volume up Button
4. Audio Source Switching Button
  - Short press to switch radio and USB play.
5. Forward Button
  - In radio mode, search the station towards HF automatically. If an effective station is met, auto search stops and the station starts playing;
  - Change the track into the next one in media source play.
6. Volume down Button

## 4. Operating System and Equipment

### 4.6.3 Basic Operations

#### ON/OFF

- When the Start or Ignition switch is at "ACC" or "ON" position, short press the power button (⏻) to turn on the audio system.
- Short press ⏻ the power button to power off under startup state. At the same time, turn off all the sound sources and display the clock interface.

#### A/C Status Bar



- Show the status of the A/C system, such as air vent mode, air speed, temperature and circulation mode.

#### Volume Control

##### Volume Adjustment

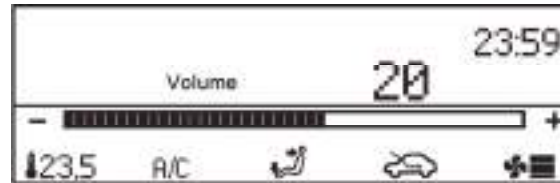

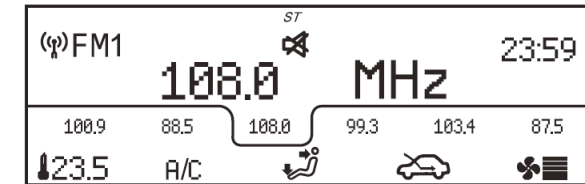

- Turn the volume adjustment knob clockwise/counter-clockwise ⏻ to turn up/down the volume.
- Short press the volume button (+/-) on the left side of the steering wheel to turn up/down the volume.

#### Mute

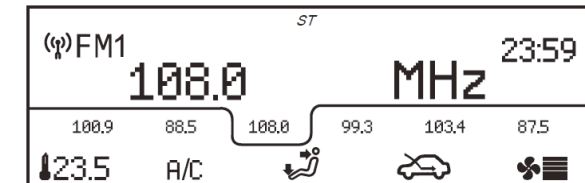

- Short press the  button on the control panel or on the left side of the steering wheel to enable the mute function. The mute icon will be shown on the interface.



- Short press the  button on the control panel or on the left side of the steering wheel again to disable the mute function. The mute icon will disappear.

**System Settings Function**

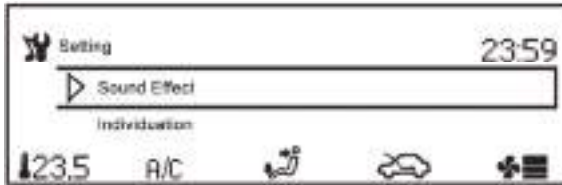

- Short press the "SET" button to enter the setting interface to set "sound effect, custom, left and right, front and rear, vehicle speed volume compensation, clock, language setting, factory reset and exit".
- Turn "SEL" to select different menu items. Short press "SEL" to enter the next menu.

**Sound Effect Setting**

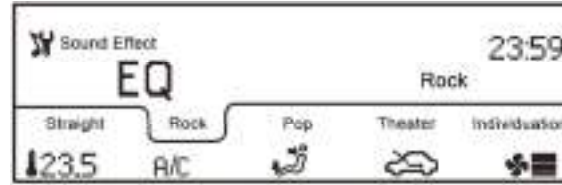

- The sound effect mode can bring different sound play effects and more music enjoyment to owner. The optional sound effects contain "flat, rock, popular, theater and custom".
- Turn "SEL" to select and short press "SEL" to confirm.

**Custom Setting**

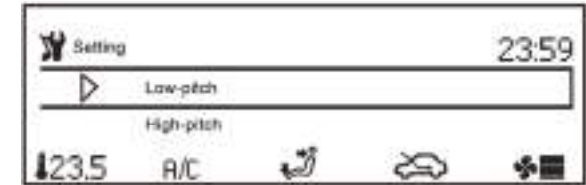

- There are two options of "bass setting and treble setting" under the custom setting. Owner can customize the treble and bass settings.

## 4. Operating System and Equipment

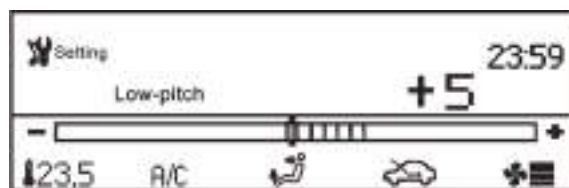

- Select "Bass", and then short press "SEL" to enter the bass setting interface to set the bass. Setting range:-12~12.
- Turn "SEL" to set and short press "SEL" to confirm.

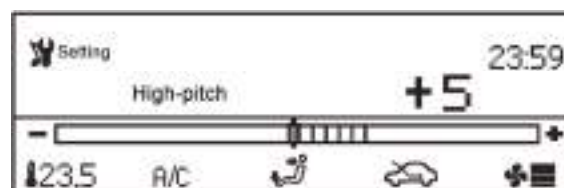

- Select "Treble", and then short press "SEL" to enter the treble setting interface to set the treble. Setting range:-12~12.
- Turn "SEL" to set and short press "SEL" to confirm.

### BAL Setting

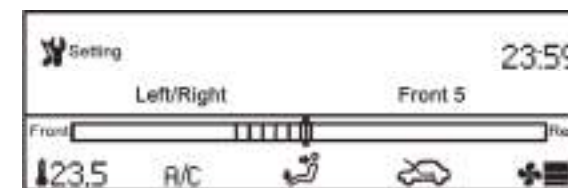

- Select "BAL", and then short press "SEL" to enter BAL setting interface to adjust the output position of sound. Setting range: left 15 ~ right 15.
- Turn "SEL" to set and short press "SEL" to confirm.



**FAD Setting\***

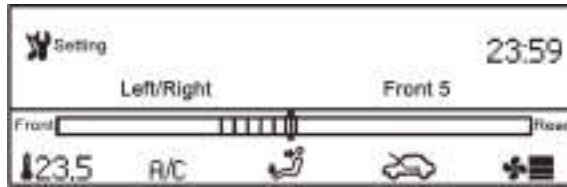

- Select "FAD", and then short press "SEL" to enter FAD setting interface to adjust the output position of sound. Setting range: front 15 ~ rear 15.
- Turn "SEL" to set and short press "SEL" to confirm.

**Vehicle Speed Volume Compensation Setting**

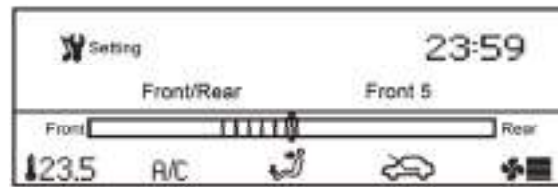

- Select "Vehicle Speed Volume Compensation", and then short press "SEL" to enter vehicle speed volume compensation setting interface to set "off, low, moderate and high".
- Turn "SEL" to select and short press "SEL" to confirm.
- The output volume performs automatic adjustment along with the speed change. The state table of volume along with speed is as follows:

Status	Volume Change
OFF	The sound will not be changed with the speed
Low	The sound will be changed with the speed at a low degree
Medium	The sound will be changed with the speed at a medium degree
High	The sound will be changed with the speed at a great degree

**Clock Setting**



- Select "Clock", and then short press "SEL" to enter the clock setting interface to set the time.
- Turn "SEL" to set and short press "SEL" to confirm.

## 4. Operating System and Equipment

### Language Setting



- Select "Language", and then short press "SEL" to enter the language setting interface to set the display in "Chinese or English".
- Turn "SEL" to select and short press "SEL" to confirm.

### Factory Reset

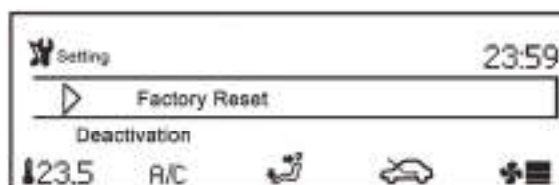

- Select "Factory Reset", and then short press "SEL" to enter the factory reset interface.

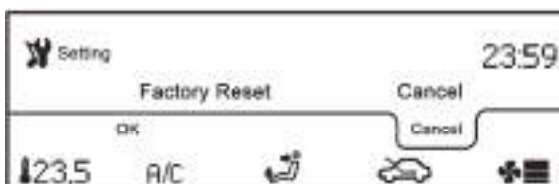

- Set "Confirm or Cancel". Turn "SEL" to select, and short press "SEL" to confirm.

### Exit Setting

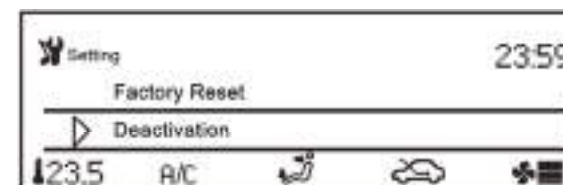

- Select "Exit", and then short press "SEL" to exit the "System Settings".

### 4.6.4 Radio

Enter the radio play mode through the following ways:

- Press button on the control panel continuously to switch to the radio mode;
- Press button on the left side of the steering wheel continuously to switch to the radio mode;
- Short press button on the control panel to enter the radio mode;

#### Band Selection



- In the radio play interface, short press button on the control panel continuously to switch the band among "FM1→FM2→FM3→AM1→AM2".

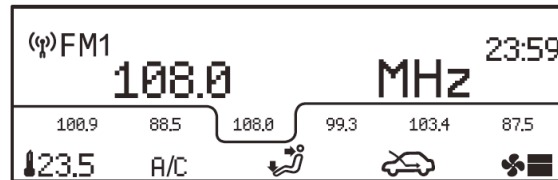

- FM interface is as shown in the figure.

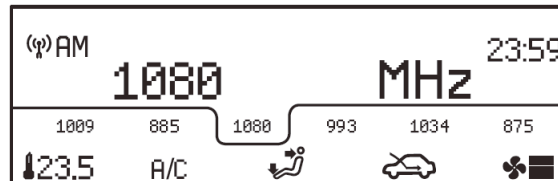

- AM interface is as shown in the figure.

#### Radio Search Function

Tune stations in manual or auto mode.

#### Manual Searching

- Long press ►► button or ► button on the left side of the steering wheel to change the station frequency by one step towards HF direction.
- Long press ◀◀ button or ◀ button on the left side of the steering wheel to change the station frequency by one step towards LF direction.
- Turn "SEL" knob clockwise to change the station frequency by one step towards HF direction.
- Turn "SEL" knob anticlockwise to change the station frequency by one step towards LF direction.

## 4. Operating System and Equipment

### Auto Searching

- Short press **▶▶** soft button or the **▶** button on the left side of the steering wheel to search the station towards HF automatically. If an effective station is met, auto search stops and the station starts playing.
- Short press **◀◀** soft button or the **◀** button on the left side of the steering wheel to search for station towards LF automatically. If an effective station is met, stop auto search and start playing.

### Pre-save

Owner can save the favorite stations into the station list. Manual saved station list and auto saved station list can be available in each band. At most 6 stations can be saved in each list. For FM bands, at most 18 stations can be saved, including FM1, FM2 and FM3. 6 stations can be saved in each band. For AM bands, at most 12 stations can be saved, including AM1 and AM2. 6 stations can be saved in each band.

### Manual Save

Firstly, search your favorite stations through auto search or manual search.

- Long press any one of the preset station buttons (1~6) on the control panel for more than two seconds. The station part flickers, and the station is shown in the corresponding preset station position at the same time, and then the current station is saved in the preset station successfully.
- If this preset station button has already had the saved station, the new station will cover the original one.

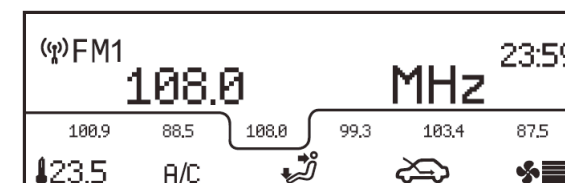

- Long press **3** to save the searched Station 108.0 to the preset Station 3 as shown in the figure. The other preset stations have the same operation.
- Press the corresponding preset station button to play the preset station.

### Auto Save

- Long press the APS button to enter auto save interface. When the effective station is searched, it will be saved to the preset station button automatically. When you use the auto save function, the original station saved in the preset station will be covered.
- Short press AM/FM button to stop searching during the search process.
- Short press the APS button to scan the pre-saved preset stations. Each station can be played for 10 seconds.

### Scanning Function

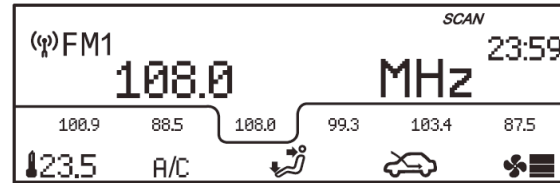

- Short press the SCAN button to display SCAN icon on the screen. At this time, HF stations will be started to be searched from the current channel, and continuously search the next effective station after 10-second play of the effective station.

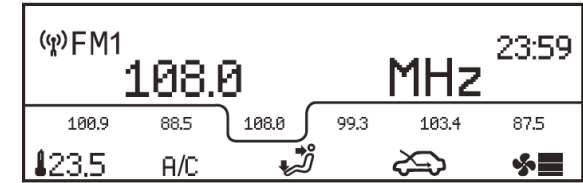

- During the scan process, if your favorite station is searched, you can short press the SCAN button again to cancel the scanning function. Then the SCAN icon will disappear, and this station will be played continuously.

## 4. Operating System and Equipment

### Reception Form of AM/FM Car Audio

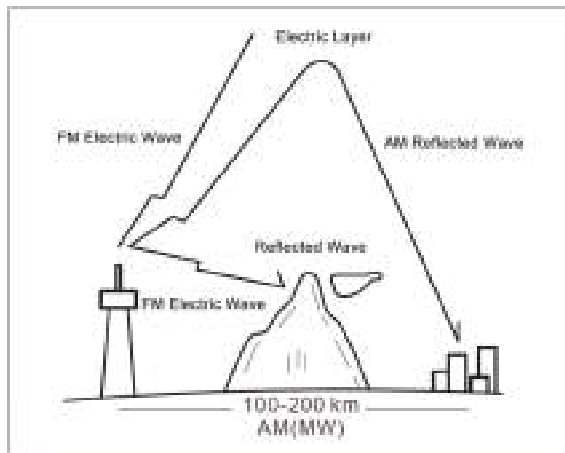

VHF channels on FM will pass through the ionosphere directly without reflection, but once they hit high mountains, high-rise buildings and other barriers, they will produce reflection. FM spreading distance is usually about 40~50 kilometers. It will become shorter when stereo signals are transmitted.

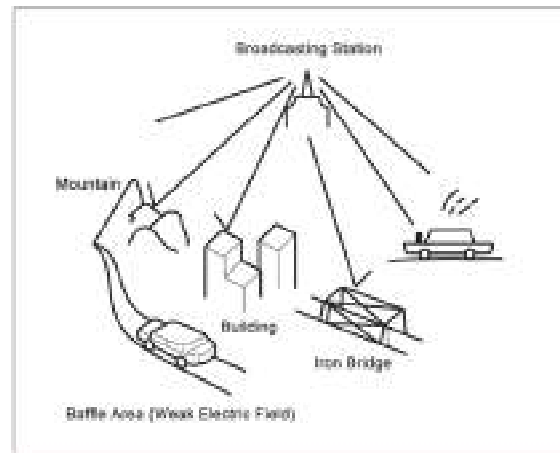

The radio is far away from the broadcasting station, so the signals are too weak to be received. As a result, the radio will only receive noises. When the car is driven between the areas to receive two strong stations with a close signal frequency at the same time, the radio may lose sound suddenly or produce noise interference.

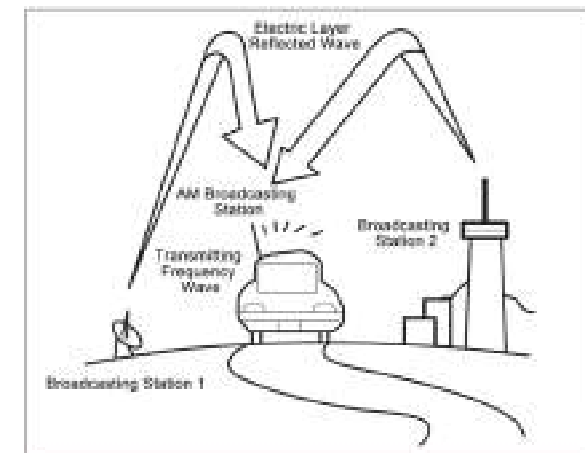

Although MW or SW of AM cannot pass through ionosphere, it will produce diffraction. As a result, when the radio waves hit high mountains and high-rise buildings, its spreading distance will be farther than that of FM. Therefore, it is likely to simultaneously receive the signals from two AM stations.

### **Description of Tunnel Mode Function**

When the car enters a tunnel in radio mode, if the radio signal is weakened so that the listening is seriously affected, the volume will be reduced to a limited one; when the radio signal recovers, the volume will return to normal automatically. When the car is running at urban canyons or mountainous areas where the radio signal is poor and unstable, the mute function will be enabled, leading to unstable volume.

## 4. Operating System and Equipment

### 4.6.5 USB Play



- The USB interface ① is located in front of the auxiliary dashboard and can be used after the cover is opened.



There are several ways to enter the USB media play mode as follows:

- When USB is inserted into the USB interface, the system will jump to the USB media play mode automatically;
- Continuously press MODE button on the control panel to switch to USB play;
- Continuously short press MODE button on the left side of the steering wheel to switch to USB play.

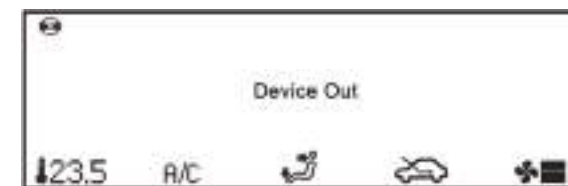

- If there is no USB device inserted, the interface as shown in the figure will be shown.





- After USB device is inserted, the interface as shown in the figure will be shown.



- When USB device cannot be read, the interface as shown in the figure will be shown.



- When USB device exits, the interface as shown in the figure will be shown.

### Previous/REW Function

- Short press **⏮** button to perform the previous.
- Long press **⏮** button to perform REW of current track content (It is only available to the REW of current track to reverse to the beginning for automatic normal play. If do not reverse to the beginning, the normal play will be recovered as releasing).

### Next/FF Function

- Short press **⏭** button to perform the next.
- Long press **⏭** button to perform FF of current track content and recover normal play as releasing (If it is forwarded to the end of the track, the next track will be played normally. If this track is the last one in the folder, the first one in the next folder will be played normally).

## 4. Operating System and Equipment

### Loop Play

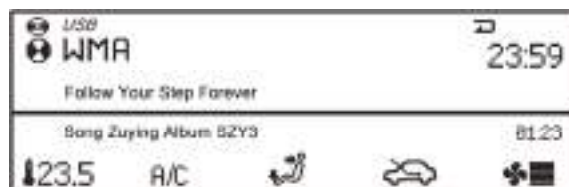

- Short press 1 [Loop Play] button to realize single loop play.

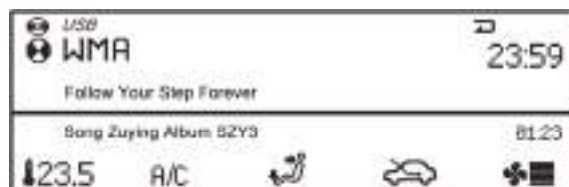

- Long press 1 [File Loop Play] button to realize file loop play.

### Random Play



- Short press 6 [Random Play] button to realize random play in the whole disk.



- Long press 6 [Folder Random Play] button to realize folder random play.

### Scanning Function





- Short press the SCAN button to scan songs automatically. Switch to the next song after automatic scan play of current track for 10 seconds.



- Long press the SCAN button to scan songs under the current play folder automatically. Switch to the next song after automatic scan play of current track for 10 seconds.

### **i** Hint

Play USB music:

- Short press  to return to the previous folder;
- Short press  to enter the next folder.

## 4. Operating System and Equipment

### 4.6.6 iPod Play

This product has been certified by the Apple iPod, supporting iPod and iPhone professional equipment to play iPod and iPhone music. iPod and iPhone professional equipment is connected to the audio host with USB line.

#### i Hint

Since iPhone uses OS system, when a third-party APP (such as QQ Music, Xiami and KuGou) runs, there will be incompatibility problems, such as unsuccessful connection, abnormal sound output, abnormal music name display, and no response when the function keys are pressed. It is recommended to run the build-in music player.

### Selection of iPod Sound Source

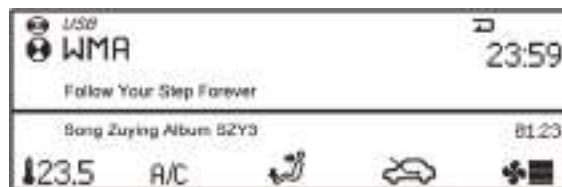

There are several ways to enter the main interface of the iPod media source as follows:

- When iPod is inserted in the USB interface with USB line, the system will jump to the iPod media play mode automatically;
- Under other media sources, press button continuously to switch to the iPod media play mode.

#### i Hint

When iPod plays music, the function and the operation method are same to that of the USB play. Please refer to the operation method of the USB play.

### 4.6.7 Precautions

The audio system is designed and manufactured according to the internal strict quality standard and international quality standard. Quality tests include severe tests such as impact resistance test, dustproof test, vibration resistance test and weather resistance test.

Our company hopes that you can enjoy music and life through the product to meet your entertainment needs. We hope we can provide complete and reliable information for you. This Manual will introduce its function to enable you more relaxed and convenient in operation. For the damage or fault caused by being unfamiliar with warning and caution items, our company has the rights not to provide free after-sales service. Therefore we prompt that please read this manual first before operation.

#### Warning

- **During the driving process, if the driver needs to observe the audio system, he/she shall observe it quickly as soon as possible. It may cause car accidents in case of long watching time.**
- **Do not disassemble or configure the product, otherwise it may lead to fault, fire, short circuit and other problems to the product.**
- **Please note to avoid the entry of water, inflammable and other sundries, otherwise it may lead to fire, machine fault, smoking and other problems.**
- **Do not touch the antenna during thundering, otherwise there is a risk of electric shock by thundering and lightning.**
- **Do not operate the product system in no parking area, otherwise it may be easy to lead to the occurrence of safety accident.**
- **If there is any fault with the product, please go to GAC MOTOR dealer for servicing. Do not disassemble the machine for maintenance arbitrarily.**

#### Caution

- During the driving process, the music volume shall be adjusted to be able to hear the outside sound, otherwise it may lead to the occurrence of accident.
- It has to be used when the engine starts. Prolonged using will lead to insufficient battery voltage when the engine is flamed out.
- Do not impose too big impact on the product. The screen may be damaged under direct excess pressure.
- To clean the screen, power off, and then wipe with a dry rag. Hard rag or chemical rag or organic solvent (such as benzene, alcohol, and paint thinner) is likely to cause scar or deterioration.

## 4. Operating System and Equipment

---

### Caution

- If there is any problem with the product and it cannot be used normally, please stop operation and contact customer service center.
- Continuous operation in abnormal state may cause more serious problems, if the product is unpacked or modified at will, free guarantee service cannot be enjoyed.

### Hint

"Short press" herein means that the button-hold time does not exceed two seconds, and "long press" means that the button-hold time exceeds more than two seconds. They are called as "short press" and "long press" for short herein.

4.6.8 Supported Formats

Media Type	Format /expanded name	Maximum Resolution	Video Code	Audio Code	Maximum Media Duration	Maximum Reading Number under Directory	Supported Coded Format of File Name
Audio frequency	WMA	—	—	WMA9 standard sampling rate: 8k, 16k, 32k, 11.025k, 22.05k, 44.1k and 48kHz, bit rate: 5-384kbps and VBR (Variable Bit Rate)	99: 59: 59	—	UTF-16LE
	MP3	—	—	WMA9 standard sampling rate: 8k, 16k, 32k, 11.025k, 22.05k, 44.1k and 48kHz, bit rate: 5-384kbps and VBR (Variable Bit Rate)	99: 59: 59	—	ID3V1TAGorISO8859-1, UTF-16, UTF-16BE
Supported format of USB disk (IPOD):		FAT16	FAT32	—	—	FAT16: Root folder 512, Sub folder 1024, FAT32: Root Folder 65535, Sub folder1024	—
Supported capacity of USB disk (IPOD):		512MB-32GB					
ID3 coded formats:		ID3V1 TAG or ISO8859-1, UTF-16, UTF-16BE, UTF-8, UTF-16LE					

Statement: The supported USB disk formats, picture formats, audio formats and video formats listed in above table are the vast majority of formats measured to support the format. It does not guarantee full support, nor rule out the existence of individual or a small range of frame rate not to be supported.

## 4. Operating System and Equipment

### 4.6.9 Characteristic Specification

Function	Item	Specification
Reception	AM received frequency	531~1629kHz
	FM received frequency	87.5~108MHz
Audio	Frequency range	0Hz~20KHz
	SNR	75dB (MP3)
	Frequency characteristics	+, -3dB
	Channel number	Left and right side stereo
Antenna	Signal receiving mode (antenna)	External antenna
Power supply	—	DC9~16.0V, ≤10A
Operating temperature	Use temperature	-30~75℃
	Storage temperature	-40~5℃
Interface	—	USB2.0 (Host)
File system	—	FAT 16/32 File System
File play specification	—	Supported audio file formats: MP3 and WMA



### 4.6.10 Pre-maintenance Inspection

When you think that some functions in the audio system are failure, before sending for maintenance, please read carefully the operation instructions in the Manual, and then check according to the following table to be conducive to eliminate the fault. If the fault still exists, please go to GAC MOTOR dealer for servicing. Do not disassemble the machine for maintenance arbitrarily.

Phenomenon	Possible Causes and Solutions
The host does not work, without display.	Check the fuses of host and car.
The host works, but there is no voice or small voice.	Turn up the volume.
	Check the FAD and BAL settings of speaker.
	Check the antenna and joint.
The machine body has gentle heating.	The radio heats normally during working.
The reception effect of radio is poor.	Check whether the antenna is extended fully and whether the connections are correct.
	Check whether the antenna amplifier in the car is damaged.
	The required station has too weak signal. Please use manual tuning.
USB cannot be read.	Replace the USB disk to try and carry out troubleshooting diagnosis.
Some audio files cannot be played.	Please make sure that the file is MP3 or WMA file. This machine is incompatible with the audio files except MP3 or WMA format.
The volume is changing during play of MP3 songs.	As the MP3 songs have extensive sources, without unified standard, it's probably caused by the different volume settings during compression of MP3 songs.
Intermittent pause occurs during music play.	It may be caused by different formats during compression of songs.

#### 4. Operating System and Equipment

Phenomenon	Possible Causes and Solutions
The media file in the storage device cannot be read.	Please make sure to check that the storage partitioned mode of the memory is FAT 16/32 of single partition on the computer. If not, it can reset as the standard required by the model on the computer.
MP3 songs cannot be read from all-in-one USB adapter.	The model is only compatible with the adapter with single USB port.
Sudden sound/Noise	It may be caused by the equipment or the noise during recording of original file of MP3. Please confirm whether it is the machine problem with other players.
Only one speaker has voice.	Check the sound field settings.
Some audio files cannot be played.	Please make sure that the file is MP3 or WMA file. This machine is incompatible with the audio files except MP3 or WMA format.
No power supply	If the fuse is damaged, replace the fuse with the same specification. Please go to the GAC MOTOR dealer for servicing in case that the fuse is damaged again.
No voice.	Check the volume adjustment.
	The FF or REW function is in use.

### 4.7 Audio System (AVN)\*

#### 4.7.1 Control Panel

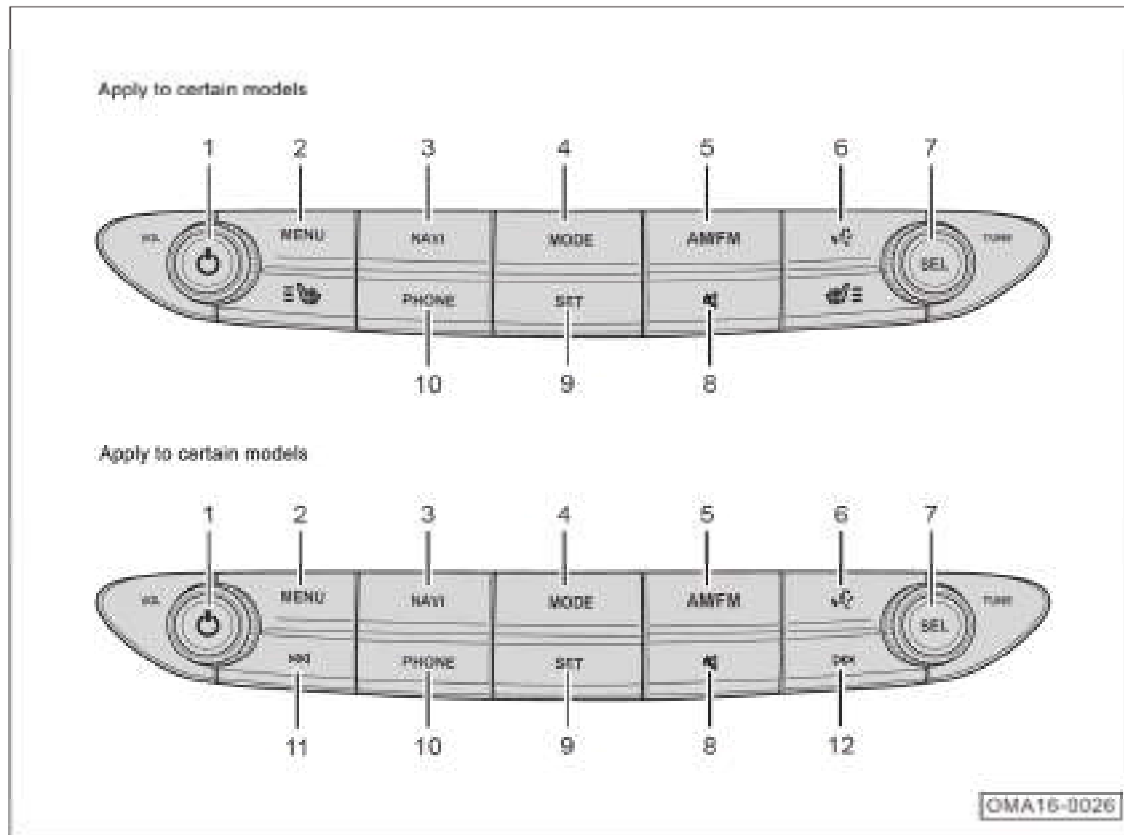

1. Power Button/Volume Adjustment Knob
  - Short press this button to power on under power-off state.
  - Under power-on state, short press this button to close the display screen, and close all the sound sources at the same time. If the screensaver interface under power-off state is set, the analog clock, digital clock or off screensaver can be shown.
  - Turn the knob clockwise to turn up the volume, and counter-clockwise to down the volume.
2. Main interface button
  - Short press this button on other media interfaces to back to the main interface of card mode.
  - In the main interface, short press this button to switch between card mode interface and button mode interface.
3. Navigation Button
  - Short press this button to enter the navigation map interface.

## 4. Operating System and Equipment

---

### 4. Audio Source Switching Button

- Short press this button continuously to switch: FM → AM → USB → Bluetooth music → FM.
- Pressing this button will not actively switch to CarLife music. If CarLife music is played currently, press this button to switch to the radio mode.

### 5. AM/FM Radio Button

- Short press this button to switch to radio mode in other sound source states.
- In radio mode, short press this button to switch the AM or FM radio band.

### 6. Voice button

- Connect the mobile phone with the host, start the CarLife function, and then short press this button for less than 0.5 seconds to start voice or end voice.

### 7. Select Button

- In radio state, clockwise rotation can increase the radio frequency; and counter-clockwise rotation can decrease the radio frequency.

### 8. Mute Button

- Short press this button to mute the media source.
- After muting, press again to unmute.

### 9. Setting Button

- Short press this button to firstly enter the "System Settings" interface; short press this button continuously to switch: System Settings → Car Settings → button mode interface.

### 10. Telephone Button

- Short press this button to enter the Bluetooth Telephone interface.

### 11. Station frequency adjustment/Previous button\*

- Short press to search the effective stations towards LF automatically under the radio interface.
- Long press to search the effective stations towards LF manually under the radio interface.
- Short press to jump to the previous under the music play interface.
- Long press for REW under the music play interface.

### 12. Station frequency adjustment/Next button\*

- Short press to search the effective stations towards HF automatically under the radio interface.
- Long press to search the effective stations towards HF manually under the radio interface.
- Short press to jump to the next under the music play interface.
- Long press for FF under the music play interface.

#### Hint

The interface or function of audio system introduced in the *User's Manual* may differ due to different vehicle configurations, i.e. it is for reference only. Please refer to the actual car you buy.

### 4.7.2 Control Buttons on the Steering Wheel

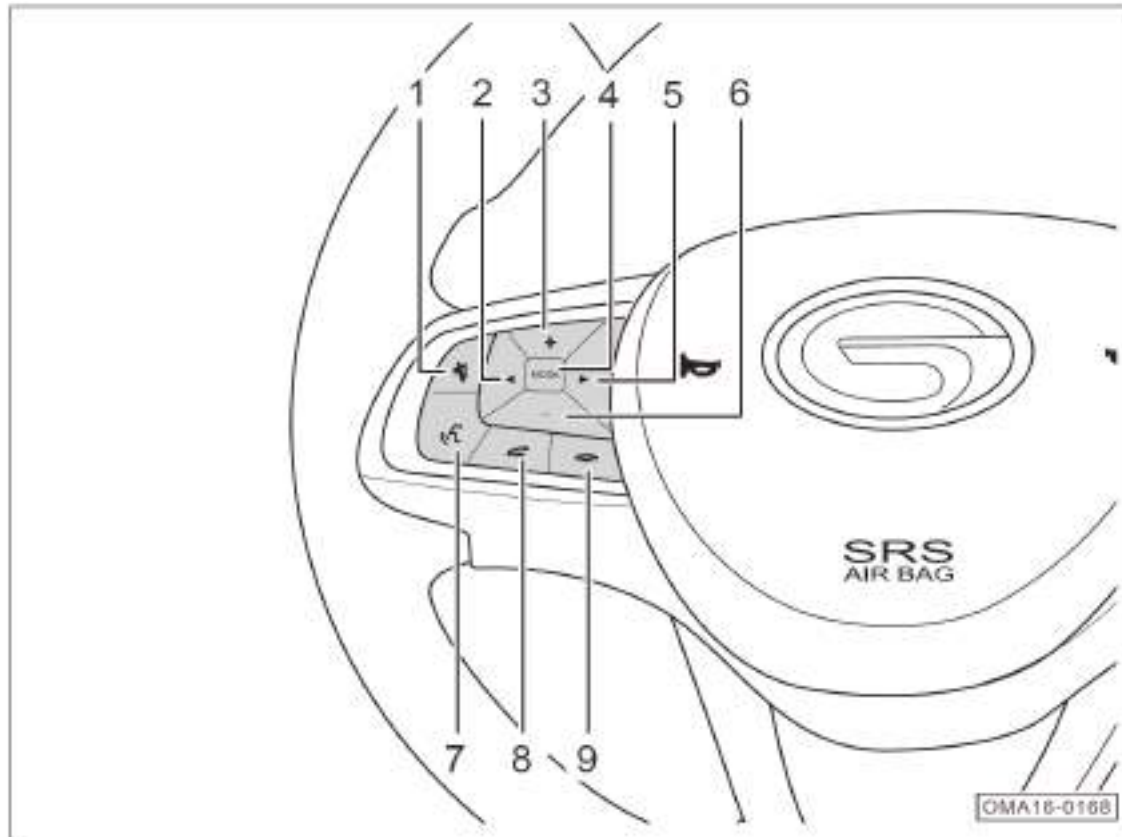

1. Mute Button
  - Short press this button to mute the media source.
  - After muting, press again to unmute.
2. Backward Button
  - In radio mode, search the station towards LF automatically. If an effective station is met, auto search stops and the station starts playing.
  - Change the track into the previous one in media source play.
3. Volume up Button
4. Audio Source Switching Button
  - Short press this button continuously to switch: FM → AM → USB → Bluetooth music → FM.
  - Pressing this button will not actively switch to CarLife music. If CarLife music is played currently, press this button to switch to the radio mode.

## 4. Operating System and Equipment

---

### 5. Forward Button

- In radio mode, search the station towards HF automatically. If an effective station is met, auto search stops and the station starts playing;
- Change the track into the next one in media source play.

### 6. Volume down Button

### 7. Voice button

- Connect the mobile phone with the host, start the CarLife function, and then short press this button for less than 0.5 seconds to start voice or end voice.

### 8. Answer Call Button

- When an incoming call is in the Bluetooth Phone system, press this button to answer.
- When there is no incoming call in the Bluetooth phone system, you can press this button to enter the "Bluetooth Setting" interface.

### 9. Hang-up Button

- When an incoming call is in the Bluetooth Phone system, press this button to reject;
- Press this button to end the current call in the call process.

### 4.7.3 Basic Operations

#### ON/OFF

- With the Start or Ignition switch at "ACC" or "ON" position and the screen saver interface displayed, short press  $\odot$  button to start the audio system.

#### Starting Tips Interface



When the Start or ignition switch is switched to "ACC" or "ON" position, the audio unit is started and "Tips" interface appears. Please read carefully the tips and operate the audio unit following these tips to prevent accidents.

#### Screen Saver

In power-on state, short press  $\odot$  button to display the screensaver interface. It can display three kinds of screensavers, such as dynamic state, clock and custom.

#### Dynamic Screensaver

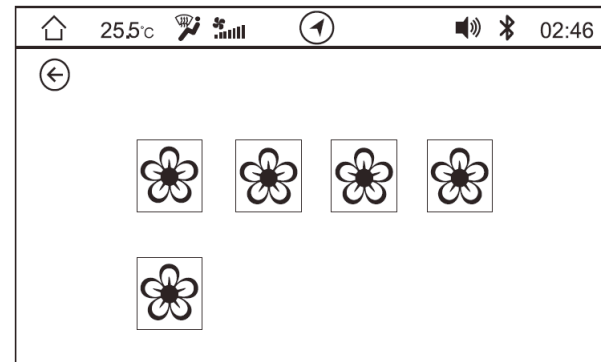

- Click the [Dynamic Screensaver] soft button on the main interface of card mode to enter the dynamic screensaver selection interface to select appropriate dynamic screensaver.

#### Clock Screensaver

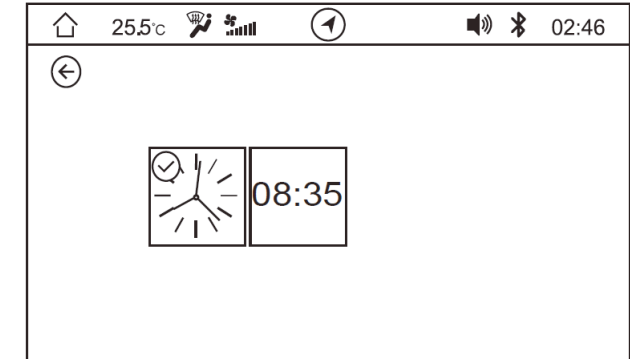

- Click the [Clock Screensaver] soft button on the main interface of card mode to enter the clock screensaver selection interface to select digital clock or analog clock screensaver.

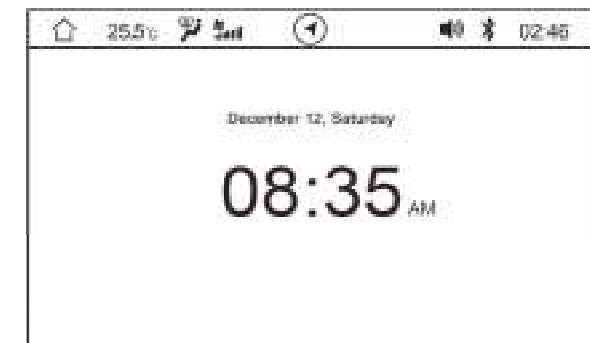

- Digital clock display.

## 4. Operating System and Equipment

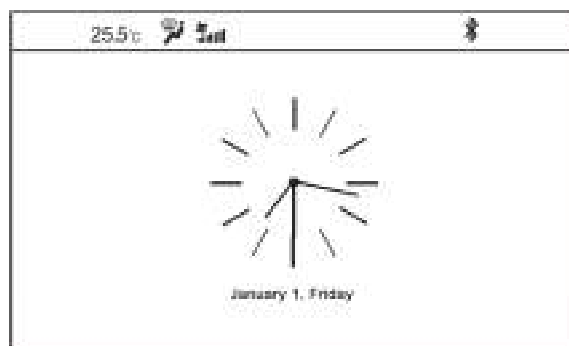

- Analog clock display.

### Custom Screensaver

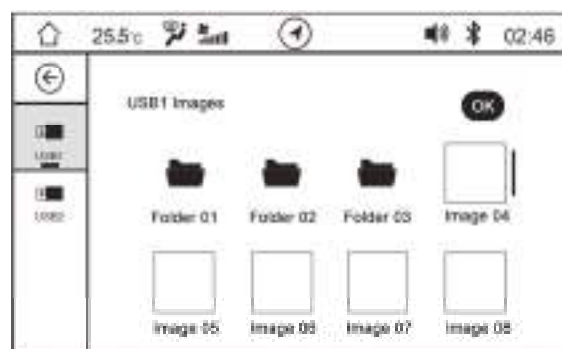

- Click [Custom Screensaver] soft button on the main interface of card mode to enter the selection interface of custom screensaver, and select a suitable picture as the screensaver depending on your personal preference.

#### **i** Hint



When the custom screensaver is selected, the unit has to be connected to the USB disk which shall contain pictures in the format supported by the unit.

### Volume Control

#### Volume Adjustment

- Turn the volume adjusting knob clockwise/counter-clockwise to turn up/down the volume.
- Short press the volume button +/- on the left side of the steering wheel to turn up/down the volume.



#### Mute

- By short pressing the  button on the left side of the steering wheel or on the control panel, the mute icon on the display goes on and the mute function is enabled;
- By short pressing the  button on the left side of the steering wheel or on the control panel again, the mute icon on the display disappears and the mute function is disabled;



### Main Interface

In other interfaces, short press MEUN or click  to enter the main interface.







The main interface contains card mode and button mode. Short press  or click  to switch each other.

### Card Mode



- The functions in card mode include navigation, radio, music, Bluetooth telephone and screensaver selection (dynamic, clock and custom). Card switching is realized by leftward or rightward sliding for page turning.

### Description of Soft Buttons

1. : Click it to switch to the main interface of button mode.
2. : Click it to enter the navigation search interface.
3. : Click it to switch to the navigation interface.
4. Panyu District, Guangzhou City: Click it to switch to the navigation interface.
5. Radio: Click it to switch to the radio interface.
6. : Radio: Click it to search the station towards LF automatically. If an effective station is searched, stop auto search and start playing; Music: Click it to switch to the previous song.
7. : Radio: Click it to search the station towards HF automatically. If an effective station is searched, stop auto search and start playing; Music: Click it to switch to the next song.
8. : Click it to play/pause.

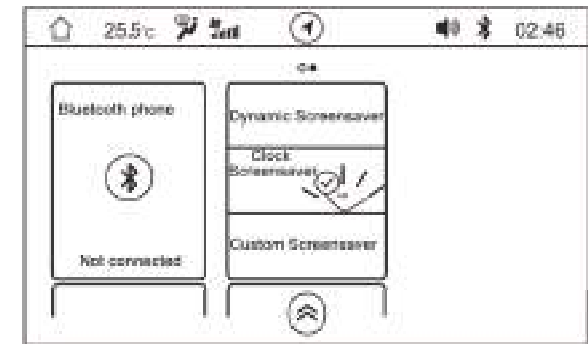

Description of soft button functions:

1. Bluetooth Telephone: Click it to switch to the Bluetooth telephone interface.
2. Dynamic Screensaver: Click it to switch to the dynamic screensaver selection interface.
3. Clock Screensaver: Click it to switch to the clock screensaver selection interface.
4. Custom Screensaver: Click it to switch to the custom screensaver selection interface.

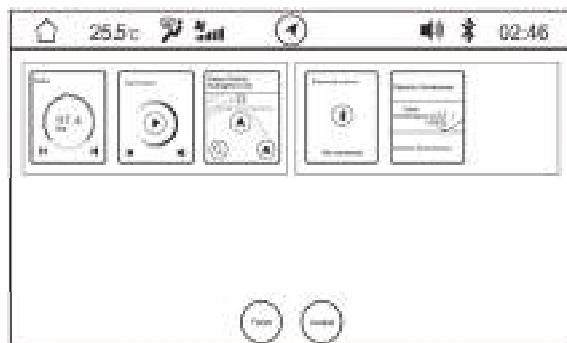

## 4. Operating System and Equipment

### Adjustment of Card Sequence



- Slide on the opposite angles of the display towards the middle with thumb and forefinger at the same time to enter the adjustment mode of card sequence.
- Long press the card to drag the card to adjust the card sequence.
- After the adjustment of the sequence, click [OK] to save.
- If do not need to save, click [Cancel] to exit.

### Button Mode

On the main interface of card mode, short press MENU on the control panel or click  or  soft button to switch the card mode to the button mode.



- The functions in button mode include CarLife, picture, video, setting and T-BOX\*.
- Click the soft buttons of corresponding functions to let the system switch to the corresponding functional interface.

### 4.7.4 Radio

Enter the radio mode through the following ways:

- Click the "Radio" in card mode to enter the radio mode;
- Press the MODE button on the control panel continuously to switch to the radio mode;
- Press MODE button on the left side of the steering wheel continuously to switch to the radio mode;
- Short press the AM/FM button on the control panel to enter the radio mode;

#### Band Selection

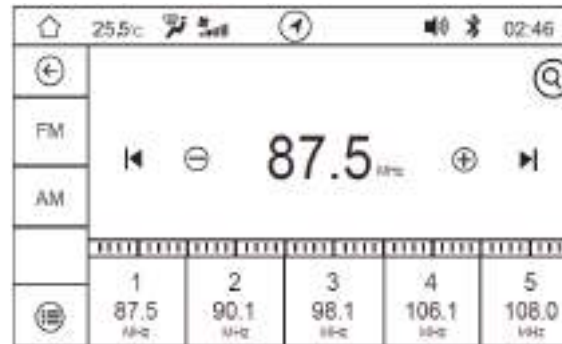

- Under the radio play interface, short press the AM/FM button on the control panel continuously to switch the band among "FM → AM → FM".
- Click FM or AM soft button on the interface to switch the band as well.

#### Radio Search Function

Radio stations are searched manually or automatically.

##### Manual Searching

- Click ⊕ soft button or turn "SEL" knob clockwise to change the station frequency by one step towards HF direction.
- Click ⊖ soft button or turn "SEL" knob counter-clockwise to change the station frequency by one step towards LF direction.
- Drag the frequency axis pointer leftward or rightward to search the stations.
- Long press ►► button to search towards HF direction\*.
- Long press ◄◄ button to search towards LF direction\*.

##### **i** Hint

- AM: 1 step size = 9KHz
- FM: 1 step size = 100KHz

## 4. Operating System and Equipment

### Auto Searching

- Click **▶|** soft button or short press **▶** button on the left side of the steering wheel to search for station towards HF automatically. If an effective station is met, stop auto search and start playing.
- Click **|◀** soft button or short press **◀** button on the left side of the steering wheel to search for station towards LF automatically. If an effective station is met, stop auto search and start playing.
- Short press **▶▶** button to search station towards HF automatically. If an effective station is met, auto search stops and the station starts playing\*.
- Short press **◀◀** button to search station towards LF automatically. If an effective station is met, auto search stops and the station starts playing\*.

### Manually Input the Frequency of Radio Station

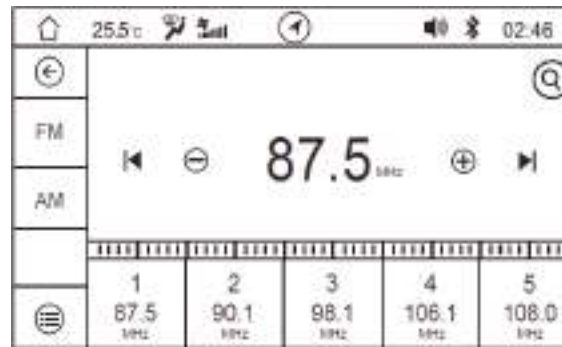

1. Click **Ⓚ** on the upper right corner to open the input keyboard.



2. Input the station frequency manually.

### Pre-save



- Long press soft buttons (1~5) on the lower part of the interface to pre-save the current playing station to the corresponding positions (1~5).
- Short press soft buttons (1~5) to play the corresponding pre-saved stations.

Auto Save



- Click  soft button to enter the auto save interface.



- If it needs to update the auto saved list, click [Search] soft button to display "searching". The system starts searching station to HF from LF automatically. The FM or AM stations with stronger signals will be saved in the auto saved list.
- During the auto search process, click other part operations or click the "Stop" soft button to break in the auto search.

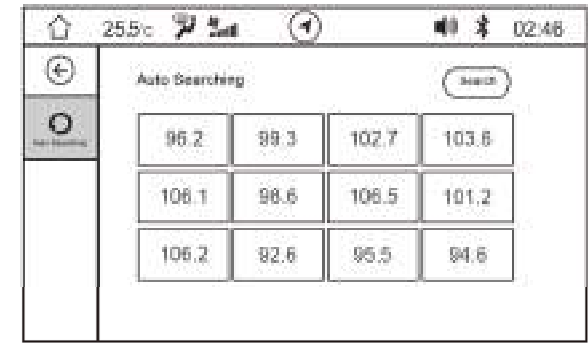

- After search, the system will save 12 stations with stronger signals in the list and start to play the station with the strongest signal.

**i Hint**

- In case of poor signal reception, less than 12 stations may be saved.
- When you use the auto save function, the original station saved in the band will be covered.

## 4. Operating System and Equipment

### Reception Form of AM/FM Car Audio

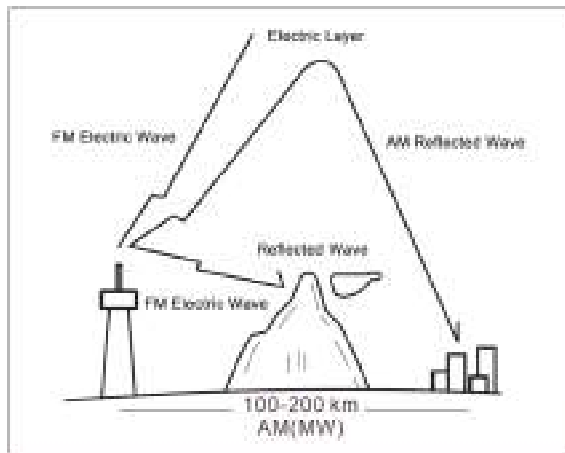

VHF channels on FM will pass through the ionosphere directly without reflection, but once they hit high mountains, high-rise buildings and other barriers, they will produce reflection. FM spreading distance is usually about 40~50 kilometers. It will become shorter when stereo signals are transmitted.

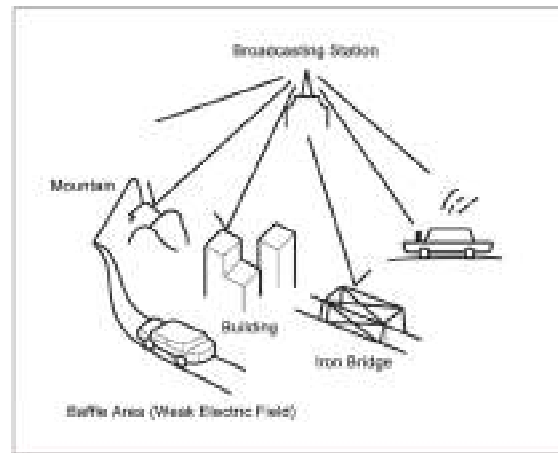

The radio is far away from the broadcasting station, so the signals are too weak to be received. As a result, the radio will only receive noises. When the car is driven between the areas to receive two strong stations with a close signal frequency at the same time, the radio may lose sound suddenly or produce noise interference.

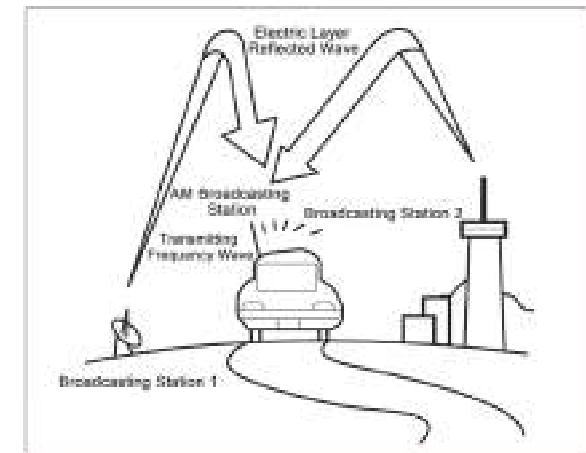

Although MW or SW of AM cannot pass through ionosphere, it will produce diffraction. As a result, when the radio waves hit high mountains and high-rise buildings, its spreading distance will be farther than that of FM. Therefore, it is likely to simultaneously receive the signals from two AM stations.

### 4.7.5 USB Play

#### Selection of USB Sound Source



- The USB interface ① is located in front of the auxiliary dashboard and can be used after the cover is opened.

There are several ways to enter the main interface of USB media source:

- Click the "Music" in card mode to enter the USB play mode;
- Short press the MODE button on the control panel continuously to switch to the USB play mode;
- Short press the MODE button on the left side of the steering wheel continuously to switch to the USB play mode.
- Click "Music" or "Radio" soft button on the main interface of the button mode to switch to the USB play mode; if the USB is unavailable, it shows "No Source". Please check whether the device is connected.



- After USB device is successfully connected, a prompt will be popped up. USB music, pictures and videos are compatible.

## 4. Operating System and Equipment

### USB Music Player







- Click  soft button to select the external device. Bluetooth (Bluetooth music), USB and iPod are compatible.





- The play interface can display the song name, singer name, total song duration and play time.

Description of soft button functions:

Icon	Description
	Previous/REW Function
	Next/FF Function
	Play
	Pause
	Drag FF/REW play progress

### Previous/REW button

- Short press  soft button to perform the Previous (when the play time of current song is lower than or equal to 5 seconds, press this button once to back to the previous; when the play time of current song is greater than 5 seconds, press this button once to back to the beginning of the song).
- Long press  soft button to perform REW of current track content (It is only available to the REW of current track to reverse to the beginning for automatic normal play. If do not reverse to the beginning, the normal play will be recovered as releasing).



### Next/FF button

- Short press ► soft button to perform the next.
- Long press ► soft button to perform FF of current track and recover normal play as releasing (If it is forwarded to the end of the track, the next track will be played normally. If this track is the last one in the folder, the first one in the next folder will be played normally).

#### i Hint

Certain models are equipped with ◀◀/▶▶ button on the control panel. Its operation method is same to that of ◀▶.

### Sound Effect Switch

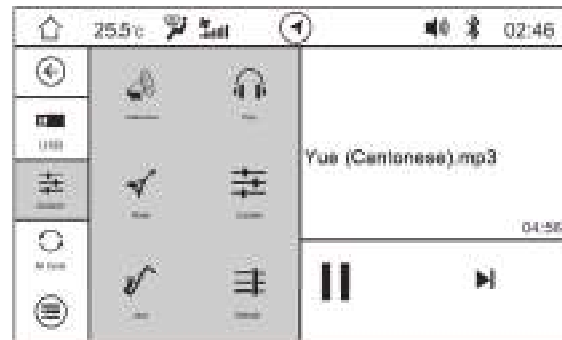

- Click "Default" soft button to switch the sound effect mode. The system supports six sound effect modes, including classic, popular, rock, default, jazz and custom.
- After the "Custom" sound effect is selected, the treble, alto and bass can be adjusted by yourself.

#### i Hint

The sound effect modes can be switched when 3D sound effect is disabled. => Refer to Page 199

### Loop Mode



Click "All Loop" soft button to select loop and random play modes according to the actual conditions:

- Random play: Play the songs according to random list and stop play after the end of play;
- Random disabling: Disable the random play;
- All loop: Play the songs according to the sequence list and play from the start again after the end of play;
- Loop disabling: Disable the loop play;
- Single loop: Play the song repeatedly. If the next song is selected, the next song will be played repeatedly.

## 4. Operating System and Equipment

### Music List



- Click  soft button to enter the list:
- Touch the corresponding class selection on the left side, such as "song", "artist" and "folder". The corresponding file list will be shown on the right side. Touch the song file on the right side to switch to the play interface of the selected song.
- Slide the scroll bar on the right side of the list upward and downward to find the song. Select the song through alphabetical order as well.

### USB Video Play



- Click "Video" soft button on the main interface of button mode or click "Video" soft button on the pop-up box as inserting the USB device to enter the video play interface.

### Hint

In view of the travel safety, the product is provided with restricted function of video play:

- When start switch or ignition switch is at "ACC" gear, the video can be played normally.
- When start switch or ignition switch is at "ON" gear and the car is in parking state, the video can be played normally. If the parking state is released, the video is prohibited to be played.
- During the vehicle travel process, when the video play is selected, a prompt window will be popped up to remind that the video cannot be played now.

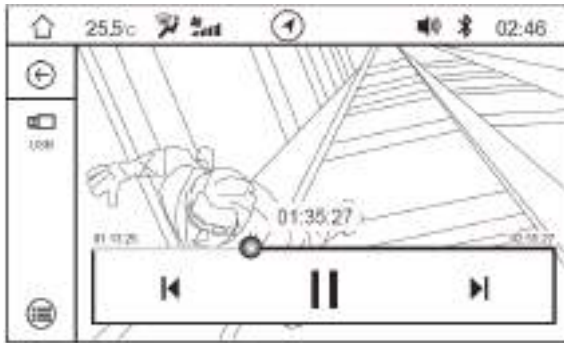

Description of soft button functions:

Icon	Description
⏮	Play the previous video
⏭	Play the next video
▶	Play
⏸	Pause
●	Drag FF/REW play progress

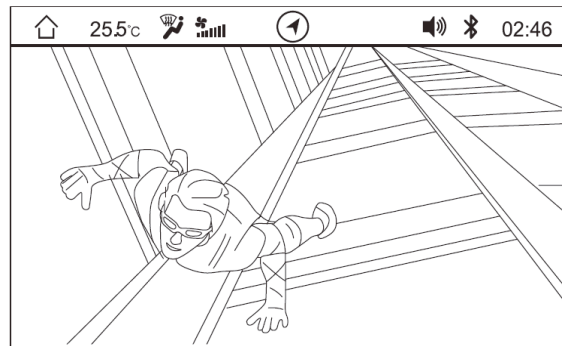

- When the video is switched to fullscreen play, click the video play interface to jump out of the soft button bar.

### Video List

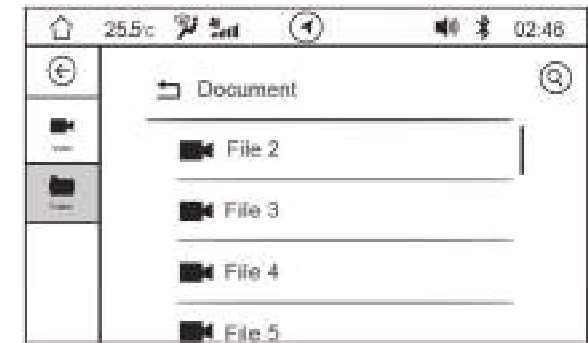

- Click 📺 soft button to enter the list:
- The list is divided into video list and folder list.
- On the video list interface, click the video to be played to enter the video play interface.
- Slide the scroll bar on the right side of the list upward and downward to find a video.

## 4. Operating System and Equipment

### USB Picture Play



- Click "Picture" soft button on the main interface of button mode or click "Picture" soft button on the pop-up box as inserting the USB device to enter the picture play interface.



Description of soft button functions:

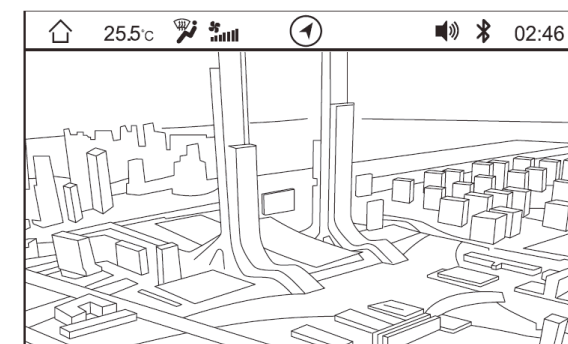

Icon	Description
⏮	Play the previous image
⏭	Play the next image
▶	Play
⏸	Pause

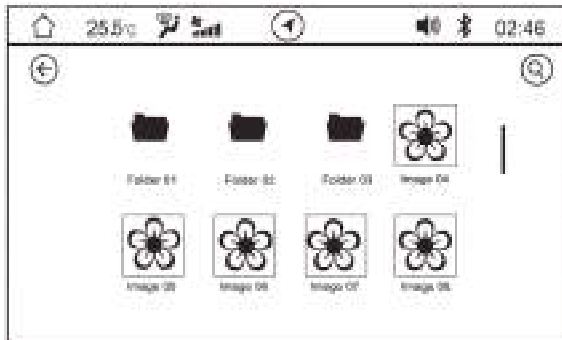

- When the picture is switched to fullscreen play, click the picture play interface to jump out of the soft button bar.
- During the picture scan process, zoom in or out the picture with two fingers.

### Image List



- Click  soft button to enter the picture list. The picture list is displayed in thumbnail form:
- Click the folder to enter the next file directory;
- Slide the scroll bar on the right side of the list upward and downward to find the picture or folder.
- Click  soft button to back to the previous folder directory.

#### Hint

Please use good-quality USB to ensure the play effect.

## 4. Operating System and Equipment

### 4.7.6 iPod Play

This product has been certified by iPod. After iPod or iPhone is connected to audio host through USB harness, music in iPod or iPhone can be played. If iPod or iPhone is not connected to audio host, it will prompt that there is no iPod when clicking “iPod” soft button.

#### System Setting

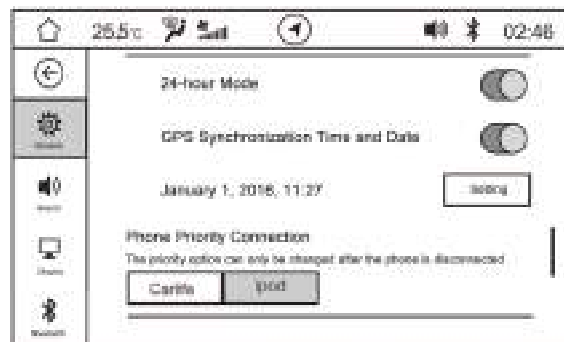

Open the general interface for audio system setting, and select ipod for the item “phone priority connection”. If CarLife is selected, ipod cannot be connected.

#### i Hint

- Refer to USB Play for procedure of iPod playing.
- In terms of USB harness connecting iPod equipment to audio host, be sure to use genuine harness; otherwise, failure of normal play may be caused.
- If iPod certification failure or failure of normal reading takes place, it is suggested to pull and plug USB harness again that connects audio host.
- If it prompts that iPod is in stop state, it is suggested to pull out iPod and replug it after clicking “play music”.

### 4.7.7 Bluetooth

#### Description

Bluetooth is a short-distance wireless communication technology. Without any physical connection, it can exchange information within 10 m. You can use the Bluetooth of the system to establish a wireless connection with your Bluetooth phone to achieve hands-free answer.

#### Instructions

- Turn on Bluetooth connection function: Turn on your phone's Bluetooth and the Bluetooth of the system unit when using the Bluetooth function, and make sure your Bluetooth phone is at a distance within 10m away from the system unit.
- The Bluetooth function of this system has passed relevant certification. If your phone in use cannot be paired to the Bluetooth of the system unit properly, or the Bluetooth functions abnormally after connection, check whether your phone meets the design requirements of the international Bluetooth standards or not.
- The Bluetooth function of this system only supports that one device is connected at a time, and generally, the Bluetooth phone also only supports that one device is connected. If your phone has searched the Bluetooth of this system, but it cannot be connected, check whether your phone has been connected to any other Bluetooth device around. If so, try to cut off the Bluetooth connection to your phone, or try to power off your phone, and then re-power on it and turn on the Bluetooth connection. Meanwhile, try to cut off all the Bluetooth connection to the system, and then turn on the Bluetooth connection function of the system.
- Just like using a mobile phone to answer calls, long-time Bluetooth conversation by connecting the system to your phone can do harm to your health due to electromagnetic radiation.
- 1000 telephone records can be downloaded.
- After the Bluetooth of the unit is turned on, use your phone to search for the Bluetooth device and connect it.

#### Entering Bluetooth Mode

You can enter Bluetooth mode by the following ways:

- Click "Bluetooth Telephone" on main interface of card mode to enter Bluetooth mode;
- Enter Bluetooth mode through short pressing "PHONE" button on the control panel;
- In non-call mode, short press  button on the left side of steering wheel to enter Bluetooth mode.

## 4. Operating System and Equipment





- If there is no Bluetooth device connected, the system will prompt in connecting new device.
- Enter Bluetooth setting interface by clicking  soft button, and use it after setting and connecting the Bluetooth function.

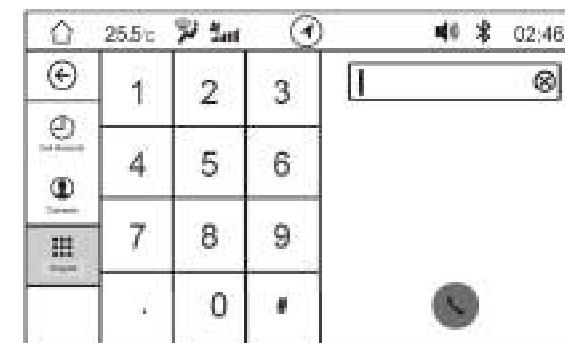

- After the Bluetooth device is connected, enter the interface and click "Audio", "Phone Book" or "Call" to enter corresponding interface.

### Make a Call



- When the phone has connected to Bluetooth of the vehicle, click "Dial" soft button on Bluetooth main interface to enter dial function interface.
- After inputting the phone number to be dialed in the dial button area (delete the inputted number by clicking  soft button, and long press and short press are both supported), click  soft button to dial the corresponding phone and enter the call state.









-If the contact is saved in the phone, the dial interface will display the contact name and default picture; if the contact is not saved, it will display the number and default picture.





During the call, clicking soft buttons on the call interface can realize:

- Click  to cut off the call;
- Click  soft button to switch Hands Free and Private mode (when the call is connected, the default mode is Hands Free);
- Click  soft button, realize mute and unmute;
- When the call is connected, click  to enter numbers.

### Answer a Call



When Bluetooth is connected and it does not enable automatic answer, clicking soft buttons on the incoming call interface can realize:

- Click  to answer the call;
- Click  to reject the call;

### Hint

In addition, press the Answer button on the steering wheel to answer the call; press the Hangup button on the steering wheel to reject the call.

## 4. Operating System and Equipment

### Call Records



- The call records after Bluetooth is connected are saved in “Call Records” of the system. On Bluetooth main interface, click the call record soft button to enter call records interface.
- If the call records are not synchronized, the system will display that call records are not synchronized. Click “Synchronize” soft button to synchronize the call records.
- The call records include received calls, missed calls and dialed calls.
- Pull down the scroll bar on the right side to browse the call records.

### Contacts

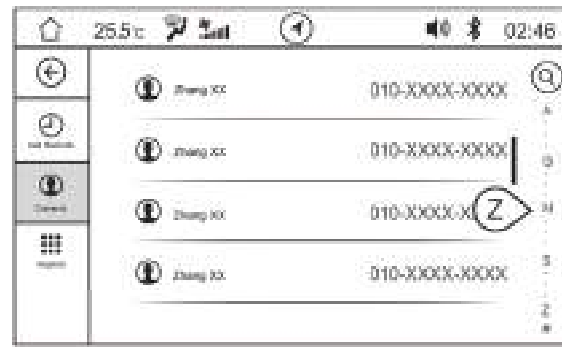

- After Bluetooth is connected successfully, click “Phone Number” soft button on Bluetooth main interface to enter phone book interface.

#### i Hint

The phone number function requires that the mobile phone supports the phonebook download function.

- If the phonebook is not synchronized, the system will display that phonebook is not synchronized. Click “Synchronize” soft button to synchronize the phonebook.

#### i Hint

It is required to confirm on the phone whether you agree to synchronize the phonebook.

- After the synchronization is completed, the system will display the contacts in alphabetical order. Pull down the scroll bar on the right to browse the contact, or pull down the alphabet on the right to list all the contacts with the initial.
- Click the contact required for dialing.
- Short press  on the top right corner to open the keyboard, input initials and English letters to find the contact number.

Bluetooth Music



- After the Bluetooth device is connected, enter the interface and click "Audio" enter corresponding interface.







- Click "Music" on main interface of card mode to enter music play interface;
- Click  soft button to select Bluetooth music, the music on device can be played through Bluetooth.

**i Hint**

- This function requires your phone to support. Some mobile phones may need to enter the music player mode.
- Check whether the information on the music player interface is displayed or not depends on the phone support.



Description of soft button functions:

Icon	Description
	Play the previous track
	Play the next track
	Play
	Pause

- Bluetooth music supports the display of song name and singer; it supports selection of preset sound effect; it does not support playing progress display, loop mode selection or play list.

## 4. Operating System and Equipment

---

### Caution

- Bluetooth only supports the connection of certain phones. Some phones may not be able to be connected to it or cannot be used normally after connection.
- When the phone is connected to the Bluetooth, after the WeChat voice is played, the Bluetooth call interface may be displayed and cannot be exited after that. This is mainly caused by the phone itself. For the car, calling and playing WeChat voice of the phone both may be considered as calling. The incomplete feedback of some phones to the status can cause loss of host interface display or display over a long time.

### 4.7.8 System Setting

You can enter the system setup interface by the following ways:

- Click "SET" soft button on card mode main interface to enter the system setting interface.
- Continuously short press the SET button on the control panel to enter the system setting interface.

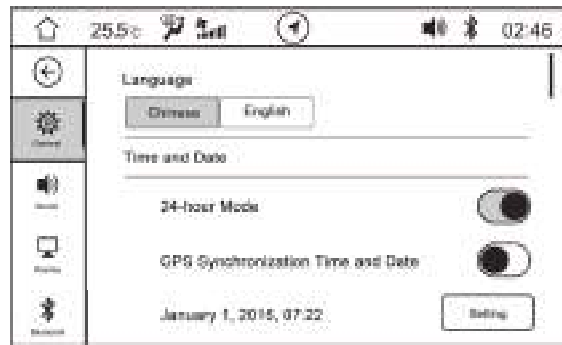

- On the system setting interface, it can make setting on "general, sound, display, Bluetooth and factory reset".
- Pull up and down the soft button column on the left side, and click the soft button to enter the corresponding setting interface.

### General Setting

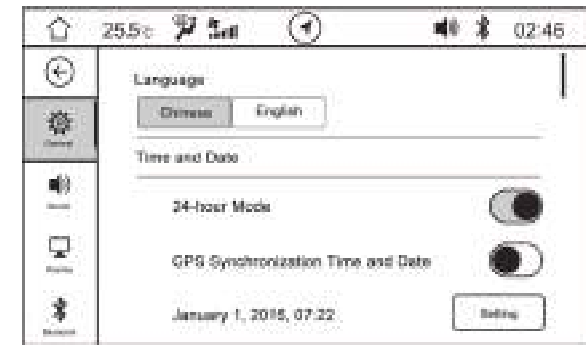

It can set display language, time and date and phone priority connection on this interface.

## 4. Operating System and Equipment

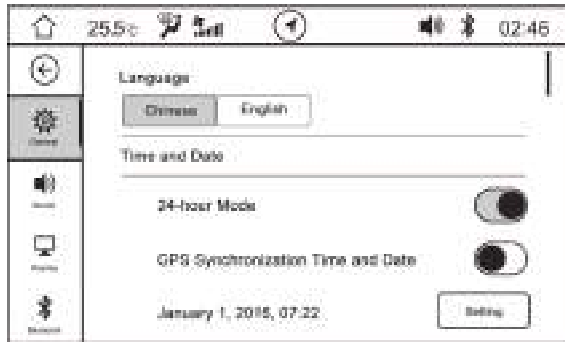

### Language

-Language setting can select Chinese or English. After restoring factory settings, it defaults to be Chinese.

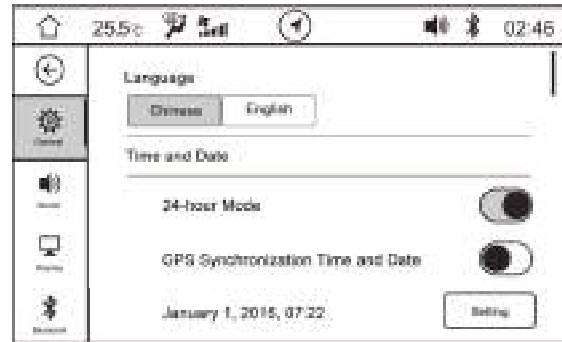

### Time and Date

- 24-hour system: After being enabled, the system time will be displayed in 24-hour system; after being closed, the system time will be displayed in 12-hour system; after restoring factory settings, it defaults to be 24-hour system.
- GPS time and date synchronizing: After being enabled, the system will automatically synchronize GPS time and date; after restoring factory settings, it defaults to be enabled.

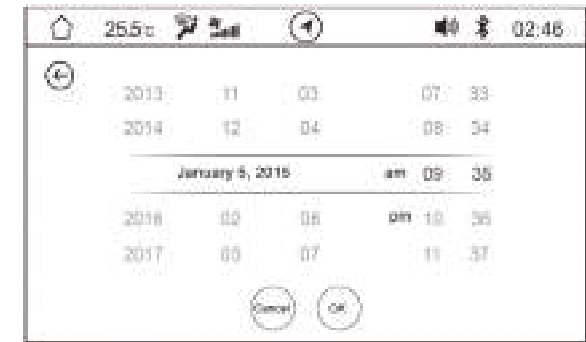

### Manual setting of time and date

- Click "SET" soft button the right of time and date to enter manual setting interface.
- Scroll year/month/date/hour/minute to adjust the date and time, which will be saved when clicking "confirm" soft button.

#### **i Hint**

When GPS time and date synchronizing function is enabled, manual setting of time and date cannot be performed. If manual setting is required, GPS time and date synchronizing function shall be disabled.

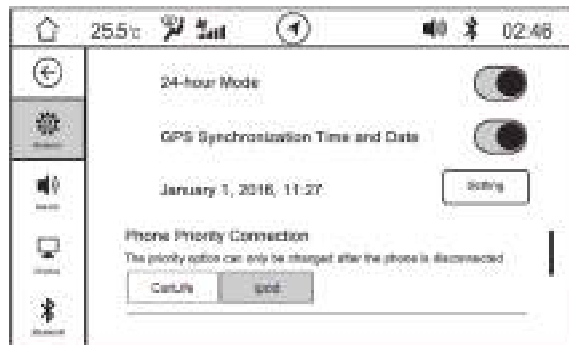

**Phone Priority Connection**

- Phone priority connection can select that the system gives priority to connect iPod; after restoring factory settings, it defaults to be iPod.

**Sound Setting**

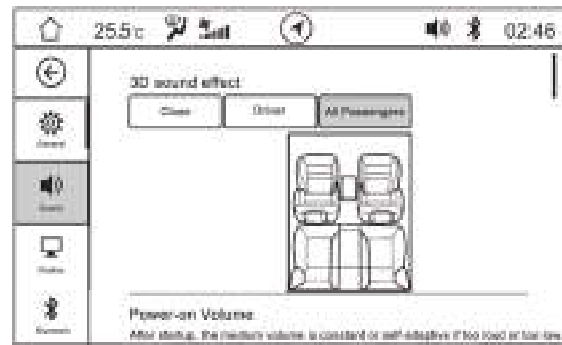

**3D sound effect**

- Select 3D sound effect (close, all passengers and driver) to set different optimum locations for listening to sounds; after restoring factory settings, it defaults to be "all passengers".

**i Hint**

Only when 3D sound effect is in off state, preset sound effect function can be set.

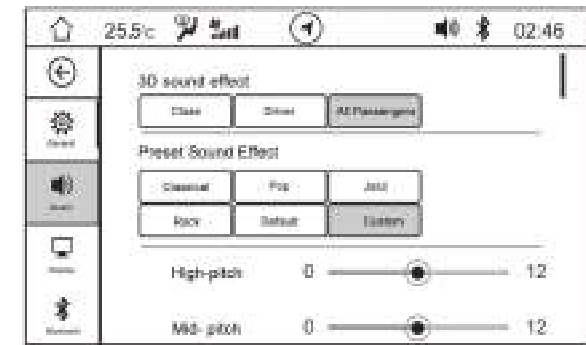

**Preset Sound Effect**

- Select preset sound effect: classics, popular, jazz, rock, default, custom, which correspond to different high, middle and low pitch combinations respectively.
- When custom is selected, the high, middle and low pitches are all defaulted to be 0, and they can be adjusted manually.
- When custom is selected, the sound field is defaulted to be "centralized", and it can be set manually.
- After factory reset, "Custom" is in default.

## 4. Operating System and Equipment

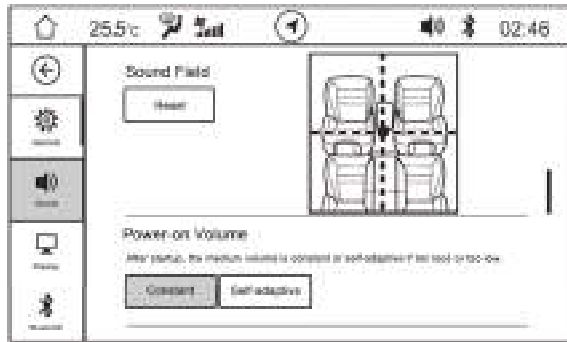

### Sound Field

- Adjust the sound field position via the touch screen.
- Click “Reset” to restore the default values for resetting.

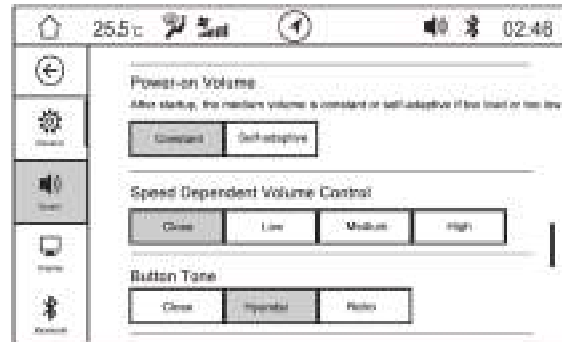

### Power-on Volume

- Constant: The power-on volume remains the same as that before the last power-off.
- Adaptive: Whatever the volume is before the last power-off, the volume of the system is defaulted to be 15 at the time of power-on after powering off.
- After restoring factory settings, it defaults to be “Adaptive”.

### Speed Dependent Volume Control

Speed dependent volume control can select off, low, medium, high, which adjusts the amplitude of sound under the influence of the acceleration or deceleration.

- After restoring factory settings, it defaults to be “Off”.
- The output volume performs automatic adjustment along with the speed change. The state table of volume along with speed is as follows:

Status	Volume Change
OFF	The sound will not be changed with the speed
Low	The sound will be changed with the speed at a low degree
Medium	The sound will be changed with the speed at a medium degree
High	The sound will be changed with the speed at a great degree





### Button Tone

- Adjust the button tone of touch screen with the options of: off, modern and vintage.
- After factory reset, "Modern" is in default.

### Reverse Media Volume

- Constant: When the host is at normal working state and the reversing media volume is set as constant, the host can play the media sound source normally at the reverse gear, and the media volume can be adjusted.
- Mute: When the host is at normal working state and the parking media volume is set as mute, the host will be mute at the reverse gear.
- After restoring factory settings, it defaults to be "Mute".

### Unlocking/Locking Whistling Prompt

Click  soft button to turn on or off the unlocking/locking prompt sound :

- On: There will be prompt when the car is unlocked/locked;
- Off: There will be no prompt when the car is unlocked/locked.
- After factory reset, "Open" is in default.

### Display Setting

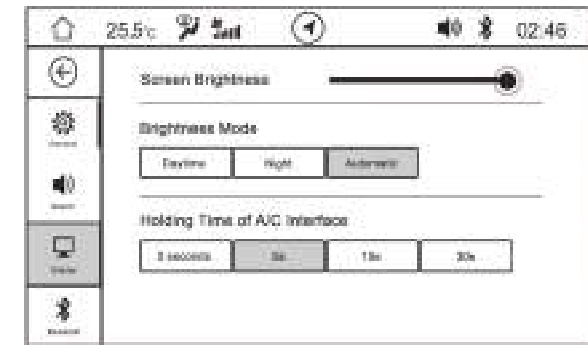

### Screen Brightness

- It can be adjusted by dragging the progress bar.

### Brightness Mode

- Day mode: day mode brightness in default;
- Night mode: night mode brightness in default;
- Automatic mode: It switches day and night modes according to the position light.
- After restoring factory settings, it defaults to be automatic mode.

### Holding Time of A/C Interface

- The holding time of A/C interface without operation can be selected as 3s, 5s, 15s or 30s.
- After factory reset, it defaults to be 5s.

## 4. Operating System and Equipment

### Bluetooth Setting

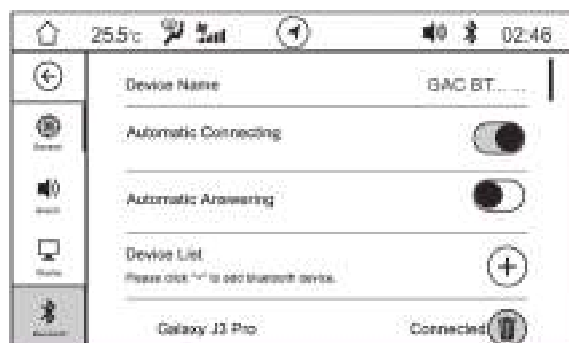

Bluetooth setting interface can view the equipment name, automatic connection or not, automatic answer or not and adding device to the device list.

#### Automatic Connecting

- On: Paired devices in the device list will be automatically connected after entering the connecting scope;
- Off: Paired devices in the device list will not be automatically connected after entering the connecting scope.

#### Automatic Answering

- At on state, the system will automatically answer the call when there is any.
- At off state, the system will not automatically answer the call when there is any; the call shall be answered manually.

### Device List

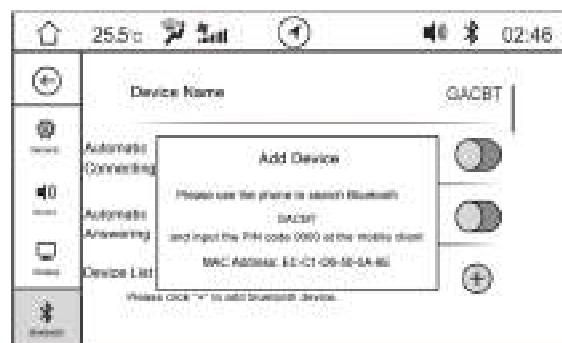

- Click  soft button to pop up the prompt box.

#### Hint

Whether to input the PIN code or not shall be judged according to different phone models.

- Search the prompted device name with mobile phone and input PIN code in the prompt box to connect the car Bluetooth. It will display in the device list after being connected successfully.
- The Paired Bluetooth devices will be listed in the device list, and if a device is successfully connected, it will be displayed as "Connected".

### Factory Reset



- Click "Reset" soft button on the factory reset interface, and the system will pop up a dialog box. Click "Confirm" to restore the system setting as the factory settings.

#### Hint

On the interface, you can check the current version information of the audio system.

### 4.7.9 Car Setting

You can enter the car setting interface by the following ways:

- Click “Car Settings” soft button on card mode main interface to enter the car setting interface;
- Continuously short press SET button on the control panel to enter the car setting interface.

Slide the car setting interface leftward/rightward/upward/ downward to switch the setting interfaces.

#### Caution

Some car setting functions will only be valid when the Start or Ignition switch is at “ON” position, so that the Start or Ignition switch shall be guaranteed at “ON” position when setting the vehicle.

Some car setting functions may differ due to different vehicle configurations, please refer to the configuration of actual vehicle.

### Driving Assist

Click “Drive Assist” soft button to enter the driving assist setting interface so as to set “safe speed prompt and steering mode” function.

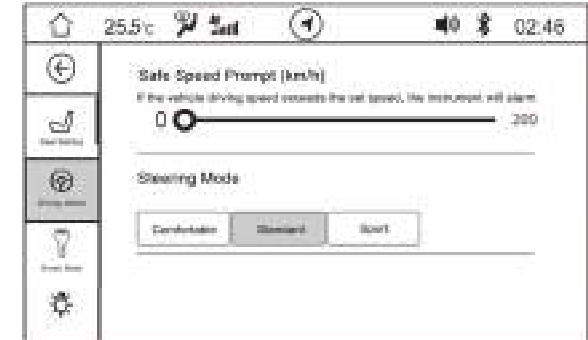

#### Safe Speed Prompt (km/h)

- Move the cursor left and right to set the speed of safe speed prompt at the range of 0~200km/h.
- After restoring factory settings, it defaults to be 0km/h.

#### Steering Mode

- Click the soft button to set as comfortable, sport or standard mode.
- After restoring factory settings, it defaults to be standard mode.

## 4. Operating System and Equipment

### Smart Body

Click “Smart Body” soft button to enter smart body setting interface, which can set remote unlocking, speed locking, automatic unlocking, automatic folding exterior rear-view mirror\*, front wiper maintenance and remote control front left window and sunroof functions.



#### Remote Unlocking

- Click soft button to set “all doors” or “only front left door”;
- After restoring factory settings, it defaults to be “all doors”.



#### Vehicle speed locking

- Click  soft button to set the function on/off.
- After restoring factory settings, it defaults to be “Off”.

#### Automatic Unlocking

Click  soft button to set the function on/off.

- After restoring factory settings, it defaults to be “Off”.

#### Exterior Rear-view Mirror Automatic Folding\*

Click  soft button to set the function on/off.

- After restoring factory settings, it defaults to be “On”.

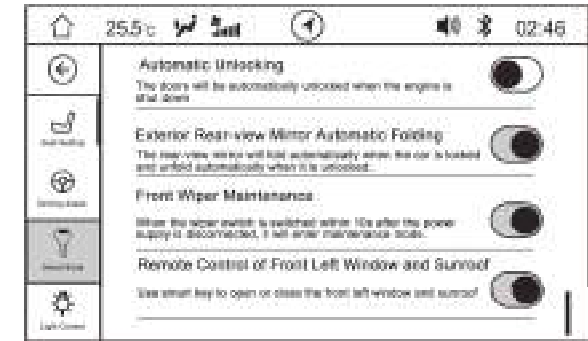

#### Front Wiper Maintenance

- Click  soft button to set the function on/off.
- After restoring factory settings, it defaults to be “On”.

#### Remote Control of Front Left Window and Sunroof

- Click  soft button to set the function on/off.
- After restoring factory settings, it defaults to be “On”.

**Light Control**

Click “Lighting Control” soft button to enter the lighting control setting interface (slide left/right to switch interfaces), which can set “auto light sensitivity”, atmosphere light control\*, follow me home, and daytime running light\*\* functions.

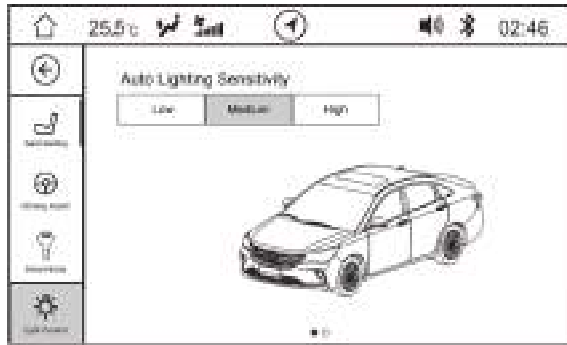

**Auto Lighting Sensitivity\***

- Click the soft button to set as "low", "medium" and "high".
- After restoring factory settings, it defaults to be "medium".

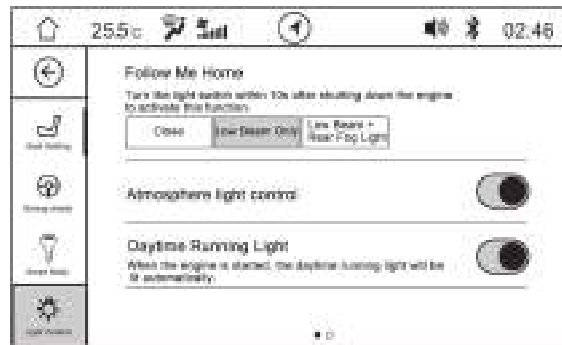

**Follow Me Home**

- Click the soft button to set as “OFF”, “low beam only” and “low beam + rear fog”.
- After restoring factory settings, it defaults to be “low beam only”.

**Atmosphere Light Control\***

- Click  soft button to set the function on/off.
- After restoring factory settings, it defaults to be “On”.

**Daytime Running Light\***

- Click  soft button to set the function on/off.
- After restoring factory settings, it defaults to be “On”.

**A/C Setting\***



**Interior/Exterior Circulation Smart Control\***

- Click  soft button to set the function on/off.
- After restoring factory settings, it defaults to be “Off”.

**A/C Comfort Curve\***

- Click the soft button to set as "soft", "normal" and "fast".
- After restoring factory settings, it defaults to be "normal".

## 4. Operating System and Equipment

---

### A/C Control

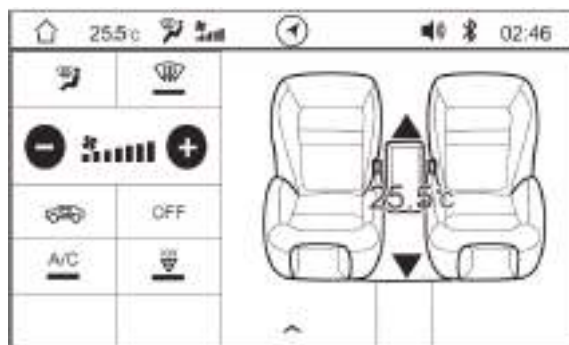

Click  on the status bar to enter A/C control interface:

: Switch between blowing modes.

: Turn on/off front defrost.

: Adjust the air speed.

: Enable/disable the anion purifier mode\*.

OFF: Turn off A/C.

: Turn on/off A/C.

: Switch the circulation mode (interior/exterior circulation).

: Increase/decrease temperature.

### Caution

Refer to detailed description provided in A/C system for A/C display and operation logic.

4.7.10 Supported Formats

**Supported USB Disk Formats**

Supported Format	FAT, FAT32, ExFAT
Supported Capacity	512MB-32GB
ID3 coded formats:	ID3 code version is related to songs. It is V1 version if ID3 information is put at the end of a song while it is V2 when the information is put at the beginning of a song. Songs determines ID3 code

**Supported Picture Formats**

Media Type	Format (expanded name)	Maximum Resolution	Maximum size	Supported Coded Format of File Name
Image	JPG	4000*2000	≤4M	.bmp, .jpg, .png, .jpeg
	PNG			
	BMP			

## 4. Operating System and Equipment

---

### Supported Audio Formats

Media Type	Format (expanded name)	Audio Code	Supported Coded Format of File Name
Audio frequency	WMA	WMA7/8/9/9.1/9.2/10	.mp3 .wma .acc .ogg .mp1 .mp2 .m4a .m4b .wav .ac3 .ape .flac .ra .amr
	MP3	MPEG -1/2/2.5	
	MP3pro	CBR VBR	
	ACC	.acc, .m4a	
	OGG	ABR, CBR, VBR	
	RA	Mono, Stereo, Multichannel	
	WAV	ADPCM, PCM	
	FLAC	Compression level 0/1/2/3/4/5/6/7/8	
	APE	Mode Fast/Normal/High/ Insane/Extra High	
	AC3	—	
	AMR	—	



Supported Video Formats

Media Type	Format (expanded name)	Maximum Resolution	Video Code	Audio Code	Supported Coded Format of File Name
Video	AVI	1920x1080	DivX4/X5	AAC (ADTS), MP2, MP3	.mov .mp4 .avi .wmv .asf .mpg .vob .rv .rmvb .3pg
			DivX6	MP3	
			MPEG4	AAC (ADTS), MP2, MP3, AC3	
			XviD		
			H.264		
	3G2		XviD	ACC, AMR	
	ASF		MPEG-4	MP3	
			WMV9	WMA9	
	3GP		MPEG-4	AMR, AAC	
	DAT		H.264	AMR	
	FLV		MPEG-1	MP2	
			H.264	AAC, MP3	
			H.263	PCM, MP3	
			H.264	AAC, MP3	
			MPEG4	AAC	
	MOV		Serenson Video	MP3	
MP4		H.264 BP/HP/MP, V-A (MPEG4), V-A (H.264)	AAC		

#### 4. Operating System and Equipment

Media Type	Format (expanded name)	Maximum Resolution	Video Code	Audio Code	Supported Coded Format of File Name
Video	MPEG (MPG)	1920x1080	MPEG1 NTSC/PAL	MP2	.mov .mp4 .avi .wmv .asf .mpg .vob .rv .rmvb .3pg
			MPEG2 NTSC/PAL	MP2/AC3	
	REAL (RMVB)/ REAL (RV)		RV30 (Real8), RV40 (Real9), RV40 (Real10)	AAC	
			RV30 (Real8), RV40 (Real9), RV40 (Real10), RV40 (1920x1080)	Cooker	
	TRP		AVC/MPEG2	AC3	
	TS		MPEG2	MP2/AC3	
	VOB		MPEG1	MP2	
			MPEG2	MP2/AC3/PCM	
	WMV		WMV8	WMA8	
			WMV9	WMA9/9.2	

Note: The supported USB disk formats, picture formats, audio formats and video formats listed in above table are the vast majority of formats measured to support the format. It does not guarantee full support, nor rule out the existence of individual or a small range of frame rate not to be supported or failure to connection/read due to non-genuine USB disk.

### 4.7.11 Precautions for Use of USB

Please carefully read the following precautions before USB play:

1. If the engine has been started, maintain USB device connected. Starting the engine under the connection of USB device may damage the USB device.
2. When the engine is started or shut down under the connection of USB device, the USB device may not react.
3. Files not in standard formats such as MP3 and WMA probably cannot be played.
4. MP3 file can be played only when the compression ratio is 8 Kbps ~ 320Kbps and WMA file can be played only when the compression ratio is 32 Kbps ~ 320 Kbps.
5. The connection of USB device may be not identified due to the status of the USB device occasionally.
6. USB device in the format of FAT16/32 only can be read.
7. USB device may not work because of compatibility, so please confirm the USB device can work before use.
8. Do not let your body or other things touch the joint of USB device.
9. USB device may be damaged by repeated plugging in a short time.
10. Suddenly unplugging USB device during file playing may damage USB device or cause abnormal conditions. So, please turn off audio system or switch to other play modes before unplugging USB device.
11. The duration for identifying the connection of USB device varies with the type of USB device, memory or format of file saved.
12. Do not use USB interface for charging, because this may reduce the product performance or result in fault.
13. USB device may be not identified when ordinary USB or extended cable is used, so please directly connect USB device to USB interface.
14. If MP3 PLAYER, mobile phone or digital camera connected cannot be identified, the head unit may not work properly.
15. SD Type USB memory stick or CF type USB memory stick and other USB devices for connecting Adapter may be not identified.
16. USB device may be poorly connected due to car vibration.
17. Do not unplug USB device immediately during the playing of USB video, otherwise, USB device may be damaged.
18. The more files, the longer time for opening and playing USB; for rapid read, make files copied to USB as few as possible and try not to place irrelevant files (e.g. APPs, maps).
19. For playing USB, the opening time may vary with different music, video or image files (for example, longer time is required for opening image files occupying large memory space, high-definition video and audio); too long opening time may result in restart.

## 4. Operating System and Equipment

---

20. Fast forward and fast backward of video playing is subject to addressing by frame; the converted video data may be not in standard format, and irregular fast forward and fast backward may occur during the playing of USB video, causing blocking; or some key frames are lost after conversion, blocking may occur, causing restart.

4.7.12 Precautions for Product Use

**⚠ Warning**

- When navigation system is used for route navigation, please drive according to the actual traffic rules. If the driver only follows the route navigation of the navigation system when driving, sometimes he may break traffic rules or even cause traffic accident.
- During the driving process, the driver shall check the images within the shortest possible time. Watching the image for a too long time may cause traffic accident.
- During the driving process, the driver shall not execute address login, facility search or other operations, which must be operated after parking. Inattention to observe the front situations may cause traffic accident.
- Do not privately disassemble or transform this product, which may cause traffic accident, fire or electric shock, etc.

**⚠ Warning**

- It should be noted that water or other foreign matters shall not intrude into the product, which may cause smoking, fire, failure, etc. In case that smoking or other abnormal conditions occur due to foreign matter intrusion or water soaking, immediately stop using, and contact your GAC MOTOR dealer as soon as possible. Any continued use may cause failure.
- Do not use at failure state, including no image display or no sound, which may cause accident, fire, electric shock, critical failure, etc.
- Turn off the touch screen before wiping, for which soft dry cloth shall be used. Do not use coarse cleaning cloth, chemical cleaning cloth or organic reagent (alcohol, benzene, disinfectant, etc.), which will damage or deteriorate the panel.

**⚠ Warning**

- During a thunderstorm, do not touch antenna or other circuits, which may cause electric shock due to lightning stroke.
- Do not operate this product in an area where parking is prohibited, which may cause traffic accident.

**👁 Caution**

- Please drive according to the traffic conditions. During the navigation process, the driver may drive the car into an area of no entry due to change of rules.
- During the driving process, the volume shall be adjusted in such a manner that the driver can hear the conditions outside the car. If the volume is too high and the driver cannot hear the conditions outside the car, accident may occur.

## 4. Operating System and Equipment

### 4.7.13 Guide on Elimination of Common Faults

When you think that some functions in the audio system fail, please read carefully the operation instructions in the Manual, and then check according to the following table. If the fault still exists, please go to GAC MOTOR dealer for servicing.

Phenomenon	Possible Causes and Solutions
The host works, but there is no voice or small voice.	Turn up the volume.
	Check the FAD and BAL settings of speaker.
The reception effect of radio is poor.	The required station has too weak signal. Please use manual tuning.
USB cannot be read.	Replace the USB disk and carry out troubleshooting diagnosis.
Some audio files cannot be played.	Please check whether the file is in supported formats. The system does not support audio files not in supported formats.
Video file plays abnormally	Please check whether the file is in supported formats. The system does not support video files not in supported formats.
The volume is changing during play of MP3 songs.	As the MP3 songs from a wide range of sources, it's probably caused by the different volume settings during compression of MP3 songs.
Intermittent pause occurs during music play.	It may be caused by different formats during compression of songs.
The media file in the storage device cannot be read.	Please make sure to check that the storage partitioned mode of the memory is FAT/FAT32 of single partition on the computer. If not, it can reset as the standard required by the system on the computer.
MP3 songs cannot be read from all-in-one USB adapter.	The model is only compatible with the adapter with single USB port.
Sudden sound/Noise	It may be caused by the equipment or the noise during recording of original file of MP3. Please confirm whether it is the system problem with other players.
Red, blue or green dots are shown.	TFT is manufactured with high density technology. In case of below 0.01% of all pixels, insufficient pixels or keeping lighting up may occur
Only one speaker has voice.	Check the sound field settings.
Color or contrast quality is reduced	The contrast and brightness are not adjusted properly.
No voice.	Check the volume adjustment.
	The FF or REW function is in use.

### 5.1 Starting and Driving

#### 5.1.1 Ignition Switch\*

##### Ignition Switch

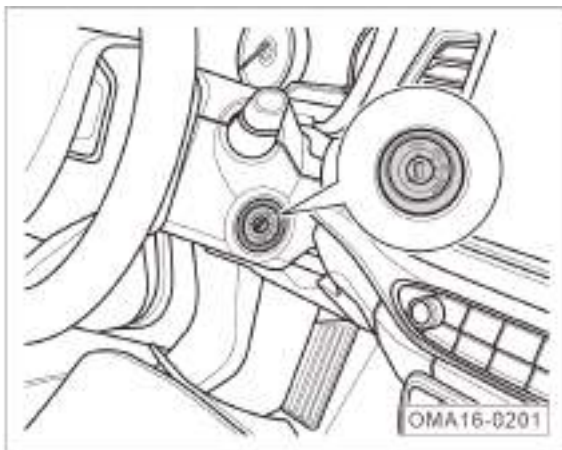

The Ignition switch has 4 gears in total.

**LOCK:** The circuit is disconnected and the key could be pulled out only at this gear.

**ACC:** The cigarette lighter and other accessory circuits are switched on.

**ON:** Instrument light is on and all electrical device circuits are switched on; the Ignition switch will switch to this gear after the engine is started.

**START:** This gear is only used to start engine.

#### **i** Hint

When the key cannot or is hard to be twisted from the "LOCK" position to "ACC", it can turn the steering wheel slightly, and separate the LOCK mechanism on steering wheel until it can twist the key to switch the ignition lock.

## 5. Driving Guide

### 5.1.2 Start Switch\*

#### Start Switch Mode

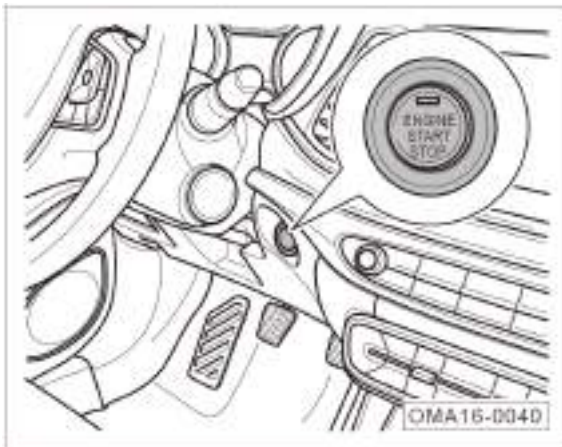

ENGINE START/STOP button (Start Switch) is similar to the traditional ignition switch. During operation, the intelligent remote control key is required to enter the car, and then press the start switch to switch all the gears or start/stop the engine.

#### i Hint

Only when the smart key is detected in the car can the Start switch be operated.

The Start switch is at "OFF" position if not operated.

When the automatic transmission shift lever is at "P" position without pressing the brake pedal, press the Start switch and then it will switch by the order of "OFF" → "ACC" → "ON" → "OFF".

OFF: Switch indicator light is off and the Start switch is off.

ACC: Switch indicator light is orange and the cigarette lighter and other accessory circuits are switched on.

ON: Switch indicator light is orange, instrument light is on and all electrical equipment circuits are switched on.

#### i Hint

When the automatic transmission shift lever is at other positions other than "P" without pressing the brake pedal, press the Start switch and then it will switch from "OFF" to "ACC". If you continue pressing, it will switch in the sequence of "ACC" → "ON" → "ACC" and not return to "OFF".

Normally, you can only switch from "ACC" to "ON" in turn. But when the automatic transmission is in the "P" gear and the Start switch keep at the "ACC" gear for an hour, it will be switched to the power saving mode and be withdrawn to the "OFF" position automatically.



When the automatic transmission shift lever is in the "P" or "N" gear position and the brake pedal is pressed, the Start switch indicator light turns green. At this time, press the Start switch to switch to the "START" gear.

START: Switch indicator light is green and the engine is started. Release the Start switch and brake pedal after starting the engine, the Start switch will switch to "ON" position automatically.

#### **i** Hint

For models with manual transmission, it is recommended to operate the Start switch when the manual transmission shift lever is in neutral position.

#### Limp Home Mode

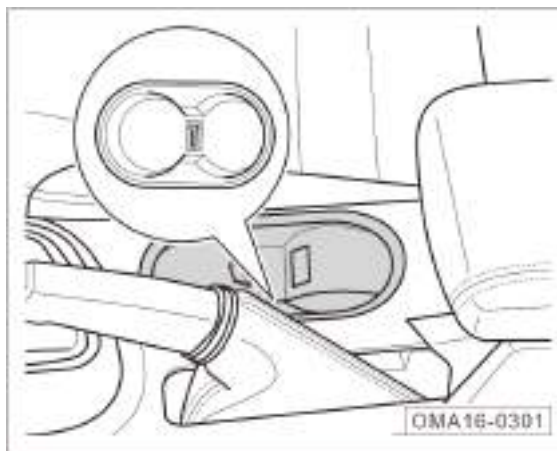

In case the engine cannot be started due to power shortage of smart remote key, place the smart remote key on the marked key position on the bottom of armrest box horizontally, press the Start switch to switch to "ACC" or "ON" position, and then tread on the brake pedal, the indicator light of Start switch will turn green; press the Start switch again to start the engine.

#### **i** Hint

- In case of power shortage of smart key, press the Start switch, the instrument cluster display will indicate "No Key Detected".
- This start method is temporary emergency startup. Please replace the battery of smart key as soon as possible.

## 5. Driving Guide

### 5.1.3 Engine Start

#### Vehicle Models with Manual Transmission

##### Vehicle Models with Ignition Switch

- Insert the mechanical key into the Ignition switch.
- Make sure that the shift lever is at neutral gear.
- Turn the mechanical key to switch the Ignition switch to “START” gear to start the engine.

##### Vehicle Models with Start Switch

- Carry the smart key into the car.
- Depress the brake pedal and maintain it at the full range, and make sure the Start switch indicator light is green.
- Make sure that the shift lever is at neutral gear.
- Press the Start switch to start the engine.

#### **i** Hint

To ensure safety, when a car with manual transmission is started, it is recommended that the clutch pedal and brake pedal be depressed simultaneously.

#### Vehicle Models with Automatic Transmission

##### Vehicle Models with Ignition Switch

- Insert the mechanical key into the Ignition switch.
- Depress the brake pedal and maintain it at the full range, and make sure the shift lever is at “P” or “N” gear.
- Turn the mechanical key to switch the Ignition switch to “START” gear to start the engine.

##### Vehicle Models with Start Switch

- Carry the smart key into the car.
- Depress the brake pedal and maintain it at the full range, and make sure the shift lever is at “P” or “N” gear and the start switch indicator light is green.
- Press the Start switch to start the engine.

#### **i** Hint

- If the engine is of cold start, it needs idle running to let it warm up before driving. At the same time, because valve lifter takes a few of seconds to reach normal working pressure, it can produce running noise, which is normal phenomenon, requiring no worry.
- If models with start switch cannot start the engine normally caused by brake signal, speed failure, or low temperature in winter and other reasons, it can try to switch the start switch to the "ACC" gear, ensure the transmission shift lever in "P" or "N" gear, and press start switch for 15 seconds, and then start the engine forcefully.

 Caution

- After the successful engine start, release the Start switch immediately.
- Engine startup time cannot exceed 15s. If engine fails to start successfully, wait about 30s to try again.
- After startup, do not depress the accelerator pedal suddenly to run the engine at high speed or overload. Otherwise, the engine can be easily damaged.
- If the battery power is too low to start the engine, you can try the emergency start by connecting cable. => Refer to Page 410
- Do not start a vehicle engine by pushing or pulling it.

 Warning

- **Do not start the engine in a poorly ventilated or enclosed room for a long time. Because engine off-gas contains harmful gas, it can cause coma and even death from suffocation.**
- **Do not leave the engine in unattended mode when the engine is running.**
- **Do not start the engine by starting auxiliary device. Otherwise, it may explode or cause the engine to run at high speed, causing casualties.**

## 5. Driving Guide

### 5.1.4 Engine Stop

#### Vehicle Models with Manual Transmission

- Depress the brake pedal and clutch pedal to stop the vehicle steadily, and apply parking brake.
- Switch the shift lever to neutral gear.
- Loosen the brake pedal and the clutch pedal, twist the mechanical key to switch the ignition switch to "LOCK" or press the start switch to shut down the engine.
- Turn the steering wheel back and forth, and engage the steering wheel lock mechanism (apply to models with Ignition switch).

#### Vehicle Models with Automatic Transmission

- Push the brake pedal, stop the vehicle, and apply the parking brake.
- Put the shift lever at "P" gear.
- Loosen the brake pedal, twist the mechanical key to switch the ignition switch to "LOCK" or press the start switch to shut down the engine.
- Turn the steering wheel back and forth, and engage the steering wheel lock mechanism (apply to models with Ignition switch).

#### Hint

The radiator fan may still run for some time after the engine is shut down.

#### Caution

- In the process of vehicle driving, in case of emergency which requires shutting down the engine, press Start switch for long time or press Start switch three times continuously. The Start switch will be withdrawn from "ON" to "ACC" gear. Shut down the engine. Then, emergency flameout is completed. The engine can be restarted a few of seconds after emergency flameout.
- During driving, in case of automatic engine shutdown or emergency flameout, put the transmission shift lever at the "N" position and press the Start switch again to restart the engine.
- If brake signal failure occurs to the engine during the startup process, it must first switch to the "ACC" gear and then press the Start switch to start the engine. In the startup process, the shift lever must be in the "P" or "N" gear.

**⚠ Warning**

- **When the engine stops and the brake booster does not work, a greater force shall be applied on the brake pedal when braking to stop the car. If the steering booster does not work, a greater force must be applied to turn the steering wheel.**
- **When driving, do not turn off the engine in case of emergency. Otherwise, the airbag will not work.**

**Precautions for Parking**

When parking, put the shift lever to the "P" gear or the neutral gear and pay attention to the following matters:

- Pay attention to the car parking direction and do not make the exhaust discharged to the plant to damage the green belt.
- Try to park on a straight road and avoid a steep slope.
- When parking, no matter the vehicle is facing the top or the bottom of the slope, the front wheels should be directed to the curb.
- The vehicle should be applied with the parking brake. Turn off all lights and other electrical equipment, and shut down the engine.
- When leaving the car, be sure to carry your valuables and keys with you, and confirm that the skylight, windows, doors and trunk lid are closed or locked.
- Check the anti-theft start locking system indicator on the instrument cluster, and confirm that the anti-theft system has been activated.

**⚠ Warning**

- **Even if you leave the vehicle temporarily, you must shut down the engine, apply the parking brake, and carry the car keys with you. Otherwise, the person left in the car may accidentally start the engine or electrical equipment, causing serious injuries and deaths.**
- **After the driver stops to leave the vehicle, do not leave the person in the car, especially the child. Otherwise, it is easy to cause suffocating, coma and even death sealed car.**
- **Do not park vehicles near flammable and explosive items.**

## 5. Driving Guide

### 5.1.5 Gear and Driving Instructions

#### Gear Instructions for Vehicle Models with Automatic Transmission

##### 6AT model

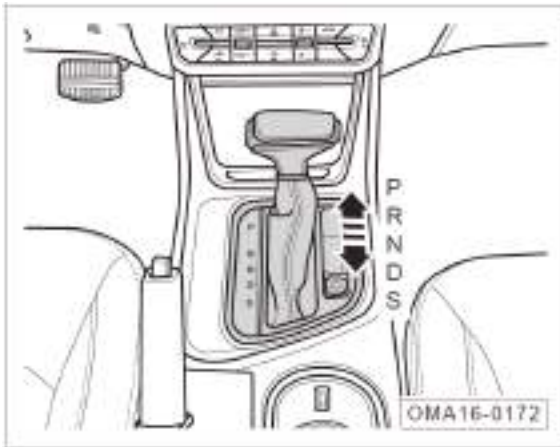

There are the following gears for shift lever from front to rear part: "P→R→N→D→S" gear. The corresponding gear light on the gearshift panel will be on after the shift lever is switched to certain gear, and the instrument cluster will display the corresponding gear.

##### 4AT model:



There are the following gears for shift lever from front to rear part: "P→R→N→D→2→L" gear. The corresponding gear light on the gearshift panel will be on after the shift lever is switched to certain gear, and the instrument cluster will display the corresponding gear.

##### Gear Display for Shift Lever

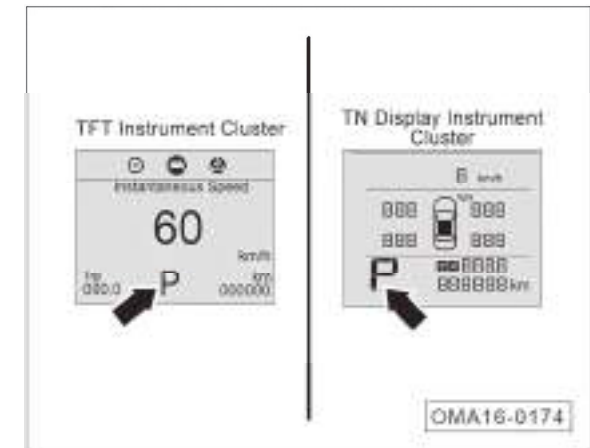

According to the received signal, the lower part of the instrument cluster display will display the "P, R, N, D" gear.

**"P" Gear (Parking Gear):**

Switch to this gear when the vehicle has parked steadily in general.

- Press the unlock button at the front end of the shift lever to switch the shift lever to the "P" gear.
- When withdrawing from the "P" gear, you need to press the unlock button at the front end of the handle and push the brake pedal .

**i Hint**

- Only when the car is completely still can the "P" gear be engaged.
- You must ensure that the engine has been started and the brake pedal has been pushed to bottom before switching from "P" gear to the other gears.

**"R" Gear (Reverse Gear) :**

Switch to this gear when reversing:

- Depress the brake pedal to stop the vehicle steadily.
- Press the unlock button at the front end of the shift lever, put the shift lever to "R" gear. At this time, the reversing light will automatically light up, and the reversing system will automatically start. => [Refer to Page 309](#)
- Release the brake pedal and depress the accelerator pedal slowly to reverse the car.

**⚠ Caution**

Before switching to "R" gear, make sure that the vehicle is completely stopped and that the engine speed cannot be too high. Otherwise, the transmission can be damaged or even an accident may occur.

**"N" Gear (Neutral Gear):**

You can directly put the shift lever from "R" or "D" to "N" gear.

**⚠ Caution**

Please depress the brake pedal and do not depress the accelerator before withdrawing the shift lever out from the "N" gear.

**⚠ Warning**

**When driving, do not switch to "N" gear to slide. Otherwise, it can easily cause driving hazards.**

## 5. Driving Guide

---

### “D” Gear (Driving Gear) :

This gear is engaged generally during driving.

- 6AT model: Directly put the shift lever from "N" or "S" to "D" gear. At this gear, the system will automatically upshift or downshift according to engine load and car speed.
- 4AT model: Directly put the shift lever from "N" or "2" to "D" gear. At this gear, the system will automatically upshift or downshift according to engine load and car speed.

### "S" Gear (Sports Gear) (Apply to 6AT Model):

Press the unlock button at the front end of the shift lever to switch the shift lever to the "S" gear.

After the shift lever is switched in "S" gear, transmission will start the sports mode. The downshift operation will be made according to the resistance change (such as pulling and uphill driving, etc.) under this mode. In addition, the engine will run at high speed to provide greater power for the vehicle. The "S" gear is mainly used for driving in the pursuit of dynamic driving, and can be used for driving in mountainous road conditions, so as to prevent frequent shifting.

#### Warning

**In driving process, do not suddenly switch the shift lever to “R” or “P” gear. Otherwise, the transmission may be damaged or even accidents may occur.**

### "2" Gear (DRIVE Gear) (Apply to 4AT Model):

Press the unlock button at the front end of the shift lever to switch from "D" gear to "2" gear; switch the shift lever from "L" gear to "2" gear directly.

This is a low gear. The transmission will be switched between gear 1 and gear 2 according to the speed and accelerator's position.



### "L" Gear (DRIVE Gear) (Apply to 4AT Model):

Press the unlock button at the front end of the shift lever to switch from "2" gear to "L" gear.

After the shift lever is switched to "L" gear, the transmission will downshift to a lower gear according to resistance change (e.g. pulling, uphill driving), and the engine will run at a higher speed to provide greater power for the car. This is a low gear and there is only one gear. The gear will not be switched according to the speed and accelerator's position.

### Driving Mode (Apply to 6AT Model):



The transmission has 3 driving modes. After switching the Start or Ignition switch to "ON" position, press the driving mode key on the shift panel continuously and switch in the modal sequence of "D→E→M→D....." repeatedly.

### "D" Mode:

In general, the transmission is in the "D" mode by default, i.e. the normal "D" driving mode.

## 5. Driving Guide

### "E" Mode:

The "E" mode is ECO mode. When the car is in this mode, not only the fuel saving strategy is applied for the TCU, but also the corresponding economic strategy is adopted for the A/C.

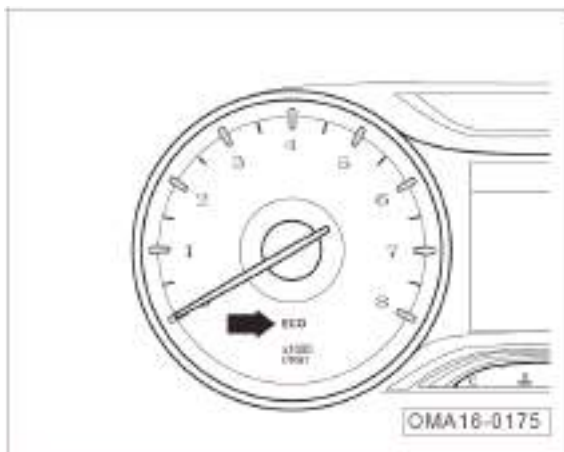

When the car enters ECO mode, the "ECO" indicator light on the instrument cluster is on.

### i Hint

- ECO mode can be applied when the shift lever is at "P, R, N, D" gear, but only works at "D" gear.
- When the current mode is ECO economic mode, if the shift lever is switched to "S" sports mode, and when the "S" gear is withdrawn, it will be switched back to ECO economic mode.
- The ECO mode has a power outage memory function, that is, when the engine is restarted after flameout, the transmission will remain in ECO mode.

### "M" Mode:

"M" mode or manual driving mode, when transmission is running in this mode, the driver can improve the driving enjoyment by pressing the "+/-" in side face of shift lever for upshift/ downshift, according to road conditions and driving habits. After entering the "M" mode, the instrument cluster will display the current actual gear (1 ~ 3). You can manually switch the gear on matter you are driving or parking.

**i Hint**

- Only on the premise of safety of the engine and transmission can the transmission perform the upshift or downshift operation. When using the "M" mode to switch the transmission to M1 - M3 gear, if the engine has reached the maximum speed which the transmission can withstand, the transmission will automatically raise a gear; In addition, in order to prevent too low motor speed, the transmission will automatically reduce a gear at a certain speed.
- The "M" mode is recommended when driving on road conditions such as mountain roads or hilly areas. Fix the transmission to a certain gear to prevent the transmission from switching frequently.
- Once the "M" mode is applied, the transmission will always be in this mode except for the engine flameout, the shift lever is switched to the "S" gear or the driving mode button exits.

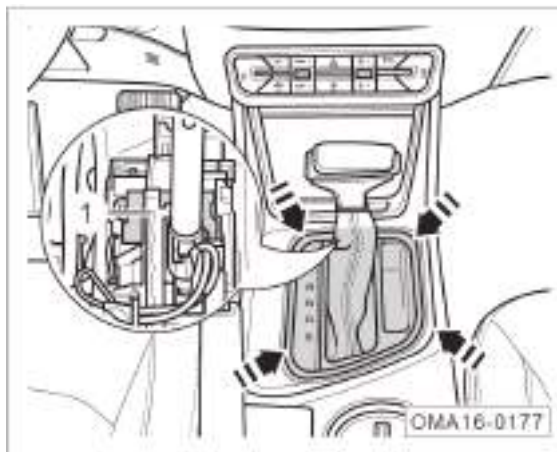
**Unlocking the Shift Lever**

- Apply parking brake.
- Make sure the Start or Ignition switch is off.
- Pry up the shift lever trim cover at the position of the arrow.
- Press the unlock switch ①. Meanwhile press the unlock button at the front end of shift lever grip and then move the shift lever from "P" to "N".
- Press the brake pedal, start the engine and check whether the shift lever restores the normal engagement operation.
- Install the middle leather panel.

**👁 Caution**

If the shift lever is locked and cannot be withdrawn from the "P" gear, this method can be used or go to GAC MOTOR dealer for maintenance timely.

## 5. Driving Guide

### Gear Instructions for Vehicle Models with Manual Transmission

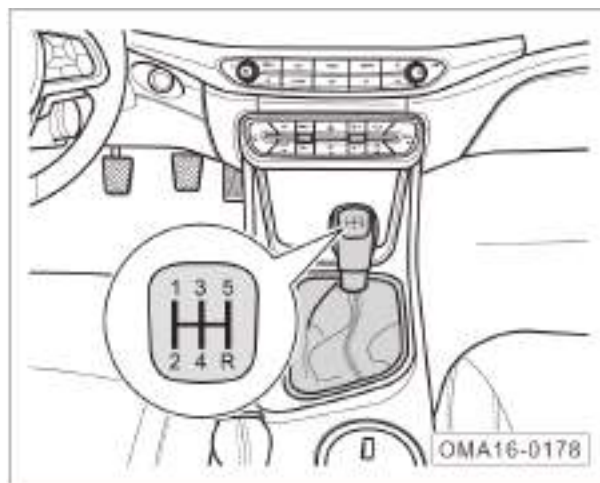

Gear positions of the models equipped with manual transmission are R, 1, 2, 3, 4, and 5.

Depress the clutch pedal to full range in case of gear shift during driving to switch the shift lever to the gear positions of 1, 2, 3, 4 or 5.

### Switch to reverse gear

- Depress the clutch pedal to full range when the vehicle is not running and the engine is idling.
- Make sure that the shift lever is at neutral gear.
- Switch the shift lever to "R" gear. At this time, the reversing light will automatically light up, and the reversing system will automatically start. => Refer to Page 309

#### **i** Hint

Before switching to "R" gear, make sure that the vehicle is completely stopped and that the engine speed cannot be too high. Otherwise, the transmission can be damaged or even an accident may occur.

- Use soft power to gear shift and avoid excessive force.
- Avoid starting at high speed.
- Do not put your hands on the shift lever during the driving, so as not to break the fork prematurely.

### Driving Instructions for Vehicle Models with Automatic Transmission



- Start the engine. => Refer to Page 274
- Press the unlock button on the front side of the shift lever, and put the shift lever to R/D/S position.
- Remove the parking brake.
- Release the brake pedal and slowly depress the accelerator pedal to start the car.
- Depress the brake pedal to stop the car steadily;

- Apply the parking brake, put the shift lever into "P" gear, and loosen the brake pedal.
- Stop the engine. => [Refer to Page 276](#)
- Take out the mechanical key, then turn the steering wheel back and forth, and engage the steering wheel lock mechanism (apply to models with Ignition switch).

### Caution

- To ensure safety, please ensure that the shift lever is at the "P" or "N" position before starting the engine, and do not start the engine in other gears.
- Idle speed of cold engine is very high, so you should drive your car only after the engine idling is stable before the engine warming.
- Do not depress the accelerator pedal violently when the car is still, which may result in high load, damaging the engine.
- After the engine stop, the system will release a warning beep if the shift lever is not switched to "P" gear.

### Driving Instructions for Vehicle Models with Manual Transmission

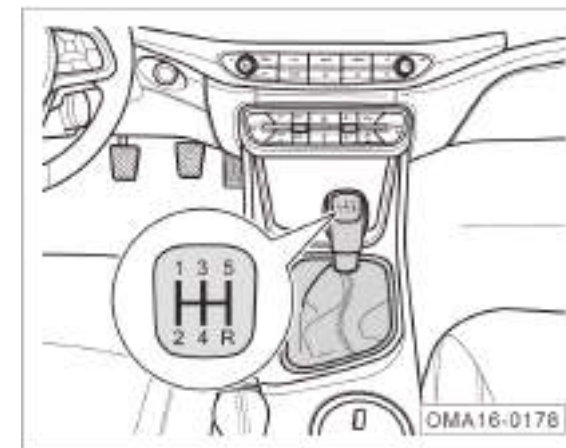

- Start the engine. => [Refer to Page 274](#)
- Put the shift lever from the neutral gear to "1" gear, remove the parking brake, slowly loosen the clutch pedal, to let the vehicle start to move.
- Depress the accelerator pedal to accelerate, put the shift lever to corresponding gear when reaching a certain speed.
- Depress the brake pedal and clutch pedal to stop the vehicle steadily;

## 5. Driving Guide

---

- Apply the parking brake, put the shift lever to the neutral gear, loosen the brake pedal and the clutch pedal.
- Stop the engine. => [Refer to Page 276](#)
- Take out the mechanical key, then turn the steering wheel back and forth, and engage the steering wheel lock mechanism (apply to models with Ignition switch).

### **i** Hint

- In order to ensure safety, please make sure the shift lever is in neutral gear before starting the engine, do not start the engine with shift lever in other gears. If the engine is started with shift lever in other gears, due to the improper operation, when you start the engine, vehicle may move forward suddenly and may lead to accidents.
- Be careful when you are switching the gear before the engine preheating because the cold engine has a high idling speed.
- Do not depress the accelerator when the vehicle is still. Otherwise, it may cause the vehicle to move unexpectedly.

### 5.1.6 Electronic Parking Brake (EPB) System \*

The model is equipped with the latest generation of motor integrated caliper EPB. The driver can enable the vehicle parking and release function through operating the EPB button. In ramp conditions, auxiliary starting function can be used. Under the parking situation, after depressing the accelerator pedal, EPB will be released automatically provide the driver with a convenient driving assistance.

#### Caution

The EPB system will park the car with fixed force according to slope. If the braking efficiency decreases:

- If the car glides after ramp parking, the EPB will increase the braking force automatically. If this situation occurs frequently, please go to your GAC MOTOR dealer as soon as possible to have your car checked and repaired.
- If the vehicle continues to glide after the automatic increase of braking force, please depress the brake pedal and drive the vehicle to the flat road. Please contact GAC Motor dealers for maintenance as soon as possible.

### Applying Static Parking Brake

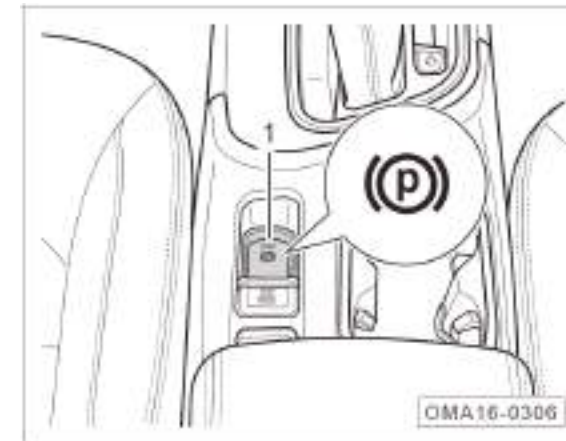

- Pull up EPB button ① to apply the parking brake until the button indicator light and ② indicator light on the instrument cluster are on, which indicates that the parking brake has been applied to prevent the sliding.
- Apply the parking brake when the vehicles are in a static state and after the Start switch or Ignition switch is in "OFF" position. Ensure that the parking brake is applied when you leave the vehicle or when you are parking.

## 5. Driving Guide

### **i** Hint

- After the car has been parked steadily, you should first apply the EPB and then put the shift lever to the "P" position.
- Applying the EPB may generate running noise, which is a normal phenomenon.
- If the car is used to pull other vehicles or is parked on a ramp with larger slope, pull the EPB button again after the completion of first parking to ensure the maximum parking force.
- On the slope of 17 %~ 30 %, a clamping will be performed again 5 minutes later upon the first application of the EPB. A certain noise is normal at this moment.

### **👁** Caution

The parking brake must be applied when parking.

- When the vehicle is in driving process, it is not allowable to decrease the speed by using EPB when unnecessary, because the parking brake only exerts power on the rear wheels, which can easily cause traffic accidents.

### Releasing Static Parking Brake

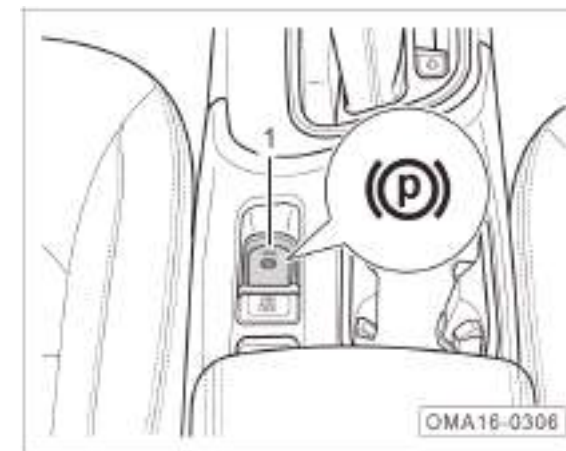

- Depress the brake pedal when the Start switch or Ignition switch is in "ON" position.
- Press the EPB button ① to release the parking brake until the button indicator light and ② indicator light on the instrument cluster are off, which indicates that the parking brake has been released.



 Hint

- If the brake pedal is not depressed, press the EPB system button to release the parking brake. The buzzer will alarm, and the instrument cluster display will prompt "please depress the brake and release the EPB".
- Releasing the EPB may generate running noise, which is a normal phenomenon.
- When the vehicle battery has no power, the system cannot release the EPB. If conditions allow, conduct the emergency start through connecting cable (=> Refer to Page 410), and then release the EPB. Please contact your GAC MOTOR dealer for handling.
- If the EPB is not applied for a long time, the system will detect the conditions automatically with audible running noise.

## Automatic Driving Release

When the door is closed and the driver has fastened the seat belt, the EPB will be released automatically when the accelerator pedal is depressed.

 Caution

- When the car is in the parking state, do not depress the accelerator pedal quickly. Otherwise, it will shorten the service life of EPB more quickly.
- The utilization of the automatic driving release will shorten the service life of the EPB, and it is recommended to be used only in case of hill-start.

 Warning

**Do not depress the accelerator pedal when any person is operating in front of/ behind or under of the car in such state that the engine is running and the transmission is in driving gear, even if the EPB is applied. Otherwise, the car will move, causing accidents and even casualties.**

## Uphill Start Assist

When the car has been parked on a slope, fasten the seat belt, start the engine, engage a corresponding gear and depress the accelerator pedal to assist uphill start and avoid the sliding. The EPB will be automatically released after a smooth start.

 Caution

The EPB cannot be automatically removed if the safety belt is not fastened.



## 5. Driving Guide

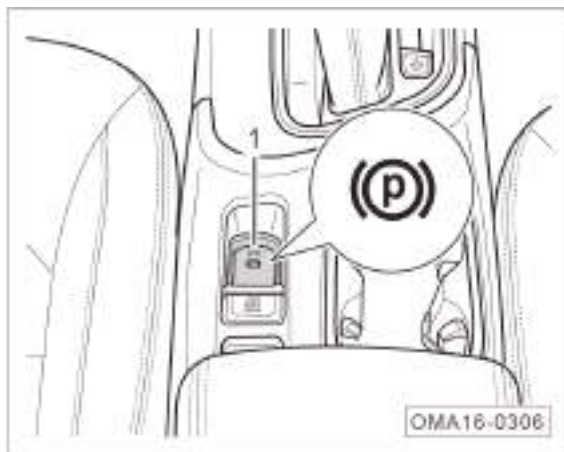

### Applying Dynamic Emergency Brake



- The dynamic emergency braking can be realized by pulling up the EPB button ① continuously in the driving process. If the accelerator pedal is depressed in emergency braking process, the system will quit braking. If the emergency braking is not triggered by driver operation, please depress the accelerator pedal repeatedly to quit braking.

#### Hint

Switch the Start or Ignition switch to "ON" position. The corresponding indicator light  (red) in the instrument cluster will be illuminated when the EPB is applied. The indicator light  will be off when the EPB is removed. In case of any of the following phenomena, please apply and release the EPB again. If the fault persists, please contact your GAC MOTOR dealer for maintenance.

- If the indicator light  flashes in red continuously, it indicates that the EPB is in partial combination/ removal state or there is a fault in the system.
- If the indicator light  lights up in red when the EPB is not applied, the system is abnormal.
- If the indicator light  (yellow) is on, it indicates that a fault is detected in the EPB system and the EPB performance decreases.

#### Caution

- Do not apply the dynamic emergency braking when unnecessary, because the parking brake only exerts power on the rear wheels, which can easily cause traffic accidents. In addition, the braking distance is longer than that when using the brake pedal, and it will shorten the service life of the parking brake system.
- If the EPB button is pulled up during driving, the buzzer will alarm and the instrument cluster display will show "Release the EPB switch".
- During the deceleration, the release state of parking brake can be recovered by releasing the EPB switch or depressing the accelerator pedal. If the EPB system is continuously pulled up until the vehicle is stopped, the parking brake will remain in combination state.

### AUTO HOLD

AUTO HOLD will keep the vehicle static automatically according to the driver's braking needs; the braking will be released automatically when the driver is tested to have intention of starting by the system (e.g., depressing the accelerator pedal); it may ensure the convenience of vehicle starting under auto release condition based on the ramp information and make the vehicle static by supercharging actively when the braking force is insufficient.

### On and Off

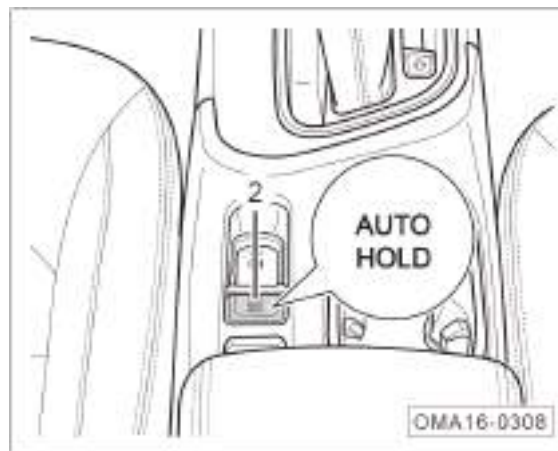

- When the engine is running and the driver's safety belt is fastened, press the AUTO HOLD button ② to enable the function, and then the indicator light is on. Press again to disable AUTO HOLD function, and then the indicator light is off.

### Activation

If the function is enabled, when the driver stops the car by using brake, the car will be parked automatically to avoid the sliding at starting.

### Deactivation

The AUTO HOLD function will be deactivated and the parking brake will not be locked in following conditions:

1. The accelerator pedal is depressed at starting.
2. The engine is shut down during driving.
3. The EPB is released manually.
4. The AUTO HOLD switch button is pressed when stepping on the brake.

## 5. Driving Guide

---

In order to ensure safety, the AUTO HOLD function activated will be disabled and the parking brake will be locked in the following conditions:

1. The engine is shut down.
2. The driver side door is opened or the seat belt is unbuckled in stop state.
3. Press the AUTO HOLD button to cancel the AUTO HOLD.

### Caution

When the car is transferred via conveyor belt to cleaning device and other devices, the AUTO HOLD function must be disabled. Otherwise, the car cannot move or may deviate from the driving track.

### EPB Adaptive Learning

In some cases (e.g. the battery suffers power failure suddenly, or the car has not been used for a long time), the red indicator light  will flicker, and manually pulling the EPB button will cause EPB unable to work. In this case, the driver shall depress the brake pedal and press EPB button to make EPB execute adaptive learning, enabling EPB to work normally.

## 5.1.7 Mechanical Parking Brake System\*

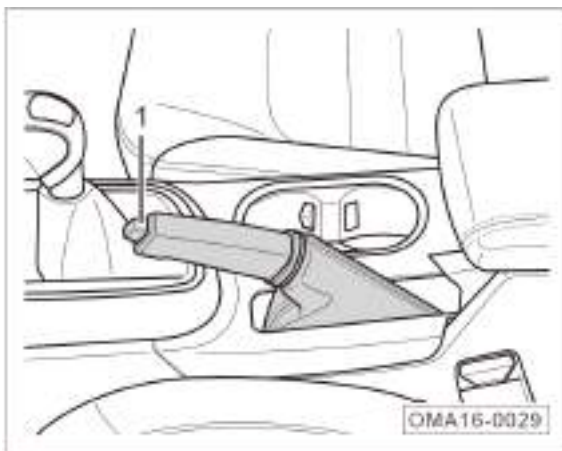
**Apply parking brake**

- Pull the handle of mechanical parking brake up to limit to apply the mechanical parking brake, when the mechanical parking brake state is removed.

**Release the mechanical parking brake**

- Pull the handle of mechanical parking brake up slightly, press the button ① in front of the handle, and press the handle to full range to release the mechanical parking brake.

**⚠ Warning**

**Make sure to apply the mechanical parking brake after parking.**

- When the start switch or ignition switch is in the "ON" position and when the mechanical parking brake is applied, the ① indicator light is on; When the mechanical parking brake is removed, the indicator light ① is off.
- When the vehicle is in driving process, it is not allowable to decrease the speed by using mechanical parking brake, because the mechanical parking brake only exerts power on the rear wheels, which can easily cause traffic accidents.
- It is forbidden to drive the vehicle when the parking brake has not been completely separated. Otherwise, it will cause the overheating of the rear wheel brake, reduce the braking efficiency, and also cause the friction lining of rear wheel brake to wear out prematurely.

## 5. Driving Guide

---

### 5.2 Service Electronic Brake System

#### 5.2.1 Anti-Lock Braking System (ABS)

Anti-lock braking system (ABS) is an important part of active safety system.

When ABS works, the friction between the wheel and the road belongs to rolling friction and it is favorable for braking by making use of maximum adhesion between the wheel and road, thereby improving the braking deceleration, shortening the braking distance, and ensuring the direction stability in the process of vehicle braking.

The ABS operation is equivalent to snubbing at a high frequency. The driver will feel the vibration of brake pedal accompanied by the “tick” sound produced by brake master cylinder operation when depressing the brake pedal in emergency. In this case, the ABS is in normal working state. Since the brake master cylinder adjusts the brake pressure constantly, a force will be fed back to the brake pedal continuously. Therefore, in this case, it is required to depress the brake pedal to the end, and it is forbidden to depress the brake pedal repeatedly.

As ABS is only the safety assistant system, its function is very limited. For example, when making a brake on sand and stone road or snowy road, it may have a longer braking distance compared with braking on concrete road or dry road. Don't take it for granted that ABS can get ideal brake performance in any situation. Therefore, do not rely on these systems too much. Only safe driving is the most important.

Under the following conditions, light depress the brake pedal to activate ABS. It is normal to feel vibration:

- When shifting gears.
- During emergency braking.
- When turning at high speed.
- When driving on slippery road.
- When driving on projected or pit road.
- When making sudden start after the vehicle is started.

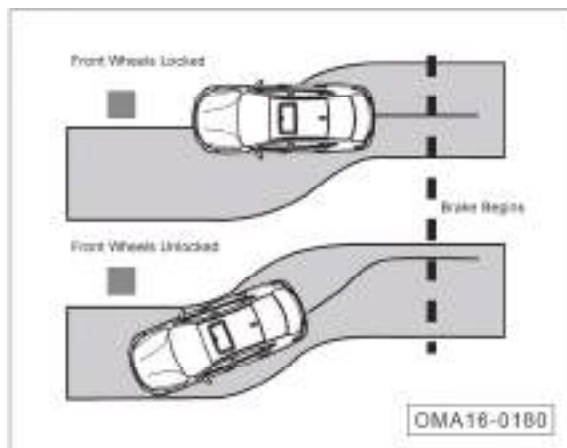

If the front wheels are locked, the vehicle can't turn and only can slide along the braking direction.

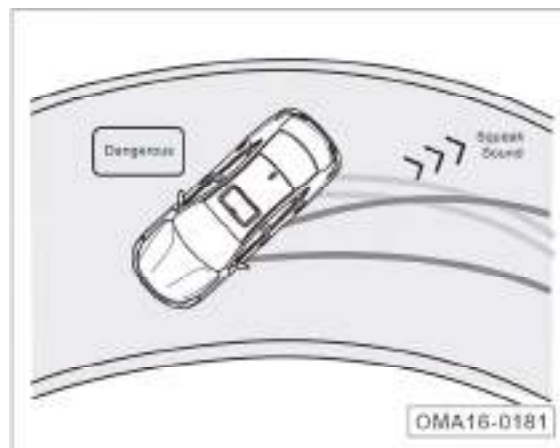

If the rear wheels are locked, the drifting condition is easy to occur (even reach to 180° drifting under serious condition).

### Anti-lock brake system (ABS) indicator light

After the Start or ignition switch is switched to the "ON" position, ABS indicator light (ABS) is on for about a few of seconds and then goes out upon the completion of system self-inspection.

The occurrence of the following conditions indicates that there is a fault in the system:

- After the Start or Ignition switch is switched to "ON" position, ABS indicator light (ABS) is not on.
- After the Start or Ignition switch is switched to "ON" position, ABS indicator light (ABS) is still on after a few of seconds.
- When the car is running, ABS indicator light (ABS) is on.

In case of above situations, stop the vehicle immediately and go to GAC MOTOR dealer to have it checked and repaired as soon as possible.

## 5. Driving Guide



---

### Warning

Always adjust the speed according to the weather, road and traffic conditions. To avoid accidents, don't take a risk to drive just depending on the limited safety functions provided by the system.

- The ABS cannot go beyond the kinematic law. It is still dangerous for a vehicle with ABS to drive on slippery road. While driving, if the ABS is adjusting the brake pressure, immediately slow down to adapt to the road and traffic conditions.
- Improper operation or modification (such as modification of parts of braking system, or wheels and tires) may affect the functions of ABS, EBD and ESP.
- Specified size of tires must be used. If the vehicle is installed with tires in improper size or non-uniform size, ABS can't work normally.

### Warning

- If the ABS indicator light  and the parking brake and braking system warning light  are on at the same time, stop the car immediately and check the brake fluid level in the brake fluid tank. => Refer to Page 347
- If the brake fluid level is normal, the failure of the braking system may be caused by the abnormal ABS control function. When braking in this case, the rear wheel may be locked soon, resulting in drifting and side sliding. Please go to your GAC MOTOR dealer for maintenance as soon as possible.



### 5.2.2 Electronic Brakeforce Distribution System (EBD)

EBD is short for Electronic Brakeforce Distribution System and is a part of ABS. When a vehicle takes normal brake, EBD can uniformly distribute brakeforce to front and rear wheels based on vehicle's loading condition.

EBD exerts more brakeforce on the rear wheel through adjusting slip rate to obtain the shortest braking distance under the premise of ensuring braking stability. In particular, the stability and maneuverability of vehicle braking are improved when driving on a road with poor conditions or a slippery road.

## 5. Driving Guide

### 5.2.3 Electronic Stability Program (ESP) \*

ESP can effectively reduce the risk of vehicle sliding.

#### Operating Principle of ESP

ESP confirms the driver's driving intention according to steering wheel angle and vehicle speed, and constantly compares the information with actual driving condition. If the vehicle deviates from the normal running route (e.g., side skidding), the ESP will correct it by applying a brakeforce to the appropriate wheels.

The ESP can be used to recover the stable driving state through the twisting force generated by braking. If the vehicle tends to oversteer (i.e. drift), the system will mainly exert the brakeforce on the front wheel at the outer bending. If the vehicle tends to understeer (i.e. excessive turning radius), the system will mainly exert the brakeforce on the rear wheel at the inner bending.













Vehicle not equipped with ESP sideslips and deviates from the normal route during driving.





Vehicle equipped with ESP can correct the brakeforce according to the sideslip amount to prevent deviating from the route.

**ESP indicator light**

- After the Start or Ignition switch is switched to "ON" position, ESP indicator light  and  are on for about a few of seconds and then goes out upon the completion of system self-inspection.
- If the ESP works in the driving process, the indicator light  will flash.
- The indicator light  will light up after the ESP function is deactivated.
- The indicator light  will light up when the ESP fails to function.
- The ESP indicator light , ABS indicator light , parking brake and braking system indicator light  are on when the ABS fails to function.

If the indicator light  is illuminated and is not extinguished after the engine starts, it indicates that the system has temporarily deactivated the ESP. If instrument cluster display shows the related text message to prompt or warn drivers, you can open the ESP by turning off the start switch or ignition switch and then opening the start switch or ignition switch. If the indicator light  is extinguished at this moment, it suggests that the system has been in working state completely.

If you disconnect the battery connector to connect it with the cable, indicator light  may be illuminated when turning on the start switch or ignition switch. The indicator light  should be extinguished after short-distance driving.

**⚠ Warning**

**You must adjust your vehicle speed according to the weather, road and traffic conditions. To avoid traffic accident, don't take a risk to drive your vehicle just depending on additional safety functions provided by the systems.**

- **Remember: ESP cannot go beyond the physical limit of road adhesion. Be sure to drive on slippery road or drive while towing a trailer with extra care.**
- **The driver must adjust the driving mode according to the road and traffic conditions.**
- **ESP cannot reduce the risk of accidents caused by improper driving such as excessive high driving speed or too close distance to the front vehicle.**
- **Improper operation or modification (such as modification of parts of braking system, or wheels and tires) may affect the functions of ABS, EBD and ESP.**

## 5. Driving Guide

---

The ESP works only when the engine is running. The ESP function can be deactivated in special circumstances. For example:



- The vehicle is running with tire chain.
- The vehicle is running on deep snowy or spongy road.
- The vehicle gets stuck in muddy road or other roads, and needs to be moved back and forth.

In the absence of such conditions, the ESP should be activated for driving safety.

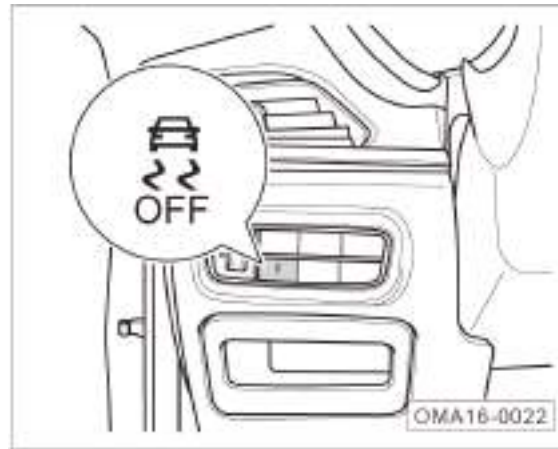
### Activation and Deactivation of ESP



Generally, the ESP system is activated by default when the vehicle is moving.

The ESP system can be deactivated by long pressing (more than 3s, less than 10s) the ESP deactivation button . At this moment, the indicator light  on instrument cluster is illuminated. Also, the instrument cluster display will display the corresponding graphic information.



### 5.2.4 Traction Control System (TCS)\*

Traction Control System (TCS) is the subsystem of the ESP. It can judge whether the drive wheel is skidding according to rotation speed of drive wheel and driven wheel. When the rotation speed of drive wheel is higher than that of driven wheel, the TCS can control the rotation speed of drive wheel to prevent the vehicle from sliding.



#### Activation and Deactivation of TCS



Generally, the TCS system is activated by default when the vehicle is moving. When the TCS system is activated/ deactivated when the ESP system is activated/ deactivated manually.

The ESP and TCS can be deactivated by long pressing (more than 3s, less than 10s) the ESP deactivation button . At this moment, the indicator light  on instrument cluster is illuminated. Also, the instrument cluster display will display the corresponding graphic information.

#### Hint

- The ESP/ TCS function will be activated automatically when the speed is greater than 80 km/h.
- The ESP/ TCS function deactivated can be reactivated by pressing the button  at a speed of less than 80 km/h.
- If you press the button  for more than 10s, the system will consider it as wrong operation and the system working state will not be affected.

## 5. Driving Guide

### 5.2.5 Hydraulic Brake Assist (HBA) \*

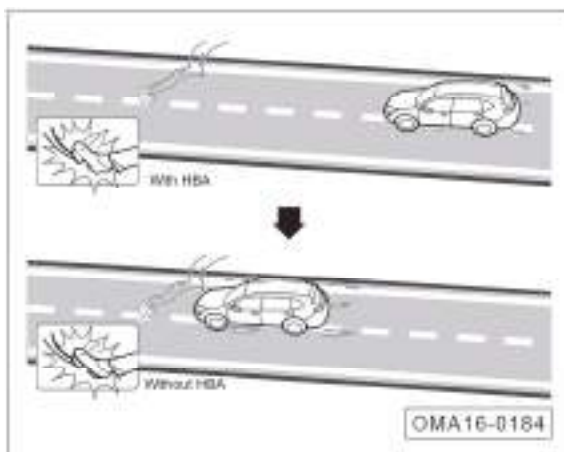

The Hydraulic Brake Assist (HBA) utilizes the pressure in the braking system to assist you to have shorter braking distance in case of emergency. It makes full use of the characteristics of ABS. The HBA will be deactivated automatically when the brake pedal is released, and then the braking system will return to its normal working state.

Most drivers can hit the brakes timely in dangerous situation, but cannot depress the brake pedal with enough force in a short time. Therefore, the braking system does not produce maximum brakeforce, resulting in the increase of braking distance, increasing the risk of the accidents.

However, for vehicles with HBA, quickly depressing the brake pedal and maintaining the state will produce a greater brakeforce than that under normal braking, which gives full play to critical value of ABS, enabling the braking system to produce the pressure required for the maximum deceleration in the shortest time. Therefore, the shortest braking distance is obtained.

#### Warning

**HBA can improve driving safety, but it is impossible to go beyond kinematics rules. Please adjust your driving speed according to the road condition and regulated traffic speed.**

### 5.2.6 Hill Hold Control (HHC) \*

HHC allows the driver to easily move his/her foot from the brake pedal to the accelerator pedal when starting on slopes without using the parking brake to avoid sliding accidents.

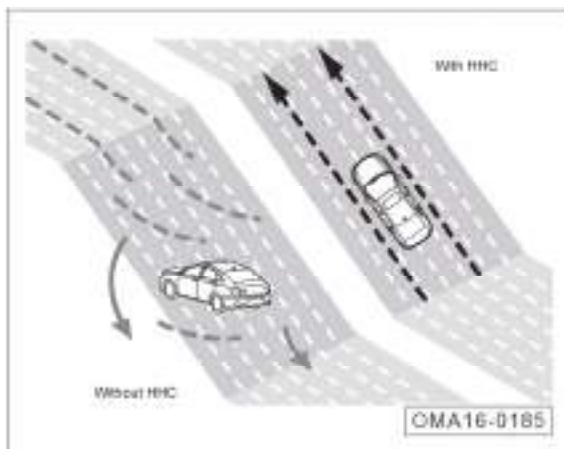

#### Activation Conditions for HAC

- HHC function is activated to apply brake pressure to the vehicle for 1s, if the driver releases the brake pedal in following conditions: ramp slope of more than 4%, shift lever not at "P" or "N" position, EPB not applied, brake pedal depressed to stop the vehicle and keep it in static state.
- During the working of HHC, when the engine torque exceeds the vehicle resistance torque, the brake pressure will be released to finish starting smoothly.
- HHC also works when the vehicle goes downhill and the shift lever is switched to "R" position.

#### i Hint

- The HHC will apply a brakeforce automatically when starting on a steep uphill or shifting to reverse gear on downhill, to prevent slipping.
- HHC is integrated on the ESP system. If the HHC fails, the ESP indicator light is illuminated and the relevant hints are displayed on the instrument cluster display.

## 5. Driving Guide

### 5.3 Driver Assistance System

#### 5.3.1 Cruise Control System \*

The cruise control system can be set at 40km/h or higher. Once the speed is set, the driver can release the accelerator pedal and the car will run at the preset speed.

#### Warning

To avoid accidents, the cruise control system cannot be used where there is dense traffic, hills, winding roads, or slippery roads.

- The set speed and the vehicle-to-vehicle distance must be adapted to the current traffic conditions. The cruise control system is only a driver assistance system and shall be used prudently.
- Be sure to disable the cruise control system timely after using.

#### Operation Button





SET/-: Set cruise control/ deceleration

RES/+: Restore cruise control/acceleration

: Start / stop cruise control

: Cancel cruise control



#### Starting Cruise Control

- Short press the button . Then the corresponding indicator light  on the instrument cluster will be on and turn white.
- Accelerate the car to the cruising speed (above 40km/h).
- Short press the SET/- button. Then the corresponding indicator light on the instrument cluster  will turn green from white.
- Release the accelerator pedal as the car is in cruise control state.





### Stopping Cruise Control

Cruise control can be disabled by the following actions and the corresponding indicator light  on instrument cluster goes out:

- Press the brake pedal.
- Put the transmission in “N” gear.
- Short press the button .
- Short press button  (disable cruise control and clear the set speed).
- Operate the EPB button.
- ESP system starts.

### Restoring Cruise Control

Cruise control can be reset by the following operation as the indicator light  on instrument cluster is white:

- By short pressing the RES/+ button at the speed of above 40 km/h, the cruise control indicator light  on the instrument cluster will turn to green from white and the speed will return to and be kept at the previously set cruising speed.

The cruise control stopped via following actions can be restored by pressing the RES/+ button:

- Step on the brake pedal.
- Put the transmission in “N” gear.
- Short press the button .

The cruise control stopped via following actions cannot be restored by pressing the RES/+ button:

- Cruise control is disabled by short pressing  the button .
- The shift lever is put in the “P” gear.

### Increasing Cruising Speed

Increasing the speed requires the following operations:

- Short press the RES/+ button to increase the speed by 2 km/h each time.
- Long press RES/+ button to increase the speed continuously.

Release the RES/+ button to start cruise control at a higher set speed.

#### Hint

- The allowable maximum cruise speed is 145 km/h. The speed above 145 km/h cannot be adjusted through pressing the RES/+ button.
- The car exits the cruise control mode as the accelerator is stepped on and then runs at the accelerated speed; after the accelerator pedal is released, the car will restore the cruise control.

## 5. Driving Guide

---

### Decreasing Cruising Speed

Decreasing the speed requires the following operations:

- Short press the SET/- button to decrease the speed by 2 km/h each time.
- Long press SET/- button to decrease the speed continuously.

The car runs at a lower speed after SET/- button is released.

#### **i** Hint

The speed below 40 km/h cannot be adjusted through pressing the SET/- button again.

### 5.3.2 Tire Pressure Monitoring System \*

Direct tire pressure monitoring system (TPMS) is adopted for this model to monitor the tire pressure and temperature information through the tire pressure sensor mounted on the wheel rim, and then the information is sent via wireless transmitter to the receiver. The receiver receives, decodes and analyzes the received signals and sends them through the bus to the instrument cluster for displaying current tire pressure and temperature. In case of low/high tire pressure, fast air leakage and over-temperature, alarm signal will be sent by the receiver and displayed on the instrument cluster.

When the Start or Ignition switch is at "ON" position, if the car does not move or moves at a speed lower than 25 km/h, the pressure and temperature values are both displayed as "---" on the instrument cluster. Several minutes after the speed is higher than 25 km/h, the instrument cluster displays current tire pressure and temperature.

#### Tire Information Display

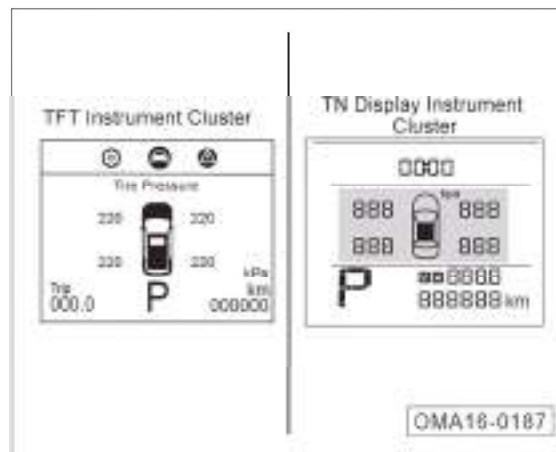

The displayed values are the corresponding pressure of the four tires.



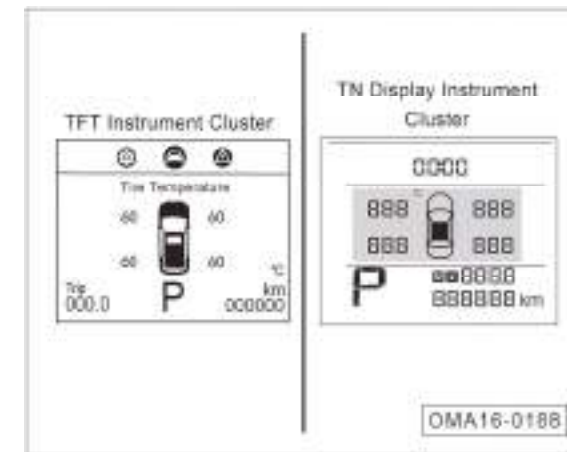

Tire Pressure



The displayed values are the corresponding temperature of the four tires.

## 5. Driving Guide

When the speed exceeds 25 km/h, the tire pressure sensor will send the data to the receiver. After being decoded analyzed, such information will be sent to the instrument cluster through the bus to display current pressure and temperature.

- If the tire pressure is higher than 330Kpa, the indicator light  of tire pressure monitoring system will be on, and the text alarm on the instrument cluster display screen will be displayed as high tire pressure.
- If the tire pressure is lower than 75% of the normal set value, the TPMS indicator light  will be on, and the text alarm on the instrument cluster display will be displayed as low tire pressure.
- If the tire pressure continuously decreases below a specified value, the TPMS indicator light  will be on, and the text alarm on the instrument cluster display will be displayed as tire leakage.
- If the tire temperature exceeds 85°C, the TPMS indicator light  will be on, and the text alarm on the instrument cluster display will be displayed as high tire temperature.

### Caution

- Some added electronic equipment may cause the abnormal operation of TPMS.
- If the tire pressure sensor or the tire needs to be replaced, or the tire position needs to be exchanged, one should learn the matching of sensors in four tires again. Please go to your GAC MOTOR dealer for learning.

### Hint

After replacing with a spare tire or with a new tire in some other places, , the low tire pressure alarm lasts during traveling because of the missing tire sensor. Do not mistake this as abnormal tire pressure signal.

### Hint

- If the tire suffers high temperature, high pressure, low pressure, or rapid air leakage, the instrument cluster will give early warning, with position of the corresponding failed tire displayed in circular manner. If the TPMS fails, the instrument cluster will give early warning, with "Please check the TPMS" displayed in circular manner.
- Where there is high temperature alarm, it is recommended to stop the car and wait until the tires cool.
- The traveling alarm not handled until the car stops will remain when the car starts again, with pressure and temperature displayed as "--". But when the speed exceeds 25 km/h, the receiver will receive updated data and update relevant data, and then the alarm disappears.

## 5.4 Reversing Assist System

### 5.4.1 Reversing Radar System

Reversing radar system can assist the driver in parking and adjusting the parking position.

Ultrasonic wave is transmitted and received by the ultrasonic sensor installed near the rear bumper. The distance between the car and the rear obstacles can be measured by the system's transmitting and receiving the reflected ultrasonic wave. As the car is near the rear obstacles, the system will send alarms with different sound according to the clearance between them: The shorter the clearance is, the shorter and quicker the sound will be; if the car is very close to the obstacles, continuous alarm will be given. By this time, if the car continues to approach the obstacles, the system will be unable to detect them anymore. Except alarm sound, the audio system display will also show the dynamic icons of radar detection.

### Activating and Deactivating the Reversing Radar System

As the Start switch or the ignition switch is at "ON" position, release the parking brake and switch the shift lever to gear "R"; when the car speed is lower than 10km/h, the rear ultrasonic sensor is enabled, and disabled when the car speed is greater than 10km/h. Release the shift lever off gear "R"; enable the parking brake; release the Start switch or the ignition switch off "ON" position; then the reversing radar turns off.

### Dynamic Icon \*

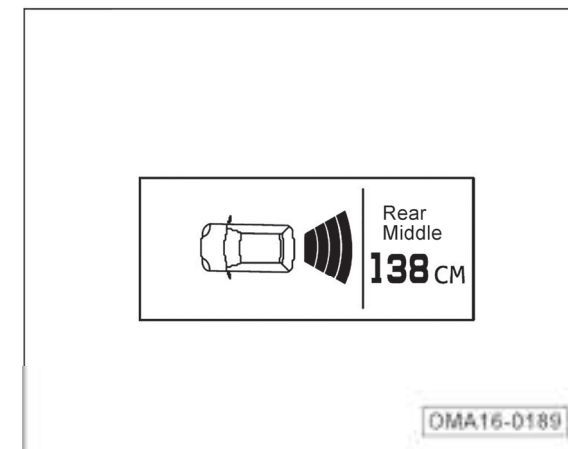

The dynamic icons shown on the audio system screen indicate the distance between the car and the front and rear obstacles.

The change of such dynamic icons synchronizes with the change of distance alarm.

## 5. Driving Guide

### Dynamic Icon \*

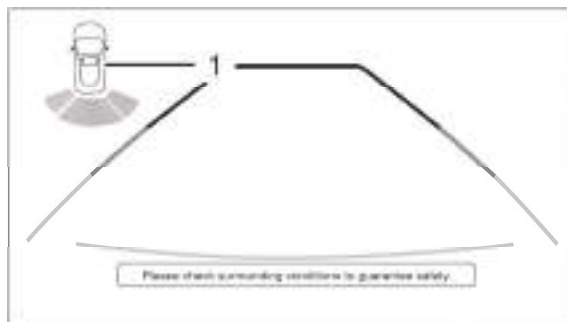

The dynamic icons ① shown on the audio system screen indicate the distance between the car and the front and rear obstacles.

The change of such dynamic icons synchronizes with the change of distance alarm.

### Distance Reference Alarm Sound

The alarm sound changes with the distance between the car bumper and the obstacles at the front of and in the back of the car; meanwhile the color \*shown on the screen changes:

Detected Obstacles	Distance to		Alarm Sound
	Middle-rear sensor	Middle-side sensor	
90~150 cm	90~120 cm		Low-speed intermittent alarm sound
60~90 cm	60~90 cm		Medium-speed intermittent alarm sound
30~60 cm	30~60 cm		High-speed intermittent alarm sound
Within 30 cm	Within 30 cm		Continuous alarm sound

### Ultrasonic Sensor Distribution



The rear ultrasonic sensor is installed on the rear bumper cover.

 Caution

- Always keep the ultrasonic sensor surface clean, and do not cover it.
- It must keep the ultrasonic sensor clean and avoid icing to make sure the bumper ultrasonic sensor works.
- When cleaning the ultrasonic sensor surface, use soft wet cloth to avoid surface scratching.

 Warning

- **The reversing radar system does not take the place of the driver's observation to the surrounding environment, so the driver shall focus attention on reversing safely and adjusting parking position according to actual conditions.**
- **Blind zone exists when the ultrasonic sensor is detecting the obstacles, so that the driver must observe carefully to avoid scraping or collision.**
- **During reversing in a narrow space or uphill, the ultrasonic sensor may detect railings, trees or slope, which is considered normal.**
- **At fast reversing speed, the detection of the ultrasonic sensor may not be as accurate. It is suggested that the revising speed does not exceed 10km/h. The continuous alarm sound from the revising radar system indicates that the car is very close to the obstacles. The driver shall stop revising immediately to avoid accident.**

 Warning

- **Clean the ultrasonic sensor with high pressure cleaning device in a short time and in gentle manner; keep at least 10 cm between the nozzle and the sensor.**
- **Water drops on the ultrasonic sensor surface of the rear bumper can influence sensitivity of the sensor. To restore sensitivity, wipe off the water drops.**
- **Surfaces of certain items cannot reflect the signals from the ultrasonic sensors, so that the sensor cannot detect such items or persons wearing such clothes.**
- **The ultrasonic sensor may not detect the objects if interfered by outdoor noise.**
- **The ultrasonic sensors are precision parts. Do not dismantle or repair one by yourself. Damage caused by such dismantling or repairing is not covered in the warranty of GAC MOTOR.**

## 5. Driving Guide

### 5.4.2 Reversing Rear-view System \*

The reversing rear-view system can provide 130° wide-angle video coverage, display a wide range of rear view by video on the audio system display to help the driver see the complex road conditions behind the car in all directions, enhancing the reversing safety.

#### Warning

**The reversing rear-view system does not take the place of the driver's observation to the surrounding environment, so that the driver shall focus attention on parking safely and adjusting parking position according to actual conditions.**

#### Start and Stop of the Reversing Rear-View System

When the Start switch or the ignition switch is at "ON" position, with the shift lever in gear "R", the reversing rear-view system works automatically; the audio system screen displays the rear view, and shows the reference distance line.

Switching the shift lever from "R" position can make the reversing rear-view system exit automatically, and the audio system will stop displaying reversing image.

#### Reference Distance Line

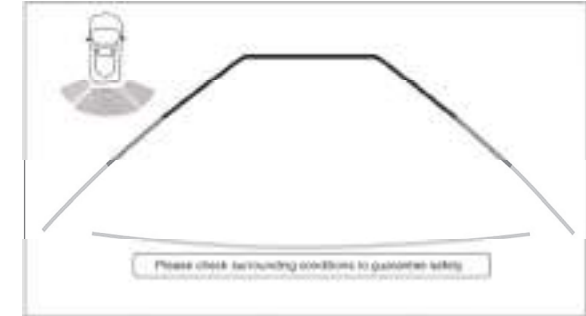

The lines in three colors on the display represent the reference horizontal distance between the line position and the rear bumper.

**Red line: 0.1~0.5m**

**Yellow line: 0.5~1m**

**Blue line: 1~3m**

#### Hint

**If the driver turns the steering wheel during reversing, the reversing image will show corresponding steering assist line.**



**Caution**

The above distance is measured on flat ground and is only taken as a reference value of view distance. If there is a slope, the above distance is not correct.

**Hint**

- The longitudinal lines on both sides of the reference distance line can be used as the reference lines for determination of the required space for reversing or parking.
- The reference distance lines change with turning of the steering wheel.

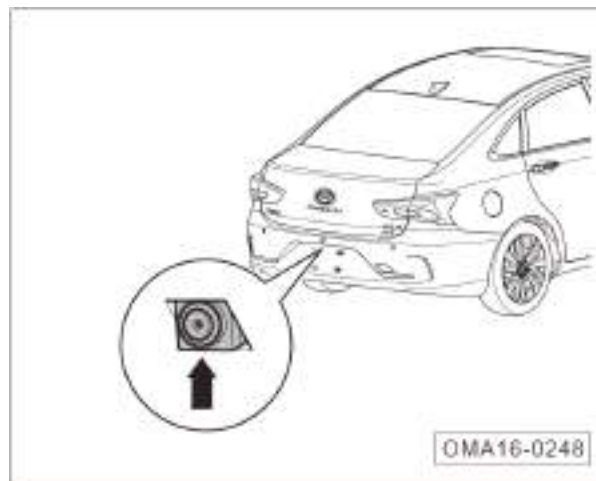
**Rear-View Camera**

The rear-view camera is mounted beside the rear number plate light.

**Warning**

- **Blind zone may exist in detecting scope of the rear-view camera, because the camera may be unable to detect children or small animals. Pay special attention to children or small animals around when reversing.**
- **Upright objects with higher elevation, such as protruding wall edges, may also not be detected by the rear-view camera.**

## 5. Driving Guide

---

### Caution

- Always keep the rear-view camera surface clean. When cleaning the rear-view camera, use soft wet cloth to avoid scratching.
- Do not use high pressure cleaning device to clean the rear-view camera for a long time, and keep a distance of at least 30 cm from the camera when cleaning.
- Do not cover the rear-view camera.

### 5.4.3 Panorama Parking System \*

The panorama parking system can provide the information of environment around the vehicle to the driver through real-time image, reduce the blind zones of driving, and forecast the movement track of the vehicle in combination with steering wheel angle and vehicle dimensions and other related parameters; adding such information into the panoramic image can make the driver fully understand the traveling direction of the vehicle and judge whether the reversing is safe.

The panorama parking system consists of a control host module and four 180° cameras. Images in the front, rear, left, and right directions relative to the vehicle are captured, spliced into the 360° bird's view through the image processing algorithm, and displayed on the display of the audio system.

#### Start and Stop of the Panorama Parking System

Panoramic parking system can be turned on/off by the following two modes of operation:

1. Start and stop through shift lever.

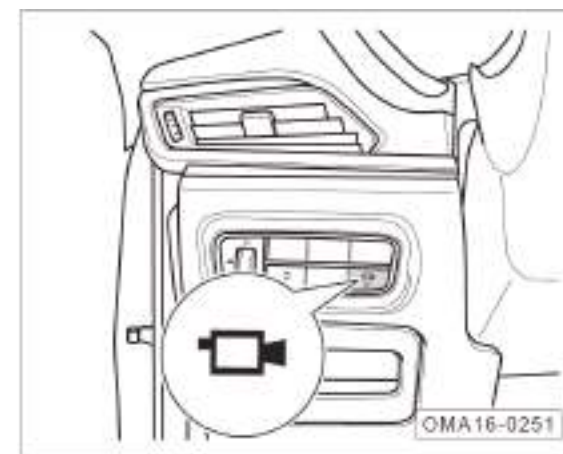

When the Start or Ignition switch is at "ON" position:

- Place the shift lever on "R" gear, the panorama parking system will automatically start;
- With the shift lever moved out of "R" gear and no operation performed by the driver, the panorama parking system will exit automatically after displaying for 30s.



2. Start and stop through button.

When the Start or Ignition switch is at "ON" position:

- Short press the button , the button light will be on and the panorama parking system will start.
- Short press the button  again, the button light will be off and the panorama parking system will stop.

## 5. Driving Guide

### **i** Hint

- When the panorama parking system starts, the audio system display will start to display the images shot around the car, with some auxiliary lines on the image.
- When the car is running at a speed of more than 30km/h, the panorama parking system will stop automatically.
- When the gearshift lever is at "R" position, the panorama parking system cannot be stopped but the display modes are allowed to be switched via the touch screen.
- If the vehicle is not on "R" gear and the system has been activated for more than 30s, the system will automatically stop (when the speed is zero).
- The panorama parking system cannot be used normally before the audio system fully starts.

### Interface Description

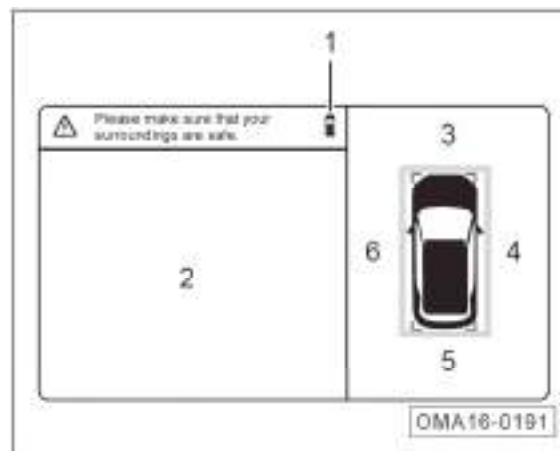

1. View instruction
2. Display: show normal interfaces
3. Front view switching touch control zone
4. Right view switching touch control zone
5. Rear view switching touch control zone
6. Left view switching touch control zone

When the shift lever is not at "R" position, click ③ / ④ / ⑤ / ⑥ touch control zone to switch front/right/rear/left view interface on the display ②.

### **i** Hint

- The display interface instruction is only for reference; in case of difference from the actually displayed, the actually displayed shall prevail.
- When the shift lever is at "R" position, the rear-view interface appears on panorama parking system by default; while the shift lever is not at "R" position, the front-view interface appears on panorama parking system by default. The front/right/rear/left view interface on the display ② can be switched through clicking ③/④/⑤/⑥ touch control zone.

### Camera Distribution



The front camera is installed below the car logo on front grille.

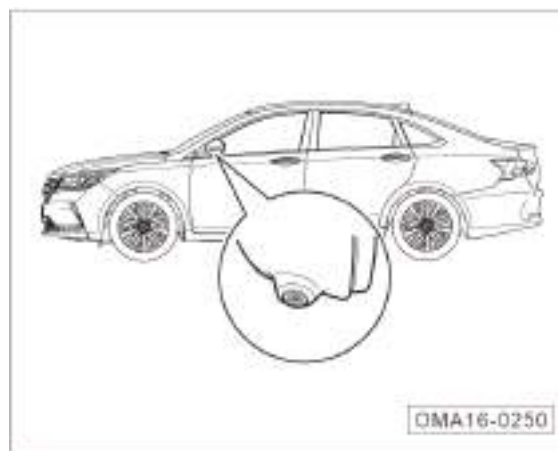

The left/right cameras are installed at the bottom of left/right exterior rear-view mirrors.

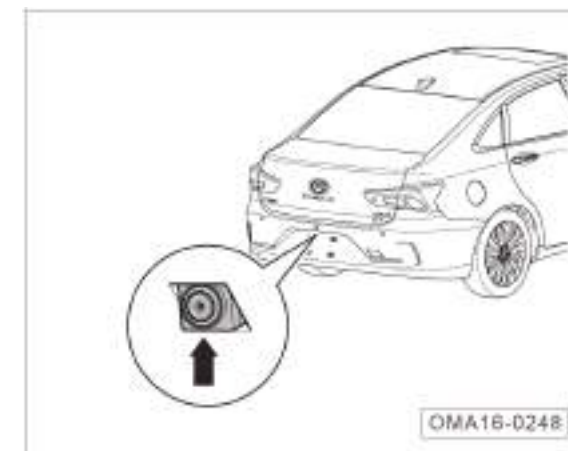

The rear-view camera is mounted beside the rear number plate light.

#### **i** Hint

- Keep the camera surface clean.
- Do not use high pressure cleaning device to clean the camera for a long time, and keep a distance of at least 30 cm from the camera when cleaning.

## 5. Driving Guide

### 5.5 Electric Power Steering (EPS) System

The EPS is a power steering system directly relying on motor to provide auxiliary torque. EPS is mainly composed of torque sensor, motor, decelerating mechanism and electric steering control unit (ECU).

By detecting the driver's torque input and signals of whole car conditions, for example, car speed and engine speed, the ECU controls the torque output of the assist motor in real-time manner, so as to realize the best steering assist, ensure flexibility at low speed and stability at high speed, and improve driving experience and car safety.

#### Steering Mode\*

There are "Standard" and "Sport" steering modes. You may have to steer harder with sport mode. "Standard" is the default mode of the system. You can set the steering mode in audio system.

=>Refer to Page 203

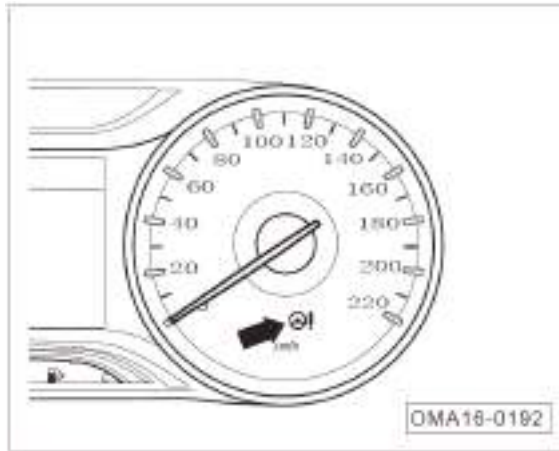

ECU is equipped with warning light alarm and text alarm. When the Start or Ignition switch is at "ON" position, the indicator light  of the electric power steering (EPS) system will be on for several seconds, the EPS control unit will finish the self-inspection, and then the indicator light will be off, which indicates that the EPS system works normally.

If the indicator light goes on after start of the engine or during driving, there is fault in the EPS system, and relevant text alarm will be shown on the instrument cluster display.

When fault occurs in the EPS system, park the car in a safe place, turn off the engine and then start the engine again. If the light is still on after re-start or during driving, please go to your GAC MOTOR dealer timely for repair.

#### Electric Steering Column Lock (Apply to Models with Start Switch)

When the Start switch is switched from "OFF" position to "ACC" or "ON" position, the electric steering column lock will unlock automatically.

When the Start switch is switched from "ACC" or "ON" position to "OFF" position and the door on driver's side is open, the electric steering column lock will lock automatically.

### 5.6 Driving Skills

#### 5.6.1 Safety Check for Driving

It is better to do safety check before driving. Checking your car for a few minutes helps safe and enjoyable driving.

#### Before Starting the Engine

1. External Check
  - Check the working condition of the lights and make sure that all the lights are under normal working condition.
  - Check the tires for incision, damage or excessive wear and make sure that the bolts are not missing or loose.
  - Check whether the fuel is sufficient.
  - Check whether the coolant is sufficient.
  - Check whether the brake fluid is sufficient.
  - Check the condition of 12V battery. Make sure that the terminal and shell are free of corrosion, loosening or cracking.
  - Check whether the front windshield washer fluid is sufficient.
  - Check whether the window glass is clean and unobstructed.
  - Check whether there is any barrier in the pedal area and make sure that there is no barrier that interferes with the pedal movement.

#### After Starting the Engine

- Make sure the instruments work well.
- For checking and confirming the brake on safe road, the car shall not deviate to any side.
- For other abnormalities: check for no loose components or leakage; listen whether there is any abnormal noise.
- After the car is stopped for a while, check whether there is leakage of lubricating oil, water or other liquid from the car bottom. Water drops from the use of A/C is normal.

## 5. Driving Guide

---

### 5.6.2 Driving during Running-in Period

To ensure your car's service life, you have to run it in at the initial stage before putting it into normal use. When your car is in running-in period, please observe the following requirements:

- The mileage of running-in period is 1,500 km.
- Drive on good roads under reduced load at limited speed.
- Avoid full-accelerator starting or rapid acceleration.
- Avoid emergency braking for the first 300km.
- Strictly follow the operating instructions and keep the normal operating temperature of the engine. Do not change the engine oil before the regular maintenance.
- Carefully do routine maintenance; frequently check and fasten the external bolts and nuts; pay attention to the changes of sounds and temperature of each assembly during running, and adjust timely.

#### Running-in of the Engine

You have to run a new engine in for 1500km. Within 1000km of traveling mileage of the car:

- The speed shall not exceed 3/4 of the maximum speed.
- Avoid full-accelerator driving.
- Avoid high engine speed.
- Do not tow a trailer.

When the traveling mileage is within 1000km-1500 km, the engine speed and car speed can be gradually increased to the maximum allowable range.

At the early stage of running-in period, the internal frictional resistance of the engine is much greater than that after the running-in. All the moving components of the engine coordinate well only after running-in.

Full running-in of the engine can increase the service life and reduce fuel consumption.

#### Running-in of Tires and Braking Pads

Drive at moderate speed within the first 500km to properly run the new tires in.

Within the first 200km ~ 300km of traveling mileage, the new braking pad cannot realize the optimal friction status, so that drive at medium or low speed and avoid emergency braking as much as possible.



**⚠ Warning**

- The best adhesion and friction cannot be realized for new tires and braking pad without running-in. Therefore, drive carefully for the first 500km to run in the tires well and avoid accidents.
- After replacement, the new braking pad shall also go through running-in period in accordance with the above requirements.
- Keep an appropriate distance with other vehicles during driving to prevent emergency braking, because at that time, both the new tires and braking pad are not fully run-in, and emergency braking may cause traffic accident.
- If the brake is damped or frozen, or the car is running on salt spreading road, the braking effect weakens.

**⚠ Warning**

- Heavy work load of the brake during running downhill makes it prone to overheat. It is recommended to slow down by shifting to a lower gear and fully use engine braking to reduce its work load.
- Always brake the car according to the road and traffic conditions. Avoid unnecessary press of brake pedal. Doing so can make the brake overheating, resulting in a longer braking distance and excessive wear.
- Do not let your car coast with the engine off, because as the brake booster is disabled, the braking distance will be much longer, making the situation accident-prone.
- Do not use the brake fluid for too long. Be sure to replace the brake fluid according to the maintenance intervals in the Warranty Manual.

## 5. Driving Guide

---

### 5.6.3 Important Tips for Driving under Different Conditions

- Drive slowly with wind blowing laterally, so as to control your car easily.
- Keep the right driving angle and avoid passing through high or sharp objects or other road barriers, or otherwise it may cause tire burst or serious damage.
- Slow down during driving on very bumpy or uneven roads. Otherwise, the car will be seriously damaged by impact and chassis scratching.
- After car washing or driving through road with deep ponding, since the braking pads and brake disc are soaked, the braking effect weakens. At this time, drive at slow speed and slightly press down the brake pedal for several times to eliminate left water drops in the brakes, and then drive normally as the braking effect resumes.

#### Warning

- **Before driving, make sure the parking brake is released fully and its indicator light is off.**
- **Do not rest your foot on the brake pedal during driving. Or otherwise it can lead to dangerous overheating, unnecessary wear and fuel wasting.**
- **When driving downward on a long slope, decelerate and downshift. Remember that using the brakes frequently can make them too overheated to work.**
- **Be careful during acceleration, up-shifting, down-shifting or braking on slippery road. Sudden acceleration or engine braking can cause wheel slipping or spinning.**
- **Do not drive any more when the brake is wet. If the brake gets wet, braking distance will be longer than usual and the car may deviate during braking. The parking brake cannot stop the car firmly, either.**

### Precautions for Driving through Ponding Road:

1. Before driving through a waterlogged road section, find out the ponding depth which shall not exceed the lower edge of car body.
2. In case of driving through water, turn off the air conditioner before starting; drive slowly; slightly step on the accelerator pedal and do not release; drive through the waterlogged section at a stable and low speed.
3. Do not park your car in water, nor reverse or turn off the engine.
4. After passing the waterlogged section, slightly step on the brake pedal for several times to evaporate water on the braking disc, so as to recover braking performance as soon as possible.

### Important Tips for Driving in Winter

1. Make sure the anti-freezing solution works well.
  - Use the coolant solution of the same model as the originally used, and select suitable coolant solution according to the environment temperature and add it to the cooling system.
  - The engine can be damaged by unsuitable coolant solution.
2. Check the conditions of battery and cable.
  - Battery energy may decrease in cold weather, so that sufficient energy shall be reserved for starting in winter.
3. Prevent the door lock from being frozen by ice and snow.
  - Spray deicing agent or glycerin into keyhole to avoid freezing.
4. Use detergent containing anti-freezing agent.
  - These products are available in GAC MOTOR dealers.
  - The mixing ratio between water and anti-freezing agent shall be based on the manufacturer's instructions.
5. There shall be no ice or snow accumulated under the mudflap.
  - Accumulated ice or snow under the mudflap causes hard steering. In winter, stop the car frequently to check if there is accumulated ice or snow under the mudflap.
6. Based on different road conditions, it is recommended that necessary emergency tools or articles should be carried.
  - It would be better to place tire chain, window scraper, a bag of sand or salt, signal flasher, scoop, connecting cable and other necessary articles in the car.
7. In cold winter (especially in the north area), frequent starting of the engine or flameout of the engine after a short time of running shall be avoided. If the engine is often in an alternate cooling and heating state, condensation water may be produced inside the engine. The condensation water attached to the oil may cause the illusion of oil emulsification. After the engine starts, this illusion will disappear. Please replace the oil regularly according to the requirements in the Warranty Manual.

## 5. Driving Guide

---

### 5.6.4 Efficient Use of the Car

- Maintain sufficient tire pressure. Insufficient tire pressure will result in tire wear and fuel waste. Tire pressure parameters => Refer to Page 307
  - Make sure wheels are accurately positioned. Inaccurate positioning makes the tires wear out faster, increases engine load and wastes fuel.
  - Do not make your car under over-load. • Excessive weight increases engine load, wasting fuel.
  - Accelerate slowly and steadily. Avoid emergency starting. Try to drive in a higher gear as soon as possible.
  - Avoid areas with dense traffic or traffic jam as much as possible to prevent continuous acceleration and deceleration, because stop-and-go driving mode wastes fuel.
  - Avoid unnecessary parking and braking and keep a stable speed. Driving according to traffic signals help avoid frequent stop. Or choose thoroughfares without traffic lights. Keep appropriate distances with other cars to avoid emergency braking. This helps reduce brake wear.
  - Do not rest your foot on the brake pedal. This causes early wear or overheating of braking pad and fuel waste.
  - Avoid hitting road shoulder while driving. Slow down when driving on uneven roads.
  - Avoiding mud or other foreign matters stuck on chassis helps reduce car weight and prevent corrosion.
  - Regularly maintain your car to keep it in its best working condition. Dirty air filter, unclean spark plugs, polluted engine oil and grease will weaken engine performance and waste fuel. To extend the service life of all components and reduce operating costs, be sure to perform regular maintenance. Maintain your car more frequently if you often drive under bad conditions.
- Fuel-saving Driving**
- Fuel-saving driving can not only save fuel but also protect environment.
- Drive slowly for several minutes after starting at low temperature, and then accelerate after the engine warms.
  - Unload unnecessary items before driving.
  - Keep proper tire pressure.
  - Try to drive on good roads.
  - Avoid rapid acceleration. Step on the accelerator pedal gently. Do not step on pedals hard for start or stop.
  - Do not open windows when driving at high speed.
  - Use the AC, audio system and other devices properly.
  - Turn off all unnecessary electric appliances.
  - Shut off the engine for long-time parking and prevent it from long-time running at idle speed.
  - Drive on flat roads at economic speed.
  - Always drive in an appropriate gear based on the running speed. Do not drive at high speed in low gear.
  - Perform regular maintenance according to instructions.

### 5.6.5 Fire Prevention

In order to prevent car fire, the following notices shall be kept in mind:

1. Flammables and explosives shall not be stored in your car;
  - In hot summer, the internal temperature of car parking in the sun can reach higher than 70 °C. If there is lighter, detergent, perfume, and other flammables and explosives in your car, it is very easy to cause fire or even explosion.
  - When there is no person in the car, the lithium battery, power bank and other articles that have fire risk in the car may also cause fire.
2. After smoking, confirm the cigarette end goes out completely;
  - Cigarette not put out completely may cause fire.
3. Please go to your GAC MOTOR dealer for check regularly.
  - Regularly check the circuits of the whole car to make sure connectors, insulation and fixing positions of all electric appliances and harness are in good condition. Once problems are found, troubleshoot timely.
4. Refitting the car circuits or adding electrical components is prohibited.
  - Adding other electric appliances (e.g. high-power audio device and xenon headlights) will overload the circuit, and the harness will be prone to heat and cause fire.
  - It is strictly prohibited to use fuse out of the rated specifications of electric appliance, or use other metal wire to substitute fuse.
5. Precautions for driving;
  - During driving and parking, especially in summer, be sure to check whether flammables exist under your car, such as hay, deadwood, leaves, or wheat straw, because the temperature of engine exhaust pipe or other components increase after long-time running, and flammables under the car may cause fire.
  - Do not park your car at scrap heaps or other rat-infested places and do not store anything that appeals to rats, like snacks. The rats may bite through the harness, leading to fire.
6. Portable fire extinguisher shall always be kept on your car, and you should know how to use it;
  - In order to guarantee safety, fire extinguisher shall be kept on your car and also be checked and replaced periodically. You should know how to use a fire extinguisher, so as to be prepared for accident.
7. During maintenance, disconnect the negative wire of battery;
8. Please use the cigarette lighter provided on this car. Do not use inverter to take electricity from cigarette lighter.

## 6. Usage and Maintenance

---

### 6.1. Maintenance Instructions

#### Safety Precautions

To avoid potential hazards, please read this chapter and make sure you have tools and technology required before maintenance.

- Make sure your car is parked on level ground, the engine is off, and the parking brake is applied.
- Use degreasant or detergent to clean parts and do not use gasoline.
- To reduce the possibility of fire or explosion, keep cigarettes, sparks, and flames away from the battery and all fuel-related parts.
- Wear goggles and protective clothing when working with the battery or compressed air.

#### Warning

**Driving after incorrect maintenance or before solving safety related failures may cause traffic accidents and lead to severe injury or death.**

#### Potential Hazards

- Carbon monoxide: Carbon monoxide from engine exhaust is poisonous. Be sure there is adequate ventilation whenever you operate the engine.
- Scald: the engine and exhaust system will produce high temperature when working, which is very easy to cause scald. Therefore, do not touch any components until the engine has been stopped for at least 30 minutes and the engine and exhaust system has cooled down.

#### Caution

Some of the most important safety precautions are given in this chapter. However, we cannot warn you of every conceivable hazard that can be raised in maintenance.

### 6.2 Interior Maintenance

#### Cleaning and Maintaining the Instrument and Plastic Parts

Clean the surfaces of the instrument and plastic parts with a clean soft cloth and fresh water.

Otherwise, use the special solvent-free plastic cleaning agent to clean them.

#### Caution

Cleaning agent with solvent may damage the plastic parts.

#### Warning

**Do not use any driver's compartment spray or cleaning agent with solvent to clean the surfaces of the instrument panel and airbag module. Doing so could loosen the surfaces and trigger the airbags, resulting in serious personal injury.**

#### Cleaning and Maintaining the Carpet

Remove dust on the carpet with a vacuum cleaner regularly. Clean the carpet with cleaner regularly to keep it clean.

#### Caution

Follow the instructions of the detergent to do the cleaning work.

#### Warning

**It is strictly forbidden to add water into foam-type cleaner. Make sure that the carpet is dry.**

#### Cleaning and Maintaining the Leather

- Vacuum dirt and dust from the leather frequently.
- Clean the leather with a soft cloth dampened with clear water.
- Then, buff it with a clean, dry cloth.
- If further cleaning is needed, use special saddle soap or detergent to clean it.

#### Caution

After you wipe the leather using the special detergent, wipe it dry as soon as possible with a soft, dry cloth.

#### Warning

**Do not place soft cloth soaked with detergent on any interior parts for a long time, to avoid discoloration or breakage to the resin or fiber of the interior braided fabrics.**

## 6. Usage and Maintenance

---

### Cleaning and Maintaining the Seat Belts

- Pull out each belt slowly and hold it there.
- Use a soft brush and neutral soap water to clean dirt.
- Let the seat belts dry completely before retracting them.

#### Caution

- Do not retract the seat belts until they are completely dry. Otherwise, the seat belt retractor may be damaged.
- Check all seat belts in the vehicle regularly and keep them clean to ensure their proper operation.

#### Warning

- **Please contact GAC MOTOR dealer for replacement in case of any damage to the base, connection unit, retractor or buckle of the seat belt.**
- **Whether damaged or not, be sure to replace the seat belts after a collision.**
- **When replacing the belt, be sure to use a new belt of the same model and structure.**
- **Prevent foreign matters or liquids from entering the seat belt buckles. Failure to do so can cause the buckles and the belts to function abnormally.**
- **Do not remove or transform the belts in any case by yourself.**
- **Do not use chemical cleaning agents to clean the seat belts to avoid damaging the seat belt base, thus affecting its function.**

### Cleaning and Replacing Filters

The vehicle is equipped with air filter, air conditioner filter, oil filter and fuel filter, which play a role in filtering gas or oil. If the filter is too dirty or blocked, the normal work of the corresponding system will be influenced, so it is recommended that the user should go to GAC MOTOR dealer periodically to clean or replace the filter according to the provisions of the Warranty Manual.



### 6.3 Exterior Maintenance

#### Vehicle Washing

Frequent washing helps preserve your car's appearance.

Wash your car in a shady area, not in direct sunlight. If your vehicle is exposed to the sun for a long time, wait until the exterior cools down before washing.

Follow the instructions of the operator when using an automatic car washer.

#### Warning

**Switch the Start switch or the Ignition switch off before washing the car.**

#### Caution

- Although the body paint is strong enough to withstand the flushing from the automatic car washer, pay attention to its impact on the paint. The washer structure, used cleaner, filtration state of fresh water, and type of wax solvent which do not meet the specified requirements are likely to damage the paint.

#### Manual Washing

- Rinse the vehicle thoroughly with clean water to remove floating dust.
- Prepare a bucket of clear water and mix the water with special washing cleaner.
- Wash the vehicle gently with soft cloth, sponge or a bristle brush and rinse it from top to bottom frequently.
- Finally, rinse the wheels, doorsills and others. Remember to replace the sponge or soft cloth during washing.
- Then rinse the vehicle thoroughly with a plenty of water.
- Then, dry it with a chamois or soft towel.

## 6. Usage and Maintenance

---

### Caution

If there is asphalt or other dirt on the car's body, special cleaner needs to be used. Then rinse the body with water to avoid damage to the finish. As drying the vehicle, check it for chips and scratches. If any, go to GAC MOTOR dealer for repair.

Be careful when washing the vehicle with a steam washer or a high pressure washer. Follow the instructions and requirements of the steam washer or the high-pressure washer when doing so and pay attention to operation pressure, temperature and washing distance.

- When washing the vehicle with a steam washer or a high-pressure washer, keep enough spraying distance with the vehicle and keep the temperature not greater than 60°C .
- Keep a spraying distance of more than 80 cm when washing the vehicle with an electric sunroof. Short distance between the high-pressure washer and the vehicle or excessive high temperature or pressure may damage your the vehicle.
- Do not face the high-pressure washer to the radar sensor or the parking camera for a long time when washing the vehicle. When washing the radar sensor or the parking camera, keep a spraying distance of more than 30 cm.

### Warning

- **Pay attention to personal safety and avoid being scratched by angular parts under the bottom of the vehicle during manual washing.**
- **Pay special attention to the bottom of the vehicle and the inside part of the wheel cover during washing and prevent your hand and arm from being hurt by sharp parts.**
- **Do not directly spray water into the engine compartment when washing the vehicle. Otherwise, the service life of parts in the engine compartment may be affect.**

### Waxing

Regular waxing helps protect vehicle body's paint and keep the body bright and clean. In order to protect body paint surface, it is suggested to apply high quality hard wax every year to protect the paint surface from being corroded due to poor environment and withstand light mechanical scratch.

The waxing operation must be executed after the surface of the whole vehicle is wiped dry. High quality paint protective wax shall be used. In general, there are two types of products:

- Body wax: A wax coats the finish and protects it from the damage by exposure to sunlight, air pollution, and other poor external environment. It always apply to new cars.
- Polishing wax: Polishing wax can restore the luster of oxidized paint or the paint without gloss. It is mainly used to restore the luster to paint.

### Cleaning and Maintaining the External Plastic Parts

In general, clean the external plastic parts with fresh water, soft cloth and bristle brush. If further cleaning is needed, use the special solvent-free plastic cleaning agent recommended by GAC MOTOR.

#### Caution

Do not use any cleaning agent with solvent to clean the plastic parts. Doing so can cause damage to the plastic parts.

### Cleaning the Windows and Exterior Rear-View Mirror

Clean the window glass and rear-view mirrors with alcoholic glass cleaner, and then dry glass surface with a clean, lint-free, soft cloth or antelope skin.

#### Caution

Do not use hot water to remove the ice and snow on the windows and rear-view mirrors. Doing so may crack the glass.

## 6. Usage and Maintenance

---

After maintaining the car body surface, the wax remaining on the glass shall be removed by special cleanser and cleaning cloth. So as to prevent scratching the windscreen wiper.

Remove the snow on the windows and rearview mirrors with a bristle brush.

Remove ice using the special deicing spray. You can also remove the ice using the scraper with extra care to avoid damage to the components. Be sure to scrape the ice in the same direction.

### Caution

- Do not scrape the ice back and forth.
- Do not use warm or hot water to remove the ice and snow on the windows and rear-view mirrors. Doing so may crack the glass.

### Cleaning the Front Wiper Blades

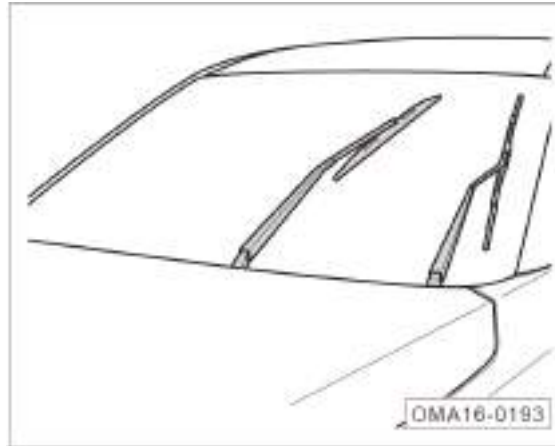

- Switch the Start or Ignition switch to “ON” gear, and then to “OFF” gear.
- Within 10s after finishing the last step, move the combination switch of wiper to gear, then the wiper arm will move for half circle.
- Lift the wiper arm and carefully remove the dust and dirt from the wiper blade with a soft cloth.
- Carefully lower the wiper arm back to the windshield when the cleaning is finished.

- Switch the Start or Ignition switch to “ON” gear again, making the wiper arm back to its original position automatically.

### Caution

- When lifting the wiper arm, grasp the hard support by hand, and do not grasp soft wiper blade.
- Carefully lower the wiper arm to prevent striking the windscreen due to instantaneous drop.
- Replace the damaged blade in time.
- A new wiper blade surface is coated with a layer of graphite which can make the wiper blade move smoothly without scratching noise. Damaged graphite layer may increase scratching noises. Be sure to repair it timely.
- Cleaner with solvent, hard sponge and sharp tools will damage the graphite layer.
- In winter or cold weather, check whether the wiper blades are frozen with the windshield before operating them. If so, remove the ice from the wiper blades firstly. Failure to do so may cause damage to the wiper blades and the wiper motor.

### Maintaining the Sealing Strips

Frequent and appropriate protection of the rubber sealing strips for the doors, windows and other parts can maintain their flexibility, prolong their service life. Such action can improve the leakproofness, making the doors easier to open and reducing the closing sound and it's difficult to get frozen in winter.

When maintaining the sealing strip, use soft cloth to remove the surface dust and dirt. Apply the special protective agent to the rubber sealing strips regularly.

### Cleaning and Maintaining the Wheels :

Regular wheel maintenance can keep the wheel artistic, and periodically removing the anti-skid salt and brake lining abrasive dust on the wheel can maintain the surface smoothness of the wheel and increase the service life. In order to protect your vehicle, it is suggested that the following operations should be executed periodically:

- Use acid-free cleanser to remove the antiskid salt and brake lining abrasive dust on the wheel every two weeks.
- Wax the alloy wheels with high-quality hard wax every three months.

### Caution

If the protective layer of the wheels is damaged, be sure to repair it in time.

## 6. Usage and Maintenance

### 6.4 Checking and Adding Fluids

#### 6.4.1 Fuel Oil

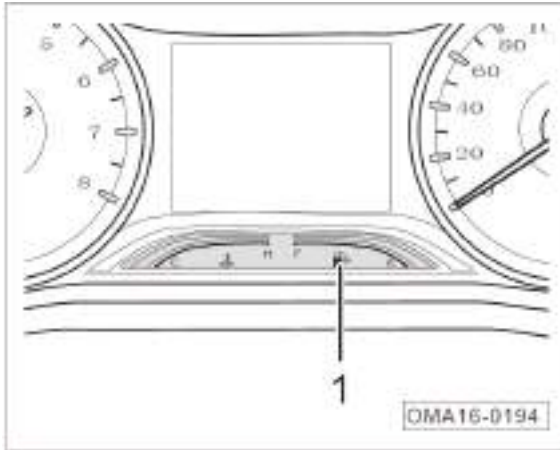

The scale of the fuel gauge ① will decrease gradually with the decrease of fuel oil during the traveling process.

The low fuel indicator light  will flash in yellow when the fuel level is too low and the instrument cluster will provide corresponding graphics & text information. Then it is required to add fuel as soon as possible.

#### Filling the Fuel

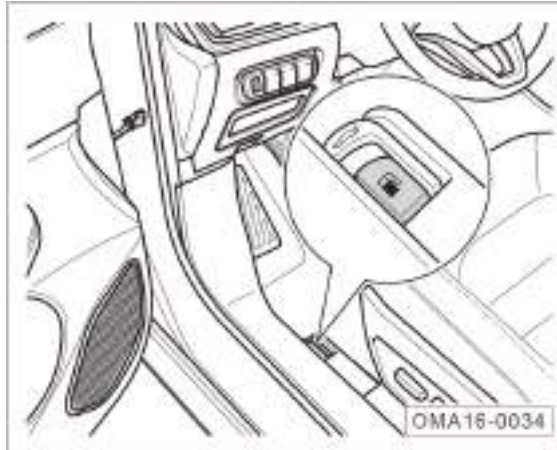

- Pull the handle of fuel tank cap and the fuel tank cap will bounce outward.

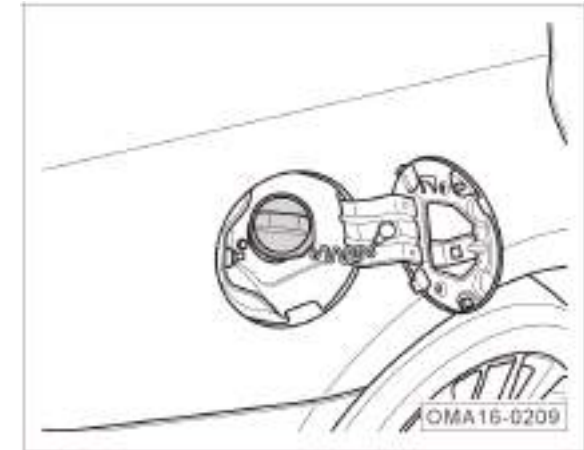

- Fully open the fuel tank cap, slowly screw out the filler cap anticlockwise, hold the filler cap at the original position for a moment when fully screwing out to allow the fuel tank to release the internal fuel vapor pressure, and then take out the filler cap.

### ⚠ Warning

- **When the weather is dry, static electricity is liable to be produced, so release the static electricity on your body before opening the filler cap to prevent the spark generated by static electricity from igniting the fuel vapor.**
- **The fuel oil is highly flammable. Therefore, igniting, naked flame or smoking is strictly prohibited when treating the fuel oil.**
- **Do not let the fuel oil contact skin or clothes. Skin directly contacting fuel oil or inhaling fuel fog will be harmful to health. If fuel oil sticks on the skin negligently, immediately wash with water.**

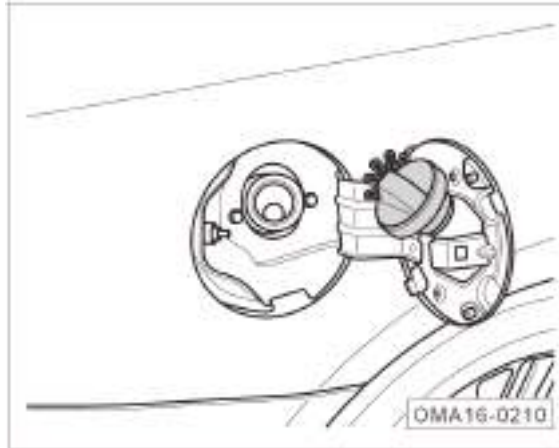

- Hang the filler cap inside the fuel tank cap, and start adding fuel oil.
- When finishing adding fuel oil, screw the filler cap clockwise until you hear three "clicks", which indicates the filler cap is fully tightened.

### i Hint

Please refer to the description on the fuel requirement label at the fuel filler door of each vehicle.

### 👁 Caution

Using fuel oil with lower grade or not meeting the standard may damage the engine or may not satisfy the performance requirements.

### ⚠ Warning

**Do not add diesel oil for gasoline engine vehicle. Do not mix diesel oil into gasoline. This will damage the fuel system and engine, and may cause fire.**

## 6. Usage and Maintenance

---

### 6.4.2 Engine Oil

#### Function of Engine Oil

Engine oil contributes to engine's lubrication, sealing, cooling, anti-corrosion, cleaning, etc.

#### Engine Oil Specification

High-quality engine oil, which can be used throughout the year, except for extreme cold weather, has been filled into the engine when the vehicle is delivered.

Check whether the specifications of the oil are applicable to your engine when purchasing.

#### Hint

- Engine oil specification: SN class and above; viscosity: SAE 5W-30

#### Warning

- **Be sure to use the engine oil applicable to the engine of your vehicle.**
- **Using the engine oil of other specifications may damage the engine and cause accidents.**

#### Oil Pressure Warning Light

After the engine starts, if the warning light  is on and meanwhile the system gives out audible alarms, the instrument cluster display screen will also display corresponding graphic & text message to prompt or warn the driver. At the moment, immediately turn off the engine. After the engine cools, inspect the engine oil level, and add engine oil if necessary.

If the engine oil level is normal but the warning light is still on, do not continue driving, nor allow the engine to idle; contact GAC MOTOR dealer as soon as possible to inspect your car.



### **i** Hint

The oil pressure warning light cannot indicate the engine oil level. Be sure to check the oil level regularly. You'd better check the oil level before driving.

### **⚠** Warning

**Ignoring the oil pressure warning light and the relevant warnings can damage the engine thus causing serious accidents.**

### Checking Engine Oil Level

All engine will consume a certain amount of engine oil. The oil consumption depends on driving mode and vehicle working conditions. Therefore, the engine oil level must be checked regularly.

When your vehicle is traveling on the expressway for a long distance in summer, or is traveling with drawbar trailer, or is climbing along the mountain road with the engine operating under severe conditions, the engine oil level shall not exceed the mark of upper limit.

### **⚠** Warning

- **Be sure to operate inside the engine compartment with extra care.**
- **The engine compartment is a high-risk area. Before opening the engine hood, please carefully read and comply with relevant warnings and instructions.**

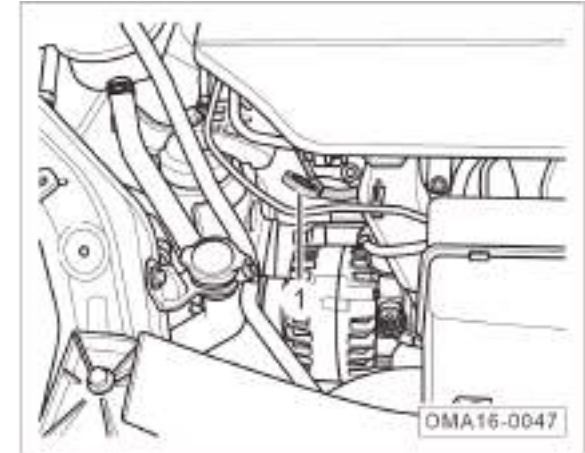

- Park your vehicle on a horizontal road and apply parking braking.
- Switch off the Start or Ignition switch.
- Open the engine hood.
- After the engine cools down, pull out the engine oil dipstick①.

## 6. Usage and Maintenance

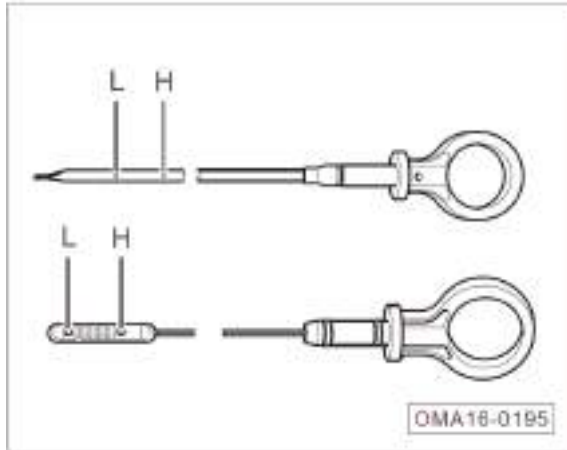

- Wipe off the oil stains on the dipstick with a clean cloth. Then insert the dipstick all the way back into its hole.
- Pull out the engine oil dipstick again, read the measured oil level, and add engine oil according to the oil level.
- Point H is the engine oil upper limit mark.
- Point L is the engine oil lower limit mark.
- The engine oil level should be between the upper and lower limit marks and close to the upper one.

### ⚠ Warning

If the engine oil level should be inspected when the engine is hot, firstly turn off the engine and wait for several minutes until the engine oil fully flows back to the oil sump, and then inspect the engine oil level. The oil level can be checked immediately when the engine is in cooling condition.

### 👁 Caution

If the engine oil is insufficient, please timely add a proper amount of engine oil. Otherwise, the engine may be damaged.

### ℹ Hint

The shape and color of engine oil dipstick for the vehicle you purchase may be different with those of the engine oil dipstick shown in the figure, but the oil level mark on the engine oil dipstick as shown in the figure applies to the engine oil dipstick of all vehicle models.

### Add the Engine Oil.

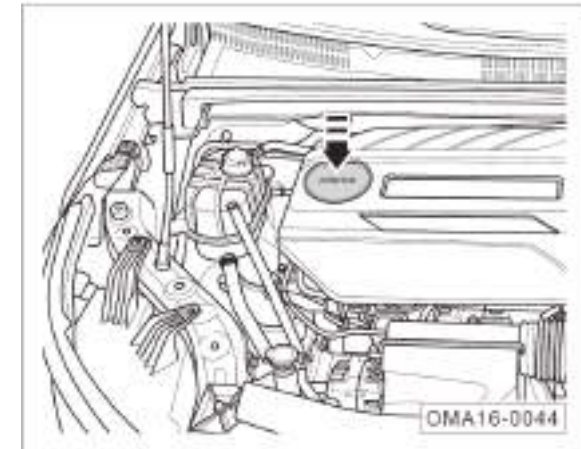

- Park your vehicle on a horizontal road and apply parking braking.
- Switch off the Start or Ignition switch.
- Open the engine hood.
- After the engine cools down, press the engine oil filler cap cover along the direction of arrow to open it.

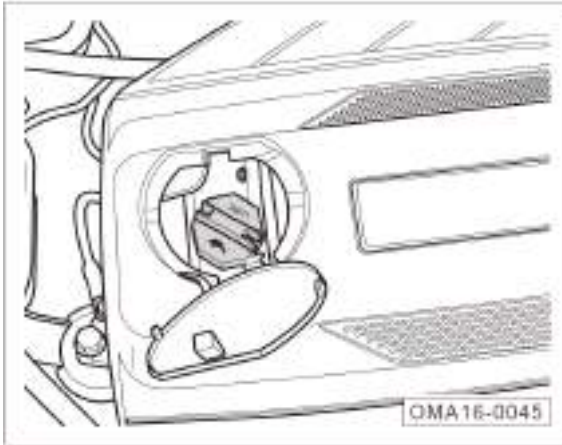

- Screw out the engine oil filler cap anticlockwise.
- Fill engine oil into the filler repeatedly by small amount, and check the engine oil level after each filling.
- When the oil level is close to the upper limit mark, i.e. the engine oil is sufficient, stop adding oil, assemble the filler cap and tighten clockwise.

### ⚠ Warning

- **Engine oil is a type of highly combustible material. Be careful to add the engine oil and do not sprinkle the engine oil onto the scorching hot engine parts or exhaust system piping.**
- **If too much engine oil is filled, please do not start the engine, and contact GAC MOTOR dealer for treatment. Otherwise, the three-way catalytic converter may be damaged.**
- **After completing the filling, the engine oil filler cap must always be tightened, so as to prevent the engine oil from spilling when the engine is operating and avoid fire.**

### Replace Engine Oil

Replace the engine oil as per the intervals specified in the Warranty Manual. Replace the engine oil at GAC MOTOR dealer.

If the vehicle is used under severe conditions, or fuel oil with higher sulfur content is used, or short-distance traveling frequently occurs, or the vehicle will idle for a long time (e.g. taxi), or the vehicle will travel in high dust area, or the vehicle will frequently travel with drawbar trailer, or the vehicle will be used in high and cold area, increase the number of maintenance times or reduce the maintenance period of several maintenance items between periodic maintenances.

## 6. Usage and Maintenance

---

### Warning

**Never replace the engine oil by yourself unless you have relevant expertise.**

- **Be sure to operate after the engine cools down, so as to prevent scald by high temperature engine oil.**
- **To prevent engine oil from getting into your eyes, be sure to wear goggles when replacing the engine oil.**
- **When unscrewing the oil drain plug, be sure to place your arm horizontally to prevent the oil from flowing along it.**
- **If the engine oil splashes on the skin, rinse it thoroughly.**
- **Put the used oil into a special container which is large enough to contain all used oil.**
- **Do not store the used oil in a food container or any other non-original container to avoid confusing, resulting in poisoning.**
- **As engine oil is toxic, please first put it on a safe place to prevent children from touching it before disposing it.**

### Caution

- Add no lubricant into engine oil; otherwise, the engine may be damaged. Any fault caused by addition of lubricant isn't included in quality guarantee.
- Disposing the used oil is a highly specialized work, requiring relevant expertise and necessary tools. Therefore, it is suggested to dispose the used engine oil by GAC MOTOR dealer.
- Improper disposal of engine oil can be harmful to the environment and water source, so do not discard it in a sewer line or dump it on the ground. In addition, the cost for treating the soil absorbing the waste engine oil is very high.

### 6.4.3 Coolant

#### Function of Coolant

The coolant possesses cooling, anti-freezing, and anti-corrosion functions.

#### Specification of Coolant

When delivery, the cooling system of this vehicle has been added with coolant, which has an anti-freezing ability of  $-35^{\circ}\text{C}$ . The coolant can be used throughout the year except for extreme cold weather, prevent the alloy components of cooling system from corrosion and the system from scaling and increase the boiling point of the coolant.

If the anti-freezing ability of coolant needs to be enhanced during severe cold seasons, the proportion of coolant additive can be increased appropriately, but the coolant concentration must not exceed 65%. Otherwise the antifreezing ability of coolant may decrease, thus weakening the cooling effect.

#### **i** Hint

Specification of coolant: DF-6,  $-35^{\circ}\text{C}$  coolant.

#### Engine coolant temperature gauge

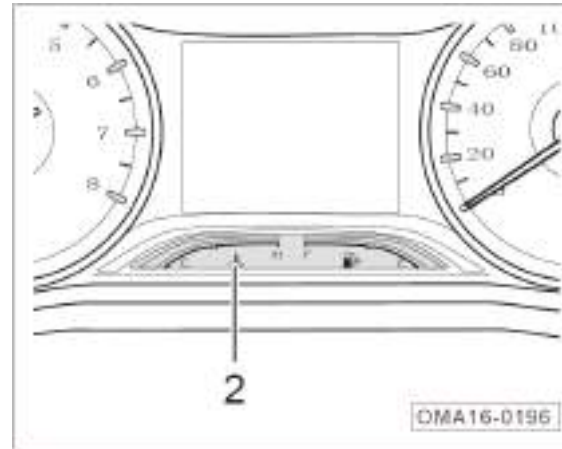

Under normal driving conditions, the scale lighting on the temperature gauge ② of engine coolant on the instrument cluster shall be approximately at the middle position. When the engine runs at heavy load and the ambient temperature is high, the coolant temperature may rise and the scale reading may increase.

#### High engine coolant temperature indicator light

When the temperature of the coolant is too high, the engine temperature indicator light (red) in the instrument cluster will be on and the instrument cluster will display corresponding graphic & text information to prompt or warn the driver. At this moment, stop the vehicle and shut the engine down. Then check the level of the coolant after the engine cools down.

If the coolant level is normal, the system overheating may be caused by the failure of radiation fan. Inspect whether the fuse of radiation fan fuses, and replace the fuse as the case may be.  
=> Refer to Page 402

If the indicator light is on again when you have driven for a short distance after the fuse is replaced, immediately stop your vehicle, turn off the engine, and contact GAC MOTOR dealer for maintenance as soon as possible.

## 6. Usage and Maintenance

### ⚠ Warning

- Be sure to operate inside the engine compartment with extra care.
- The engine compartment is a high-risk area. Before opening the engine hood, please carefully read and comply with relevant warnings and instructions.
- If you see vapor or coolant overflowing from the engine compartment, do not open the hood. Doing so can seriously scald you. Open the engine hood after there is no steam or coolant spilling from the engine compartment.

### Checking the Coolant Level

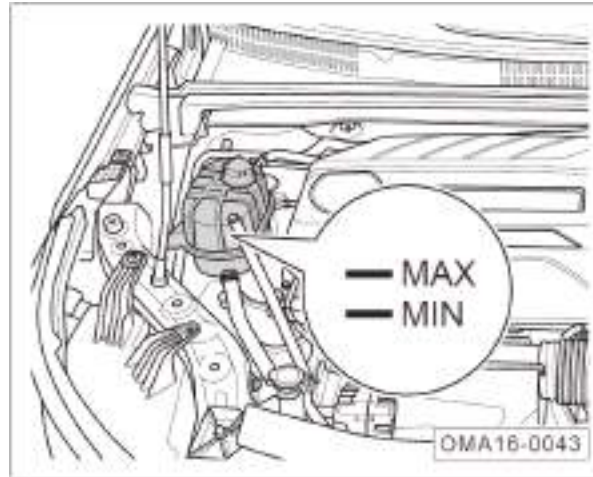

- Park your vehicle on a horizontal road and apply parking braking.
- Switch off the Start or Ignition switch.
- Open the engine hood.
- Open the engine hood, and inspect whether the liquid level in the expansion tank is within the scope of marker line on the side.
- “MAX” refers to the upper limit mark of coolant.
- “MIN” refers to the lower limit mark of coolant.
- The coolant level should be between the upper and lower limit marks and close to the upper one.

- If the coolant level is lower than the “MIN” mark, add coolant.

### 👁 Caution

- Whether the coolant level is normal or not is crucial to the proper operation of the engine cooling system.
- In order to correctly inspect the coolant level, the vehicle shall be parked on level road and the engine shall be at cold status.

## Adding Coolant



After inspecting the coolant level, add coolant if necessary in the following steps:

- Wrap the expansion tank cover with a large and thick cloth and carefully screw it out anticlockwise.
- Slowly add coolant to make the coolant level reach the scope of marker line on the side of expansion tank.
- Install and tighten the expansion tank cover clockwise.

### Caution

- Please firstly inspect the level before adding coolant, and get ready according to the inspection requirements.
- When the engine is in warm or hot condition, the cooling system has high pressure. At this moment, never open the coolant expansion tank cover. Doing so may cause scalding by steam.
- Each time when screwing the expansion tank cover, use cloth to wrap the cover to avoid scald.
- Add new coolant only and the discharged coolant can not be reused.

### Hint

When the engine is hot, the coolant level may exceed the MAX mark slightly.

### Warning

- **The coolant must be stored in its original container. Keep both the coolant and the used coolant out of the reach of children.**
- **Do not store the coolant in a food container or other non-original container to avoid confusing, resulting in poisoning.**
- **Make sure the anti-freezing capability of the coolant is sufficient in cold weather. Add enough DF-6 coolant based on the environment temperature. Otherwise, the coolant may be frozen, resulting in breakdown of the vehicle. In addition, the driver and passengers will be exposed to severe cold due to the disabled heating system.**

## 6. Usage and Maintenance

---

### Caution

- Do not mix the original coolant with other unrecognized coolant. Otherwise, the engine may be seriously damaged.
- If the coolant is needed to be added, only add new coolant. The coolant must meet the provisions of this Manual; do not add other types of coolant even if no DF-6 coolant can be purchased temporarily. If necessary, add pure water temporarily. But, to restore the normal concentration, you must add the recommended coolant as required as soon as possible.
- If the coolant in the coolant expansion tank discolors, and no coolant of other color mixes, replace the coolant periodically according to the requirements of the Warranty Manual.

### Caution

- Do not add coolant until the engine cools down. After adding coolant, make sure the coolant level is at or below the MAX mark. Otherwise, the excessive coolant will spill out of the cooling system when the engine becomes hot.
- If a large amount of coolant is consumed, add cold coolant after the engine cools down; otherwise, the engine may be damaged. Great loss of coolant implies a leakage failure in the cooling system. Go to GAC MOTOR dealer to inspect the cooling system as soon as possible, so as to avoid damaging the engine.
- Collect and dispose the used coolant in accordance with environmental protection laws and regulations.



### 6.4.4 Windshield Washing Liquid and Wiper Blade

#### Adding Windshield Washer Fluid

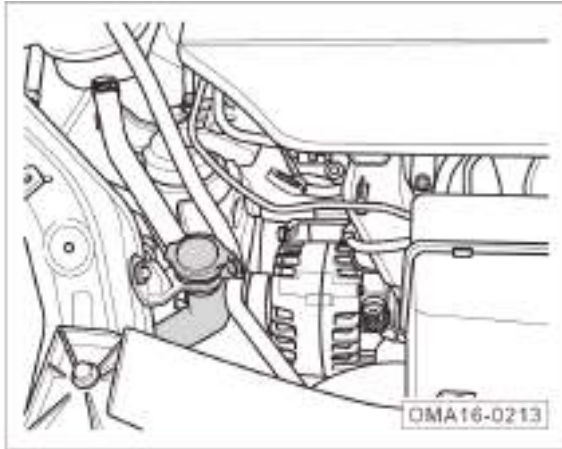

Windshield cleaning device will have its washing liquid supplied by the washing fluid tank in the engine compartment. Each time when the washing liquid is checked, if the washing liquid level is found to be too low, timely add washing liquid into the washing liquid tank.

Pure water is difficult to completely clean the windshield, so washing liquid additive accepted by GAC MOTOR must be added into the pure water; please prepare the washing liquid according to the proportion specified in the outer packing of additive.

#### Warning

- **Be sure to operate inside the engine compartment with extra care.**
- **The engine compartment is a high-risk area. Before opening the engine hood, please carefully read and comply with relevant warnings and instructions.**
- **Windshield washing liquid shall not be added with coolant or any other additive. Otherwise, oil stain may remain on the windshield when cleaning, which may seriously influence the forward visibility, and is very easy to cause accident.**

#### Caution

Do not mix the windshield washer fluid with other cleaning agents. Doing so may cause the washer fluid to be decomposed, blocking the windshield washer nozzle.

## 6. Usage and Maintenance

### Replacing Front Windshield Wiper Blade

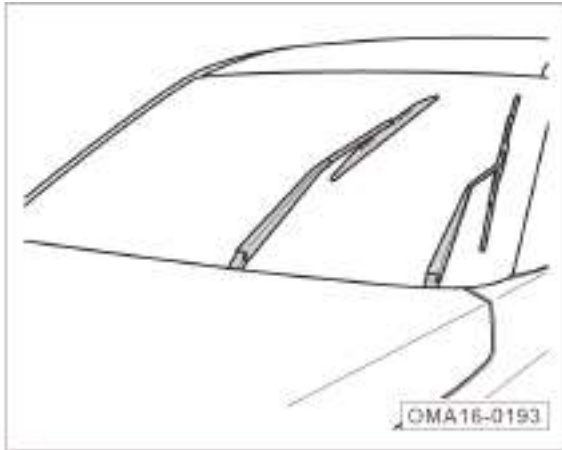

- Switch the Start or Ignition switch to "ON" gear, and then to "OFF/ LOCK" gear.
- Within 10s after finishing the last step, move the wiper combination switch to gear. By this time, the wiper arm will move for half circle.



- Lift the wiper arm, adjust the wiper blade as shown and then press the wiper blade to remove it.
- Slowly lower the wiper arm.
- Place a new wiper blade back to the wiper arm in reverse steps, and install after hearing a "click".
- Carefully lower the wiper arm back to the windshield.
- Switch the Start or Ignition switch to "ON" gear, making the wiper arm back to its original position automatically.

It is recommended to replace your wiper blade at GAC MOTOR dealer when necessary.

#### Caution

- When lifting the wiper arm, grasp the wiper arm with hand, and do not grasp the soft wiper blade.
- Be sure to use new wiper blade with the same length and specification.
- Carefully lower the wiper arm to prevent striking the windshield due to instantaneous drop.
- Check the condition of the wiper blades regularly, and replace them as required. Timely replace the damaged wiper blade.
- Seriously worn or dirty wiper blade is very easy to scratch the windshield, and will influence the forward visibility and reduce the driving safety during use.

### 6.4.5 Brake Fluid

#### Function of Brake Fluid

The brake fluid is used to transfer power in the hydraulic brake system.

Check the brake fluid level or replace the brake fluid regularly as per the Warranty Manual.

#### Specification of Brake Fluid

High-quality brake fluid, which can be used throughout the year except for extreme cold weather, has been filled when the vehicle is delivered.

Check whether the specifications of the brake fluid are applicable to your vehicle when purchasing.

#### **i** Hint

- Specification of brake fluid: DOT4 synthetic brake fluid.

#### Brake system indicator light

- If the brake system indicator light (Ⓢ) is on during traveling, it may be because the brake fluid level in the tank is too low. To prevent accidents, immediately stop your vehicle in such case to check the level of the brake fluid. If the brake fluid level decreases under the “MIN” mark, it may be because there is some leakage in the brake system. Stop driving in such case and contact GAC MOTOR dealer for inspection as soon as possible.

During the using of your vehicle, the system will automatically adjust the brake fluid level due to the wear of braking pad, causing slight decrease of brake fluid level, which is a normal phenomenon and requires no worry.

#### **i** Hint

If the brake fluid storage tank is blocked by other parts in the engine compartment, preventing inspection of the brake fluid level directly, go to GAC MOTOR dealer.

#### Inspecting the Brake Fluid Level

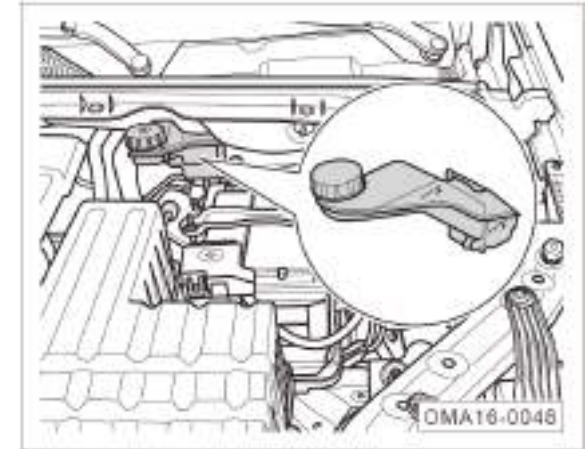

- Check whether the brake fluid level is between the MAX and MIN marks on the side of the tank when the engine cools down.
- MAX refers to the upper limit mark of brake fluid.
- MIN refers to the lower limit mark of brake fluid.
- The brake fluid level should be between the MAX and MIN marks.

## 6. Usage and Maintenance

- If the liquid level is lower than the “MIN” mark, add the brake fluid.

### Warning

- Be sure to operate inside the engine compartment with extra care.
- The engine compartment is a high-risk area. Before opening the engine hood, please carefully read and comply with relevant warnings and instructions.

### Replacing Brake Fluid

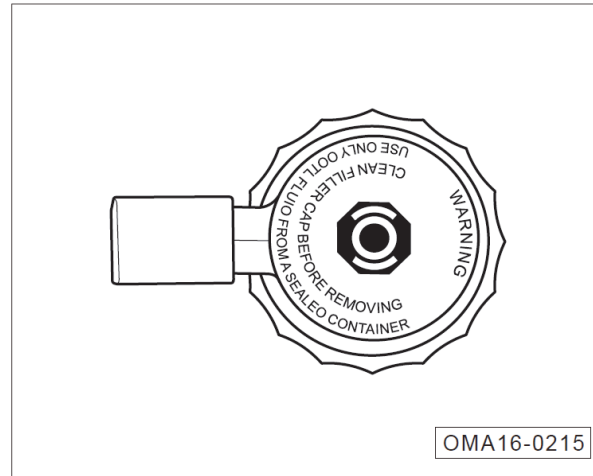

It is suggested that the GAC MOTOR dealer replace the brake fluid with standard one to ensure normal operation of the brake system.

The brake fluid is water-absorbing. It can absorb moisture from the air around constantly in the process of usage. Excessive moisture content in the brake fluid will corrode the brake system, greatly reduce the boiling point of the brake fluid and reduce the braking effect.

### Caution

The brake fluid is corrosive to the body paint. If you get brake fluid on the body paint, wipe it off timely.

### Hint

Collect and dispose the used brake fluid in accordance with environmental protection laws and regulations.

### Warning

Using waste brake fluid or brake fluid not suitable for this vehicle will greatly decrease the braking effect, or even cause failure of the brake system.

- The brake fluid container is labeled with the specifications. Always use the brake fluid with correct specifications.
- The brake fluid is toxic.
- Do not store the brake fluid in a food container or any other non-original container to avoid confusing, resulting in poisoning. Store the brake fluid in its original sealed container and put it in a safe place. Keep the container away from children to avoid poisoning accidents





### Warning

Brake fluid must be replaced according to the schedule specified in the Warranty Manual, because if the brake fluid stays inside the system for a long time, air lock will be produced inside the pipeline of braking system. In this case, it will reduce brake effect and driving safety, and even cause complete failure of the braking system and accidents.

## 6. Usage and Maintenance

### 6.4.6 Battery

#### Alert Symbols and Descriptions of Battery Operation

	Always wear goggles when operating!
	The electrolyte of storage battery belongs to a strong corrosive material, so that protective gloves and goggles must be worn when operating!
	Make sure the workplace is free of open flames, sparks, naked lights and smoke.
	Highly explosive mixed gas will be generated when the battery is charged!
	Children must keep away from the electrolyte and vehicle battery!

Do not perform any operation on the battery unless you are familiar with the operational process and have proper equipment. Otherwise, let your GAC MOTOR dealer do this.

#### Warning

- **Be sure to operate inside the engine compartment with extra care.**
- **Before operation, carefully read and comply with relevant safety warnings and instructions about the operation of the battery.**
- **Do not perform operation on the battery unless you have enough expertise.**
- **Do not open the battery. Beware of chemical burns and battery explosion.**
- **Damaged or leaked battery isn't allowed to use. It should be recycled and disposed according to laws and regulations of environmental protection.**
- **Make sure the workplace is free of open flames, sparks, naked lights and smoke. When operating the cables and electrical equipment, be sure to prevent sparks and static electricity. Do not allow the battery terminals to be short-circuited. Otherwise, high energy electric sparks from short circuit may injure operators.**

#### Charging system warning light

This warning light indicates the generator fault.

Setting the Start or Ignition switch at "ON" position, the warning light  of the charging system will be on, and it shall go out when the engine starts.

If the warning light comes on when the car is moving, it indicates that the generator cannot charge the battery any more. Go to near GAC MOTOR dealer to check the car as soon as possible.

### Check battery

Please regularly check the battery capacity when driving for a long distance or in hot areas or using the battery for a long time.

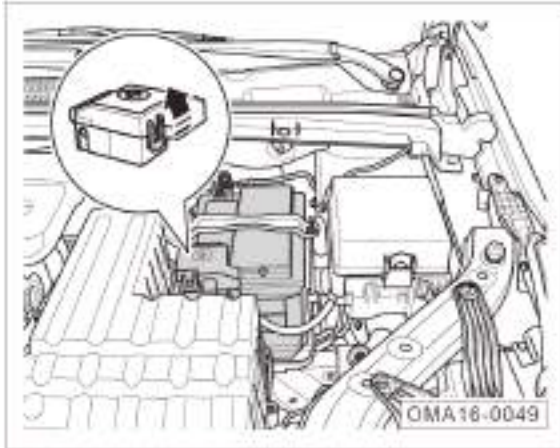

- Turn over the battery positive pole cover in the direction of the arrow.
- Check the battery connection for corrosion or loosening and check the battery appearance for cracks and expansion. In any case mentioned above, go to your GAC MOTOR dealer for troubleshooting as soon as possible.

### Charging Battery and Replacing Battery

If your vehicle is always driven for short distances or stored for a long time, perform more frequent checks for the battery than the specified maintenance intervals.

If the battery's capacity is insufficient or the battery is damaged, it is difficult to start the car. In this case, we recommend you to have your GAC MOTOR dealer charge or replace the battery.

### Charge the Battery

Battery charging requires relevant expertise and must be done in a controllable environment, so it should be done by your GAC MOTOR dealer.

If the Start or Ignition switch fails to turn off after the engine is closed, the battery will discharge rapidly when any electric device on the car is used.

1. Do not use any electrical equipment for an extended period after the engine is shut down.
2. When leaving the vehicle, be sure to close the doors tightly and turn off all the electrical equipment (e.g., lights, etc.)
3. If the engine cannot be started after electric equipment is used, do not continuously start the engine, restart the engine after 5~10min. If the engine still cannot be started, please contact your GAC MOTOR dealer for maintenance.

## 6. Usage and Maintenance

---

### Replacing the Battery

Your battery is installed properly and safely.

The battery can meet the vehicle maintenance, performance and safety requirements.

#### Caution

- Battery shall be replaced with the one of the specified type => **Refer to Page 390**. Please go to your GAC MOTOR dealer for replacement.
- To avoid damaging your vehicle's electrical system, do not connect the solar panels or battery charger and other power generation equipment to the 12V power outlet or cigarette lighter.
- As the battery contains toxic materials such as sulfuric acid and lead, dispose it carefully and don't take it just as a common household waste.

#### Hint

- After replacement, reconnect the battery to the electrical system of the car, and then the indicator light  of electronic stability program (ESP) will be on.
- The indicator light shall go out after the car travels at a speed of 15~20km/h for a short distance.



### 6.5 A/C Filter

#### Check and Clean Air Filter

Periodically inspect or clean the A/C filter according to the provisions of the Warranty Manual. When the vehicle is driven in dusty environment, the A/C filter may become very dirty and replacement is recommended in time.

#### Removing and Installing A/C Filter

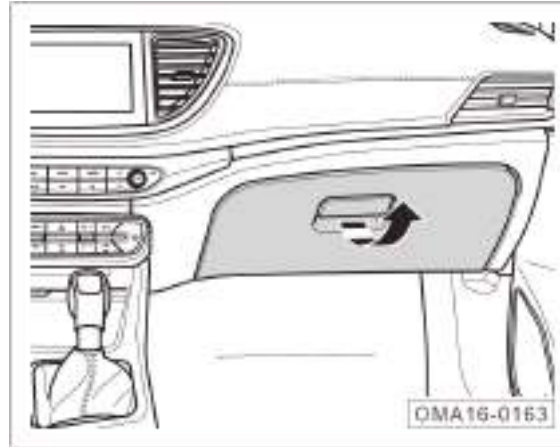

1. Pull the opening handle in direction of the arrow to open the glove box.

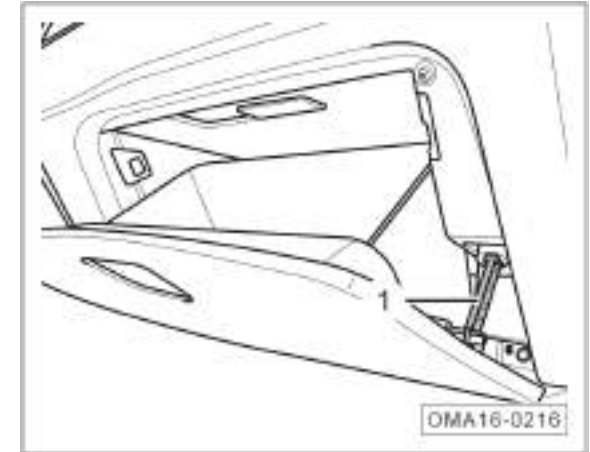

2. Disengage the damper ① of the glove box\*.

## 6. Usage and Maintenance

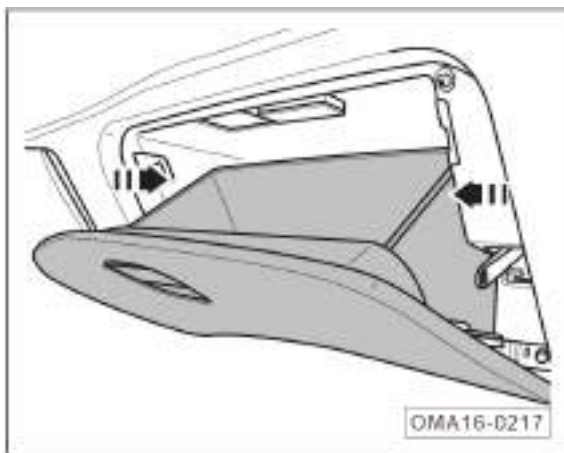

3. Press the glove box in the direction of the arrow and pull it out and disengage it.

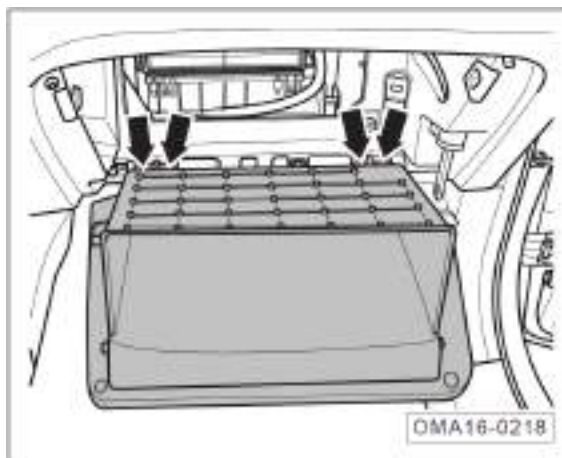

4. Disengage the fixing clip at the bottom of the glove box ( see the arrow-) and remove the glove box .

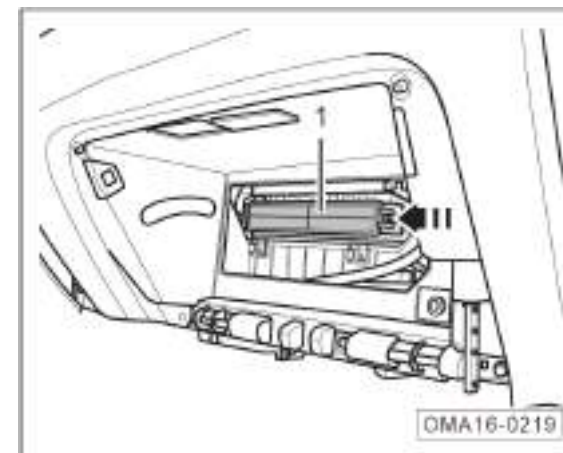

5. Press and disengage the clip of the filter element cover in the direction of the arrow and remove the filter element cover ①.

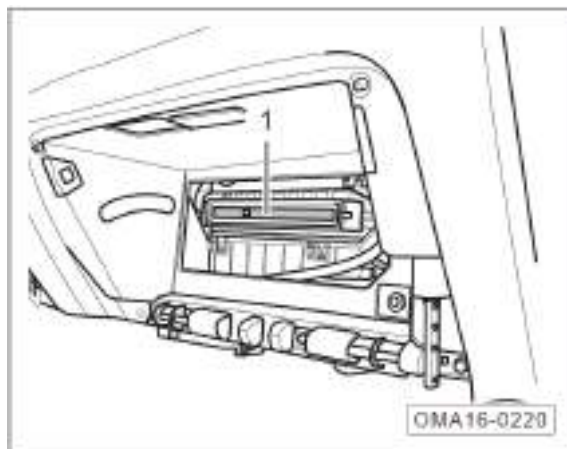

6. Remove the A/C filter ①.



7. Clean the A/C filter with compressed air or flap it.

### **i** Hint

The A/C filter cannot be cleaned with water as it is made of special materials and cannot contact moisture.



8. Install the A/C filter in opposite steps after cleaning.

### **i** Hint

Install the A/C filter according to the "UP" mark (see the arrow) on it.

## 6. Usage and Maintenance

---

### 6.6 Replacing Bulbs

#### Safe Operation Instructions for Replacing the Lights

Check the following lights:

1. Headlight (low beam and high beam)
2. Front/ rear position lights
3. Daytime Running Light\*
4. Brake light
5. Turn signal light
6. Turn signal light
7. Reversing light
8. Hazard warning indicator light
9. Number plate light
10. High brake light
11. Front fog light\*
12. Rear fog light
13. Interior lights

If you find any bulbs are burned out, replace them as soon as possible. Before replacing the bulb, be sure to check the relevant fuse. The blown fuse can cause the light failure. In addition, do the following:

1. Turn the relevant light switch to the OFF position.
2. Move the light combination switch control lever to the middle position.
3. Switch the Start or Ignition switch to "OFF/LOCK" position.

#### Caution

Only replace the burned-out bulb with a new one of the same rating. The bulb specification is marked on the bulb glass or the socket.

Bulb specification of this car. => Refer to Page 392

#### For example:

LL = long-lasting bulbs, with life longer than that of standard bulbs.

Blue = blue/ white bulbs, matching with the color of gas discharge lights (Xenon).

### Procedure of Replacing Bulbs

When replacing any bulb, do not touch the glass with your fingers. Otherwise, the bulb heat may evaporate your fingerprint and make it condense on the bulb reflector, reducing the light illumination.

Check the light operating condition after replacement. After replacing light bulbs, go to GAC MOTOR dealer to inspect the light beam adjustment status of lights.

#### **i** Hint

Basically the same methods will be used for removing or installing the bulbs on the left and right sides, so that only the removing or installing for left side will be described herein.

Don not touch the bulb glass while removing/installing a bulb.

#### **⚠** Warning

**Unless you have the expertise about the operational process, safe operation specifications and the tools, have your GAC MOTOR dealer replace the bulb.**

- **Turn off the relevant switch and let the bulb cool down before replacing it.**
- **During operation, pay attention to the sharp components on the headlight housing and the combination taillight housing in engine compartment. Be sure to protect your hands from being scratched.**

### Replacing High Beam Light Bulb

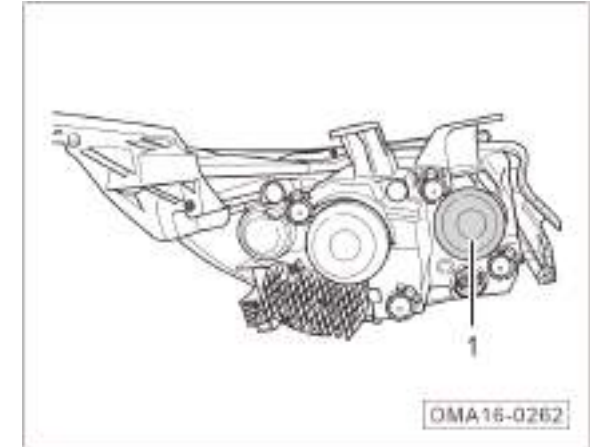

1. Switch off the Start or Ignition switch.
2. Take out the rubber back cover ①.

## 6. Usage and Maintenance

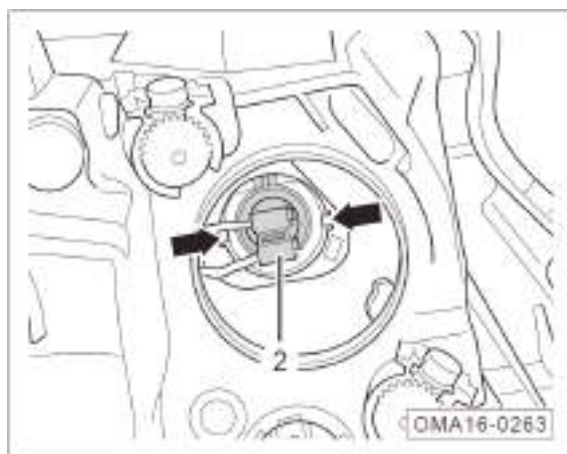

3. Disengage the clip of the high beam bulb at the position indicated by the arrow and remove the high beam bulb ②.

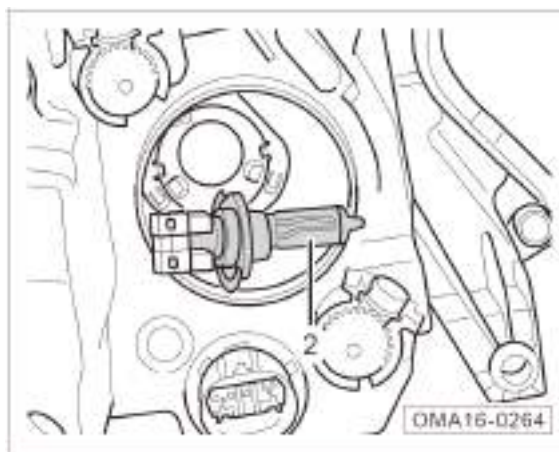

4. Pull out the high beam bulb ② from the high beam connector.
5. Generally, perform the installation in the reverse order of removal procedures

### Replacing Low Beam Light Bulb

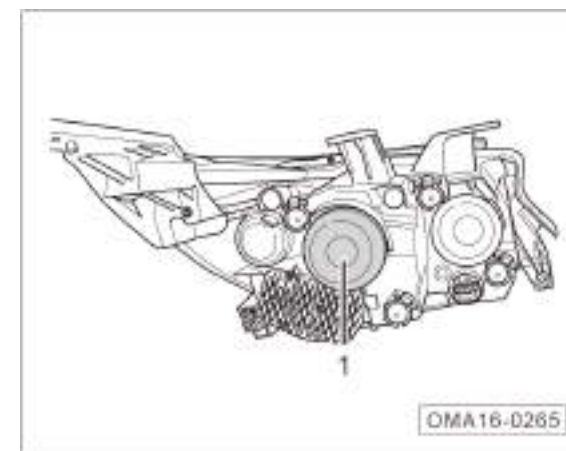

1. Switch off the Start or Ignition switch.
2. Take out the rubber back cover ①.

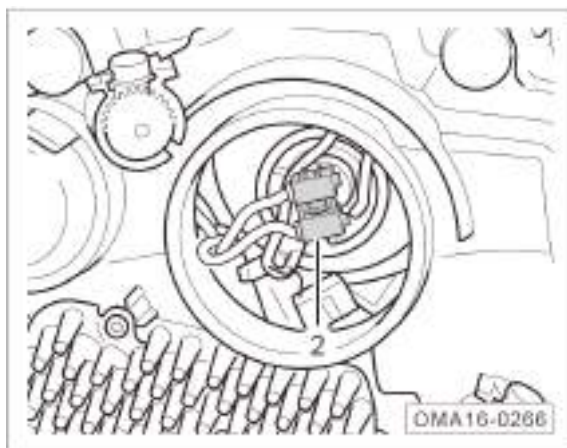

3. Disconnect the low beam connector ②.

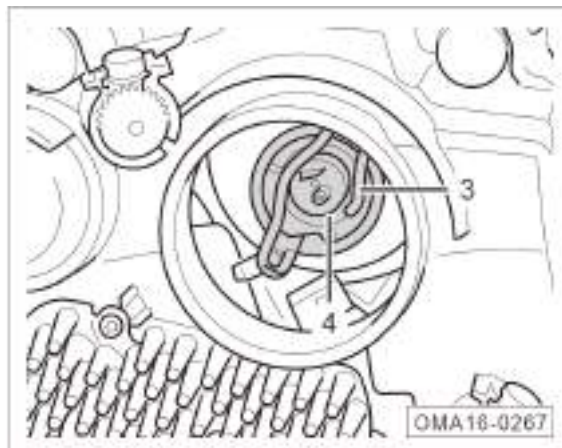

4. Press the clip ③ of the low beam bulb and remove the low beam bulb ④.
5. Generally, perform the installation in the reverse order of removal procedures

### Replacing Front Turn Signal Light Bulb

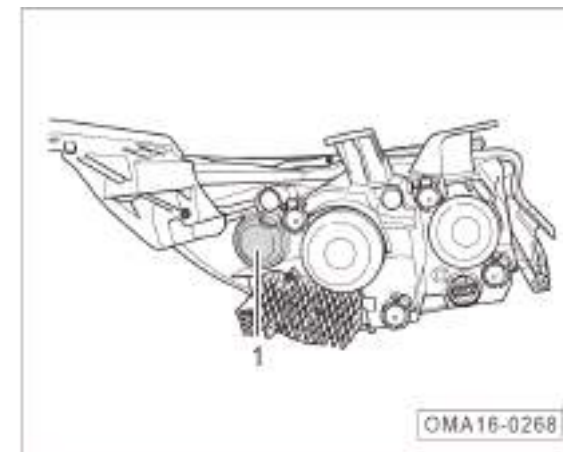

1. Switch off the Start or Ignition switch.
2. Take out the rubber back cover ①.

## 6. Usage and Maintenance

---

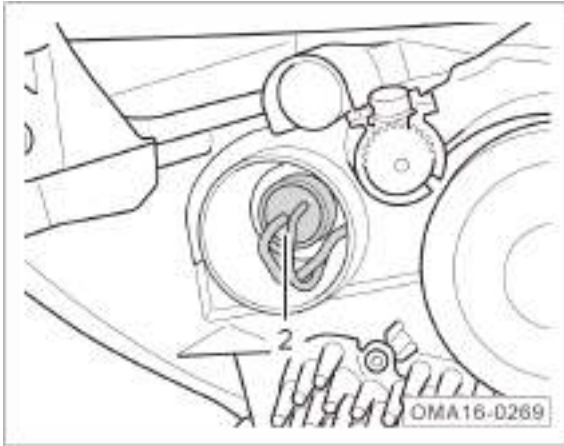

3. Rotate counter-clockwise and take out the front turn signal holder and bulb ②.

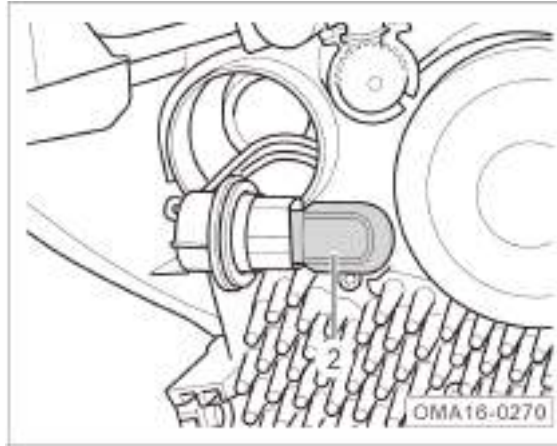

4. Remove the front turn signal bulb ② from the front turn signal holder.
5. Generally, perform the installation in the reverse order of removal procedures

### Replacing Front Position Light

The front position light and front combination light should be seen as an entirety. Only LED bulbs are used. It's not allowed to replace any set of LEDs separately in repair work. If one set of LEDs are broken, more load will be applied to the other intact LEDs, which will significantly shorten their service life.

In case of any failure of the front position light, please have your vehicle checked and repaired at GAC MOTOR dealer as soon as possible.



### Replacing Daytime Running Light\*

The daytime running light and front combination light should be seen as an entirety. Only LED bulbs are used. It's not allowed to replace any set of LEDs separately in repair work. If one set of LEDs are broken, more load will be applied to the other intact LEDs, which will significantly shorten their service life.

In case of any failure of the daytime running light, please have your vehicle checked and repaired at GAC MOTOR dealer as soon as possible.

### Replacing Front Fog Light Bulb\*

The front fog light is installed on the bumper and it is hard to assemble and disassemble. Therefore, in case of any failure of the front fog light, please have your vehicle checked and repaired at GAC MOTOR dealer as soon as possible.

### Replacing Rear-View Mirror Side Turn Signal

The turn signal light on rear-view mirror side uses LED bulb, the turn signal light assembly on rear-view mirror side shall be replaced as a whole and replacing a single LED bulb is not allowed.

In case of any failure of the rear-view mirror side turn signal, please have your vehicle checked and repaired at GAC MOTOR dealer as soon as possible.

## 6. Usage and Maintenance

### Removing Rear Combination Light A

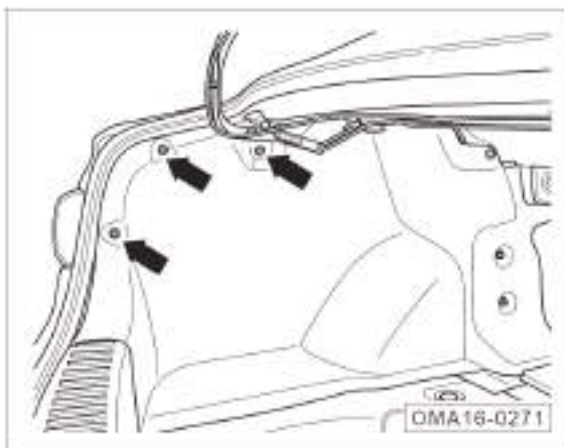

1. Switch off the Start or Ignition switch.
2. Open the trunk lid.
3. Prise out the fixing plastic nails ① and open the trunk side trimming.

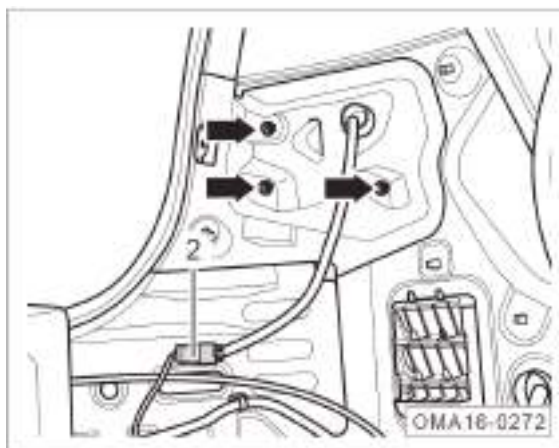

4. Disconnect the connector ② of rear combination light A.
5. Unscrew the fixing nuts (see arrow) of rear combination light A.

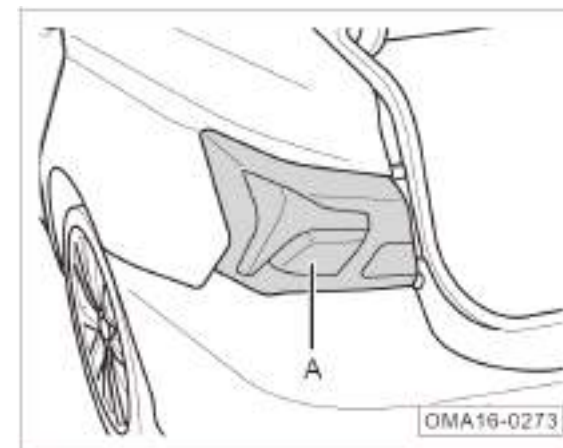

6. Remove the rear combination light A backwards.
7. Generally, perform the installation in the reverse order of removal procedures

### Replacing Rear Turn Signal Light Bulb

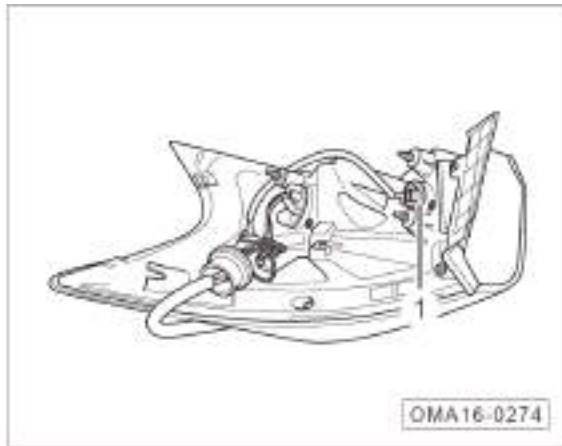

1. Remove the rear combination light A. => Refer to Page 362
2. Rotate counter-clockwise and take out the rear turn signal holder and bulb ①.

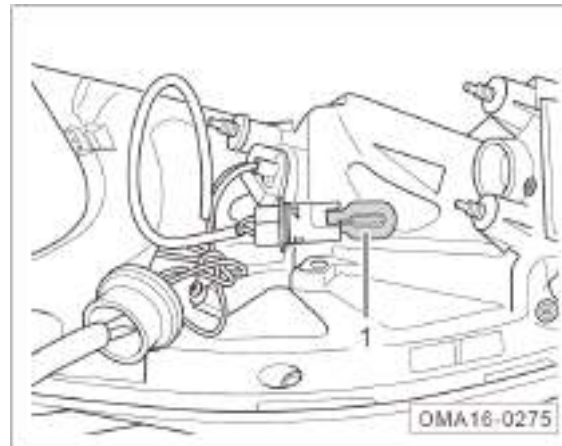

3. Remove the rear turn signal bulb ① from the rear turn signal holder.
4. Generally, perform the installation in the reverse order of removal procedures

### Replacing Brake Light Bulb

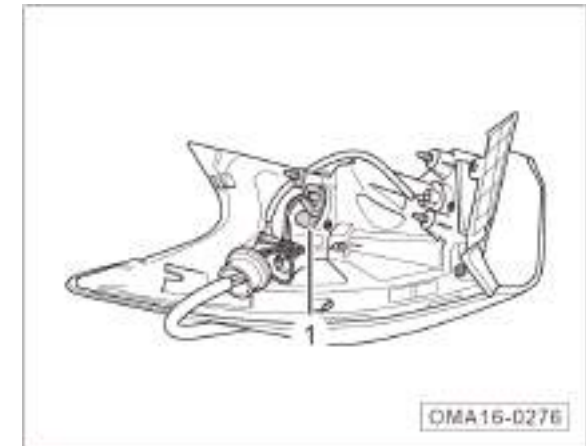

1. Remove the rear combination light A. => Refer to Page 362
2. Rotate counter-clockwise and take out the brake light holder and bulb ①.

## 6. Usage and Maintenance

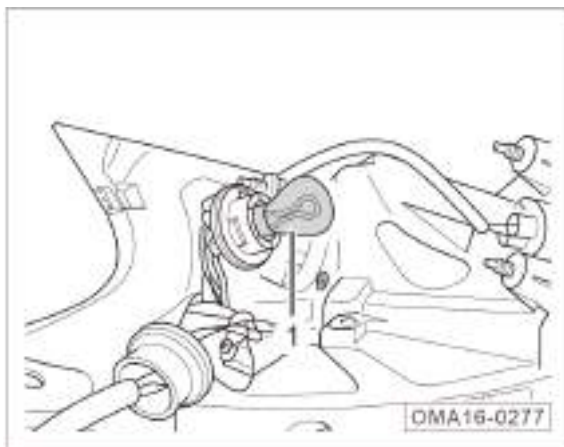

3. Rotate counter-clockwise and take out the brake light bulb ① from the brake light holder.
4. Generally, perform the installation in the reverse order of removal procedures

### Replacing Rear Position Light

The rear position light and rear combination light should be seen as an entirety. Only LED bulbs are used. It's not allowed to replace any set of LEDs separately in repair work. If one set of LEDs are broken, more load will be applied to the other intact LEDs, which will significantly shorten their service life.

In case of any failure of the rear position light, please have your vehicle checked and repaired at GAC MOTOR dealer as soon as possible.

### Replacing Reverse Light Bulb



1. Switch off the Start or Ignition switch.
2. Open the trunk lid.
3. Prise out the fixing plastic nails (see the arrows) and open the trunk lid trimming.



4. Disconnect the connector ① of rear combination light B.
5. Unscrew the fixing nuts (see arrow) of the rear combination light B.



6. Remove the rear combination light B backwards.



7. Rotate counter-clockwise and take out the reverse light holder and bulb ②.

## 6. Usage and Maintenance

### Replacing Rear Fog Light Bulb

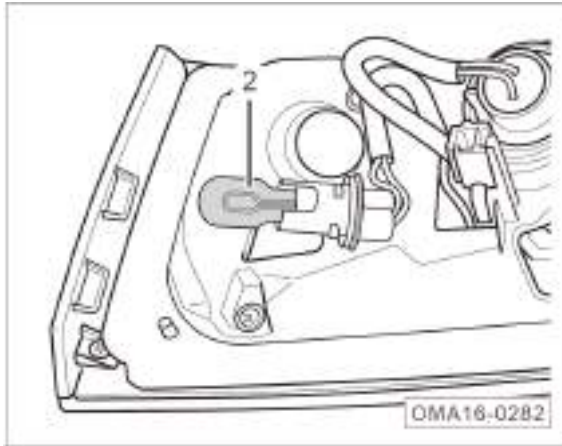

8. Remove the reverse light bulb ② from the reverse light holder.
9. Generally, perform the installation in the reverse order of removal procedures



1. Switch off the Start or Ignition switch.
2. Open the trunk lid.
3. Prise out the fixing plastic nails (see the arrows) and open the trunk lid trimming.

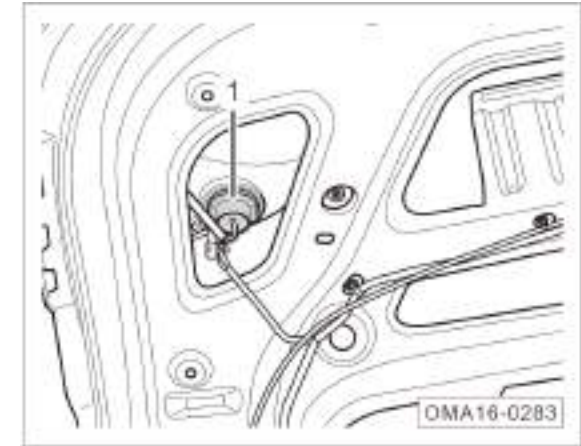

4. Rotate counter-clockwise and take out the rear fog light holder and bulb ①.

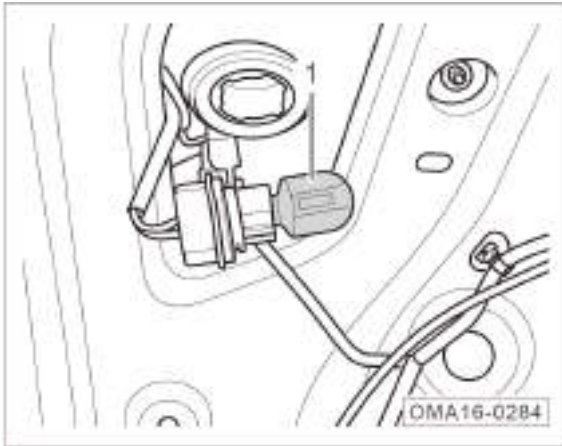

5. Remove the rear fog light bulb ① from the rear fog light holder.
6. Generally, perform the installation in the reverse order of removal procedures

### Replacing High brake light

High brake light consists of LED bulb. It's not allowed to replace any single set of LEDs. Replace the high brake light assembly if necessary.

In case of any failure of the high brake light, please have your vehicle checked and repaired at GAC MOTOR dealer as soon as possible.

### Replacing Number Plate Light Bulb

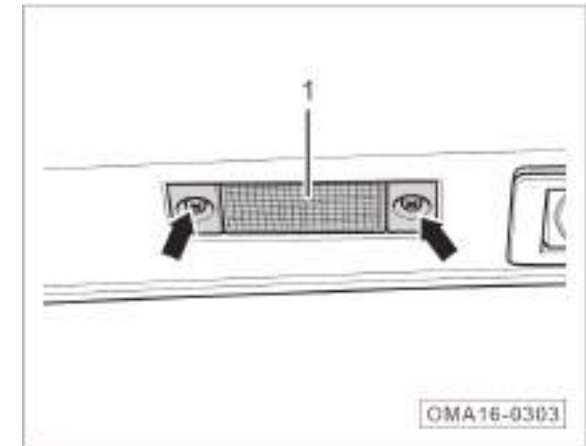

1. Switch off the Start or Ignition switch.
2. Unscrew the fixing screws (see the arrows) of the number plate light assembly and take out the assembly ①.

## 6. Usage and Maintenance

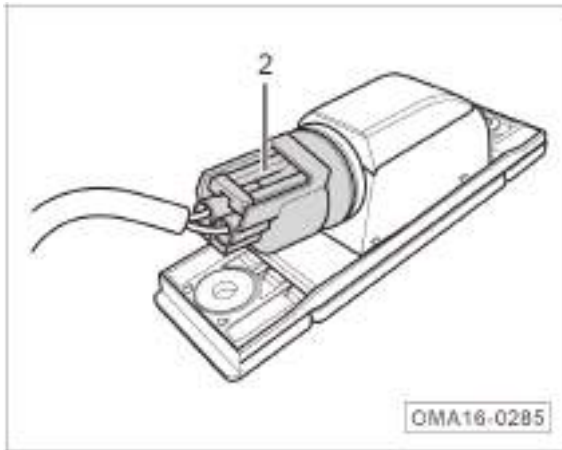

3. Rotate counter-clockwise number plate light harness assembly ② and take out the number plate light bulb.

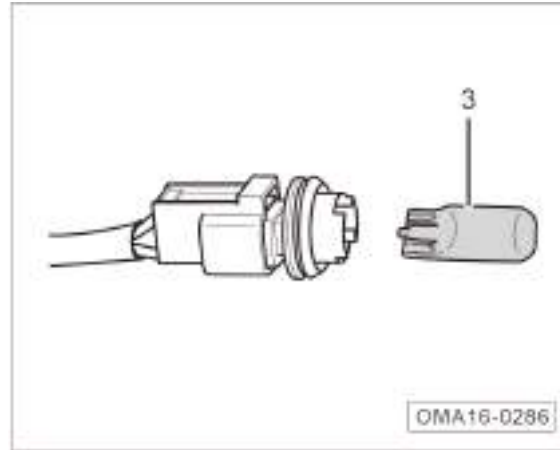

4. Remove the number plate light bulb ③ from the number plate light holder.
5. Generally, perform the installation in the reverse order of removal procedures

### Replacing Front Roof Light Bulb

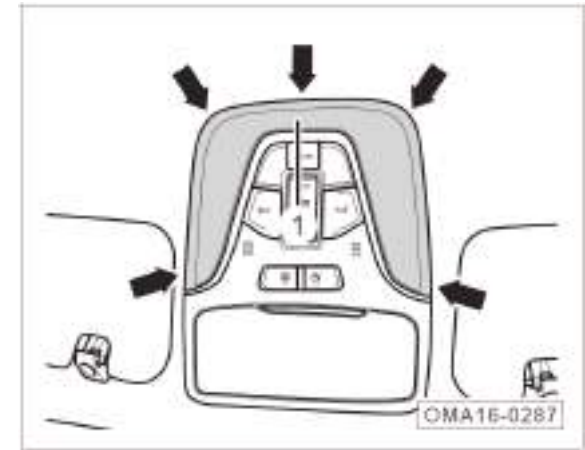

1. Switch off the Start or Ignition switch.
2. Pry up the light housing ① at the positions indicated by the arrows with a straight screwdriver wrapped by cloth.



### Replacing Rear Roof Light Bulb\*



3. Remove the front roof light bulb ②.
4. Generally, perform the installation in the reverse order of removal procedures

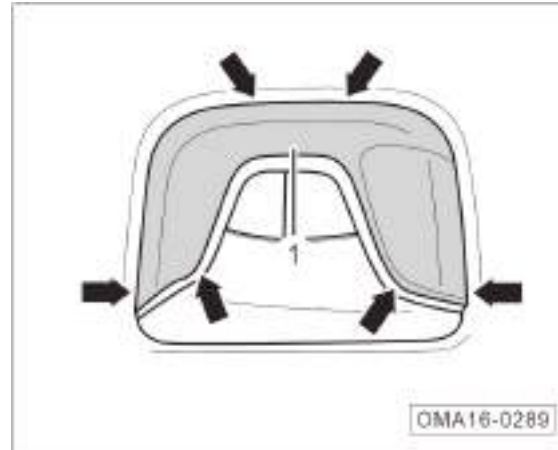

1. Switch off the Start or Ignition switch.
2. Pry up the light housing ① at the positions indicated by the arrows with a straight screwdriver wrapped by cloth.



3. Press the bulb fixing bracket and remove the rear roof light bulb ②.
4. Generally, perform the installation in the reverse order of removal procedures

## 6. Usage and Maintenance

### Replacing Vanity Mirror Light Bulb\*

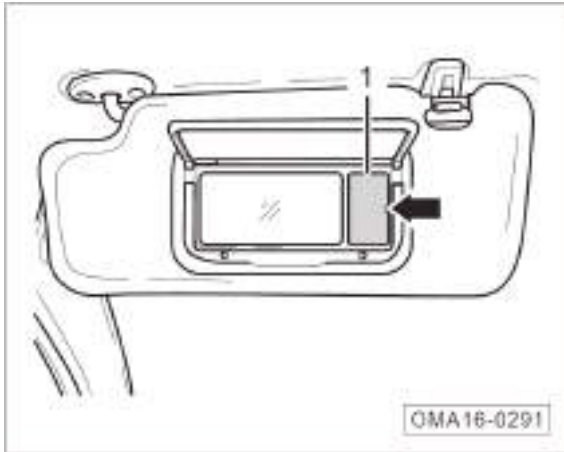

1. Switch off the Start or Ignition switch.
2. Open the vanity mirror.
3. Carefully pry out the vanity mirror light housing ① at the position of the arrow.

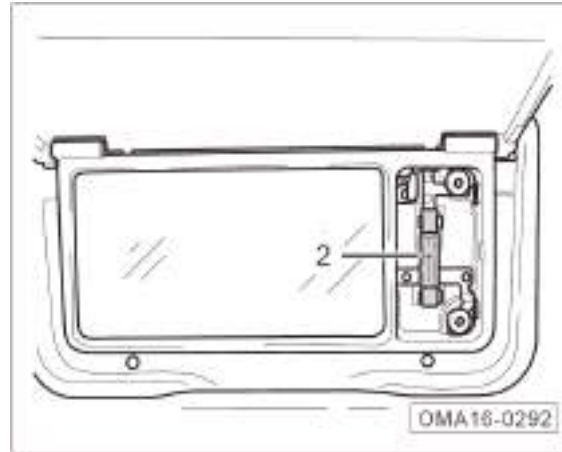

4. Take out the vanity mirror light bulb ②.
5. Generally, perform the installation in the reverse order of removal procedures

### Replacing Glove Box Light

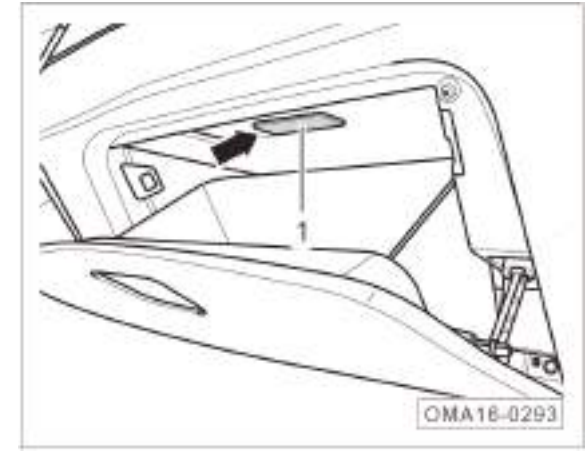

1. Switch off the Start or Ignition switch.
2. Open the glove box.
3. Pry up the fixing clip (see the arrow) of the glove box light and remove the glove box light ①.

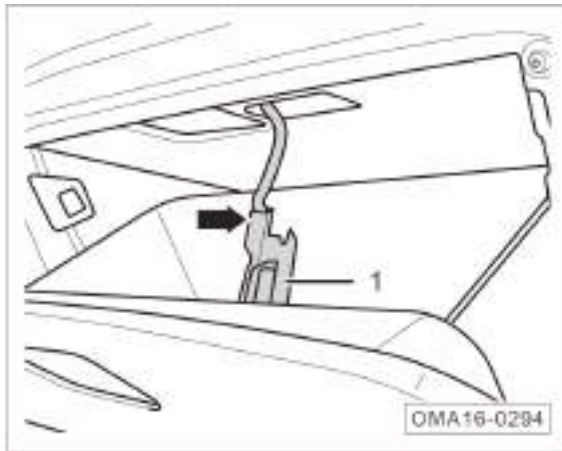

4. Disconnect the connector (see the arrow) of the glove box light and remove the glove box light ①.

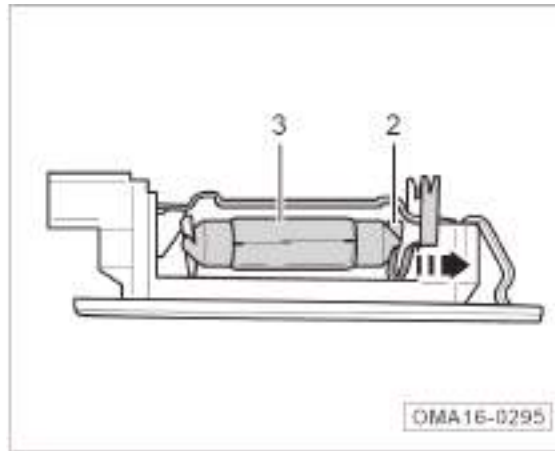

5. Press the metal clamp ② in direction of the arrow and take out the glove box light bulb ③.
6. Generally, perform the installation in the reverse order of removal procedures

### Replacing Atmosphere Light\*

The instrument panel atmosphere light is located in the instrument panel. Complex components shall be dismantled to replace the instrument panel atmosphere light. In order to avoid unnecessary parts damage, if the atmosphere light bulb fails, it is recommended to replace the atmosphere light at the GAC MOTOR dealer as soon as possible.

## 6. Usage and Maintenance

### Replacing Door Courtesy Light Bulb\*

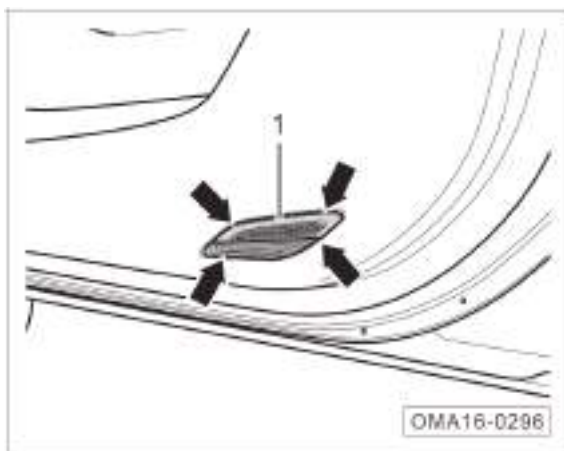

1. Switch off the Start or Ignition switch.
2. Prise out the door courtesy light ① at the position indicated by the arrows.

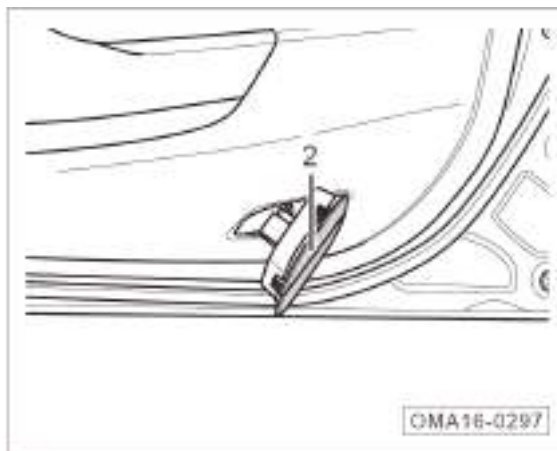

3. Disconnect the plastic clip and dismantle the door courtesy light cover ②.

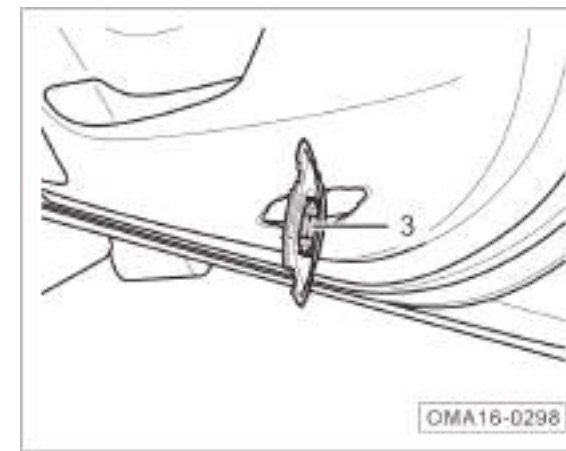

4. Take out the door courtesy light bulb ③.
5. Generally, perform the installation in the reverse order of removal procedures

### Replacing Trunk Light

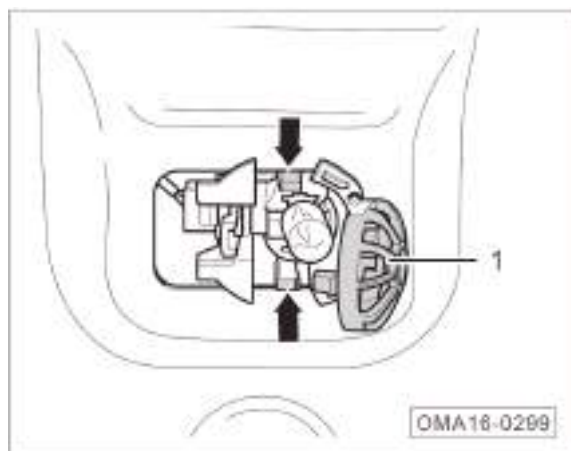

1. Switch off the Start or Ignition switch.
2. Open the trunk lid.
3. Press the clips of the trunk light cover at the positions indicated by the arrows and open the trunk light cover ①.



4. Remove the trunk light bulb ② from the trunk light holder.
5. Generally, perform the installation in the reverse order of removal procedures

## 6. Usage and Maintenance

---

### 6.7 Wheels

#### Warning

You cannot get the best adhesion from a new tire during the first 500km, so drive your vehicle at a moderate speed with care to avoid accidents.

- The tire which has not been run in or has been overworn provides insufficient adhesion, directly affecting the braking effect.
- If the vehicle vibrates abnormally or departures, stop the vehicle at a safe place immediately and check the tires for damage.
- If uneven excessive wear of the tires is found, go to GAC MOTOR dealer for inspection as soon as possible.

#### Warning

Tire burst or air leakage during traveling can cause serious traffic accidents.

- Do not drive with damaged tires or wheels or tires worn to the wear mark of tread pattern. Otherwise, it may cause accidents. Because the damaged tires may explode during traveling and cause traffic accidents and injure persons. replace such tires and wheels timely.
- Tire pressure must comply with specifications. Otherwise it may cause accidents. If the tire pressure is insufficient, constant high-speed driving will cause tire deflection, resulting in tire overheating which may lead to tire shelling or burst.
- Always prevent the tires from touching chemicals, oil, grease, fuel and brake fluid.

#### Warning

- Try to avoid using a tire more than six years old. If no other choice, be sure to drive at a low speed with extra care.
- Do not use any old wheels and tires with dubious background under any circumstances. Such wheels and tires which may be already damaged invisibly will cause the vehicle out of control while driving, resulting in accidents.

### Prevention Measures for Wheel Fault

- To cross over curbs or similar obstacles, slow down your vehicle and drive in the vertical direction of the obstacle as far as possible.
- Prevent the tires from touching grease, oil and fuel.
- Periodically inspect the tire damage state (e.g. tire cut, crack, bump and other damage).
- Periodically remove sundries embedded in the tire tread.

### Notice of Tire Storage

- Make a mark on the tire to indicate the direction of rotation before removing the tire. Re-install the tire according to the mark to keep the direction of rotation and the dynamic balance state of the wheel unchanged.
- Store the removed wheels and tires in a cool and dry place. It's better to store them in a shaded place without direct sunlight.
- Tires which have not been installed on the wheels should be stored upright.

### New Tires and Wheels

Carefully select new tire and wheel.

Please use tires of the same structural form and size (rolling circumference) on all wheels. The tire pattern shall be of the same specification as far as possible.

Try not to replace one tire only. At least the two tires on the same axle shall be replaced simultaneously.

Do not use any tire whose effective size exceeds the standard approved by our Company.

The tire and wheel combination from our Company is recommended to be installed and used.

## 6. Usage and Maintenance

---

### Specifications of Rims and Tires

**Rim:**

**6.0J×15\***

**6.5J×16\***

**6.5J×17\***

**Tire:**

**195/65R15\***

**205/55R16\***

**205/50R17\***

**Spare Tire:**

**T-type tire: T125/80D16**

#### **i Hint**

The tire information label is located below the B-pillar on the driver's side. Select the rims and tires based on the recommended size and type on the information label.

### Non-full Size Tire

The spare tire is different from the standard tire in such aspects as structure, pattern, speed grade and load index. Therefore, the spare tire cannot replace the standard tire.

Please replace the spare tire as soon as possible to avoid potential hazards due to prolonged using.

#### **i Hint**

- The spare tire can only be used temporarily in emergency circumstances, with the maximum speed not exceeding 80km/h and the traveling mileage not exceeding 100km.
- The service life of the spare tire is about 3 years, after which it shall be replaced.

### Summer Tire

The tread depth shall not be less than 3mm. A very high risk of hydroplaning exists when the tread depth is less than 3mm.

### Winter Tire

Winter tire can improve the driving performance of vehicles on snow and ice covered roads.

- Winter tire shall be used on all four wheels.
- Only winter tire allowable for this vehicle can be used.
- It should be noted that the maximum speed applicable to winter tire is relatively low.
- It should be noted that sufficient tread depth shall be reserved on the tread of winter tire (The tread depth shall not be less than 4mm, otherwise the winter applicability will be restricted).
- After installing the tire, inspect the inflation pressure of the tire.



### Warning

- **The winter and summer tires are designed according to the traveling conditions on their respective typical lanes under corresponding season conditions. Winter tire is recommended in winter. At low temperature, the adaptability of summer tire is obviously poor, and it may lose adhesive force and braking capacity.**
- **Under severe cold conditions, if a summer tire is used, crack may appear on the tire, which will damage the tire completely, and cause excessive tire noise and out of balance.**

### Hidden Damage

The damage of tires and rims is often invisible. If abnormal vibration or deflection occurs when the vehicle is traveling, the tire may be damaged. If you are suspicious of tire damage, be sure to decrease the speed immediately. Stop the vehicle and inspect the tire damage condition. If the damage is unable to be perceived from outside, please slow down and continue driving, and go to GAC MOTOR dealer as soon as possible for inspection.

### Tire Marked with Rolling Direction

Some tires are marked with arrows on their sides to indicate rolling direction. This rolling direction must be followed when the tire is used. This guarantees that the travel performances of the tire are optimized in terms of preventing hydroplaning phenomenon, enhancing adhesive ability, reducing traveling noise, extending friction durability, etc.

## 6. Usage and Maintenance

### Tire Pressure

Unless the vehicle ran several kilometers at a low speed in the past three hours, can the tire pressure be checked and adjusted. The friction and deflection deformation during traveling cause the tire temperature rise and air expansion, resulting in inaccurate inspection of tire pressure, so check the tire pressure when they are cold.

The tire pressure described in this Manual is based on the tire pressure in summer and winter under cold condition. The hot tire pressure will be higher than the cold tire pressure. If the cold tire pressure meets the specification, do not let air out when the tire becomes hot. Otherwise, the tire pressure will be insufficient, resulting in sudden tire burst during moving.

Whether the tire pressure is normal or not is crucial for the vehicle moving at a high speed. Therefore, check the tire pressure before long-distance running. The pressure in the spare tire shall be kept at the maximum pressure specified for your vehicle.

### Checking Tire Pressure



Tire Pressure kPa (kgf/cm <sup>2</sup> )		
Model	Front Tire	Rear Tire
195/65R15 91H	220kPa	220kPa
205/55R16 91V	220kPa	220kPa
205/50R17 93V	230kPa	230kPa

OMA16-0369

The standard pressure data of the original tires are also given on the tire information label on the B-pillar on the driver's side.

- Look up the data label to find out tire pressure suitable for this car (pressure listed is suitable for tires in summer and winter).
- Unscrew the protective cap of the valve stem (If the protective cap is lost, be sure to re-install a new one timely).
- Install the tire pressure gauge to the valve stem.

- Check the tire pressure when the tires are cold. When the temperature rises, the pressure is a little bit higher than the specification. But there is no need to reduce the tire pressure.
- Adjust the tire pressure according to the vehicle's load.
- Remember to check the pressure of the spare tire at the same time.
- Re-install and tighten the protective cap of the valve stem.

#### Hint

For some models, the cluster screen can display current tire pressure.

**⚠ Warning**

- **Abnormal tire pressure may cause tire burst, resulting in accidents, personal injury or even death.**
- **Check the tire pressure once a month at least and before long-distance driving. Make sure the tire pressure meets the specification to avoid accidents.**
- **Insufficient tire pressure will exacerbate tire deflection, resulting in tire overheating which may lead to tire shelling and burst.**
- **Both underinflated and overinflated tires may cause early wear, and adversely reduce the vehicle's handling stability.**

**Tire Service Life**

The service life of tire depends on tire pressure, driving style and tire assembly condition.

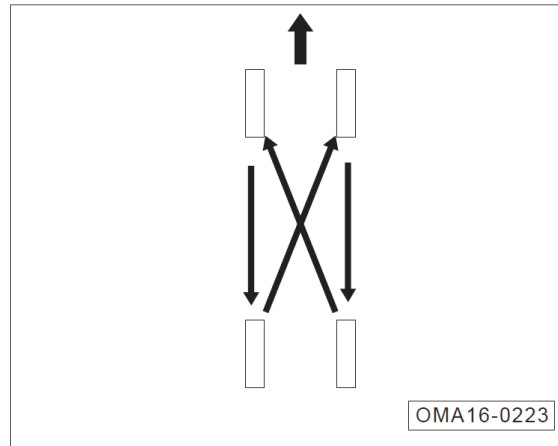

If the front tires are worn more seriously than the rear tires do, it is recommended to exchange the tires as shown in the figure, thereby making all the tires have the similar service life.

**⚠ Warning**

**If the vehicle is equipped with tire pressure monitoring system, the tire exchange or replacement shall be operated in GAC Motor dealer.**

**Tread Wear Marks**

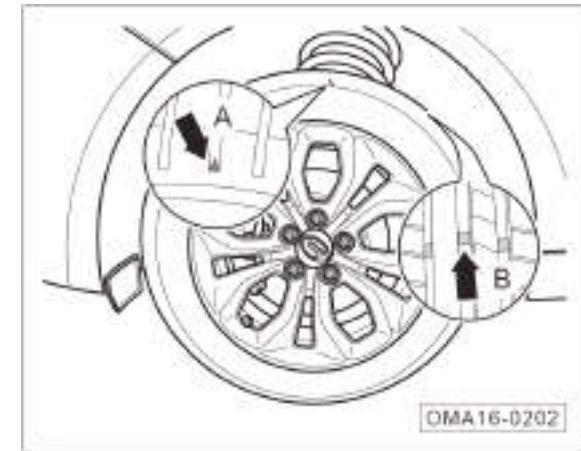

The pattern of external circumference (see arrow B) is used for directing the position of “tread wear indication mark” raised on the bottom of tire tread pattern groove.

The raised “tread wear indication mark” (see arrow B) is 1.6mm high. If the worn tread pattern is of the same height with such raised mark, the tire cannot be used safely, and must be replaced immediately.

## 6. Usage and Maintenance

---

### Caution

Sudden turning, acceleration and emergency braking can cause tires to wear out faster. Try to avoid the above driving models as far as possible.

### Wheel Balance

The wheels of a new vehicle have been balanced, however, during the running process, the wheels may be out of balance due to various influences, which can be perceived from the shaking of steering mechanism.

The imbalance of wheel will cause excessive wear of steering system, wheel suspension mechanism and tire, so that the wheel shall be rebalanced.

In addition, if a new tire is installed or the tire is repaired, the wheel must also be rebalanced.

### Incorrect Wheel Alignment

The misalignment of wheels will cause uneven excessive wear of tires, and affect the traveling safety; if uneven excessive wear of tires is found, go to GAC MOTOR dealer to inspect the wheel alignment as soon as possible.

### 6.8 Tire Chain

When driving on snow or ice road or in other severe environments in winter, the tire wear degree may increase or other failure may occur. The following suggestions must be observed in order to reduce the failure in winter:

- When driving in deep snow, it is necessary to install tire chain. If a tire chain is to be installed, an equivalent product with its size and type conforming to the tire specification must be selected. Otherwise, the vehicle performance and safety will be adversely affected.
- When decelerating, make the best of the braking function of the engine. Emergency braking on roads with snow or ice will cause vehicle drifting or slipping. Keep a safe distance with the front vehicle, slightly tread the brake pedal, and note that the tire chain installed can provide certain force of friction but cannot prevent the occurrence of sideslip.

#### Hint

Different countries and regions have different laws and regulations on tire chain, which shall be referenced before a tire chain is assembled. Do not install a tire chain without understanding the laws and regulations of a country or region, which may restrict the use of tire chain.

#### Caution

If a tire chain is to be installed, make sure that the size and type of the tire chain are consistent with those of the standard tire. Otherwise, the driving safety and maneuverability of the vehicle will be adversely affected.

Installing tire chain on all tires shall guarantee the balanced driving under various weather conditions. Keep in mind that the vehicle may be short of power after being installed with tire chain. Drive with care even if the road condition is good. The driving speed shall not exceed the specified speed for tire chain, nor exceed 50km/h, whichever is smaller.

## **6. Usage and Maintenance**

---

### **6.9 Maintenance Instructions for Car Body Anti-Theft**

Normal use requires no maintenance. Contact GAC MOTOR dealer when a problem occurs.

### 7.1 Vehicle Identification Numbers

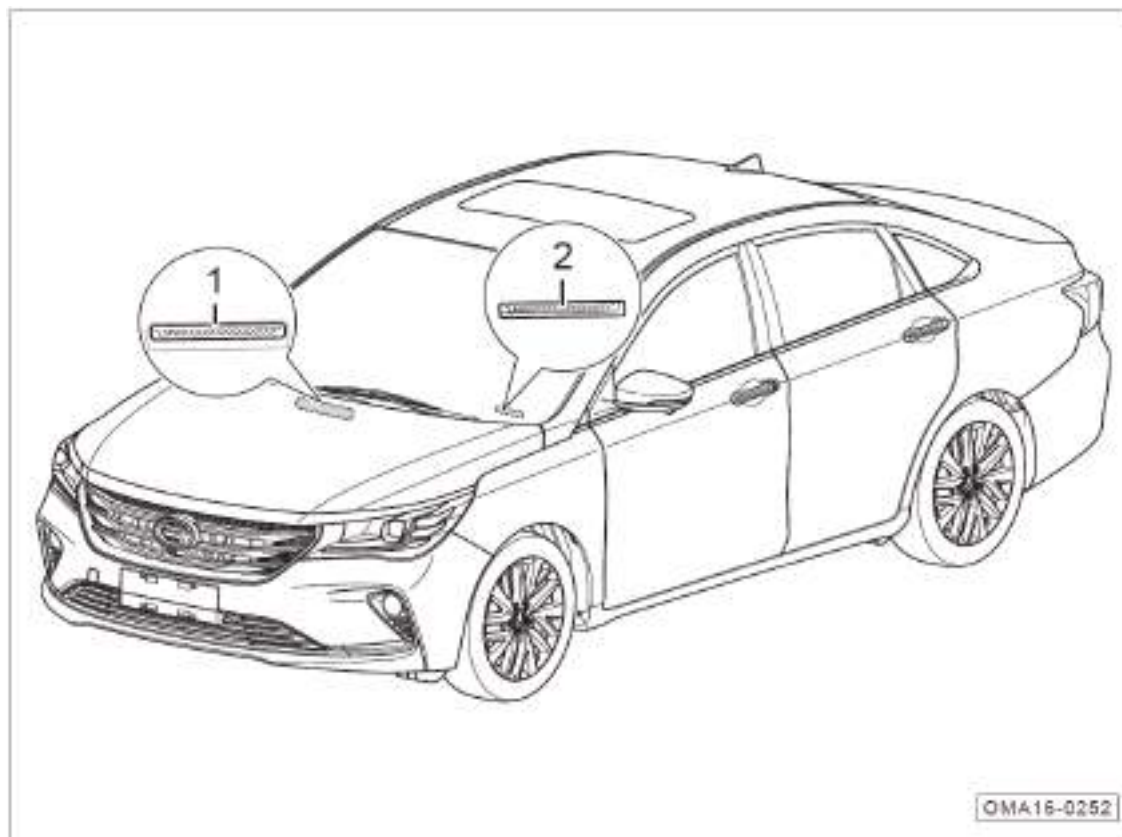

The positions of vehicle identification numbers (VINs) are shown in the figure:

1. Vehicle identification number (VIN): on the engine compartment diaphragm
2. Vehicle identification number (VIN): on the left side of instrument panel

#### **i** Hint

The vehicle identification number (VIN) positions shown in the figure do not apply to all vehicles, and the position indication and quantity of vehicle identification numbers (VINs) are not complete. Please refer to the actual vehicle.

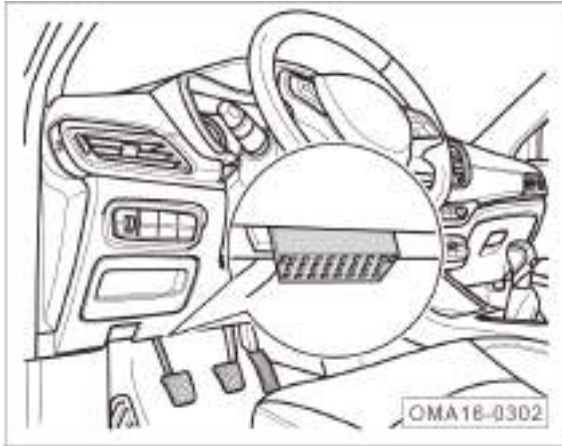
**OBD Diagnosis Interface**

The OBD interface for reading the electronic VIN is located at rear left lower part of the dashboard. It can be used to read electronic VIN, vehicle status information and other data via a special diagnosis tester.

**i Hint**

Go to the GAC MOTOR dealer to consult and purchase the diagnosis tester.

**Engine number**

The engine number (see the arrow) is marked on the engine cylinder block (behind the generator).



## 7.2 Vehicle Parameters

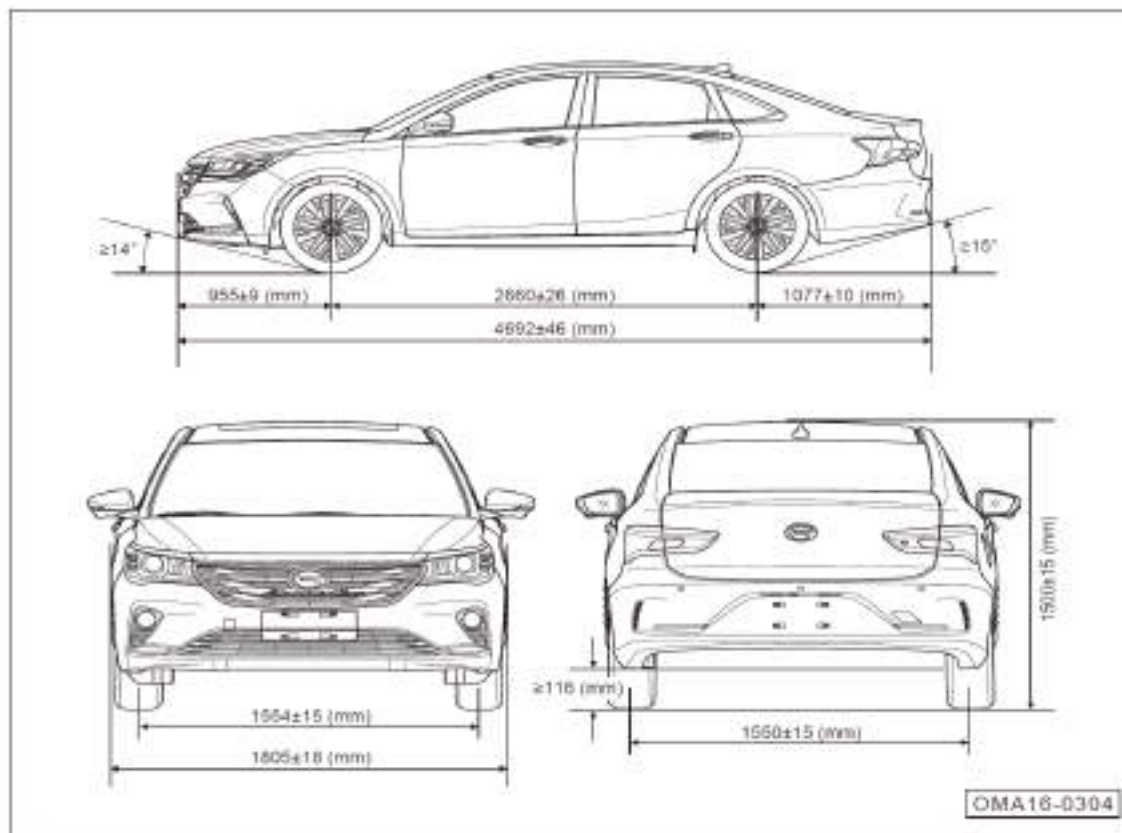

## Dimension

Item	Parameters		
	Value	Unit	
Total length	4692±46	mm	
Total width	1805±18	mm	
Total height	1500±15	mm	
Wheel base	2660±26	mm	
Tread	Front Wheel	1554±15	mm
	Rear Wheel	1550±15	mm
Front overhang	955±9	mm	
Rear overhang	1077±10	mm	
Minimum ground clearance (full load)	≥116	mm	
Approach angle (full load)	≥14	°	
Departure angle (full load)	≥15	°	

Note: The left/right exterior rear-view mirror near the connection between the lower A-pillar and the front door and the antenna on the rear roof are not included in the width.

## 7.

## Technical Data

## 7.3 Vehicle Parameters

## Mass

Model	Complete Vehicle Kerb Mass (kg)			Max. Total Mass (kg)		
	Kerb Mass	Front Axle Load	Rear Axle Load	Max. Total Mass	Front Axle Load	Rear Axle Load
GAH7150F1M5, GAH7150F2M5 GAH7150F1M5A, GAH7150F2M5A	1270±38	775±23	495±14	1695	895	800
GAH7150F2A5 GAH7150F2A5A	1270±38	770±23	500±15	1695	895	800
GAH7130F1M5, GAH7130F2M5 GAH7130F1M5A, GAH7130F2M5A	1285±38	787±23	498±14	1740	935	805
GAH7130F1A5, GAH7130F1A5A	1300±39	807±24	493±14	1740	935	805
GAH7130F2A5, GAH7130F2A5A	1321±39	816±24	505±15	1740	935	805

## Integrated Parameters

Item	Performance Parameters					Unit
	GAH7150F1M5 GAH7150F2M5 GAH7150F1M5A GAH7150F2M5A	GAH7150F2A5 GAH7150F2A5A	GAH7130F1M5 GAH7130F2M5 GAH7130F1M5A GAH7130F2M5A	GAH7130F1A5 GAH7130F1A5A	GAH7130F2A5 GAH7130F2A5A	-
Number of occupants	5	5	5	5	5	oriented
Minimum turning diameter	≤11	≤11	≤11	≤11	≤11	m
Maximum gradeability	≥35	≥35	≥35	≥35	≥35	%
0km/h ~ 100km/h accelerating time	≤14.8	≤16	≤12.8	≤12.8	≤12.8	S
Maximum speed	≥175	≥164	≥192	≥185	≥185	km/h
Fuel consumption under urban conditions	≤8.5	≤9.0	≤8.6	≤9.4	≤9.5	L/100km
Fuel consumption under suburb conditions	≤5.3	≤5.7	≤5.4	≤5.5	≤5.6	L/100km
Fuel consumption under comprehensive conditions	≤6.5	≤6.9	≤6.6	≤6.9	≤7.0	L/100km

## 7.

## Technical Data

## Engine Parameters

Model	4A13M1	4A15K1
Layout pattern	Front-transverse mounted	Front-transverse mounted
Type	Gasoline, spark ignition type, in-line, four-stroke, water-cooling, multi-point electronic controlled injection, double overhead camshafts, exhaust turbocharging	Gasoline, spark ignition type, in-line, four-stroke, water-cooling, multi-point electronic controlled injection, double overhead camshafts, exhaust turbocharging
Number of cylinders	4	4
Ignition order	1-3-4-2	1-3-4-2
Cylinder diameter (mm)	75	75
Stroke (mm)	75	84.6
Displacement (mL)	1325	1495
Compression ratio	9.8: 1	11:1
Rated power / Rotated speed per Minute (kW/(r/min))	101/5500	84/6000
Maximum net power / rotated speed per minute (kW/(r/min))	93/5500	79/6000
Maximum torque / rotated speed per minute (N*m/ (r/min) )	202/1500~4200	150/4500
Maximum net torque / rotated speed per minute (N*m/ (r/min) )	192/1500~4200	141/4500
Idling stabilization RPM (r/min)	700	700

Note: <sup>1)</sup> Adding fuel oil with sulfur content higher than the standard for a long time may cause excessive emission. Please pay attention to use the fuel oil meeting the standards of vehicle selling place.

## Oil Specification and Capacity

Item	Specification	Volume	
Fuel oil	Please refer to the description on the fuel requirement lable at the fuel filler door of each vehicle.	-	50L
Engine coolant <sup>1)</sup>	DF-6, -35°C coolant	Total (1.3T 5MT model)	6.5L
		Total (1.3T 6AT model)	6.9L
		Total (1.5L 5MT model)	6.0L
		Total (1.5L 4AT model)	5.9L
Engine oil (1.3T model)	Engine oil specification: SN class and above Engine oil viscosity: SAE 5W-30	Replacement (including engine oil filter) <sup>2)</sup>	4.4L
		Total <sup>3)</sup>	4.5L
Engine oil (1.5L model)	Engine oil specification: SN class and above Engine oil viscosity: SAE 5W-30	Replacement (including engine oil filter) <sup>2)</sup>	4.4L
		Total <sup>3)</sup>	4.5L
ATF	AW-1	Total (6AT)	6.7L
	AW-1	Total (4AT)	4.65L
Manual transmission gear oil	SAE75W-90APIGL-4 (Petronas)	Total	2.5L
Brake fluid	DOT4	Total (MT model)	0.75L
		Total (AT model)	0.75L
Windshield washer fluid tank	50% ethyl alcohol or isopropyl alcohol and 50% water with a hardness not greater than 205g/t	-	4L
A/C refrigerant	R134a	-	500±15g

Note: 1) Including the coolant in the storage tank and the coolant remaining in the engine.

2) Excluding the coolant remaining in the engine.

3) Volume required for overhaul of engine assembly.

## 7.

## Technical Data

## 7.4 Vehicle Parameters

## Transmission

Vehicle Model	Transmission Model	Transmission Type	Drive Type
GAH7150F1M5	5MF26D	5MT	Front-wheel drive
GAH7150F1M5A	5MF26B		
GAH7150F2M5			
GAH7150F2M5A			
GAH7150F2A5	SII6	4AT	
GAH7150F2A5A			
GAH7130F1M5	5MF26F	5MT	
GAH7130F1M5A	5MF26E		
GAH7130F2M5	5MF26F		
GAH7130F2M5A	5MF26E		
GAH7130F1A5	TF-71SC	6AT	
GAH7130F1A5A			
GAH7130F2A5			
GAH7130F2A5A			

## Transmission Parameter

Transmission Model	5MF26D	5MF26B	SII6	5MF26F	5MF26E	TF-71SC
Final drive ratio	4.235		4.375	3.684		3.944
1 <sup>st</sup> gear	3.833		2.875	3.833		4.044
2 <sup>nd</sup> gear	2.045		1.568	2.045		2.371
3 <sup>rd</sup> gear	1.323		1	1.323		1.556
4 <sup>th</sup> gear	1.029		0.697	1.029		1.159
5 <sup>th</sup> gear	0.825		—	0.825		0.852
6 <sup>th</sup> gear	—		—	—		0.672
Reverse gear	3.583		2.3	3.583		3.193

**Wheels**

Rim	6.0Jx15*	6.5Jx17*
	6.5Jx16*	
Tire Specification	195/65R15*	205/50R17*
	205/55R16*	
Tire Pressure	Front wheel / Rear wheel	Front wheel / Rear wheel
	220kPa/220kPa	230kPa/230kPa
Spare tire specification	T125/80D16	
Spare tire pressure	420kPa	

The standard pressure data of the original tires are pasted on the tire information label on the B-pillar of the driver's side.

**Suspension**

Type	Front	Rear
	McPherson independent type	Torsion beam semi-independent type

**Steering gear**

Type	Pinion-and-rack EPS
Power type	Electric power

**Steering angle value**

Steering angle value	Maximum steering angle of inner wheel	38.54°
	Maximum steering angle of outer wheel	32.58°

**Brake**

Type	Vacuum servo, X type hydraulic double-loop
Front Wheel	Disc brake
Rear Wheel	Disc brake
Parking brake	Electrical Parking Brake (EPB), acting on rear brake*
	Mechanical parking brake system, acting on rear brake*

**Wheel Dynamic Balancing Value**

Name		The Residual Amount of Dynamic Unbalance
Front Wheel	Inside	≤ 8g
	Outside	≤ 8g
Rear Wheel	Inside	≤ 8g
	Outside	≤ 8g

**Brake Pedal Free Stroke**

Name	Parameters
Stroke	125±3mm
Free stroke	≤11 mm

## 7.

## Technical Data

## Technical Parameters of Brake Lining

Name	Parameters
Wear limit for front brake lining (excluding its backing plate)	2mm
Wear limit for rear brake lining (excluding its backing plate)	2mm

## Wheel Alignment Number

Name	Parameters	
Front Wheel	Toe-in of single wheel	3'±3'
	Wheel camber	-21'±30'
	Kingpin caster angle	7°16'±30'
	Kingpin inclination angle	13°±30'
Rear Wheel	Toe-in of single wheel	4'±30'
	Wheel camber	-55'±30'

## Battery

Model	Valta T5	
Parameters	Rated voltage	12V
	20hr rated capacity	55Ah
	Low-temperature start current (EN)	530A

## Fuse

Instrument Panel Fuse Box	=> Refer to Page 404
Engine Compartment Fuse Box	=> Refer to Page 407

## Lights

Lights	Parameters	
Front combination light	High beam	H712V55W
	Low Beam	H712V55W
	Daytime Running Light*	LED13.5W
	Front position light	LED1.34W
	Front turn signal light	12VWY21W
Front Fog Light*	H1612V19W	
Guest greeting light *	LED 0.5W (total power: 1.44W)	
Rear-view mirror side turn signal light	LED 0.5W (total power: 1.44W)	
Rear combination light	Rear Fog Light	12VW21W
	Rear position light	LED A: 6.75W/B: 2W
	Rear turn signal light	12VWY16W
	Reversing light	12VW16W
	Brake Light	12VP21W
Number Plate Light	12VW5W	
High brake light	LED3W	
Front roof lights	12VW8W	
Rear Roof Lights*	12VC8W	
Courtesy Light*	Philips 1207 12V 5W	
Glove Box Light	12VC5W	
Trunk Light	12VW5W	
Atmosphere Light*	LED0.2W	



<b>Lights</b>	<b>Parameters</b>
Sun visor vanity mirror light*	12V C5W

If the bulb is to be replaced =>Refer to Page 356, please refer to the configuration of the actual vehicle, because some bulbs only apply to certain vehicles!

## 8. Handling of Accident

### 8.1 Vehicle Tools and Spare Tire

#### Vehicle Tools

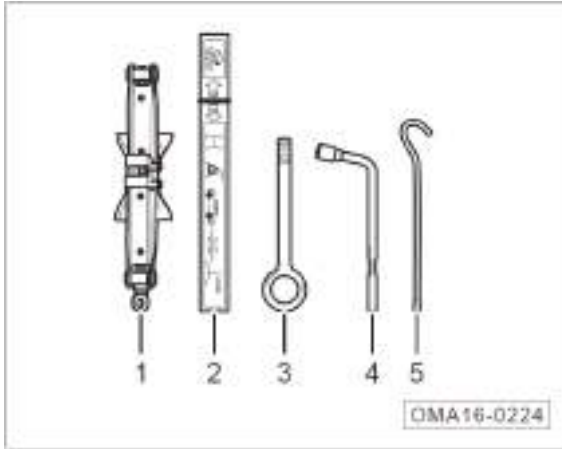

The vehicle tools include the following:

1. Jack
2. Warning triangle
3. Towing hook
4. Removal wrench for wheel bolts
5. Special wrench for jack

#### ⚠ Caution

After using a jack, recover it to the state before use, and then place the special spanner for jack and the jack into the accompanied foam tool box.

#### ⚠ Warning

- Tighten the wheel bolts according to the specified torque correctly. Failure to do so may make the bolts become loose when the vehicle is moving, resulting in accidents.

#### ⚠ Warning

**Improper use of the jack may cause serious damage.**

- Only use the jack on solid and level ground.
- Only use your jack to jack up your vehicle. Do not use your jack to jack up other weights or vehicles.
- Do not start the engine when using the jack. Doing so can cause accidents.
- To avoid the risk of personal injury, do not put any part of your body under the vehicle when the vehicle is on the jack.
- Place appropriate protective support under the vehicle if the operation has to be done under the vehicle.

### Spare Tire

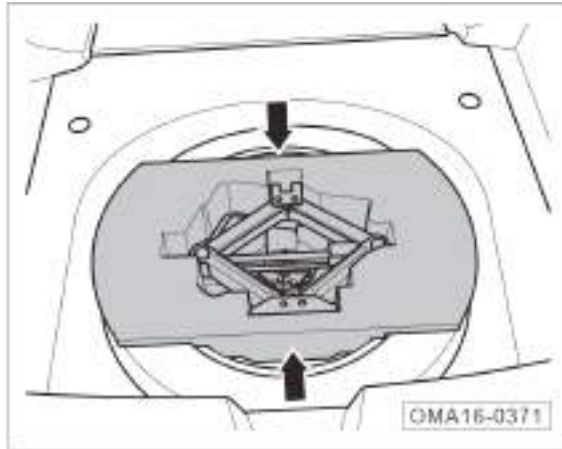

The spare tire is located under the trunk carpet. Please take out the spare tire by the following method:

- Open the trunk lid.
- Remove the whole trunk carpet.
- Take out the accompanied foam tool box (see the arrows).

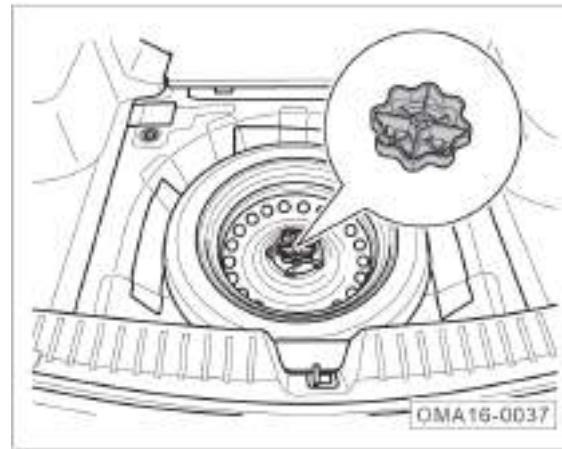

- Unscrew anticlockwise the hand wheel in the middle of the spare tire.
- Take out the spare tire.
- Install in the reverse order.

### ⚠ Caution

Spare tire has been inflated; check the pressure regularly to ensure the maximum pressure and check it several times a year.

### ⚠ Warning

- Use it in strict accordance with the operating requirements of spare tire to avoid risks.
- It is forbidden to install more than one spare tire.
- Do not use the spare tire which has been damaged or worn down to the wear mark.
- After finishing installing the spare tire, check its pressure and make sure it is within the specified range.
- When using the spare tire, make sure that the speed does not exceed 80km/h and avoid rapid acceleration and emergency braking.

## 8. Handling of Accident

### 8.2 Usage of Warning Triangle

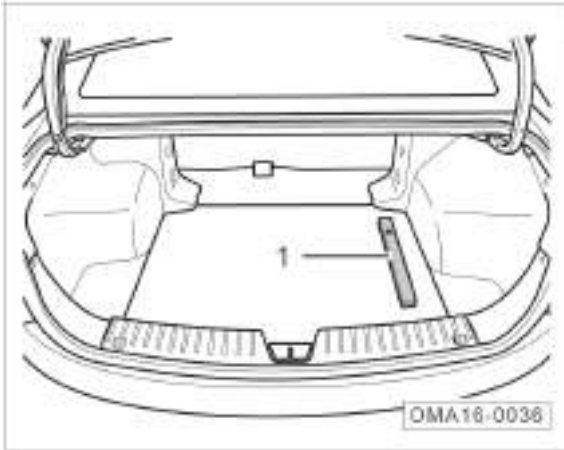

- Open the trunk lid, take out and unfold the warning triangle ①.

### Location of Placement



General roads		Expressway
Daytime	Night	
≥ 50 m	≥ 80 m	≥ 150 m

#### Caution

The above data is for reference only. For specific distance, please follow the relevant traffic regulations.

### 8.3 Usage of Reflective Vest

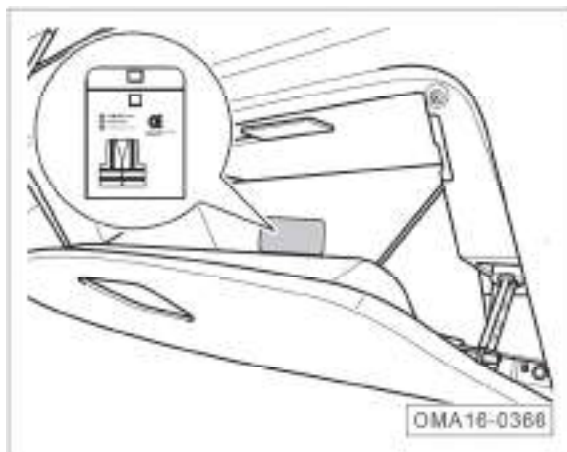

- Take the reflective vest out of the glove box if the car should be parked due to any car accident or other faults.

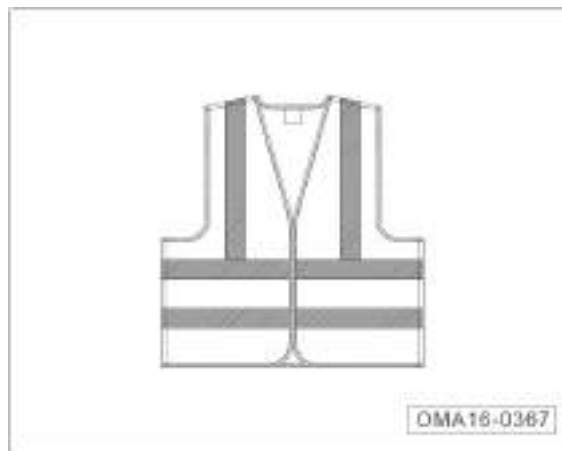

- Wear the reflective vest.

#### **i** Hint

- During accident handling, wear the reflective vest as required irrespective of the lighting conditions to draw attention of the passerby or other drivers.
- After using the reflective vest, return it to the glove box properly, or wash it when necessary as per the notes on the collar to ensure reflecting performance.

## 8. Handling of Accident

### 8.4 Replacing the Flat Tire

#### Preparations

- Park the vehicle on firm and level ground far away from traffic lanes.
- For vehicle models with automatic transmission, switch the shift lever to “P” gear; for vehicle models with manual transmission, switch the shift lever to gear 1.
- Apply parking brake.
- Switch the Start or Ignition switch to “OFF/ LOCK” position and turn on the hazard warning indicator light.
- Put the warning triangle at the appropriate place behind the vehicle.
- Unload the weights in the vehicle as much as possible. Find appropriate objects to place under other wheels to prevent the vehicle from moving.
- Take out the vehicle tools and the spare tire.

#### Warning

- **When puncture, air leakage or other problems occur, stop the car and replace the tire. Park your vehicle in an area far away from traffic lanes. Turn on the hazard warning indicator lights, and place the warning triangles in position.**
- **All passengers must get off the car and wait in a safe place.**

#### Unscrewing the Wheel Bolts



Take out the wrench for removing wheel bolts from the accompanied tool bag. Put the wrench firmly on the wheel bolt and loosen the bolt for one circle counterclockwise in direction of the arrow.

#### Warning

**Only loosen each wheel bolt one circle before using the jack to lift up the vehicle.**

### Lifting the Vehicle

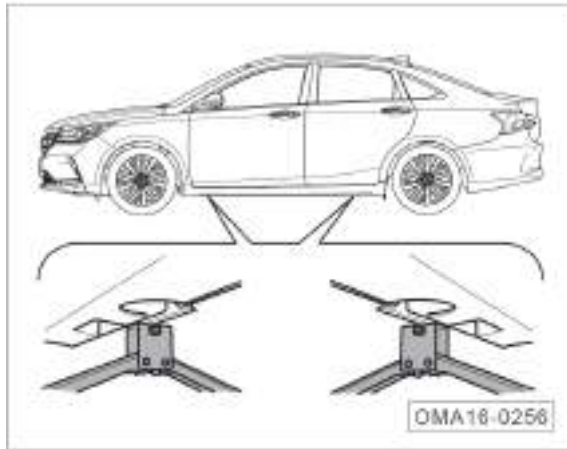

- Find the jacking point nearest to the flat tire. Place the jack under the jacking point.
- Lift the jack and align the groove of the jack with the protruding beam under the body.

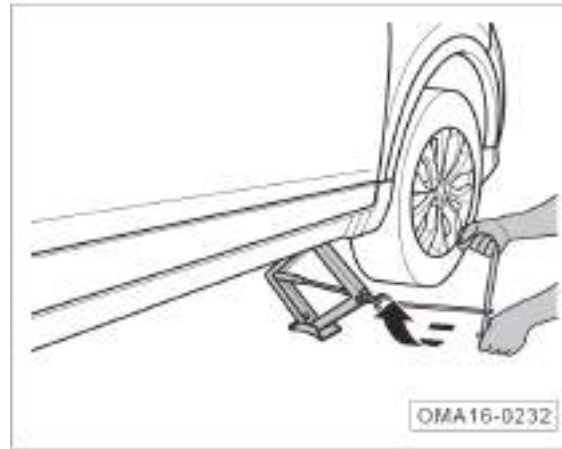

- Check whether the jack is placed steadily and fits the ground tightly.
- Assemble the wrench for removing wheel bolts as well as special wrench for jack, and jack.
- Lift the jack in direction of the arrow to lift the vehicle and make the tire off the ground.

#### Caution

After loosening the bolts of the flat tire, execute lifting and other subsequent replacement operations, so as to facilitate wheel bolt disassembly.

#### Warning

- **Make sure the jack is used on firm and level ground.**
- **Make sure the jack is placed under the proper jacking point.**
- **Follow the precautions for operating the jack.**
- **Disconnect your vehicle from the trailer (if equipped).**
- **When lifting the car, continually observe its conditions. If the car inclines obviously, stop lifting and find out the cause before trying again.**

## 8. Handling of Accident

### Removing the Flat Tire

- Remove the wheel bolts with the wrench with the tire off the ground.
- Remove the flat tire.

### Installing the Spare Tire

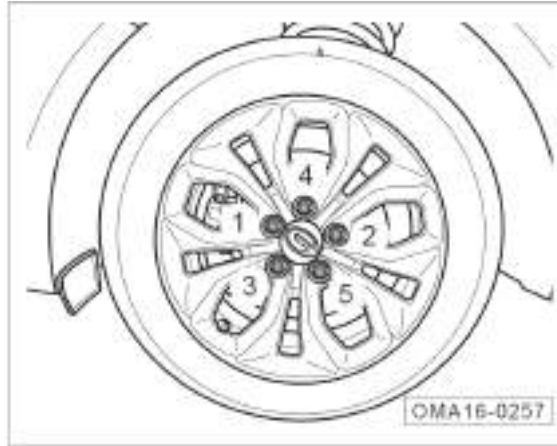

- Mount the spare tire on the vehicle.
- Install all wheel bolts, and pre-tighten them with the wrench as per the orders 1-5 shown in the figure.
- Lower the vehicle.
- Tighten all wheel bolts with the wrench.

### Caution

- Tighten them in a diagonal sequence.
- After installing the wheel, go to GAC MOTOR dealer to inspect the tightening torque of wheel bolts as soon as possible.
- Tightening torque of bolts:  $125 \pm 10 \text{ N}\cdot\text{m}$

### Warning

**Keep the threads of the wheel bolts and hub clean, and make sure the bolts can be screwed easily. No grease or other attachment is permitted.**



### Notes to Wheel Replacement

- The replaced tire shall be timely and correctly placed into the spare tire installation position.
- Clean the tools and put them to the original position after use.
- Check the tightening torque of the wheel bolts as soon as possible.
- Change the damaged tire as soon as possible.
- When a tire is replaced, if any bolt is corroded or difficult to screw, replace it and clean the threaded hole before checking the wheel bolt's tightening torque.

#### Caution

The spare tire/ replaced tire must be securely fixed on the spare tire installation position.

## 8. Handling of Accident

### 8.5 Fuse

#### Fuse in Instrument Panel Fuse Box

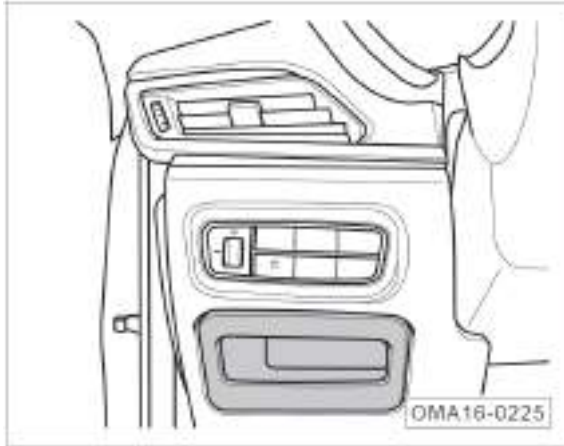

- Withdraw and remove the storage shelf for lower panel in the cab, and then you will see the fuse on the instrument panel fuse box.

#### Fuse in Engine Compartment Fuse Box

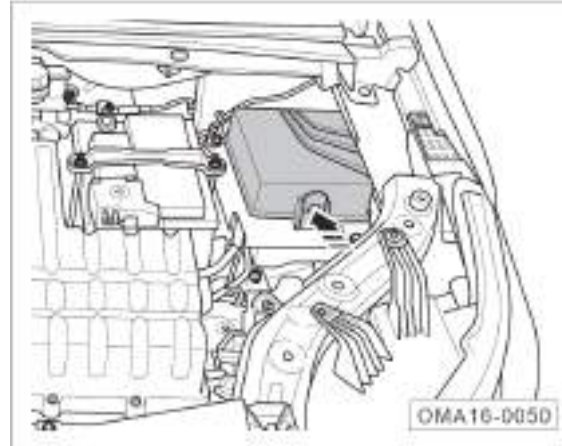

- Open the engine hood. => Refer to Page 90
- Press the fixing clip in direction of the arrow and release the fuse box cover.
- Remove the fuse box cover upward, and then you can see the fuse on the fuse box of the engine compartment.

#### Replace the fuse

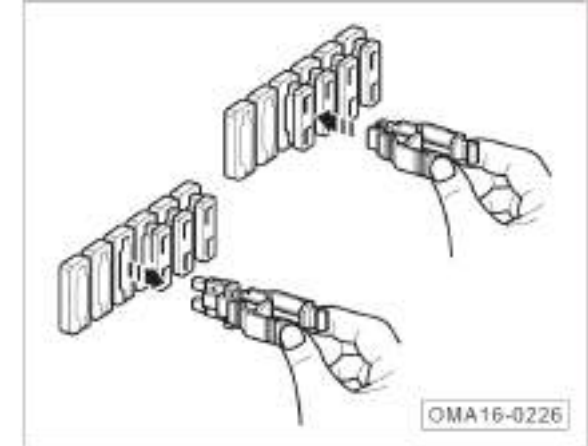

- Use the fuse extractor in the fuse box of engine compartment to extract or install the fuse.

### Blown fuses



- If the fuse is blown (as indicated by the arrow), replace with a new one with the same color and identification (We recommend you go to your GAC MOTOR dealer for replacement).

#### Warning

- Do not use the fuse whose rated current value is higher than the specified value. Otherwise, other components of the electrical system may be damaged.
- Make sure the color and identification of the new fuse are the same as those of the original one.
- Do not use a sheet metal, paper clip and the like to replace the fuse.
- Keep the inside of the fuse box clean and dry.

#### Caution

Turn off all the electrical equipment before replacing the fuses.

# 8. Handling of Accident

## 8.5.1 Fuses in the Instrument Panel Fuse Box

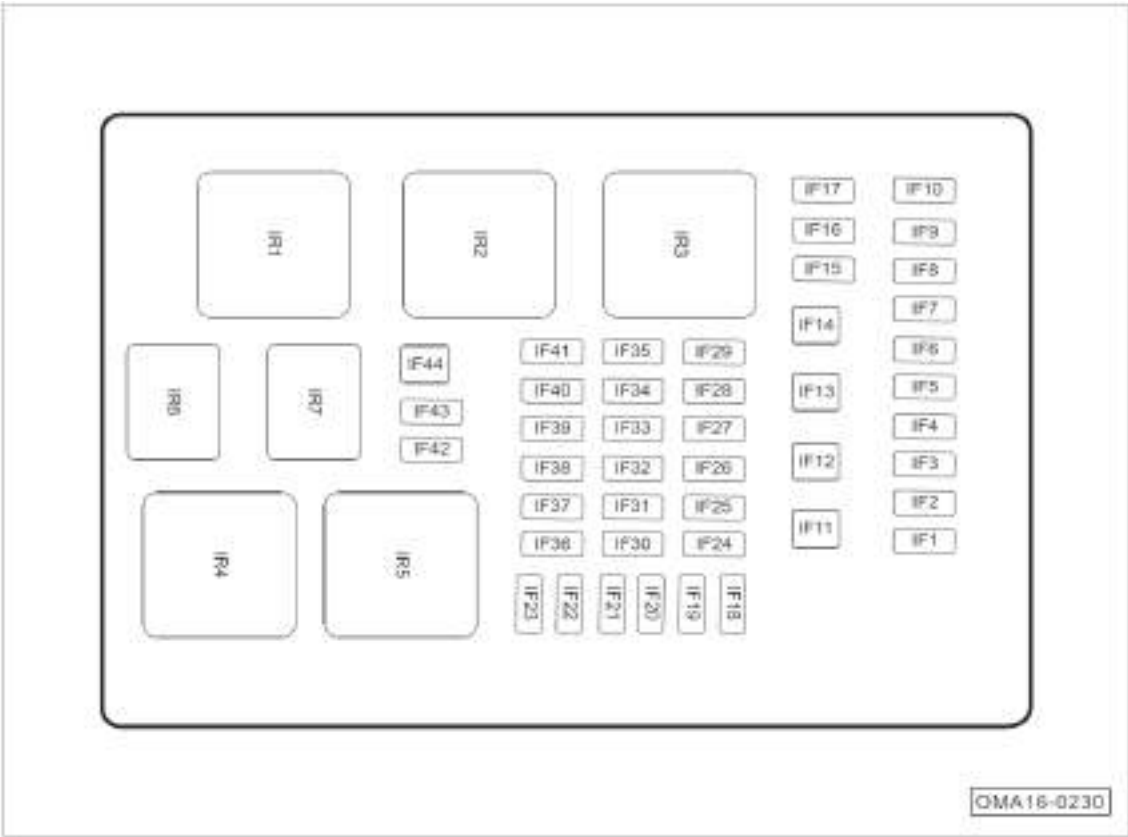

This figure does not apply to all vehicle models. Please check the purpose of the fuses on the real vehicle. The fuses depend on the vehicle model.

No.	Rated Value	Function/Component
IF1	SHORT PIN	Short pin
IF2	20A	Body control module (light power supply)
IF3	7.5A	Gateway control unit
IF4	10A	Body control module (turn signal power supply)
IF5	15A	AUDIO Control Unit
IF6	15A	Sunroof Control Unit
IF7	7.5A	Trunk light / front left courtesy light / front right courtesy light / rear-view mirror folding relay / rear-view mirror unfolding relay
IF8	15A	Body Control Module
IF9	-	-
IF10	-	-
IF11	-	-
IF12	20A	Body control module (front left window regulator power, rear left window regulator power)
IF13	20A	Body control module (front right window regulator power, rear right window regulator power)
IF14	30A	IG1 relay/ACC relay/Ignition switch
IF15	20A	Front left seat connector (seat adjustment power)
IF16	7.5A	OBD Diagnostic Interface
IF17	-	-
IF18	10A	Instrument cluster / T-BOX control unit / panorama parking control unit
IF19	15A	Body control module (wiper cleaning power)

No.	Rated Value	Function/Component
IF20	20A	Front left seat connector (seat heating power)
IF21	-	-
IF22	20A	Body control module (door lock power supply)
IF23	-	-
IF24	20A	Cigarette Lighter
IF25	7.5A	Body control module / PEPS control unit
IF26	10A	AUDIO control unit / rear-view mirror adjustment switch
IF27	7.5A	Smartphone wireless charging module / USB charging port
IF28	-	-
IF29	7.5A	Blower relay / electronic anti-glare rear-view mirror / PEPS control unit / defogging relay
IF30	7.5A	Gateway control unit / body control module / PEPS control unit
IF31	10A	Sunroof control unit / rain and light sensor / front central console panel / T-BOX control unit / instrument cluster / A/C control unit / front left seat connector / left dashboard switch group
IF32	7.5A	Steering angular speed sensor / EPB control unit / TPMS control unit / EPS control unit / ABS/ESP control unit
IF33	7.5A	Front left combination light (adjustment motor) / front right combination light (adjustment motor) / reversing radar control unit / panorama parking control unit / headlight height adjustment switch / anion generator / A/C control panel
IF34	10A	Supplemental Restraint System Control Unit

## 8. Handling of Accident

No.	Rated Value	Function/Component
IF35	7.5A	Shift lever / 4AT control unit / 6AT control unit / brake switch / engine control unit
IF36	7.5A	High brake light / TPMS control unit / EPB switch
IF37	7.5A	PEPS control unit / ESCL
IF38	7.5A	Ignition switch / PEPS control unit / PEPS immobilizer coil
IF39	10A	Front central console panel / A/C control unit / A/C control panel
IF40	7.5A	Body control module / starter relay 1 / starter relay 2 / engine control unit
IF41	-	-
IF42	-	-
IF43	7.5A	Left rear-view mirror heater/right rear-view mirror heater
IF44	30A	Rear Defogging Heater
IR1	-	IG2 Relay
IR2	-	ACC Relay
IR3	-	IG1 relay
IR4	-	-
IR5	-	Defogging relay
IR6	-	Exterior rear-view folding relay
IR7	-	Exterior rear-view mirror unfolding relay

### Hint

One electric appliance may be equipped with multiple fuses, or several electric appliances may share a common fuse.

### Caution

For replacement of fuse, consult your GAC MOTOR dealer.

### Warning

**Using an inappropriate or repaired fuse can cause a fire or personal injury or death.**

8.5.2 Fuse in Engine Compartment Fuse Box

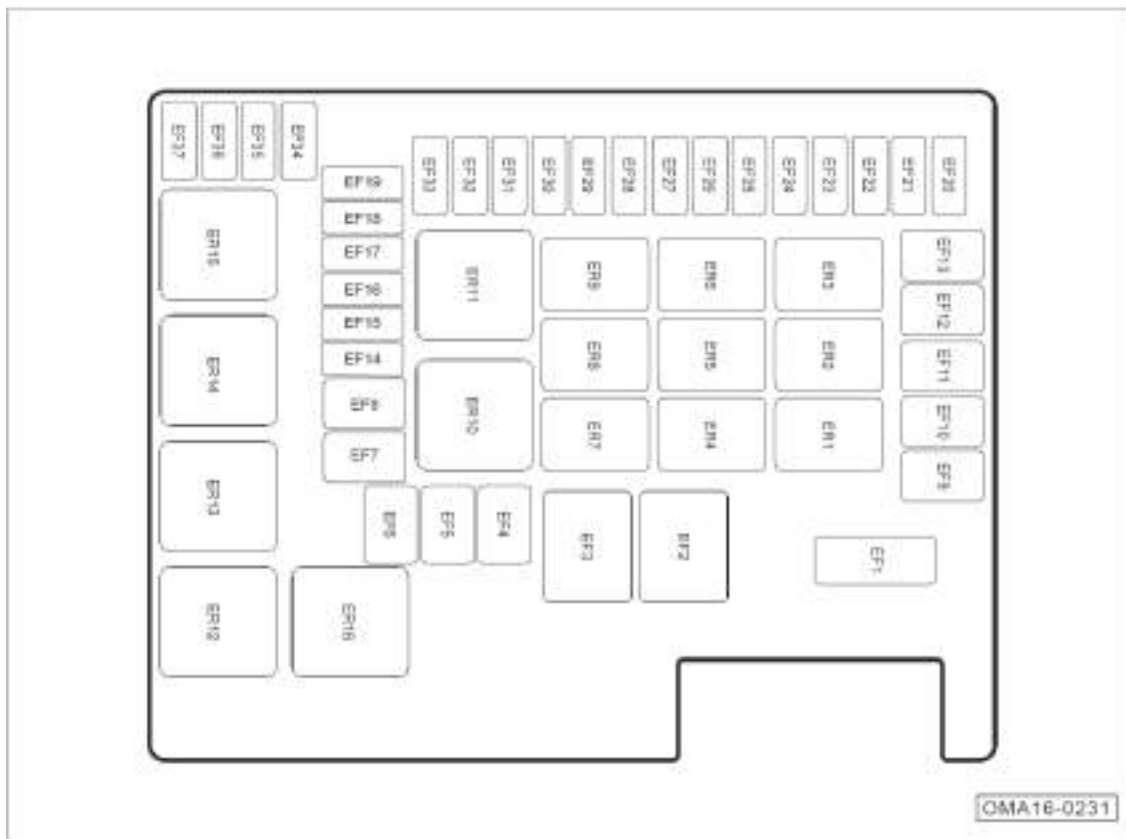

This figure does not apply to all vehicle models. Please check the purpose of the fuses on the real vehicle. The fuses depend on the vehicle model.

## 8. Handling of Accident

No.	Rated Value	Function/Component
EF1	125A	Main fuse
EF2	80A	EPS control unit
EF3	50A	Instrument Panel Fuse Box
EF4	40A	High-speed fan relay / low-speed fan relay
EF5	50A	High-speed fan relay
EF6	40A	ABS/ESP control unit
EF7	-	-
EF8	30A	Blower Relay
EF9	-	-
EF10	50A	Instrument Panel Fuse Box
EF11	-	-
EF12	30A	Starter relay 1 / Starter relay 2 / IG2 relay / Ignition switch
EF13	20A	Wiper relay/wiper speed regulation relay
EF14	-	-
EF15	25A	ABS/ESP control unit
EF16	15A	High Beam Relay
EF17	7.5A	A/C compressor relay
EF18	-	-
EF19	-	-
EF20	15A	Fuel Pump Relay
EF21	30A	Electronic Parking Brake Control Unit
EF22	7.5A	Engine control unit/brake switch
EF23	15A	Speaker Relay

No.	Rated Value	Function/Component
EF24	30A	Electronic Parking Brake Control Unit
EF25	-	-
EF26	-	-
EF27	15A	4AT control unit / 6AT control unit
EF28	SHORT PIN	Short pin
EF29	SHORT PIN	Short pin
EF30	10A	Fuel injector and fuel pump relay
EF31	15A	Ignition Coil
EF32	10A	Engine Control Unit
EF33	7.5A	Low-speed fan relay / high-speed fan relay / starter relay 2 / A/C compressor relay / front oxygen sensor / rear oxygen sensor
EF34	10A	Front left combination light (low beam)
EF35	10A	Front right combination light (low beam)
EF36	7.5A	Engine Control Unit
EF37	10A	Clutch position sensor (MT model) / variable camshaft timing (intake end) / carbon canister solenoid valve / turbocharger wastegate (1.3T model) / discharge valve (1.3T model) / variable camshaft timing (exhaust end)
ER1	-	Wiper Relay
ER2	-	Wiper speed regulation relay
ER3	-	Fuel Pump Relay
ER4	-	-



No.	Rated Value	Function/Component
ER5	-	-
ER6	-	Speaker Relay
ER7	-	Low Beam Relay
ER8	-	A/C compressor relay
ER9	-	High Beam Relay
ER10	-	Starter Relay 1
ER11	-	Main Relay
ER12	-	High-speed fan relay
ER13	-	Blower Relay
ER14	-	Starter Relay 2
ER15	-	-
ER16	-	Low-speed fan relay

**i Hint**

One electric appliance may be equipped with multiple fuses, or several electric appliances may share a common fuse.

**👁 Caution**

For replacement of fuse, consult your GAC MOTOR dealer.

**⚠ Warning**

**Using an inappropriate or repaired fuse can cause a fire or personal injury or death.**

## 8. Handling of Accident

### 8.6 Emergency Start

#### Jumper Cable

If you can not start the engine because of low battery energy, you can use the jumper cable to connect with another vehicle's battery to start the engine.

#### Caution

Connect the positive terminals of the batteries before connecting the negative ones.

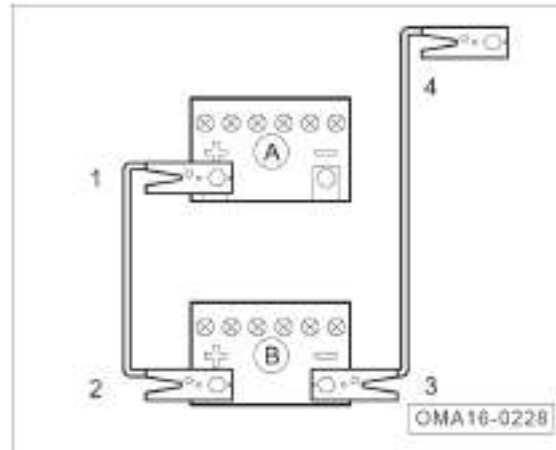

- Start the engine of the vehicle with booster battery and let it idle, and then start the engine of the vehicle with flat battery until the engine runs smoothly.
  - Once your car runs stably, disconnect the jumper cable in reverse sequence.
- Switch the Start or Ignition switch to "OFF/LOCK" position.
  - Connect one end ① of the red cable to the positive electrode (+) of flat battery "A", and the other end ② to the positive electrode (+) of booster battery "B".
  - Connect one end ③ of the black cable to the negative electrode (-) of booster battery "B", and the other end ④ to the engine cylinder block or the metal component securely connecting with the engine cylinder block of the vehicle with flat battery "A".

### Warning

- Do not remove the jumper cables until the Start or Ignition switch is switched off.
- Turn on the air blower and rear windshield heater in the vehicle with flat battery to reduce the voltage peak resulting from removing the cables.
- Place the jumper cables in position to prevent them from touching other moving parts.

### Warning

A battery can explode if you can not use the jumper cable properly, seriously injuring anyone nearby.

- Make sure the voltage of the booster battery is equal to that of the flat battery, and the capacity of the booster battery is similar to that of the flat battery. Otherwise, it may cause explosion.
- Keep open flames away from the battery to avoid explosion.
- Do not connect the negative cable to the negative electrode of the flat battery directly. Make sure there is no static near the battery. Otherwise, combustible gas produced by the battery can be ignited by sparks, causing explosion.
- Do not connect the negative cable to the fuel system component or brake pipe. During operation, do not face the battery to avoid acid burns.

## 8. Handling of Accident

### 8.7 Emergency Towing

The front and rear parts of the vehicle are both provided with emergency traction port of threaded hole structure, to which the towing hook (a vehicle tool) can be installed for traction operation.

#### **i** Hint

The towing hook shall be placed on the vehicle so as to be used when needed.

#### **⚠** Warning

**The emergency traction operation of the vehicle has certain risk. Unless you have the experience, do not tow other vehicle to avoid accidents.**

### Install Front Towing Hook

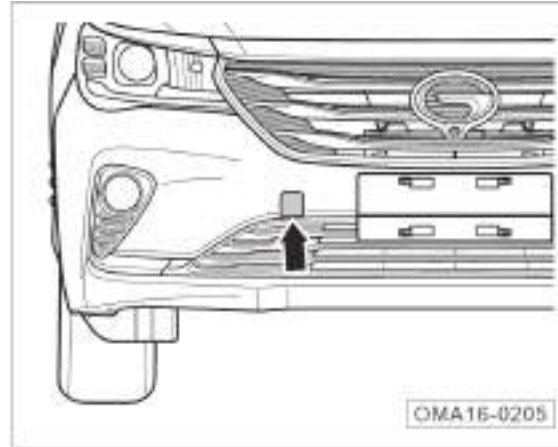

- Take out the towing hook and the wrench for removing wheel bolts from the tool bag in the trunk.
- Open the towing hook cover with a word knife at the position indicated by the arrow.

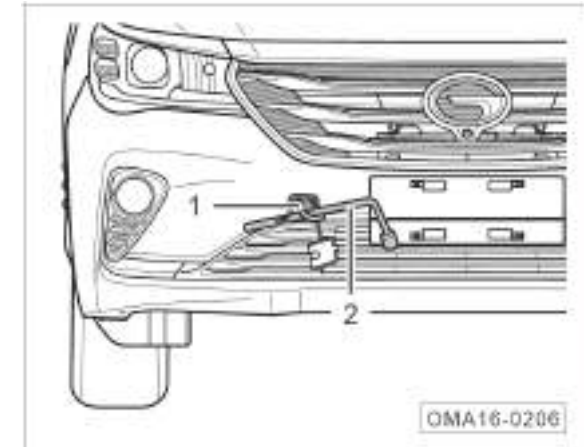

- Screw the towing hook ① into the threaded hole clockwise.
- Insert the wrench for removing wheel bolts ② into the towing hook port, and rotate the wrench clockwise to securely screw the towing hook into the threaded hole.
- After towing, screw out the towing ring in reverse sequence and put the bumper cover in place.

### Install Rear Towing Hook

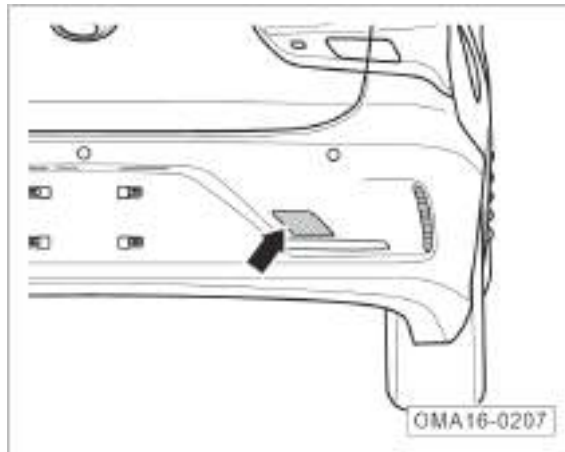

- Take out the towing hook and the wrench for removing wheel bolts from the tool bag in the trunk.
- Open the towing hook cover with a word knife at the position indicated by the arrow.

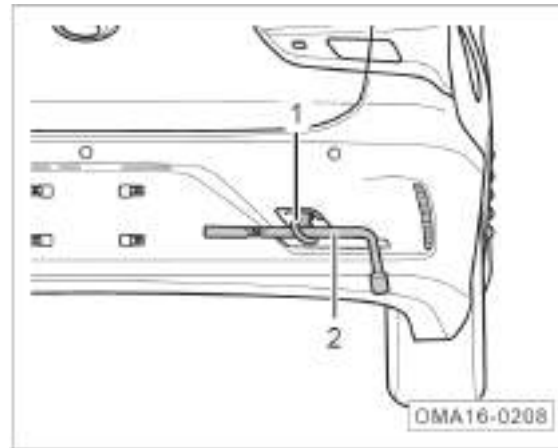

- Screw the towing hook ① into the threaded hole clockwise.
- Insert the wrench for removing wheel bolts ② into the towing hook port, and rotate the wrench clockwise to securely screw the towing hook into the threaded hole.
- After towing, screw out the towing ring in reverse sequence and put the bumper cover in place.

### Precautions for Traction

Before emergency traction, be sure to operate according to the following precautions:

- The drivers of the towing and towed vehicles must turn on the hazard warning indicator lights, and must observe the local traffic regulations.
- The towing hook must be securely screwed into the threaded hole. Otherwise, the towing hook may slip from the threaded hole during traction process.

## 8. Handling of Accident

---

During emergency traction process, be sure to operate according to the following precautions:

- If the towed vehicle is equipped with mechanical key ignition switch, make sure that the ignition switch is always kept at "ON" position. Otherwise, serious traffic accidents may be caused due to steering wheel unable to be turned during towing.
- Always remember that the brake booster and steering booster of the towed vehicle will not work. Therefore, press the brake pedal in advance.
- Travel smoothly, and do not accelerate, decelerate or turn sharply during towing.
- For the vehicles equipped with manual transmission, engage the clutch slightly and slowly when starting the car, while for the vehicles equipped with automatic transmission, depress the accelerator pedal slowly.
- Start and move slowly until the tow rope strains, and then accelerate gradually.
- During the traction operation, the tow rope must always be strained.

If the vehicle transmission suffers oil leakage, during the emergency traction, only the driving wheel of the vehicle can be lifted for traction, and:

- Put the shift lever at "N" position.
- The towing speed shall not be greater than 50km/h.
- The maximum towing distance shall be 50km.

### Warning

- **The oil pump of the transmission cannot work when the engine is off. The transmission will be at a working condition of poor lubrication when the vehicle is towed at a high speed and for a long distance, which will damage the transmission. Therefore, if the towing distance is too long, the front wheels must be lift up.**
- **If the rear part of the car is lift up for traction, the wheels will rotate backwards and the gear in transmission will reach a very high rotating speed, causing serious damage to the transmission within a short time.**

### Towing

If your car has an accident and requires to be towed, we suggest using a platform truck to tow your car. If it is not available, you can also use a wheeled truck to tow your car if necessary.

Select proper towing method according to the configuration and fault condition of your car. But the following precautions must be noted:

### Towing Method

- Contact your GAC MOTOR dealer or the professional towing company for towing, and do not tow the vehicle by yourself without full confidence, otherwise the vehicle is very easy to be damaged.
- All towing methods require the use of safety chain system and shall comply with relevant traffic laws.
- You must tow your car according to the specification; otherwise it may cause the damage to your car and threaten traffic safety.

### Tow the Car by Using a Platform Truck

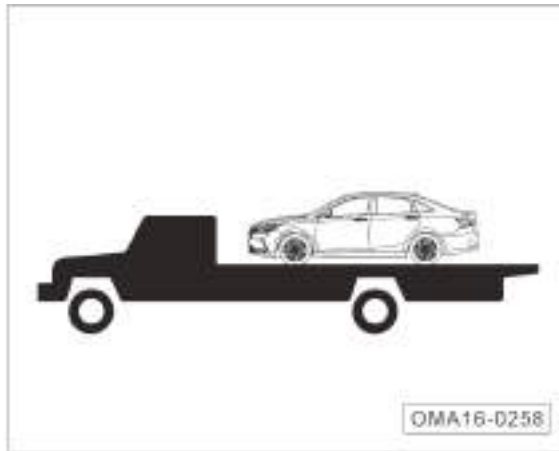

This towing method is applicable to all models of fault cars. We suggest using this method as much as possible.

#### Caution

Pay attention to apply parking brake and fix four wheels, to prevent the vehicle from moving during emergency braking of the trailer.

### Tow the Car from the Front by Using a Wheeled Truck

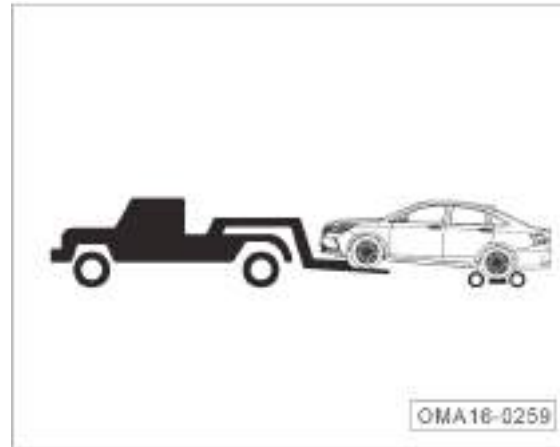

If this method is used and the towing platform is placed beneath the rear wheels of the car to be towed, all models of faulty cars can be towed.

If this method is used but no towing platform is placed beneath the rear wheels of the car to be towed, only the following cars can be towed at a low speed:

2WD (front drive) vehicles, with intact rear wheels and axles and parking brake handle completely released

#### Caution

- For cars equipped with electronic parking brake (EPB), when they are towed, towing platform must be placed under the rear wheels. Otherwise, the brake and tires may be damaged.
- When lifting the front part of the vehicle, guarantee that appropriate ground clearance shall be reserved for the rear part, otherwise the outer cover of rear bumper or underbody of the towed vehicle may be damaged.

## 8. Handling of Accident

---

### Tow the Car from the Rear by Using a Wheeled Truck

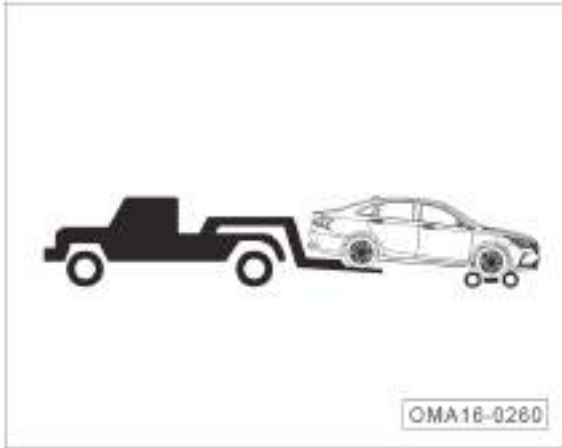

If your vehicle's front wheels and front axle are damaged, the towing platform needs to be placed beneath your vehicle's front wheels.

#### Caution

Do not tow the vehicle with the front wheels down to the ground, which will seriously damage the transmission.

### Lifting Truck is Strictly Forbidden to Use.



Do not use lifting truck to tow the car from the front or rear of the car, otherwise, it may cause damage to the body.



## 9. Environmental Protection Information

### 9.1 Environmental Protection Information No.

Vehicle Model	Environmental Protection Information No.	S/N
GAH7130F1M5	CN QQ G5 Z2 008U000001	000001
		000002
GAH7130F2M5	CN QQ G5 Z2 008U000002	000001
		000002
GAH7130F1A5	CN QQ G5 Z2 008U000003	000001
		000002
GAH7130F1A5A	CN QQ G5 Z2 008U000004	000001
		000002
GAH7130F2A5	CN QQ G5 Z2 008U000005	000001
		000002
GAH7130F2A5A	CN QQ G5 Z2 008U000006	000001
		000002
GAH7150F1M5	CN QQ G5 Z2 008U000007	000001
		000002
GAH7150F2M5	CN QQ G5 Z2 008U000008	000001
		000002
GAH7150F2M5A	CN QQ G5 Z2 008U000009	000001
		000002
GAH7150F2A5	CN QQ G5 Z2 008U000010	000001
		000002
GAH7150F2A5A	CN QQ G5 Z2 008U000011	000001
		000002

**9. Environmental Protection Information**

---

<b>Vehicle Model</b>	<b>Environmental Protection Information No.</b>	<b>S/N</b>
GAH7150F1M5A	CN QQ G5 Z2 008U000012	000001
		000002
GAH7130F1M5A	CN QQ G5 Z2 008U000013	000001
		000002
GAH7130F2M5A	CN QQ G5 Z2 008U000014	000001
		000002

Note: 1) For environmental protection information, please refer to the corresponding vehicle model.

## 9. Environmental Protection Information

### 9.2. Environmental Protection Information

Item	Environmental Protection Information	
<b>Vehicle Model</b>	GAH7130F1M5, GAH7130F2M5 GAH7130F1M5A, GAH7130F2M5A	GAH7130F1A5, GAH7130F2A5 GAH7130F1A5A, GAH7130F2A5A
Engine model/manufacture	4A13M1 / GAC Motor Co., Ltd.	
Catalytic converter model/manufacture	Front: 1388615X / front: Faurecia (Guangzhou) Automobile Parts and Systems Co., Ltd. Sanshui Branch Company Carrier: front: unit 1: NGK (Suzhou) Environmental Ceramics Co., Ltd. Coating: front: unit 1: Wuxi Weifu Environmental Catalysts Co., Ltd. Encapsulation: front: Faurecia (Guangzhou) Automobile Parts and Systems Co., Ltd. Sanshui Branch Company	
Fuel evaporative control device model / manufacturer	2140003AAF00/Guangdong Hengbo Filter Co., Ltd. or 2140003AAF00/Hengbo Holdings Co., Ltd.	
Oxygen sensor model/manufacture	Front: LSF4; rear: LSF4/United Automotive Electronic Systems Co., Ltd.	
Crankcase emission control device/ manufacturer	10090081310000/Ningbo Shentong Moulding Co., Ltd.	
EGR model/manufacture	/	
OBD model/manufacture	ME17/United Automotive Electronic Systems Co., Ltd.	
IUPR monitoring	Confirm to requirements	
ECU model/version/manufacture	ME17/ME17/United Automotive Electronic Systems Co., Ltd.	
Transmission model/number of gear positions	Manual/5	Auto/6
Muffler model/manufacture	Front: 82421915; rear 82421917/ Ningbo Branch of Shanghai Tenneco Exhaust System Co., Ltd.	
Turbocharger model/manufacture	RHF3 / Wuxi IHI Turbo Co., Ltd.	
Intercooler type	/	

## 9. Environmental Protection Information

Item	Environmental Protection Information	
Vehicle Model	GAH7150F2A5, GAH7150F2A5A	GAH7150F1M5, GAH7150F2M5 GAH7150F1M5A, GAH7150F2M5A
Engine model/manufacturer	4A15K1 / GAC Motor Co., Ltd.	
Catalytic converter model/manufacturer	Front: 1920148X / front: Faurecia (Guangzhou) Automobile Parts and Systems Co., Ltd. Sanshui Branch Company Carrier: front: unit 1: NGK (Suzhou) Environmental Ceramics Co., Ltd. Coating: front: unit 1: Wuxi Weifu Environmental Catalysts Co., Ltd. Encapsulation: front: Faurecia (Guangzhou) Automobile Parts and Systems Co., Ltd. Sanshui Branch Company	
Fuel evaporative control device model / manufacturer	2140003AAF00/Guangdong Hengbo Filter Co., Ltd. or 2140003AAF00/Hengbo Holdings Co., Ltd.	
Oxygen sensor model/manufacturer	Front: RE94; rear: RE94 / Beijing Delphi Wanyuan Engine Management Systems Co., Ltd.	
Crankcase emission control device/ manufacturer	10090081310000/Ningbo Shentong Moulding Co., Ltd.	
EGR model/manufacturer	/	
OBD model/manufacturer	MT62.1 / Beijing Delphi Wanyuan Engine Management Systems Co., Ltd.	
IUPR monitoring	Confirm to requirements	
ECU model/version/manufacturer	MT62.1 / MT62.1 / Beijing Delphi Wanyuan Engine Management Systems Co., Ltd.	
Transmission model/number of gear positions	Auto/4	Manual/5
Muffler model/manufacturer	Front: 82421915; rear 82421916/ Ningbo Branch of Shanghai Tenneco Exhaust System Co., Ltd.	
Turbocharger model/manufacturer	/	
Intercooler type	/	

**This Manual describes information related to configurations, functions, performance parameters and product schematic drawings of vehicles from GAC MOTOR. Its contents are effective when printing is allowed. But actual car configurations and functions are subject to actually delivered cars. If there is any difference between the product schematic drawing and actual car, the actual one should prevail.**

**GAC MOTOR reserves the right to alter, supplement or terminate the contents or technical specifications in this Manual without further notification.**

**All copyright is reserved by GAC MOTOR. Without written permission by GAC MOTOR, no printing and extracting of all or part contents of this Manual is allowed.**