

**OBD System Declaration Materials for  
SGMW\_CN200S\_1.5T\_MT\_CN5**

## Contents

1	Malfunction Indicator (MI).....	4
1.1	Description of the malfunction indicator (MI) .....	4
1.2	Icon of MI.....	4
2	All parts monitored by OBD system.....	4
3	The working principle of OBD system monitoring projects .....	6
3.1	Catalyst aging monitoring .....	6
3.1.1	DKATSP system.....	6
3.2	Misfire monitoring .....	10
3.2.1	Overview of misfire monitoring .....	10
3.2.2	Adaptive.....	11
3.2.3	Misfire monitoring.....	11
3.2.4	Misfire monitoring: three models .....	12
3.2.5	Emissions worsening misfire detection: the first 500 working cycles after engine start.....	13
3.2.6	Emissions worsening misfire: after the first 500 working cycles after engine start .....	14
3.2.7	Detection of damage and misfire of catalytic converter .....	14
3.2.8	Flowcharts.....	15
3.3	Oxygen sensor monitoring .....	18
3.3.1	Summary .....	18
3.3.2	Oxygen sensor signal monitoring .....	19
3.3.3	Oxygen sensor heating monitoring .....	20
3.3.4	ATP monitoring .....	21
3.4	Other parts and components monitored by OBD system .....	23
3.4.1	Monitoring of evaporation desorption control system.....	23
3.5	Continuous monitoring of cooling water temperature sensor line .....	23
3.6	Broken line monitoring .....	23
4	Output and format of OBD Fault Code.....	23
5	Vehicle OBD information.....	24
5.1	OBD preprocessing and demonstration cycle description .....	24
5.2	Scanning tool communication protocol.....	24
5.3	Misfire rate statement .....	24
5.3.1	Rate of misfire of emission deterioration.....	24
5.3.2	Catalyst damage misfire rate.....	24
5.4	Schema 5 and mode 6 test value definitions .....	25
6	Diagnostic rate (In-Use Performance Ratio).....	31
6.1	General requirements .....	31
6.2	Ignition cycle counter .....	33
6.3	Denominator counter .....	34
6.3.1	Requirements for general denominator counters .....	34

6.3.2	Special requirements for increasing denominator counters .....	34
6.4	List of OBD parts and system monitoring items .....	35
6.5	Working interrupts of molecular counters, denominator counters and general denominator counters .....	36
6.6	Other description .....	36
7	Measures to prevent damage and change of discharge control computers .....	37
8	OBD system defect description .....	37
9	OBD function monitoring fault simulator.....	38
9.1	Engine misfire generator .....	38
9.2	Oxygen sensor fault simulator.....	39
9.3	Cracking catalyst samples .....	39
10	Diagnostic interface communication mode .....	40

# 1 Malfunction Indicator (MI)

## 1.1 Description of the malfunction indicator (MI)

When parts or system failures result in vehicle emissions exceeding regulatory requirements, MI activates at the time required.

The MI operated in a flashing light with a frequency 1 Hz during which engine misfire occurs at a level likely to cause catalyst damage as specified.

If the error of activating MI is repaired, the MI lamp is extinguished after the required operation cycle.

When the MIL lamp flickers, the MIL lamp will return to its pre-flicker state if the system detects no damage to the catalyst.

## 1.2 Icon of MI



Figure 1: Icon of MI

# 2 All parts monitored by OBD system

All parts and components monitored by the OBD system are shown in the table below:

Table 1: A list of parts monitored by the OBD system

Parts and Components	Use
Upstream oxygen sensor	The upstream oxygen sensor is installed upstream of the three-way catalytic converter to monitor the oxygen concentration in the exhaust gas. The mixed gas closed loop control system is based on feedback from upstream oxygen sensor signals.
Downstream oxygen sensor	The downstream oxygen sensor is installed downstream of the three-way catalytic converter to measure the oxygen concentration in the exhaust gas after the three-way catalytic converter.
Three-way catalytic converter	Three-way catalytic converter is a device that converts toxic gases into non-toxic gases in the exhaust gas. There

Parts and Components	Use
	<p>is chemical reaction inside the catalytic converter to oxidize the poisonous gases in the exhaust to non-toxic gases.</p> <p>Three-way catalytic converter oxidizes carbon monoxide (CO), unburned hydrocarbon (HC), nitrogen oxides (NO<sub>x</sub>) into carbon dioxide, nitrogen N<sub>2</sub>, and water H<sub>2</sub>O.</p>
Throttle valve position sensor	The throttle position sensor measures throttle opening for engine load calculation.
Carbon canister control valve	Adjust and control the carbon tank to adsorb the vapor from the fuel tank into the intake manifold.
Engine speed sensor	The engine speed sensor, namely the engine crankshaft position sensor, monitors the engine speed and the synchronization signal of the calculation system.
Air conditioning pressure sensor	Monitor the air conditioning pressure and determine whether the air conditioning system works.
Air conditioning temperature sensor	Monitor the air conditioning temperature to determine whether the air conditioning system works.
Phase sensor	The phase sensor is the engine camshaft position sensor, which judges the synchronization signal of cylinder and calculation system.
Engine water temperature sensor	The engine water temperature sensor measures the cooling water temperature of the engine and is used to correct the intake mass.
Battery voltage	Battery voltage is within reasonable limits, and other diagnostic conditions are necessary.
Speed sensor	The speed sensor monitors the speed of the vehicle and calculates the activation mileage of the MIL lamp.
Oil level sensor	Used to indicate fuel allowance
Fuel injector	As part of the fuel system, the injector fuel into the intake port.
Oil pump	The oil pump pumps the oil pan to the oil rail and establishes a certain oil pressure in the oil system.
Stepper motor	The ECU signal controls the step number of the stepper motor, thus controlling the intake volume of the side channel and the idle speed of the engine.
Air conditioning compression engine	Part of air conditioning system.
Cooling fan	The electric driven cooling fan cooled the engine temperature.
Malfunction Indicator (MI)	The MI is activated at the required time when a component or system failure causes vehicle emissions to exceed

Parts and Components	Use
	regulatory requirements.
Intake manifold pressure / temperature sensor	The intake manifold pressure / temperature sensor is mounted on the intake manifold for measuring inlet pressure and temperature.
Boost pressure sensor	The boost pressure sensor measures the upstream intake pressure of the throttle and monitors the boost system based on the boost pressure.

### 3 The working principle of OBD system monitoring projects

#### 3.1 Catalyst aging monitoring

##### 3.1.1 DKATSP system

###### 3.1.1.1 System overview

Oxygen stored in the catalytic converter during lean mixture combustion is partially or wholly used to oxidize unburned hydrocarbons (HC), carbon monoxide (CO) and nitric oxide (NO) produced by concentrated mixture combustion. Many studies have shown that there is a nonlinear relationship between the conversion efficiency and oxygen storage capacity of the catalytic converter. As time goes on, it decreases.

Catalyst monitoring directly measures the oxygen storage (OSC) of the mixture during the transition from concentration to dilution. The upstream oxygen sensor (HO2S) accurately controls the air-fuel ratio, and the downstream oxygen sensor (HO2S) is used to measure the oxygen storage capacity of the catalyst. The required devices are shown below.

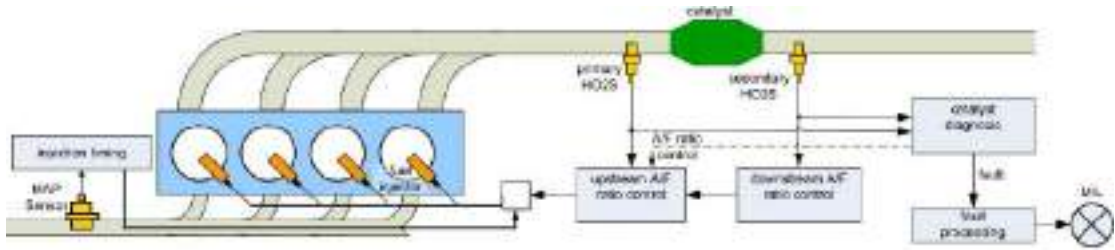

Figure 2: Catalytic converter aging monitoring system

### 3.1.1.2 Catalyst aging monitoring

In the first of a two-step process a reference state is to actively enrich the mixture to completely empty the residual oxygen in the catalytic converter. When the downstream oxygen sensor indicates a sudden change in the mixture from dilute to concentrate (when the voltage of the downstream oxygen sensor is higher than the matched threshold), the concentration of the mixture in the flushing catalytic converter is calculated. The concentration of the mixture is twice as much as the critical oxygen storage required to ensure that the oxygen in the catalytic converter is completely emptied.

Next, the mixture is diluted actively, and the catalyst begins to store the residual oxygen in the exhaust. When the downstream oxygen sensor indicates the dilute mixture, the catalyst is filled with oxygen. As shown in the following formula.

$$OCS(t) = \int_{t_1}^{t_2} air\ mass\ flow * \left(\frac{A}{F} - 1\right) * dt \dots\dots\dots \left[ \frac{Kg}{h} * sec \right]$$

DKATSP repeats active enrichment and dilution (matching repetitions) in an operating cycle and calculates the average oxygen storage. The actual conversion efficiency of the catalyst is determined by comparing the actual measured average oxygen storage (OSC) with the critical catalyst model oxygen storage (OSC) calculated by temperature and inlet mass. When the ratio of the average value of OSC to the critical catalyst (OSC) is lower than the calibrated threshold, the system indicates the minimum failure of the catalytic converter. The aging diagnosis of the catalytic converter is made once every operation cycle.

### 3.1.1.3 Flowcharts

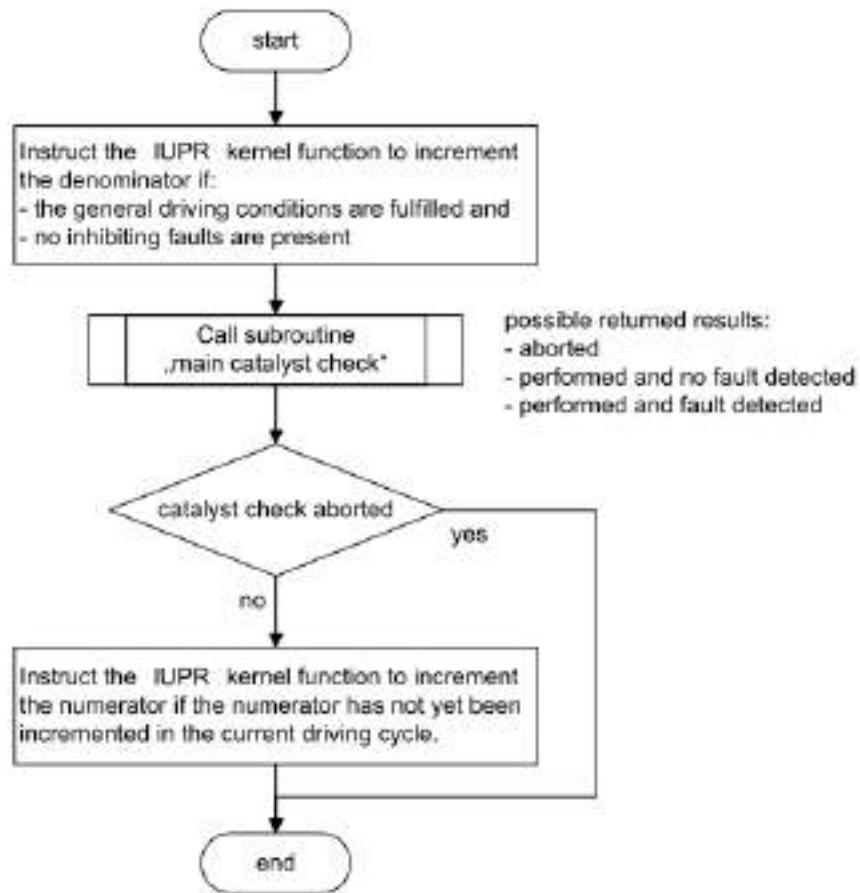

Figure 3: Aging monitoring of catalytic converters-main flowchart



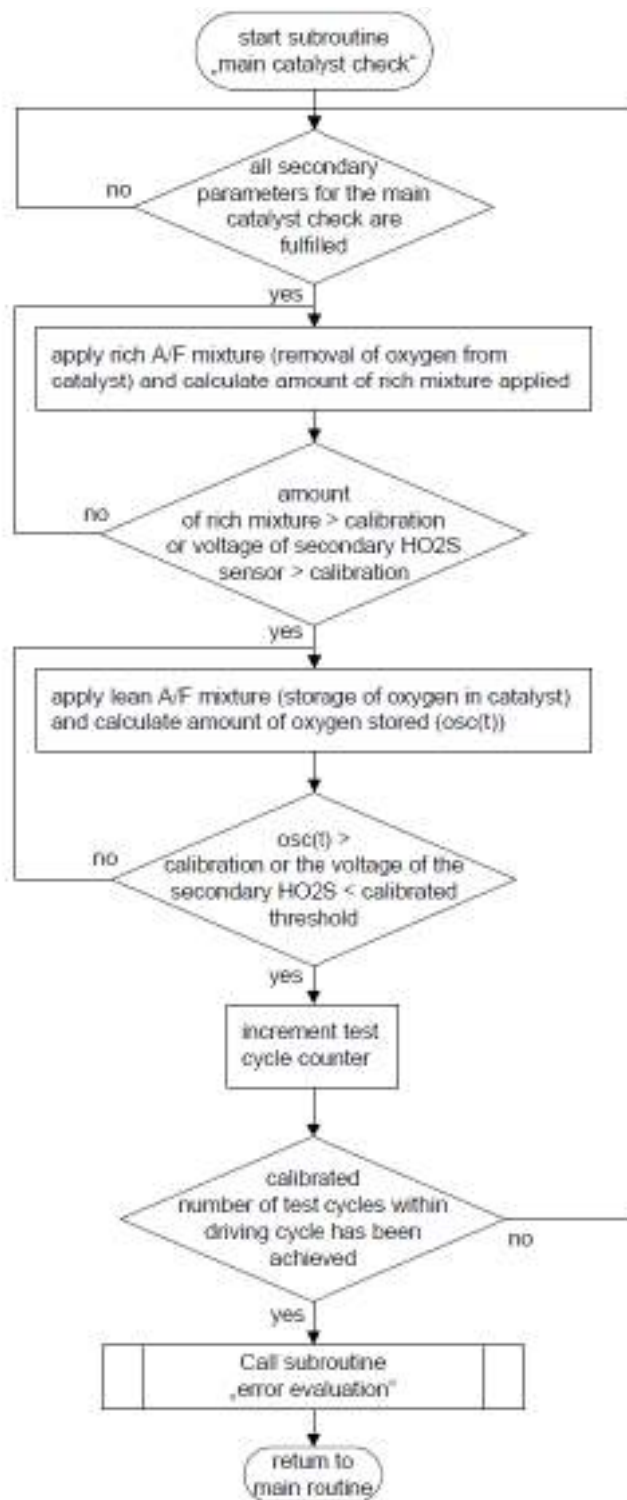

Figure 4: Aging monitoring of catalytic converters-main monitoring process subroutine

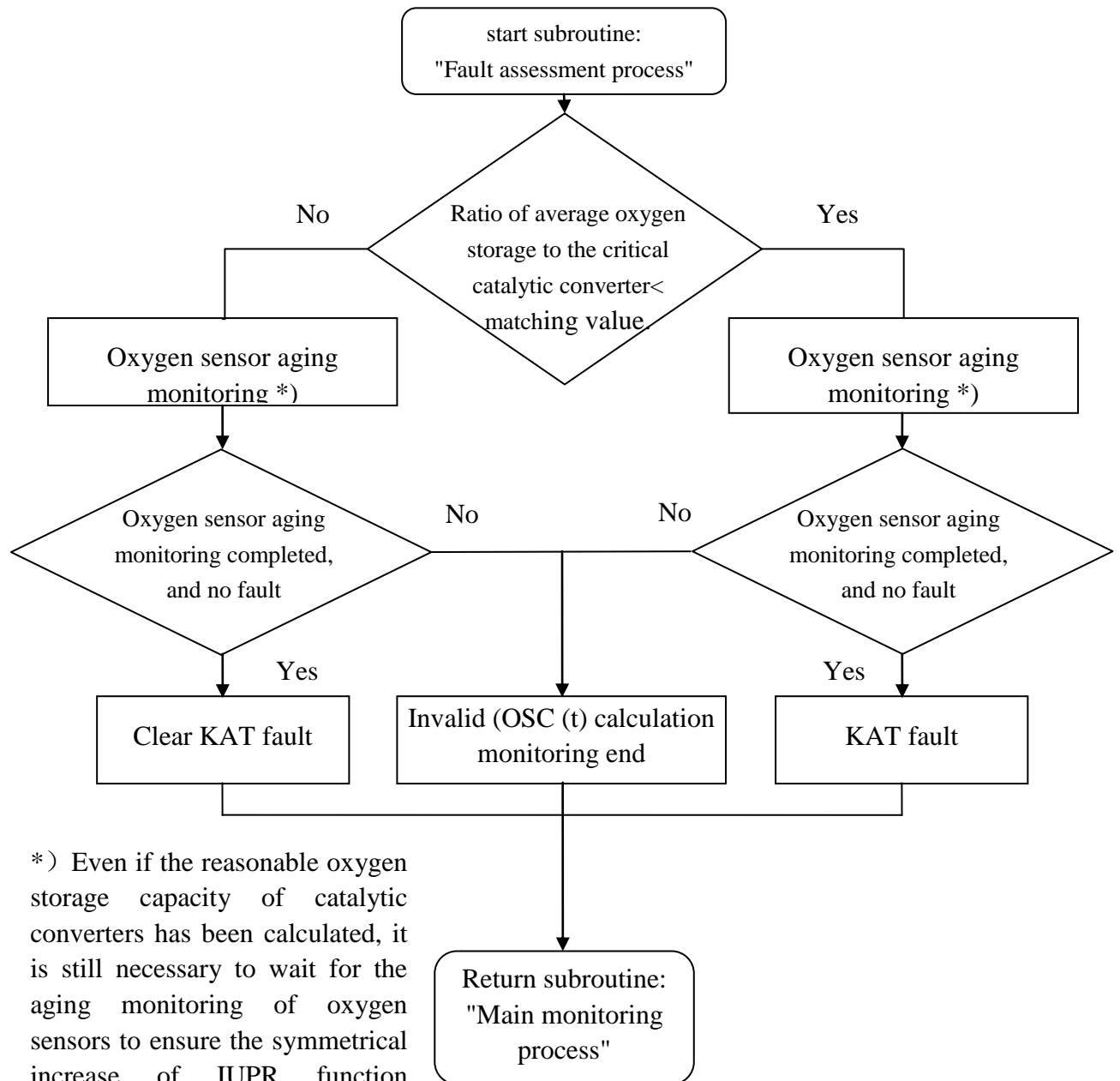

Figure 5: Catalyst monitor – subroutine “error evaluation”

## 3.2 Misfire monitoring

### 3.2.1 Overview of misfire monitoring

The basic principle of engine misfire detection is to calculate crankshaft angular acceleration in each independent combustion process.

In order to calculate the angular acceleration, a toothed speed sensor with a reference mark is installed on the crankshaft. The speed sensor is divided into several segments, the number of segments is half the number of even cylinders, and the number of cylinders is odd.

See the table below for the relationship between the number of cylinders, sectional windows, and sectional numbers. In each case, the sectional windows are calculated based on the 720-degree total sectional window, which happens to be the crankshaft angle at which all cylinders rotate in one cycle of the engine.

Table 1: Segmentation window sample

Engine cylinder number	3	4	5	6	8	10	12
Segmented window [° Crankshaft]	$720^\circ / 3 = 240^\circ$	$720^\circ / 4 = 180^\circ$	$720^\circ / 5 = 144^\circ$	$720^\circ / 6 = 120^\circ$	$720^\circ / 8 = 90^\circ$	$720^\circ / 10 = 72^\circ$	$720^\circ / 12 = 60^\circ$
Piecewise number	3	2	5	3	4	5	6

The crankshaft produces a certain angular acceleration when it is propelled and accelerated by each combustion. The time when the crankshaft rotates through the sectional windows is calculated by the engine speed sensor, and the angular acceleration of the cylinders can be calculated in relative sectional periods. The need for fire and oil is self-learning and oil supply self-learning.

### 3.2.2 Adaptive

Manufacturing tolerances, combustion quality fluctuations between cylinders and aging wear of cylinders all affect the calculation of angular acceleration of the segmented window. Therefore, adaptive processes are used to learn and correct these system deviations, which involve different engine speeds and load conditions.

### 3.2.3 Misfire monitoring

When a cylinder is unburned or not fully burned, it takes longer for the corresponding sectional window to pass through the crankshaft position sensor, and

the acceleration of the corresponding sectional window will exceed the matching threshold. The system is diagnosed as misfire.

The scope of the fire monitoring is shown in the following figure. The maximum speed limit of the detection range is 5800 rpm. C, which is 13.33 KPa lower than the zero torque point on the maximum speed line. No detection outside this range.

Misfire supervision area

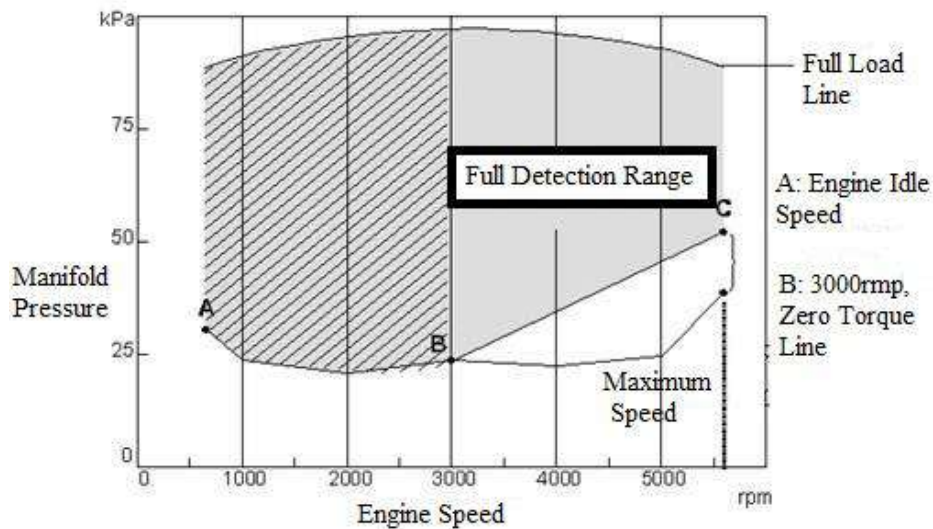

### 3.2.4 Misfire monitoring: three models

All three methods of misfire detection can be used for misfire detection. The three methods overlap to ensure accurate detection of all possible misfires. Three fire monitoring methods are described below.  $t[x]$  represents the sectional window time and  $N$  represents the number of cylinders. The following is an example of a 4-cylinder engine with ignition sequence 1-3-4-2.

The first method (angular acceleration) is used as the calculated value from the current combustion to the next combustion in the ignition sequence.

The misfire detection method is mainly used to detect single random misfire and single cylinder continuous misfire.

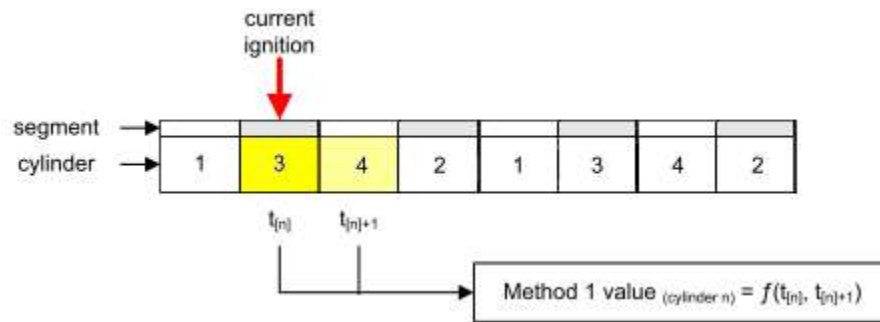

Figure 6: The first method of misfire monitoring

The second method (angular acceleration to calculate the angular acceleration of the current combustion process to the next combustion process)

The misfire detection method is mainly used to detect multi cylinder continuous misfire and single cylinder continuous misfire.

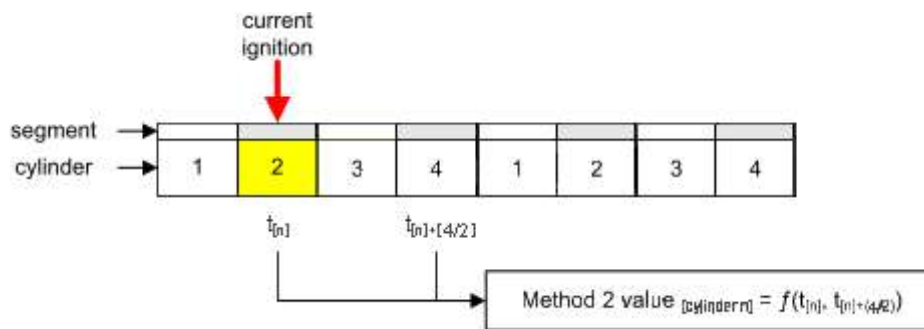

Figure 7: The second method of misfire monitoring

The third method

This method can detect random and continuous misfires, and asymmetric multi-cylinder misfires can also be detected by subtracting 360 crankshaft corners.

Any misfire detection method detects that the angular acceleration is greater than the corresponding misfire threshold value, and then the misfire is diagnosed. All three misfire detection methods have independent misfire detection threshold value.

### 3.2.5 Emissions worsening misfire detection: the first 500 working cycles after engine start

Misfire detection cycle is the first 500 working cycles (crankshaft rotating 1000 revolutions) after engine starting. If the number of misfire detected in the first 500 working cycle exceeds the misfire threshold, the MDnpl error is diagnosed. If the

number of misfire in any one of the cylinders exceeds 10% of the total number of misfire in all cylinders, the cylinder is diagnosed as misfire.

### 3.2.6 Emissions worsening misfire: after the first 500 working cycles after engine start up

Misfire detection cycle is the second 500 working cycles (crankshaft rotating 1000 revolutions) after engine start-up. When the number of misses detected in each 500 working cycle exceeds the misfire threshold, the misfire failure count is added 1. When the number of misses causing emission deterioration is increased four times, the MDmin error is diagnosed. When the number of misfires in all cylinders exceeds 10% of the total number, the cylinder is caught in misfire.

### 3.2.7 Detection of damage and misfire of catalytic converter

Misfire detection cycle is engine 100 working cycles (crankshaft rotation 200 revolutions). According to engine speed and load, detect a misfire, the number of misfire counter plus 1.

The malfunction indicator (MIL) will always flicker when the number of misfires counted in the misfire detection cycle exceeds the calibration threshold, indicating the detection of a malfunction of the damaged catalytic converter. MIL will stop flickering when no malfunction of the damaged catalytic converter is detected during the misfire detection cycle of the damaged catalytic converter (100 working cycles).

The MIL status then depends on the number of MDmax failures counted, extinguishing the MIL only when a failure of the damaged catalytic converter is detected in the current cycle or in the previous cycle, and lighting the MIL lamp when a failure of the damaged catalytic converter is detected in both previous cycles.

3.2.8 Flowcharts

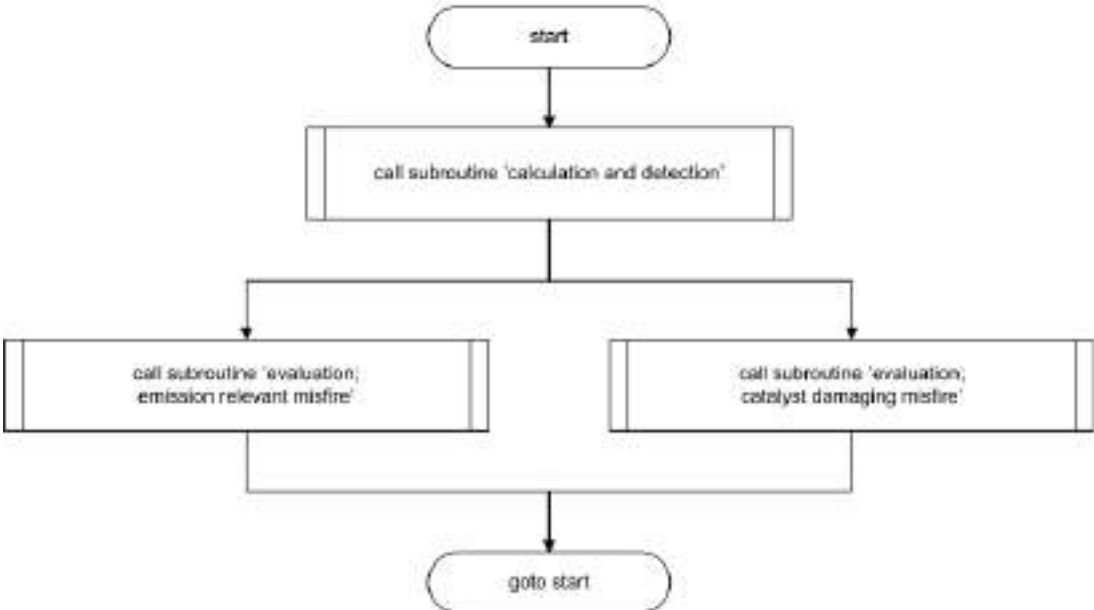

Figure 8: Misfire detection-main flowchart

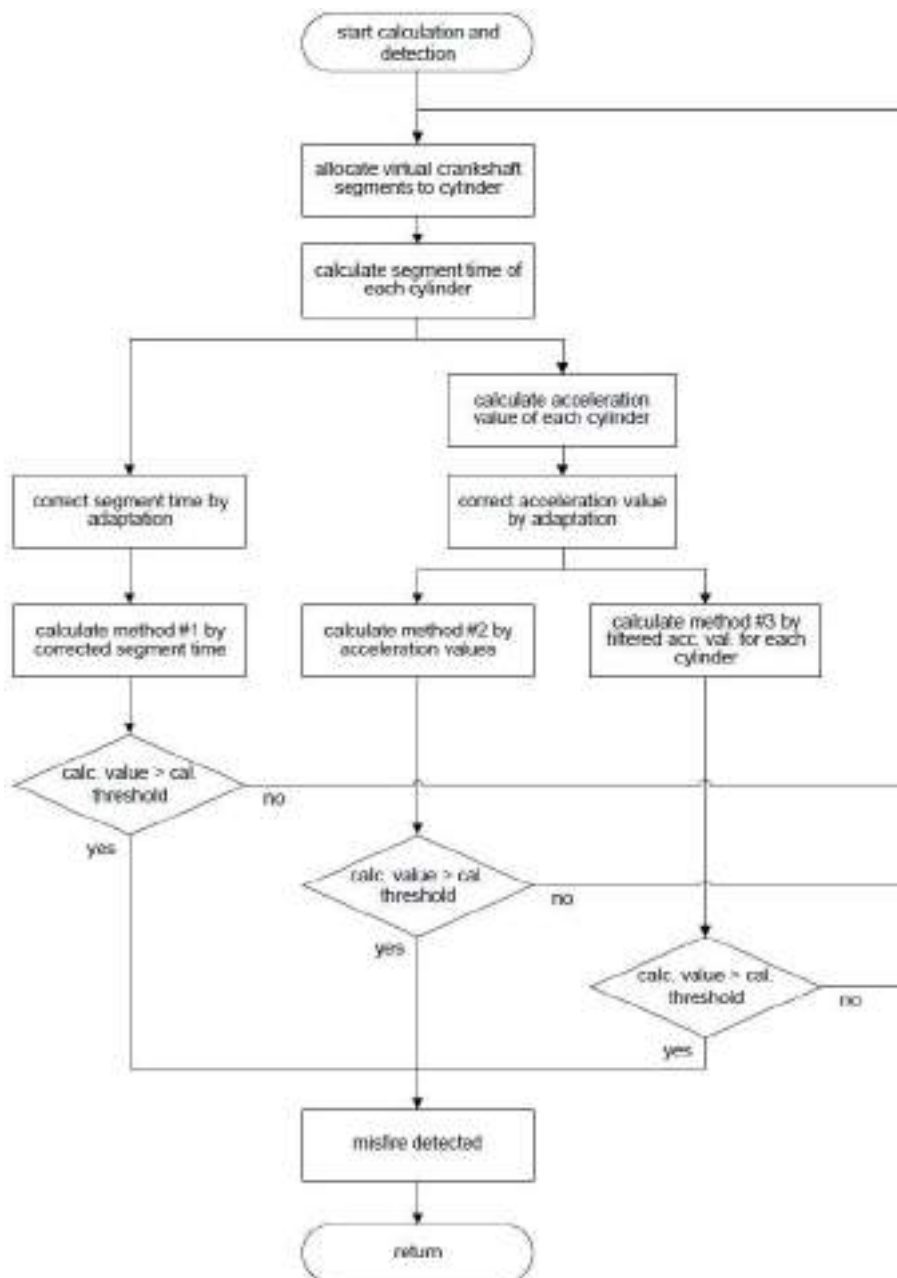

Figure 9: Misfire monitoring - subroutine "calculation and monitoring"



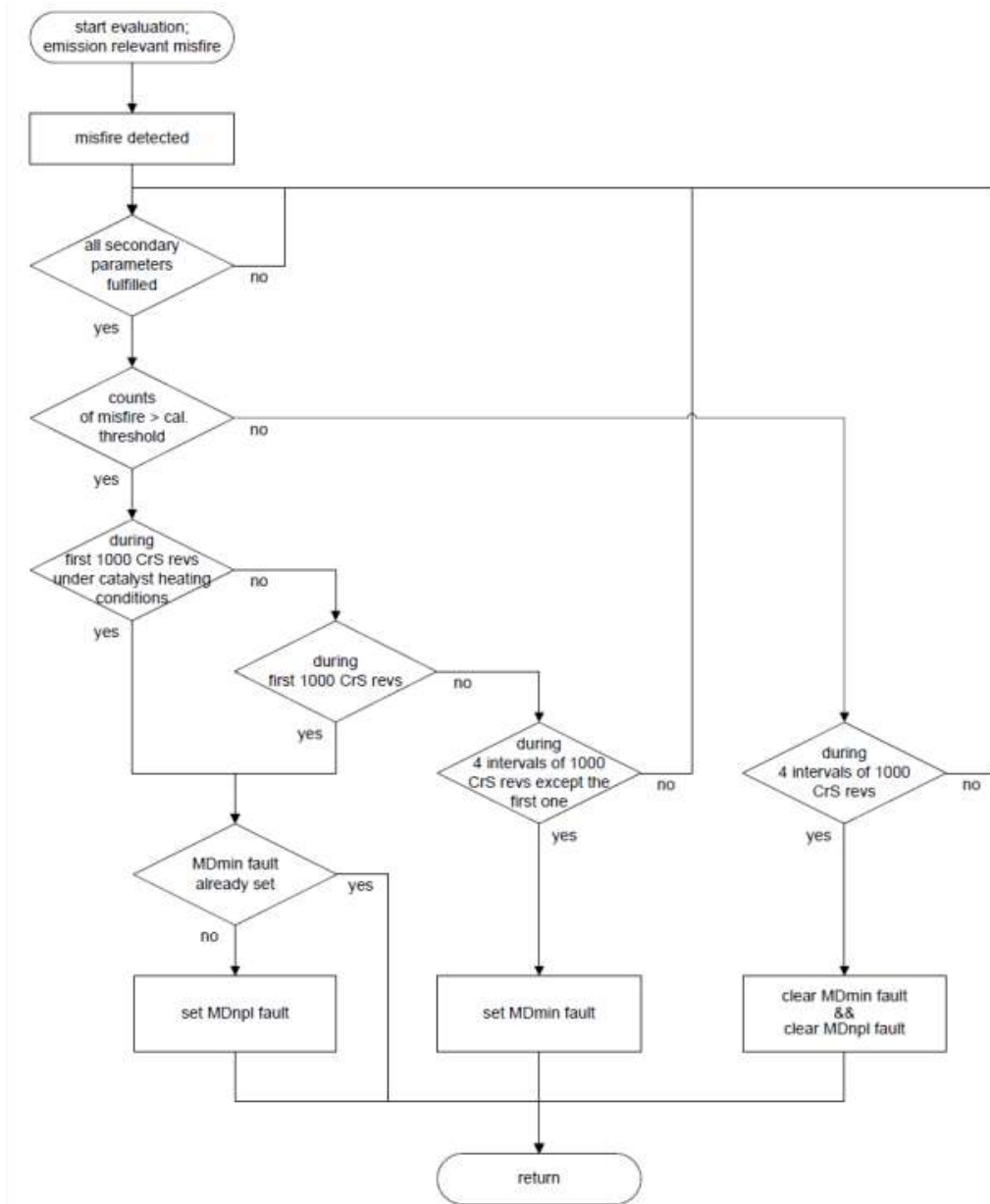

Figure 10: Misfire monitoring --subprogram "emission deterioration misfire monitoring"

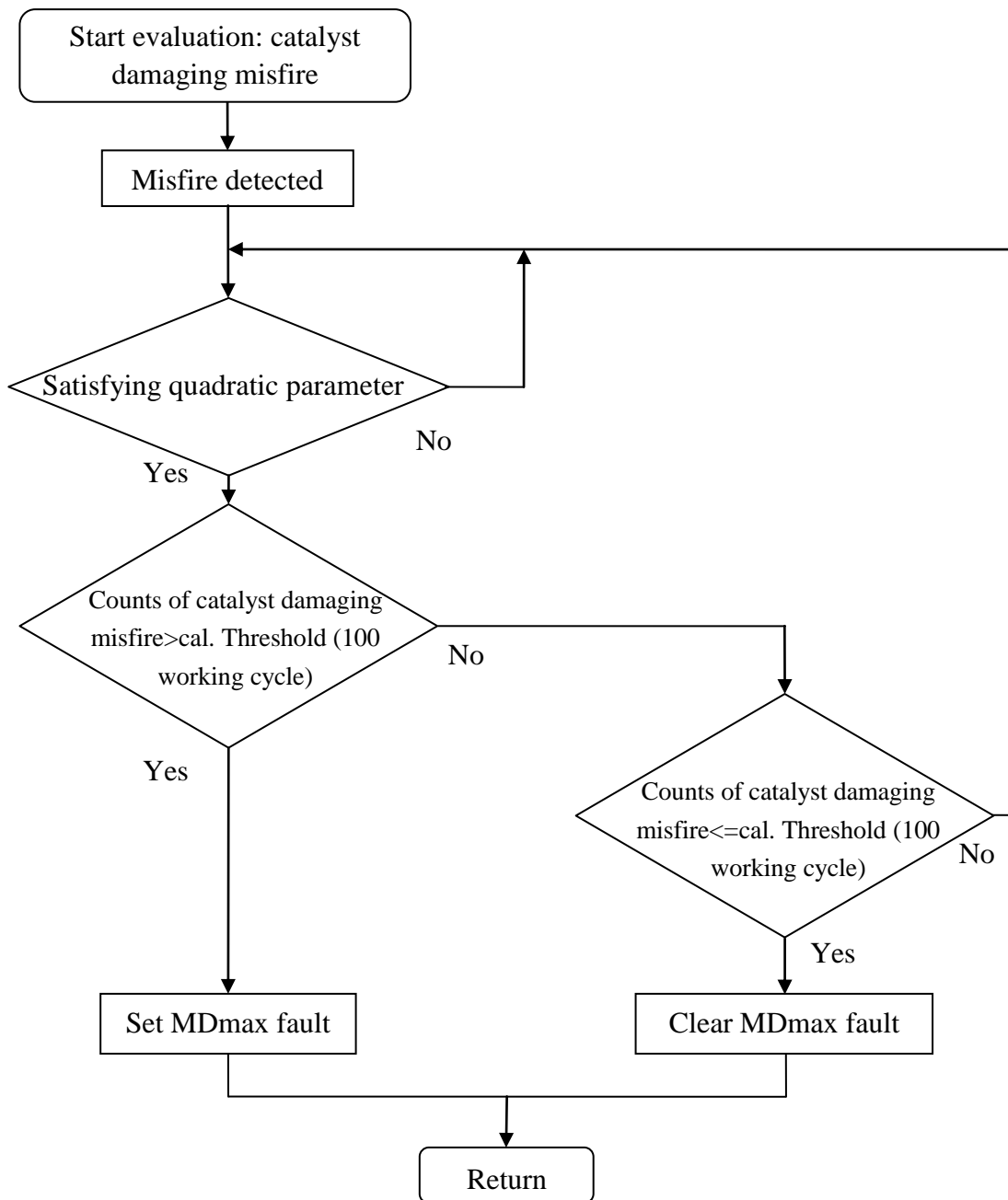

Figure 11: Misfire monitoring - subprogram "damage catalyst monitoring"

### 3.3 Oxygen sensor monitoring

#### 3.3.1 Summary

Oxygen sensors diagnose and monitor the working state of the upstream oxygen sensor and the downstream oxygen sensor, including oxygen sensor circuit diagnosis, heating diagnosis and aging diagnosis.

Oxygen sensor line monitoring (upstream and downstream oxygen sensors)

Oxygen sensor heating monitoring (upstream and downstream oxygen sensors)  
Upstream oxygen sensor response hysteresis, unilateral aging monitoring  
Upstream oxygen sensor response hysteresis and two-sided periodic aging monitoring

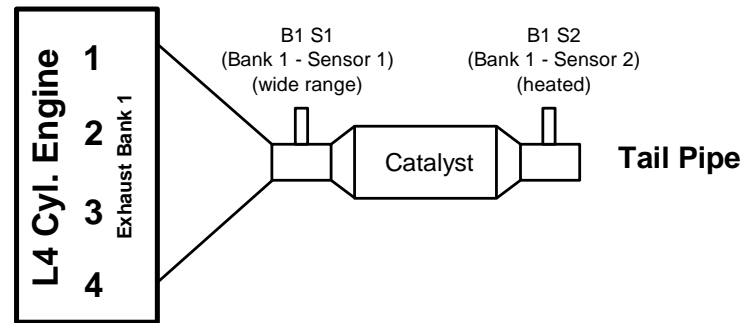

Figure 12: Schematic diagram of oxygen sensor arrangement

### 3.3.2 Oxygen sensor signal monitoring

The internal resistance of the cold oxygen sensor is very large, and the signal voltage of the oxygen sensor is stable in a certain range (not affected by the oxygen concentration of the mixture). With the temperature of the oxygen sensor rising, the internal resistance of the oxygen sensor decreases. Oxygen sensor signal monitoring includes:

High potential of upstream oxygen sensor signal: upstream oxygen sensor signal voltage value exceeds the limit (short circuit for power supply);

Low potential of upstream oxygen sensor signal: the signal voltage of upstream oxygen sensor is lower than the limit (short circuit to ground);

Upstream oxygen sensor signal open circuit: upstream oxygen sensor signal open circuit;

The upstream oxygen sensor signal is unreasonable: the upstream oxygen sensor signal short circuit to the heating signal.

### 3.3.3 Oxygen sensor heating monitoring

Under high temperature exhaust and circuit heating, the internal resistance of oxygen sensor decreases and the temperature rises. If the circuit of the oxygen sensor fails, the internal resistance of the oxygen sensor is greater than the normal value. The heating monitoring of the oxygen sensor includes heating circuit monitoring (only for CJ circuit heating) and oxygen sensor internal resistance monitoring.

Oxygen sensor heating monitoring is suitable for upstream oxygen sensors and downstream oxygen sensors.

#### 3.3.3.1 Oxygen sensor heating circuit monitoring

Heating circuit monitoring includes:

Oxygen sensor heating circuit open circuit: heating circuit open circuit;

Oxygen sensor heating circuit low potential: ground short circuit;

Oxygen sensor heating circuit high potential: short circuit to power supply.

#### 3.3.3.2 Oxygen sensor Nernst internal resistance monitoring

When the heating circuit of the oxygen sensor fails, the Nernst internal resistance of the oxygen sensor is much greater than that of the normal circuit heating. The Nernst internal resistance of the oxygen sensor is determined by the exhaust temperature and the circuit heating, in which the internal resistance characteristic is recorded in a MAP. The exhaust temperature and circuit heating are filtered. When the exhaust temperature and circuit heating fluctuate, the effect of delay on the internal resistance of oxygen sensor is delayed.

When the Nernst internal resistance of oxygen sensor is greater than the normal value, it is diagnosed as a reasonable failure.

### 3.3.4 ATP monitoring

Because the average voltage of oxygen sensor is constant when the dynamic characteristic of concentration-dilution switching of oxygen sensor is deteriorated, it is necessary to diagnose and monitor the concentration-dilution switching characteristic by periodic aging of oxygen sensor.

The cycle time is controlled by the closed-loop control system %LR, and the cycle time calculation is limited to a certain engine speed and load. Even when the engine speed and load enter the cycle aging monitoring window, part of the effective calculation period may be considered invalid. It eliminates interference from aging monitoring.

Compared with the upper limit TSVKO and the lower limit TSVKU, the filter period time  $t_{psvkmf\_w}$  is larger than the upper limit, the maximum error  $B_{mxlatp}$  position. When below the lower limit, the minimum error  $B_{mnlstp}$  position, and the error flag  $E_{latp}$  position. When  $B_{mxlatp}$  or  $B_{mnlstp}$  are reset, the error flag  $E_{latp}$  is also reset. After the cycle aging diagnosis of ANZDPVK, the diagnostic location is completed by  $Z_{latp}$ .

### 3.3.4.1 Atp monitoring flowchart

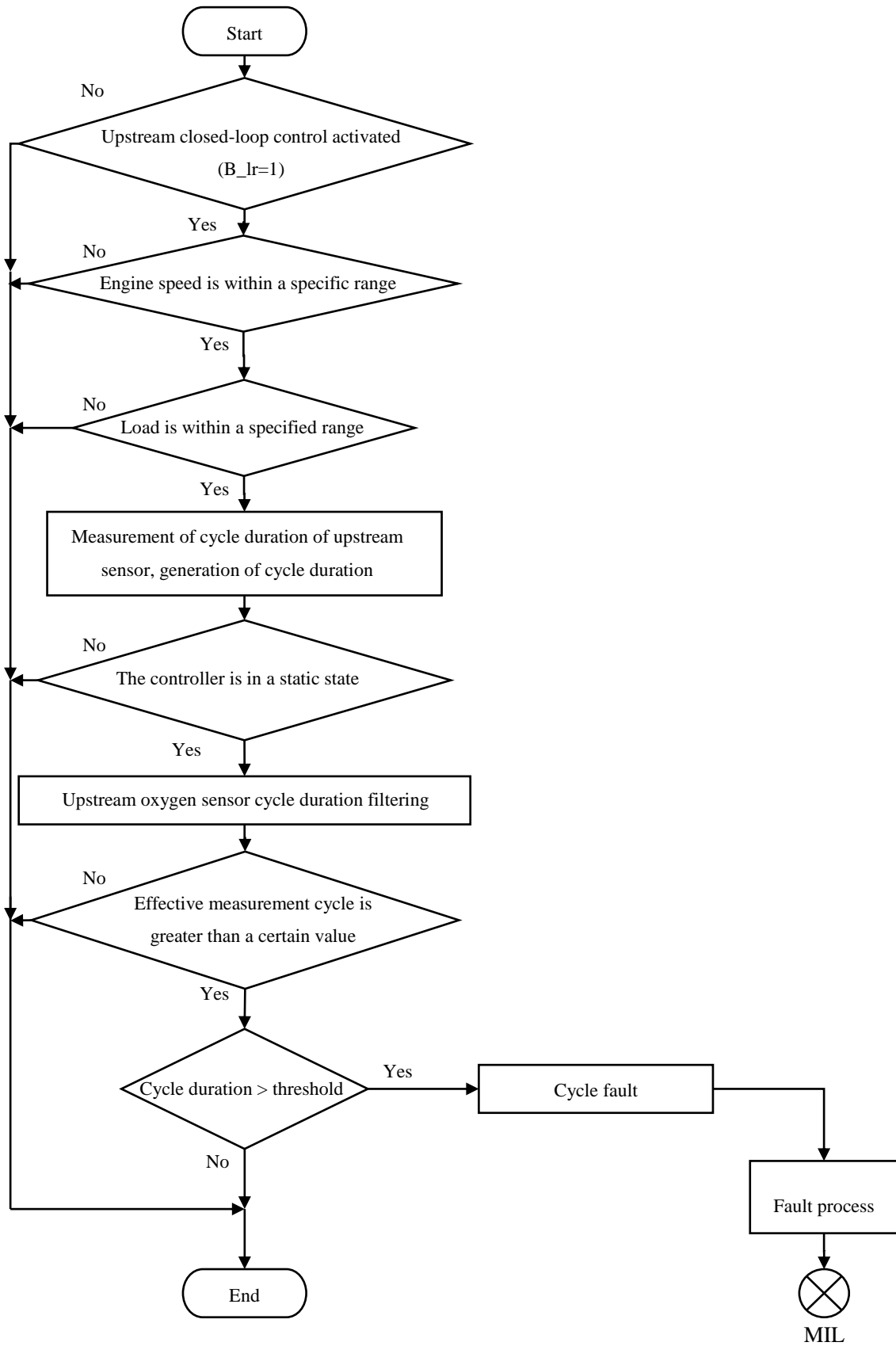

Figure 13: Monitoring process of periodic aging of oxygen sensor

### 3.4 Other parts and components monitored by OBD system

#### 3.4.1 Monitoring of evaporation desorption control system

The circuit continuity of the solenoid in the fuel evaporation system is monitored continuously in this system to ensure the normal operation of the evaporation system. If the error condition is monitored, the error code will be recorded and the error lamp will be lit. As soon as the failure condition is satisfied, the system will turn on the fault lamp and record the activation requirement of the fault code MIL.

#### 3.5 Continuous monitoring of cooling water temperature sensor line

OBD system continuously monitors the water temperature sensor circuit to ensure that the cooling water temperature sensor works properly. If the system detects a fault in the water temperature sensor, the system will work in place of the cooling water temperature, which will have an impact on the emission. If the error is monitored, the error information will be recorded, and the MIL light will be lit to remind the driver.

#### 3.6 Broken line monitoring

When OBD system is monitored, the continuity of all sewage related parts will be monitored to ensure the normal operation of all sewage systems.

## 4 Output and format of OBD Fault Code

OBD fault code output and format reference annex 1:  
SGMW\_CN200S\_1.5T\_MT\_CN5\_EOBD Summary Table\_V00.xls.

## 5 Vehicle OBD information

### 5.1 OBD preprocessing and demonstration cycle description

For details of the diagnostic conditions for the monitored components in the OBD system, see annex 1: See attachment 1: SGMW\_CN200S\_1.5T\_MT\_CN5\_EOBD Summary Table\_V00.xls.

### 5.2 Scanning tool communication protocol

The support protocol is based on ISO15765-4 (CAN).

### 5.3 Misfire rate statement

#### 5.3.1 Rate of misfire of emission deterioration

For vehicles equipped with spark ignition engines, the misfire rate reaches 2.3%, which will cause the emission value of type I test to exceed the OBD limit.

#### 5.3.2 Catalyst damage misfire rate

Exceeding a certain misfire rate may lead to too high catalytic converter temperature, resulting in irreversible damage to the catalytic converter.

Table 2 : Catalyst damage misfire rate

Catalyst damage misfire rate						
Engine speed (rpm) Load (%)	2000	2720	3400	4200	5000	5800
25	23.3%	20.0%	16.9%	12.0%	10.0%	9.0%
35.16	22.2%	14.9%	11.0%	10.0%	8.0%	8.0%
44.92	17.9%	12.0%	10.0%	8.0%	7.0%	7.0%
55.08	13.0%	10.0%	9.0%	8.0%	7.0%	7.0%



64.84	12.0%	9.0%	8.0%	8.0%	7.0%	7.0%
75	12.0%	9.0%	8.0%	7.0%	7.0%	7.0%

#### 5.4 Schema 5 and mode 6 test value definitions

Mode \$5 and mode \$6 output oxygen sensor diagnostic test values online, the required output test ID can indicate the required information, test value definition, test value range and output display format refer to SAE J1979 DA.

The following table defines standard test code, referring to SAE J1850, ISO 9141-2, and ISO 14230-2.

Table 3: Test code definition

Test ID	Test value	Min value	Max value	Description
\$01		0 V	1.275 V	Rich to lean sensor threshold voltage (constant)
\$02		0 V	1.275 V	Lean to rich sensor threshold voltage (constant)
\$03		0 V	1.275 V	Low sensor voltage for switch time calculation (constant)
\$04		0 V	1.275 V	High sensor voltage for switch time calculation (constant)
\$05		0 s	1.02 s	Rich to lean sensor switch time (calculated)
\$06		0 s	1.02 s	Lean to rich sensor switch time (calculated)
\$07		0 V	1.275 V	Minimum sensor voltage for test cycle (calculated)
\$08		0 V	1.275 V	Maximum sensor voltage for test cycle (calculated)
\$09		0 s	10.2 s	Time between sensor transitions (calculated)
\$0A		0 s	10.2 s	Sensor period (calculated)
\$0B				Not applicable for SAE J1850, ISO 9141-2, and 14230-2
\$0C				Not applicable for SAE J1850, ISO 9141-2, and 14230-2
\$0D-\$1F				ISO/SAE reserved
\$21-\$2F		0 s	1.02 s	manufacturer Test ID description

Test ID	Test value	Min value	Max value	Description
\$30-\$3F		0 s	10.2 s	
\$41-\$4F		0 V	1.275 V	
\$50-\$5F		0 V	12.75 V	
\$61-\$6F		0 Hz	25.5 Hz	
\$70-\$7F		0 counts	255 counts	
\$81-\$9F	manufacturer specific values / units			
\$A1-\$BF				
\$C1-\$DF				
\$E1-\$FE				
\$FF				ISO/SAE reserved

The following table defines the test code definition, referring to ISO 15765-4.

Table 4: Test code definition

Test ID	Test value	Min value	Max value	Description
\$1		0 V	7.999 V	Rich to lean sensor threshold voltage (constant)
\$2		0 V	7.999 V	Lean to rich sensor threshold voltage (constant)
\$3		0 V	7.999 V	Low sensor voltage for switch time calculation (constant)
\$4		0 V	7.999 V	High sensor voltage for switch time calculation (constant)
\$5		0 s	65.535 s	Rich to lean sensor switch time (calculated)
\$6		0 s	65.535 s	Lean to rich sensor switch time (calculated)
\$7		0 V	7.999 V	Minimum sensor voltage for test cycle (calculated)
\$8		0 V	7.999 V	Maximum sensor voltage for test cycle

Test ID	Test value	Min value	Max value	Description
				(calculated)
\$9		0 s	65.535 s	Time between sensor transitions (calculated)
\$0A		0 s	65.535 s	Sensor period (calculated)
\$0B		0 counts	65535 counts	EWMA (Exponential Weighted Moving Average) misfire counts for previous driving cycles (calculated, rounded to an integer value)
\$0C		0 counts	65535counts	Misfire counts for last/current driving cycles (calculated, rounded to an integer value)
\$0D-\$7F				Reserved for future standardization
\$80-\$FE				Manufacturer defined Test ID range — This parameter is an identifier for the test performed within the On-Board Diagnostic monitor.
\$FF				ISO/SAE reserved

The following table applies only to ISO 15765-4.

Table 5: Standard monitor ID definition of vehicle Diagnostic system in Mode 6

Monitor ID	On-Board Diagnostic Monitor ID Name
00	OBD Monitor IDs supported (\$01 - \$20)
01	Exhaust Gas Sensor Monitor Bank 1 – Sensor 1
02	Exhaust Gas Sensor Monitor Bank 1 – Sensor 2
03	Exhaust Gas Sensor Monitor Bank 1 – Sensor 3
04	Exhaust Gas Sensor Monitor Bank 1 – Sensor 4
05	Exhaust Gas Sensor Monitor Bank 2 – Sensor 1
06	Exhaust Gas Sensor Monitor Bank 2 – Sensor 2
07	Exhaust Gas Sensor Monitor Bank 2 – Sensor 3
08	Exhaust Gas Sensor Monitor Bank 2 – Sensor 4
09	Exhaust Gas Sensor Monitor Bank 3 – Sensor 1
0A	Exhaust Gas Sensor Monitor Bank 3 – Sensor 2

Monitor ID	On-Board Diagnostic Monitor ID Name
0B	Exhaust Gas Sensor Monitor Bank 3 – Sensor 3
0C	Exhaust Gas Sensor Monitor Bank 3 – Sensor 4
0D	Exhaust Gas Sensor Monitor Bank 4 – Sensor 1
0E	Exhaust Gas Sensor Monitor Bank 4 – Sensor 2
0F	Exhaust Gas Sensor Monitor Bank 4 – Sensor 3
10	Exhaust Gas Sensor Monitor Bank 4 – Sensor 4
11-1F	ISO/SAE reserved
20	OBD Monitor IDs supported (\$21-\$40)
21	Catalyst Monitor Bank 1
22	Catalyst Monitor Bank 2
23	Catalyst Monitor Bank 3
24	Catalyst Monitor Bank 4
25-30	ISO/SAE reserved
31	EGR Monitor Bank 1
32	EGR Monitor Bank 2
33	EGR Monitor Bank 3
34	EGR Monitor Bank 4
35	VVT Monitor Bank 1
36	VVT Monitor Bank 2
37	VVT Monitor Bank 3
38	VVT Monitor Bank 4
39	EVAP Monitor (Cap Off / 0.150")
3A	EVAP Monitor (0.090")
3B	EVAP Monitor (0.040")
3C	EVAP Monitor (0.020")
3D	Purge Flow Monitor
3E-3F	ISO/SAE reserved
40	OBD Monitor IDs supported (\$41 – \$60)

Monitor ID	On-Board Diagnostic Monitor ID Name
41	Exhaust Gas Sensor Heater Monitor Bank 1 – Sensor 1
42	Exhaust Gas Sensor Heater Monitor Bank 1 – Sensor 2
43	Exhaust Gas Sensor Heater Monitor Bank 1 – Sensor 3
44	Exhaust Gas Sensor Heater Monitor Bank 1 – Sensor 4
45	Exhaust Gas Sensor Heater Monitor Bank 2 – Sensor 1
46	Exhaust Gas Sensor Heater Monitor Bank 2 – Sensor 2
47	Exhaust Gas Sensor Heater Monitor Bank 2 – Sensor 3
48	Exhaust Gas Sensor Heater Monitor Bank 2 – Sensor 4
49	Exhaust Gas Sensor Heater Monitor Bank 3 – Sensor 1
4A	Exhaust Gas Sensor Heater Monitor Bank 3 – Sensor 2
4B	Exhaust Gas Sensor Heater Monitor Bank 3 – Sensor 3
4C	Exhaust Gas Sensor Heater Monitor Bank 3 – Sensor 4
4D	Exhaust Gas Sensor Heater Monitor Bank 4 – Sensor 1
4E	Exhaust Gas Sensor Heater Monitor Bank 4 – Sensor 2
4F	Exhaust Gas Sensor Heater Monitor Bank 4 – Sensor 3
50	Exhaust Gas Sensor Heater Monitor Bank 4 – Sensor 4
51-5F	ISO/SAE reserved
60	OBD Monitor IDs supported (\$61 – \$80)
61	Heated Catalyst Monitor Bank 1
62	Heated Catalyst Monitor Bank 2
63	Heated Catalyst Monitor Bank 3
64	Heated Catalyst Monitor Bank 4
65-70	ISO/SAE reserved
71	Secondary Air Monitor 1
72	Secondary Air Monitor 2
73	Secondary Air Monitor 3
74	Secondary Air Monitor 4
75-7F	ISO/SAE reserved

Monitor ID	On-Board Diagnostic Monitor ID Name
80	OBD Monitor IDs supported (\$81 – \$A0)
81	Fuel System Monitor Bank 1
82	Fuel System Monitor Bank 2
83	Fuel System Monitor Bank 3
84	Fuel System Monitor Bank 4
85	Boost Pressure Control Monitor Bank 1
86	Boost Pressure Control Monitor Bank 2
87-8F	ISO/SAE reserved
90	NOx Adsorber Monitor Bank 1
91	NOx Adsorber Monitor Bank 2
92-97	ISO/SAE reserved
98	NOx/SCR Catalyst Monitor Bank 1
99	NOx/SCR Catalyst Monitor Bank 2
9A-9F	ISO/SAE reserved
A0	OBD Monitor IDs supported (\$A1 – \$C0)
A1	Misfire Monitor General Data
A2	Misfire Cylinder 1 Data
A3	Misfire Cylinder 2 Data
A4	Misfire Cylinder 3 Data
A5	Misfire Cylinder 4 Data
A6	Misfire Cylinder 5 Data
A7	Misfire Cylinder 6 Data
A8	Misfire Cylinder 7 Data
A9	Misfire Cylinder 8 Data
AA	Misfire Cylinder 9 Data
AB	Misfire Cylinder 10 Data
AC	Misfire Cylinder 11 Data
AD	Misfire Cylinder 12 Data

Monitor ID	On-Board Diagnostic Monitor ID Name
AE	Misfire Cylinder 13 Data
AF	Misfire Cylinder 14 Data
B0	Misfire Cylinder 15 Data
B1	Misfire Cylinder 16 Data
B2	PM Filter Monitor Bank 1
B3	PM Filter Monitor Bank 2
B4-BF	ISO/SAE reserved
C0	OBD Monitor IDs supported (\$C1 – \$E0)
C1-DF	ISO/SAE reserved
E0	OBD Monitor IDs supported (\$E1 – \$FF)
E1-FF	Vehicle manufacturer defined OBDMIDs

## 6 Diagnostic rate (In-Use Performance Ratio)

### 6.1 General requirements

IUPR is the core part of computing logic in OBD system. The following parts / systems (subsystem A... .F) track and record functional diagnosis status separately and output in standard format.

Three-way catalytic converter

Upstream oxygen sensor

Downstream oxygen sensor

VVT and EGR systems (when required)

Fuel evaporation system (when required)

Secondary air system (when required)

All functional diagnoses recorded by IUPR have a communication interface (functional diagnostic marker) to communicate with IUPR functions. In addition, the IUPR function tracks and records the ignition cycle counter, the general denominator counter for each operation cycle, and determines the minimum diagnostic rate for each function under each subsystem. The IUPR molecular counter and denominator

counter, ignition cycle counter and general denominator counter are also output in the scan tool output mode \$9.

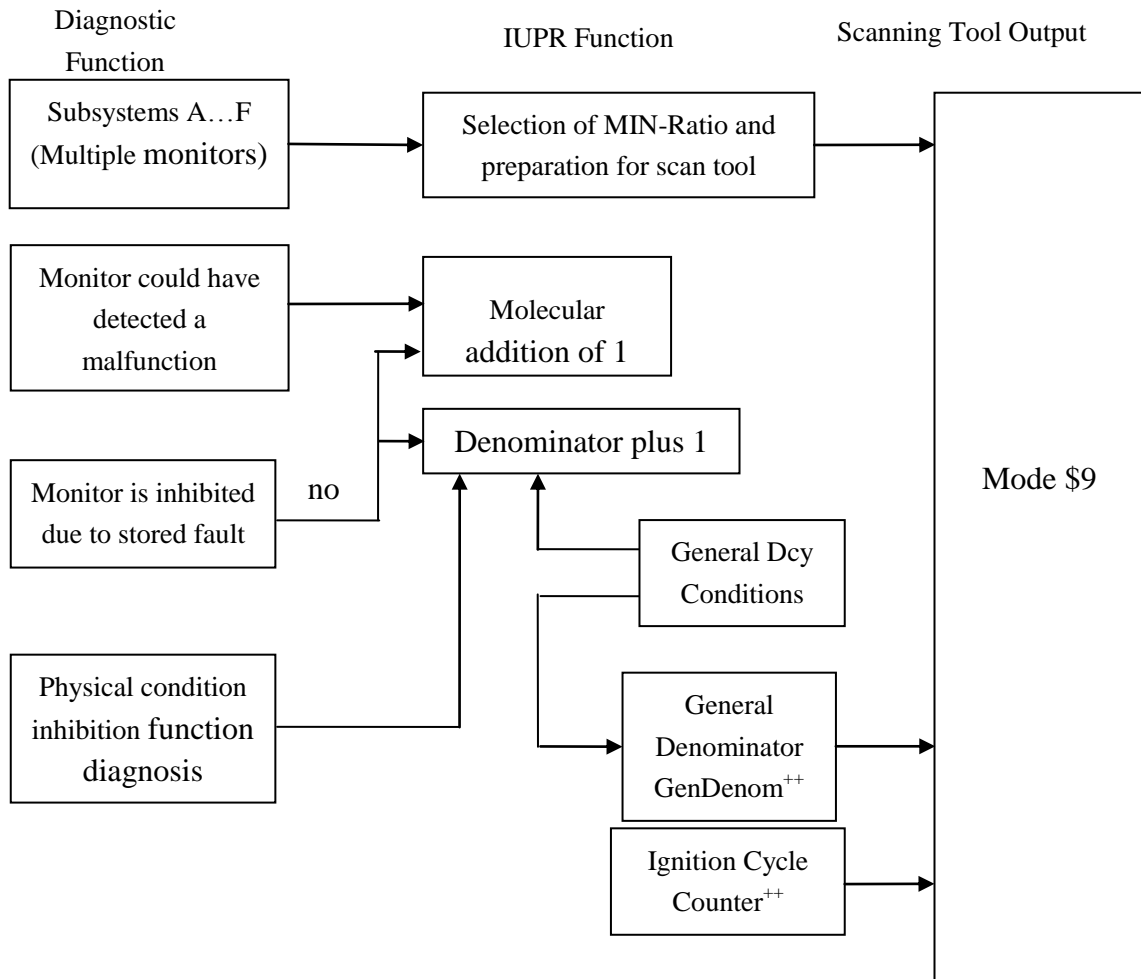

Figure 14: Schematic diagram of diagnostic rate (IUPR) calculation process



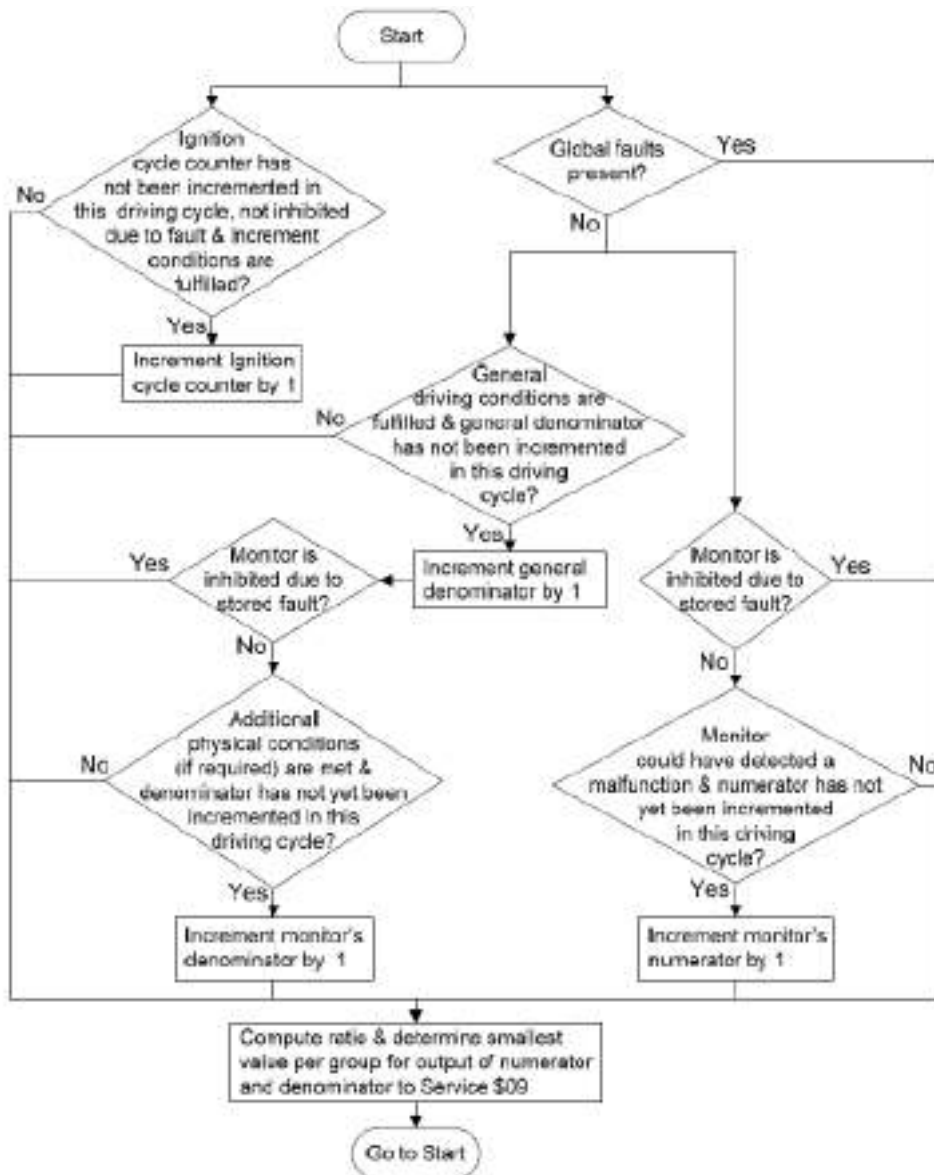

Figure 15: Minimum diagnostic rate flowchart

## 6.2 Ignition cycle counter

In each operation cycle, the ignition cycle counter is increased by an integer of 1 and only once. When the ignition cycle counter is increased to a maximum of 65535, the ignition cycle counter counts from zero in the next operation cycle to avoid data overflow.

Ignition cycle counter plus 1 condition: engine starting conditions 1s~3s, ignition cycle counter within 10 s plus 1.

The engine speed sensor determines the starting conditions of the engine. If the engine speed sensor fails and enters the fault memory, the ignition cycle counter does not increase.

## 6.3 Denominator counter

### 6.3.1 Requirements for general denominator counters

The general denominator counter is used to measure the number of times a car runs. In each cycle, the general denominator counter increases by an integer of 1 and only once. According to the general denominator counter format definition, when the general denominator counter increases to a maximum of 65535, the general denominator counter counts from zero in the next cycle to avoid data overflow.

If and only if all of the following conditions are met, the general denominator counter increases in 10 s:

When the altitude is below 2440 meters, and the ambient temperature is greater than or equal to  $-7^{\circ}\text{C}$ , the cumulative start-up time of the engine is greater than or equal to 600 s.

When the altitude is below 2440 meters, and the ambient temperature is greater than or equal to  $-7^{\circ}\text{C}$ , the cumulative running time of the vehicle at the speed of 40 km/h or above is greater than or equal to 300 s.

When the altitude is below 2440 meters, and the ambient temperature is greater than or equal to  $-7^{\circ}\text{C}$ , the vehicle idling time (acceleration pedal is loosened, speed is not more than 1.6 km/h) is not less than 30 s.

No job interruption conditions are generated for general denominator counters.

### 6.3.2 Special requirements for increasing denominator counters

The denominator counter is used to measure and display the number of vehicle driving events and to take into account the specific monitoring conditions. During the running cycle, the specific monitoring conditions are met and the general denominator

counter is increased according to the regulations. In the absence of the working interruption conditions of the denominator counter, the denominator counter is increased once in the running cycle.

a) When the secondary air system order appears in the "on" state for more than 10 seconds, the secondary air system monitoring denominator counter increases. When the OBD system intervenes in the secondary air system only for monitoring purposes, the operation time is not counted in the "on" state of the order;

b) For a system activated only during cold start, the denominator counter monitored by the system increases when the time of the component or policy command in the "on" state is greater than or equal to 10s;

c) For variable valve timing (VVT) and control systems, the denominator counter for monitoring increases when the command executor opens a certain degree twice (more than 2s each time) or the execution time is greater than or equal to 10s (whichever happens first);

d) When the additional requirements for other monitored denominator counters are not breached, the denominator counters monitored by the following components are increased only during the cold-start operating cycle:

- Engine coolant temperature sensor;
- Clean air (ambient air, intake, pressurized air, intake manifold) temperature sensor;

e) When the following conditions are met, the number of denominator counters monitored by the booster control system increases:

- Meeting the conditions of general denominator counter;
- Turbocharging control system working time greater than or equal to 15s.

#### 6.4 List of OBD parts and system monitoring items

The list of monitoring items for OBD components and systems is shown in Annex 1: SGMW\_CN200S\_1.5T\_MT\_CN5\_EOBD Summary Table\_V00.xls.

## 6.5 Working interrupts of molecular counters, denominator counters and general denominator counters

When a fault is detected, the fault causes the monitoring conditions to be unsatisfactory (the unresolved or determined fault codes are stored), and the OBD system stops the monitoring of the molecular counter and the mother counter to further increase within 10s. The OBD system resumed the increase of the molecular counter and denominator counter in 10s.

The OBD system stops the progress of the specific monitoring molecular counter and the denominator counter within 10s when any component fails and the corresponding unresolved fault code is stored in the monitoring criteria used to determine the specific monitoring denominator counter definition (i.e. speed, ambient temperature, altitude, idle operation, engine cold start or running time, etc.). When a fault is no longer monitored (by self-cleaning or by scanning tools to clear the pending fault code), the OBD system restores the increase of the monitored molecular and denominator counters within 10s.

The OBD system stops the increase of the general denominator counter in 10s when any part of the unit that is used to determine the general denominator counter increase condition (i.e. speed, ambient temperature, altitude, idle running or running time, etc.) fails and stores the corresponding pending fault code. Under any other conditions, the general denominator counter does not stop increasing. When a fault is no longer monitored (by self-cleaning or by scanning tools to clear the pending fault code), the OBD system restores the increase in the general denominator counter within 10s.

## 6.6 Other description

The ignition cycle counter, the molecular counter, the denominator counter and the general denominator counter are increased by an integer of 1, and one operation cycle is increased at most once. The ignition counter and the general denominator counter are counted from zero in the next operation cycle when the maximum value is

65535. When a molecular counter or denominator counter of a monitoring unit or system reaches a maximum value of 65535, the molecular counter and denominator counter are divided by two at the same time and the timing is started. The ignition cycle counter, the molecular counter, the denominator counter and the general denominator counter are stored in Flash.

The tamper proofing of counters is consistent with the preventive and alteration measures of software and data in ECU.

## 7 Measures to prevent damage and change of discharge control computers

In order to prevent changes in software and data in ECU, the following measures are taken for ECU in batch production.

The refresh of ECU requires password, and the password of each item is different. Only if the password is correct, can ECU be refreshed.

The software has CheckSum detection function. When the software detects incorrect CheckSum, the system program will stop running. CheckSum error protection prevents the user's ECU from being refreshed by unauthorized data. CheckSum errors do not occur on a software Department-approved batch and sample status ECU. Occurs only when samples ECU is not recognized by the software department or refreshed by unauthorized tampering with ECU.

## 8 OBD system defect description

Defects and specific description	No	Defect period	No
----------------------------------	----	---------------	----

## 9 OBD function monitoring fault simulator

### 9.1 Engine misfire generator



Schematic diagram of misfire generator

Table 6: Misfire generator

Name	Type	Manufacturer
Misfire generator	Operating unit : Y280 V00 078 Output power stage:Y280 V01 078	Robert Bosch Gmbh
Misfire Generator	MiF-A8-002	Huijing Electronic Technology (Shanghai) Co., Ltd. Shining View
MISGEN3 Ignition coil without drive	Pendant: Part# GEL1110010.A Coil Connection Box: Part# GEL1110020.A	Global Electronics
MISGEN3 Ignition coil with drive	Pendant: Part# GEL1110040 Coil Connection Box: Part# GEL1110050	Global Electronics

## 9.2 Oxygen sensor fault simulator

Table 7: Oxygen sensor fault simulator

Name	Type	Manufacturer
LSF fault simulator	0281YH0039	Robert Bosch GmbH



## 9.3 Cracking catalyst samples

1) 160000KM aging catalyst was obtained by catalytic converter supplier aging 150 hours according to GM875 standard;

2) EOBD limited catalysts are aged by the catalytic converter supplier according to the actual emission results and referring to GB18352.5-2013 five-stage OBD emission limits.

Schematic diagram of cracking catalyst sample



## 10 Diagnostic interface communication mode

The communication mode supported by ECU is ISO standard ISO 14230: through KW2000 scan tool communication.