

*Before you Drive* 1

*Driving Controls* 2

*Audio System* 3

*Maintenance* 4

*Emergency Information* 5

*Technical Data* 6

## Introduction

### THE OWNER'S HANDBOOK

This handbook describes all of the MG Rover models and standard equipment specifications within the model range. Some of the information, therefore, may not apply to your particular car.

For your convenience, the handbook is divided into subject or activity-based sections. These are listed on the previous page and are mostly self-explanatory. However, if you experience difficulty in locating a specific item or piece of information, you should consult the alphabetical index near the back of the book.

You should also be aware that the final (Service History) section of this handbook is, in effect, a separate publication, which enables a record to be kept of the routine services and inspections carried out on the car. This section also provides a facility for the dealer to record brake fluid and coolant changes, and the fitting of any major replacement components needed during the life of the car.

Finally, always remember that if you have any queries, concerning the operation or specification of your car, your MG Rover dealer will be glad to advise you.

© MG Rover Group Limited 2003

All rights reserved. No part of this publication may be reproduced, stored in a retrieval system or transmitted in any form, electronic, mechanical, recording or other means without prior written permission from MG Rover Group Limited.

Publication Part No. RCL 0547LAN  
English Export 02/2003

As part of the MG Rover Group environmental policy, this publication is printed on paper made from chlorine free pulp.

### SYMBOLS USED

The following symbols used within the handbook call your attention to specific types of information.

 ***This warning symbol identifies procedures that must be followed precisely, or information that must be considered with great care, in order to reduce the risk of personal injury or serious damage to the car.***

 ***This recycling symbol identifies those items that must be disposed of safely in order to prevent unnecessary damage to the environment.***

 ***This symbol identifies those features that can be adjusted or disabled/enabled by an MG Rover dealer***

\* An asterisk appearing within the text, identifies features or items of equipment that are either optional, or are only fitted to some vehicles in the model range.

### STATUS AT TIME OF PRINTING

MG Rover operate a policy of constant product improvement and therefore reserve the right to change specifications without notice at any time. Whilst every effort is made to ensure complete accuracy of the information in this handbook, no liabilities for inaccuracies or the consequences thereof, including loss or damage to property, or injury to persons, can be accepted by the manufacturer or the dealer who supplied the handbook, except in respect of personal injury caused by the negligence of the manufacturer or dealer.

## Introduction

### SECURITY CARD

The security card contains important emergency information. It is ESSENTIAL that you keep the card safe from theft and ensure that it is passed to the new owner if you sell the car.

- **VIN (Vehicle Identification Number):** This number is unique to your vehicle and is essential proof of its specification. The number can also be found in various locations around the vehicle (see 'IDENTIFICATION NUMBERS', page 151).
- **Key number:** This is the number of the starter/door key – essential if you ever need to obtain a replacement.
- **Emergency key access code:** This unique code is essential in order to start the car if the handset has been lost or damaged.
- **Locking wheel nut number:** If your vehicle has locking wheel nuts, you will have been provided with a special wheel nut adaptor to remove them. Quote this number if a replacement adaptor is required.
- **Radio serial number:** This unique number is stamped into the case of the audio unit, and is proof of the unit's specification and your ownership in the event of theft.
- **Radio security code number:** This unique code must be entered into the radio whenever the power supply has been disconnected. Without this code, the radio unit will not operate.

 **Never leave the security card inside the car when it is left unattended. Keep the card on your person in case of emergencies.**

### IN AN EMERGENCY

#### IMPORTANT

##### Remember the breakdown safety code

If a breakdown occurs while travelling:

- Wherever possible, consistent with road safety and traffic conditions, the car should be moved off the main thoroughfare, preferably into a lay-by. If a breakdown occurs on a motorway, pull well over to the inside of the hard shoulder.
- Switch on hazard lights.
- If possible, position a warning triangle or a flashing amber light at an appropriate distance from the vehicle to warn other traffic of the breakdown, (note the legal requirements of some countries).
- Consider evacuating passengers through nearside doors onto the verge as a precaution in case your vehicle is accidentally struck by other traffic.

#### IMPORTANT

When the time comes to sell your car, please remember to pass this handbook and the Security Card to the new owner. Both must be considered part of the car and essential to its operation.



---

## *Before you Drive*

---

1

- 6 Controls*
  - 7 Locks & Alarm*
  - 16 Seats*
  - 19 Seat Belts*
  - 24 Child Restraints*
  - 26 Airbag SRS*
  - 31 Steering Column*
  - 32 Mirrors*
  - 34 Windows*
  - 36 Sunroof*
  - 38 Heating & Ventilation*
  - 45 Interior Equipment*
  - 51 In-Car Telephones*
  - 52 Load Carrying*
  - 58 Towing*
-

## Controls

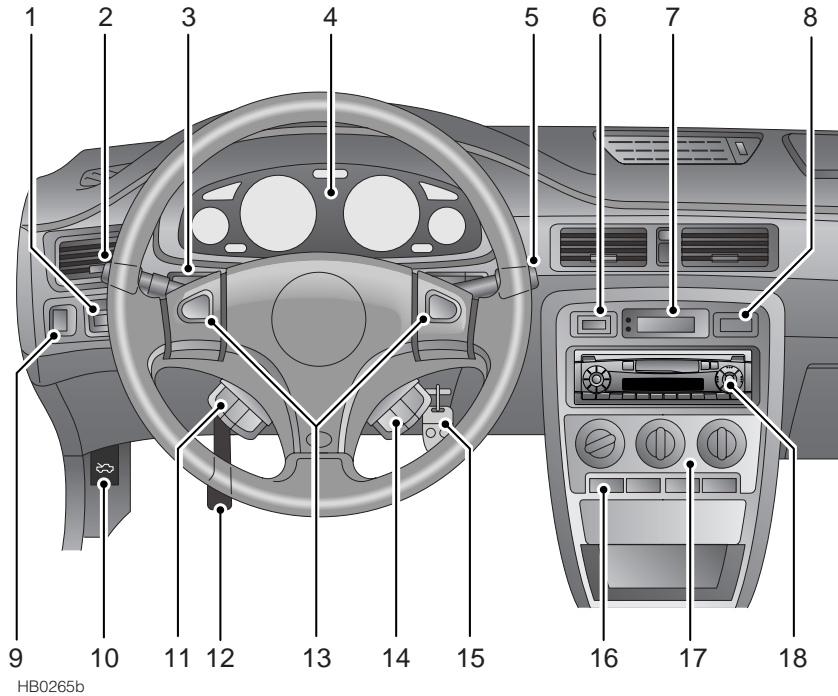

1. Exterior mirror controls
2. Lighting and direction indicators controls
3. Fog light switches
4. Instrument panel
5. Wiper/washer controls
6. Hazard warning light switch
7. Clock/audio system display
8. Rear screen demister switch
9. Headlight beam height control
10. Bonnet release
11. Remote audio controls\*
12. Steering column adjustment lever
13. Horn switches
14. Cruise control switches\*
15. Starter switch
16. Air conditioning switch\*
17. Heating and ventilation controls
18. Audio system\*

## Locks & Alarm

### KEYS AND HANDSETS

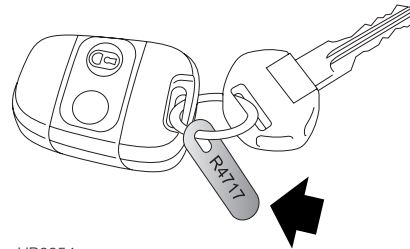

HB0054

You have been supplied with two remote handsets and a pair of identical keys.

The key number is stamped on a tag (arrowed in illustration) attached to the key ring. Check that the key number has been entered in the space provided on your Security Information card.

If the key or handset is lost, contact an MG Rover dealer, who can supply replacement or additional keys and handsets.

**⚠ Keep the Security Information card, key tag, spare key and handset in a safe place - NOT IN THE CAR!**

### ALARM SYSTEM

Your car is fitted with a sophisticated electronic anti-theft alarm and engine immobilisation system, which conforms to "The British Industry's Criteria For Vehicle Security". In order to ensure maximum security and operating convenience, you are strongly advised to gain a full understanding of the alarm system, by thoroughly reading this section of the handbook.

### LOCKING THE CAR AND ARMING THE ALARM Using the remote handset

1

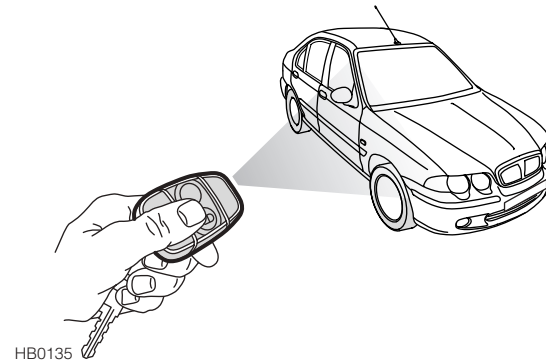

HB0135

The handset has two buttons which, when pressed, send a coded radio signal to a receiver in the car. The 'padlock' symbol button activates the alarm and a plain button deactivates the alarm. On models with central door locking the 'padlock' symbol will also lock the car and the plain button will unlock the car.

While it is not necessary to point the handset at the car, the handset must be within range when the buttons are pressed. Note that the operating range may vary depending upon handset battery condition and may sometimes be limited by physical and geographical factors beyond your control.

## Locks & Alarm

---

### Locking

#### *Locking with the remote handset:*

1. Shut the doors, bonnet and luggage compartment.
2. Press the lock (padlock symbol) button once:
  - all doors are locked
  - perimeter alarm activated (protects the doors, bonnet and boot)
  - engine immobilisation activated
  - interior space protection activated★
3. The direction indicator lights flash three times to confirm that the car is securely locked and the anti-theft alarm indicator light (in the instrument panel) starts to flash. If the direction indicator lights fail to flash, this indicates a mislock (see 'Mislock', page 9).

#### *Locking with the key:*

1. Insert the key and turn the door lock towards the front of the car:
  - all doors locked
  - perimeter alarm activated (protects the doors, bonnet and boot)
  - engine immobilisation activated
  - NO INTERIOR SPACE PROTECTION
2. The direction indicator lights flash three times to confirm that the car is securely locked and the anti-theft alarm indicator light (in the instrument panel) starts to flash. If the direction indicator lights fail to flash, this indicates a mislock (see 'Mislock', page 9).

<p><b>FOR MAXIMUM SECURITY, ALWAYS USE THE HANDSET TO LOCK AND UNLOCK THE CAR</b></p>
---

(except when interior space protection is provided and the car is to be locked with passengers or animals inside, or with a window or sunroof open, in which case the car should be locked using the key.

#### *Unlocking with the remote handset:*

- Press the unlock (plain) button once. This will disarm the alarm, unlock the doors and re-mobilise the engine. If the handset fails to unlock the car, use the key and resynchronise the handset (see 'Handset re-synchronisation', page 15).

#### *Unlocking with the key:*

- Turn the key in the driver's door lock towards the rear of the car to disarm the alarm and unlock the doors.

**NOTE:** *If the remote central door locking/unlocking fails to operate, check the fuse (number 6) located in the main fuse box and replace if necessary. If the fuse has blown, the central door locking can still be operated manually by using the key in the driver's door and the engine can be remobilised by pressing the unlock button on the handset.*



## Locks & Alarm

---

### **Mislock**

If the direction indicator lights fail to flash three times when the alarm is armed, this indicates that a door or other aperture is not fully closed, in which case the alarm system will still be armed and the engine immobilised, but interior space protection\* will not have been activated. Once the open door or aperture is closed, the direction indicators will flash three times to confirm that the alarm system has rearmed.

If the direction indicators still fail to flash, even though all door, luggage compartment and bonnet apertures are closed, this indicates a fault with the alarm system and you should contact your dealer.

Once armed, the alarm will sound if the taildoor, bonnet or any door is opened.

### **Anti-theft alarm indicator light**

After locking, the RED indicator light on the instrument panel flashes rapidly while the alarm system is arming itself.

After 10 seconds, the indicator light adjusts to a slower frequency, and continues flashing as an anti-theft deterrent until such time as the alarm is disarmed.

### **If the alarm is triggered**

The alarm, once activated, will be triggered by any one of the following actions:

- Operation of the starter switch.
- Activation of the driver or passenger door switches (on opening).
- Opening of the tailgate/boot.
- Opening of the bonnet.
- Triggering of the volumetric sensor\* (interior space protection).

If the alarm is triggered, the horn will sound for 30 seconds, followed by a period of 15 seconds silence. This will be repeated for 10 cycles or until the alarm is switched off or reset.

Once the 10 cycles are completed, the alarm will need to be reset before the detectors can trigger the alarm for a further 10 cycles.

To silence the alarm, press either button on the handset, or unlock/lock the driver's door using the key.

## Locks & Alarm

### Interior space protection\*

**!** *Never activate interior space protection if passengers or animals are to be left inside the car - any movement will activate the alarm.*

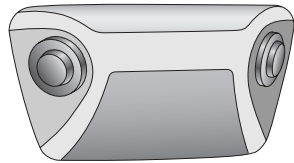

HB0052

On cars fitted with interior space protection, twin sensors situated at the top of the right hand door pillar, monitor the interior space and activate the alarm if an intrusion into the passenger compartment is detected (entry gained through a window or sunroof, for example). Interior space protection is only activated when the alarm is armed using the handset.

### Door sill locking buttons

Each door can be locked from inside the car by pushing down the locking button on the door sill.

**NOTE:** *When the driver's door locking button is operated, the central locking system operates all door locks together.*

### CHILD-PROOF DOOR LOCKS

**!** *NEVER leave children unsupervised in the vehicle.*

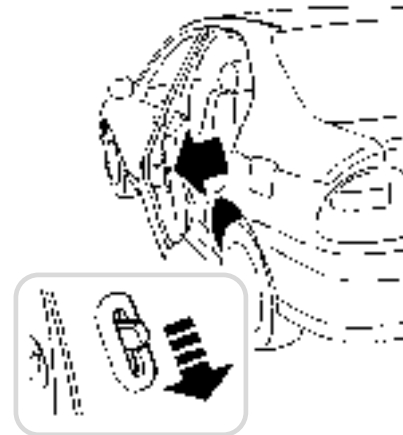

HB0136

Move the locking levers on the rear doors down to engage the child locks.

With the child-proof locks engaged, the rear doors cannot be opened from inside the car, thereby avoiding the risk of a door being opened accidentally while the car is moving.

## Locks & Alarm

### GLOVEBOX LOCK

**!** *DO NOT drive with the glove box open. An open glovebox could cause injury to a front seat passenger in the event of a collision.*

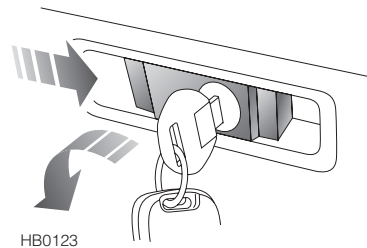

Turn the key anti-clockwise to unlock the glovebox. Squeeze the catch to the left of the lock to open (see illustration).

To lock the glovebox, turn the key clockwise.

### LUGGAGE COMPARTMENT

**!** *Do not drive with the luggage compartment open as poisonous exhaust gases will enter the car.*

1

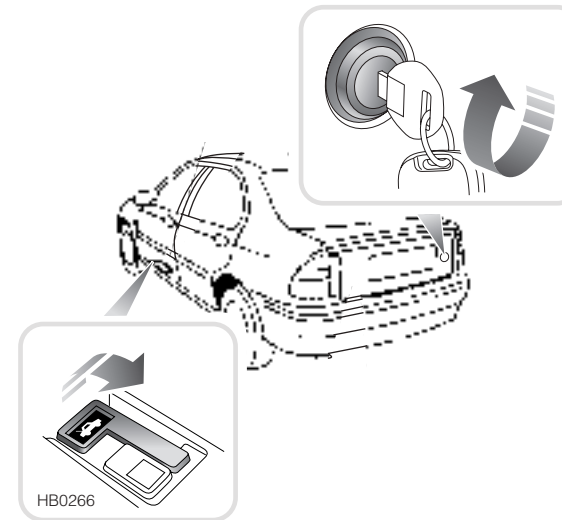

To open, use the key in the lock or, from inside the car, lift the release lever adjacent to the driver's seat. The luggage compartment light switches on automatically when the taildoor (or boot lid) is opened.

The luggage compartment is automatically locked when the taildoor (or boot lid) is closed.

## Locks & Alarm

---

For convenience, with the alarm system armed, the luggage compartment can be unlocked and opened USING THE KEY without activating the alarm (the rest of the car will remain protected and the engine immobilised during this process). The alarm will automatically rearm as soon as the luggage compartment is closed.

### ENGINE IMMOBILISATION

Engine immobilisation is an important aspect of the car's security system, that occurs automatically whenever the alarm is armed.

The system also includes a feature known as passive immobilisation, whereby the engine immobilises automatically thirty seconds after the starter switch has been turned off and the driver's door opened and closed. Passive immobilisation is indicated by a steady flashing of the anti-theft alarm indicator light.

The engine is re-mobilised by a signal transmitted from the handset to the starter switch. This occurs automatically whenever the key is inserted into the starter switch and turned to position II, provided the handset is in close proximity to the switch.

For this reason, it is important to keep the handset on the same ring as the starter key. If the handset has become detached, the re-mobilisation signal can only be transmitted by pressing the handset button.

IMPORTANT
<ol style="list-style-type: none"><li>1. The engine will re mobilise itself automatically whenever the starter switch is turned on, provided the key and handset are on the same keyring.</li><li>2. The engine can also be re-mobilised by pressing the handset buttons.</li><li>3. Automatic re-mobilisation will not occur if BOTH handsets are kept on the same keyring.</li></ol>



### Warning bleep

If the starter switch is turned and the engine fails to re-mobilise, a warning beeper will sound. To re-mobilise the engine, press the plain button on the remote handset.

If the handset is lost or damaged, use the door key to enter the Emergency Key Access Code.

## Locks & Alarm

### ENGINE IMMOBILISATION OVERRIDE (Emergency key access code)

If the handset is lost or fails to operate, the engine can be remobilised by using the starter key in the driver's door lock to enter the numerical values of the four digit emergency key access code (recorded on the Security Card).

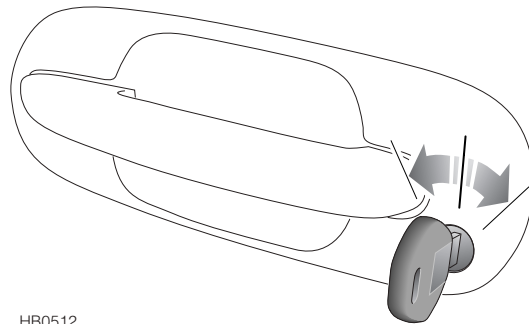

HB0512

With the starter switch turned off and the driver's door locked, enter the code as follows:

1. Insert key into driver's door lock and to enter the **FIRST** digit of the code, turn the key (anti-clockwise) to the **UNLOCK** position the number of times indicated by the first digit of the code. For example, if the first digit is 4, turn the key 4 times.

Ensure the key is **FULLY** returned to the centre position after each turn of the key.

2. Turn the key clockwise to the **LOCK** position the number of times indicated by the second digit of the code. Remember, the key must be **FULLY** returned to the centre position after each turn of the key.

3. Turn the key to the **UNLOCK** position the number of times indicated by the third digit of the code, returning the key to the centre position each time.

4. Turn the key to the **LOCK** position the number of times indicated by the fourth digit of the code, returning the key to the centre position each time.

#### IMPORTANT

Each turn of the key must be undertaken with care and precision. Ensure the key turns through the **FULL** extent of its travel and is **FULLY** returned to the centre position after each turn.

1

## Locks & Alarm

---

**If the correct code has been entered:** the alarm indicator light on the instrument panel will stop flashing and illuminate for 1 second. A 5 minute time delay will commence, during which the engine will remain immobilised.

DO NOT lock or unlock the doors using the remote handset or key during the 5 minute delay. If this occurs, the emergency key access code will need to be re-entered. If the car needs to be secured, use the door sill locking buttons to lock the doors, ensuring that the remote handset or key is not left inside the car.

During the 5 minute delay, the starter key may be turned to positions 'I' or 'II' and the relevant electrical systems can be operated (in starter position 'II' the immobilisation warning buzzer will sound).

After the 5 minute time delay elapses, a period of 10 minutes commences, during which the engine must be started. Failure to start the engine during this period, will result in the engine re-immobilising and therefore, the emergency key access code will need to be re-entered, followed by the 5 minute delay, before the engine can be started.

**If an incorrect code has been entered:** a warning bleep will sound when the key is turned to the final unlocked position. In this case, open and close the driver's door (this will cancel the error), and enter the code again.

After three incorrect entries, a ten minute delay period is invoked during which the security system will not accept any further attempts to enter a code.

IMPORTANT
<ul style="list-style-type: none"><li>• NEVER leave the Security Card in the car.</li><li>• Memorise the key access code or keep the Security Card on your person in case of emergencies (a damaged handset for example).</li></ul>

## Locks & Alarm

### REMOTE HANDSET

**!** *The handset contains delicate electronic circuits and must be protected from impact and water damage, high temperatures and humidity, direct sunlight and the effects of solvents, waxes and abrasive cleaners.*

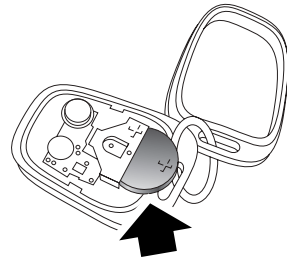

HB0053

The handset battery should last for approximately three years dependent upon use. When the battery needs replacing it will be apparent from the following symptoms:

- A gradual deterioration in range and performance.
- Each time the handset lock button is operated the indicator light on the instrument panel will flash rapidly for 45 seconds.

It is recommended that you fit an MG Rover YWK 10003 or a Panasonic CR2032 replacement battery.

### Battery replacement

1. Carefully prise the handset apart, start from the keyring end using a small coin or screwdriver. Avoid damaging the seal between the two halves of the case and **DO NOT** allow dirt or moisture to get inside the handset.
2. Slide the battery out of its clip, taking care to avoid touching the circuit board or the contact surfaces of the clip.
3. Press and hold each button in turn for at least five seconds (this will drain any residual power from the handset).
4. Fit the new battery, ensuring that correct polarity is maintained ('+' side facing up). Finger marks will adversely affect battery life; if possible, avoid touching the flat surfaces of the battery and always wipe the battery clean before fitting.
5. Press the two halves of the handset firmly together, ensuring that both halves are joined fully and will prevent dirt or moisture from entering the handset.
6. Unlock the car using the key, then operate the handset lock button at least four times to re-synchronise the handset to the car.

The handset is now ready for use.

### Handset re-synchronisation

If the handset fails to arm or disarm the alarm, this may be because the coded signal transmitted by the handset, is no longer synchronised with the receiver unit in the starter switch.

To re-synchronise the handset, hold the handset in close proximity to the car and operate either handset button at least four times in quick succession.

1

## Seats

### CORRECT SEATING POSITION

**⚠** *To avoid the risk of loss of control and personal injury, DO NOT adjust the seats while the car is moving.*

The driver and front passenger seats should be positioned as far rearward as practical. Ideally the seat should be positioned so that the steering wheel can be held with the arms slightly bent and the seat back in a nearly upright position.

**⚠** *DO NOT allow front seat occupants to travel with the seat backs reclined steeply rearwards. Optimum benefit is obtained from the seat belt with the backrest angle set to approximately 25° from the upright (vertical).*

Head restraints are designed to restrain rearward movement of the head in the event of an accident or sudden stop - a properly adjusted head restraint can considerably reduce the risk of neck and head injuries.

Make sure your driving position is comfortable and enables you to maintain full control of the vehicle. A properly adjusted seat helps reduce the risk of injury from sitting too close to an inflating airbag.

### HEAD RESTRAINTS

**⚠** *Adjust the head restraint so that the cushion is level with the back of the head - NOT THE NECK!*

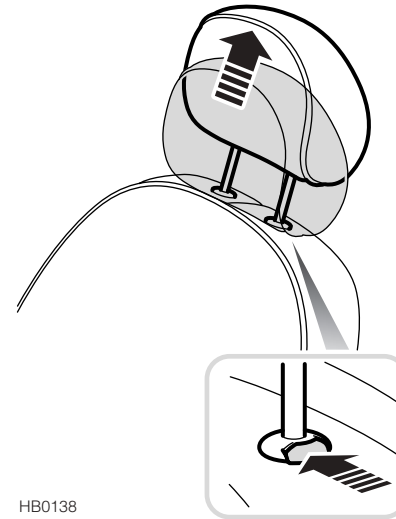

HB0138

*Front seat head restraint shown, rear seat similar.*

Lift or push down on the padded cushion, to adjust the height of the restraint, so that the padded cushion is level with the back of the head.

Depress the button (arrowed in illustration) to raise or lower the head restraint, and also to remove.



## Seats

### FRONT SEAT ADJUSTMENT

**!** *Your car may be fitted with side impact airbags. If so, refer to the Airbag SRS section of this handbook before fitting seat covers, or carrying out any repair or retrimming operations to the seat or seat covers.*

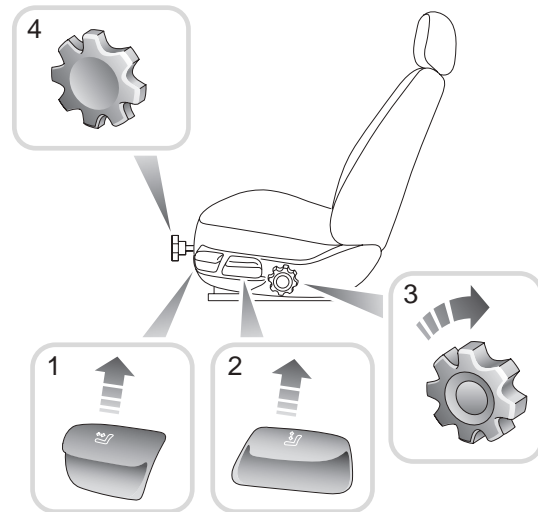

HB0267

#### 1. Forward/rearward adjustment

Lift the lever to slide the seat forward or back. Ensure that the seat is locked in position before driving.

#### 2. Height adjustment\*

Ensure the seat is occupied before adjusting the height. Lift the lever and apply weight to lower the seat rearwards, or allow the seat to rise forwards as required.

**NOTE:** *While adjusting the height of the driver's seat, grip the steering wheel to more accurately control the rate of rise or fall.*

**!** *Take care when adjusting the height of the front seats - a rear passenger's feet might become trapped when lowering the seat rearwards.*

#### 3. Backrest adjustment

Rotate the handwheel to adjust the backrest to the required angle.

#### 4. Lumbar support adjustment\*

Rotate the handwheel to increase or decrease support to the lumbar region of the back.

1

## Seats

---

### REAR SEAT ARMREST\*

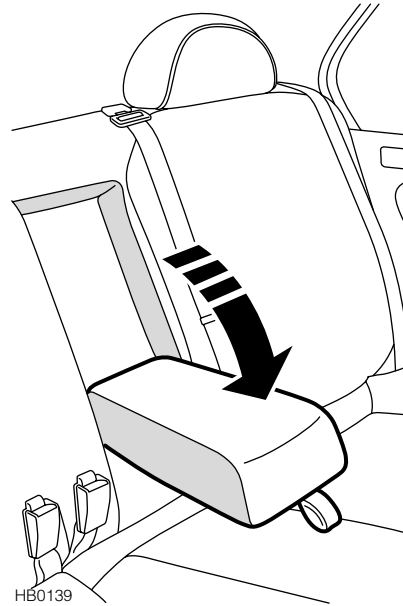

Pull the loop to fold down the armrest.

### REAR SEATS

For information on folding the rear seats, refer to *'FOLDING THE REAR SEATS'*, page 54.

## Seat Belts

### SEAT BELT SAFETY

The seat belts fitted to your vehicle are intended for use by adult sized occupants. Each belt should be used by one occupant only.

Observe the following precautions:

- DO make sure ALL passengers are securely strapped in at all times – even for the shortest journeys.
- ALWAYS adjust seat belts to eliminate any slack in the webbing. DO NOT slacken the webbing by holding the belt away from the body – to be fully effective, the seat belt must remain in full contact with the body at all times.
- ALWAYS fit the lap strap as low on the hips as possible (never across the abdomen), and ensure that the diagonal belt passes across the shoulder without slipping off or pressing on the neck.
- DO NOT wear seat belts over hard, sharp or fragile items in clothing, such as pens, keys, spectacles etc.
- Always replace a seat belt assembly that has withstood the strain of a severe vehicle impact, or if the webbing shows signs of fraying.
- Where possible use the seat belts to secure large items of luggage that are to be carried on the seats – in the event of an accident, unsecured items become flying missiles capable of causing serious injury.
- DO NOT use a seat belt that is twisted or obstructed in any way that could impede its smooth operation.
- DO NOT allow front seat occupants to travel with the seat backs reclined steeply rearwards. Optimum benefit is obtained from the seat belt with the seat back angle set to approximately 25° from the upright (vertical) position.
- DO NOT allow foreign matter (particularly sugary food and drink particles) to enter the seat belt locks – such substances can render the locks inoperative.

- In most countries, all occupants are required by law to wear a seat belt, unless they have been issued with a medical exemption certificate.
- During pregnancy, women should wear the lap belt across the hips below the baby, with the diagonal belt passing across the shoulder, between the breasts and to one side of the baby – if in doubt, consult a doctor.

 ***The airbag supplementary restraint system (SRS) is designed to add to the overall effectiveness of the seat belts. It does not replace them. SEAT BELTS MUST ALWAYS BE WORN!***

1

## Seat Belts

### SEAT BELTS

**!** *Ensure that all seat belts are worn correctly - an improperly worn seat belt increases the risk of death or serious injury in the event of a collision. Read the instructions below and the advice contained under the heading 'Seat belt safety' on the previous page.*

#### Fastening the belt

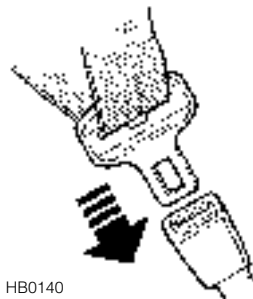

HB0140

Pull the seat belt steadily over the shoulder and across the chest and, ensuring the webbing is not twisted, insert the metal tongue plate into the buckle nearest the wearer - a 'click' indicates that the belt is securely locked.

**NOTE:** *Where possible, rear seat passengers should adjust their position to enable the seat belt webbing to cross the shoulder without pressing on the neck.*

Seat belts are designed to bear upon the bony structure of the body (pelvis, chest and shoulders) and can only be worn safely with the seats in a near-upright position; DO NOT allow the front passenger to travel with the seat steeply reclined (see also 'Seating positions', page 27).

#### Releasing the belt

Press the red button on the seat belt buckle.

#### Adjusting the upper anchorage (front seat belts only)



HB0141

To reduce the likelihood of injury in an accident, the seat belt upper anchorage point should be adjusted so that the belt webbing crosses the shoulder, **MIDWAY BETWEEN THE NECK AND THE EDGE OF THE SHOULDER.**

Adjust the height of the front seat anchorage point, by pressing the button (arrowed in illustration) and sliding the anchor up or down.

## Seat Belts

### CENTRE REAR BELT (5 door models)

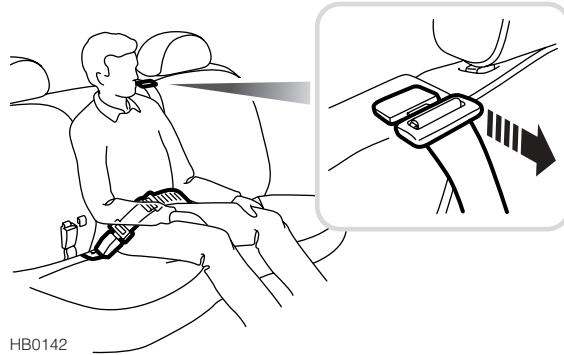

The central rear seating position is fitted with a lap belt only. It is essential that all slack is removed from the webbing and that the belt fits snugly **AS LOW ON THE HIPS AS POSSIBLE**. Fit the tongue plate into the buckle (marked 'CENTRE') nearest the centre of the seat.

**NOTE:** The centre belt tongue plate will not latch into either of the outer seating position buckles.

To unfasten the belt, press the RED button attached to the seat belt buckle. When not in use, the tongue plate should be clipped into the socket at the top of the seat (see inset).

### Adjusting the belt

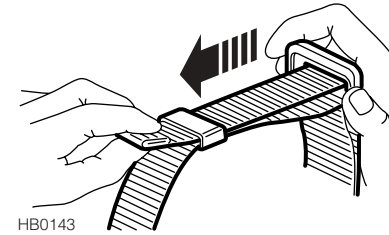

To adjust the length of the belt, turn the adjuster at right angles to the webbing (as shown in the illustration) and then pull the webbing through the adjuster to the required length.

Once the belt is fastened, the webbing will be 'locked' to the length that has been set.

### CENTRE REAR BELT (4 door models)

The central rear seating position is fitted with a three point shoulder/lap belt similar to the belts fitted to the other seating positions. Ensure that the shoulder belt passes across the left shoulder and that the metal tongue plate is inserted into the buckle nearest the wearer.

## Seat Belts

---

### SEAT BELT PRE-TENSIONERS

**⚠** *The seat belt pre-tensioners will only be activated once and then **MUST BE REPLACED** by an MG Rover dealer. Failure to replace the pre-tensioners will reduce the efficiency of the car's front restraint systems.*

The seat belt pre-tensioners activate in conjunction with the airbag SRS to provide additional protection in the event of a severe frontal impact on the vehicle (see 'AIRBAG SUPPLEMENTARY RESTRAINT SYSTEM (SRS)', page 26). The pre-tensioners automatically retract the seat belts. This reduces any slack in both the lap and diagonal portions of the belts, thereby reducing forward movement of the belt wearer in the event of a severe collision.

**NOTE:** *The seat belt pre-tensioners will NOT be activated by minor impacts.*

The airbag SRS warning light on the instrument panel, will alert you to any malfunction of the seat belt pre-tensioners (see 'Airbag SRS warning light', page 29).

**NOTE:** *After any impact, always have the seat belts and pre-tensioners checked and, if necessary, replaced by an MG Rover dealer.*

If the pre-tensioners have been activated, the seat belts will still function as restraints, and must be worn in the event that the vehicle remains in a driveable condition.

### Disposing of vehicles

If you sell your car, be sure to inform the new owner that the vehicle is fitted with pre-tensioners, and make the new owner aware that the pre-tensioners must be examined and replaced by qualified personnel after a period of 15 years.

If your car is to be scrapped, unactivated pre-tensioners are potentially very dangerous and must be safely deployed in a controlled environment by qualified personnel, before it is scrapped.

## Seat Belts

---

### CARING FOR SEAT BELTS

 *Always replace a seat belt assembly where the webbing shows signs of fraying.*

Regularly inspect the belt webbing for signs of fraying, cuts and wear; also pay particular attention to the condition of the fixing points and adjusters.

Do not bleach or dye the webbing and avoid contaminating the webbing with polish, oil or chemicals (see 'Seat belts', page 150).

#### Three tests for checking seat belts

1. With the seat belt fastened, give the webbing nearest the buckle a quick pull - the buckle should remain securely locked.
2. With the seat belt unfastened, unreel the webbing to the limit of its travel. Check that unreeling is free from snags and snatches and further check the webbing for visual signs of wear or fraying.  
Allow the webbing to retract, checking that retraction is smooth, continuous and complete.
3. With the webbing half unreeled, hold the tongue plate and give it a quick forward pull - the mechanism must lock automatically and prevent any further unreeling.

If a seat belt should fail any of these tests, contact your dealer immediately.

## Child Restraints

### CHILD SEATS

Children are more likely to receive injuries from inflating airbags than taller occupants (see 'AIRBAG SUPPLEMENTARY RESTRAINT SYSTEM (SRS)', page 26). For this reason, it is recommended that children should always be seated in the rear of the vehicle, in a child safety seat or restraint system appropriate to their age and size. The range of safety seats approved for use in your car is outlined in the table on the following page and is also listed in the MG Rover accessories brochure, which is available from your MG Rover dealer.

For optimum protection, it is recommended that children weighing up to 13 kg (or approximately 18 months of age) are restrained in an MG Rover-approved rear facing child seat in an outer rear seating position.

All infant and child restraint systems are designed to be secured in the car by means of a standard seat belt.

When installing and using any infant or child restraint system, always follow the manufacturer's instructions. Failure to properly secure the child restraint system can endanger the child in a collision or sudden stop and cause injury to other passengers.

**⚠ DO NOT install a rearward facing child seat in the front passenger seat if a front passenger airbag is fitted - an inflating airbag could impact with the seat causing serious injury, or even death for the child.**



The above symbol affixed to the fascia panel of your car, warns against the use of a REAR FACING child seat in the front passenger seat. This type of child seat could cause serious injury to your child in the event of an airbag deployment.



HB0235

If it is necessary for a child to travel in the front, it is essential that the vehicle seat is set fully rearwards and that the child is seated in a FRONT FACING child safety seat, which prevents any part of the child's head coming into close proximity with the side airbag (note the warning label shown above).



## Child Restraints

### Child restraint seating options - 5-door models

Mass Group (As indicated on child safety seat packaging)	Seating Positions		
	Front Passenger	Rear Outboard	Rear Centre
<b>0</b> = Up to 10 kg (0 - 9 months)	X	L	X
<b>0+</b> = Up to 13 kg (0 - 18 months)	X	L	X
<b>I</b> = 9 to 18 kg (9 months - 4 years)	X	L	X
<b>II &amp; III</b> = 15 to 36 kg (4 - 12 years)	X	L	X
L = Suitable for particular child restraints, detailed in the table alongside. These restraints may be of the specific vehicle, 'restricted' or 'semi-universal' categories. X = Seat position NOT suitable for children of this mass group.			

Recommended Child Restraints (L)
Britax Babysure Britax Rock-a-tot
Britax Babysure Britax Rock-a-tot
Britax Elite
Britax Horizon booster Britax Kid

1

### Child restraint seating options - 4-door models

Mass Group (As indicated on child safety seat packaging)	Seating Positions		
	Front Passenger	Rear Outboard	Rear Centre
<b>0</b> = Up to 10 kg (0 - 9 months)	X	U	U
<b>0+</b> = Up to 13 kg (0 - 18 months)	X	U	U
<b>I</b> = 9 to 18 kg (9 months - 4 years)	X	U	U
<b>II &amp; III</b> = 15 to 36 kg (4 - 12 years)	X	U	U
U = Suitable for 'Universal' category restraints approved for this mass group. X = Seat position NOT suitable for children of this mass group.			

## Airbag SRS

### AIRBAG SUPPLEMENTARY RESTRAINT SYSTEM (SRS)

**⚠** *The airbag SRS provides **ADDITIONAL** protection in a severe impact only. It does not replace the need to wear a seat belt.*

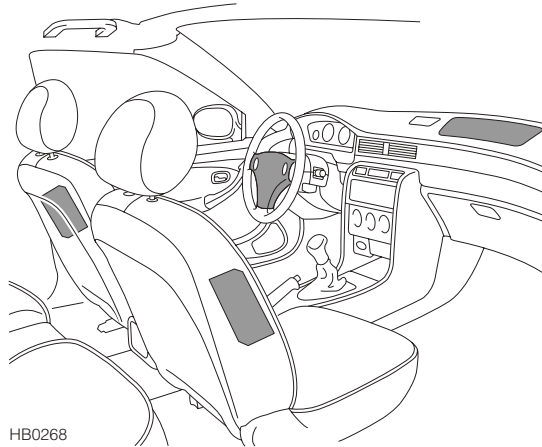

HB0268

The airbag SRS incorporates a driver's airbag, front passenger airbag and optional side airbags for both front seats.

Provided the front seat occupants are correctly seated, with seat belts properly worn, the airbags provide additional protection to the chest and facial areas in the event of the car receiving a severe frontal impact, and to the side of the body facing the impact, if a severe side collision occurs.

*NOTE: Inflation and deflation of the airbags takes place very quickly and will not protect against the effects of secondary impacts that may occur.*

The front airbags are located in the centre pad of the steering wheel and in the fascia panel above the glovebox. Side airbags are positioned in the backrest padding on the outward side of both front seats.

**⚠** *Do not allow a front seat passenger to obstruct the operation of the airbag by placing feet, knees or any other part of the person, or any other objects in contact with, or in close proximity to, an airbag module.*

## Airbag SRS

---

### Airbag deployment

To ensure correct deployment of the airbags, it is essential that obstructions are not allowed to intervene between the airbag and the occupant. The following are examples of the type of obstructions that could either impede correct operation of the airbags, or jeopardise personal safety in the event of an airbag deployment:

- Accessories attached to or obscuring an airbag cover, including the part of a front seat containing a side airbag\* or the pillars between the front and rear doors.
- Items of hand luggage, or other objects placed over an airbag cover.
- Feet, knees or any other part of the anatomy in contact with, or in close proximity to, a front airbag cover.
- Head, arms or any part of the anatomy in contact with, or in close proximity to, a side airbag.
- Items of clothing or cushions, draped over the part of the front seat containing the side airbag.
- Unapproved seat covers fitted over a front seat (in particular, be aware that seat covers approved for other cars will NOT be suitable for your car). If in doubt, seek advice from an MG Rover dealer.

**!** *DO NOT attach or position items onto an airbag cover (steering wheel centre pad or fascia panel) which could interfere with the inflation of the airbag or, if the airbag inflates, be propelled inside the car, causing injury to the occupants.*

### Seating positions

In order to provide optimum protection in the event of a severe impact, it is necessary for the airbags to deploy with considerable speed.

An inflating airbag can cause facial abrasions and other injuries if the occupant is too close to the airbag at the time of its deployment.

**!** *To minimise the risk of accidental injury from inflating airbags, seat belts should be correctly worn at all times. In addition, both driver and front seat passenger should adjust their seats to provide the maximum practical distance from the front airbags, and also ensure that a gap is maintained between the upper torso and the side of the vehicle, to enable unobstructed inflation of the side airbags\*.*

1

## Airbag SRS

### HOW THE AIRBAG SRS OPERATES

In the event of a collision, the airbag control unit monitors the rate of deceleration or acceleration induced by the collision, to determine whether the airbags should be deployed.

**NOTE:** *The airbag SRS is not designed to operate as a result of rear collisions, minor frontal or side impacts, or if the car overturns; nor will it operate as a result of heavy braking or driving over bumps and potholes.*

Operation of the airbag SRS is dependent entirely on the rate at which the car's passenger compartment changes speed as a result of a collision. The circumstances affecting different collisions (vehicle speed, angle of impact, type and size of object hit, for example), vary considerably and will affect the rate of acceleration or deceleration accordingly.

It follows, therefore, that significant superficial damage can occur without the airbags deploying or, conversely, that a relatively small amount of structural damage may cause the airbags to be deployed.

In the case of a severe frontal collision, both front airbags and seat belt pre-tensioners will be deployed. In the case of a severe side collision, only the side airbag (if fitted) on the impact side of the car will inflate. However, there may also be impact conditions whereby one set of side and both front airbags deploy at the same time, or where front and side airbags respond separately as a result of a secondary impact occurring after the initial collision has taken place.

**!** *An inflating airbag can cause facial abrasions and other injuries. Minimise the risk of injury by ensuring that front seat occupants are wearing their seat belts and are seated correctly, with the seat as far back as is practical.*

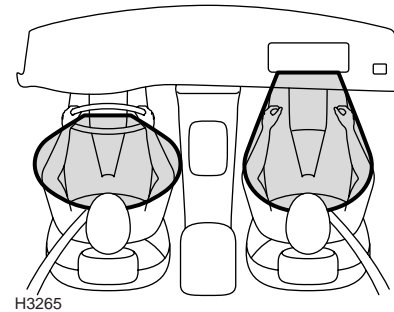

Airbag inflation is virtually instantaneous and occurs with considerable force, accompanied by a loud noise. The inflated bag, together with the seat belt restraint system, limit the movement of a front seat occupant, thereby reducing the risk of injury to the head and upper torso.

**NOTE:** *After inflation, some airbag components are hot - DO NOT touch until they have cooled.*

When an airbag inflates, a fine powder is released. This is not an indication of a malfunction, however, the powder may cause irritation to the skin and should be thoroughly flushed from the eyes and any cuts or abrasions of the skin. After inflation, an airbag will deflate immediately, providing a gradual cushioning effect for the occupant and ensuring the driver's forward vision is not obscured.

## Airbag SRS

### Side airbags\*

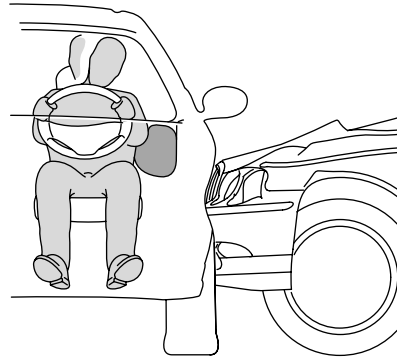

H3266

Side airbags are designed to protect the thorax region of the torso and will only deploy in the event of a severe side impact. They will not inflate as a result of a frontal or rear impact only.

In the event of a severe side collision, the airbag on the impact side of the car breaks through the seat covering, rapidly inflating to form a cushion between the occupant and the side of the car. The airbag on the non-impact side of the car will not be deployed.

Note that a part of the outer side of the seat trim (identified by the woven 'airbag' label) is specially constructed to enable the airbag to deploy.

**⚠** *Ensure that a gap is maintained between the upper torso and the side of the car, to enable unobstructed inflation of the side airbag.*

**NOTE:** *The manufacture and materials of the seat are critical to the performance of the airbag. For this reason, unapproved seat covers must NEVER be fitted, and it is recommended that any repair or replacement to the front seats be carried out by an MG Rover dealer.*

1

### Airbag SRS warning light

A warning light, mounted on the instrument panel, will alert you to any malfunction of the airbag SRS and seat belt pre-tensioners. The light will illuminate as a bulb and system check when the starter switch is turned to position 'II' and will extinguish after approximately six seconds. The system should always be checked by a dealer if any of the following symptoms occur:

- The warning light fails to illuminate when the starter switch is turned to position 'II'.
- The warning light fails to extinguish within approximately six seconds after the starter switch is turned to position 'II'.
- The warning light illuminates while the car is being driven.

## Airbag SRS

---

### SERVICE INFORMATION

After 15 years from the initial date of registration (or installation date of a replacement airbag SRS), some components will need to be replaced by an MG Rover dealer, who should stamp and sign the appropriate page of the Service History section of this book once the work has been completed.

In addition, ALWAYS contact your dealer if;

- an airbag inflates.
- the front of the vehicle is damaged (even if the airbag has not inflated).
- any part of an airbag module covers show signs of deterioration or damage.

The components of the airbag SRS are sensitive to electrical and physical interference; it is recommended that you ALWAYS seek the assistance of an MG Rover dealer to carry out any of the following:

- Removal or repair of any wiring or component in the vicinity of the airbag SRS components, including the steering wheel, steering column, front seats, fascia and instrument panel.
- Installation of electronic equipment such as a mobile phone, two-way radio or in-car entertainment system.
- Attachment of accessories to, or modification of, the front or side of the vehicle.
- Removal, replacement or retrimming of a front seat cover.

**⚠ DO NOT service, repair, replace, modify or tamper with any part of the airbag SRS, or wiring in the vicinity of an airbag SRS component; this could cause the system to activate, resulting in personal injury.**

### Disposing of the vehicle

If you sell your vehicle, be sure to inform the new owner that the vehicle has an airbag SRS and make the new owner aware of the airbag module replacement date, shown in the Service History.

If the vehicle is to be scrapped; uninflated airbags are potentially very dangerous and must be safely deployed in a controlled environment by qualified personnel, before a vehicle is scrapped.

## Steering Column

### STEERING COLUMN ADJUSTMENT

**!** *DO NOT attempt to adjust the height of the steering column while the car is in motion. This is extremely dangerous!*

1

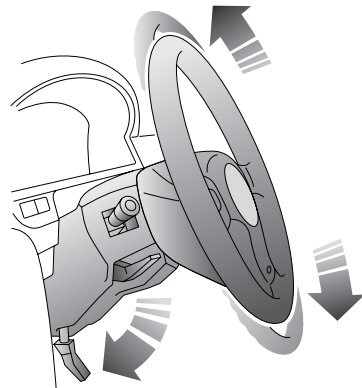

HB0589

The angle of the steering column can be adjusted to suit your driving position:

1. With the car stationary, push the locking lever fully down to free the steering column.
2. Move the steering wheel (up or down) into a position which is comfortable, making sure the instrument panel is clearly visible.
3. When adjustment is complete, pull the locking lever fully up to lock the steering column in position.

# Mirrors

## EXTERIOR MIRRORS

**NOTE:** Objects viewed in exterior mirrors may appear further away than they actually are.

### Electrical operation

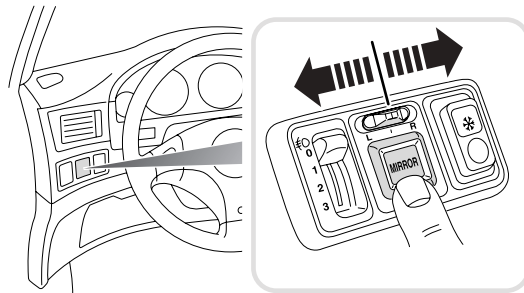

HB0269

1. Move the mirror selector switch to the 'L' or 'R' position (to adjust either left or right mirror).
2. With the starter switch turned to position 'II', press the appropriate side of the selector switch to tilt the mirror glass up/down/left or right.
3. When adjustment is complete, return the selector switch to the OFF position (midway between 'L' and 'R').

### Heating elements

Electrically controlled exterior mirrors have automatic, integral heating elements for dispersing ice and mist.

### Manual operation

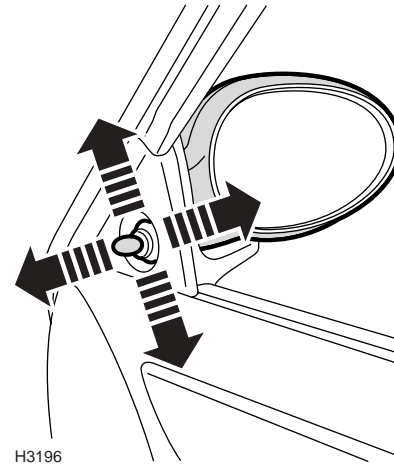

H3196

Manually operated mirrors are adjusted by moving the lever as shown in the illustration.



## Mirrors

### Mirror folding

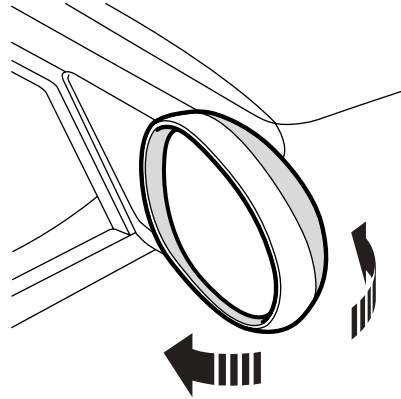

H3197

The bodies of both electrically and manually controlled mirrors are designed to fold rearwards or forwards on impact and can also be folded back towards the side windows into a 'park' position to enable the car to negotiate narrow openings.

### INTERIOR MIRROR

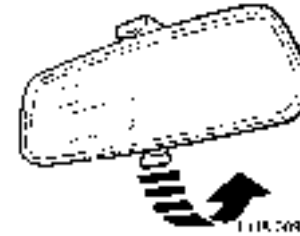

The interior mirror can be dipped to reduce glare from following vehicles. At night, move the lever at the base of the mirror forward to 'dip' the mirror. Normal visibility is restored, by pulling the lever back to its original position.

**NOTE:** In some circumstances, the view reflected in a 'dipped' mirror, can confuse the driver as to the precise position of following vehicles. Remember to take additional care!

### VANITY MIRROR

To use the vanity mirror, pull down the passenger's sun visor.

To avoid possible scorching of the seats by the sun reflected in the vanity mirror, always return the visor to its stowed position when not in use.

## Windows

### POWER-OPERATED WINDOW CONTROLS

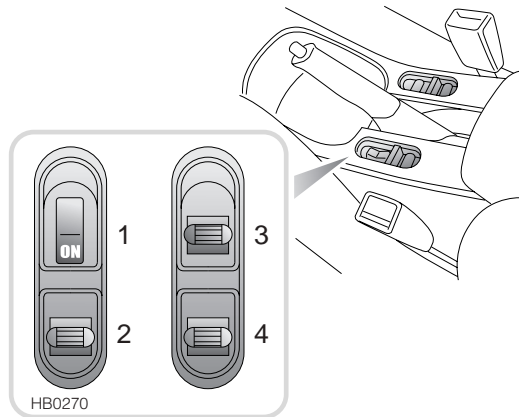

1. Isolation switch.
2. Left hand rear window.
3. Right hand front window.
4. Right hand rear window.

**NOTE:** The rear windows will only operate if the isolation switch is not activated.

### OPERATING THE WINDOWS

The electric windows can only be operated when the starter switch is at position 'II' and for up to 30 seconds after the starter switch is turned off (provided a door is not opened in the meantime).

#### Driver's window

To open the driver's window, press the switch down and release - the window will continue opening until either it is fully open or until motion is stopped by pulling the switch up.

To close the driver's window, pull the switch up - the window will stop moving as soon as the switch is released.

#### Passenger windows

All of the passenger windows can be operated from the central control panel. Push the appropriate switch down to open and pull up to close - the window will stop moving as soon as the switch is released.

In addition, the rear windows can also be controlled by the individual switches mounted on each rear door.

## Windows

---

### **Isolation switch\***

The isolation switch (marked 'ON') controls power to the front passenger and rear window switches.

When carrying children isolate the rear windows by pressing the isolation switch down to the OFF position. This will prevent any possibility of injury through unintentional operation of the windows.

 **Accidental closing of a power-operated window on fingers, hands or on any other vulnerable parts of the body can result in serious injury. Always heed the following precautions:**

- **ISOLATE** the rear window switches when carrying children
- **ENSURE** children are kept clear when raising or lowering a window.
- **DO NOT** leave children alone in the car.
- **ENSURE** that all adult passengers are familiar with the controls and the potential dangers of power operated windows.

## Sunroof

### SUNROOF OPERATION\*

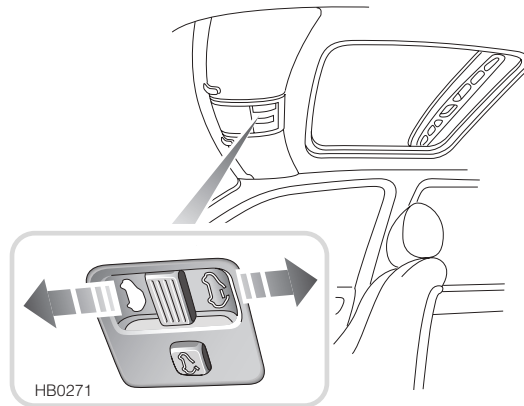

The sunroof can be operated when the starter switch is turned to position 'II' and for up to 30 seconds after the starter switch is turned off, unless a door is opened in the meantime.

**⚠ DO NOT open or close the sunroof in sub-zero temperatures, or when the roof is covered with snow or ice - damage to the motor or roof panel could occur.**

### Opening and closing

Pull the switch to the rear to open, push forward to close. Movement of the roof will stop as soon as the switch is released.

Pull the switch to the rear - the roof will open until it reaches a pre-set aperture, calculated to minimise air turbulence within the car.

Push the switch forwards to close the roof.

**NOTE:** The sunroof visor slides open automatically when the sunroof is opened, but must be closed manually. Rear edge tilt ventilation will be increased by opening the visor.

**⚠** Accidental closing of a sunroof on fingers, hands or any vulnerable part of the body, can result in serious injury. Always heed the following precautions:

- ENSURE passengers are kept clear when closing the roof.
- DO NOT leave children alone in the car.
- ENSURE that all adult passengers are familiar with the controls and the potential dangers of operating the sunroof.
- DO NOT allow passengers to extend any part of their bodies through the sunroof aperture while the car is moving - injury from flying debris, branches of trees or other obstructions could occur.

## Sunroof

### Tilting the rear edge

1

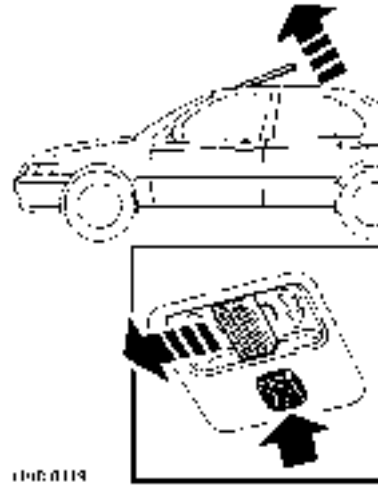

To raise the rear edge of the roof; with the sunroof closed, press the button (arrowed in illustration). To return the tilted roof to the closed position, pull the OPEN/CLOSE switch forward.

## Heating & Ventilation

### VENTILATION

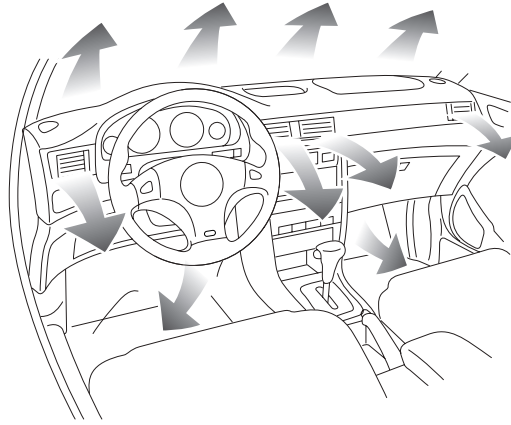

The heating and ventilation system provides fresh or heated air to the interior of the car from the air intake grille in front of the windscreen.

**NOTE:** Always keep the air intake grille clear of obstructions such as leaves, snow or ice.

Air outlets are provided to the windscreen, face and feet – the location of those vents is shown in the illustration above.

### Centre face level vents

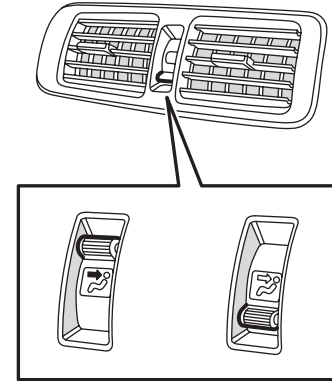

Air will flow from the centre vents when face level, or foot and face level air distribution is selected. With the air flow lever set at the lower position (white arrow showing), air temperature will vary according to the position of the air temperature control.

With the air flow lever moved to the upper position (blue arrow showing), a small quantity of unheated air is drawn from outside the car and blended with air from the heater unit, independent of the air distribution setting. Dependent on the position of the temperature control, this will result in a slight reduction in air temperature, enabling slightly cooler air to be directed towards the face.

## Heating & Ventilation

### Side face level vents

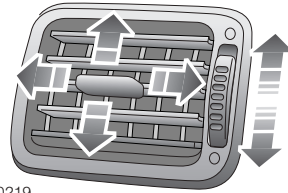

HB0219

Rotate the thumbwheel up to open, or down to close the vents. Direct the air flow by moving the control in the centre of the louvres, either up or down, or from side to side.

### Upper vent

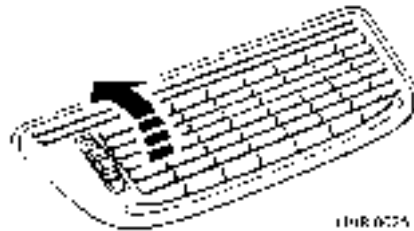

HB0224

The upper vent is operational only when face level, or foot and face level vents have been selected using the air distribution control. Rotate the thumb wheel forwards to open, or rearwards to close the vent.

### Pollen filter\*

A pollen filter, located behind the glovebox, will help to keep the car interior free from pollen and dust. To remain fully effective the filter should be replaced at least every 12 months or 20,000 km, preferably at the time of a main service.



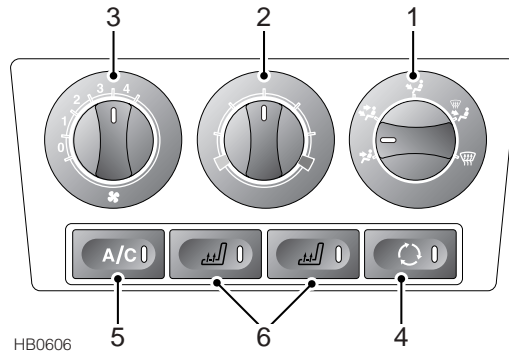

1

## Heating & Ventilation

### HEATING



#### 1. Air distribution control

-  Face level vents only.
-  Foot and face level vents.
-  Foot level vents.
-  Foot level, windscreen and side window vents.
-  Windscreen and side window vents.

**NOTE:** Air flow from foot and screen vents can be varied by positioning the control between the distribution settings.

#### 2. Air temperature control

- BLUE: Unheated air
- RED: Heated air

#### 3. Blower switch

Turn the switch clockwise to increase the blower speed.

**NOTE:** With the blower switched off, the volume of air entering the vehicle is dependent on driving speed alone.

#### 4. Recirculated air supply button

With this button pressed, the heater recirculates the air already inside the car, preventing the entry of traffic fumes.

**NOTE:** Leaving the system in recirculation mode can cause the windscreen to mist. If this happens, switch off recirculation immediately.

#### 5. Air conditioning switch\*

Press to operate. The indicator light in the switch illuminates when the air conditioning is switched on.

**NOTE:** The air conditioning will not operate if the blower switch is turned to '0'.



## Heating & Ventilation

### 6. Heated front seats\*

With the starter switch turned to position 'II', press the appropriate switch to heat either, or both the front seats (indicator light in the switch illuminates). The seat heaters are thermostatically controlled and operate to achieve and then maintain a pre-determined temperature.

The seat heaters will not switch off automatically, they must be deselected by pressing the switch a second time, otherwise they will operate whenever the starter switch is in position 'II'.

**!** *The seat heaters consume considerable power from the battery. For this reason, they should only be operated with the engine running.*

### USING YOUR HEATER

Fresh air enters the heater through the air intake grille in front of the windscreen and is extracted through vents at the rear of the car. The air intake grille must always be kept clear of obstructions, including leaves, snow and ice.

The heating system uses heat from the engine to warm the air inside the car. For this reason, the heater unit will not operate unless the engine is running, and full heating is not available until the engine has reached its normal operating temperature.

The following examples, show some basic heating and ventilation settings. Further adjustment of the controls, will result in a wider range of options, enabling you to obtain the most suitable output from the heater at all times.

Remember; with the blower switched off, the volume of air entering the car is dependent on driving speed alone.

### Heating

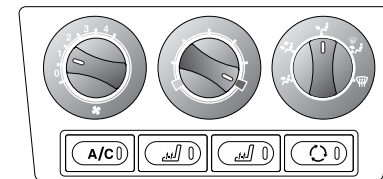

HB0607

Set the controls as shown. Increase the blower speed as required and adjust the centre face level vents to emit heated air only.

1

## Heating & Ventilation

### Maximum ventilation

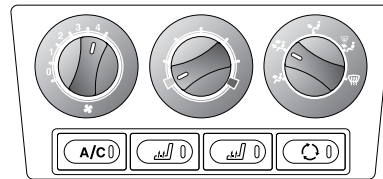

HB0608

Set the controls as shown. Open all the face level vents and adjust the centre vents to deliver fresh, unheated air. When the car interior reaches a satisfactory temperature, adjust the blower speed to the most comfortable setting.

### Defrost windscreen

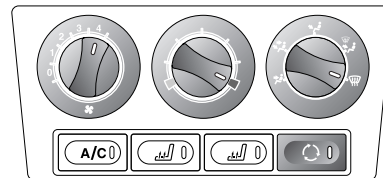

HB0609

Set the controls as shown. To obtain maximum heated air flow from windscreen and side window vents, keep the face level vents closed.

### AIR CONDITIONING\*

The air conditioner provides additional cooling and also reduces moisture from the air.

#### Using the air conditioning

The air conditioning can only be used when the engine is running. It is also important to keep the windows and sunroof closed.

**NOTE:** The air conditioner will only operate when the blower is switched on. It will not operate with the blower switched off, nor when the temperature is near freezing point.

Operation of the air conditioning system places an extra load on the engine. In very hot conditions, or when the engine is required to work unusually hard (climbing long hills or driving in congested traffic, for example), this could result in high engine temperatures. If the pointer nears the RED zone of the temperature gauge, switch off the air conditioning until the engine temperature returns to normal.

To help cool the engine, the air conditioning fans may continue to operate for up to five minutes after the starter switch is turned off. During this period, if the air conditioning and blower switches are left on, the switch indicator light will remain illuminated.

In conditions of high humidity, slight screen misting may be experienced when the air conditioning system is switched on. This is a natural occurrence on most automotive air conditioning systems. It is not a fault; misting will clear after a few seconds once the air conditioning system is operating.

## Heating & Ventilation

### Maintaining the air conditioning

The air conditioning system is sealed and major maintenance should only be carried out by a qualified technician. To maintain the system in peak condition however, owners should ensure that the system is operated for a short period every week (even during the cold winter months); with the engine at its normal operating temperature, run the air conditioning for at least ten minutes while driving at a steady speed.

Surplus water, produced by the dehumidifying process, is expelled from the system via drain tubes beneath the car. This may result in a small pool of water forming on the road when the car is stationary and is not a cause for concern.

### Cooling

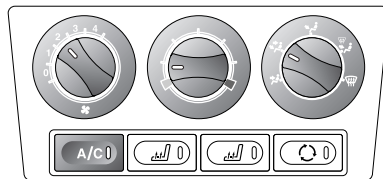

HB0610

After starting the engine, press the air conditioning switch to operate the air conditioner. Set the blower speed, air distribution and temperature controls to suit your requirements.

### Rapid cooling

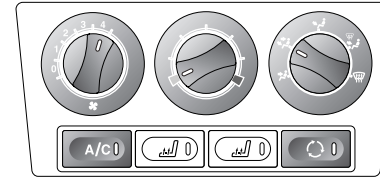

HB0611

Start the engine and switch on the air conditioning.

Set the blower to maximum speed and switch on air recirculation (this will prevent warm air being drawn into the car from outside).

Once the interior is cool, switch off air recirculation and then reset the blower as required.

## Heating & Ventilation

---

### Reducing humidity

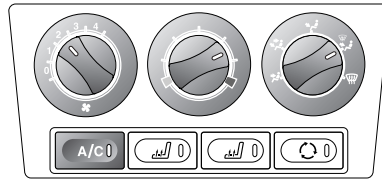

HB0612

Air conditioning reduces moisture from the air and can be used to demist windows quickly in damp weather. Used in conjunction with the heater, it also makes the interior of the car warm and dry.

This setting is ideal for most driving conditions, when the outside temperature is above freezing point. After switching on the air conditioner, initially set the controls as shown and progressively adjust the temperature control and blower speed, to suit your requirements.

**NOTE:** *If the car interior is particularly hot when you start the engine, it will take time for the air conditioner to become fully effective. Before switching on the air conditioning, it is best to ventilate the car for a short while by operating the blower at a fast speed, with windows and sunroof open. Remember to close the windows and sunroof before you operate the air conditioner.*

## Interior Equipment

### INTERIOR LIGHT

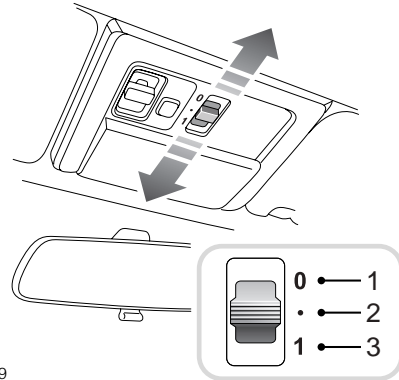

HB0279

#### **Switch positions:**

1. Light permanently off
2. Light illuminates automatically when a door is opened
3. Light illuminates continuously

With the switch in the centre position, the interior light illuminates automatically when the doors are unlocked, and remains illuminated for 15 seconds after all the doors are closed, or until the starter switch is turned on.

### **Luggage Compartment Light**

Illuminates automatically when the luggage compartment is opened.

### **Glovebox Light\***

Operates automatically when the exterior lights are switched on and the glovebox lid is opened.

1

## Interior Equipment

---

### SUN VISOR

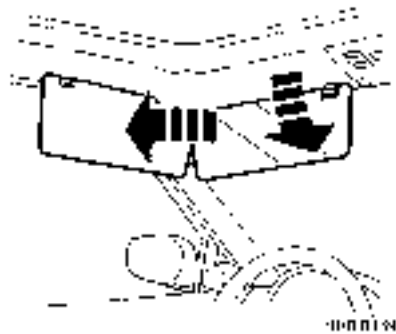

To shield your eyes from the sun, pull the visor down from the roof; the visor can be used to shield the upper part of the windshield, or the side window as required.

**NOTE:** The passenger's sun visor is fitted with a vanity mirror on the underside.

### CLOCK

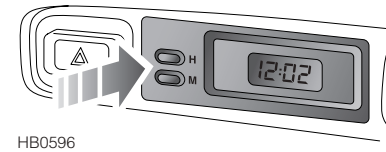

The digital clock display illuminates when the starter switch is turned on and dims for night viewing when the sidelights are switched on.

Press the hour ('H') and minute ('M') buttons to set the time. If both buttons are pressed together, the display will change between 24 hour and 12 hour displays.

On some models, the clock also displays information about the operation of the audio unit fitted to your car.

**NOTE:** If the battery is disconnected, the clock will need to be reset.

## Interior Equipment

### CUP HOLDER & PEN CLIP\*

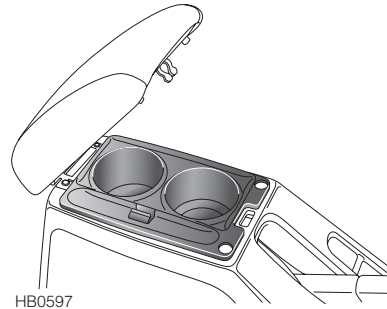

Lift the front edge of the lid to open. Stowage space is provided for a pen and two cup rests for use when the car is stationary. The cup rests can be removed from the centre armrest, to access a stowage box.

**!** *The cup holder should not be used when the car is in motion.*

### DRIVER'S PERSONAL STORAGE

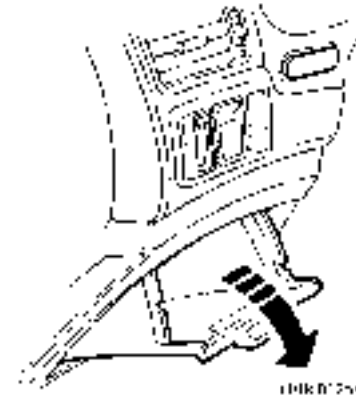

Pull down to open (for instructions showing removal and replacement of the storage container, see 'MAIN FUSE BOX', page 169).

1

## Interior Equipment

### ASHTRAYS

**!** *Ashtrays are fire hazards - DO NOT use for waste paper or other combustible materials.*

#### Front ashtray

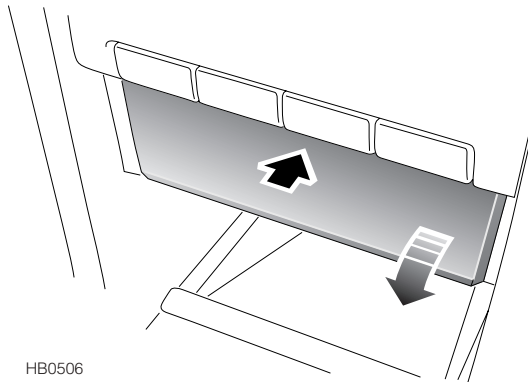

HB0506

Push the top of the cover to open (solid arrow).

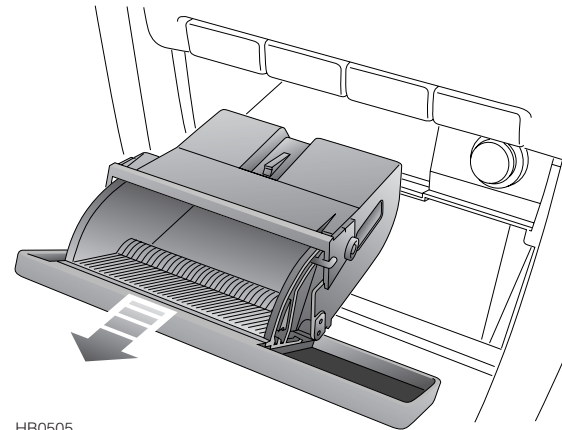

HB0505

To remove for emptying, open the cover and pull out the entire ashtray unit.



## Interior Equipment

### Rear ashtray



Pull out to open. To remove for emptying, open the ashtray fully and then lift the base up and outwards.

Replace as shown in inset, ensuring that the retaining spring is inserted first before the base of the ashtray is eased into the aperture.

### CIGAR LIGHTER\*

 **ONLY hold the cigar lighter by the handle.**

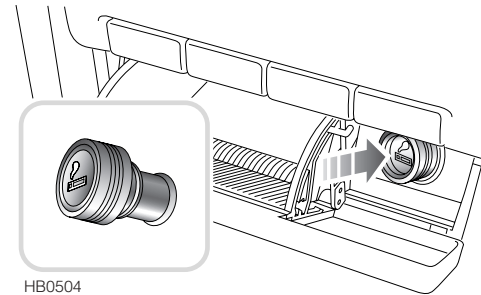

Push the top of the ashtray cover to open (see 'ASHTRAYS', page 48). With the starter switch turned to position 'I' or 'II', push the lighter in to heat up. When ready, the lighter will partially eject and can then be withdrawn for use. **DO NOT** hold the lighter in while it is heating - this could cause it to overheat.

**NOTE:** *DO NOT plug accessories into the cigar lighter socket (an auxiliary power socket is available as an accessory - consult your dealer).*

1

## Interior Equipment

---

### AUXILIARY POWER SOCKET\*

**!** *NEVER plug non-approved accessories into a power socket - damage to the car's electrical systems could occur.*

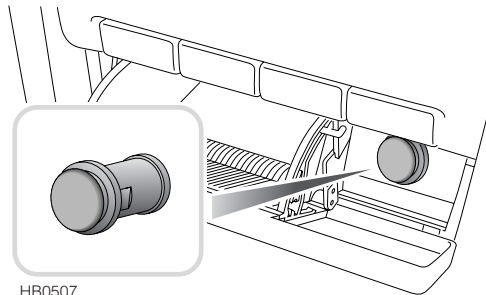

Push the top of the ashtray cover to open (see 'ASHTRAYS', page 48). Remove the power socket cover (as illustrated).

The power socket will operate with the starter switch at position 'I' or 'II', and can be used to power MG Rover approved accessories that use a maximum of 180 watts. Always run the engine during prolonged use of electrical accessories, otherwise the battery may become discharged.

## In-Car Telephones

---

### IN-CAR TELEPHONES

**!** *Refrain from operating a telephone fitted with its own aerial inside the car (see main text).*

Your car uses a number of electronic systems designed to provide you with maximum comfort, safety and economy. These systems may be affected by the use of non-approved mobile communication equipment inside the car. However, the use of an external aerial will greatly reduce the likelihood of this occurrence.

**!** *Using any hand-held appliance while driving can be dangerous. Always stop the car before making or receiving a call and ensure the telephone is switched off while you are driving.*

For your safety, always note the following precautions before fitting or using an in-car telephone, or any electrical equipment:

- Only use an installation kit incorporating an aerial external to the vehicle.
- Ensure that the installation is carried out by a competent installer.
- Refrain from operating a mobile phone fitted with its own aerial inside the car - the electromagnetic field radiated by the phone may interfere with the car's electrical systems.

## Load Carrying

### REAR WINDOW SHELF (5 door models only)

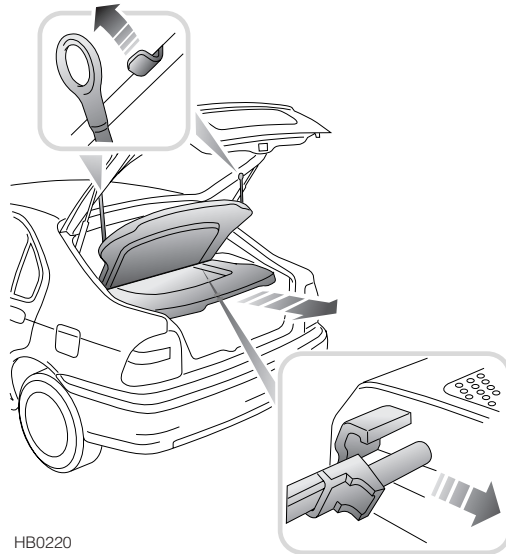

**⚠ DO NOT** carry hard, heavy, or sharply pointed objects on the rear window shelf - they could damage the rear window demisting elements, or become dangerous projectiles in the event of an accident or emergency braking.

The rear window shelf can be removed, to increase the height of the luggage area, as follows:

- Release the lifting straps. Then, with the shelf horizontal, hold the front edge and pull smartly to the rear to disengage the shelf from the retaining clips on each side.
- To refit, position the shelf with the two locating pins set into the retaining clips on both sides. Then, push the shelf firmly towards the front of the car, making sure it is securely clipped in position before attaching the lifting straps and closing the taildoor.

## Load Carrying

### COLLAPSABLE STORAGE BOX\*

The box is located in the loadspace and can be used to store loose items, to prevent them from becoming projectiles in the event of an accident or emergency manoeuvre. The box can also be used to stow items such as dirty boots, to protect the car interior from damage.

Erect the box as follows:

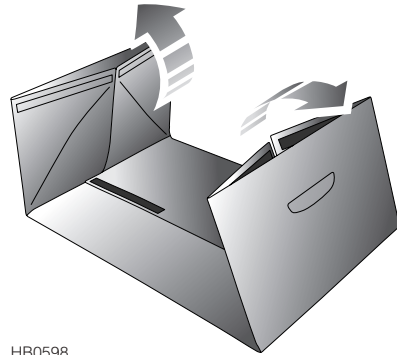

HB0598

1. Lift the handled sides of the box first.

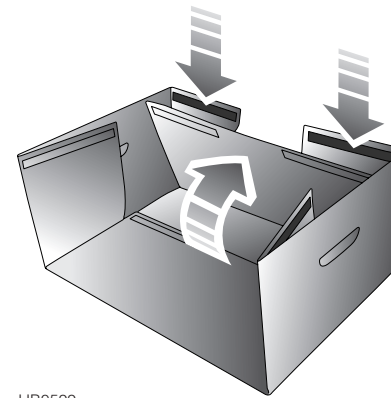

HB0599

2. Lift the back of the box and secure the velcro fastenings where shown.

1

## Load Carrying

### FOLDING THE REAR SEATS

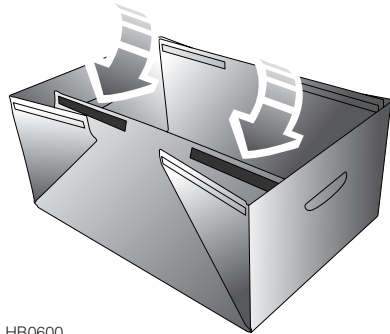

HB0600

3. Lift the front of the box and secure the velcro fastenings. The box is now ready for use.

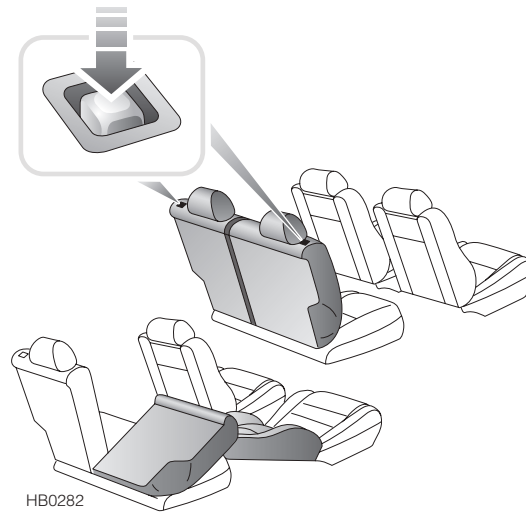

HB0282

The backrest is divided into two parts; either, or both of which, can be folded forward to increase the luggage space. Press the backrest release buttons (arrowed in illustration) to release the backrest.

**⚠ DO NOT carry unsecured equipment, tools or luggage that could move, causing personal injury in the event of an accident, or emergency manoeuvre - where possible, use the seat belts to secure luggage carried on seats.**

## Load Carrying

### Accommodating long loads

Remove the head restraint from the front passenger and rear seats (see 'HEAD RESTRAINTS', page 16), move the front passenger seat forwards as far as possible and fully recline the backrest. Finally, fold the appropriate part of the rear seat backrest fully forward as shown.

When returning the seat to its normal, upright position, ensure that the rear seat belts are not trapped behind the backrest and that the seat retaining catches are securely latched.

**!** *DO NOT carry long loads which require driving with the taildoor open - poisonous fumes will be drawn into the interior of the car!*

### Maximum luggage space (5 door models only)

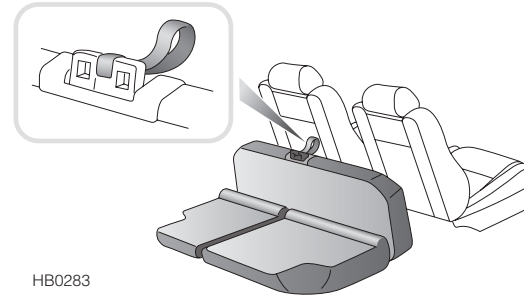

To create an extra large luggage area; pull the lifting strap (highlighted in illustration) and tip the rear seat cushion forwards. Remove both rear head restraints, then release both parts of the backrest and fold them forwards as shown.

When returning the backrest to the upright position, ensure that the rear seat belts are not trapped behind the backrest and that the seat retaining catches are securely latched.

1

## Load Carrying

---

### ROOF RACKS

To ensure absolute safety, only fit accessories that have been designed and tested for your car. Your MG Rover dealer will provide details of approved tow bars and roof racks.

The total load must NEVER exceed that given in 'TOWING WEIGHTS', page 197, and must include the weight of the roof rack within the load.

**⚠** *A loaded roof rack can reduce the stability of the car, particularly when cornering and encountering cross winds. All loads should be evenly distributed and secured within the periphery of the roof rack.*

### TOW BARS

**⚠** *Only fit towing accessories that have been approved by MG Rover, otherwise serious damage to the car may result.*

To ensure absolute safety, only fit accessories that have been designed and tested for your car. Your MG Rover dealer will provide details of approved tow bars.

The permissible maximum towing weight, the maximum rear axle weight and towing hitch downward load and the maximum towing hitch overhang, are given in 'Technical Data'. In the interest of safety, these must not be exceeded.

**⚠** *DO NOT use the rear lashing point for towing purposes - serious damage to the car may result.*

#### Tow bar mounting points

**⚠** *The tow bar is attached to the vehicle body NOT the chassis and fitment requires specialised skills and knowledge. It is therefore essential that only a tow bar approved for use with your car is fitted and that it is fitted by qualified personnel.*

The following information locating the mounting points is for reference only and does not include details of the tow bar installation process. The mounting points shown are for the installation of an approved tow bar - no other means of attaching a tow bar should be used.



## Load Carrying

The illustration shows the bumper assembly and rear trim removed.

- The inset shows the 6 mounting points located on the right hand side of the luggage compartment - the mounting points for the left hand side are symmetrically identical.
- The main illustration identifies the exterior rear mounting points for both 4-door (A) and 5-door (B) models.

If a towing hitch with a detachable tow bar is fitted, always detach the tow bar when the car is not being used for towing.

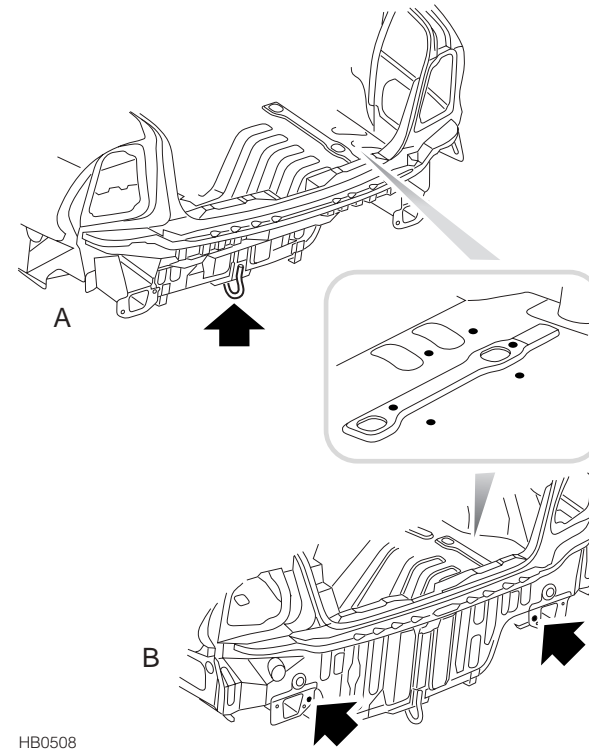

HB0508

*A = 4 door models*  
*B = 5 door models*

1

## Towing

### TOWING A TRAILER

**NOTE:** Towing regulations vary from country to country. It is very important to ensure that national regulations governing towing weights and speed limits are observed (refer to the relevant national motoring organisation for information). The maximum permissible towed weights quoted in 'TOWING WEIGHTS', page 197, refer to the car's design limitations and NOT to any specific territorial restriction.



HB0157

It is the driver's responsibility to ensure that car and trailer are loaded and balanced so that the combination is stable when in motion. When preparing your car for towing, pay careful attention to the trailer manufacturer's recommendations and also follow the guidelines below:

- Ensure that the car tyre pressures are correct for towing and that the trailer tyre pressures are as recommended by the trailer manufacturer.
- Check the operation of trailer brakes and lights.

- For maximum stability, ensure that trailer loads are properly secured and unable to shift position during transit. Also, position loads so that most of the weight is placed close to the floor and, where possible, immediately above or close to the trailer axle(s).
- After loading the trailer, check that the weight on the tow hitch point (this is also called the draw-bar loading weight, or nose weight), does not exceed 70 kg.
- Where the load weight can be divided between trailer and tow vehicle, loading more weight into the vehicle will generally improve the stability of the combination.
- The car's maximum rear axle weight and maximum gross train weight (see 'TOWING WEIGHTS', page 197) must not be exceeded, when the trailer is attached and any passengers or luggage are in place inside the car. For high trailer weights, this may require passengers and/or luggage to be removed from the car.

**⚠ Ensure that the maximum vehicle laden weight and maximum rear axle weight are not exceeded.**

## ***Driving Controls***

---

- 60** *Instruments*
- 62** *Warning Lights*
- 65** *Starting & Driving*
- 69** *Catalytic Converter*
- 70** *Environmental Driving*
- 72** *Manual Gearbox*
- 73** *Automatic Transmission - 1.8 models*
- 77** *Automatic Transmission - 2.0 models*
- 83** *Fuel System*
- 87** *Lights & Indicators*
- 89** *Wipers & Washers*
- 91** *Fascia Switches*
- 92** *Cruise Control*
- 94** *Brakes*
- 98** *Parking Aid*

## Instruments

### INSTRUMENT PANEL

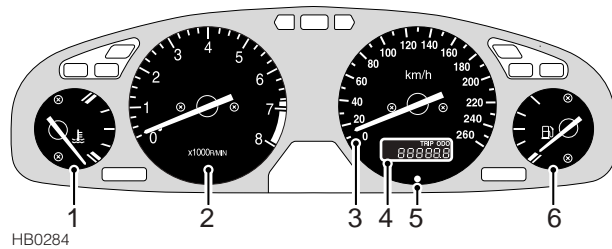

#### 1. Temperature gauge

This gauge indicates the temperature of the engine coolant. During normal operation, the pointer will rise from the lower (cold) mark to the middle part of the gauge, where it will remain while the engine is operating at its normal temperature.

In severe driving conditions, such as very hot weather or extended hill climbing, the pointer may reach the upper WHITE mark. If the pointer rises to the RED mark, the coolant is too hot and severe engine damage could result; stop the car as soon as safety permits and seek qualified assistance.

#### 2. Tachometer

Indicates engine speed in revolutions per minute. To protect the engine from damage, NEVER allow the tachometer pointer to enter the RED sector. Note that the range of the red sector will vary according to engine type.

**NOTE:** Speed restriction limiters will prevent engine speed rising above a pre-determined level.

#### 3. Speedometer

Indicates road speed in kilometres per hour.

#### 4. Digital display



The display shows the following:

- Odometer reading (shows the total distance travelled by the car). The word 'ODO' is also displayed.
- Trip recorder (for recording individual journey distances). The word 'TRIP' is also displayed.
- Automatic gear selector position ('P', 'R', 'N', 'D') - automatic transmission only.
- The word 'SPORT' confirms the selection of Sport mode - automatic transmission only.
- Manual mode gear selection information ('1', '2', '3', '4', '5' or '6' on 1.8 CVT models and '1', '2', '3', '4' or '5' on 2.0 petrol models) - automatic transmission only.

## Instruments

---

### 5. Trip recorder reset button

Whenever the starter switch is turned on, the display shows the odometer reading. By pressing the trip recorder reset button briefly, the display will change to show the trip recorder reading (a further press of the button returns the display to the odometer reading).

With the trip reading displayed, press and hold the reset button for two seconds to cancel the trip reading and reset the display to zero.

### 6. Fuel gauge

The pointer indicates the fuel level, even when the starter switch is turned off. After refuelling, the gauge slowly rises to the new level after the starter switch is turned on.

**NOTE:** *Driving on twisting or hilly roads, may disturb the accuracy of the gauge. It is advisable to check the fuel level when the car is on level ground.*

 **Never allow the car to run out of fuel - the resultant misfire could damage the catalytic converter.**

## Warning Lights

### WARNING LIGHT POSITION AND OPERATION

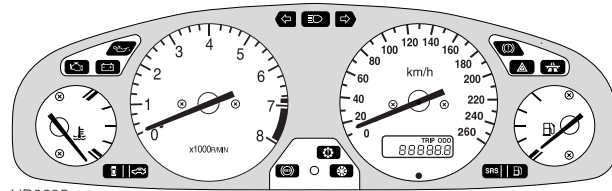

HB0285

Petrol models

**NOTE:** Some warning lights apply to different petrol models - refer to the description of the relevant warning light for confirmation of applicability.

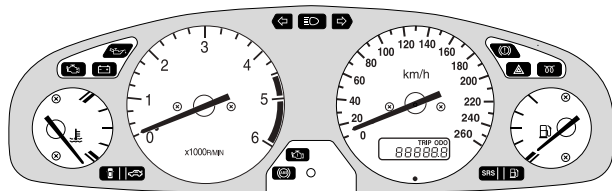

HB0286

Diesel models

#### Direction indicators - GREEN



The left or right warning light flashes in time with the left or right direction indicator lights, whenever they are operated. If either warning light fails to illuminate, or flashes very rapidly, this means that one of the indicator lights is not operating.

**NOTE:** If the hazard warning lights are operated, both warning lights will flash together.

#### Headlight main beam - BLUE



Illuminates when the headlights are switched to main beam.

#### Low oil pressure - RED



Illuminates as a bulb check when the starter switch is turned to position 'II' and extinguishes when the engine is started. If the light remains on, flashes on and off, or illuminates continuously whilst driving, serious engine damage could occur; stop the car as soon as safety permits and SWITCH OFF THE ENGINE IMMEDIATELY. Seek qualified assistance before driving.

#### Battery charging - RED



The light illuminates as a bulb check when the starter switch is turned to position 'II' and extinguishes as soon as the engine is running. If it remains on, or illuminates whilst driving, a fault with the battery charging system is indicated. Seek qualified assistance urgently.

## Warning Lights

### Check engine - AMBER



The light illuminates as a bulb check when the starter switch is turned to the second position and extinguishes when the engine is started. If the light illuminates while the engine is running, this indicates the detection of a fault by the engine management system.

**If the light illuminates, and the car drives normally:** Contact your local dealer to arrange a service appointment at your earliest convenience - YOU MAY STILL DRIVE THE CAR.

**If the light flashes and/or the car does not drive normally:** Avoid high speeds and seek immediate assistance from your dealer.

### Handbrake & brake system - RED



The light illuminates when the handbrake is applied and extinguishes when it is fully released. If the light illuminates while the handbrake is released, a fault with the braking system is indicated. You should stop the car and seek qualified assistance before continuing.

### Hazard warning lights - RED\*



Illuminates in conjunction with the direction indicator warning lights when the hazard warning lights are operated.

### Cruise control - AMBER (2.0 petrol models only)\*



The light illuminates when the cruise control master switch is switched on, and extinguishes when it is switched off.

### Glow plugs - AMBER (diesel models only)



Illuminates when the starter switch is turned to position 'II'. When the engine is cold, wait for the light to extinguish before starting.

### Door open - RED



Illuminates when any of the doors are open. DO NOT drive the car with the light illuminated.

### Luggage compartment open - RED



Illuminates if the taildoor is open. DO NOT drive the car with the light illuminated - poisonous exhaust fumes will enter the car.

### Airbag supplementary restraint system - RED



The light illuminates when the starter switch is turned to position 'II' and extinguishes within approximately six seconds. If the light fails to illuminate, or extinguish after six seconds, or illuminates once the engine is started, the system is faulty - seek qualified assistance urgently.

**NOTE:** Where a driver's airbag only is fitted, the warning light is located in the centre of the steering wheel. For driver and passenger twin airbag installations, the warning light is located on the instrument panel.

### Low Fuel - AMBER



The low fuel warning light illuminates when the fuel remaining is 8 litres or less - you should refuel at the first opportunity.

## Warning Lights

---

### Anti-lock braking system - AMBER\*



The warning light illuminates briefly when the starter switch is turned on. If the light fails to extinguish, or illuminates at any other time, there is a fault with the ABS system; on completion of your journey seek advice from your dealer before further vehicle use.

### Engine malfunction - AMBER (diesel models only)



The light illuminates when the starter switch is turned to position 'II' and extinguishes after approximately six seconds. If it remains on, or illuminates at any other time, the engine management system requires attention. Stop the car and switch off the engine for at least 30 seconds; if the light illuminates again after the engine is restarted, it is permissible to continue driving, but qualified assistance must be sought as soon as possible to prevent potential engine damage.

### Transmission fault - AMBER (1.8 automatic models)



If the light illuminates while driving, a fault with the automatic gearbox is indicated. In this eventuality, reduced performance will be evident and engine speeds will be limited to 3,500 rev/min approx.

You may continue driving but should exercise extreme caution when carrying out any manoeuvre normally reliant upon the car's speed and acceleration. On completion of your journey seek qualified assistance before further vehicle use.

### Transmission fault - AMBER (2.0 automatic models)



Illuminates when a fault with the gearbox is detected.

When the light illuminates and '4' appears in the trip recorder display, the car can still be driven to get you home, but the transmission will attempt to stay in fourth gear as much as possible, to avoid damage to the gearbox. Avoid driving any long distances and consult your dealer at the earliest opportunity.

If the light illuminates and '4' does not appear in the trip recorder display, stop the car as soon as safety permits and seek qualified assistance.

### Snow mode - GREEN (2.0 petrol models only)



Illuminates when Snow mode has been activated (see 'Snow mode', page 79) and extinguishes when Snow mode is cancelled or if the gear selector lever is moved out of position 'D' (Drive).



## Starting & Driving

### STARTER SWITCH

**!** *DO NOT* remove the key or turn the starter switch to position '0', while the car is in motion. This will cause the steering lock to engage and make it impossible to steer the car.

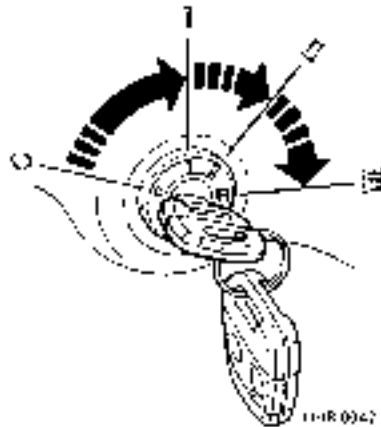

The starter switch uses the following sequence of key positions to operate the steering lock, electrical circuits and starter motor:

#### '0' - Steering locked

With the key removed, the steering column will be locked and most electrical circuits are non-operational.

#### 'I' - Steering unlocked

Turn the switch to position 'I' to unlock the steering. The audio system and cigar lighter can now be operated.

#### 'II' - Electrical circuits on

With the switch in position 'II', all instruments, lights and electrical circuits are operational.

#### 'III' - Starter motor operates

Turn the switch to position 'III' to operate the starter motor; release the key as soon as the engine starts (the key will automatically return to position 'II').

#### Unlocking the steering

After inserting the key, a small movement of the steering wheel while turning the starter switch to the first position will help to disengage the steering lock.

#### Locking the steering

After removing the key, turn the steering wheel towards the kerb until the lock engages.

## Starting & Driving

---

### PETROL MODELS

**⚠** *Never start or leave the engine running in an unventilated building – exhaust gases are poisonous and contain carbon monoxide, which can cause unconsciousness and may even be fatal.*

**⚠** *Catalytic converters can be damaged if the wrong fuel is used, or if an engine misfire occurs. Before starting the engine, you should be aware of the precautions detailed under ‘Catalytic converter’.*

#### Starting the engine

1. Check that the handbrake is on and that the gear lever is in neutral (‘N’ or ‘P’ for automatic transmission).
2. Switch off all unnecessary electrical equipment (including the air conditioning★).
3. Turn the starter key to position ‘III’ and release the key as soon as the engine has started.

**NOTE:** *Continued use of the starter will not only discharge the battery, but may damage the starter motor and the catalytic converter.*

DO NOT press the accelerator pedal while starting and DO NOT operate the starter for more than 15 seconds at a time. If the engine fails to start, switch off and wait for at least 10 seconds before trying again.

**NOTE:** *When starting manual transmission cars in freezing conditions or when the battery is in a low state of charge, depress the clutch before starting and hold it down until the engine is running.*

#### What to do if the engine fails to start, or starts but will not continue running:

- Press the accelerator pedal half way down while operating the starter. DO NOT operate the starter for more than 15 seconds and release the accelerator as soon as the engine starts.
- If the engine still fails to start, operate the starter again, this time fully depressing the accelerator pedal to clear the engine of excess fuel. Ensure the starter motor is not operated for more than 15 seconds and release the accelerator as soon as the engine starts.
- DO NOT pump the accelerator pedal during starting.

#### Starting in cold climates

In temperatures of -10° C and below, fully depress the clutch pedal while starting and hold it down until the engine is running. As the starter motor may need to operate for longer, it is essential that all unnecessary electrical equipment is switched off while cranking.

**NOTE:** *In cold conditions, engine cranking times will increase (but must not be allowed to exceed 15 seconds), and the battery charging and oil pressure warning lights may take several seconds to extinguish.*

## Starting & Driving

### DIESEL MODELS

**!** *Never start, or leave the engine running, in an unventilated building - exhaust gases are poisonous and contain carbon monoxide, which can cause unconsciousness and may even be fatal.*

**!** *Catalytic converters can be damaged if the wrong fuel is used, or if an engine misfire occurs. Before starting the engine, you should be aware of the precautions detailed under 'Catalytic converter'.*

#### Starting the engine

1. Check that the handbrake is applied and that the gear lever is in neutral.
2. Switch off all unnecessary electrical equipment (including the air conditioning).
3. Insert the key and turn the starter switch to position 'II'. Wait until the glow plug warning light extinguishes.
4. Turn the key to position 'III' to operate the starter motor; DO NOT press the accelerator pedal during starting and release the key as soon as the engine is running.

**NOTE:** *Continued use of the starter will not only discharge the battery, but may damage the starter motor and the catalytic converter.*

If the engine stalls, you MUST return the starter switch to position '0', then turn the starter switch to position 'II' and wait until the glow plug warning light goes out before attempting to restart; the engine will not start by turning the starter switch from position 'II'.

**NOTE:** *When starting cars in freezing conditions or when the battery is in a low state of charge, depress the clutch before starting and hold it down until the engine is running.*

In temperate climates, DO NOT operate the starter for longer than 10 seconds; if the engine fails to start, switch off and wait for 10 seconds before re-using the starter.

#### Precautions

- The diesel engine must not be run above fast idle speed until the oil pressure warning light extinguishes. This will ensure that the engine and turbo-charger bearings are properly lubricated before being run at speed.
- ALWAYS allow the engine to idle for 10 seconds before switching off.

#### Starting in cold climates

In temperatures of  $-10^{\circ}$  C and below, partially depress the accelerator pedal and fully depress the clutch pedal while starting. Keep the pedals in this position until the engine is running. As the starter motor may need to operate for longer, it is essential that all unnecessary electrical equipment is switched off while cranking.

**NOTE:** *In cold conditions, engine cranking times will increase (but must not be allowed to exceed 10 seconds), and the battery charging and oil pressure warning lights may take several seconds to extinguish.*

## Starting & Driving

---

### ALL MODELS

#### Warming up

In the interest of fuel economy, it is advisable to drive the car soon after starting. Remember that harsh acceleration, or labouring the engine before the normal operational temperature has been reached, can damage the engine.

#### Parking

After bringing the car to a stop, ALWAYS apply the handbrake and select neutral ('P' for cars with automatic transmission), before releasing the foot brake and switching off the engine.

**⚠** *After switching off, cooling fans may continue rotating for several minutes to prevent the engine from overheating. In some circumstances, the cooling fan may not start rotating until after the engine is switched off. If the bonnet is opened, keep clear of fans whenever the engine is warm.*

#### Towing - switching off

After periods of strenuous towing (particularly at high altitude or in hot weather), it is good practice to allow the engine to idle for a few minutes before switching off. This will enable the engine cooling system to continue operating for a while in order to reduce underbonnet heat.

### RUNNING-IN

The engine, gearbox, brakes and tyres need time to 'bed-in' and adjust to the demands of everyday motoring. During the first 1,000 km, it is essential that you drive with consideration for the running-in process and heed the following advice:

- Do not allow the engine to exceed 3,000 rev/min in any gear.
- Do not operate at full throttle in any gear.
- Do not allow the engine to labour in any gear.
- Avoid heavy braking where possible.

After the running-in distance has been completed, engine speeds can be gradually increased.

## Catalytic Converter

### CATALYTIC CONVERTER

**!** *Exhaust temperatures can be extremely high, do not park on ground where combustible materials such as dry grass or leaves could come into contact with the exhaust system - in dry weather a fire could result.*

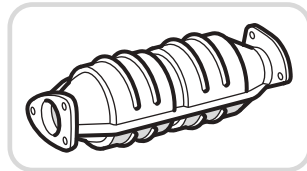
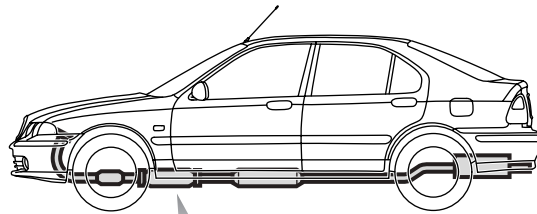

HB0160

The exhaust system on your car incorporates a catalytic converter which converts poisonous exhaust emissions from the engine into environmentally less harmful gases, thereby reducing atmospheric pollution.

Catalytic converters are easily damaged through improper use, particularly if the wrong fuel is used, so be sure to take notice of the following precautions to minimise the chance of accidental damage.

#### Fuel

- Use ONLY fuel recommended for your car.
- Never allow the car to run out of fuel - this could cause a misfire which could damage the catalyst.

#### Starting

- Do not continue to operate the starter after a few failed attempts, seek qualified assistance.
- Do not operate the starter if an engine misfire is suspected, nor attempt to clear a misfire by pressing the accelerator pedal.
- Do not attempt to push or tow start the car.

#### Driving

Any engine misfire, loss of engine performance or engine run-on, could seriously damage the catalytic converter. For this reason, it is vital that unqualified persons do not tamper with the engine, and that regular maintenance is carried out in accordance with the service interval plan in the 'Service History' section.

- Do not overload or excessively 'rev' the engine, or turn off the engine when the car is moving with a drive gear selected.
- Consult your dealer if you think your car is burning too much oil, as this will progressively reduce catalyst efficiency.
- If a misfire is suspected, or the car lacks power, you may drive SLOWLY (at risk of catalyst damage) to a dealer, provided the engine has reached its normal operating temperature.
- Do not run the engine with a spark plug or lead removed or use any device that requires an insert into a spark plug hole.
- Do not drive on terrain likely to subject the underside of the car to heavy impacts.

## Environmental Driving

---

### PROTECTING THE ENVIRONMENT

Environmental issues are increasingly influencing our lives, and the motor car is sometimes seen as a major source of air pollution.

In a great many respects, however, criticism of the car and its manufacturer is misplaced, for few industries have done more to reduce pollution than the motor industry. MG Rover is no exception. Your car has been designed with the latest technology in order to minimise the environmental impact of exhaust emissions. Even so, any further reduction in emissions is in everyone's interest and, to this end, there are a number of ways in which you, the owner, can also make a contribution.

#### Starting the engine

Although it is a common perception that cars should be 'warmed up' before being driven, this is not the case.

The majority of poisonous emissions are produced immediately following a cold start and in the period while the engine is warming up. Because the car warms up much faster while it is being driven, it is less harmful to the environment to drive away immediately after starting rather than to allow the engine to idle.

#### Driving style

The way in which you drive your car has a significant bearing on environmental pollution, as well as affecting the amount of fuel you use:

- ***Avoid full throttle acceleration***

Steady, rather than rapid, acceleration uses considerably less fuel, reduces exhaust pollutants and also minimises the wear to mechanical components.

- ***Avoid driving at maximum speed***

Fuel consumption, exhaust emissions and noise levels all increase significantly at high speeds. For example, travelling at 100 km/h uses up to 20 per cent less fuel than driving at 112 km/h.

- ***Do not drive in a low gear for longer than necessary***

Driving in lower gears uses more fuel and creates more noise. Change up to a higher gear as soon as possible, provided it does NOT cause the engine to labour.

- ***Drive smoothly***

Anticipating obstructions and slowing down well in advance, avoids the need for unnecessary acceleration and harsh braking. A smooth driving style not only reduces fuel consumption, but can reduce the emission of poisonous gases by two thirds or more.

- ***Switch off the engine when waiting in traffic***

When it is obvious that the car will be stationary for several minutes or more, and provided it is safe to do so, switch off the engine. The impact on the environment of starting the engine again will be less than the effect of allowing the engine to idle for 45 seconds or more.

## Environmental Driving

---

### Maintenance

- ***Have the car regularly serviced***

Regular servicing from a qualified technician will ensure optimum fuel economy and minimise exhaust pollutants, as well as effectively extending the service life of the car.

- ***Check the tyre pressures regularly***

Under-inflated tyres increase the rolling resistance of the car which, in turn, increases fuel consumption. Over or under-inflated tyres wear out more rapidly and also have a detrimental effect on the car's handling characteristics.

- ***Do not carry unnecessary loads***

The additional weight of unnecessary loads wastes fuel, especially in stop/start conditions where the car is frequently required to set off from stationary.

- ***Remove roof racks***

The additional air resistance created by roof racks and carriers increase drag and waste fuel (an unladen roof rack can increase fuel consumption by as much as 0.3 l/100km).

## Manual Gearbox

---

### GEAR LEVER

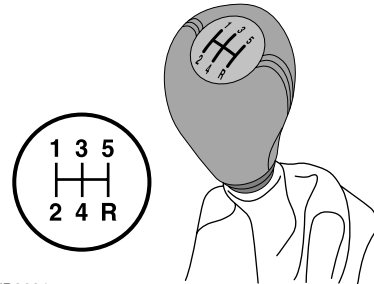

The gear positions are indicated on the gear lever knob.

Synchromesh engagement is provided on all forward gears and, in the neutral position, the gear lever is spring loaded to rest naturally between 3rd and 4th gears.

#### **Selecting reverse gear**

Before selecting reverse gear, ENSURE THE CAR IS STATIONARY; then, fully depress the clutch pedal and pause briefly before moving the gear lever into position.

### Precautions while driving

- Do not rest your hand on the gear lever while driving - pressure from your hand may cause premature wear to the gear selector mechanism.
- Do not rest your foot on the clutch pedal when driving - excessive wear to the clutch will result.
- Do not hold the car stationary on a hill by slipping the clutch. This will wear out the clutch. Always use the handbrake.



## Automatic Transmission - 1.8 models

### STEPSPEED CONTINUOUSLY VARIABLE TRANSMISSION

The 'Stepspeed' transmission system provides both automatic and manual operation of the gears.

By default the transmission is naturally in automatic mode. With the engine started, selection of 'R' (Reverse), 'N' (Neutral) or 'D' (Drive) can be made by moving the selector lever backward or forward in a similar manner to any other automatic gearbox.

However, this gearbox is of the continuously variable transmission (CVT) type. This means that the gearbox has an infinite number of ratios available to provide a continuous and smooth progression from the lowest to the highest ratio (and vice versa) without the apparent gear changes associated with a conventional automatic gearbox.

### GEAR SELECTOR

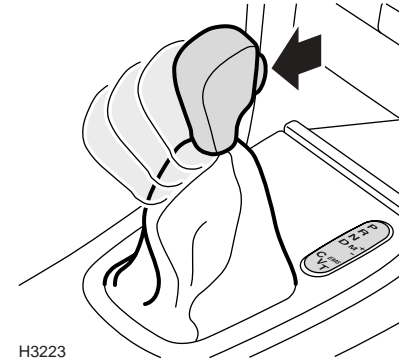

2

#### Selector release button

The gearbox is fitted with a locking mechanism, designed to minimise the risk of accidental selection of the 'P' (Park) and 'R' (Reverse) positions.

The selector release button (arrowed in illustration) must be pressed while selecting 'P' and 'R' and also to enable the lever to be moved out of the 'P' and 'R' positions.

**!** *DO NOT press the selector release button, while selecting 'N' (Neutral) from 'D' (Drive). This could result in the mis-selection of 'R' (Reverse) and cause an accident.*

**!** *To prevent transmission wear, keep engine speed as low as possible while moving the selector between 'D' (Drive) and 'R' (Reverse).*

## Automatic Transmission - 1.8 models

---

### Selector lever positions

An indicator light on the selector panel and a number or letter on the trip recorder display in the instrument panel identify the selected gear position.

**⚠ DO NOT select 'P' (Park) or 'R' (Reverse) if the car is moving.**

- 'P' - Park  
This position mechanically locks the transmission and should be selected before starting the engine and before switching the engine off. To avoid transmission damage, ensure the car is completely stationary, with the handbrake applied, before selecting 'P'.  
The selector release button **MUST** be pressed, in order to move the selector lever into, or out of, the Park position.
- 'R' - Reverse  
Before selecting reverse, ensure the car is stationary, with the brakes applied.  
Press the selector release button in order to move the selector lever into reverse.
- 'N' - Neutral  
Select neutral when the car is stationary and the engine is required to idle for a brief period (at traffic lights for example). In neutral the transmission is not locked, so the handbrake must be applied whenever 'N' is selected. Press the selector release button to move from neutral to reverse.

- 'D' - Drive  
Select this position for driving; the transmission will adjust to the appropriate ratio, according to vehicle speed and accelerator position.

**⚠ DO NOT select 'D' (Drive) when the car is moving backwards.**

### Sport mode

In Sport mode the CVT characteristics of the gearbox are retained, with full automatic progression through the gear ratios. By selecting Sport mode, however, the power transmitted to the road wheels is increased, resulting in improved acceleration. In addition, the engine revs are higher in all driving conditions, making the car more responsive to driver demands.

To select Sport mode, move the gear selector lever sideways across the gate (from the Drive position towards the RH side of the car) - the word 'SPORT' will illuminate in the display.

Sport mode can be deselected at any time by returning the selector lever to the 'D' (Drive) position.

## Automatic Transmission - 1.8 models

### MANUAL GEAR SELECTION

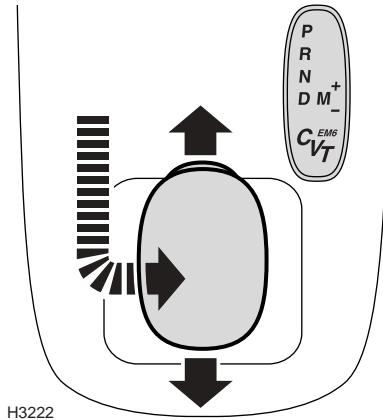

There are six predetermined gear ratios, all of which can be selected sequentially by a single forward or rearward movement of the gear selector lever, as follows:

- With 'D' (Drive) selected, move the gear selector lever sideways from the 'D' (Drive) position towards the right side of the car (this is precisely the same as selecting Sport mode).
- The transmission then automatically selects the ratio most appropriate to the car's road speed and accelerator depression.

- A single forward movement of the selector lever will change the transmission to a higher gear, while a rearward movement of the lever will change down to a lower gear. Repeated forward or rearward movements of the selector lever can be made until the desired gear ratio has been selected (the selected gear will be indicated in the digital display).
- To deselect manual mode, simply move the selector lever sideways back to the 'D' position. Automatic gear changing will then resume.

**NOTE:** The Stepspeed system is able to protect the transmission from damage by disallowing gear changes that are potentially injurious to the power unit and, similarly, by preventing gear changes that may be dangerous (e.g. changing into 1st gear at very high speed). To further protect the transmission, up-changes occur automatically whenever a predetermined engine speed is reached. Similar down-changes will also occur at low engine speeds to prevent the engine from stalling.

## Automatic Transmission - 1.8 models

---

### USING THE AUTOMATIC GEARBOX

The following information is particularly important for driver's who are unfamiliar with the techniques required to drive cars with automatic transmission.

#### Starting

The engine can only be started with the selector lever in the 'P' (Park) or 'N' (Neutral) positions.

- ALWAYS apply the handbrake and foot brake before starting the engine.
- KEEP BOTH BRAKES APPLIED while moving the selector to a drive gear position.
- DO NOT 'rev' the engine or allow it to run above normal idle speed while selecting 'D' (Drive) or 'R' (Reverse), or while the car is stationary with a drive gear already selected.
- ALWAYS keep the brakes applied until you are ready to move off - remember, once a drive gear has been selected, an 'automatic' will tend to creep forward (or backward).
- DO NOT allow the car to remain stationary for any length of time with a drive gear selected and the engine running (always select 'N' (Neutral), if the engine is to idle for a prolonged period).

#### Cold weather operation

If the car has been standing for a long period (e.g. overnight) in cold or freezing temperatures, a delay may occur between gear selection and engagement of the gearbox. This characteristic will only be evident when making the initial gear selection after a cold start, and will disappear once the car is being driven.

During this delay, the engine should be allowed to idle WITHOUT any operation of the throttle; pressing the accelerator pedal before the gears have engaged will cause an uncomfortable jolt and may even damage the transmission.

#### Driving

When driving, the transmission will automatically adjust to the most appropriate ratio, according to accelerator position, vehicle speed and terrain (whether the car is travelling uphill, downhill or on the flat).

When accelerating, the engine speed will increase above the equivalent road speed, as the transmission adjusts to the most appropriate ratio. When the accelerator pedal is released, engine speed will drop independently of road speed.

#### Parking

After bringing the car to a stop, ALWAYS apply the handbrake and select 'P', before releasing the foot brake and switching off the engine.

#### Freeing the car from snow or mud

With engine idling, select 'D' or 'R' and increase engine speed very slightly making sure the front wheels do not spin. If the wheels do spin, use minimum engine speed to regain grip. If unsuccessful, engage 'D' or 'R' alternately and use minimum engine speed until grip is regained.

#### Emergency starting



***Cars fitted with automatic transmission CAN NOT be 'push' or 'tow' started.***

## Automatic Transmission - 2.0 models

### STEPSPEED AUTOMATIC TRANSMISSION

The 'Stepspeed' transmission system provides both automatic and manual operation of the gears.

By default the transmission is naturally in automatic mode. With the engine started, selection of 'R' (Reverse), 'N' (Neutral) or 'D' (Drive) can be made by moving the selector lever backward or forward in a similar manner to any other automatic gearbox.

### GEAR SELECTOR

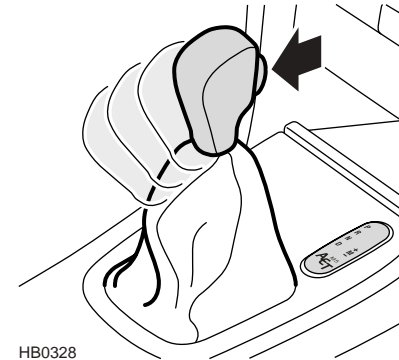

2

### Selector release button

The gearbox is fitted with a locking mechanism, designed to minimise the risk of accidental selection of the 'P' (Park) and 'R' (Reverse) positions.

The selector release button (arrowed in illustration) must be pressed while selecting 'P' and 'R' and also to enable the lever to be moved out of the 'P' and 'R' positions.

**⚠ DO NOT press the selector release button, while selecting 'N' (Neutral) from 'D' (Drive). This could result in the mis-selection of 'R' (Reverse) and cause an accident.**

**⚠ To prevent transmission wear, keep engine speed as low as possible while moving the selector between 'D' (Drive) and 'R' (Reverse).**

## Automatic Transmission - 2.0 models

---

### Selector lever positions

An indicator light on the selector panel and a number or letter on the trip recorder display in the instrument panel identify the selected gear position.

**⚠ DO NOT select 'P' (Park) or 'R' (Reverse) if the car is moving.**

- 'P' - Park

This position mechanically locks the transmission and should be selected before starting the engine and before switching the engine off. To avoid transmission damage, ensure the car is completely stationary, with the handbrake applied, before selecting 'P'.

The selector release button **MUST** be pressed, in order to move the selector lever into, or out of the Park position.

- 'R' - Reverse

Before selecting reverse, ensure the car is stationary, with the brakes applied.

Press the selector release button in order to move the selector lever into reverse.

- 'N' - Neutral

Select neutral when the car is stationary and the engine is required to idle for a brief period (at traffic lights for example). In neutral the transmission is not locked, so the handbrake must be applied whenever 'N' is selected. Press the selector release button to move from neutral to reverse.

- 'D' - Drive

Select this position for driving; the transmission will adjust to the appropriate ratio, according to vehicle speed and accelerator position.

**⚠ DO NOT select 'D' (Drive) when the car is moving backwards.**

### Sport mode

In Sport mode, full automatic progression through the gear ratios. By selecting Sport mode, however, the power transmitted to the road wheels is increased, resulting in improved acceleration. In addition, the engine revs are higher in all driving conditions, making the car more responsive to driver demands.

To select Sport mode, move the gear selector lever sideways across the gate (from the Drive position towards the RH side of the car) - the word 'SPORT' will illuminate in the display.

Sport mode can be deselected at any time by returning the selector lever to the 'D' (Drive) position.

## Automatic Transmission - 2.0 models

---

### Snow mode

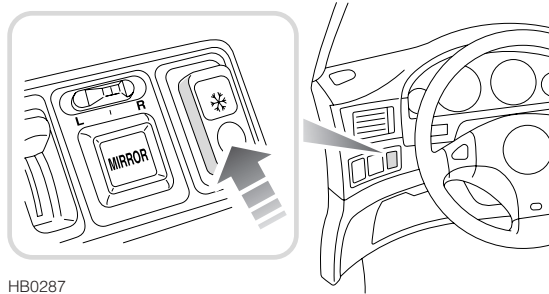

With the selector lever in 'D', press the switch on the fascia to select snow mode (the Snow mode warning light in the instrument panel will illuminate). Snow mode should be selected when moving from rest on loose or slippery surfaces. In Snow mode, the car will move off in a higher ratio, providing less torque to the road wheels, thereby reducing the possibility of wheel spin.

Press the switch again to cancel Snow mode (the warning light will extinguish).

## Automatic Transmission - 2.0 models

### MANUAL GEAR SELECTION

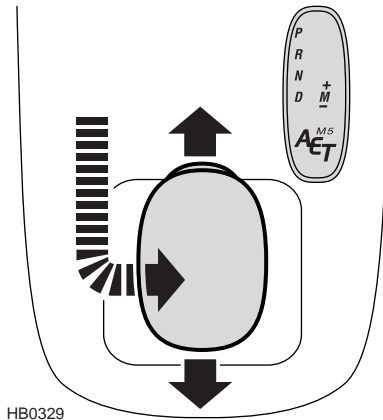

There are five predetermined gear ratios, all of which can be selected sequentially by a single forward or rearward movement of the gear selector lever, as follows:

- With 'D' (Drive) selected, move the gear selector lever sideways from the 'D' (Drive) position towards the right side of the car (this is precisely the same as selecting Sport mode).
- The transmission then automatically selects the ratio most appropriate to the car's road speed and accelerator depression.
- A single forward movement of the selector lever will change the transmission to a higher gear, while a rearward movement of the lever will change down to a lower gear. Repeated forward or rearward movements of the selector lever can be made until the desired gear ratio has been selected (the selected gear will be indicated in the digital display).

- To deselect manual mode, simply move the selector lever sideways back to the 'D' position. Automatic gear changing will then resume.

**NOTE:** The Stepspeed system is able to protect the transmission from damage by disallowing gear changes that are potentially injurious to the power unit and, similarly, by preventing gear changes that may be dangerous (e.g. changing into 1st gear at very high speed). To further protect the transmission, up-changes occur automatically whenever a predetermined engine speed is reached. Similar down-changes will also occur at low engine speeds to prevent the engine from stalling.



## Automatic Transmission - 2.0 models

---

### **AUTOMATICALLY SELECTED MODES**

The transmission control system automatically selects different gear change modes, listed below, designed to suit a variety of driving conditions.

***NOTE:** Automatically selected modes cannot be selected by the driver and will not operate if Sport or Snow mode have already been selected.*

### **Hill ascent, trailer and high altitude mode**

A suitable gear change pattern is selected to counter momentum loss, caused by the more frequent gear changing which can occur when climbing hills, or when towing a trailer or caravan. This gear change pattern is also selected at high altitudes to combat low engine torque.

### **Hill descent control**

Unless some form of braking is applied, vehicles will naturally increase speed while travelling downhill. On most automatic vehicles, this results in the highest gear being selected, thereby reducing engine braking to a minimum.

However on your vehicle, the hill descent mode provides engine braking by causing the transmission to automatically change to a lower gear on steep downhill gradients, provided the following criteria occur:

- Road speed exceeds 30 km/h.
- The foot brake is applied for at least one second.
- The accelerator pedal is fully released.

***NOTE:** Hill descent mode is cancelled when the throttle is reapplied.*

### **Stop/Go mode**

When driving in slow traffic, the 1st gear is inhibited, preventing constant gear changes between 1st and 2nd gear. The car will move off using the 2nd gear, helping to create a smoother ride.

### **Cruise control mode**

When cruise control is activated, a suitable gear change pattern is selected which is less sensitive to throttle changes. This reduces the amount and frequency of gear changes, providing a smoother ride.

### **Cold start mode**

In very cold conditions, the automatic transmission will stay in the lower gears for longer, to help the engine reach its normal operating temperature more quickly. This will help to improve overall fuel economy and driveability, and reduce emissions.

### **High coolant temperature mode**

In high ambient temperatures during extreme load conditions, it is possible for the engine and the gearbox to overheat. At a certain temperature, the transmission will select a gear change pattern designed to aid the cooling process, whilst enabling the gearbox to continue performing normally in high temperatures.

### **Smooth change mode**

Engine torque is reduced during gear changes, creating a much smoother ride.

## Automatic Transmission - 2.0 models

---

### USING THE AUTOMATIC GEARBOX

The following information is particularly important for driver's who are unfamiliar with the techniques required to drive cars with automatic transmission.

#### Starting

The engine can only be started with the selector lever in the 'P' (Park) or 'N' (Neutral) positions.

- ALWAYS apply the handbrake and foot brake before starting the engine.
- KEEP BOTH BRAKES APPLIED while moving the selector to a drive gear position.
- DO NOT 'rev' the engine or allow it to run above normal idle speed while selecting 'D' (Drive) or 'R' (Reverse), or while the car is stationary with a drive gear already selected.
- ALWAYS keep the brakes applied until you are ready to move off - remember, once a drive gear has been selected, an 'automatic' will tend to creep forward (or backward).
- DO NOT allow the car to remain stationary for any length of time with a drive gear selected and the engine running (always select 'N' (Neutral), if the engine is to idle for a prolonged period).

#### Driving

When driving, the transmission will automatically adjust to the most appropriate ratio, according to accelerator position, vehicle speed and terrain (whether the car is travelling uphill, downhill or on the flat).

#### Parking

After bringing the car to a stop, ALWAYS apply the handbrake and select 'P', before releasing the foot brake and switching off the engine.

#### Freeing the car from snow or mud

With engine idling, select 'D' or 'R' and increase engine speed very slightly making sure the front wheels do not spin. If the wheels do spin, use minimum engine speed to regain grip. If unsuccessful engage 'D' or 'R' alternately and use minimum engine speed until grip is regained.

#### Emergency starting

 **Cars fitted with automatic transmission *CAN NOT* be 'push' or 'tow' started.**

## Fuel System

---

### TYPE OF FUEL

#### Petrol engines

**Petrol fuel specification:** 95 RON unleaded petrol to EN 228 specification.

The RON value (octane rating) and type of petroleum (unleaded or leaded) available at garage forecourts, will vary in different parts of the world. For example, in most European countries 95 RON unleaded fuel is readily available, but in other parts of the world fuel supplies may be limited to leaded or lower octane fuels only.

Before a new car is delivered to the first owner, the engine is tuned to suit the fuel supplies commonly available in the market in which the car is to be purchased. However, if the car is later exported to a different country, or is used to travel between different territories, you should be aware that the available fuel supplies may not be compatible with the engine specification. If in doubt, consult an MG Rover dealer for advice.

The RON value quoted above is a MINIMUM requirement for the United Kingdom and most European markets and can be safely exceeded.

IN AN EMERGENCY (and only if the correct fuel is unavailable), lower octane rated fuel can be used for very limited periods of moderate, low speed motoring, provided engine 'knocking' does not occur.

#### Diesel engines

**Diesel fuel specification:** Good quality diesel fuel to EN 590 specification.

The quality of diesel fuel can vary in different countries and only clean, good quality fuel should be used. It is important that the sulphur content of diesel fuel does not exceed 0.3%. In Europe, all supplies should be within this limit, but in other parts of the world, you should check with your supplier.

Ensure that the fuel filter element is changed at the recommended service intervals.

### SAFETY ON THE FORECOURT

 ***Petroleum gases are highly inflammable and, in confined spaces, are also extremely explosive.***

Always take care when refuelling:

- Switch off the engine.
- Do not smoke or use a naked flame.
- Do not use a mobile phone.
- Avoid spilling fuel.
- Do not overfill the tank.

## Fuel System

### FUEL FILLER

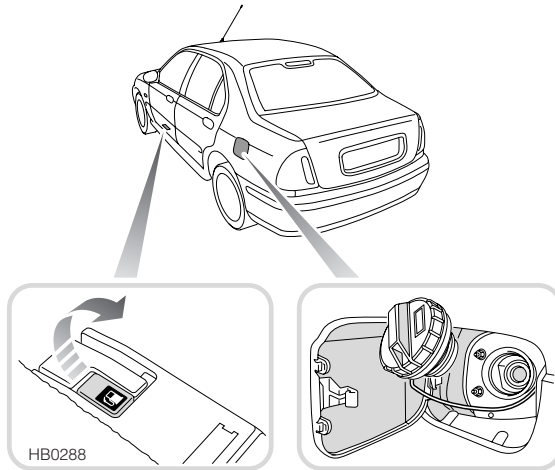

#### Fuel filler flap

The fuel filler is located in the rear left-hand wing. Pull the floor mounted lever adjacent to the driver's seat to release the fuel filler flap.

#### Fuel filler cap

Unscrew slowly to remove. When replacing, tighten clockwise until the fuel cap ratchet clicks at least three times. Remember to close the filler flap after refuelling.

### FUEL FILLING

**!** *Use only the recommended fuel! Serious damage to the catalytic converter will occur if the wrong fuel is used.*

Always fill the tank SLOWLY, until the filler nozzle automatically cuts-off the fuel supply. DO NOT attempt to fill the tank beyond this point, or spillage could result due to expansion of the fuel.

#### Petrol engines

The filler tube is designed to accept a narrow filler nozzle, of the type found on pumps that deliver ONLY unleaded fuel. A flap lies across the filler neck; insert the nozzle sufficiently to fully open the flap before filling.

**!** *DO NOT fully fill the tank if the vehicle is to be parked in direct sunlight, or high ambient temperature - expansion of the fuel could cause spillage.*

#### Diesel engines

The diesel fuel filling system on garage forecourts is designed to fill at a maximum of 45 litres per minute. Use of commercial vehicle diesel pumps with a higher fill rate, may result in premature pump cut-off and fuel spillage.

## Fuel System

### Filling difficulties

The fuel delivery rate of filling station pumps, can vary significantly from one garage forecourt to another. This, coupled with the fact that modern pumps are equipped with a sensor which automatically cuts off the supply as soon as turbulence is detected in the upper part of the car's filler neck, could result in isolated fuel filling problems.

If individual owners experience difficulty, the following advice may be useful:

- Fully insert the filler gun, then withdraw the gun up to the first ridge on the underside of the nozzle.
- Hold the filler gun with the trigger directly below the nozzle (at right angles to the ground). Twisting the gun to either side, is unlikely to ease the filling process.
- Fill the tank slowly - DO NOT fully squeeze the trigger.

### EMPTY FUEL TANK

**!** *Never allow the car to run out of fuel - the resultant misfire could destroy the catalytic converter.*

### Petrol engines

In the event of the fuel tank running dry, start the engine carefully after refuelling. If the engine runs unevenly, switch off and contact your dealer before attempting to restart the engine.

### Diesel engine

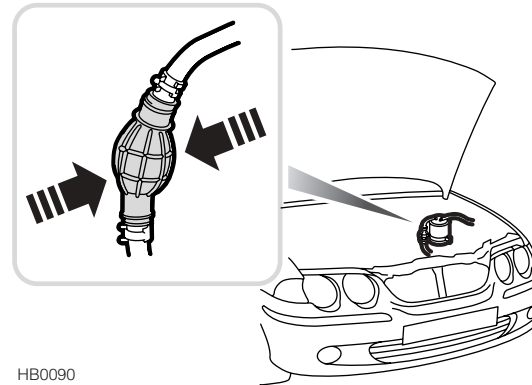

In the event of the fuel tank running dry, it will be necessary to hand-prime the fuel system (after refuelling) by squeezing the priming bulb in the engine compartment (where shown in illustration), until the bulb feels solid.

Take care to ensure that the primer bulb is not trapped when the bonnet is closed. DO NOT attempt to start the engine until the system is properly primed.

## Fuel System

---

### FUEL CUT-OFF SWITCH (Petrol engine models only)

**!** *ALWAYS check for fuel leaks before resetting the fuel cut-off switch.*

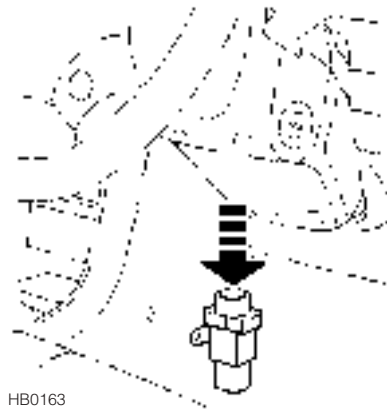

The fuel cut-off switch is a safety device which, in the event of a collision or sudden impact, automatically cuts off the fuel supply to the engine.

The switch is located behind the front ashtray on the driver's side of the centre console. After the switch has been activated, it must be reset by pressing the rubber top (arrowed in illustration) before the engine can be restarted.

**NOTE:** *On diesel models, the fuel cut-off system resets automatically and therefore, does not need to be reset by the driver.*

## Lights & Indicators

### LIGHTING SWITCH

#### Side and headlights

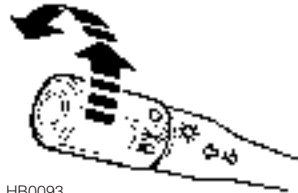

HB0093

Turn the control to the first position to illuminate the side, tail and instrument panel lights. Turn the control to the second position to illuminate the headlights.

#### Headlight main and dipped beams



HB0094

Pull the lever fully towards the steering wheel to change headlight beams (the BLUE warning light on the instrument panel illuminates when the headlights are on main beam).

To briefly flash the main beams on and off, pull the lever part way towards the steering wheel and then release.

**⚠ Take care not to dazzle oncoming vehicles when driving using main beam headlights.**

### Direction indicators

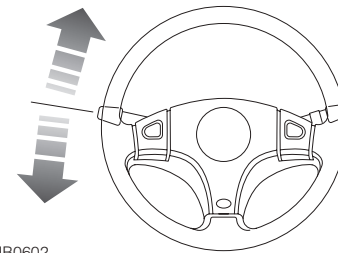

HB0602

Move the lever down to indicate a LEFT turn, or up to indicate a RIGHT turn. The indicators will cancel automatically once a turn has been completed.

Hold the lever half-way up or down against spring pressure to indicate a lane change.

The appropriate GREEN warning light on the instrument panel will flash in time with the direction indicators.

#### 'Lights on' warning buzzer

If the exterior lights are left on after the starter switch is turned off, a warning buzzer will sound as soon as the driver's door is opened. The buzzer will cease as soon as the lights are switched off, or the door is closed.

## Lights & Indicators

---

### HEADLIGHT BEAM HEIGHT CONTROL

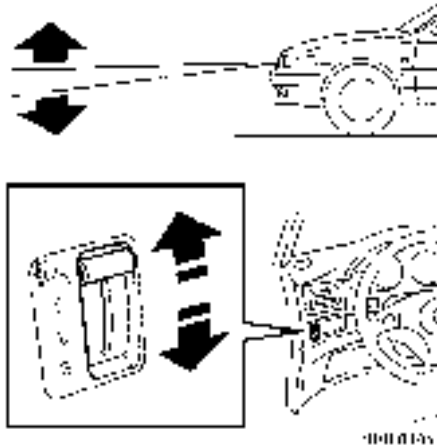

The angle of the dipped beams is affected by the distribution of passenger and luggage weight within the car. It is important that the headlights are adjusted to ensure that the point at which they meet the road surface provides adequate illumination ahead of the vehicle, without dazzling other road users.

Using the following load conditions as a guide, adjust the height of the headlight beams by moving the control up or down (see inset).

- **Position '0'**  
Driver, or driver and front seat passenger only (no luggage).
- **Position '1'**  
Driver and four passengers (no luggage).
- **Position '2'**  
Driver, four passengers and FULL luggage compartment.
- **Position '3'**  
Driver, NO passengers and FULL luggage compartment.

*NOTE: These loading definitions assume that all loads will be within the limits of the maximum permissible axle and vehicle weights*



## Wipers & Washers

### WIPER CONTROLS

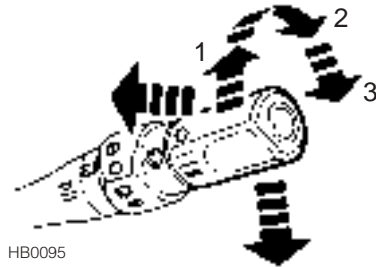

The wipers and washers will only operate when the starter switch is turned to position 'II'.

Rotate the end of the lever to select different wiper speeds

1. Intermittent wipe
2. Normal speed wipe
3. Fast speed wipe

#### IMPORTANT

- DO NOT operate the wipers on a dry screen.
- In freezing or very hot conditions, ensure that the blades are not frozen or stuck to the glass before being operated.
- In winter, remove snow or ice from around the arms and blades, including the wiped area of the screen.

*NOTE: If reverse gear is selected while the front wipers are operating (at any speed setting), the rear screen wiper will operate automatically for three wipes.*

### Single wipe

Pull the lever down and release immediately.

*NOTE: With the lever held down, the wipers will operate at high speed until it is released.*

### Windscreen washer

Pull the lever towards the steering wheel. The windscreen washers will operate for as long as the lever is held in this position.

*NOTE: The wipers operate automatically during windscreen washing.*

On cars fitted with heated windscreen washer jets, the heater prevents the jets from being rendered inoperative by freezing, but does not prevent the water from freezing on the screen; therefore, a suitable screenwash must still be added to the washer reservoir (see 'WINDSCREEN WASHER TOP-UP', page 143).

## Wipers & Washers

---

### Rear window wash/wipe

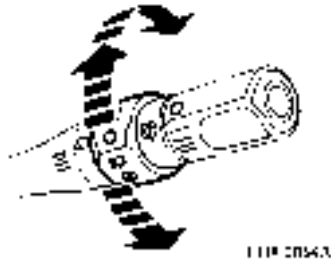

Rotate the switch clockwise to the first position to operate the rear wiper. After wiping continuously four times, the wiper continues intermittently until switched off.

Rotate the switch further clockwise, to the second position, to operate the rear screen washer AND wiper. Hold in this position for the required duration of the wash.

Rotate the switch anti-clockwise to operate the rear screen washer alone (without the wiper).

**NOTE:** *If reverse gear is selected while the front wipers are operating (at any speed setting), the rear screen wiper will operate automatically for three wipes.*

### HEADLIGHT WASHERS\*

The headlight washers operate automatically with the front screenwash system, provided the headlights are switched on.

## Fascia Switches

### Fascia Switches

 **Fog lights should ONLY be used when visibility is severely restricted – other road users could be dazzled in clear conditions.**

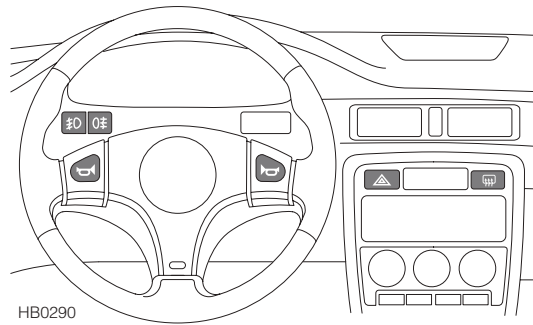

### Rear screen demister

 Press to operate; the indicator light in the switch illuminates whenever the demister is on and extinguishes when the demister is turned off.

The demister will only function with the engine running and will switch off automatically after approximately 15 minutes.

 **The heating elements on the inside of the rear screen are easily damaged. DO NOT scrape or scratch the glass. DO NOT stick labels over the heating elements.**

### Horn

 To operate, press either of the switches set into the steering wheel pad.

### Hazard warning lights

 Press to operate. All the direction indicators and direction indicator warning lights will flash together. Use ONLY in an emergency to warn other road users when your car is causing an obstruction or is in a hazardous situation. Remember to switch off before driving away.

### Front fog lights\*

 Press to operate; the indicator light in the switch illuminates when the fog lights are on and extinguishes when they are switched off. The fog lights will only operate with the starter switch in position 'II' and with the side or headlights turned on.

The front fog lights extinguish automatically when the sidelights or starter switch are turned off but will illuminate again as soon as the starter switch and sidelights are next switched on, unless deselected manually.

**NOTE:** If the sidelights are left on when the starter switch is turned off, the indicator light in the front fog light switch remains on to remind drivers to manually deselect the fog lights if they are not needed.

### Rear fog guard lights

 Press to operate; the indicator light in the switch illuminates when the rear fog guard lights are on, and extinguishes when they are switched off. The rear fog guard lights operate ONLY when the starter switch is at position 'II' and when the headlights or front fog lights are switched on.

**NOTE:** The rear fog guard lights extinguish automatically when the headlights are switched off and will need to be reselected manually.

## Cruise Control

### CRUISE CONTROL

Cruise control enables the driver to maintain a constant road speed without using the accelerator pedal. This is particularly useful for motorway cruising, or for any journey where a constant speed can be maintained for a lengthy period.

The cruise control system has three switches; a master switch on the fascia panel (highlighted in illustration) and two control switches, marked 'SET+' and 'RES', mounted on the steering wheel.

#### IMPORTANT

- DO NOT use cruise control on winding or slippery roads, or in traffic conditions where a constant speed cannot easily be maintained.
- ALWAYS switch off the master switch when you no longer intend to use cruise control.
- DO NOT rest your foot under the accelerator pedal while cruise control is engaged - your foot could be trapped.

### Engaging cruise control

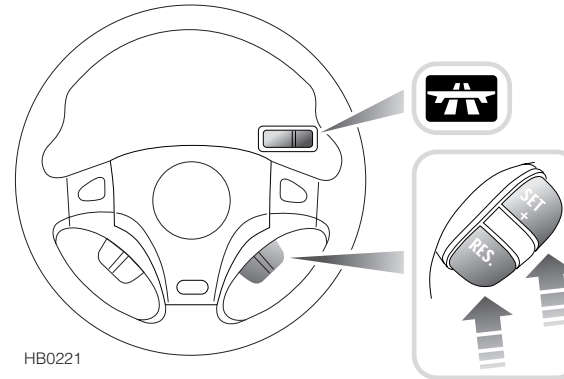

1. Press the master switch (the warning light in the instrument panel illuminates).
2. Accelerate until the desired speed is reached (this must be above the systems minimum operational speed of 45 km/h).
3. Press the 'SET+' switch to set the road speed in the cruise control system's memory. Cruise control will now maintain that road speed automatically.

With cruise control operating, speed can be increased temporarily, eg. for overtaking, by normal use of the accelerator. When the accelerator is released, road speed will return to the selected cruising speed.

## Cruise Control

---

### To increase cruising speed

Press and hold the 'SET+' switch; the car will accelerate automatically. Release the switch when the desired speed has been reached. Alternatively, the speed can be increased incrementally by slowly tapping the 'SET+' switch. For each tap the speed will increase by 1.6 km/h.

### To reduce cruising speed

Use one of the following methods:

- Use the brake pedal to slow the car until the required speed has been reached, then press the 'SET+' switch to establish a new cruising speed (remember that cruise control will not operate at speeds below 45 km/h).
- Alternatively, press the 'RES' switch once. This will cut off cruise control and, provided the brake pedal is not used, the car will slow down gradually. When the desired speed has been reached, press the 'SET+' switch to establish the new cruising speed.

### Disengaging cruise control

Cruise control will disengage, without cancelling the speed held in its memory, when:

- The brake or clutch pedal is pressed.
- Your road speed falls to less than 75% of the set speed (this could occur when climbing hills or when towing).
- The 'RES' switch is pressed.

To re-engage cruise control at the previously set speed, press the 'RES' switch.

**NOTE:** *The speed held in the cruise control memory will be cancelled when either the cruise control master switch, or the starter switch are turned off.*

## Brakes

---

### FOOT BRAKE

The hydraulic braking system operates through dual circuits; if one circuit should fail, the other will continue to function. However, in the event of a brake failure where only one circuit is operational, the car should **ONLY** be driven at slow speed to the nearest dealer. In these circumstances, exercise **EXTREME CAUTION** and be aware that much greater pedal effort and longer stopping distances will be required.

### Servo assistance

The braking system is servo assisted, but **ONLY** while the engine is running. Without servo assistance greater brake pedal effort is necessary to safely control the car, resulting in longer stopping distances. Always be aware of the following:

- **NEVER** allow the car to freewheel with the engine turned off.
- **ALWAYS** take particular care when being towed with the engine turned off.

If the engine should stop for any reason while driving, bring the car to a halt as quickly as traffic conditions safely allow, and **DO NOT** pump the brake pedal lest the braking system lose any remaining servo-assistance available.

**⚠** ***NEVER** move the car without the engine running because brake servo assistance may not be available. The brakes will still function, but more pedal pressure will be required to operate them.*

### Wet conditions

Driving through water or even very heavy rain may adversely affect braking efficiency. Dry the braking surfaces by intermittent light application of the foot brake, after first ensuring that you are at a safe distance from other road users.

## Brakes

### Brake system warning light



The light illuminates when the handbrake is applied and extinguishes when it is fully released. If the warning light illuminates while driving, or fails to extinguish when the handbrake is fully released, a fault with the braking system is indicated. Check the brake fluid level; if the light continues to illuminate, seek qualified assistance before continuing.

**!** *If the brake warning light illuminates while driving, bring the car to a halt as quickly as traffic conditions and safety permit and seek qualified assistance before continuing. Do not drive with the warning light illuminated.*

### Brake pads

Brake pads require a period of bedding in. For the first 300 km, avoid situations where heavy braking is required.

Remember that regular servicing is vital to ensure that all the brake components are examined for wear at the correct intervals, and changed when required to ensure long term safety and optimum performance.

**!** *DO NOT rest your foot on the brake pedal while driving; this may overheat the brakes, reduce their efficiency and cause excessive wear.*

### Brake wear indicators

All disc brakes are fitted with audible brake wear indicators. When the brake pads need replacing, a distinctive metallic 'screeching' sound will be heard (this is not to be confused with the sound of brakes squeaking, which sometimes occurs during light braking and is usually caused by dust on the braking surfaces).

### HANDBRAKE

**!** *DO NOT drive with the handbrake applied, or apply the handbrake while the car is in motion; this could result in loss of control, prevent the anti-lock braking system from functioning correctly, and may even cause damage to the rear brakes.*

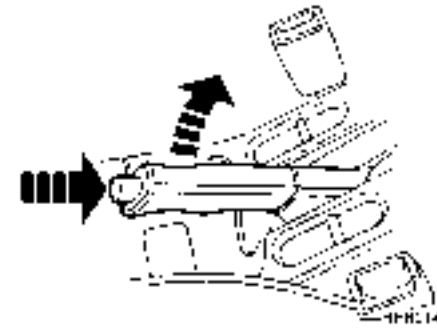

The handbrake operates on the rear wheels only. To apply the handbrake, pull the lever up. Always apply the handbrake FULLY whenever you park the car.

To release, pull the lever up slightly, depress the button (arrowed in illustration) and fully lower the lever.

When parking on a steep slope, do not rely on the handbrake alone to hold the car. On manual gearbox models, leave the car parked with the gearbox in a low forward gear when facing uphill and in reverse gear when facing downhill. On automatic gearbox models, selection of 'P' (park) will lock the transmission and, together with the handbrake, prevent the car from rolling away.

2

## Brakes

---

### ANTI-LOCK BRAKES (ABS)

**!** *ABS cannot overcome the physical limitations of stopping the car in too short a distance, cornering at too high a speed, or the danger of aquaplaning, i.e. where a layer of water prevents adequate contact between the tyres and the road surface.*

*The fact that a car is fitted with ABS must never tempt the driver into taking risks that could affect his/her safety or that of other road users. In all cases, it remains the driver's responsibility to drive within normal safety margins, having due consideration for prevailing weather and traffic conditions.*

The purpose of the anti-lock braking system (ABS) is to prevent the wheels from locking while braking, thereby enabling the driver to retain steering control of the car.

Under normal braking conditions, (where sufficient road surface friction exists to reliably bring the car to a halt without the wheels locking), ABS will not be activated. However, should the braking force exceed the available adhesion between the tyres and the road surface causing the wheels to lock (on slippery roads, for example), then ABS will automatically come into operation.

This will be recognisable by a rapid pulsation felt through the brake pedal.

### Electronic brake force distribution

Your car is equipped with Electronic Brake force Distribution (EBD), which, in order to maintain braking efficiency, automatically proportions the distribution of braking forces between front and rear axles, under all load conditions.

For example; under light loads EBD applies less effort to the rear brakes in order to maintain vehicle stability; however if the car is heavily laden or towing, then more effort will be applied to the rear brakes.

The EBD system incorporates a monitoring system, which checks that all electrical components are in working order when the starter switch is turned on and also at frequent intervals while the car is being driven. The EBD monitoring system is linked to the brake system warning light on the instrument panel. If this light illuminates while driving, or remains illuminated for more than three seconds after the starter switch is turned on, there is a fault with the braking system, and EBD may not be available. If this occurs, stop the car as soon as safety permits and seek qualified assistance immediately. **DO NOT** drive the car with the brake system warning light illuminated.



## Brakes

### Braking in an emergency

 **DO NOT pump the brake pedal at any time; this will interrupt operation of the ABS and may increase braking distance.**

If an emergency situation occurs, the driver should apply full braking effort even when the road surface is slippery. The anti-lock braking system will constantly monitor the rotational speed of the wheels and vary braking pressure to each according to the amount of traction available. This will ensure that the wheels do not lock and that the car is brought to a halt in the shortest possible distance for the prevailing road surface conditions.

**NOTE:** *On soft surfaces such as powdery snow, sand or gravel, the braking distance required by the anti-lock braking system may be greater than for non-ABS braking, even though improved steering would be experienced. This is because the natural action of locked wheels on soft surfaces is to build up a wedge of surface material in front which assists the car to stop.*

No matter how hard you brake, you should be able to continue steering the vehicle as NORMAL.

However, always remember that anti-lock braking operates only AFTER the driver has already lost control. ABS cannot reliably compensate for driver error or inexperience.

### ABS Warning light



The ABS incorporates a monitoring system, which checks that all the electrical components are in working order as soon as the starter switch is turned on, and also at frequent intervals during a journey.

The warning light on the instrument panel is an important part of this system. The light should illuminate for approximately 2 seconds when the starter switch is turned to the second position and then extinguish.

If the warning light fails to extinguish or illuminates while driving, a fault has been detected by the self-monitoring system and full ABS control may not be available. If this occurs, consult your dealer at the earliest opportunity.

In addition, when starting the engine, a single 'knock' may be heard coming from the engine compartment. Very slight movement may also be felt at the brake pedal. Both are normal symptoms of the anti-lock braking system self-checking process.

**NOTE:** *The normal (non-ABS) braking system remains fully operational and is not affected by partial or full loss of the ABS. However, braking distances may increase.*

## Parking Aid

### PARKING AID\*

**!** *The parking aid is not infallible. It is for guidance only! The sensors may not be able to detect certain types of obstruction, e.g. narrow posts or small objects no more than a few inches wide, small objects close to the ground, objects above the level of the boot and some objects with non-reflective surfaces.*

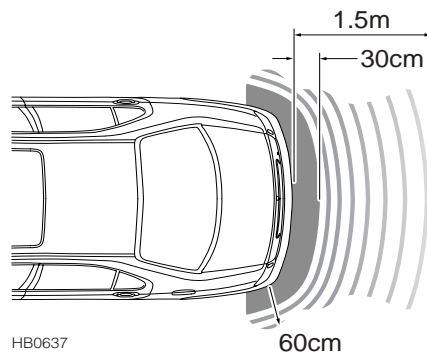

Four ultrasonic sensors, situated in the rear bumper, scan an area behind the car, searching for obstructions. If an obstruction is detected, the sensors calculate its distance from the rear of the car and communicate this information to the driver by sounding warning chimes. It is important to remember that the system is no more than an AID to parking. It is not foolproof in operation, nor is it a substitute for observation and personal judgement.

**!** *Keep the sensors free from dirt, ice and snow. If deposits build up on the surface of the sensors, their performance may be impaired. When washing the car, avoid aiming high pressure water jets directly at the sensors from close range.*

### Parking aid in operation

With the starter switch turned to position 'II', the parking aid operates automatically whenever reverse gear is selected and is switched off as soon as reverse is deselected.

When reverse is selected a short 'bleep' will sound to confirm that the system is working (note that a one second delay will occur before the 'bleep' sounds).

**NOTE:** *If a longer, higher pitched sound is emitted (for a duration of 5 seconds) when reverse gear is selected, this indicates a fault with the system - contact your dealer for assistance.*

While reversing:

- If an obstruction is located within the 1.5 m range of the rear parking aid sensors, or 60 cm of the corner sensors, the warning commences chiming. As the car moves closer to the obstruction, the chimes are transmitted more rapidly.
- Once the obstruction is within 30 cm of the rear bumper, the chimes merge into a continuous warning tone.

**NOTE:** *In the case of cars equipped with factory fitted towing equipment, the parking aid will not operate while a caravan or trailer is hitched to the car.*

- If the distance between the car and an obstruction to the side of the car remains unchanged for over three seconds, the warning chimes cease.

## ***Audio System***

---

- 100** Audio System Identification*
- 101** Radio Reception*
- 102** Remote Audio Controls*
- 103** Radio*
- 108** Cassette Player*
- 110** Compact Disc Player*
- 114** Radio Tuning*
- 119** Traffic Information*
- 120** Radio Data System*
- 121** Clock & Time*
- 122** Menu Functions*
- 123** CD Changer*
- 125** Security Code*

## Audio System Identification

### AUDIO SYSTEM SPECIFICATION

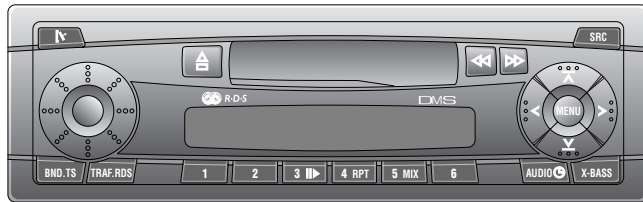

AS0039

*CC32 Audio System  
(radio/cassette player)*

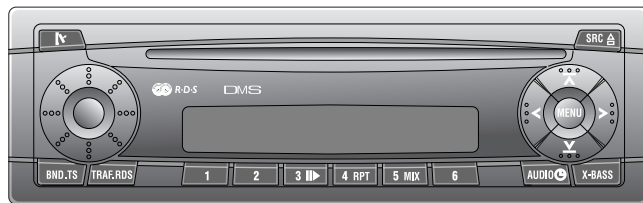

AS0031

*CD32 Audio System  
(radio/single-play CD player)*

This section of the handbook covers only those audio systems fitted as standard to cars within the model range at the time of manufacture.

If, at the time of ordering your car, you specified a different audio system, it will have been fitted by your dealer before you took delivery of your car. In this case, you will have received an additional operating manual detailing the features and operation of your audio system, which should be used in place of the instructions that follow.

You are requested to read the audio operating instructions carefully in order to gain maximum enjoyment from the system.

#### **CD changer location\***

The optional CD changer is mounted in the luggage compartment. For operating instructions, see '*MULTI-CD CHANGER CONTROLS\**', page 112 and '*10-DISC CHANGER*', page 123.

## Radio Reception

### RADIO RECEPTION

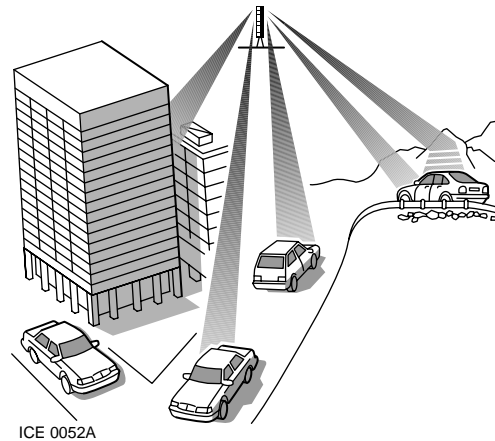

Distortion, interference and lack of signal clarity, are often attributed to a fault in the radio - this is rarely the case.

Problems of this kind are usually caused by phenomena such as atmospheric conditions, signal strength, hilly terrain, tall buildings, bridges and even electrical interference from power lines.

**Please remember:** A car radio receives signals while the vehicle is in motion (unlike a domestic set) - constantly changing direction and moving away from, or nearer to, the transmitter whilst negotiating terrain with widely differing reception characteristics. Some interference is to be expected from time to time.

FM transmitters can only broadcast over a limited range and good, clear signals will only be received in the immediate area of the transmitter. When travelling, it may be necessary to re-tune the radio from time to time, to offset the effects of moving from one transmitter area to another.

While RDS automatic retuning eases this problem, some manual retuning may still be needed (especially for local stations) in areas of weak reception.

The broadcast range for good stereo reception (usually within a 50 to 65 km radius of the transmitter) is noticeably less than it is for mono.

FM Signals (like light waves) travel in a straight line, so large obstacles, such as tall buildings, can shield the car from the signal causing distortion or loss of reception (known as dead spots).

Distortion can also occur if FM signals received directly from the transmitter mix with signals which have been reflected by obstructions such as mountains, hills and tall buildings (this is known as multi-path distortion).

## Remote Audio Controls

---

### REMOTE AUDIO CONTROLS\*

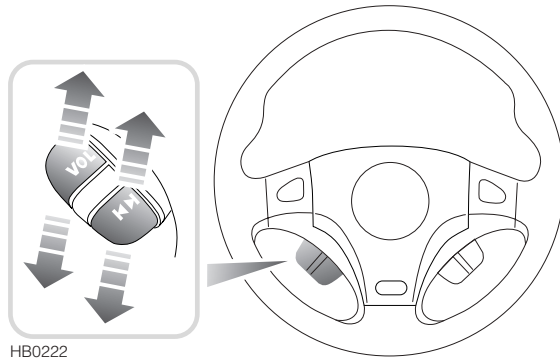

#### Volume control

**VOL.** Lift or press the switch to increase or decrease volume.

#### Search/select control

**◀▶** Lift or press the switch to search forwards or backwards through the frequency range.

## Radio

### DETACHABLE CONTROL PANEL

For added protection against theft, remove the control panel and take it with you when you leave the car. DO NOT leave the control panel inside the car.

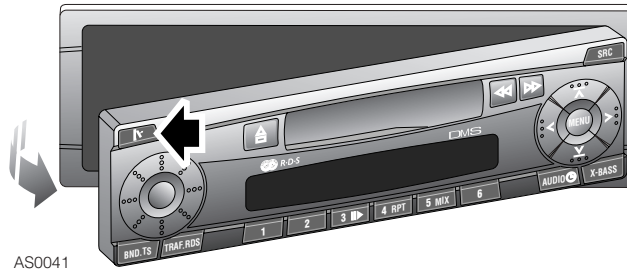

### Removing the control panel

Press the release button (arrowed in illustration) to unlock the control panel, then pull the control panel away from the audio unit as shown.

If the audio unit is switched on when the control panel is removed, the unit switches off automatically and switches back on when the control panel is replaced.

**NOTE:** If a tape or CD is loaded, it need not be ejected before removing the control panel.

When not in use, keep the control panel in the protective case supplied.

### Replacing the control panel

Place the right side of the panel into position, then push the left-hand side into the front of the audio unit until it clicks into place.

#### IMPORTANT

- DO NOT subject the control panel to severe shocks, or expose it to direct sunlight or other sources of heat.
- Avoid direct skin contact with the electrical contacts on the rear of the control panel. Periodically, clean the contacts on both the control panel and audio unit with a clean, dry, lint-free cloth, or use methylated spirits if available.
- When replacing the control panel, do not press the display.

3

# Radio

## SOUND CONTROLS

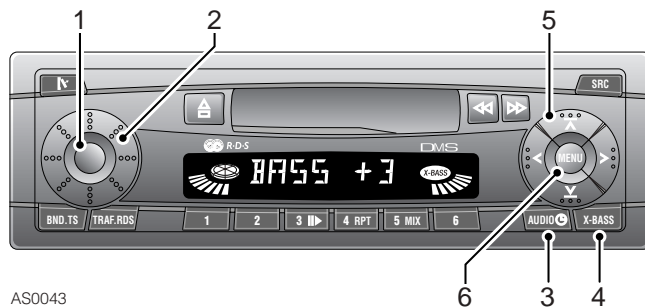

AS0043

### 1. On/off button

Press to switch on (the display shows 'CODE' followed by 'ROVER'). Press and hold for at least two seconds to switch off.

**NOTE:** The audio unit can be operated without the starter switch turned on. However, it will switch off automatically after one hour in order to avoid draining the battery.

### 2. Volume control

The volume can be adjusted in steps from 0 to 66. Rotate to left or right (the volume level is shown in the display).

The volume can also be adjusted using the remote switches on the steering wheel (see 'REMOTE AUDIO CONTROLS\*', page 102).

**NOTE:** If you have a car telephone with a mute signal output connected to the stereo system, radio tape or CD play automatically mutes to a preset level while the telephone is in use (see 'Muting the sound', page 105).

### 3. Audio selection control

Use in conjunction with the <> and  $\uparrow$   $\downarrow$  controls (5) to adjust bass, treble, balance and fader levels. Note that different bass and treble levels can be set for each sound source (e.g. radio, tape or CD).

**Bass:** To increase or reduce bass response:

1. Press the AUDIO control - ('BASS' shows in the display).
2. Press  $\uparrow$  or  $\downarrow$  to adjust bass response.
  - 'BASS +7' = maximum bass
  - 'BASS 0' = normal bass
  - 'BASS -7' = minimum bass

**Treble:** To increase or reduce treble response:

1. Press the AUDIO control - ('BASS' shows in the display).
2. Press either < or > until 'TREB' appears in the display.
3. Press  $\uparrow$  or  $\downarrow$  to adjust treble response.
  - 'TREB +7' = maximum treble
  - 'TREB 0' = normal treble
  - 'TREB -7' = minimum treble

**Balance:** To adjust the balance between right and left speakers:

1. Press the AUDIO control - ('BASS' shows in the display).
2. Press either < or > until 'BAL' appears in the display.
3. Press the  $\uparrow$  or  $\downarrow$  to adjust the right/left balance.
  - 'BAL +9' = maximum sound from RIGHT
  - 'BAL 0' = equal balance
  - 'BAL -9' = maximum sound from LEFT



## Radio

---

**Fader:** To adjust the balance between front and rear speakers:

1. Press the AUDIO control - ('BASS' shows in the display).
2. Press < or > until 'FADER' appears in the display.
3. Press  $\updownarrow$  or  $\updownarrow$  to adjust the front/rear balance.
  - 'FADER +9' = maximum sound from FRONT
  - 'FADER 0' = equal balance
  - 'FADER -9' = maximum sound from REAR

#### 4. X-Bass control

Use the X-BASS feature to boost bass responses at low volume. Separate levels can be set for each sound source (e.g. radio, tape or CD).

1. Press the X-Bass control.
2. Repeatedly press either the <> or  $\updownarrow$  controls (5) until the required setting is displayed.
  - 'X BASS OFF' = feature switched off.
  - 'X BASS 1' = minimum boost.
  - 'X BASS 2' = medium boost.
  - 'X BASS 3' = maximum boost.
3. Press the X-Bass control to store the required setting.

**NOTE:** After 8 seconds without further adjustment, all audio settings are stored and the selection mode (including X-BASS) cancels automatically.

#### Muting the sound

Briefly press the on/off button (1) ('MUTE' appears in the display). The volume will instantly reduce to a preset level. The preset volume level can be adjusted as follows:

1. Press the MENU button (6).
2. Press the  $\updownarrow$  control until 'MUTE LVL' is displayed.
3. Press the <> controls to adjust the volume.
4. Press the MENU button twice to store the setting.

#### Setting the power-on volume

The default volume (the volume level present when the audio unit is switched on) can be adjusted, as follows:

1. Press the MENU button (6).
2. Press  $\updownarrow$  until 'ON VOL' is displayed.
3. Press < or > to reduce or increase the volume.
4. Press the MENU button twice to store the setting.

**NOTE:** If 'LAST VOL' is selected, the power-on volume will be the same as the volume level that was set when the unit was last switched off, provided this did not exceed volume level 38.

## Radio

---

### **Output level display**

Illuminated bars flash in the display to provide a graphic indication of the sound control settings as they are adjusted. At other times, the display symbolises the radio's output level. The output level display can be enabled or disabled as follows:

1. Press the MENU button (6).
2. Press the **↔** control until 'PEAK LVL' is displayed.
3. Press **<** or **>** to select 'PEAK ON' or 'PEAK OFF'.
4. Press the MENU button twice to store the setting.

### **Treble reduction feature (HICUT) - FM only**

HICUT improves reception in poor operating conditions. If interference occurs, the treble is automatically reduced. The feature can be enabled or disabled as follows:

1. Press the MENU button (6).
2. Press the **↔** control until 'HICUT' is displayed.
3. Press the **<** or **>** controls to select 'HICUT 1' (treble reduction activated), or 'HICUT 0' (no treble reduction).
4. Press the MENU button to store the setting.

# Radio

## RADIO CONTROLS

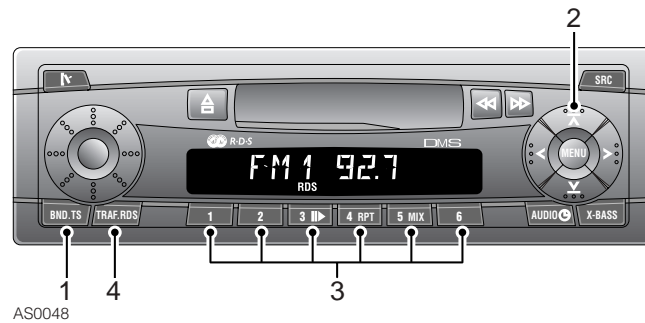

### 1. Waveband/Travelstore selector (BND.TS)

Press briefly to select the required waveband. There are three memory banks for the FM waveband (FM1, FM2 and FMT - each has the same tuning range) and two AM wavebands, MW and LW.

Press and hold to activate Travelstore (see 'TRAVELSTORE', page 117).

**NOTE:** Pressing the waveband selector briefly during tape or CD play will change the audio mode to radio tuner operation.

### 2. Tuning controls

Briefly press either the **▲** or **▼** controls. The unit automatically searches up or down the frequency range and tunes to the next receivable station (see 'TUNING', page 114).

Radio frequencies can also be selected using the remote switches on the steering wheel (see 'REMOTE AUDIO CONTROLS\*', page 102).

### 3. Pre-set buttons

Use to store up to 6 radio stations on each waveband or memory bank (see 'Programming the pre-sets', page 116).

Press briefly to select a stored frequency.

Press and hold to store a frequency.

### 4. Traffic information/RDS control

**Traffic information:** Press briefly to switch on (or switch off) traffic information mode (see 'Selecting traffic information', page 119). Press briefly to return to normal radio, tape or CD reception during a traffic information broadcast.

**Radio Data System (RDS):** Press and hold for two seconds or more to select or inhibit RDS (the 'RDS' indicator illuminates when RDS has been activated) (see 'RADIO DATA SYSTEM (RDS)', page 120).

## Cassette Player

### CASSETTE PLAYER CONTROLS (CC32 only)

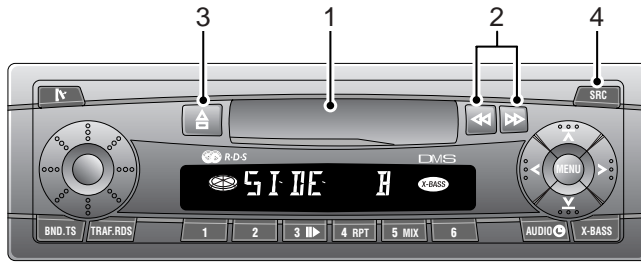

AS0040

#### 1. Cassette compartment

Insert the tape with the open side to the right and push in carefully. The radio mutes and tape play starts immediately (display shows 'CASSETTE' then 'SIDE A' or 'SIDE B').

At the end of either side of the tape, play automatically continues in the opposite direction.

If the set is switched off during tape play, the cassette remains in stand-by mode. Play resumes when the set is switched on again.

**NOTE:** Inserting a cassette when the starter switch is turned off will switch on the audio unit in cassette mode, but playback will be limited to one hour.

#### 2. Fast forward/rewind/tape reverse

During tape winding, 'FORWARD' or 'REWIND' shows in the display.

- To forward or reverse wind, fully press either one of the two buttons.
- To stop tape winding, half press the remaining (unlocked) button. Tape play will automatically resume.
- To reverse the direction of tape play, half press both buttons simultaneously.

#### 3. Tape eject

Press FULLY to eject the cassette tape. The audio unit returns to radio mode, selecting the waveband and frequency last in use.

#### 4. Tape mode selection

Press briefly to change to or from radio or tape mode.

To change to radio reception during tape play, press either the tape mode selection button, or the waveband selection button - tape play will stop and the radio automatically selects the frequency last in use. To return to tape play, press the mode button.

## Cassette Player

---

### CARE OF CASSETTE PLAYER AND TAPES

Use only good quality tapes with a maximum capacity of ninety minutes (C90). Check that both spools rotate freely and remove any loose turns at the start of the tape by winding one spool with a pen or pencil.

#### Cassette player

In use, the tape head accumulates dust and contamination, gradually impairing sound reproduction and, in extreme cases, reducing volume too. To combat contamination, clean the tape head periodically (after approximately every 20 hours playing time) by passing a wet type cleaning cassette through the player.

**NOTE:** *Because your cassette player is fitted with auto reverse, the cleaning cassette must be played in both directions.*

The tape will require more frequent cleaning in winter, as contamination is greater in conditions of low temperature and increased humidity. However, the use of good quality tapes keeps the build up to a minimum.

#### Cassette tapes

- Always store cassettes in their boxes when not in use.
- Never leave cassettes in the vehicle during extremes of temperature. In particular, do not leave tapes in direct sunlight as they may warp and become unusable, or jam the tape player mechanism.
- Fast forward, or rewind tapes every 8 to 10 plays to prevent them from becoming too tightly wound.
- Ensure that labels attached to the cassette are glued firmly in place.
- DO NOT leave tapes in the cassette player for more than a few hours in very cold or humid conditions - the oxides on the tape surface may contaminate the cassette player mechanism.

**NOTE:** *After continuous playing, cassettes may become hot to touch. This is normal and will not harm good quality tape.*

## Compact Disc Player

### SINGLE PLAY CD CONTROLS (CD32 only)

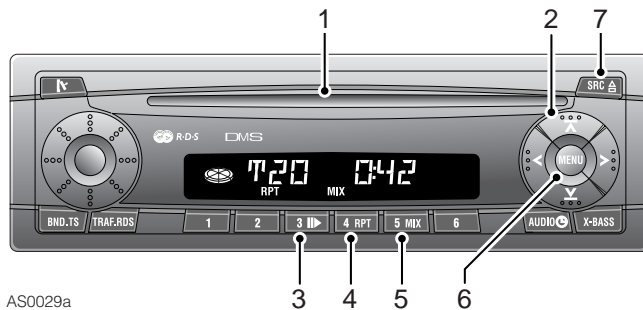

AS0029a

#### 1. CD compartment

With the starter switched on, partially insert a disc, with the label side uppermost, until resistance is felt, at which point the disc will be drawn into the player and playback starts automatically.

If a disc is already loaded, press the SRC button (7) until 'CD' appears in the display. Playback starts from the point on the disc at which play last stopped.

To remove a disc, press and hold the SRC button (7).

**NOTE:** Inserting a disc when the starter switch is turned off will switch on the audio unit in CD mode, but playback will be limited to one hour.

#### IMPORTANT

- Use standard 12cm CDs only.
- DO NOT use 8 cm CD singles, or irregularly shaped or damaged CDs - these may damage the compact disc player.

#### 2. Track selection/search

**Track Selection:** Press one of the <> or  $\overline{\Delta}$   $\nabla$  controls to select the next, or previous track. Press the control repeatedly to move forward or back through the tracks on the disc.

**Fast track selection:** Press and hold either the  $\overline{\Delta}$  or  $\nabla$  control. The CD player skips tracks (forward or back) until the control is released.

**Fast search:** With a CD playing, press and hold the appropriate < or > control to play forward or back through the current track at a greatly increased speed (volume reduces).

#### 3. Pausing playback

To pause playback, press pre-set button 3 ('PAUSE' appears in the display). Press again to cancel pause.

#### 4. Repeat play

Press pre-set button 4 (RPT) to repeat the current track ('RPT TRCK' is displayed and the RPT indicator illuminates in the lower part of the display). Press again to cancel the repeat function ('RPT OFF' is displayed and the RPT indicator extinguishes).

#### 5. Random play (MIX)

Press pre-set button 5 (MIX) to play each track in a random order ('MIX CD' is displayed and the MIX indicator illuminates in the lower part of the display). Random play continues until the button is pressed again ('MIX OFF' is displayed and the MIX indicator extinguishes).

**NOTE:** With random play selected, the track selection controls (2) can be used to skip to the next randomly selected track, or to the start of the current track.

## Compact Disc Player

---

### 6. Track scanning

Track scanning enables you to listen to the first few seconds of each track on the disc.

Press and hold the MENU button (6) for two seconds ('SCAN' appears in the display). Press the MENU button again to stop the scan at your chosen track.

*NOTE: The scan time can be adjusted to suit your requirements (see 'MENU CONTROL FUNCTIONS', page 122).*

### 7. CD mode selection/CD eject control

Press briefly to change to or from CD or radio modes.

With the audio unit switched on, press and hold for two seconds or more to eject a disc.

### Changing the display

The information appearing in the display can be set to show either: the track number (e.g 'T18 PLAY'), or the track number and elapsed time display (e.g T12 2:39'), as follows:

1. Press the MENU button (6).
2. Press the **⏏** control until 'CD DISP' is displayed.
3. Press the **<>** controls alternately to select 'PLAY' or 'TIME'.
4. Press the MENU button twice to store your selection.

## Compact Disc Player

### MULTI-CD CHANGER CONTROLS\*

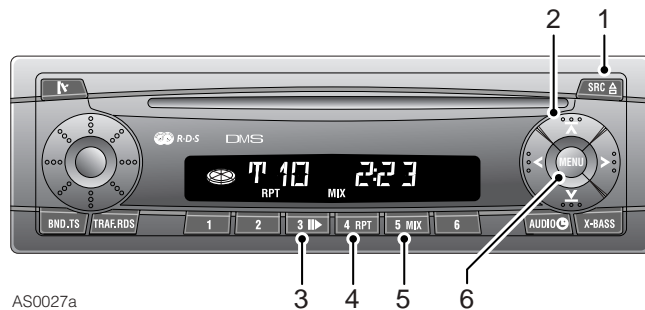

#### 1. CD changer mode selection

Press the SRC button (1) once or twice until 'CHANGER' appears in the display.

Playback commences from the track on the disc that was last played, or from the start of the first disc if the magazine is newly inserted. The display initially identifies the disc (e.g. 'DISC 07'), and then the track number and playing time (e.g. T14 0:68). At the end of each disc, playback continues automatically with the next disc and so on (missing discs are skipped if less than ten have been loaded, in which case the display will show 'NO CD'). Once all the discs have been played, playback reverts to the first track on the first disc that was played.

#### 2. Disc and track selection/search

**Disc selection:** Briefly press the  $\blacktriangleright$  control to advance to the next disc, or the  $\blacktriangleleft$  control to return to the start of the previous disc. Press the controls repeatedly to move forward or back through all the discs in the magazine.

**Track Selection:** Press one of the  $\blacktriangleleft$  or  $\blacktriangleright$  controls to select the next, or previous track. Press the controls repeatedly to move forward or back through the tracks on the disc.

**Fast track selection:** Press and hold the  $\blacktriangleright$  or  $\blacktriangleleft$  control. The CD player skips tracks (forward or back) until the control is released.

**Fast search:** With a CD playing, press and hold the appropriate  $\blacktriangleleft$  or  $\blacktriangleright$  control to play forward or back through the current track at a greatly increased play speed (volume reduces).

#### 3. Pausing playback

To pause playback, press pre-set button 3 ('PAUSE' appears in the display). Press again to cancel pause.

#### 4. Repeat play

**To repeat the current track:** Press pre-set button 4 ('RPT TRCK' is displayed briefly and the RPT indicator illuminates).

**To repeat the current disc:** With RPT TRCK already selected, press pre-set button 4 a second time ('RPT DISC' appears briefly in the display and the RPT indicator illuminates).

To deselect the repeat feature, press pre-set button 4 several times until 'RPT OFF' appears in the display and the RPT indicator extinguishes.

**NOTE:** One or both repeat play features will be deselected if track or disc selection, or track scanning is activated.



## Compact Disc Player

---

### 5. Random play (MIX)

Press pre-set button 5 (MIX) to play the tracks on the current disc in a random order ('MIX CD' is displayed briefly and the 'MIX' indicator illuminates).

Random play can also be applied to all of the discs in the changer. With 'MIX CD' selected, press pre-set button 5 a second time ('MIX ALL' appears briefly in the display).

Random play will continue until pre-set button 5 is pressed again, ('MIX OFF' is displayed and the 'MIX' indicator extinguishes) or track scanning is activated .

**NOTE:** *With random play selected, the track selection controls (2) can be used to skip to the next randomly selected track, or to the start of the current track.*

### 6. Track scanning



Track scanning enables you to listen to the first few seconds of each track on every disc in the changer in ascending order.

1. Press and hold the MENU button (6) for two seconds ('SCAN' appears in the display).
2. Press the MENU button again to stop the scan at your chosen track.

**NOTE:** *The scan time can be adjusted to suit your requirements (see 'MENU CONTROL FUNCTIONS', page 122).*

### Changing the display

The information appearing in the display can be set to show either: the track number and disc number (e.g 'T07 D6'), or the track number and elapsed time display (e.g T09 3:28'), as follows:

1. Press the MENU button (6).
2. Press the  control until 'CDC DISP' is displayed.
3. Press the  controls alternately to select 'TIME' or 'CD NO'.
4. Press the MENU button twice to store your selection.

## Radio Tuning

### TUNING

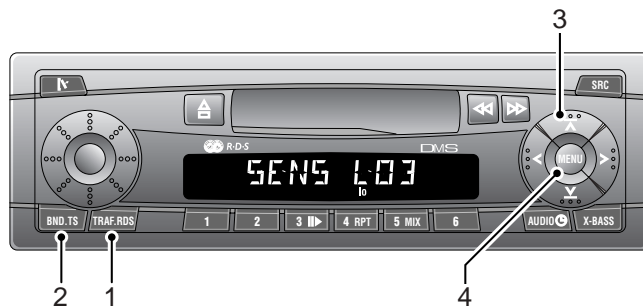

AS0046

#### Manual tuning

**NOTE:** Manual tuning on the FM waveband can only be undertaken with RDS and PTY deactivated.

If you know the frequency of the radio station you are seeking, or you need to select a radio station that is too weak to be found by automatic tuning, use manual tuning, as follows:

1. Press the waveband selector (2) to select the desired waveband or memory bank.
2. If necessary, press and hold the RDS button (1) until RDS is deactivated (the RDS indicator disappears from the display), and disable PTY (see 'Switching PTY on and off', page 118).
3. Operate one of the <> tuning controls (3) until the desired frequency has been reached.

**Fast manual tuning:** By keeping either of the <> tuning controls depressed, the waveband is scanned rapidly down or up until the control is released.

#### Automatic tuning

Select the required waveband, then briefly press the  $\nabla$  or  $\blacktriangleright$  tuning control (3).

The radio searches the frequency range (up or down depending upon which tuning control was pressed) for a radio station of acceptable strength. Once a suitable station is found, the search stops. To continue searching, press one of the tuning controls again.

#### Tuning sensitivity

The sensitivity with which automatic tuning takes place can be adjusted. For example, the tuner can be configured to enable it to respond only to those radio stations which provide strong reception or, alternatively, to radio stations with weaker transmissions as well.

1. Press the MENU control (4).
2. Press the  $\nabla$  or  $\blacktriangleright$  controls (3) until 'SENS' appears in the display.
3. Press the <> controls (3) to set the required sensitivity ('SENS LO1' indicates that the tuner is at its lowest sensitivity setting and will tune to strong signals only, while 'SENS HI6' indicates that the tuner is most sensitive). If 'SENS LO' has been selected, the 'lo' indicator illuminates in the display.
4. Press the MENU button to store your selection.

**NOTE:** Different tuning sensitivities can be set for FM and MW/LW.

## Radio Tuning

---

### **Waveband scan**

Waveband scanning enables you to listen to all receivable stations on the selected waveband for between 5 and 30 seconds each.

*To start scanning:* Press the MENU button (4) for two seconds ('SCAN' is displayed briefly, followed by the frequency or station name flashing).

*To stop scanning:* Briefly press the MENU button again.

**NOTE:** *The scan time can be adjusted to suit your requirements (see 'SCANTIME' in 'MENU CONTROL FUNCTIONS', page 122).*

### **MONO/STEREO**

Whenever the FM waveband is selected, the radio automatically reproduces stereo sound, provided a suitable signal is available.

However, if a signal becomes too weak for good stereo reception, only mono sound is produced until the signal strengthens sufficiently for stereo sound reproduction.

## Radio Tuning

### RADIO PRE-SET BUTTONS

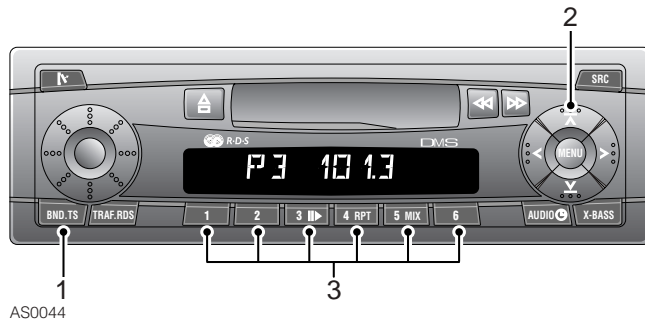

AS0044

The six pre-set buttons (3) can be used to manually store up to eighteen FM stations (six each on FM1, FM2 and FMT), six MW stations and six LW stations.

### Programming the pre-sets

- Press the waveband selector (1) to select the required waveband or memory bank (FM1, FM2, FMT, MW or LW).
- Using the tuning buttons (2), select the desired frequency (see *'TUNING'*, page 114).
- Press and hold one of the pre-set buttons (3). The radio will mute briefly while the frequency is being stored. If 'BEEP ON' has been selected (see *'MENU CONTROL FUNCTIONS'*, page 122), an audible 'beep' will confirm that the frequency has been stored.
- Release the pre-set as soon as radio sound is restored and the new frequency details are displayed.

### Operating the pre-sets

Once the pre-set buttons have been programmed, select the desired waveband, then press the pre-set button of your choice. The display initially shows the pre-set number you have selected and the station frequency e.g: 'P3 101.3'. This is followed by the waveband and station frequency (or station name).

## Radio Tuning

### TRAVELSTORE

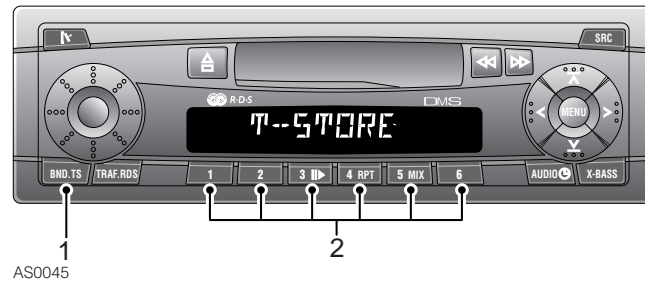

Travelstore operates on the FM waveband only and enables you to rapidly tune and store the six strongest FM radio signals in a single operation. This facility is particularly useful if you are in an unfamiliar area and have little knowledge of local transmitter frequencies.

#### Programming Travelstore

Press and hold the waveband selector (1) – the radio mutes, an audible ‘beep’ will sound (if ‘BEEP ON’ has been selected – see ‘MENU CONTROL FUNCTIONS’, page 122) and the display shows ‘T-STORE’.

Travelstore scans the FM waveband to find the six strongest frequencies and then stores them in the FMT memory bank in order of signal strength. Radio sound is restored once the operation is complete.

If Travelstore is unable to locate and store six stations, the display shows (‘-----’) for any unoccupied pre-sets, and the radio reverts to the last recalled pre-set frequency on the FMT waveband.

**NOTE:** Travelstore overwrites any stations already stored on the FMT memory bank.

**NOTE:** If Travelstore is programmed with traffic information active, then programming will be limited to those stations capable of providing traffic information. In some areas this could severely limit the frequencies available to Travelstore and, for this reason, it is recommended that traffic information is switched off before Travelstore is programmed.

**NOTE:** Station frequencies can also be stored manually onto pre-sets in the FMT memory bank (see ‘RADIO PRE-SET BUTTONS’, page 116).

#### Operating Travelstore

To tune to a Travelstore frequency, select the FMT waveband then press the pre-set button (2) of your choice. The display will initially indicate the selected pre-set number and then display the frequency or station name and FMT waveband e.g. ‘FMT 89.5’.

3

## Radio Tuning

### PROGRAMME TYPE (PTY)

Some radio stations broadcasting on the FM waveband provide programme type (PTY) information that can be received by the radio tuner. Using the PTY feature, radio broadcasts of a particular programme type can be selected.

#### PTY Programme types

NEWS	ROCK Music	PHONE IN
AFFAIRS	MOR Music	TRAVEL
INFO	LIGHT Music	LEISURE
SPORT	CLASSICS	JAZZ
EDUCATE	OTHER Music	COUNTRY
DRAMA	WEATHER	NATIONAL Music
CULTURE	FINANCE	OLDIES
SCIENCE	CHILDREN	FOLK Music
VARIED	SOCIAL	DOCUMENT
POP Music	RELIGION	TEST

#### Switching PTY on and off

To switch programme type on ('PTY ON') or off ('PTY OFF'), see *'MENU CONTROL FUNCTIONS', page 122*. When PTY is selected the 'PTY' indicator will illuminate in the lower part of the display.

The language in which the programme type is displayed can be set to either English, French or German by using the MENU button (see 'PTY LANG' in *'MENU CONTROL FUNCTIONS', page 122*).

#### Selecting a programme type

1. With PTY switched on, repeatedly press one of the <> controls, or briefly press a pre-set button until the desired programme type is displayed (see accompanying table).
2. Press one of the  $\uparrow$   $\downarrow$  controls. The radio will search for (and then tune to) the next radio station on the waveband broadcasting the desired programme type. During the search, the display will alternately show 'SEARCH' and the programme type.

If no station of the desired programme type can be found, the display will briefly show 'NO PTY' and then return to the previously tuned station. However, if the tuned radio station, or another station on the same broadcasting network, later broadcasts a programme of the desired programme type, the radio will automatically switch to this broadcast (even during tape or CD play).

#### Storing PTY programmes on the pre-set buttons

With the desired programme type selected, press and hold one of the pre-set buttons. The programme type is then stored on the pre-set button.

## Traffic Information

### TRAFFIC INFORMATION BROADCASTS

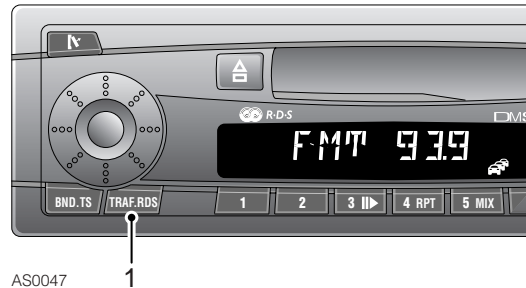

On the FM waveband, your radio is able to receive traffic information broadcasts automatically as and when they occur.

#### Selecting traffic information

Briefly press the TRAF-RDS control (1) - the traffic jam symbol illuminates in the display. To switch off the traffic information feature, briefly press the control again.

Unwanted traffic information broadcasts can be aborted by pressing the control. In this case, because the feature is being disabled DURING a traffic information broadcast, disablement is only temporary - the feature will return as soon as the next traffic information bulletin is broadcast.

A warning beep will sound if:

- The car leaves the reception area of the traffic information station being received.
- While listening to a tape or CD the car leaves the reception area of the traffic information station currently tuned and the subsequent automatic search cannot find a new traffic information station.
- The radio is retuned from a traffic information station to a station that does not broadcast traffic information.

In each case, either switch off the traffic information feature, or tune to a station that broadcasts traffic information.

#### Traffic information broadcasts during tape or CD play

When the radio is in traffic information mode, tape or CD play will be interrupted by traffic information broadcasts automatically as and when they occur.

#### Setting the volume for Traffic announcements

The volume of traffic information broadcasts can be set independently from the volume required for other audio functions (see 'TA VOLUME' in 'MENU CONTROL FUNCTIONS', page 122).

**NOTE:** The volume for traffic information broadcasts can also be adjusted by turning the volume control during traffic announcements.

3

## Radio Data System

---

### **RADIO DATA SYSTEM (RDS)**

Your radio is equipped with RDS (Radio Data System). RDS is being introduced in European countries and operates on the FM waveband. The system enables the audio unit to receive other information in addition to radio signals, including:

- *the programme service name*: enables the set to display the radio station name instead of the frequency.
- *alternative frequencies for the FM radio station being received*: enables the audio unit to automatically select the strongest available signal, thereby maintaining the best possible reception.
- *traffic information*: enables the audio unit to give priority to traffic information broadcasts over other radio, tape or CD programmes.
- *EON (enhanced other networks)*: enables the audio unit to broadcast traffic information from radio stations other than the one to which the radio is currently tuned (provided they are all members of a linked network).
- *PTY (programme type)*: enables the audio unit to be programmed to select broadcasts of a specific programme type.

**NOTE:** *In some countries, not all FM radio stations broadcast RDS. If a non-RDS station is received, these features will not be available.*

### **Receiving RDS stations**

With RDS active, whenever an RDS radio station is received, the station name illuminates in the display. The audio constantly scans all alternative frequencies on which that station can be received, and automatically switches to the strongest available signal.

This is particularly useful on long journeys where the car travels through different transmitter areas serving the same radio station.

To select (or inhibit) RDS, press and hold the TRAF.RDS control for two seconds or more – the ‘RDS’ indicator illuminates when RDS has been activated.

### **Local radio and regional broadcasts**

Reception of most local radio stations is intentionally limited to a comparatively small area around the transmitter. Once the limit of the reception range is reached, it is unlikely that the RDS facility will be able to locate an alternative frequency for the local radio station being received.

In some countries, certain broadcasting companies transmit regional programmes on the FM waveband, either continuously or periodically during the day. This may result in the audio unit changing between a number of different regional radio stations within the radio programme you have selected.

This facility is selectable and can be enabled or disabled using the menu control (see ‘REG ON’ and ‘REG OFF’ in ‘MENU CONTROL FUNCTIONS’, page 122).



## Clock & Time

### CLOCK

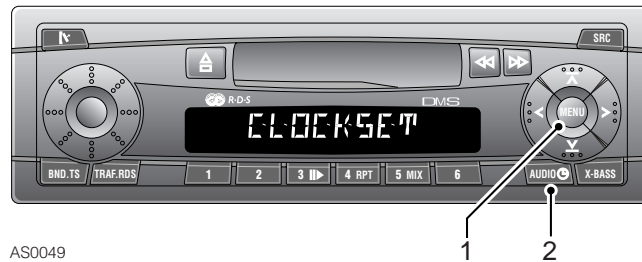

AS0049

To display the time, press and hold the clock control (2). The display will be present for approximately two seconds.

#### Setting the time

1. Press the MENU button (1).
2. Press the **▲** or **▼** control until 'CLOCKSET' appears in the display.
3. Press the **▶** control. The time shows in the display with the minute figures flashing.
4. Adjust the minutes by pressing the **▲ ▼** controls (up to increase or down to reduce).
5. Once the minutes have been set, press the **◀** control. This will cause the hour digits to flash.
6. Adjust the hours by pressing the **▲ ▼** controls (up to increase or down to reduce).
7. Once all changes are complete, press the MENU button twice.

#### Changing between 12 and 24 hour displays

1. Press the MENU button (1).
2. Press the **▲** or **▼** control until '12H MODE' or '24H MODE' appears in the display.
3. Press the **◀▶** controls to switch between displays.
4. Press the MENU button to store your selection.

#### Clock displays when the audio is switched off

*With the starter turned ON:*

The audio unit can be programmed to display the time, as follows:

1. With the audio switched on, press the MENU button (1).
2. Press the **▲** or **▼** control until either 'CLOCK ON' or 'CLOCKOFF' appears in the display.
3. Press the **◀▶** controls to switch between displays (with 'CLOCKOFF' selected, the time display is prohibited).
4. Press the MENU button to confirm your selection.

*With the starter turned OFF:*

The time can be displayed when both the audio unit AND starter switch are turned off, as follows:

- Briefly press the clock button (2). The time is displayed for approximately 8 seconds.

**NOTE:** This feature is available in both 'CLOCK ON' and 'CLOCKOFF' modes.

3

## Menu Functions

### MENU CONTROL FUNCTIONS

The following tables identify the full range of functions obtainable by pressing the menu button and then using the **▲** or **▼** controls. Once an adjustment has been completed, press the menu button once (or twice) to exit the menu and store the settings.

TAVOLUME	Select to adjust audio volume for traffic broadcasts - press <b>&lt;&gt;</b> controls to increase or reduce volume.
PEAK LVL	With PEAK ON selected, display shows graphic representation of radio output level - press <b>&lt;&gt;</b> controls to select PEAK ON or PEAK OFF.
HICUT 1 HICUT 0	HICUT enables or prohibits the automatic reduction of treble response in poor reception areas. HICUT 1 enables, HICUT 0 prohibits - press <b>&lt;&gt;</b> controls to select.
ON VOL	Default volume when audio is switched on - press <b>&lt;&gt;</b> controls to increase or reduce volume.
MUTE LVL	Audio volume when mute is activated - press <b>&lt;&gt;</b> controls to increase or reduce volume.
AUX ON AUX OFF	This feature is not recommended for use with Rover 75 and MGZT models. Set to AUX OFF.
SENS	Adjusts sensitivity of radio tuning - press <b>&lt; or &gt;</b> to increase or reduce tuning sensitivity.
SCANTIME	Select to adjust scanning time for radio and CD play - press <b>&lt; or &gt;</b> to adjust (between 5 and 30 seconds).
PTY ON PTY OFF	Select to enable or prohibit programme type (PTY) selection - press the <b>&lt;&gt;</b> controls to toggle between PTY ON and PTY OFF.

PTY LANG	Select to change PTY language - press <b>&lt; or &gt;</b> to select English, French or German.
CLOCK ON CLOCKOFF	Enables or prohibits time display when audio is switched off - press <b>&lt;&gt;</b> controls to toggle between 'CLOCK ON' and 'CLOCK OFF'.
CLOCKSET	Select to adjust time display - press <b>&lt; or &gt;</b> to select minutes or hours, and <b>▲</b> or <b>▼</b> to adjust the time.
12H MODE 24H MODE	Select to change clock display mode - press <b>&lt;&gt;</b> controls to toggle between 12 & 24 hour modes.
BEEP ON BEEP OFF	An audible signal accompanies some operations where a control is pressed for 2 seconds or more - press <b>&lt; or &gt;</b> to toggle between BEEP ON and BEEP OFF.
REG ON REG OFF	Reception of regional programme variations can be enabled or prohibited - use the <b>&lt;&gt;</b> controls to select REG ON or REG OFF.

**NOTE:** Some of the above functions are not available during tape or CD play, or MW/LW operation. Dependent upon the audio specification, one of the following functions may also be available during CD or tape play:

CD DISP	Select to change single play CD display - press <b>&lt;&gt;</b> controls to select TIME (display shows track playing time) or PLAY (display shows track number).
CDC DISP	Select to alter multi CD changer display - press <b>&lt;&gt;</b> controls to select TIME (display shows track playing time) or CD NO (display shows disc number).
RM ON RM OFF	Select to enable or prohibit radio broadcasts during tape wind/rewind - press the <b>&lt;&gt;</b> controls to select.

## CD Changer

### 10-DISC CHANGER

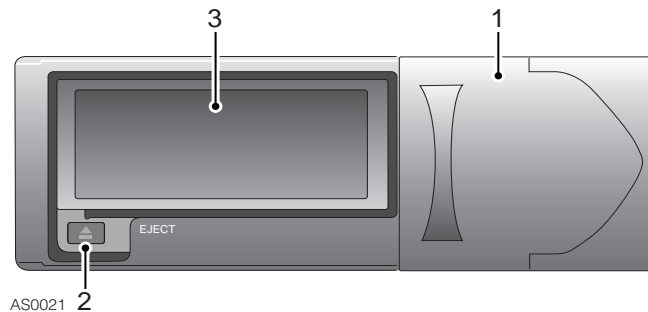

Fully open the sliding cover (1) to insert or remove the magazine. Keep the cover closed at all other times to prevent dust and dirt from entering. Press the button (2) to eject the magazine.

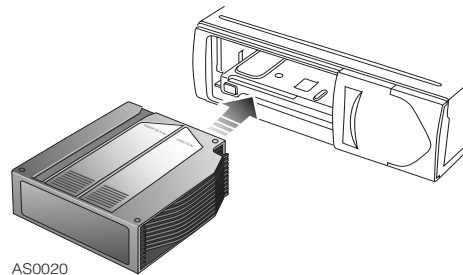

Only insert the magazine (3) in the direction of the arrow marked on the magazine casing and push it fully into the changer. Finally, close the cover.

### Loading & unloading the magazine

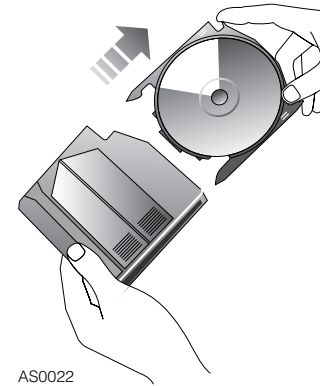

Holding the magazine as shown (arrow on magazine casing uppermost), remove each CD tray in turn.

Place a disc (label side uppermost) onto each tray - holding **ONLY** the outside edge and centre hole of the disc. Load only one disc in each tray. Correctly align the tray with the parallel slots on each side of the magazine and push the tray fully into the magazine. Individual trays may be left empty, but all ten trays should be loaded into the magazine.

To unload the magazine, hold the magazine with the arrow uppermost, pull out each tray in turn, holding the tray securely so as not to drop the disc. Unload one disc at a time and handle only the edge and centre of the disc.

**NOTE:** Additional magazines can be obtained from an MG Rover dealer.

## CD Changer

---

### CARING FOR CD CHANGERS

IMPORTANT
<ul style="list-style-type: none"><li>• Use standard 12cm CDs only.</li><li>• DO NOT use 8cm CD singles, or irregularly shaped or damaged CDs - these may damage the compact disc changer.</li><li>• Excessive temperatures (typically in excess of 55°C) may disrupt operation of the changer unit.</li><li>• Significant variations in temperature, particularly in moisture laden atmospheres, may result in condensation forming inside the changer. This may adversely affect operation of the changer, in which case remove the magazine and wait until any moisture has evaporated.</li><li>• The CD autochanger should only be used as described - any other application or method of use could result in the user being exposed to invisible laser radiation exceeding the limit of laser class 1.</li></ul>



### CARING FOR COMPACT DISCS

Dirt, dust, condensation and heat can damage discs. Always observe the following precautions:

**NEVER** touch the horizontal playing surface (the unlabelled side) of a disc! Handle discs by holding the outer edges, or the edge of the central hole and the outer edge, between finger and thumb.

**ALWAYS** return discs to their boxes after use (dirt detracts from the sound quality).

**NEVER** leave the disc or the box exposed to excessive heat or direct sunlight!

**NEVER** use a solvent or abrasive cleaner! Dust or dirt should be removed from the playing surface by wiping with a clean, dry, lint-free cloth always wipe in a straight line from the centre to the edge of the disc!

## Security Code

### SECURITY CODE INFORMATION

To reduce the risk of theft, your audio unit was programmed with a four-digit security code before the car left the factory. Once activated, this code prevents the unit from functioning if it is illegally removed from the car.

In addition, the audio unit is further protected by a time delay penalty system: a one hour time delay is imposed after the third and all subsequent code entry attempts.

Your car was supplied with a Security Information card. This card contains a record of the four digit security code, as well as the audio unit's unique serial number. The serial number is also stamped into the metal side of the audio unit and, in the event of theft, would confirm proof of ownership.

It is VERY IMPORTANT that you keep a safe record of the security code and heed the following advice:

- NEVER keep a record of the security code in the car.
- If you lose your code number, contact an MG Rover dealer, who will be able to obtain this information for you.

### ENTERING THE SECURITY CODE

If power to the audio unit has been interrupted (car battery disconnected, for example), the code MUST be entered before the unit can be operated. Enter the code as follows:

- Switch on the radio ('CODE' appears in the display, followed by '0000').
- Press pre-set button 1 the required number of times to enter the first digit of the code.
- Press pre-set button 2 the required number of times to enter the second digit of the code.
- Repeat this process using pre-set buttons 3 and 4 to enter the third and fourth digits of the code.
- When the correct code is displayed, press the  control to store the code.

**NOTE:** *If three incorrect codes have been entered, the first one hour time delay period commences. During the delay period, 'WAIT 1 H' appears in the display - DO NOT switch off. At the end of the delay period, 'CODE' reappears in the display and you can then enter the correct code.*

3



---

## ***Maintenance***

---

- 128** Maintenance*
- 131** Bonnet Opening*
- 132** Engine Compartment*
- 135** Engine*
- 137** Cooling System*
- 138** Brakes*
- 139** Power Steering*
- 140** Battery*
- 143** Washers*
- 144** Wipers*
- 145** Tyres*
- 148** Cleaning & Vehicle Care*
- 151** Identification Numbers*
- 153** Parts & Accessories*

---

## Maintenance

---

### **ROUTINE SERVICING**

The safety, reliability and performance of your car will depend partly on how well it is maintained.

Maintenance is the owner's responsibility, and you must ensure that owner maintenance operations, routine services, brake fluid and coolant changes are carried out when required and according to the manufacturer's recommendations.

#### **Service history**

This handbook includes a Service History section, which enables a record to be kept of all routine services that are carried out on the car. This section of the book also provides a facility for the dealer to record brake fluid and coolant changes, as well as the fitting of replacement airbag modules and seat belt pre-tensioners.

Ensure your dealer signs and stamps the book after each service.

#### **Brake fluid replacement**

The brake fluid requires replacement every two years, irrespective of the distance the car has travelled.

*NOTE: Brake fluid replacement will be an additional cost.*

#### **Coolant replacement**

The engine coolant (anti-freeze and water solution) needs to be replaced every four years regardless of the distance the car has travelled. Your dealer will replace the coolant at the scheduled routine service nearest to the conclusion of each four year period, to avoid the need for an additional dealer visit.

*NOTE: Coolant replacement will be an additional cost.*

### **EMISSION CONTROL**

Your car is fitted with emission and evaporative control equipment designed to meet specific territorial and legal requirements. You should be aware that unauthorised replacement, modification or tampering with this equipment by an owner or motor vehicle repairer could be unlawful and subject to legal penalties.

In addition, engine settings must not be tampered with. These have been established to ensure that your car complies with stringent exhaust emission regulations. Incorrect engine settings may adversely affect exhaust emissions, engine performance and fuel consumption, as well as causing high temperatures, which could result in damage to the catalytic converter and the engine.



## Maintenance

---

### OWNER MAINTENANCE

In addition to the routine services, a number of simple checks must be carried out more frequently. You can carry out these checks yourself and advice is given on the pages that follow.

**!** *Any significant or sudden drop in fluid levels, or uneven tyre wear, should be reported to a dealer without delay.*

#### *Daily checks*

- Operation of lights, horn, direction indicators, wipers, washers and warning lights.
- Operation of seat belts and brakes.
- Look for fluid deposits underneath the car that might indicate a leak.

#### *Weekly checks*

- Engine oil level.

*NOTE: The engine oil level should be checked more frequently if the car is driven for prolonged periods at high speeds.*

- Coolant level.
- Brake fluid level.
- Power steering fluid level.
- Screen washer fluid level.
- Tyre pressures and condition.
- Operate air conditioning (if fitted).

### SPECIAL OPERATING CONDITIONS

If your car is frequently used in dusty conditions, or operated in extreme climates where sub-zero or very high ambient temperatures are normal, more frequent attention may need to be paid to servicing requirements. Contact an MG Rover dealer for advice.

## Maintenance

---

### SAFETY IN THE GARAGE

**⚠** *Cooling fans may commence operating up to 4 minutes after the engine is switched off, and continue operating for up to 8 minutes. Keep clear of all fans while working in the engine compartment.*

If you need to carry out maintenance, observe the following safety precautions at all times:

- Keep your hands and clothing away from drive belts and pulleys.
- If the car has been driven recently, **DO NOT TOUCH** exhaust and cooling system components until the engine has cooled.
- **DO NOT TOUCH** electrical leads or components while the engine is running, or with the starter switch turned on.
- **NEVER** leave the engine running in an unventilated area – exhaust gases are poisonous and extremely dangerous.
- **DO NOT** work underneath the car with a wheel changing jack as the only means of support.
- Ensure sparks and naked lights are kept away from the engine compartment.
- Wear protective clothing, including, where practicable, gloves made from an impervious material.
- Remove metal wrist bands and jewellery before working in the engine compartment.
- **DO NOT** allow tools or metal parts of the car to make contact with the battery leads or terminals.

### Poisonous fluids



*It is illegal to pollute drains, water courses or soil. Use authorised waste disposal sites to dispose of used oil and toxic chemicals.*

Fluids used in motor vehicles are poisonous and should not be consumed or brought into contact with open wounds. These include: battery acid, anti-freeze, brake and power steering fluid, petrol, diesel, engine oil and windscreen washer additives.

For your own safety, **ALWAYS** read and obey all instructions printed on labels and containers.

### Used engine oil

Prolonged contact with engine oil may cause serious skin disorders, including dermatitis and cancer of the skin. Wash thoroughly after contact.

## Bonnet Opening

### BONNET OPENING

**!** *DO NOT drive with the bonnet retained by the safety catch alone.*

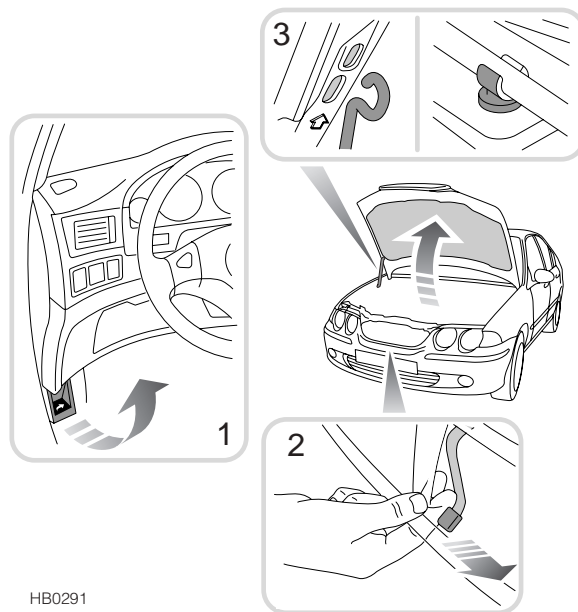

HB0291

1. From inside the car, pull the bonnet release handle.
2. Move the bonnet safety catch lever to the right.
3. Raise the bonnet and then fit the support stay into the cut-out in the underside of the bonnet (see inset)

### Closing the bonnet

Replace the support stay in its retaining clip, then lower the bonnet, allowing it to drop for the last 150 mm to its closed position.

Check that the lock is FULLY engaged by attempting to lift the front edge of the bonnet. This should be free from all movement.

## Engine Compartment

### 1.4, 1.6 & 1.8 PETROL ENGINE

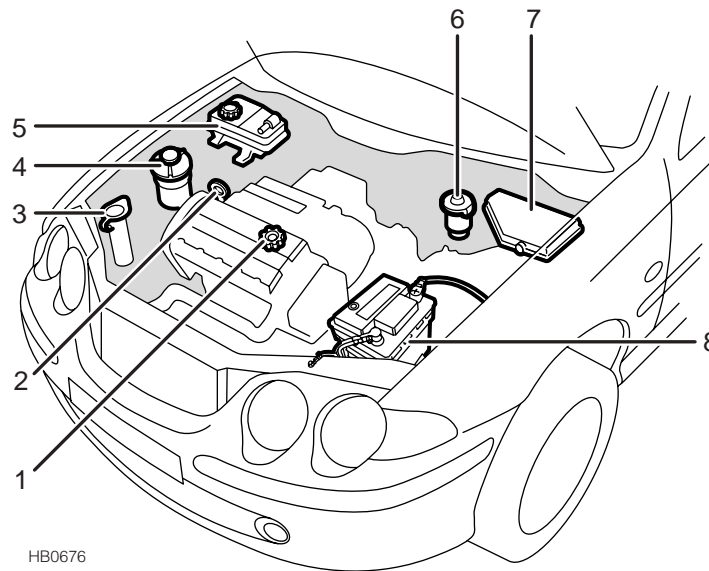

HB0676

1. Engine oil filler (yellow cap)
2. Engine oil dipstick (yellow)
3. Washer reservoir
4. Power steering reservoir
5. Cooling system reservoir
6. Brake fluid reservoir
7. Fusebox - engine compartment
8. Battery

**⚠** *While working in the engine compartment, always observe the safety precautions listed under 'SAFETY IN THE GARAGE', page 130.*

## Engine Compartment

### 2.0 & 2.5 PETROL ENGINE

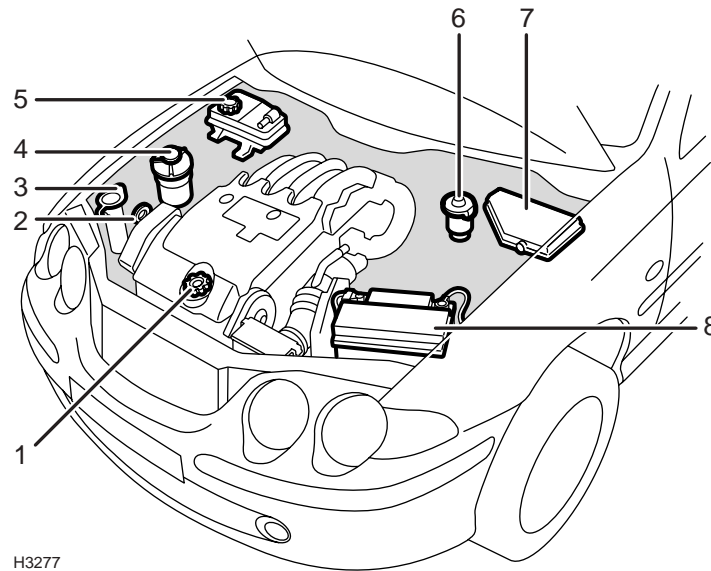

H3277

1. Engine oil filler (yellow cap)
2. Engine oil dipstick (yellow)
3. Washer reservoir
4. Power steering reservoir
5. Cooling system reservoir
6. Brake fluid reservoir
7. Fusebox - engine compartment
8. Battery

4

**!** While working in the engine compartment, always observe the safety precautions listed under 'SAFETY IN THE GARAGE', page 130.

## Engine Compartment

### DIESEL ENGINE

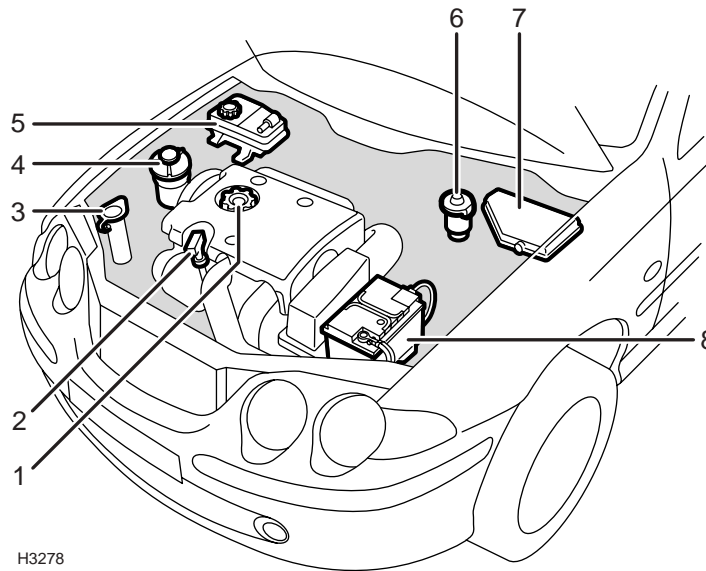

H3278

1. Engine oil filler (yellow cap)
2. Engine oil dipstick (yellow)
3. Washer reservoir
4. Power steering reservoir
5. Cooling system reservoir
6. Brake fluid reservoir
7. Fusebox - engine compartment
8. Battery

**!** *While working in the engine compartment, always observe the safety precautions listed under 'SAFETY IN THE GARAGE', page 130.*

## Engine

### ENGINE OIL LEVEL CHECK & TOP-UP

**!** *Driving the car with the engine oil level ABOVE the upper mark, or BELOW the lower mark on the dipstick, will damage the engine.*

Check the oil level weekly, or whenever you fill up with fuel. Ideally, the oil level should be checked with the engine cold and the car resting on level ground. However, if the car is in use and the engine is already warm, then wait for at least two minutes after switching off before checking the level.

**NOTE:** *Check the engine oil more frequently if the car is driven at high speeds for prolonged periods.*

#### Oil level check & top-up

**!** *Take care to avoid spilling engine oil onto a hot engine - a fire may result!*

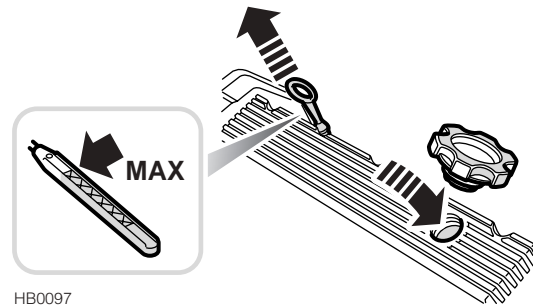

HB0097

1.4, 1.6 & 1.8 Petrol engines

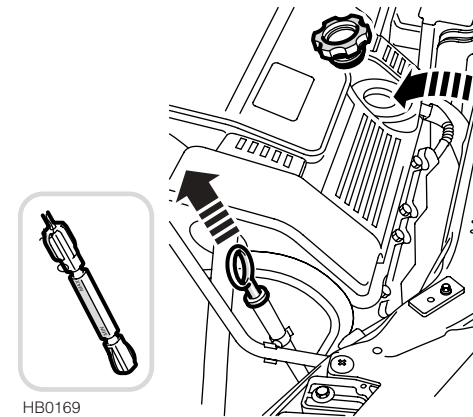

HB0169

2.0 & 2.5 Petrol engines

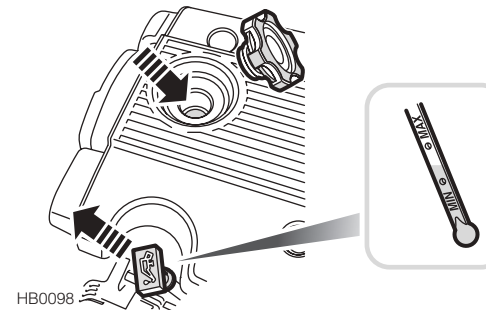

HB0098

Diesel engines

Withdraw the dipstick and wipe the blade clean, then re-insert the dipstick and withdraw again to check the level.

## Engine

---

To top-up, remove the oil filler cap and add oil to maintain a level between the upper and lower marks on the dipstick. As a general guide, if the level on the dipstick is:

- nearer to the upper mark than the lower, add no oil.
- nearer to the lower mark than the upper, add half a litre of oil.
- at or below the lower mark, add one litre of oil.

### **DO NOT fill above the upper mark!**

After adding oil, wait for a five minutes and then recheck the level and add more oil if necessary. Finally, ensure the dipstick is replaced and the filler cap replaced and fully tightened.

### **Oil specification**

Oils manufactured to the specifications below, are suitable for use in temperatures between  $-20^{\circ}\text{C}$  to  $+30^{\circ}\text{C}$  (if climatic temperature falls outside these limits, seek advice from your dealer).

To ensure optimum engine life and performance, oils used for topping-up and refilling the engine must match the minimum ACEA specifications shown below – oils of a lower numerical value must NEVER be used!

***NOTE:** Mixing oil additives with the engine oil is not recommended and could damage the engine.*

***Petrol engines:** Use any brand of 10W/40 engine oil meeting the minimum specification: ACEA A2.*

***NOTE:** For 1.4, 1.6 & 1.8 petrol engines, ACEA A1 or A2 oils can be used - the A1 specification may improve fuel economy.*

***Diesel engines:** Use any brand of 10W/40 or 15W/40 engine oil, meeting the minimum specification: ACEA B2.*



## Cooling System

### COOLANT CHECK & TOP-UP

**⚠** *DO NOT remove the reservoir cap when the cooling system is hot - escaping steam or water could cause serious injury.*

The coolant level should be checked weekly when the cooling system is cold and with the car resting on level ground.

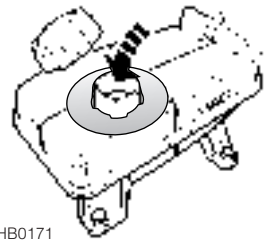

HB0171

Remove the filler cap, and top-up to the MAX' mark with a 50% mixture of water and anti-freeze (see 'Coolant specification'). Ensure the cap is tightened fully after top-up is completed.

**NOTE:** *When topping-up, avoid spillage on body panels - anti-freeze will damage painted surfaces.*

If the coolant level falls appreciably during a short period, suspect leakage or overheating and arrange for your dealer to examine the car.

### ANTI-FREEZE

**⚠** *Anti-freeze is poisonous and can be fatal if swallowed - keep containers sealed and out of the reach of children. If accidental consumption is suspected, seek medical attention immediately.*

**⚠** *Prevent anti-freeze coming into contact with the skin or eyes. If this occurs, rinse immediately with plenty of water.*

Anti-freeze contains important corrosion inhibitors. The anti-freeze content of the coolant must be maintained at 50% ± 5% all year round (not just in cold conditions). To ensure that the anti-corrosion properties of the coolant are retained, the anti-freeze content should be checked once a year and the coolant completely renewed every four years, regardless of mileage. Failure to do so may cause corrosion of the radiator and engine components.

**NOTE:** *DO NOT add rust inhibitors or other additives to the coolant - these may not be compatible with the coolant or engine components.*

#### Coolant specification

Use ONLY a 50% mix of water and Havoline Extended Life Coolant (XLC), or any ethylene glycol based anti-freeze (containing no methanol) with Organic Acid Technology (OAT) corrosion inhibitors, meeting BTC type coding 4E.

In an emergency - and only if this type of anti-freeze is unavailable - top-up the cooling system with clean water, but be aware of the resultant reduction in frost protection. DO NOT top-up or refill with other anti-freeze formulations. If in doubt consult a dealer.

## Brakes

### BRAKE FLUID

**!** Brake fluid is highly toxic - keep containers sealed and out of the reach of children. If accidental consumption of brake fluid is suspected, seek medical attention immediately.

**!** Prevent brake fluid coming into contact with the skin or eyes. If this occurs, rinse immediately with plenty of water.

**!** Take care not to spill brake fluid onto a hot engine - a fire may result.

The level of fluid in the brake reservoir may fall slightly during use, as a result of brake pad wear and will need to be topped-up from time to time. If there is any appreciable drop in level over a short period, consult your dealer. **DO NOT drive if the fluid level is below the 'MIN' mark on the reservoir.**

**!** Contact your dealer immediately if brake pedal travel is unusually long or if there is any appreciable drop in brake fluid level.

#### Brake fluid specification

Any proprietary brand of brake (or brake and clutch) fluid meeting DOT 4 specification.

IMPORTANT
Brake fluid must be completely replaced every two years regardless of mileage.

### Check & Top-up



Wipe the filler cap clean before removing, to prevent dirt from entering the reservoir. Unscrew the cap 1/4 turn anti-clockwise and lift to remove. Top-up the reservoir to the 'MAX' mark using a recommended fluid.

**NOTE:** Brake fluid will damage painted surfaces. Soak up any spillage with an absorbent cloth immediately and wash the area with a mixture of car shampoo and water.

Use only new fluid from a sealed container (old fluid from uncapped containers or fluid previously bled from the system will have absorbed moisture and/or air, and adversely affect braking performance).

To refit the cap, press down firmly while turning clockwise - this will ensure the cap is securely locked in position.

## Power Steering

### POWER STEERING FLUID\*

**!** *Power steering fluid is highly toxic – keep containers sealed and out of the reach of children. If accidental consumption of fluid is suspected, seek medical attention immediately.*

**!** *If power steering fluid should come into contact with the skin or eyes, rinse immediately with plenty of water.*

#### Check & Top-up

Check the fluid level every week. The engine should be switched off with the system cold. You should also ensure that the steering wheel is not turned between stopping the engine and checking the fluid level.

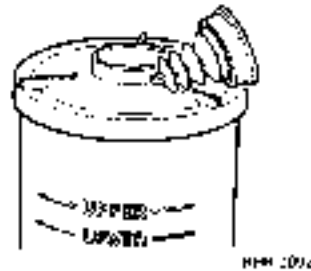

Wipe the filler cap clean to prevent dirt from entering the reservoir. Remove the filler cap and top-up to the 'UPPER' level mark with a fluid meeting Dexron IID or III specification. **DO NOT OVERFILL!**

**NOTE:** *Power steering fluid will damage painted surfaces. Soak up any spillage with an absorbent cloth immediately and wash the area with a mixture of car shampoo and water.*

#### Fluid specification

Use any fluid to Dexron IID or III specification.

**NOTE:** *The colour of commercially available power steering fluids may differ from that used to fill the system during manufacture. This is not a cause for concern.*

#### Emergency operation

Any frequent or regular need to top-up the fluid should be investigated by a qualified dealer.

Under no circumstances should the car be driven with the fluid level below the lower mark on the reservoir, or if a rapid or significant loss of fluid is detected. However, if it can be established that fluid loss is slow, then the reservoir may be topped-up to the upper level mark to enable the car to be driven a short distance to the nearest dealer for examination.

If the fluid has dropped below the lower level mark, top-up the reservoir **BEFORE** starting the engine, or damage to the steering pump could result.

## Battery

### BATTERY MAINTENANCE

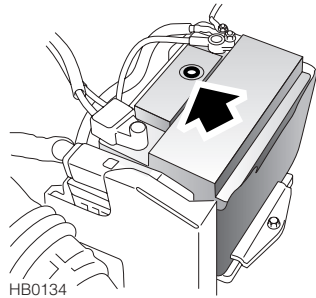

The battery is designed to be maintenance free, so topping-up is unnecessary. On the top of the battery there is a battery condition indicator (arrowed in illustration). Examine the indicator periodically to check the battery's condition. When the indicator shows:

- GREEN - the battery is in a good state of charge.
- DARK (turning to black) - the battery needs charging.
- CLEAR (or light yellow) - the battery must be replaced. Do not charge the battery or jump start the car with the battery in this condition.

**NOTE:** If necessary, clean the top of the battery to ensure a clear view of the condition indicator. Use a torch if natural light is poor.

If the indicator shows clear or yellow, tap the indicator with a screwdriver to disperse any air bubbles - if the indicator colour is unchanged, the battery must be replaced.

### Battery safety

**!** Batteries contain sulphuric acid, which is both corrosive and poisonous. If spillage occurs:

- On clothing or the skin - remove any contaminated clothing immediately, flush the skin with large amounts of water, and seek medical attention urgently.
- In the eyes - flush with clean water immediately for at least 15 minutes. Seek medical attention urgently.
- Swallowing battery acid can be fatal unless IMMEDIATE action is taken - seek medical attention urgently.

**!** Remove any metal wrist bands and jewellery before working in the engine compartment.

# Battery

## Battery disconnection and removal

### IMPORTANT

- DO NOT reverse the polarity of the battery - the electrical system may be damaged if the battery leads are connected to the wrong terminals.
- Keep the battery upright at all times - damage will be caused if the battery is tilted more than 45°.
- NEVER run the engine with the battery disconnected, or disconnect the battery while the engine is running.

Before disconnecting or removing the battery, disarm the alarm, and ensure that the starter switch and all electrical equipment is turned off.

Disconnect the negative ('-') cable first and then the positive ('+') cable (when reconnecting, connect the positive cable first and then the negative cable).

 **Do not allow the battery terminals or cables to make contact with tools or metal parts of the car.**

To release the battery from the car, undo the bolt securing the battery clamping plate and remove the clamping plate.

Use the attached carrying handles (if fitted) to lift the battery from the car.

## Quick release battery clamp\*

In some countries, the positive battery terminal is fitted with a quick-release clamp. Unscrew to release the clamp.

## Battery replacement

Only fit a replacement battery of the same type and specification as the original - other batteries may differ in size and shape or have different terminal positions, which could cause damage to the battery, leaking acid, or fire.

When replacing, ensure the battery is fitted the right way round (if in doubt, refer to the engine compartment illustrations earlier in section). Fit the battery clamping plate and tighten the clamping plate bolt until the clamping plate is free from movement; this will prevent the battery from moving in the event of an accident or sudden stop.

After disconnection of the vehicle battery, the remote handset may need to be re-synchronised (see '*Handset re-synchronisation*', page 15).

## Battery

---

### Battery disposal

 Used batteries are hazardous to the environment, and should be recycled. If in doubt seek advice about disposal from an MG Rover dealer or your local authority.

### Battery charging

 **DO NOT charge the battery if it is connected to the car - this may seriously damage the car's electrical system.**

 **DO NOT attempt to charge the battery if the battery condition indicator is clear or light yellow.**

 **DO NOT charge the battery if it is suspected of being frozen.**

As the battery ages, it may not retain its charge as effectively as when it was new. Cars that are used infrequently, or are used excessively for short journey motoring, or operation in cold climates, may need the battery to be charged regularly.

Always check the battery condition indicator before charging.

Batteries generate explosive gases, contain corrosive acid and produce levels of electric current sufficient to cause serious injury. While charging, always heed the following precautions:

- Before charging, disconnect and remove the battery from the car - charging the battery with the cables connected may damage the car's electrical system.
- Make sure the battery charger leads are securely clamped to the battery terminals BEFORE switching on the battery charger. Do not move the leads once the charger is switched on.

- While charging, shield your eyes, or avoid leaning over the battery.
- Keep the area around the top of the battery well ventilated.
- Do not allow naked lights near the battery (batteries generate inflammable hydrogen during and after charging).
- The battery will be charged sufficiently once the battery condition indicator shows GREEN. When charging is finished, switch off the battery charger BEFORE disconnecting the leads from the battery terminals.

*NOTE: The battery will take longer to charge in a cold environment.*

After charging, leave the battery for one hour before reconnection to the car - this will allow time for explosive gases to disperse, thereby minimising the risk of fire or explosion.

## Washers

### WINDSCREEN WASHER TOP-UP

**!** *Some screenwash products are inflammable, particularly if high or undiluted concentrations are exposed to sparks. Do not allow screenwash to come into contact with naked flames or sources of ignition.*

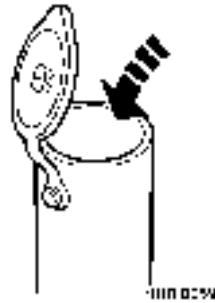

Check the reservoir level every week. To ensure proper cleaning of the windscreen and to prevent freezing in cold weather, top-up with a mixture of water and a proprietary brand of screenwash. Preferably mix the recommended quantities of water and screenwash in a separate container before topping-up the system, and always follow the instructions on the container.

**NOTE:** *DO NOT use an anti-freeze or vinegar/water solution in the washer reservoir - anti-freeze will damage painted surfaces, while vinegar can damage the windscreen washer pump.*

Note that body panels may suffer discoloration as a result of screenwash spillage. Take care to avoid spillage, particularly if an undiluted or high concentration of screenwash is being used. If spillage occurs, wash the affected area immediately with water.

### WASHER JETS

Operate the washers periodically to check that the nozzles are clear and properly directed.

The windscreen washer jets are set during manufacture and should not need adjusting. However, if adjustment is ever necessary, insert a needle into the jet orifice and lever gently to position each jet so that the spray is directed towards the centre of the windscreen.

Should any jet become obstructed, insert a needle or thin strand of wire into the orifice to clear the blockage.

### HEADLIGHT WASHERS\*

The headlight washers are supplied by the windscreen washer reservoir. The direction of the washer jets is set during manufacture and should not require adjustment.

## Wipers

### WIPER BLADES

#### IMPORTANT

- Grease, silicon and petrol based products impair the blade's wiping capability. Wash the wiper blades in warm soapy water and periodically check their condition.
- If signs of hardness or cracking in the rubber are found, or if the wipers leave streaks or unwiped areas on the screen, then the wiper blades should be replaced.
- Clean the windscreen regularly with an approved glass cleaner and ensure the screen is thoroughly cleaned before fitting replacement wiper blades.
- Only fit replacement wiper blades that are identical to the original specification.

### Replacing wiper blades

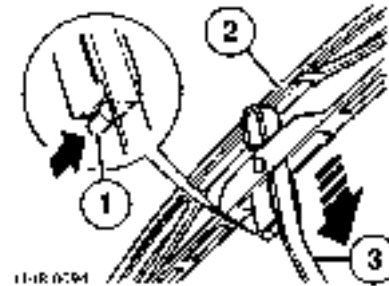

Lift the wiper arm away from the windscreen. With the blade at 90° to the arm as shown, disconnect the blade by pushing in the locking tab (1) and sliding the blade (2) down the arm (3).

Fitting a replacement blade is a reversal of this process; position the new blade assembly on the wiper arm and slide the blade fully towards the hooked end of the arm until it locks in place. Check that the blade is securely locked before returning the wiper assembly to the windscreen.



# Tyres

## CARING FOR YOUR TYRES

**⚠ DEFECTIVE TYRES ARE DANGEROUS! Do not drive if any tyre is damaged, is excessively worn, or is inflated to an incorrect pressure.**

Always drive with consideration for the condition of the tyres, and regularly inspect the tread and side walls for any sign of distortion (bulges), cuts or wear.

The most common causes of tyre failure are:

- Bumping against kerbs
- Driving over deep potholes in the road
- Driving with under or over-inflated tyres

**NOTE:** *If possible, protect tyres from contamination by oil, grease, fuel and other automotive fluids.*

## Tyre pressures

Correctly inflated tyres will ensure that you enjoy the best combination of tyre life, ride comfort, fuel economy and road handling.

Under-inflated tyres wear more rapidly, can seriously affect the car's road handling characteristics and fuel consumption, as well as increasing the risk of tyre failure. Over-inflated tyres give a harsher ride, wear unevenly and are more prone to damage.

Check the pressures (including the spare wheel★) at least every week, when the tyres are cold - be aware that it only takes approximately 1.6 km of driving to warm up the tyres sufficiently to affect the tyre pressures.

Air pressure naturally increases in warm tyres; if it is necessary to check the tyres when they are warm (after the car has been driven for a while), you should expect the pressures to have increased. In this circumstance, NEVER let air out of the tyres in order to match the recommended pressures.

The recommended pressures for cold tyres, see 'TYRE PRESSURES', page 191.

## Valves

Keep the valve caps screwed down firmly - they prevent dirt from entering the valve. Check the valve for leaks (listen for a tell-tale hissing) when you check the tyre pressure.

# Tyres

## Tyre wear indicators

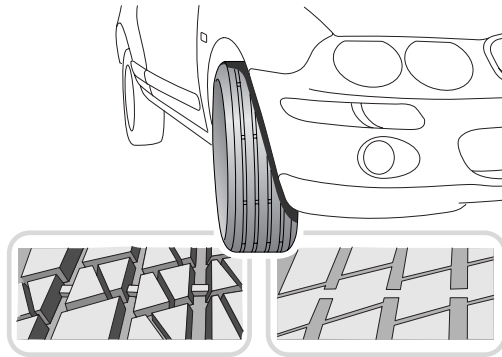

HB0067

Tyres fitted as original equipment have wear indicators moulded into the tread pattern at several points around the circumference. When the tread has worn down to 1.6 mm, the indicators will come to the surface of the tread pattern, producing the effect of a continuous band of rubber across the width of the tyre.

**NOTE:** *If tyre wear is uneven (on one side of the tyre only) or becomes abnormally excessive, the wheel alignment should be checked by your dealer.*

The indicators provide warning that there is insufficient tread remaining to provide good traction, particularly on wet roads, and that the tyres no longer comply with legislation requiring a minimum tread depth of 1.6 mm.

For safety, a tyre **MUST** be replaced as soon as a wear indicator becomes visible.

## Punctured tyres

Your car is fitted with tubeless tyres, which may not leak if penetrated by a sharp object, provided the object remains in the tyre. If you are aware of this occurring, reduce speed immediately and drive with caution until the spare wheel can be fitted or repairs undertaken.

A puncture of this kind will eventually cause the tyre to lose pressure, which is why regular (and frequent) checking of tyre pressures is important. Punctured or damaged tyres must be permanently repaired or replaced as soon as possible.

## Replacement tyres

**⚠ DO NOT replace wheels with any type other than genuine MG Rover parts. Alternative wheels, which do not meet original equipment specifications may adversely affect the car's driving characteristics and should not be fitted.**

Wheel rims and tyres are matched to suit the handling characteristics of the car. Changing the specification of a wheel or tyre can adversely affect the car's handling and, ultimately, your own safety in emergency road situations.

To be safe, **ONLY** fit replacement tyres that comply with the original specification (see 'WHEELS & TYRES', page 190). In addition, ensure that the load and speed ratings shown on the side wall of each tyre are the same as (or exceed) those of the original equipment. Contact your dealer for further information or assistance.

Always have replacement wheels and tyres balanced before use.

## Tyres

---

### SNOW CHAINS

 **DO NOT fit unapproved snow chains – this could damage brake components.**

Unsuitable snow chains could damage the tyres, wheels, suspension, brakes or bodywork of your car. Only fit chains that have been recommended by an MG Rover dealer and approved by MG Rover for use on your car.

In use, always observe the following precautions:

- Fit snow chains to the front wheels only.
- Always adhere to the snow chain fitting and retensioning instructions and the speed limitations for varying road conditions.
- DO NOT exceed speeds of 50 km/h.
- Avoid tyre damage and excessive chain wear by removing snow chains when driving on snow free roads.

## Cleaning & Vehicle Care

### WASHING YOUR CAR

**!** *Some high pressure cleaning systems will penetrate door, window and sunroof seals, and damage lock mechanisms. DO NOT aim water jets directly at components that might be easily damaged.*

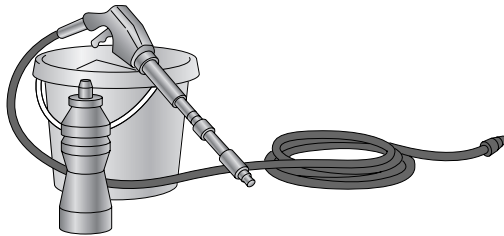

HB0068

Road dirt, oil, airborne pollutants and deposits from birds and trees can damage the paintwork. In order to preserve the paint finish, wash the car frequently and observe the following care points:

- DO NOT use hot water to wash the car.
- DO NOT use detergents or washing up liquid.
- In hot weather, DO NOT wash the car in direct sunlight.
- When using a hose, DO NOT aim the water directly at window, door or sunroof seals, or through wheel apertures onto the brake components.

If the car is particularly dirty, use a hose to flush grime and grit from the bodywork, prior to washing. Then, wash the car using cold or lukewarm water containing a good quality wash and wax shampoo. Always use plenty of water to ensure that grit is flushed from the surface and not ground into the paintwork.

After washing, rinse the bodywork with clean water and dry off with a chamois leather.

### Removing tar spots

Use white spirit to remove tar spots and stubborn grease stains from the paintwork, then wash the area immediately with soapy water to remove all traces of the spirit.

### Cleaning the underside

From time to time, but particularly during winter months if salt has been used on the roads, use a hose to wash the underside of the car. Flush away accumulations of mud and thoroughly clean those areas where debris can easily collect (wheel arches and panel seams, for example).

### Engine compartment

The engine compartment must only be cleaned by steam cleaning.

**!** *DO NOT use a high pressure hose to clean the engine compartment - damage to the car's electronic systems may occur.*

### Automatic car washes

**!** *Automatic car washes may damage roof and boot mounted spoilers. Avoid using automatic car washes with brushes. Before using any automatic car wash, always check its suitability for your car. If in any doubt seek assistance from the car wash operator.*

**!** *ALWAYS remove the radio aerial before entering an automatic car wash.*

## Cleaning & Vehicle Care

---

### Body protection

After washing, examine the paintwork for damage. Treat paint chips and scratches with an MG Rover paint touch-up pencil. If the damage has revealed bare metal, use a coloured primer first, then apply the correct colour base coat and finish off with a lacquer pencil, if appropriate. Carry out this treatment after washing but before polishing or waxing.

More extensive damage to paint or bodywork must be repaired in accordance with the manufacturer's recommendations. Failure to do this will invalidate the Anti-Corrosion Warranty. If in doubt, ask your MG Rover dealer for advice.

### Polishing the paintwork

Occasionally treat the paint surface with an approved polish containing the following properties:

- Very mild abrasives that will remove surface contamination without removing or damaging the paint.
- Filling compounds that will fill scratches and reduce their visibility.
- Wax to provide a protective coating between the paint and the elements.

***NOTE:** If possible, avoid applying polish or wax products to window glass and rubber seals.*

### Wiper blades

Wash in warm soapy water. DO NOT use spirit or petrol based cleaners.

### Windows and mirrors

Regularly clean all windows, inside and out, using an approved glass cleaner.

*Windscreen:* In particular, clean the outside of the screen with glass cleaner after washing the car with wash and wax products, and before fitting new wiper blades.

*Rear screen:* Clean the inside with a soft cloth, using a side to side motion to avoid damaging the heating elements. DO NOT scrape the glass or use abrasive cleaning compounds - this will damage the heating elements.

*Mirrors:* Mirror glass is particularly susceptible to damage; DO NOT use abrasive cleaning compounds or metal scrapers.

## Cleaning & Vehicle Care

---

### CLEANING THE INTERIOR

#### Plastic materials

Clean plastic-faced materials with diluted upholstery cleaner, then wipe with a damp cloth.

**NOTE:** *DO NOT* polish dashboard components - these should remain non-reflective.

#### Carpet and fabrics

Clean with diluted upholstery cleaner - test a concealed area first.

#### Leather

Clean leather trim with warm water and a non-detergent soap. Dry and polish the leather with a dry, clean, lint-free cloth.

**NOTE:** *DO NOT* use petrol, detergents, furniture creams or polishes as cleaning agents.

#### Instrument pack, clock and audio system displays

Clean with a dry cloth only. **DO NOT** use cleaning fluids or sprays.

#### Audio system detachable control panel

Periodically clean the electrical contacts on the back of the control panel and the matching contacts on the audio unit with a clean, dry, lint-free cloth. Use methylated spirits if available.

#### Airbag module covers

To prevent damage to the airbag SRS, the steering wheel centre pad and the area of the dashboard containing the passenger airbag should **ONLY** be cleaned sparingly with a damp cloth and upholstery cleaner.

 **DO NOT** allow these areas to be flooded with liquid and **DO NOT** use petrol, detergent, furniture cream or polishes.

#### Seat belts

Extend the belts, then use warm water and a non-detergent soap to clean. Allow the belts to dry naturally; **DO NOT** retract them or use the car until they are completely dry.

 **DO NOT** use bleaches, dyes or cleaning solvents on seat belts.

## Identification Numbers

### IDENTIFICATION NUMBERS

When communicating with your dealer, always quote the Vehicle Identification Number (VIN). If your communication concerns the engine or gearbox, it may be necessary to quote these numbers too.

#### Identification number locations

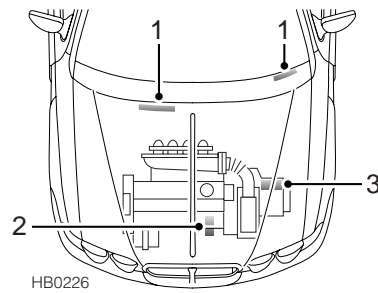

1.4, 1.6 & 1.8 Petrol models

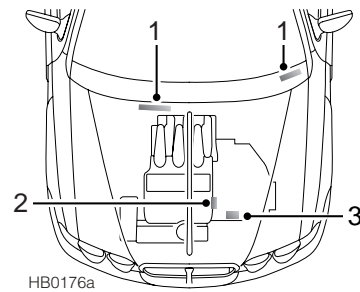

2.0 & 2.5 Petrol models

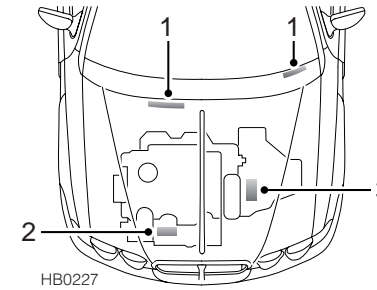

Diesel models

1. Vehicle identification number (VIN)
2. Engine number  
*1.4, 1.6 & 1.8 Petrol engines:* Stamped into the front face on the gearbox side of the cylinder block.  
*2.0 & 2.5 Petrol engines:* Stamped into the front face of the engine block.  
*Diesel engines:* Stamped into the front face on the engine block, where shown.
3. Gearbox number  
*Except 2.0 & 2.5 petrol models:* On a label attached to the upper face of the gearbox housing.  
*2.0 & 2.5 petrol models:* Stamped on a label attached to the upper face of the gearbox housing

#### Body number

Stamped on a plate inside the luggage compartment, adjacent to the spare wheel well.

4

## Identification Numbers

### Vehicle identification number (VIN)

The VIN (and recommended maximum vehicle weights) is stamped on a plate at the foot of the left hand door pillar and also stamped into the centre of the bulkhead at the top, inside the engine compartment. In addition, as a deterrent to car thieves and to help the police, the VIN is stamped into a plate, visible through the bottom left hand corner of the windscreen.

**NOTE:** The body colour and trim codes are also stamped on the VIN plate and must be quoted if paint or trim items are required.

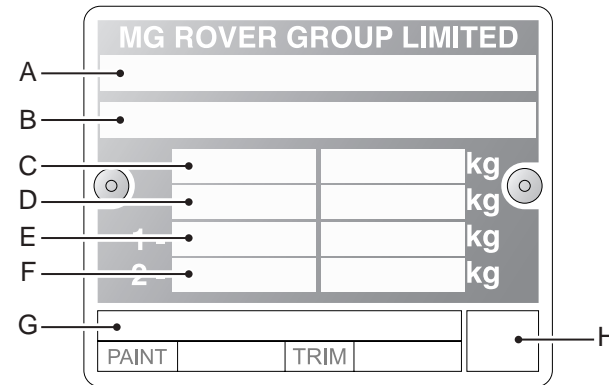

HB0002

The VIN plate on the door pillar contains the following information:

- A. Vehicle Identification Number (VIN)
- B. Type approval
- C. Gross vehicle weight (where required)
- D. Gross train weight (where required)
- E. Maximum front axle load (where required)
- F. Maximum rear axle load (where required)
- G. Derivative name
- H. Smoke coefficient number (where required)



## Parts & Accessories

---

### PARTS & ACCESSORIES

**⚠** *The fitting of parts and accessories that have not been approved by MG Rover, or the carrying out of non-approved alterations or conversions, may be dangerous and could affect the safety of the car and occupants, and also invalidate the terms and conditions of the car's warranty.*

To ensure your future driving pleasure and safety, we strongly recommend that only MG Rover approved parts are fitted to your car. Genuine MG Rover parts and accessories are the only components approved by MG Rover to meet rigorous original equipment standards for fitment and performance.

To enhance your motoring pleasure, a comprehensive and versatile range of quality accessories is available. This wide range of genuine MG Rover products is an integral part of the car's design and development programme and will help to guarantee continued reliability, safety and performance.

**⚠** *An airbag SRS is fitted to your car, ALWAYS consult an MG Rover dealer before fitting any accessory.*

Genuine MG Rover parts are the ONLY parts built to original equipment specifications AND approved by MG Rover designers; this means that every single part and accessory has been thoroughly tested by the same engineering team that designed and built the car. As a result, all genuine MG Rover parts and accessories are guaranteed for twelve months with unlimited mileage.

**⚠** *It is extremely hazardous to fit parts or accessories where installation requires the dismantling of, or addition to, either the electrical or fuel systems.*

A full list and description of all accessories is available from your MG Rover dealer.

### Travelling abroad

In some countries, it is illegal to fit parts which have not been made to the vehicle manufacturer's specification.

Owners should ensure that any parts or accessories fitted to the car while travelling abroad, will also conform to the legal requirements of their home country.



## *Emergency Information*

- 156* Emergency Starting
- 158* Vehicle Recovery
- 160* Puncture Repair & Wheel Changing
- 168* Fuse Replacement
- 174* Bulb Replacement

## Emergency Starting

### USING BOOSTER CABLES

**!** *During normal use, batteries emit explosive hydrogen gas, sufficient to cause severe explosions capable of causing serious personal injury - ensure sparks and naked lights are kept well away from the engine compartment.*

Using booster cables (jump leads) from a donor battery, or a battery fitted to a donor vehicle, is the only approved method of starting a car with a flat battery. Push or tow starting is NOT recommended!

**!** *DO NOT disconnect the discharged battery. Make sure that BOTH batteries are of the same voltage (12 volts), and that the booster cables are approved for use with 12 volt car batteries.*

If the battery from a donor vehicle is to be used, the vehicles should be parked with their battery locations adjacent to one another. Ensure that the two vehicles do not touch.

Apply the handbrakes and ensure that the gear levers on both vehicles are in neutral ('P' for cars with automatic transmission).

#### IMPORTANT

If the battery has become discharged, while the alarm system is armed, you should be aware that the alarm may start sounding as soon as battery power is restored (when a replacement battery is installed, or booster cables are connected). If the alarm starts sounding, disarm the alarm by pressing the handset LOCK button four times in quick succession and then pressing the unlock button once.

### Recommended earth points for your car

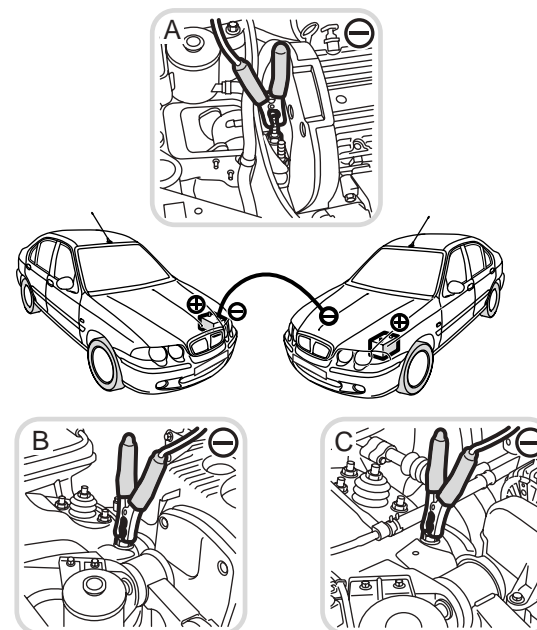

HB0179

A - 1.4, 1.6 & 1.8 petrol models  
B - Diesel models  
C - 2.0 petrol models

## Emergency Starting

### Starting the car

Turn off the starter switch and ALL electrical equipment of BOTH vehicles, then follow the instructions that follow:

**!** *Ensure that each booster cable connection is securely made and that there is no risk of the clips accidentally slipping from the battery terminals (as a result of engine vibration, for example); this could cause sparking, which could lead to fire or explosion.*

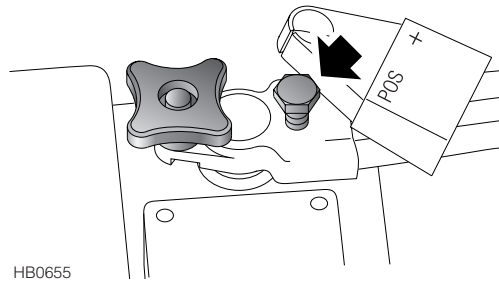

*Positive battery terminal connection with quick release clamp fitted.*

1. Connect the RED booster cable between the positive (+) terminals of both batteries.

**NOTE:** *On cars fitted with a quick-release battery clamp, it may not be possible to connect the booster cable securely to the terminal. In this case, attach the booster cable to the head of the bolt provided (arrowed in illustration).*

2. Connect the BLACK booster cable from the negative (-) terminal of the donor battery, to a good earth point (e.g. an engine mounting, chassis member or other unpainted surface), at least 0.5 m from the battery and well away from fuel and brake lines on the disabled vehicle (see illustration).

**!** *DO NOT connect a booster cable to the negative (-) terminal of the discharged battery!*

3. Check that the cables are clear of moving parts of both engines, then start the engine of the donor vehicle and allow it to idle for a few minutes.
4. Now start the engine of the vehicle with the discharged battery - DO NOT crank the engine for more than 15 seconds at a time.
5. Once both engines are running normally, allow them to idle for two minutes, before switching off the engine of the donor vehicle and disconnecting the booster cables. DO NOT switch on any electrical circuits on the previously disabled vehicle, until AFTER the booster cables have been removed.
6. Disconnecting the booster cables must be an exact reversal of the procedure used to connect them, i.e. disconnect the BLACK cable from the earth point on the disabled vehicle FIRST.

## Vehicle Recovery

---

### TOWING FOR RECOVERY

If your car is to be towed, most qualified recovery specialists will use wheel lift equipment to suspend the front wheels, while the rear wheels remain on the ground. However, if it is necessary for the car (except 1.8 models with automatic transmission) to be towed with all four wheels on the ground, abide by the following procedure.

#### *Before being towed:*

**⚠ DO NOT remove the starter key or turn the starter switch off while the car is being towed on four wheels - this will prevent the steering wheel from being turned.**

1. Turn the starter key to the first position to unlock the steering and then to the second position to enable the brake lights, wipers and direction indicators to be operated if necessary. If, due to an accident or electrical fault, it is considered unsafe to turn the starter switch to the first position, disconnect the battery before turning the switch.
2. Place the gear lever in neutral ('N' for cars with automatic transmission).
3. Release the handbrake.

#### *While being towed observe the following:*

- Without the engine running, greater effort will be required to operate the brake pedal and turn the steering wheel. Longer stopping distances will also be experienced.
- While towing for recovery, the towing vehicle should never exceed 50 km/h.

### Models with automatic transmission

Ideally, cars fitted with an automatic transmission should only be moved by trailer/transporter. If these facilities are unavailable, move the vehicle on suspended tow (with the front wheels raised) with 'N' selected in the gearbox.

**⚠ 1.8 models with automatic transmission MUST NOT under any circumstances be towed on all four wheels. Without the engine running the gearbox is not adequately lubricated.**

It is acceptable (if it is ESSENTIAL for the car to be moved and no other option is available) for 2.0 models with automatic transmission to be towed on all four wheels providing you adhere strictly to the following:

- DO NOT allow the car to be towed further than 50 km.
- Restrict the towing speed to a maximum of 50 km/h.

## Vehicle Recovery

---

### TRANSPORTER OR TRAILER LASHING

**!** *DO NOT use the lashing points to tow your car behind another vehicle, or use the lashing points to tow a trailer or caravan.*

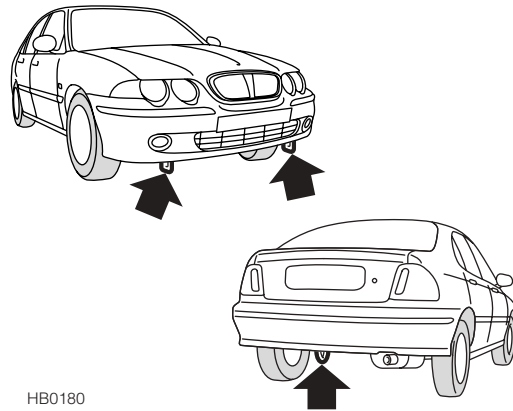

HB0180

If your car is to be transported on the back of a trailer or transporter, use the recommended lashing points at the front and rear of the car only. **DO NOT** secure lashing hooks, 'T' bars or trailer fixings to any other part of the car.

## Puncture Repair & Wheel Changing

### INSTANT TYRE REPAIR (ITR) COMPONENTS\*

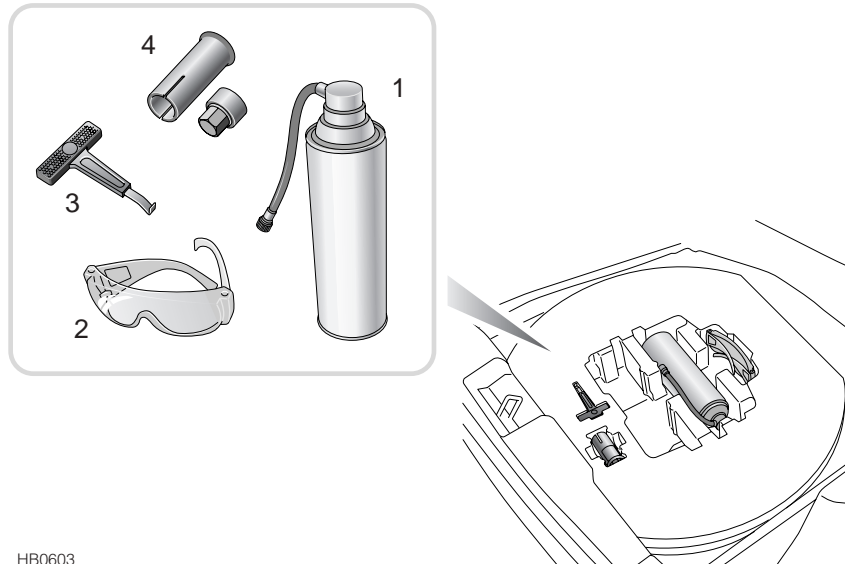

HB0603

**!** *ALWAYS read and obey all instructions and warnings printed on the tyre sealant canister.*

1. Tyre sealant canister.
2. Safety goggles.
3. Wheel nut cover removal tool\*.
4. Locking wheel nut removal tool\*.

*NOTE: ITR is standard equipment for most cars and is designed to provide a temporary repair solution for most tyre tread punctures.*

*For information on how to use ITR, please refer to 'INSTANT TYRE REPAIR (ITR)\*', page 162.*



## Puncture Repair & Wheel Changing

### SPARE WHEEL & TOOLS\*

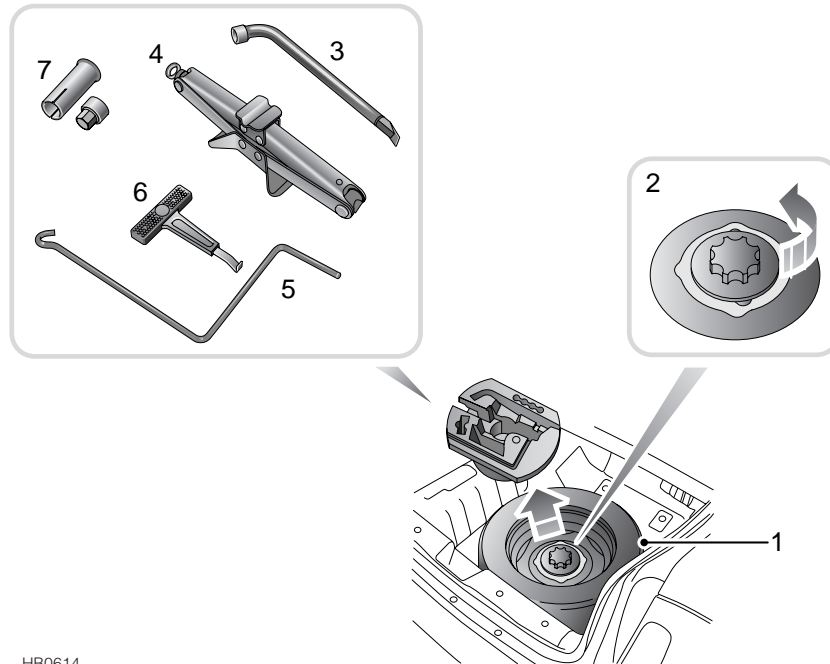

1. Spare wheel.
2. Spare wheel clamp.
3. Wheel nut spanner.
4. Jack.
5. Jack handle.
6. Wheel nut cover removal tool\*.
7. Locking wheel nut removal tool\*.

**NOTE:** The fitment of a space saver or full size spare wheel and associated tools is available as an option at the time of manufacture and replaces the Instant Tyre Repair (ITR) system.

For information on how to change the wheel, please refer to 'CHANGING A WHEEL', page 164.

HB0614

## Puncture Repair & Wheel Changing

### INSTANT TYRE REPAIR (ITR)\*

ITR provides a temporary solution to enable you to reach a dealer or tyre specialist, where the tyre must be repaired or replaced. Have the tyre repaired or replaced as soon as possible.

Always choose a safe place to stop, away from the main thoroughfare. Always ask your passengers to get out of the car and wait in a safe area away from other traffic.

**NOTE:** Switch on the hazard warning lights to alert other road users.

### SAFETY PRECAUTIONS

**!** Read the directions and warnings on the sealant canister beforehand and wear the safety goggles supplied when using the sealant.

**!** The tyre sealant contains fluorocarbons and solvents which are harmful if swallowed or inhaled and are irritating to the eyes.

- If swallowed, DO NOT induce vomiting - seek medical assistance immediately.
- If inhaled, breathe fresh air. If breathing is adversely affected, seek immediate medical assistance.
- If in contact with the eyes, immediately flush the eyes with water for 15 minutes. If irritation persists, seek medical assistance.
- DO NOT breathe gas/fumes/vapour/spray from the canister. Inhalation of canister vapours may cause drowsiness and dizziness.

**!** Keep the tyre sealant canister out of the reach of children. Store the canister in its correct location beneath the loadspace floor; temperatures in other locations may exceed safe storage conditions.

**!** DO NOT puncture or incinerate the canister, or expose to heat, flame or direct sunlight - this may cause the canister to rupture.

**!** Under no circumstances should speeds of 45 km/h be exceeded when driving with a tyre repaired using ITR, until the tyre is inflated to its correct pressure. Once the tyre is correctly inflated, the car must NOT be driven at speeds exceeding 80 km/h.

### Using ITR

1. Inspect the deflated tyre for cause of puncture. If possible, remove foreign bodies (e.g. screws and nails) from the tread.

**NOTE:** The system can be used to repair small punctures in the tread only. In the event of side wall or severe tread damage, seek assistance from the breakdown services.

2. Remove the tyre sealant canister and the safety goggles from the rear loadspace and put on the safety goggles.

**NOTE:** If the ambient temperature is below 0° C, warm the canister inside the car, using the car heating system.

3. Remove the valve cap from the punctured tyre.
4. Vigorously shake the canister (for approximately 30 seconds), then screw the filler tube clockwise onto the tyre valve.

## Puncture Repair & Wheel Changing

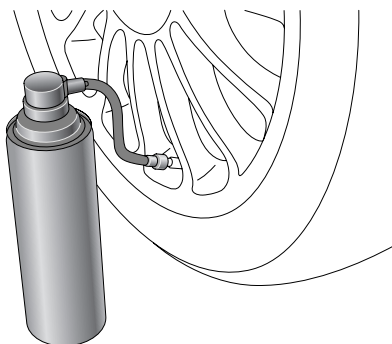

HB0604

5. Hold the canister upright and flip up the protective cap.
6. Press the button to inflate the tyre. Hold the canister stationary to avoid straining the filler tube.
7. Empty the ENTIRE contents of the canister into the tyre. When the sealant stops flowing through the tube, release the button and unscrew the tube from the valve.

**NOTE:** If tyre sealant comes into contact with the car's paintwork, wash the area with water as soon as possible.

8. If the wheel rim is clear of the ground, drive the car IMMEDIATELY for approximately 4 miles (6 km) to spread the sealant evenly inside the tyre. Drive gently and DO NOT exceed 45 km/h. If the wheel rim does not lift from the ground, DO NOT drive the car; seek assistance from the breakdown services.

9. Drive immediately to a service station and inflate the tyre to the correct pressure (see 'TYRE PRESSURES', page 193). If the required pressure cannot be reached, then the tyre is too severely damaged and you should seek assistance from the breakdown services. **DO NOT DRIVE THE CAR!**
10. If the correct tyre pressure was achieved, continue driving. Drive carefully and do not exceed 80 km/h. At the earliest opportunity, have the tyre repaired or replaced by a dealer or tyre specialist and replace the used canister of tyre sealant.

**!** Always inform the tyre repairer that tyre sealant has been used. If the tyre is to be subsequently deflated, only do so in a well ventilated area.

### Replacing the sealant canister

Always replace a used or out of date tyre sealant canister with one of the same type and capacity. Where possible, return the canister to an MG Rover dealer for safe disposal and to obtain a replacement.

## Puncture Repair & Wheel Changing

### CHANGING A WHEEL

Always choose a safe place to stop away from the main thoroughfare. Always ask your passengers to get out of the car and wait in a safe area, away from other traffic.

**NOTE:** Switch on the hazard warning lights to alert other road users.

Before changing a wheel, ensure the front wheels are in the straight ahead position, apply the handbrake and engage 1st gear (select 'P' for automatic gearbox cars). Observe the following precautions:

- Ensure the jack is positioned on firm, level ground; NEVER on soft ground, or over metal gratings or manhole covers. DO NOT place additional material between the jack and the ground, this may jeopardise the safety of the jacking operation.
- If jacking on a slope, place chocks at the front and rear of the wheel diagonally opposite the one to be removed.
- NEVER jack the car with passengers inside or with a caravan or trailer connected!

#### **Important information for owner's of 180 models equipped with a space saver spare wheel.**

Because your vehicle has an uprated braking system fitted, it is not possible to use the space saver wheel on the front hubs. In the event of a front wheel puncture, you will be required to fit the space saver wheel to a rear hub and use the wheel removed from the rear to replace the punctured front wheel.

### Removing the wheel trim (steel wheels only)

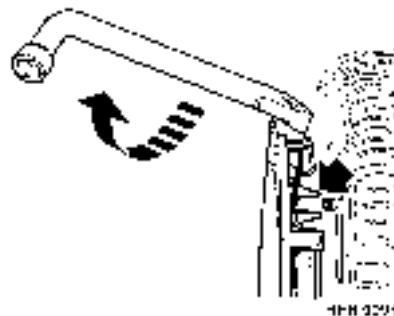

Slide the flat, wedge end of the wheel nut spanner behind the edge of the wheel trim. Working carefully around the wheel, apply a twisting action to the tool, to prise the trim from the wheel.

**NOTE:** When refitting the wheel trim, ensure that the valve stem is located between the valve stem guides (plastic lugs arrowed in illustration).

## Puncture Repair & Wheel Changing

### Removing the wheel nut cover (alloy wheels)\*

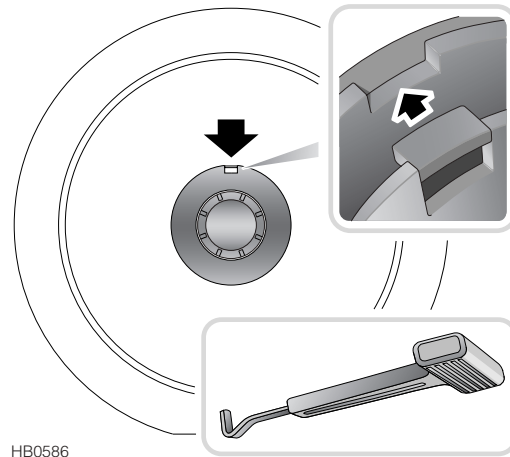

Insert the hooked end of the removal tool into the small rectangular aperture in the wheel nut cover (arrowed in illustration). Pull the wheel nut cover from the wheel to access the wheel nuts.

### Positioning the jack

**!** *NEVER work beneath the car with the jack as the only means of support. The jack is designed for wheel changing only!*

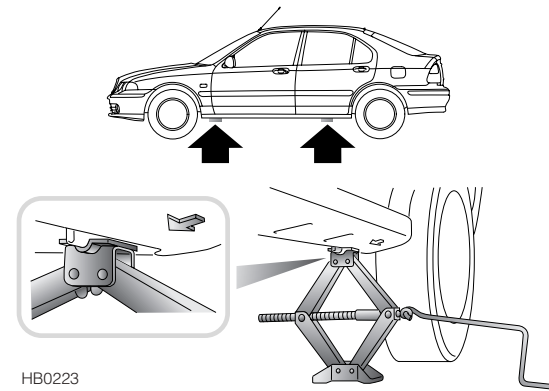

Position the jack under the jacking point nearest the wheel to be removed (note that arrows pressed into the sills identify the four jacking points). Turning the jack screw by hand, raise the jack until the jack head fits snugly around the centre of the jacking point. Ensure that the base of the jack is in full contact with the road surface.

**!** *Never jack the car using any jacking points other than the designated points shown. Serious damage to the car could result.*

5

## Puncture Repair & Wheel Changing

---

### Changing the wheel

1. Before raising the car, use the wheel nut spanner to slacken each of the wheel nuts half a turn anti-clockwise (refer to the following page for information about locking wheel nuts).
2. Attach the jack handle and turn the jack screw clockwise to raise the car until the tyre is clear of the ground.
3. Remove the wheel nuts and wheel.

*NOTE: Avoid placing wheels (and wheel trims) face down on the ground - the surface may be scratched.*

4. Fit the spare wheel and tighten the wheel nuts (domed side towards the wheel) until the wheel is seated firmly against the hub.
5. Lower the car and remove the jack, then FULLY tighten the wheel nuts in a diagonal sequence.
6. Refit the wheel trim (steel road wheels only), ensuring that the valve stem is located between the valve stem guides (plastic lugs arrowed in wheel trim removal illustration). Use firm pressure with the flat of the hand to press the wheel trim into position.

*NOTE: The wheel trim must not be fitted to the space saver spare wheel.*

7. Finally, return the tools and the wheel (face down) to the luggage compartment.

**!** *Always check the tyre pressure after changing a wheel, and have the tightness of the wheel nuts checked by a dealer as soon as possible!*

### The following precautions must be observed when the space saver spare wheel is in use:

- The space saver spare wheel is for temporary use only. It must be replaced by the normal sized wheel as soon as possible.
- Only one space saver wheel is to be used on the car at any one time.
- A maximum speed of 80 km/h must be observed.
- The inflation pressure of the space saver tyre must be maintained at 4.2 bar.
- The use of snow chains is NOT permitted on the space saver spare wheel.
- DRIVE CAUTIOUSLY; the space saver tyre is smaller in size and higher in pressure than a regular tyre. It will cause a harsher ride and may have less traction on some road surfaces.

## Puncture Repair & Wheel Changing

### LOCKING WHEEL NUTS\*

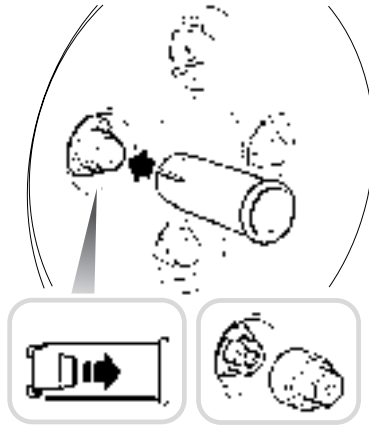

HB0108

Cars with alloy wheels are fitted with one locking wheel nut on each wheel. These are visually very similar to standard wheel nuts, but can only be removed using the special tools provided.

**NOTE:** A code number is stamped on the face of the socket. Ensure the number is recorded on the Security Information card supplied. Quote this number if a replacement is required. **DO NOT** keep the Security Information card in the car!

### Removing the locking wheel nut

1. Push the plastic extractor tube firmly onto the locking wheel nut cover (see left inset). By pulling the tube squarely away from the wheel, the stainless steel nut cover can be pulled from the nut (see right inset).
2. Fit the metal key socket over the wheel nut.
3. Using the wheel wrench, unscrew the wheel nut in the normal way.

Keep the key socket and extractor with the tool kit in the space provided.

**NOTE:** The socket can be conveniently retained inside the extractor tube when not in use.

## Fuse Replacement

### FUSES

Fuses are simple circuit breakers, which protect the car's electrical equipment by preventing the electrical circuits from being overloaded.

A blown fuse may be indicated when the item of electrical equipment it protects, stops working.

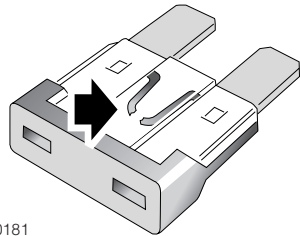

HB0181

Check a suspect fuse by removing it from the fuse box and looking for a break in the wire inside the fuse.

Only replace a fuse with one of the same, or lower rating.

### Fuse boxes

There are two fuse boxes; the main fuse box located behind the driver's personal storage compartment inside the car and the other in the engine compartment. The location and value of each fuse, is shown on the charts attached to the rear of the driver's storage compartment and the underside of the engine compartment fuse box cover. They are also shown on the following pages.

Spare fuses are provided in the main fuse box, however these are not numbered in the following illustration.

### Fuse colours

In both fuse boxes, the fuses are colour coded to identify their amperage ratings as follows:

ORANGE	5 amp
BROWN	7.5 amp
RED	10 amp
BLUE	15 amp
YELLOW	20 amp
CLEAR	25 amp
GREEN	30 amp



## Fuse Replacement

### MAIN FUSE BOX

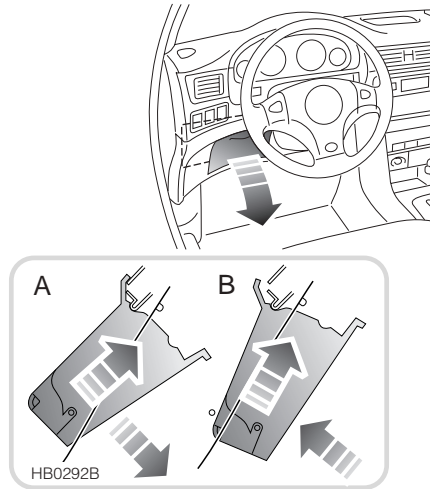

To access the interior fuse box, first remove the driver's personal storage compartment as follows (see diagram 'A'):

- Open the storage compartment, then push it upwards (against spring pressure) to release it from the retaining pivots (one on each side near the bottom). At the same time, pull the storage compartment out and away from the surrounding panel.

To replace the storage compartment (see diagram 'B'):

- Locate and align the indents at the top (one on each side) of the storage compartment with the two retaining springs.

- Push the storage compartment upwards (holding it against the pressure of the two springs) while pushing the bottom into position. Note that the storage compartment pivots near its base and will latch into place once the two pivot pins have engaged with the appropriate slots low down on each side of the storage compartment.

### Checking or renewing a fuse

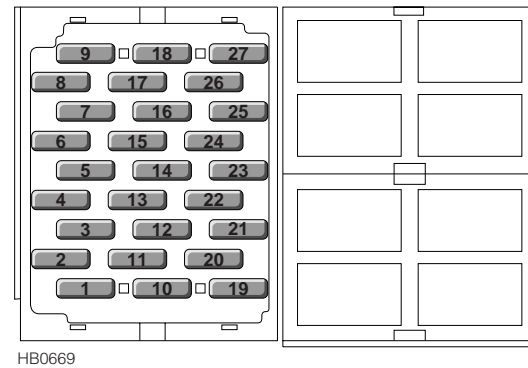

Always turn off the starter switch and the appropriate electrical circuit before removing a fuse. To remove a fuse, press the removal tweezers onto the head of the fuse and pull. Always replace a fuse with another of the same (or lower) rating. If a replacement fuse blows almost immediately, this indicates a serious electrical problem and the circuit **MUST** be checked by an MG Rover dealer.

## Fuse Replacement

### Main fuse box fuse specifications

Fuse number	Rating (AMPS)	Circuit protected
1	20A	Anti-theft alarm
2	20A	Window - RH rear
3	15A	Engine management system
4	20A	Window - LH rear, Sunroof
5	10A	Interior lights, Luggage compartment light
6	20A	Window - front passenger
7	30A	Sunroof
8	20A	Window - driver
9	20A	Heated seats★
10	10A	Headlight - RH main beam
11	10A	RH side light, RH tail light, Number plate lights
12	10A	Headlight - LH main beam
13	10A	LH side light, LH tail light, Interior illumination
14	10A	Headlight - RH dipped beam
15	10A	Daylight running lights, Interior illumination (Scandinavia only)
16	10A	Headlight - LH dipped beam
17	10A	Multi-function unit, Windows
18	20A	Headlight washers★
19	15A	Clock, Audio System, Cigar Lighter
20	10A	Engine management system

## Fuse Replacement

Fuse number	Rating (AMPS)	Circuit protected
21	20A	Windscreen wipers and washers, Headlight levelling
23	15A	Engine management system, Cruise control
24	10A	Anti-lock brakes
25	10A	Anti-theft alarm, Reversing lights, Headlight levelling, Automatic gearbox selector illumination, Direction indicators, Instruments
26	15A	Rear wiper and washer, Door mirrors, Heater blower and recirculation, Air conditioning, Daylight running lights (Scandinavia only), Heated seats*
27	5A	Airbag SRS

## Fuse Replacement

### Spare fuses

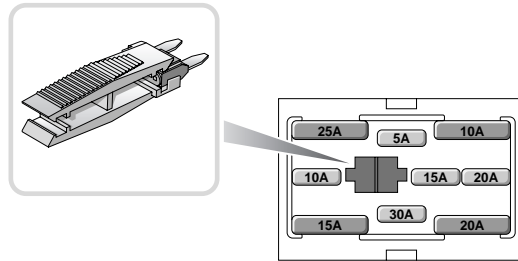

HB0677

A separate module containing spare fuses of varying values is attached to one side of the main fuse box. The module contains:

- Five mini-size fuses suitable for the main fuse box.
- Four larger fuses suitable for the engine compartment fuse box.
- A double-ended fuse extraction tool, suitable for removing both mini and larger-size fuses.

### ENGINE COMPARTMENT FUSES

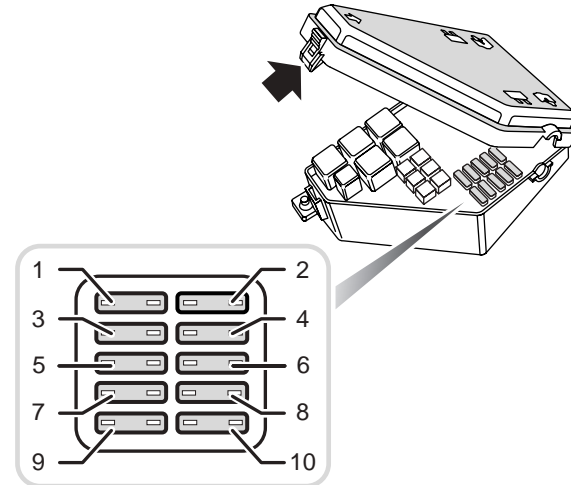

HB0113

The fuse box is located to the rear of the engine compartment on the left hand side. Press the catch (arrowed in illustration) to release the cover.

**NOTE:** Owners are advised against removing or replacing the fusible links and relays identified on the underside of the fuse box lid. Failure of any of these items should be investigated by a qualified technician.

## Fuse Replacement

---

### Engine compartment fusebox fuse specifications

Fuse number	Rating (AMPS)	Circuit protected
1	15A	Engine management system
2	20A	Engine management system
3	15A	Engine management system
4	10A	Engine management system
5	20A	Multi-function unit
6	15A	Front fog lights★
7	15A	Hazard warning lights
8	15A	Brake lights, clock
9	10A	Air conditioning★
10	20A	Fuel pump

## Bulb Replacement

---

### REPLACING BULBS

Check the operation of all exterior lights before you drive the car.

**NOTE:** Only replace bulbs with the same type and specification.

Before replacing any bulb, turn off the lighting switch to avoid any possibility of a short circuit.

### Replacement bulbs

Bulb	Watts
Headlight dipped beam	H7 55
Headlight main beam	H1 55
Sidelight	5
Front fog lights	H1 55
Direction indicators	21
Side repeater lights	5
Reverse lights	21
Rear fog guard lights	21
Tail lights	5
Brake lights	21
Number plate light	5
Interior light	5
Luggage compartment light	5
Glovebox light	5

### Halogen bulbs

Halogen bulbs are used for headlight dipped and main beams and for front fog lights. This type of bulb may shatter in use if the glass has been scratched, or contaminated with oil or perspiration. Take care NOT to touch the glass with your fingers; always use a cloth to handle the bulb. If necessary, clean the glass with methylated spirits to remove fingerprints.

## Bulb Replacement

### HEADLIGHTS AND SIDELIGHT

Your car is equipped with twin headlights, the inboard set being the dipped beam lights and the outer set are the main beam. The bulbs can be reached from inside the engine compartment.

#### Headlights - Dipped Beam

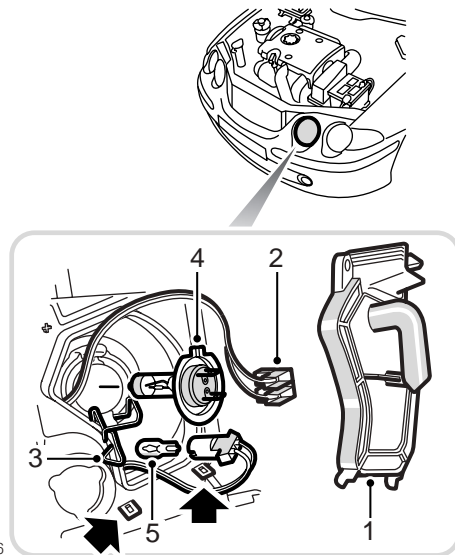

- Press the plastic cover release catch and pivot the cover (1) away from the rear of the light unit.
- Pull the electrical connector (2) from the back of the headlight bulb.

- Unhook the wire retaining clip (3), and pivot away from the rear of the bulb.
- Remove the bulb (4).

When replacing the bulb, ensure that the rectangular tab is vertically aligned at the top.

When replacing the electrical connector, check with the illustration to ensure that it is fitted the correct way round

When replacing the plastic cover, angle the cover so that the two hooked pegs at the base of the cover locate securely in the corresponding sockets in the light unit (these are arrowed in the illustration), then close the cover. Ensure that the catch is secure.

**!** *During use, Halogen headlight bulbs may shatter if the glass has been scratched, or contaminated with oil or perspiration. DO NOT touch the glass. If handled, clean with methylated spirits and a clean cloth.*

#### Sidelight

**Replacement bulb:** 5 watt.

The sidelight holder is directly below the dipped beam headlight bulb. With the cover removed, pull the bulb holder from the light unit and pull the bulb (5) from the holder.

## Bulb Replacement

### Headlights - Main Beam

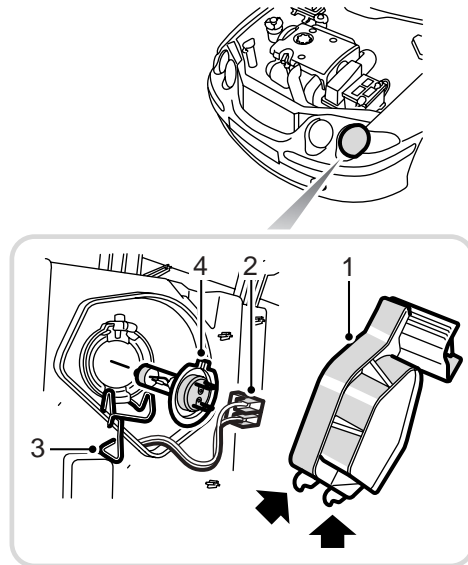

- Press the plastic cover release catch and pivot the cover (1) away from the rear of the light unit.
- Pull the electrical connector (2) from the back of the headlight bulb.
- Unhook the wire retaining clip (3), and pivot away from the rear of the bulb.
- Remove the bulb (4).

When replacing the bulb, ensure that the rectangular tab is vertically aligned at the top.

When replacing the electrical connector, check with the illustration to ensure that it is fitted the correct way round

When replacing the plastic cover, angle the cover so that the two hooked pegs at the base of the cover (arrowed in illustration) locate securely in the corresponding sockets in the light unit, then close the cover. Ensure that the catch is secure.

**⚠** *During use, Halogen headlight bulbs may shatter if the glass has been scratched, or contaminated with oil or perspiration. DO NOT touch the glass. If handled, clean with methylated spirits and a clean cloth.*

### FRONT FOG LIGHTS\*

As removal of the front bumper is necessary, we recommend that front fog light bulb replacement should only be carried out by qualified personnel.



## Bulb Replacement

### FRONT DIRECTION INDICATORS

**Replacement bulb:** 21 watt.

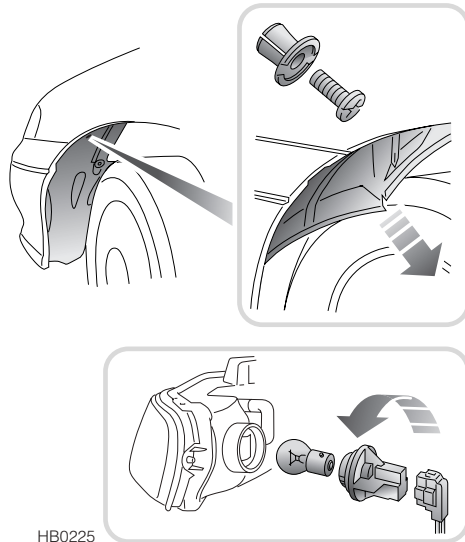

HB0225

The direction indicator bulbs are accessible from behind the wheel arch liners, as follows:

Turn the steering wheel to full left lock to access the right indicator bulb or full right lock to access the left indicator bulb.

Use a screwdriver to remove the plastic screw-socket securing the wheelarch liner (see inset) and pull the wheelarch liner down until it naturally folds along the crease line. This will open up a gap, enabling you to reach behind the liner and feel the rear of the bulb holder.

Twist a quarter turn anti-clockwise to release the bulb holder from the headlight unit, then push and twist to remove the bulb.

When replacing, note that the screw-socket is made in two parts - as it is tightened, the inner 'screw' progressively expands the outer 'socket' thereby securing the liner to the wing panel.

## Bulb Replacement

### SIDE REPEATER LIGHTS

Replacement bulb: 5 watt.

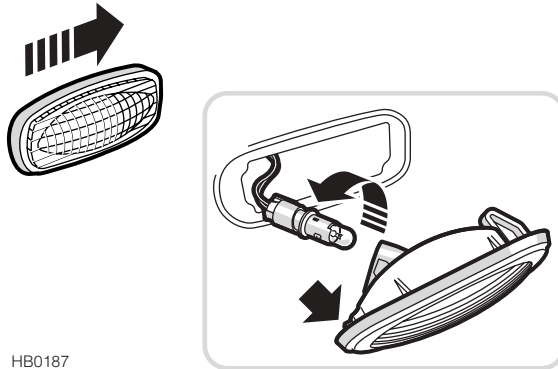

HB0187

Push the lens firmly towards the front of the car to release the light unit, then withdraw the light from the wing.

Twist anti-clockwise to release the bulb holder from the light unit. Pull to remove the bulb from its socket.

When refitting the light unit, first locate the two tabs (arrowed in illustration), ensuring that they are pointing towards the rear of the car, then fit the remainder of the light unit into the aperture.

### REAR LIGHTS (4 door models)

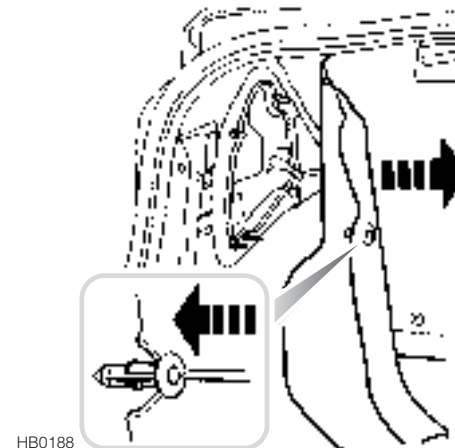

HB0188

From inside the luggage compartment, remove the fastener (illustrated in inset) and pull back the moulded lining as shown.

To remove the fastener, use a pointed tool to push in the centre (see inset) - the fastener can then be easily extracted from the moulded lining.

**⚠** Take care to avoid any contact with a hot exhaust system, when carrying out any maintenance at the rear of the car.

## Bulb Replacement

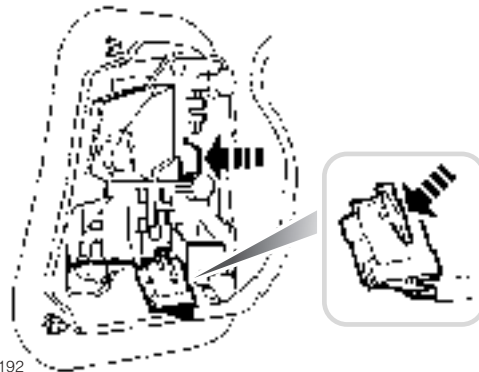

HB0192

Detach the electrical connector from the back of the light unit by depressing the release catch (arrowed in inset) and then pulling the connector free.

Pull the lever (arrowed in illustration) towards the centre of the car to release the light unit, then withdraw the light unit from the rear of the car.

When refitting, ensure levers are securely clipped into the light unit by pushing the levers outwards.

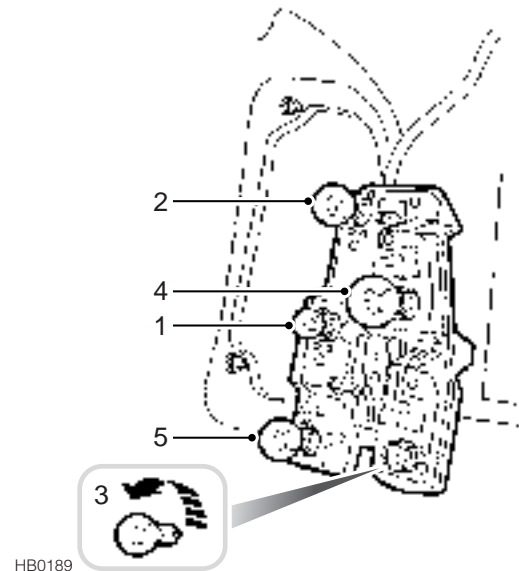

HB0189

### **Replacement bulbs:**

1. Tail light 10 watts
2. Brake light 21 watts
3. Reversing light 21 watts
4. Direction indicator light 21 watts
5. Fog guard light 21 watts

## Bulb Replacement

### REAR LIGHTS (5 door models)

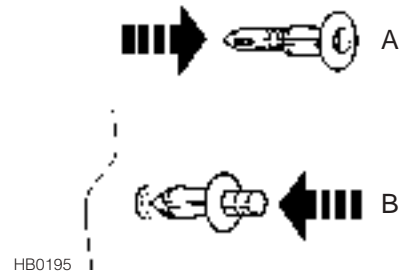

To replace the fastener, push on the pointed end (arrowed in illustration 'A') until the centre protrudes from the collar (as illustration 'B').

Insert the fastener through the moulded luggage compartment lining and into the hole in the body, then push the centre of the fastener (as arrow 'B') until it locks (flush with the collar).

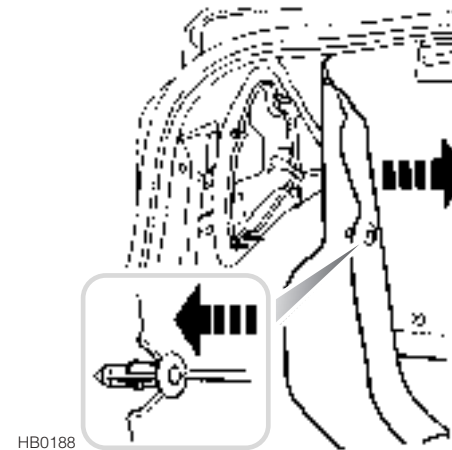

From inside the luggage compartment, remove the fastener (illustrated in inset) and pull back the moulded lining as shown.

To remove the fastener, use a pointed tool to push in the centre (see inset) - the fastener can then be easily extracted from the moulded lining.

**⚠** *Take care to avoid any contact with a hot exhaust system, when carrying out any maintenance at the rear of the car.*

## Bulb Replacement

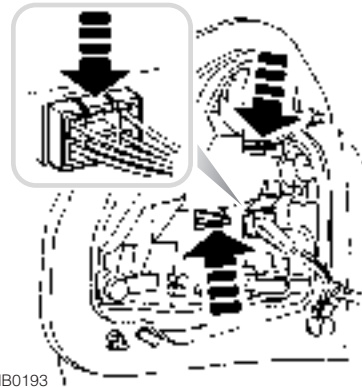

HB0193

Detach the electrical connector from the back of the light unit by depressing the release catch (arrowed in inset) and then pulling the connector free.

Squeeze both levers (arrowed in main illustration) to release the light unit, then withdraw the light unit from the rear of the car.

When refitting, ensure levers are securely clipped into the light unit by pushing the levers outwards.

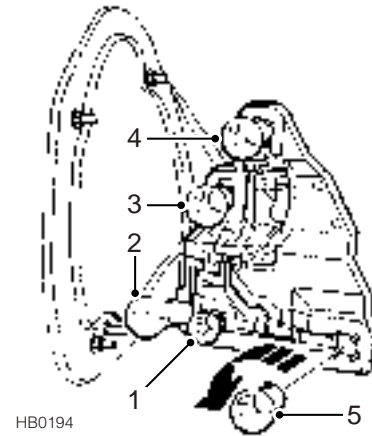

HB0194

### **Replacement bulbs:**

1. Tail light 10 watts
2. Brake light 21 watts
3. Reversing light 21 watts
4. Direction indicator light 21 watts
5. Fog guard light 21 watts

## Bulb Replacement

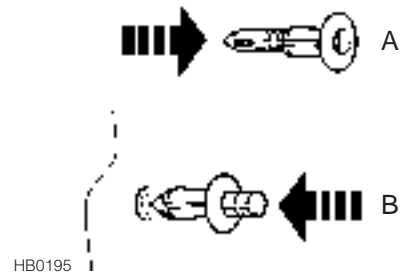

To replace the fastener, push on the pointed end (arrowed in illustration 'A') until the centre protrudes from the collar (as illustration 'B').

Insert the fastener through the moulded luggage compartment lining and into the hole in the body, then push the centre of the fastener (as arrow 'B') until it locks (flush with the collar).

### NUMBER PLATE LIGHT

Replacement bulbs: 5 watt.

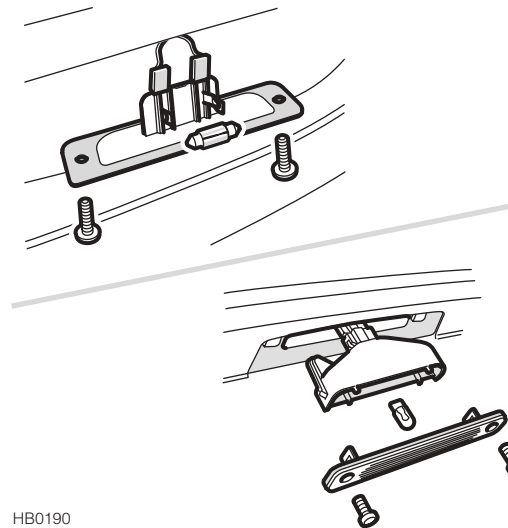

*The upper part of the illustration represents the process for 4-door models, the lower part represents 5-door models.*

Remove both screws to release the light unit, and remove the lens. Pull to remove the spent bulb.

## Bulb Replacement

### INTERIOR LIGHT

Replacement bulbs: 10 watt

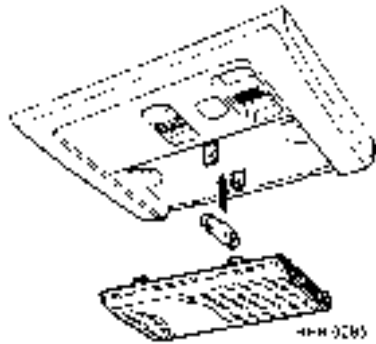

Pull down on the front edge of the lens to remove it from the light housing. Spring the bulb connectors apart to release the bulb.

When replacing the lens, fully insert the tabs on the rear edge first.

### LUGGAGE COMPARTMENT LIGHT (4 door models)

Replacement bulb: 10 watt

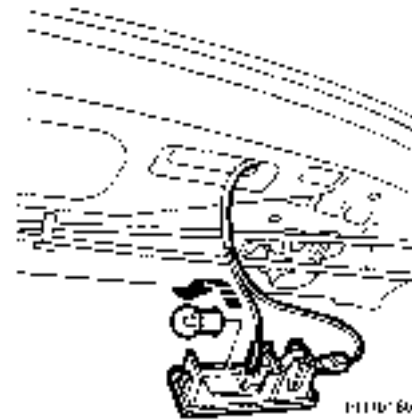

Use a small screwdriver to prise the lens from the light housing. Twist the bulb to remove.

## Bulb Replacement

---

### LUGGAGE COMPARTMENT LIGHT (5 door models)

**Replacement bulb:** 10 watt

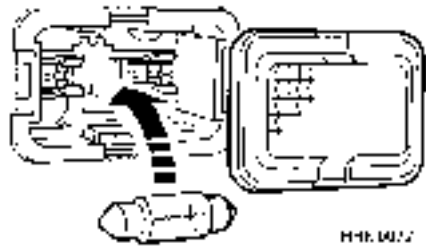

Use a small screwdriver to prise the lens from the light housing.  
Pull the bulb to remove.



***Technical Data***

---

- 186** *Technical Data*
- 198** *Fuel Consumption*
- 199** *Declaration of Conformity*

## Technical Data

### ENGINES

#### 1.4 litre petrol

Fuel	UNLEADED 95 RON to EN 228 specification is recommended †
Capacity	1396 cm <sup>3</sup>
Firing order	1-3-4-2
Idle speed	825 ± 50 rev/min
Bore	75 mm
Stroke	79 mm
Number of cylinders	4 in-line
Compression ratio	10.3:1
Ignition system	MEMS3 breakerless, electronic
Spark plugs	GSP 66527
Spark plug gap	1.00 mm ± 0.05 mm
† Unleaded fuels of 95 - 98 RON can be used.	

#### 1.6 litre petrol

Fuel	UNLEADED 95 RON to EN 228 specification is recommended †
Capacity	1588 cm <sup>3</sup>
Firing order	1-3-4-2
Idle speed	825 ± 50 rev/min
Bore	80 mm
Stroke	79 mm
Number of cylinders	4 in-line
Compression ratio	10.5:1
Ignition system	MEMS3 breakerless, electronic
Spark plugs	GSP 66527
Spark plug gap	1.00 mm ± 0.05 mm
† Unleaded fuels of 95 - 98 RON can be used.	

## Technical Data

### 1.8 litre petrol

Fuel	UNLEADED 95 RON to EN 228 specification is recommended †
Capacity	1796 cm <sup>3</sup>
Firing order	1-3-4-2
Idle speed	825 ± 50 rev/min
Bore	80 mm
Stroke	89.3 mm
Number of cylinders	4 in-line
Compression ratio	10.5:1
Ignition system	MEMS3 breakerless, electronic
Spark plugs	GSP 66527
Spark plug gap	1.00 mm ± 0.05 mm
† Unleaded fuels of 95 - 98 RON can be used.	

### 2.0 litre petrol

Fuel	UNLEADED 95 RON to EN 228 specification is recommended †
Capacity	1997 cm <sup>3</sup>
Firing order	1-6-5-4-3-2
Idle speed	750 ± 50 rev/min
Bore	80 mm
Stroke	66.2 mm
Number of cylinders	6 V-arrangement
Compression ratio	10.5:1
Ignition system	Siemens engine management system
Spark plugs	GSP 66527
Spark plug gap	1.00 ± 0.05 mm
† Unleaded fuels of 95 - 98 RON can be used.	

## Technical Data

### 2.5 litre petrol

Fuel	UNLEADED 95 RON to EN 228 specification is recommended†
Capacity	2497 cm <sup>3</sup>
Firing order	1-6-5-4-3-2
Idle speed	750 ± 50 rev/min
Bore	80 mm
Stroke	82.8 mm
Number of cylinders	6 V-arrangement
Compression ratio	10.25:1
Ignition system	Siemens engine management system
Spark plugs	GSP 66527
Spark plug gap	1.00 ± 0.05 mm
† Unleaded fuels of 95 - 98 RON can be used.	

### 2.0 litre diesel

Fuel	Diesel to EN 590 specification
Capacity	1994 cm <sup>3</sup>
Firing order	1-3-4-2
Idle speed	805 ± 50 rev/min
Bore	84.5 mm
Stroke	88.9 mm
Number of cylinders	4 in-line
Compression ratio	19.5:1

## Technical Data

### CAPACITIES

Fuel tank (usable)	55 litres
Engine oil (and filter) refill:	
1.4, 1.6 & 1.8 petrol engines	4.5 litre
2.0 & 2.5 petrol engines	5.2 litre
Diesel engine	4.8 litre
Manual gearbox refill:	
1.4 & 1.6 petrol engines	1.8 litre
1.8 petrol & 2.0 diesel engines	2.0 litre
Automatic gearbox refill	
1.8 petrol engine	4.5 litre
2.0 petrol engine	4.0 litre
Cooling system fill from dry	
1.4 & 1.6 petrol engines	5.3 litre
1.8 petrol engine	5.5 litre
2.0 & 2.5 petrol engines	5.75 litre
2.0 diesel engine	7.0 litre
Washer reservoir	6.0 litres

### ELECTRICAL

<b>Battery type:</b>	
1.4 & 1.6 petrol models	H4, sealed for life
1.8, 2.0 & 2.5 petrol models	H5, sealed for life
Diesel models	H6, sealed for life
<b>Battery rating:</b>	
1.4, 1.6 & 1.8 petrol models	45 amp/hr
2.0 & 2.5 petrol models	63 amp/hr
Diesel engines	75 amp/hr
Voltage and polarity	12 V, negative (-) earth

## Technical Data

### WHEELS & TYRES

#### Wheel size and type

Type	Size
Steel wheels	
14" wheels	5.5J x 14
15" wheels	6.0J x 15
Alloy wheels:	
14" wheels	5.5J x 14
15" wheels	6.0J x 15
16" wheels	6.5J x 16
17" wheels	7.0J x 17
Spare wheels:	
space-saver steel†	3.5J x 15
regulation steel	5.5J x 14, or 6.0J x 15
Road wheel nut torque	110 Nm
† The space-saver spare wheel is for temporary use only, with maximum road speed limited to 80 km/h. Only one space-saver spare wheel should be used at any one time.	

#### Tyre specification

Wheel size	Tyre
5.5J x 14 (steel & alloy)	185/65 R14 86T 185/65 R14 86H
6.0J x 15 (steel & alloy)	195/55 R15 85H
6.5J x 16 (alloy)	205/45 R16 87W 205/50 R16 87V
7J x 17 (alloy)	205/45 R17 84Y
3.5J x 15 (space-saver)	T125/80 R15 95M (space-saver)
5.5J x 14 and 6.0J x 15 steel spare wheels should be fitted with a tyre of identical specification to that fitted to the road wheels of the car. <b>NOTE:</b> When replacing tyres, make sure the supplier is aware that all tyres should conform to one specification.	

## Technical Data

### TYRE PRESSURES

		Tyre pressures - bar				
		185/65 R14	195/55 R15	205/45 R16	205/50 R16	205/45 R17
<b>Normal driving conditions</b>						
1.4 models	F	1.9	2.1	2.3	-	-
	R	1.9	2.1	2.1	-	-
1.6 models	F	1.9	2.1	2.3	2.1	2.1
	R	1.9	2.1	2.1	2.1	2.1
1.8 models - Manual transmission	F	1.9	2.1	-	2.1	2.1
	R	1.9	2.1	-	2.1	2.1
1.8 models - Automatic transmission	F	1.9	2.1	-	2.1	2.1
	R	1.9	2.1	-	2.1	2.1
2.0 models - Automatic transmission	F	-	2.2	2.3	-	-
	R	-	2.1	2.1	-	-
2.5 models	F	-	-	-	-	2.3
	R	-	-	-	-	2.1
2.0 - Diesel models	F	2.1	2.2	2.3	2.3	2.3
	R	2.1	2.1	2.1	2.1	2.1

**NOTE:** If a space saver spare wheel and T125/80 R15 tyre is fitted, the inflation pressure of the tyre must be maintained at 4.2 bar.

## Technical Data

		Tyre pressures - bar				
		185/65 R14	195/55 R15	205/45 R16	205/50 R16	205/45 R17
<b>Maximum load conditions (car loaded to maximum gross vehicle weight)</b>						
1.4 models	F	1.9	2.1	2.4	-	-
	R	1.9	2.1	2.2	-	-
1.6 models	F	1.9	2.1	2.4	2.1	2.1
	R	1.9	2.1	2.2	2.1	2.1
1.8 models - Manual transmission	F	1.9	2.1	-	2.1	2.1
	R	1.9	2.1	-	2.1	2.1
1.8 models - Automatic transmission	F	1.9	2.1	-	2.1	2.1
	R	1.9	2.1	-	2.1	2.1
2.0 models - Automatic transmission	F	-	2.3	2.4	-	-
	R	-	2.3	2.2	-	-
2.5 models	F	-	-	-	-	2.3
	R	-	-	-	-	2.1
2.0 - Diesel models	F	2.2	2.3	2.4	2.3	2.3
	R	2.2	2.3	2.2	2.1	2.1



## Technical Data

		Tyre pressures - bar				
		185/65 R14	195/55 R15	205/45 R16	205/50 R16	205/45 R17
<b>Speeds above 160 km/h</b>						
1.4 models	F	2.1	2.2	2.6	-	-
	R	2.1	2.2	2.4	-	-
1.6 models	F	2.1	2.2	2.6	2.1	2.1
	R	2.1	2.2	2.4	2.1	2.1
1.8 models - Manual transmission	F	2.1	2.2	-	2.1	2.3
	R	2.1	2.2	-	2.1	2.1
1.8 models - Automatic transmission	F	2.1	2.2	-	2.1	2.3
	R	2.1	2.2	-	2.1	2.1
2.0 models - Automatic transmission	F	-	2.6	2.6	-	-
	R	-	2.6	2.4	-	-
2.5 models	F	-	-	-	-	2.6
	R	-	-	-	-	2.3
2.0 - Diesel models	F	2.4	2.5	2.6	2.3	2.3
	R	2.4	2.5	2.4	2.1	2.1

## Technical Data

---

		Tyre pressures - bar				
		185/65 R14	195/55 R15	205/45 R16	205/50 R16	205/45 R17
<b>Towing</b>						
1.4 models	F	1.9	2.1	2.4	-	-
	R	2.2	2.4	2.5	-	-
1.6 models	F	1.9	2.1	2.4	2.1	2.1
	R	2.2	2.4	2.5	2.2	2.4
1.8 models - Manual transmission	F	1.9	2.1	-	2.1	2.1
	R	2.2	2.4	-	2.2	2.4
1.8 models - Automatic transmission	F	1.9	2.1	-	2.1	2.1
	R	2.2	2.4	-	2.2	2.4
2.0 models - Automatic transmission	F	-	2.2	2.4	-	-
	R	-	2.5	2.5	-	-
2.5 models	F	-	-	-	-	2.3
	R	-	-	-	-	2.4
2.0 - Diesel models	F	2.2	2.3	2.4	2.3	2.3
	R	2.5	2.5	2.5	2.2	2.4

## Technical Data

### DIMENSIONS

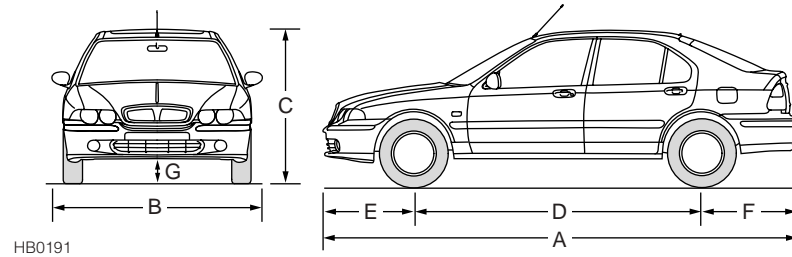

	45 models	ZS models
Overall length - A		
- 4 door models	4517 mm	4532 mm
- 5 door models	4362 mm	4377 mm
Overall width (including mirrors) - B	1923 mm	1923 mm
Overall height (sunroof closed) - C	1394 mm	1386 mm
Wheelbase - D	2620 mm	2620 mm
Front overhang - E	850 mm	865 mm
Rear overhang - F		
- 4 door models	1047 mm	1047 mm
- 5 door models	892 mm	892 mm
Ground clearance (at unladen weight) - G	135 mm	127 mm
Maximum overhang of coupling point		
- 4 door models	1117 mm	1117 mm
- 5 door models	967 mm	967 mm
Turning circle	10.3 m	11.2 m

## Technical Data

### WEIGHTS

		1.4	1.6	1.8	2.0	2.5	2.0 Diesel
Approximate unladen vehicle weight †							
- Manual transmission	kg	1105 - 1205	1105 - 1205	1125 - 1215	-	1235 - 1285	1230 - 1325
- Automatic transmission	kg	-	-	1150 - 1240	1265 - 1320	-	-
Max. laden vehicle weight							
- Manual transmission	kg	1640	1640	1640	-	1720	1720
- Automatic transmission	kg	-	-	1640	1720	-	-
Max. front axle load							
- Manual transmission	kg	845	845	845	-	940	940
- Automatic transmission	kg	-	-	845	940	-	-
Max. rear axle load	kg	840	840	840	840	840	840
† Unladen vehicle weight is calculated with no occupants and fuel tank 90% full.							

**NOTE:** When towing, the maximum laden weight can be increased by up to 100 kg and the rear axle load can be increased by 15%, provided road speed is limited to a maximum of 100 km/h.

## Technical Data

### TOWING WEIGHTS

		1.4	1.6	1.8	2.0	2.5	2.0 Diesel
Max. trailer weight (unbraked)	kg	500	500	500	500	500	500
Max. trailer weight (braked)	kg	1000	1000	1000	1000	1000	1000
Max. nose weight (Tow hitch downward load) †	kg	70	70	70	70	70	70
Max. roof rack load	kg	65	65	65	65	65	65
Gross train weight = maximum laden vehicle weight + maximum trailer weight† To increase stability, it is recommended that you adjust the nose weight to the maximum limit, when loading to the maximum trailer weight							

**NOTE:** The maximum towing weights shown are to an industry defined standard and represent the maximum weight that can be towed by the car, allowing it to restart efficiently on a 12% gradient at sea level. Any extra weight, such as luggage and/or passengers should be deducted from the maximum towing weight.

## Fuel Consumption

---

### FUEL CONSUMPTION

The fuel consumption figures shown below have been calculated using a standard testing procedure (the new EC test procedure from Directive 99/100/EC), and produced in accordance with The Passenger Car Fuel Consumption (Amendment) Order 1996. Under normal use, a car's actual fuel consumption figures may differ from those achieved through the test procedure, depending on driving technique, road and traffic conditions, environmental factors, vehicle load and condition.

#### Fuel consumption figures

	URBAN	EXTRA-URBAN	COMBINED	CO <sub>2</sub>
	l/100km	l/100km	l/100km	g/km
1.4 16v	9.3	5.7	7.0	168
1.6 16v	9.4	5.6	7.0	168
1.8 16v manual	9.7	5.8	7.3	174
1.8 16v auto	11.9	6.5	8.5	203
2.0 24v	14.6	7.0	9.8	234
2.5 24v	14.1	6.8	9.5	227
2.0 diesel - 83 kW	7.8	4.3	5.6	150
2.0 diesel	7.3	4.3	5.4	150

#### Urban cycle

The urban test cycle is carried out from a cold start and consists of a series of accelerations, decelerations and periods of steady speed driving and engine idling. The maximum speed attained during the test is 50 km/h with an average speed of 19 km/h.

#### Extra-urban cycle

The extra urban test cycle is carried out immediately after the urban test. Approximately half of the test comprises steady-speed driving, while the remainder consists of a series of accelerations, decelerations and engine idling. The maximum test speed is 120 km/h and the average speed 63 km/h. The test is carried out over a distance of 7 km.

#### Combined

The combined figure is an average of the urban and extra-urban test cycle results, which has been weighted to take account of the different distances covered during the two tests.

## Declaration of Conformity

**DECLARATION OF CONFORMITY**

**CE 0523** 

This declaration is the responsibility of the manufacturer/ authorised representative within the Community:  
TRW Automotive Electronics  
45 College Road Perry Barr Birmingham, B44 8JQ, UNITED KINGDOM  
This certifies that:

The 44,925MHz Transmitter designated: 17TN  
and The 128KHz Immobilizer designated: 5AS99A

Complies with the essential protection requirements of R&TE Directive 1999/5/EC (in the application of the laws of the Member States) relating to Radio Spectrum Matters, EMC and Electrical Safety. This declaration applies to all specimens manufactured in accordance with the technical documentation described in the Annex II, TRW Automotive Electronics keep this documentation at the disposal of the relevant national authorities of any Member State for judgement purpose. Assessment of compliance of the product with the requirements relating to the essential requirements set in Article 3 R&TE, was based on Annex I and Annex IV of the Directive 1999/5/EC and the following standards:

Radio Spectrum: EN 400124:1999, EN 94140  
EMC: EN 101653 & EN 101419 Part 1 & 2  
Safety: EN 60950:2005:2005 (based on EN 60950:2001)

 The designated models 17TN and 5AS99A are not submitted to harmonised standards. These devices are licensed even if not distributed in the European Union which will apply the R&TE Directive, Austria, Belgium, Denmark, Estonia, Finland, France, Germany, Greece, Ireland, Iceland, Italy, Luxembourg, Netherlands, Norway, Portugal, Spain, Sweden, Switzerland and the UK.

(Name and  
Signature)  
Z. M. ... .., UK,  
21/08/11

(Signature)  
  
Chris ... ..

HB0170





## Index

### A

ABS .....	96
ABS warning light .....	97
Access code .....	13
Accessories .....	153
Air conditioning .....	40, 42
Air distribution .....	40
Air recirculation .....	40
Air vents .....	38
Airbag SRS .....	26
Airbag SRS service information .....	30
Airbag SRS warning light .....	29
Alarm indicator light .....	9
Alarm system .....	7
Anti-freeze .....	137
Anti-lock braking (ABS) .....	96
Ashtrays .....	48
Audio equipment .....	100
Automatic gearbox .....	73, 77

### B

Battery .....	140, 189
Battery charging .....	142
Battery check .....	140
Battery disconnection .....	141
Battery safety .....	140
Blower (heater) .....	40
Body number .....	151
Bonnet opening .....	131

Booster cables .....	156
Boot (opening) .....	11
Boot light bulb .....	183, 184
Brake fluid .....	138
Brake lights .....	178, 180
Brake pad wear indicator .....	95
Brake warning light .....	95
Brakes .....	94, 138
Bulb replacement .....	174

### C

Capacities .....	189
Cassette player controls - C42 .....	108
Cassette tapes .....	109
Catalytic converter .....	69
Central door locking .....	8
Centre Rear Belt .....	21
Child proof door locks .....	10
Child seats .....	24
Cigar lighter .....	49
Cleaning - car interior .....	150
Cleaning - paintwork .....	148
Clock .....	46
Clock display - CD32 .....	121
Cold climates .....	66, 67
Collapsible storage box .....	53
Compact disc changer (10-disc) .....	123
Compact disc changer location .....	100
Compact disc player controls - CD32 .....	112

## Index

---

Compact disc single play controls - CD32 .....	110
Continuously variable transmission .....	73, 77
Coolant top-up .....	137
Cooling system .....	137
Cup holder .....	47

### D

Data .....	186
Defrosting .....	41
Demisting .....	41
Digital display .....	60
Dimensions .....	195
Dipped beam headlights .....	87
Dipstick .....	135
Direction indicator bulb (front) .....	177
Direction indicator bulb (rear) .....	178, 180
Direction indicator lights .....	87
Door locking cut-off switch .....	86
Door mirror - folding .....	33
Door mirrors .....	32
Driver's personal storage .....	47

### E

Electronic brake force distribution .....	96
Emission control .....	128
Empty fuel tank .....	85
Engine compartment fuses .....	172
Engine immobilisation .....	12

Engine immobilisation override .....	13
Engine number .....	151
Engine oil .....	135
Environmental driving .....	70

### F

Face level vents .....	38
Fog lights - front .....	91
Folding storage box .....	53
Foot brake .....	94
Fuel consumption .....	198
Fuel cut-off switch .....	86
Fuel filler .....	84
Fuel filling .....	84
Fuel gauge .....	61
Fuel specification .....	83
Fuel system .....	84
Fuel system priming- Diesel .....	85
Fuse colours .....	168
Fuses .....	168
Fuses - removal .....	172
Fuses - spare .....	172

### G

Gauges .....	60
Gearbox number .....	151
Gears - automatic .....	73, 77
Gears - manual .....	72

## Index

---

General data .....	186	Interior light .....	183
Glovebox .....	11	Interior space protection .....	10

### H

Handbrake .....	95
Handset battery replacement .....	15
Handset resynchronisation .....	15
Hazard warning lights .....	91
Head restraints .....	16
Headlight beam height adjuster .....	88
Headlight bulb .....	175
Headlight flash .....	87
Headlight levelling .....	88
Headlight washers .....	143
Headlights .....	87
Heated front seats .....	41
Heated rear screen .....	91
Heater fan .....	40
Heating .....	40

### I

Identification numbers .....	151
Ignition .....	65
In-car telephones .....	51
Indicators .....	87
Inertia switch .....	86
Instrument panel .....	60
Interior door handles .....	10

### J

Jacking .....	165
---------------	-----

### K

Key access code .....	13
Keys .....	7

### L

Lashing points .....	159
Lights on warning buzzer .....	87
Load carrying .....	54
Locking - models with central door locking .....	8
Locking wheel nuts .....	167
Luggage compartment (opening) .....	11
Luggage compartment light bulb .....	183, 184
Lumbar support .....	17

### M

Main beam headlights .....	87
Main fuse box .....	169
Maintenance .....	128
Manual transmission .....	72

## Index

---

Mirrors - door .....	32
Mirrors - interior .....	33
Mirrors (cleaning) .....	149
Mislock .....	9
Mobile phones .....	51

---

### O

---

Oil level (engine) .....	135
Oil top-up .....	135
Owner maintenance .....	129

---

### P

---

Parts .....	153
Pen clip .....	47
Phones .....	51
Poisonous fluids .....	130
Polishing the paintwork .....	149
Pollen filter .....	39
Power socket .....	50
Power steering fluid .....	139
Pre-tensioners .....	22
Puncture repair system .....	162
Punctured tyres .....	146

---

### R

---

Radio controls - CD32 .....	103
Radio data system (RDS) .....	120

Radio equipment .....	100
Radio reception .....	101
Radio tuning - CD32 .....	114
Rear Armrest .....	18
Rear fog guard light bulb .....	178, 180
Rear fog guard lights .....	91
Rear light bulb .....	178, 180
Rear screen heater .....	91
Rear seats .....	54
Rear seats - folding .....	54
Rear view mirror .....	33
Rear window isolation switch .....	35
Rear window shelf .....	52
Rear window wash/wipe .....	90
Recirculation .....	40
Remote audio controls .....	102
Remote handset .....	7
Remote handset battery .....	15
Reverse light bulb .....	178, 180
Roof racks .....	56
Routine servicing .....	128
Running-in .....	68

---

### S

---

Safety in the garage .....	130
Seat belt care .....	23
Seat belt pre-tensioners .....	22
Seat belt safety .....	19
Seat belts .....	20



## Index

---

### W

Warning lights .....	62
Washer jets .....	143
Washer reservoir - top-up .....	143
Washing the car .....	148
Weights .....	196
Wheel changing .....	164
Wheels .....	190
Windows .....	34
Windows (cleaning) .....	149
Windscreen washer top-up .....	143
Windscreen wipers .....	89
Wiper blade (cleaning) .....	149
Wiper blade replacement .....	144
Wiper controls .....	89

END OF OWNER'S HANDBOOK