

PERSONA

Proton
PERSONA

OWNER'S MANUAL
References & Tips

VVT



Introduction

OWN000GINFO16001

IMPORTANT

The owner's manual and service booklet are part of your PROTON vehicle. Make sure these documents are available in this vehicle at all times. These documents should be kept in the vehicle at all times for the benefit of the car owner.

Indication of applicable

The sign " * " indicates the differences of available equipment according to country where the vehicle is sold or the class of the vehicle. For additional information, contact an authorised PROTON sales outlet or refer to the model catalogues.

Guidelines: How to read this manual

CAUTIONS, WARNING & NOTE

There will be CAUTION and WARNING signs/symbols throughout the manual. Please adhere to the instructions provided to avoid injury to passengers and driver, and to avoid damage to the vehicle.

The sign  CAUTION indicates that damage to the vehicle and its equipment can occur if instructions are not followed.

The sign  WARNING indicates that driver and passengers could incur injury if instruction are not followed.

The sign NOTE indicates additional descriptions to the operations or procedures.

Contents

These are the information contained in this owner's manual:

Overview

Indicates the equipment in the new vehicle and short instructions of the controls.

General Information

Indicates the general precautions for the safety of the vehicle, driver and passengers.

Lock and Unlock

Indicates the operation and the maintenance of the safety and the security of the vehicle.

Seats and Seat Belts

Indicates the instructions and procedures to adjust the positions of the seats for the driver and the passengers.

Instruments and Controls

Indicates the procedures for each applicable functions for daily operations.

Start and Drive

Indicates the complete procedure for each driving equipment that will operate from start until arrival at destination.

For Pleasant Driving

Indicates the operation of each available equipment to make the journey more pleasant.

For Emergencies

Indicates the action to be taken during emergencies and solution to the problems.

Maintenance

Indicates the tips and actions for regular service maintenance that the owner can do.

Specifications

Indicates the technical specifications and descriptions of the vehicle.

Abbreviations

A/T	Automatic Transmission
ALC	Automatic Light Control
A/C	Air Conditioning
ABS	Anti-lock Brake System
ACC	Accessories
ACU	Airbag Control unit
AFC	Average Fuel Consumption
ATF	Automatic Transmission Fluid
AVS	Average Vehicle Speed
BA	Brake Assist
CVT	Continuous Variable Transmission
DRL	Daytime Running Light
DTE	Distance To Empty
EPS	Electric Power Steering
ESC	Electronic Stability Control
ECU	Engine Control Unit
EBD	Electronic Braking Distribution

GSL	Gear Shift Lock
GSI	Gear Shift Indicator
HHA	Hill Hold Assist
IAFM	Intake Air Fuel Module
IFC	Instantaneous Fuel Consumption
JT	Journey Time
LED	Light Emitting Diode
M/T	Manual Transmission
RLS	Rain Light Sensor
RON	Research Octane Number
RDS	Reverse Distance Sensor
SSB	Start Stop Button
SRS	Supplemental Restraint System
TCU	Transmission Control Unit
TC	Traction Control
USB	Universal Serial Bus
VIN	Vehicle Identification Number

Table of contents

General Information	1
Lock and Unlock	2
Occupant's Safety	3
Instruments and Controls	4
Starting and Driving	5
For Pleasant Driving	6
For Emergencies	7
Maintenance	8
Specifications	9

Exterior (1)

OWND01OVIEW16002

- 1 - Hood
- 2 - High beam lamps
- 3 - Position lights
- 4 - Low beam lamps/Follow home light
- 5 - Turn-signal lights
- 6 - Wiper and washer
- 7 - Front windshield
- 8 - Side turn signal lights
- 9 - Front fog lamps
- 10 - Front parking sensors

NOTE

" * " - If fitted - in accordance with the various Country & Vehicle Specifications

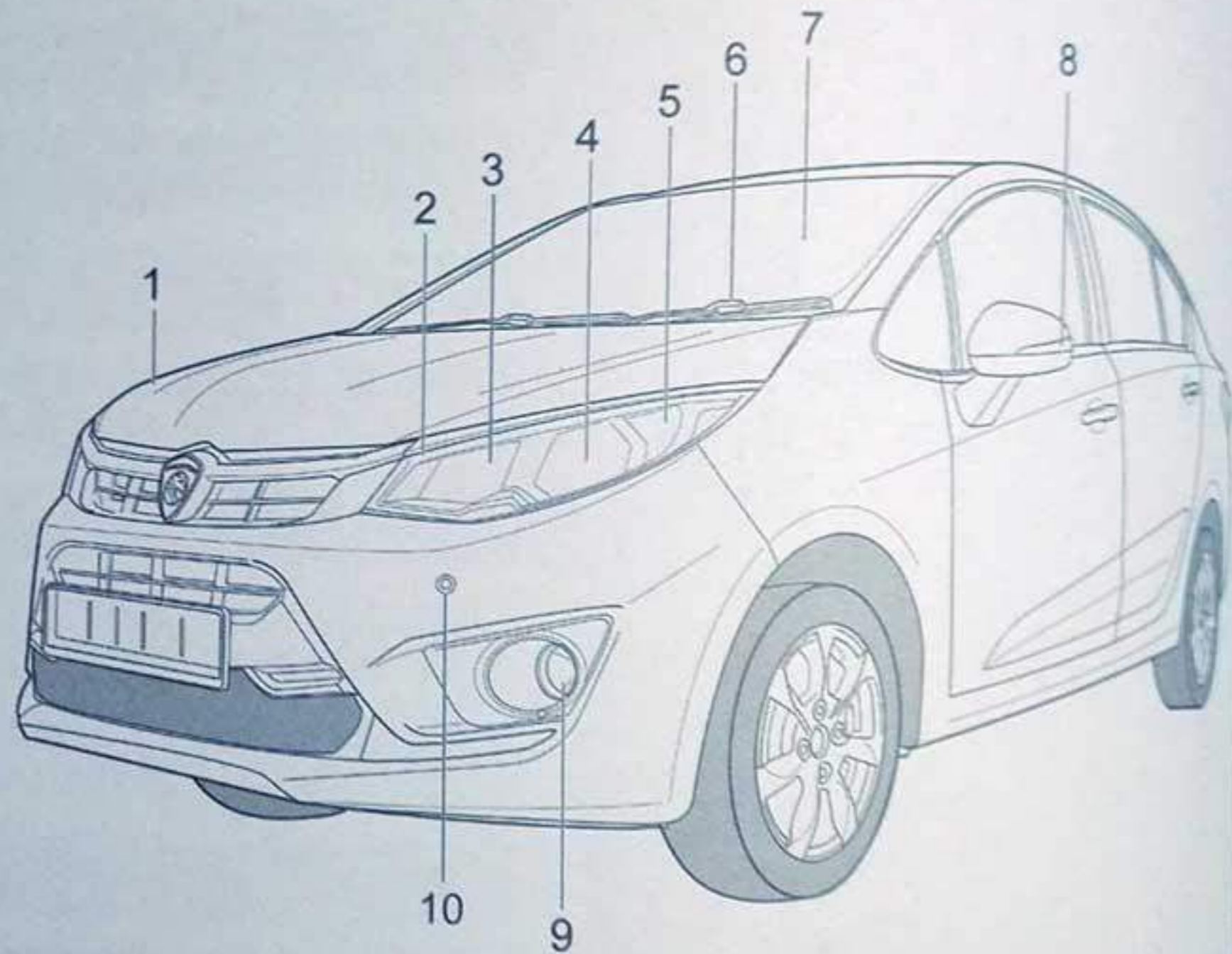

Exterior (2)

OWN001OVIEW16003

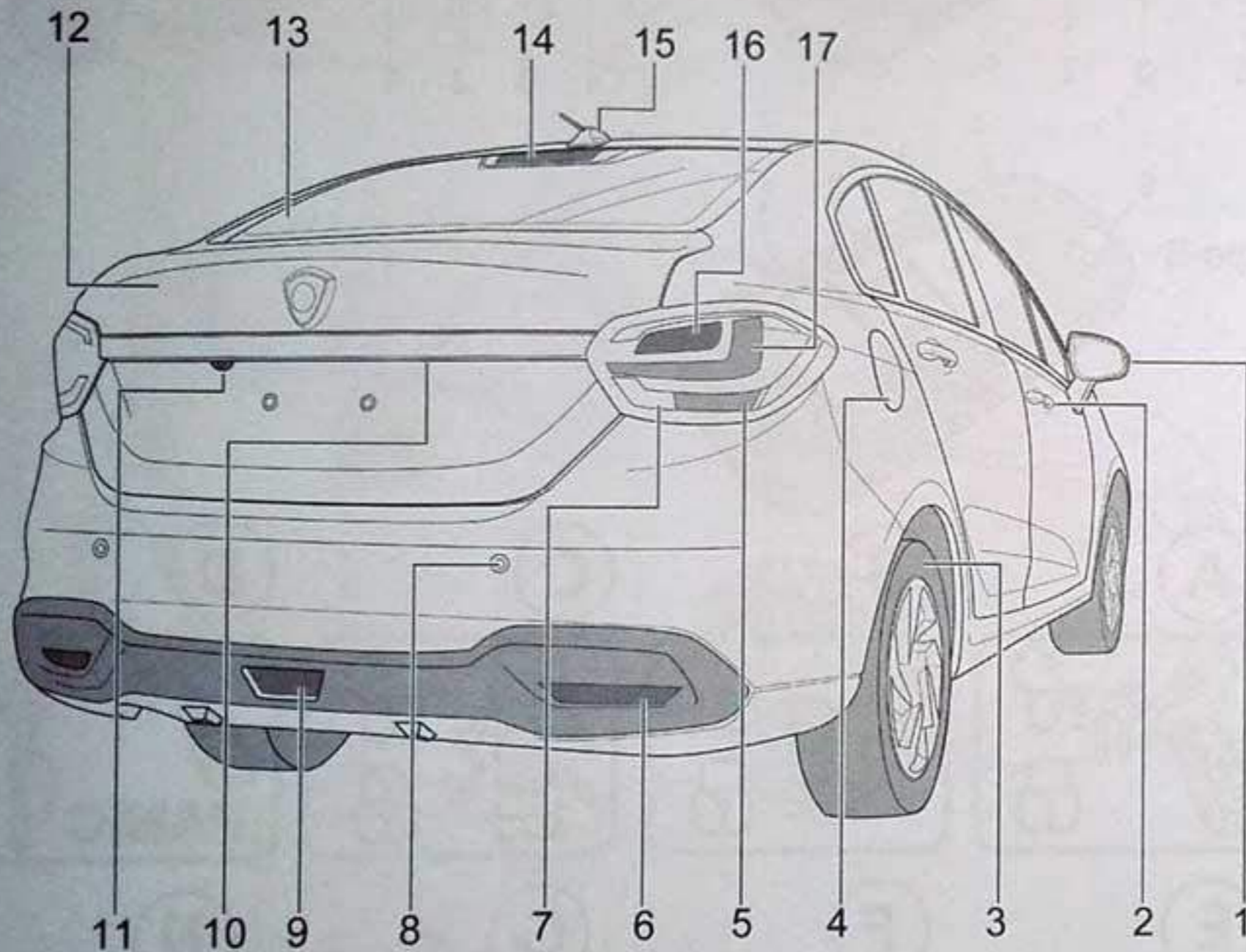

- 1 - Door mirrors
- 2 - Door handles
- 3 - Wheels & tyres
- 4 - Fuel filler lid
- 5 - Rear turn signal lights
- 6 - Rear retro reflectors
- 7 - Reverse lights
- 8 - Rear parking sensors
- 9 - Rear fog lamps *
- 10 - License plate lights
- 11 - Rear view camera *
- 12 - Trunk lid
- 13 - Rear windshield
- 14 - High mounted stop light (HMSL)
- 15 - Antenna
- 16 - Tail lights
- 17 - Brake and tail lights

NOTE

" * " - If fitted - in accordance with the various Country & Vehicle Specifications

Keys and remote keys operation

OWN001OVIEW16004

Basic functions

- 1 - PANIC button
- 2 - UNLOCK / Trunk lid remote release button *
- 3 - LOCK button
- 4 - LED indicator
- 5 - Key release button *

Operations

- A - Remote Keyless Entry
- B - Buzzer Acknowledge
- C - Central Locking
- D - Panic Alarm
- E - Trunk Lid Remote Release
- F - Double Stage Unlocking
- G - Vehicle Search
- H - Auto Re-Locking

Refer to page 32 for details.

NOTE

"*" - If fitted - in accordance with the various Country & Vehicle Specifications

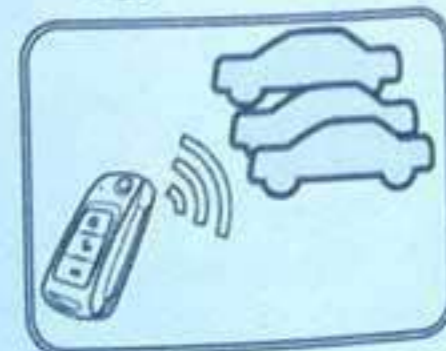
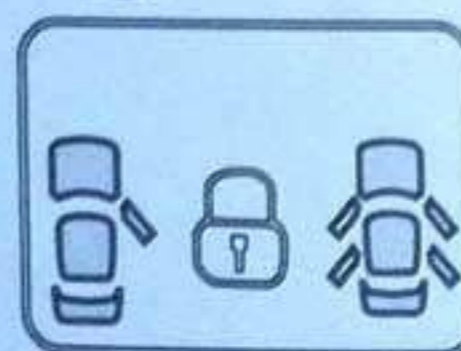
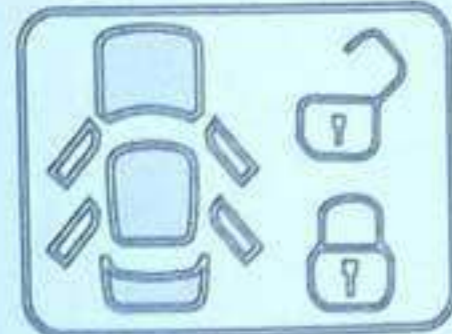
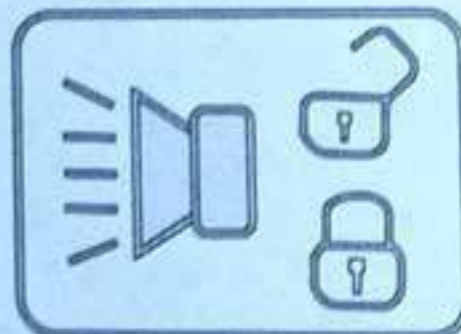
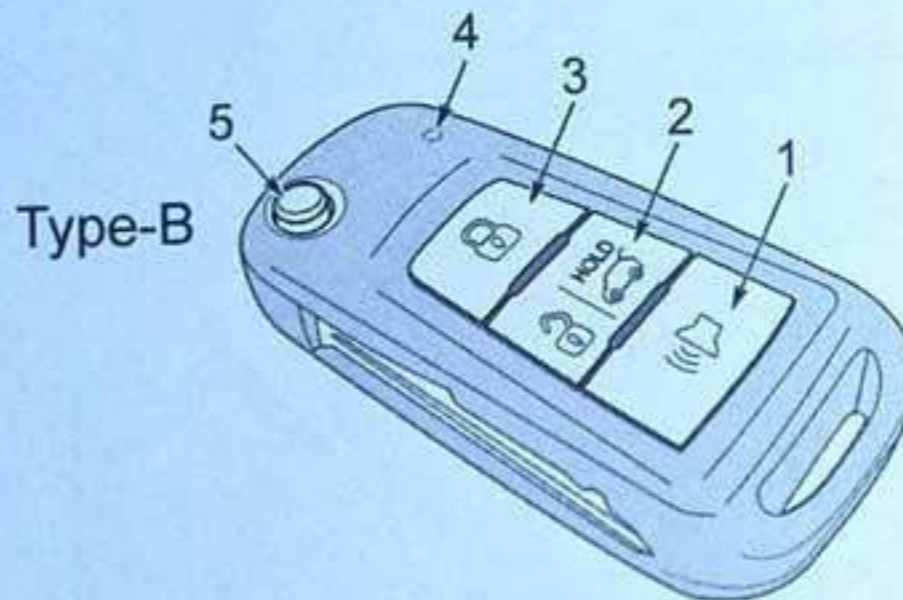
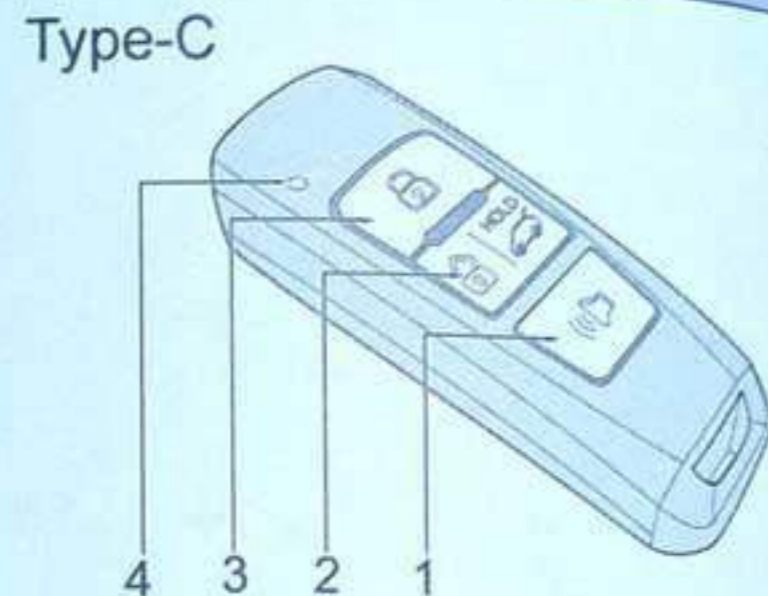
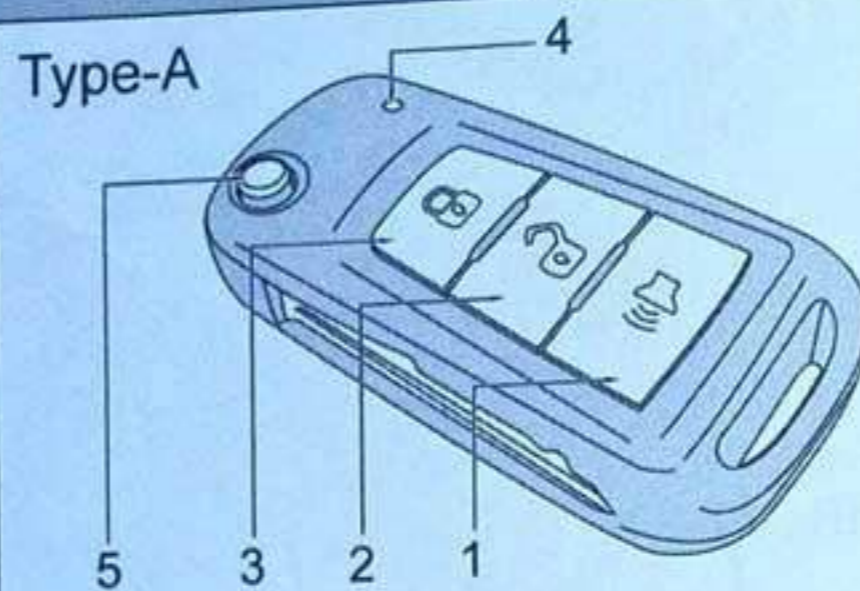

Accessibility

OWN0010VIEW16005

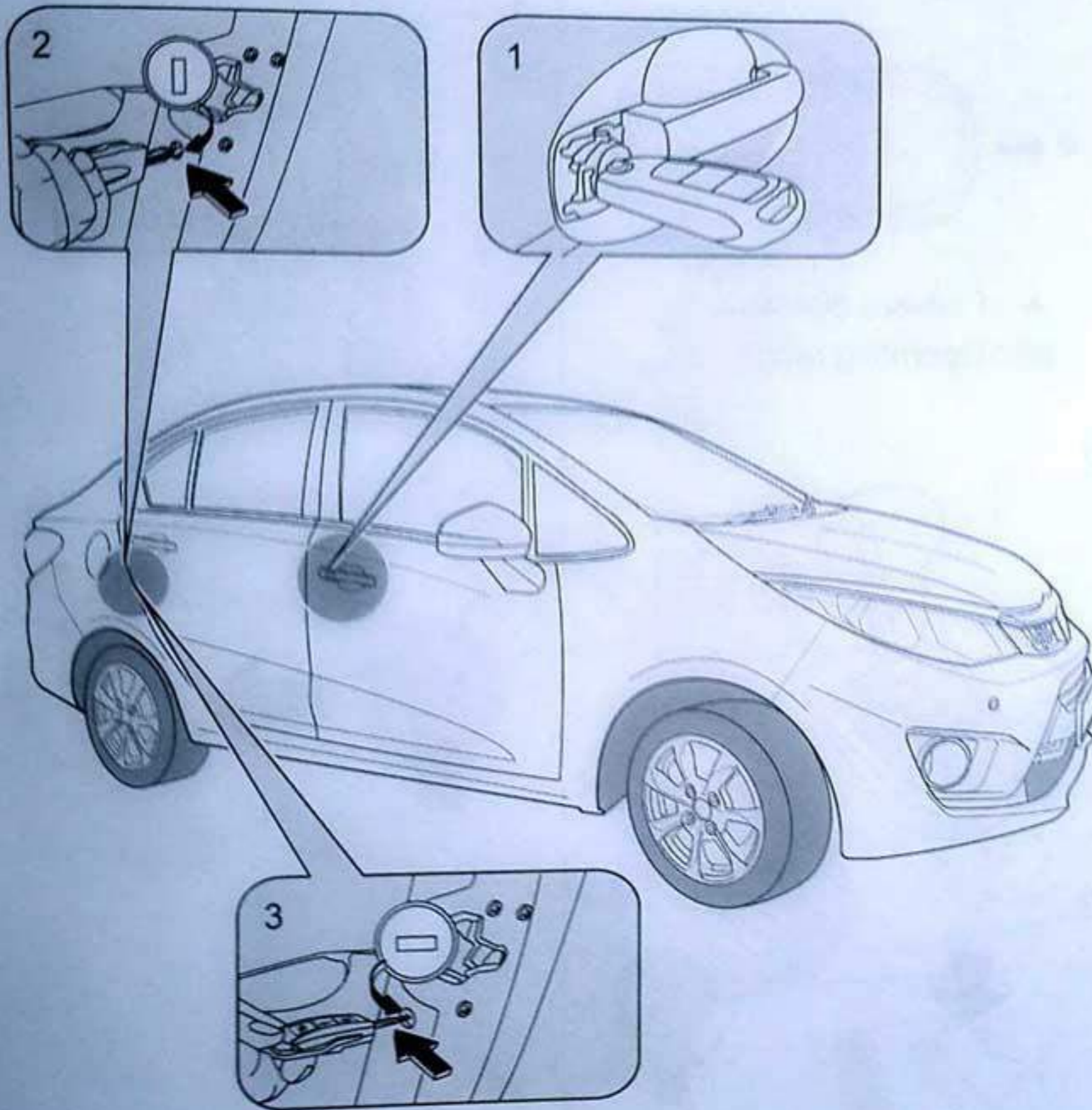

- 1 - Accessing into the vehicle's interior through driver's door or central locking (in case of emergency) - P 41
- 2 - Disable child lock at rear doors - P 39
- 3 - Enable child lock at rear doors (door is set so that it cannot be opened from inside) - P 39

Operation using start stop button (CVT) *

OWN001OVIEW16019

To start the engine;

- 1 - Make sure the key fob is inside the cabin area (within the operating range).
- 2 - Place the shift lever in P (Park) position.
- 3 - While pressing the brake pedal, press the start stop button (A).

To stop the engine;

- 1 - Place the shift lever in P (Park) position.
- 2 - Press the start stop button (A) once to off the engine. The indicator light (B) will go OFF.

NOTE

If the gear shift lever is not in P (park) position, you can turn off the system completely by pressing the LOCK button at the remote transmitter.

" * " - If fitted - in accordance with the various Country & Vehicle Specifications

Start the Engine

1

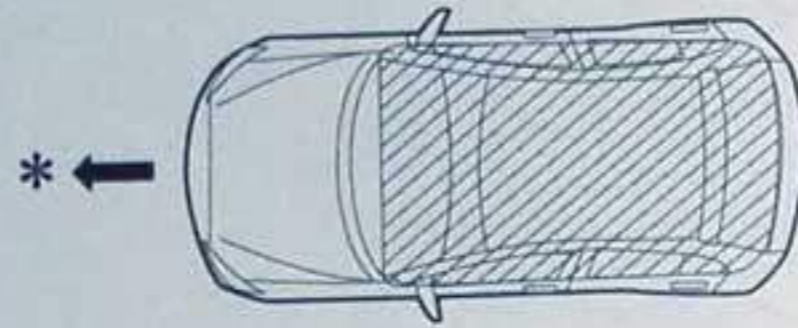

* : Forward direction
 [Hatched Box] : Operating range

2

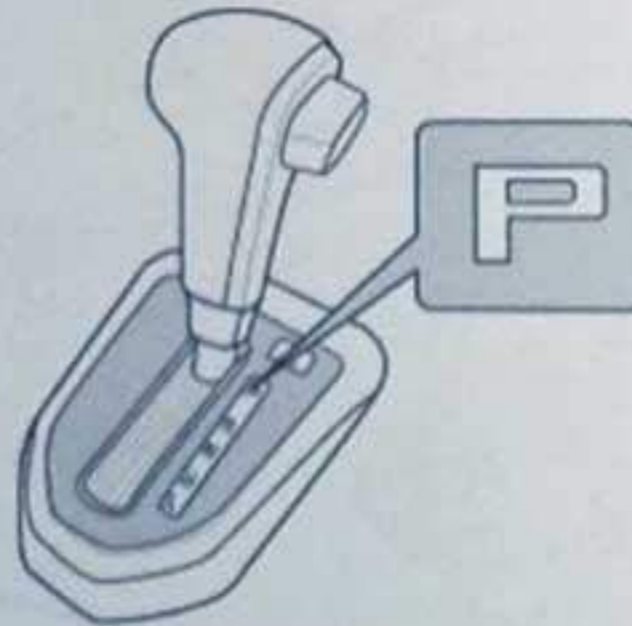

3

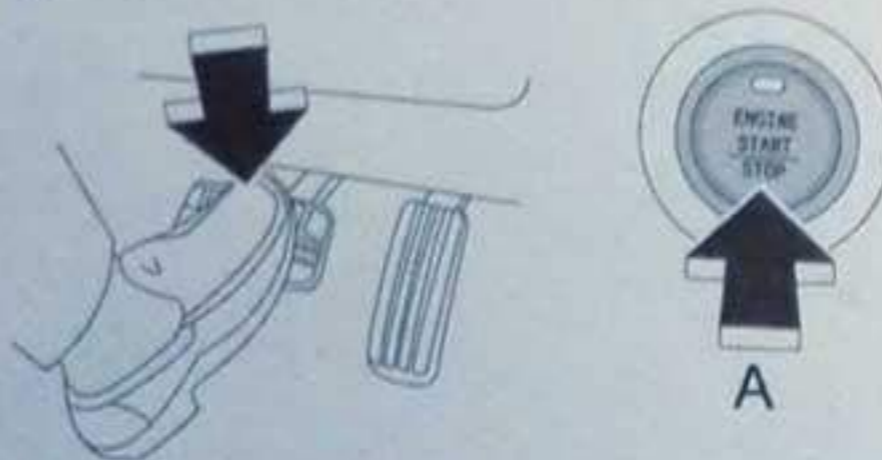

Stop the Engine

1

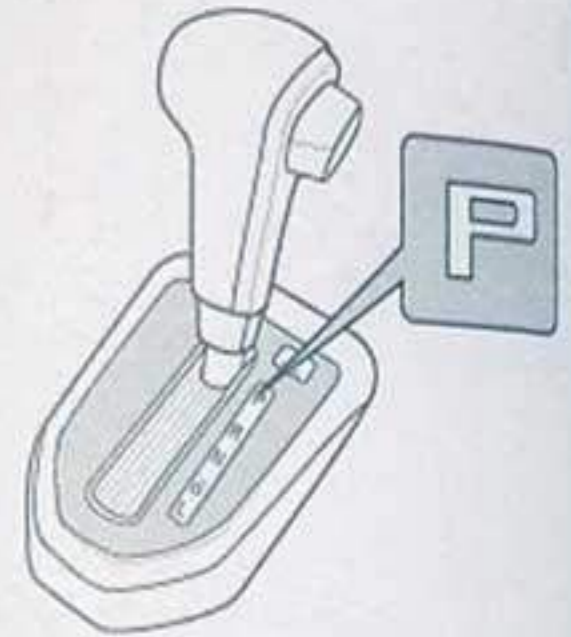

2

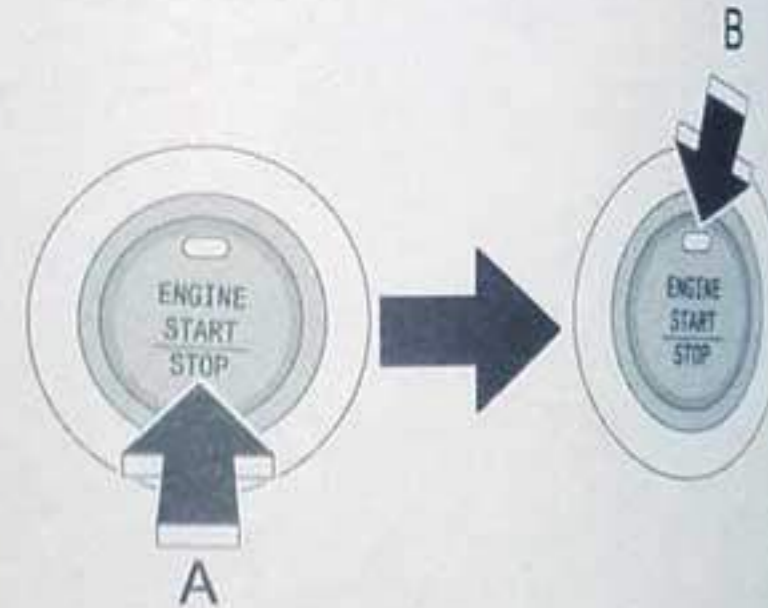

Fuel usage & filling the fuel tank

OWN001OVIEW16006

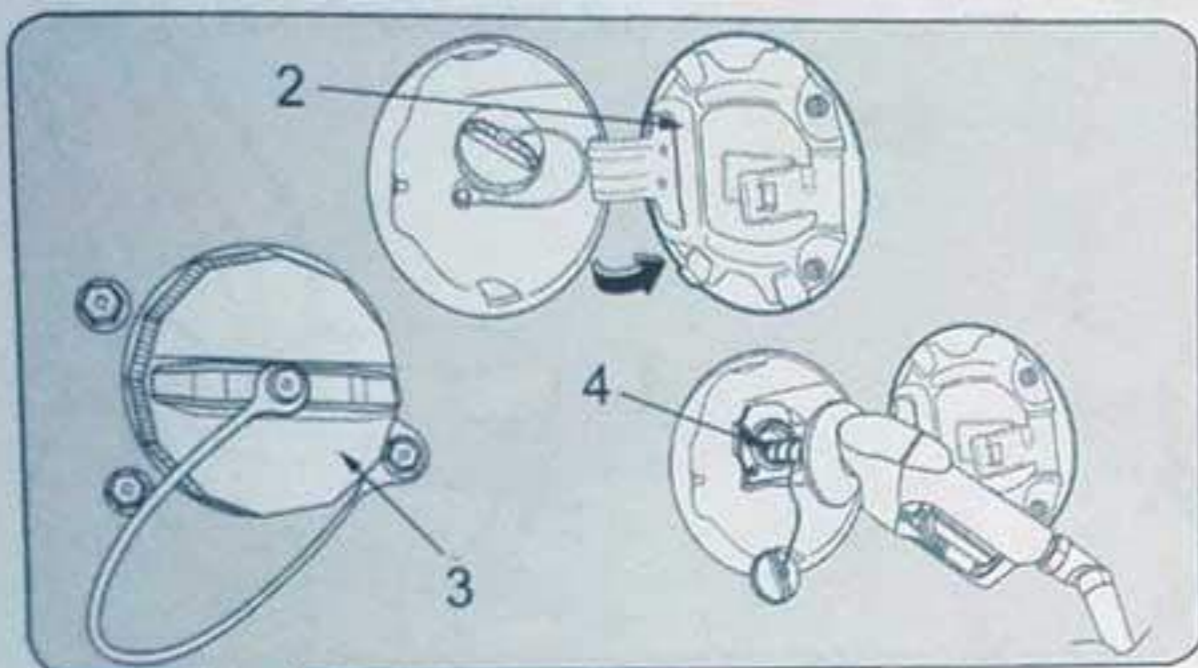

- 1 - Fuel lid release lever
- 2 - Open fuel lid
- 3 - Fuel tank cap
- 4 - Fuel tank filling inlet

FUEL INFORMATION

Refer to page 176.



Seats adjustment

OWN001OVIEW16007

- 1 - Front seatback recliner lever
- 2 - Driver's seat height adjuster lever (pump type)
Pump upward – increases the seat height.
- 3 - Front seat forward and backward lever
- 4 - Rear back seat folding button *
- 5 - Push the seatback down

NOTE

" * " – If fitted - in accordance with the various Country & Vehicle Specifications

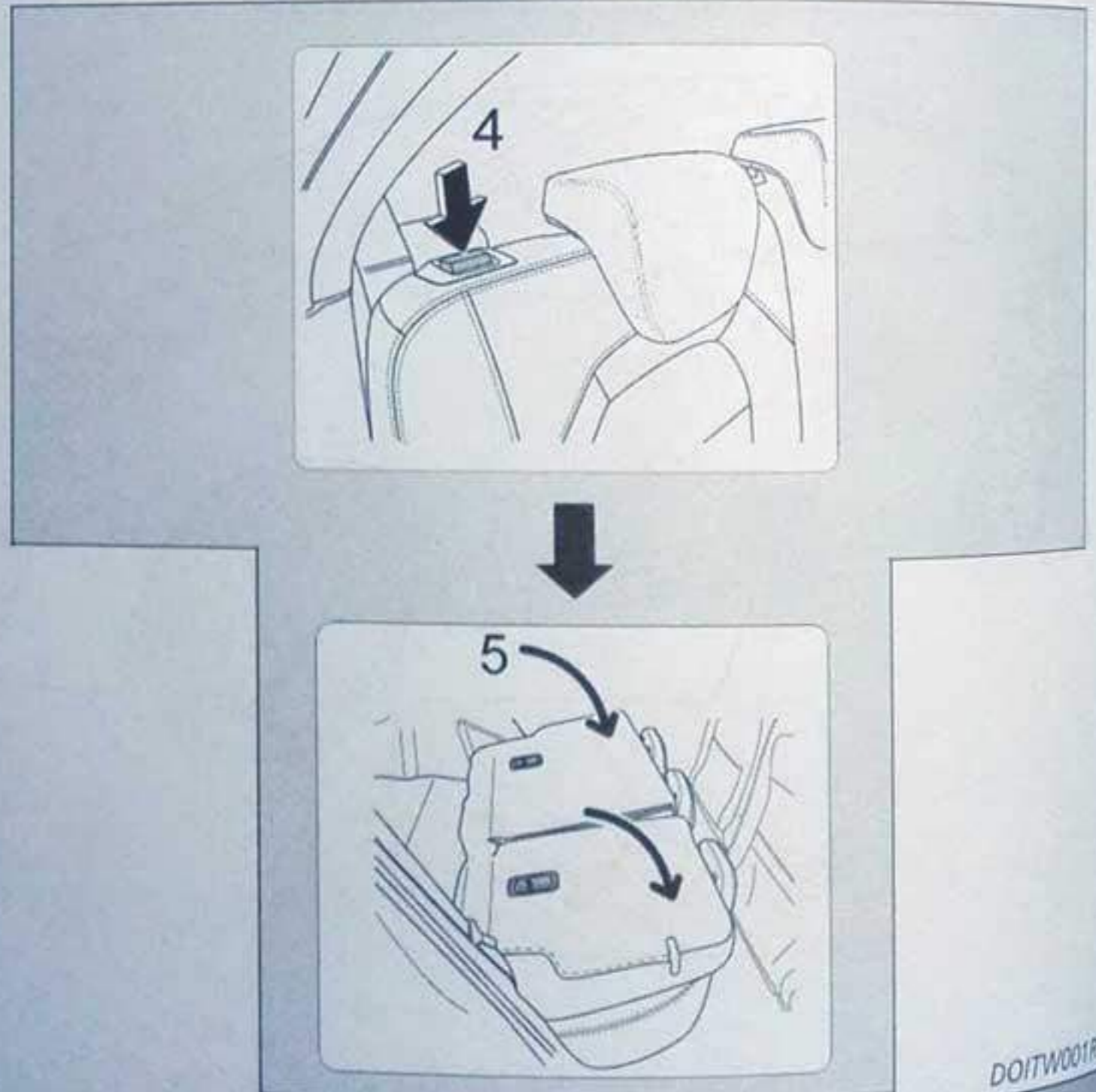

Instruments and controls

OWN0010VIEW16008

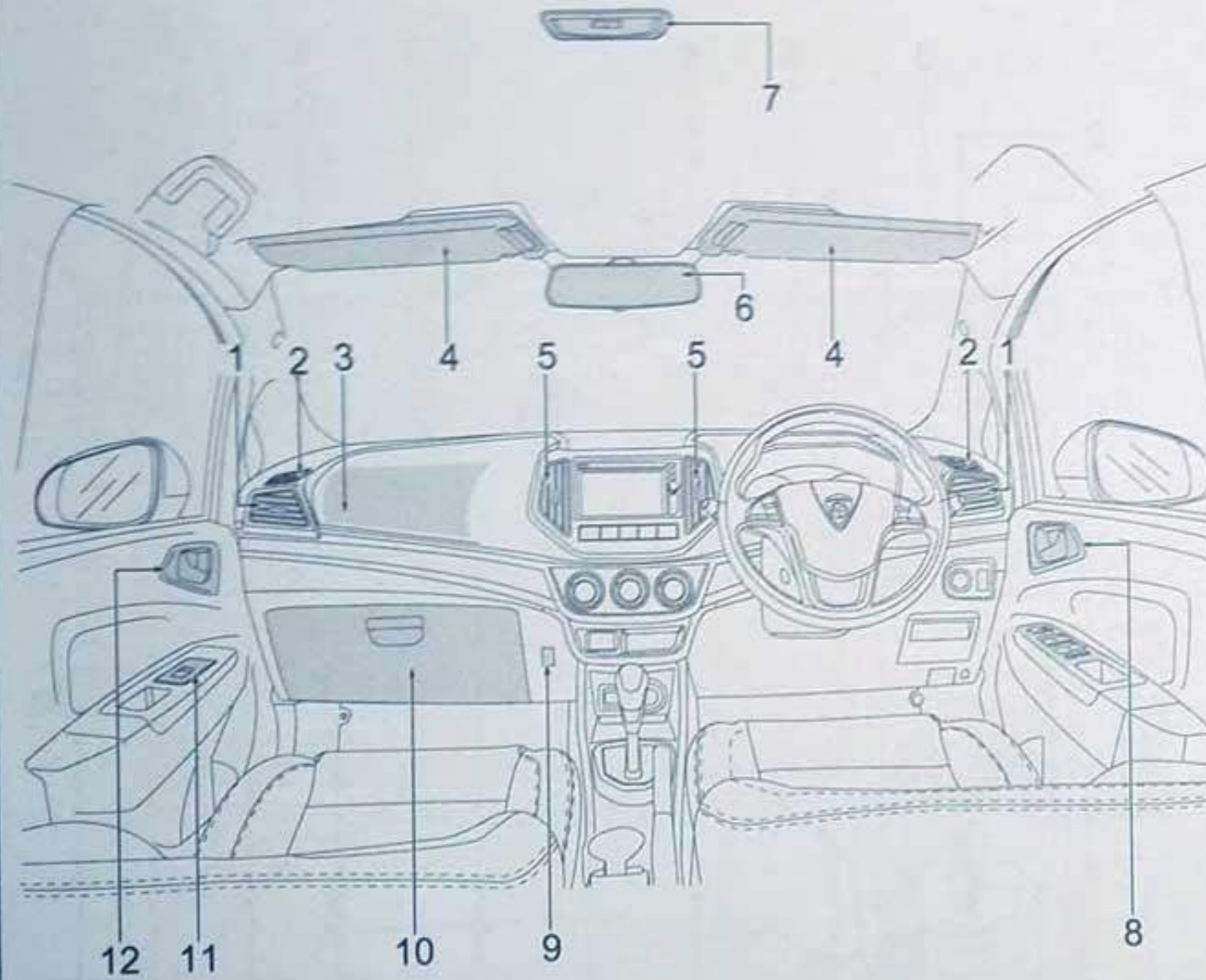

- 1 - Side air ventilator
- 2 - Side defroster
- 3 - Passenger airbag
- 4 - Sun visor
- 5 - Centre ventilator
- 6 - Rear view mirror
- 7 - Room lamp
- 8 - Door lever (driver's side)
- 9 - Utility hook
- 10 - Glove box
- 11 - Power window switch (passenger's side)
- 12 - Door lever (passenger's side)

DOITW001R16008

Instruments and controls

OWN001OVIEW16009

- 1 - Central door lock switch
- 2 - Hazard switch
- 3 - ESC off switch
- 4 - Multimedia display *
- 5 - Headlamp switch and turn-signal combination lever
- 6 - Audio volume control switches *
- 7 - Audio control/mode switches *
- 8 - Wiper-washer switch
- 9 - Power window glass control switches
- 10 - Side view mirror control switch
- 11 - Headlamp leveling switch
- 12 - Hood release lever
- 13 - Start stop button *
- 14 - Air conditioning switches
- 15 - USB port and power socket
- 16 - Parking brake lever
- 17 - Front parking sensor switch *

NOTE

" * " - If fitted - in accordance with the various Country & Vehicle Specifications

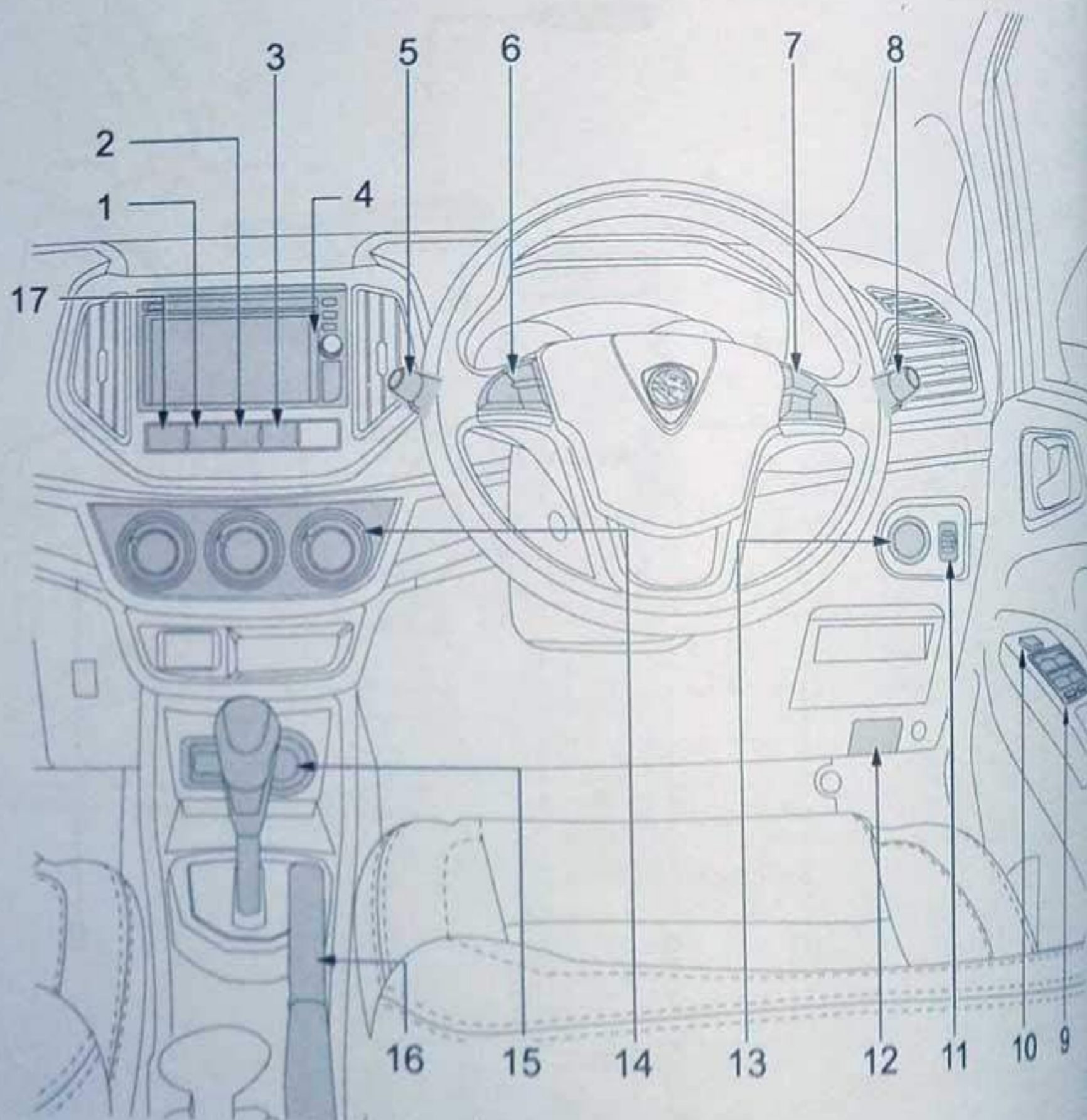

Multimedia and Navigation *

OWN001OVIEW16010

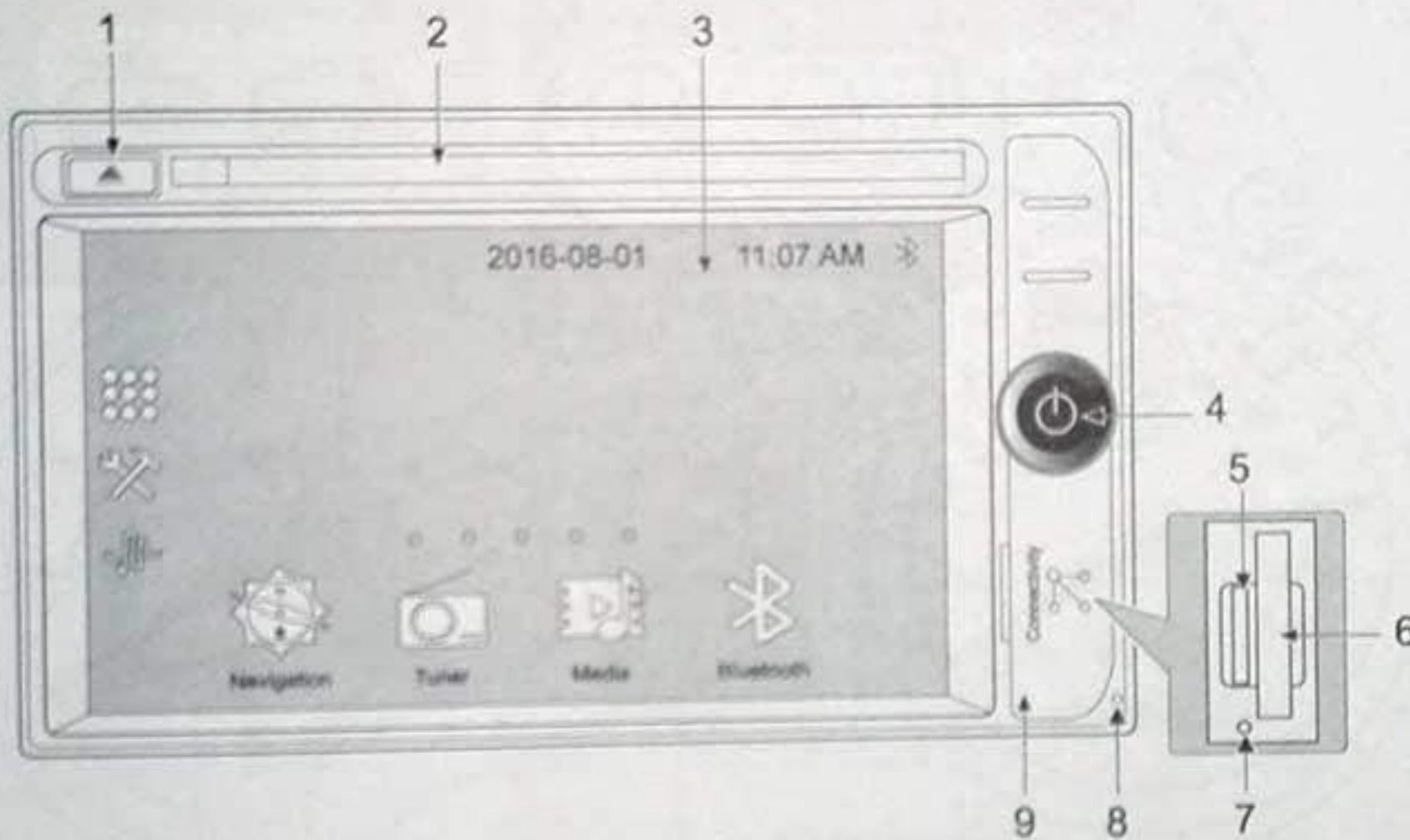

- 1 - Eject button
- 2 - Disc slot
- 3 - Touch screen user interface
- 4 - Rotary / encoder knob
 - **Short press:** Toggle between MENU screen or operating mode
 - **Long press:** Toggle between clock mode or operating mode
 - **Turn:** Adjust volume
- 5 - Micro SD card slot
- 6 - SD card slot
- 7 - Reset button
- 8 - Microphone
- 9 - Connectivity cover – Remove the cap to insert Micro SD card or SD card

NOTE

The Multimedia and Navigation Manual is installed in the Multimedia and Navigation system. Go to Settings > Manual.

" * " – If fitted - in accordance with the various Country & Vehicle Specifications

Centre floor console

OWN001OVIEW16012

12

- 1 - Auxiliary interface
- 2 - USB interface
- 3 - Power socket (12 V)
- 4 - USB interface (1.5 A) *
- 5 - USB interface (2.1 A) *
- 6 - Cup holder

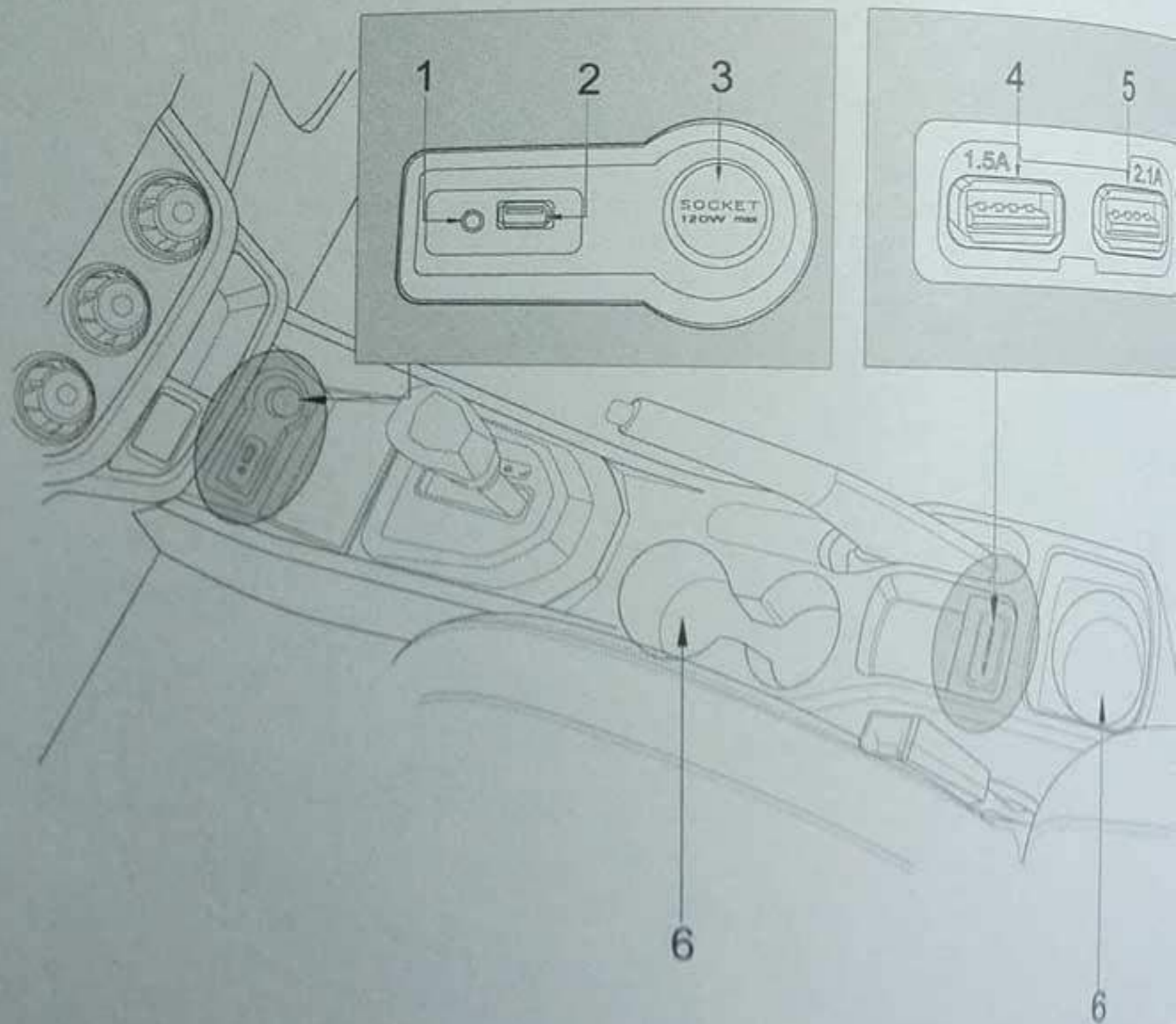

Meter and Gauges

OWN001OVIEW16013

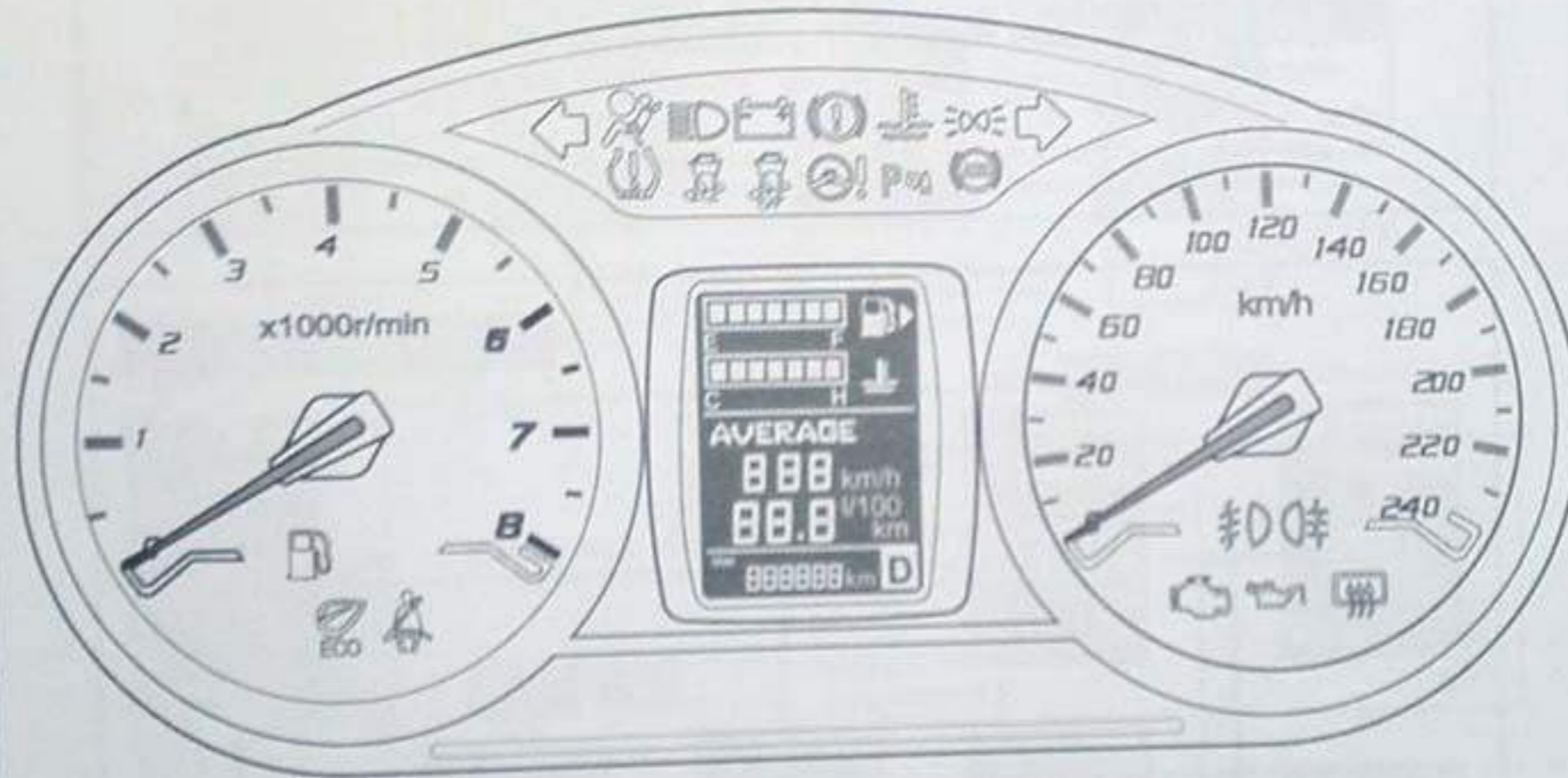

- 1 - Left turn signal indicator
 - 2 - SRS warning
 - 3 - High beam lamp indicator
 - 4 - Battery charge warning
 - 5 - Brake warning
 - 6 - Coolant temperature warning
 - 7 - Position lamp indicator
 - 8 - Right turn signal indicator
 - 9 - ESC (active/fail) indicator
 - 10 - ESC (off) indicator
 - 11 - EPS warning
 - 12 - Front parking sensor indicator
 - 13 - ABS warning
 - 14 - Low fuel warning
 - 15 - Driver's and front passenger's seat belt warning
 - 16 - ECO indicator
 - 17 - Front fog lamp indicator *
 - 18 - Rear fog lamp indicator *
 - 19 - Engine check warning
 - 20 - Oil pressure warning
 - 21 - Rear defogger indicator
- Refer to page 76 for details.

NOTE

"*" - If fitted - in accordance with the various Country & Vehicle Specifications

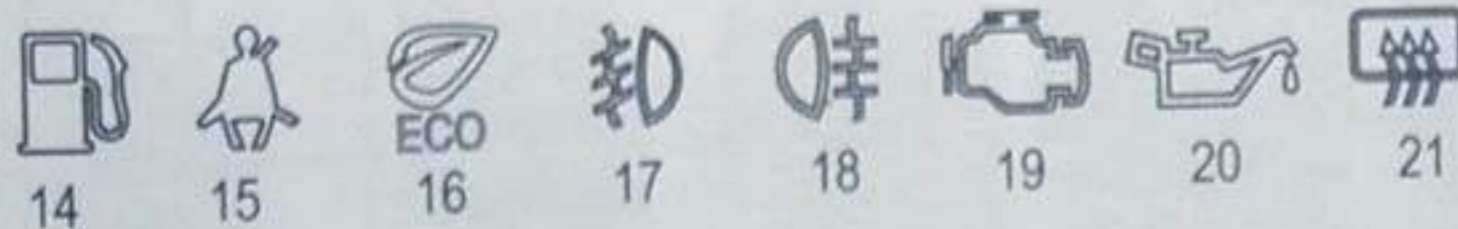

Multi information display before and during ignition ON

OWN001OVIEW16014

NOTE

Refer to page 81 – 91 for detail descriptions of each display.

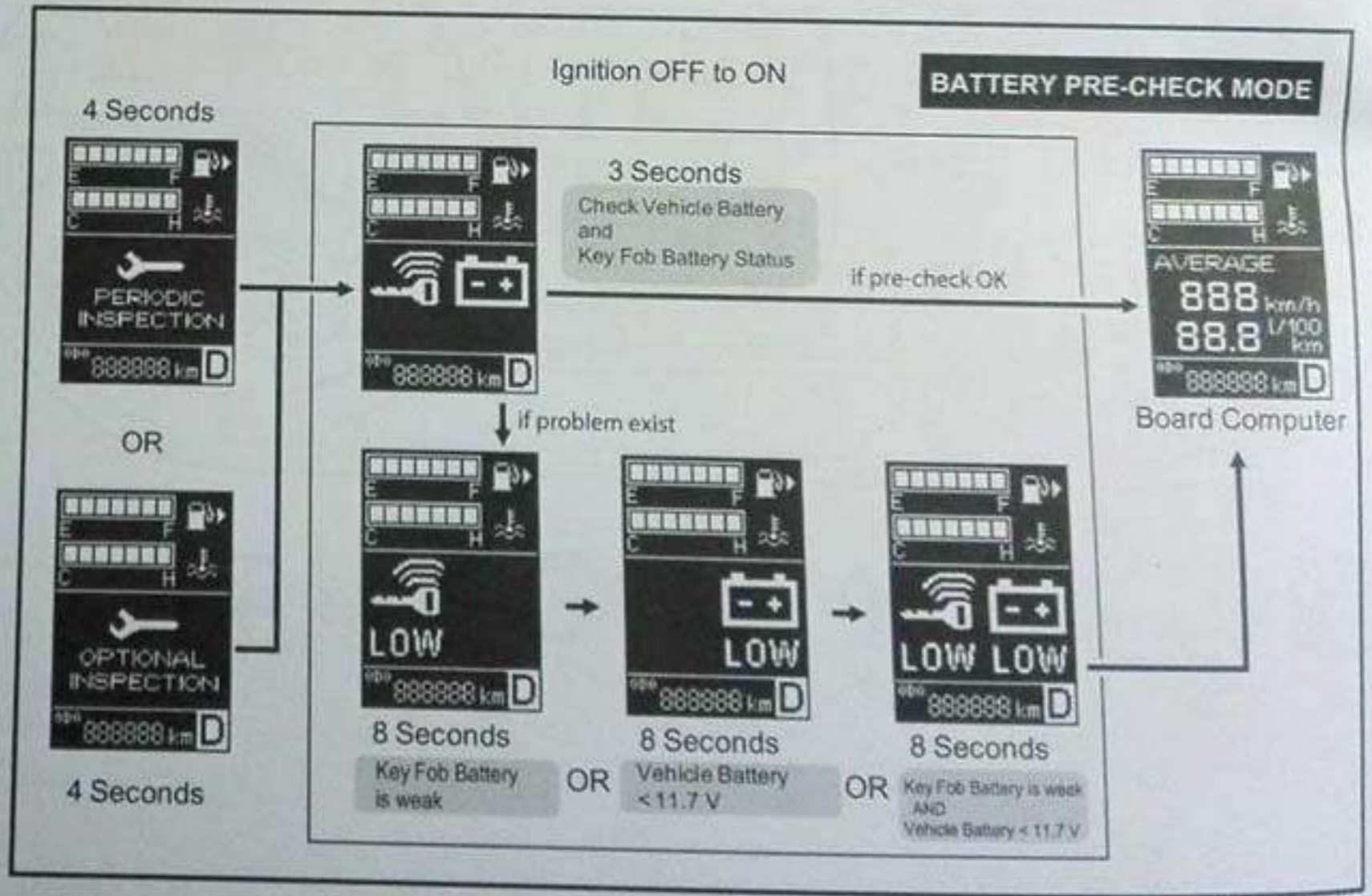
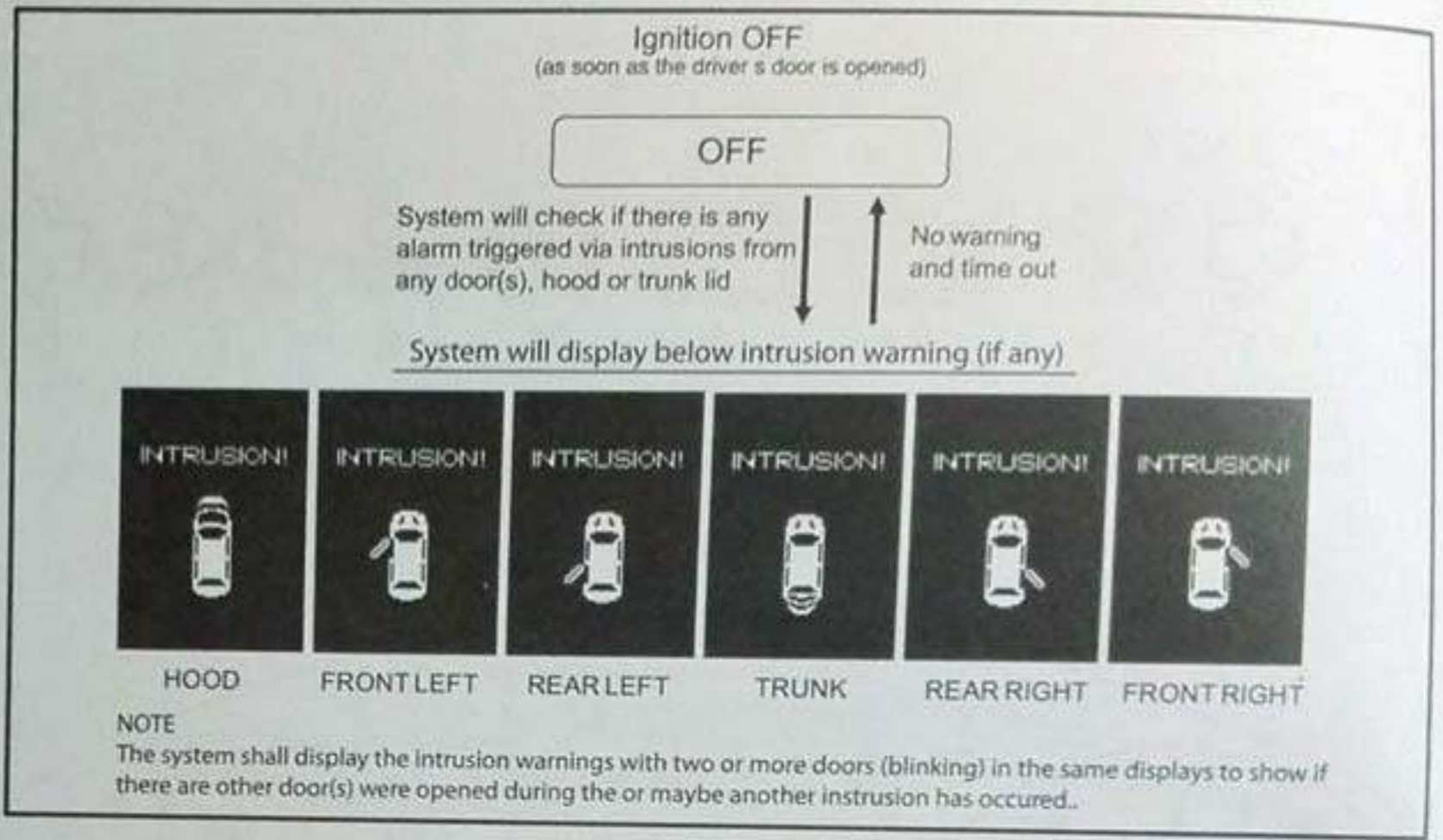

Multi information display operation

OWN001OVIEW16015

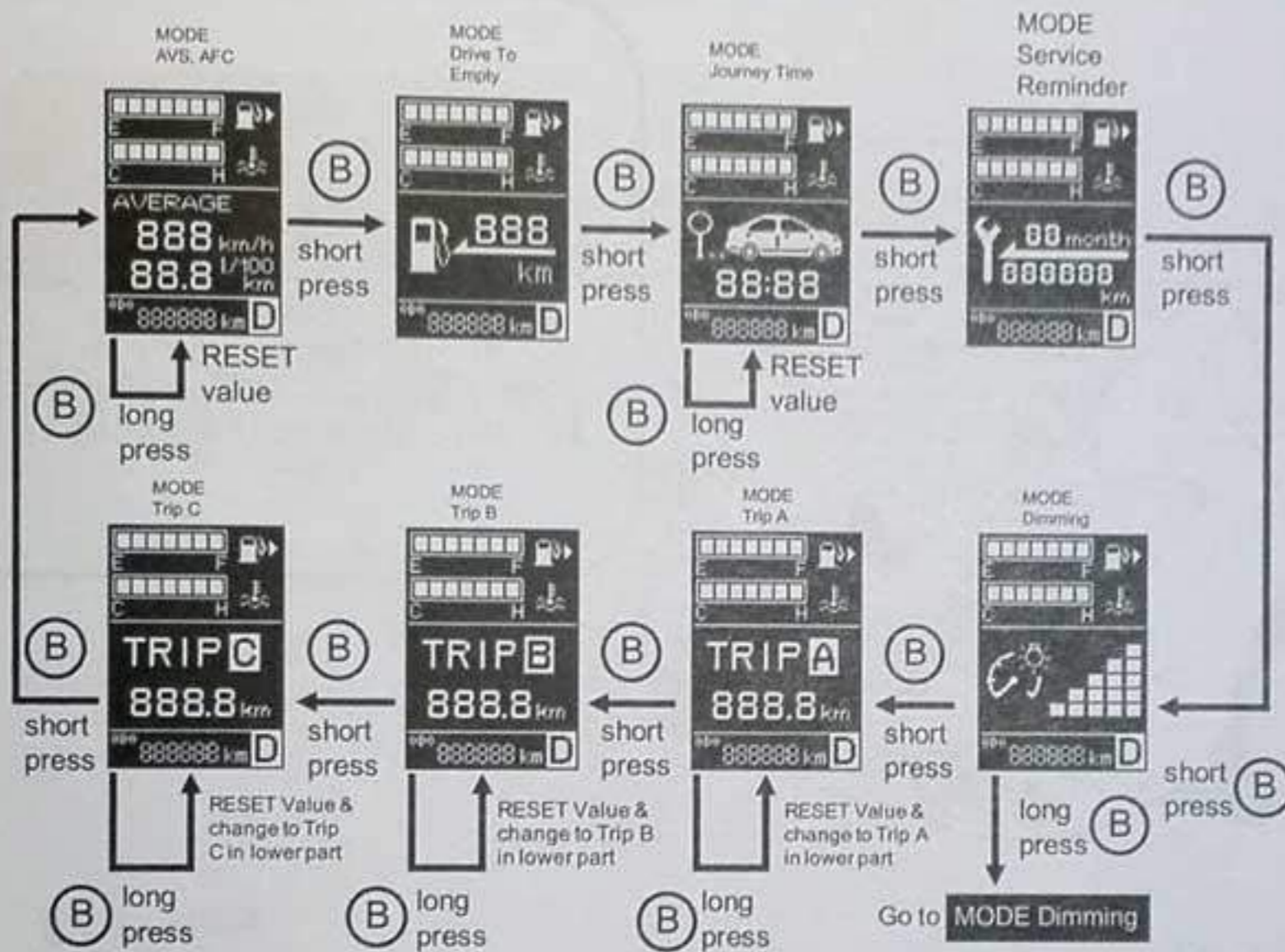

The multi information display button (B) is located at the tip of the wiper lever (see illustration).

Press this button to change the display sequentially.

NOTE

- (1) Short press – Press button (B) less than 2 seconds
- (2) Long press – Press button (B) more than 2 seconds

Refer to page 81 – 91 for detail descriptions of each display.

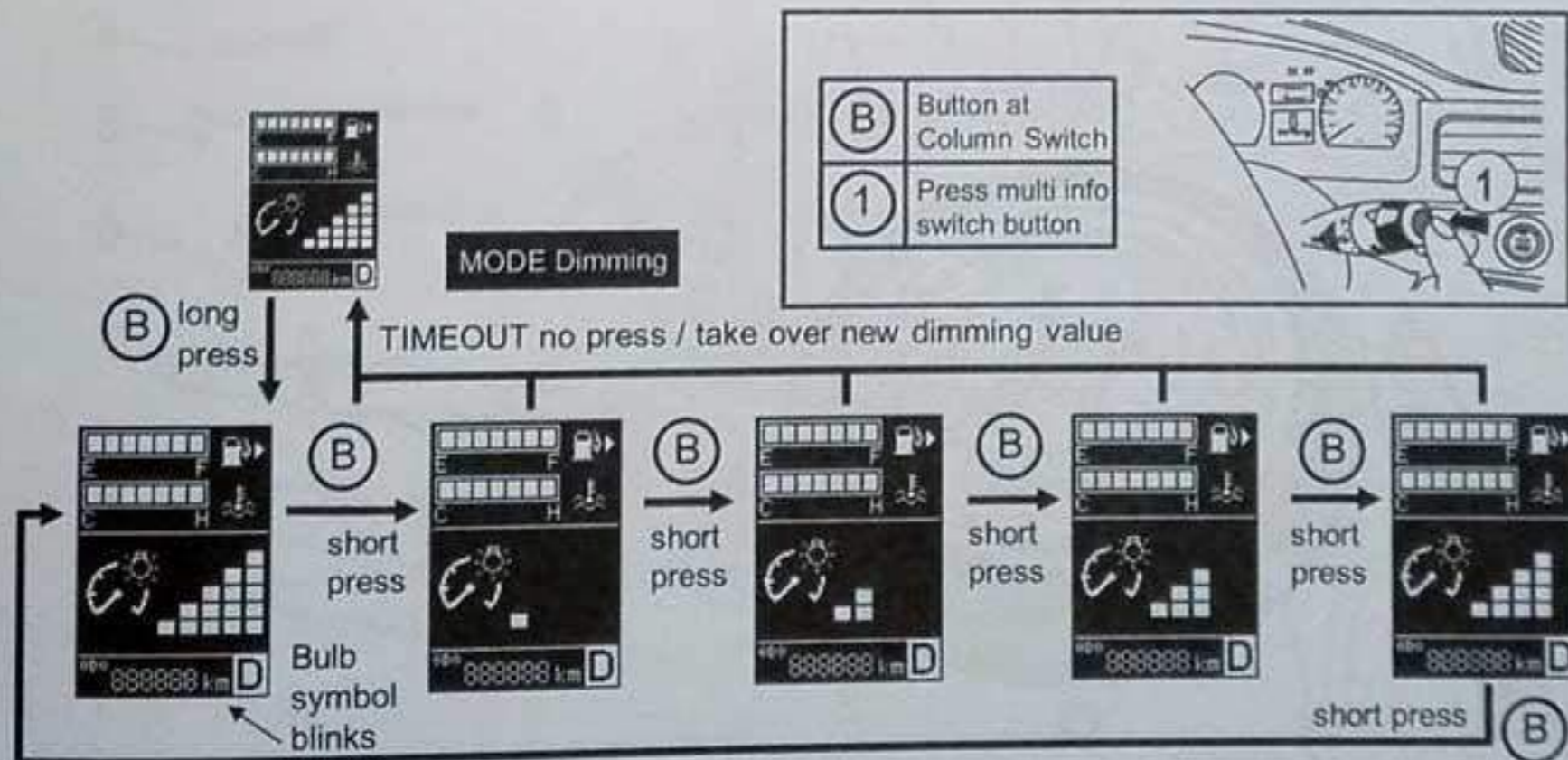

Tools and jack

OWN001OVIEW16016

- 1 - Lift up the floor board of the trunk.
- 2 - Location of the tools, jack and spare tyre - P 134
- 3 - Screw driver
- 4 - Spanner (8x10)
- 5 - Bar
- 6 - Wheel nut wrench
- 7 - Jack
- 8 - Tool bag

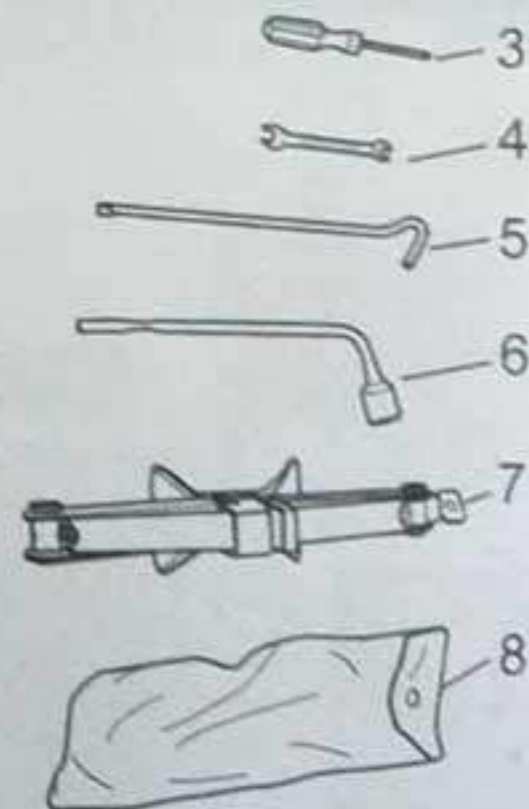
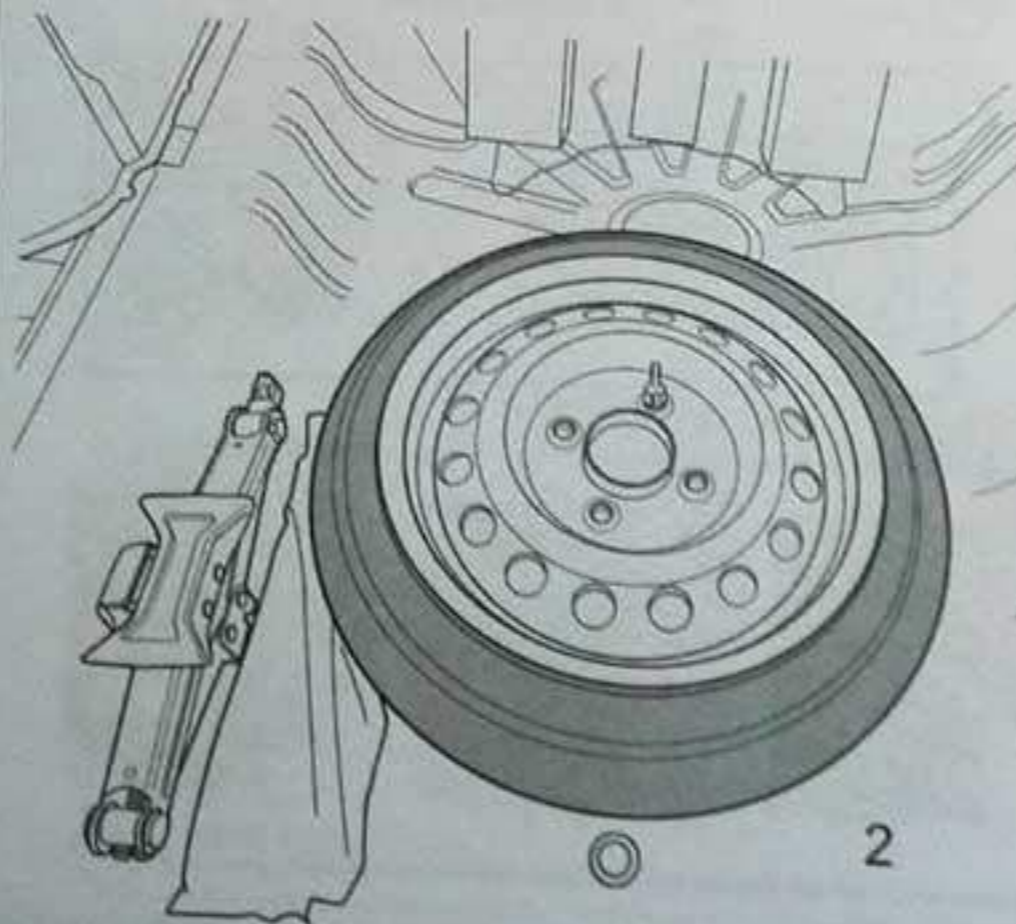
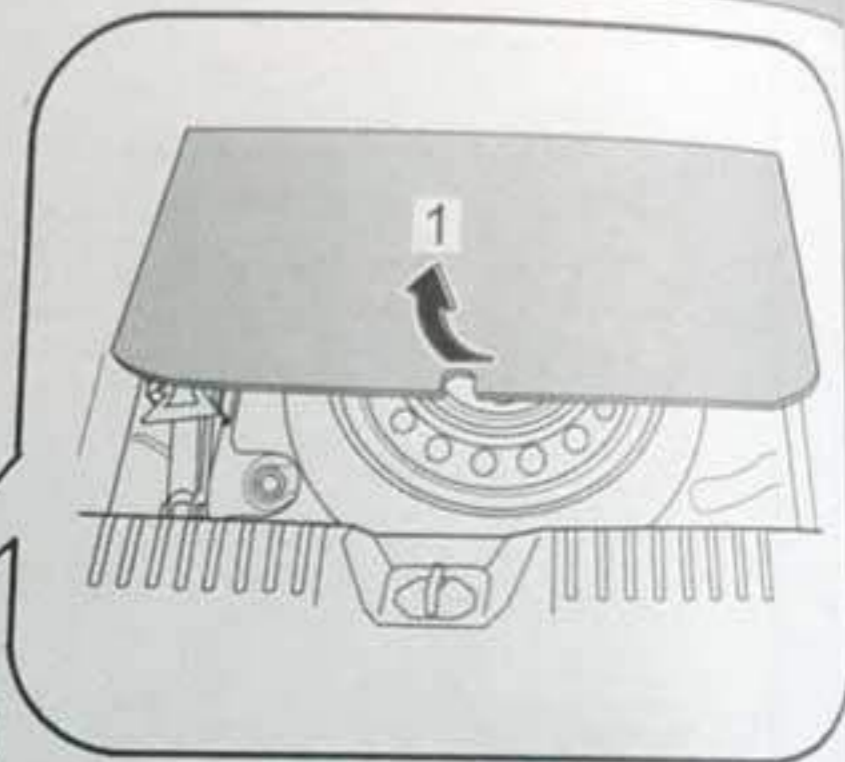
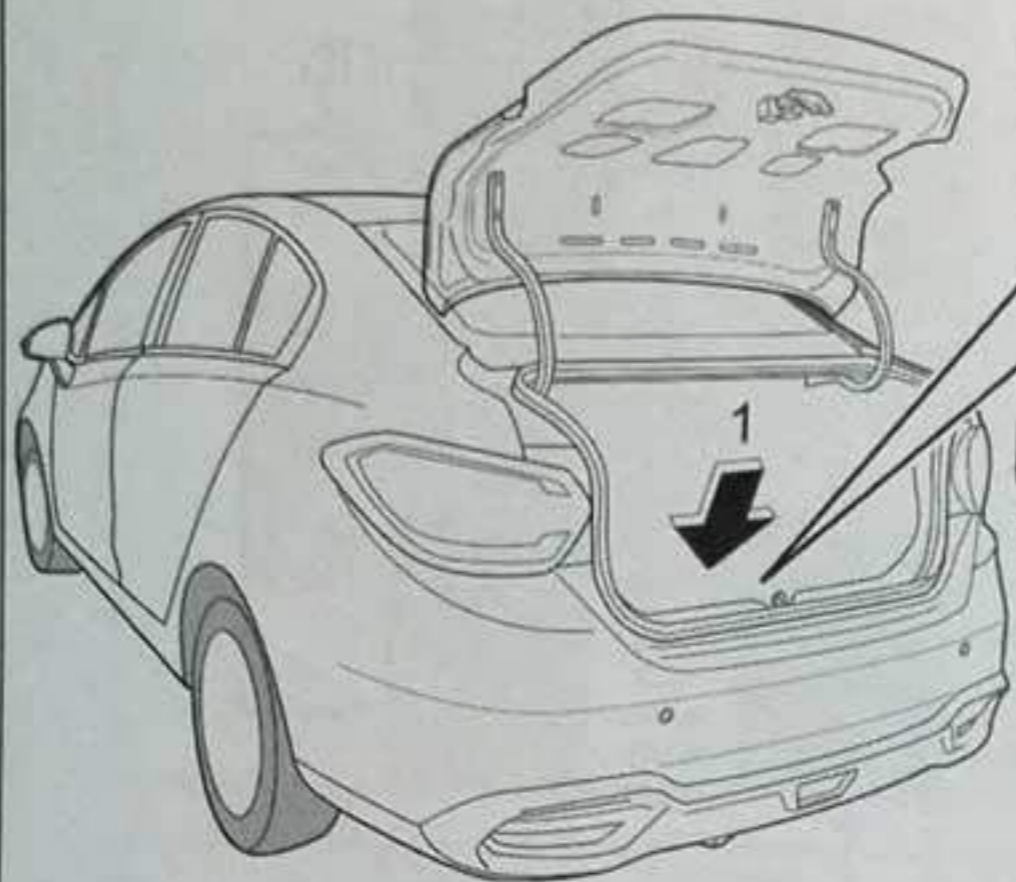

Engine Compartment

OWN001OVIEW16017

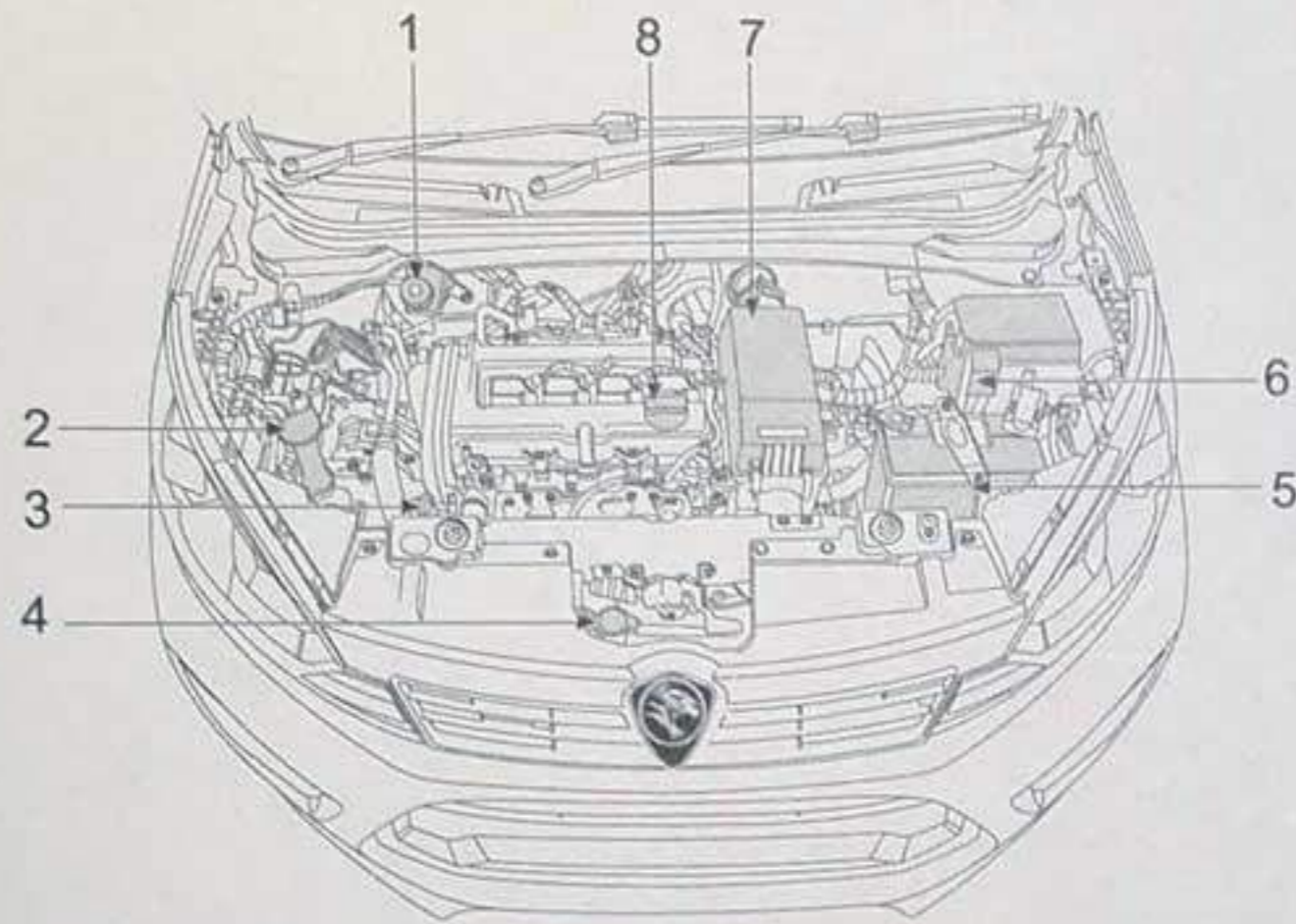

- 1 - Brake and clutch fluid reservoir
- 2 - Washer reservoir
- 3 - Engine oil level gauge
- 4 - Engine coolant radiator cap
- 5 - Battery
- 6 - Fuse junction box
- 7 - Engine air filter
- 8 - Engine oil cap
- 9 - Coolant radiator reservoir

Refer to page 164 for detail information.

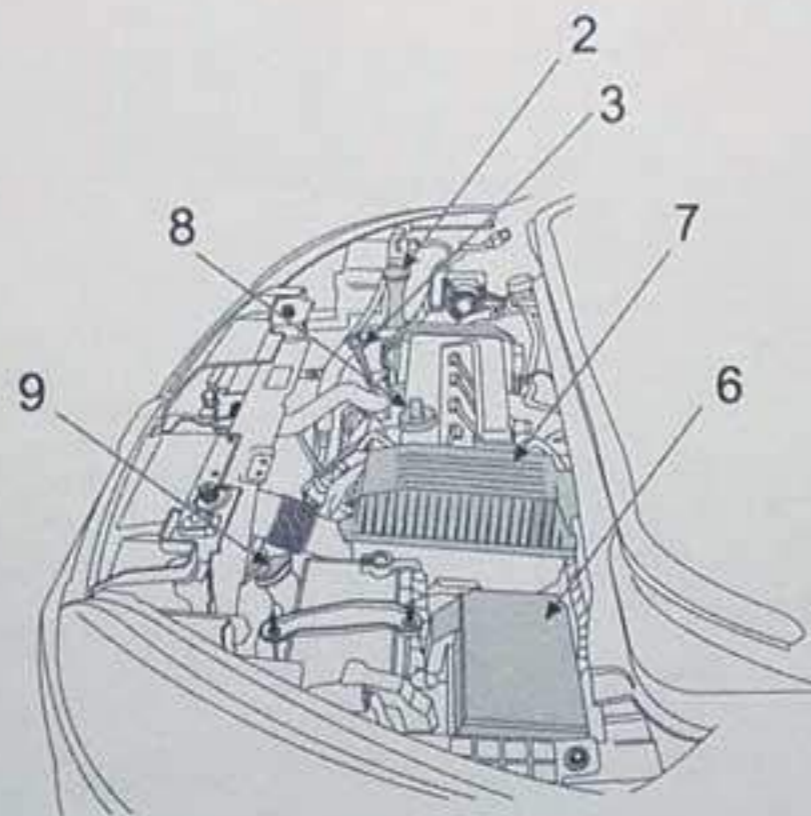

Indication of applicability

Optional equipment marked with an asterisk "*" may differ according to the country it is sold in or the sales classification; refer to the sales catalogue

DOIRW001R14016

General Information

Important Safety Precautions	20
	22
Vehicle Safety Features	22
Vehicle Security Features	24

Important Safety Precautions

OWN002GINFO16005

The safety information provided in this manual is very important.

Always Wear the Seat Belt

A seat belt is the best protection in all types of collisions. The airbags are additional protection to the seat belts, but do not replace the seat belts. The driver and passengers should wear the seat belts correctly all the time.

Child Restraint

Children aged 12 and below must be put in the rear seat. Infants and small children must use the child restraint system. Larger children must use a booster seat and the 3-point seat belt until they can use the seat belt correctly without a booster seat.

Know The Airbag Hazards

Airbags give protection to the passengers. Airbags also can cause injuries to the passengers if the passengers do not or cannot sit correctly. Make sure all instructions and warnings in this manual are complied.

Do not drink and drive

Alcohol and driving do not mix. Do not drink and drive.

The Task of Driving

Drive safely. Monitor the road, other vehicles and pedestrians. Make sure the situation is safe as traffic conditions can change.

Control Your Speed

Obey the maximum speed limit. Do not drive fast unless traffic condition permit.

Keep Your Vehicle in Safe Condition

A tyre blowout or a mechanical failure can be very dangerous. Regularly check your tyre pressures and tyre condition. Send the vehicle for the periodical service maintenance as required.

Installation of accessories

Before you install any accessories, refer to your authorised PROTON service outlet.

The installation of accessories and optional parts must be done according to the limits approved by the law in your country and according to the guidelines and warnings contained in the documents that come with this vehicle. Only approved PROTON accessories can be installed in the vehicle.

Installation of any electrical devices for example a vehicle immobiliser or a radio transceiver, should not have any interference with the engine management computer or other electrical systems. Malfunctions can occur.

Tyres and wheels which do not comply with the requirement must not be used. Refer to the "Specifications" section for information on topic "Tyres and wheels".

Modifications or alterations to the electrical or fuel systems

PROTON makes safe and high quality vehicles. To maintain this safety and quality, any installation of accessories or changes likely to affect the electrical or fuel systems be referred to an authorised PROTON outlet as incorrect installation can cause damage or fire.

PROTON genuine parts



DOINW002R09001

PROTON vehicles are made of the highest quality parts according to PROTON quality standards and specifications. Always use PROTON approved parts to ensure the PROTON vehicle continue to operate and perform at its optimum level. PROTON genuine parts are available at authorised PROTON outlets.

NOTE

PROTON has a right to cancel any warranty claim if parts different from PROTON approved parts are used.

Safety instructions for used engine oils

WARNING

- (1) Any contact to skin can cause dangerous skin disorders including dermatitis and cancer.
- (2) Prevent contact of the engine oil with skin as far as possible. Clean skin if there is any contact.
- (3) Keep away from children.
- (4) Do not discard used engine oils into drains, water channels and onto the ground.

Contact the local authority to get the information on how to discard used engine oils, oil filters or other vehicle parts.

Vehicle Safety Features

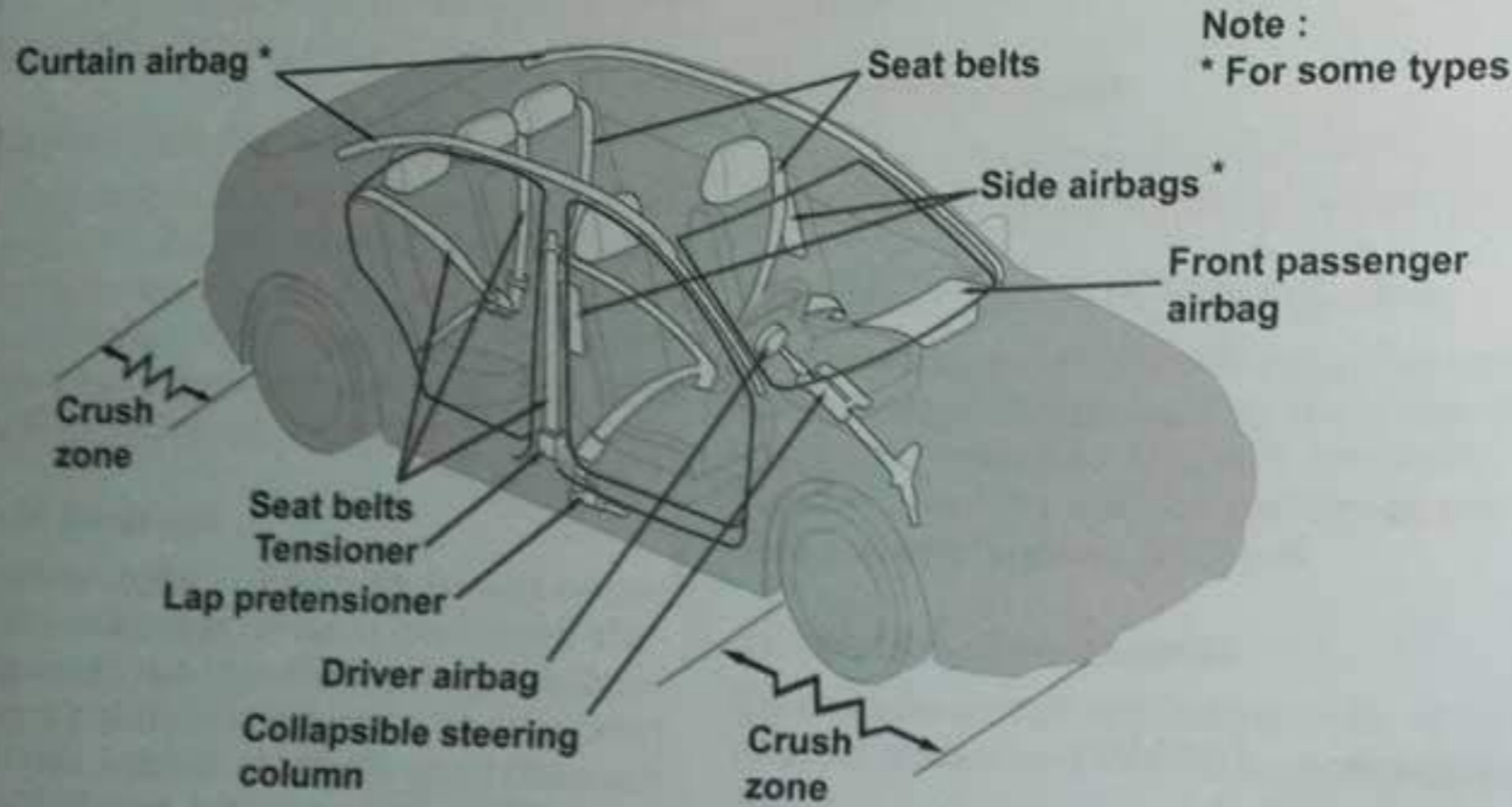

The vehicle has safety equipment that give protection to driver and passengers during a collision. Refer to the diagram.

Know The Airbag Hazards

The SRS airbags give additional protection with the seat belts to give protection to the driver and front passenger against injuries to the head and chest during some moderate-to-severe front collisions.

The SRS airbag does not replace the seat belts.

1. Components of Supplemental Restraint System (SRS)

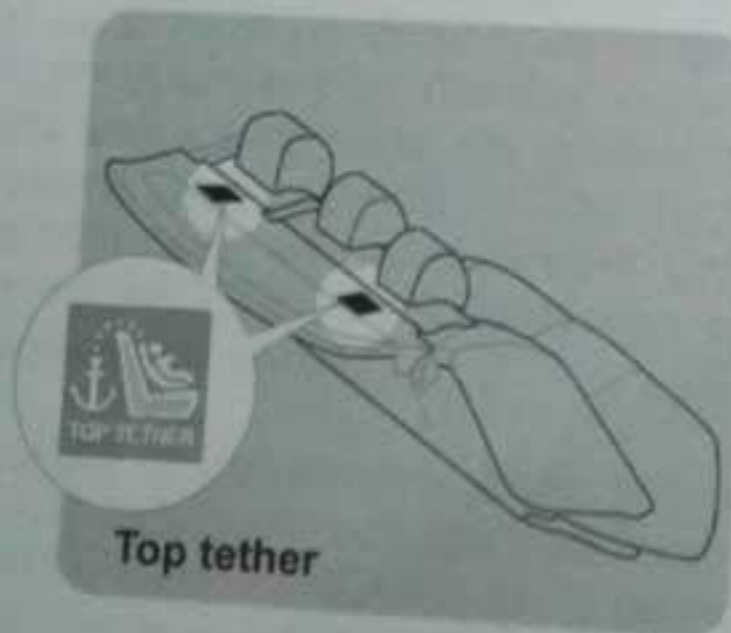
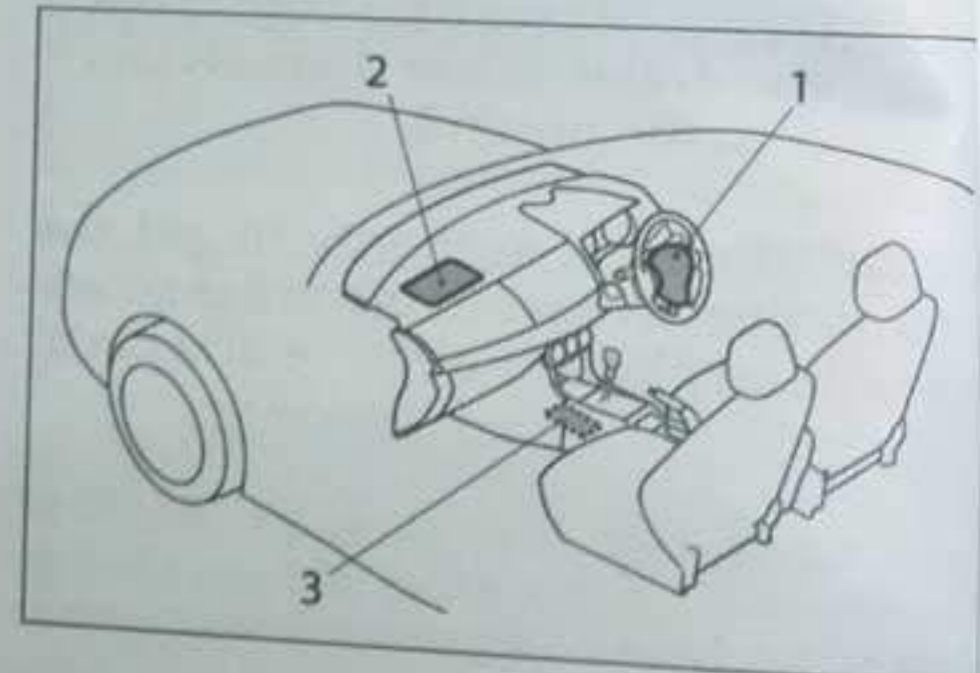

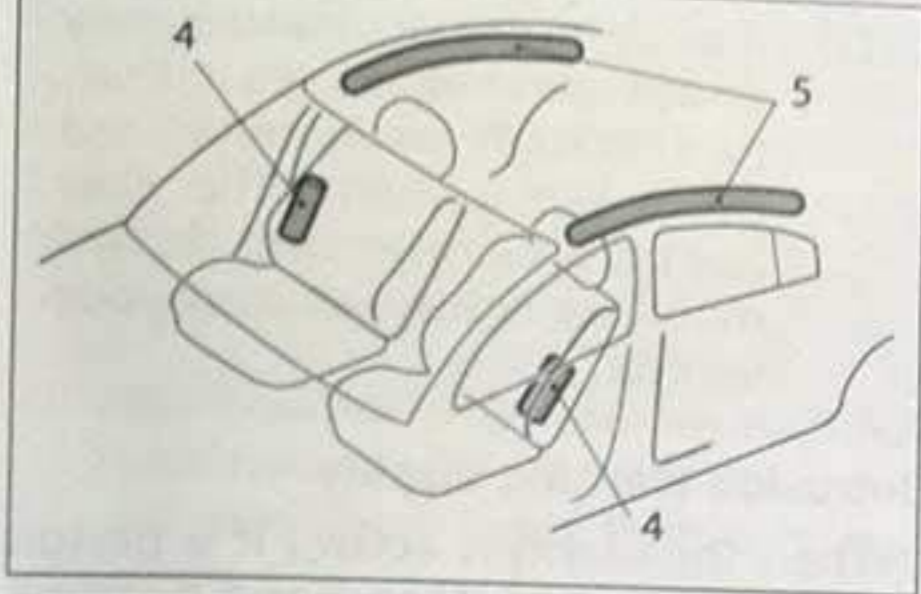

DOIQW004R11007

The SRS includes these components:

- 1 - Driver airbag module (includes clock spring)
- 2 - Front passenger airbag module
- 3 - Airbag Control Unit - ACU (includes the impact sensor)
- 4 - Side airbag modules
- 5 - Curtain airbag modules *

⚠ WARNING

THIS VEHICLE HAS AIRBAGS. ALWAYS FASTEN YOUR SEAT BELT.

- (1) The seat belts help to keep the passenger correctly in position.
- (2) The seat belts decrease the risk of injury in rollovers, rear collisions and lower-speed front collisions. These airbags do not deploy in those conditions.

(3) The seat belts decrease the risk that a person can be discarded from this vehicle in a collision.

(4) The airbags quickly deploy with a large force. If you do not sit correctly, these airbags cannot give correct protection to you and can cause an injury to you and your passenger.

Any work around and on the airbag system components must be only done at an authorised PROTON service outlet.

Incorrect work can cause the airbags to malfunction or the airbag can suddenly activate to deploy and cause an injury.

Always wear your seat belt



DOISW002R13008

- 1. Adjust the driver seat as far to the rear until you have complete control of your vehicle.



DOISW002R13010

- 2. Adjust the seat back to a straight position with sufficient space between your chest and the airbag cover in the centre of the steering wheel.

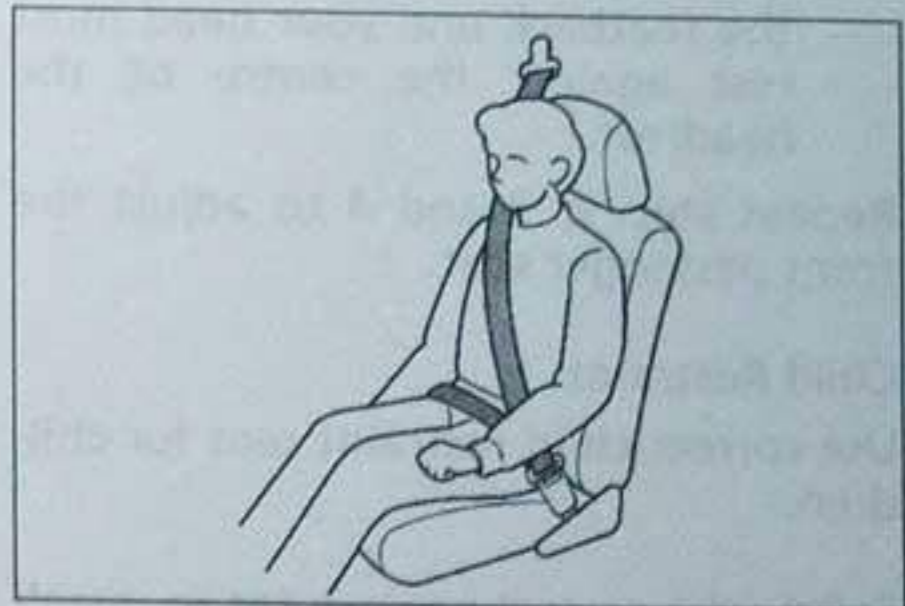

DOISW002R13009

- 3. When your seat belt has correctly fastened, sit straight against the seatback.

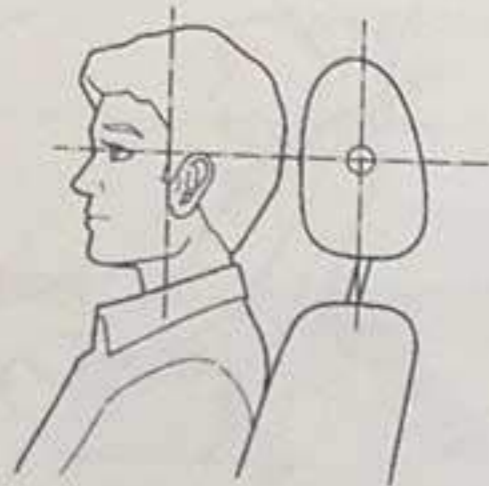

DOISW002R13011

4. Your head must rest against the centre of the headrest.
5. Before you drive, adjust the front passenger seat as far to the rear. Sit in a vertical position and against the seatback and your head must rest against the centre of the headrest.

Repeat step 2, 3 and 4 to adjust the front passenger seat.

Child Restraint

Use correct child restraint seat for children.

Follow the correct procedures to install the child restraint seat to the vehicle.

Vehicle Security Features

OWN002GINFO16008

Immobiliser

This vehicle has an immobiliser that gives protection to the vehicle from anyone trying to start the engine.

A transponder inside the key sends an ID code to an antenna on the ignition switch.

If the ID code is correct, the control unit of the engine will let you to start the engine.

If your vehicle is installed with a key ignition switch, put the key into the key slot of the ignition switch.

If your vehicle is installed with keyless entry system and start stop button, the remote transmitter must be inside the vehicle. Refer to page 36. Then only you can operate the start stop button.



CAUTION

- (1) Do not let the keys touch any magnetic items.
- (2) Do not damage the key. There is a transponder inside the key.

- (3) If a key is missing, immediately drive your vehicle to an authorised PROTON service outlet and get a replacement. The new key must be reset with the immobiliser control unit of your vehicle.

Intrusion warning display

(When the alarm is active) If a person tries to open any door, hood or trunk lid, the vehicle system will record .

(After you deactivate the alarm) When the driver's door is open, the meter cluster will show an intrusion warning display for 10 seconds. A part of the display flashes to indicate the position of the an open door, hood or trunk lid.

For example, when the front left passenger door is opened. The intrusion warning display flashes the front left passenger door:



Refer to page 81 – 91 for other intrusion warning displays.

Anti-theft protection

This vehicle has an anti-theft protection for doors, trunk lid, hood, ignition and starter protection.

When the alarm system is active, an open door, hood or trunk lid will activate the alarm warning.

For vehicles with start stop button:
Make sure that the key is inside the cabin area and start the engine.

When the alarm warning activates, the system operates as follow:

1. The horn or siren makes a sound continuously for 30 seconds.
2. All turn signal lights flash continuously.

How to disable the alarm warning

Press the  UNLOCK-button to deactivate the alarm warning.

This action will clean all the recorded data of alarm warnings.

How to reset the alarm warning

If the alarm warnings (audio and visual) activates and the remote transmitter cannot stop the alarm warning, the remote transmitter has a weak battery. Apply these steps:

- 1 - Insert the key blade into the key slot at the driver door to unlock and open the door.
- 2 - For vehicles with ignition switch: Insert the key blade into the ignition key and start the engine.

Lock and Unlock

Keys and Remote Transmitter	28
Alarm Indicator	31
Remote Keyless Entry System	32
Keyless Entry System	36
Child-lock at Rear Doors	39
Door	40
Central-door Lock (CDL) Switch	41
Other Features of Lock and Unlock	42
Hood	42
Trunk Lid	43
Power Window Glass Control	44

Keys and Remote Transmitter

OWN003LOCKS16001

Key Type A

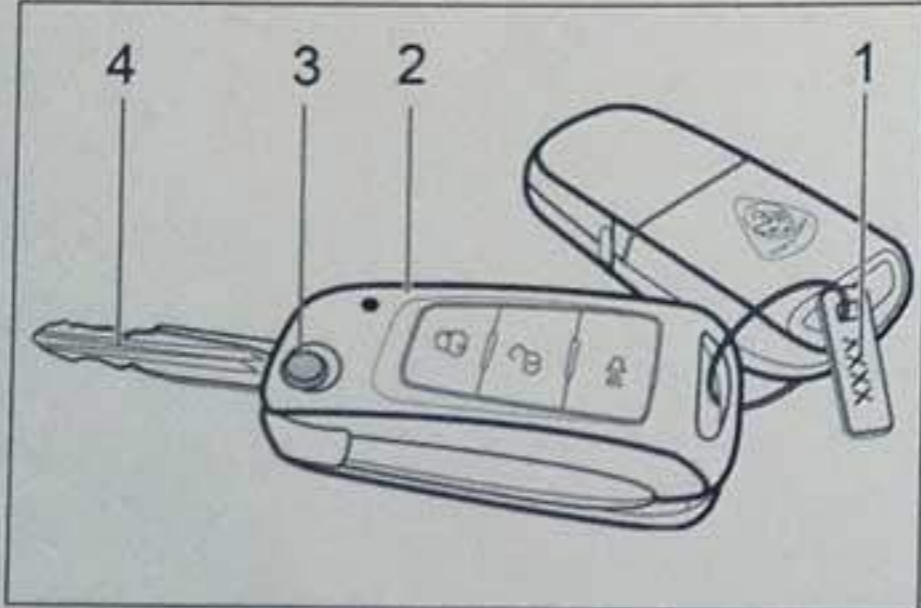

DOIQW003R13007

Key Type B

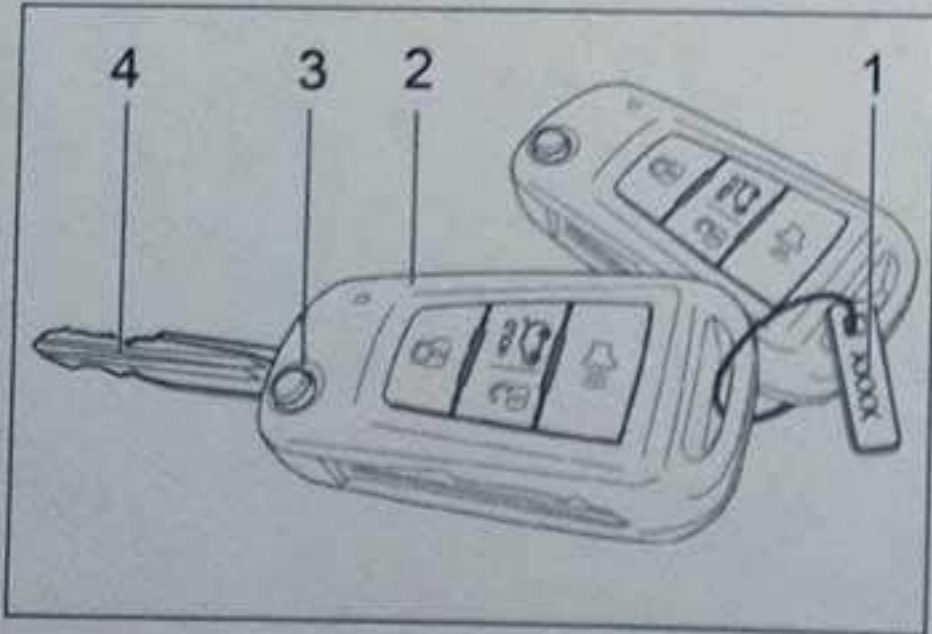

DOITW003R16022

Type C

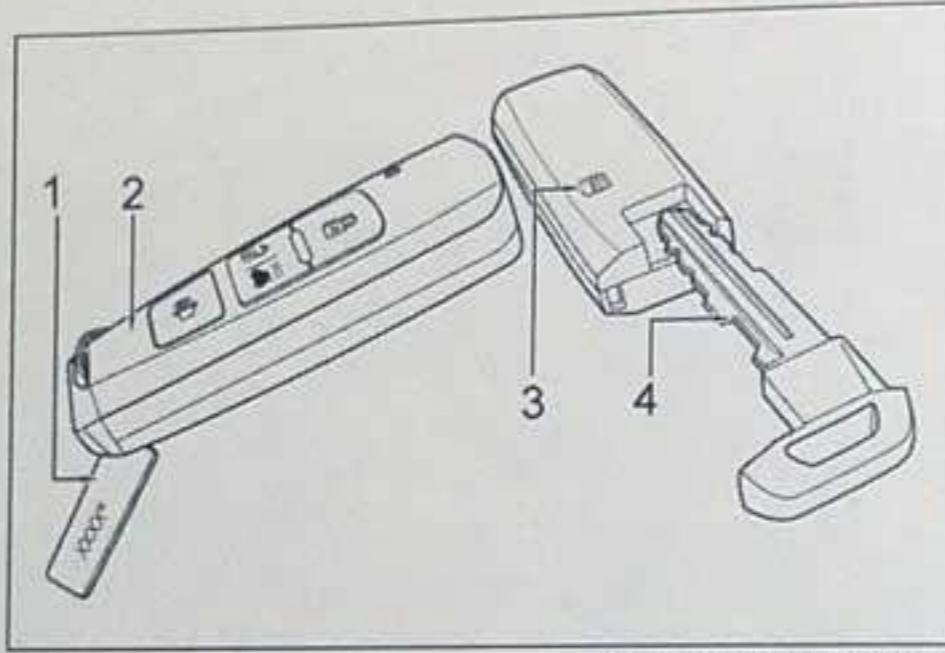

DOIRW003R14003

- 1 - Key plate
- 2 - Remote transmitter
- 3 - Release button for key blade
- 4 - Key blade

PROTON gives two set of keys. Use the key blades to unlock and lock, open the driver's door. Keep one spare key in a safe area.

The key number is shown on the key plate.

CAUTION

- (1) Record and safely keep this key number. If the first key is lost, go to an authorised PROTON service outlet. Show the number on the key plate to the service personnel to get a replacement key.

- (2) Always keep a spare key. The spare key can be used when the vehicle is accidentally locked with the key inside.

Release button for key blade

Type A & B

Type-A



Type-B



DOITW003R16022

- To release the key blade – Press the button to release the key blade.
- To return the key blade – When you press and hold the button, return the key blade into position.

Type C

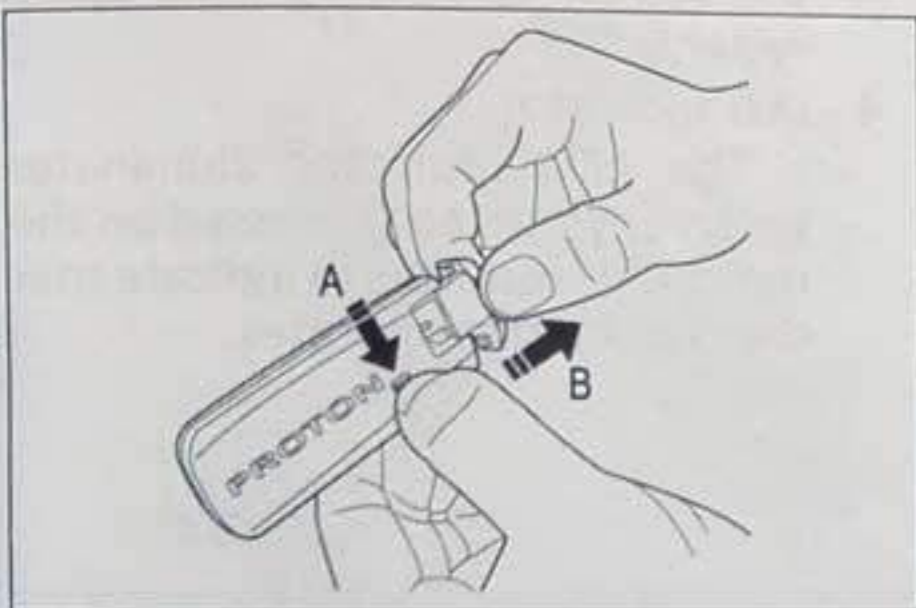

DOIRW003R14008

- To release the key blade – Press the release lever (A), and pull the key blade out.

Remote transmitter

The key has a remote transmitter.

The operation range of the remote transmitter is approximately 20 metres from the centre of the vehicle.

This range can change according to the location of the vehicle, for example, near to a power station or radio station.

If the battery of the remote transmitter is weak, you cannot use the transmitter to lock or unlock the doors.

For type A & B remote transmitters – Replace the 1 unit of battery with a Manganese Dioxide Lithium type (CR1620) battery.

For type C remote transmitter – Replace the 1 unit of battery with a Manganese Dioxide Lithium type (CR1632) battery.

Refer to page 156 for information about replacement of the battery for remote transmitter.

The key slot at the driver's door outer handle can also be used to lock or unlock the door. Refer to page 40.

Remote transmitter care

- Avoid dropping or throwing the transmitter.
- Protect the transmitter from extreme temperature.
- Do not immerse the transmitter in any liquid.
- If remote transmitter is lost, contact an authorised PROTON service outlet.

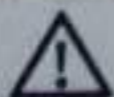
 **CAUTION**

Use only the same battery type. If you fit a wrong battery, the PCB transmitter can damage.

Operation of the remote transmitter (type A)

Type A

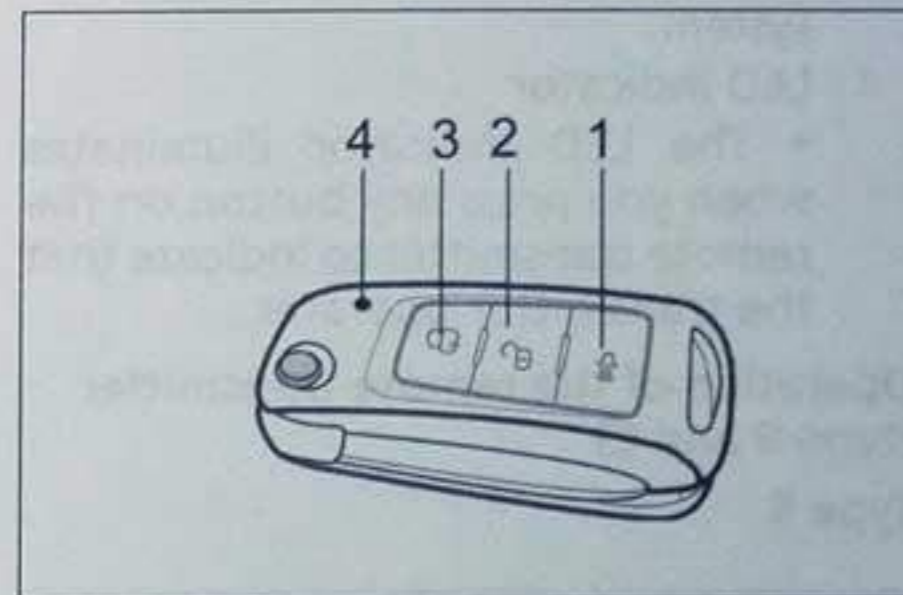

DOIQW003R13009

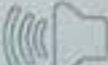
1 -  PANIC-button

- Press the PANIC-button (1) to activate the panic alarm mode. Press again the PANIC-button (1) to deactivate the panic alarm mode.

2 -  UNLOCK-button (2)

- Press the UNLOCK-button (2) to unlock the vehicle. This action also deactivates the alarm system.
- Press and hold the UNLOCK-button (2) more than 3 seconds to release the trunk lid lock (**for some types**).
- Press the toggle switch on the trunk lid door to fully release the lock.
- Lift the trunk lid door to fully open.

3 - LOCK-button

- Press the LOCK-button (3) to lock the vehicle and activate the alarm system.

4 - LED indicator

- The LED indicator illuminates when you press any button on the remote transmitter to indicate that the transmitter operates.

Operation of the remote transmitter (type B and C)

Type B

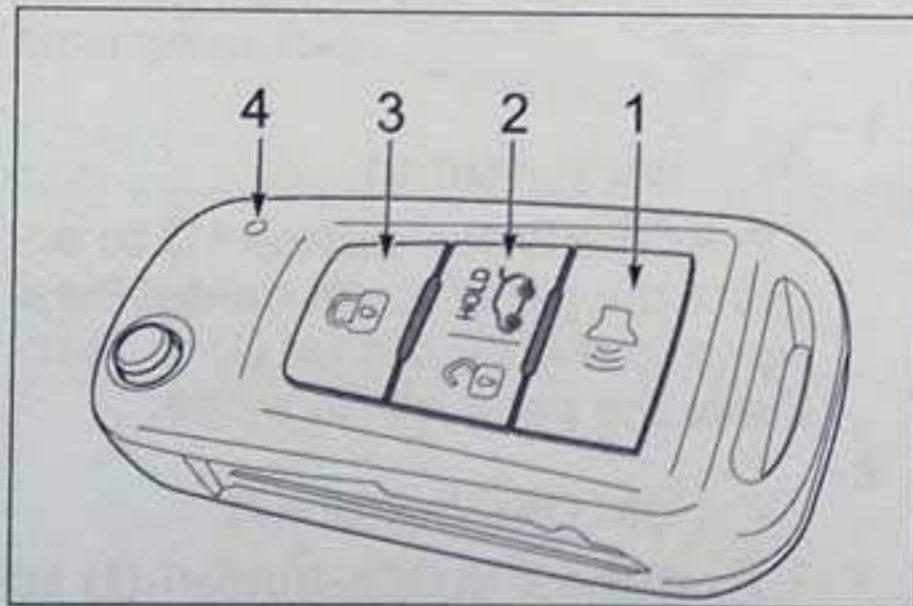

DOITW003R16024

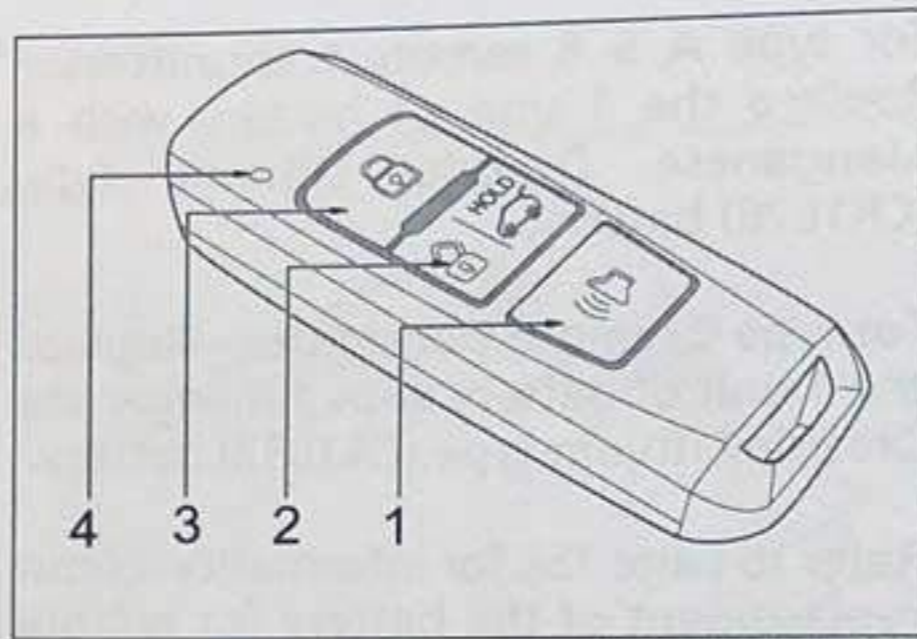

DOITW003R16025

Type C

1 - PANIC-button

- Press the PANIC-button (1) to activate the panic alarm mode. Press again the PANIC-button (1) to deactivate the panic alarm mode.

2 - UNLOCK-button (2)

- Press the UNLOCK-button (2) to unlock the vehicle. This action also deactivates the alarm system.

trunk lid RELEASE-button (2)

- Press and hold the trunk lid RELEASE-button (2) more than 3 seconds to release the trunk lid lock.
- Press the toggle switch on the trunk lid door to fully release the lock.
- Lift the trunk lid door to fully open.

3 - LOCK-button

- Press the LOCK-button (3) to lock the vehicle and activate the alarm system.

4 - LED indicator

- The LED indicator illuminates when any button is pressed on the remote transmitter to indicate that the transmitter operates.

Alarm Indicator

OWN003LOCKS16002

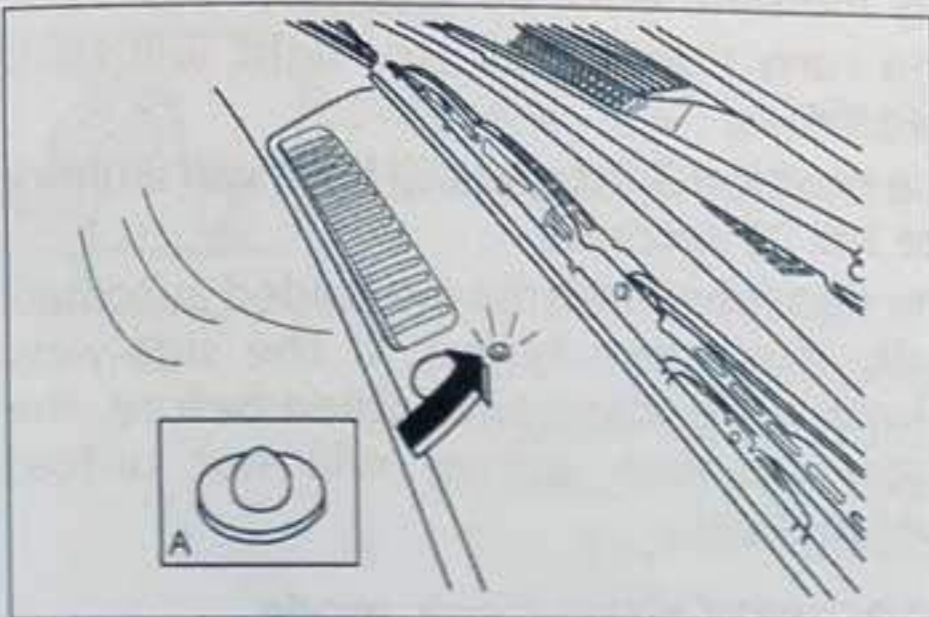

DOIQW003R12001

A – LED indicator for alarm

The alarm LED indicator is in the centre of the instrument panel. This indicator shows the alarm mode status as follow:

Alarm off mode

When the LED indicator turns OFF, the vehicle is in the disarm mode.

The alarm system is not in operation.

Pre-arm mode

The alarm LED indicator illuminates for 6 seconds, to indicate that the vehicle prepares to enter the arm mode.

The alarm system is not in operation during the 6 seconds.

Arm mode

When the LED indicator flashes, the vehicle is in the arm mode.

If a door opens during the arm mode, the alarm warning will activate.

During the alarm warning, the horn or siren* sounds and hazard lamp flashes.

* if fitted

NOTE

When parking and leaving the vehicle, make sure the alarm system is set to arm mode. Press the LOCK button on the remote transmitter to set the alarm system to arm mode.

Remote Keyless Entry System

OWN003LOCKS16003

Alarm system features

The remote transmitter has switches to lock or unlock the doors and activate or deactivate the alarm system. The description of each operation is shown below.

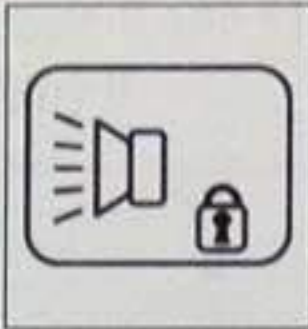

How to activate the alarm

While the alarm is not active (disarm mode), press the  LOCK-button on the remote transmitter.

- If all doors are closed, all doors will lock.
- The turn signal indicator on the meter display will flash one time.
- The door view mirrors are folded automatically (for some types).
- The alarm system will enter the pre-arm mode (the alarm LED indicator will illuminate for 6 seconds).

When the arm mode starts, the LED indicator flashes.

How to deactivate the active alarm

While the alarm is active (arm mode), press the

 UNLOCK-button of the remote transmitter.

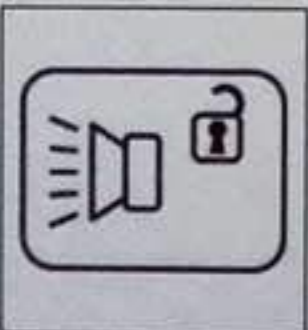

How to activate alarm-panic mode

Press the  PANIC-button of the remote transmitter to activate the alarm panic-mode.

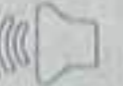
Press the  PANIC-button again to deactivate the alarm panic-mode.

NOTE

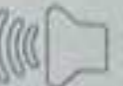
Press the  PANIC-button while the alarm system is in arm or disarm mode.

While in alarm panic-mode, the system will operate same as the alarm warning.

- If all doors are closed, all doors will unlock.
- If the switch of the room lamp is in the door position, the room lamp will gradually illuminate for 30 seconds.
- The turn signal indicator light will flash two times.
- The position light and tail light will illuminate for 25 seconds.
- The door view mirrors are folded automatically (for some types): If the side-view mirror were manually folded before, the door rear-view mirror will not unfold automatically.

Lock and unlock

Lock

Press the  LOCK-button of the remote transmitter

- All doors will lock.
- Turn signal indicator lights flash one time.
- The alarm LED indicator will illuminate for 6 seconds, then flashes.
- The door side view mirror is folded automatically *

Unlock

Press the  UNLOCK-button of the remote transmitter

- All doors will unlock.
- The outside mirror will unfold automatically. (All doors must be closed.)
- The room lamp will illuminate gradually in 30 seconds.
- Turn signal indicator lights flash two times.
- Position light and tail light will illuminate for 25 seconds.

NOTE

If the switch of the room lamp is in the door position, the interior light will illuminate gradually for 30 seconds. Refer to page 97.

Trunk lid release *

Press and hold the  trunk lid RE-LEASE button on remote transmitter more than 3 seconds. The trunk lid lock will release. Press the trunk lid switch and lift the trunk lid to fully open.

Central door lock (CDL) mode

You can operate the central door lock through methods, as follows:

- Use the remote transmitter.
- Use the switch for the central door lock in the centre of the instrument panel. Refer to page 42.

When you activate the central door lock, all doors will lock and unlock.

Driver door unlock (DDU) mode

The driver door unlock (DDU) is a function that can unlock and open the driver door. The other doors stay locked.

You can set the system to the DDU mode.

How to activate the driver door unlock (DDU) mode

1. Press the  LOCK button and  UNLOCK button together until the turn signal indicator lights flash two times.

* if fitted

2. The central-door lock mode will deactivate.
3. Driver door unlock mode will activate.

Operation during driver door unlock mode

For vehicle without keyless entry system

Press the  UNLOCK button. Only the driver door unlocks.

Press again the  UNLOCK button. All other doors will unlock.



Operation for vehicle with Keyless entry system

Press the  UNLOCK button the door handle switch. Only the driver door will unlock.

Press again the  UNLOCK button the door handle switch. All other doors will unlock.

How to disable the driver door unlock (DDU) mode

Disable the (DDU) mode and return to the central-door lock (CDL) mode.

Press the  LOCK and  UNLOCK buttons together until the turn signal lights flash two times.

- Driver door unlock mode will deactivate and the system will activate the CDL mode.



Automatic doors relock

This automatic doors relock feature will automatically activate only by the below conditions:

1. The alarm system is active.
2. The doors, hood and trunk lid were closed and lock.

Press the  UNLOCK button and all doors, hood and trunk lid stay closed and lock in approximately 30 seconds:

- All doors, hood and trunk lid lock again.
- Alarm system is active again.
- Side view mirrors are automatically folded again.

Door ajar warning

This open-door warning will automatically activate only by the below condition:

- A door, hood or trunk lid is open or not correctly closed.

Press the  LOCK button, these conditions occur:

- The turn signal lights flashes 5 times.

The LED indicator  on the meter display illuminates in 3 seconds to indicate an open door, hood or trunk lid.

The horn will make a sound 5 times and continuously sounds for 30 seconds.

Additional features

Vehicle search-mode

This feature helps to find this vehicle.

While the vehicle alarm system is active (arm mode), press the  LOCK button two times.

- The turn signal lights will flash three times.
- The position and tail lights will illuminate in 30 seconds.

Keyless Entry System *

OWN003LOCKS16004

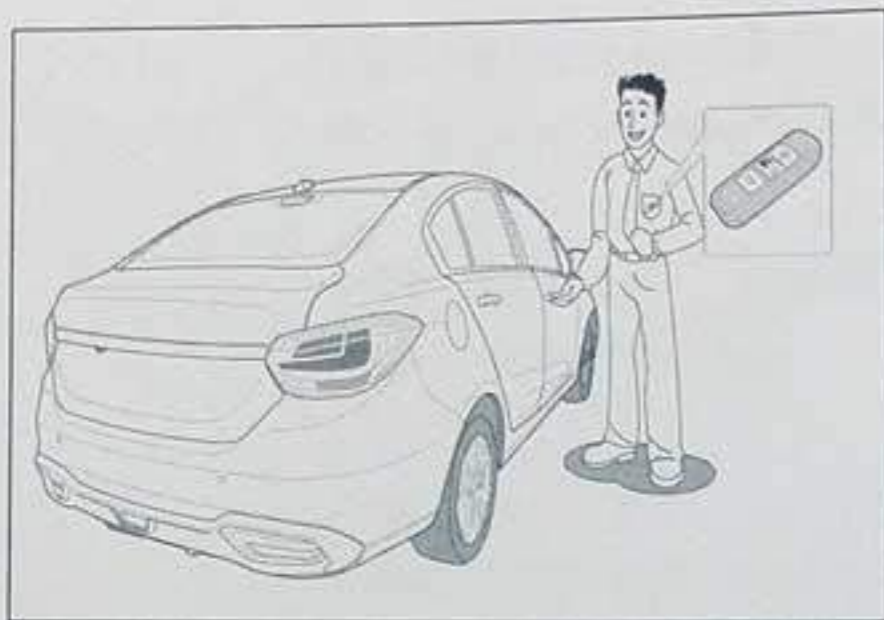

DOITW003R16001

With the remote transmitter within a specified range, this system allows you to lock and unlock the doors and the trunk lid from outside the vehicle.

With the remote transmitter inside the vehicle, start the engine

WARNING

The operation of keyless entry system can cause an effect as follow:

- (1) The radio wave transmitted by the remote transmitter can cause an effect to a medical equipment. Any person that uses a pacemaker must refer to the supplier of the electric medical equipment for any possible problems.

* if fitted

- (2) The radio wave transmitted by the remote transmitter can cause an effect to an aircraft navigation and communication systems. Do not operate the remote transmitter while you are on aircraft. During a flight, make sure you do not accidentally operate the buttons of the transmitter.

CAUTION

- (1) Always keep the remote transmitter with you.
- (2) Make sure you have the remote transmitter and lock the vehicle before leaving the vehicle.

Operation range of the keyless entry system

The operation range to lock or unlock the doors and open the trunk lid is as follows:

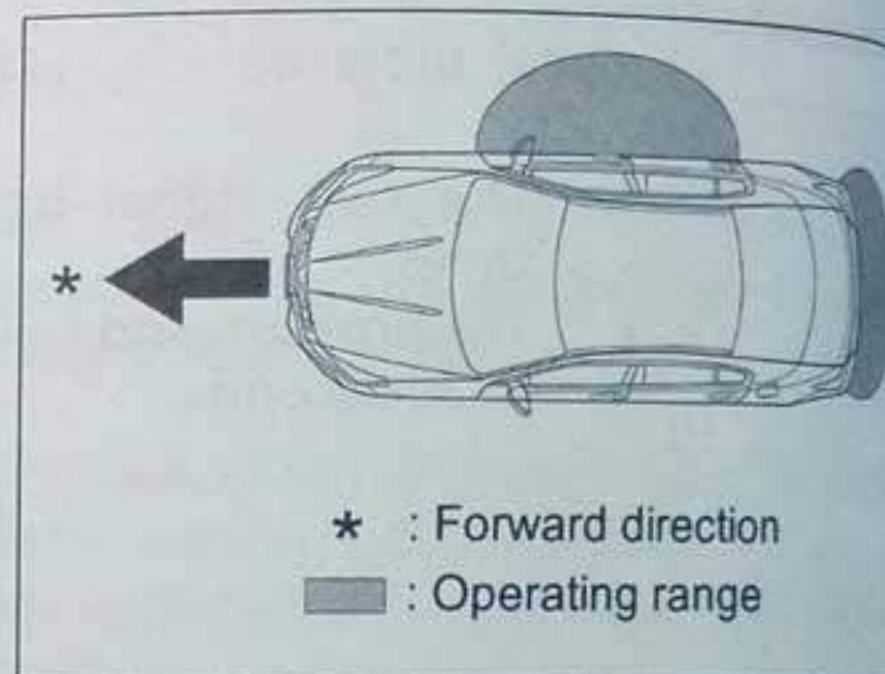

DOITW003R16005

The operation range is approximately 1.2 – 1.5 metres from the driver's door handle and 1 metre from the centre of the trunk lid switch.

WARNING

If the remote transmitter is in the specified operation range, any person can operate the door switch and the trunk lid switch. Any person can lock or unlock the doors and open the trunk lid. Any person can operate the start stop button to start the engine and operate any electrical equipment inside the vehicle.

Operation Limits

The remote transmitter uses a weak electromagnetic wave. The below conditions can cause interference to the key-less entry operation.

1. The battery in the remote transmitter is low.
2. Near a strong radio wave source, for example, near a power station or broadcast station.
3. When you use the wireless devices, for example, a mobile phone or transceiver.
4. The remote transmitter touches metals.
5. Near other remote controls that transmits a radio wave.
6. You put the remote transmitter near any electrical devices, for example, computers.
7. You park this vehicle near a meter of the parking facility.

Operation range to start the engine

The operation range is in the interior of the vehicle.

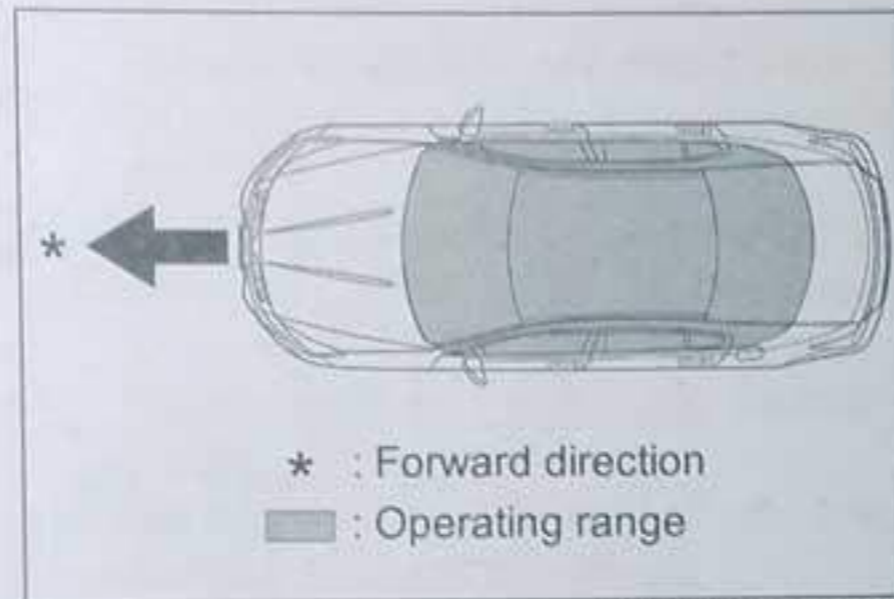

DOITW003R16006

The voltage of the battery of the remote transmitter is low

The meter display will show an indicator as shown in the below illustration:

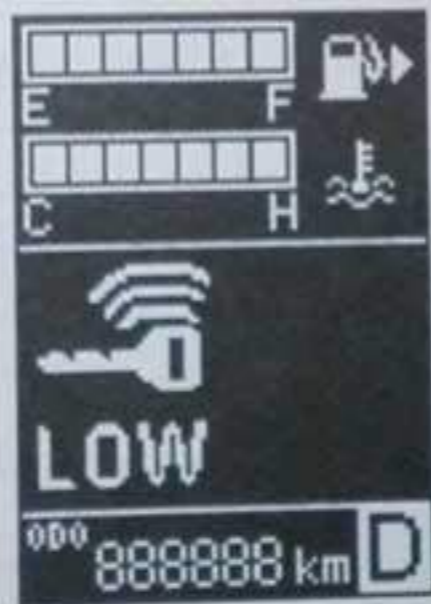

When starting the engine, a low battery voltage in the remote-transmitter can cause a problem.

If starting the engine in this condition, follow these procedures:

Vehicle with CVT transmission;

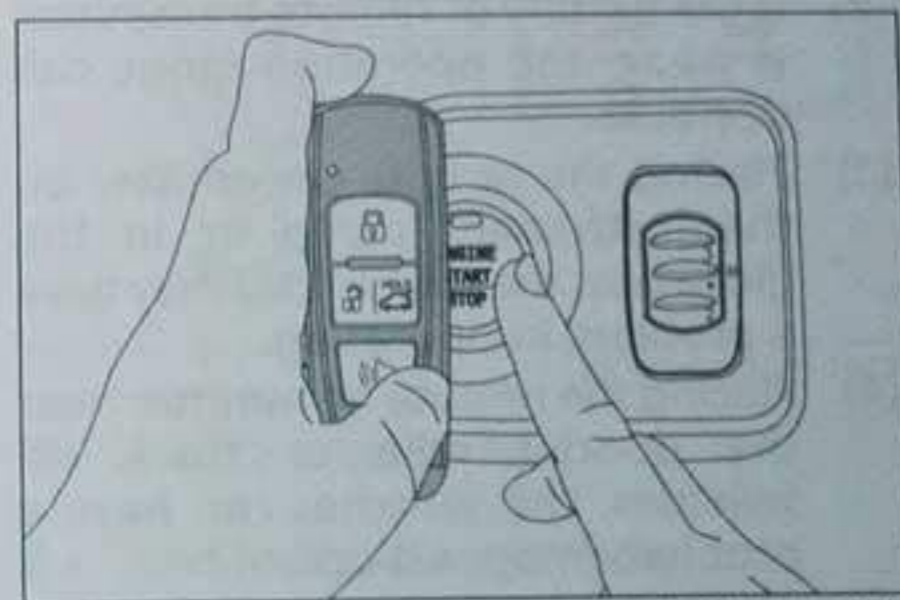

DOITW003R16008

1. Put the remote transmitter on the start stop button surface as shown in the illustration.
2. Press and hold the brake pedal.
3. Press the start stop button to turn the ignition to the ON position.
4. Press the button again to start the engine.

The service life of the transmitter battery

A continued use and extended periods of operation near source of strong radio wave can decrease the service life of the battery in the remote transmitter.

NOTE

- (1) If there are strong electromagnetic waves, the operation range can decrease.
- (2) If the battery of remote transmitter is weak, the operation range can decrease.
- (3) Placing the remote transmitter on the instrument panel or in the glove box, the transmitter may have a problem in operating.
- (4) Placing the remote transmitter near the door handle or trunk lid switches, the switches can have a problem in operation.

If the vehicle system does not operate when pressing any switch on the remote transmitter, replace the battery. Refer to page 156.

If the remote transmitter is missing, contact an authorised PROTON service outlet for a replacement.

The lock, unlock and alarm features in keyless entry system



DOITW003R16002

A – Toggle switch

Use the toggle switch (A) to lock or unlock the doors.

How to lock the doors in keyless entry system



Follow these lock procedures:

1. Before locking the vehicle, make sure all doors and trunk lid close.
2. Make sure the remote transmitter is with the driver.
3. Press the toggle switch (A) on the outer handle of the driver door when you are in the operation range.

The vehicle system will operate as follows:

- The system will lock all doors and trunk lid.
- The alarm system will activate.
- The turn signal lights will flash one time.
- The alarm LED indicator will quickly flash in 6 seconds. After that, the indicator will flash normally.
- The side view mirrors will be automatically folded.*

NOTE

The Keyless Entry system WILL NOT lock the vehicle for some conditions as follows:

- (1) The remote transmitter is inside the vehicle.
- (2) Doors, trunk lid or bonnet are open.
- (3) The ignition switch is in the ON position.

Key Left In Reminder

If the remote transmitter is inside the vehicle, the doors will not lock through the toggle button (A). The horn also will make a sound (four times).

How to unlock the doors in keyless entry system



Follow these unlock procedures:

1. Make sure you have the remote transmitter with you.
2. Press the toggle switch (A) at the outer handle of the driver door in the operation range.

The vehicle system will operate as follows:

- The system will unlock all doors and trunk lid.

NOTE

The first setting for the doors lock and unlock can be different (refer to page 41).

- The alarm system will deactivate.
- Outside mirror will automatically unfold.*
- Interior lights will illuminate for 30 seconds (if the switch of the room lamp is at the "DOOR" position).
- Room lamp will gradually illuminate for 30 seconds.
- Turn signal lights will flash two times.
- Position light and tail light will illuminate for 25 seconds.

Child-lock at Rear Doors

OWN003LOCKS16005

The child-lock will not let a child accidentally open the rear doors.

CAUTION

When you drive with a child in the rear seat, make sure you set the child-lock to lock position.

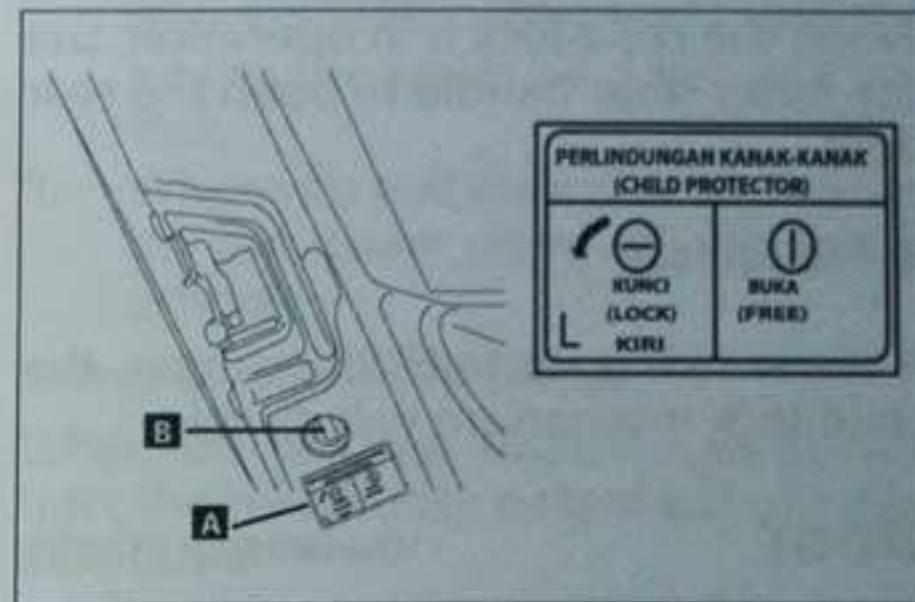

DOIQW003R11019

A – Child protector label

B – Child-lock release switch

Each rear door has a child-lock release switch (B), as shown in the illustration.

Operation of child-lock release switch

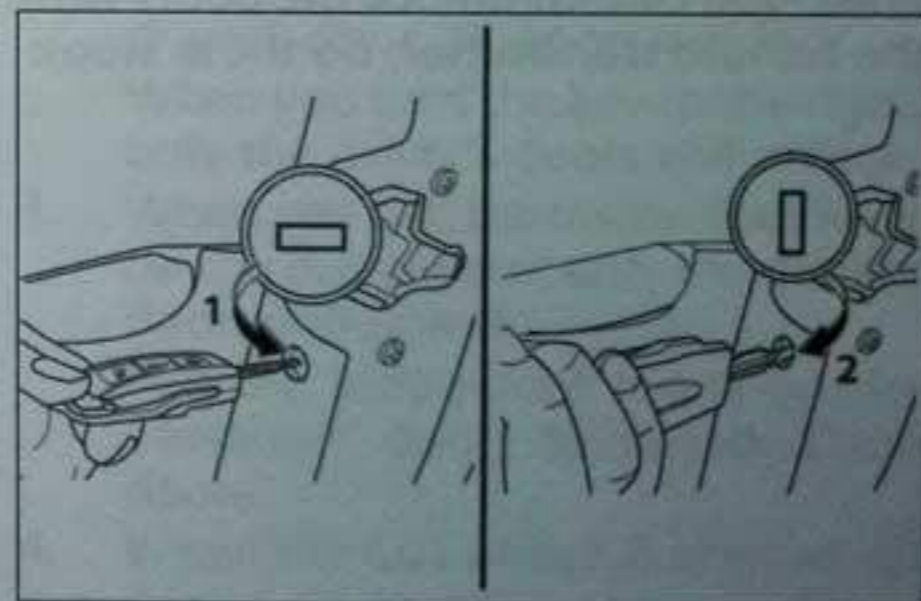

DOIQW003R13010

1 – To lock

If this switch is set to the LOCK position, you cannot open the rear doors from inside the vehicle.

When the child-lock is in operation, use the outer-door handle to open the rear door.

2 - To release

If the switch is set to FREE position, the child-lock mechanism will disable.

Door

OWN003LOCKS16006

Operation from outside the vehicle

After you use the remote transmitter to unlock the vehicle, pull the outer-door handle to open the door.

NOTE

When you cannot unlock the doors with the remote transmitter, do these steps:

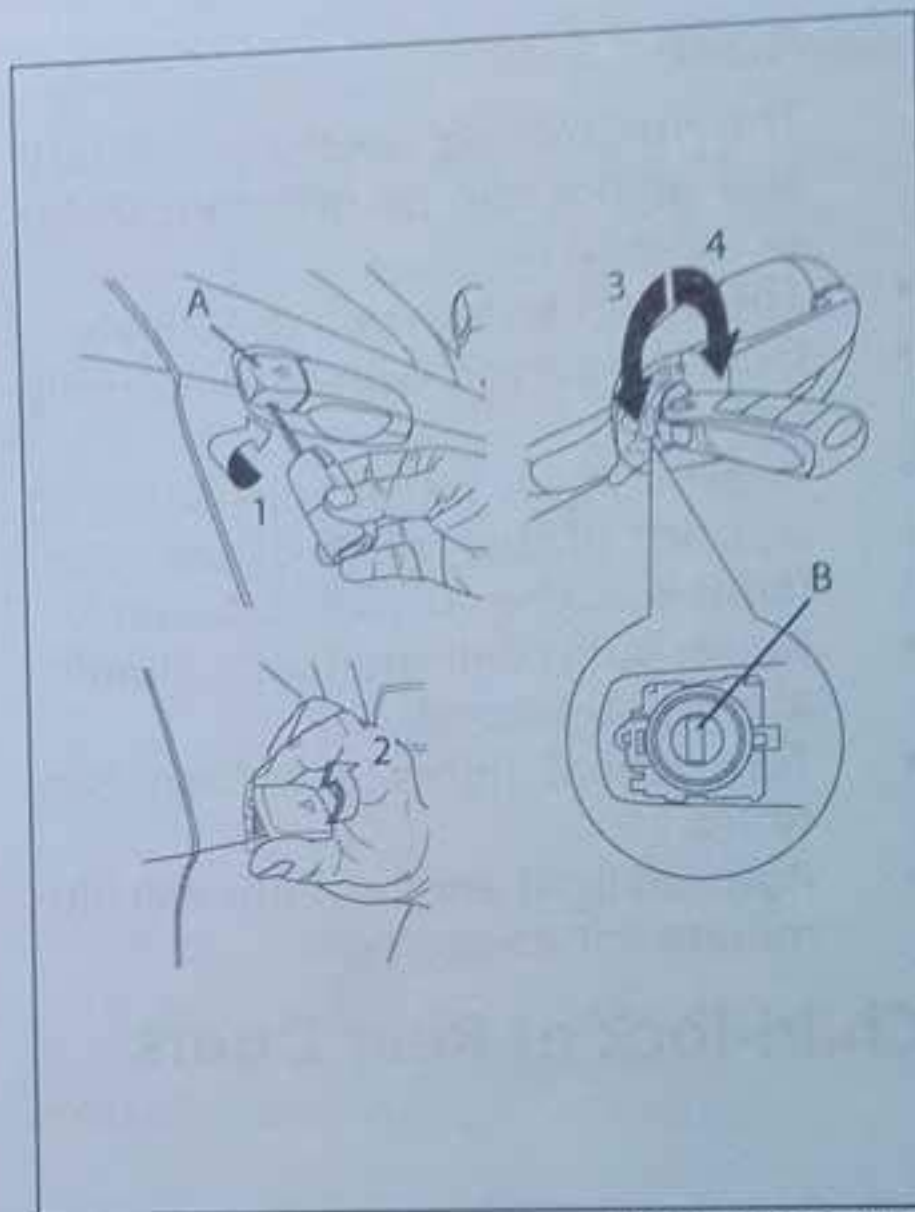

DOIQW003R11018

- 1 - Put the key blade into the cover slot (A) as shown in the illustration. Twist the key and the cover (A) will open.
- 2 - Remove the cover (A). Put the key into the key cylinder (B).
- 3 - Turn the key to the left side to unlock
- 4 - Turn the key to the right side to lock.

Operation from inside the vehicle

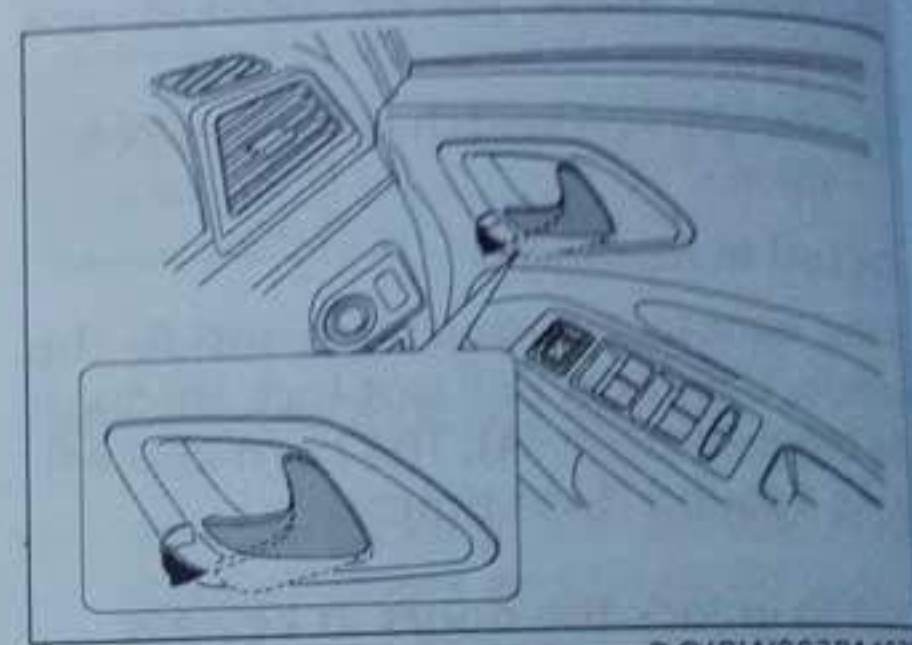

DOIRW003R14022

Pull the inside-door handle toward you to open the door.

NOTE

- (1) If the Central Door Lock is in operation, the first pull of the inside-door handle will unlock the door. The second pull will open the door. For the driver door, first pull will unlock all doors. The second pull will open the driver door.
- (2) Press the switch of Central Door Lock to lock all doors. Refer to page 41 for the operation of Central Door Lock.



CAUTION

Make sure you close all doors before you start to drive.

Do not lock the doors while the key is inside the vehicle.

Central-door Lock (CDL) Switch

OWN003LOCKS16007

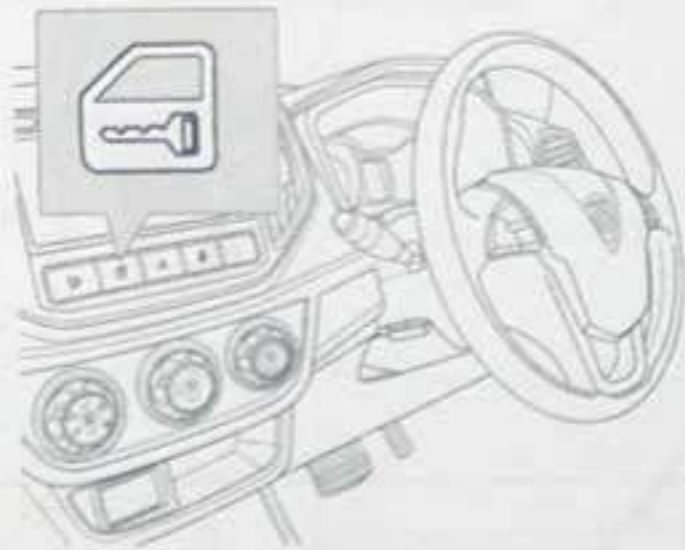

DOITW003R16009

The CDL switch is in the centre of instrument panel.

CAUTION

If a person presses the CDL switch many times, the CDL switch will be disabled for 20 seconds.

To lock

When you are in the vehicle with the doors close, press the CDL switch to lock all doors.

To unlock

When you are in the vehicle with the doors closed and locked, follow these steps to unlock and open the doors.

1. Press the CDL switch. All doors will unlock. Pull the inside-door lever. The door will open.
2. Pull the inside-door lever on the driver door. All doors will unlock. Pull again the inside-door lever. The door will open.

NOTE

- (1) In an emergency, use the key slot at the driver's door to unlock the doors. Refer to page 40.
- (2) If you open the door and the alarm system starts an alarm warning, you can reset the alarm warning as follows:
Vehicle with ignition switch: Start the engine.
Vehicle with start stop button: Make sure the key is inside the cabin area. Start the engine.

The differences between CDL and DDU modes

Central Door Lock (CDL)

When Central Door Lock is in operation, the vehicle lock system will operate as follows:

1. When you press the LOCK button on the remote transmitter, all doors will lock. When you press the UNLOCK button, all doors will unlock.
2. When you put the key blade into the key hole on the driver's door and turn the key to the left, all

doors will lock. When you turn the key to the right, all doors will unlock.

3. When you pull the inside-door lever on the driver door, all doors will unlock.

Driver Door Unlock (DDU)

When Driver Door Unlock is in operation, the vehicle lock system will operate as follows:

1. When you press the LOCK button on the remote transmitter, all doors will lock.
When you press the UNLOCK button, only the driver's doors will unlock. Press the UNLOCK button again to unlock the other doors.
2. When you turn the key blade to the left side on the key cylinder on the driver's door, all doors will lock.
When you turn the key to the right, only the driver's doors will unlock.
3. When you pull the inside-door lever on the driver door, only the driver's doors will unlock.
Pull the inside-door levers on the passenger doors to unlock these doors.
4. When the CDL switch is pressed, all doors will unlock.

Other Features of Lock and Unlock

OWN003LOCKS16008

Ignition OFF Unlock

When you stop the vehicle and turn the ignition to the OFF position, all doors automatically unlock.

To disable

You can disable this function of automatic unlock.

While the ignition is in the ON position, press and hold the central-door lock switch **for a while**.

Speed Auto Door Lock

If the vehicle conditions are as follows, all doors automatically lock after the vehicle speed reaches 20km/h:

1. Central Door Lock is unlocked.
2. All doors are closed.
3. There is no record of hits or failures from the electronic-control control unit of the Airbag (ACU).

If the vehicle conditions are as follows, all doors automatically lock after the vehicle speed reaches more than 5km/h:

1. The vehicle speed reaches more than 5km/h and less than 20km/h for more than 30 second.

2. Central Door Lock is unlocked.
3. All doors are closed.
4. There is no record of hits and failures from electronic-control unit of the Airbag (ACU).

NOTE

The Speed Auto Door Lock only operates once until you restart the engine.

To disable

You can disable this function of automatic lock.

While the ignition is in the ON position, press and hold the central-door lock switch **for a while**.

Crash-unlock

When the vehicle hits an obstruction and its airbags deploy, the function of Crash-unlock will automatically unlock all doors.

The crash unlock will not operate under the following conditions:

1. The vehicle battery has a failure.
2. There is no connection between the of the airbag-control units (ACU) system to Advance Body Control Module (ABCM).

Hood

OWN003LOCKS16008

Hood release

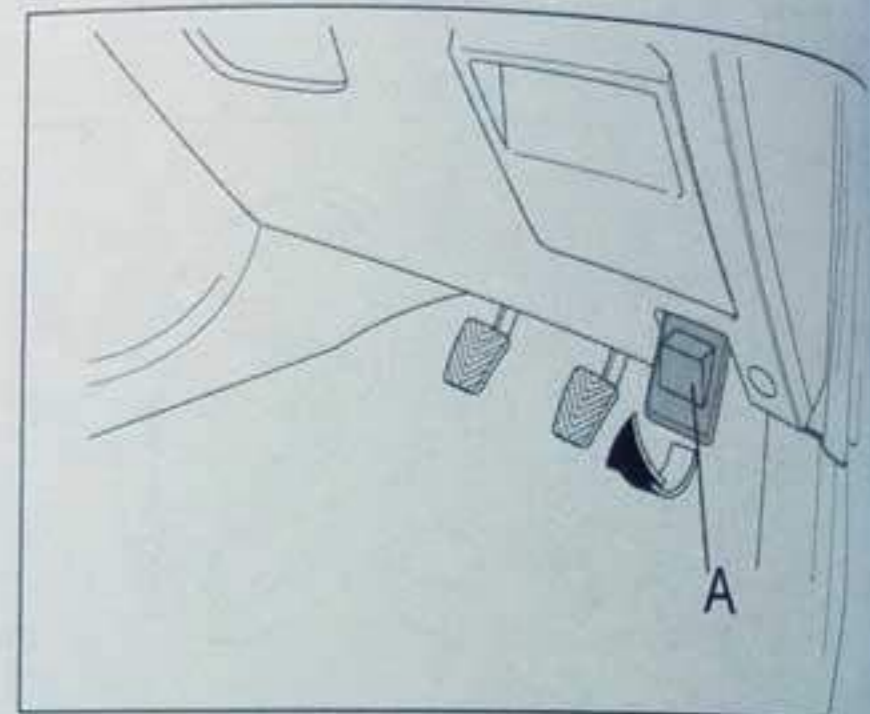

DOIRW003R1402

A – Release lever

Pull the release lever to unlock the hood.

How to fully open the hood

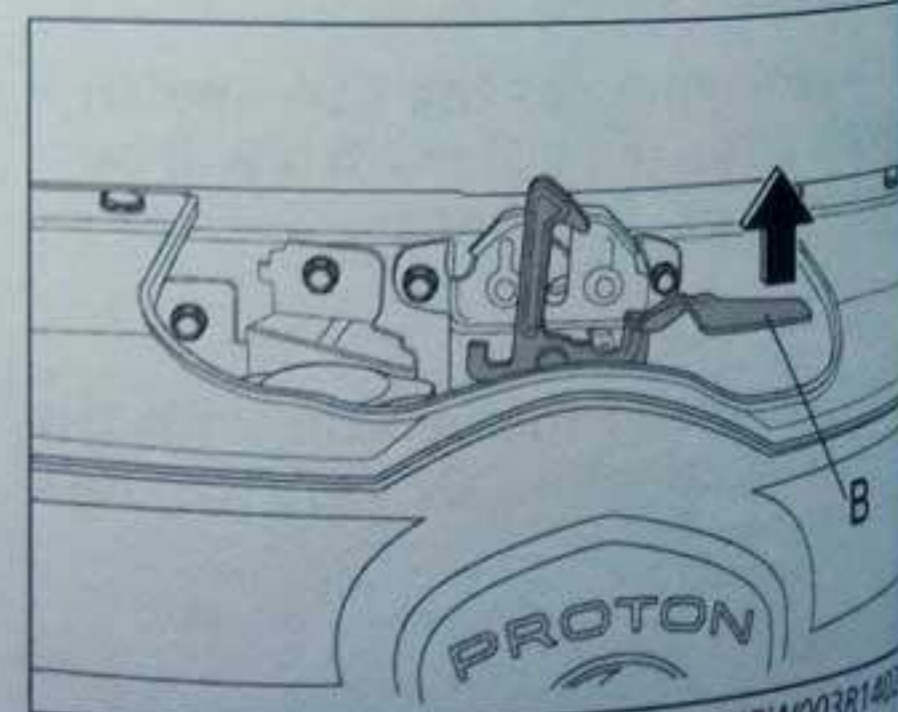

DOIRW003R1402

B – Safety lock

Lift the hood.

You will see a safety lock (B).

Press B and lift the hood to fully open.

NOTE

Make sure the wipers are in park position before you lift the hood.

Hood-support bar

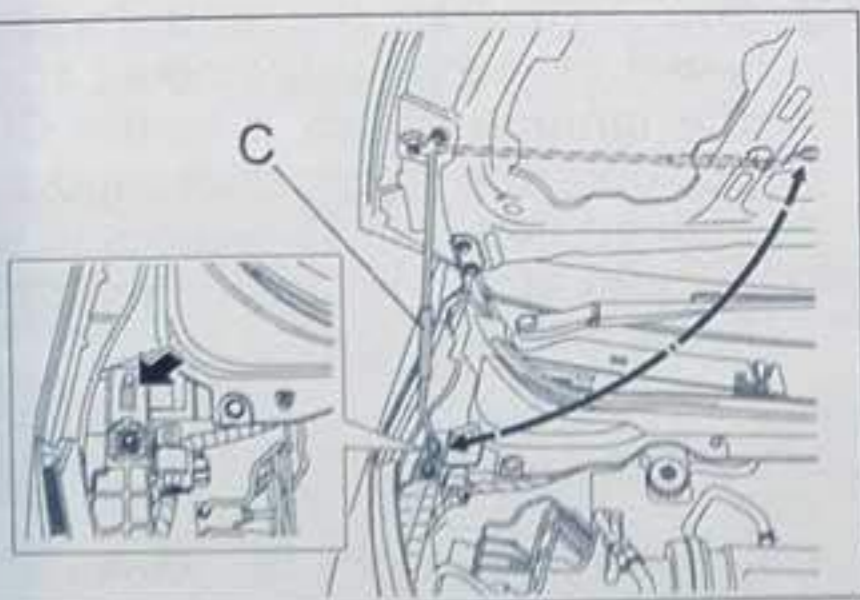

DOIRW003R14025

C - Support bar

Install the support bar end into its slot to let the hood stay open.

How to close the hood

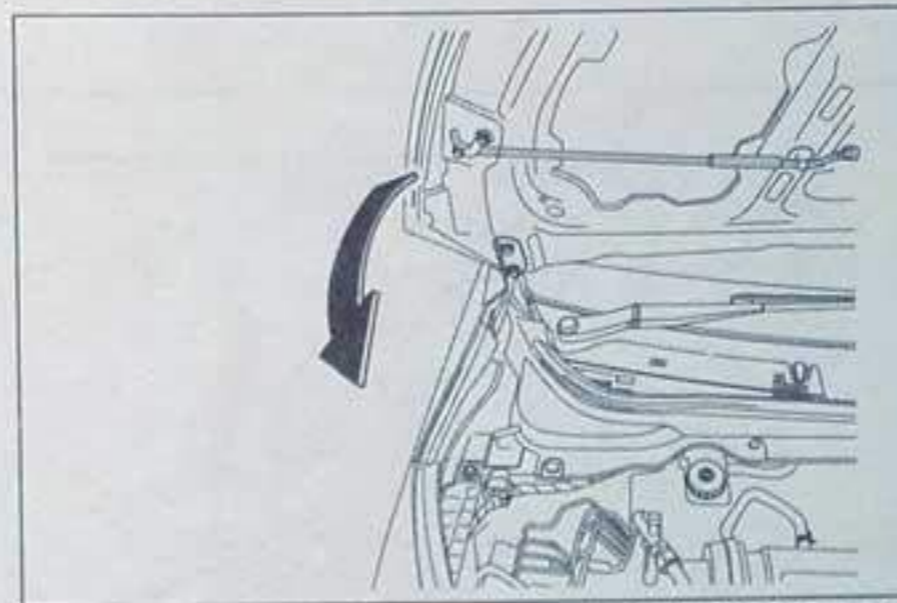

DOIRW003R14026

1. Release the support bar from its slot position.
2. Return the support bar to its store position.
3. Slowly lower and hold the hood to a position 30 cm from the top of its close position.
4. Release the hood to drop to its close position.

NOTE

- (1) If the hood does not close, increase the height of the drop position.
- (2) Do not push the hood with your hand. The hood can bend.

CAUTION

Make sure you safely lock the hood so that the hood does not open while you drive.

Trunk Lid

OWN003LOCKS16010

43

Operation of the trunk lid switch

The trunk lid switch is at the lower centre of the trunk lid, as shown in the illustration.

While the alarm system is active, press the UNLOCK button on the remote transmitter to unlock all doors.

Press this trunk lid switch to open the trunk lid.

The operation of the remote-transmitter to open the trunk lid *

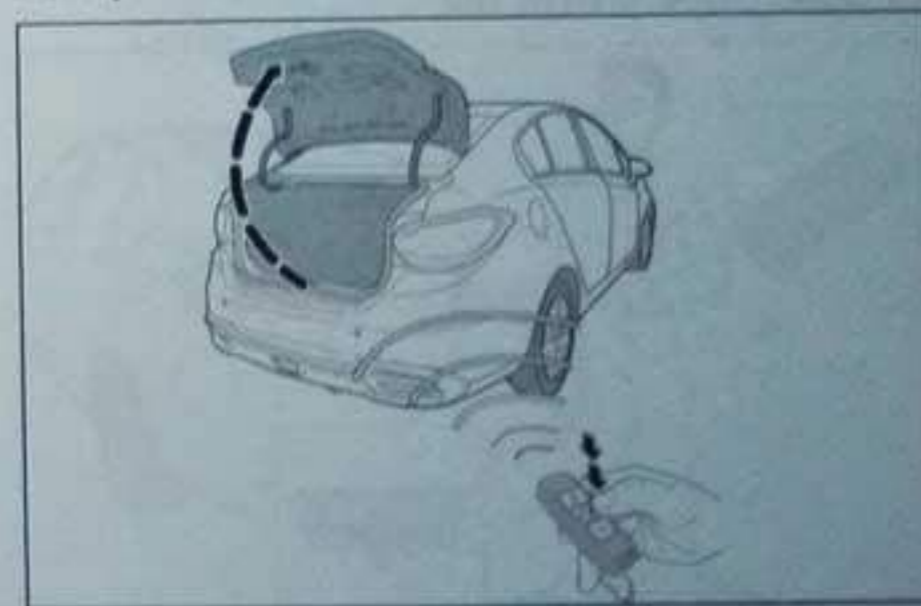

DOITW003R16007

1. Press the UNLOCK button on the remote transmitter for **more than 3 seconds**.
2. Press the trunk lid switch on the trunk lid.
3. Lift the trunk lid to open.

* if fitted

2

To close, push the trunk lid to its close position. Make sure you safely close the trunk lid.

NOTE

1. When the trunk lid opens, the luggage compartment lamp illuminates.
2. When the trunk lid closes, the luggage compartment lamp turns off.
3. If the vehicle battery is weak, you cannot open the trunk lid with the remote transmitter. Replace with a new battery.

The operation of keyless entry system to open the trunk lid *



DOITW003R16004

While the alarm system is active, press the trunk lid switch to unlock.

* if fitted

Power Window Glass Control

OWN003LOCK516011

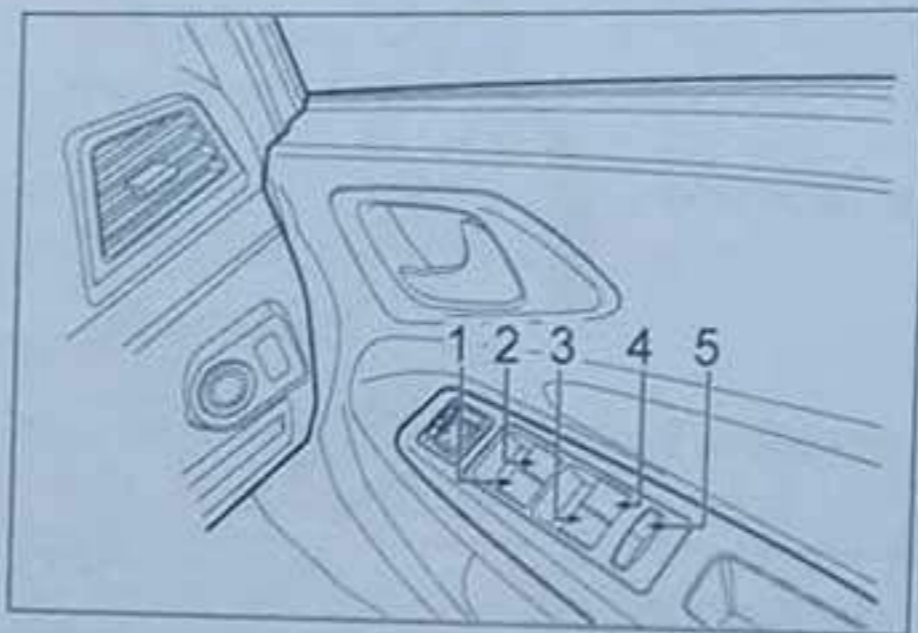

DOIRW003R14028

The control switch panel of the power window is on the driver side of the door armrest. You can operate the control switch panel with the ignition switch in the ON position.

The power window glass switch is as shown in the illustration.

- 1 - Window glass for front-passenger door
- 2 - Window glass for driver door
- 3 - Window glass for rear-left door
- 4 - Window glass for rear-right door
- 5 - Window lock

Operation

The switches can operate the front and rear windows. A window will open or close when you operate the switch.

Press the switch to open the window.

Lift the switch to close the window.

The window glass will move when the switch is operated.

NOTE

- (1) To prevent run out of the battery, operate the window switches while the engine running.
- (2) You can operate the control switch panel of the power window after the ignition switch is in the OFF position; the driver door must be opened between 30 seconds to 60 seconds after the ignition switch is in the OFF position.

⚠ WARNING

- (1) Before you close the window glass, make sure there is no obstruction (hand, finger) between the window glass and the window frame.
- (2) Do not leave a person who does not know how to operate the vehicle inside the vehicle. Make sure you turn off the ignition switch and remove the key before you leave the vehicle.
- (3) Do not try to operate a driver switch and passenger switch together in opposite directions.

This action can cause a window malfunction.

Driver switch

Automatic down system *

If the window glass switch on the driver's door is fully pressed, the window glass moves to open.

When the window glass is moving, lift the switch to stop its movement.

Automatic up system *

Fully pull the switch, then immediately release the switch to close the window glass at the driver door.

When the window glass is moving, press switch to stop its movement.

Anti-trap feature *

The anti-trap feature is installed only for the window glass in the driver door. If an object blocks the window glass when the window glass is closing, the window glass will move in the opposite direction.

CAUTION

When the window glass closes, do not put any part of your body in between the window glass and window frame.

Lock or unlock switch

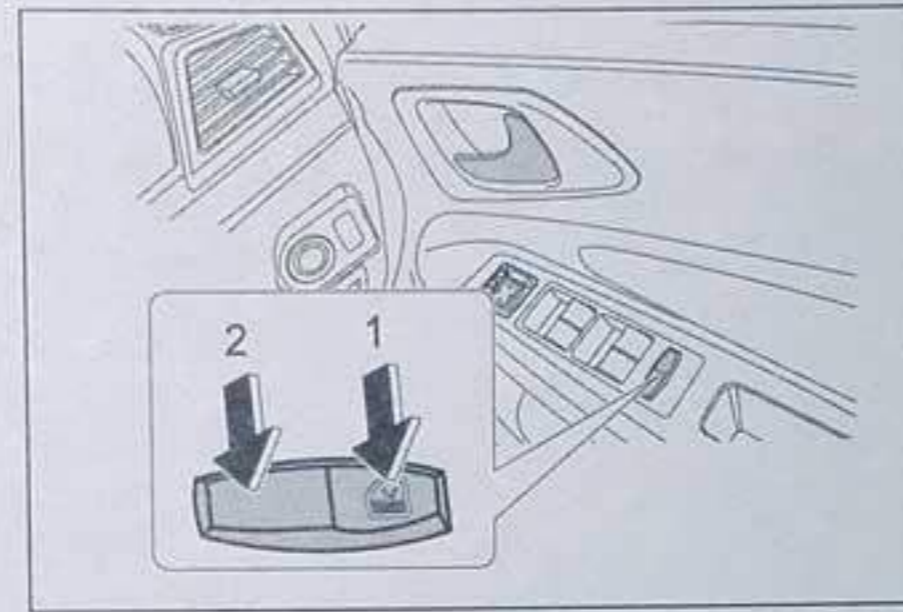

DOIRW003R14029

- 1 - Press (1) to lock
- 2 - Press (2) to unlock

When this switch is in the "lock" position, the passenger cannot operate any of the passenger switches for the power windows.

CAUTION

Do not leave a person who does not know how to operate the vehicle inside the vehicle. Make sure you set the window to lock position. The passenger switch will be disabled.

Passenger switch

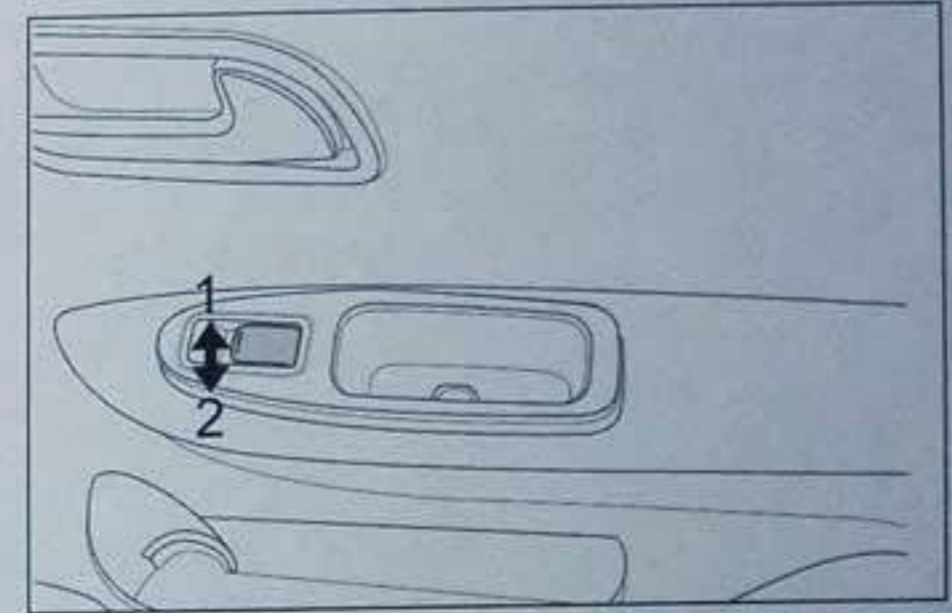

DOINW003R09015

- 1 - Lift the switch to close the window.
- 2 - Press the switch to open the window.

Occupant's Safety

Front Seats	48
Rear Seats	49
Head Restraints	49
Seat Belts	50
Pregnant Women Restraint	53
Child Restraint Seat	53
Child Restraint Seat Installation (in the front seat)	54
Child Restraint System (CRS)	56
Child Restraint System (CRS) Mountings	59
SRS Airbags	60
General Information Applicable for the SRS Airbags	65



Front Seats

OWN004SEATS16001

How to adjust the front seat to the front or rear position

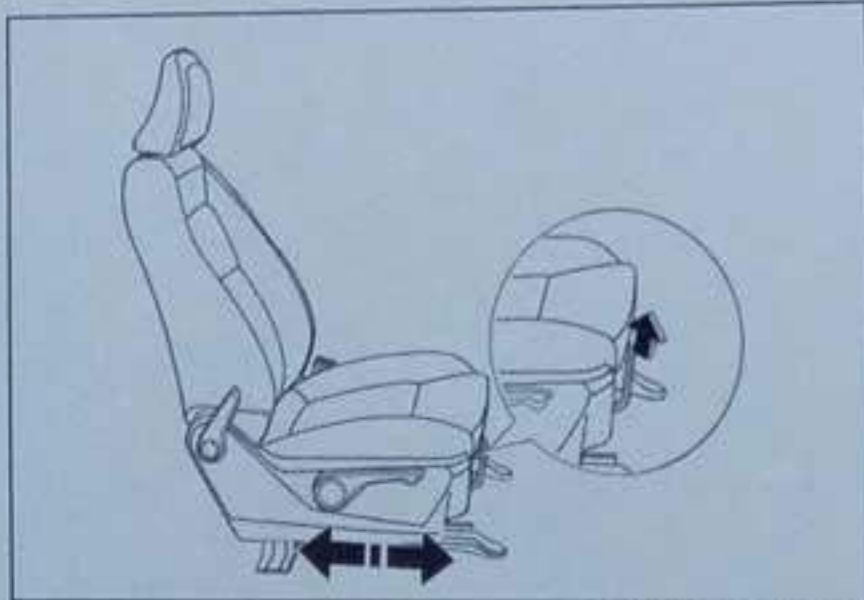

DOIRW004R14010

1. Pull and hold the seat adjusting lever to adjust the seat to the front or rear.
2. Release the adjusting lever to safely lock the seat in its new position.

WARNING

Make sure the seat is safely locked. Move the seat to the front or rear to ensure the seat is locked.

How to adjust the seat back to the recline position

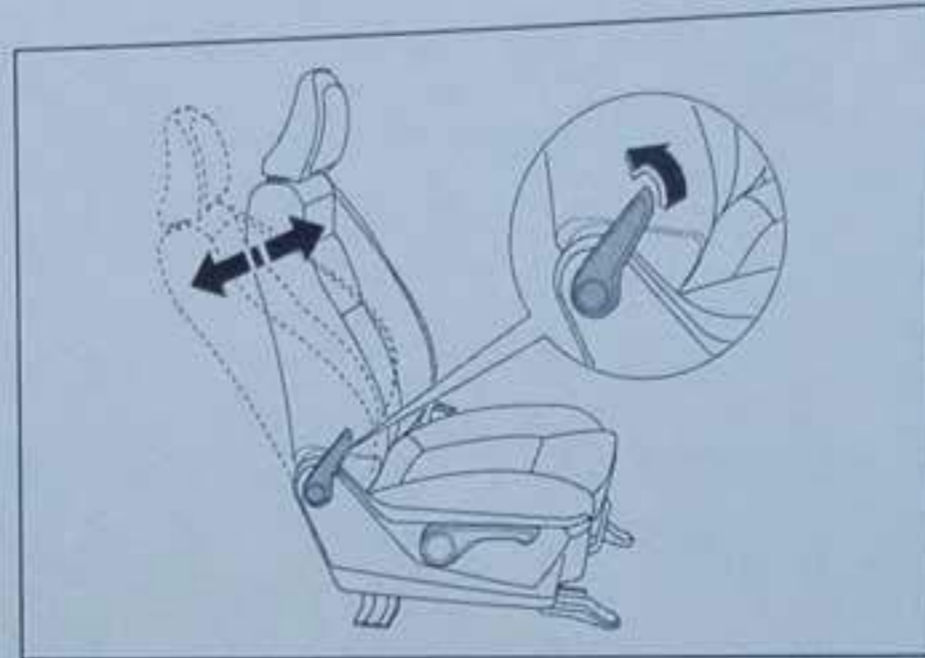

DOIRW004R14011

1. Pull and hold the lock lever of the seatback.
2. While you hold the lock lever, slightly move the seatback to the front.
3. Then, Move the seat back to the rear.
4. Release the lock lever to safely lock the seatback in its new position.

CAUTION

The mechanism for the recline position of the seat back is a spring-loaded type. When the lock lever is operated, this mechanism causes the seat back to return to the vertical position. Before you use the lever, sit with your body on the seat back. While you pull and hold the lock lever, hold the seat back with

your hand to control the return motion.

How to adjust the seat height (driver's seat only)

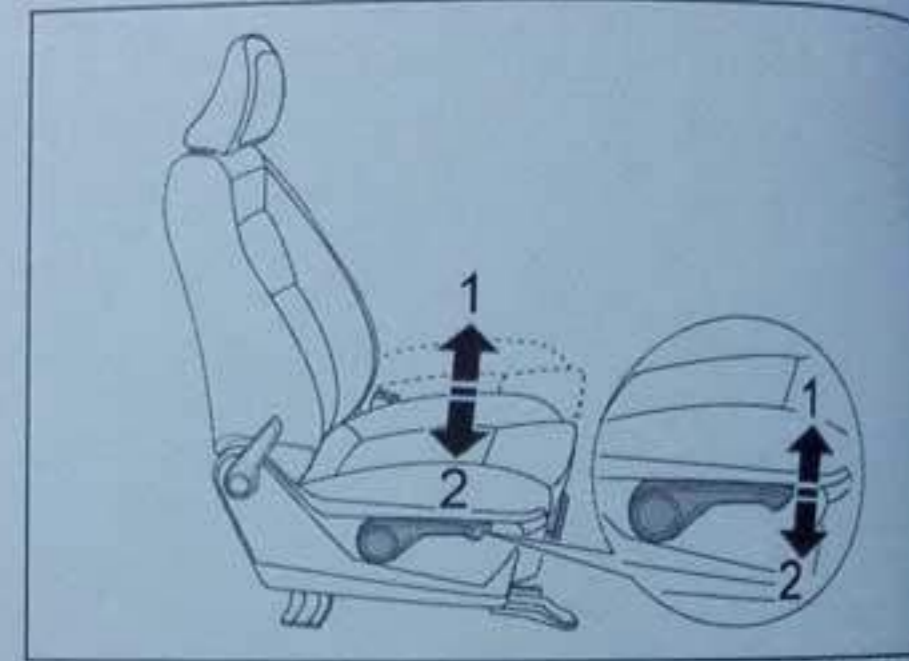

DOIRW004R14012

Operate the lever again and again to lift or lower the seat.

1 – To lift; pull the lever repeatedly.

2 – To lower; push the lever down repeatedly.

Rear Seats

OWN004SEATS16002

How to extend the luggage compartment *

You can create more space from the luggage compartment and the passenger cabin to store more items and long objects.

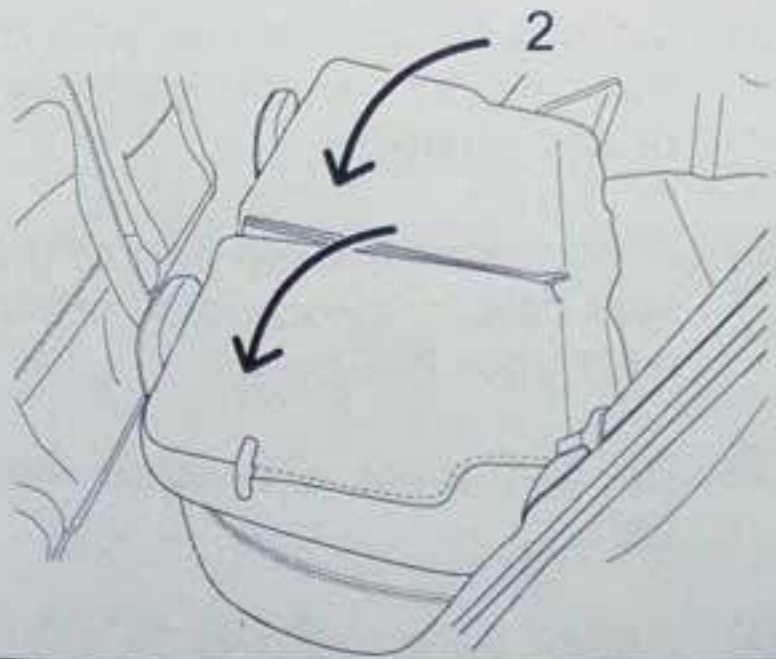
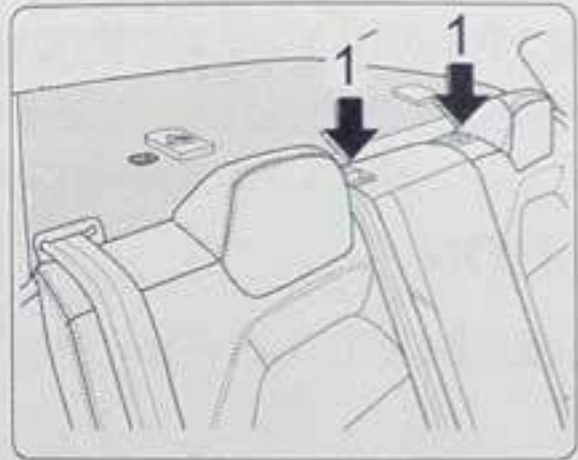

DOITW004R16006

- 1 - Press and hold the release-button of the seatback (1).
- 2 - Push the seatback down.

CAUTION

Before the rear seat back is folded, make sure you put all buckle holders flat and away from the ISOFIX lower-anchorage.

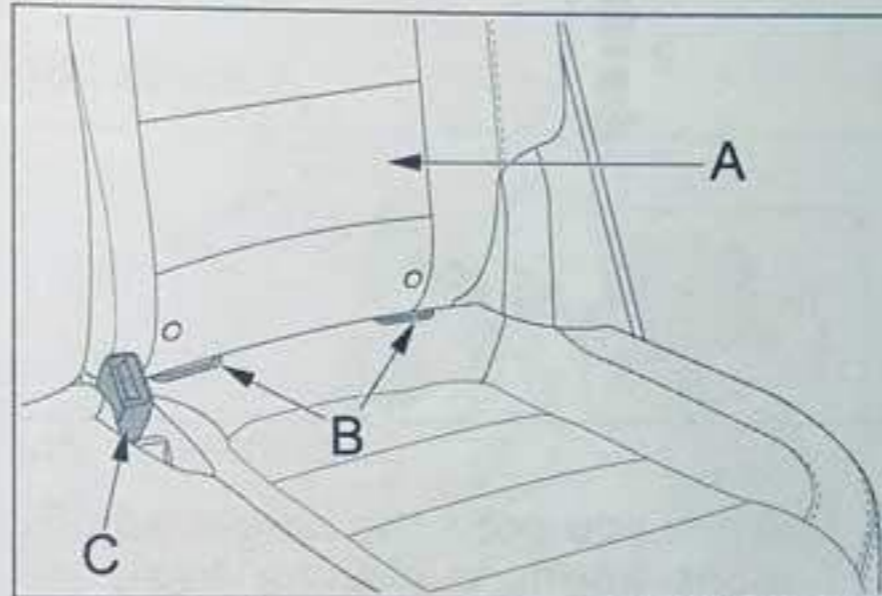

DOIRW004R14017

Symbol	Description
A	Rear seatback
B	ISOFIX lower-anchorage
C	Buckle holder of the seat belt

3 - Push and flat the rear seatback to the front.

NOTE

The right and left rear seatbacks are in 60/40-split configuration.

Head Restraints *

OWN004SEATS16003



DOIQW004R11003

The head restraint is made to give protection to the head during rear hit.

How to adjust the height of the head restraint *



DOIRW004R14018

1. While you press the knob, move the head restraint.

* if fitted

2. Make sure the centre position of the head restraint aligns to your eye level. This configuration helps to decrease the risks of injury in a collision.

NOTE

After any adjustment, move the head restraint to make sure that the head restraint is locked in position.

 **CAUTION**

- (1) Correctly adjusted head restraints give you proper protection.
- (2) Do not put any item between your back and the seat back; This can reduce the effectiveness of the head restraint.
- (3) For maximum protection, the back of your head must be placed against the centre of the head restraint.

How to remove the head restraints *

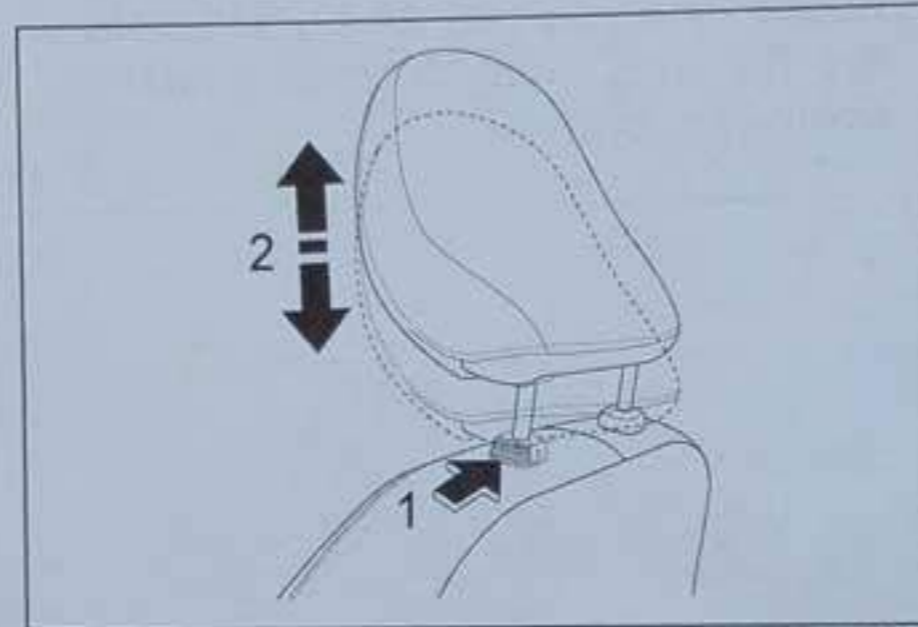

DOIRW004R14018

1. While you press the height-adjustment knob, move the head restraint.
2. Disengage the two holders of the head restraint from its slots.

 **CAUTION**

Do not drive without head restraints or with incorrectly adjusted head restraints.

How to install the head restraints *

1. Install the two holders of the head restraint to its slots. Make sure the head restraint faces the correct direction.
2. While you press the height-adjustment knob, move the head restraint. Make sure the centre posi-

tion of the head restraint aligns to your eye level.

NOTE

After any adjustment, move the head restraint to make sure that the head restraint is locked in position.

Seat Belts

OWN004SEATS16004

You and your passengers must correctly wear the seat belts. The seat belts give protection to you and your passengers in a collision.

 **CAUTION**

- (1) One seat belt is only for one person.
- (2) Do not wear the top part of the seat belt under your arm or out position.
- (3) Always put the lap-part of the seat belt as low as possible and near your hip-bones.
- (4) Do not wear a twisted seat belt.
- (5) Adjust your seatback to a correct vertical position. If the seat back is in a recline position, you can be out position from the seat belt and cause injury.

3-point seat belt type (with emergency-lock mechanism)

This vehicle has 3-point seat belt type with emergency-lock system. The seat belt will adjust its length according to the movement of a person body.

In normal driving, the retractors lets you move freely in your seat while it keeps some tension on the belt.

During collision or sudden stop occurs, the seat belt automatically locks to help restraints your body.

To fasten



DOIQW004R12020

1. Slowly pull the seat belt while you hold the plate.
2. Hold the latch plate with your hand.
3. Put the latch plate into the buckle until a "click" sound is heard.

NOTE

When you pull the seat belt, the seat belt possibly can gets locked. Pull the belt once with a small force and release. Slowly pull the belt again. Put the plate into the buckle until a "click" sound is heard.

To release

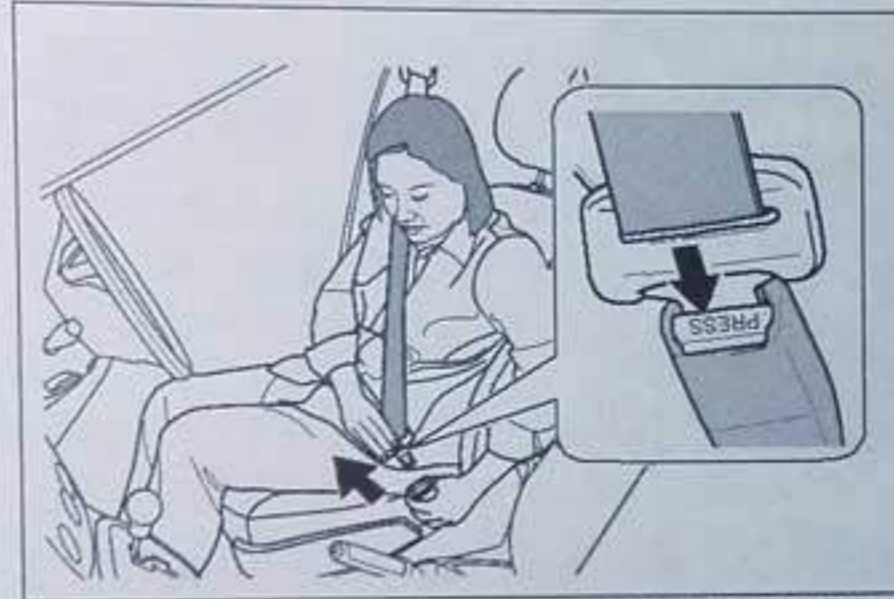

DOIQW004R12021

1. Hold the plate.
2. Press the button on the buckle to release the plate.

NOTE

The belt will automatically retract. While the seat belt retracts, hold the latch plate and let the belt slowly retract.

Adjust the anchor height position of the seat belt

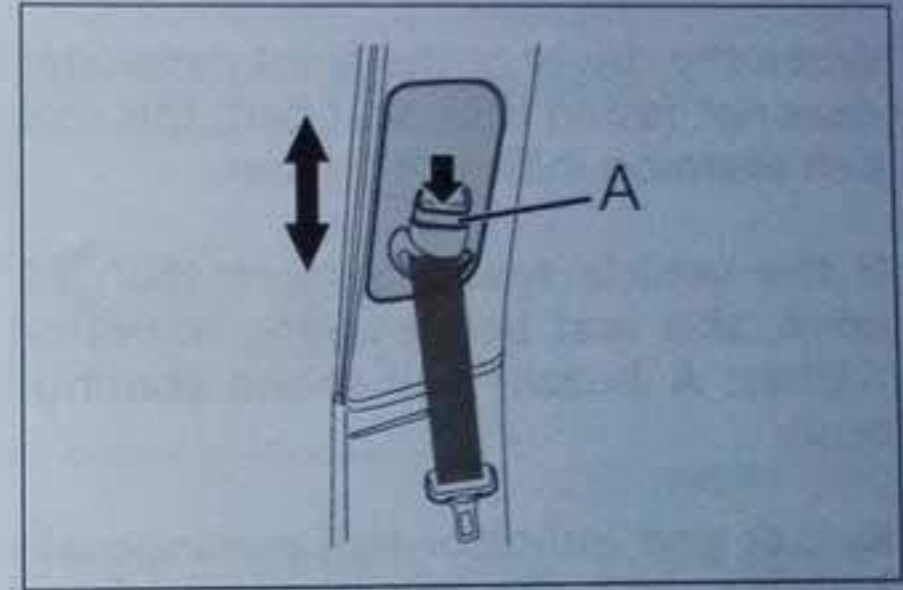

DOIRW004R14001

A – Release button

1. Press the button (A) to adjust the anchor height position.
2. Adjust the anchor to the correct position where the seat belt must across your shoulder. Make sure that the seat belt does not touch or across your neck and your arm.

Seat belt warning indicator for the driver and the front passenger

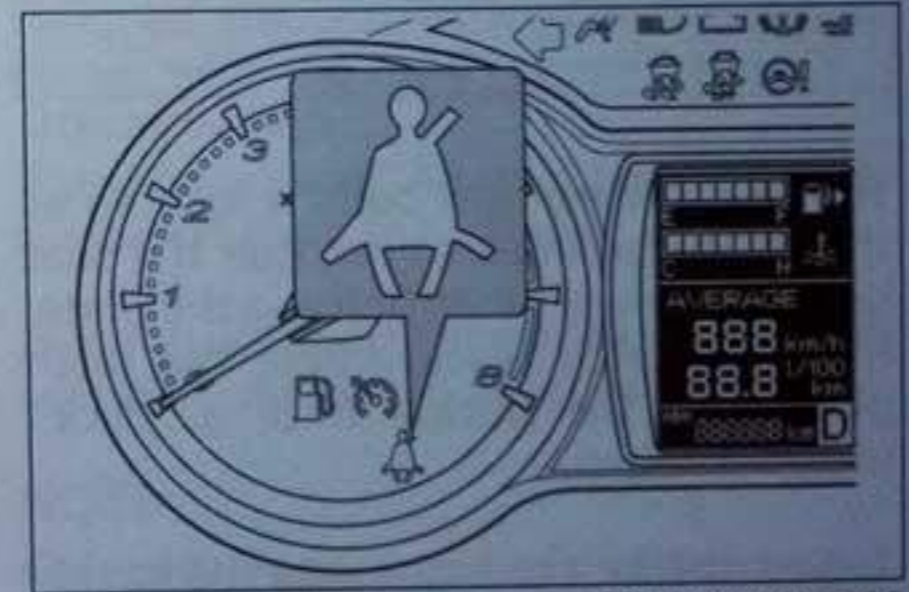

DOIRW004R14006

The seat belt warning indicator is at the meter combination.

When the driver or the front passenger does not fasten their seat belt, this seat belt warning indicator flashes.

If the vehicle speed is more than 25 km/h, this seat belt warning indicator flashes; A buzzer will sound continuously.

Buzzer and indicator will continuously activate until the driver or the front passenger fasten their seat belts.

Rear seat belts

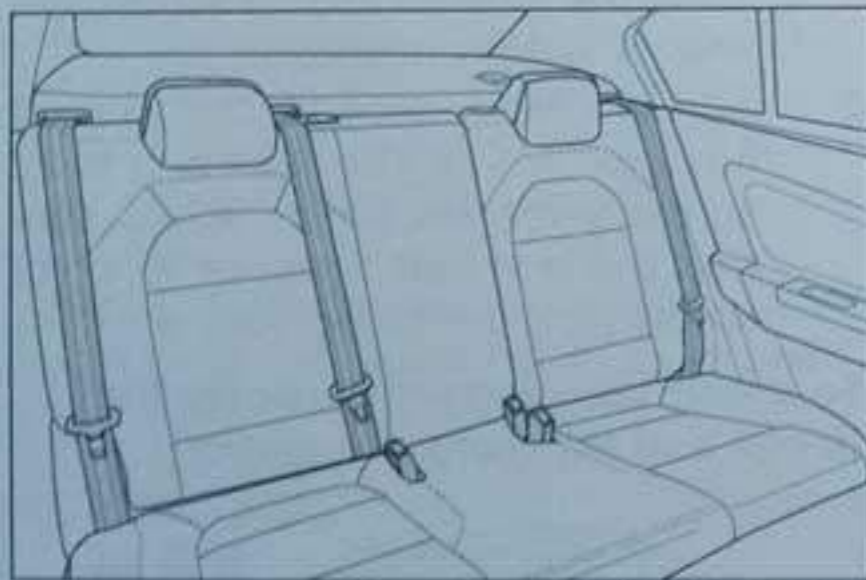

DOITW002R16002

The rear centre seat belts is located as shown in the illustration. Pull the seat belts out slowly while holding the plate. Hold the latch plate, insert the latch plate into the buckle until a "click" sound is heard.

Tug on the belt to make sure the buckle is latched.

* if fitted

CAUTION

Before the rear seatback is folded, make sure you put the all buckle holder flat and in place.

Seat belt warning indicator for rear passenger *



The rear seat belt warning indicator is at the multi-info display.

This indicator will first flash for 30s and close.

If the rear passenger release their seat belt, the buzzer will sound "beep" one time.

Seat belt End-Lock Phenomenon

Front and rear seat belts is equipped with lockable retractor which if its activate, it can lock the seat belt.

Seat belt lock caused by End-Lock phenomenon, where user cannot pull the seat belt out.

To release the End-Lock, pull out the seat belt with some force, release a little, then pull again.

Seat belt inspection

1. Check the belts for any cuts, worn or damaged webbing or metal parts. If there is a fault, replace the belts.
2. Clean dirty belts with a neutral-clean solvent and warm water. After cleaning, let the belts dry in a shade. Do not try to bleach or dye the belts as it may affect the belt quality.

CAUTION

Get your vehicle to an authorised PROTON service outlet. Inspect the seat belt assemblies, retractors and components after any collision. PROTON recommends that seat belt assemblies be replaced after any collision.

Pregnant Women Restraint

OWN004SEATS16005

WARNING

PROTON recommends that pregnant women must also fasten their seat belt. Seat belt will reduce the possible injuries to the mother and the unborn child. Wear the lap part of the seat belt across the thighs and tightly against the hips as much as possible. Do not place the belt across the waist. Refer to your doctor for information.

Child Restraint Seat

OWN004SEATS16006

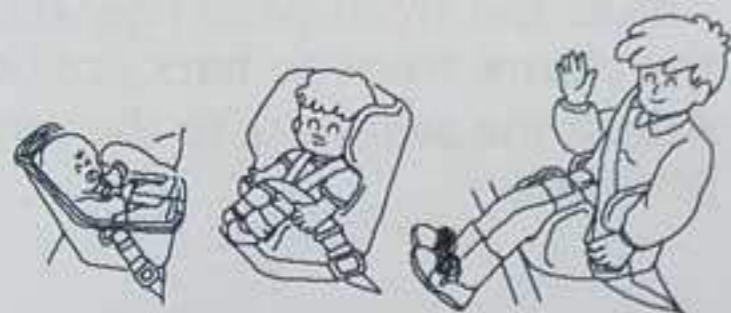

DOIAW004R3014

Always put the child-passenger in the child restraint seat.

Select a suitable child restraint seat according to their age, size and weight.

The applicable regulation related to travel with children-passengers can be different from one area to one other. Obey the applicable regulation.

NOTE

Statistics shows that a child passenger is safer when correctly seated in the rear seat rather than the front seat.

WARNING

- (1) Do not hold a child-passenger in your arms. Use a correct child restraint seat.
- (2) An adult-passenger must carefully monitor and sit with the child-passenger in the rear seat.
- (3) Each child restraint seat is only for one person.
- (4) Your vehicle possibly has an active passenger airbag at the instrument panel; Do not install a rear-face child restraint seat in the front-passenger seat.
- (5) Use the rear-face child restraint seat only in the rear seat.
- (6) If possible, use front-face child restraint seat in the rear seat. If you install front-face child

restraint seat in the front seat, adjust the seat far to the rear.

Infants and children-passenger

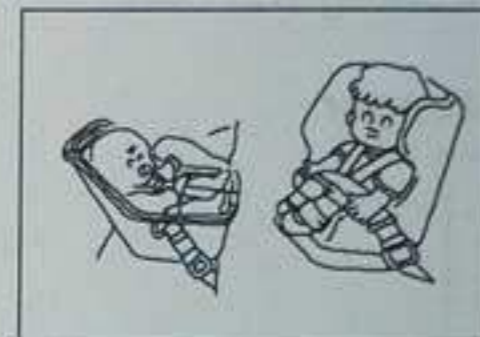

DOIQW004R11019

If there is an infant, use an infant carrier.

If there is a child passenger and the belt covers their faces or throats, use a child restraint seat.

Make sure the child restraint seat correctly fit in the vehicle.

INSTALL THE CHILD RESTRAINT SYSTEM IN THE REAR SEAT for a higher degree of safety.

When you install a child restraint seat, refer to the instructions manual that comes with the child restraint seat.

If you do not use the child restraint seat, remove it from the vehicle.

Install the child restraint seat with the seat belt, if need to be in vehicle.

NOTE

Before you select any child restraint seat or infant carrier, make sure the seat fits

in the rear seat. Some child restraint seat cannot be properly installed.

Select child restraint system that does not move after tightening the belt.

Larger children-passenger



DOIQW004R11020

Larger children-passenger must sit in the rear seat and wear the combination lap-shoulder belts.

CAUTION

- (1) Larger children-passengers who do not wear the seat belt can be thrown out from the vehicle in an accident.
- (2) Do not leave children-passengers in a vehicle without adult-passenger control.

Warning label



DOIQW004R12015

This warning label is at the sun-visor on the front-passenger side.

WARNING

Your vehicle possibly has an active passenger airbag at the instrument panel; Do not install a rear-face child restraint seat in the front-passenger seat. The children-passenger may be injured or killed.

Child Restraint Seat Installation (in the front seat)

OWN004SEATS16001

When you install a child restraint seat in the front-passenger seat, follow these precautions:

Rear-face type of child restraint seat

This vehicle possibly has an active airbag at the instrument panel. If the front-passenger airbag is active, Do not install the rear-face type of child restraint seat in the front seat. If the airbag deploys, the children-passenger may be injured or killed.

Front-face type of child restraint seat

When you install this type of child restraint seat, follow these steps:

1. Adjust the front-passenger seat to the centre front-to-back position.
2. Adjust the seat back to the vertical position.

3. Move the front seat into the most front position (1).
4. From front position (1), move the front seat to the rear position (2) approximately 5 or 6 notches.

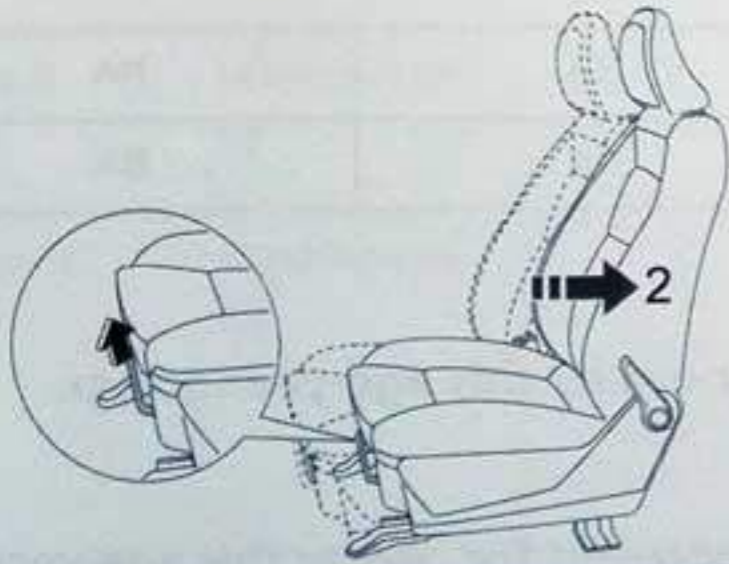
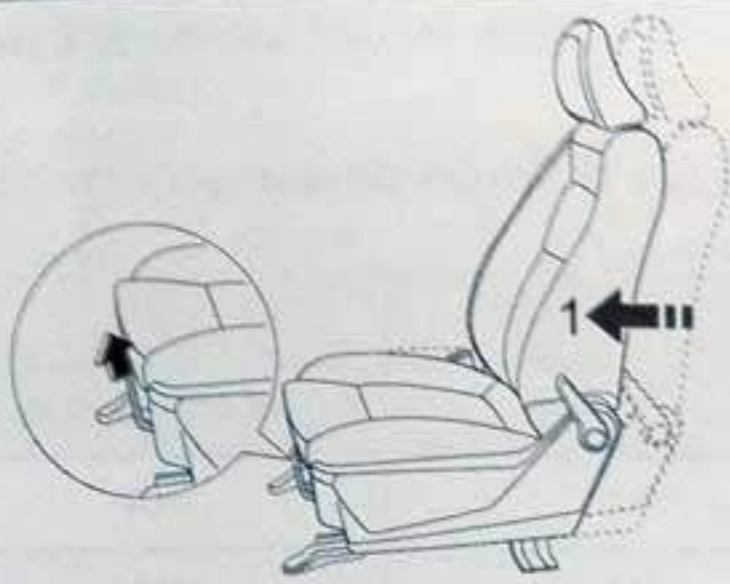

Child Restraint System (CRS)

Table 1: Information of vehicle handbook on the applicable Child Restraint System position for children-passenger maximum age-year of 12

MASS GROUP		SEATING POSITION (or other position)			
		Front Passenger	Rear Outboard	Rear Center	Additional seats
Group 0	< 10 kg (0 to 9 months)	X	U	NA	NA
Group 0+	< 13 kg (0 to 24 months)	X	U	NA	NA
Group 1	9 to 18 kg (9 to 48 months)	X	U	NA	NA
Group 2	15 to 36 kg (4 to 12 years)	X	U	NA	NA

Description of symbols:

- U = This position is applicable for the "universal" class of the CRS; Also approved for use by this age-year group.
- X = This position is not applicable for children-passenger in this age-year group.
- UF = This position is applicable for the front-face "universal" class of the CRS; Also approved for use by this age-year group.
- L = This position is applicable for specified CRS as shown on attached list. These CRS possibly of the classes of "specific-vehicle", "restricted", "semi-universal" or "universal".
- B = This position is applicable for the "built-in" class of the CRS; Also approved for use by this age-year group.
- NA = This position is not applicable.

NOTE

If you must install the child restraint seat in the front seat, turn off the passenger airbag (if equipped).

Table 2: Information of vehicle handbook on the applicable installation of ISOFIX Child Restraint Systems (CRS) for Different ISOFIX Positions

MASS GROUP		Size class	Fixture	Vehicle ISOFIX positions					
				Front Passenger	Rear Outboard	Rear Center	Intermediate Outboard	Intermediate Centre	Other sites
Carycot		F	ISO/L1	X	X	X	X	X	X
		G	ISO/L2	X	X	X	X	X	X
			1		X	X	X	X	
Group 0	Maximum 10 kg	E	ISO/R1	X	X	X	X	X	X
			1		X	X	X	X	
Group 0+	Maximum 13 kg	E	ISO/R1	X	X	X	X	X	X
		D	ISO/R2	X	X	X	X	X	X
		C	ISO/R3	X	X	X	X	X	X
			1		X	X	X	X	
Group 1	9 to 18 kg	D	ISO/R2	X	X	X	X	X	X
		C	ISO/R3	X	X	X	X	X	X
		B	ISO/F2	X	X	X	X	X	X
		B1	ISO/F2X	X	IL	X	X	X	X
		A	ISO/F3	X	X	X	X	X	X
			1						
Group 2	15 to 25 kg		1						
Group 3	22 to 36 kg		1						

⁽¹⁾ For the CRS which do not hold the identification of ISO or XX size class (A to G) for the applicable mass group, the vehicle manufacturer must indicate the vehicle specified ISOFIX CRS recommended for each position.

Description of symbols:

- IUF = This position is applicable for the ISOFIX front-face type of CRS of "universal" class; Also approved for use in the mass group
- IL = This position is applicable for the specified ISOFIX CRS as shown in the attached list. These ISOFIX CRS types are those classes of the "specific-vehicle", "restricted" or "semi-universal".
- X = This ISOFIX position is not applicable for the ISOFIX CRS in this mass group and this size class.

Child Restraint System (CRS) Mountings

OWN004SEATS16009

Lower anchorage location

There are two mounting points for the lower anchorage at the rear seat to attach the child restraint seat with the ISOFIX mountings.

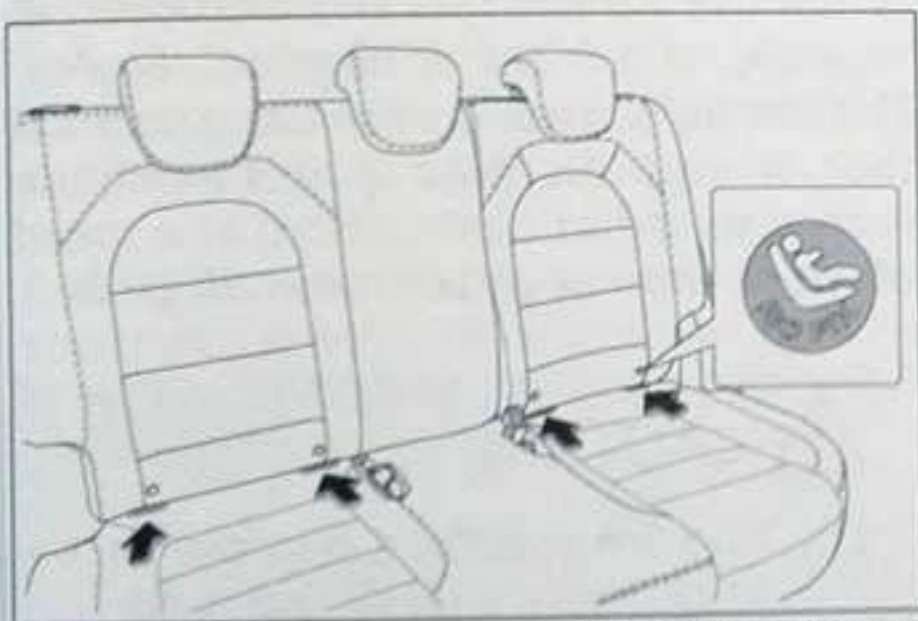

DOIRW004R14015

Top tether anchorage locations

There are two mounting points at the rear shelf. Attach each tether strap of the child restraint seat to each of these mountings.

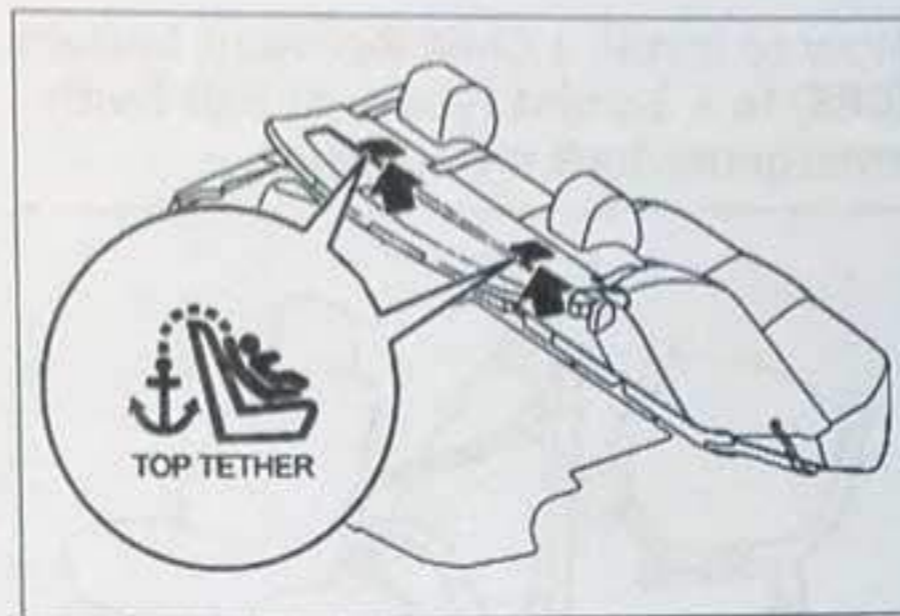

DOITW004R16003

WARNING

CRS anchorage only support those loads set correctly by installed child restraint seat. Do not use this anchorage as normal seat belts or attach other items to the vehicle.

How to install a CRS to the lower anchorage (ISOFIX mountings) and the top tether anchorage

Attach your child restraint seat to the rear seats that have the lower anchorage.

When you use the lower anchorage, it is not necessary to attach the child restraint seat with the vehicle seat belts.

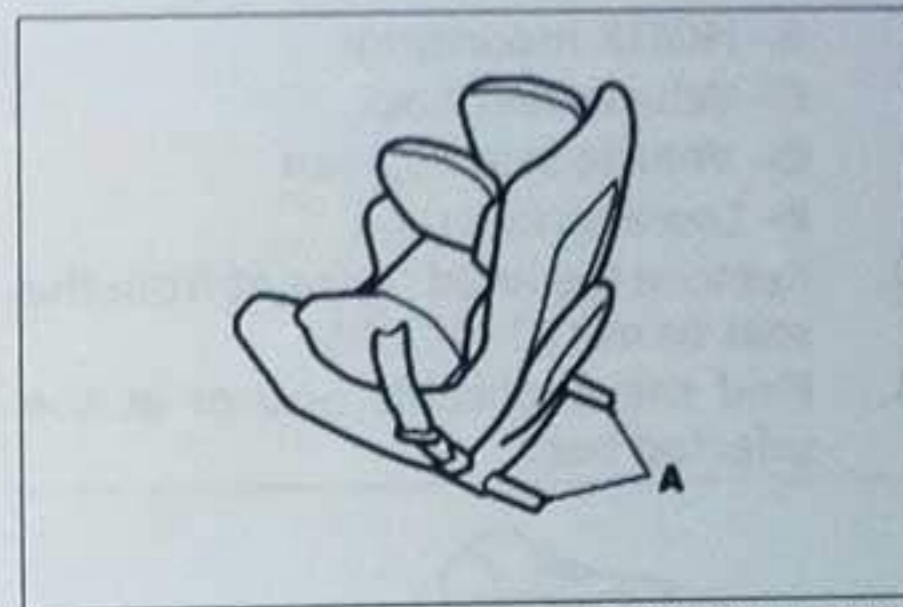

DOIQW004R11011

A – CRS connectors

To install

1. Remove any obstructions in or around the connectors.
2. Make sure you store the vehicle seat belt.
3. Push the connectors (A) of the child restraint system into the ISOFIX mounting (B). Follow the supplied instructions that comes with the child restraint system.

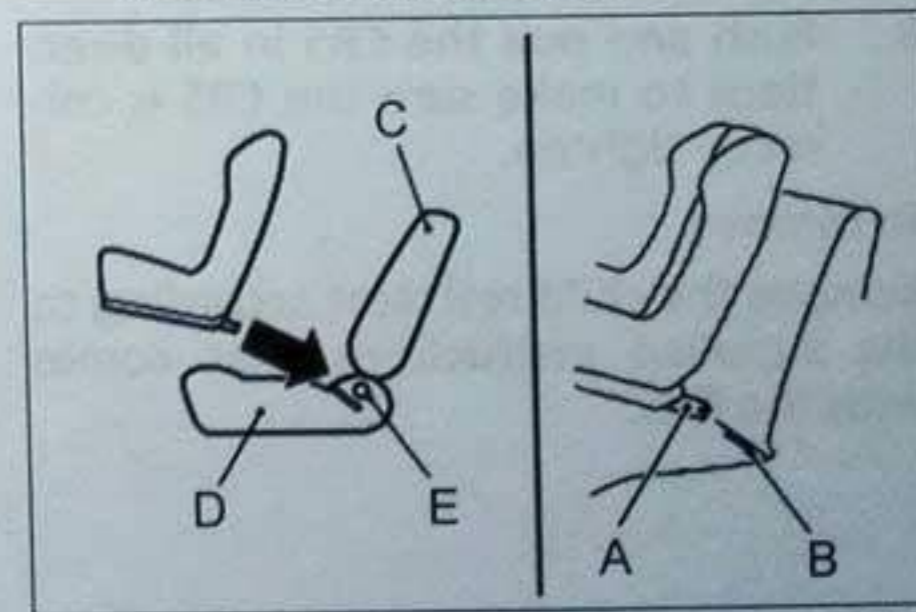

DOIRW004R14016

A – Connector

- B- ISOFIX mountings
- C- Vehicle seat back
- D- Vehicle seat cushion
- E- Lower anchorage

4. Remove the head restraint from the seat to install the CRS.
5. Find the applicable anchor at the selected seat.

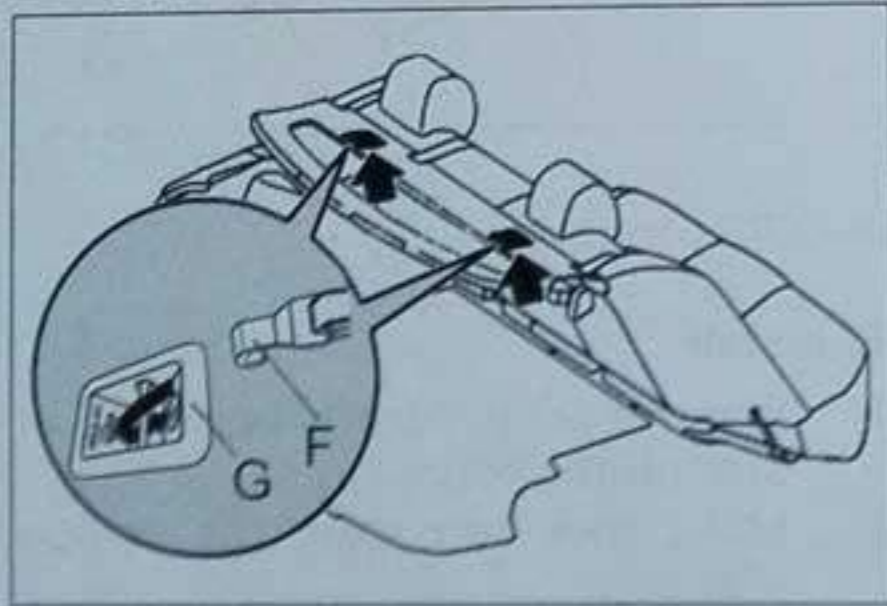

DOITW004R16004

6. Fasten the tether strap hook (F) of the CRS to the tether anchor bracket (G).
7. Tighten the top tether strap.
8. Push and pull the CRS in all directions to make sure the CRS is correctly tighten.

To remove

Remove the child restraint according to the supplied instructions that comes with the CRS.

How to install a Child Restraint System (CRS) to a 3-point type seat belt (with emergency-lock mechanism)

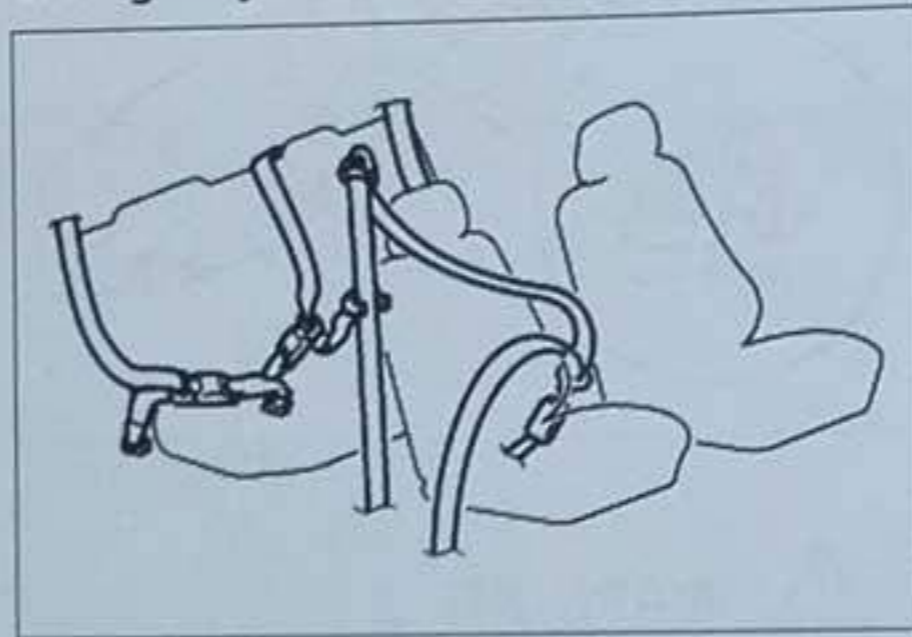

DOIQW004R11014

Installation:

1. Fasten the seat belt to the CRS.
2. Make sure a "click" is heard when you fasten the latch plate into the buckle.
3. Push and pull the CRS in all directions to make sure the CRS is correctly tighten.

SRS Airbags

OWN0045EAT516010

Front airbags

There are two front airbags; a driver airbag and a front passenger airbag.

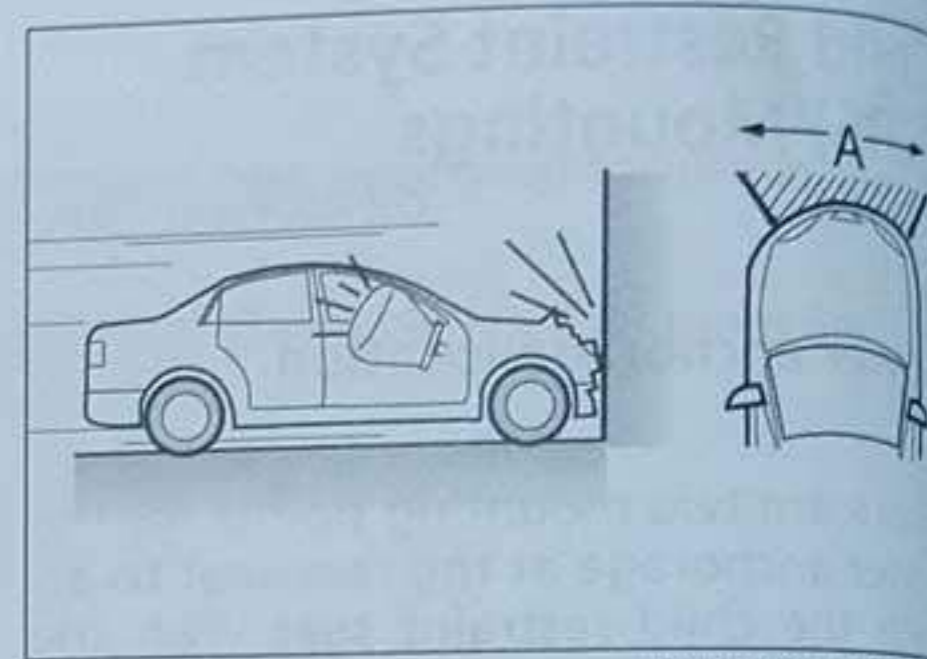

DOIKW004R06019

When the vehicle hits an obstruction at area (A), the front airbags will deploy. The airbag control unit senses a collision that is equivalent to a front-collision with a solid flat obstruction; at a speed of more than approximately 20 km/h.

⚠ CAUTION

- (1) The front airbag deploys at a very high speed and with a large force. When a person hits the airbag during the first step of front airbag inflation, the person may possibly be injured. Always wear your seat belt correctly. Maintain a proper position when driving.
- (2) When the front airbag deploys, a sudden loud noise and there will be white smoke or powder will released.

This condition does not indicate a fire in the car and will not cause any permanent-side effects on the person.

- (3) Immediately after the airbag deploys, the airbag and its component parts will become very hot. Do not touch the items.

The conditions that cause the front airbag to deploy

The amount of damage to the vehicle body does not cause the SRS airbag to deploy in a front-collision.

During some collisions, the vehicle body structures absorb the front-collision energy; preventing the driver and passenger from injury.

The front body structure probably collapses to absorb the front-collision energy; and under this condition, the front airbags may not deploy.

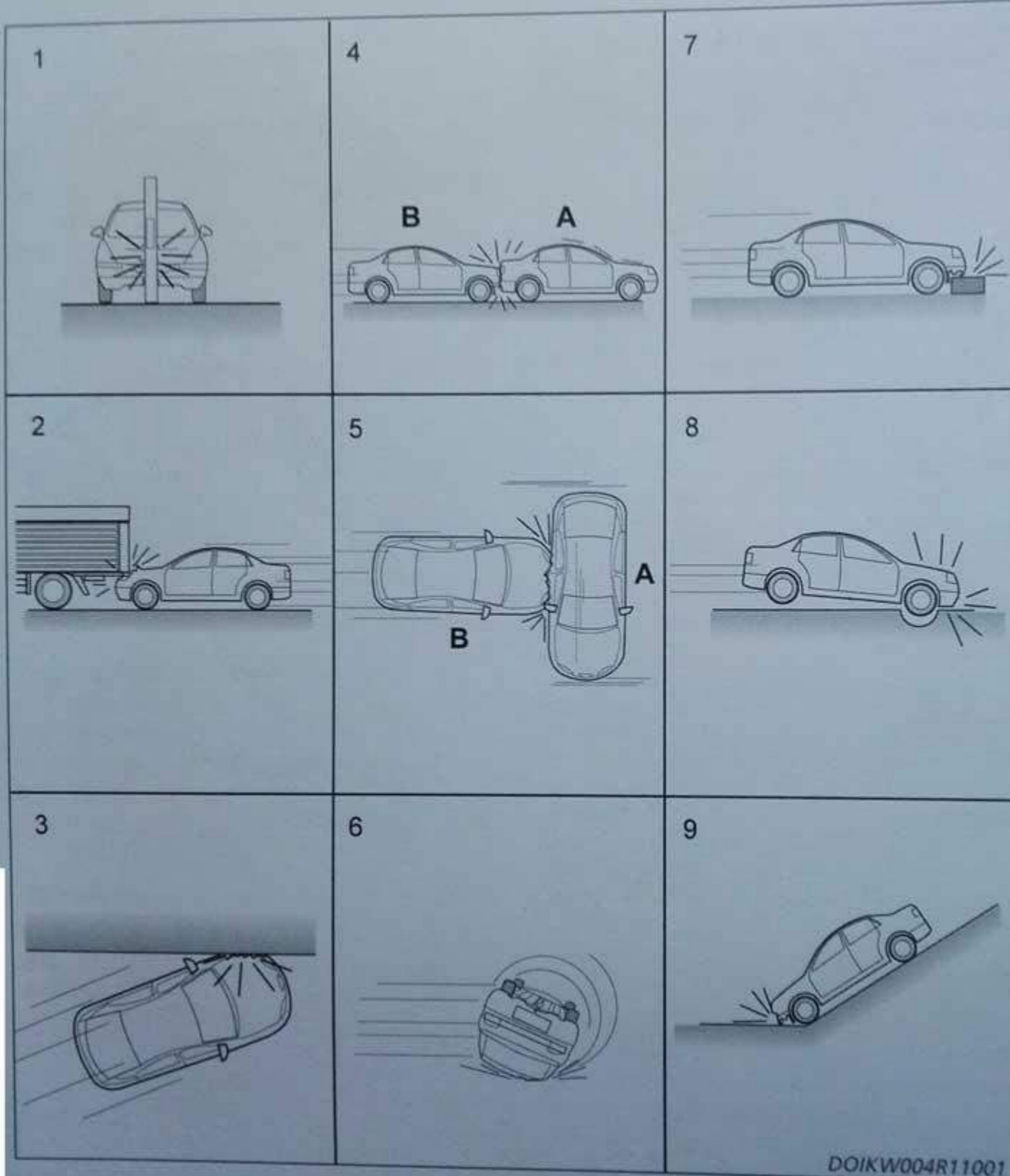

The front airbag MAY NOT deploy:

1. When the vehicle hits a utility-pole, tree or equivalent object.
2. When the vehicle hits the undercarriage of another vehicle, for example a truck.
3. When the vehicle hits an obstruction at an angle.

NOTE

The front area of the vehicle body collapses to absorb the energy from front-collision. Under these conditions, the front airbag may not deploy caused by the collapsing of the vehicle body.

The front airbag WILL NOT deploy:

4. When another vehicle (B) hits behind your vehicle (A).
5. When another vehicle (B) hits the side of your vehicle (A).
6. When your vehicle rolls over onto its side or roof.

NOTE

Under these specified conditions, the front airbag does not deploy and cannot give protection to the driver and front passenger.

Curtain airbags and side airbags *

The front airbag MAY deploy:

7. When the vehicle hits a lifted road divider or equivalent object.
8. When the vehicle hits into a hole.
9. When the vehicle moves down a steep slope and hits the ground.

NOTES

If the undercarriage of the vehicle hits an obstruction at a moderate-to-severe rate of collision, the front airbag may deploy. Drive carefully on the road conditions that can cause sudden shock to the undercarriage of the vehicle.

⚠ CAUTION

The airbag does not give protection to the driver and passengers in all types of collisions. Make sure you correctly wear your seat belt.

The seat belts in your vehicle are the primary protection in a collision.

The front airbags give only the additional protection.

For safety of all passengers, make sure all wear seat belts and wear it correctly.

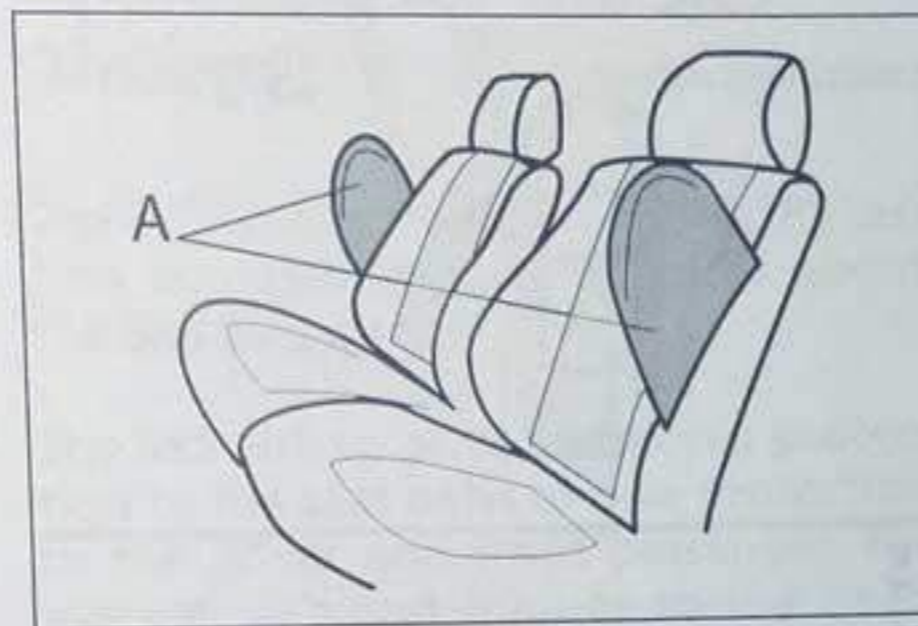

DOIQW004R11008

A – Side airbag



DOIQW004R11016

A – Curtain airbag

When an obstruction hits the vehicle at the centre of the passenger compartment, the curtain airbags and side airbags deploy; The collision is at a medium-to-severe rate. The typical condition is another vehicle (B) hits the side

of your vehicle (A) as shown in the illustration:

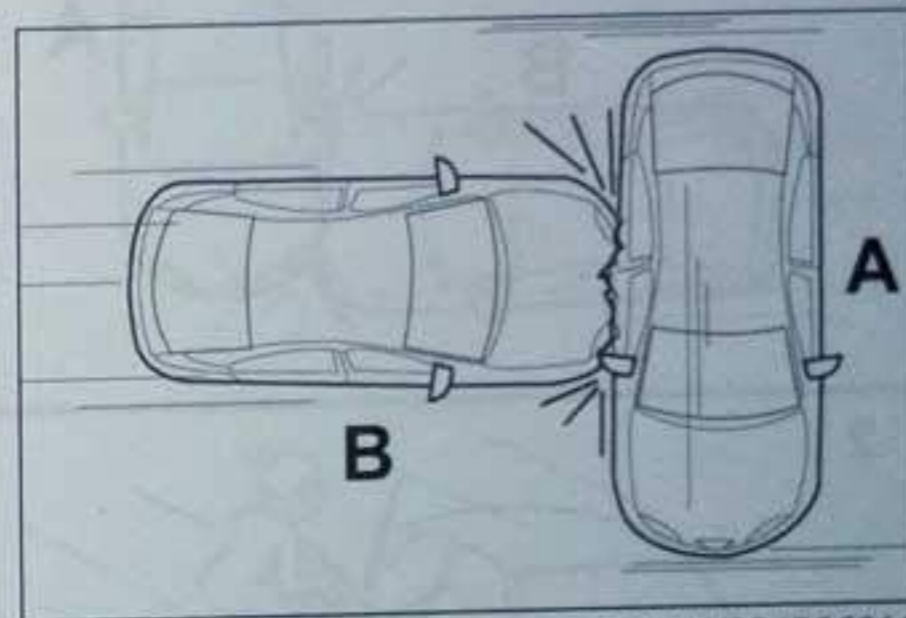

DOIKW004R06011

The conditions that cause the curtain airbag and the side airbag to deploy

The vehicle body structure absorbs the shock to prevent the driver and the passenger from injury; during some types of side collisions.

NOTE: The roof pillar and the side area of the vehicle body collapse to absorb the side-collision energy; under these conditions, the curtain airbag and side airbags possibly not deploy.

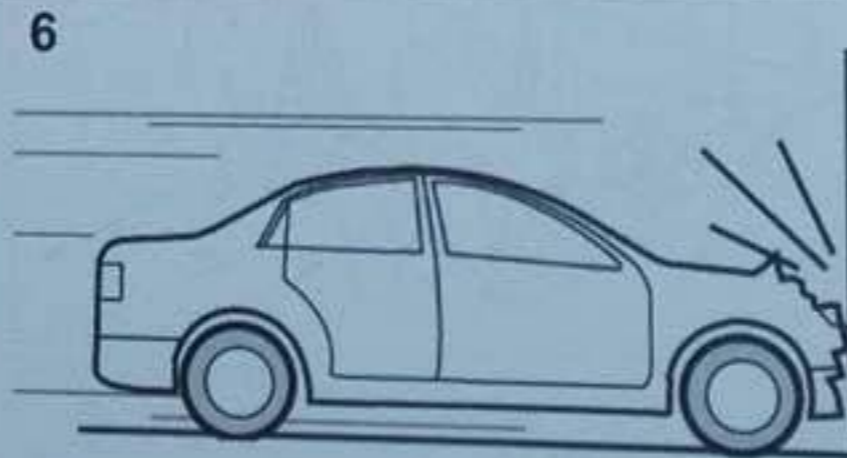
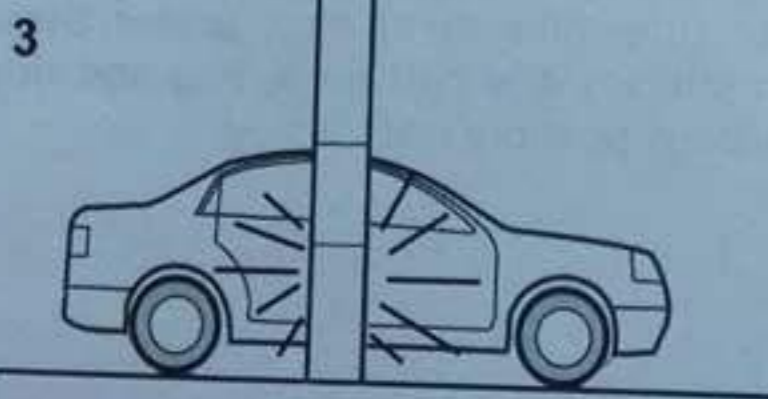
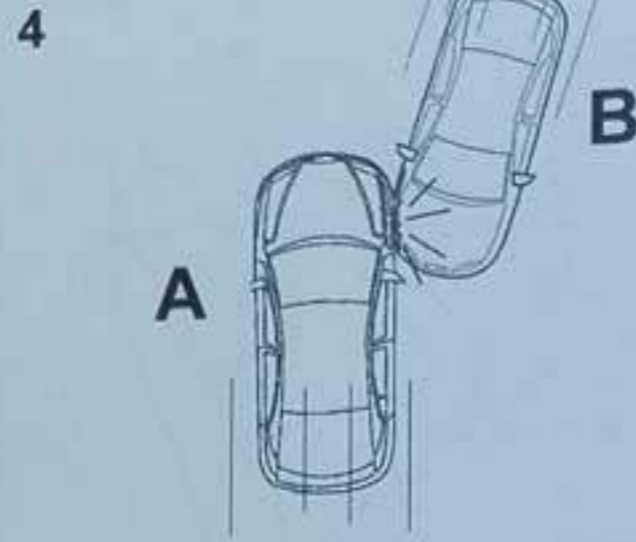
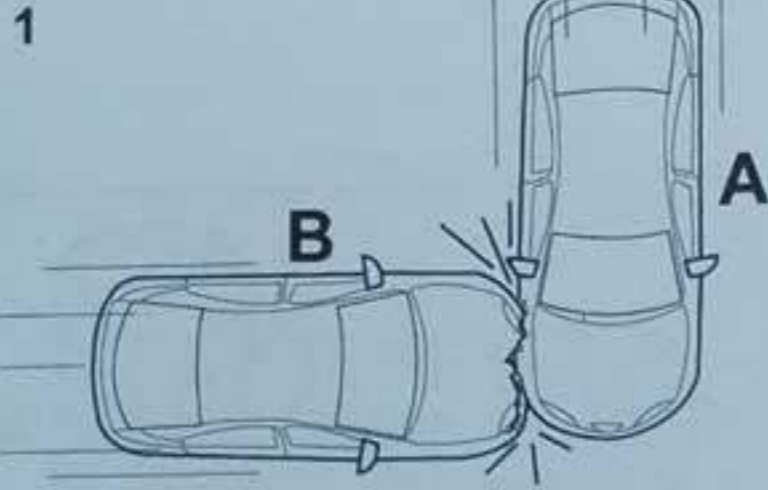

The curtain airbag and side airbag MAY NOT deploy:

1. When vehicle (B) hits the side of your vehicle (A) far from the passenger compartment.
2. When a motorcycle or other small vehicles hits the side of your vehicle.
3. When your vehicle hits a utility-pole, tree or other equivalent object.
4. When another vehicle (B) hits your vehicle (A) at a diagonal side-collision.
5. When your vehicle rolls over onto its side or roof pillar, the curtain airbag and side airbag possibly not deploy.

NOTE

The vehicle body collapses to absorb the side-collision energy. Under these conditions, the curtain airbag and side airbag possibly not deploy.

The curtain airbag and side airbag WILL NOT deploy:

6. When your vehicle has a head on collision.
7. When another vehicle (B) hits the behind of your vehicle (A).

NOTE

Under these specified conditions, the airbags do not deploy to give protection to the passengers.

CAUTION

The seat belts in your vehicle are the primary protection in a collision.

The curtain airbags and side airbags give the additional protection.

For safety of all passengers, make sure all wear seatbelts and wear it correctly.

General Information Applicable for the SRS Airbags

OWN004SEATS16011

The information written in this SRS section contains important points about the SRS airbags*.

The SRS airbag gives additional protection to the seat belts to give protection to the driver and front passenger. For example, against injuries to the head and chest during some moderate-to-severe front collisions.

The SRS airbag does not replace the seat belts.

Any work around and on the front airbag system components must be only done at an authorised PROTON service outlet. Incorrect work can suddenly activate the airbag to deploy and cause an injury; Also causes the airbag to malfunction.

1



2



3



4



5



Safety precautions for front airbags

WARNING

THE VEHICLE HAS FRONT AIRBAGS..

- (1) Do not rest your head or chest on the steering wheel or the instrument panel.
- (2) Do not place your feet or leg against the instrument panel above the glove box.
- (3) Keep infants and small children-passengers in the child restraint seat .
- (4) While the passenger airbag is active, Do not install the rear-face type of child restraint seat in the front seat. The force of a passenger airbag that inflates can push that specified child restraint seat into the seat and cause injury. Use the rear-face type of child restraint seat only in the rear seat.

If the situation permits, use the front-face type of child restraint seat in the rear seat. If you use the specified child restraint seat in the front seat, adjust the seat as far to the rear.

- (5) Do not put any items onto the padded cover of the steering wheel and the instrument panel above the glove box. When the airbags deploy, these items may hit and cause injury to the driver and passenger. The items refer to trim materials, badges and other similar items.

Safety precautions for the side airbag *

⚠ WARNING

THE VEHICLE HAS SIDE AIRBAGS. PASSENGERS MUST ALWAYS SIT CORRECTLY.

- (1) The side airbags give the additional protection to the driver and passenger seat belts during certain side-collisions.
- (2) Always correctly fasten your seat belt. The driver and passenger must sit correctly in their seats.
- (3) Do not rest your head or body against the side window glass or door.



DOITW004R16005

- (4) The side airbags deploy with a large force. The driver and the passenger must not rest their arms outside the window and must not put your head or body against the door. If the side airbags deploy, the driver or the passenger may be injured.
- (5) Do not allow the rear passengers to hold the seat back of the front seats. The side airbag can possibly deploy and cause an injury.
- (6) Do not install or change the seat covers on the seats that have side airbags. These changes may cause interference for the side airbag to inflate correctly.
- (7) Do not install a front-face or rear-face types of child re-

straint seat in the front-passenger seat.



DOIKW004R06039

- (8) If the situation permits, use only a front-face type of child restraint seat in the rear seat. Do not let the children's head rest against or near the area where the side airbag is. If the side airbag deploys, this action can cause an injury to the children.
- (9) Do not put any objects near or in the front seat. These objects may stop the side airbags to inflate correctly. When the side airbag deploys and cause these objects to fly, this condition can cause injury to the driver or the front-passenger.
- (10) Do not put any adhesive labels or trim materials on the seat back of the front seats. These items may cause interference

* if fitted

for the airbag to deploy correctly.

The operation of airbag system

All airbags have marks. The marks are shown as "SRS AIRBAG"

Operation of the front airbags

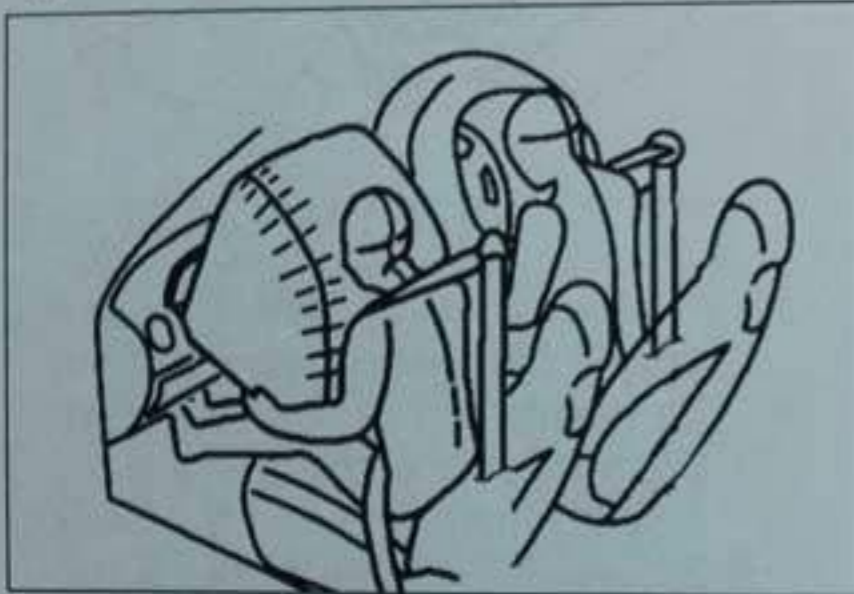

DOIKW004R03023

The front airbags deploy only in a moderate-to-severe front collision. These front airbags possibly deploy during some lower-speed front collisions in rollovers and also in rear collision. There is a minimum force-value set for the airbag to deploy. When the system senses a front-collision and the sensed force value is enough, the switches will close a circuit. This action will start the ignition of the materials in the inflator that makes nitrogen gas and deploy the airbags.

* if fitted

Operation of the side airbags *

In a side collision, only the side of the vehicle the had side-collision will deploy its side airbag. If the side-collision is on the front-passenger side, only the front-passenger side airbag will deploy even there is no passenger..

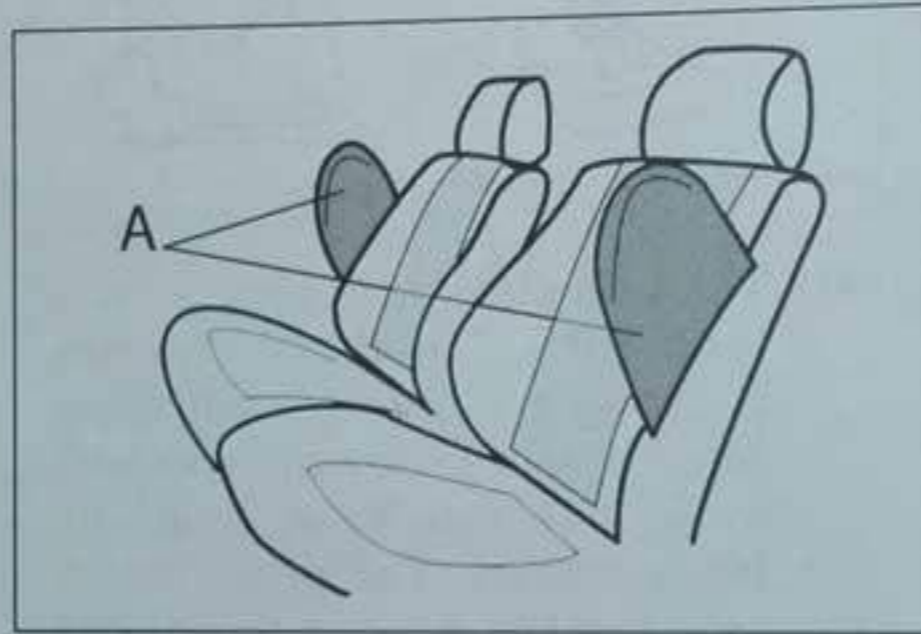

DOIQW004R11008

A - Side airbag

The airbags quickly deflate after the airbag deployed. Some smoke and powder released by the side airbag. The sudden inflation of the device may affect the driving vision cause a minor injury to the person.

The airbag may not deploy in certain front end collision although the vehicle is badly damaged. The system senses that the sensed force-value does not align to the minimum force-value to cause the airbag to deploy.

Operation of the curtain airbags *



DOIQW004R11016

A - Curtain airbags

The curtain airbags are installed in the front pillar, rear pillar and roof-side rail. The curtain airbag only deploys on the side of the vehicle that had side collision. Also will deploy without any passenger at the front-passenger seat or the rear seat.

WARNING

- (1) Front airbags give protection to the driver and the front-passenger in a front collision; With a moderate-to-severe force .

Side airbags will give protection to the driver and the front-passenger in a side-collision; With a moderate-to-severe force.

Follow all precautions about the seat belts use and the sitting position. These two items do not give protection in rear collisions, rollovers, weak-front collisions and weak-side collisions.

- (2) Do not attach any items to the padded cover of the steering wheel. These items can cause injury. These items are trim material, badges and other similar materials. If the airbag deploys, these items can cause injury to the driver .
- (3) Do not or attach any items to the instrument panel above the glove box that has an airbag. If the airbag deploys, these objects may cause injury to the passenger.
- (4) Do not attach or put any accessories to or in front of the windshield. These objects can cause an interference to the airbag inflation or cause injury.
- (5) After the airbag is inflated, some airbag system components become hot; Do not touch these components after inflation.
- (6) The airbag system only operates one time. After the

airbags deploy, these airbags will not operate again. These airbag must be replaced. Send this vehicle to an authorised PROTON service outlet for inspection of the complete airbag system.

- (7) If your vehicle had a front collision before but the airbags did not deploy, make sure the airbag system is inspected. Get a replacement (if necessary) by an authorised PROTON service outlet.

Front seat belts pretensioner with load limiter

The front seat belts have automatic seat belt pretensioners with load limiter for additional protection. When this mechanism activates, the pretensioners immediately tighten the belts and the load limiter absorbs the load during collision. The belt force is kept at a controlled and set parameter to help hold the driver and front passenger in position.

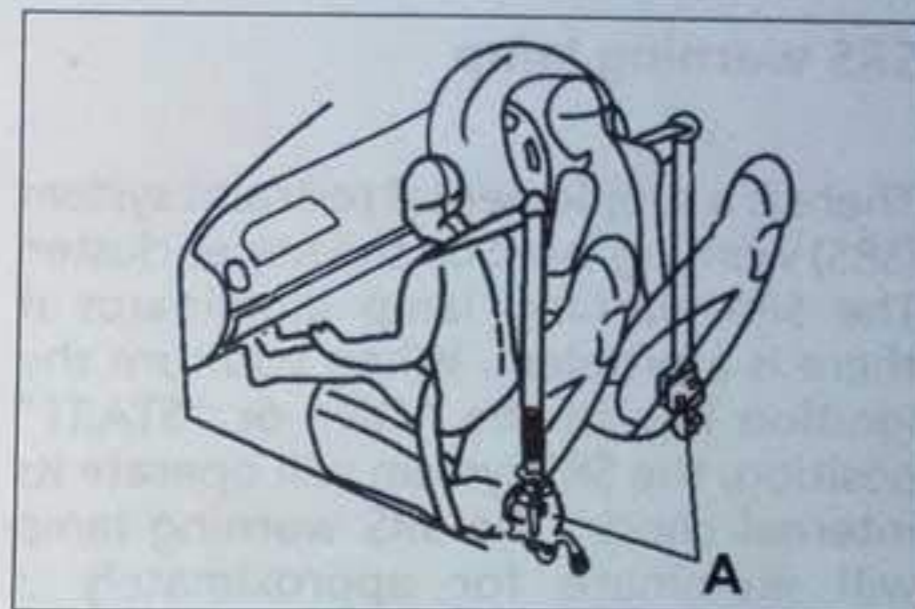

DOIMW004R07008

A – Seat belt with pretensioner

The pretensioners activate in front collisions and not activated during side-collision. The pretensioners operate only with the ignition switch in the ON position and activate independently of the front airbags.

After the pretensioner system is activated, the seat belts stay lock-tight; Until the seat belts are released.

NOTE

- (1) If there is a problem with your automatic seat belt pretensioners, the SRS warning lamp will illuminate. Immediately have your system checked by an authorised PROTON service outlet.
- (2) After any impact-collision, have the system checked by an authorised PROTON service outlet.

SRS warning lamp

There is a supplemental restraint system (SRS) warning lamp on the meter cluster. The SRS warning lamp illuminates if there is a problem. When you turn the ignition key to the "ON" or "START" position, the SRS system will operate its internal check. The SRS warning lamp will illuminate for approximately 3 seconds and turn off. When the SRS warning lamp turns off, the SRS system is active.

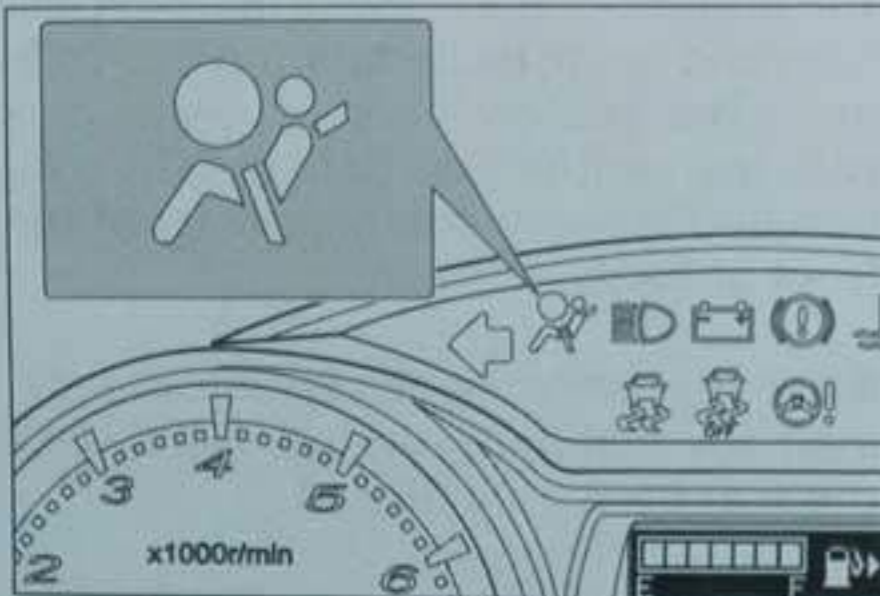

DOIRW004R14003

WARNING

The SRS warning lamp may not operate under the following conditions:

- (1) The SRS warning lamp does not illuminate when you start the vehicle.

- (2) The SRS warning lamp does not turn off after approximately 3 seconds.
- (3) The SRS warning lamp illuminates while driving.

If these recorded conditions occur, immediately get your vehicle to an authorised PROTON service outlet for inspection.

Do not ignore the SRS warning lamp; If a collision occurs, the airbags may not deploy.

SRS servicing

Get an inspection to your SRS system by an authorised PROTON service outlet after 10-years the system was made.

WARNING

- (1) Only an authorised technician from an authorised PROTON service outlet can carry out a task on or near to the SRS components; The tasks include any service, inspection, maintenance, repair and discard of any SRS components or wiring.

Incorrect work on the SRS components can cause the airbags to deploy accidentally

or cause the SRS system to malfunction.

- (2) Do not change your steering wheel, the retractor of the seat belt or any of the SRS components.

For example replacement of the steering wheel, changes to the front bumper or body structure; All these changes can cause a problem to the SRS performance and cause possible injury.

- (3) If your vehicle had any collision before, get your vehicle to an authorised PROTON service outlet for SRS inspection. Make sure the SRS system works.

- (4) The SRS sensors are under the centre console. If the carpet is wet, do not start the ignition. This problem may cause the airbags to deploy. Disconnect the battery and have the car towed to an authorised PROTON service outlet for repairs.

- (5) Do not add seat-cover or replace the front seat back covers without referring to an authorised PROTON service outlet. Additional seat covers can prevent the side airbags to inflate during a collision (if-installed).

NOTE

- (1) When you sell this vehicle, tell the new owner that this vehicle has SRS system. Refer that owner to the applicable section in this owner's manual.
- (2) When you write-off this vehicle, make sure you get this vehicle to an authorised PROTON service outlet. Make sure the SRS system is safely deactivated.
- (3) The SRS system only activates one time in a collision. If the airbag has been deployed, follow these procedures:
 - Get the vehicle towed to an authorised PROTON service outlet.
 - Refer to an authorised PROTON service outlet to change the SRS system components.
 - When replacing the SRS components, use approved PROTON parts.

Service label and information label *

The service label and information labels are attached as shown in the illustration.

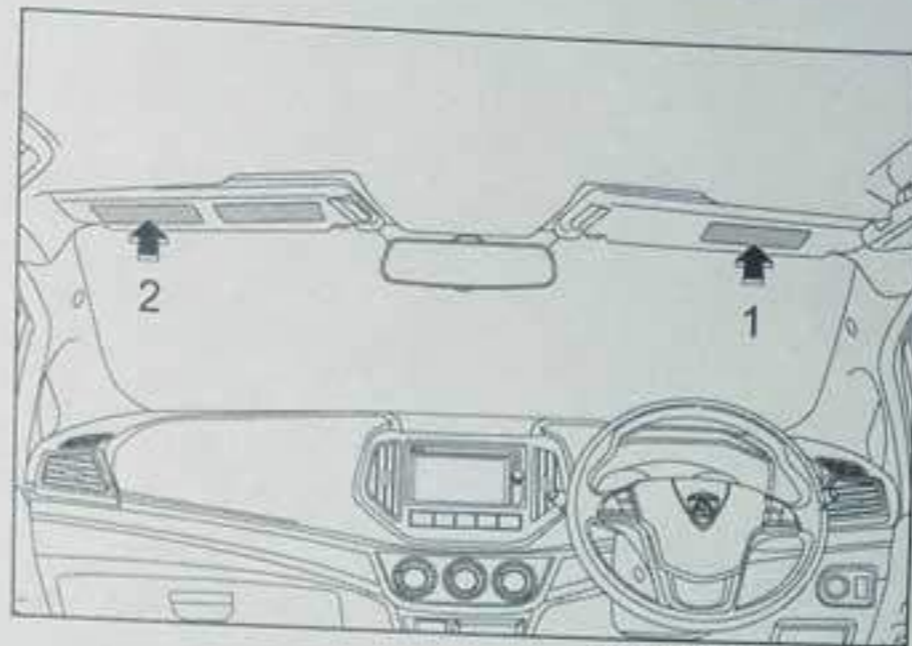

DOITW004R16001

1 - Airbag caution label (at the driver sun visor)

2 - Airbag caution label (at the front passenger sun visor)



DOIRW004R14014

3 - Airbag caution label (at the instrument panel) (if-installed)

Instruments and Controls

Instruments	74
The Speedometer	74
Water Temperature Gauge	75
Fuel Gauge	75
Indicator and Warning Lamps	76
Information Display	81
Headlamps and Turn Signal Lights Control Switches	91
Wiper and Washer Control System	94
Rear-window Demister or Defogger Switch	95
Hazard Warning Flasher	96
Central Door Lock	96
Room Lamps	97
Headlamps Leveling Switch	97

Instruments

OWN005INSCO16001

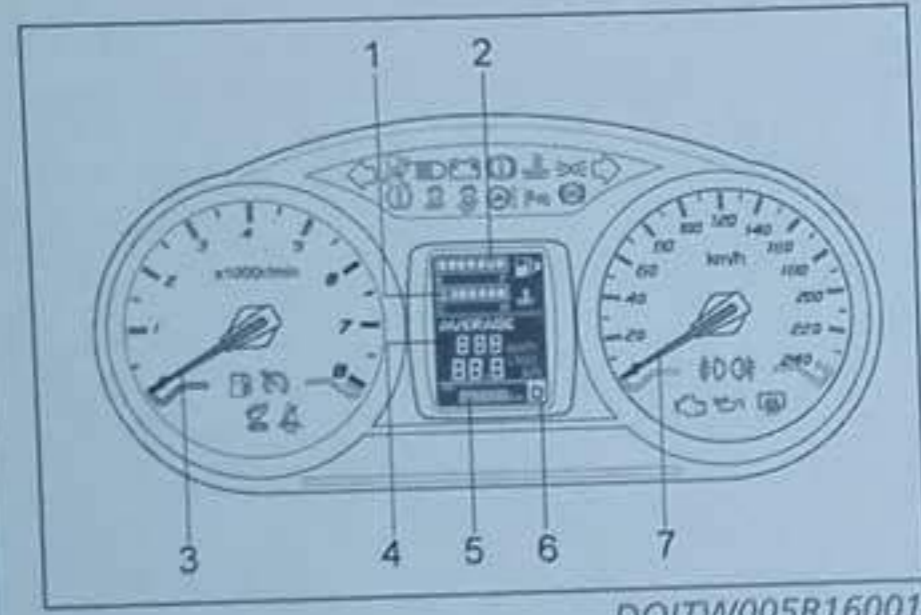

DOITW005R16001

- 1 - Temperature gauge
- 2 - Fuel gauge
- 3 - Tachometer
- 4 - Information display
- 5 - Odometer and Tripmeter
- 6 - Gear selection display
- 7 - Speedometer (km/h)

The Speedometer

OWN005INSCO16002



DOITW005R16002

The speedometer indicates the vehicle speed in kilometers per hour (km/h).

Tachometer

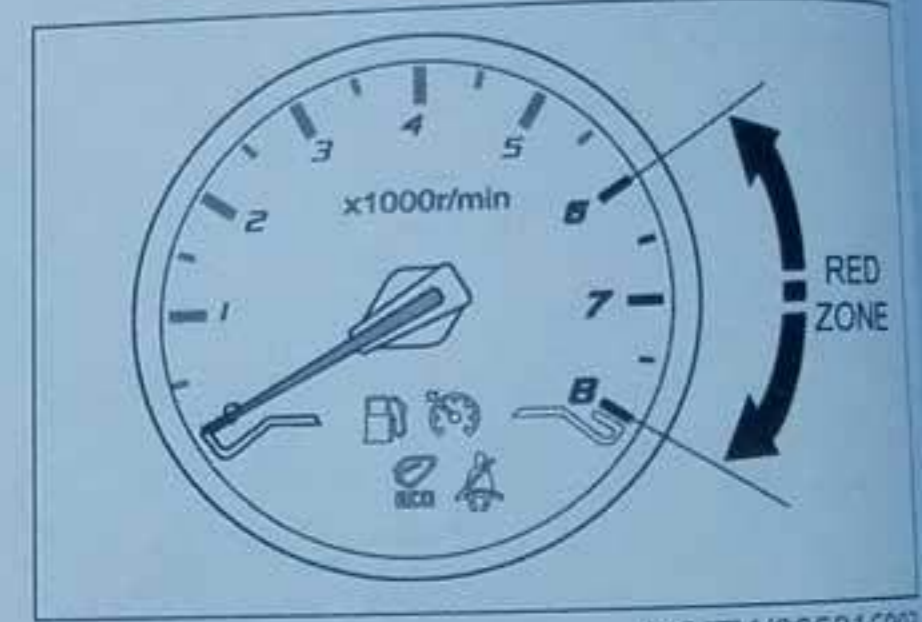

DOITW005R16003

The tachometer indicates the engine speed (revolutions per minute). The tachometer shows when driving at high engine speed (red zone).

Red zone range :

- 1. CVT and MT : 6000 to 8000 rpm

Water Temperature Gauge

OWN005INSCO16003

When the engine is in operation, the water temperature gauge will indicate the engine coolant temperature.

NOTE

If the water temperature gauge shows six or seven temperature bars, stop the vehicle. Let the engine to cool. See below illustrations.

The vehicle engine gets very hot during the following conditions for example:

- (1) Driving on a long hill during a hot day.
- (2) Decreasing the vehicle speed or stopping after high-speed driving.
- (3) Letting the engine operate more than necessary with the air conditioner turned ON.

Water temperature warnings

There are two warnings related to the hot temperature conditions:

1 – “High” temperature



All six temperature bars of the water temperature gauge flash. The temperature warning lamp of the meter cluster also illuminates.

2 – “Very high” temperature



All seven temperature bars of the water temperature gauge flash. The meter cluster will show temperature-warning lamp and will make a warning sound.

Fuel Gauge

OWN005INSCO16004

The fuel gauge shows the approximate fuel remaining in the tank.

Fuel indication and warnings

Fuel gauge – FULL



This symbol shows the level of the fuel in the fuel tank is full. All fuel gauge bars are visible.

Fuel gauge – LOW



This symbol shows the level of the fuel in the fuel tank is low. The remaining bar flashes and the symbol “” stays illuminated. Approximately six liters of fuel is in the fuel tank. Fill more fuel.

Fuel gauge - EMPTY

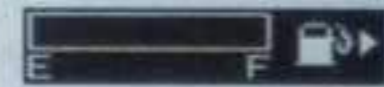

The fuel in the fuel tank is at very minimum level. There is no bar. The symbol “” flashes. Fill more fuel.

Indicator and Warning Lamps

OWN005IN5CO16005

When turning the ignition to ON position, some indicators and warnings are shown in colours. When turning the ignition switch to OFF position, these indicator and warnings return to transparent black colour.

- 1 - Left turn signal indicator
- 2 - SRS warning
- 3 - High beam indicator
- 4 - Battery charge warning
- 5 - Brake warning
- 6 - Engine coolant temperature warning
- 7 - Position lamp indicator
- 8 - Right turn signal indicator
- 9 - ESC (active/fail) indicator
- 10 - ESC (off) indicator
- 11 - EPS warning
- 12 - Front parking sensor indicator
- 13 - ABS warning
- 14 - Low fuel warning
- 15 - Driver's and front passenger's seat belt warning
- 16 - ECO indicator
- 17 - Front fog lamp indicator *
- 18 - Rear fog lamp indicator *
- 19 - Engine check warning
- 20 - Oil pressure warning
- 21 - Rear defogger indicator

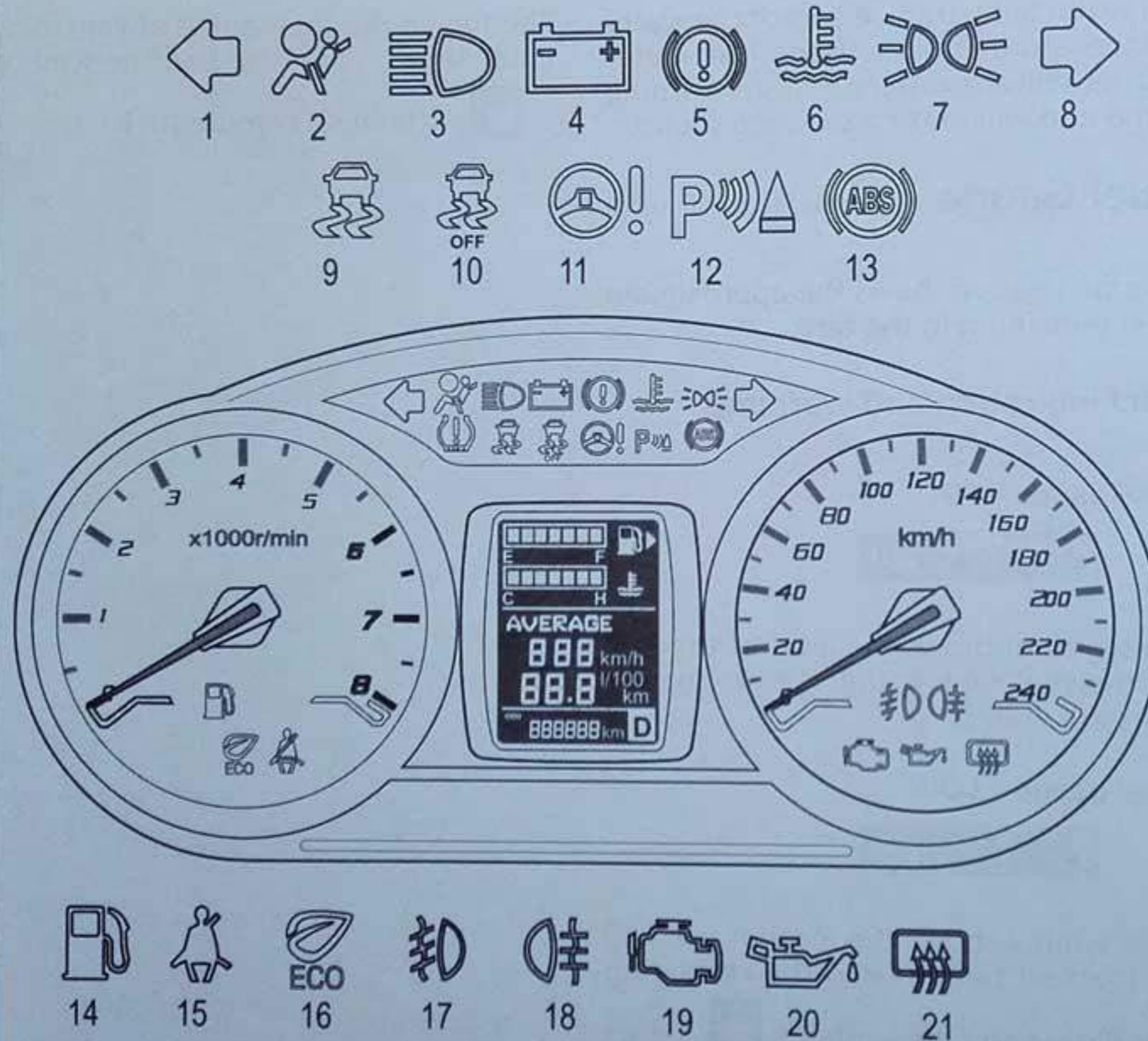

* if fitted

DOITW001R16006



Rear defogger indicator

When turning on the rear defogger, this indicator illuminates.



Seat belt warning (for the driver and front passenger)

When turning the ignition switch to ON position, this warning illuminates.

When the vehicle speed reaches 25 km/h and the driver or the front passenger does not fasten the seat belt:

1. The seat belt warning illuminates.
2. The buzzer continuously makes a sound.
3. Buzzer and indicator will continuously activate until the driver or the front passenger fastens the seat belt.



CAUTION

For safety, fasten seat belt before driving.



Left turn signal indicator

When the turn signal light operates, this indicator flashes.



SRS warning

When there is a fault in the SRS airbag or the pretensioner, SRS warning illuminates.



Low fuel warning

Low fuel warning illuminates in amber colour indicates the fuel is low. Fill fuel to your fuel tank.



Engine check warning

When the ignition switch is at the ON or START position, this warning illuminates for a while and goes off.

If this warning illuminates while the engine operates, there is a problem in the emission control system. Immediately contact an authorised PROTON service outlet.



High beam indicator

When the high beam operates, this indicator illuminates.



Front fog indicator

When the front fog lamps operate, this indicator illuminates.



Brake warning

When the ignition switch is turned to ON position, this warning illuminates for a while.

The brake warning illuminates in these conditions:

- The lever of the parking brake is engaged.
- The quantity of the brake fluid in the reservoir is low.
- The EBD or HHA system function has a failure.

If the brake warning does not illuminate when the lever of the parking brake is pulled, immediately contact an authorised PROTON service outlet.

If the brake warning illuminates while driving, there is a problem in the brake system. Park

the vehicle in a safe place according to these recommended procedures:

1. If the performance of the brake pedal is bad, push harder against the brake pedal.
2. If the brakes has a failure, use the engine brake to decrease the speed. Slowly pull the lever of the parking brake to park the vehicle. Push the brake pedal to operate the stop light (brake light) to give a warning to the surrounding vehicles.



CAUTION

- (1) Suddenly applying the parking brake is dangerous because the wheels may get locked.



Battery charge warning

When the ignition switch is turned to ON or START position, this warning illuminates for a while and goes off. If this warning illuminates while the engine is operating, there is a problem in the charge-system. When this condition occurs, safely stop and park the vehicle in a safe area. Contact an authorised PROTON service outlet.

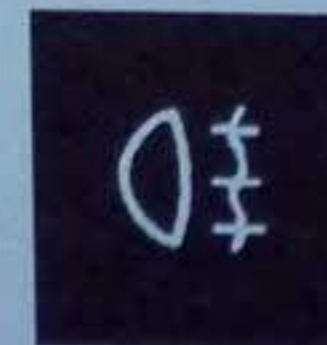

Rear fog lamp indicator

When the rear fog lamps operate, this indicator illuminates.



ESC indicator

(1) ESC active-indicator display: When the ESC function is active, this indicator illuminates.

(2) ESC fail-warning display: When there is a fault in the ESC function, this warning stays illuminate.



ESC OFF warning display

This warning illuminates to indicate that the ESC function is disabled.



Position lights indicator

When the position lights operate, this indicator illuminates.



ABS warning

When there is a fault in the ABS function, this warning illuminates.



Oil pressure warning

This lamp illuminates when turning the ignition switch is turned to ON position and turns off. If this warning illuminates while the engine is operating, the oil pressure is at low. When this condition occurs, safely stop the vehicle and turn off the engine. Contact an authorised PROTON service outlet for inspection.

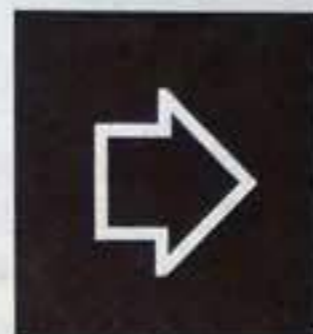

Right turn signal indicator

When the right turn signal light operates, this indicator flashes.

If the signal light quickly flashes, possibly its bulb has blown or there is a problem in its wiring connection.



Engine coolant temperature warning

This warning illuminates if the engine is very hot (the temperature of the engine coolant is above 113 °C (235.4 °F))



ECO indicator

This vehicle is equipped with an ECO indicator that illuminates whenever the vehicle is being driven in a fuel efficient manner.



DOIRW005R14042

EPS warning

When the ignition switch is turned to ON position, this warning illuminates and turns off again.

If this warning stays illuminated in RED colour while the engine operates, there is a malfunction in the electric power steering system. Contact an authorised PROTON service outlet for inspection.

When the ignition switch is turned to the ON position and this warning stays illuminate in AMBER colour, the steering setting must be reset. This condition occurs because of:

1. Replaced weak vehicle battery with new battery.
2. The battery terminal was disconnected and reconnected.

How to reset the steering setting

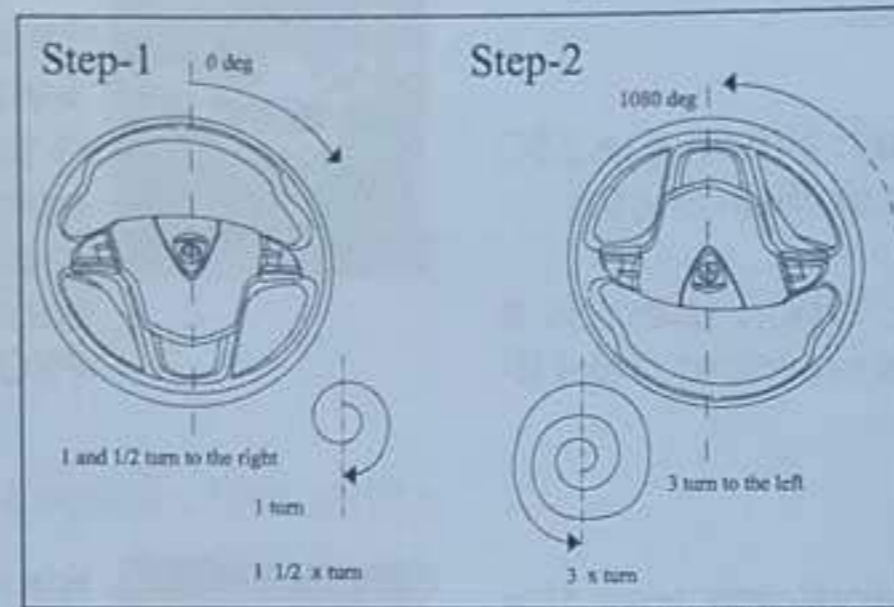

DOIRW005R14052

- 1 - Start the engine and turn the steering wheel until the front tyres are straight. Set this position as the centre position (0 degree).
Turn the steering wheel to the right until stop (approximately one and half complete turn – 540 degree).
- 2 - Turn the steering wheel to the left until stop (approximately three complete turn – 1080 degree) in one continuous action.
The AMBER colour electric power steering warning will go off momentarily.

NOTE

If the engine is not in operation, the electric power-steering motor does not operate. Turn the steering wheel with more force.



WARNING

If the warning stays illuminated, immediately get the vehicle to an authorised PROTON service outlet for inspection.

Information Display

OWN005IN5CO16019

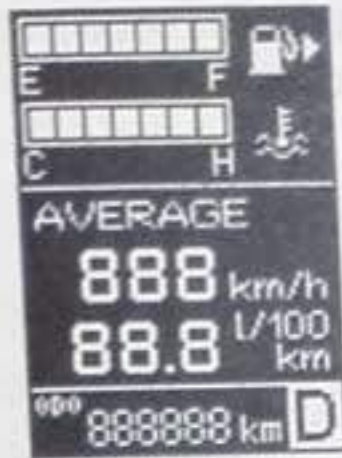

A

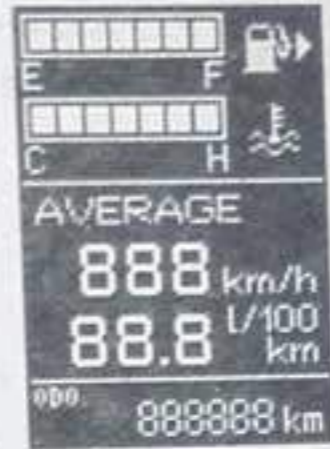

B

Above illustration shows the information display. The display is different according to the vehicle specifications.

A – For the vehicle with Continuous Variable Transmission (CVT)

B – For the vehicle with Manual Transmission (MT)

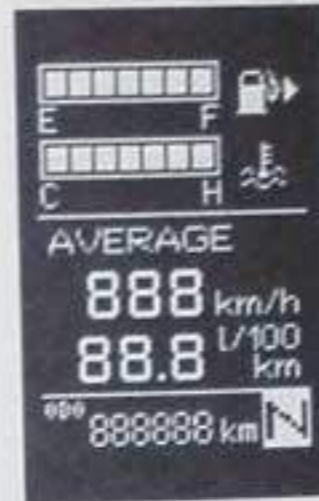

Average Vehicle Speed (AVS) & Average Fuel Consumption (AFC)

This display shows the AVS from the last reset to the new time

This display also shows the AFC from the last reset to the new time.



Distance To Empty (DTE)

This display shows the approximate driving range (how many more kilometers or miles the vehicles can be driven).

When the driving range is less than approximately 50 kilometres (30 miles), the system is shown as "---". Immediately refuel.



Journey Time (JT)

JT shows the travel period in hours and minutes (hh:mm). When turning the ignition switch to the ON position, JT starts. The engine operates from the last reset of the JT.

If the battery is disconnected, the system will reset the JT data.

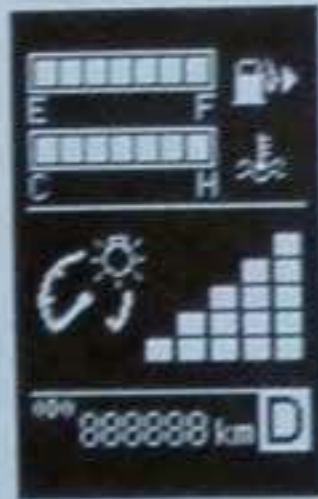

Dim setting (bright level control)

Changing the bright level of the meter cluster.

Press the INFO button more than 2 seconds to enter the dim setting.

Press the INFO button for less than 2 seconds to adjust the bright level. The bright level automatically moves through different levels.



Tripmeter counter (Trip A)

This display shows the travel distance between 2 points.

Press the INFO button for more than 2 seconds will reset the stored value of Trip A.



Tripmeter counter (Trip B)

This display shows the travel distance between 2 points.

Press INFO button for more than 2 seconds will reset the stored value of Trip B.



Tripmeter counter (Trip C)

This display shows the travel distance between 2 points.

Press INFO button for more than 2 seconds will reset the stored value of Trip C.



Service Required

This display shows that the start stop button has failure.

Go to an authorised PROTON service outlet for inspection.



Periodic inspection display

The vehicle must be regularly sent for service maintenance. When the schedule for service has come and the ignition switch is turned to ON position, this display is shown quickly. Immediately contact with an authorised service outlet for periodic inspection.

Service reminder

This display shows the remaining distance and months until the next periodic inspection.



Optional inspection

This display shows the optional service inspection different from periodic inspection. Only your service outlet can set this optional display



Gear Shift Lock (GSL)

This display shows that the system has locked the gear lever in P.

Any try to move the gear lever from P position is not permitted.

When the ignition is in OFF position, the information display will show this display.

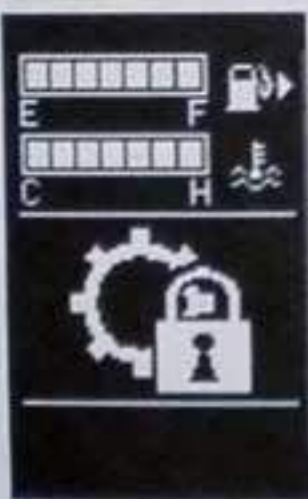

Gear Shift Unlock

This display shows the system has unlocked the gear lever in P.

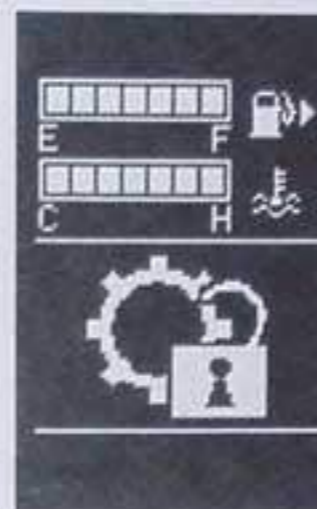

When the ignition is in OFF position, the information display will show this display.



The battery voltage of the remote transmitter is low

This warning indicates the battery of the remote transmitter is low in voltage. Immediately replace with a new battery.

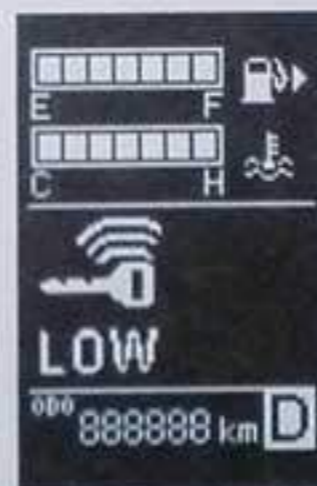

The battery voltage of the vehicle system is low

This warning indicates battery of the vehicle system is low in voltage. Immediately replace with a new battery.

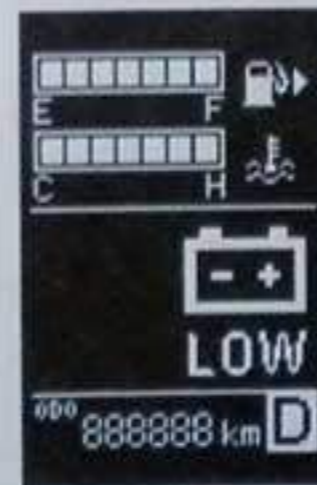

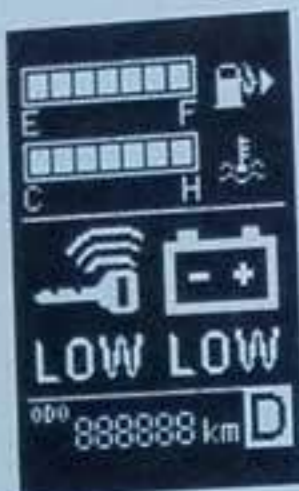

The battery voltage of the remote transmitter and the vehicle are low

This warning indicates battery voltage of the remote-transmitter and the vehicle system are low. Immediately replace with a new battery.



Key left warning *

For model that has ignition switch type of start system, the system will operate as follows:

When the engine is turned off and the key is not removed from the barrel, this warning will illuminate approximately 10 seconds when the driver's door is opened.

For model that has start stop button, the system will operate as follows:

When the engine is turned off and the remote transmitter is left in the vehicle, this warning will illuminate approximately 10 seconds when the driver's door is opened.



Light left-on warning

If the lights are left turned on and the ignition is turned off, this warning will continue to illuminate until you turn off the light.



Follow Home lamp indicator
Indicates that the Follow Home function is activated.



Left turn signal light bulb failure warning
Indicates that the system of left turn signal is malfunction.

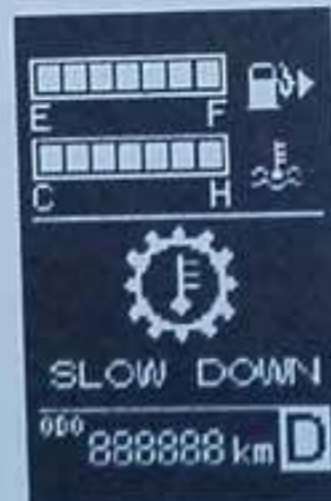

CVT overheat warning *

Indicates that the temperature of the CVT transmission is higher than its permitted temperature range. The vehicle speed must be reduced.

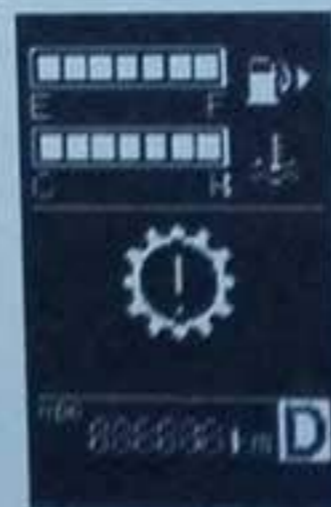

CVT malfunction *

Indicates that the CVT is malfunctioning and the vehicle speed must be reduced.

Send the vehicle to the authorised PROTON service outlet for inspection.



Key not detected warning *

This warning tells that the remote transmitter is not inside the cabin area and is not in the operation range. Refer to page 36.

(Vehicle speed > 5 km/h)

* If installed with keyless entry system



Rear seat belts warning indicator (for rear right position)

This warning tells that the rear passenger at the rear right seat has not fastened the seat belt.



Rear seat belts warning indicator (for rear centre position)

This warning tells that the rear passenger at the rear centre seat has not fastened the seat belt.



Rear seat belts warning indicator (for rear left position)

This warning tells that the rear passenger at the rear left seat has not fastened the seat belt.

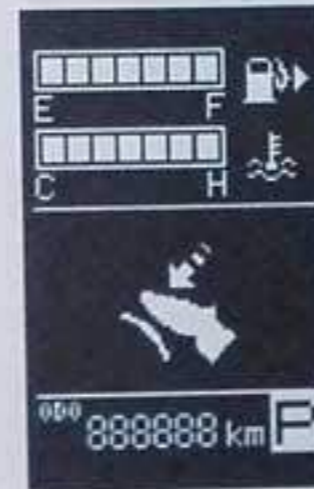

Warning - Press the brake pedal warning (for CVT) *

When the gear lever is in P position and the start stop button is pressed, this display appears. This warning display is shown to remind that the brake pedal must also be pressed to start the engine.

If the brake pedal is not pressed with the gear lever is in P position, the ignition status will be as follow:

OFF → ACC → ON → OFF



This illustration shows the same warning when the ignition is in OFF position.



Warning – Press the clutch pedal (for MT) *

While the gear lever is in N position, pressing the start stop button, this display appears. This warning display tells that the clutch pedal must also be pressed to start the engine.

If the clutch pedal is not pressed with the gear lever is in N position, the ignition status will be as follow:

OFF → ACC → ON → OFF

This illustration shows the same warning when the ignition is in the OFF position.

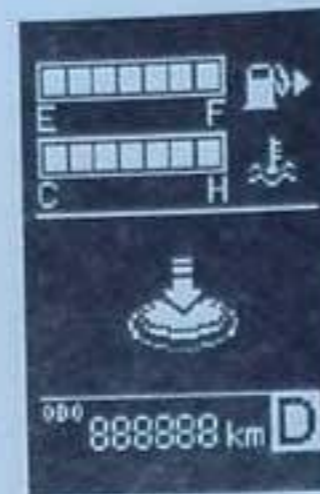

Warning – Press the start stop button *

While the gear lever is in P position, pressing the brake paddle, this display appears. This warning display is shown to tell that the start stop button must also be pressed to start the engine.



This illustration shows the same warning when the ignition is in OFF position.

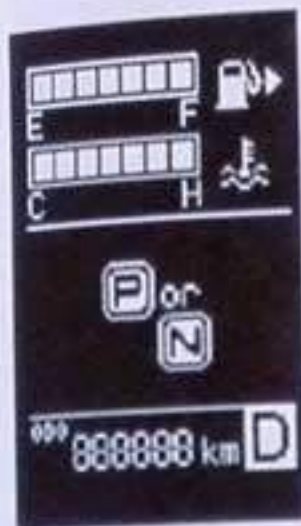

Change the gear to P or N position *

This warning is shown to tell that the gear lever must be changed to P or N position and to press the brake pedal to start the engine.

NOTE

For your safety, start the engine with the gear lever in P position.



This illustration shows the same warning when the ignition is in OFF position.



Stop warning – Change gear to P position *

This warning illuminates to tell that the gear lever must be changed to P position.

If the engine is turned off with the gear not in P position, the engine will turn off but the ignition switch will stay in ACC position.

Put the gear lever in P position. Press the start stop button to completely turn off the vehicle system.

WARNING

Always put the gear lever in P position before turning off the engine to make ensure minimum energy use.

When the ignition is in OFF position, the information display will show this display.



Stop warning – Change gear to R position *

This warning illuminates to tell that the gear lever must be changed to R position.

If the engine is turned off with the gear not in R position, the engine turns off, but the ignition switch stays in ACC position.

Put the gear lever in R position. Press the start stop button to turn off the vehicle system. The system also will lock the gear lever.





Stop warning – Press the start stop button *
 This warning tells that the start stop button must be pressed to completely turn off the vehicle system.

While the gear lever is at the P position, the indicator of the start stop button is **AMBER** colour.



This illustration shows the same warning when the ignition is in OFF position.



Front-left door is open
 This warning light illuminates when the front-left door is opened and the ignition is at any position.



This illustration shows the same warning when the ignition is in OFF position.



Front-right door is open
 This warning light illuminates when the front-right door is opened with the ignition at any position.



This illustration shows the same warning when the ignition is in OFF position.

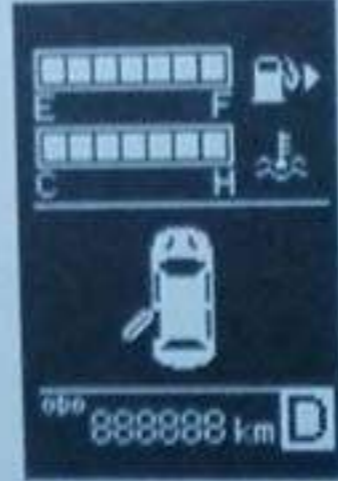

Rear left door is open
 This warning light illuminates when the rear-left door is open with the ignition in any position.



This illustration shows the same warning when the ignition is in OFF position.

* if fitted



Rear right door is open

This warning light illuminates when the rear-right door is open with the ignition in any position.



When the ignition is in OFF position, the information display will show this display.



Front hood is open

This warning illuminates when the front hood is open with the ignition in any position.



This illustration shows the same warning when the ignition is in OFF position.

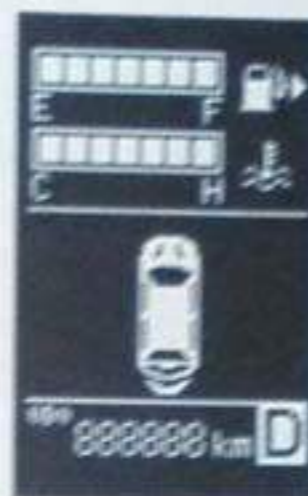

Trunk lid is open

This warning light illuminates when the trunk lid is open with the ignition in any position.



This illustration shows the same warning when the ignition is in OFF position.

Intrusion warning displays

While the system is in arm mode and a person open any door, hood or trunk lid, the alarm system will cause a panic alarm. The system will keep the information on the door, hood or trunk lid that is opened. If a persons open another door, hood or trunk lid, the system will record the information.

If you disarm the alarm system and you open the driver door, the display flashes for 10 seconds. This display shows the location of the door, hood or trunk lid which is opened.



Intrusion warning for front left door



Intrusion warning for front right door



Intrusion warning for rear left door



Intrusion warning for rear right door



Intrusion warning for front hood







Intrusion warning for trunk lid

How to disable the intrusion-warning display
Turning the ignition to ON position will erase all intrusion-alarm records.

Headlamps and Turn Signal Lights Control Switches

OWN005INSCO16007

Indicators	Operations
OFF	All lamps deactivate
AUTO mode *	<p>Put the ignition switch in the ON position.</p> <p>In AUTO mode, the automatic on/off control activates depend on the outside-light level.</p> <p>When automatic on/off control activates, the headlamps, position lamps, rear tail lamps, license plate lamps and instrument panel will automatically illuminate.</p> <p>NOTE When the ignition switch is turned to OFF position, all lamps will automatically turn off.</p>
	The position lamps, tail lamps, license plate lamps and instrument panel illuminate.
	The headlamps and other lamps illuminate.
	Front fog lamp illuminates.
	Rear fog lamp illuminates.

NOTE

- (1) On vehicles that have the Rain Light sensor (RLS), can be adjusted the sensor setting of the automatic on/off control. For more information, contact your authorized PROTON service outlet.
- (2) When the automatic on/off control deactivates the headlamps, the front fog lamps will deactivate. When the automatic on/off control activates the headlamps, the front fog lamps stay deactivated. Operate the switch to activate again the front fog lamps.

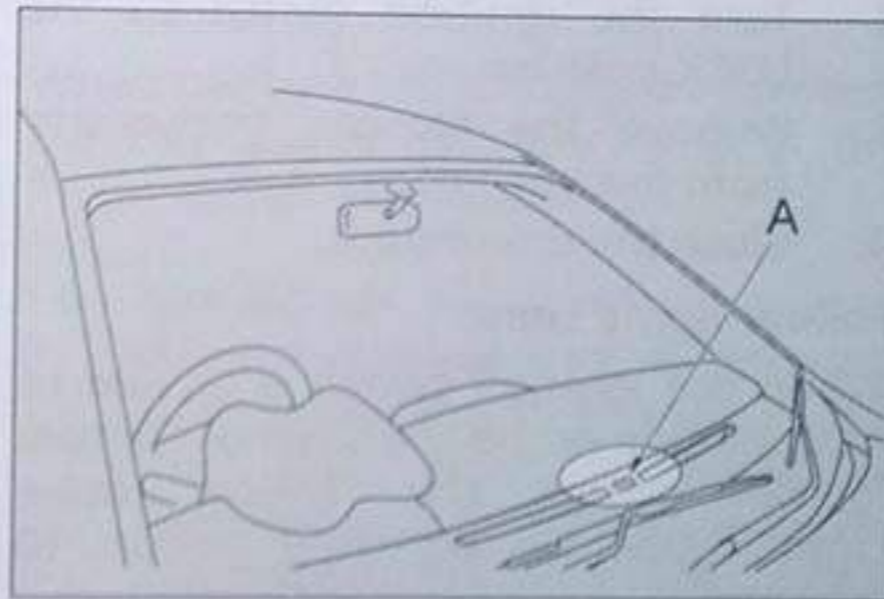

DOIRW005R14048

- (3) Do not put object to the windscreen that cover the sensor (A) for the automatic on/off control.
- (4) If the switch in the AUTO position and the lamps do not turn on or turn off, manually operate the switch. Send the vehicle to and authorised PROTON service outlet for inspection.

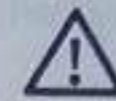

WARNING



When the engine is not in operation, make sure to turn off the lamp. Continue use of the lamps will weaken the battery.

NOTE

During wet-weather conditions or when cleaning the vehicle, a mist can fill the inner surface of the lens. Turn on the headlamps to clean the mist. The heat from the bulb will clear the mist. If the water collects in the lamp, go to an authorised PROTON service outlet for inspection.

- To align the light beam for the lamp, send your vehicle to the nearest PROTON service outlet for calibration.

How to let the lamps stay illuminated:

1. Turn the lamp switch to the OFF position while the ignition switch is in the LOCK or ACC position.
2. Turn the lamps switch to the position of  or  again, the headlamps will illuminate.

The lamp buzzer (For vehicle without start stop button)

When leaving the lamp turned on, the buzzer makes a high-pitch sound at intervals. Turn off the ignition, remove the key from the ignition switch. Open the driver door.

The multiple information display will show this warning display:



The buzzer can be deactivate as follows:

1. Turn the lamp switch to the OFF position
2. Remove the key from the ignition switch.
3. Close the driver door.

The lamp buzzer (For vehicle with start stop button)

When leaving the lamp turned on, turn off the ignition and open the driver door, the buzzer will make high-pitch sound at an intervals.

The multi-information display will show this warning display.



The buzzer can be deactivated as follows:

1. Turn the lamp switch to the OFF position.
2. Turn the ignition switch to the LOCK position.
3. Remove the remote transmitter from the key slot.
4. Close the driver door.

Follow Home Light

When the ignition switch is turned to ACC position or the key is removed from ignition switch, the "Follow Home Light" must be activated within 10 minutes.

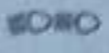
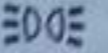
1. Operate the headlamp combination lever and follow this sequence in 2 seconds:
OFF →  or  > OFF
2. Make sure all doors are closed. The headlamps will illuminate for 30 seconds.

High/Low beam change

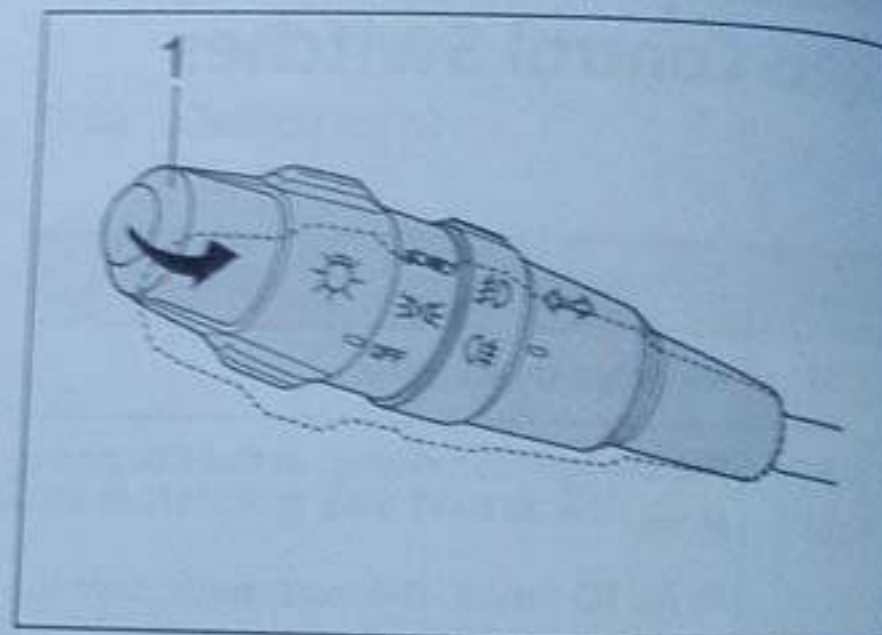

DOITW005R16068

From low beam to high beam

When the light switch is in the  position and the lever pulled to (1) for more than 2 seconds, the beam changes from low to high. While the high beam illuminates, the high beam indication

lamp  in the meter cluster will illuminate.

When the lever is pulled to (1) again, the high beam changes to the low beam.

Headlamps flasher

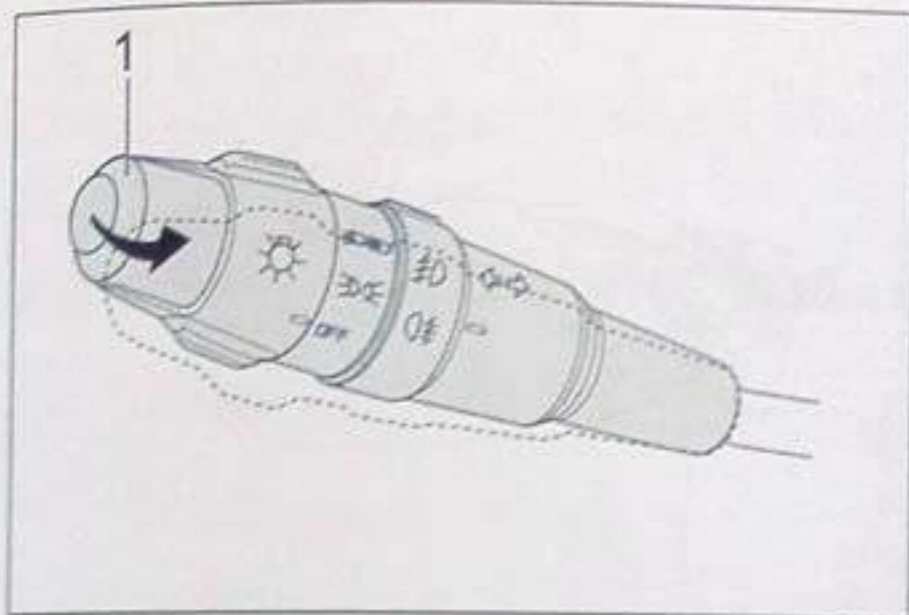

DOITW005R16069

When the light switch is at the OFF or  position and the lever is pulled to (1), the headlamps flash.

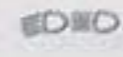
When the light switch is at the "  position, pull the lever to (1) two times, to make the headlamps flash.

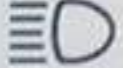
When the high beam illuminates, the high beam indication lamp  in the meter display will illuminate.

Turn or lane change signals

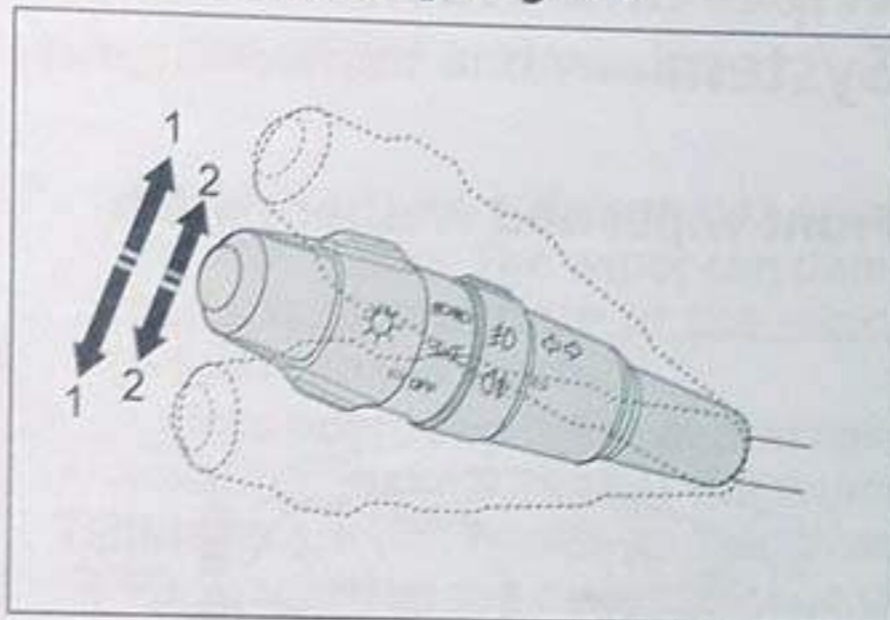

DOITW005R16070

When the ignition switch is in the ON position, push the lever up or down.

When the turn signal lamp is activated, the turn signal indicator lamp in the meter cluster also flashes.

1 - Turn-signals

Making a normal turn, use this position. When the turn is done, the lever will return automatically. There are situations when the lever may not return after a turn is done. For example, when making small turn. If this condition occurs, manually return the lever.



2 - Lane-change signals

When changing a lane, make a small push on the lever and immediately release the lever and immediately release the lever. The turn-signal lamp flashes five times.

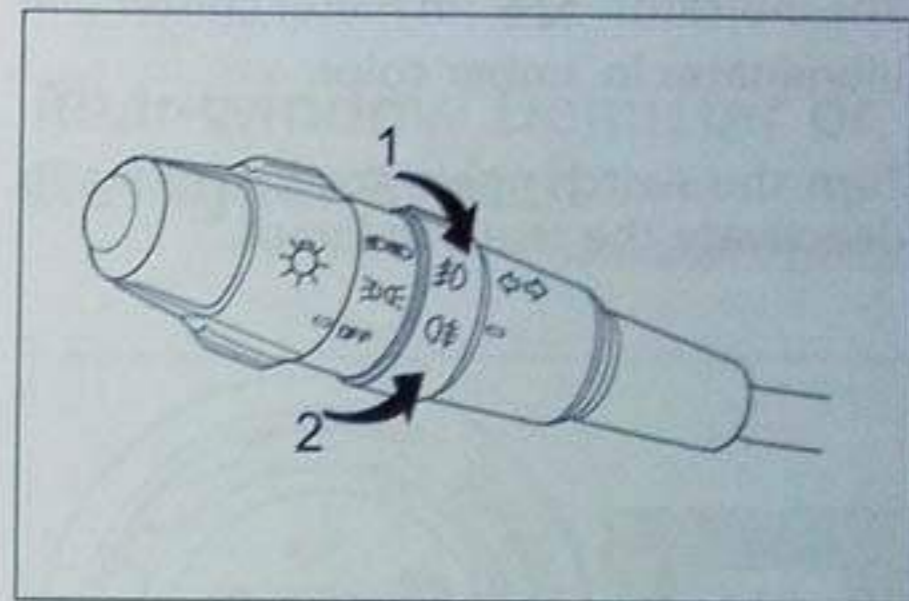
Front and rear fog lamps *



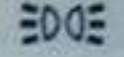

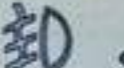
DOITW005R16071

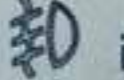
When the light switch is at  position or  position, turn the front fog lamp  switch to the centre (as shown in illustration) to activate the front fog lamps.

The indicator  in meter cluster will illuminate in green color.

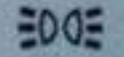
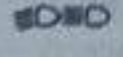
Turn the switch again to the centre to deactivate the front fog lamps.

When the light switch is at  position or  position, turn the rear fog lamp  switch to the centre (as shown in illustration) to activate the rear fog lamps.

* if fitted

The indicator  in meter cluster will illuminate in amber color.

Turn the switch again to the centre to deactivate the rear fog lamps.

Wiper and Washer Control System

OWN005INSCO16008

Front wiper and washer switch

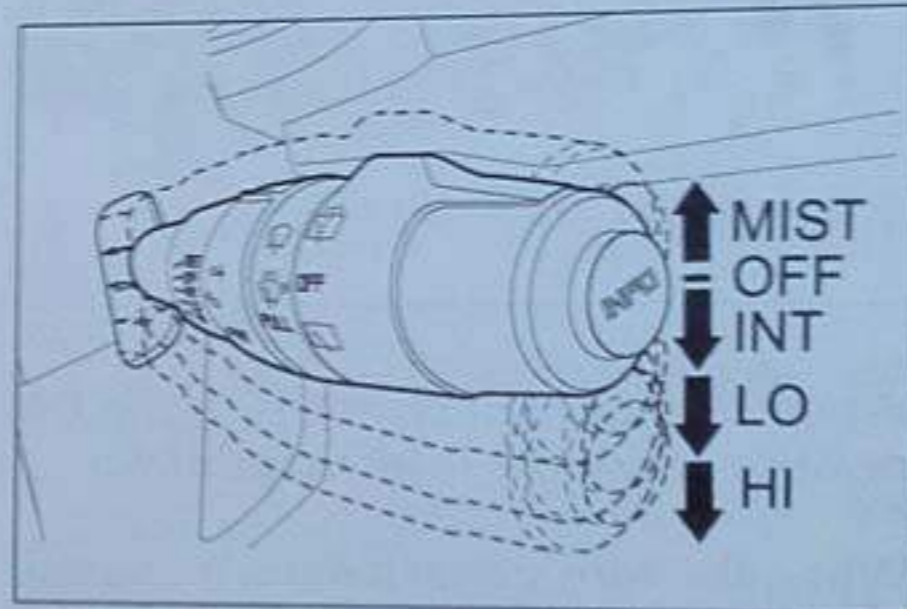

DOIRW005R14009

NOTE

The windscreen wipers can be activated if the ignition switch or the start stop button is in the ON position.

Indicators	Operations
MIST	The wiper operates one time.
OFF	Off
INT *	The wiper operates at a specified interval cycle
LO	The wiper operates at slow speed
HI	The wiper operates at high speed

MIST function

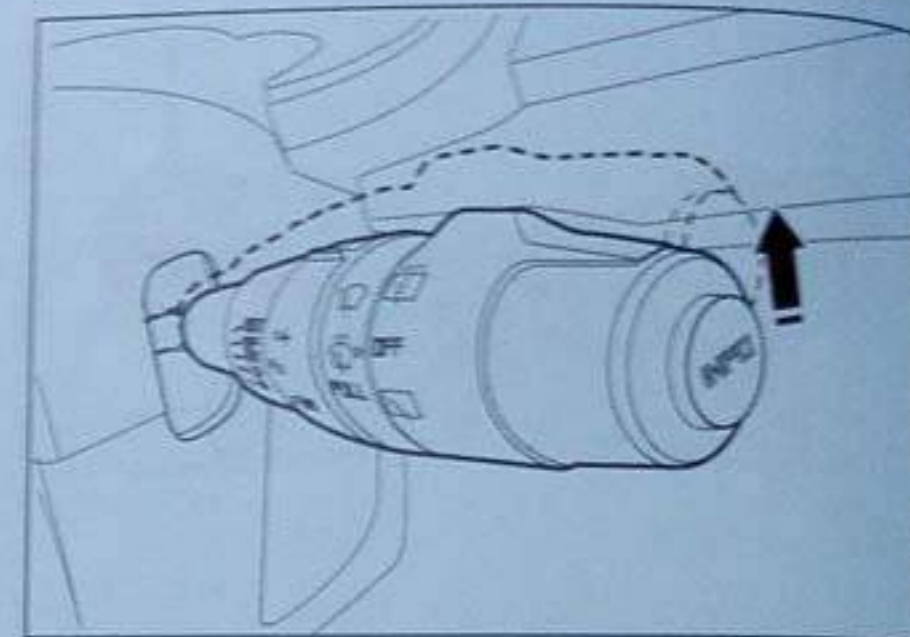

DOIRW005R14012

Move the lever in the direction of the arrow and release. The wipers will operate once. Use this function when driving in mist or rain.

If the lever is moved to the MIST position and release, the wiper will operate once. The wipers continue to operate if the lever is held in the MIST position.

INT function*

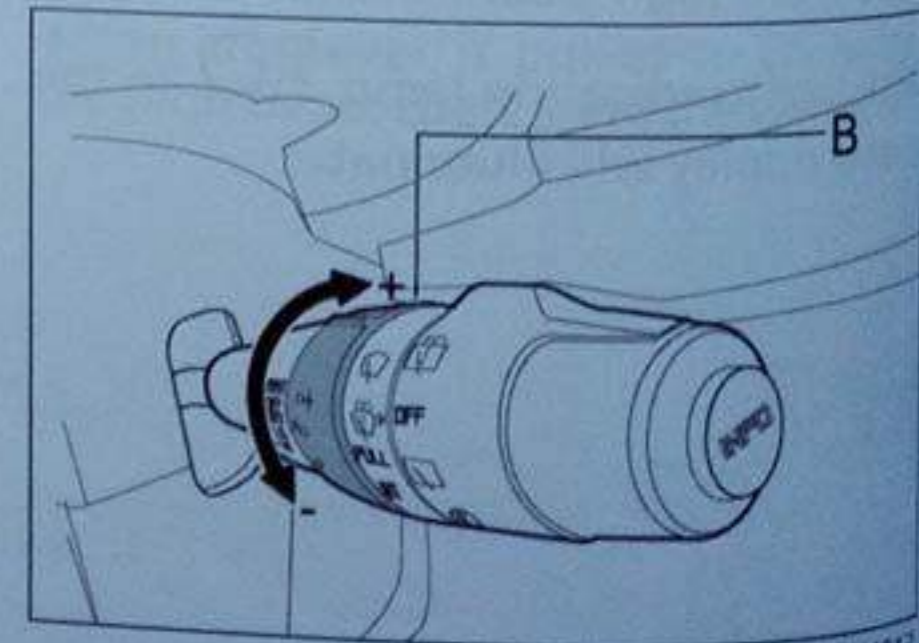

DOIRW005R14013

When the switch (B) is turned to INT position, the wiper operates at a specified interval cycle. The wiper will start a wipe cycle and pause according to the set interval delay.

Adjust the interval time in INT position

"+" : Longer interval delay

"-" : Shorter interval delay

Turn the switch (B) to adjust the interval delay time.

Front windscreen washer

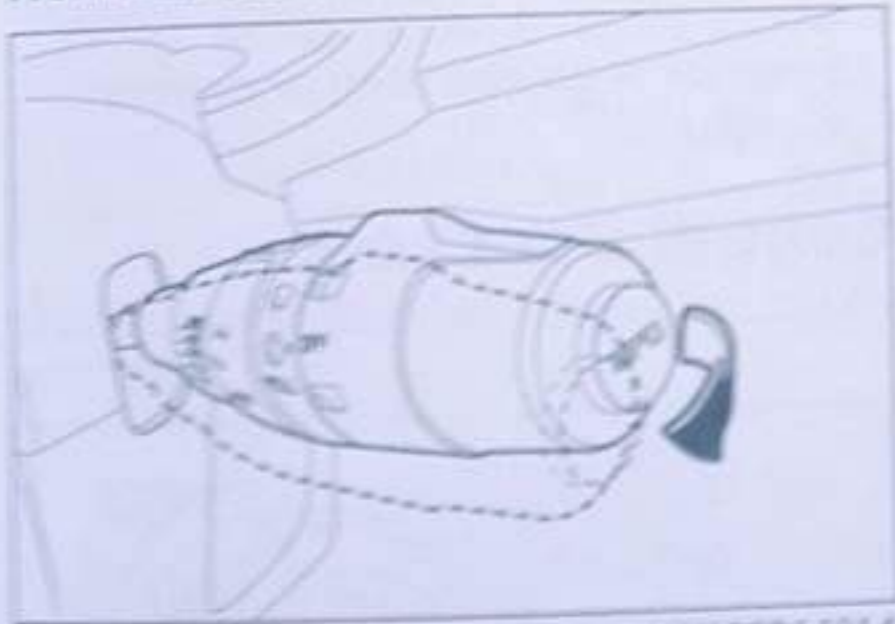

DOIRW005R14014

Pull the lever. The washer will continue to spray a washer fluid onto the windscreen and the wipers will continue to operate until the lever is released.

Follow these precautions when using the wiper and washer

1. When the glass is dry, do not operate the wipers. The wiper can damage the glass surface or the wiper blades can get worn.
2. Before operating the wipers in cold weather, make sure that the wiper blades are not frozen to the glass. This condition can cause damage to the motor.
3. Do not use the washer continuously for more than 20 seconds. Do not operate the washer if there is no washer fluid in its reservoir. These conditions can cause damage to the pump.
4. Regularly check the level of washer fluid in the reservoir. If the fluid level is low, add some washer fluid.
5. During cold weather, make sure to add a recommended washer solution that will not freeze in the washer reservoir. The wrong washer solution can cause damage to the system components.
6. During cold weather, make sure the washer fluid does not freeze on the glass.
7. If the wiper stops moving because of ice or other particles on the glass, do not turn the wiper lever to OFF position. Park your vehicle in a safe area. Turn off the ignition and clean the particles from the

glass until the wipers operate correctly.

Rear-window Demister or Defogger Switch

OWN005INSCO16009

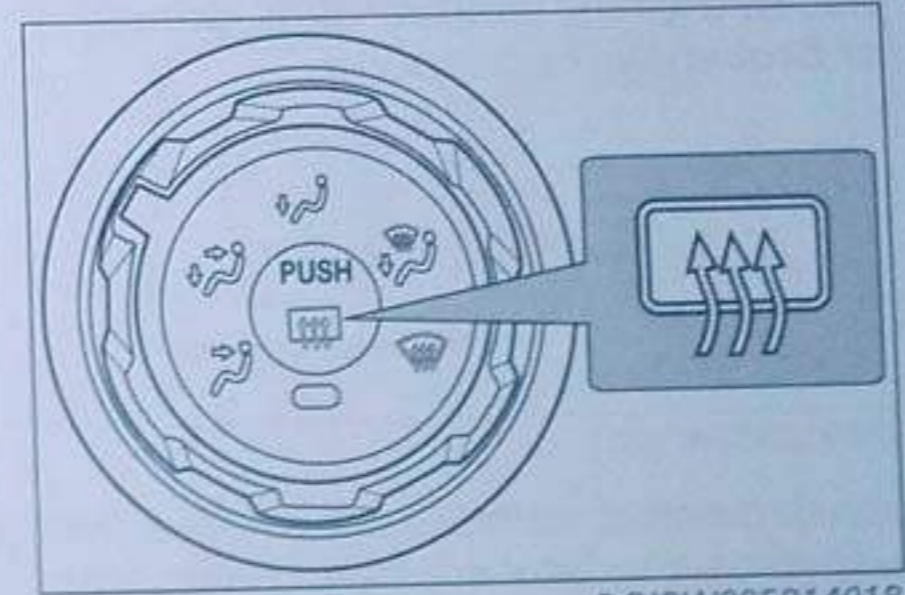

DOIRW005R14018

When the engine is in operation, the rear-window demister or defogger can be activated.

Press the switch to turn on the rear-window demister or defogger. When the demister or defogger operates, the indicator lamp will illuminate.

To turn off the demister or defogger, press the switch again.

If the demister or defogger is not turned off, this function will turn off automatically in approximately 20 minutes.

NOTE

- Use a soft-cleaning cloth to clean the inner side of the rear-window and clean lightly along the heater wires. Be careful to prevent damage to the wires.
- Do not let any objects touch the inner side of the rear-window glass. Damaged or broken wires can occur.

Hazard Warning Flasher

OWN005INSCO16010

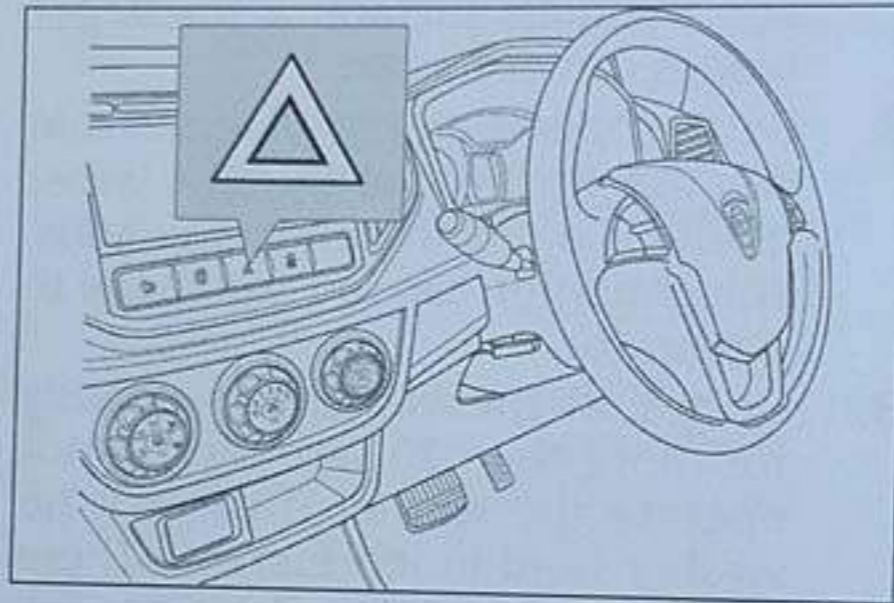
Hazard warning flasher switch

DOITW005R16007

The hazard warning flasher can be activated, regardless of the ignition switch position.

Press the switch to turn on the hazard warning flashers. Press the switch again to turn off the hazard warning flashers.

When activating the hazard warning flasher, all turn-signal lamps flash continuously. The turn-signal indicator lamps in the instrument panel will also flash.

CAUTION

If the lights continue flash for a longer period, more battery power

is used. When the battery is weak or flat, the engine may not start.

Purpose of hazard warning flasher

Use this hazard warning to inform drivers behind of hazards in front.

CAUTION

Do not use the hazard warning while driving. Driving with the activated hazard warning is very dangerous.

When the hazard warning is activated, other drivers cannot be informed of any turning or change in direction.

Central Door Lock

OWN005INSCO16011

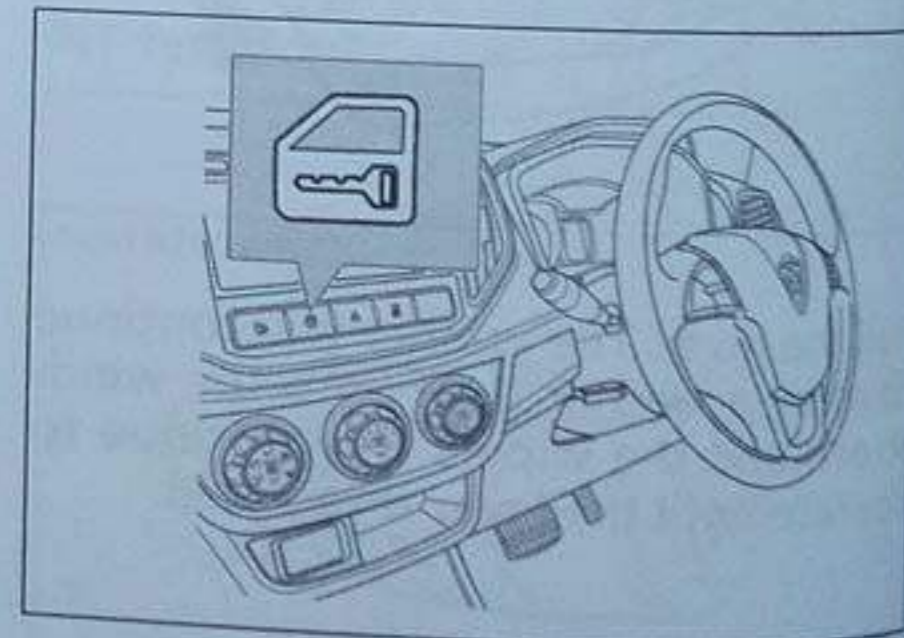

DOITW003R16009

The switch of the Central Door Lock is in the centre of the instrument panel.

When this switch is pressed, the system locks or unlocks all doors.

Room Lamps OWN005INSCO16012

Room lamp switches

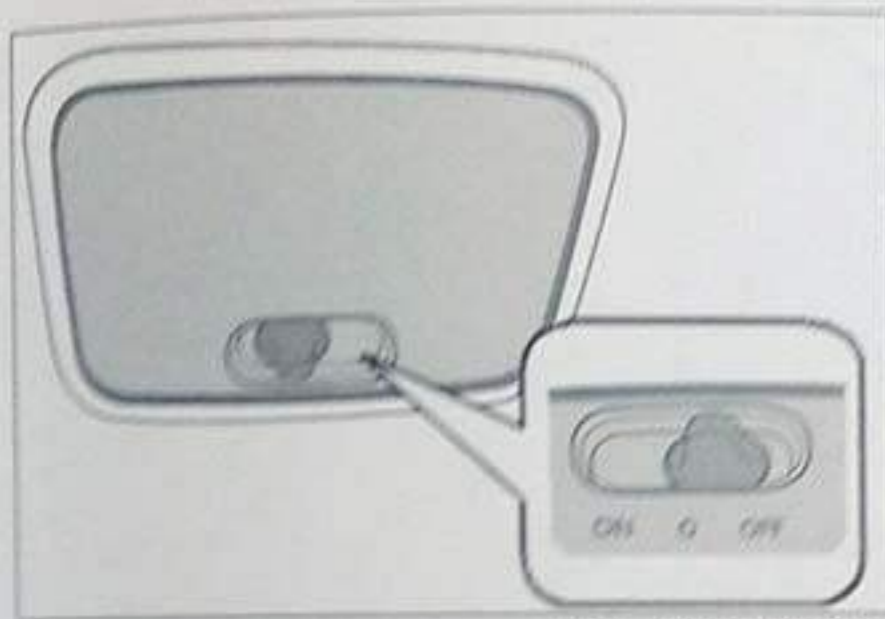

DOINW005R09021

The switch for the room lamp has three positions.

- (OFF) - The lamp is not illuminated.
- (DOOR) - When any door is opened, the room lamp illuminates. When you close all doors, the room lamp turns off.
- (ON) - The lamp illuminates.

NOTE

When the switch is at the DOOR position, the room lamps operate as follows:

- (1) If the door is closed while the engine is in operation, the lamp gradually turns off.
- (2) If the door is closed with the ignition in the OFF position, the lamp gradually turns off after 30 seconds.

Courtesy light

When the remote transmitter is operated, the interior lamps will gradually illuminate. The bright level gradually increases for 2.8 seconds and gradually decreases for 3.4 seconds.

NOTE

- (1) Do not leave the room lamp illuminated when the engine is not in operation.
- (2) If is not turned off the room lamp, the lamp automatically turns off 20 minutes when the vehicle is locked.

Headlamps Leveling Switch *

OWN005INSCO16017

97

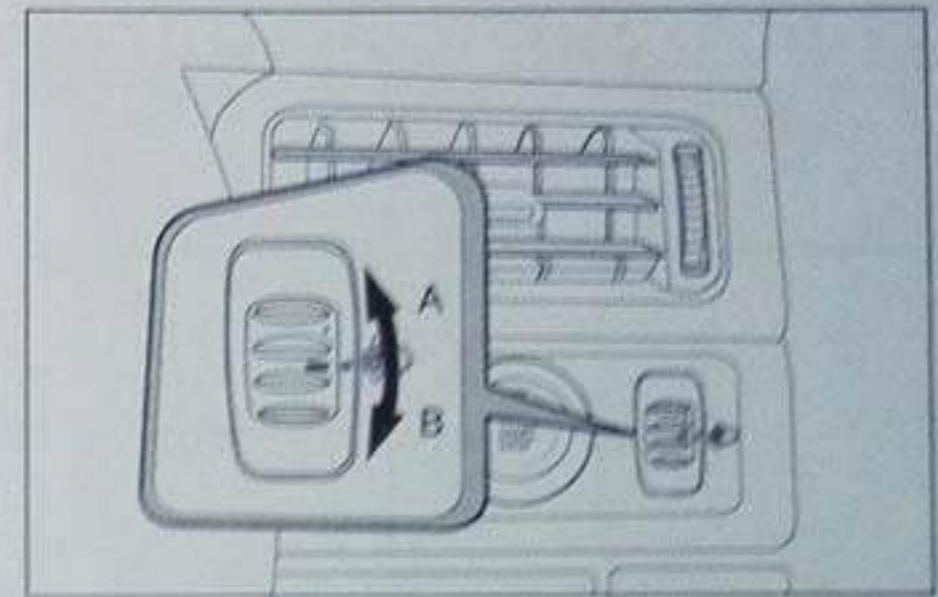

DOITW006R16006

The angle of the headlamps beam varies depending upon the load carried by the vehicle.

The headlamps leveling switch can be used to adjust the headlamps illumination distance (when the lower beam is illuminated) so that the headlamps' glare does not distract the drivers of approaching vehicles.





Set the switch by turning the rotary dial to make an adjustment;

A – Up

B – Down

Refer to the following table to the appropriate position according to the number of people and the load in the vehicle.

* if fitted

Vehicle condition	Switch position
	"0.0"
	"0.0"
	"1.0"
	"1.5"
	"3.0"



: 1 person [about 75 kg (750 N, 165.4 lbs)]

Max load up to 1829 kg.



: Luggage up to max rear axle means weight on rear axle up to 790. kg (7900 N, 1742 lbs)

Starting and Driving

Break-in Period	100
Recommended Fuel	100
Economical Driving	101
Engine Ignition Switch	102
Start Stop button	103
Starting	106
Continuous Variable Transmission (CVT)	107
Manual Transmission (MT)	110
Gear Shift Lever Lock	110
Parking Brake	112
Braking	113
Brake Systems	114
Steering Wheel Height Adjustment	117
Electric-power Steering (EPS)	118
Maniverter	118
Drive-by-wire and Driver Safety	119
Inside rear-view Mirror	119
Side-view Mirrors	119
Parking Aid System	121



Break-in Period

OWN006START16001

Break-in period is the period in which the new vehicle is operated according to certain limits. During the first 1000 km of operation, these precautions must be followed:

1. Do not operate the engine at high rpm.
2. Prevent sudden acceleration, sudden brake and extended high-speed operation.
3. Keep the speed of your vehicle to the speed limit (during break-in period) shown in table.
The approved speed limits shown must be followed.
4. Do not load more than the specified limits.
5. Do not tow another vehicle that is larger than your vehicle.

NOTE

Following these precautions will ensure the vehicle's fuel efficiency and performance are at optimum level.

Speed limit (during break-in period):

Vehicle with Continuous Variable Transmission (CVT)

Drive range	Speed limit (km/h)
"L" (LOW)	25
"D" (DRIVE)	90

Vehicle with Manual Transmission (MT)

Drive range	Speed limit (km/h)
1st	25
2nd	50
3rd	70
4th	90
5th	110

CAUTION

The above data of speed limit is for the user's guide.

Always follow the speed limits according to the limit set by the local authority.

Recommended Fuel

OWN006START16002

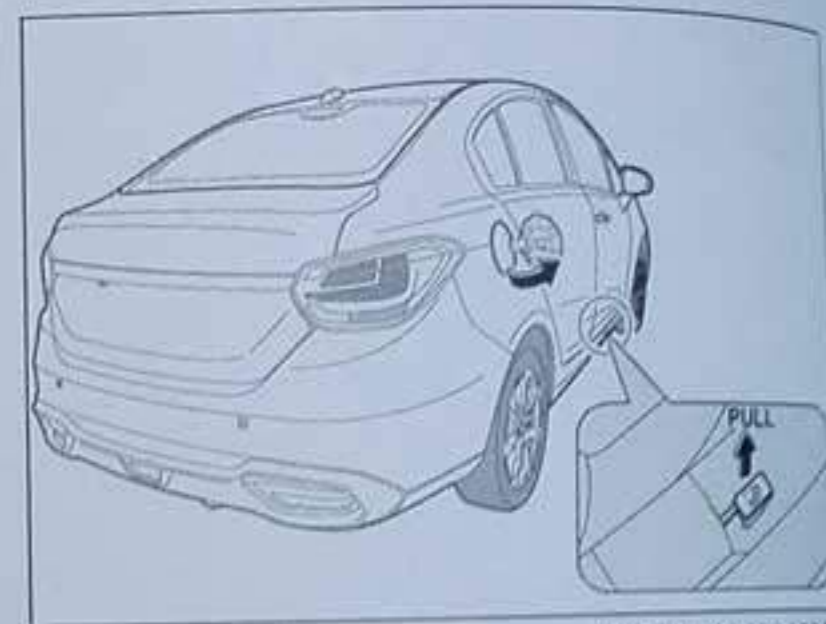

DOITW006R16001

Fuel specification

Refer to page 176.

Refuel

1. Before fuelling, switch off the engine.

CAUTION

Fuel is an explosive and flammable material. Keep any flames away from the fuel. Do not smoke.

2. Use the release lever next to the driver seat to open the fuel filler door.
3. Put the nozzle of the fuel filler into the port of the fuel tank until it stops.

4. After the automatic first stop, do not continue fill in more fuel. Disengage the fuel filler from the port of the fuel tank.

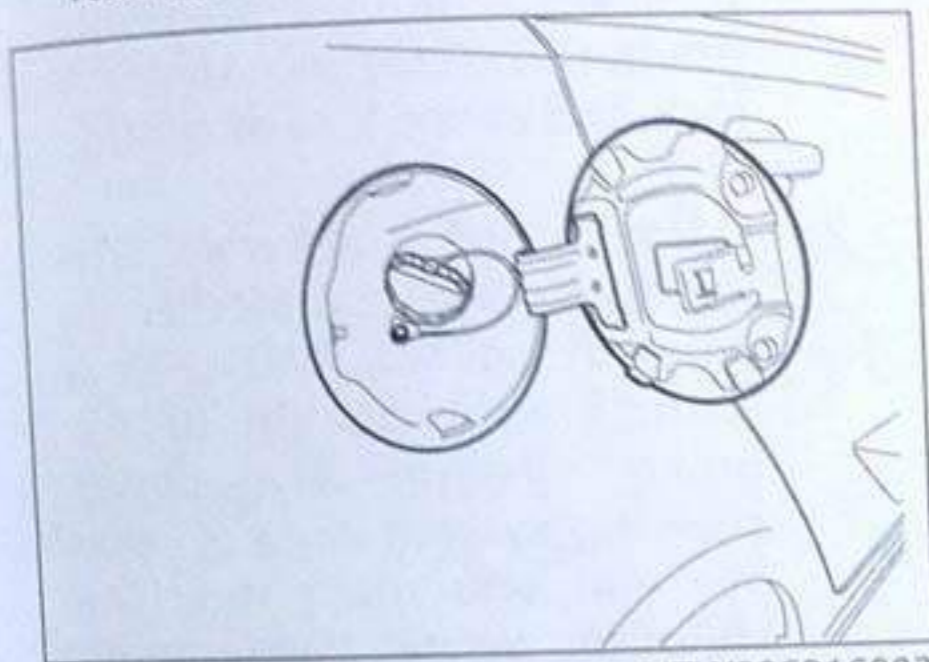

DOITW006R16002

5. Install the tank cap. Turn the tank cap to the right until tighten.

CAUTION

- (1) There is a label indicates **UNLEADED FUEL ONLY** on the fuel filler lid of this vehicle.

This vehicle has a fuel filler tube that can accept a smaller diameter nozzle of an unleaded fuel filler. Do not use the leaded petrol type of fuel. Leaded petrol can damage the system of emission control, decrease the performance of the acceleration and increase the fuel consumption.

- (2) Do not let fuel spill on the exterior surfaces of the vehicle. The fuel can cause damage to the paint.

USE UNLEADED PETROL ONLY

Economical Driving

OWN006START16003

The requirement for low fuel consumption is a correctly adjusted engine. You can extend the life of your vehicle and get the most economical operation, Send your vehicle to an authorised PROTON service outlet at according to the recommended periodical service maintenance.

The level of fuel consumption and the generation of exhaust gas and noise are very related to how you drive. Monitor precautions below to reduce the wear of brakes, tyres and engine.

1. Starting

Prevent sudden acceleration. Sudden acceleration can cause higher fuel consumption.

2. Shifting

Change your gear only at the correct speed and engine speed. Always use the highest gear when driving at high speed.

3. City traffic

Frequent start and stop increases the level of fuel consumption. Use the roads with smooth traffic flow. When you use a congested roads, do not use the low gear with high engine speeds.

4. Idling

This vehicle uses fuel in idle position.

5. Speed

This vehicle uses more fuel at higher speed. Do not drive at full speed.

6. Tyre inflation pressure

Check the pressure of the tyres at regular intervals. Tyres with low pressure can increase the resistance of the tyre to the road and the fuel consumption. Tyres with low pressure cause the wear of the tyre and cause a change in the driving stability.

7. Load

Do not store unnecessary objects in the luggage compartment and on the roof. When you drive in a city where frequent stop and start is necessary, the increased weight of the vehicle will have a large effect to the level of fuel consumption. The increased air resistance caused by objects on the roof will also increase level of fuel consumption.

8. Cold engine starting

This vehicle uses more fuel when you start a cold engine. This vehicle uses more fuel if the hot engine is

put in idle position. After the engine has started, drive immediately.

Engine Ignition Switch *

OWN006START16005

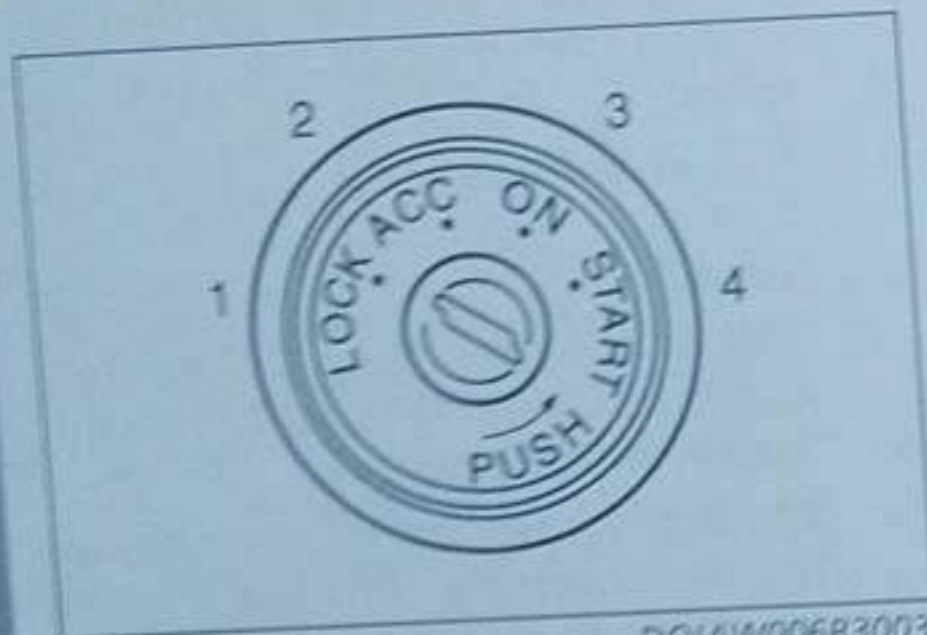

DO1AW006R3003

How to start the engine

- 1 - When the engine is not running and the steering wheel is in the LOCK position, insert the key into the ignition switch.
- 2 - When the ignition switch is put into the ACC position, some instruments for example radio will operate.
- 3 - When the engine starts, all electrical systems will operate.
- 4 - When the ignition switch is put into the START position, the starter motor will operate and start the engine. After the engine has started, release the key and the key will automatically return to the "ON" position.

* if fitted

How to stop the engine and remove the key

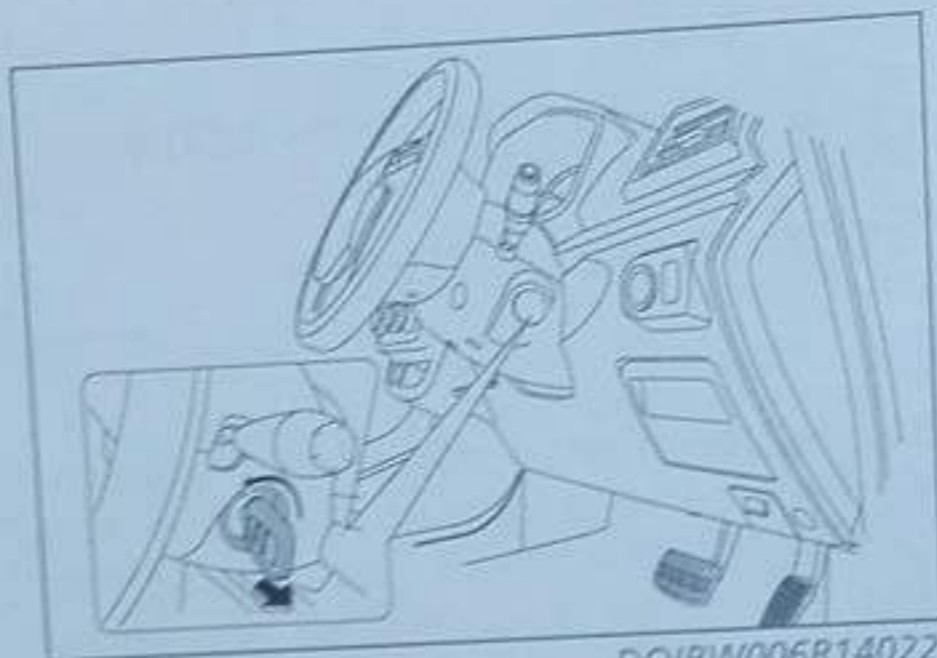

DOIRW006R14022

1. Turn the ignition switch into the ACC position to stop the engine.
2. When the ignition switch is in the ACC position, push the key in and turn to the LOCK position. Remove the key.

Ignition key reminder

When the key is in the LOCK or the ACC position and the driver's door is opened, you will hear the interval sounds from the meter cluster as a reminder to remove the key from the ignition switch. The Information display at the meter cluster will indicate the "Key Left In" warning. Refer to topic on page 81 to 91.

When the ignition key is removed, the sound and the multi info display will stop.

CAUTION

- (1) Do not remove the ignition key from the ignition switch while driving. The steering wheel will lock and cause loss of control.
- (2) If the engine stops while driving, the brake servomechanism will not operate and cause a reduction in quality of the brake system. The power steering system will not operate and you must steer the steering wheel with more force.
- (3) When the engine does not operate, do not leave the ignition switch in the ON position. The battery of the vehicle will discharge.
- (4) When the engine does not operate, do not put the ignition key to the START position. The starter motor or starter ring gear may be damaged.
- (5) In certain temperature conditions, the radiator fan may continue to operate for while after the engine has stopped.

How to lock and unlock the steering wheel *

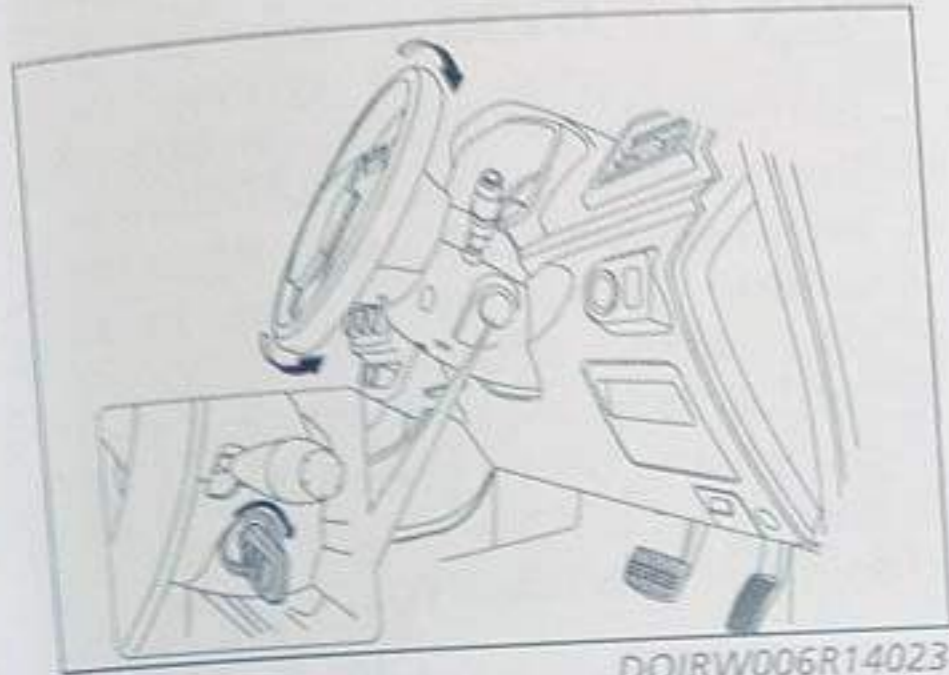

DOIRW006R14023

To lock

While in the LOCK position, remove the key from the ignition switch. Turn the steering wheel (to the left or right) until the steering wheel locks.

To unlock

Make a small degree turn on the steering wheel away from its lock position to unlock the lock pin of the steering wheel and put the ignition switch to the ACC position to completely release the wheel.

CAUTION

When you leave the vehicle, remove the key.

Start Stop button *

OWN006START16006

Operation of start stop button

Start the engine

- 1 - Make sure the remote transmitter is inside the cabin area. There is an immobilizer code inside the remote transmitter.

NOTE

The operation range to start is as shown in the illustration;

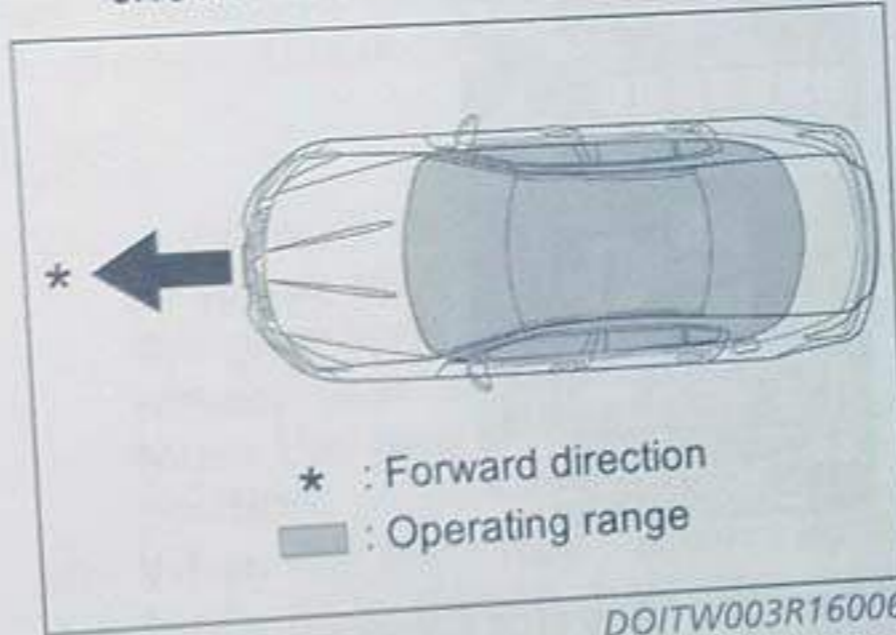

DOITW003R16006

- 2 - Put the gear shift lever in the P position.
- 3 - Press the brake pedal and press the start stop button.

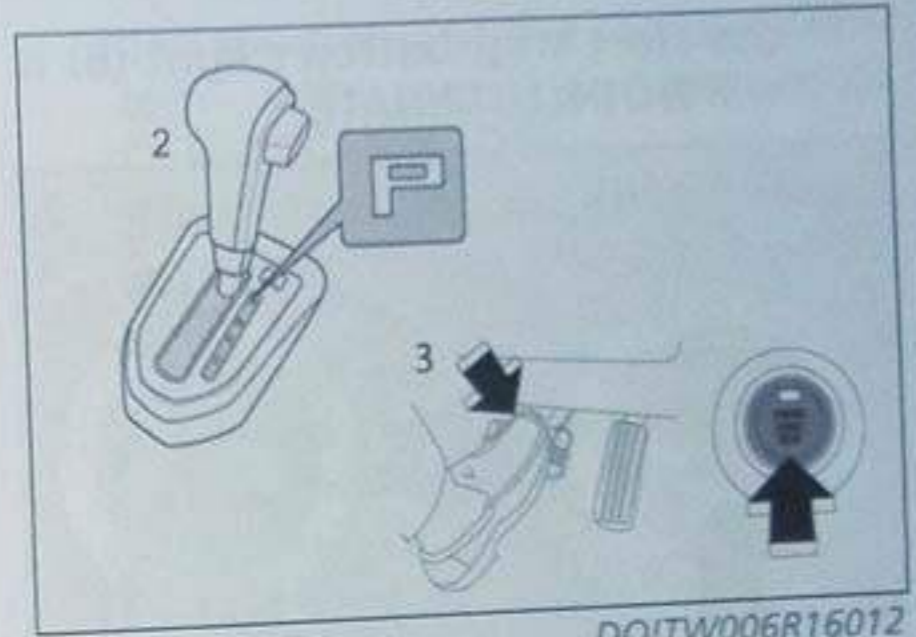

DOITW006R16012

NOTE

If the engine does not start, repeat the procedure of "Start the engine".

Turn OFF the engine and the complete system

- 1 - Put the gear shift lever to the P position.



DOITW006R16014

- 2 - Press the start stop button (A). When the system is in OFF mode,

* if fitted

the start stop button's light (B) is will NOT ILLUMINATE.

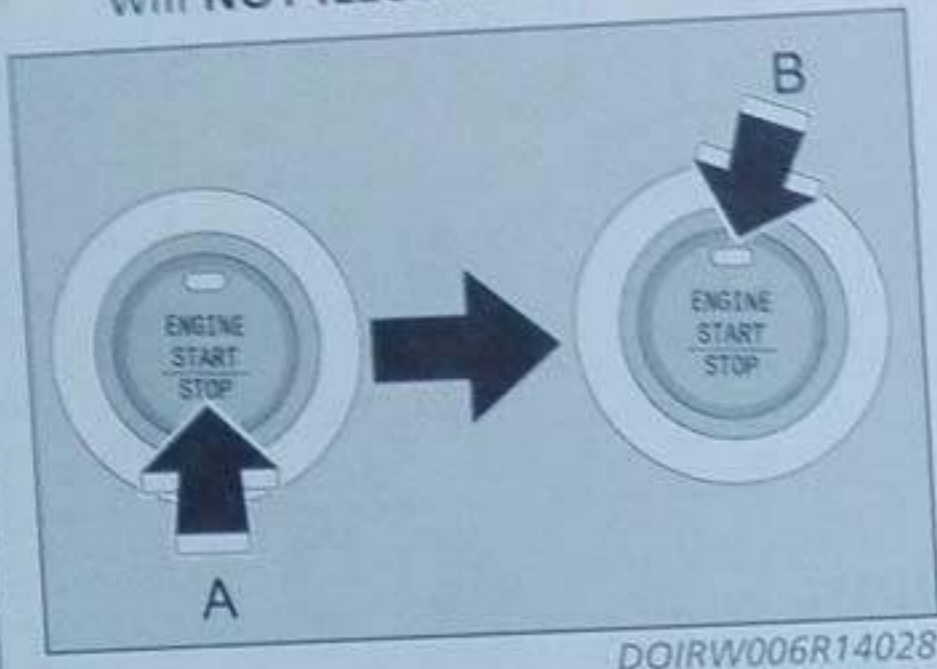

Turn OFF the engine and the complete system in other gear positions

To park the vehicle with the gear in the other gear positions, do the following:

NOTE

Always apply the parking brake when parking for safety.

- 1 - Park on a flat ground.
- 2 - While the engine is idling, put the gear shift lever in N (Neutral) position.
- 3 - Press the start stop button to turn off the engine.

NOTE

When the engine is off, the gear shift lever can also be placed in R, D or L position.

- 4 - Make sure the driver's door and the other doors are closed.
- 5 - From outside of the vehicle, press

the LOCK  button on the remote transmitter to stop the complete system.

Key Not Detected Warning



When the 'Key Not Detected' warning lamp appears when starting the engine, do the following:

- 1 - Put the remote transmitter at the floor console area.
- OR
- 2 - Put the remote transmitter at the top surface of the start stop button.

EMERGENCY STOP

 CAUTION

EMERGENCY STOP: You can turn off the running engine (START/RUN) or vehicle power (ON), only when the vehicle is not in motion. In an emergency situation when the vehicle is in motion, you can turn the engine off by pressing the start stop button for more than 5 seconds or 5 times consecutively.

Illuminated start stop button

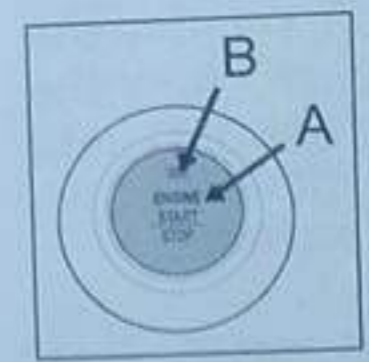

When the front door is opened, the start stop button's light (A) illuminates.

The start stop button's light (B) indicates the current status of the system of the vehicle. Understand the following descriptions described in the topic "Start stop button status" before operating this system.

Start stop button status

Status : OFF

When the complete system is in OFF mode, the start stop button's light (B) will NOT ILLUMINATE.

NOTE

When the driver's door is opened and the buzzer sounds, warning that the complete system has not turned off. Press the start stop button again. The buzzer will stop and the complete system will turn off.

Status : ACC (Accessory)

When the complete system is in OFF mode, press the start stop button. The complete system turns to ACC mode.

When the complete system is in ACC mode, the start stop button's light (B) turns to AMBER.

All electrical accessories are activated.

Do not leave the complete system in the ACC mode. The vehicle battery can get weak because the engine is not running to charge the battery.

Status : ON

When the complete system is in ON mode, the start stop button's light (B) turns to AMBER colour.

The gear shift lever can be moved.

During the first ON mode, the pre check warning light will appear on the meter cluster.

Do not leave the complete system in the ON mode. The vehicle battery can get weak because the engine is not running to charge the battery.

Status : START/RUN

To start the engine, press the brake pedal. The start stop button's light (B) turns to GREEN to indicate that the engine is ready to start. Press the start stop button to start the engine

NOTE

- (1) If the start stop button's light (B) does not turn to GREEN, possibly the gear shift lever is not in the correct gear to start the engine. Move the gear shift lever to the P position.
- (2) When the start stop button's light (B) turns to GREEN, press the start stop button to start the engine. After the engine has started, the start stop button's light (B) will not illuminate.
- (3) For safety, start the engine with the gear shift lever in the P position.
- (4) If the start stop button is pressed without pressing the brake pedal while the gear shift lever is in the P position, the engine will not start

and the status of the complete system will move in sequence: OFF→ACC→ON→OFF

- (5) If the start stop button is pressed without pressing the brake pedal while the gear shift lever is in N, R or D position, the engine will not start and the ignition will remain in ACC mode.

WARNING

- Do not press the start stop button when the vehicle is in motion. This vehicle will lose its directional control and brake function, which may cause an accident.

- Do not reach the start stop button or any other control buttons through the steering wheel while the vehicle is in motion. Your hand or arm in the area can cause loss of vehicle control, and result in injuries.

- Do not attach any loose objects around the driver's seat. Loose objects can move while driving, causing interference to the driver and resulting in an accident.

Starting

OWN006START16004

How to start the engine

Refer to the instruction to start on page 102 (for vehicle with engine ignition switch) and page 103 (for vehicle with Push-Start button)

General tips and warnings

1. This vehicle has an electronically controlled fuel injection type of system. When you start the engine, do not press the accelerator pedal.

CAUTION

- (1) Do not push or tow to start the vehicle.
- (2) Do not operate the engine at high rpm or drive the vehicle at high speed until the engine has reached its correct temperature.

2. Do not operate the starter motor continuously for longer than 10 seconds. This action can weaken the battery.
(In case of vehicle without start stop button) If the engine does not start, turn the ignition switch back to the "LOCK" position, wait for a few seconds and then try again.

3. If the engine does not start because the battery is weak or flat, refer to the "Emergency Jump-start" topic on page 141 for instructions to start the engine.
4. **Always ensure the engine temperature has reached optimum level before driving.** Operation with correct engine temperature will extend your vehicle engine life and make sure smooth operation of your vehicle.
5. Monitor the coolant temperature gauge from the meter cluster for the correct temperature for the engine of this vehicle.
The optimum engine temperature for operation of this vehicle is



6. When the engine temperature increases, the pointer of the coolant temperature gauge starts to move (the engine idle speed decreases). When the temperature the engine reach its correct temperature, drive this vehicle immediately to prevent additional fuel consumption.

WARNING

Do not keep the engine running in poorly ventilated areas when moving in or out.
The Carbon monoxide from the exhaust is odourless and can cause loss of life.

Flooded engine

When the air-fuel mixture inside the combustion cylinder of the engine exceeds the top explosive limit for the type of fuel. An engine in this condition will not start until the additional mixture is cleaned.

In this situation, first, operate the starter for 5 to 6 seconds while fully pressing the accelerator pedal, then start the engine without pressing the accelerator pedal.

At extreme cold ambient temperature

If the engine won't start, press the accelerator pedal about halfway during cranking. Once the engine starts, release the accelerator pedal.

Starting in extreme cold ambient temperature at high altitude (Above 1,500 metres / 5,000 feet)

If the outside temperature is less than freezing temperature or if the vehicle was not driven a number of days, start the engine and increase the engine temperature until the optimum operating temperature is reached.

Engine stops

CAUTION

If the engine stops while the vehicle is in motion, do not try to move the gear shift lever to the P (Park) posi-

tion (for CVT model). If the condition of the traffic and the road permit, put the gear shift lever in the N (Neutral) position while the vehicle moves and press the Push-Start button to restart the engine.

Drive your vehicle immediately to the authorised PROTON service outlet for inspection.

Continuous Variable Transmission (CVT)

OWN006START16007

The CVT changes the gear ratio automatically to adjust the driving conditions of the vehicle and gives smooth-and-shock-free operation and best fuel efficiency.

Gear shift lever operation

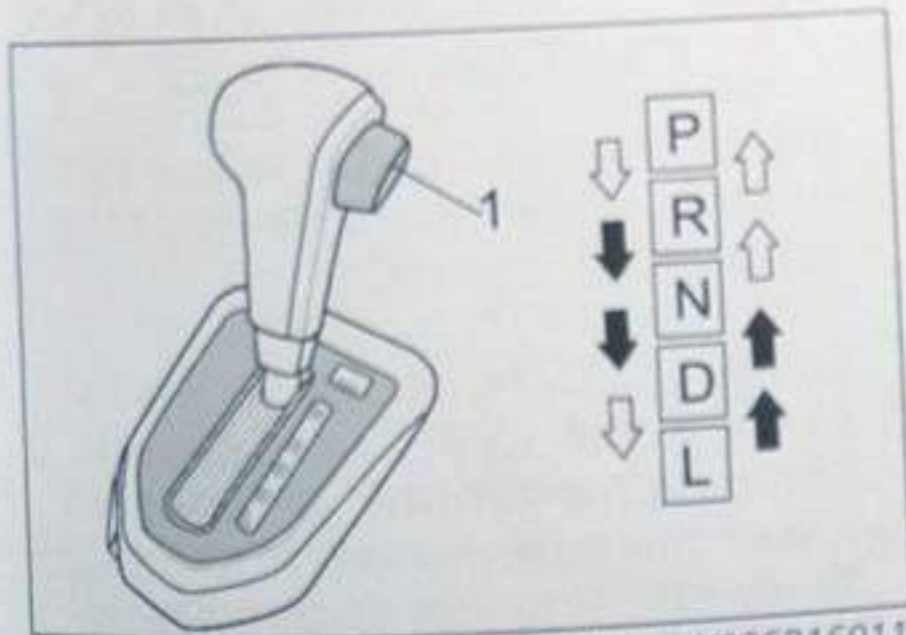

DOITW006R16011

1 - Knob push button

The knob push button of the gear shift lever prevents accidental selection of the incorrect gear. Know and follow the instruction given :

↓ : Press the knob push button (1) to enable you to move the gear shift lever.

WARNING

Press the brake pedal when you move the gear shift lever from the "P" (Park) position to the other gear positions.

↓ : Move the gear shift lever and not necessary to push the knob push button (1).

⚠ WARNING

- (1) Do not press the knob push button (1) when you move the gear shift lever during the operations indicated by the ↓ symbol shown in the illustration, as it can accidentally move the gear shift lever to the "P", "R" or "L" position.
- (2) Do not place your foot onto the accelerator pedal when pressing the brake pedal and moving the gear shift lever from the "P" (Park) position.

NOTE

- (1) Make sure you move the gear shift lever to the correct gear position. Check your gear position display in the meter cluster when you move the gear shift lever. Stay a while in the selected gear position before you move to the next gear position.
- (2) If the brake pedal is not pressed, the shift-lock-device activates to prevent you move the gear shift lever from the "P" (Park) position.

Gear shift lever positions

"P" (PARK)

Use "P" (Park) gear position when you park your vehicle. In "P" (Park) position, the gear locks the output shaft of the transmission. This mechanism causes the vehicle cannot move to the back or front.

WARNING

Apply the parking brake when you stop and park your vehicle to prevent the vehicle moves to the rear or front.

We recommend you to start the engine in "P" (Park) position.

"R" (REVERSE)

When you engage the gear shift lever to "R" (Reverse) position, you can drive this vehicle in the reverse direction.

When reverse, the reverse lamp illuminates automatically.

"N" (NEUTRAL)

When you engage the gear shift lever to "N" (Neutral) position, the transmission disengages. Use this gear position when the vehicle stops for an extended length of time during driving for example when there a traffic congestion.

CAUTION

When the vehicle is in motion, do not change the gear shift lever to the "P" (Park) or "R" (Reverse) position to prevent transmission damage.

WARNING

- (1) When the vehicle is in motion, do not move the gear shift lever to the "N" (Neutral) position. You can accidentally move the gear shift lever to the "P" (Park) or "R" (Reverse) position and loss the engine brake. These actions can result in an accident.
- (2) On a slope, you must start the engine in the "P" (Park) position: Do not start the engine in the "N" (Neutral) position.

- (3) Press the brake pedal when you change the gear shift lever into or out of "N" (Neutral) and "P" (Park) position.

"D" (DRIVE)

When you engage the gear shift lever to "D" (Drive) position, the vehicle will be driven forward.

CAUTION

When the vehicle is in motion, do not change the gear shift lever from the "R" (Reverse) to the "D" (Drive) position to prevent a transmission damage.

Gear selection display

The selected gear position is shown in the information display of the meter cluster.



When a malfunction occurs in the CVT

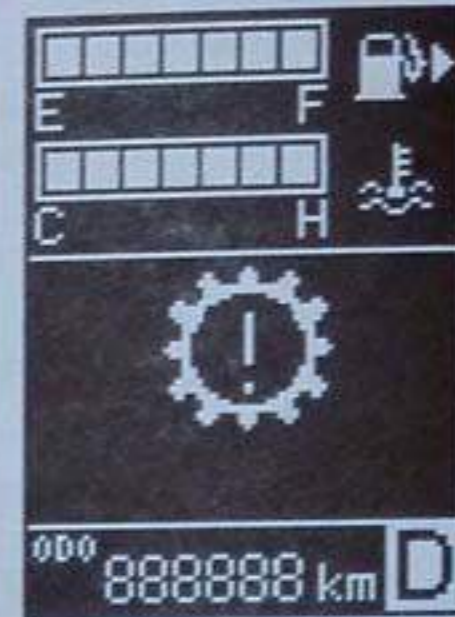

If the CVT indicator appears in the information display of the meter cluster, probably there is a system malfunction. If this indicator appears when the engine is in operation, there is a problem in the transmission control unit (TCU).

CAUTION

If a malfunction occurs in the CVT while driving, the CVT warning lamp will illuminate.

[When the CVT warning lamp is appears] : The CVT fluid overheats. The engine control activates to lower the temperature of the CVT fluid, causing the engine revolutions and vehicle speed to decrease. Proceed as procedures follows:

- (1) Slow down your vehicle.
- (2) Stop your vehicle in a safe area, move the gear shift lever in the "P" (Park) position. Open the bonnet with the engine running to lower the temperature of the engine.
- (3) When the temperature of the engine is low, make sure that the warning display does not appear. If the display does not show, you can continue to drive. If the warning display remains, drive your vehicle to an authorised service outlet for inspection.

Operation of the CVT

CAUTION

- (1) When the vehicle stops and the engine is running, the CVT gear may engage and the vehicle will move. Press the brake pedal before moving the gear shift lever into "D" (Drive) or "R" (Reverse). Release the brake pedal when you start to drive.
- (2) Do not press the accelerator pedal when you change the gear shift lever from the "P"

(Park) or "N" (Neutral) position. This action can cause a sudden acceleration.

- (3) Always press the brake pedal with the right foot.
- (4) Do not apply the brake pedal with the left foot, as it can impede the driver's movement during an emergency.
- (5) Do not you press the accelerator pedal and press the brake pedal same time as this can causes a change in the performance of the brakes. The brake pads will wear off faster.

When this vehicle stops and the engine is running, do not press the accelerator pedal and held the brake pedal. This action can damage the CVT.

When you push the accelerator pedal and the brake pedal with the gear shift lever in the "D" (Drive) position, the engine revolutions in the "D" (Drive) position does not increase compared to the same operation with the gear shift lever in the "N" (Neutral) position.

Passing acceleration

To increase more speed in "D" (DRIVE) position, press the accelerator pedal to

the floor. The CVT will automatically change to a lower gear.

Driving uphill

When you drive up a hill, if the TCU will sense that the vehicle is unable to maintain its speed, the CVT will not change to a higher gear position.

In this condition, the TCU temporarily prevents change in gear. After the vehicle reaches the top of the hill, the system will operates normally.

Driving downhill

When you drive down a hill, the TCU will automatically change to a lower gear position. This function helps the brake force from the engine and reduce the brake pressure.

Waiting

When you stop this vehicle with the engine running, for example at traffic lights, you can leave the gear in the "D" (Drive) position while pressing the brake pedal.

If you must stop this vehicle with the engine in running, move the gear shift lever to the "N" (Neutral) position and apply the parking brake.

CAUTION

Do not stop the vehicle at a slope with the CVT engaged. Always ap-

ply the parking brake and if necessary, apply the brake pedal.

Parking

Stop this vehicle. Apply the parking brake and move the gear shift lever to the "P" (Park) position.

Manual Transmission (MT) *

OWN0065TART16008

The pattern of the gear change positions is shown at the top of the gearshift lever knob. Always make sure to push the clutch pedal before you move the gear shift lever.

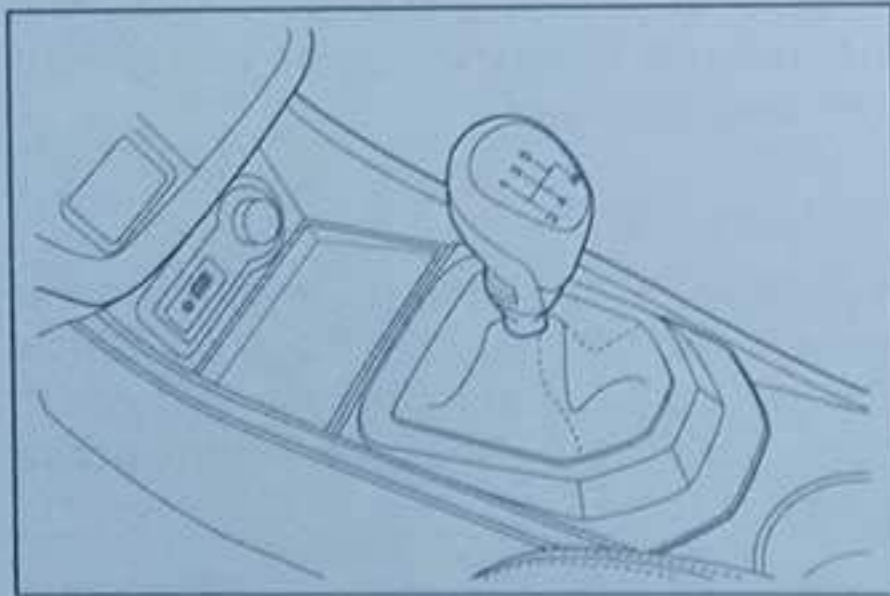

DOIRW006R14029

CAUTION

• Do not move the gear shift lever into R (Reverse) position while the vehicle moving forward. This action can damage the transmission.

* if fitted

• When not changing a gears, do not foot the clutch pedal for no reason. This action can cause the clutch wear or damage in short time.

NOTE

- (1) If the gear shift lever cannot be moved to the 1st gear, press again the clutch pedal and move the gear shift lever.
- (2) When this vehicle stops, move the gear shift lever from 5th position to "R" (Reverse) position, move the gear shift lever to the "N" (Neutral) position before moving the gear shift lever to "R" (Reverse) position.

Changing gears

Always change the gear when the vehicle speed is within the permissible engine speed. Correct gear selection will increase the fuel economy and extend the engine life. Do not change the gear position from high to low position at high speed. This action increases the engine speed (the tachometer needle moves into the red zone) and may damage the engine.

Possible driving speed

Drive range	Speed limit (km/h)
1st	35

Drive range	Speed limit (km/h)
2nd	70
3rd	100
4th	140
5th	180

5th gear position is an overdrive ratio and reduces the engine speed to the lower range of the 4th gear position. Move the gear shift lever to 5th gear position at the correct vehicle speed for maximum fuel economy.

CAUTION

The speed limit data shown in the table is an approximate values guidance.

Do not over speed when you drive. Always follow the speed limits according to the limit set by the local authority.

Gear Shift Lever Lock

OWN0065TART16008

Auto shift lock (for CVT) *

You cannot move the gear shift lever from "P" (Park) position to another gear position unless the ignition switch is in the ON position.

When the ignition switch is in the ON position, press the brake pedal and move the gear shift lever away from P (Park) position.

! WARNING

Always press the brake pedal when moving from the "P" (Park) position into another gear position to prevent accidental movement of the vehicle which can cause injury to a person in or around the vehicle.

Shift lock release

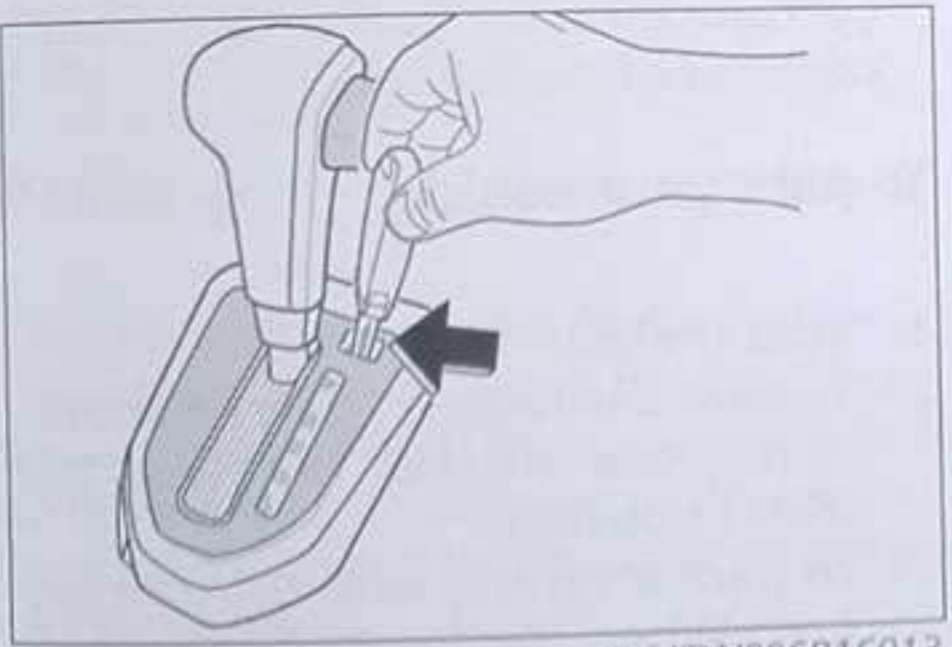

DOITV006R16013

If you cannot move the gear shift lever from the "P" (Park) position, proceed as follows:

- 1. Insert the key blade into the slot (as shown in the illustration).
- 2. While inserting the key blade into the slot, move the gear shift lever.

- 3. Drive your vehicle to an authorised PROTON service outlet immediately for inspection.

Gear shift lock (for CVT) *

Gear shift lock is an additional mechanism to lock the vehicles with Start/stop button.

Gear shift lock activates when the gear shift lever is in the "P" (Park) position.

Gear shift lock – Unlocking



This symbol appears in the information display of the meter cluster indicating that the system has unlocked the gear shift lock.

When the vehicle is in arm mode, the gear shift lock mechanism can be unlocked as described below:

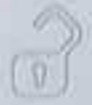
- Press the UNLOCK  button on the remote transmitter
- Press the toggle button of the keyless entry at the outer door handle

When the vehicle is in disarm mode, the gear shift lock mechanism can be unlocked from inside as describes below:

- Press the UNLOCK  button on the remote transmitter
- Press the Push-Start button to set the ignition to ON position.

Gear shift lock – Locking



This symbol appears in the information display of the meter cluster indicating that the system has locked the gear shift lock mechanism.

When the gear shift lever is in "P" (Park) position, press the Push-Start button to set the ignition to OFF position. The gear shift lock mechanism will lock.

NOTE

Using the UNLOCK  button of the remote transmitter or the toggle switch of the keyless entry system at the outer door's handle to disarm the vehicle, the gear shift lock mechanism will unlock.

* if fitted

When the gear shift lock mechanism is unlocked, the mechanism of gear shift can be locked as described:

- Press the LOCK  button of the remote transmitter
- Press the toggle button of keyless entry at the outer door handle
- Automatic Relock (if there is no doors/trunk lid opens within 30 seconds)

The gear shift lock gives protection to this vehicle against automotive theft.

If the gear shift lock mechanism malfunctions, there is no manual release that can be done. Contact an authorised PROTON service outlet immediately for inspection.

Parking Brake

OWN006START16010

Operation of parking brake

To apply the parking brake

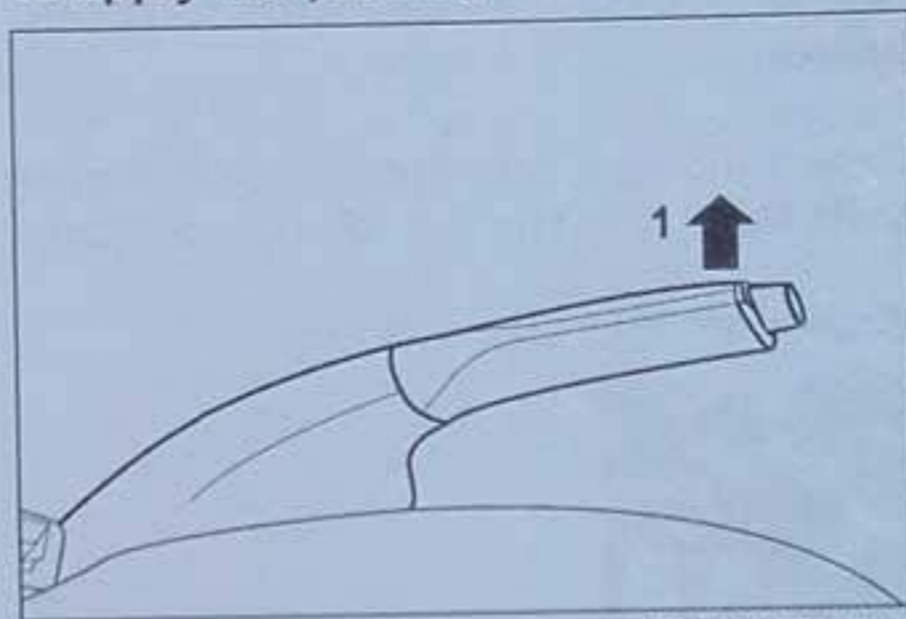

DOIRW006R14004

1 – To apply the parking brake, pull the parking brake lever to the up position.

To release the parking brake

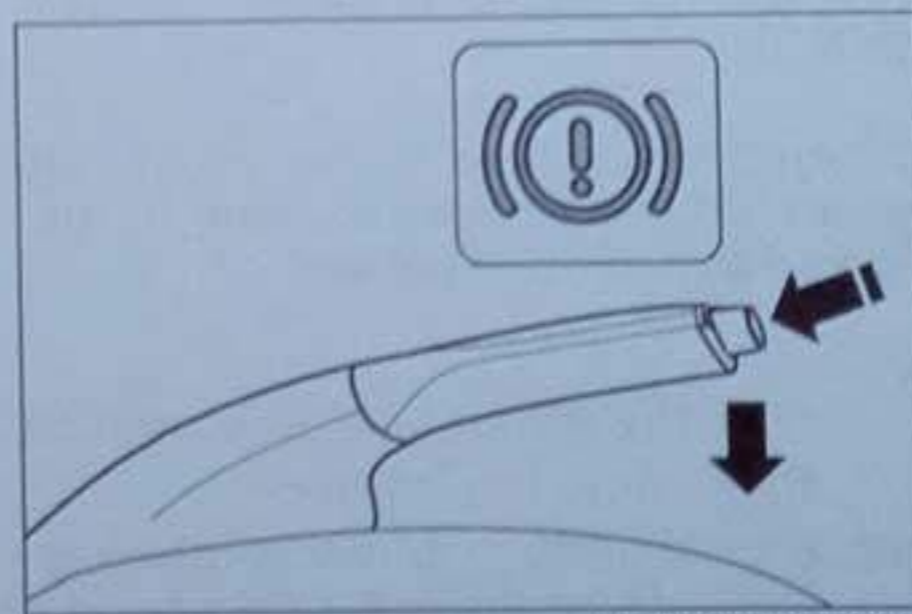

DOIRW006R14005

To release the parking brake, pull the parking brake lever one notch up, press and hold the button at the end of hand grip and lower down the brake lever.

CAUTION

Before driving, make sure that the parking brake is fully released and the parking brake warning lamp

 does not appear.

Do not drive without fully release the parking brake as it will cause the brakes to overheats, reduce the performance of brake force and possible brake failure.

To park your vehicle

1. Stop the vehicle
2. To park a vehicle with CVT transmission; Move the gear shift lever to P (Park) position.
To park a vehicle with MT transmission; When the front of the vehicle is parked on an up slope position, move the gear shift lever to 1st gear position.
When the front of the vehicle is parked on a down slope position, move the gear shift lever to R (Reverse) position.

NOTE

When parking on a hill, apply the parking brake and turn the front wheels toward the kerb on a downhill grade; away from the kerb on an uphill grade.

3. Apply the parking brake. (See topic "Operation of parking brake")
4. Turn off the engine. Make sure the ignition is in the OFF position.
5. Close all doors.
6. Press the LOCK button on the remote transmitter.

NOTE *

The toggle button of the Keyless entry at the outer door handle can be used to lock the vehicle.

Braking

OWN006START16011

Each component of the brake system is important to safety. Drive the vehicle to an authorised PROTON service outlet to do the service maintenance at the recommended periodical service interval in the service booklet.

Brake system

1. The brake system is divided into two brake circuits. If one brake circuit has a failure, the other brake circuit is available to stop the vehicle. If this condition occurs, press the brake pedal harder. Stop

driving immediately and have the brake system repaired at the authorised PROTON service outlet.

2. When the engine does not operate, the brake force of the brake booster decreases after pushing the brake pedal one or two times. In this situation, press the brake pedal harder than usual.

Warning lamp

The parking brake warning lamp  shows you if the brake system operates correctly. Refer to section "Instruments and controls" on page 76 to 81.

 **WARNING**

- (1) When pressing the brake pedal harder, the applied brake force will immediately lock each wheel from rotation. This action possibly becomes very dangerous if the brake pedal is pressed hard on a wet road. The vehicle will slide.
- (2) On vehicles with ABS system, the wheels are electronically controlled when the hard braking pressure is applied. Pulsation will be felt when the brake pedal is pressed. System prevents the vehicle from sliding.

- (3) If the brake system has a failure, the parking brake warning lamp  will illuminate. In this situation, drive slowly to an authorised PROTON service outlet immediately for inspection.

When the brake discs are wet

After driving in a heavy rain, the brake discs will be wet. While driving at a low speed immediately after the engine has started, press the brake pedal to make sure the brakes operate correctly.

If the brakes do not operate correctly, lightly press and release the brake pedal while driving. Do this procedure again until the brake discs dry.

When driving downhill

The brakes will overheat when applied driving downhill. To reduce speed, use a lower gear.

Brake pads and linings

1. When your vehicle has new brake pads or brake linings, do not apply the brakes hard for the first 200 kilometres of driving.

* If fitted

- When the brake pads have reached their limit, a warning device in the disc brakes makes a loud sound when braking. Have the brake pads replaced by your PROTON service outlet when the sound is heard.

CAUTION

- Do not place thick floor mat or any objects around the brake pedal. These objects possibly can prevent the full push of the brake pedal stroke that is necessary in an emergency. Make sure that the brake pedal can operate freely always.
- Do not place the left foot on the brake pedal while driving. This may result in accidental application of hard braking. The brake pads will overheat and wear out quickly.

Brake Systems

OWN006START16012

Electronic Braking Distribution (EBD)

EBD electronically adjusts the brake force between front and rear axles to help reduce the distance for the vehicle to stop.

Brake assist (BA)

When the system senses a panic-stop, BA increases the level of brake force after the brake pedal is pushed.

Traction Control (TC)

When the vehicle increases speed on wet roads, TC maintain the drive-power and prevents the front wheels from rotation.

Anti-lock Braking System (ABS)

When the brake pedal is pressed hard, ABS does not let the wheels to lock, keeps the forward-driving stable and supplies sufficient brake force.

When the vehicle is driven on a road that has a layer of snow, ice or oil and the brake pedal is pressed hard, the additional brake force may cause the vehicle to slide. When the vehicle slides, the brake force will decrease and the distance for the vehicle to stop will increase.

Driving hints

- When sudden braking is applied (the ABS will activate), the operation of the steering will change. Steer the vehicle carefully in these conditions.
- The distance for the vehicles with ABS to stop is shorter than the

vehicles without ABS. This difference will change according to the road condition and other conditions. Keep a safe distance from the vehicle in front for a vehicle without an ABS.

- The distance for the vehicles with ABS to stop on a road with gravel or snow is probably longer than the vehicle without ABS. These roads must be driven at lower speeds.

CAUTION

- ABS cannot fully prevent accidents caused by weather or the driver. For example, when over speed at turns or aquaplaning. In this condition, driver must be responsible and take the safety precaution.
- Make sure the same type and size of tyres are used on all four wheels.
- Do not replace the differential of this vehicle with a limited slip differential. The ABS probably may not be activated.
- If the tyres are mixed, The ABS probably may not be activated.

ABS warning indicator

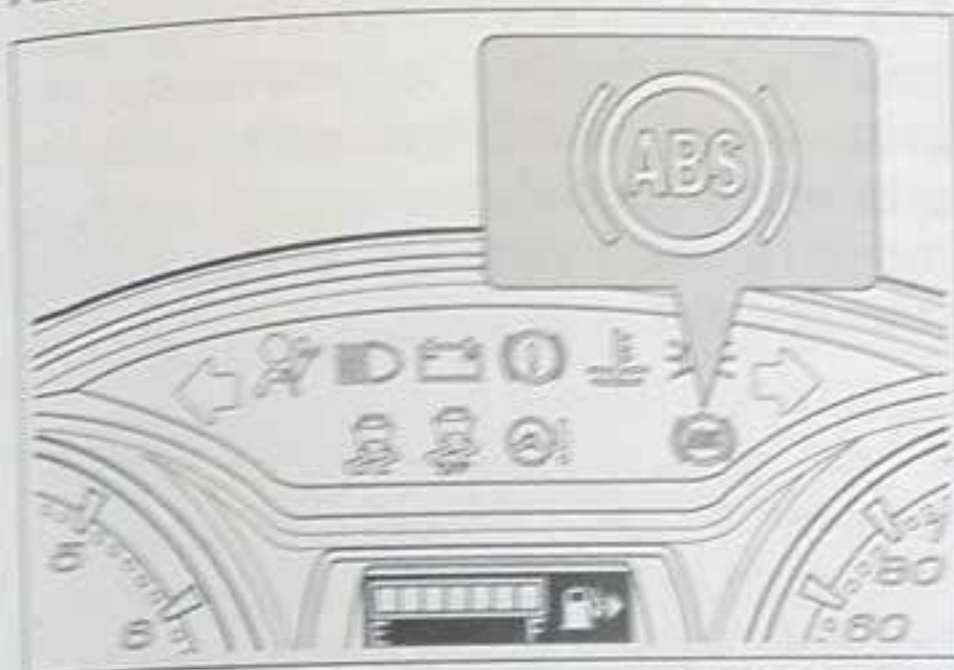

DOIRW006R14021

When the ignition switch is turned to the ON position, the ABS warning lamp will illuminate for 3 seconds.

If the ABS has a malfunction, the ABS warning indicator will stay illuminated. In this situation, only the standard brake system will be in operation.

When the ABS warning indicator illuminates while driving, take the following action:

1. Stop the vehicle in a safe area and turn off the engine. Start the engine again and check if the ABS warning indicator stop illuminates. If the ABS warning indicator does not illuminate, there is no problem. If the ABS warning indicator stays illuminated or illuminates again when driving, drive vehicle immediately to an authorised PROTON outlets for inspection.

2. Starting the engine with jumper cables before the battery is sufficiently charged, the engine will not run smoothly. The ABS warning indicator flashes to caution not to drive the vehicle.

In this situation, start the engine and in idle position until the battery is sufficiently charged.

WARNING

If there is malfunction when applying the brakes, the standard brake

warning  will illuminate.

When this condition happens, do not press the brake pedals hard. Drive the car slowly to an authorised PROTON service outlet.

NOTE

- (1) The brake system operates with normal pedal operation. When the anti-lock function is activated, series of pulses is felt at the brake pedal and there will be a screeching sound. This condition indicates that the system is working.
- (2) Immediately after starting the engine and the vehicle starts to move, there will be a sound from the motor the engine compartment. When pressing the brake pedal, there will

be a sudden jerk. This condition is caused by the self-diagnosis operation of the ABS and does not indicate any malfunction.

- (3) ABS does not operate at low speeds (approximately 10 km/h or lower) and the brake system operates according to the normal brake system.
- (4) After driving the vehicle on dirt roads, remove all dust or mud from the wheel areas. When cleaning the wheels of vehicles with ABS, do not damage the wheel speed sensors and cables at each wheel.

Electronic Stability Control (ESC) *

ESC system gives stable control to the vehicle when making at turn move. ESC checks the stabilizes the steering and the vehicle direction. ESC applies the brakes at each wheel and stabilizes the vehicle.

WARNING

Do not over speed or make a sudden turn at corners. The ESC system cannot prevent accidents. The actions of over speeding, make sudden turns and aquaplaning can cause accidents. Only a safe and careful driver can prevent the accidents. Do not make a sudden turns that cause the vehicle to loss traction. Always follow the normal

* if fitted

precautions when driving. Drive within the speed limits all the time.

ESC system is an electronic system that helps the driver to keep the vehicle in control under bad conditions. ESC is not a replacement for safe driving procedures. Vehicle speed, road conditions and driver steering input are parameters that cause an effect on the performance of ESC operation. The driver is fully responsible to drive and make turns at corners at the correct speed and safety.

When applying the brakes and the wheels lock a groaning sound will be heard from the brakes or a series of pulses in the brake pedal will be felt. This condition is normal and shows that the ESC system is in working.

When ESC operates



1. The ESC indicator light flashes.
2. A series of pulse will be felt when the brake pedal is pressed.
3. Trying to get away from a mud or wet road while pressing the accelerator pedal, will not increase the engine rpm (revolutions per minute).



* if fitted

To turn off the ESC system

Press the "ESC OFF" button (ESC OFF) for more than 3 seconds to deactivate the ESC.

ESC operation off

1. When the ESC is not activated and the vehicle speed exceed 150 km/h, the ESC system will be activated automatically.

The "ESC OFF" indicator  at the meter cluster will stay illuminated and the ESC indicator  will flash.

2. When the ESC is not activated and the ignition switch is turned OFF, the complete system is turned off. When restarting the engine, the ESC will operate again automatically.
3. When ESC is not activated, the ABS system operates normally.

Hill Hold Assist (HHA) *

HHA system activates to help the driver to drive the vehicle from its stop position at a slope up position (for example from a ramp of a car park, traffic lights or while reversing into a parking space). HHA keeps the pressure of the brake momentarily and does not let the vehicle to move back before the driver gets to press the accelerator pedal.

When HHA is active, the vehicle will stay in a fixed position at the slope up position for 4 seconds after you release the brake pedal. In this 4 seconds, press the accelerator pedal. the vehicle starts to move to the front, the brakes will be released automatically.

WARNING

HHA does not replace the parking brake. When leaving the vehicle, always apply the parking brake and put the gear shift lever in P (Park) position (for CVT) or N (Neutral) position (for MT).

Activating HHA

When the vehicle has to be stopped at a slope up position, press the brake pedal. If the sensors sense that the vehicle is at a slope up position, HHA will activate automatically.

The activation of HHA system depends on the type and model of the vehicle:

For MT model:

1. When the vehicle faces the slope up position and the gear shift lever is in the N (Neutral) position.
2. When the vehicle faces to the slope down position and the gear shift lever is in R (Reverse) position.

Steering Wheel Height Adjustment

OWN006START16013

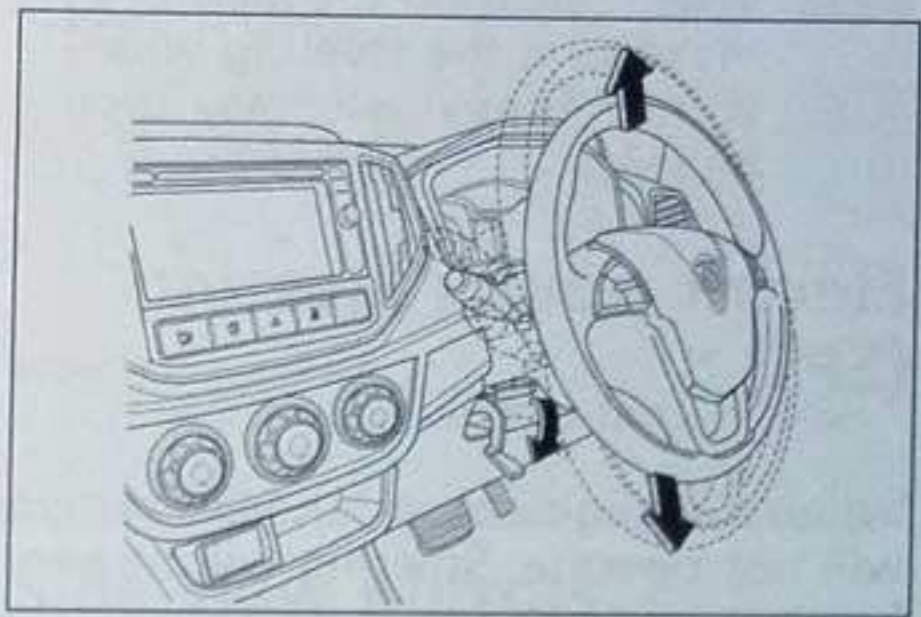

DOITW006R16007

1. While holding the steering wheel with your hand, release the lock lever of the steering wheel.
 2. After releasing the lock lever, the steering wheel will be in free position. Adjust the steering wheel to the required height.
 3. After adjustment, return the lock lever to its original position to tighten the lock.
- 1 - Lock position
2 - Release

CAUTION

When the vehicle is at a slope up position, the HHA system will not activate when neutral gear is engaged (for CVT transmission).

WARNING

If the HHA system has a malfunction, the brake warning  in the meter cluster will illuminate. In this situation, immediately drive your vehicle slowly to an authorized PROTON service outlet for inspection.

WARNING

- (1) After you adjust the height of the steering wheel, make sure that the lock lever is returned to its original position.

3. When the degree of slope up position is greater than 7% and less than 30%.
4. When the driver's door is not open.

For CVT model:

1. When the vehicle faces to the slope up position and the gear shift lever is in forward gear position.
2. When the vehicle faces to the slope down position and the gear shift lever is in R (Reverse) position.
3. When the degree of slope up position is greater than 3% and less than 30%.
4. When the driver's door is not open.

When HHA activates, the vehicle will remain at the slope up position for 4 seconds after releasing the brake pedal. This 4 seconds, press the accelerator pedal. The vehicle starts to travel to move the brakes will be released automatically.

NOTE

- (1) This function activates if the vehicle moves forward or reverses.
- (2) HHA cancels if the driver's door is opened when the vehicle stops at a slope.
- (3) HHA is not activated if the driver's door is not closed correctly.
- (4) If the HHA system has a malfunction, HHA is not activated and the brake warning lamp illuminates at the meter cluster.

- (2) Do not adjust the steering wheel while driving.
- (3) When releasing the lock lever, make sure the steering wheel is held firmly as it may drop heavily.

Electric-power Steering (EPS) *

OWN006START16014

When the engine stops, the EPS system will not operate. Steering will be very heavy.

CAUTION

- (1) Do not turn off the engine while driving.
- (2) Do not leave the steering wheel in the fully-turned position for extended periods when not operating the vehicle.

Maniverter

OWN006START16015

The maniverter has a catalytic converter and an exhaust manifold.

Use ONLY unleaded petrol.

The catalytic converter of the maniverter has a device that collects the exhaust

* if fitted

gases and very good in reducing the exhaust emission. The catalytic converter is installed in the exhaust system.

Always keep the engine correctly tuned to prevent damage to the catalyst.

CAUTION

If the engine is not properly maintained, the catalytic converter may be damaged. If the engine malfunctions because of engine misfire or other loss of performance, tow the vehicle to an authorised PROTON service outlet. The continued operation of the vehicle with the engine overheating can damage the catalytic converter of the maniverter and the vehicle.

WARNING

- (1) Do not operate the vehicle in areas that have flammable materials. For example, dry grass or leaves in contact with the hot exhaust can cause a fire.
- (2) Do not apply an undercoating paint to the catalytic converter.

The maniverter will be damaged if the catalytic converter gets hot quickly. Take the following precautions to prevent

the ignition of the remaining petrol in the catalytic converter.

- 1 - Use ONLY unleaded petrol.
- 2 - Do not drive with a low level of fuel. If the fuel supply to the engine stops, the catalytic converter may be damaged.
- 3 - Do not turn off the ignition while driving.
- 4 - Do not push the vehicle to start the engine. If the battery of the vehicle is weak or flat, use another battery to jump start the engine.
- 5 - When the engine is running do not remove the spark plug.
- 6 - Do not run the engine long if there is malfunction.
- 7 - Do not press the accelerator pedal hard after switching off the engine as the remaining fuel in catalytic converter can cause damage to the can converter.
- 8 - Stop the vehicle if there is a reduction in performance or the engine malfunction. If the situation does not allow stopping the vehicle, reduce speed until it stops.
Send the vehicle to the nearest authorised PROTON service outlet for inspection.
- 9 - If there is an engine malfunction, a burnt odour may indicate catalyst overheat. Stop the vehicle, switch off the engine and let it cool.
When the engine is cool, immediately send the vehicle to an author-

ised PROTON service outlet for repair and service.

Drive-by-wire and Driver Safety

OWN006START16016

This vehicle has a drive-by-wire system. This system removes the function of a mechanical linkage (for example accelerator cable) between the accelerator pedal and the engine. The engine management system uses the information supplied by the parameters of certain components for example the pedal position and throttle actuator to control the engine speed.

The fuel injection system monitors the drive-by-wire system to ensure the safety of the system, the driver and the passengers.

Fail-safe mode

If there is a malfunction, a fail-safe mode will activate.

During fail-safe mode, the engine check warning lamp in the meter cluster will illuminate. All available power will decrease according to the defective component. The accelerator pedal can be pressed but the engine management system controls the engine speed and the maximum speed. Drive the vehicle immediately to an authorised PROTON service outlet for inspection.

WARNING

- (1) Do not drive this vehicle in the fail-safe mode longer than necessary. When the engine check warning illuminates, drive the vehicle immediately to the authorised PROTON service outlet.
- (2) When the vehicle stops, do not stay in forward or reverse gear position. Put the gear shift lever in neutral gear position to prevent possible damage to the transmission caused by the transmission oil overheating.

Inside rear-view Mirror

OWN006START16017

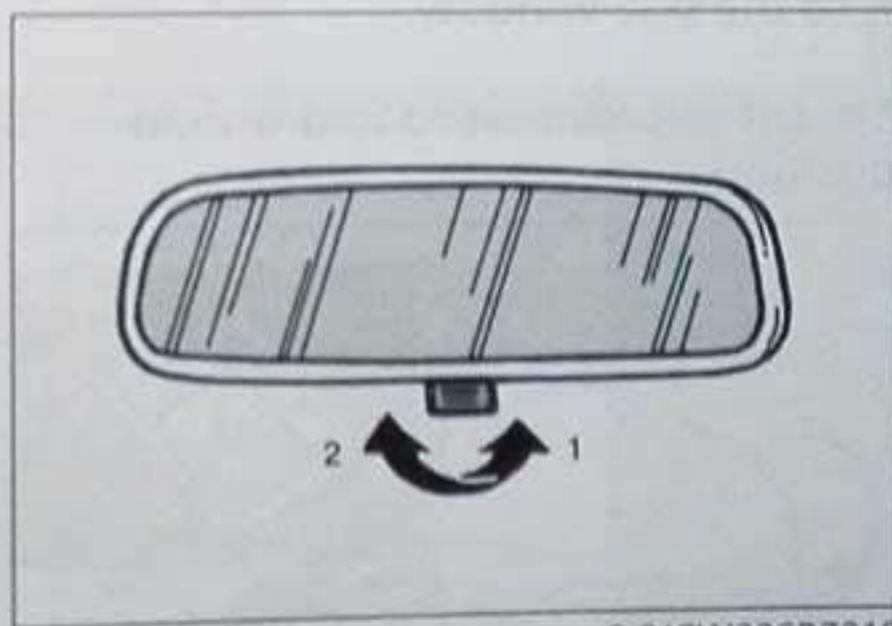

DOICW006R7019

Use the lever under the mirror assembly to adjust the mirror to decrease the

glare from the headlights of vehicles behind during night driving.

- 1 - Normal
- 2 - Anti-glare

WARNING

- (1) Do not adjust the rear-view mirrors while driving.
- (2) Adjust the mirrors before driving.

Side-view Mirrors

OWN006START16018

Switches

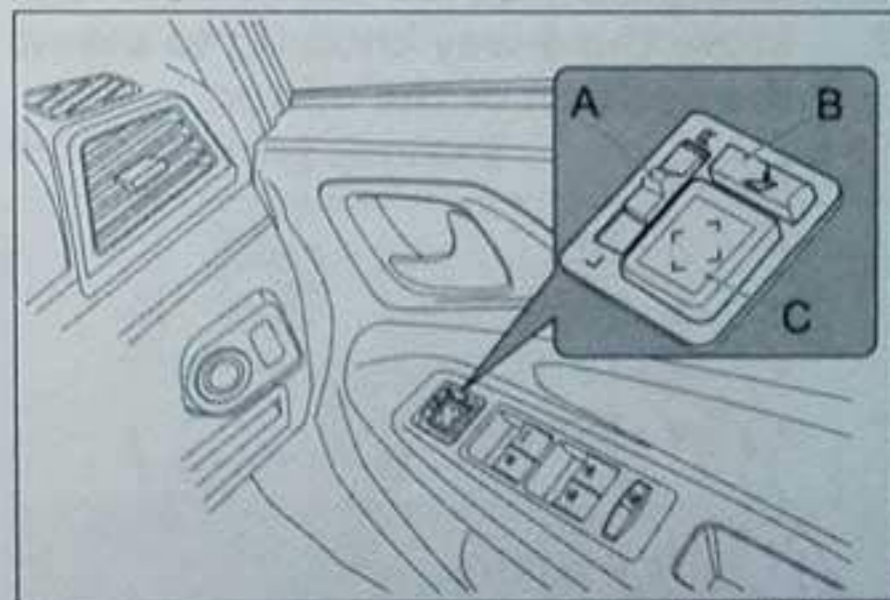

DOIRW006R14009

A – Toggle switch to select left or right door side-view mirror

B – Switch to adjust the two door side-view mirrors to fold/unfold

C - 4-way knob to adjust the mirror position

How to adjust the mirror

1. Turn the ignition switch to the ON or ACC position.
2. Press lever (A) to select which door side-view mirror.

NOTE

- Position "L" - To select the LEFT side-view mirror
- Position "R" - To select the RIGHT side-view mirror
- Position "N" - NEUTRAL position

After making the adjustments, return the lever (A) to "N" (Neutral) position to prevent accidental changes of the view while driving.

3. Move the 4-way knob (C) to adjust the position of the mirror.

NOTE

- ^ - Up
- > - Right
- < - Left
- v - Down

WARNING

Do not adjust the door side-view mirrors or the mirror while driving.

* if fitted

How to adjust the side-view mirrors to fold/unfold position

The door side view mirrors can be adjusted to fold/unfold position to prevent damage when parking in tight parking spaces.

WARNING

Unfold the door side-view mirrors and adjust the mirror to correct positions before driving.

Manual adjustment to fold/unfold position

- 1 - To unfold the side-view mirror, move it away from the side window.
- 2 - To fold the side-view mirror, move it to the side window.

Electric adjustment to fold/unfold position

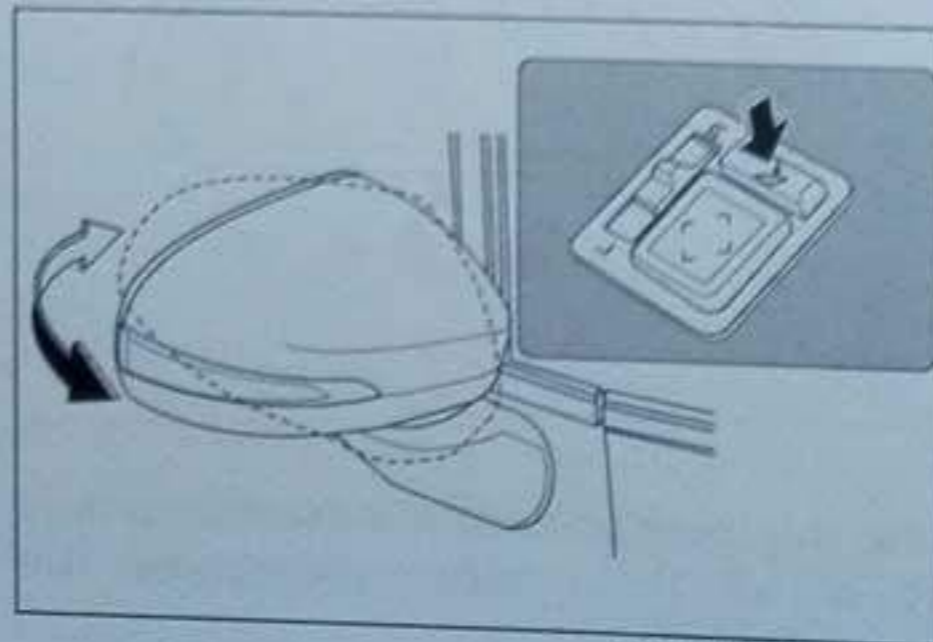

DOIRW006R14011

Use the switch (B) to adjust the door side view mirrors to fold/unfold position.

Automatic fold/unfold *

When you press the LOCK  button of the remote transmitter, the door side-view mirrors will automatically fold.

While the door side-view mirror is folded, if you press the UNLOCK  button of the remote transmitter, the door side-view mirrors will unfold automatically.

Resetting fold position

If the door side-view mirror is accidentally folded away from its correct position, adjust the door mirror to its correct position as shown below;

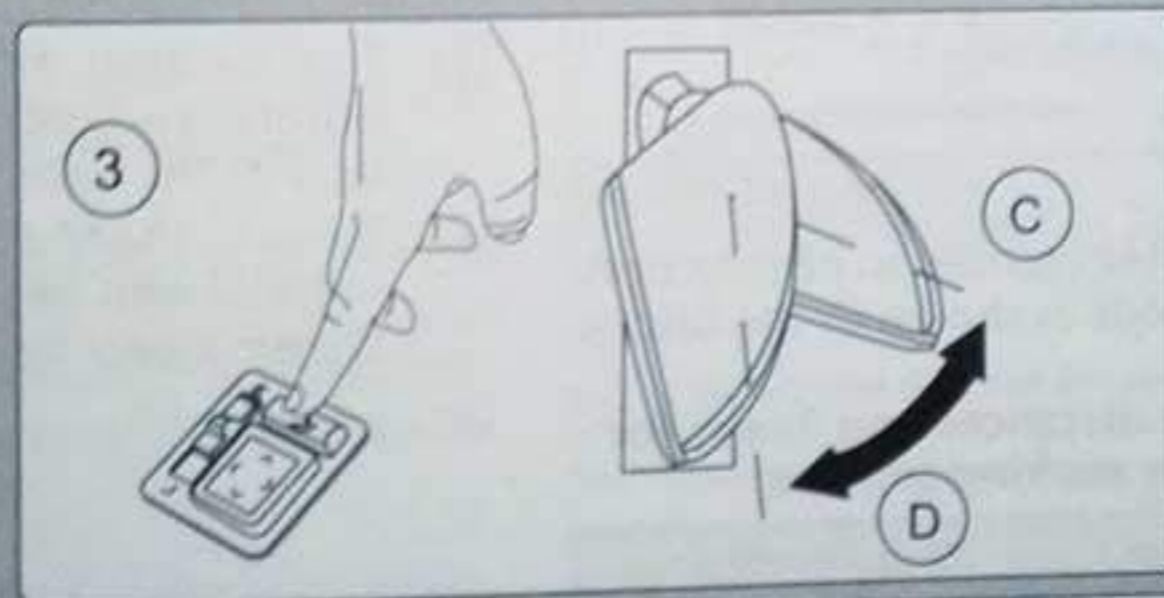
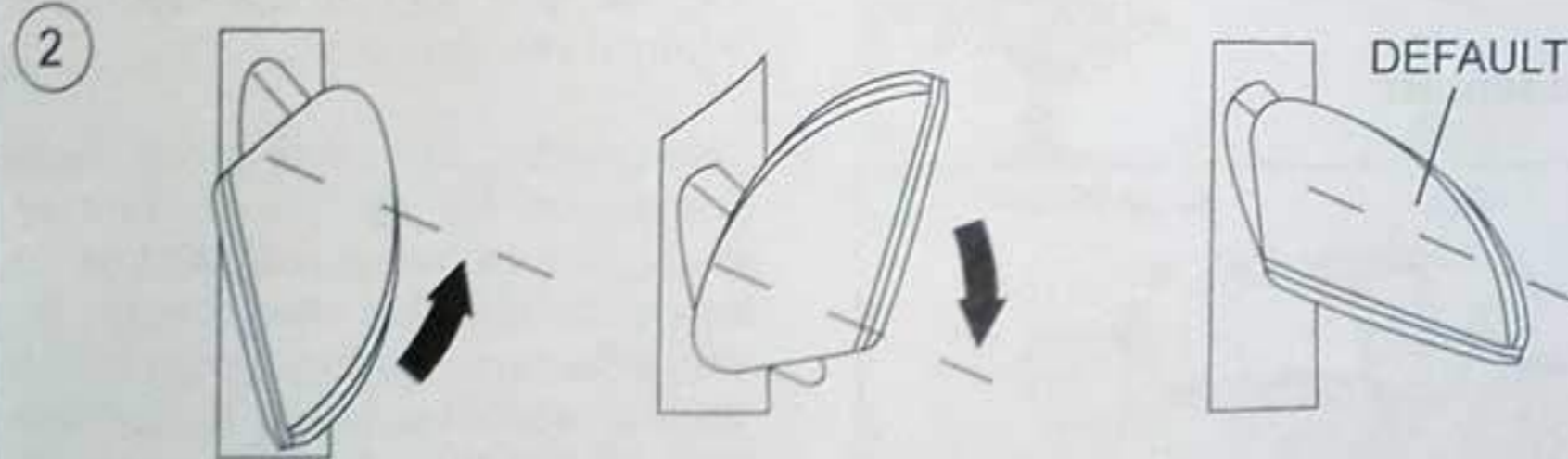
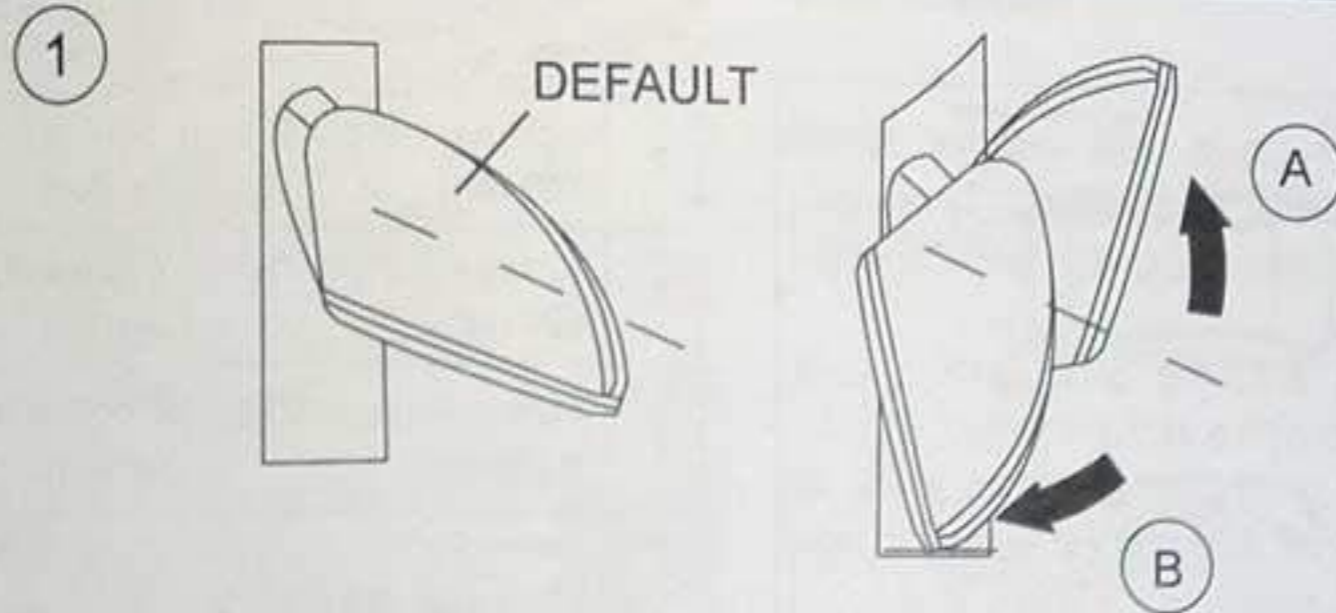

DOITW006R16015

- 1 - Accidentally folded to position (A) or position (B).
- 2 - Move the door side-view mirror to the correct position until you hear a click sound is heard.
- 3 - Activate the switch to fold in (D) or fold out (C) to check the door side-view mirror is in the correct position.

Parking Aid System

OWN006START16019

The parking aid system will tell if the vehicle senses any obstruction while parking the vehicle into or away from a tight parking space.

The system has two front corner sensors, two rear corner sensors and two rear centre sensors.

Front parking sensors

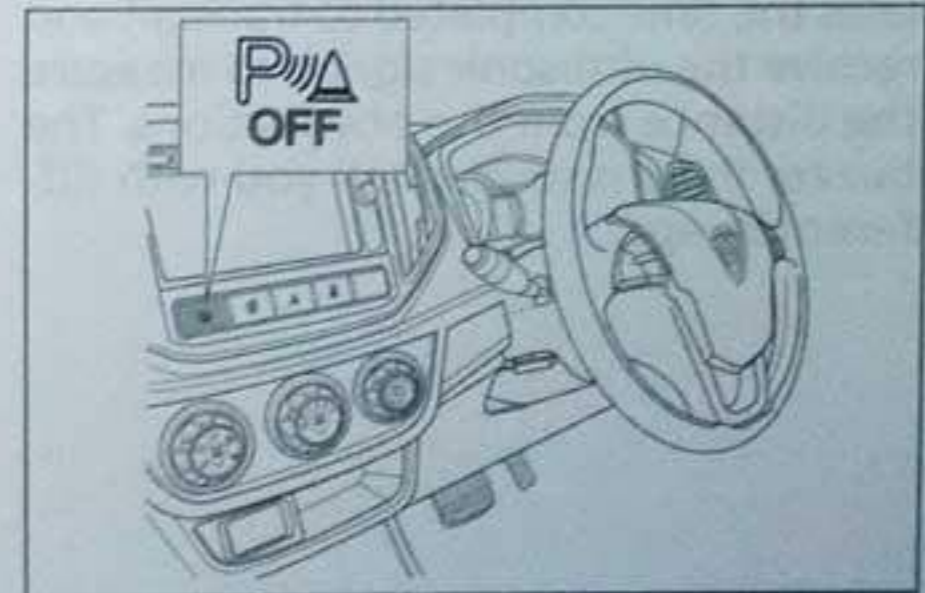

DOITW003R16010

To activate the front parking sensors, press the switch as shown in illustration

with the ignition switch in the ON position. The indicator in the meter cluster combination will illuminate. To turn off the system, press the switch again

The front corner sensors detect an obstacle when the shift lever is in any position, and the vehicle speed is less than 15 km/h.

Rear parking sensors

When engaged in a reverse gear position, the rear parking sensors transmit and receive the ultrasonic signals.

Not all obstructions are sensed. Look out for obstructions near the vehicle to park safely.

Operation

The parking aid system has four-level distance sensors, an electronic control unit (ECU) and a buzzer. The ECU calculates the time completed to transmit and receive the ultrasonic signals to measure the distance from the obstructions. The buzzer in turn sounds tell you with different beeps.

Corner sensors

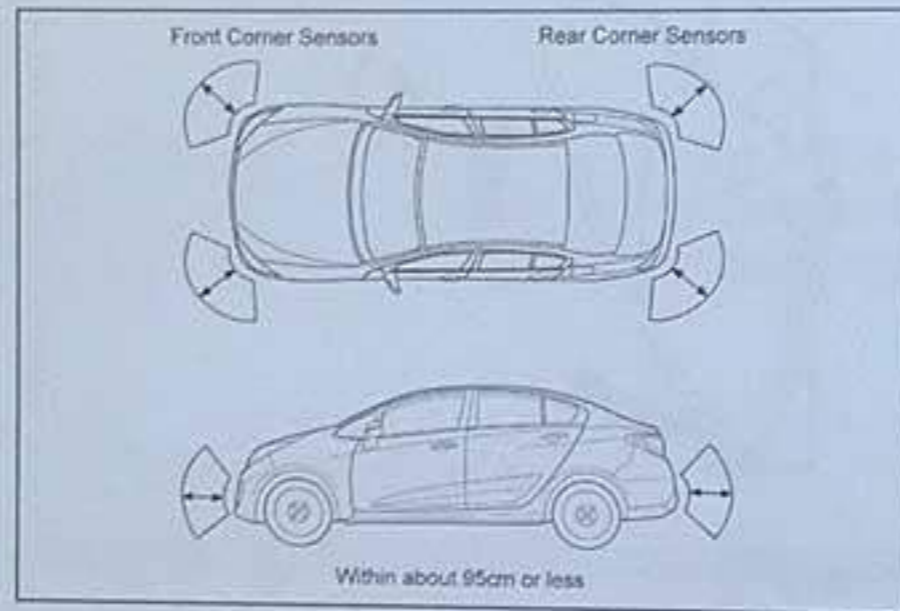

DOITW006R16008

Centre sensors

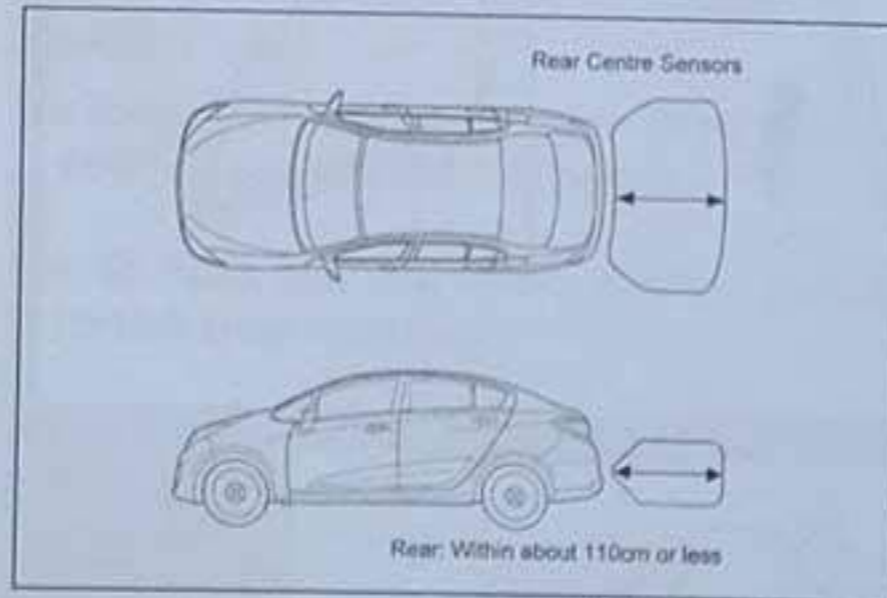

DOITW006R16009

When the system senses an obstruction, a beeper sounds as shown in the tables.

Approximate distances and Beeps for front and rear parking sensors:

No.	Approximate distances:	Frequency of beep sound:
1.	Approximately 200 - 450 mm	Continuous beep

No.	Approximate distances:	Frequency of beep sound:
2.	Approximately 450 - 700 mm	1-beeps for each second
3.	Approximately 700 - 950 mm	4-beeps for each second
4.	Approximately 950 - 1,200 mm	8-beeps for each second

WARNING

Do not put any accessories on or around the sensors.

The parking aid system only helps the driver. The system does not replace the full responsibility of the driver to operate this vehicle. The manufacturer is not responsible for any accidents caused by the carelessness of the drivers.

NOTE

- (1) The parking aid systems may be different according to the specification of the vehicle.
- (2) Refer to the Multimedia Navigation manual and get to know how the system operates.

Rear view camera *

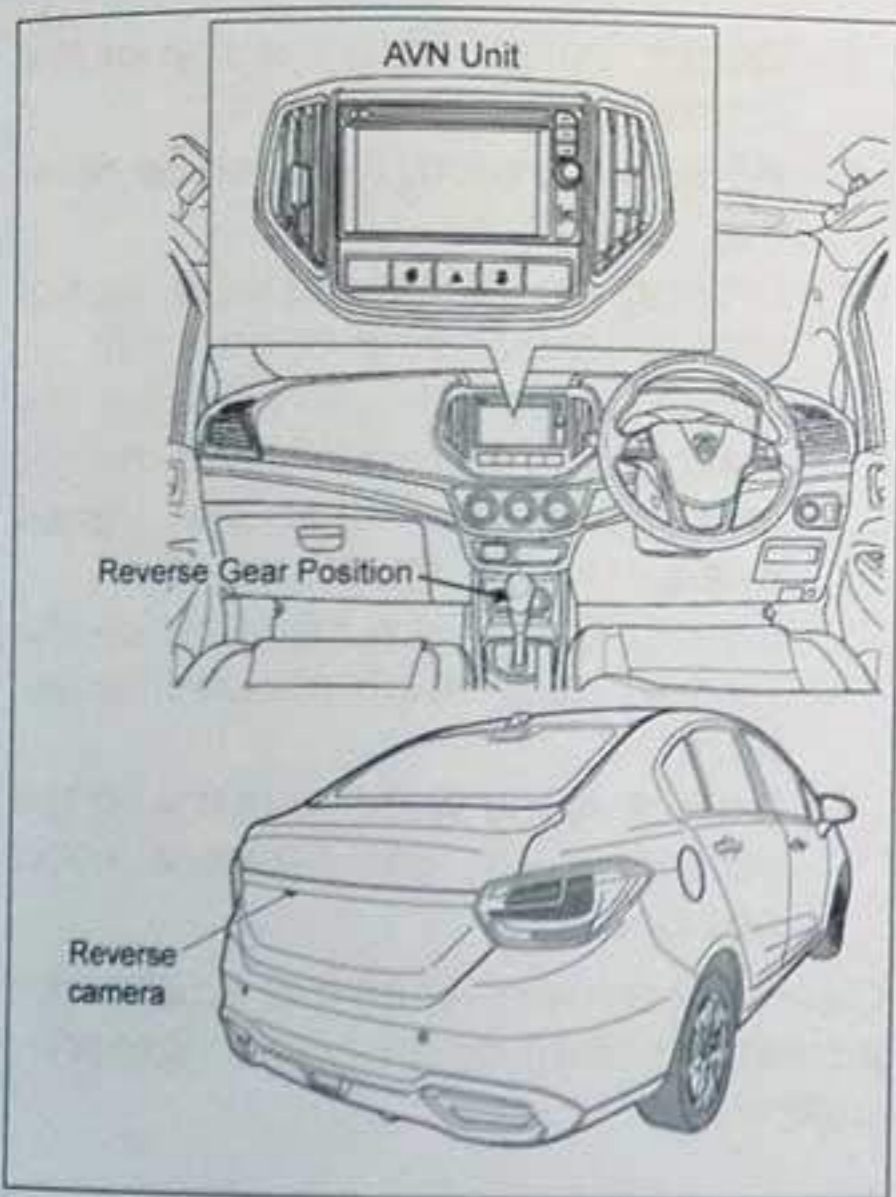

DOITW006R16004

A rear-view camera is located at the rear bumper as shown in illustration.

When the ignition switch is in the ON position and the gear shift lever is put to "R" (Reverse) position, the multimedia navigation display will show the rear view of this vehicle.

Refer to multimedia and navigation manual for more information.

Limitation

Even when the system is on, always check if there are obstacles near the vehicle before parking.

The ultrasonic signals may not sense obstructions with different shapes, low or thin, or materials that absorb an ultrasonic-wave as shown in the diagram.

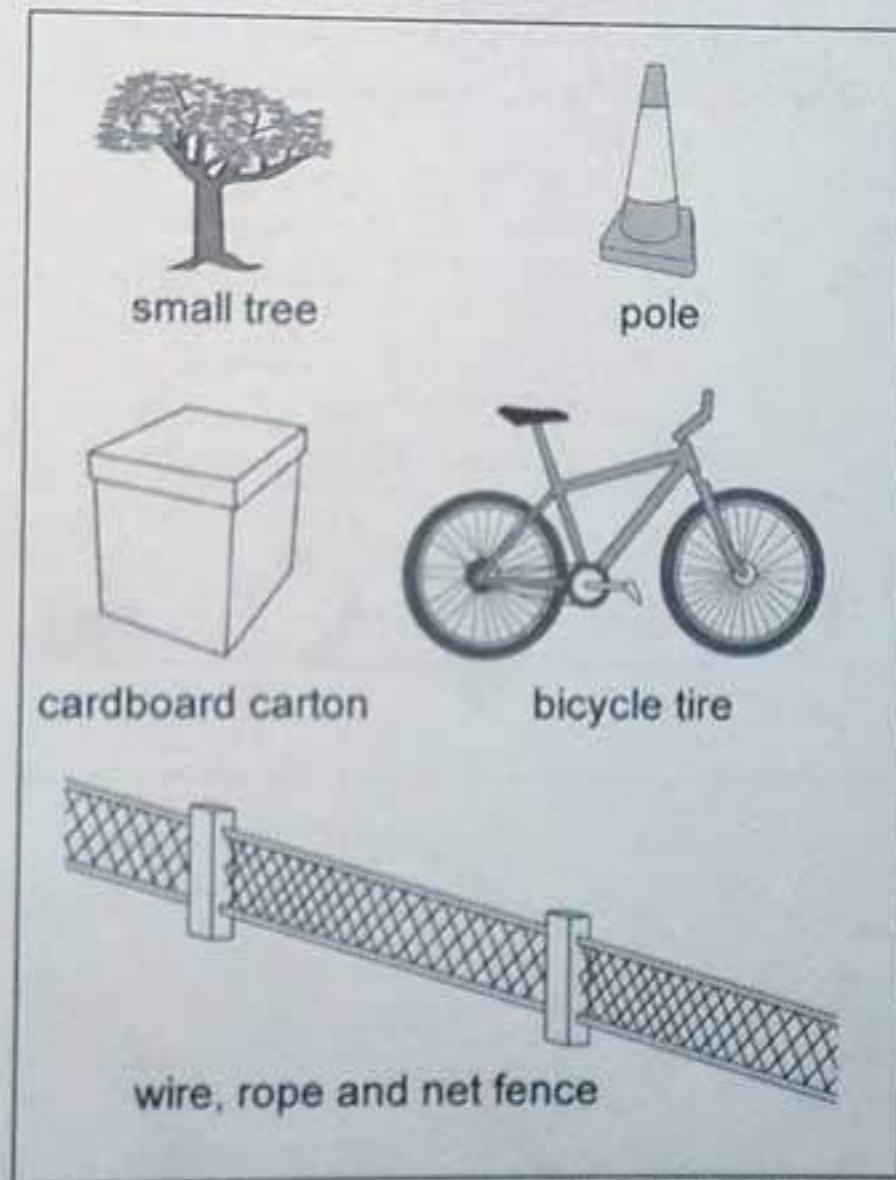

DOINW006R09026

1



2



3

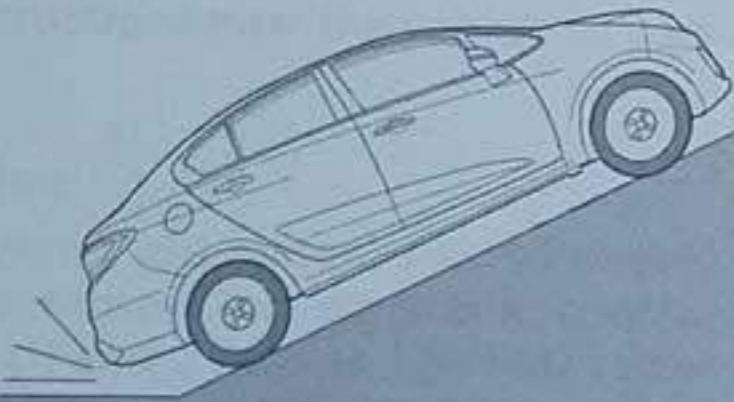

4



5

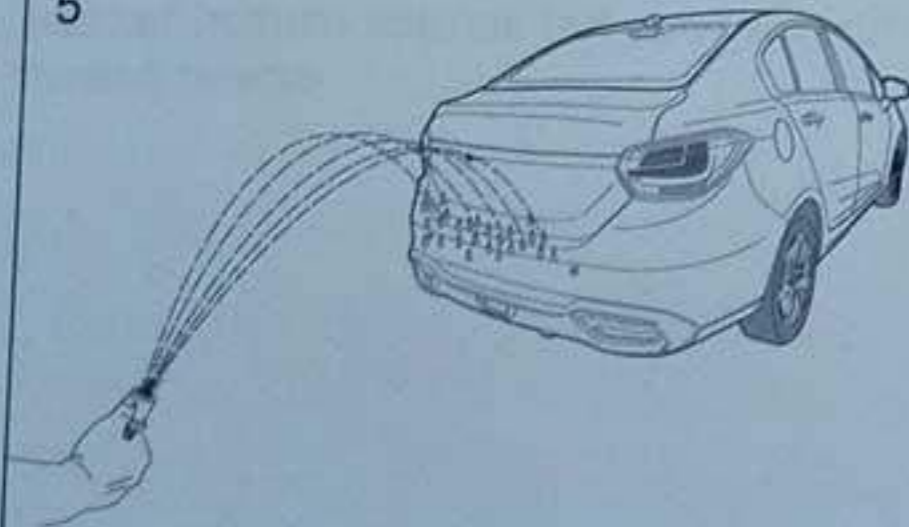

6



Under certain conditions, may not work:

- 1 - Water frozen onto the top of the sensors.
- 2 - When dirt, mud, ice or snow cover the sensors.
- 3 - Driving on rough surfaces, gravel roads, grass, bump or on a hill.
- 4 - When the vehicle is overloaded, the vehicle will become low in height and make the ultrasonic signals nearer the obstructions.
- 5 - Do not spray water directly on the sensors with high-pressure water hose.
- 6 - Do not spray water directly on the sensors with high-pressure water nozzle.

Clean the sensors when dirt caused with a cleaning cloth or spray with low-pressure water.

Drive vehicle slowly. The sensors may not sense small or narrow objects.

For Pleasant Driving

Ventilators	126
Air Conditioning System	126
Accessories	130



Ventilators

OWN007PDRIV16001

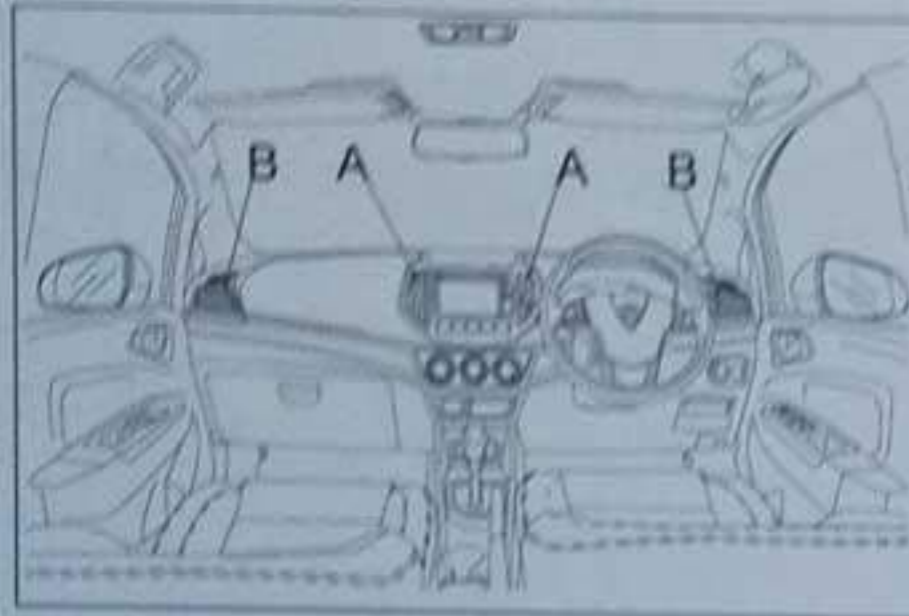

DOITW007R16001

A – Centre ventilators

B – Side ventilators

Air flow and direction adjustments

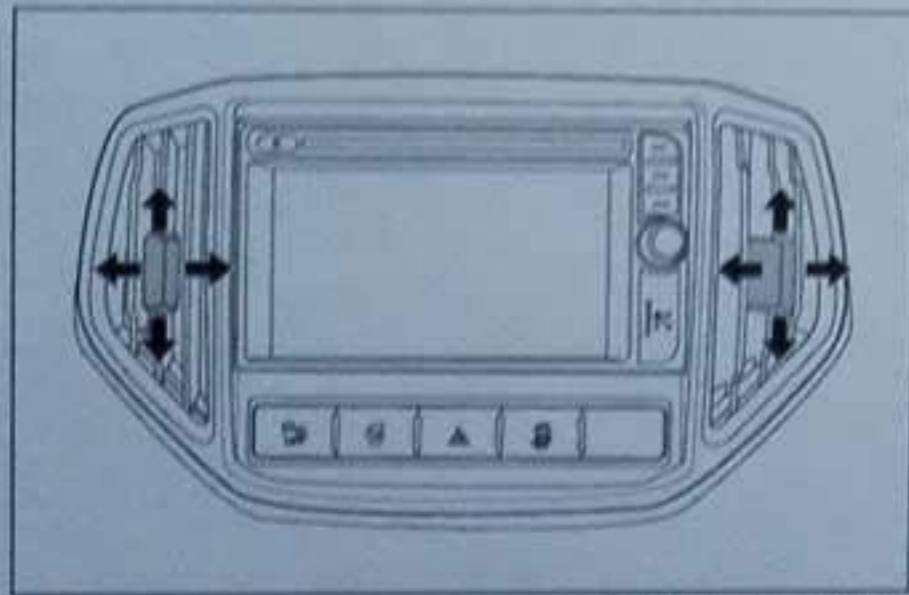

DOITW007R16002

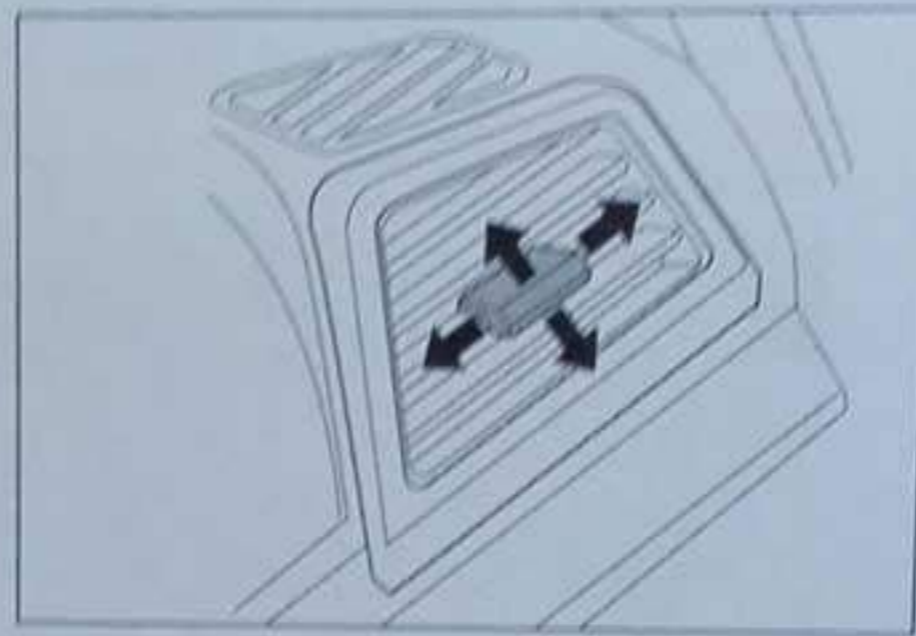

DOIRW007R14003

To adjust the direction of the air flow, move the adjustment knob horizontally and vertically.

NOTE

If there is a sudden cool moist air from the ventilators, this condition is normal and does not indicate any problem.

Air Conditioning System

OWN007PDRIV16002

The air conditioning system controls the cooling and ventilation inside the cabin of the vehicle. The control panel of the air conditioning system is found at the centre of the instrument panel.

Manual air conditioning system

The control switches

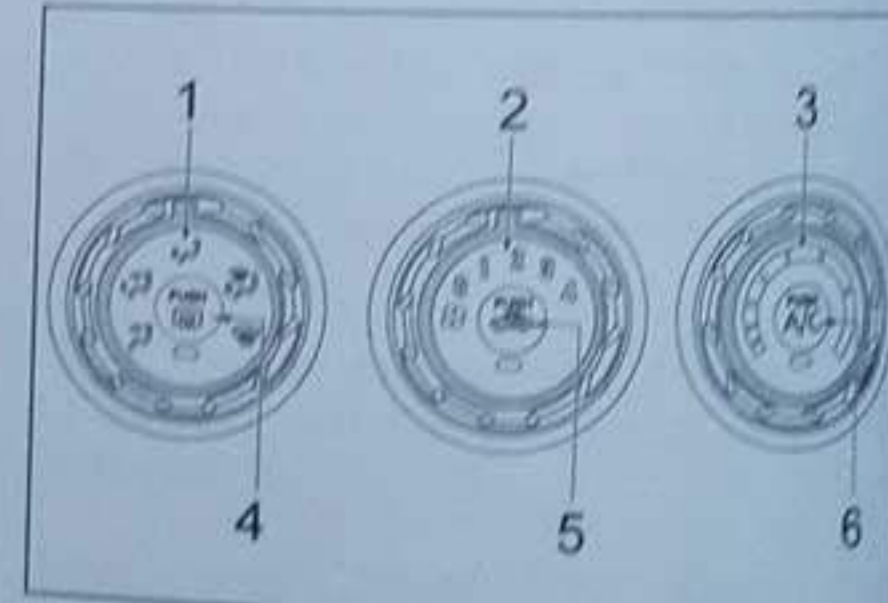

DOIRW007R14004

- 1 - Mode selection dial
- 2 - Blower speed selection dial
- 3 - Temperature control dial
- 4 - Rear defogger switch
- 5 - Air selection switch
- 6 - Air conditioning switch

1) Temperature control dial

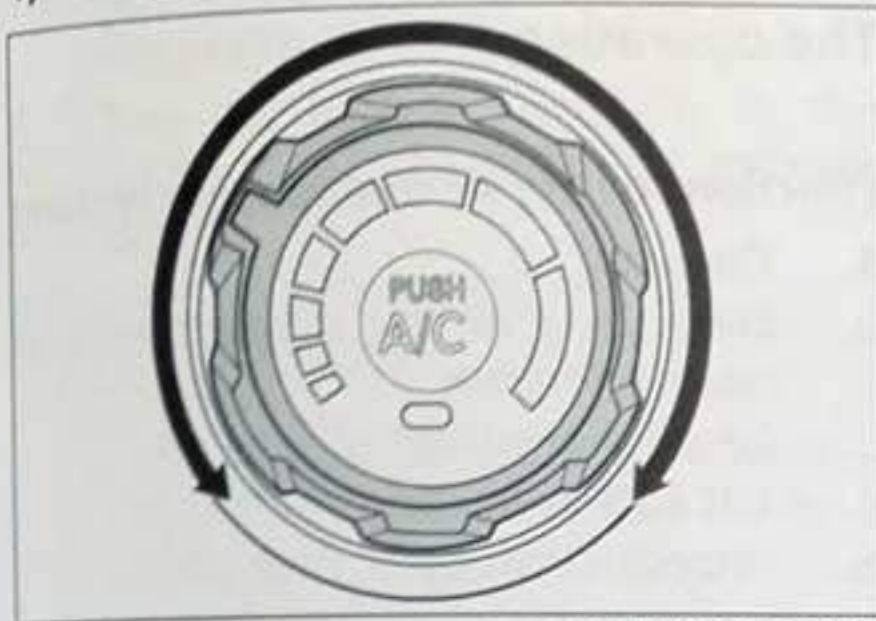

DOIRW007R14005

1. Turn the temperature control dial to the left or right direction.

- When the dial is turned to the right, temperature of the air will decrease (colder).

2) Air selection switch

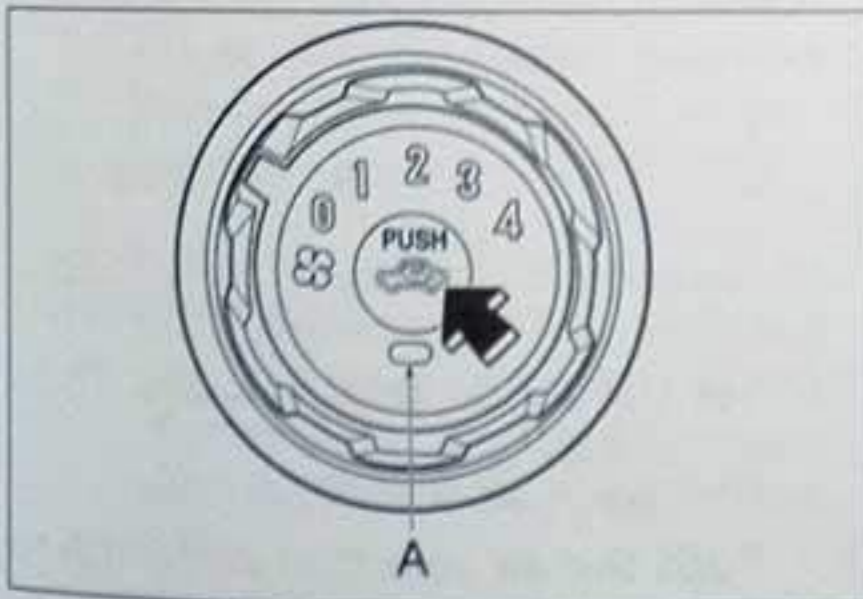

DOIRW007R14006

To change the position of the air selection, push the air selection switch.

- "Outside" position: Indicator lamp (A) is deactivated. During "outside" position

The air circulation uses the air flow from outside of the vehicle

- "Recirculation" position: Indicator lamp (A) is activated. The air circulation uses the air inside the passenger compartment.

⚠ CAUTION

- Use the "outside" position to keep the windscreen and side windows clear. Also use this position to quickly remove fog from the windscreen.

- Use the "air recirculation" position if the air outside of the vehicle is dirty.

- Use the "air recirculation" position to get a high-cooling performance.

- The extended operation of the "air recirculation" position for a longer period can cause a fog to the windows.

- Regularly set to the "outside" position to increase the air ventilation to prevent a fog to the windows.

3) Blower speed selection dial

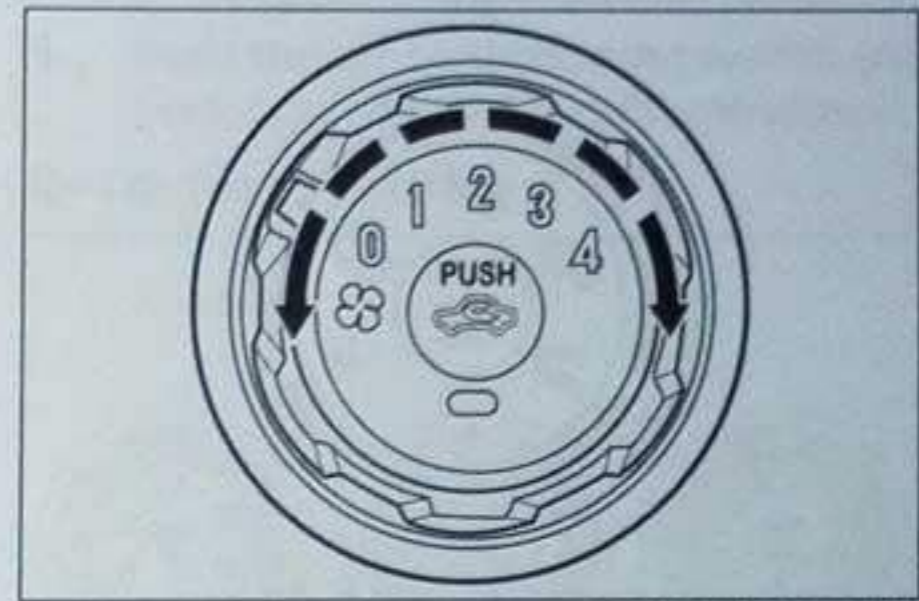

DOIRW007R14007

Select the blower speed and turn the blower speed selection dial to the left or right direction. When you turn the dial to the right, the blower speed will increase gradually.

4) Air conditioning switch

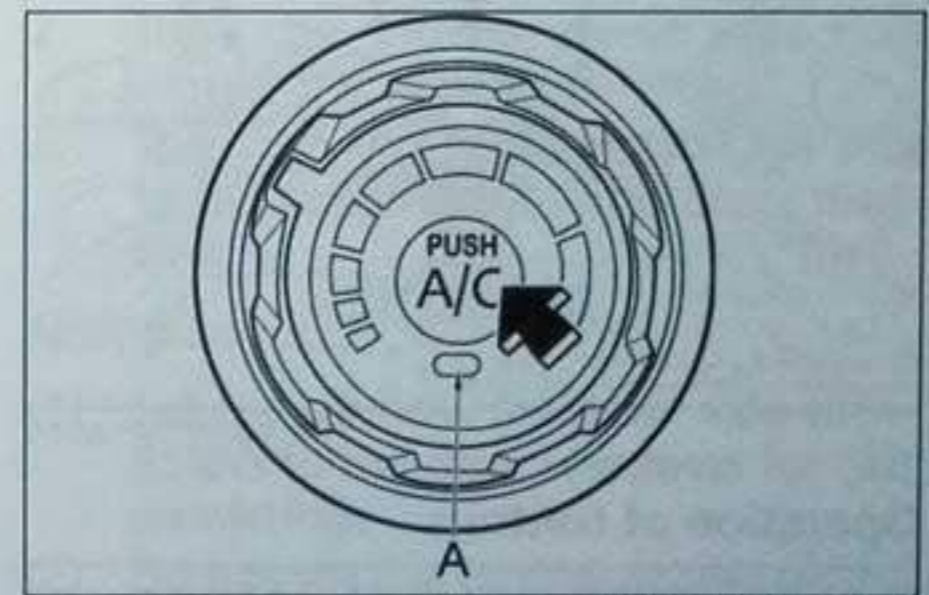

DOIRW007R14008

Push the switch to turn on the air conditioning system. The indicator lamp (A) will illuminate.

Push the switch again to turn off.

5) Mode selection dial

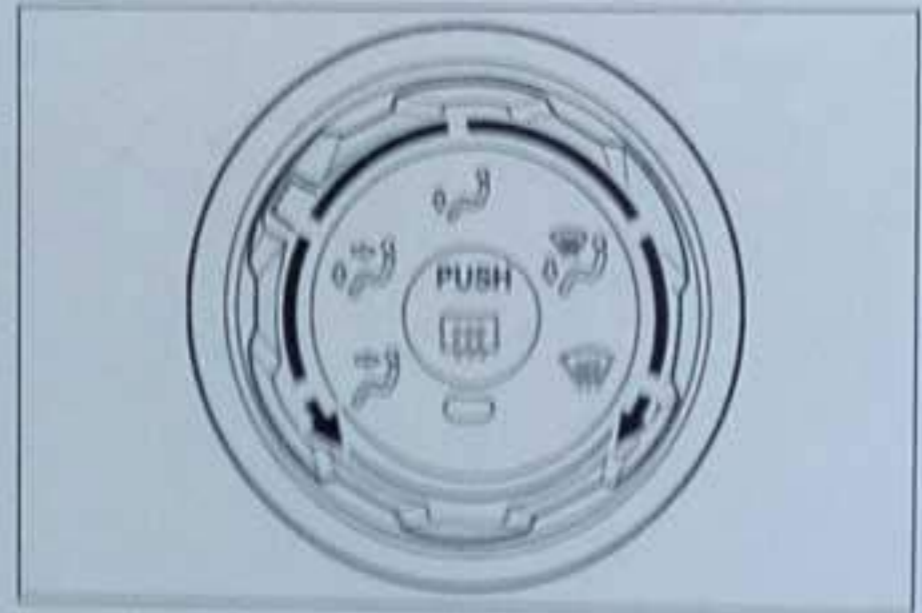

DOIRW007R14009

Set the direction of the air flow and turn the mode selection dial to the right or left.

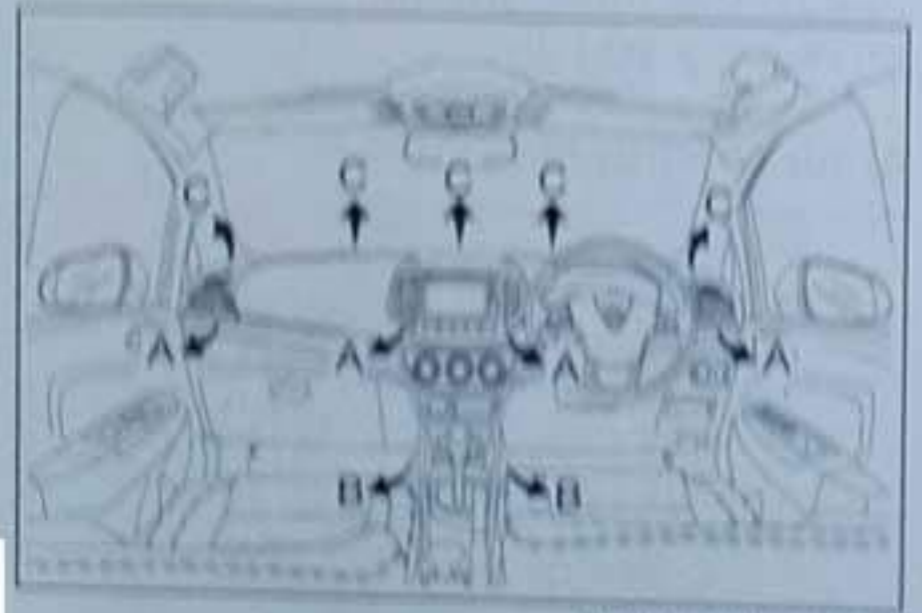

DOIRW007R14010

Operation of controls

Mode selection	Air outlets
	A
	A,B

* if fitted

	B,C ¹
	B,C
	C
1- Small amount of air flow	

: FACE position

The air flows to the top body part of the passenger area.

: FACE-FOOT position

The air flows to the top body and foot parts of the passenger area

: FOOT position

The air flows to the foot areas and removes fog or ice from the windshield

: FOOT-DEFROST position

The air flows to the foot areas and removes fog or ice from the windshield

: DEFROST position

The air flows removes fog or ice from the windshield

Manual air conditioning system - The operation *

Functions of the air conditioning system:

1. Cooling
2. Demisting of the windscreen and door windows
3. Usual demisting
4. For fast demisting
5. Introduction of outside air

Below are some recommended settings:

A- Cooling

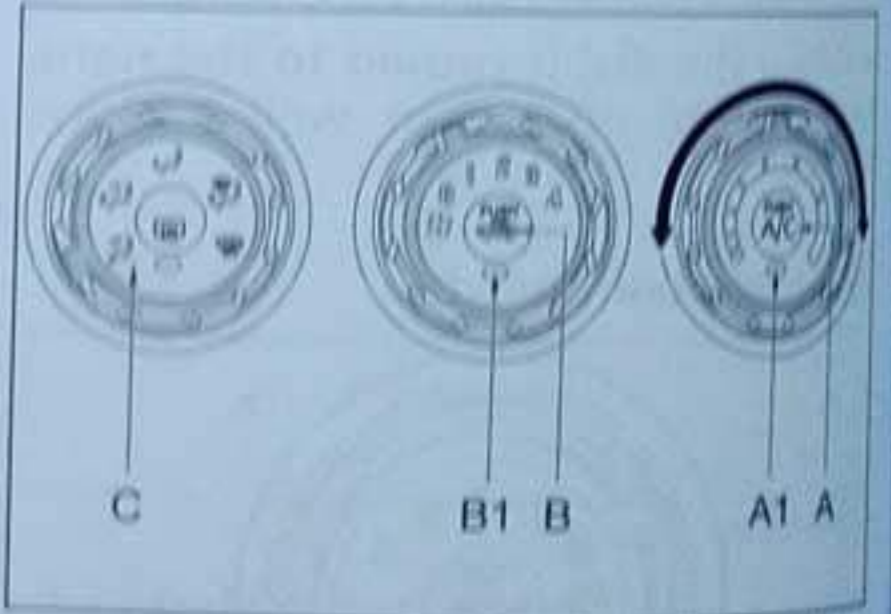

DOIRW007R14011

1. Set the mode selection dial (C) to the position.
2. Push the air selection switch (B) to set the "recirculation" position (indication lamp B1 is illuminated).
3. Push the air conditioning switch (A) (indicator lamp A1 is illuminated).

- Turn the temperature control dial (A) to the right or left to set the temperature.
- Turn the blower knob (B) to the right or left to set your blower speed.

CAUTION

- If the outside air is dirty, set the air selection switch (B) to the "recirculation" position.
- To operate the system at high-cooling performance, set the air selection switch (B) to the "recirculation" position. Turn the temperature control dial to the most right side.

The windows can possibly get fog. Set the air selection switch (B) to the "outside" position regularly to increase the ventilation.

- Long hours of driving may cause drowsiness. Regularly set the air selection switch (B) to the "outside" position to make sure sufficient oxygen in the cabin.

B- Demisting of the windscreen and door windows

To remove the mist from the windscreen and door windows, use the mode selection dial (" " or " ").



CAUTION

Make sure to have a clear view through all windows for safety purpose.

C- Usual demisting

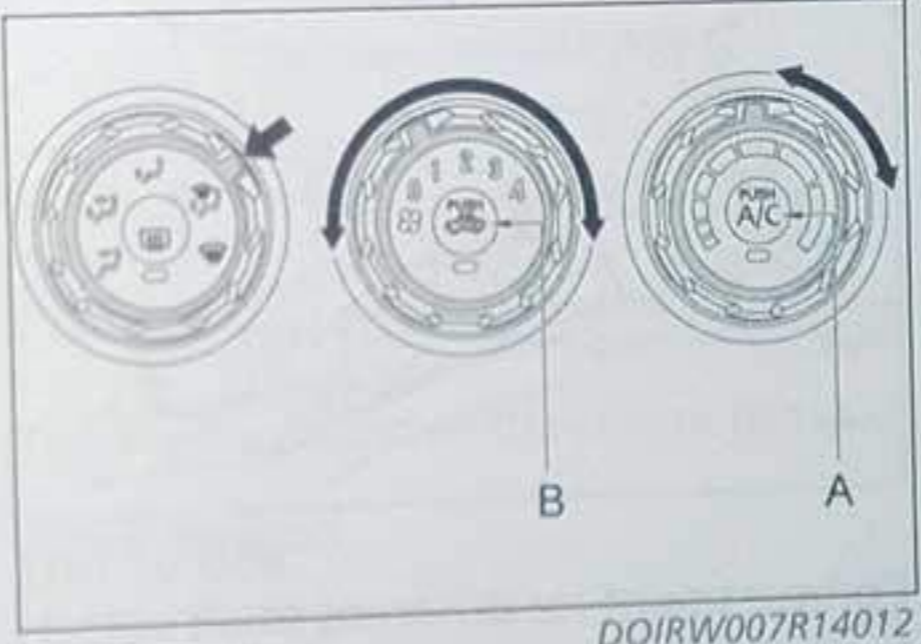

DOIRW007R14012

Use this setting to keep the windscreen / door windows clear and keep the foot area warm.

- Set the air selection switch (B) to the outside position.
- Set the mode selection dial to the " " position.
- Turn the blower speed selection dial to set your blower speed.

- Turn the temperature control dial to set your temperature.
- Push the air conditioning switch (A) (indicator lamp A1 is illuminated).

D- For fast demisting

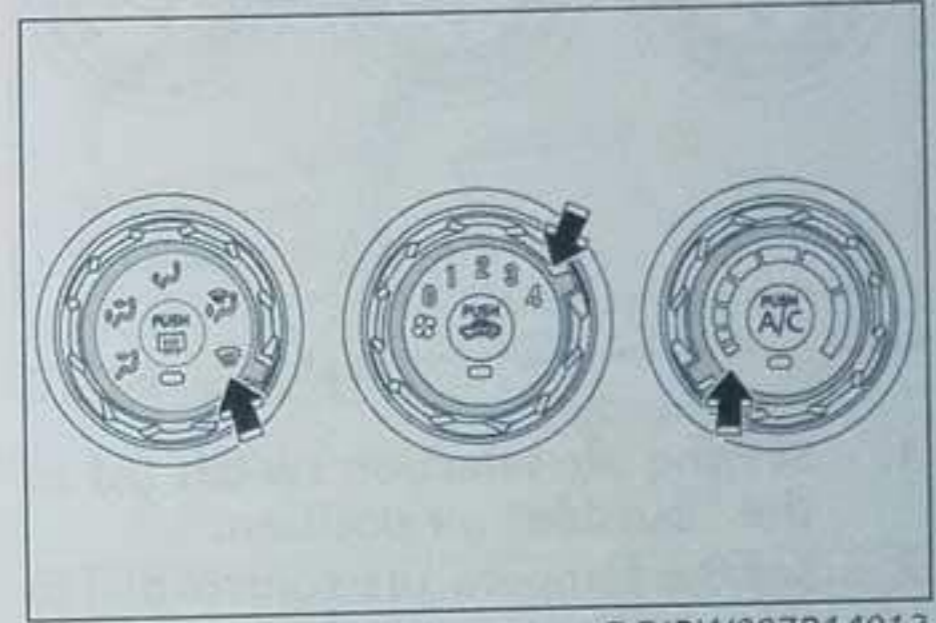

DOIRW007R14013

- Set the mode selection dial to the " " position.
- Turn the blower speed selection dial to the maximum speed.
- Turn the temperature control dial to the maximum temperature position.

NOTE

- Set the air flow from the side ventilators to the door windows for fast demisting.
- Do not set the temperature control dial to the maximum cool position. Cool air will blow against the window glasses and prevent demisting procedure.

E- Introduction of outside air

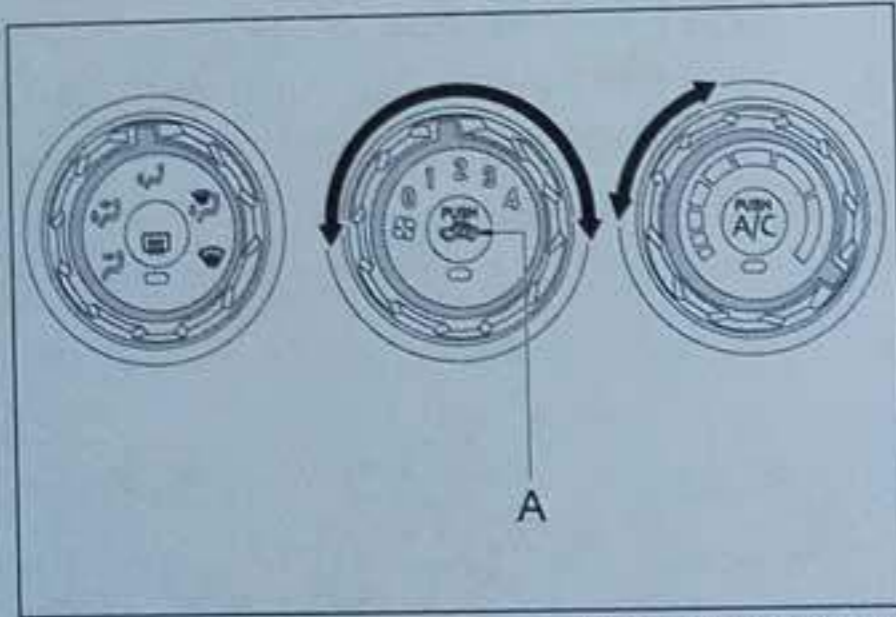

DOIRW007R14014

1. Set the air selection switch (A) to the "outside" air position.
2. Set the temperature control dial to the positions shown in the illustration.
3. Turn the temperature control dial to the right (for the maximum cold).
4. Turn the blower speed selection dial to set your blower speed.

Accessories *

OWN007PDRIV16007

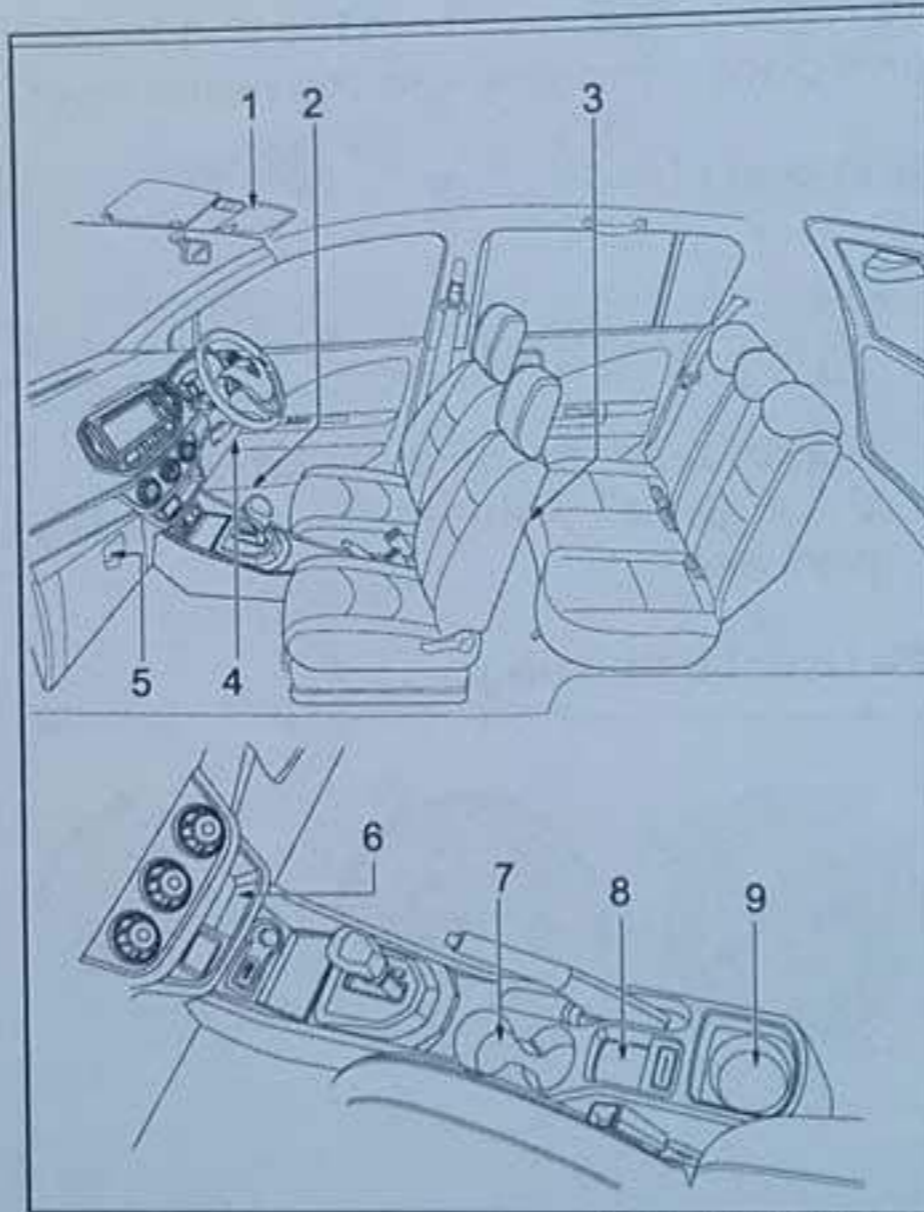

DOITW007R16004

Compartment for different small objects :

- 1 - Ticket holder
- 2 - Map pocket at front door
- 3 - Back pocket at front seat
- 4 - Utility box (side for the driver)
- 5 - Glove box
- 6 - Shelf - centre panel lower
- 7 - Cup holder at front
- 8 - Centre console
- 9 - Cup holder at rear

Vanity mirror *

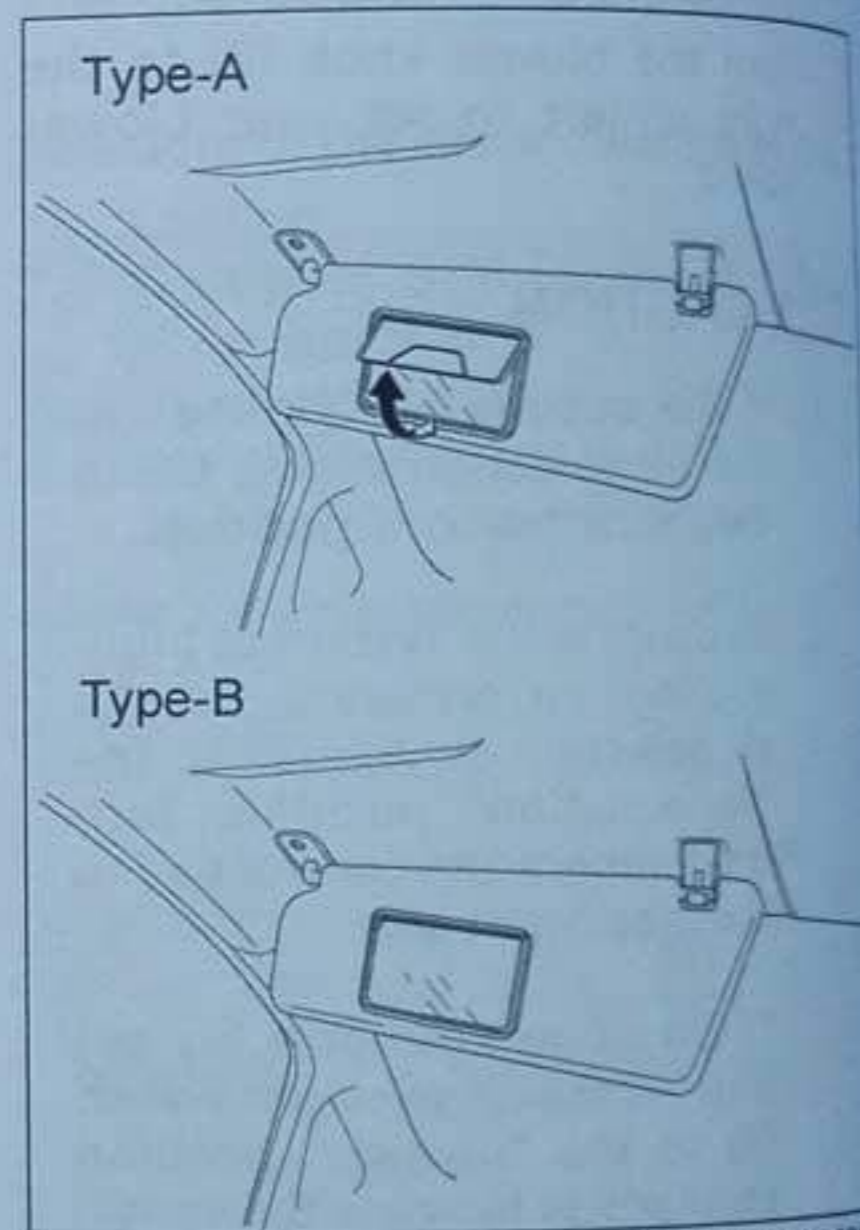

DOIRW007R14016

A vanity mirror is installed behind of the sun visor at the driver and passenger side.

Ticket holder *

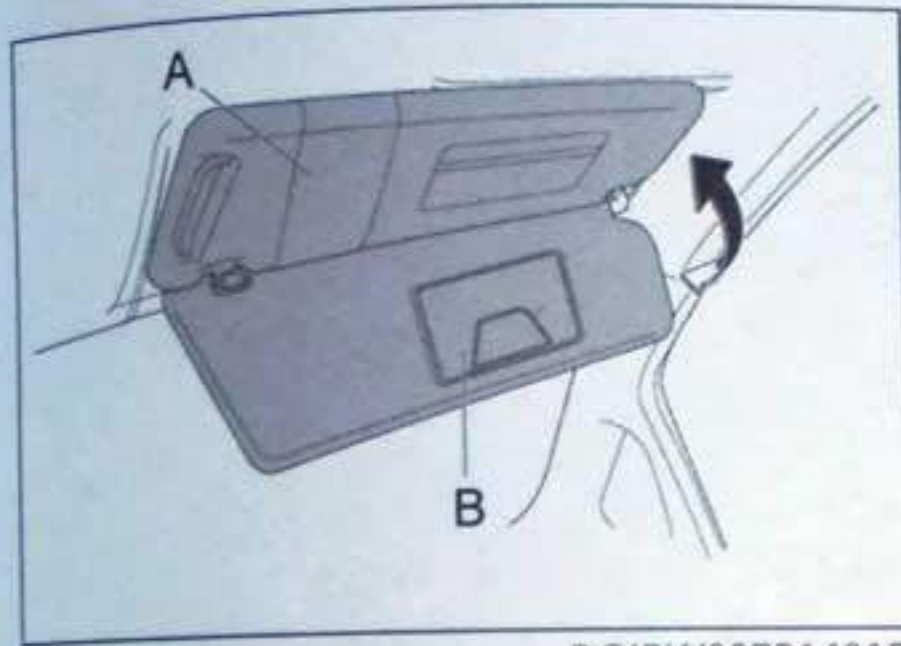

DOIRW007R14015

Use this ticket holder to store parking-ticket, toll-tickets and other equivalent objects.

A- Strap ticket holder at behind sun visor (side of the driver)

B- Ticket holder at vanity mirror

Glove box (passenger side)

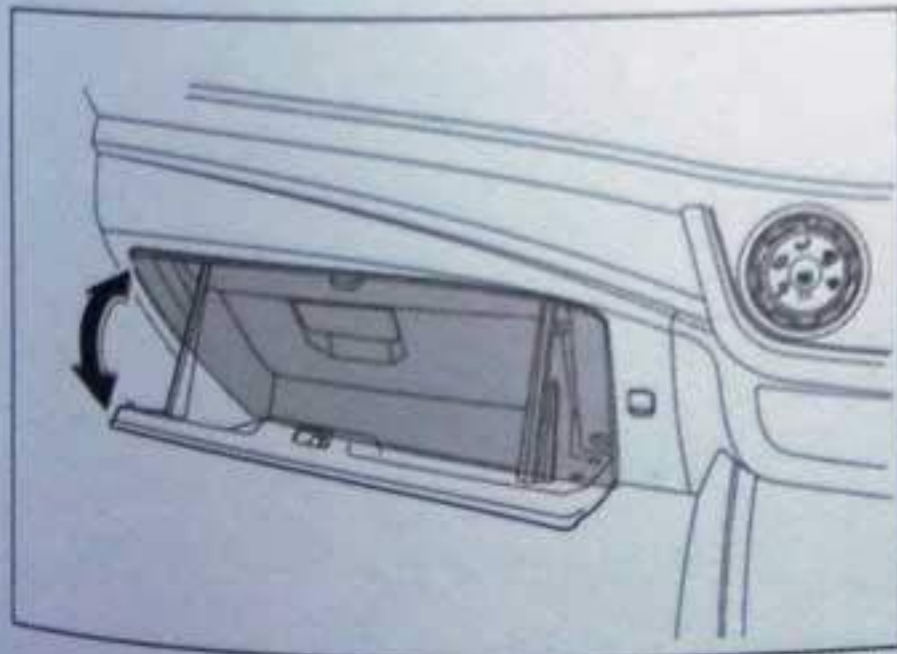

DOIRW007R14019

The glove box is found at the front-passenger seat.

To open, pull the handle as shown in the illustration. Close the glove box after you use.

Shelf

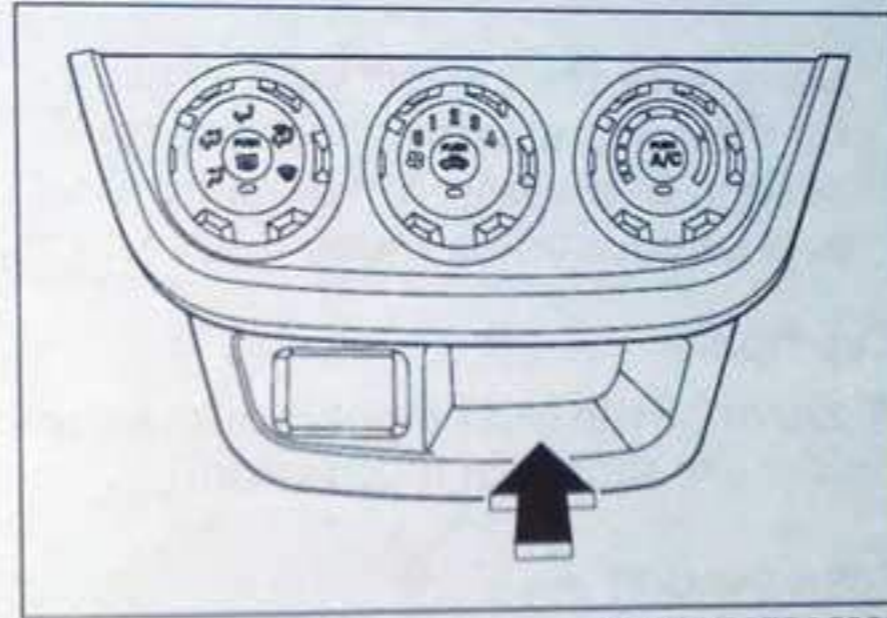

DOITW007R16003

The shelf is found at the centre console.

Utility box

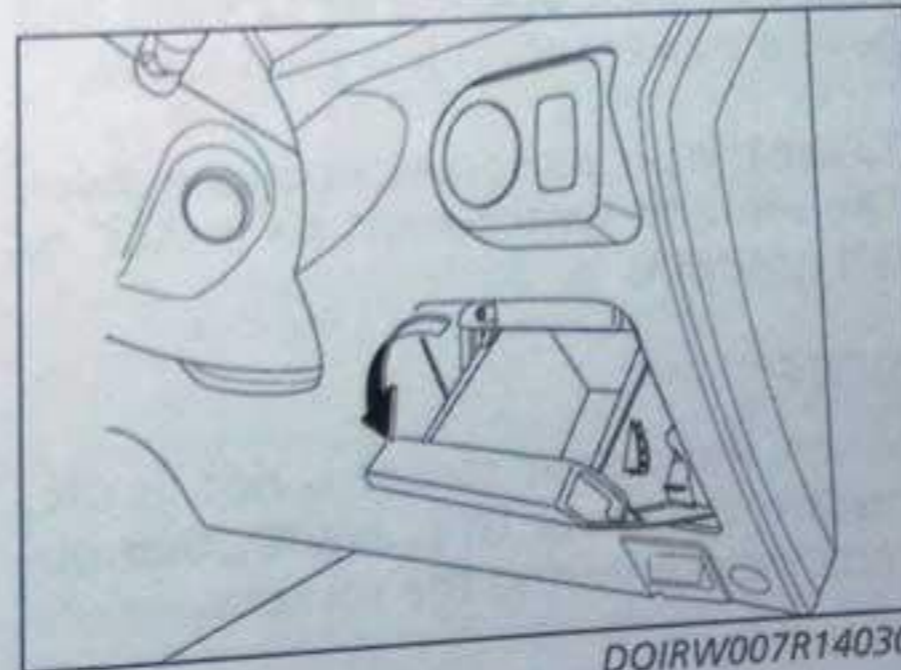

DOIRW007R14030

This utility box found at the driver area.

Bottle-holder

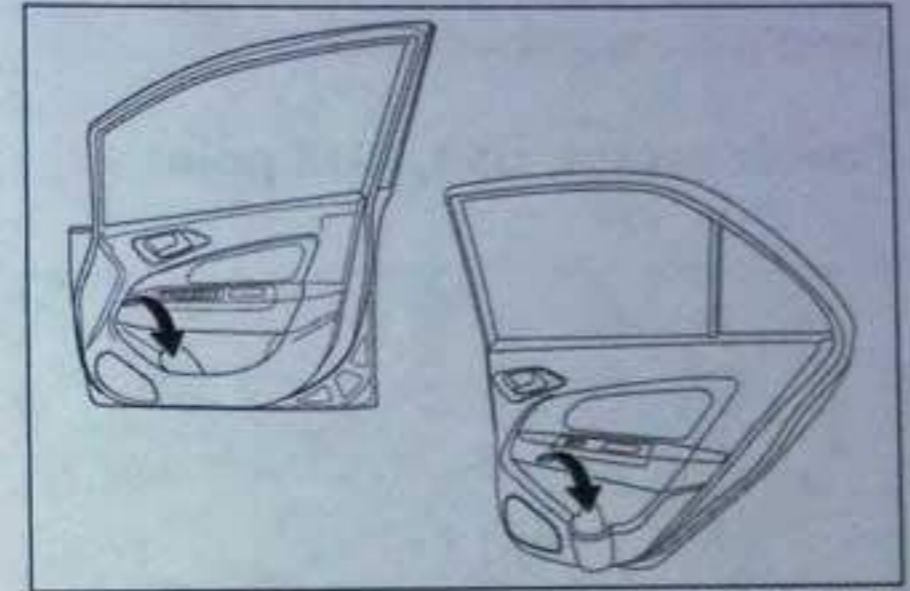

DOIRW007R14024

The bottle-holder is found at the door trim of doors.

Utility-hook

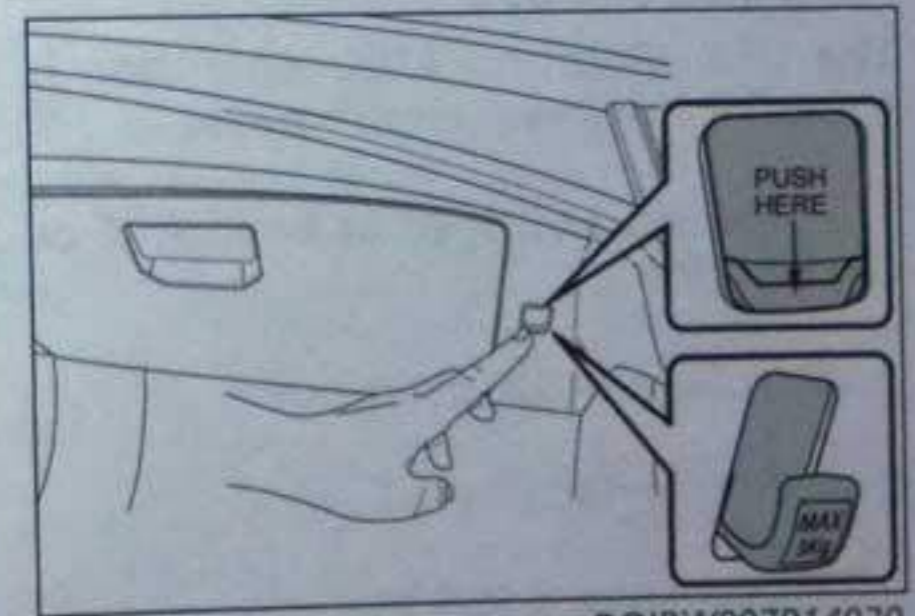

DOIRW007R14020

Utility-hook is found at the lower passenger side.

* if fitted

NOTE

Maximum load : 3 kg

Do not hang any item that in total the weight is more than the limit.

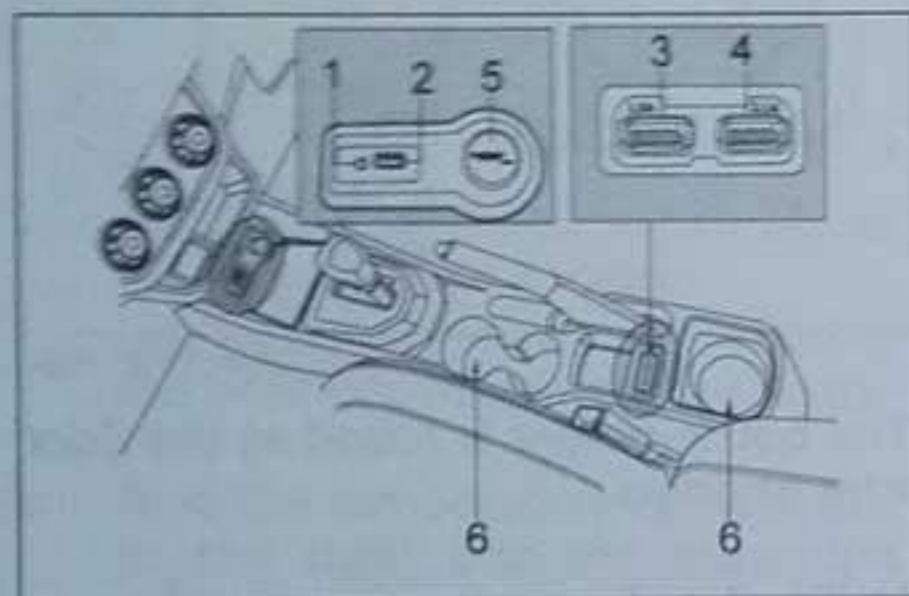
Power socket, USB, AUX point

DOIRW007R14025

AUX, iPod and USB

The USB, iPod and AUX connection is found at the lower centre panel.

The ignition switch must be in ACC or ON position.

1 – Auxiliary (AUX) interface

2 – USB interface

3 – USB interface (1.5 A)

4 – USB interface (2.1 A)

5 – Power socket

6 – Cup-holders**NOTE**

Refer to the radio manual for more information about the operation of the USB and iPod.

**CAUTION**

Make sure the correct port is used for different devices. Incorrect connection to the port can damage the port or your audio-video device.

Cup-holder

A cup or bottle can be put into the cup-holder are shown in illustration.

Power-socket

The location of the power socket is shown in illustration;

Use the power-sockets to connect electrical accessories; The compatible accessories must operate at 12 volts and have a power rating less than 120W.

To use the power socket, open the cover. The ignition switch must be in ACC or ON position.

NOTE

When the power socket is not in use, put on the cover to prevent other objects from entering the socket.

For Emergencies

If the Vehicle has a Failure	134
Spare Tyre, Tools and Jack	134
Lift the Vehicle with a Jack	134
How to Change a Tyre	136
Engine Temperature Gets High	139
Tow-carriage	140
Emergency Jump-start	141
Fuse Box	143
Change a Blown Fuse	146
Replacement of lamp bulbs	147
Replacement of the remote-transmitter battery	156
Emergency trunk lid release	158

If the Vehicle has a Failure

OWN009EMERG16001

If the vehicle has a failure, move the vehicle to the side of the road and activate the hazard warning flashers.

NOTE

If the engine stops, the vehicle operations and controls are disabled. Park the vehicle in a safe area and follow the procedures below:

- (1) The brake booster does not operate and the pedal force will increase. Push the brake pedal with more force.
- (2) When the power steering motor does not operate, steering will be heavy. Turn the steering wheel with more force.

If the vehicle warranty is applicable, contact PROTON toll-free number for the roadside help.

Spare Tyre, Tools and Jack

OWN009EMERG16002

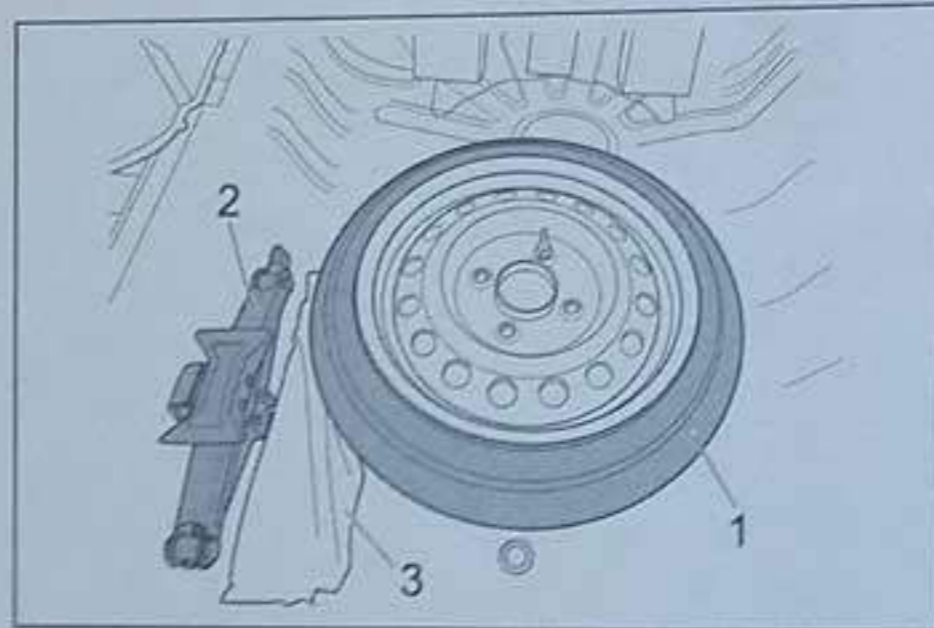

DOITW009R16001

Find the storage location of the spare tyre, tools and jack.

- 1 - The spare tyre
- 2 - Jack

Tools

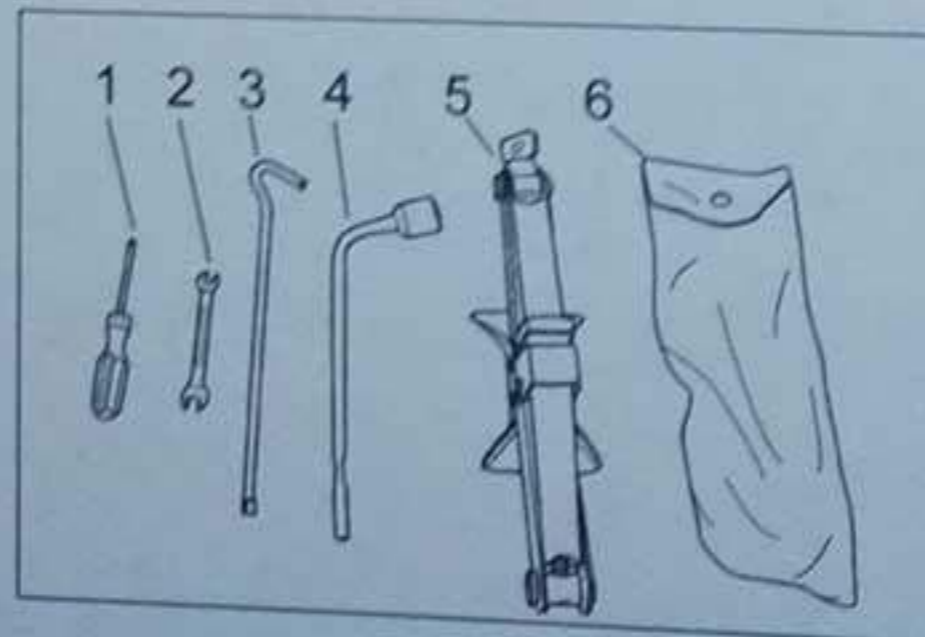

DOIQW009R12036

Make sure the tool set is available when receiving vehicle from the approved PROTON service outlet.

- 1 - Screwdriver
- 2 - Spanner (8 x 10)
- 3 - Tyre bar
- 4 - Tyre wrench
- 5 - Jack
- 6 - Tool bag

NOTE

Make sure the tool set is kept in a safe place.

Lift the Vehicle with a Jack

OWN009EMERG16003

CAUTION

Before operating the jack to lift the vehicle, carefully read and know these precautions.

- (1) Install the jack **ONLY** at the specified position at the under-carriage body.

If the jack is installed at an incorrect position, the vehicle body may be damaged and the jack may possibly tip over; the vehicle may fall and cause injury.

- (2) Always put the jack on a flat, hard surface.

If the jack is placed on a hill or soft surface, the jack may tip over; the vehicle will fall and cause an accident. Before placing the jack, make sure the surface is away from any loose stones / pebbles.

- (3) Make sure the jack is placed on a level and hard ground.
- (4) Make sure the vehicle wheels on the ground are provided with a stopper; no person should be in the vehicle when the car is jacked.
- (5) When the vehicle is jack, no person or body part should be under the vehicle.

⚠ WARNING

- (1) Lift the vehicle until the tyre position is high to install or remove the tyre or tyre-chain.



DOIQW009R11017

- (2) Do not go below the vehicle while the vehicle is on the jack.
- (3) Do not move or leave the lifted vehicle hold on the jack for extended time.
- (4) Do not start or operate the engine while the vehicle is on the jack. The vehicle may move and the jack possibly tip over.
- (5) Do not turn the lifted wheels. The tyres remaining on the ground may turn, causing the vehicle body to fall off the jack.

How to use the jack

Before jacking the vehicle, first stop the vehicle in a safe, flat location.

1. Park the vehicle on a level and stable ground without any loose stones / pebbles.
2. Turn on the hazard flashers.
3. Install a warning triangle.
4. Flash signal lamp at sufficient distance from the vehicle and have all the passengers leave the vehicle.
5. Put the ignition to the "OFF" or "LOCK" position.
6. Correctly engage the parking brake. (For vehicle with manual transmission) Move the gear lever to the "N" (neutral) position.

(For vehicle with automatic transmission AT or CVT) Move the gear lever to the "P" (park) position.

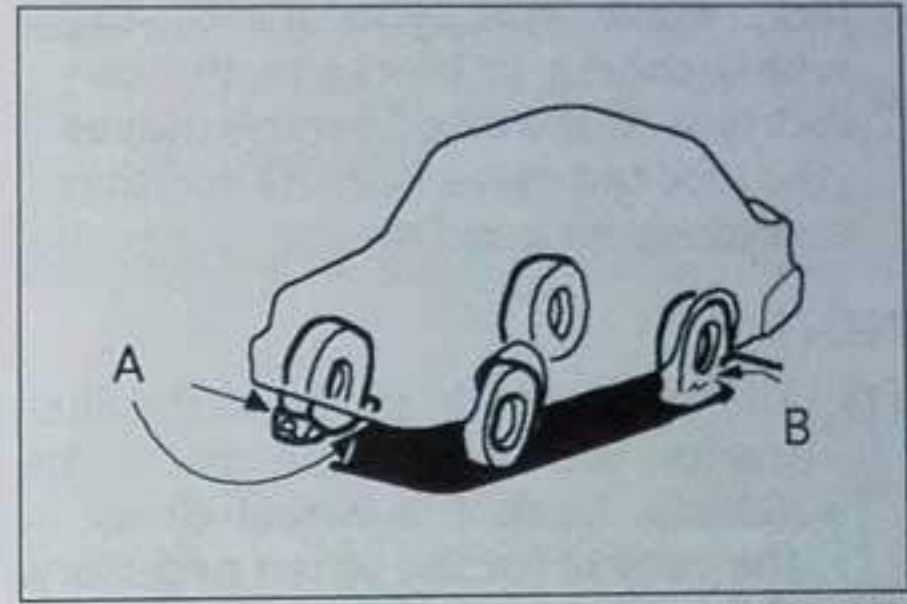

DOIAW009R3008

A – Wheel chock / block

B – Tyre (to change or install tyre-chain)

- 7. Put a wheel chock or block (A) at the tyre opposite the tyre (B).

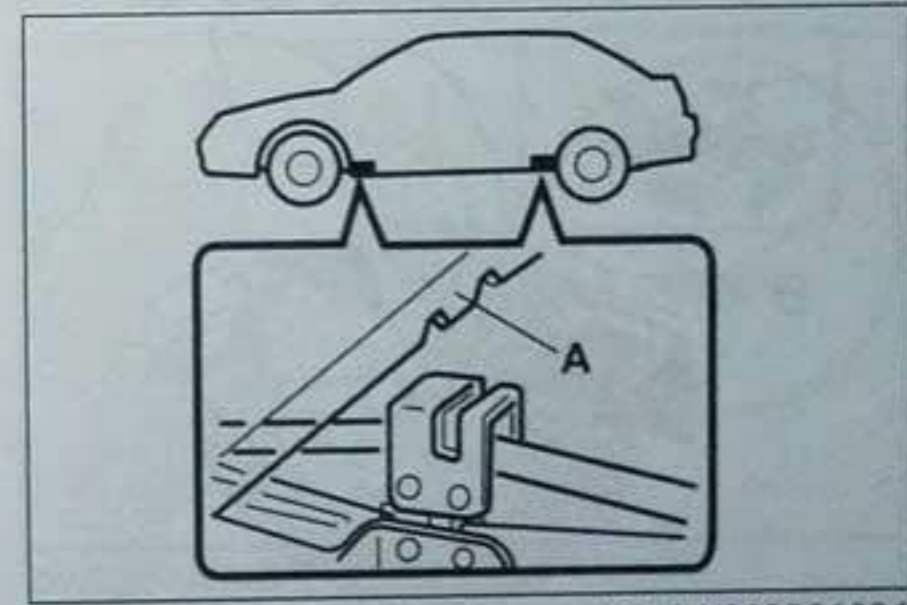

DOIFW009R01034

A - Jacking point

⚠ WARNING

When you lift the vehicle with a jack, make sure you install the wheel chocks or blocks to the correct tyre. If the lifted vehicle moves, the jack can move from its position and cause an accident.

NOTE

- (1) The wheel chocks shown in the illustration do not come with the vehicle. Keep the wheel chock in the vehicle for use when necessary.
- (2) If no wheel chock is available, use a rock or other objects with a same size to hold the wheel in position.
8. Install the jack at the jacking points shown in the illustration. Make use the jacking point near to the tyre (B).

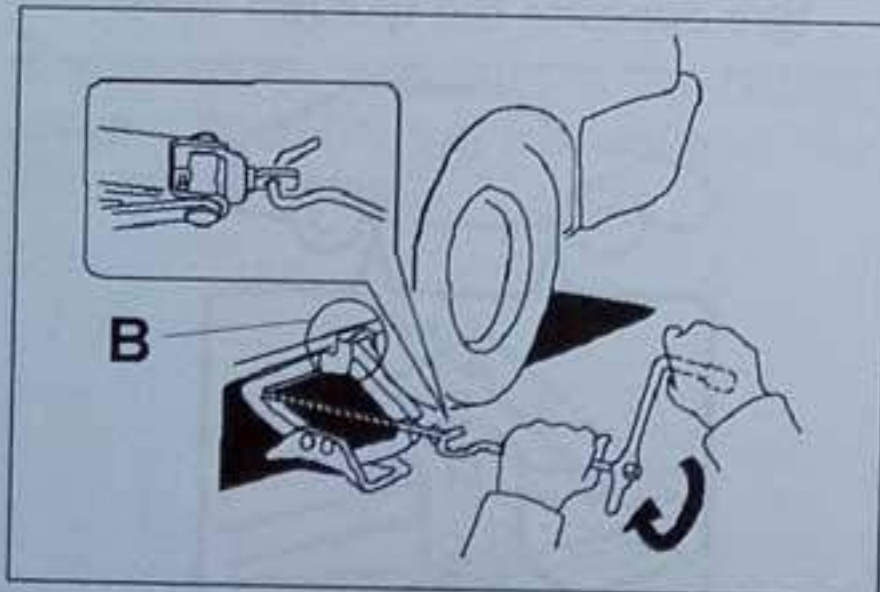

DOIIW009R9005

9. Turn the jack until the flange part (B) installs in the groove at the top of the jack.

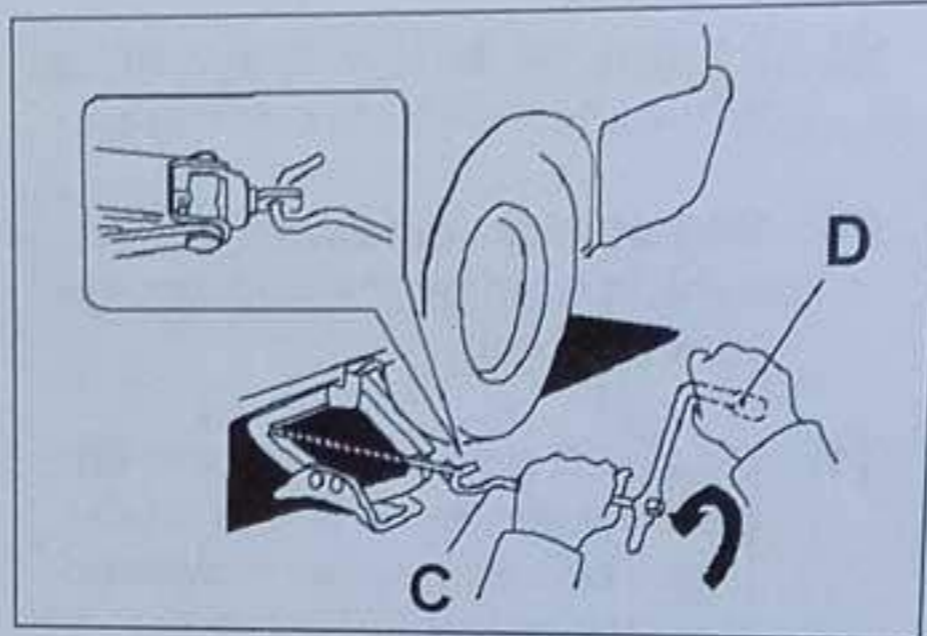

DOIIW009R9006

10. Install the bar (C) into the wheel nut wrench (D). Set the end of the bar to the shaft end of the jack, as shown in the illustration. Slowly turn the wheel nut wrench until the tyre is high enough to fit the inflated spare tyre.

⚠ CAUTION

- (1) Use only the jack included with the vehicle.
- (2) Use only the jack to change the wheels and install tyre-chains.

NOTE

- (1) To lift the vehicle, turn jack handle to the right-side direction.
- (2) To lower the vehicle, turn jack handle to the left-side direction.

How to Change a Tyre

OWN009EMERG16004

Before changing a tyre, first stop the vehicle in a safe, flat location.

1. Park the vehicle on level and stable ground, without loose small stones.
2. Correctly set the parking brake.
3. Turn on the hazard flashers and install the supplied warning triangle.
4. Flash signal lamp at sufficient distance from the vehicle and have all passengers leave the vehicle.
5. Install the wheel chock or block (A) at the tyre that is opposite from the tyre (B) you change. If wheel chocks are not available, use a rock or other object with a same size.

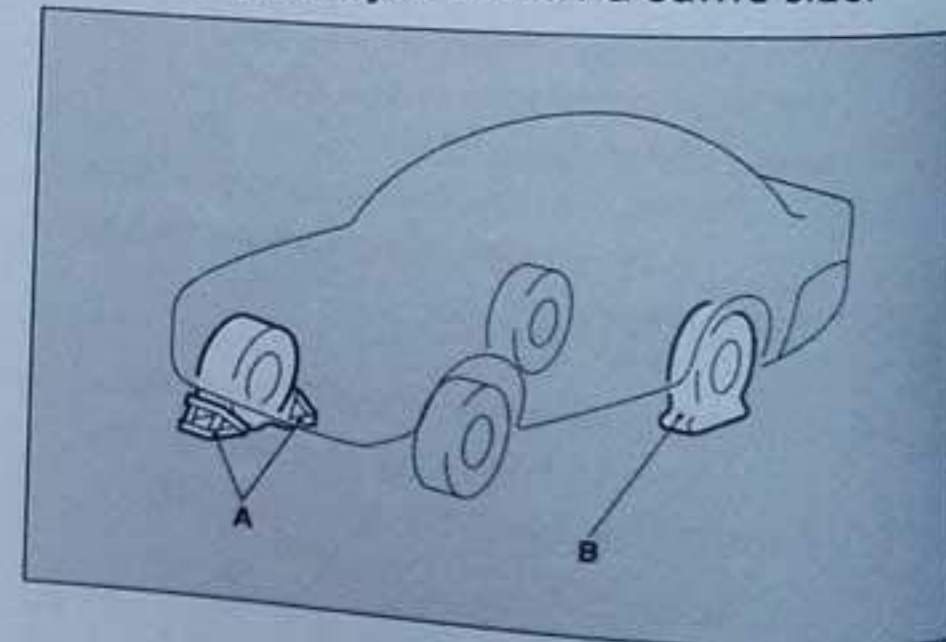

DOIPW009R10005

6. Get the supplied jack, bar and wheel nut wrench.

WARNING

When lifting the vehicle with a jack, make sure to install the wheel chocks or blocks to the correct tyre. The jack can move from its position and cause an accident.

NOTE

- (1) The wheel chocks shown in the illustration do not come with the vehicle. Keep the wheel chock in the vehicle for use when necessary.
- (2) If no wheel chocks are available, use other objects with the same size to hold the wheel in position.

Spare wheel information

Check the air pressure of the spare tyre frequently and make sure the tyre is fit for emergency use.

Keep the spare tyre at the maximum specified air pressure. The spare tyre is stored below the trunk floor board of the luggage compartment.

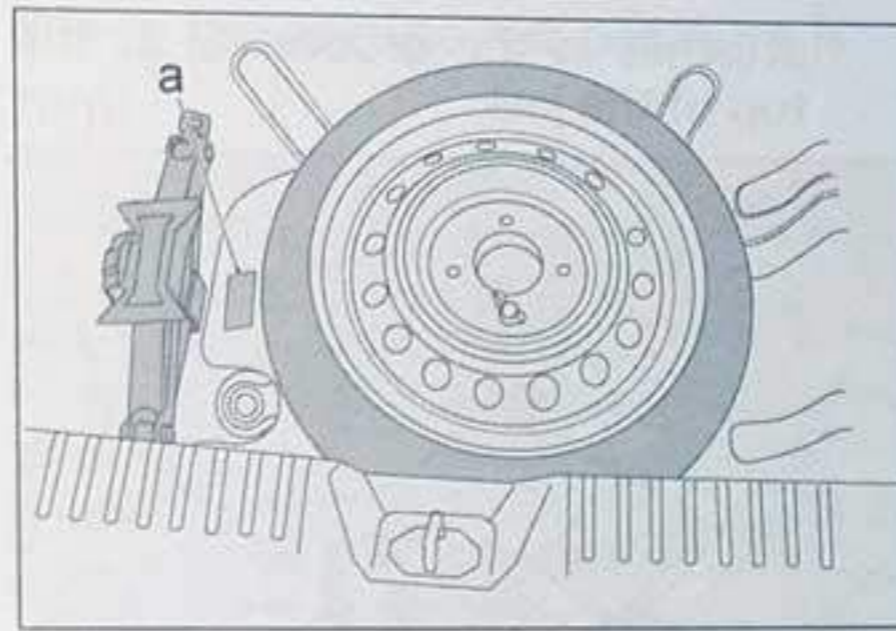

DOIRW009R14047

The spare tyre information label as shown in illustration (a).

CAUTION

- (1) Use one temporary spare tyre in any one time.
- (2) Make sure you check and keep the air pressure at the maximum specified pressure all the time.
- (3) Driving with not sufficient tyre pressure can cause an accident. Drive slowly when using a spare tyre without sufficient tyre pressure.
- (4) The spare tyre is for temporary use only until the tyre is repaired or replaced.
- (5) Do not drive the vehicle at speed more than 80 km/h (49.7

mph) while using the spare tyre.

How to remove the spare tyre

1. Lift the floor board of the trunk compartment.

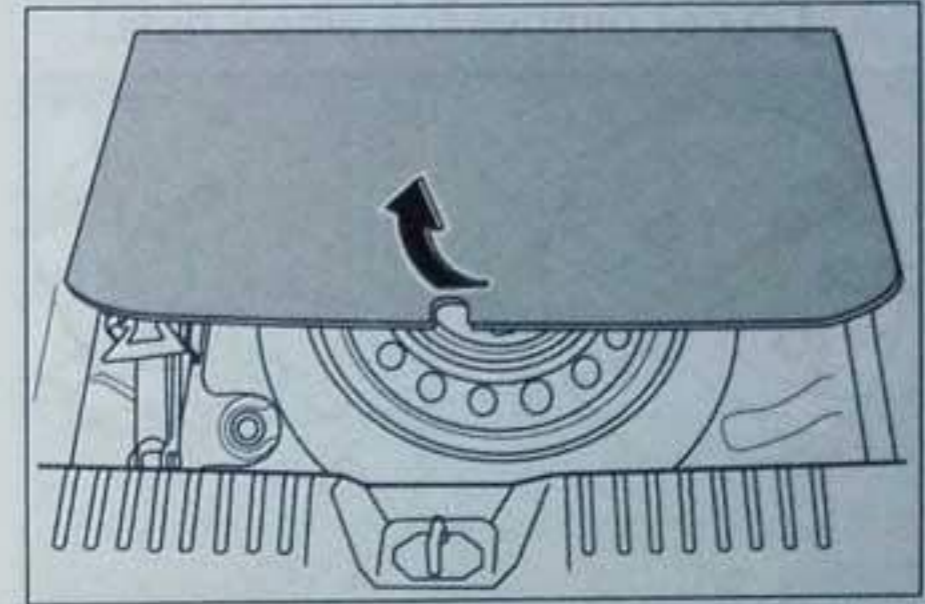

DOIRW009R14048

2. Turn the clamp to the left-side to remove the installation clamp (C). Remove the spare tyre.

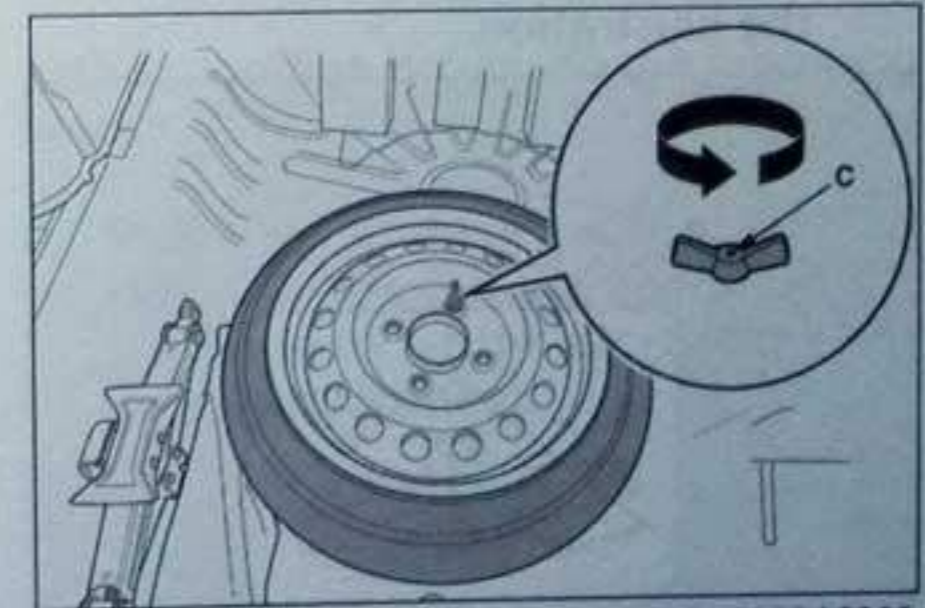

DOITW009R16002

How to change a tyre

1. On vehicles with wheel covers, first remove the covers. Loosen the wheel nuts a quarter turn with the wheel nut wrench. Do not remove the wheel nuts.

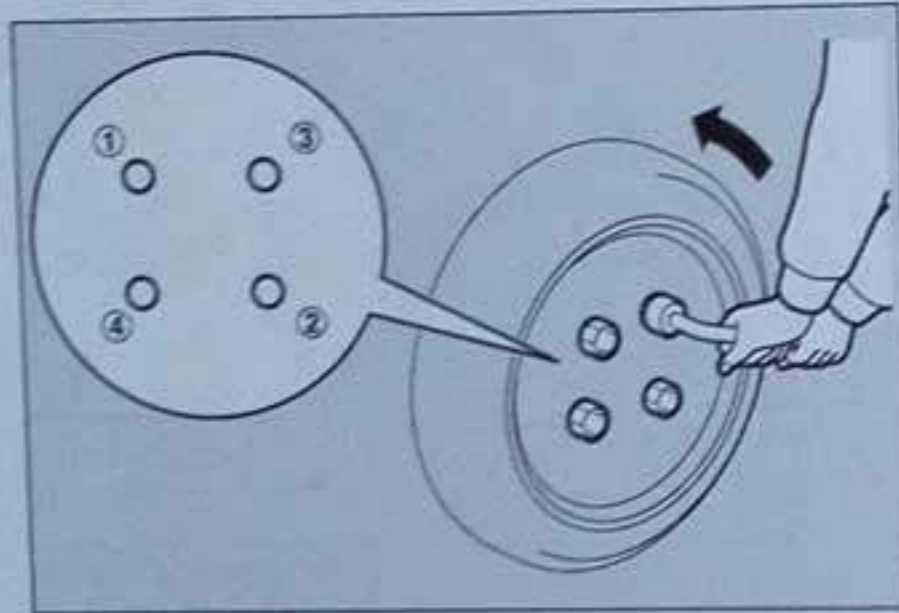

DOITW009R16005

2. Put the jack at the bottom of one of the jacking points (A) shown in the illustration.

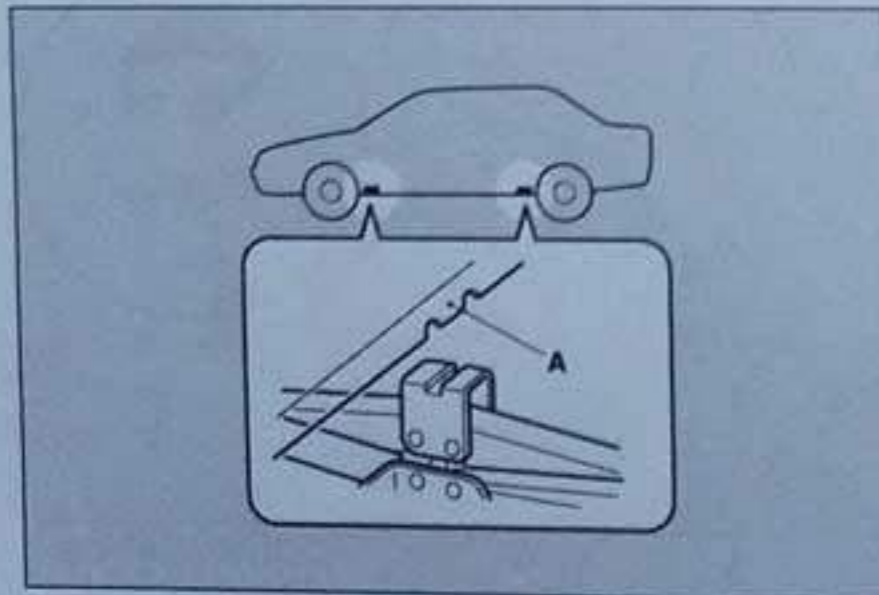

DOIPW009R10001

3. Turn the jack to the right with your hand. Turn until the flange part (B)

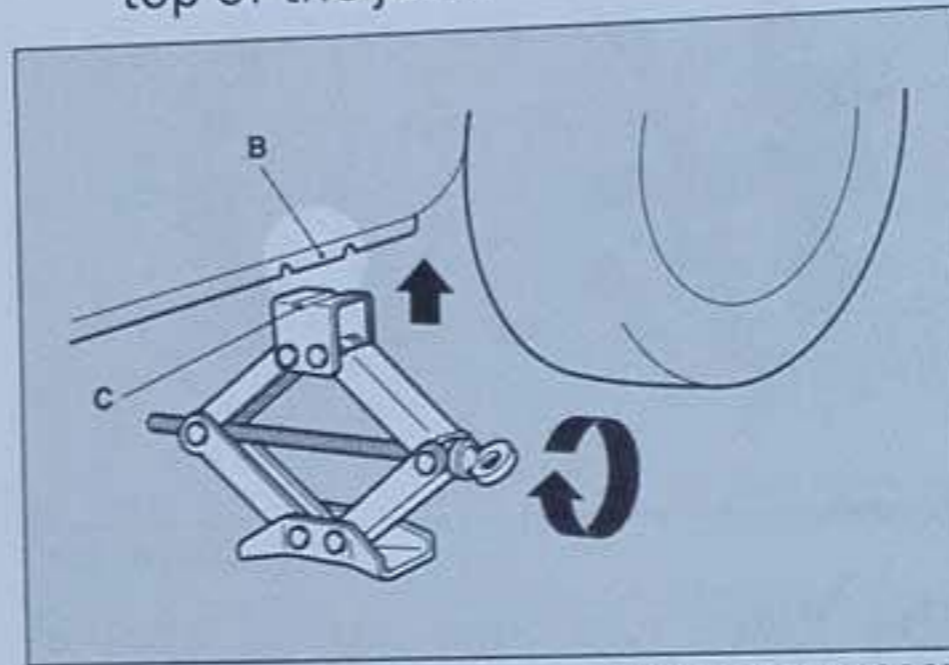

DOIPW009R10002

4. Install the end of the bar (hook end shape) into the shaft of the jack end. Install the bar (D) into the wheel nut wrench (E). Slowly turn the wheel nut wrench until the tyre is lifted from the ground.

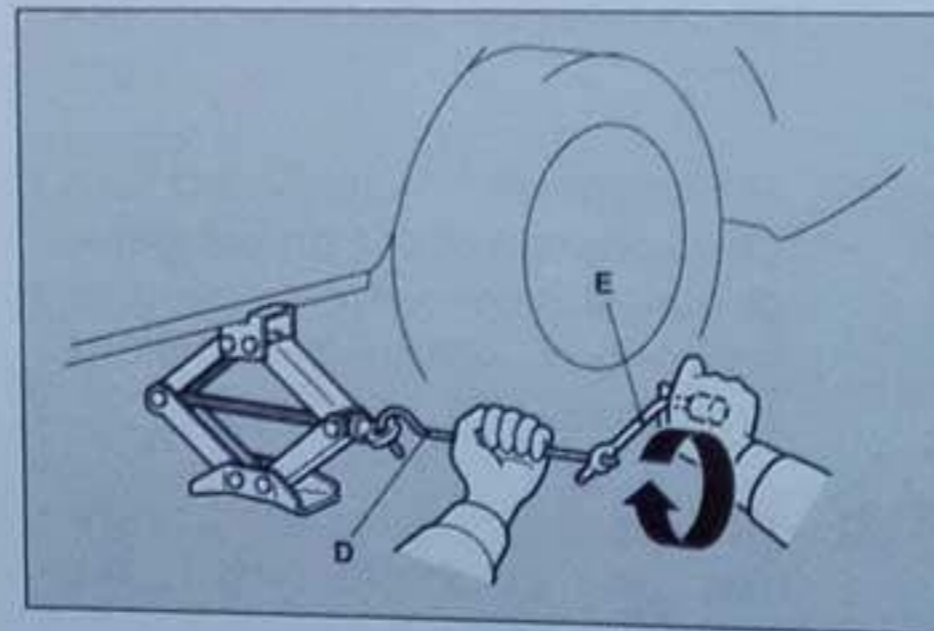

DOIPW009R10003

5. Remove the wheel nuts with the wheel nut wrench, then remove the wheel.

6. Clean out any mud on the hub surface (F), hub bolts (G) or in the installation holes (H) in the wheel.

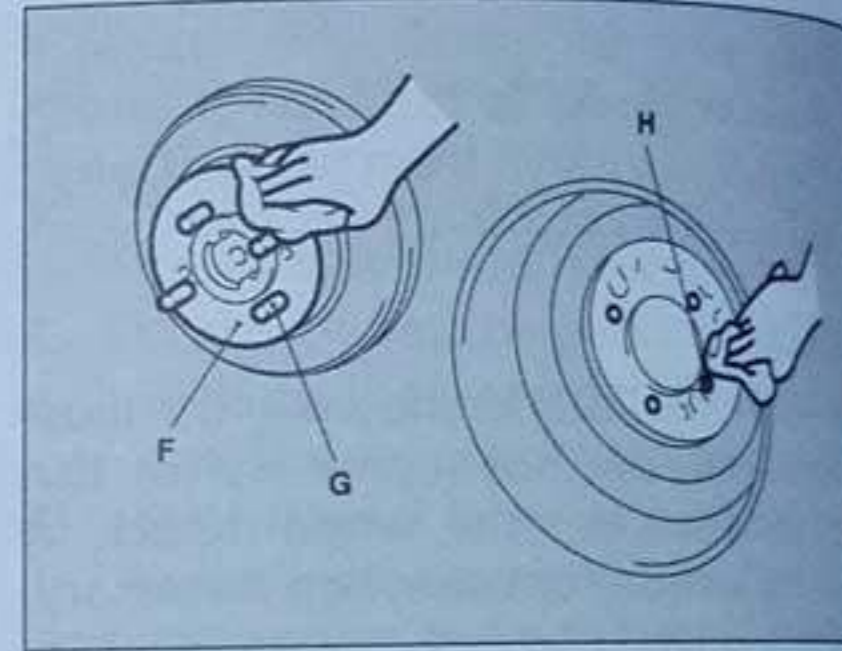

DOITW009R16006

7. Install the spare tyre. Tighten the wheel nut with your fingers.

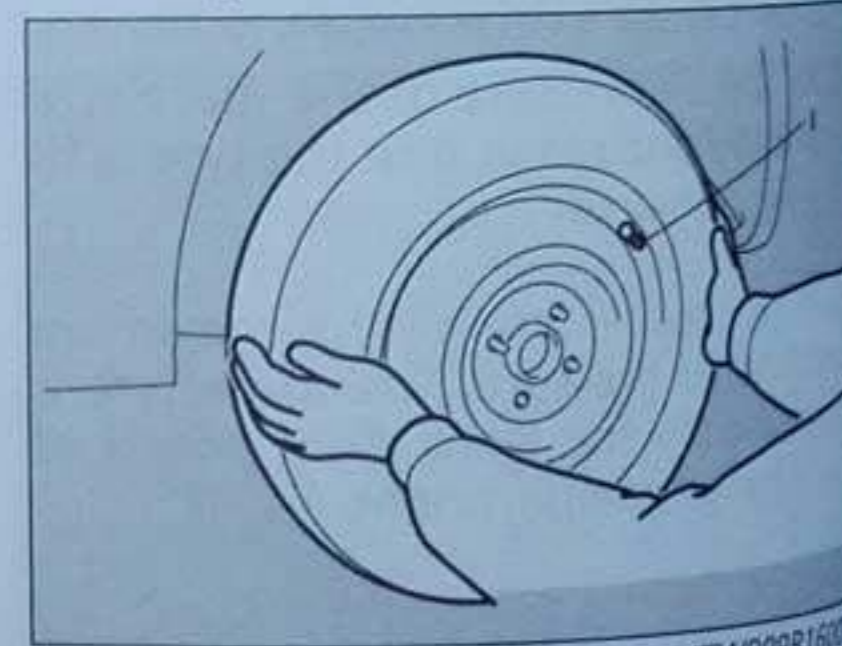

DOITW009R16007

8. Tighten the wheel nuts with the wheel nut wrench. Push the end of the tyre wrench with your hand until the nut is fully locked.

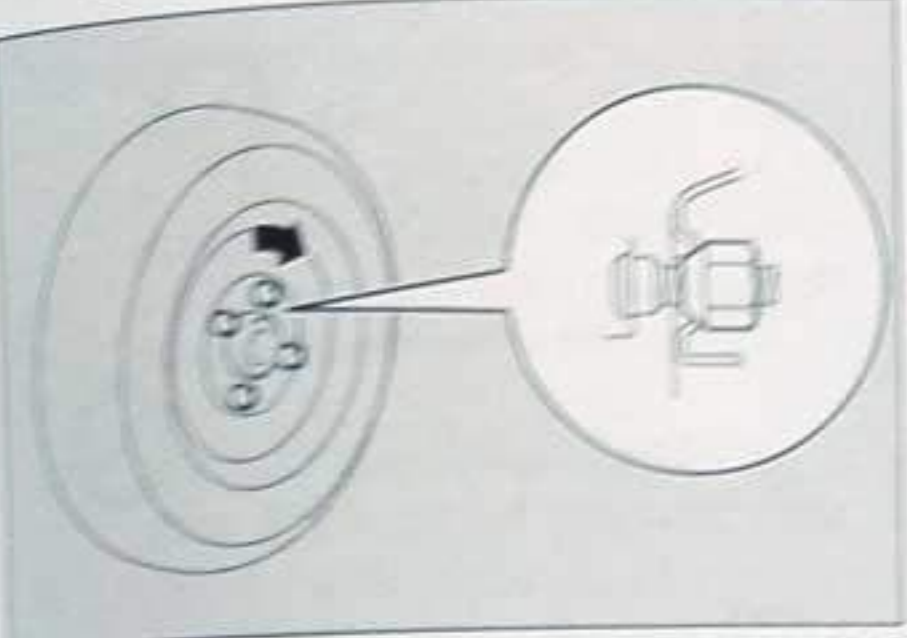

DOITW009R15008

9. On vehicles with wheel covers, install the covers.

Engine Temperature Gets High

OWW009BEMERIG16005

These warnings is shown on the meter display to indicate that the engine temperature is higher than the permissible temperature; for the engine to operate.

When the engine temperature is high

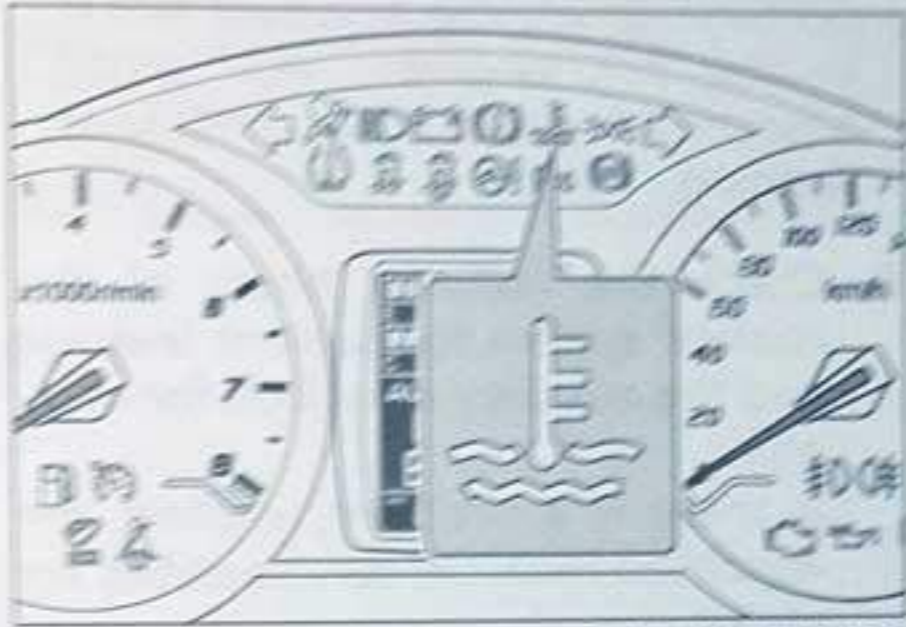

DOITW009R15030

The above warning of engine coolant temperature is shown at the meter cluster and the water temperature gauge is shown



When the engine temperature is very high

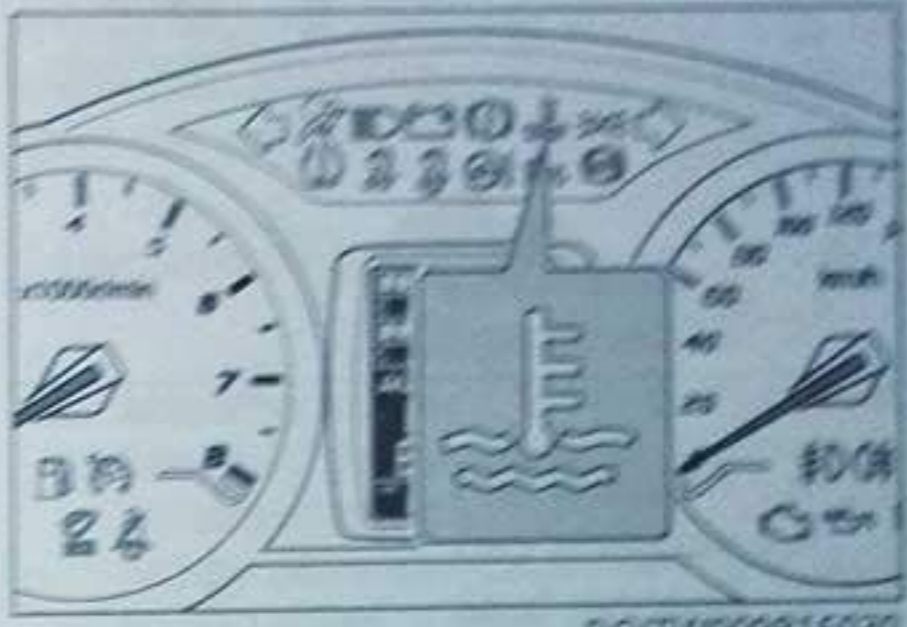

DOITW009R16030

The above warning of engine coolant temperature is shown at the meter cluster and the water temperature gauge is shown



If this condition occurs, do the following steps:

1. Stop the vehicle in a safe area.
2. When the engine is in operation, lift the hood to let the air cool the engine compartment.

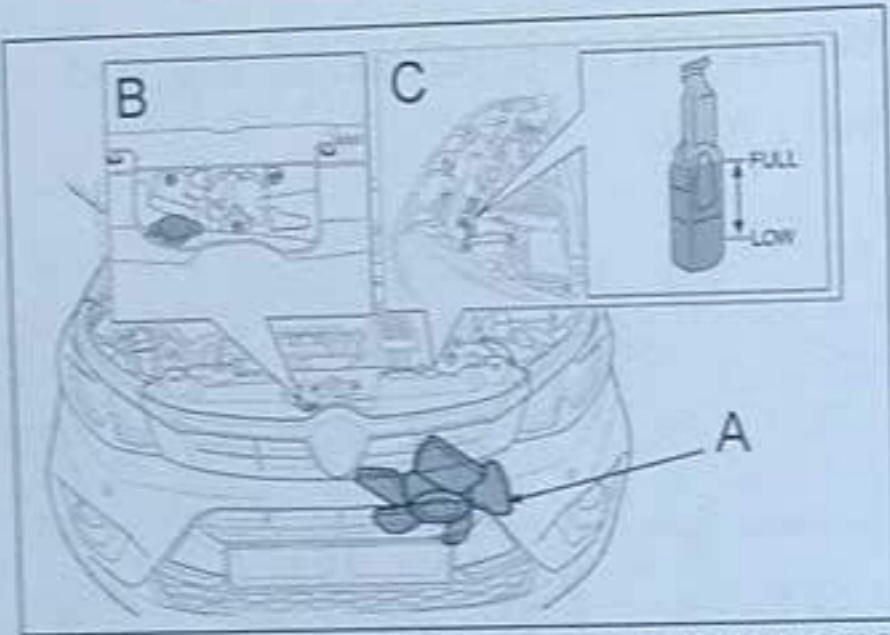

DOITW009R16003

- A - Radiator fan
- B - Radiator cap
- C - Reserve-tank

3. After the engine coolant temperature has dropped, switch off the engine.
4. Check the coolant level in the reserve-tank.

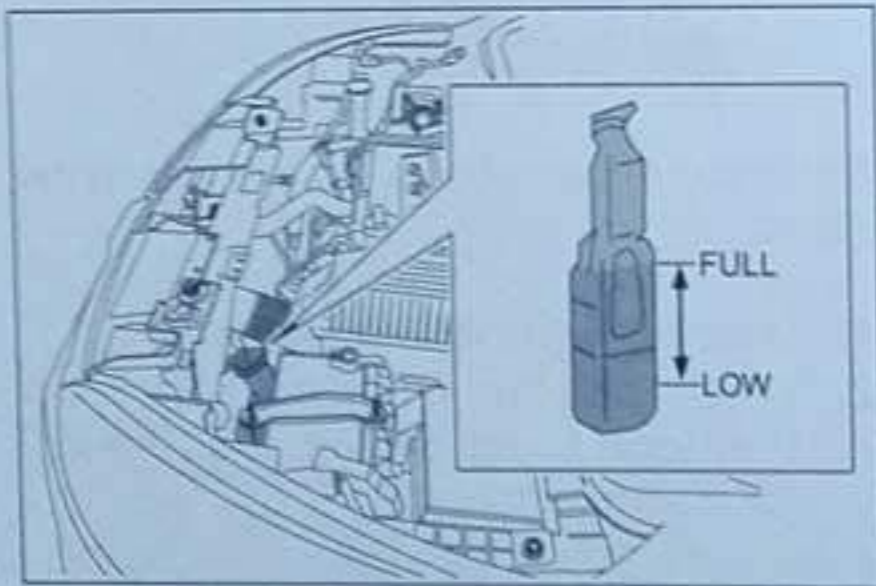

DOITW009R16004

5. Add coolant to the radiator and reserve-tank if necessary (refer to the "Maintenance section").

CAUTION

The cylinder head and block will be damage when you add cold water in the hot engine ; Add small amount of water while engine is running.

6. Check the radiator hoses of the coolant system for coolant leakage and the auxiliary drive belt for damage.
If there is a problem, contact the approved PROTON service outlet for repair.

Tow-carriage

OWN009EMERG16006

It is possibly for the vehicle to be towed by another vehicle with a rope or by a tow-carriage. The regulations about tow possibility are different from area to area.

Type A



Type B

Towing with rear wheels off the ground



Type C

Towing with front wheels off the ground



Type D

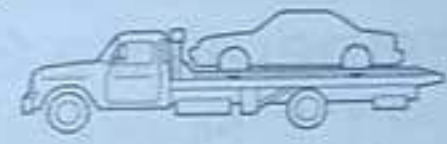

Type E



DOIQW009R11011

Tow the vehicle by a tow-carriage

When a tow-carriage tows your vehicle, lift the front wheels high off the ground.

CAUTION

- (1) If the transmission does not operate correctly or damaged, send the vehicle with the front wheels on a carriage. Use only type C, D or E carriage.

Emergency Jump-start

OWN009EMERG16007

If your engine does not start caused by weak battery, use a jump-cable to jump-start the engine.

Selection of jump-cable

1. Use the correct jump-cables that can hold the capacity of the electric current during jump-start; Incorrect jump-cables can cause heat damage to its cables. Check the product information.
2. Use only jump-cable with insulation at the battery clamps.
3. Normally the insulation of the positive (+) clamp of the jump-cable is shown as **Red** color. The insulation of the negative (-) clamp of the jump-cable is shown as **Black** color.

Prepare to connect the jump-cable

Get the other vehicle close enough for the jump-cables to reach. Read these precautions before connecting the jump-cables.



CAUTION

- (1) Make sure the vehicles' bodies do not touch each other to prevent an undesirable ground connection. In this condition,

(2) DO NOT tow the vehicles with AT or CVT with the front wheels on the ground (Type B). Make sure the vehicle is towed with the front wheels high off the ground.

(3) DO NOT tow the vehicle by a sling lift type of tow-carriage (Type A) as shown. The sling rope part may damage the front bumper.

(4) When the vehicle travels down a long slope, the brake may become hot and not hold. Tow the vehicle on a type D or E equipment in such a situation.

(5) If the rear wheels do not operate correctly or damage, tow the vehicle with type D or E equipment.

(6) To prevent the entry of exhaust gas from the tow-equipment, set the air selection knob to an inside-air circulation position.

(7) Make sure to turn off the ignition when towing the vehicle with Electronic Stability Control (ESC). If this type of vehicle is towed, the ESC may be activated, causing an accident.

(8) When the CVT transmission fluid level is low, DO NOT tow the vehicle with the rear wheels high off the ground.

the vehicle may not start and the bad grounding can damage the electrical systems.

- (2) Check the battery (booster battery) voltage of other vehicle; The booster battery must have a voltage rate of 12-volt and the capacity (Ah) must be more than the weak battery.
- (3) If the booster battery uses different system, a short-circuit can damage the two vehicles during jump-start.
- (4) Check the jump-cables for any damage and corrosion before using.
- (5) Correctly engage the parking brake on each vehicle.

WARNING

- (1) Put the gear lever in the "P" (PARK) position (for an automatic transmission) or "N" (NEUTRAL) position (for a manual transmission).
- (2) Turn the ignition to the OFF position. Make sure the jump-cables or clothing do not get bonded by the radiator fan or drive-belt. Injuries can occur.

(3) Turn off all lights, heater and other electrical loads to prevent from sparks to occur during jump-start.

(4) Remove the cover of the battery positive (+) terminal before you connect the jump-cable to the battery.

Connect the jump-cable

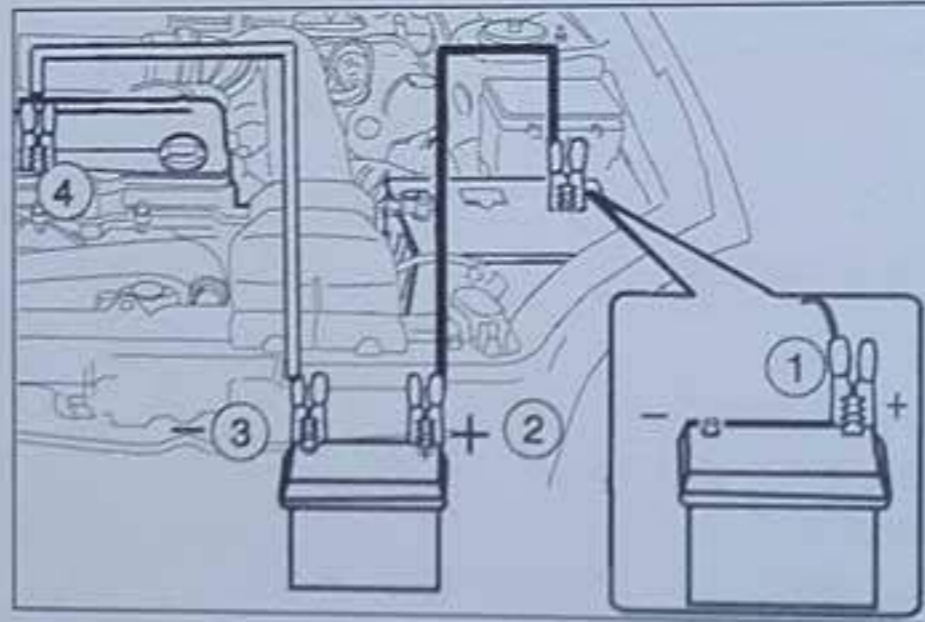

DOIKW009R07016

The above illustration shows the correct connection sequence start from (1), then (2), then (3) and last (4).

1. Connect the Red color end of the jump-cable to the positive (+) terminal of the weak battery.
2. Connect the Red color end of jump-cable to the positive (+) terminal of the booster battery.
3. Connect the Black color end of the jump-cable to the negative (-) terminal of the booster battery.

4. Connect another Black color end to the engine hanger of the vehicle with the weak battery. This connection (4) is for ground.

CAUTION

- Make sure you follow the connection sequence starts from (1), then (2), then (3) and last (4).
- DO NOT make connection (4) to the negative (-) terminal of the battery. The flammable gases caused by the battery possibly can cause a fire and an explosion. Make sure the connection (4) is correctly made to the engine hanger.
- DO NOT connect the positive (+) clamp of the jump-cable to the negative (-) terminal of the booster battery. Sparks caused by the battery can cause an explosion of the battery.
- DO NOT connect the negative (-) clamp of the jump-cable to the fuel lines with metal coating, fuel filter or brake lines; These connections can cause a fire.
- DO NOT let the installed jump cables entangle with the cool-

ing fan or any rotation part in the engine compartment.

Start to jump-start

After installing the jump-cable, start to jump-start. Follow these procedures:

1. Start the ignition of the vehicle engine with the booster battery.
2. Let the engine with the booster battery run for some time.
3. Start the engine in the vehicle with the weak battery.
4. After the engine starts, disconnect the cables in the reverse sequence. Remove the clamps of the jump-cable start from (4), then (3), then (2) and last (1).

After jump-start

Read these precautions after jump-start on the weak battery.

1. When you let the engine to charge the installed weak battery, the weak battery can cause a fire and an explosion to the vehicle. Let the engine to charge the weak battery, disconnect the negative (-) terminal connected to the battery.
2. When you charge the weak battery, keep away from any sparks and flames from the weak battery.

3. When charging the weak battery in a closed space, make sure sufficient ventilation is available.
4. When the weak battery is being charged, remove all battery caps.
5. The electrolyte of the battery, the battery acid, is a corrosive mixed sulfuric acid. If hands, eyes, clothing and the painted surface of the vehicle come in contact with this electrolyte (battery acid), clean with water. If the electrolyte gets into eyes, flush with water immediately and get medical treatment.
6. Always wear protective eye goggles when working near the battery.
7. Do not try to pull or push the vehicle to start the engine; You may damage the vehicle.

NOTE

If the vehicle has anti-lock brake system and the battery is not fully charged, do not drive the vehicle. This condition can cause an incorrect rotation of the engine and the ABS warning lamp to illuminate. Refer to the "Start and drive" section.

Fuse Box

OWN009EMERG16008

Each circuit has a fuse to prevent the electrical system from short-circuit or incorrect load capacity of electric current. There is one fuse box in the driver compartment and one fuse box in the engine compartment.

Fuse box in driver compartment

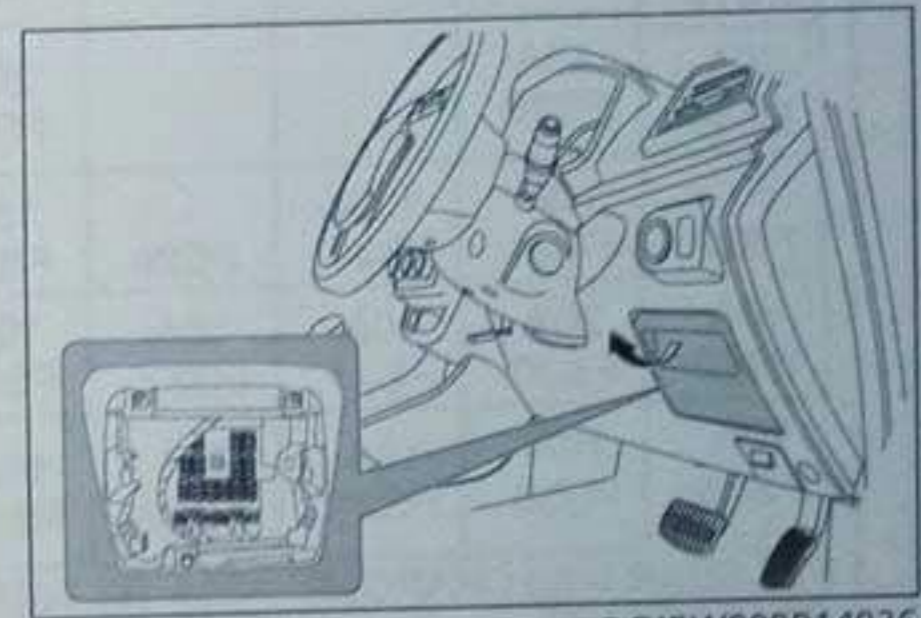

DOIRW009R14036

The fuse box in the driver compartment is at instrument panel as shown in the illustration.

Fuse load capacity

There are complete information of the electrical systems and the fuse capacities on the cover of the fuse box.

10A FS1	*10A FS2	FS3		SB1	FS4
15A FS5	10A FS6			FS7	10A FS8
15A FS9	20A FS10			FS11	10A FS12
15A FS13	15A FS16			15A FS17	15A FS14
15A FS15	15A FS20			20A FS21	10A FS18
20A FS19	10A FS24	10A FS25	FS26	15A FS27	10A FS22
FS23	20A FS30	10A FS31	10A FS32	10A FS33	10A FS28
10A FS29	10A FS36	15A FS37	20A FS38	15A FS39	20A FS34
10A FS35					FS40

RLY 1	RLY 2	RLY 3 (20A)
		POWER SOCKET

* RLY 4 (20A)	* RLY 5 (35A)	* RLY 6 (35A)
IG1 OFF	IG1 ON	ACC

* RLY 7 (35A)
IG2

RLY 8 (35A)
POWER WINDOW

* : OPTION

FS1 REAR USB CHARGER
 FS2 BACK UP2
 FS3 SPARE
 FS4 SPARE
 FS5 FRT SOCKET
 FS6 DIAGNOSIS
 FS7 SPARE
 FS8 HEATED MIRROR
 FS9 SUPER LOCK
 FS10 DEFOGGER
 FS11 SPARE
 FS12 START
 FS13 BCM

FS14 RR WIPER
 FS15 METER
 FS16 RR FOG/OSRVM
 FS17 PKE
 FS18 FRT&RR WASHER
 FS19 HAZARD
 FS20 DOOR LOCK
 FS21 HORN
 FS22 HVAC
 FS23 SPARE
 FS24 SSB
 FS25 REV/FRT PARKING
 FS26 SPARE
 FS27 MODULE2

FS28 MODULE3
 FS29 OSRVM
 FS30 AUDIO2
 FS31 ESC
 FS32 ACU
 FS33 BACK UP1
 FS34 FRT WIPER
 FS35 AUDIO1
 FS36 BATTERY SAVER
 FS37 MODULE1
 FS38 GSL
 FS39 ECU/TCU
 FS40 SPARE
 SB1 SPARE

Code	Electrical system	Capacity
FS1	REAR USB CHARGER	10 A
FS2	BACK UP2	10 A
FS3	SPARE	-
FS4	SPARE	-
FS5	FRONT SOCKET	15 A
FS6	DIAGNOSIS	10 A
FS7	SPARE	-
FS8	HEATED MIRROR	10 A
FS9	SUPER LOCK	15 A
FS10	DEFOGGER	20 A
FS11	SPARE	-
FS12	START	10 A
FS13	BCM	15 A
FS14	REAR WIPER	15 A
FS15	METER	15 A
FS16	REAR FOG / OSR- VM	15 A
FS17	PKE	15 A
FS18	FRONT / REAR WASHER	10 A
FS19	HAZARD	20 A
FS20	DOOR LOCK	15 A
FS21	HORN	20 A

Code	Electrical system	Capacity
FS22	HVAC	10 A
FS23	SPARE	-
FS24	SSB	10 A
FS25	REVERSE / FRONT PARKING	10 A
FS26	SPARE	-
FS27	MODULE2	15 A
FS28	MODULE3	10 A
FS29	OSRVM	10 A
FS30	AUDIO2	20 A
FS31	ESC	10 A
FS32	ACU	10 A
FS33	BACK UP1	10 A
FS34	FRONT WIPER	20 A
FS35	AUDIO1	10 A
FS36	BATTERY SAVER	10 A
FS37	MODULE1	15 A
FS38	GSL	20 A
FS39	ECU / TCU	15 A
FS40	SPARE	-
SB1	SPARE	-

Central fuse box in engine compartment

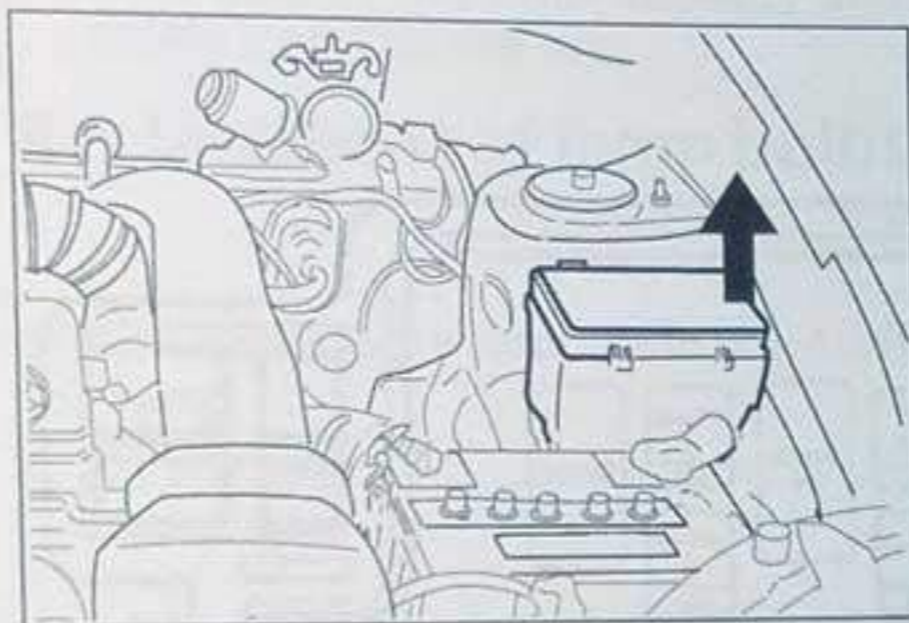

DOIKW009R03011

The central fuse box is in the engine compartment, at the position shown in the illustration. Open the fuse box cover to reach the fuse.

Engine compartment

There are complete information of the electrical systems and the fuse capacities on the inner cover of the central fuse box.

NOTE

There are spare-fuses in the central fuse box.

Always use a fuse of the same capacity for replacement.

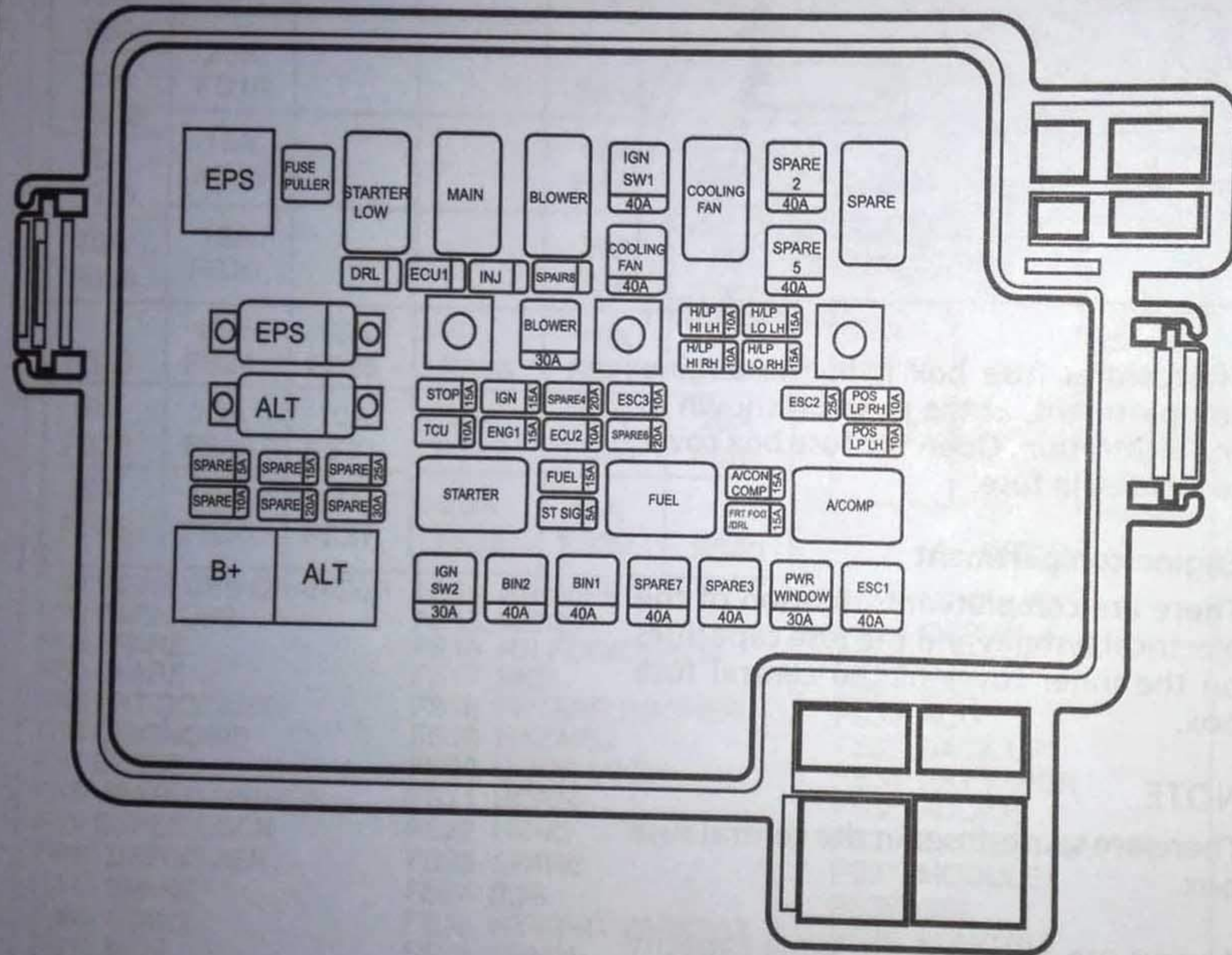

Change a Blown Fuse

OWN009EMERG16009

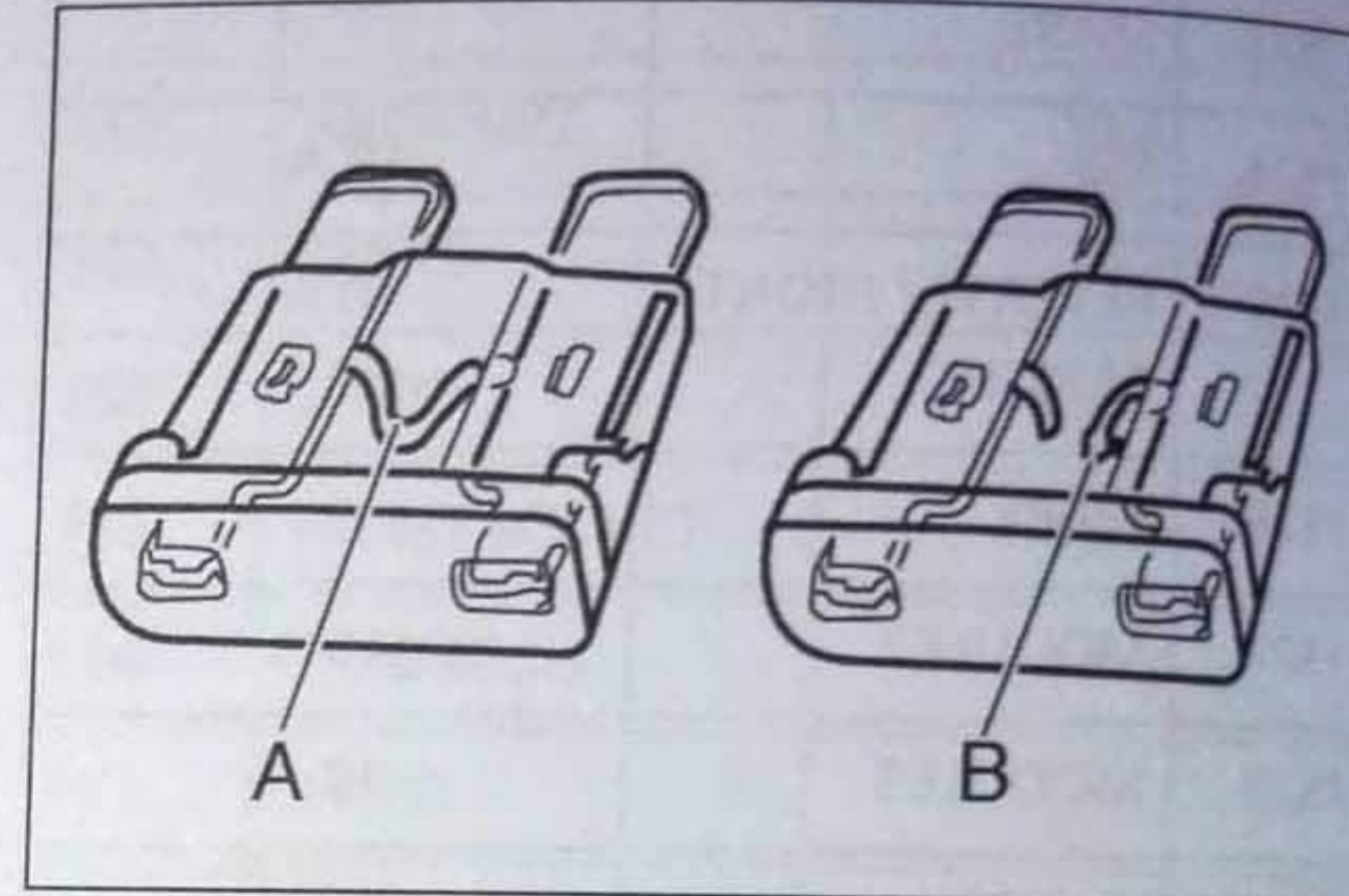

DOIAW009R10004

A – Normal fuse

B – Blown fuse

1. Before you replace a fuse, always turn off the electrical item and put the engine switch in the LOCK position.
2. Remove the fuse box cover.
3. Refer to the table of the load capacities for the fuses. Check the fuse that is related to the problem.

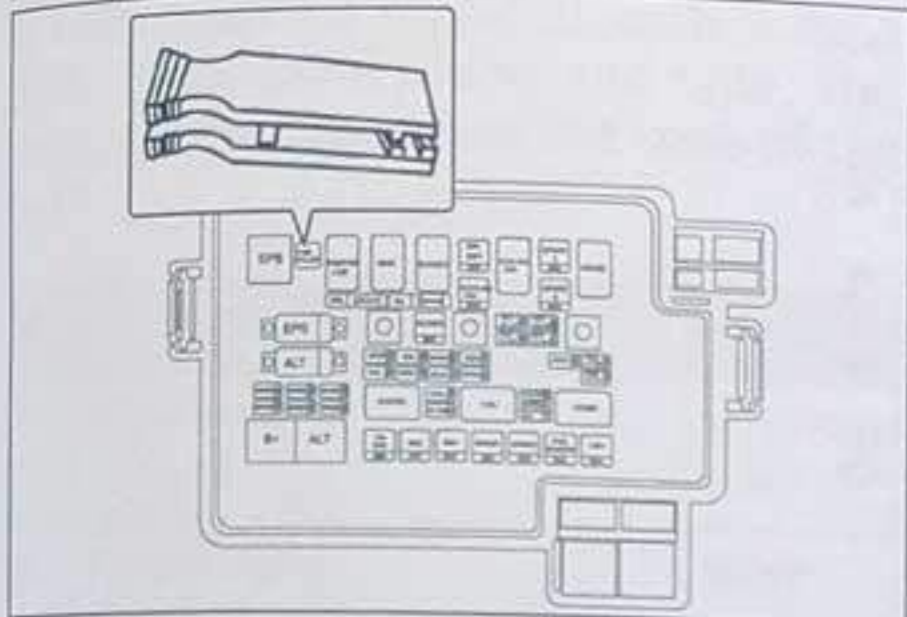

DOIRW009R14002

4. There is a puller and spare-fuses attached to the fuse box cover (inside the vehicle).

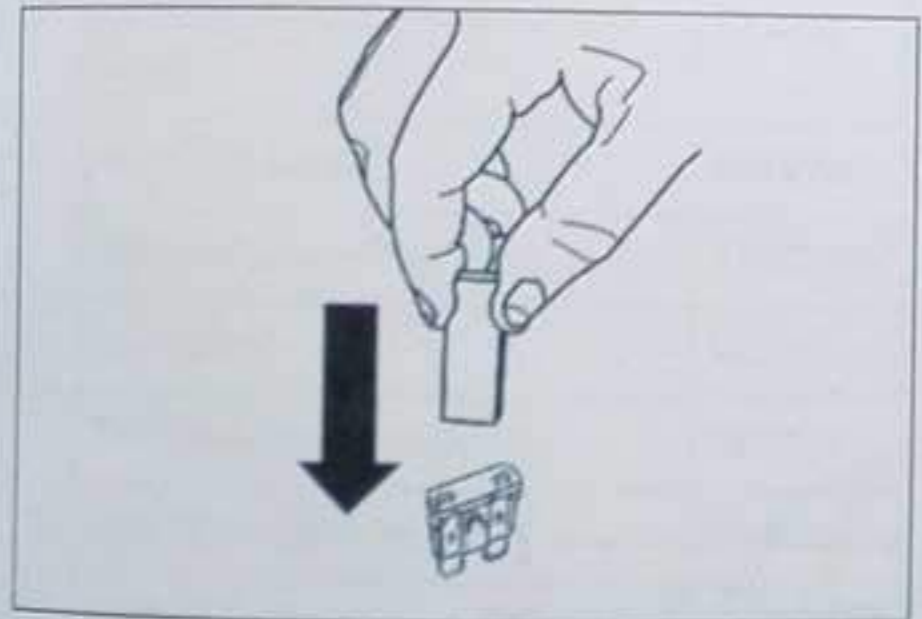

DOIKW009R07012

5. Remove the fuse puller from the fuse housing.
6. Hold the puller as shown in the illustration.
7. Push the puller on the identified fuse until a click sound is heard.
8. Pull the fuse straight away from the fuse housing.
9. Check the identified fuse. If the fuse is not blown, immediately, contact

an authorised PROTON service outlet for inspection.
 10. If the fuse is blown, replace with a new fuse of the same capacity and safely insert to the clip.

Replacement of lamp bulbs

OWN009EMERG16010

Before replacing a lamp bulb, turn off the lamp.

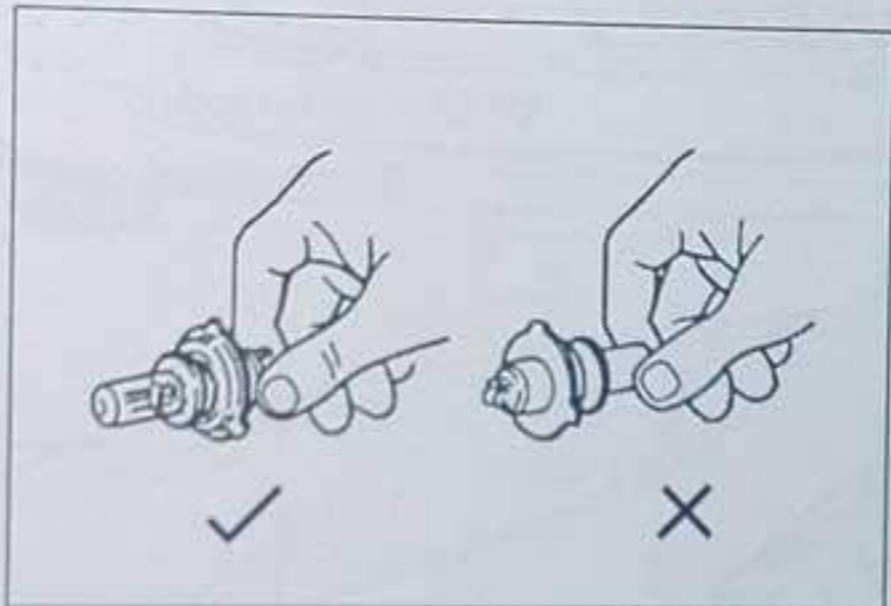

DOICW009R02004

CAUTION

- (1) Do not hold the halogen lamp bulb with a bare hand and dirty glove.

When the bulb becomes hot, the vapor will compress on the reflector; and the oil stain contacted to the glass by the bare hand will dry.

If the glass surface is dirty, clean the glass surface with alcohol or paint thinner solvent. Let the surface dry before installation.

- (2) Bulbs are very hot after turning off.

Before touching and replacing a bulb, wait for the bulb to cool.

NOTE

- (1) Refer to a skilled technician to carry out the work correctly.
- (2) During rainy weather or after wash-cleaning the vehicle, the lens may mist. This condition does not indicate any problem.

Turn on the lamp. The heat will remove the mist. If some water collects inside the lamp, go to an authorised Proton service outlet for inspection.

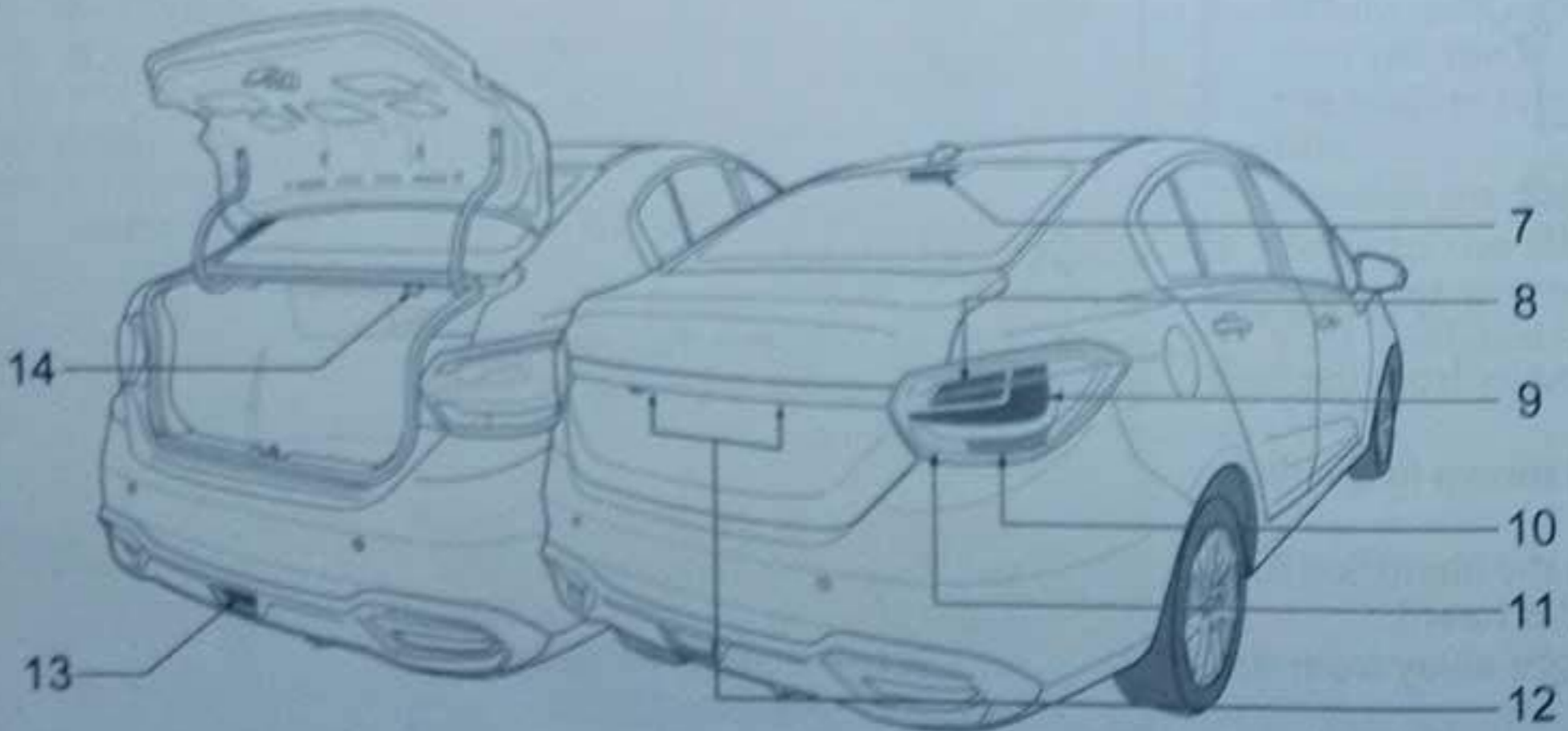
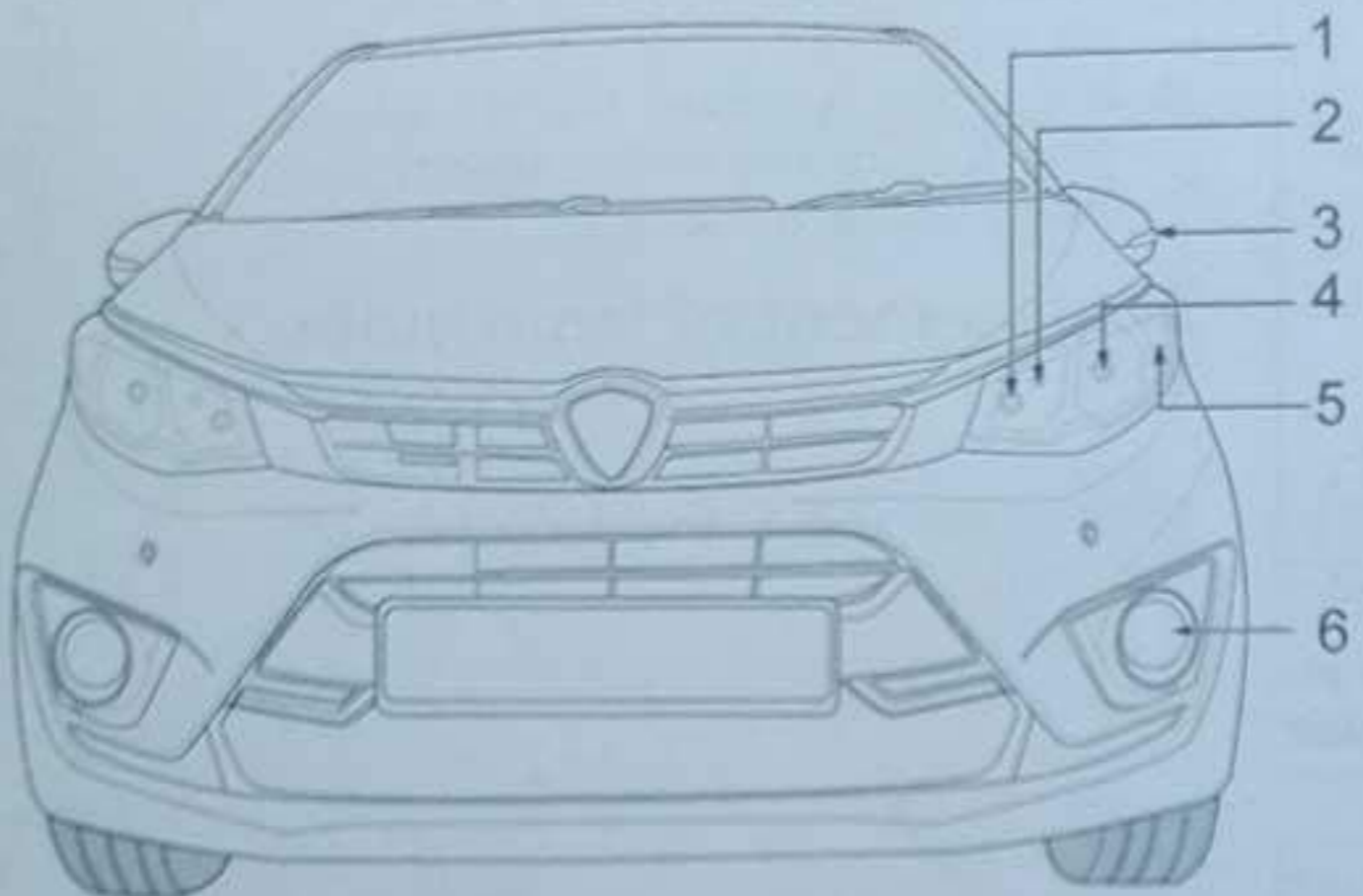

A bulb must be replaced with a new bulb of the same rating and type. The information is shown at the base of the bulb.

No	Item	Capacity
1	High beams	H7 55W/H 55W*
2	Position lights	W5W
3	Turn signal lights (at side mirror of the door)	5W
4	Low beams	H7/55W
5	Turn signal lights (in the headlamps)	PY21W
6	Front fog lamps	H8/35W*
7	High-mounted-stop-light	12V/2.3W
8	Tail lights	W5W
9	Tail lights and stop lights	P21/5W
10	Rear turn signal lights	PY/21W
11	Backup lights, reverse lights	W16W
12	License plate light	W5W
13	Rear fog lamps	P21W
14	Luggage compartment lamp	12V/3.4W

Interior lighting

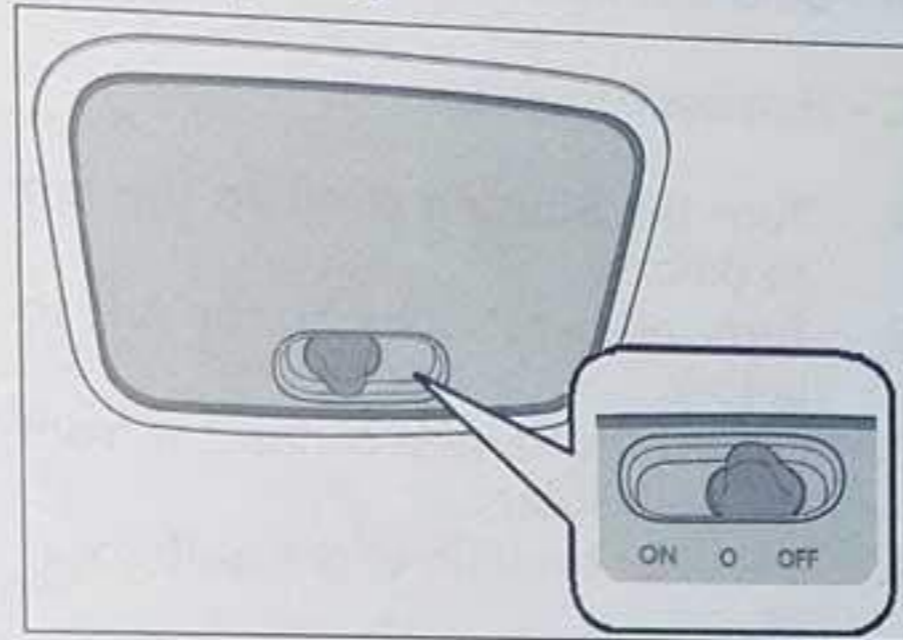

DOINW005R09021

1. Room lamp – 10 W

Front headlamps

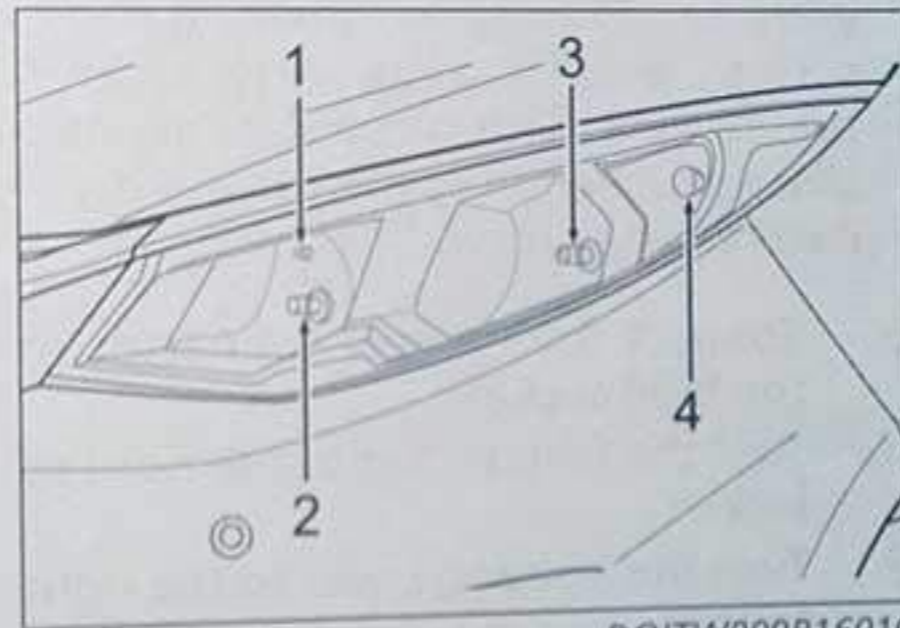

DOITW009R16010

- 1 - Position lights
- 2 - High beam
- 3 - Low beam
- 4 - Front turn signal lights

Rear combination lights

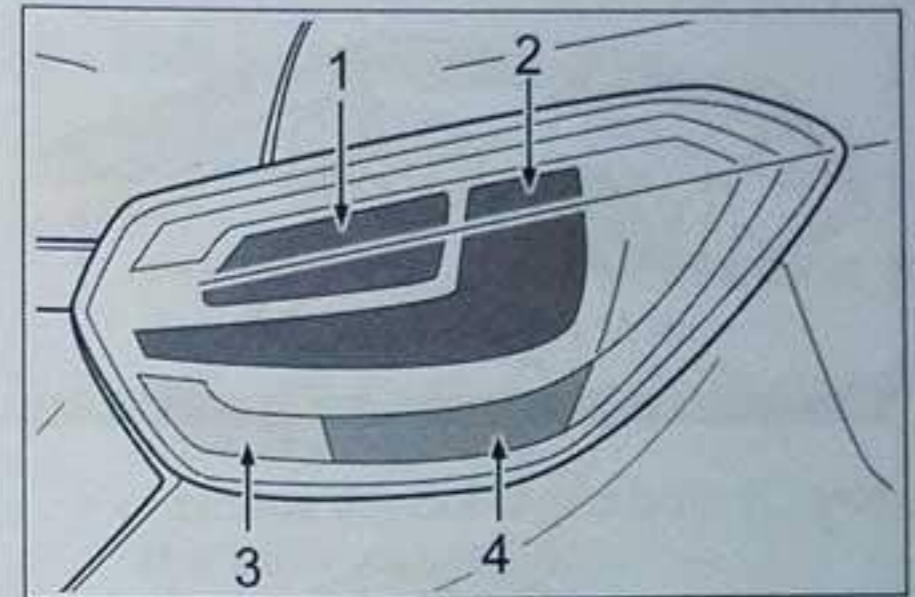

DOITW009R16011

- 1 - Tail light
- 2 - Tail light and stop light
- 3 - Reverse light
- 4 - Rear turn signal light

How to replace a damaged bulb

Replacement of the bulb of the high beam

Open the hood to reach the headlamp.

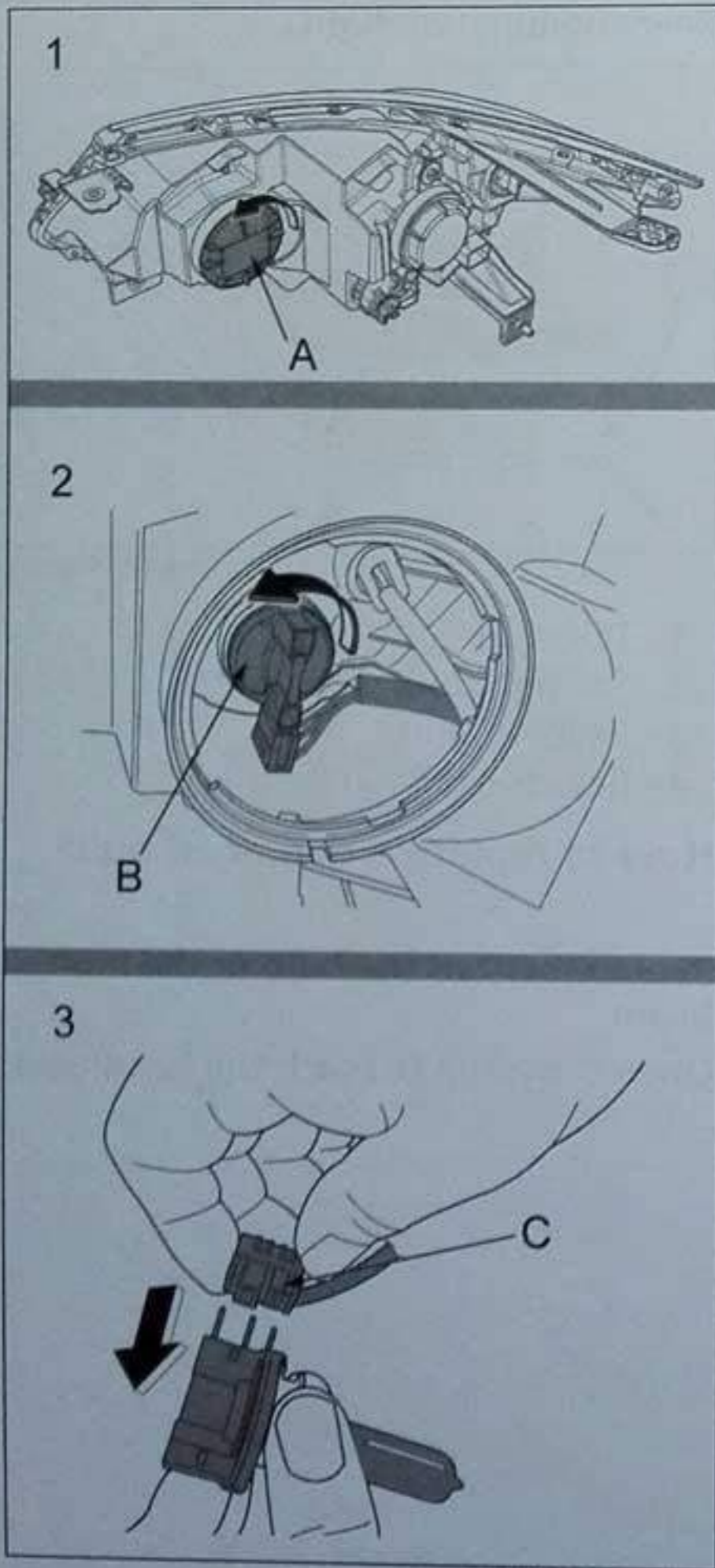

B – Bulb socket

C – Harness connector

1. Turn the housing cover to the left to unlock.
2. Turn the bulb socket to the left to unlock.
3. Pull off the harness connector from the bulb socket.
4. Install a new bulb to the bulb socket.

⚠ CAUTION

Do not touch the surface of the bulb with hands or dirty glove. If the surface does become dirty, clean the surface with alcohol or paint thinner solvent. Let the surface dry before installation.

5. Connect the harness connector to the bulb socket.
6. Turn the bulb socket to the right to lock.
7. Turn the housing cover to the right to lock.
8. Make sure the assembly is lock-tight.

Replacement of the bulb of the low beam

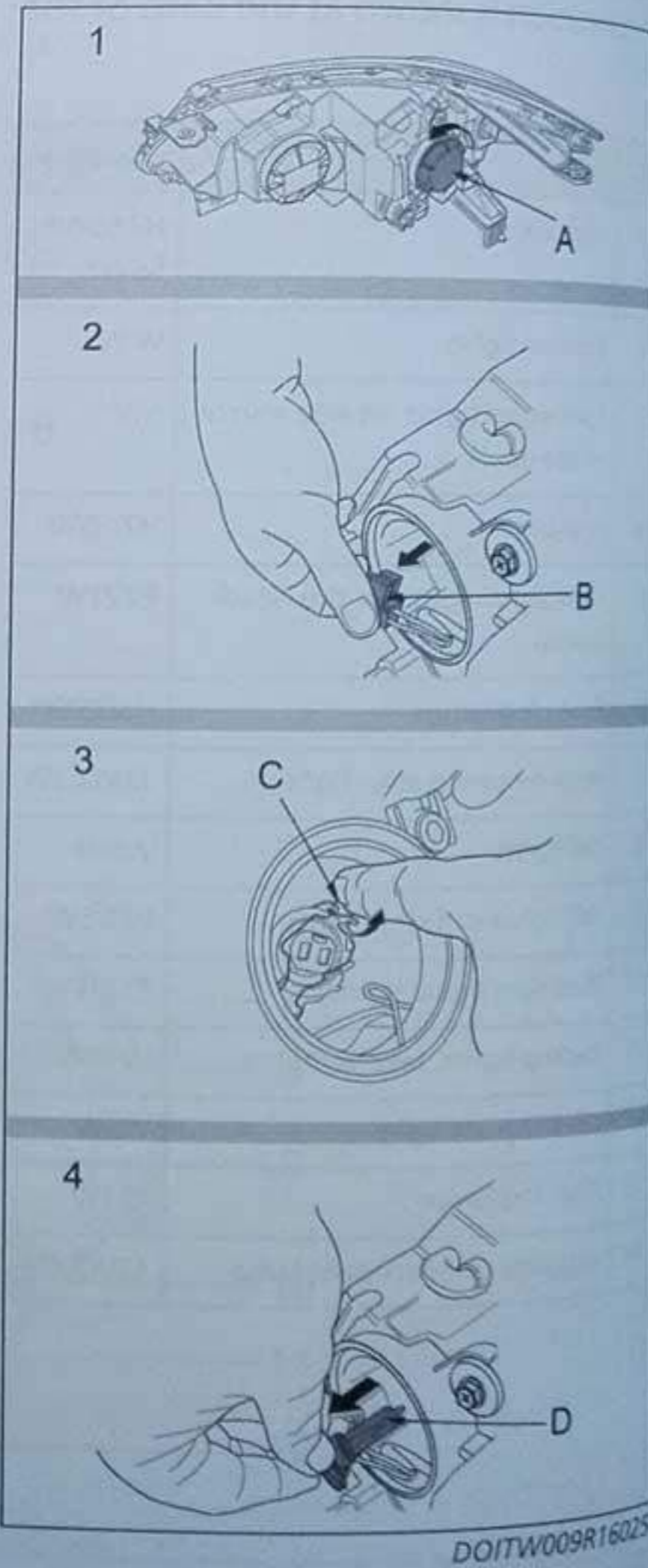

A - Housing cover

B - Harness connector

C - Spring retainer

D - Bulb socket

1. Turn the housing cover to the left to unlock.
2. Pull the harness connector from the bulb socket.
3. Unlock the bulb retainer spring properly.
4. Remove the damaged bulb and install a new bulb.

CAUTION

Do not touch the surface of the bulb with hands or dirty glove. If the surface does become dirty, clean the surface with alcohol or paint thinner solvent. Let the surface dry before installation.

5. Lock the bulb retainer spring properly.
6. Connect the harness connector to the bulb socket.
7. Turn the housing cover to the right to lock.
8. Make sure the assembly is lock-tight.

Replacement of the bulbs of the position lights *

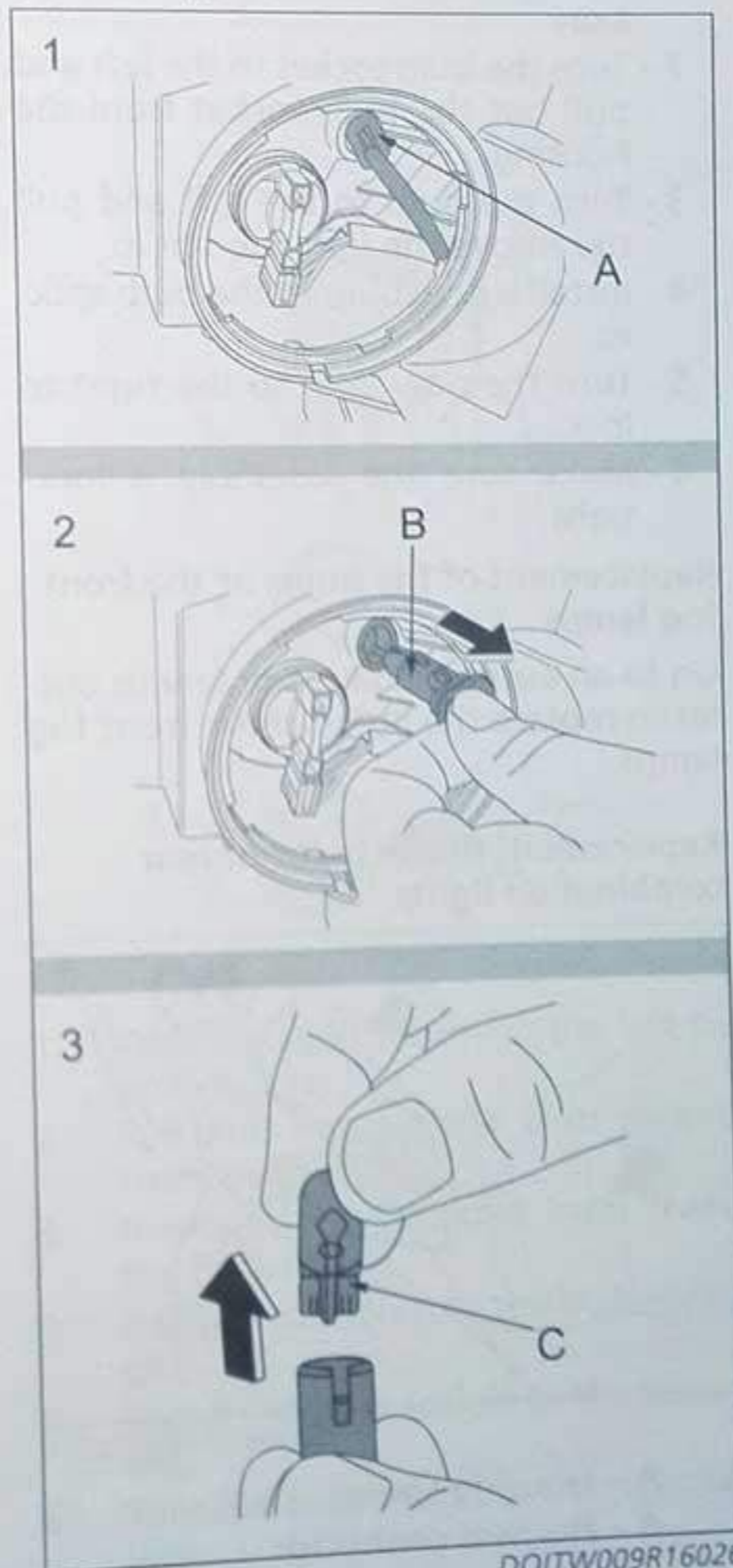

DOITW009R16026

A - Harness connector

B - Bulb socket

C - Bulb

- 1 - The location of the bulb socket is shown in the illustration.
- 2 - Pull and remove the bulb socket from the housing.
- 3 - Remove the damaged bulb (C) from the bulb socket (B).
- 4 - Install a new bulb to the bulb socket.
- 5 - Install the bulb socket to the housing.
- 6 - Make sure the assembly is lock-tight.

* if fitted

Replacement of the bulbs of the front turn signal lights

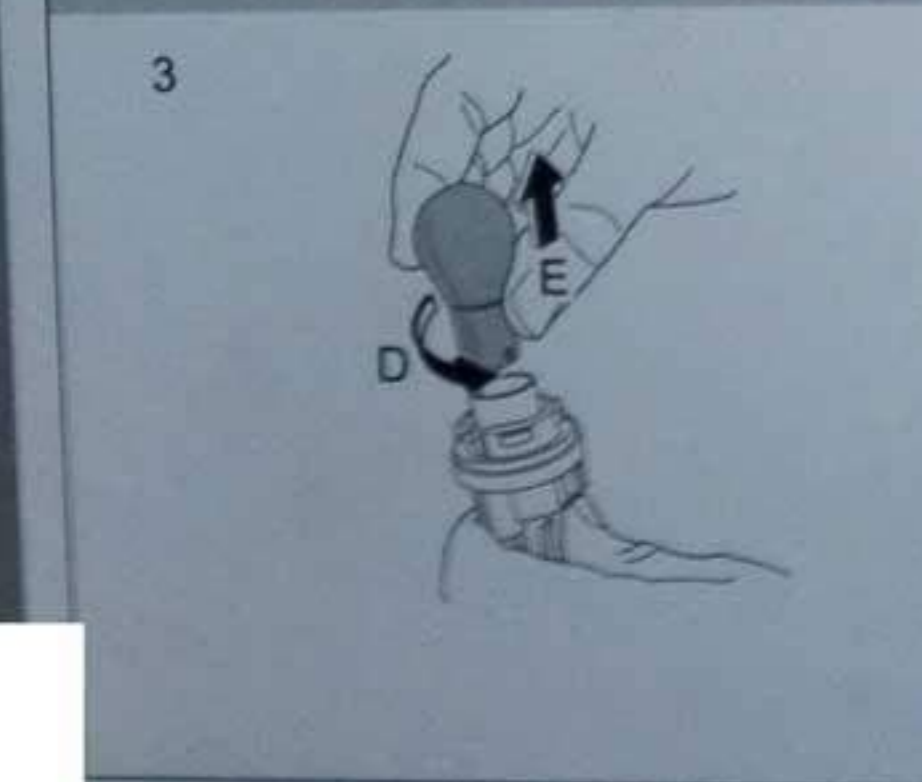
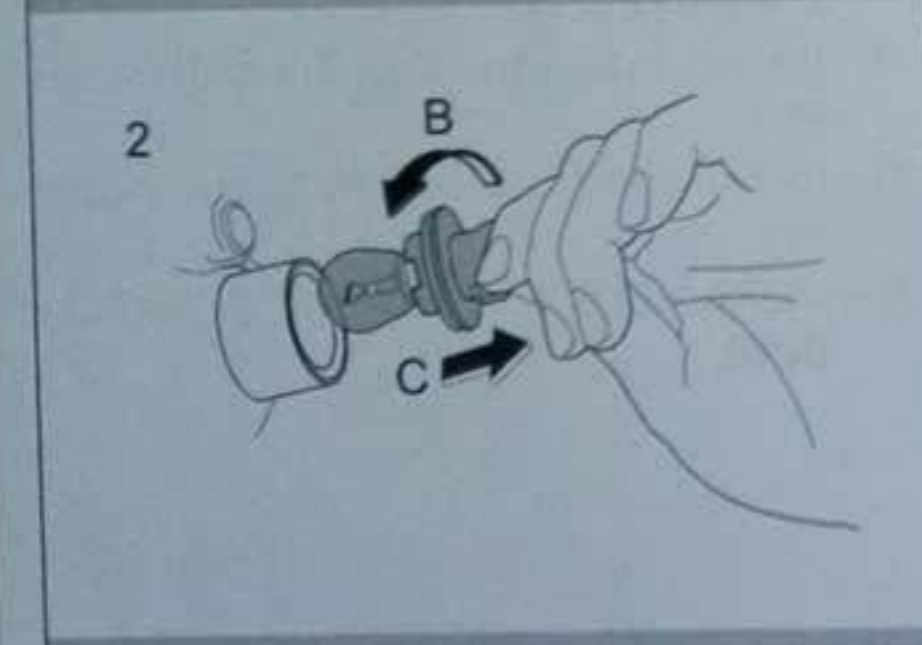
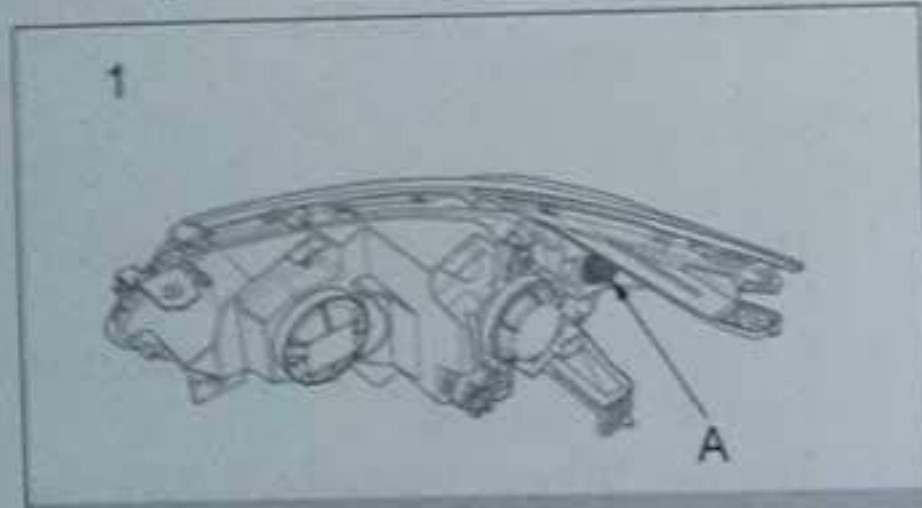

DOITW009R15027

- 1 - The bulb socket of the front turn signal light is shown in the illustration.
- 2 - Turn the bulb socket to the left and pull out the bulb socket from the housing.
- 3 - Turn the bulb to the left and pull to remove the damaged bulb.
- 4 - Install a new bulb to the bulb socket.
- 5 - Turn the new bulb to the right to lock.
- 6 - Make sure the assembly is lock-tight.

Replacement of the bulbs of the front fog lamps

Go to an authorised Proton service outlet to replace the bulbs of the front fog lamps.

Replacement of the bulbs of rear combination lights

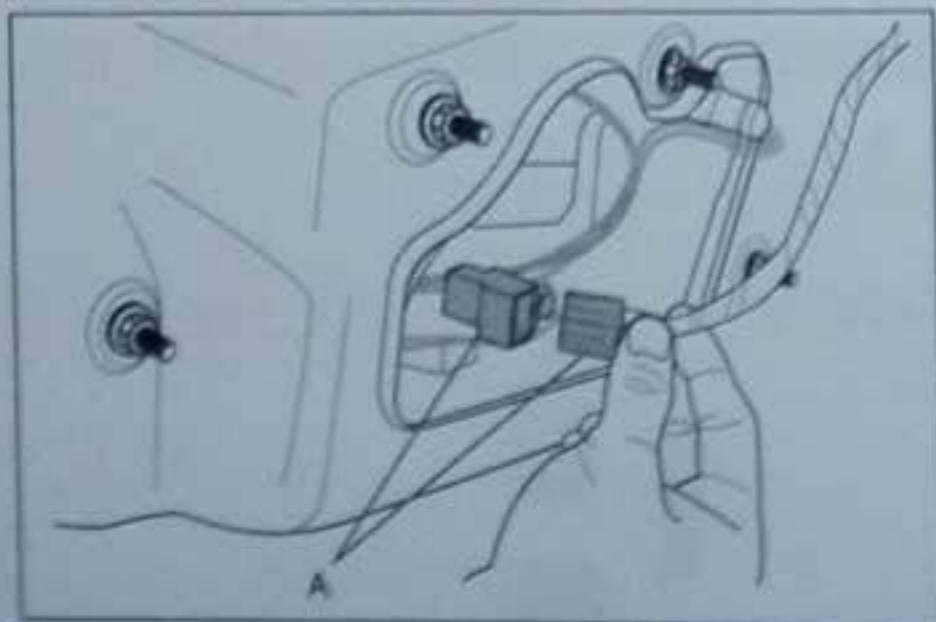

DOITW009R15014

1. A - Housing cover
A - Harness connector

Disconnect harness connector (A)

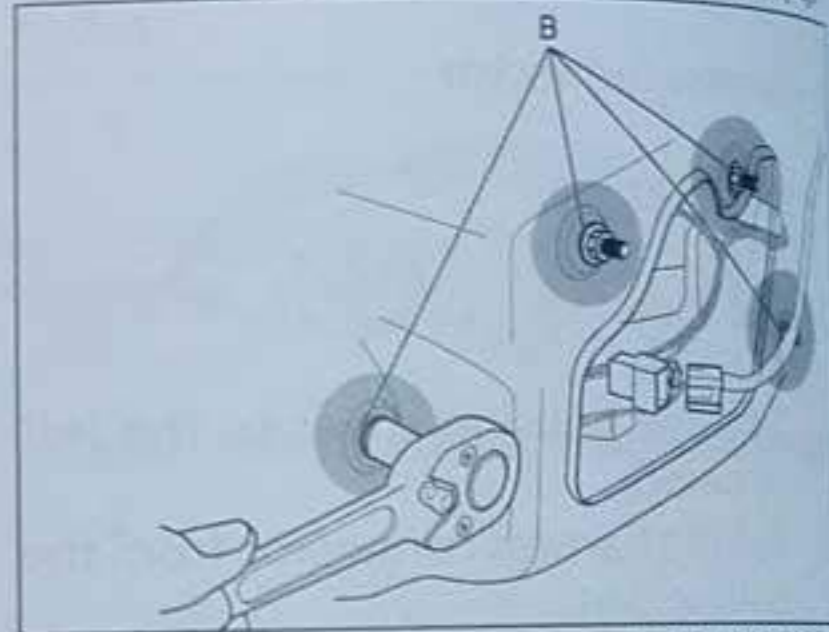

DOITW009R15015

2. B - Bolts
Remove the four pieces bolts (B).

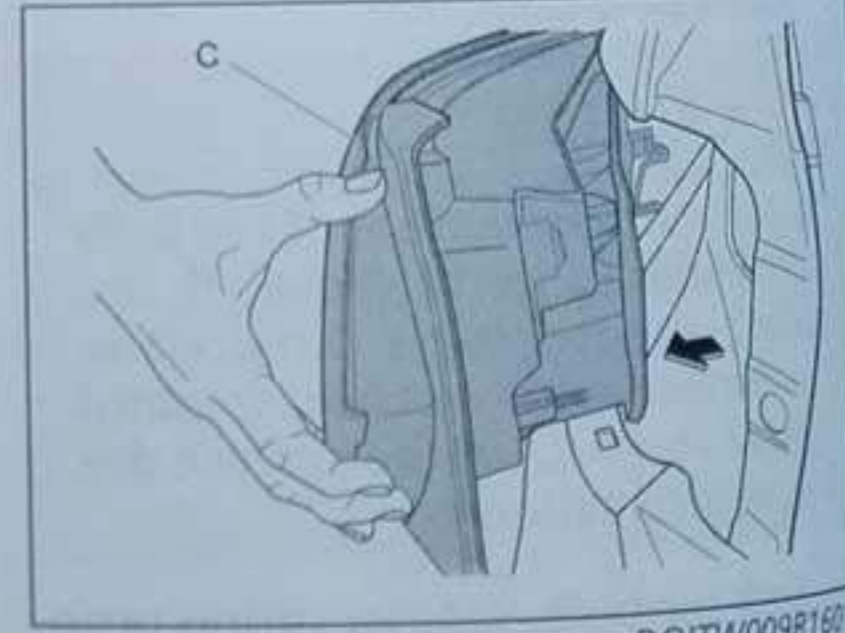

DOITW009R15016

3. C - Rear combination lights assembly
Remove the rear combination lights assembly.

Replacement of the bulb of the backup light (F) and position light (G)

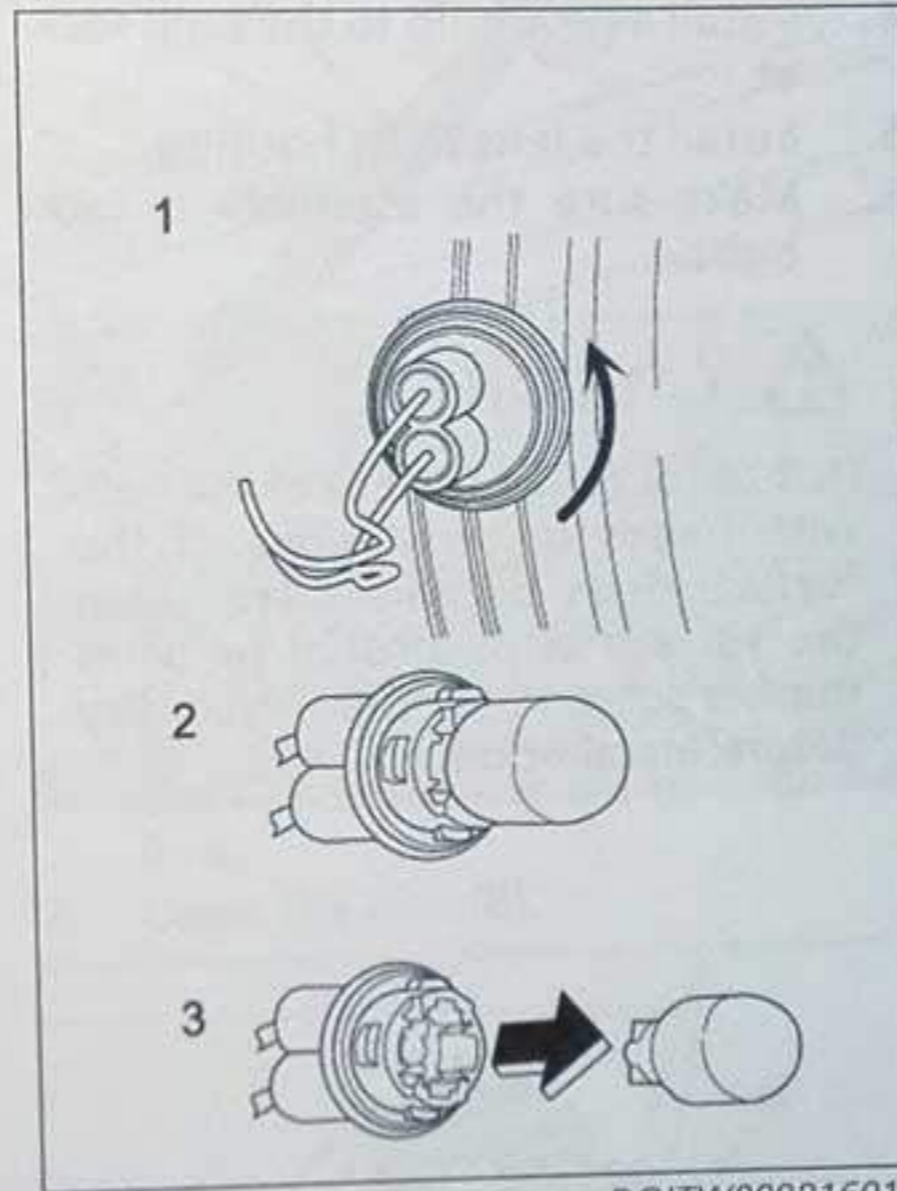

DOITW009R16018

1. Turn the bulb socket to the left to unlock.
2. Pull and remove the bulb socket from the housing.
3. Remove the damaged bulb from the bulb socket.
4. Install a new bulb to the bulb socket.
5. Install the bulb socket to the housing.
6. Turn the bulb socket to the right to lock.

7. Make sure the assembly is lock-tight.

Replacement of the bulbs of the rear turn signal lights and brake lights/position lights

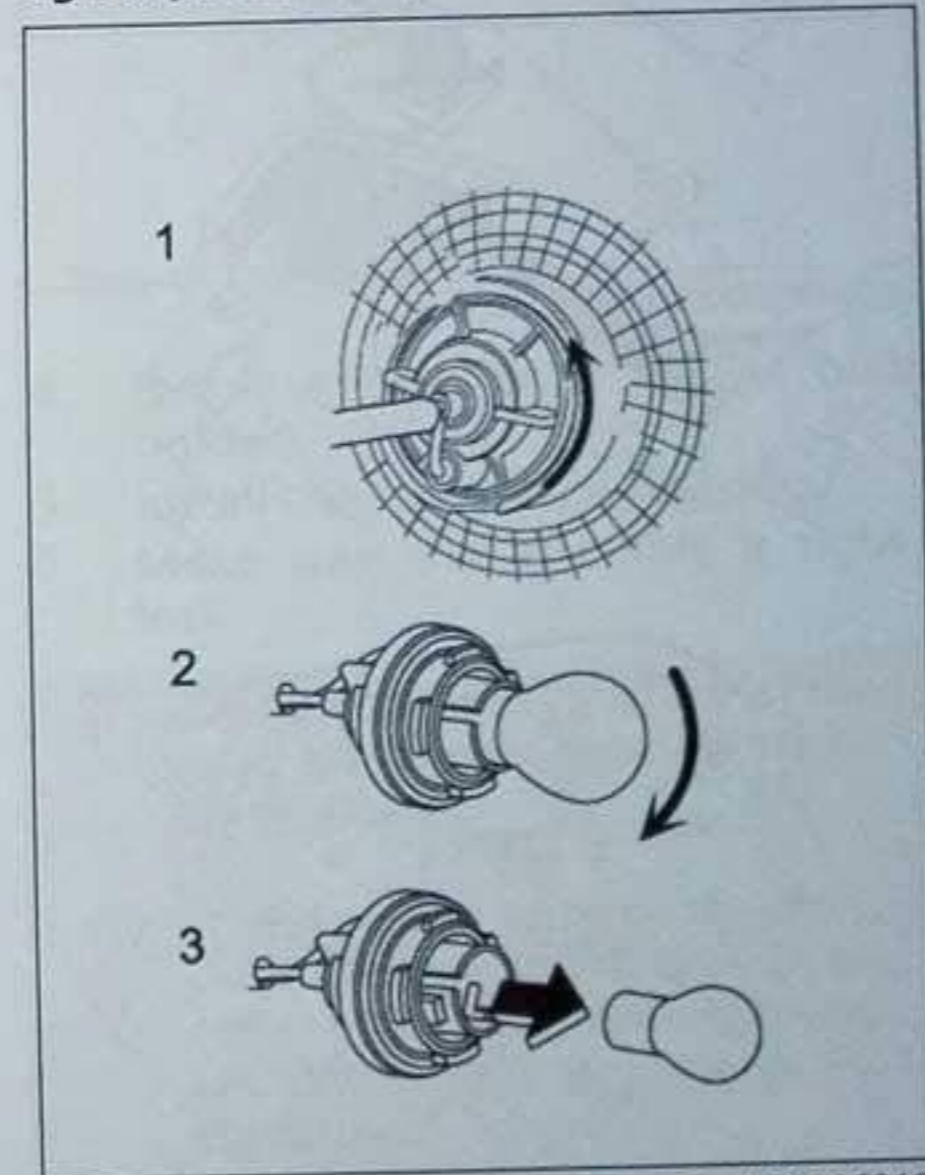

DOITW009R16019

1. Turn the bulb socket to the left.
2. Pull and remove the bulb socket from the housing.
3. Remove the damaged bulb from the bulb socket.
4. Install a new bulb to the bulb socket.
5. Install the bulb socket to the housing.

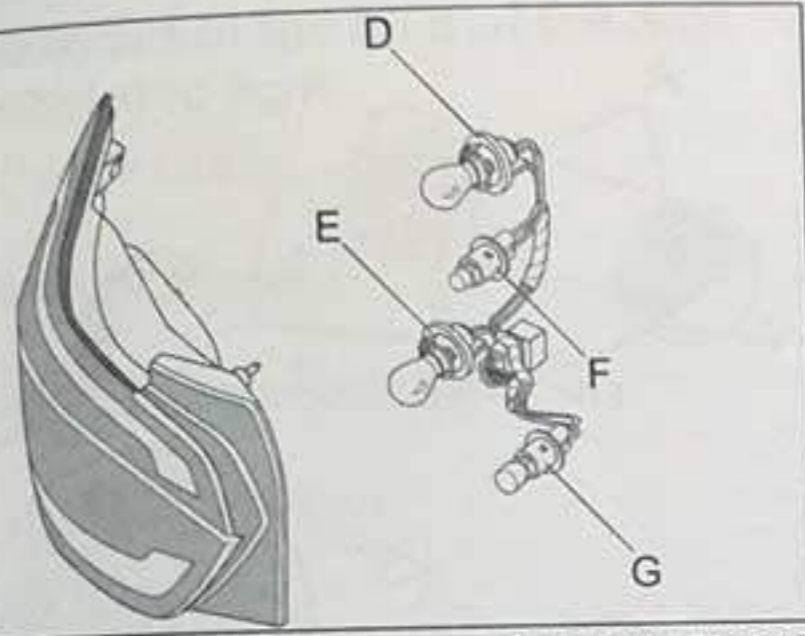

DOITW009R16017

4. The rear combination light integrates different types of lights as shown in the illustration of rear combination lights' wiring harness connector.

D - Brake light/position light

E - Turn signal light

F - Backup light

G - Position light

To replace these bulbs, refer to the next topics.

- Turn the bulb socket to the right.
- Make sure the assembly is lock-tight.

Replacement of the bulb of the room lamp

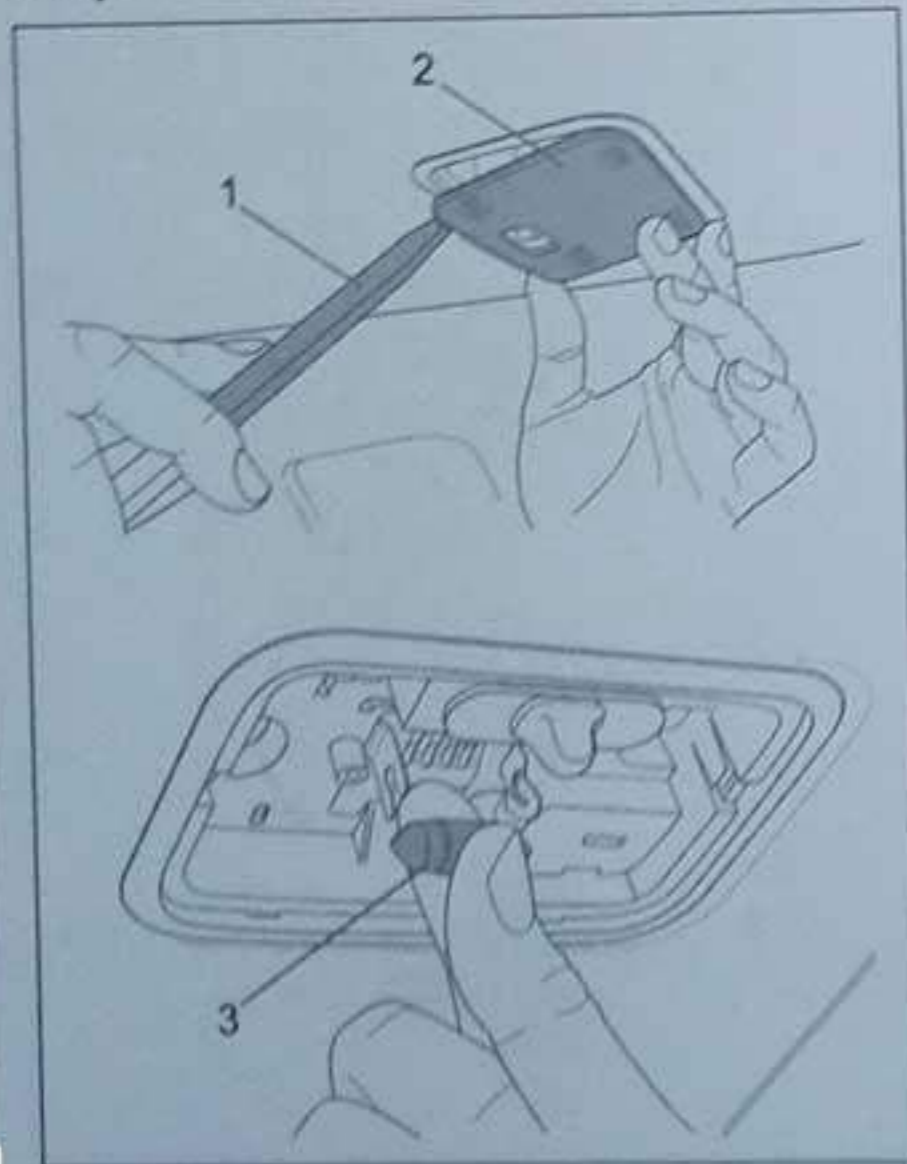

DOITW009R16012

1 – Screwdriver

2 – Lens

3 – Bulb

- Put the (-) screwdriver into the slots of the lens.
- Make a small twist with the screwdriver to open the lens.

- Remove the damaged bulb from the bulb socket.
- Install a new bulb to the bulb socket.
- Install the lens to its housing.
- Make sure the assembly is lock-tight.

⚠ CAUTION

Do not touch the surface of the bulb with hands or dirty glove. If the surface does become dirty, clean the surface with alcohol or paint thinner solvent. Let the surface dry before installation.

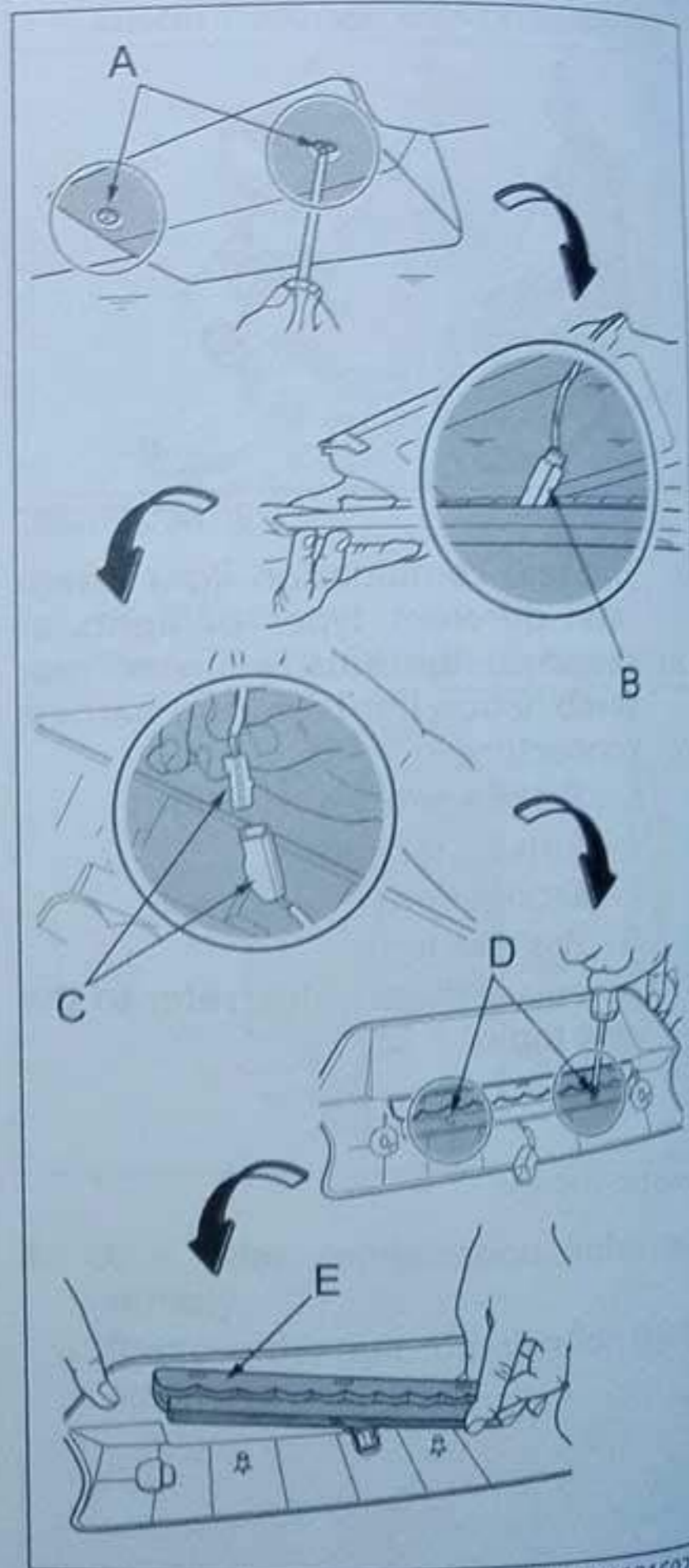

DOITW009R16023

Replacement of the bulb of the high mounted stop light

A – Cover's screws

B – Harness connector

C – Harness connector assembly

D – LED bulb's screws

E – LED bulb

1. Use (+) screwdriver to loosen the cover's screws from the housing.
2. Pull out the housing high mounted stop light to the body panel.
3. Disconnect the harness connector of the housing.
4. Use (+) screwdriver to loosen the screws of the high mounted stop light (LED bulb).
5. Remove the damaged LED bulb and install a new LED bulb.
6. Tighten the screws of the LED bulb to the housing.
7. Connect the harness connector assembly. Make sure the assembly is lock-tight.
8. Put the harness connector inside the hole of the body panel.
9. Tighten the cover's screws to the housing. Make sure the assembly is lock-tight.

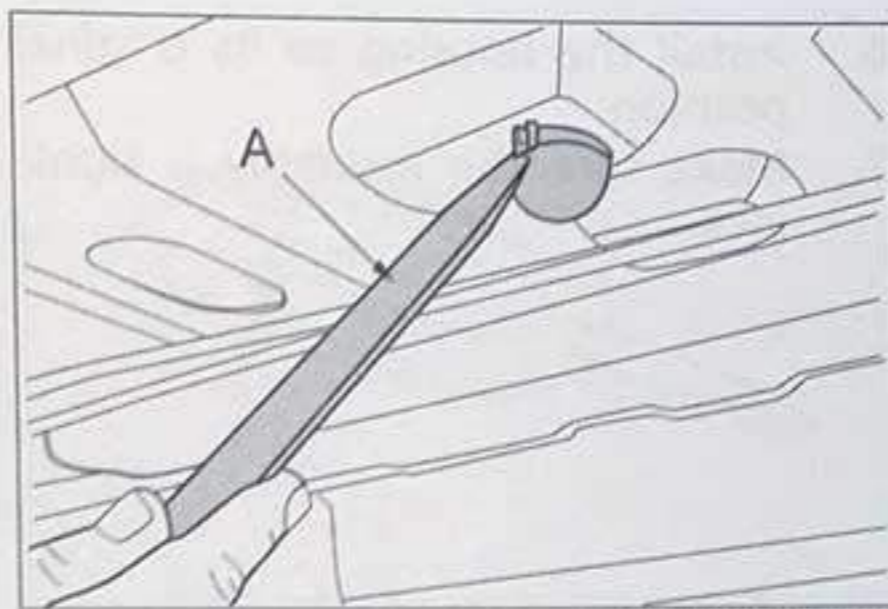

DOITW009R16020

1. Seal the tip of the (-) screwdriver with a cleaning cloth. Put the tip of the screwdriver (A) into the slots of the lens. Make a small twist with the (-) screwdriver (A) to open the lens.
2. Open the lens (B).

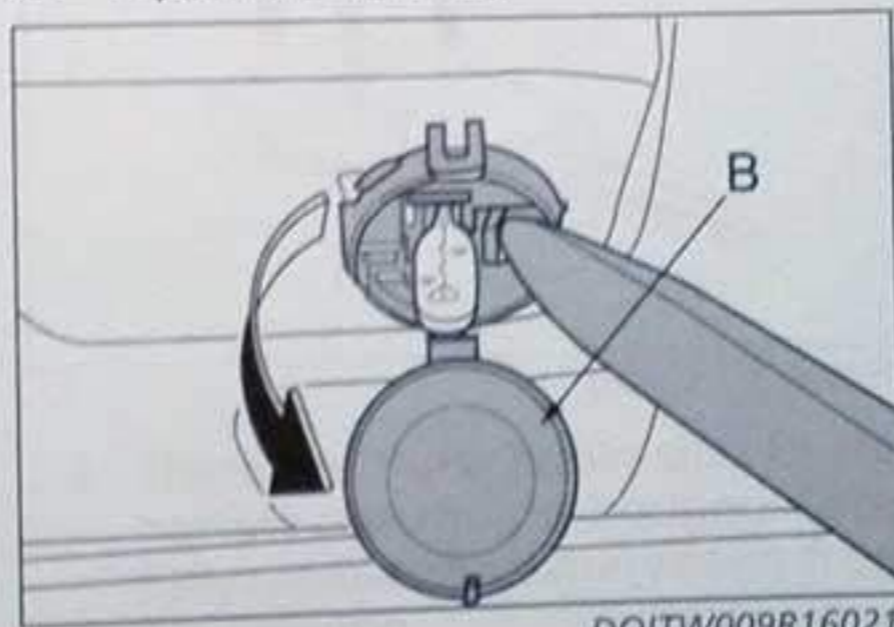

DOITW009R16021

3. Remove the damaged bulb (C) from the bulb holder.

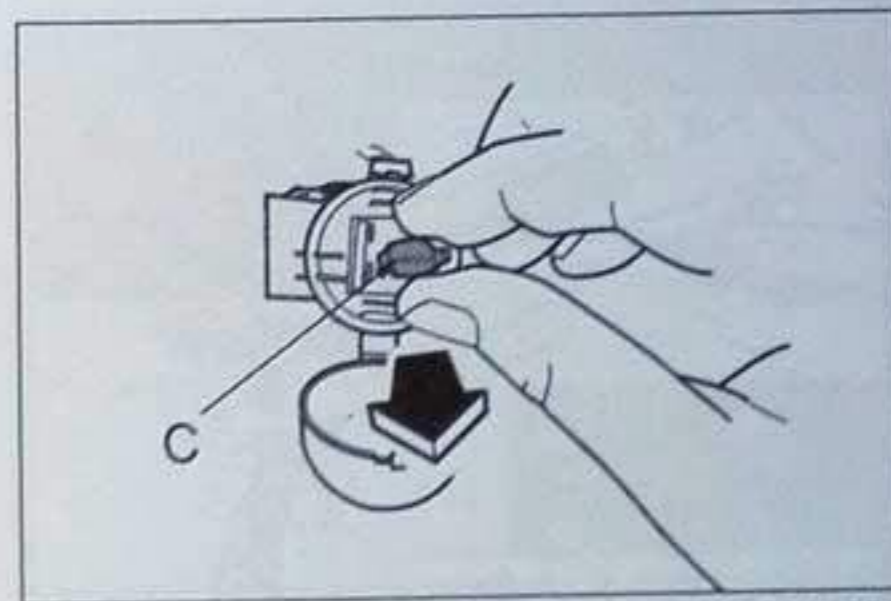

DOITW009R16022

4. Install a new bulb to the bulb holder.
5. Install the lens to the housing.
6. Make sure the assembly is tight-lock.

- (1) Do not touch the surface of the new bulb with bare hands or dirty gloves.
- (2) If the glass surface is dirty, clean the glass surface with alcohol or paint thinner solvent. Let the surface dry before installation.

Replacement of the bulb of the luggage compartment lamp

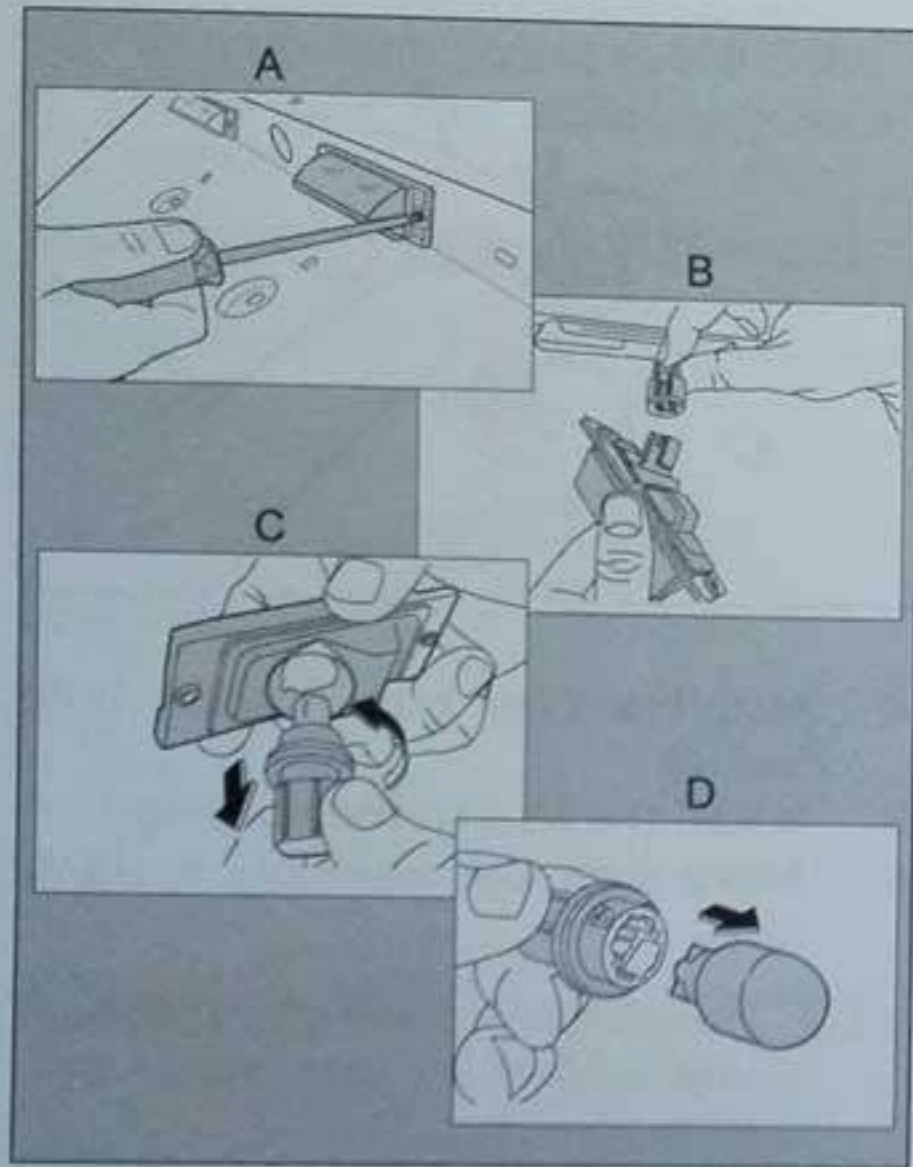

DOITW009R16013

Replacement of the bulb of the license plate light

1. Use (+) screwdriver to loosen 2 pieces screws (A) of the housing.
2. Remove the bulb from the harness connector (B).
3. Turn the bulb holder to the left side and remove the bulb holder from the housing.
4. Remove the damaged bulb from the bulb housing.
5. Install a new bulb to the bulb holder and install back to the housing.

6. Install the housing to its original position.
7. Make sure the assembly is tight-lock.

Replacement of the remote-transmitter battery

OWN009EMERG16011

Key: Type A & B

When the remote-transmitter battery is low, the information display at the meter cluster gives below warning display:

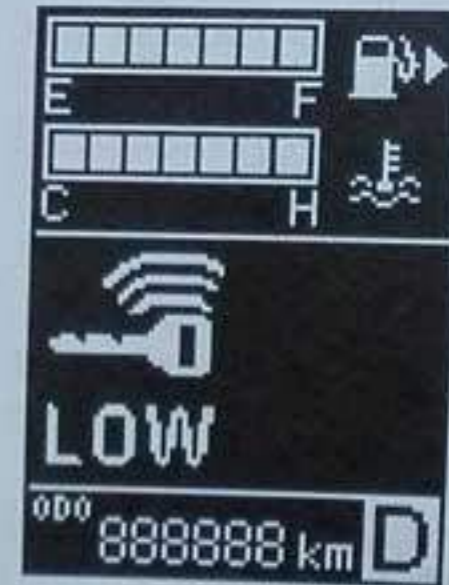

Replace with new battery (CR1620 type).

How to replace the battery

The shown procedures is for A and B types of remote transmitter:

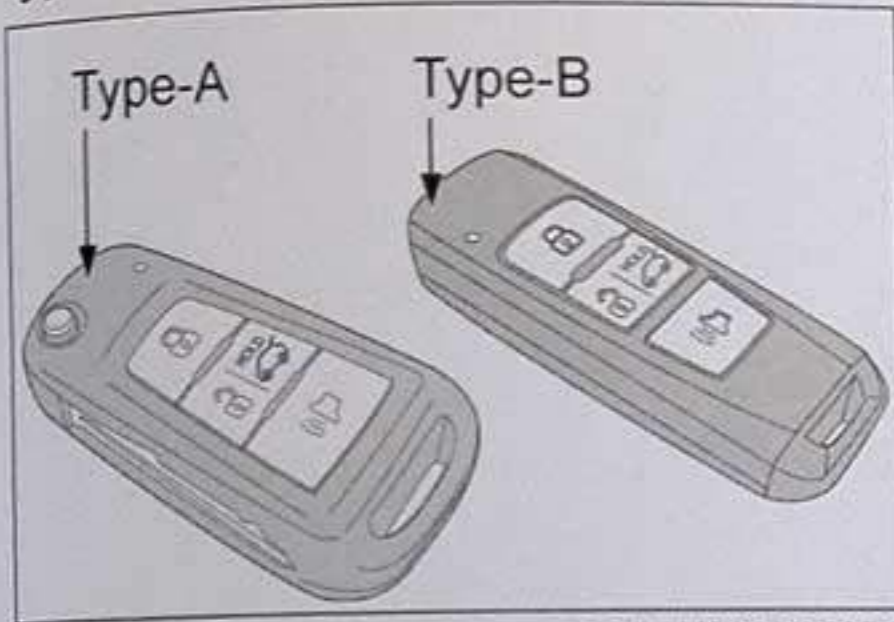

DOITW009R16031

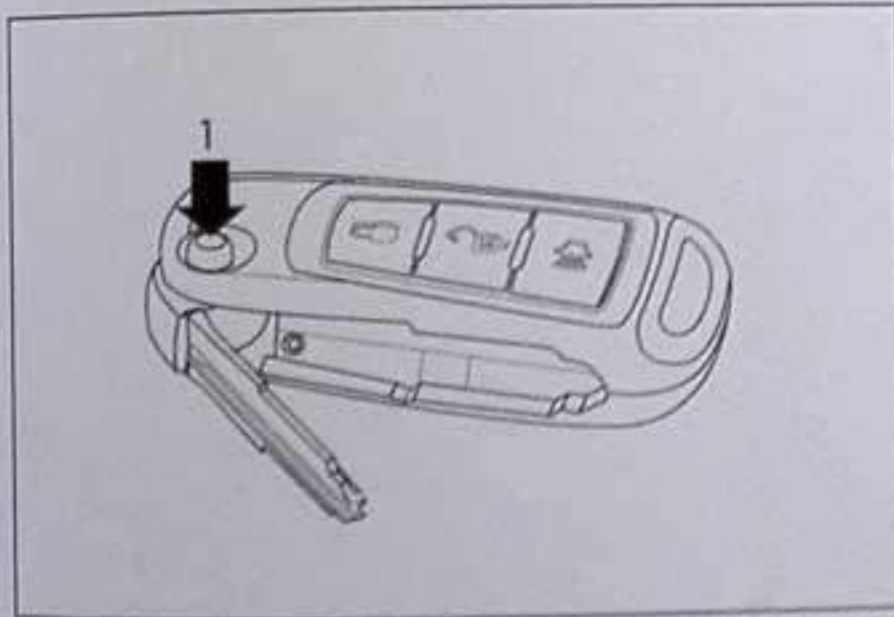

DOIQW009R12032

1 - Push the shown button to release the key blade.

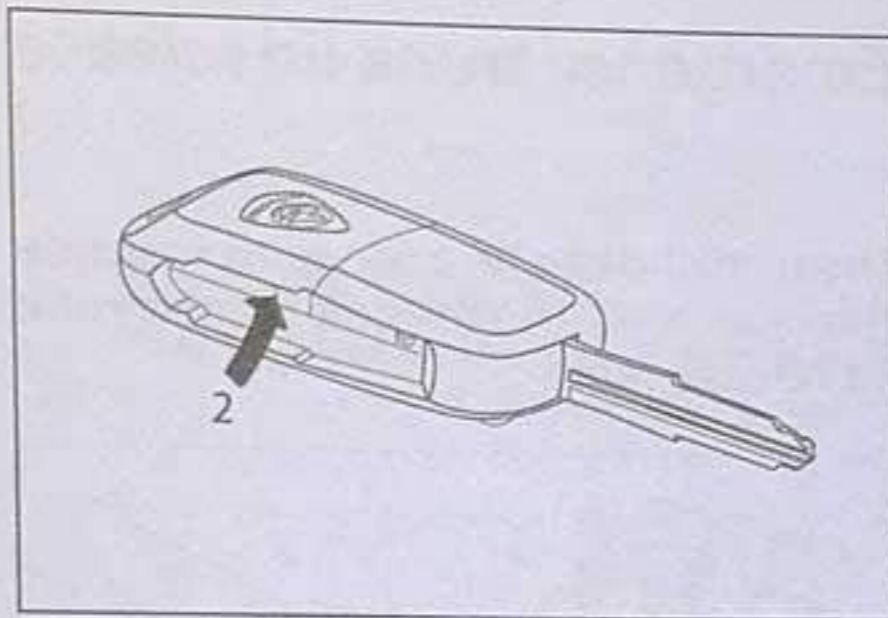

DOIQW009R12033

2 - From the shown side, pull until the hook of the cover makes an opening.

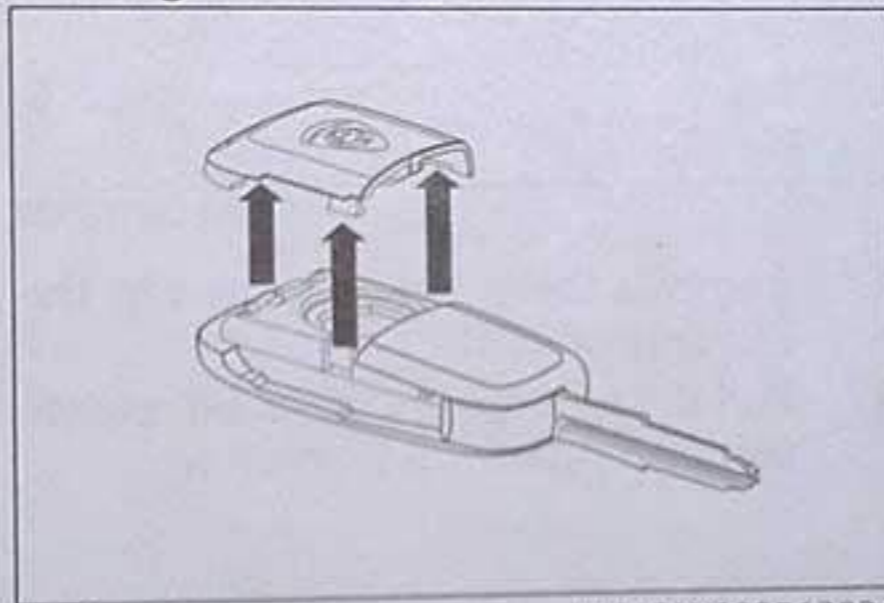

DOIQW009R12034

3 - There are three hooks that fit the battery cover to the housing. Carefully remove the battery cover from the housing.

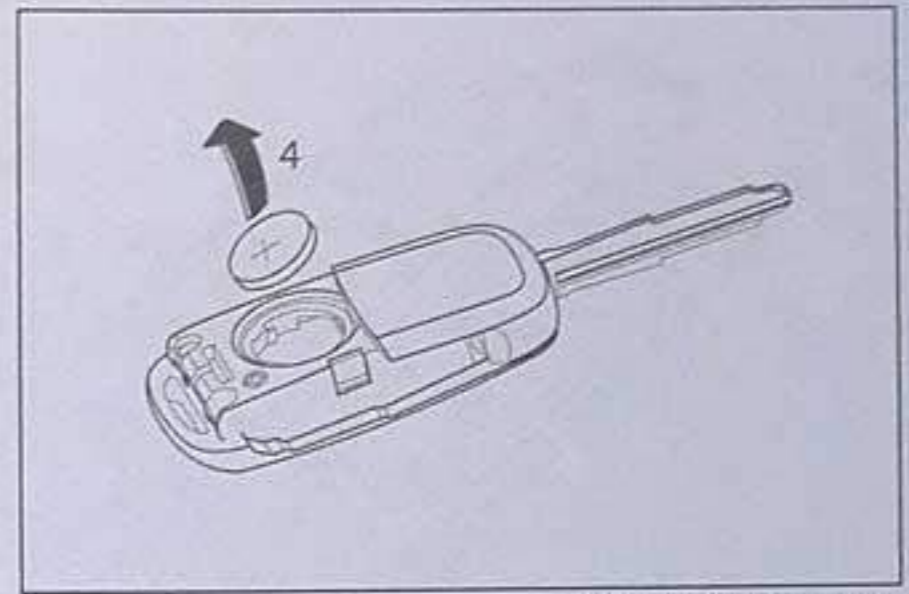

DOIQW009R12035

4 - Remove the damaged battery. Install a new battery. Make sure the battery is inserted with the correct polarity.

The shown procedures is for C type of remote transmitter:
Replace with new battery (CR1632 type).

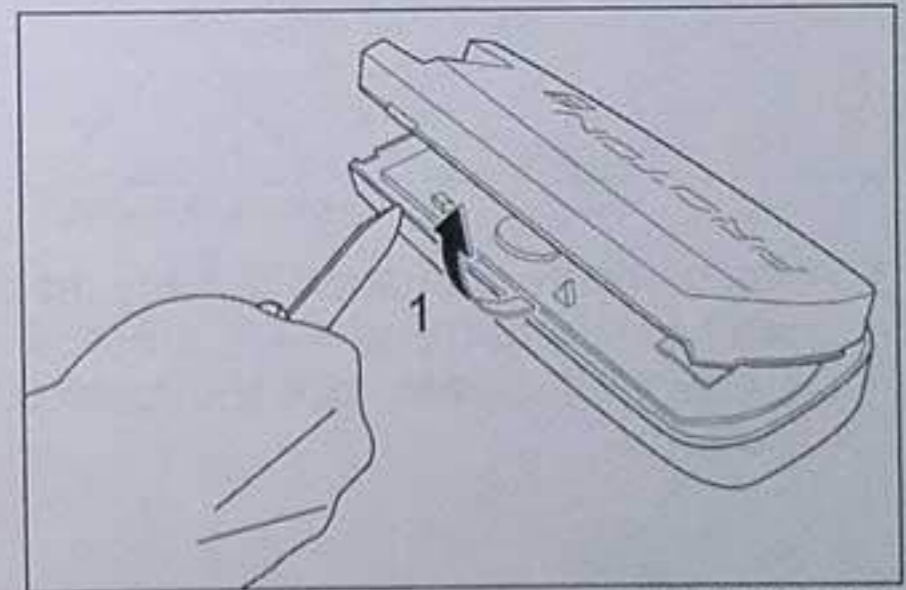

DOIQW009R14032

1. From the shown side, pull until the hook of the cover makes an opening.

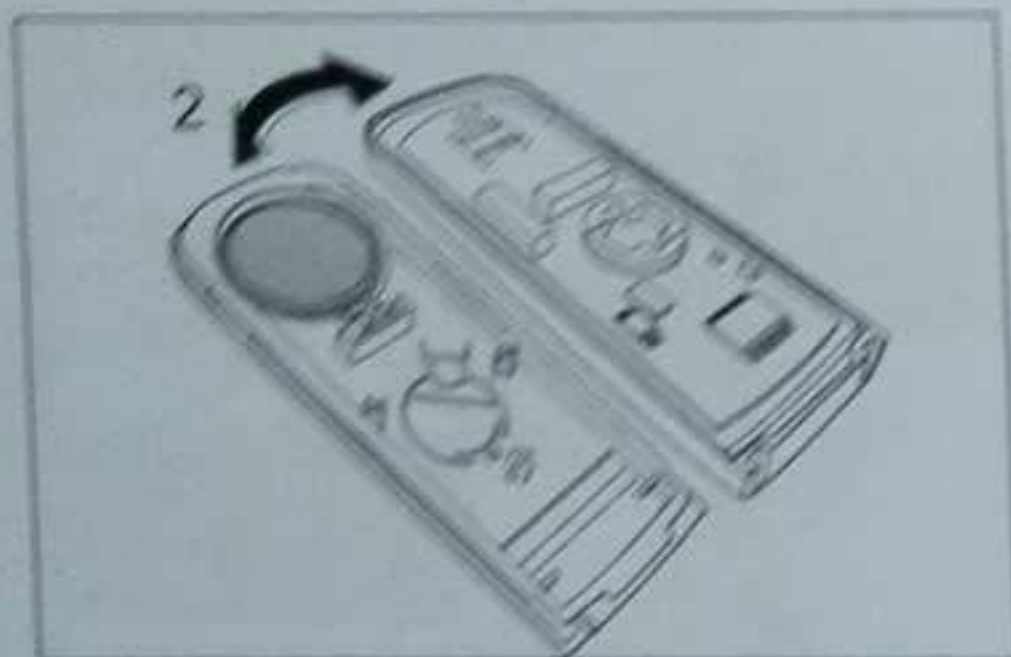

DOIRW009R14033

2. Open the cover.

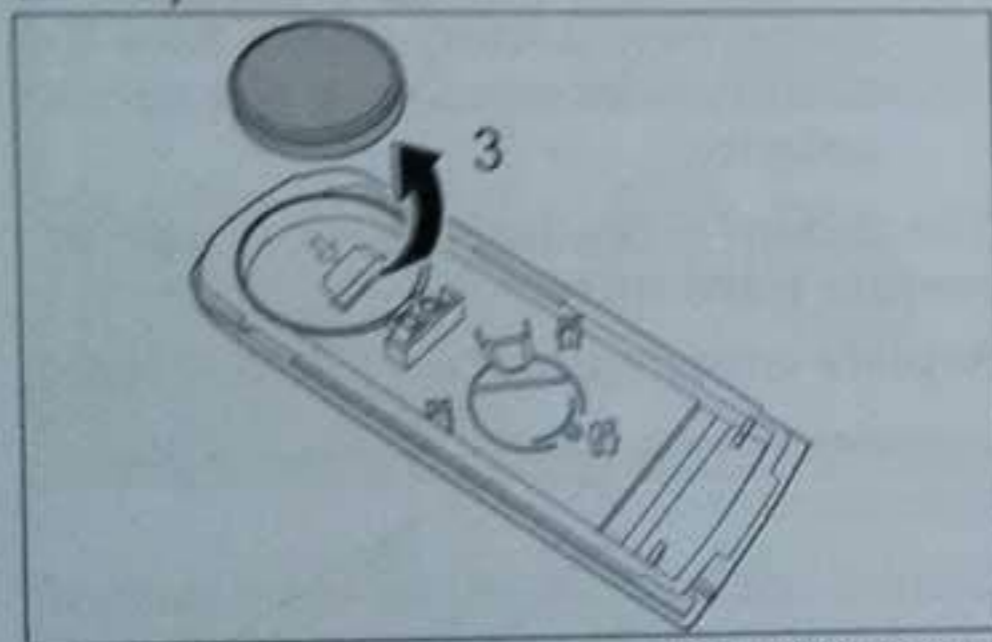

DOIRW009R14034

3. Remove the damaged battery. Install a new battery. Make sure the battery is inserted with the correct polarity.

Emergency trunk lid release

OWN009EMERG16012

The trunk lid can be opened from inside the cabin area. Use the emergency trunk lid release cable.

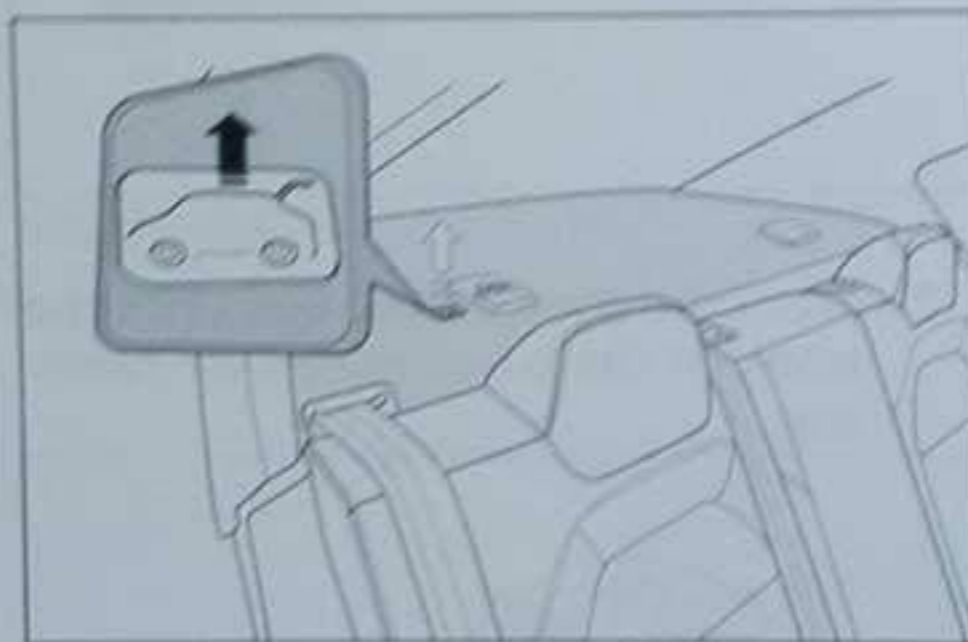

DOITW009R16028

1. Remove the cover as shown in the illustration.
2. Pull the emergency trunk lid release cable to open the trunk lid.

Maintenance

Vehicle Maintenance	160
Maintenance guidelines and precautions	163
Maintenance under hood	164
Maintenance on equipment	167
Maintenance on tyres	169

Vehicle Maintenance

OWN010MAINT16005

To maintain the value of the vehicle, make sure the vehicle operates in a good condition as follows:

1. Frequently clean and polish the vehicle to clean any materials that may damage the vehicle interior and exterior.
2. Regularly check the vehicle for scratches on the painted surfaces. Scratches can cause body rust. Immediately repair these scratches.
3. Follow the recommended periodical service maintenance as shown in the service booklet.

CAUTION

- (1) Do not clean your vehicle exterior and interior with materials that are corrosive. Contact an approved PROTON service center for help in the selection of these materials.
- (2) Carefully select the proper materials to clean, wax and polish the exterior of your vehicle.

Exterior

The items shown below can be dangerous to you and may damage the vehicle body and paint:

- Chemical in the dirt from the road surface
- Sea-water
- Anti-freeze liquid for road use.
- Soot and dust, powder from factories, acid / alkaline solvent, road tar and other chemical materials.
- Bird-droppings, carcasses of insects and tree sap

Chemical solvents can cause corrosion and damage to the paint, metal and plastic parts of the vehicle body. The vehicle should be cleaned immediately.

How to clean the exterior of your vehicle

NOTE

Do not clean your vehicle in sunlight. Park the vehicle in the shade and spray it with water to remove loose dirt. Then with clean water and a car brush or sponge, clean the vehicle from top to bottom.

Use a mild soap if necessary. Clean with a soft cleaning cloth. After cleaning the vehicle, carefully clean the joints and flanges of the doors, hood, where dirt may collect.

CAUTION

- (1) When you cleaning the under-carriage side of the vehicle, wear a pair of rubber gloves to give protection to the hands.
- (2) Try not to use an automatic car wash equipment. The brushes may possibly damage the paint surface and other installed component for example rear spoiler. Refer to the car wash attendant for any possible damage.
- (3) Do not spray or splash water on the electrical components in the engine compartment, which may possibly cause a problem at the circuit.
- (4) Some types of spray equipment apply high pressure hot water and heat to clean the vehicle. This method may possibly damage the vehicle resin parts and cause water to leak into the vehicle interior.

When using this type of equipment, make sure monitoring the following.

Keep a good distance of approximately more than 40 cm

(15.7 in) between the vehicle body and the spray nozzle.

When cleaning around the door glass, hold the nozzle at a distance of more than 50 cm (19.7 in) and at correct angles to the glass surface.

How to wax the exterior of your vehicle
Wax can prevent the paint of your vehicle from any dust and road chemical. Apply a wax solution after you clean the vehicle every three months. Do not polish the vehicle in sunlight. Wax after the surfaces cooled.

CAUTION

- (1) Do not use wax that contains high abrasive materials.
- (2) Do not use petrol or paint thinner to remove any road tar or other contamination that is on the painted surface.
- (3) Do not apply wax on areas that have black matt coating. This type of wax causes the change in colour and patches. Immediately clean with a piece of soft cleaning cloth and warm water to the dirty area.
- (4) Be careful when applying wax around the sunroof opening

area. Do not put any wax at the weather strip (black rubber). If the weather strip is dirty with wax, the weather strip cannot keep a weather-proof seal with the sunroof.

How to polish the exterior of your vehicle

If the paint work is dirty or loose its gloss finish, polish your vehicle.

CAUTION

Do not polish the matt finish parts and plastic bumpers . Polishing these parts will damage the matt finish.

Damaged paint

Any small cracks and damages in the layer of paint must be painted quickly with touch-up paint to prevent corrosion.

Check body areas near to road the tyres carefully for damage to the layer of paint caused by stones / pebbles. The plate of vehicle information number (VIN) is in the engine compartment.

Servicing of plastic parts

Use a sponge or chamois leather. If the car wax bonds on a gray or black rough surface of the bumper or moulding, the surface becomes white. Clean the sur-

face using warm water and soft cleaning cloth or chamois leather.

CAUTION

- (1) Do not use a scrubbing brush or other hard tools. This tool may possibly damage the plastic-part surface.
- (2) Do not use wax containing material (polish powder) which may possibly damage the plastic-part surface.
- (3) Do not cause the plastic parts to be in contact with brake fluids, engine oils, grease, paint thinner or battery electrolyte. These liquids can cause a stain or a colour change to the plastic parts. Immediately clean with soft cleaning cloth with a neutral detergent and water.

Chrome parts

To prevent mark and corrosion of chrome parts, clean the chrome parts with water, completely dry the parts and apply special protective coating.

Alloy wheels

Clean the alloy wheels and apply a correct protection coating to prevent the alloy wheels from corrosion or other damage caused by road chemical.

NOTE

- (1) When cleaning the alloy wheels, do not use abrasive type of cleaner.
- (2) Any alloy wheels that come in contact with sea water or road chemicals must be cleaned quickly.
- (3) Brushes possibly damage the aluminium wheel surface. Make sure to use a sponge or chamois leather.
- (4) Do not apply hot water directly from the steam-cleaner to the wheel surface.

Window glass

Clean the window glass only with a sponge and water.

After you clean the glass, dry the glass with a cleaning cloth.

NOTE

To clean the inside of the rear window, make sure you use a soft cleaning cloth. Clean the window glass along the demister heater wires to prevent damage the heater wires.

Wiper blades

Use a soft cleaning cloth to clean the wiper blades. If the wiper blade does not clean correctly, replace the wiper blades.

Chassis protection

The vehicle chassis has been factory treated for rust and corrosion. Some areas were applied with anti-corrosion

* if fitted

treatment and wax. Get your vehicle to your authorised PROTON service outlet each 12 months to have body sheet metal inspected for condition.

Engine compartment

Clean the engine compartment from start to the end of winter. Make sure the flanges, the openings and the auxiliary parts are clean from any dust; Coming from the chemical and other corrosive materials from the road.

If salt and other chemicals that are applied to the roads in the area, clean the engine compartment every 3 months.

Interior care

After you clean the vehicle interior with water or soap products, let your vehicle dry in a good airflow area.

NOTE

Carefully read the instructions at the label.

Plastic, vinyl leather and fabric

1. Lightly clean with gauze or other soft cleaning cloth soaked with water base neutral detergent.
2. Put the cleaning cloth in clean water and rinse.

Upholstery

1. To maintain the value of the new vehicle, always keep the interior

clean; for example the upholstery part.

Use a vacuum cleaner and a brush to clean the seats.

To clean the vinyl and synthetic leather, use a correct upholstery clean-solution and a cleaning cloth; Apply 3% solution of neutral detergent in lukewarm-water.

2. Clean the carpet with a vacuum cleaner and remove any dirt with carpet cleaner. Lightly apply carpet cleaner to cleaning cloth to remove oil and grease.

Genuine-leather *

1. Lightly clean with gauze or other soft cleaning cloth soaked with 5% solution of neutral detergent for wool part.
2. Put the cleaning cloth in water and rinse. Repeat until clean.
3. Apply a leather protecting agent to the genuine-leather surface.

**CAUTION**

- (1) If the genuine-leather is wet, clean with a dry soft cleaning cloth.
- (2) Remove small stains on genuine-leather with leather clean-solution.
- (3) If you polish hard against the genuine-leather with a nylon brush or synthetic-fibre, the

genuine-leather surface can be damage.

- (4) Organic solvent (for example benzene, alcohol and gasoline), acid and alkaline solvent may change the colour of the genuine-leather surface. Use only neutral detergent.
- (5) Be careful of dirt or oil stains which can cause mildew on the genuine-leather surface. Clean the dirt to prevent damage.
- (6) Exposure to long hours in the sun may damage the genuine leather.
- (7) Vinyl products on the leather seats may also deteriorate due to the hot weather.

Maintenance guidelines and precautions

OWN010MAINT16001

To keep the car in good running condition, follow the service recommendation by PROTON.

This maintenance section contains those procedures of the service maintenance that the owner can do. If you find there is a malfunction or other problems, go to an authorised PROTON service outlet for inspection.

Before you do your maintenance

Before you do your maintenance, carefully follow these safety precautions.

WARNING

- (1) When you check or service items inside the engine compartment, make sure you turn off the engine. Let the engine cool first.
- (2) If you must do work in the engine compartment with the engine running, be careful with your clothing and body parts. Keep away from any parts that turn for example radiator fan and drive-belts.
- (3) When the engine is not running, the radiator fan can turn on automatically. Turn the ignition switch to the "OFF" position. Remove the key for your safety.
- (4) Do not smoke. Any open flames can cause sparks around fuel or the battery. The fumes are flammable.
- (5) Be careful when you do work around the battery. The battery contains poisonous and corrosive sulphuric acid.

- (6) Do not go below the vehicle while the vehicle is on a jack. Always use jack supports or other solid supports.
- (7) Be careful when you operate the components and the materials in the vehicle. Refer to an authorised PROTON service outlet for necessary information.

Maintenance under hood

OWN010MAINT16002

Engine oil check

All engines burn some quantity of engine oil in normal operation. Check the engine oil level at regular intervals.

How to check the engine oil level

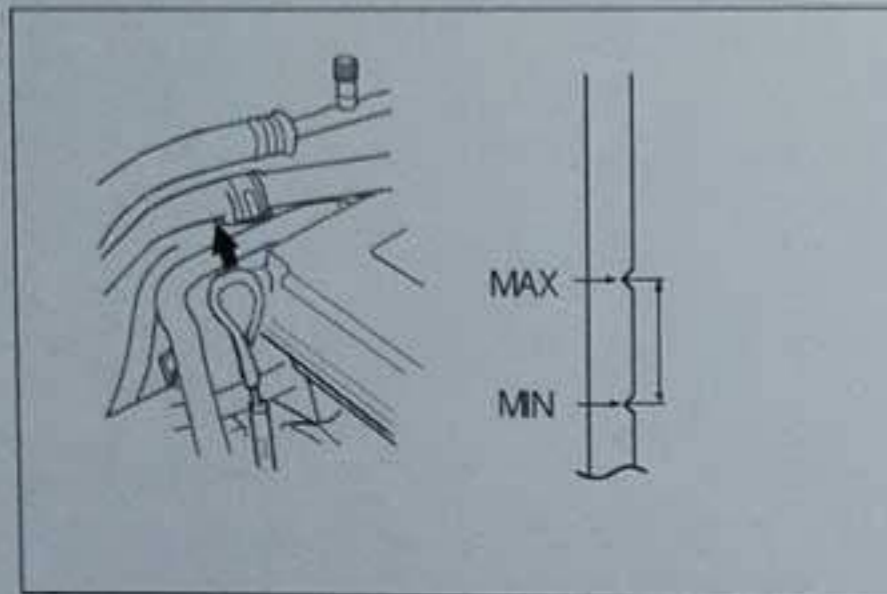

DOIKW010R03001

Check the engine oil level when the engine is warm, but not in running.

1. Park the vehicle on a level surface.
2. Turn off the engine.
3. Let the engine oil in circulation return to the oil pan for a minute.
4. Remove and clean the dipstick with a cleaning cloth.
5. Put the dipstick into the dipstick holder until the dipstick stops.
6. Remove the dipstick and read the oil level.

7. The engine oil level must be in the range indicated in the illustrations.

If the oil level is below the specified limit, add engine oil.

Selection of engine oil

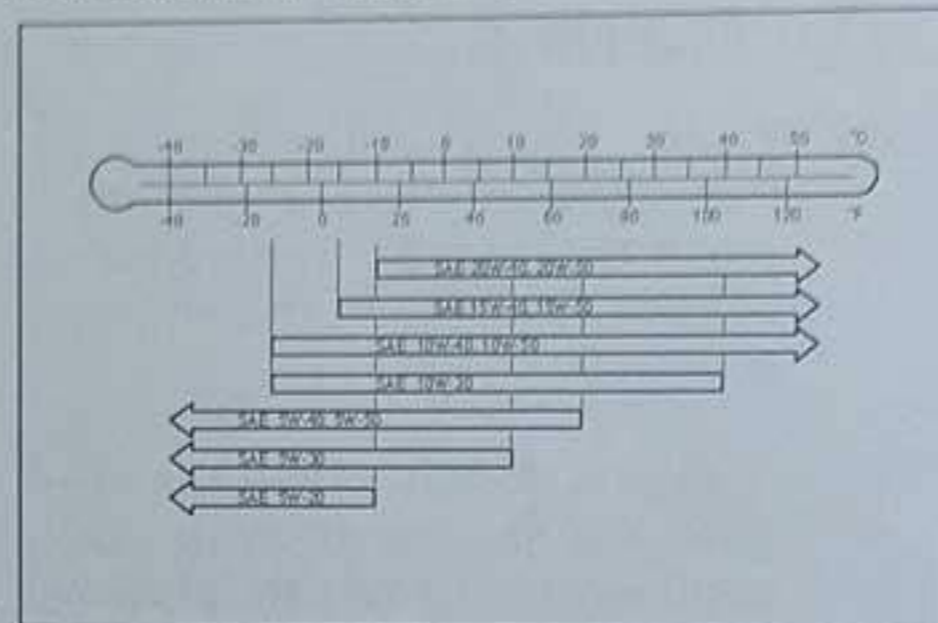

DOIAW010R3003

1. For correct engine oil specification of this vehicle, refer to the "Lubrications" topic in "Specification" section.
2. The above chart shows the selection of engine oil with the correct SAE viscosity number according to the outside temperatures range.

NOTE

Do not use engine oil with a lower API class that will cancel the vehicle warranty.

How to add engine oil

1. Remove the cap found on the cylinder head cover.

2. Add enough oil to increase the level to less than the specified maximum level.

NOTE

- (1) Use the specified engine oil and do not mix different types of oil.
- (2) If possible, do not mix different types of engine oils.

3. After you add the engine oil, close the cap.

NOTE

Refer to "General Information" section for information of the used engine oils.



DOIRW010R14003

CAUTION

Clean any oil spills with a soft cleaning cloth when you change or add engine oil.

Engine coolant check

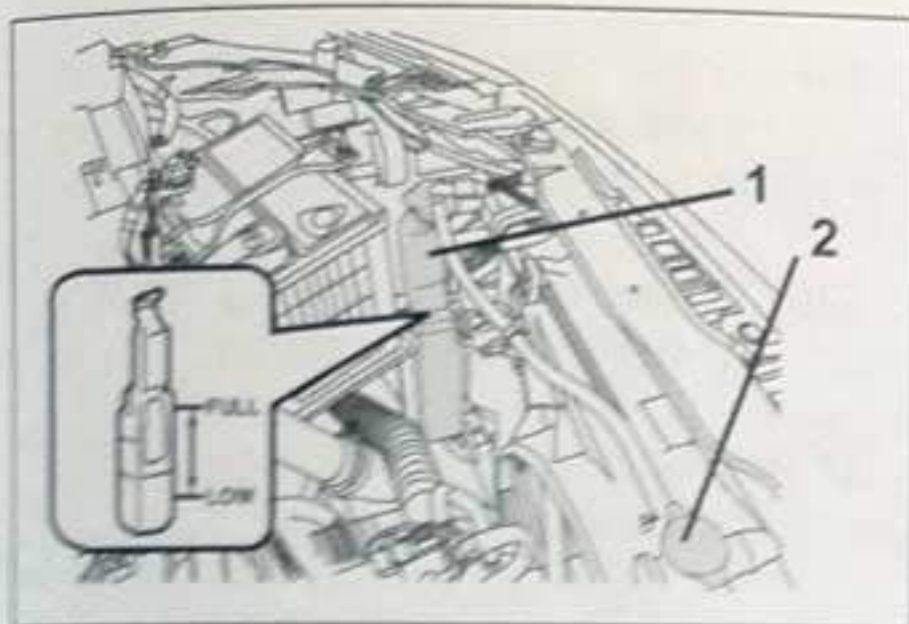

DOIOW010R11002

- 1 - Engine coolant reservoir tank
- 2 - Radiator cap

CAUTION

The cooling system is a closed system. Normally the decrease of coolant is minimum. Any visible fall in the coolant level in the reservoir tank indicates a leakage. If this condition occurs, go to an authorised PROTON service outlet for inspection.

The reservoir tank that holds the coolant is in the engine compartment. The reservoir tank has "LOW" and "FULL" marks as shown in the illustration.

Check the level of engine coolant while the engine is warm and running.

⚠ CAUTION

- (1) Do not open the reservoir tank lid or radiator cap while the engine is hot. The coolant system is under pressure and any hot coolant release can cause dangerous burns.
- (2) Regularly check the coolant level.

The coolant level in this tank must be between the "LOW" and "FULL" marks.

If the coolant level in the reservoir tank decreases to the "LOW" mark at the reservoir tank, open the lid and add some coolant.

If the reservoir tank is cleaned, remove the radiator cap and add coolant until the level reaches the filler neck.

Anti-corrosion

The anti corrosion agent of the engine coolant is an ethylene glycol type. The cylinder head and the water-pump housing are made of aluminium alloy. Change the engine coolant regularly to prevent the corrosion of these parts. Do not replace the coolant with a clear water.

Anti-freeze concentration

The concentration of anti-freeze varies according to the ambient temperature.

For good anti-corrosion and anti-freeze performance, keep the anti-freeze concentration in the range of 25 to 35%.

⚠ CAUTION

Concentration more than 35% can cause a reduction in the anti-freeze and the cooling performance.

Battery check

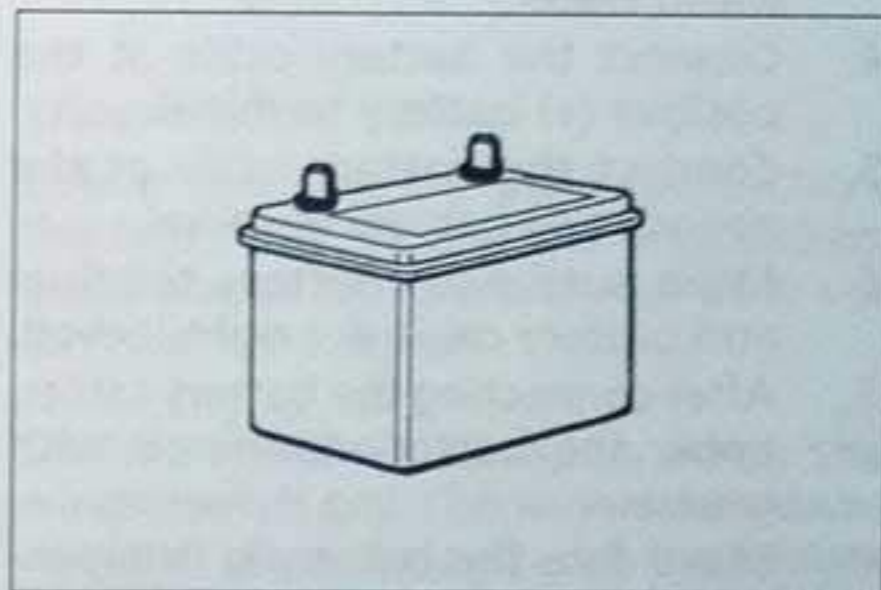

DOIGW010R06001

A good battery is important for starting the engine and maintain the function of the vehicle's electrical system.

Always check the battery condition.

NOTE

When you send the vehicle for service, make sure the authorised PROTON service personnel check the battery condition.

Check the battery terminal

Make sure the battery terminals are clean and not corroded. To clean the battery terminals, follow the instructions below :

1. Disconnect the battery cable at the negative (-) battery terminal.
2. Disconnect the battery cable at the positive (+) battery terminal.
3. After disconnecting the battery cables, clean the terminals with warm water.
4. Connect the battery cable at the positive (+) battery terminal.
5. Connect the battery cable at the negative (-) battery terminal.
6. Make sure each battery terminal and battery cable are tight-locked.
7. After connecting the battery cables, apply the battery terminals with grease.
8. Make sure the battery is firmly installed and does not move during travel.
9. If the vehicle has electronic power-steering system, reset the steering setting. Refer to topic "How to reset the steering setting" of EPS warning lamp in "Indication and warning lamps".

NOTE

DO NOT remove the top label on the battery. If the label is damage, the vehicle warranty will be cancelled.

WARNING

- (1) When working near the battery, always wear protective eye goggles.
- (2) The battery electrolyte is very corrosive. Do not let the battery come in touch your eyes, skin, clothing or the painted surfaces of the vehicle. Immediately flush any spilled electrolyte with water.
- (3) Always obey the procedure how to disconnect and connect the battery cables.
- (4) Do not disconnect the battery while the engine is running. The electrical components may be damaged.
- (5) Do not disconnect the battery with the ignition switch is in the ON position.
- (6) Do not cause a short-circuit to the battery.
- (7) The battery operates correctly in a high clean electrolyte. Any contamination to the electrolyte will reduce the battery performance.

- (8) Do not smoke or cause an open flame near the battery.
- (9) Ensure good ventilation when changing or using the battery in a closed space.
- (10) When quick charging disconnect the battery cables.
- (11) Always disconnect the negative (-) terminal first.

Brake and clutch fluid check

Check the brake and clutch fluid level in the reservoir tank.

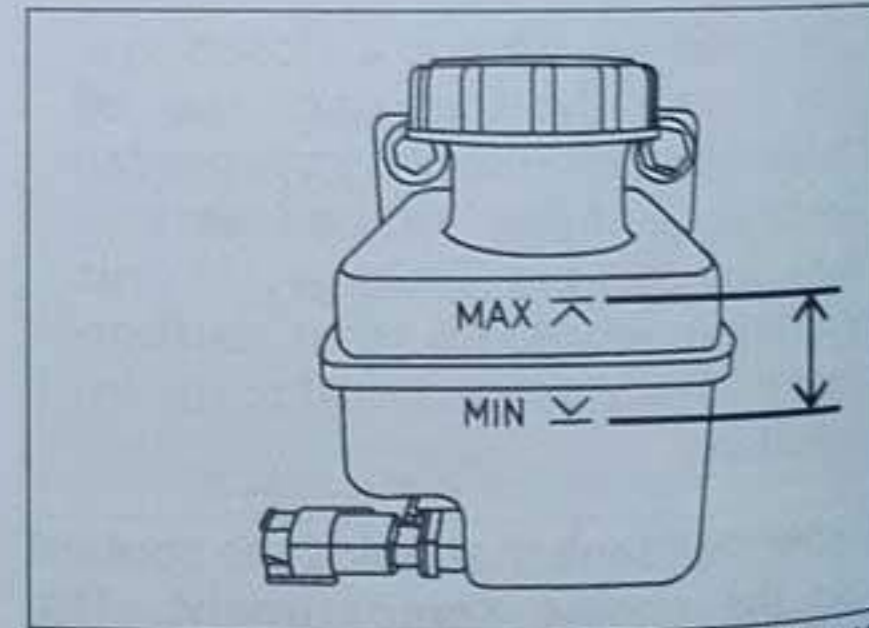

DOIQW010R11001

Regularly check the brake and the clutch system for any leakage.

The fluid level must be between the "MAX" and "MIN" marks on the reservoir tank.

NOTE

Use brake fluid with DOT3 or DOT4 only.

Fluid level

The fluid level falls with the wear of the brake pads. This condition does not indicate any problem.

If the fluid level quickly falls, a fluid leakage in the brake or clutch system may have occurred. Immediately go to an authorised PROTON service outlet for inspection.

The fluid is hygroscopic; Easily absorbs moisture from the air. Any moisture in the fluid will cause an effect to the brake system and reduce the brake performance. The fluid reservoir has a special cap to prevent the entrance of air. Do not remove this cap. Fully tighten the cap to prevent contamination from particles or moisture.

There is a float that monitors the fluid level. When the fluid level is below the "MIN" mark, the brake warning light at the meter display will illuminate.

Fuel lines, engine coolant hoses and exhaust gas leakage

Look under the vehicle body.

1. Check the hoses and joints for any leaks of engine coolant, oil and exhaust gas.

2. Check the hoses and joints for any loose connection, break, cracks, wet marks and other damages.



WARNING

- (1) If you find a possible fuel leak or smell fuel odor, do not operate the vehicle. Contact an authorised PROTON service outlet for help.
- (2) Be careful when you work on the fuel system. Gasoline is very flammable.
- (3) Do not smoke or cause an open flame near the fuel system.

Maintenance on equipment

OWN010MAINT16003

167

Meter, gauge, indication lamp and warning lamp operation

Start the engine to check the operation of all meters, gauges, indication lamps and warning lamps.

Wiper and washer operation

Wiper blades

Before you operate the wipers, check the wiper blades and the windscreen. Good blades are necessary for clear vision when you drive.

Do not operate the wipers when the windscreen is dry. The wipers may damage the glass surface and the blades wear off faster.

Regularly replace the wiper blades.

Washer fluid

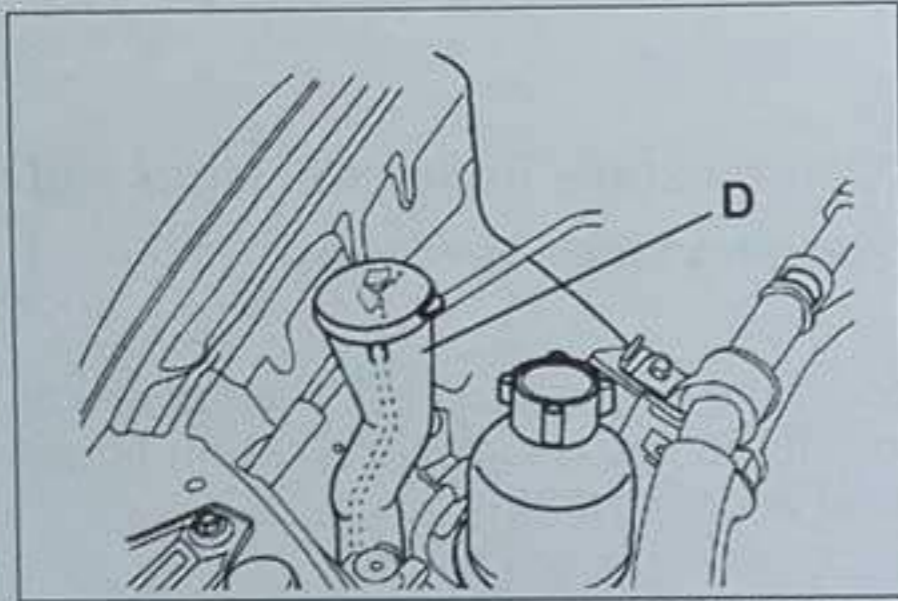

DOIQW010R11003

If the fluid level is low, add washer fluid to the washer tank (D).

CAUTION

- (1) Always use clean water to prevent the nozzle from blockage.

Dirty water can cause a blockage to the channels in the washer system.

- (2) Use washer fluid that contains an anti-freeze solvent. This type of solvent prevents the washer fluid in the washer system from getting frozen during low-temperature weather.

NOTE

The front and rear washer system use the same washer tank.

Exterior and interior lamps operation

Operating the lamp switch and the combination switch. Make sure that all lamps properly operates.

If there are lamps that do not operate, possibly a fuse or a lamp bulb has blown. If there is no blown fuse, check the lamp bulb.

Refer to the "For emergencies" section in this manual for the inspection and replacement of the fuses and the lamp bulbs.

If there is a fault, get your vehicle to an authorised PROTON service outlet for inspection.

Parking brake – lever stroke

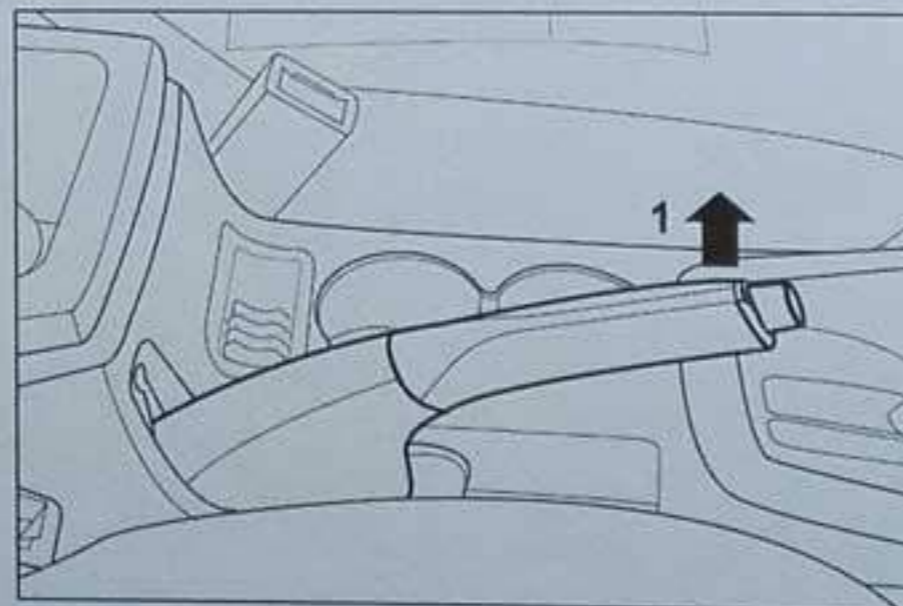

DOIQW006R11002

While you pull the lever to the top position, count the number of "clicks" that the ratchet makes. One click shows a lever movement of one notch. The lever must move the specified number of notches for normal brake operation.

Parking brake – lever stroke;

- 1 - Drum type – 6 to 8 notches

If the lever stroke is not in the standard range, go to an authorised PROTON service outlet for lever adjustment.

Brake pedal free-play

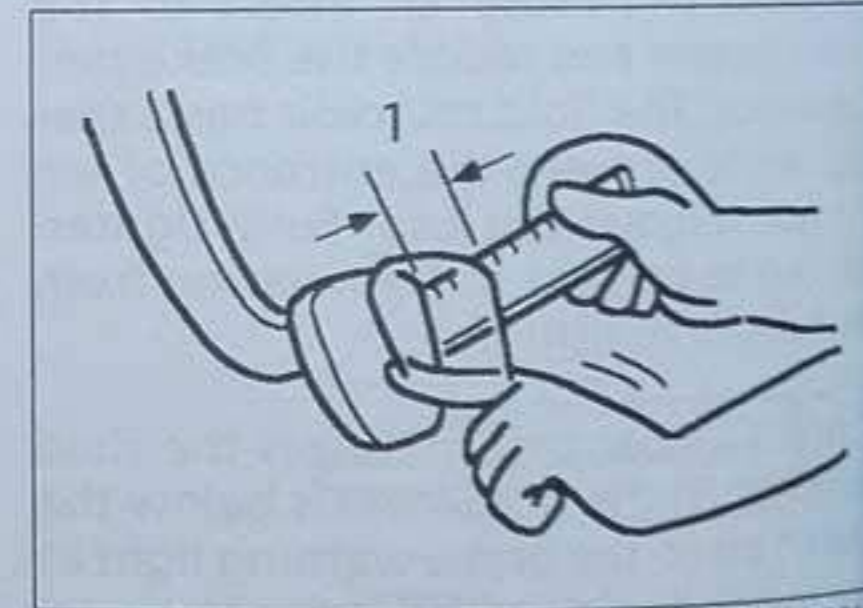

DOIAW010R3015

Stop the engine. Push the brake pedal repeatedly with your fingers until you feel the first resistance.

This distance must be in the specified range.

- 1 - Brake pedal free-play : 3 to 8 mm

If the distance is not in the specified range, go to an authorised PROTON service outlet for adjustment.

Clutch pedal free-play *



DOIAW010R3015

Push the clutch pedal with your fingers until first resistance is felt.

This distance must be in the specified range.

1 - Clutch pedal free-play : 6 to 13 mm

If the clutch is not in the standard range, have the clutch pedal adjusted at an authorised PROTON service outlet.

Ventilation slots

Make sure the ventilation slots in front of the windscreen is clean all the time.

Hinges and latches lubrication

Check all latches and hinges. To lubricate clean and apply multipurpose grease.

Weather strips

Apply a silicone grease to the weather strips at the door and hood openings. This silicone grease helps to prevent these weather strips from getting frozen.

Maintenance on tyres

OWN010MAINT16004

To safely operate the vehicle, the tyres must be in good condition with sufficient tread and correctly inflated.

This section shows how to check the tyres and make sure these tyres are in good condition.

Tyres visual check

Check the tyres for any cuts and other damage caused by metal pieces or small stones / pebbles.

Check the tyres for any bulges or bumps in the tread or side of the tyre.

Immediately replace the tyre if the tyre condition is as follows:

1. There are deep cuts or cracks.
2. There is visible fabric or cord.
3. The tyre tread has worn.

CAUTION

Do not drive with worn tyres. Worn tyres possibly can cause your vehicle to skid on a wet road.

Check the tyre tread

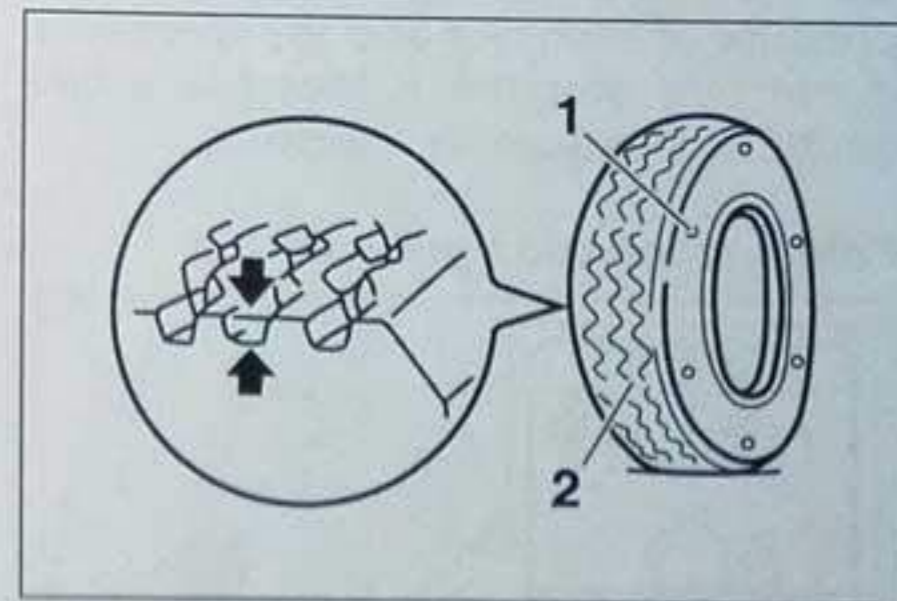

DOIAW010R10001

1 - Position of the indicator of the tread wear

2 - Indicator of the tread wear

How to Read Your Treads

Make sure the tread depth of the tyres is more than 1.6 mm.

Some tyres have wear indicators on the tyres. Worn tyres will show these wear indicators in six areas on the surface of the tyres. Immediately replace the worn tyres.

* if fitted

Check the tyre inflation pressure

Correctly inflated tyres gives the combination of better driving, fuel economy and tread life and even tyre wear.

Visually check tyres before driving.

Normally tyre pressure decreases 10 to 20 kPa (0.1 to 0.2kgf/cm) a month. Regularly use a tyre gauge to measure the pressure of each tyre and the spare tyre. If the tyre pressure is low, use a tyre gauge to measure the pressure.

Cold tyre inflation pressure

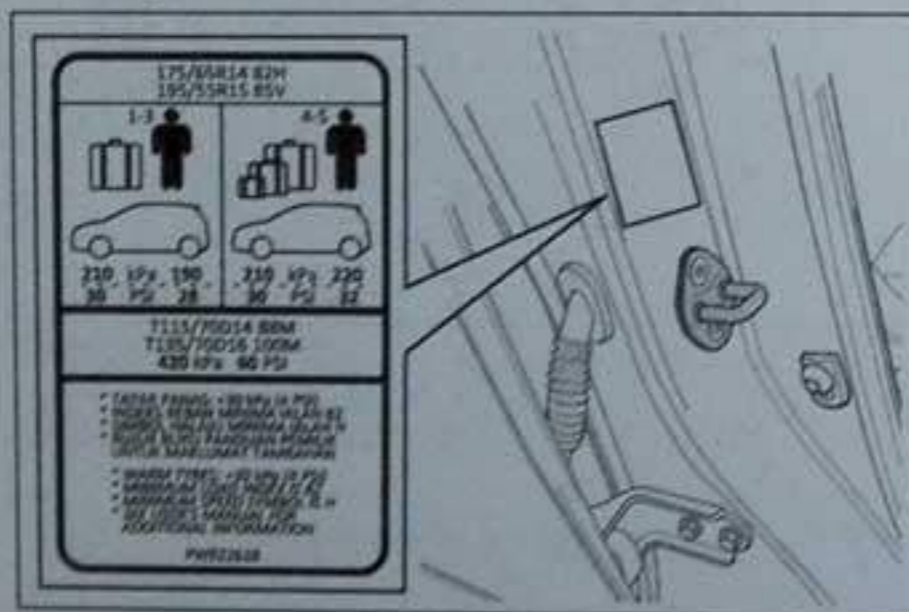

DOIRW010R14002

There is label that shows the recommended cold tyre pressure at your doorjamb.

Check the pressure of all tyres when these tyres are cold.

NOTE

Tyres are cold when the vehicle is parked at minimum three hours or driven less than a kilometre.

After adjusting the tyre inflation pressure, check the tyres for any damage and air leaks.

Make sure again the rubber caps are reinstalled on the valves.

Rotation of tyres

On a front-wheel drive vehicle, the front tyres steer the vehicle and give traction. The front tyre tread can wear faster than the rear tyres.

Tyre wear may not be the same for all tyres due to incorrect tyre pressure, wheel alignment and sudden braking.

PROTON recommends that rotation of tyres be carried out every 20,000 km. The rotation of tyres helps to balance the wear and extend the tyre life.

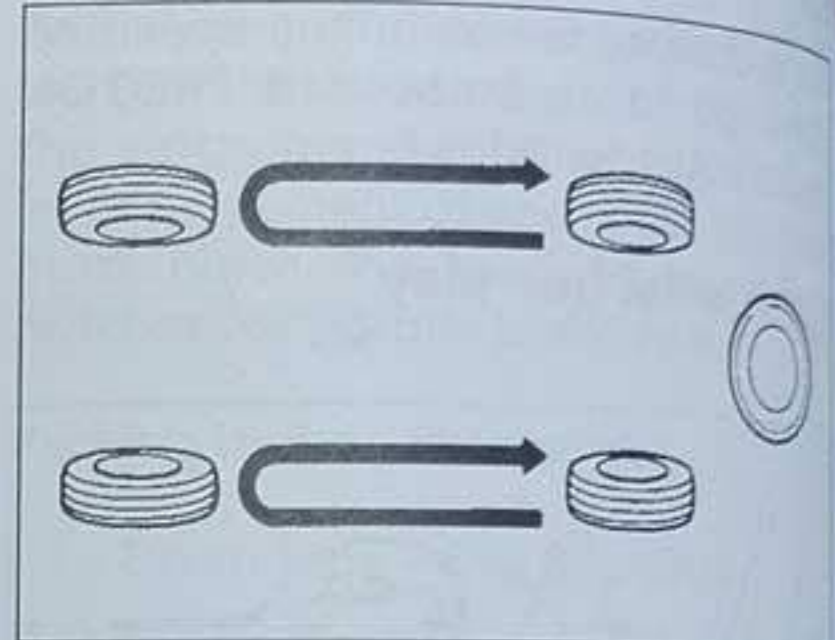

DOIRW010R3008

The above illustration shows a model with a small size spare tyre.

Change the position of the wheels in sequence as shown in the illustration.

When you do the rotation, check the tyre condition (refer to topic Tyres visual check).

Go to an authorised PROTON service outlet to have all wheels checked.

Specifications

Chassis number	172
Engine number	172
Vehicle identification number plate	172
Dimensions	174
Weight	175
Performance	176
Fuel information	176
Engine	177
Transmission	178
Electrical system	179
Tyres and wheels	179
Other specifications	180
Lubrications	181

Chassis number

OWN011SPECS15006

1st location (under the driver seat)

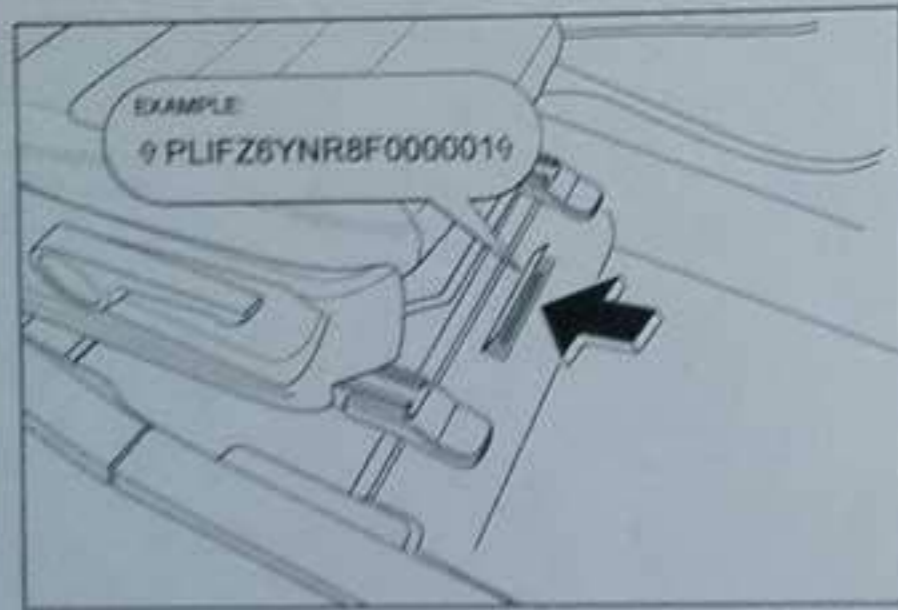

DOIRW011R14002

The mark of chassis number is on the front floor crossmember under driver seat. Open the floor carpet and find the chassis number.

2nd location (under rear-passenger seat)



DOIRW011R14003

The mark of chassis number is on the rear floor of the rear seat. Remove the seat cushion and you will see the number directly on the rear floor.

Engine number

OWN011SPECS15007

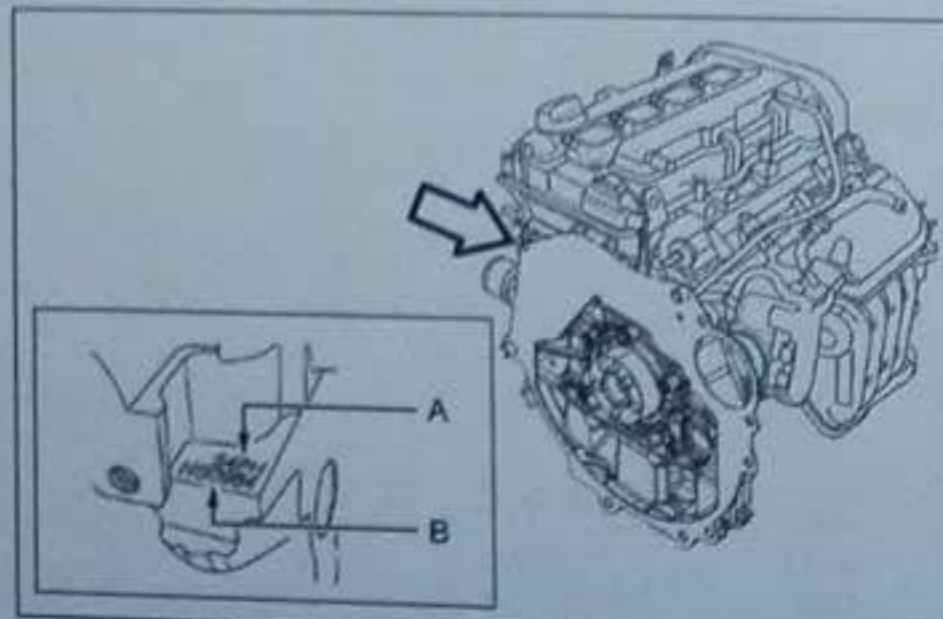

DOIRW011R14004

The mark of engine number is on the engine cylinder block as shown in the illustration.

Symbol	Description
A	Model-number of the engine
B	Serial number of the engine

Vehicle identification number plate

OWN011SPECS15008

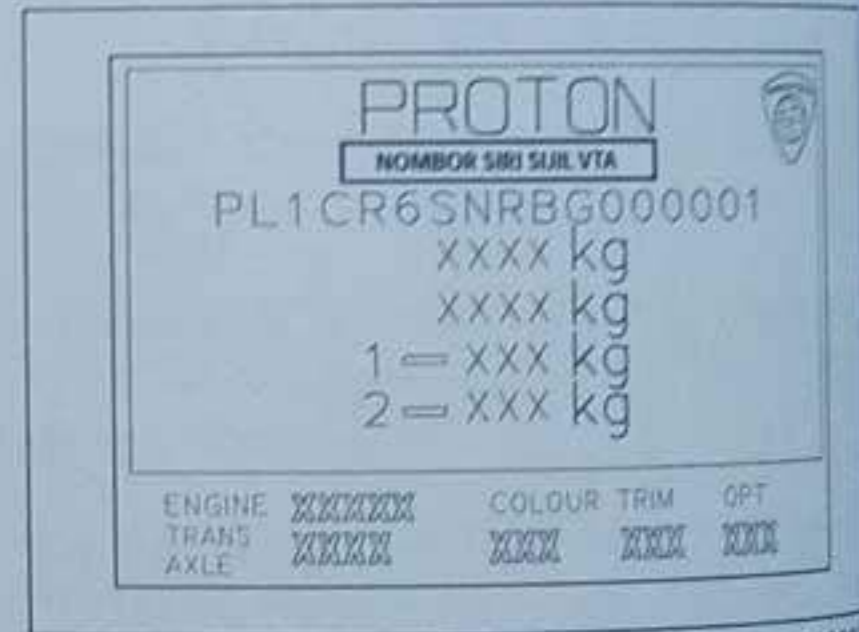

DOIQW011R13002

The vehicle identification number (VIN) plate is onto the side of center pillar of the driver.

This plate shows the codes of vehicle model, engine model, transmission model and colour.

Use this number for reference when you look for the replacement parts or do service maintenance.

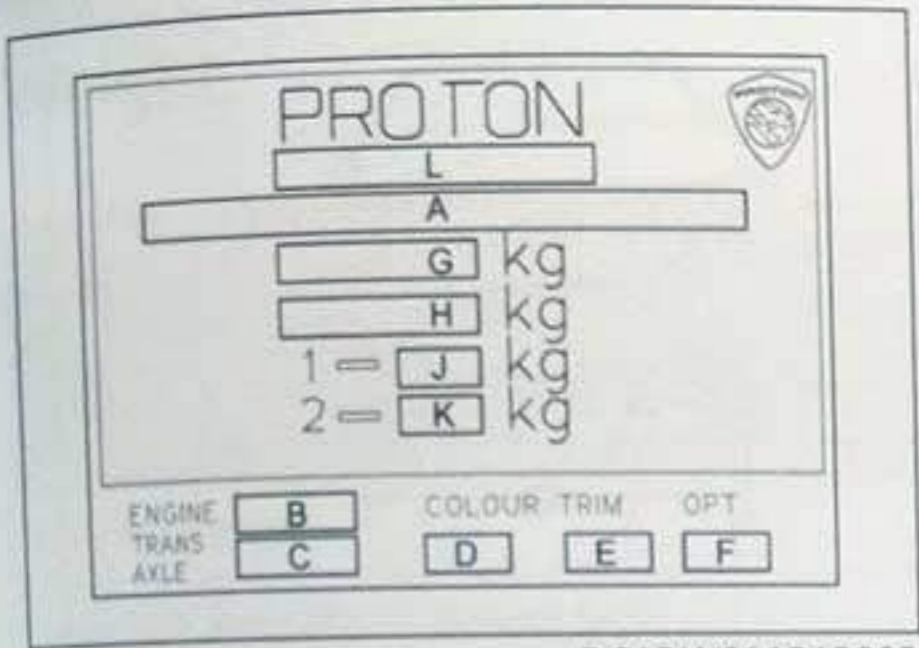

DOIQW011R13003

A – VIN code

B – Engine-model code

C – Transmission-model code

D – Exterior code

E – Interior code

F – Option-code

G – Gross Vehicle Weight

H – Gross Vehicle Weight Combination

J – Front Axle weight

K – Rear Axle weight

L – Serial number of the Certificate of Vehicle Type Approval (VTA)

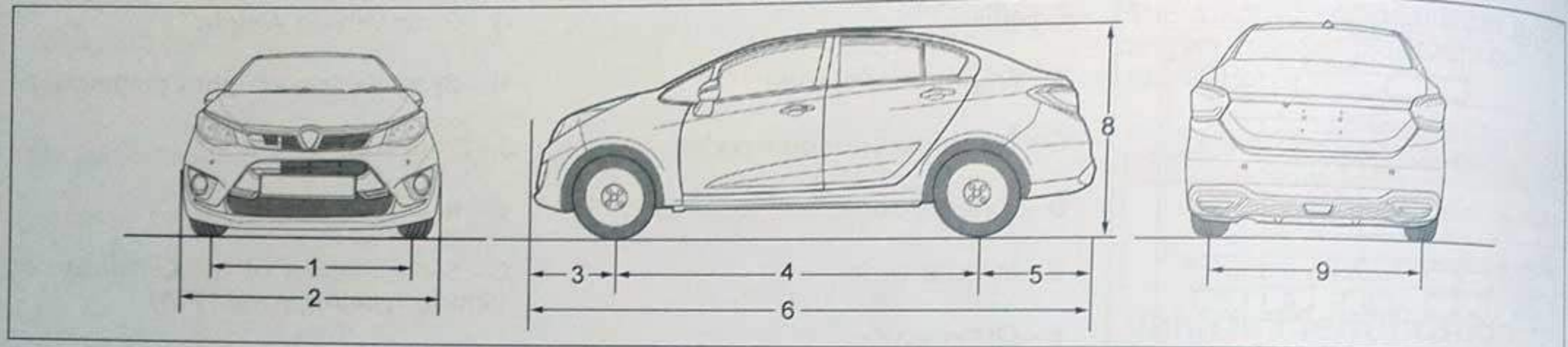

DOITW011R1600

OWN011SPEC515005

Dimensions

Items		Dimensions
1	Front track	1490 mm
2	Total width	1722 mm
3	Front overhang	823 mm
4	Wheel base	2555 mm
5	Rear overhang	1009 mm
6	Total length	4387 mm
7	Ground clearance (without a load)	155 mm
8	Total height	1554 mm
9	Rear track	1490 mm

Items		1.6L VVT			
		Standard		Executive	Premium
		SMT	CVT2+	CVT2+	CVT2+
Kerb weight (kg)		1155	1175	1195	1210
Maximum gross vehicle weight (kg)		1565	1585	1605	1620
Maximum axle load (kg)	Front	860			
	Rear	790			
Payload (kg)		410			
Seat capacity		5 persons (includes driver)			

Performance

OWN0115PECS15011

176

Items	1.6L VVT			
	Standard		Executive	Premium
	SMT	CVT2+	CVT2+	CVT2+
Maximum speed (km/h)	175	170	170	170
Minimum turn radius (Wheel) (m)	< 5.0			

NOTE

The above results are only guides. You will possibly get different result when you operate this vehicle.

The driving pattern, road traffic conditions, level of the vehicle maintenance and any adjustment possibly can cause the different results. There is no warranty from PROTON that you will get the same result.

Fuel information

OWN0115PECS15012

Items	Descriptions
Recommended fuel	Unleaded petrol octane rating (DIN-51607) RON 95 or other higher RON
Fuel tank capacity	Approximately 40 litres

Items	1.6L VVT	
	M/T	CVT2+
Engine type	Four cylinder in line, water cooled, four-cycle, Double Overhead Camshaft	
Engine model	S4PH-5-NHM	S4PH-5-NHC
Total Displacement	1597	
Bore (mm)	76.0	
Stroke (mm)	88.0	
Compression ratio	10:1	
Firing order	1-3-4-2	
Maximum output (DIN) kW/rpm	80/5750	
Maximum torque (DIN) Nm/rpm	150/4000	
Fuel System	Multi Port Injection	
Fuel Type	Petrol	

Transmission

OWN011SPECS15014

178

Specifications

MODEL		1.6L			
		Standard		Executive	Premium
		5M/T	CVT2+	CVT2+	CVT2+
GEAR RATIO	Minimum	-	0.43	0.43	0.43
	Maximum	-	2.44	2.44	2.44
	1st	3.636	-	-	-
	2nd	2.045	-	-	-
	3rd	1.414	-	-	-
	4th	1.051	-	-	-
	5th	0.756	-	-	-
	6th	-	-	-	-
	7th	-	-	-	-
	Reverse-gear	3.615	2.680	2.680	2.680
	Final-gear	4.250	5.760	6.65	6.65

Electrical system

OWN011SPECS15015

179

Items		Descriptions
Battery	Type	46B24RS Maintenance Free
	Capacity	12 V – 45Ah
Alternator output		12 V – 110 A
Spark plug type		NGK LKAR7C-9
Starter motor output		12 V – 1.2kW

Tyres and wheels

OWN011SPECS15016

Items		1.6L		
		Standard	Executive	Premium
Tyre	Tyre size	185/55 R15		
Wheel	Type, Size	14" x 5.5 JJ Alloy Rim	15" x 6.0 J Alloy Rim	
	Offset	46 mm		
Spare tyre	Size	T115-70-D14		
Spare-wheel	Type, Size	4T x 14 Steel Rim		

Other specifications

180

Specifications

Items			Descriptions
Fuel System	Fuel control		Electric controlled injection
	Fuel pump		Electric motor type
Clutch			Dry single-disc clutch with diaphragm spring, hydraulic action
Steering system			Electric powered-steering
Steering adjust			Tilt-steering
Suspension	Type	Front	Macpherson strut with coil spring and stabilizer bar
		Rear	Torsion beam with damper and coil spring
Service brake	Type		Hydraulic, dual-diagonal circuit
	Front		14" ventilated-disc
	Rear		8" drum brake
Parking brake			Mechanical parking brake on rear wheels

No	Items	Quantity	Recommended lubricants	
1	Brake Fluid	Follow the requirement	Brake fluid DOT3 or DOT4	
2	Clutch fluid	Follow the requirement	Brake fluid DOT3 or DOT4	
3	Engine coolant	5.0 litres	WESTON-936-LLC or HAVOLINE XLC includes 0.65 litres in the reservoir tank	
4	CVT transmission fluid	4.1 – 4.3 liters	ESSO EZL-799 (A) or PETRONAS TUTELA CVT - PPT	
5	Manual transmission fluid	5MTT200A	1.8 liters	CASTROL-BOT-130M
		6MTT250	1.675 liter	CASTROL-BOT-350M3
6	Engine oil	Oil pan	Approximately 3.75 litres	SAE 10W-30 or equivalent "SERVICE SL" or high grade
		Oil filter	Approximately 0.3 litres	
7	Refrigerant (air conditioning)	450g	HFC-134a	

Index



PROTON

- | | | | | | |
|---------------------------------------|-----|--|----------|--|-----|
| Accessibility | 5 | Cleaning the inside of your vehicle | 162 | Front parking sensors | 121 |
| Accessory | 130 | - Plastic, Vinyl leather, etc | 162 | Front seats - adjustment | 48 |
| Alarm indicator | 31 | Clutch, Pedal free play | 169 | Fuel, Capacity (Fuel usage) | 100 |
| Alternator specification | 179 | Continuous Variable Transmission (CVT) | 107, 110 | Fuel gauge | 75 |
| Anti-lock Braking System (ABS) | 114 | Crash unlock | 42 | Fuel information | 176 |
| Automatic fold/unfold | 120 | Curtain and side airbags | 63 | Fuse box | 143 |
| | | CVT gear lever operation | 107 | - Fuses at driver compartment | 143 |
| | | | | - Fuses at engine compartment | 145 |
| Battery check | 165 | Deployment of airbags | 60 | gear shift lock | 110 |
| Battery specification | 179 | Dimensions | 174 | Genuine leather | 162 |
| Brake and clutch fluid | 166 | Doors | 40 | Genuine parts | 20 |
| Brake assist (BA) | 114 | Driver's door key cylinder, Tailgate | 5 | Glove box | 131 |
| Brake pedal free play | 168 | Driver switch | | | |
| Brake system, Braking | 113 | - Anti-trap feature | 45 | Hazard warning flasher switch | 96 |
| Brake systems | 114 | - Auto-down system | 45 | Headlights and turn-signal lights control switches | 91 |
| Brake warning lamp | 78 | - Auto-up system | 45 | head restraint | 49 |
| Break-in period | 100 | - Lock/unlock switch | 45 | head restraints - adjustment | 49 |
| Bulb capacity | 148 | Economical driving | 101 | Hill Hold Assist (HHA) | 116 |
| | | Electrical system specification | 179 | Hinges and latches lubrication | 169 |
| Catalytic converter | 118 | Electric fold/unfold | 120 | Hood | 42 |
| Central door lock | 96 | Electric power steering | 118 | How to change a tyre | 136 |
| - Central door lock switch | 41 | Electric Power Steering warning lamp | 80 | | |
| Centre floor console | 12 | Electronic Braking Distribution (EBD) | 114 | If the vehicle breaks down | 134 |
| Changing a fuse | 146 | Electronic Stability Control (ESC), Suis mematikan ESC | 115 | Ignition switch | 102 |
| Chassis number | 172 | Emergency starting, Weak battery | 141 | Immobiliser | 24 |
| Child lock | 39 | Emergency trunk lid release | 158 | Important Safety Precautions | 20 |
| - Operation | 39 | Engine compartment | 17 | Indicator and warning lamps | 76 |
| Child restraint seat | | Engine coolant check | 165 | Information display | 81 |
| - Selection | 53 | Engine number | 172 | Instrument (driver) | 10 |
| - SRS warning label | 54 | Engine oil check | 164 | Instruments | 74 |
| Child restraint system | 56 | Engine specification | 177 | Intrusion history | 24 |
| Child seat in the front | 54 | Engine start stop button | 103 | Intrusion warning display | 24 |
| Cleaning the exterior of your vehicle | 160 | ESC active warning display, ESC fail warning display | 79 | | |
| - Alloy wheels | 161 | Exterior | 2, 3 | Jacking up the vehicle | 134 |
| - Chassis and underbody protection | 162 | Exterior and interior lamp operation | 168 | - How to change a tyre | 135 |
| - Chrome parts | 161 | | | | |
| - Damaged paint | 161 | Follow home light | 91 | Keyless Entry system | 36 |
| - Engine compartment | 162 | Front airbags | 60 | - Locking, unlocking and alarm features | 38 |
| - Polishing | 161 | Front fog Lamps, Rear fog lamps | 93 | - Operating range for starting the engine | 37 |
| - Servicing of plastic parts | 161 | | | - Operating range of the keyless entry system | 36 |
| - Washing | 160 | | | | |
| - Waxing | 161 | | | | |
| - Window glass | 162 | | | | |
| - Wiper blades | 162 | | | | |

Keys, Remote keys	4	Replacement of lamp bulbs	147	Wiper control switch, Washer control switch	94
Keys and remote transmitter	28	- Bulb capacities	148		
- Key blade release button	28	- Replace headlamp high-beam bulb	149		
- Keys	28	- Replace headlamp low-beam bulb	150		
- Remote transmitter	29	replace punctured tyre, tools and jack	16		
		Room lamp switch	97		
Lubrications	181				
		Seat belts	50		
Manual air conditioning, Automatic air conditioning	126	seats	8		
Manual transmission, Shifting	110	Spark plug type	179		
Meter, Gauges	13	Speedometer	74		
Meter and Gauges	13	Starter motor specification	179		
Mirrors		Starting	106		
- Electric remote-controlled outside rear-view mirrors	119	Steering, Steering wheel height adjustment	117		
- Inside rear-view mirror	119	Supplementary restraint system (SRS)	22, 65		
- Vanity mirror	130	Tailgate release	33		
Multi information display before and during ignition ON	14	Tailgate release - using PKE	44		
Multi information display operation	15	Tailgate release - using remote transmitter	43		
Multimedia and Navigation	11	ticket holder	131		
		Tools	134		
Other features of lock and unlock		Tools and jack	134		
- Ignition OFF Unlock	42	Towing	140		
- Speed Auto Door Lock	42	Traction Control (TC)	114		
Other specifications	180	Transmission, Manual transmission	110		
		Transmission specification	178		
Parking aid system	121	Tyre rotation	170		
Parking brake	112	Tyres, Wheels	179		
- To apply the parking brake	112	upholstery	162		
- To park your vehicle	112	Ventilators	126		
- To release the parking brake	112	Washer fluid	168		
Parking brake lever stroke	168	Washing	160		
Performance	176	Water temperature gauge	75		
Pregnant women restraint	53	Weight	175		
		Wheel condition	169		
rear seats - adjustment	49	Windows glass control switches	44		
Rear view camera	123	- Driver switch	45		
Rear window demister switch	95	- Operation	44		
Remote keyless entry system		- Passenger switch	45		
- How to reset the alarm warning	25	Wiper blades	167		
- RKE	32				
remote key - replace battery	156				