



PURE DRIVING PASSION

Owner's Handbook

© 2012 Fisker Automotive, Inc.

All rights reserved. Information contained in this document is based on the latest information available at the time of printing and is subject to the copyright and other intellectual property rights of Fisker Automotive, Inc. (Fisker), its affiliated companies and its licensors. All rights are reserved to make changes at any time without notice. No part of this document may be reproduced, stored in a retrieval system, or transmitted in any form or by any means, electronic, mechanical, photocopying, recording, or otherwise, nor may these materials be modified or reposted to other sites, without the prior expressed written permission of the publisher.



1 Introduction

- 1.2 Introduction
- 1.3 Information About Your Vehicle
- 1.6 Consumer Information

2 Overview

- 2.2 Exterior
- 2.3 Interior
- 2.4 Instruments and Displays

3 Vehicle Security

- 3.2 Locking and Unlocking the Vehicle
- 3.7 Trunk
- 3.8 Glove Compartment and Valet Mode

4 Occupant Safety

- 4.2 Seats and Steering Column
- 4.5 Seat Belts
- 4.9 Child Restraints
- 4.13 Supplementary Restraint System (SRS)

5 Controls and Operation

- 5.2 Instruments
- 5.6 Wipers and Washers
- 5.7 Exterior Lighting
- 5.9 Power Windows
- 5.10 Mirrors
- 5.11 Touch-screen
- 5.14 Climate Control
- 5.20 Starting and Driving
- 5.25 Brakes
- 5.28 Electronic Stability Control
- 5.29 Cruise Control
- 5.31 Exterior Sound
- 5.32 Parking Aids
- 5.34 Voice Command System
- 5.36 Garage Door Opener
- 5.38 Accessory Sockets

6 Power

- 6.2 Charging the Vehicle
- 6.9 Solar Roof
- 6.10 Fuel Filling

7 Maintenance

- 7.2 Maintenance Requirements
- 7.4 Hood
- 7.5 Engine Compartment
- 7.12 Wipers and Washers
- 7.13 Cleaning and Vehicle Care
- 7.18 Fuses
- 7.21 Raising the Vehicle
- 7.22 Vehicle Recovery

8 Wheels and Tires

- 8.2 Tire Care
- 8.8 Tire Pressure Monitoring System (TPMS)
- 8.10 Tire Repair Kit
- 8.14 Tire Information
- 8.20 Glossary of Terms

9 Technical Specifications

- 9.2 Vehicle and Component Identification
- 9.3 Vehicle Dimensions and Weights
- 9.5 Wheels and Tires
- 9.6 Subsystem Specifications

Index



Introduction

- 1.2 WELCOME TO THE FISKER FAMILY
- 1.2 USING THIS MANUAL
- 1.2 SYMBOLS GLOSSARY
- 1.2 NOTES ABOUT THIS MANUAL

Information About Your Vehicle

- 1.3 ELECTRIC VEHICLE PRECAUTIONS
- 1.3 MAINTENANCE AND REPAIRS TO YOUR VEHICLE
- 1.3 BODY REPAIRS
- 1.4 VEHICLE MODIFICATIONS
- 1.4 QUALITY CONTROL
- 1.4 CALIFORNIA PROPOSITION 65
- 1.4 CALIFORNIA PERCHLORATE ADVISORY
- 1.5 DATA RECORDING

Consumer Information

- 1.6 IF YOU NEED ASSISTANCE
- 1.6 REPORTING SAFETY DEFECTS



WELCOME TO THE FISKER FAMILY

From everyone at Fisker, thank you for purchasing one of our vehicles.

Your Karma is designed to deliver uncompromised responsible luxury and performance - Pure Driving Passion.

We are committed to providing you with an ownership experience that is second to none, and we look forward to serving you in the years ahead.

USING THIS MANUAL

For your own safety, follow the instructions and warnings contained in this manual. Ignoring them could result in damage to the vehicle or personal injury to you or others. Vehicle damage caused by failing to follow instructions is not covered by the New Vehicle Limited Warranty.

Keep this manual in your vehicle as a reference for the safe and enjoyable use of your vehicle. Should you resell your car, leave this manual with it for the next owner.

If you are unable to find the information you need, it may be contained within one of the additional documents included in your Owner's literature pack:

- *Quick Reference Guide* - a summarized version of this document allowing you to quickly familiarize yourself with the vehicle.
- *Touch-screen User's Manual* - describes how to use the features of the touch-screen.
- *New Vehicle Limited Warranty and Servicing* - details of the vehicle warranty and servicing requirements for your vehicle.
- *Tire Warranty* - details the warranty for the vehicle's tires.

SYMBOLS GLOSSARY

The following symbols used within this manual call your attention to specific types of information.

 **WARNING:** Indicates either an instruction which must be followed precisely, or information that should be considered with great care in order to avoid the possibility of personal injury or injury to others.

 **CAUTION:** Indicates either an instruction which must be followed precisely, or information that should be considered with great care in order to avoid the possibility of damage to your vehicle.

 This symbol identifies instructions that should be observed in order to prevent unnecessary damage to the environment.

NOTES ABOUT THIS MANUAL

All specifications and descriptions are accurate at the time of printing. Because improvement is a constant goal at Fisker Automotive, we reserve the right to make changes at any time, without notice and without obligation.

Note: This manual applies to all Fisker Karmas. As a result, you may find some explanations for equipment or options not installed on your vehicle

Copyright © 2011 Fisker Automotive, Inc. All rights reserved.



ELECTRIC VEHICLE PRECAUTIONS

IMPORTANT

Your Fisker Karma is an electric vehicle with a range-extending gasoline engine.

The Karma has both high-voltage DC and AC systems as well as a 12-volt system. Both the DC and AC high voltage systems are very dangerous and can cause personal injury, severe burns, electric shock and even fatal injury unless appropriate precautions are taken.

Always observe and obey the instructions on labels attached to components on the vehicle - they are there for your safety.

Do not touch, attempt to remove or replace any high voltage parts, wiring (identified by the orange outer sleeving) or connectors.

If the vehicle is involved in an accident, do not touch any high voltage wiring, connectors or the components connected to the wiring.

If a vehicle fire occurs, extinguish it with a Class D powder-type fire extinguisher.

MAINTENANCE AND REPAIRS TO YOUR VEHICLE

Fisker Automotive recommends having maintenance and repairs for your Karma performed by an authorized Fisker Retailer.

To locate your nearest authorized Fisker Retailer, go to www.fiskerautomotive.com or contact Fisker Consumer Affairs.

BODY REPAIRS

If you're involved in a collision, you want your vehicle to be returned to its pre-accident condition when repaired. That's why it is important to make sure your vehicle is repaired with only genuine Fisker Automotive parts.

Some repair shops and insurance companies may suggest using non original equipment or salvaged parts to save money. However, these parts do not meet Fisker's high standards for quality, fit and corrosion resistance. In addition, non original equipment and salvaged parts (and any damage or failures they may cause) are not covered by any Fisker warranty.

The best way to ensure that your vehicle is repaired with genuine Fisker Automotive parts is to take it to a Fisker Retailer. Each Retailer works with selected collision repair centers that meet Fisker's strict requirements for training, equipment, quality, and customer satisfaction. These repair centers use genuine Fisker Automotive parts exclusively in the repair of Fisker vehicles.



VEHICLE MODIFICATIONS

⚠ *WARNING: The installation of non-approved parts and accessories, or the carrying out of non-approved modifications, may be dangerous and could affect the safety of the vehicle and occupants and also invalidate the terms and conditions of the vehicle warranty.*

⚠ *WARNING: Fisker Automotive will not accept any liability for death, personal injury or damage to property which may occur as a direct result of non-approved modifications or the installation of non-approved accessories.*

If you have a disability which may require modification to the vehicle, please contact Fisker Automotive before any modifications are made.

QUALITY CONTROL

You may have noticed a few miles (kms) on the odometer when you took delivery of your Karma. This is a result of the comprehensive process used to ensure the quality of your vehicle.

This process includes extensive inspections during and after production. The final inspection takes place at the selling Retailer and includes a road test conducted by a trained Fisker Automotive Technician.

CALIFORNIA PROPOSITION 65

⚠ *WARNING: Certain vehicle components contain or emit chemicals known to the State of California to cause cancer and birth defects or other reproductive harm. In addition, certain fluids contained in vehicles and certain products of component wear contain or emit chemicals known to the State of California to cause cancer and birth defects or other reproductive harm.*

CALIFORNIA PERCHLORATE ADVISORY

⚠ *WARNING: Certain components of this vehicle such as air bag modules, seat belt pre-tensioners and Lithium batteries may contain Perchlorate Material - Special handling may apply for service or vehicle end of life disposal. See <http://www.dtsc.ca.gov/hazardouswaste/perchlorate>.*



DATA RECORDING

Service data recording

Service data recorders in your vehicle are capable of collecting and storing diagnostic information about your vehicle. This potentially includes information about the performance or status of various systems and modules in the vehicle such as engine, throttle, steering or brakes. In order to properly diagnose and service your vehicle, Fisker Automotive and service facilities may access vehicle diagnostic information through a direct connection to your vehicle.

Event data recording

This vehicle is equipped with an Event Data Recorder (EDR). The main purpose of an EDR is to record, in certain crash or near crash-like situations, such as an air bag deployment or hitting a road obstacle, data that will assist in understanding how a vehicle's systems performed. The EDR is designed to record data related to vehicle dynamics and safety systems for a short period of time, typically 30 seconds or less.

The EDR in this vehicle is designed to record such data as:

- How various systems in your vehicle were operating;
- Whether or not the driver and passenger safety belts were buckled/fastened;
- How far (if at all) the driver was depressing the accelerator and/or brake pedal; and,
- How fast the vehicle was traveling;
- Where the driver was positioning the steering wheel.

These data can help provide a better understanding of the circumstances in which crashes and injuries occur.

Note: EDR data are recorded by your vehicle only if a non-trivial crash situation occurs; no data are recorded by the EDR under normal driving conditions and no personal data (e.g., name, gender, age, and crash location) are recorded. However, other parties, such as law enforcement, could combine the EDR data with the type of personally identifying data routinely acquired during a crash investigation.

To read data recorded by an EDR, special equipment is required, and access to the vehicle or the EDR is needed. In addition to the vehicle manufacturer, other parties, such as law enforcement, that have the special equipment, can read the information if they have access to the vehicle or the EDR.



IF YOU NEED ASSISTANCE

Both Fisker Automotive and your Fisker Retailer are dedicated to serving your automotive needs. Your complete satisfaction is our first priority. Should you have a problem or concern, please take the following steps to ensure the quickest possible response:

Step 1 - Discuss the situation with a Retailer manager, such as the service manager or customer satisfaction manager. If necessary, ask the Retailer owner or general manager for assistance. In most cases, a satisfactory solution can be reached at this step.

Step 2 - If the Retailer does not address your concern to your satisfaction, call the Fisker Consumer Affairs at:

1 (855) 575 7577

You may also write to us at:

Fisker Consumer Affairs Department
5515 East La Palma
Anaheim, CA 92807.

Whether calling or writing, please provide the following information:

- 17-digit Vehicle Identification Number (VIN) found on the vehicle registration paperwork and on the certification label located on the driver's door pillar
- Current vehicle odometer reading
- Name of your selling and servicing Fisker Retailers
- Your day and evening contact telephone numbers
- Your email address

REPORTING SAFETY DEFECTS

United States

If you believe that your vehicle has a defect which could cause a crash or could cause injury or death, you should immediately inform the National Highway Traffic Safety Administration (NHTSA) in addition to notifying Fisker Automotive.

If NHTSA receives similar complaints, it may open an investigation, and if it finds that a safety defect exists in a group of vehicles, it may order a recall and remedy campaign. However, NHTSA cannot become involved in individual problems between you, your dealer, or Fisker Automotive.

To contact NHTSA, you may call the Vehicle Safety Hotline toll-free at 1-888-327-4236 (TTY: 1-800-424-9153); go to <http://www.safercar.gov>; or write to:

Administrator
National Highway Traffic Safety
1200 New Jersey Avenue SE.
Washington, DC 20590.

You can also obtain other information about motor vehicle safety from <http://www.safercar.gov>.

Canada

If you believe that your vehicle has a defect which could cause a crash or could cause injury or death, you should immediately inform Transport Canada, in addition to notifying Fisker Automotive.

To contact Transport Canada, call their toll-free number: 1-800-333-0510.



Exterior

2.2 EXTERIOR OVERVIEW

Interior

2.3 INTERIOR OVERVIEW

Instruments and Displays

2.4 INSTRUMENT CLUSTER

2.5 TOUCH-SCREEN



EXTERIOR OVERVIEW



FCM0075

1. Hood. See [Hood, page 7.4.](#)
2. Solar roof. See [Solar Roof, page 6.9.](#)
3. Charging port cover. See [Charging the Vehicle, page 6.2.](#)
4. Tire Pressure Monitoring System (TPMS). See [Tire Pressure Monitoring System \(TPMS\), page 8.8.](#)
5. Exterior door release. See [Locking and Unlocking the Vehicle, page 3.2.](#)
6. Wheels and tires. See [Tire Care, page 8.2.](#)
7. Fuel filler cover. See [Fuel Filling, page 6.10.](#)
8. Trunk. See [Trunk, page 3.7.](#)
9. Exterior sound. See [Exterior Sound, page 5.31.](#)
10. Vehicle recovery eye. See [Vehicle Recovery, page 7.22.](#)
11. Exterior lighting. See [Exterior Lighting, page 5.7.](#)
12. Exterior mirrors. See [Mirrors, page 5.10.](#)



INTERIOR OVERVIEW



FCM12008

- | | |
|-------------------------------------|--------------------------------|
| 1. Exterior mirror control | 12. Glove compartment open |
| 2. Exterior lights and turn signals | 13. Touch-screen interface |
| 3. STEALTH/SPORT mode selection | 14. Mode selector |
| 4. Audio and phone controls | 15. Power windows |
| 5. Instrument cluster | 16. Horn |
| 6. Cruise control | 17. Steering column adjustment |
| 7. HILL mode selection | 18. Hood release (recessed) |
| 8. Wipers and washers | 19. Fuel filler cover release. |
| 9. Start/Stop button | 20. Parking brake |
| 10. Master door locking | 21. Trunk release |
| 11. Hazard warning flashers | |



INSTRUMENT CLUSTER



FOM0010

1. Speedometer
2. Mode indicator
3. Odometer
4. Compass
5. Clock/Driver information display
6. Driving mode
7. External temperature
8. Trip display
9. Power meter
10. Battery charge level indicator
11. Fuel level indicator
12. Total range
13. Battery range
14. Indicator lights



TOUCH-SCREEN



- | | |
|---------------------------|--|
| 1. Compass | 10. Volume |
| 2. Current operating mode | 11. Driver's heated seat |
| 3. Secondary time zone | 12. Windshield defogger |
| 4. Primary time zone | 13. Rear window heater |
| 5. Climate | 14. Electronic Stability Control (ESC) |
| 6. Audio | 15. Park Distance Control (PDC) |
| 7. Phone | 16. Exterior mirror fold |
| 8. Navigation | 17. Front passenger's heated seat |
| 9. System | |

Note: For detailed instructions on how to use the many features of the touch-screen, please refer to the "Touch-screen User's Manual" provided in the Owner's Literature Pack.



Locking and Unlocking the Vehicle

- 3.2 ABOUT THE KEY FOB
- 3.2 USING THE KEY FOB
- 3.3 MEDICAL SAFETY
- 3.4 REPLACING THE KEY FOB BATTERY
- 3.4 CARING FOR THE KEY FOB
- 3.4 TYPE APPROVAL
- 3.5 OPENING THE DOORS
- 3.5 MASTER LOCK AND UNLOCK SWITCH
- 3.5 AUTOMATIC LOCKING
- 3.5 CHILD SAFETY LOCKS
- 3.6 EMERGENCY ACCESS

Trunk

- 3.7 OPENING THE TRUNK
- 3.7 TRUNK INTERIOR RELEASE HANDLE

Glove Compartment and Valet Mode

- 3.8 GLOVE COMPARTMENT
- 3.8 VALET MODE



ABOUT THE KEY FOB



The security system, entry to the vehicle and starting the vehicle are controlled by the key fob. The doors and the trunk can be locked and unlocked using the key fob buttons.

You have been supplied with two key fobs which also have an emergency key blade.

Obtaining replacement keys and key fobs

If you lose a key fob or an emergency key blade, contact your local Fisker Retailer to obtain a replacement.

When ordering a new key fob, bring all available key fobs for the vehicle to your Fisker Retailer to allow the system to be reprogrammed. If a key fob or the key number is not available, your Fisker Retailer can obtain the key code from a restricted access database.

USING THE KEY FOB

⚠ WARNING: Always remove the key fob from the vehicle if children or animals are to be left unsupervised in the vehicle. Accidental operation of the vehicle's systems may result in injury.

⚠ CAUTION: Remove all key fobs from the vehicle when it is left unattended. This will ensure the vehicle is left in a secure condition.



The buttons on the key fob operate as follows:

1. Lock
 - Press once to lock the vehicle and activate the vehicle's security system. The vehicle lights will briefly flash to confirm the alarm is active.
2. Unlock
 - Press once to unlock the driver's door.
 - Press twice to unlock all the doors.
 - Press and hold to activate the express window down function.



3. Trunk

- Press twice in quick succession to unlock the trunk.
- Press and hold to activate the Panic alarm. The headlights and sidelights will flash and the horn will sound. Press again to deactivate the alarm.

Note: The lock and unlock settings for your vehicle can be configured to your personal preferences via the touch-screen.

The buttons on the key fob transmit a coded radio signal to a receiver in your vehicle. It is not necessary to point the key fob at your vehicle, but you must be within operating range. The operating range will vary according to the condition of the key fob battery and other physical factors.

If the vehicle cannot be locked or unlocked using the buttons on the key fob, you may need to change the key fob battery.

Note: Interference from other radio equipment operating on a similar frequency may also affect the operation of the key fob. If this happens, operate the key fob as close to your vehicle as possible. If you are still unable to unlock your vehicle with the key fob, use the manual door lock.

MEDICAL SAFETY

⚠ WARNING: Any person fitted with an implanted medical device should ensure that the device is kept at a distance of at least 8.7 inches (22 cm) away from any transmitter mounted in the vehicle. This is to avoid any possibility of interference between the system and the device. Interference may cause the implanted medical device to malfunction, causing serious injury or death.



Transmitters which detect the presence of the key fob are located in the following locations on your vehicle:

1. Behind the touch-screen
2. Beneath the center console
3. Trunk - underside of the rear parcel shelf



REPLACING THE KEY FOB BATTERY

 If the vehicle detects that the key fob battery is low an indicator light will illuminate on the instrument cluster. Please change the key fob battery as soon as possible.

To change the key fob battery:

1. Place the key fob button side down on a soft surface.



2. Using a small flat bladed tool, carefully release the rear cover from the key fob.
3. Remove the rear cover.



4. Remove the battery.
5. Fit the new battery (type CR2032) with the '+' side facing upwards. If possible, avoid touching the flat surfaces of the battery because finger marks will reduce

battery life. Wipe the battery clean before fitting.

6. Re-assemble the two halves of the key fob by aligning them and pressing them together until they snap into place.



Used batteries must be disposed of correctly, as they contain harmful substances. Seek advice on disposal from your local Fisker Retailer and/or your local authority.

CARING FOR THE KEY FOB

 **CAUTION:** *The key fob contains delicate electronic circuits and must be protected from impact, water damage and high temperatures. Avoid contact with solvents, waxes and abrasive cleaners. Do not leave the key fob exposed to direct sunlight.*

TYPE APPROVAL

Hereby, Fisker Automotive, declares that this remote vehicle entry system is in compliance with the essential requirements and other relevant provisions of Directive 1999/5/EC.

The Declaration of Conformity can be obtained by writing to:

Lear Corporation Wireless Department,
21557 Telegraph Road,
Southfield,
Michigan, 48033
USA.



OPENING THE DOORS

Note: The exterior and interior door releases are disabled when the vehicle is locked.

From outside the vehicle



With the vehicle unlocked, lightly press the touch pad located behind the door handle to release the door.

From inside the vehicle

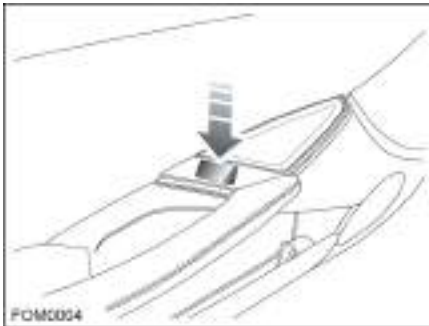

To open the door from the interior of the vehicle, press the switch marked **OPEN** on the interior door panel.

MASTER LOCK AND UNLOCK SWITCH



To lock or unlock all the doors while in the vehicle, press the master locking switch located above the touch-screen.

AUTOMATIC LOCKING

Dependent upon configuration, the vehicle's doors will either lock automatically when a speed of 5 mph (8 km/h) is reached or when **D** (Drive) or **R** (Reverse) is selected.

Note: This feature can be configured to your personal preference via the touch-screen.

CHILD SAFETY LOCKS

Child safety locks are fitted to both of the rear doors to prevent children from using the rear door switches and accidentally opening the doors when the vehicle is in motion or parked.

The child safety locks are automatically activated by inhibiting the operation of the rear windows, see [Rear window inhibit](#), page 5.9.

It is recommended that the child safety locks are activated whenever children are being carried in the rear seats.



EMERGENCY ACCESS

Emergency unlocking

If the key fob buttons fail to unlock, lock or open the trunk, replace the key fob battery. If the key fob still fails to unlock the vehicle, you can unlock the passenger's door using the key blade.

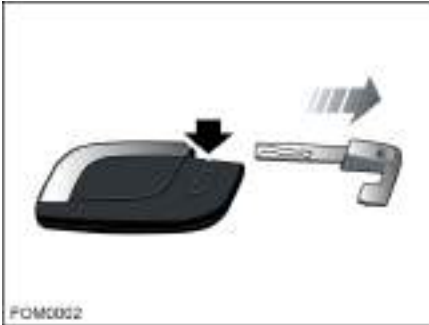

Press the button on the reverse of the key fob and slide the key blade free.



Insert the blade into the lock located on the passenger door handle. Turn the key counter clockwise to open the door.

The vehicle's alarm will sound when the door is opened. To switch off the alarm, press the brake pedal and press the Start/Stop button. If a recognised key fob is detected, the alarm will be deactivated and the vehicle will enter Drive mode.

Note: The alarm is also deactivated when the vehicle enters Accessory mode (as long as a valid key fob is recognised).

Note: If this fails to work, use the keyless start backup procedure. See [Keyless start backup procedure, page 5.21.](#)

Manual door opening



In the event of a power failure, each of the doors can be manually opened from inside the vehicle by pulling the release cable located below the door handle.

To access the release cable, press the lower edge of the cover below the door handle and remove the cover.



OPENING THE TRUNK



To open the trunk, either press the trunk release button on the key fob twice in quick succession or press the trunk release button on the left-hand dashboard closing panel.

To close, firmly apply downward pressure to the center of the trunk lid.

Note: The trunk release button is disabled if the vehicle is locked, Valet mode is enabled or when the vehicle's speed exceeds 5 mph (8 km/h).

TRUNK INTERIOR RELEASE HANDLE

Your vehicle is equipped with a mechanical trunk release handle that provides a means of escape in the event that a person becomes locked inside the trunk. Adults are advised to familiarize themselves with the operation and location of the release handle.

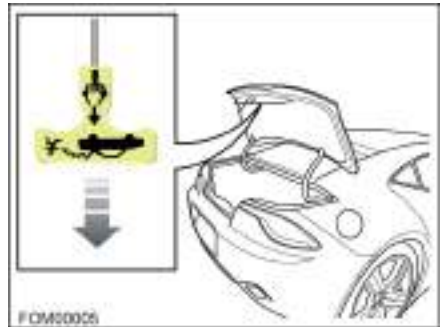

A T-shaped handle is located inside the trunk above the latch at the center of the trunk lid. This handle is made using a luminescent material that glows for hours after a brief exposure to ambient light.

To open the trunk from the inside, pull the T-shaped handle and push up on the trunk lid.



GLOVE COMPARTMENT



To open the glove compartment, press the switch located above the touch-screen.

Note: The glove compartment cannot be opened when the vehicle is locked or when Valet mode is enabled.

VALET MODE

For your peace of mind, your vehicle has a Valet mode for those times that your vehicle is parked by another person.

When Valet mode is active, access to the trunk and glove compartment is restricted, providing a secure location for storing personal items.

Valet mode can only be deactivated by entering a PIN (Personal Identification Number).

Activating Valet mode



 To activate Valet mode, touch the **SYSTEM** icon on the touch-screen.

 Touch the **SETTINGS** icon to access the vehicle settings area.



 Use the up arrows to change the currently displayed settings to **EXTERIOR | VALET MODE**.



The current status for the Valet mode is displayed in orange.

Enter a PIN using the on screen key pad and then touch **ENTER** to activate Valet mode. The status will change with **ON** being highlighted in orange.

Deactivating Valet mode

The process to deactivate Valet mode is the same as for activating it.

You will need to enter the same PIN to disable Valet mode as was entered to activate it.

Enter the PIN and then touch **ENTER**. If the correct PIN code was entered, the status will change with **OFF** being highlighted in orange.

If you enter an incorrect PIN, a message is displayed telling you that you've made an invalid entry.

Note: If Valet mode is active, and you can't remember or don't know what the PIN is to deactivate it, you will need to take the vehicle to a Fisker Retailer who will be able to reset the system.



Seats and Steering Column

- 4.2 CORRECT SEATING POSITION
- 4.2 STEERING COLUMN POSITION
- 4.2 INTEGRATED HEADRESTS
- 4.3 ELECTRIC SEATS
- 4.3 SEAT HEATERS
- 4.4 DRIVER'S SEAT MEMORY
- 4.4 EASY ENTRY AND EXIT

Seat Belts

- 4.5 ABOUT SEAT BELTS
- 4.5 SEAT BELT SAFETY
- 4.6 WEARING THE SEAT BELT
- 4.7 WEARING SEAT BELTS WHEN PREGNANT
- 4.7 SEAT BELT REMINDER
- 4.8 SEAT BELT TENSIONERS
- 4.8 CARING FOR SEAT BELTS

Child Restraints

- 4.9 CHILD RESTRAINTS
- 4.10 USING A NON LATCH CHILD RESTRAINT
- 4.10 USING A LATCH CHILD RESTRAINT
- 4.11 UPPER TETHER STRAP ANCHORAGES

Supplementary Restraint System (SRS)

- 4.13 LOCATION OF AIR BAGS
- 4.13 IMPORTANT INFORMATION
- 4.14 HOW THE SYSTEM WORKS
- 4.15 DEPLOYMENT EFFECTS
- 4.15 OBSTRUCTION OF AIR BAGS
- 4.15 PASSENGER AIR BAG DEACTIVATION
- 4.16 AIR BAG WARNING LABELS
- 4.16 SRS WARNING INDICATOR
- 4.17 AIR BAG SERVICE INFORMATION
- 4.17 VEHICLE MODIFICATIONS



CORRECT SEATING POSITION

⚠ WARNING: Children under 4ft 5in (1.35 m) tall or younger than 12 years of age must be secured in a suitable child restraint. See [Child Restraints, page 4.9](#).



To reduce the risk of injuries in the event of an accident, observe the following:

- The driver and front passenger should select a seat position that allows the seat belt to be worn correctly, but is as far away from the front air bags as possible.
- Sit in an upright position with the base of your spine as far back as possible and the seatback reclined no more than 30 degrees.
- The position of the driver's seat must allow the driver to drive the vehicle safely. The distance from the driver's seat to the pedals must be such that the driver can fully depress the pedals. The distance between the driver's chest and the center of the air bag cover should, ideally, be more than 10 inches (254 mm). The driver's arms should be slightly bent when holding the steering wheel.
- Position the seatbelt so that it is mid-way between your neck and your shoulder. Fit the strap tightly across your hips, not across your stomach.

STEERING COLUMN POSITION

⚠ WARNING: Never adjust the steering wheel position while the vehicle is in motion. Doing so will reduce control of the vehicle, and may cause unpredictable steering movements.

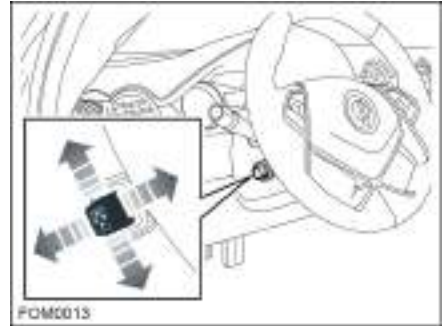

With the vehicle stationary adjust the steering column to the desired driving position.

INTEGRATED HEADRESTS

The front and rear seats provide integrated head restraints in the seatback. The head restraints are not adjustable.

⚠ WARNING: To minimize the risk of neck injuries in the event of a collision, the driver and front seat passenger should adjust the seatback inclination such that the headrest is in an upright position.



ELECTRIC SEATS

⚠ WARNING: Do not adjust any part of a seat while the vehicle is in motion. Vehicle movement may cause the seat to suddenly shift, potentially causing injury or loss of control.

⚠ WARNING: To prevent possible injury, ensure that rear passengers cannot become trapped as the seat moves.

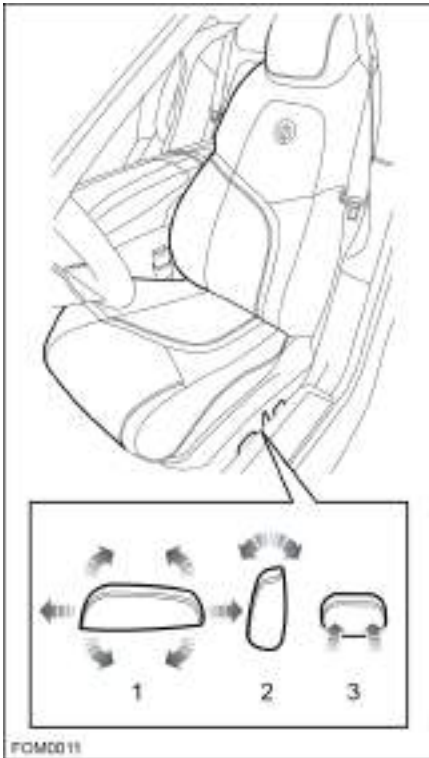

1. Cushion tilt adjustment and forward/backward adjustment
2. Backrest adjustment
3. Lumbar support

SEAT HEATERS

The seat heaters can be operated only when the vehicle is in Drive mode. The seat heaters will maintain a pre-determined temperature according to the level selected.

The seats can be heated at three different heat levels.

- Press once to operate at the highest heat level. Three indicators will illuminate.
- Press twice to operate at the medium heat level. Two indicators will illuminate.
- Press a third time to operate at the lowest heat level. A single indicator will illuminate.
- Press a fourth time to turn off the heaters.

Switching off the vehicle will automatically turn off the seat heaters.

Front seat heaters

 To turn on a front heated seat, touch the appropriate heated seat icon on the touch-screen.

Rear seat heaters

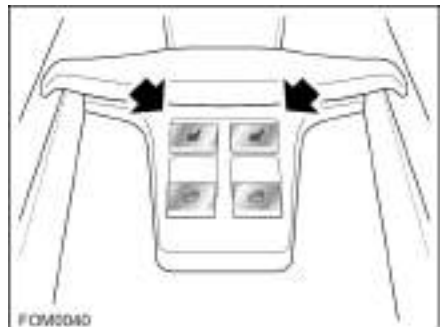

To turn on a rear heated seat press the appropriate switch on the rear center console switch pack.



DRIVER'S SEAT MEMORY

 **WARNING:** Before activating the seat memory, ensure that the area immediately surrounding the seat is clear of obstructions and that all occupants are clear of moving parts.

The vehicle can memorize two different driver seat and steering column positions.

The seat and steering column position are stored against the key fob currently used to unlock the vehicle. When you unlock the vehicle, the seat and steering column will automatically adjust to the stored memory position for that key fob.

Adjust the seat and steering column to the desired position, and then store the program in the seat memory via the touch-screen. See the procedure below.



Touch the **SYSTEM** icon



Touch the **SETTINGS** icon



Touch the up arrow to access the **Interior & Easy Entry/Exit** selection.

Touch the Enable setting.

Touch the up arrows to access the **Memory/Seat Position** selection.

Adjust the driver seat and steering wheel for Driver #1.

Touch the lock/unlock buttons on Driver #1's key fob. This stores the memory position for Driver #1.

Touch the **Set** selection (under the **Primary Seat Memory** selection).

Repeat the above steps for the Secondary Seat Memory.

EASY ENTRY AND EXIT

Entry and exit mode provides automatic movement of the steering column and driver's seat making it easier to enter or exit the vehicle.

Note: This feature can be enabled or disabled via the vehicle's touch-screen, see [Vehicle settings, page 5.13](#).

Exit

When the Start/Stop button is pressed, the steering column will move to the uppermost tilt position and the driver's seat will move to the exit position.

Entry

When the driver's door is closed and the Start/Stop button is pressed, the steering column and driver's seat will return to the previous position.

Note: If the steering column or driver's seat is adjusted during entry or exit operation, automatic movement will stop.



ABOUT SEAT BELTS

! *WARNING: Seat belts should be worn by all occupants, for every journey no matter how short. Failure to do so greatly increases the risk of death or serious injury in the event of an accident.*

Seat belts and child restraint systems are the most effective means of restraining vehicle occupants from impact forces, which, in turn, minimizes the danger of injury from interior impacts and the effects of whiplash. Therefore wearing a seat belt is required by law in most states.

Both the driver and passenger seating positions are equipped with three-point inertia reel seat belts. Inertia reel belts are tensioned automatically and allow freedom of movement during normal driving conditions.

The belt reel automatically locks, preventing movement of occupants, whenever your vehicle experiences the force associated with hard acceleration, braking, cornering or on impact in a collision. The reel may also lock when driving on steep hills or slopes.

SEAT BELT SAFETY

! *WARNING: Children under 4ft 5in (1.35 m) tall or younger than 12 years of age must be secured in a suitable child restraint. Follow the manufacturer's instructions when installing child restraint systems.*

! *WARNING: A seat belt which is not worn, is worn incorrectly, or has not been engaged fully in the seat belt buckle, cannot perform its intended function. To avoid injuries, ensure that all vehicle occupants wear their seat belt correctly at all times.*

! *WARNING: Seat belts are designed to bear upon the bony structure of the body, and should be worn low across the pelvis, over the shoulder and across the chest. Avoid wearing the lap section of the belt across the abdominal area.*

! *WARNING: Always adjust the belt to remove slack. Seat belts worn too loose can result in injuries because they allow excessive forward movement in an accident.*

! *WARNING: Do not route the belt across sharp edged or fragile objects especially if these are on or in your clothing. The seat belt could be damaged and you could be injured.*

! *WARNING: Seat belts should not be worn with any part of the strap twisted.*

! *WARNING: Each belt assembly must only be used by one occupant; it is dangerous to put a belt around a child being carried on the occupant's lap.*

! *WARNING: It is essential that seat belts that have been worn in an accident are replaced, even if damage to the assembly is not obvious. The belt anchors must also be checked.*

! *WARNING: No modifications or additions should be made that prevent the seat belt mechanism from taking up slack, or that prevent the seat belt being adjusted to remove slack. A slack belt greatly reduces the level of occupant protection.*

! *WARNING: If any damage, wear, cuts, defects, or impaired operation are noted with the seat belts, the vehicle should be taken to your Fisker Automotive Retailer for immediate attention. Do not use the vehicle if the seat belts cannot be operated correctly.*



WEARING THE SEAT BELT

Fastening the seat belt



1. Draw the belt out smoothly, ensuring that the belt height, the seat position and your position on the seat are correct. The belt should lay flat across the pelvis, chest and mid-point of the collar bone between the neck and shoulder.
2. With the belt correctly positioned, place the metal tongue into the buckle nearest to you. Press until a click is heard.

Releasing the belt

Note: When releasing the belt, it is advisable to hold it near the buckle before pressing the release button. This will prevent the belt from retracting too quickly.

To release the seat belt, press the red button.

Adjusting the height of the front shoulder belt

⚠ WARNING: After adjustment, release the adjustment button and then try to move the anchor point up or down to ensure it is locked into position.



The height of the shoulder belt should be adjusted so that the belt passes over the center of your shoulder. The belt should be away from your face and neck, but not falling off your shoulder.

To adjust the height of the shoulder belt, press the adjustment button and move the shoulder belt anchor to the desired position. Release the button to lock the anchor in position.



WEARING SEAT BELTS WHEN PREGNANT

! *WARNING: Pregnant woman should always wear seat belts to protect themselves and their unborn child.*

! *WARNING: Never place anything between you and the seat belt to cushion the impact in the event of an accident.*



The lap portion of the belt should be worn as low as possible across the hips, not the waist. Position the diagonal part of the belt between the breasts and to the side of the abdomen. Ensure that the seat belt is not slack or twisted.

If you have any concerns about wearing seat belts, contact your doctor.

SEAT BELT REMINDER

The driver's seat belt includes a buckle sensor, to detect when the buckle is latched.

! If the driver's seat belt is not fastened, an indicator light on the instrument cluster will illuminate.

In addition, if the seat belt is unfastened when the vehicle is in Drive mode and the vehicle's is moving at a speed greater than 5mph (8 km/h), an audible chime will sound for 15 seconds as a belt reminder.



SEAT BELT TENSIONERS

⚠ WARNING: *Once the seat belt tensioners have been activated, they must be replaced. After any accident, always have the air bags, seat belt tensioners and any associated components checked and, if necessary, replaced by a Fisker Automotive Retailer.*

The seat belts are equipped with tensioners that activate in conjunction with the air bags and provide additional protection in the event of a severe frontal impact on your vehicle.

The tensioners automatically retract the seat belt buckle, reducing any slack in both the lap and diagonal portions of the belts, resulting in reduced forward movement of the occupant.

Following an accident in which the tensioners have been activated, the seat belts continue to function as restraints and must be worn if you drive your vehicle.

CARING FOR SEAT BELTS

⚠ WARNING: *Regularly check the condition of all belts. Replace seat belts if you notice any damage to the belt webbing, fittings, retractor mechanisms or buckles.*

Three tests for checking seat belts:

1. With the seat belt fastened, give the webbing nearest the buckle a quick pull. The buckle should remain securely locked.
2. With the belt unfastened, unreel the webbing to its limit. Check that unreeling is free from snags and visually check the webbing for wear. Allow the webbing to retract, checking that retraction is smooth and complete.
3. With the webbing half unreeled, hold the tongue plate and pull forward quickly. The mechanism must lock automatically and prevent further unreeling.

If a seat belt fails any of these tests, contact a Fisker Automotive Retailer immediately to have the seat belt inspected.

For seat belt cleaning information, see [Cleaning and Vehicle Care, page 7.13.](#)



CHILD RESTRAINTS

⚠ WARNING: *Your vehicle is fitted with an air bag system that has no provision for switching off or deactivating the front passenger air bag.*

⚠ WARNING: *Extreme hazard! Do not use a rearward facing child restraint on a seat protected by an air bag in front of it. Doing so increases the risk of death or serious injury when the air bag deploys. The best place for a child is properly restrained in the rear seats.*

⚠ WARNING: *Do not use a forward facing child seat, until a child is above the minimum weight of 20 lb. (9 kg) and able to sit up unaided. Up to the age of two, a child's spine and neck are not sufficiently developed to avoid injury in a frontal impact.*

⚠ WARNING: *Do not allow a baby or infant to be held or carried on the lap. The force of a crash can increase effective body weight by as much as thirty times, making it impossible to hold onto the child. At all times, children should be restrained in age and size appropriate child seats to reduce the risk of injury in a crash.*

The seat belts fitted to your vehicle are designed for adults and larger children. For their safety, it is very important that all infants and children under 12 are restrained in a suitable child safety seat appropriate to their age and size.

Only fit a child seat that has been approved for use in your vehicle, and ensure that the manufacturer's fitting instructions are followed exactly. Consult a Fisker Automotive Retailer for a list of approved child seats.

Note: The legislation which governs how and where children should be carried when travelling in a vehicle, is subject to change. It is the responsibility of the driver to comply with all regulations in force.

Child restraints for small children and babies

Child seats and restraint systems designed for your vehicle will be one of two types:

- Those secured in vehicle seats by the seat belts.
- LATCH (Lower Anchors and Tether for CHildren) type child restraints, employing anchor bars built into the rear seat frame.

All new and most older type child restraint systems incorporate an upper tether strap which can be attached to an anchorage point on the vehicle.

Child restraints for larger children

In a situation where a child is too large to fit into a child safety seat, but is still too small to safely fit the 3 point seat belt properly, a booster seat is recommended for maximum safety. Follow the manufacturer's fitting instructions exactly, then adjust the seat belt to suit.

Children typically require the use of a booster seat appropriate to their age and size, thereby enabling the seat belts to be properly fitted, reducing the risk of injury in a crash.



Choosing a child restraint

Secure any child under 4ft 5in (1.35 m) tall or younger than 12 years of age travelling in the vehicle in an appropriate category restraint according to their weight. Contact a Fisker Automotive Retailer for advice.

Category	Weight
Category 0	Up to 22 lbs (10 kg)
Category 0+s	Up to 29 lbs (13 kg)
Category I	20 to 40 lbs (9 to 18 kg)
Category II	33 to 55 lbs (15 to 25 kg)
Category III	48 to 80 lbs (22 to 36 kg)

USING A NON LATCH CHILD RESTRAINT

Carefully follow the instructions provided by the manufacturer of the restraint system.

Make sure that a child falls into the correct weight range for the seat. Avoid dressing a child in bulky clothing and do not place any objects between the child and the restraint system.

Always use the appropriate child restraints and adjust harnesses for every child, every trip.

Ensure that you have removed all slack from the vehicle's seat belt.

Regularly check the fit of a child seat and replace seats or harnesses that show signs of wear.

USING A LATCH CHILD RESTRAINT

⚠ WARNING: *If the restraint is not correctly anchored, there is a significant risk of injury to the child in the event of a collision or emergency braking.*

⚠ WARNING: *Child restraint anchorages are designed to withstand only loads imposed by correctly fitted child restraints. Under no circumstances are they to be used for adult seat belts, harnesses or for attaching other items to the vehicle. Doing so will greatly increase the risk of serious injury or death in the event of an accident.*

Your vehicle's rear passenger seats are equipped with the LATCH child restraint anchorage system.

We recommend that you carefully follow the instructions supplied by the manufacturer when installing your LATCH compatible child seats.



Lower LATCH anchorage points are located between the seat back rest and rear cushion as indicated by the child seat identification tab on the seat.

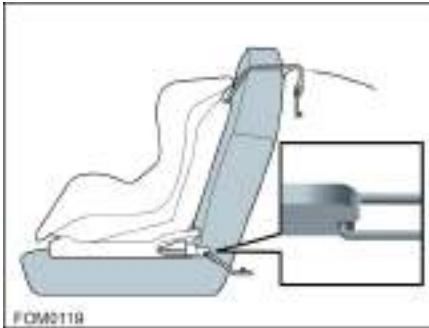

To install your child seat with a LATCH restraint system, slide the child seat until it engages onto the anchor bars.

Once the LATCH child seat is installed, test the security of the installation, before seating a child. Attempt to twist the child seat from side to side and to pull it away from the vehicle seat, then check that the anchors are still securely in place.

UPPER TETHER STRAP ANCHORAGES

⚠ WARNING: Always check the upper tether strap for damage or wear and tear. A child could be seriously injured or killed in a sudden stop or collision if the child restraint upper tether strap is damaged or not functioning properly.

Upper tether anchorages are provided at each seating position equipped to accept LATCH child restraints.

Note: Always ensure that if an upper tether is provided, it is secured and tightened properly, as this provides maximum protection for a child.

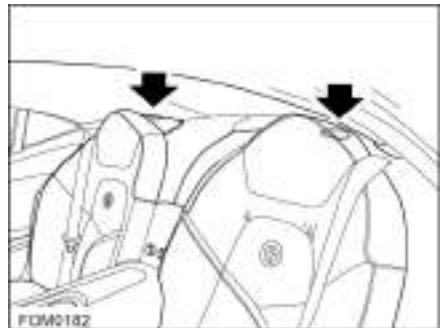

Anchor points for the upper LATCH child restraints are located behind the rear seat headrests.

Note: Due to the restricted access in the rear of your vehicle, the easiest way to actually view the upper anchorage point is by standing outside the vehicle and looking through the rear window.



With the rear door open, reach through the door and remove the protective cover located behind the headrest.



Attach the tether strap hook to the tether anchor point.

Tighten the tether strap according to the child restraint manufacturer's instructions.



LOCATION OF AIR BAGS

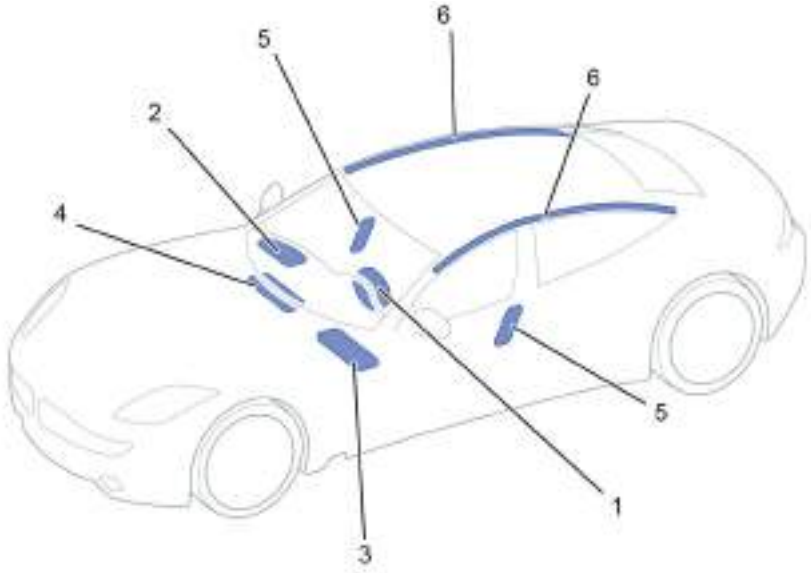

1. Driver's front air bag
2. Passenger front air bag
3. Driver's knee air bag
4. Passenger knee air bag
5. Side air bags
6. Curtain air bags

The exact location of the air bag modules are indicated by the word **AIR BAG** on the trim or a label sewn into the seat cover.

IMPORTANT INFORMATION

⚠ WARNING: Always remember; the air bags are a Supplementary Restraint System providing additional protection in certain types of collision only - they do not replace the need to wear a seat belt. To reduce the risk of severe injury or death in the event of a crash, all occupants in all seating positions, including the driver, should always wear their seat belt.

⚠ WARNING: Occupants not properly restrained in designated seating positions are at high risk of death or serious injury in the event of air bag deployment.

⚠ WARNING: Do not use a child restraint on a seat with an operational air bag in front of it. There is a risk of death or serious injury when the air bag deploys.



HOW THE SYSTEM WORKS

⚠ WARNING: *The air bags are a Supplemental Restraint System providing additional protection in certain types of collisions only - they do not replace the need to wear a seat belt.*

Operation of the air bag system depends on the rate at which your vehicle's passenger compartment changes speed as a result of a collision.

In the event of a collision, the air bag control unit monitors the rate of deceleration induced by the collision to determine whether the air bags should be deployed.

When deployed, air bags inflate instantly, with considerable force accompanied by a loud noise. The inflated bag, together with the seat belt restraint system, limits the movement of the occupants, thereby reducing the risk of injury to the head and upper torso.

The air bag system is not designed to operate as a result of:

- Rear collisions
- Minor front impacts
- Minor side impacts
- Heavy braking
- Driving over bumps or potholes

It follows, therefore, that significant superficial damage can occur without the air bags deploying or, conversely, that a relatively small amount of structural damage can cause the air bags to be deployed.

Knee air bags

The knee air bags are designed to work in conjunction with the deployment of the front air bags. When deployed, the knee air bags limit the forward motion of the driver or front passenger by restricting leg movement, thereby positioning the occupant so that the front air bags work more effectively.

Side air bags

⚠ WARNING: *Ensure that a gap is maintained between the side of the vehicle and the torso, to enable unobstructed inflation of the seat-mounted side air bags.*

⚠ WARNING: *Do not use non-approved seat covers or accessory seat covers on a front seat as these will prevent the side air bag from deploying correctly in an accident. If in doubt, consult a Fisker Automotive Retailer.*

Side air bags are designed to protect the thorax region of the torso and pelvis and will only deploy in the event of a severe side impact. They will not inflate as a result of frontal or rear impacts only. The air bags on the non-impacted side of the vehicle will not be deployed.

Curtain air bags

⚠ WARNING: *For the curtain air bags to deploy correctly, the roof lining and A post trim must be undamaged and fitted correctly. Any damage or suspect fitting should be referred to a Fisker Automotive Retailer for inspection.*

Curtain air bags are designed to protect the head in the event of a severe side impact or rollover event. They will not inflate as a result of frontal or rear impacts alone.



DEPLOYMENT EFFECTS

⚠ *WARNING: The powder release by air bag deployment could cause short-term breathing difficulties for persons suffering from asthma or other respiratory conditions. To prevent breathing difficulties, leave the vehicle as soon as possible or open a window.*

⚠ *WARNING: Inflation and deflation of the air bags take place instantaneously and will not provide protection against the effects of secondary impacts that can occur during multiple vehicle collisions.*

⚠ *WARNING: After an air bag has been triggered, air bag parts are hot, do not touch them. Have the air bags replaced at a Fisker Automotive Retailer.*

If the air bags are deployed, a bang will be heard and a small amount of fine powder may be released. The noise will not damage your hearing and the powder does not constitute a health hazard nor does it imply that a fire has broken out.

The SRS warning indicator will illuminate to indicate that the system has been deployed.

Air bag deployment slows down and restricts the movement of the vehicle occupant reducing the load on the body. The air bags are in a depressurized state following an accident.

Safety features

Along with the deployment of the air bags, the following events will also occur to assist you and any recovery personnel:

- the doors will unlock.
- the hazard warning lights will switch on.
- the interior lighting will switch on.
- the fuel supply to the engine will be switched off.
- the high voltage supply will be isolated.

The high voltage supply and the fuel supply to the engine can be restored by first turning the vehicle OFF and then putting the vehicle into Accessory mode.

OBSTRUCTION OF AIR BAGS

⚠ *WARNING: Do not allow passengers to obstruct the operation of the air bags by placing parts of their body, or any other objects in contact with, or in close proximity to, an air bag module.*

⚠ *WARNING: Do not attach or position items on an air bag cover which could interfere with the inflation of the air bag or be propelled inside the vehicle and injure occupants.*

PASSENGER AIR BAG DEACTIVATION

⚠ *WARNING: Your vehicle is fitted with an air bag system that has no provision for switching off or deactivating the front passenger air bag.*



AIR BAG WARNING LABELS

Air bag warning information is printed on the driver's and passenger's sun visor.



WARNING

DEATH or SERIOUS INJURY can occur:

- Children 12 and under can be killed by the air bag.
- The BACK SEAT is the SAFEST place for children.
- NEVER put a rear-facing child seat in the front.
- Sit as far back as possible from the air bag.
- ALWAYS use SEATBELTS and CHILD RESTRAINTS.

SRS WARNING INDICATOR

 A warning indicator in the instrument cluster alerts you of any malfunction of the air bag system.

The components of the system being monitored include:

- SRS warning indicator.
- Clock spring.
- Air bag modules.
- Seat belt tensioners (front seat belts).
- Air bag diagnostic control unit.
- Crash sensors.
- Air bag wiring harnesses.

When the key is turned to the ON position, the air bag control unit monitors the readiness of the system's electrical circuits.

Contact a Fisker Automotive Retailer if:

- The warning indicator fails to illuminate when the vehicle is first put into Accessory or Drive mode.
- The warning indicator fails to extinguish within approximately six seconds after the vehicle is put into Accessory or Drive mode.
- The warning indicator illuminates while your vehicle is being driven.



AIR BAG SERVICE INFORMATION

⚠ WARNING: *The disposal of used air bag units is subject to stringent regulations, and should only be handled by a Fisker Automotive Retailer.*

For your safety, a Fisker Automotive Retailer, who is familiar with your vehicle, must perform the following tasks:

- Removal, replacement, repair, or modification, of any wiring or component in the vicinity of air bag system components, including the steering wheel, steering column, dashboard, instrument cluster and roof lining.
- Modification to the front or side of your vehicle, including the bumper and chassis.

In addition, always seek the assistance of a Fisker Automotive Retailer if:

- An air bag inflates.
- A seat belt tensioner activates.
- The front or side of your vehicle is damaged, even if the air bag has not inflated.
- Any part of an air bag module cover shows signs of cracking or damage.

VEHICLE MODIFICATIONS

⚠ WARNING: *Occupants with disabilities which may require modification of the vehicle must contact a Fisker Automotive Retailer before any modifications are made.*



Instruments

- 5.2 INSTRUMENT CLUSTER
- 5.3 INDICATOR ICONS - UPPER PANEL
- 5.3 WARNING AND INFORMATION MESSAGES
- 5.4 INDICATOR LIGHTS - LOWER PANEL
- 5.5 TRIP COMPUTER

Wipers and Washers

- 5.6 WIPERS AND WASHERS

Exterior Lighting

- 5.7 EXTERIOR LIGHTING
- 5.8 TURN SIGNALS
- 5.8 HAZARD WARNING FLASHERS

Power Windows

- 5.9 POWER WINDOWS

Mirrors

- 5.10 EXTERIOR MIRRORS
- 5.10 INTERIOR REAR VIEW MIRROR

Touch-screen

- 5.11 OVERVIEW
- 5.12 USING THE TOUCH-SCREEN

Climate Control

- 5.14 CONTROLS OVERVIEW
- 5.15 USING THE SYSTEM
- 5.18 WINDSHIELD DEFOGGER
- 5.18 HEATED REAR WINDOW
- 5.18 VENTILATION
- 5.19 OPERATING NOTES

Starting and Driving

- 5.20 STARTING THE VEHICLE
- 5.23 SELECTING A PROPULSION MODE
- 5.24 DRIVING MODES

Brakes

- 5.25 GENERAL INFORMATION
- 5.25 ANTI-LOCK BRAKING SYSTEM (ABS)
- 5.26 REGENERATIVE BRAKING
- 5.27 PARKING BRAKE

Electronic Stability Control

- 5.28 ELECTRONIC STABILITY CONTROL (ESC)

Cruise Control

- 5.29 CRUISE CONTROL

Exterior Sound

- 5.31 EXTERIOR SOUND

Parking Aids

- 5.32 PARK DISTANCE CONTROL (PDC)
- 5.33 REAR VIEW CAMERA

Voice Command System

- 5.34 USING THE VOICE COMMAND SYSTEM
- 5.35 VOICE COMMANDS

Garage Door Opener

- 5.36 HOMELINK® TRANSMITTER
- 5.36 PROGRAMMING A DEVICE
- 5.37 ENTRY GATE/CANADIAN PROGRAMMING
- 5.37 INFORMATION AND ASSISTANCE

Accessory Sockets

- 5.38 ACCESSORY POWER OUTLETS
- 5.38 USB AND AUX CONNECTIONS



INSTRUMENT CLUSTER



FCM001D

- | | |
|-------------------------------|------------------------------------|
| 1. Speedometer | 8. Trip display |
| 2. Mode selection indicator | 9. Power meter |
| 3. Odometer | 10. Battery charge level indicator |
| 4. Compass | 11. Fuel level indicator |
| 5. Driver information display | 12. Total range |
| 6. Driving mode | 13. Battery range |
| 7. External temperature | 14. Indicator lights |



INDICATOR ICONS - UPPER PANEL

The following indicator icons may be displayed in the upper segment of the instrument cluster during normal driving conditions.

	Driver alert. Will be accompanied by a message on the instrument cluster.
	High voltage battery charge level low
	12V battery fault. Please refer problem to your Fisker Retailer.
	Exterior sound system fault. Please refer problem to your Fisker Retailer.
	Brake fluid level low
	Rear Fog Lamp
	Check engine (MIL). Please refer problem to your Fisker Retailer.
	Depress brake pedal
	Exterior light bulb failure
	Check fuel cap/door
	Door open
	Hood open
	Trunk open
	Hood and trunk open
	Key fob left in vehicle
	Key fob battery low
	Low fuel level

	Washer fluid low
	Steering system fault. Drive with care. Please refer problem to your Fisker Retailer.
	Low/Dipped Beam Headlight
	Parking lamps on
	Cruise control operating















WARNING AND INFORMATION MESSAGES

The middle segment of the instrument cluster displays warning and information messages. Typical information messages displayed include, vehicle servicing, charge level, stability control, and brake system.



INDICATOR LIGHTS - LOWER PANEL

The following indicator lights may illuminate in the lower segment of the instrument cluster during normal driving conditions.

	Fasten seat belt
	Air bag malfunction
	Parking brake applied
	Brake system fault
	High coolant temperature/Low oil pressure
	High voltage system fault. Please refer problem to your Fisker Retailer.
	Anti-lock Braking System (ABS)
	TPMS Malfunction
	ESC is On
	External cord connected
	ESC is Off
	Head lamp high beams on
	Left turn signal operating
	Right turn signal operating

TRIP COMPUTER



There are two trip range memories available, A and B. You can specify which trip memory is viewed on the instrument cluster via the touch-screen.

Selecting trip A or B



Touch the **SYSTEM** icon on the touch-screen.



Touch the **SETTINGS** icon to access the vehicle settings area.



Use the up (or down) arrows to change the currently displayed settings to **TRIP COMP | TRIP RANGE**.

The currently displayed trip computer range will be displayed in orange. Touch the icon for the trip computer you wish to display.

Resetting trip A or B

To reset a trip range memory, make sure the trip range you want to reset is highlighted and touch the **RESET** icon.

Note: Resetting trip A will not affect the information stored for trip B and vice versa.



WIPERS AND WASHERS

! *CAUTION: Do not operate the wipers on a dry windshield.*

! *CAUTION: In freezing or very hot temperatures, ensure that the wiper blades are not frozen or adhered to the windshield before operating.*

! *CAUTION: In winter, remove any snow or ice from the windshield, wiper arms and blades before operating.*

The wipers and washers are controlled by the right-hand steering column lever.

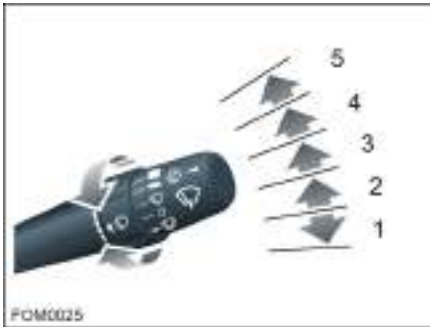

With the vehicle in Accessory or Drive mode, move the lever up or down to select the required wiper mode.

1. Single wipe
2. Off
3. Intermittent wipe mode
4. Normal speed operation
5. High speed operation

Intermittent wipe

With the wiper control in position **3**, rotate the collar clockwise to increase the interval between wipes. Rotate the collar counterclockwise to decrease the interval between wipes.

Windshield washer



Press and release the end of the lever to operate the windshield washer.

Head lamp washers

The head lamp washers operate in conjunction with every fifth operation of the windshield washers.

EXTERIOR LIGHTING

The exterior lights are controlled by the left-hand steering column lever.



Turn the rotary control on the end of the lever to select the required lighting mode.

- OFF
- AUTO: head lamps and side lamps will switch on automatically when the ambient light falls below a pre-defined level.
- Side lamps only
- Side lamps and head lamps

Head lamp low beam



An indicator light on the instrument cluster will illuminate when the head lamp low beams are operating.

Head lamp high beam



With the head lamps on, push the column lever away from the steering wheel to select high beam. An indicator light on the instrument cluster will illuminate when high beam is selected.

To switch back to low beam, pull the lever towards the steering wheel.

To flash the head lamps on high beam, pull the lever fully towards the steering wheel and release it.

Head lamp courtesy delay

The headlamp courtesy delay operates whenever the vehicle is turned off and the exterior lighting switch is in the AUTO position. The head lamps will remain illuminated for up to two minutes.

Note: The head lamp courtesy delay settings can be configured to your personal preference via the touch-screen.

The courtesy delay may be cancelled at any time by either selecting Accessory mode or turning the exterior lighting switch to the OFF position.

Approach lighting

If the exterior lighting switch is in the AUTO position, the head lamps will illuminate when the vehicle is unlocked using the key fob.

Note: The approach lighting setting can be configured to your personal preference via the touch-screen.

Daytime running lamps

In certain markets, the side lamps, license plate lamps and head lamp low beams will illuminate, with the vehicle in Drive mode and the exterior lights switch in the off position.

Note: The instrument cluster illumination remains off.

Rear fog lamps

With the headlights on, rotate and release the collar on the lever to turn the rear fog lamps on.



An indicator illuminates on the instrument cluster when the fog lights are operating.



TURN SIGNALS



With the vehicle in Accessory or Drive mode, move the lever up or down to operate the turn signals.

 A left or right indicator light on the instrument cluster will flash when the direction indicator lamps are operating.

When the lever is held momentarily up or down against spring pressure and then released, the turn signals will flash to indicate a lane change.

HAZARD WARNING FLASHERS



Press the switch to operate. The front and rear turn signals will flash along with the turn signal indicator lights on the instrument cluster. Use in an emergency to warn other road users that your vehicle is disabled.

Press the switch again to switch off the hazard flashers.



POWER WINDOWS

⚠ WARNING: Closing power windows on fingers, hands or other vulnerable parts of the body may result in serious injury. Ensure that your passengers are familiar with the window controls and aware of the potential dangers.

The power windows can be operated in Accessory or Drive modes.



1. Left-hand front window
2. Right-hand front window
3. Left-hand rear window
4. Right-hand rear window

Press and hold the front of the respective switch to lower the window. Pull and hold the front of the respective switch to raise the window. Release the switch at any point to stop window movement.

Express window operation

All of the windows can be fully opened or closed with a single press of the switch. Firmly press or lift (and then release) the front of the switch, to open or close the window. Window movement can be stopped by pressing the switch again.

Rear window operation

The rear windows can be operated from the switches on the rear center console if the rear window inhibit switch has not been activated.

Rear window inhibit

⚠ WARNING: If children are carried in the rear seats, the rear window inhibit switch should be used to prevent operation of the windows. If the windows are operated by young children there is a risk of death or serious injury.



To disable the rear window switches, press the rear window inhibit switch (arrowed). A light on the switch will illuminate when the rear windows switches are inhibited.

Note: Inhibiting the rear window switches also activates the child safety locks.

Press the switch again to cancel.

Note: The windows can still be operated using the switches located in the front of the vehicle.

Remote window opening

All the windows can be remotely opened from outside the vehicle by pressing and hold the unlock button on the key fob.



EXTERIOR MIRRORS

⚠ WARNING: *Dependant upon the type of mirror glass fitted to your vehicle, distances may be difficult to judge accurately. Objects viewed in the mirror may be closer than they appear.*



To adjust the exterior mirror position:

- Select the required mirror using the mirror selector switch.
- Use the mirror control to set the desired mirror position.

Folding the exterior mirrors

 To fold or unfold the exterior mirrors press the mirror fold icon on the touch-screen.

Note: Automatic folding and unfolding of the exterior mirrors, when the vehicle is locked or unlocked, can be configured to your personal preference via the touch-screen.

INTERIOR REAR VIEW MIRROR



The rear view mirror will automatically dim in proportion to the level of glare detected from a following vehicle's headlights.

If desired, this feature can be manually switched off. An indicator light (arrowed) will illuminate when the feature is active.

Note: If the rear window is obscured, or the light falling on the mirror is otherwise obstructed, the automatic dimming may not operate correctly.

OVERVIEW



FCM0015US

- | | |
|---------------------------|--|
| 1. Compass | 10. Volume |
| 2. Current operating mode | 11. Driver's heated seat |
| 3. Secondary time zone | 12. Windshield defogger |
| 4. Primary time zone | 13. Rear window heater |
| 5. Climate | 14. Electronic Stability Control (ESC) |
| 6. Audio | 15. Park Distance Control (PDC) |
| 7. Phone | 16. Exterior mirror fold |
| 8. Navigation | 17. Front passenger's heated seat |
| 9. System | |



USING THE TOUCH-SCREEN

! WARNING: *Only operate, adjust or view the touch-screen when it is safe to do so. If necessary, stop the vehicle to make changes, or safely operate features of the touch-screen system.*

The touch-screen can be operated whenever the vehicle recognizes a key fob within the vehicle.



Immediately after start-up, the touch-screen will display a message warning you off the dangers of operating the touch-screen while the vehicle is in motion.

You must touch **AGREE** to confirm you are aware of these dangers before you can operate any of the touch-screen features.

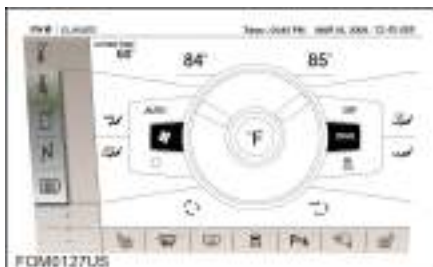

The touch-screen has two main areas of control. Icons down the left-hand side which control features of the touch-screen, and icons along the bottom which control features on the vehicle.

To activate a feature, touch its respective icon with your finger. Ensure that only one finger at a time is in contact with the screen, to prevent incorrect entries.

Note: A short, light press is sufficient to operate functions. Do not use excessive pressure.

Touch-screen features

Touching the icon for a feature will change the main display to the appropriate screen and give you access to additional options.

Below is a list of the top level features for the system:

	Climate
	Audio
	Radio
	Satellite Radio
	USB Audio
	Bluetooth Audio
	AUX (Auxiliary) Input
	Phone
	Navigation
	System
	Diagnostics
	Settings
	Energy flow

Note: For your convenience, you can change between the touch-screen features using the voice command system. See [Voice Command System, page 5.34](#).



Care points

To ensure that the touch-screen continues to operate correctly, some basic care points are listed below.

- Clean only with a lightly moistened soft cloth.
- Do not use chemical agents, or domestic cleaners, to clean any part of the touch-screen or its surround.
- Do not allow any sharp, hard or abrasive objects to come into contact with the touch-screen.
- Where possible, try to park the vehicle so as to avoid exposing the touch-screen to direct sunlight for long periods.

Audio system volume



To adjust the volume of the audio system, touch the + or - icons at the bottom left-hand corner of the touch-screen. Each touch will adjust the volume by one increment between **0** (mute) and **30** (MAX).

The current audio setting will be briefly shown overlaid in the center of the screen.

Vehicle settings

A number of the vehicle settings can be configured to you personal preferences. To access the vehicle settings:



Touch the **SYSTEM** icon on the touch-screen.



Touch the **SETTINGS** icon to access the vehicle settings area.



Use the up (or down) arrows to change the currently displayed settings to required setting.

Note: A full list of configurable vehicle settings, and descriptions, can be found in the *“Touch-screen User’s Manual”*.

Using the touch-screen in detail

The following pages explain how to use the Climate Control system in detail. For all the other touch-screen features, please refer to the *“Touch-screen User’s Manual”*.



CONTROLS OVERVIEW

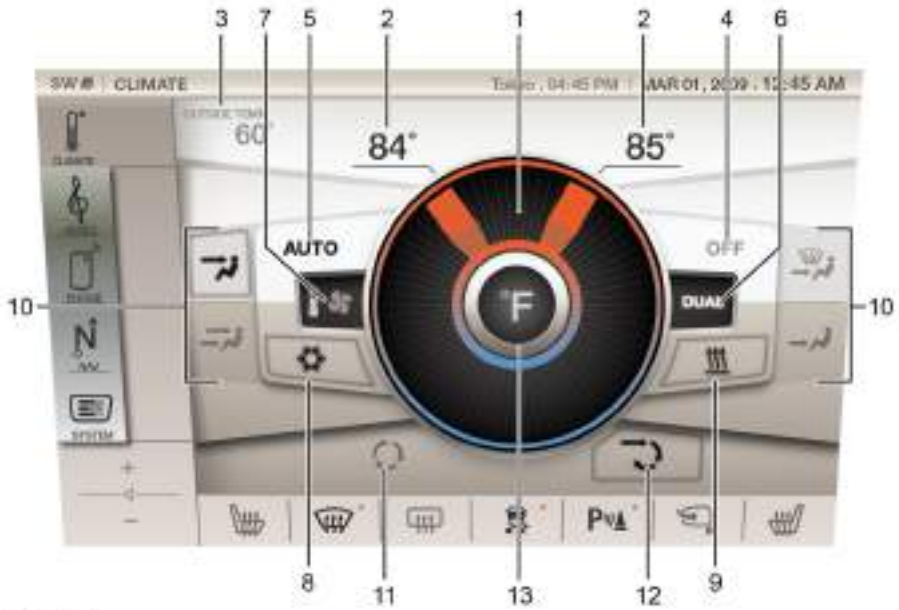

FCM0054US

1. Temperature/blower speed adjustment
2. Interior temperature zone settings
3. Outside air temperature
4. OFF
5. AUTO climate
6. Dual zone temperature
7. Display blower speed/temperature control
8. Air conditioning
9. Heating
10. Air distribution
11. Air recirculation
12. Fresh air
13. Temperature display option



USING THE SYSTEM

Note: The blower, heating and air conditioning systems are powered by the battery. Prolonged use will decrease the range of the vehicle in STEALTH.

AUTO climate control

The climate control system features automatic temperature and air distribution control and is programmed to maintain optimum levels of comfort within the vehicle in all but the most severe climatic conditions.

It is recommended that automatic climate control is selected as the normal operating mode.

AUTO Touch the icon to switch on automatic climate control and then adjust the temperature to the desired temperature.

The system will then automatically adjust the heating, air conditioning, air distribution, blower speeds and air recirculation to maintain the desired temperature.

The air distribution and blower controls can be operated independently to override AUTO mode. If AUTO mode is overridden, the icon will no longer be highlighted. Press AUTO again to return to automatic mode.

Note: If you use the air distribution and blower controls independently, the system may not be able to maintain the set temperature.

Blower speed/temperature control

 Touch the icon to alternate between controlling the blower speed and the interior temperature.



When the blower speed control is active, touch a point on the center dial to increase or decrease the desired blower speed between **0** and **10**.



When the temperature control is active, touch a point on the center dial to set the desired interior temperature.



Dual zone temperature

DUAL Touch the icon to switch between single zone and dual zone temperature control.



When dual mode is active, you can independently adjust the temperature for the driver and passenger sides of the interior.

Touch a point, up or down on the center dial, to set the desired interior temperatures.

Touch the icon again to switch back to single zone temperature control. The temperature setting will automatically adjust to the temperature set for the driver's side of the interior.

Air conditioning

Note: Air conditioning can be used on its own or in conjunction with the heating system.



Touch the icon for cool and dehumidified air.



Adjust the temperature control to control the amount of cooling.

It is recommended that air conditioning is used throughout a journey, to control window fogging and odors.

Switching off air conditioning will reduce cooling performance, the amount of cooling available will be determined by the outside air temperature. However, the reduced load on the high voltage battery may improve vehicle range.

Note: Using the system for prolonged periods with the air conditioning off may cause the windows to fog in certain climatic conditions.



Heating

Note: The heating system can be used on its own or in conjunction with the air conditioning system.

 Touch the icon to operate heating system and warm the air from the vents.







Adjust the temperature control to control the amount of heating.

Note: Although the seat heaters consume energy from the high-voltage battery, they require less energy than the heating system and are an alternative way of keeping warm in the vehicle.

Air distribution

Touch the respective air distribution icon to change the location in which air enters the interior of the vehicle.

-  Face level vents
-  Face and foot level vents
-  Windshield and foot level vents
-  Foot level vents

Note: Only one air distribution setting can be selected at a time.

Air recirculation

 Touch the icon to activate air recirculation.

Air recirculation prevents air entering from outside, and recirculates the air inside the vehicle.

This prevents the entry of traffic fumes. Air recirculation also significantly influences the dehumidifying and cooling performance of the air-conditioning system.

Fresh air

 Touch the icon to switch off air recirculation and allow fresh air to be drawn into the vehicle from the outside.

Temperature display option



With the touch-screen displaying the temperature adjustment control, touch and hold the center of the control to alternate between displaying the temperature in °F or °C.

OFF

Touch the icon to switch off the heating system, air conditioning and blower. Any air entering the vehicle through the vents will be dependent upon the vehicle speed.



WINDSHIELD DEFOGGER

 Touch the icon to operate the windshield defogger. An orange indicator will be displayed on the icon when the defogger is operating.

When activated, the windshield defogger automatically adjusts the climate control settings to provide maximum air flow to the windshield.

- Air distribution set to windshield vents.
- Air conditioning is switched on.
- Heating is switched on and set to maximum level.
- Blower fan is switched on.

Touch the icon again to switch off the windshield defogger and return the system to its previous settings.

HEATED REAR WINDOW

 **CAUTION:** To avoid damage to the heating elements, do not attach labels to the rear window. Also, do not scrape or use abrasive materials to clean the inside of the rear window.

 With the vehicle in Drive mode, touch the icon to operate the rear window heater. An orange indicator will be displayed on the icon when the heater is operating.

The rear window heater will operate for a timed period before automatically switching off.

VENTILATION

Air is drawn into the vehicle through the grille in front of the windshield. Keep the grille clear of obstructions (leaves, snow, etc).



Rotate the thumb wheel left or right to open and close the face level vents. Move the louvres up, down, or from side to side to direct the airflow.

The outer face level vents can be directed onto the side windows to aid in defogging in cold weather.

Note: When you open the face level vents, airflow to the foot and windshield vents is reduced.

Cabin air filter

Your vehicle has a cabin air filter installed that prevents pollen, industrial fall-out, road dust and other particles from entering the vehicle via the vents.

The cabin air filter must be replaced every 20,000 miles (32,000km). Failure to replace the air filter will result in reduced air flow into the vehicle.



OPERATING NOTES

- Heating is provided by a high voltage electric heater and cooling is provided by a high voltage all-electric air conditioning system. Both of these systems are located under the hood.
- In addition to cooling the passenger compartment, the air conditioning system also cools the high voltage battery coolant.
- In high ambient temperatures, the air conditioning system may be activated even if you have manually switched it off on the touch-screen. This is normal, with priority being given to cooling the high voltage battery to ensure that cell temperatures stay within a range that supports long life and efficient performance.
- For the climate control system to function efficiently, all windows should be closed, and the air intake vents free from ice, snow, leaves or other debris.
- To reduce the time for the vehicle to reach a comfortable temperature during hot weather, drive with the windows slightly open for two to three minutes after start-up.
- In very humid conditions, slight screen fogging may be experienced when the air conditioning system is turned on. This is a natural occurrence and will clear after a few seconds.
- Surplus water produced by the dehumidifying process is drained beneath the vehicle. This may result in a small pool of water forming when the vehicle is stationary and is not a cause for concern.



STARTING THE VEHICLE



The Start/Stop button is used to put the vehicle into Accessory and Drive modes.

Note: The Start/Stop button will only be operational if a valid key fob is detected within the vehicle.

Accessory mode

In Accessory mode, all the electrical features and controls, except the heating and air conditioning system, can be operated but the vehicle can not be driven.

To put the vehicle in Accessory mode:

1. Ensure the vehicle the key fob is inside the vehicle.
2. Make sure the brake pedal is NOT applied.
3. Press the Start/Stop button.

The vehicle enters Accessory mode and the indicator lights on the instrument cluster illuminate briefly.

4. The amber indicator light on the Start/Stop button will illuminate.

 The brake pedal indicator light will illuminate in the instrument cluster.

Note: If left in Accessory mode, the vehicle will automatically turn itself off after 10 minutes.

Drive mode

In Drive mode, the vehicle's high voltage electrical system is engaged allowing the vehicle to be driven.

To put the vehicle in Drive mode:

1. Ensure the key fob is inside the vehicle.
2. Depress the brake pedal.
3. Press the Start/Stop button.

 Once the vehicle enters Drive mode, a steady READY indicator message is displayed in the instrument cluster.

Note: If the READY indicator message flashes, a fault has been detected.

4. The green indicator light on the Start/Stop button will illuminate.
5. After a short interval the READY message will change to STEALTH.

Note: Drive mode can be selected from either OFF or Accessory mode.

Turning off the vehicle

To turn off the vehicle:

1. Ensure the **P** (Park) is selected.
2. From either the Accessory or Drive mode, press the Start/Stop button to turn the vehicle off.

Note: The vehicle cannot be put into Accessory mode if the vehicle is in motion.



Emergency shut down procedure

⚠️ WARNING: *The vehicle's electrical system powers the power steering pump, brake servo pump, anti-lock braking system and electronic stability control system. Shutting down the electrical system with the vehicle in motion will increase braking distances, as well as requiring greater effort to steer the vehicle, with a possibility of the wheels locking causing the vehicle to skid. Only enact this shutdown procedure in an emergency.*

In an emergency situation, if you need to be able to shut the vehicle down while it is still in motion, the vehicle electrical system can be turned off by pressing the Start/Stop button three times in quick succession or by pressing and holding until the vehicle powers off.

Key fob not detected

If the Start/Stop button is pressed and the key fob is not detected by the vehicle, a warning message will be displayed in the instrument cluster. If you have the key fob and it is still not detected, use the keyless start backup procedure.

🔑 If the vehicle is in Accessory or Drive modes and the vehicle can no longer detect the key fob, an indicator light will illuminate and the warning message "KEY FOB LEFT VEHICLE" will be displayed on the instrument cluster. This will be accompanied by a rapid chime.

Note: Always make sure you have the key fob with you before making a journey as you will be unable to restart the vehicle once it has been switched off.

Keyless start backup procedure

If the vehicle has been unlocked using the emergency key blade or the key fob is not detected by the vehicle, it will be necessary to use the keyless start backup to disarm the security system and start the vehicle.



Position the key fob against the A post trim panel located in the driver's side foot well with the buttons facing the pedals.

Note: There are markings on the trim panel to help locate the correct position.

When the key fob is positioned in this area it will be recognized by the vehicle and a message will be displayed in the instrument cluster.

Holding the key fob in position and the brake pedal depressed, press and release the Start/Stop button to put the vehicle in Drive mode.

Once the vehicle is in Drive mode you no longer need to hold the key fob against the trim panel.

Note: If the key fob is still not recognized, or the vehicle fails to enter Drive mode, contact Fisker Automotive or your local Fisker Retailer.



Type approval

The passive start system complies with part 15 of the FCC rules and IC-RSS-210 Industry Canada. Operation is subject to the following conditions:

1. This device may not cause harmful interference.
2. This device must accept interference received, including interference that may cause undesired operation.

USA FCC ID:	KOBKRC11A
Canada IC:	3521A-KRC11A



SELECTING A PROPULSION MODE



With the vehicle in Drive mode, press the required button to select a mode.

Note: If the READY indicator light flashes when selecting a mode, a fault has been detected. Try selecting the mode again, if the fault persists contact your Fisker Automotive Retailer.

- **P (Park)**

With Park engaged the propulsion unit is locked and the rear wheels cannot turn. To select another mode when the vehicle is in Park, the vehicle must be in Drive mode and the brake pedal depressed.

Note: **P (Park)** is automatically engaged whenever a charging cable is connected to the charging port to prevent the vehicle being accidentally driven while still connected.

- **R (Reverse)**

Selectable whenever the vehicle is stationary or its forward speed is less than 30 mph (48 km/h).

- **N (Neutral)**

Allows the vehicle to be stationary without the propulsion unit being locked.

To select another mode when the vehicle is in **N (Neutral)** and moving at a speed less than 5 mph (8 km/h), you must press the brake pedal. At speeds above 30 mph (48 km/h) you can only select the drive mode suitable for the current direction of travel.

- **D (Drive)**

Selectable whenever the vehicle is stationary or its speed is less than 30 mph (48 km/h) in reverse.

The instrument cluster will show the currently selected mode and the button associated with the mode will also illuminate.

Note: Similar to a conventional automatic transmission, when you select **D (Drive)** or **R (Reverse)**, the vehicle will move (creep) if you do not have the parking brake applied or the brake pedal depressed.



DRIVING MODES

Your vehicle has three selectable drive modes. The currently selected driving mode is displayed on the instrument cluster.

With the vehicle in Drive mode, the desired driving mode is selected using the selection paddles on the steering column.

Note: The vehicle will default to STEALTH each time the vehicle is powered off.

STEALTH and SPORT modes



In STEALTH mode, the vehicle is powered exclusively from the high voltage battery until the charge level of the battery falls to approximately 15% of its fully charged capacity. When the charge level reaches this threshold, the engine will automatically start to run the generator.

In SPORT mode, the vehicle is powered by both the generator and high voltage battery. This provides more power to the traction drive motors and improves vehicle performance.

To change between STEALTH and SPORT, briefly pull the left-hand paddle towards you and release. Pull and release the paddle again to select the alternative mode.

HILL mode

⚠ WARNING: It is recommended that you do not use HILL mode on surfaces covered in snow or ice as this could adversely affect vehicle handling.

HILL mode simulates the engine braking you would experience on a traditional vehicle when descending a hill and increases the amount of energy generated through regenerative braking.

HILL mode has two operating levels which simulate different levels of engine braking. With a little bit of practice, you will come to understand which operating mode is most suitable for the terrain you are driving.



To select HILL mode, briefly pull the right-hand paddle towards you and release. The instrument cluster will display the word **HILL** and the mode indicator in the center of the speedometer will display **1**.

To increase the level of engine braking, pull and release the paddle again. The mode indicator will display **2**.

To deselect HILL mode and return to the previously selected drive mode, pull and release the paddle again.

Note: If the vehicle is operating in HILL mode 1, either operate the paddle twice in quick succession or pull and hold the paddle to deselect HILL mode.



GENERAL INFORMATION

 **WARNING:** *Driving through heavy rain or water can have an adverse effect on braking efficiency. Under such circumstances, it is recommended that you lightly apply the brakes intermittently, to dry the brakes.*

 **WARNING:** *Do not rest your foot on the brake pedal while the vehicle is in motion unless you are applying the brake pedal.*

Your vehicle is fitted with an advanced electro-hydraulic brake control unit that combines the vehicle's conventional hydraulic brake system with its regenerative braking system to meet the requirements for slowing the vehicle.

The brake control module interprets the braking request and uses regenerative braking, conventional hydraulic braking or a combination of both as necessary.

Unlike conventional vehicles which have a vacuum operated brake servo to assist in the application of the brakes, a pump within the control unit pressurizes the brake fluid to apply the brakes. You may occasionally hear the pump when the system is operating. This is normal and not a cause for concern.

 If the brake warning light illuminates while driving, accompanied by the message "SERVICE BRAKES", stop the vehicle as soon as safety permits and have the cause investigated by your local Fisker Retailer.

In the event of a brake problem or a loss of vehicle power, the brake system can still be operated to bring the vehicle to a stop but the brake pedal may be harder to push and the stopping distance may be longer.

ANTI-LOCK BRAKING SYSTEM (ABS)

 **WARNING:** *Always maintain an appropriate stopping distance from the vehicle in front. ABS cannot overcome the physical limitations of trying to stop the vehicle in too short a distance, cornering at too high a speed, or the danger of hydroplaning, i.e. where a layer of water prevents adequate contact between the tires and the road surface.*

 **WARNING:** *Always drive with consideration for the current road, weather and traffic conditions.*

The ABS is designed to prevent the wheels from locking while braking, thereby enabling steering control to be retained.

Under normal braking ABS will not be activated. However, if the braking force exceeds the available adhesion between tires and road causing the wheels to lock, then ABS will automatically come into operation.

The ABS monitoring system checks that all electrical components are working correctly as soon as the vehicle is put into Accessory mode, and also at frequent intervals during a journey.

 The ABS warning light illuminates briefly as a bulb check when the vehicle is put into Accessory mode. If the light illuminates at any other time, the system has detected a fault and the ABS system has been shut down.

Note: The other functions of the braking system remain fully operational and are not affected by any loss of the ABS. However, braking distances may increase.



Emergency braking

⚠ WARNING: *Do not pump the brake pedal; this will interrupt operation of the ABS and may increase braking distance.*

In an emergency, apply full pedal effort even when the road surface is slippery. ABS will monitor the rotational speed of the wheels and vary braking pressure to each according to the amount of traction available, thereby ensuring that the wheels do not lock and that the vehicle is brought to a stop in the shortest possible distance. Steering control will be maintained no matter how hard you brake.

Note: On soft surfaces (powdery snow, sand or gravel), the braking distance required by the ABS may be greater than for non-ABS braking, even though improved steering would be experienced. This is because the action of locked wheels on soft surfaces is to build up a wedge of surface material in front which assists the vehicle to stop.

REGENERATIVE BRAKING

Whenever the vehicle is moving and your foot is off the accelerator, regenerative braking slows the vehicle and feeds energy back to the high voltage battery.

By anticipating your stops and simply removing your foot from the accelerator to slow down, you can take advantage of the energy gained from regenerative braking.



The power meter on the instrument cluster provides real-time feedback on the level of regenerative braking indicating the amount of energy being generated and fed back to the high voltage battery.

The amount of regenerative braking can vary depending on the current state of the battery. For example, you'll experience a reduction in regenerative braking if the battery is extremely hot or cold or if the battery is already charged to its maximum allowable level.

PARKING BRAKE



Applying the parking brake

With the vehicle stationary, pull the lever (arrowed) and release it to apply the parking brake.

 The indicator light on the instrument cluster will illuminate.

Note: If the lever is operated while the vehicle is travelling, the park brake will be fully applied. The stop lamps will not illuminate. This function works even when the vehicle is shut-off.

Releasing the parking brake

With your foot on the brake pedal, pull the lever to release the parking brake. The indicator light on the instrument cluster will turn off.

Error messages

 **WARNING:** *If an error is detected by the parking brake, never rely on the parking brake to hold the vehicle on a slope.*

If an error is detected by the parking brake system, both the brake system and parking brake warning lights on the instrument cluster will flash and a message will be displayed in the instrument cluster.

Message	Action
<i>PARK BRAKE ERROR</i>	The system has detected an error. Refer problem to your Fisker Retailer as soon as possible.
<i>PARK BRAKE CANNOT APPLY</i>	The parking brake cannot be applied. Refer problem to your Fisker Retailer as soon as possible.
<i>PARK BRAKE CANNOT RELEASE</i>	The parking brake cannot be released. Do not drive vehicle! Refer problem to your Fisker Retailer as soon as possible.
<i>CALIBRATION REQUIRED, APPLY FOOT AND PARK BRAKE</i>	Apply the foot brake and then apply the parking brake to calibrate the system.

Emergency use

 **CAUTION:** *Driving the vehicle with the parking brake applied, or repeated use of the parking brake to slow the vehicle, may cause serious damage to the brake system.*

In an emergency, with the vehicle travelling more than 2mph (3km/h), pulling and holding the parking brake lever gives a gradual reduction in speed.

Note: If the vehicle is moving and the parking brake is applied, the system will automatically release the parking brake after 10 seconds to prevent damage to the system and the message “PARK BRAKE CANNOT APPLY” is displayed.

The parking brake must be reapplied to continue slowing the vehicle.



ELECTRONIC STABILITY CONTROL (ESC)

⚠ WARNING: No electronic system can remove the need for safe driving practices. Although the Electronic Stability Control can help to maintain control of the vehicle, it cannot prevent any accident which may result from the vehicle turning at too high a speed or from careless/dangerous driving techniques.

Note: By default ESC is switched on every time you start your vehicle.

The Electronic Stability Control (ESC) system uses various sensors to monitor driver inputs and vehicle motion. Under certain driving conditions, the ESC system helps to perform the following functions:

- Controls brake pressure to reduce wheel slip on one slipping drive wheel so power is transferred to a drive wheel on the same axle that is not slipping.
- Controls brake pressure and traction motor output to reduce drive wheel slip based on vehicle speed.
- Controls brake pressure at individual wheels and traction motor output to help the driver maintain control of the vehicle in the following conditions:
 - Understeer.
 - Oversteer.

 When the ESC system is operating the indicator light on the instrument cluster will flash to indicate it is in use.

Turning off ESC

⚠ CAUTION: Driving with ESC deactivated can put additional loads on the brakes. It is recommended that ESC is switched on for normal driving conditions.

In some driving conditions it may prove helpful to deactivate ESC to improve mobility. These conditions include:-

- Starting on a loose surface, such as gravel or snow.
- Driving in deep snow, sand or mud.
- Rocking the vehicle out of a hole or deep rut.



 To turn off ESC, touch and hold the ESC button on the touch-screen for approximately three seconds.

 The ESC OFF indicator light will illuminate on the instrument cluster.



CRUISE CONTROL

! WARNING: Do not use cruise control in traffic conditions where a constant speed cannot easily be maintained or on winding or slippery road surfaces.

! WARNING: It remains the driver's responsibility to always ensure that a safe speed is maintained within the speed limit, taking account of traffic and road conditions.

! WARNING: Cruise control should not be used in ice and snow conditions.

Cruise control enables you to maintain a constant road speed without using the accelerator pedal. This is particularly useful for any journey where a constant speed can be maintained for lengthy periods.

Note: It is important to remember that it is possible for the vehicle to increase speed when travelling downhill. This may result in the vehicle speed exceeding the set speed.



Cruise control is controlled by the switches on the steering wheel.

Engaging cruise control

To engage cruise control, the vehicle's speed must be between 20 mph (32 km/h) and 193 km/h (120 mph).

- Accelerate until your desired cruising speed is reached.
- Press the thumb wheel to the left (SET) position and release.



An indicator light on the instrument cluster illuminates when cruise control is operating.

If required, vehicle speed can be increased through normal use of the accelerator. When the accelerator pedal is released, road speed will return to the previously set cruising speed.

Note: The minimum set and resume speed is 20 mph (32 km/h).

Canceling cruise control



Cruise control can be canceled by pressing the switch on the steering wheel. The indicator light on the instrument cluster will turn off.

Note: Cruise control is also canceled when the brake pedal is pressed, HILL mode is selected, ESC is turned Off or if the vehicle's speed falls below 10 mph (16 km/h).

Resuming cruise control

- To resume cruise control at the previously set speed, press the thumb wheel to the right (RES).

Note: Cruise control will only be resumed if the vehicle's speed is more than 20 mph (32 km/h).



Changing the cruising speed

The vehicle's set cruising speed can be adjusted as follows:

- To decrease the set speed, press and hold the thumb wheel to the left.
To decrease the speed in smaller increments move the thumb wheel to the left and release. Each operation of the thumb wheel will decrease the speed by 1 mph (2 km/h).
- To increase the set speed, press and hold the thumb wheel to the right.
To increase the speed in smaller increments move the thumb wheel to the right and release. Each operation of the thumb wheel will increase the speed by 1 mph (2 km/h).



EXTERIOR SOUND

Unlike a traditional vehicle powered by an internal combustion engine, electric vehicles are inherently quiet at low speeds.

Although this potentially provides a large benefit by reducing the levels of traffic noise from passing vehicles, sound also acts as a warning to other road users. It signifies the presence of a vehicle, its speed, direction and acceleration.

To help reduce this safety risk, your vehicle has been fitted with an exterior sound system to alert pedestrians and other road users to your presence.



Two speakers are located on the exterior of your vehicle, one under the front of the vehicle and another under the rear.

Using the system

Note: The exterior sound system is controlled automatically by the vehicle. There is no need for driver intervention.

When the vehicle is put into Drive mode, the exterior sound system is switched on. A pulsing sound will be heard from the exterior speakers.

As the vehicle's speed increases, the pitch of the sound increases until the vehicle's speed reaches approximately 30 mph (50 km/h). At this speed the volume of the sound will fade out and the exterior sound is turned off.

The exterior sound will remain off until the vehicle's speed is reduced to approximately 28 mph (45 km/h). At this speed, the exterior sound is switched on and the sound will fade in. As the vehicle slows, the pitch of the sound will decrease.

 If a fault is detected with the exterior sound system, an indicator light will be displayed on the instrument cluster and the system will be switched off. Refer the problem to your local Fisker Retailer as soon as possible.

Note: The exterior sound system remains active even when the vehicle is in (P) Park.



PARK DISTANCE CONTROL (PDC)

! **WARNING:** *The PDC system may not detect moving objects such as children and animals, until they are dangerously close. Always maneuver with caution and always use your mirrors.*

! **CAUTION:** *The PDC system is for guidance only and is not intended to replace the driver's visual checks for obstructions when maneuvering. The sensors may not be able to detect certain types of obstructions (for example, narrow posts, small objects close to the ground and some objects with dark, non-reflective surfaces).*

The PDC system alerts the driver to any obstructions that need to be avoided while maneuvering at low speeds.



The vehicle is fitted with eight ultrasonic sensors, four on the front bumper and four on the rear bumper.

The range of the front sensors, and the two sensors on the corner of the rear bumper is approximately 3 feet (90 cm). The sensors in the center of the rear bumper have a range of approximately 5 feet (1.5 metres).

You are made aware of any obstruction, within range, by an intermittent tone. As the vehicle moves closer to the obstruction, the frequency of the intermittent tone increases.

! **CAUTION:** *Systems which use the same frequency band as the parking sensors may cause irregular tones to be emitted.*

When the distance between the sensors and the obstruction is less than 1.5 feet (45 cm), the tone becomes continuous.

P **!** Touch the PDC icon on the touchscreen to disable PDC.

Note: PDC is automatically switched off when the vehicle's forward speed exceeds 10 mph (16 km/h).

Cleaning the sensors

! **CAUTION:** *When washing the vehicle, avoid aiming high pressure water jets directly at the sensors. Do not use abrasive materials or hard/sharp objects to clean the sensors.*

If the sensors are obscured by dirt, ice or snow their performance may be impaired.



REAR VIEW CAMERA

⚠ WARNING: *It remains the driver's responsibility to detect obstacles and estimate the vehicle's distance from them when reversing. Some overhanging objects or barriers, which could possibly cause damage to the vehicle, may not be visible by the camera.*



When fitted, the rear view camera is located above the rear license plate.



When **R** (Reverse) is selected the touch-screen will automatically display the view from the camera.

Cleaning the camera

⚠ CAUTION: *Do not use chemical based cleaners or harsh abrasives. These can scour the surface and permanently damage the camera lens.*

For the best picture, always keep the rear view camera clean, and do not cover the camera lens.

To clean the camera lens, use a soft cloth moistened with water and car shampoo to remove any build up of dirt on the surface. Use a soft dry cloth to dry the surface and polish the lens.



USING THE VOICE COMMAND SYSTEM

The voice command system provides a safe and convenient way of operating certain vehicle systems, without the need to operate the controls manually. This enables you to concentrate fully on driving the vehicle and removes the need to divert your attention from the road ahead, in order to change settings or receive feedback from systems.

A number of voice commands are available and with a little experience, you will find them easy and convenient to use.

The voice command system allows for activation of the phone and navigation systems, as well as for switching between features of the touch-screen.

The system is controlled using the voice button on the steering wheel. Voice commands are picked up by a dedicated microphone and audible feedback will be heard through the audio system speakers.

Language settings

Voice feedback is given in the same language as is currently set for the touch-screen display. For example, if the Voice recognition language is set to French, the system will not recognize other languages (e.g. English).

Activating the system



To activate the voice command system, press and release the voice button on the steering wheel (arrowed). The system will respond with *"Please say a command"*. Any output from the audio system will be muted.

Note: It is only necessary to press the voice button at the beginning of each voice session.

Giving a command

Note: If background noise is excessive (e.g. driving with windows open), the voice system may not recognize a given voice command.

Press and release the Voice button on the steering wheel and, after the system responds, say one of the commands listed later in this section.

Note: Always wait until the system finishes responding before giving a voice command.

Give commands while facing forwards, in a natural speaking voice as if talking to a passenger or on the phone. Most accents are understood without difficulty, but if the system does not recognize the command, the system will respond with *"I'm sorry, I did not understand you"* and allow two more attempts to say the command.



The system will repeat the command (as understood by the system) back to you as confirmation. The command will then be acted on or the system will ask for further information.

Canceling voice command

To cancel a voice command, press and hold the Voice button on the steering wheel until a double tone is heard.

Note: If a phone call is received during a voice session, voice control is cancelled.

VOICE COMMANDS

This is a list of the voice commands used to change modes on the touch- screen.

Voice commands
Climate Control
Radio
Satellite Radio
USB
Aux-In
Bluetooth Stereo
Phone
Navigation
Destination Entry
Vehicle System
Exit or Quit

Dependent upon the mode selected, you may then be prompted for additional commands.

Phone specific commands

Voice commands	
Dial number	Say up to 24 digits to dial including star or pound.
	Dial
	Connect
	Yes
	No
	Correction
	Go Back
	Exit or Quit
Dial voice tag	Say voice tag to dial
	Dial
	Connect
	Yes
	No
	Correction
	Go Back
	Exit or Quit
Phone book	
Help	
Exit or Quit	

Navigation specific commands

Voice commands
State
City
Street
House number
Middle of the street
City center
Numbers 0 to 9
Next, Previous, Up, Down



HOMELINK® TRANSMITTER

⚠ WARNING: Do not use this HomeLink® transmitter with any garage door that lacks safety stop and reverse features. A garage door opener which cannot detect an object in the path of a closing door and then automatically stop and reverse the door does not meet current safety standards. Using a garage door opener without these features increases the risk of serious injury or death.

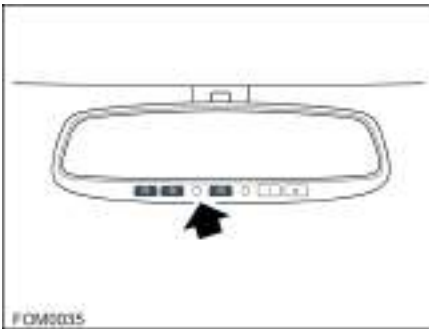

 The HomeLink® universal transmitter is built into the rear view mirror and provides a convenient way to replace up to three hand-held transmitters with a single built-in device.

PROGRAMMING A DEVICE

⚠ WARNING: When programming your HomeLink® transmitter, you will be operating the garage door or gate. Be sure that people and objects are out of the way, to prevent potential harm or damage.

1. Make sure the vehicle is in Accessory mode.
2. If you have previously programmed your HomeLink® transmitter, proceed to step 3.
3. Press and hold the two outer buttons for approximately 20 seconds. When the

indicator light (arrowed) begins to flash, release the buttons. Do not hold the buttons for longer than 30 seconds.

This initializes the HomeLink® transmitter and erases previous settings from all three channels.

Note: Do not perform this step when programming additional hand-held transmitters.

3. Decide which one of the three channels you want to program.
4. Position the end of your hand-held transmitter 1-3 inches (25 - 75 mm) away from the buttons.
5. Simultaneously press and hold both the mirror button you want to program and hand-held transmitter button. The indicator light will flash slowly and then rapidly after the mirror successfully receives the frequency signal from the hand-held transmitter. Release both buttons.
6. Press and hold the programmed garage door opener button and observe the indicator lamp.
 - If the indicator is continuous, programming is complete and your device should activate when the garage door opener button is pressed and held for approximately 1 to 2 seconds and then released.
 - If the indicator lamp blinks rapidly for two seconds and then turns a continuous light, proceed with the following instructions for Programming rolling code device equipment.



Programming rolling code device equipment

Note: The assistance of a second person may make the following steps quicker and easier. Once the button has been pressed there are only 30 seconds in which to complete Step 3.

1. At the garage door opener receiver (motor head unit) in the garage, locate the learn or smart button/switch.
The name of the button or switch may vary between manufacturers.
2. Press and release the learn or smart button.
3. Return to the vehicle and firmly press and hold the programmed garage door opener button for two seconds and release.
4. Repeat the press, hold, release sequence three times to complete the programming process.
5. The garage door opener in the rear-view mirror should now activate the rolling code device.

Reprogramming a single button

To program a device to a previously trained button:

1. Press and hold the desired pre-programmed garage door opener button for at least 20 seconds, but no longer than 30 seconds, until the indicator light begins to flash.
2. Without releasing the rear-view mirror button, position the hand-held transmitter approximately 1-3 inches (25 - 75 mm) away from the transceiver in the rear-view mirror, keeping the indicator light in view.
3. Carry out Step 3 of Programming a device.

ENTRY GATE/CANADIAN PROGRAMMING

The technology of some entry gates requires you to press and re-press (cycle) the hand-held transmitter button every two seconds during programming.

Continue to press and hold the desired rear-view mirror button while you cycle your hand-held transmitter until the indicator light flashes rapidly.

INFORMATION AND ASSISTANCE

 **CAUTION:** For security purposes, it is recommended that all programmed transceiver buttons are erased before the vehicle is sold or disposed of.

For information on the range of available compatible products or accessories, or for assistance, you should contact your Dealer.

If you would like additional information on the Homelink Universal Transceiver, compatible products or to purchase other accessories, contact your Dealer or you can also contact the Homelink helpline on 1-800-355-3515 or at www.homelink.com.

Note: Keep the original transmitter for future use or programming procedures if, for example, you purchase a new vehicle.

Note: The manufacturer is not responsible for any radio or TV interference caused by unauthorized modifications to this equipment. Such modifications could void the user's authority to operate the equipment



ACCESSORY POWER OUTLETS

Note: The 12V power outlets are suitable for accessories requiring up to 10A or a maximum of 125 watts.

Front 12V power outlet



The front power outlet is located in the center console storage compartment and is always powered.

Note: Extended use of this outlet while the vehicle is off may drain the 12V battery.

Rear accessory power outlets

Note: The rear accessory power outlets only operate when the vehicle is in Accessory or Drive mode.

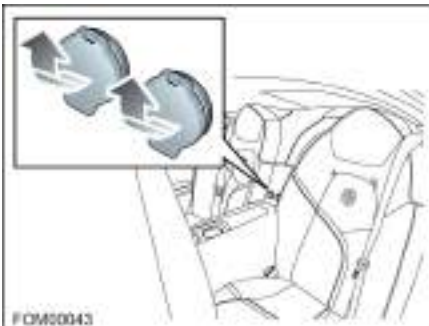

A USB and a 12V power socket are located between the rear seats.

Note: The 12V power outlet and the USB charging port (5V) have hinged covers to protect them when not in use.

USB AND AUX CONNECTIONS



A USB port and a 3.5mm input socket are provided for connecting portable media players to the audio system.

Connect your media player and select either **USB** or **AUX** on the touch-screen. For details of using your media player with the audio system, please refer to the supplied *"Touch-screen User's Manual"*.



Charging the Vehicle

- 6.2 CHARGING SYSTEM COMPONENTS
- 6.3 GENERAL INFORMATION
- 6.3 CHARGING PORT
- 6.3 CONVENIENCE CHARGING CORD
- 6.4 USING THE CONVENIENCE CHARGING CORD
- 6.6 CHARGING THE VEHICLE
- 6.7 EV CHARGE STATION
- 6.8 CHARGING TIME
- 6.8 COLD WEATHER CHARGING CONSIDERATIONS

Solar Roof

- 6.9 ABOUT THE SOLAR ROOF

Fuel Filling

- 6.10 SAFETY PRECAUTIONS
- 6.10 FUEL FILLER
- 6.11 RUNNING OUT OF FUEL
- 6.11 FUEL SPECIFICATION
- 6.11 ALTERNATIVE FUELS
- 6.11 FUEL TANK CAPACITY



CHARGING SYSTEM COMPONENTS

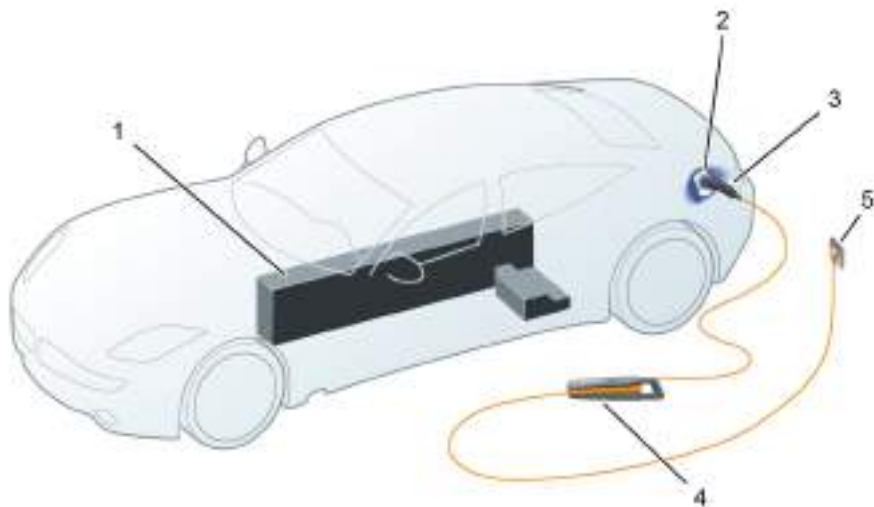

FOM0154

1. High voltage battery
2. Charging port
3. Charging cord connector

4. Convenience charging cord
5. Electrical outlet



GENERAL INFORMATION

Your vehicle uses an electric propulsion system to drive the vehicle at all times. To extend the operating range of the vehicle, an internal combustion engine will drive a generator to produce electricity as required.

The high voltage battery is the primary source and a generator powered by a gasoline engine is the secondary source.

Your vehicle has two operating modes, STEALTH and SPORT. See *DRIVING MODES*, page 5.24.

In STEALTH mode the vehicle is predominately powered by the high voltage battery. With a fully charged battery, your vehicle has a range of approximately 50 miles (80 km).

CHARGING PORT



The charging port is located on the left-hand side of the vehicle. An arrow on the battery gauge points to that side of the vehicle.



To open the charging port cover, press the rear edge of the cover and release. The cover will unlatch and gently spring open.

To close the charging port cover, press firmly in the center until the cover latches in place.

CONVENIENCE CHARGING CORD

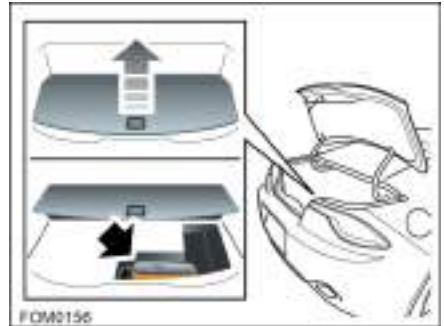

The vehicle is supplied with a convenience charging cord that will connect to most power outlets, allowing you to charge your vehicle either at home or when away.

The charging cord is stored under the trunk floor next to the tire repair kit.

Storing the charging cord

The charging cord can easily be stored by unplugging the charging cord connector from the vehicle and then winding the cord around in an arm length loop as you approach the wall outlet plug.

Remove the plug from the wall and use the Velcro strap to secure the loops before placing the unit in the storage area under the luggage compartment floor.

Compliance

This device complies with Part 15 of the FCC rules and with ICES-003E of Industry Canada.



USING THE CONVENIENCE CHARGING CORD

⚠ WARNING: *Using the charging cord with a worn or damaged wall outlet may cause burns or start a fire. Periodically, check the wall plug and charging cord while the vehicle is charging. If the plug feels hot, unplug the charging cord and have the outlet replaced by a qualified electrician.*



1. Charge rate switch
2. Charge level indicators
3. Charging cord status indicators
4. Vehicle cord connector
5. Wall outlet plug

Electrical outlets

Ideally, the AC outlet should be grounded and on a dedicated circuit rated at 15A or more. That means there should be no other major appliances connected to the same circuit.

If a non dedicated circuit is used, the current rating of the wall outlet circuit breaker could be exceeded and cause it to trip or open.

If you are having issues using the charging cord at a particular wall outlet, try the following:

- Use another wall outlet if available
- Remove other loads on the same circuit
- Charge the vehicle in reduced level mode using the charge rate switch

Extension cords

⚠ WARNING: *Use of an extension cord may increase the risk of electric shock or other hazards.*

The use of an extension cord is not recommended. If an extension cord is used because of limited access to a power outlet, please observe the following guidelines:

- The wall outlet should be RCD protected.
- The extension cord should be RCD protected.
- The extension cord should be 12 or 14 gage, and must be a 3 pin conductor.
- The extension cord should be rated for outdoor usage.

Note: The charging cord automatically detects the amount of current it can draw from the wall outlet. Using an extension cord with a long cord or smaller gage conductors may prevent the vehicle from charging.



Connecting and disconnecting the convenience charging cord

To connect the convenience charging cord:

1. Insert the plug into a wall outlet.
2. Attach the cord connector to the vehicle charging port.
3. Press the charge rate switch to begin charging the vehicle.



To disconnect the convenience charging cord:

1. Disconnect cord from vehicle.
2. Disconnect cord from wall outlet.

Charge rate switch

Note: To change the charging rate, the unit must be connected to the wall outlet but not connected to the vehicle.

The charge rate switch is a momentary push button switch that toggles between the high and the low charging rate mode.

-  Low charging rate
-  High charging rate

The charge level indicators on the unit indicate the currently selected charging mode.

Charging status indicators

The status indicators illuminate green or flashing red to identify the charge cord status.



1. AC present
2. Fault detected

When both indicators are green, the vehicle can be charged.

If any indicator is flashing red, the charging cord will not allow the vehicle to charge.

- Flashing red AC present - indicates the AC voltage is out of range.
- Flashing red AC present and Fault detected - indicates the AC outlet does not have a ground connection.

Charging is not permitted for safety reasons. The AC outlet must be repaired or another outlet source should be used.

- Flashing red Fault detected - indicates a charging cord fault.

The unit will automatically attempt to reset itself. If the flashing continues for more than 30 seconds, unplug the charging cord from the wall to reset. If the fault remains, contact your Fisker Retailer for advice.



CHARGING THE VEHICLE

⚠ CAUTION: The connector end of the charging cord is heavy and may damage the vehicle's paint if dropped when connecting or disconnecting.

Note: The vehicle should be plugged into a charger when the ambient temperature is at or below 32°F (0°C).

Note: When using an EV charging station that offers a delayed charging feature, actual charging may not begin for up to 1 hour after the unit is programmed to begin.

Note: To optimize the performance of the High Voltage Battery, Fisker Automotive recommends that the vehicle is charged to full capacity using either the convenience cord or the wall charger at least once a week.

1. Position the vehicle so that the charging cord can easily reach the charging port on the vehicle.

2. Press the Start/Stop button to take the vehicle out of Drive mode, the READY indicator on the instrument cluster will turn off.

Note: The vehicle will not charge if the vehicle is in Drive mode and the charge cord is connected.

3. Open the charging port cover.

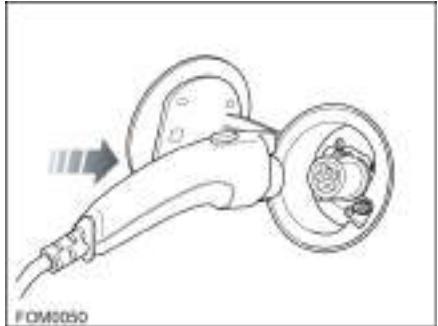

4. Connect the charging cord to the vehicle's charging port. A spring loaded clip on the front of the connector engages with the port to lock it in place.

Note: The vehicle will automatically engage **P** (Park) to prevent the vehicle from being driven with the charging cord still connected.

5. While the vehicle is charging, the charging indicator light on the instrument cluster will briefly illuminate and the battery charge level indicator will begin to rise. The convenience chargers's charge level indicator will blink left to right to display the current charge level.



Note: During charging or in high ambient temperatures, the cooling fans and coolant pumps may automatically switch on for a period of time to cool the cells in the battery. The fans and pumps may be audible when in operation. This is normal and not a cause for concern.

6. When the vehicle is fully charged the charge indicator will be illuminated (solid).

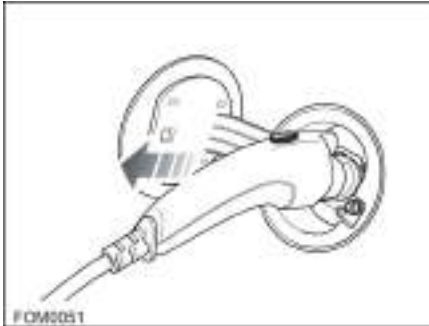

7. Press the button on the charging connector to release the locking clip and then remove the connector from the charging port.

Note: If you try to put the vehicle into Drive mode with the charging cord attached, the charging indicator on the instrument cluster will flash to remind you to disconnect the charging cord.

8. Close the charge port cover.

EV CHARGE STATION



The optional EV Charge Station is the fastest way to recharge your vehicle when at home. Connected to a high voltage/high amperage electricity supply, the EV Charge Station will significantly reduce the time for charging your vehicle.

Usually installed at the location you store your vehicle overnight, the EV Charge Station provides you with an easily accessible connection for charging your vehicle when not in use.

Refer to the user manual supplied with the EV Charge Station for details on how to safely charge your vehicle.

Note: For further details on the EV Charge Station, please contact your Fisker Retailer.



CHARGING TIME

The amount of time it takes to fully charge the vehicle is dependent upon the remaining battery charge level and the available electrical supply (amperage and voltage).

As a guide, the following are an approximate time to charge the high voltage battery from fully depleted.

110V	Convenience charging cord	12 hours
220V	EV Charge Station	6 hours

Note: Charge time is also impacted by both the ambient air temperature and the temperature of the vehicle's high voltage battery. If the temperature is outside the optimal range, the vehicle's heating and cooling system will operate to warm or cool the high voltage battery accordingly. This will consume some of the energy used for charging.

COLD WEATHER CHARGING CONSIDERATIONS

Do not allow the vehicle to remain in temperature extremes for long periods without being driven or plugged in. When not operating the vehicle it is recommended that the vehicle be plugged in and charging when temperatures are below 32°F (0°C).

The charging system may run fans and pumps that result in sounds from the vehicle while it is turned off. Additional unexpected clicking sounds may be caused by the electrical devices used while charging.

Note: In cold weather conditions, ice may form around the charge port door. The charge port door may not open on the first attempt. Remove ice from the area and repeat attempting to open the charge port door.

Note: Keep the vehicle plugged in, even when fully charged, in order to keep the battery temperature prepared for the next drive. This is important when outside temperatures are extremely cold.



ABOUT THE SOLAR ROOF



Your vehicle is equipped with a solar paneled roof. The solar roof not only helps to recharge the battery but also aids the cabin climate control system.

The solar roof is capable of generating a half kilowatt-hour a day and is estimated to provide up to 200 miles (321km) of additional range a year.



SAFETY PRECAUTIONS

! *WARNING: Gasoline vapors are highly flammable, have a low flash point and are explosive, especially in confined spaces. Avoid exposing the gasses to any potential sources of ignition as the resulting fire and explosion may cause serious injuries and/or death.*

! *WARNING: Never fill the vehicle's fuel tank while the vehicle is charging or connected to a charging station. An accidental spark could cause an explosion or fire resulting in serious injury or death.*

! *WARNING: Switch off the engine when refuelling, as it is both a source of extreme temperatures and electrical sparks. Failure to do so may cause a fire or explosion.*

! *WARNING: Switch off any personal electronic devices such as mobile phones, or music players. They have the potential to trigger an explosion or a fire.*

! *WARNING: Do not smoke, use an open flame or cause sparks while refuelling. The resulting fire and/or explosion may cause serious injury or death.*

! *WARNING: Only use containers specifically designed for carrying fuel and always remove them from the vehicle to fill them. Failure to do so may result in spillage and cause a fire.*

! *WARNING: Do not overfill the fuel tank. Overfilling may cause spillage when the vehicle is driven. Spillage may also occur if the fuel expands in high ambient temperatures.*

FUEL FILLER

 The fuel filler is located on the right-hand side of the vehicle. An arrow on the fuel gauge points to that side of the vehicle.

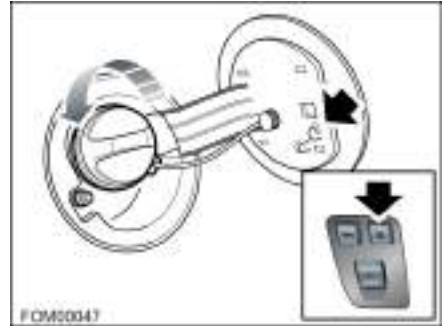

When your vehicle is stationary and unlocked, press the fuel filler cover release button located on the driver's side dashboard closing panel.

The fuel filler cover will gently spring open. Twist the fuel filler cap counter clockwise to release.

A strap secures the fuel filler cap to the vehicle to prevent loss. A holder is provided on the flap to store the cap while refuelling.

 When replacing the fuel filler cap, tighten it until it clicks three times. Failure to do so may cause the indicator icon on the instrument cluster to illuminate due to increased evaporative emission levels.





RUNNING OUT OF FUEL

 **CAUTION:** Avoid running out of fuel. Doing so can cause damage to the vehicle's engine, fuel pump and emission control systems.

 When the remaining fuel reaches a approximately 10% of the maximum fuel level, the fuel gauge display will turn red. If the fuel level falls to approximately 3%, the low fuel warning icon illuminates.

FUEL SPECIFICATION

 **CAUTION:** Do not use leaded fuels, lead substitutes or fuel additives. Doing so can cause damage to the engine, fuel and emission control systems.

 **CAUTION:** Only use high quality fuel as using a lower quality can cause damage to the engine, fuel and emission control systems.

 **CAUTION:** Fuel system cleaning agents should not be used as they maybe harmful to fuel system components on your vehicle.

 **CAUTION:** If the fuel tank is filled with the wrong type of fuel, do not start the engine. It is essential that you seek qualified assistance. Running the engine can cause serious engine and fuel system damage.

The correct fuel specification for your vehicle is shown on the inside of the fuel filler cover.

Only use Premium Unleaded fuel. Unleaded fuel is essential for proper operation of the emission control system.

Even a very small quantity of leaded fuel will damage your vehicle's emission control system and could invalidate the emissions warranty.

ALTERNATIVE FUELS

Ethanol fuels

 **CAUTION:** Do not use E85 fuels (85% Ethanol content). If E85 fuels are used serious engine and fuel system damage will occur.

Fuels containing up to 10% ethanol may be used. Ensure the fuel has an octane rating no lower than that recommended on the inside fuel filler cover.

Methanol fuels

 **CAUTION:** Do not use fuels that contain methanol. The use of fuels containing Methanol will seriously damage fuel system components. Damage caused by using this type of fuel will not be covered under the vehicle warranty.

Reformulated gasoline

 **CAUTION:** Fisker Automotive does not recommend the use of reformulated gasolines that contain the additive MMT (Methylcyclopentadienyl Manganese Tricarbonyl). Fuels containing MMT can reduce spark plug life and the performance of the emission control system.

FUEL TANK CAPACITY

Avoid the risk of running out of fuel and never intentionally drive the vehicle when the fuel gauge indicates that the tank is empty.

Total tank capacity	10 U.S. gallons (38 liters)
Usable tank capacity	9.5 U.S gallons (36 liters)



Maintenance Requirements

- 7.2 GENERAL INFORMATION
- 7.2 SCHEDULED MAINTENANCE
- 7.2 OWNER MAINTENANCE
- 7.3 SAFETY
- 7.3 FUEL AND EMISSION SYSTEMS COMPONENTS

Hood

- 7.4 OPENING AND CLOSING

Engine Compartment

- 7.5 OVERVIEW
- 7.6 ENGINE OIL
- 7.7 BRAKE FLUID
- 7.8 POWER STEERING FLUID
- 7.9 COOLANT
- 7.10 WASHER FLUID
- 7.11 APPROVED FLUIDS AND CAPACITIES

Wipers and Washers

- 7.12 CHECKING THE WIPER BLADES
- 7.12 REPLACING THE WIPER BLADES
- 7.12 WASHERS

Cleaning and Vehicle Care

- 7.13 CLEANING THE EXTERIOR
- 7.14 CLEANING THE SOLAR ROOF
- 7.14 UNDERHOOD CLEANING
- 7.14 POLISHING THE BODY
- 7.14 PAINT DAMAGE AND RECTIFICATION
- 7.14 USING A CAR COVER
- 7.15 CLEANING THE INTERIOR
- 7.16 FLOOR MATS
- 7.17 VEHICLE STORAGE

Fuses

- 7.18 REPLACING A FUSE
- 7.18 ENGINE COMPARTMENT FUSE BOX
- 7.19 FUSE SPECIFICATIONS

Raising the Vehicle

- 7.21 JACKING AND LIFTING THE VEHICLE

Vehicle Recovery

- 7.22 TRANSPORTING THE VEHICLE
- 7.22 ATTACHING THE VEHICLE RECOVERY EYE
- 7.23 SECURING THE WHEELS



GENERAL INFORMATION

The safety, reliability and performance of your car will depend partly on how well it is maintained. Maintenance is the owner's responsibility and you must ensure that the appropriate maintenance is performed when required and according to the recommendations specified by Fisker Automotive.

SCHEDULED MAINTENANCE

The scheduled maintenance requirements for your vehicle are shown in the Warranty and Service Booklet supplied in the owner's literature pack.

Most of the necessary maintenance and servicing of your vehicle will require specialist knowledge or equipment, and should preferably be entrusted to a Fisker Automotive Retailer.

Fluid replacement

Brake fluid requires changing every 50,000 miles (80,000 km) or 5 years, whichever comes sooner.

Coolant must be changed every 150,000 miles (240,000 km) or 5 years, whichever comes sooner.

Note: These fluids will be changed by a Fisker Automotive Retailer at the service nearest the conclusion of each period of time.

Vehicle service history

When you have your vehicle serviced at a Fisker Automotive Retailer, your service information is recorded in the Fisker Global Service History database. It can be accessed by any Fisker Automotive Retailer - a great convenience if you relocate or need to have your vehicle serviced while traveling.

OWNER MAINTENANCE

⚠ WARNING: *Any significant or sudden drop in fluid levels, or uneven tire wear should be rectified immediately.*

In addition to the scheduled maintenance, a few simple checks must be carried out more frequently. You can carry out these checks yourself and advice is given on the pages that follow

Daily checks

- Battery charge level.
- Check all exterior lights, horn, turn signals, wipers and washers.
- Check the operation of the brakes, including the parking brake.
- Check the operation of the seat belts.
- Look for fluid deposits underneath the vehicle that might indicate a leak

Monthly checks

- Check the engine oil level. Refer to [ENGINE OIL, page 7.6.](#)
- Check the brake fluid level. Refer to [BRAKE FLUID, page 7.7.](#)
- Check the power steering fluid level. Refer to [POWER STEERING FLUID, page 7.8.](#)
- Check the washer fluid level. Refer to [WASHER FLUID, page 7.10.](#)
- Check the coolant level. Refer to [COOLANT, page 7.9.](#)
- Check condition and pressure of each tire. Refer to [Tire Care, page 8.2.](#)
- Check operation of the air conditioning system. Refer to [Climate Control, page 5.14.](#)





SAFETY

 **WARNING:** *If the vehicle has been driven recently, do not touch any exhaust and cooling system components until they have cooled.*

 **WARNING:** *Never leave the engine running in an unventilated area - exhaust gases are poisonous and extremely dangerous.*

 **WARNING:** *Keep your hands and clothing away from pulleys and cooling fans. Some fans may continue to operate even when the vehicle is OFF.*

 **WARNING:** *Remove metal wrist bands and jewelry, before working in the engine compartment.*

 **WARNING:** *When filling-up fluid reservoirs, position a cloth around the neck of the reservoir to absorb any fluid spillage which could result in a fire.*

Poisonous fluids

Fluids used in motor vehicles are poisonous and should not be consumed or brought into contact with open wounds. These fluids include; battery acid, antifreeze, brake and power steering fluid, gasoline, engine oil and windshield washer additives.

For your own safety, always read and obey all instructions printed on fluid container labels.

Used engine oil

Prolonged contact with engine oil may cause serious skin disorders, including dermatitis and cancer of the skin. Always wash thoroughly after contact.

 It is illegal to pollute drains, water ways or soil. Use authorized waste disposal sites to dispose of used oil and other chemicals.

FUEL AND EMISSION SYSTEMS COMPONENTS

Emission control

Your vehicle is designed with various items of emission and evaporative control equipment, designed to meet specific territorial requirements. You should be aware that unauthorized replacement, modification or tampering with this equipment by an owner or repair shop, may be unlawful and subject to legal penalties.

In addition, engine settings must not be tampered with. These have been established to ensure that your vehicle complies with stringent exhaust emission regulations. Incorrect engine settings may adversely affect exhaust emissions, engine performance and fuel consumption, as well as causing high temperatures, which will result in damage to the catalytic converter and the vehicle.

Fuel system

 **WARNING:** *Under no circumstances should any part of the fuel system be dismantled or replaced by anyone other than a suitably qualified vehicle technician. Failure to comply with this instruction may result in fuel spillage with a consequent serious risk of fire.*

 **WARNING:** *Keep sparks and open flames away from the engine compartment.*

 **WARNING:** *Wear protective clothing, including, where practicable, gloves made from an impervious material*



OPENING AND CLOSING

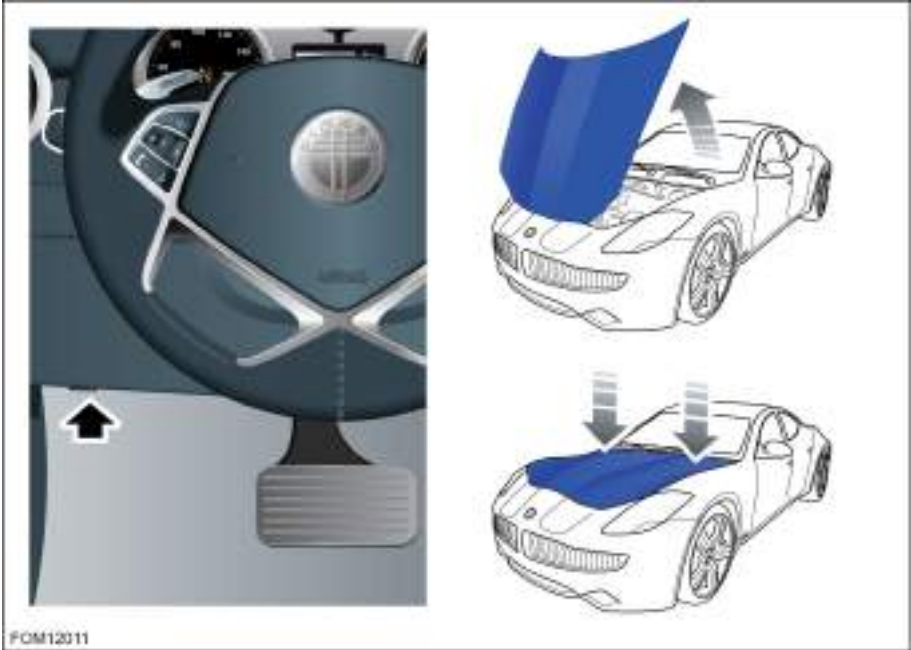

⚠ WARNING: *Never work on a vehicle that is plugged in. Always remember to unplug the vehicle before working under the hood or the underside of the vehicle.*

Opening the hood

⚠ WARNING: *Make sure that the hood is in the fully open position before working in the engine compartment. In windy conditions, you may need to secure the hood to prevent the hood from being closed by the wind.*

1. Pull the (recessed) hood release handle located on the lower edge of the dashboard closing panel.
2. Raise the hood.
3. Ensure the hood is in the fully open position.

Closing the hood

1. Lower the hood to the closed position.
2. Press down firmly on each side of the hood (see illustration) to engage the locks.

Note: You will hear the locks ‘click’ into place.

⚠ CAUTION: *Before driving, check that the locks on both sides of the hood are fully engaged by attempting to lift the hood. There should be no movement.*

OVERVIEW

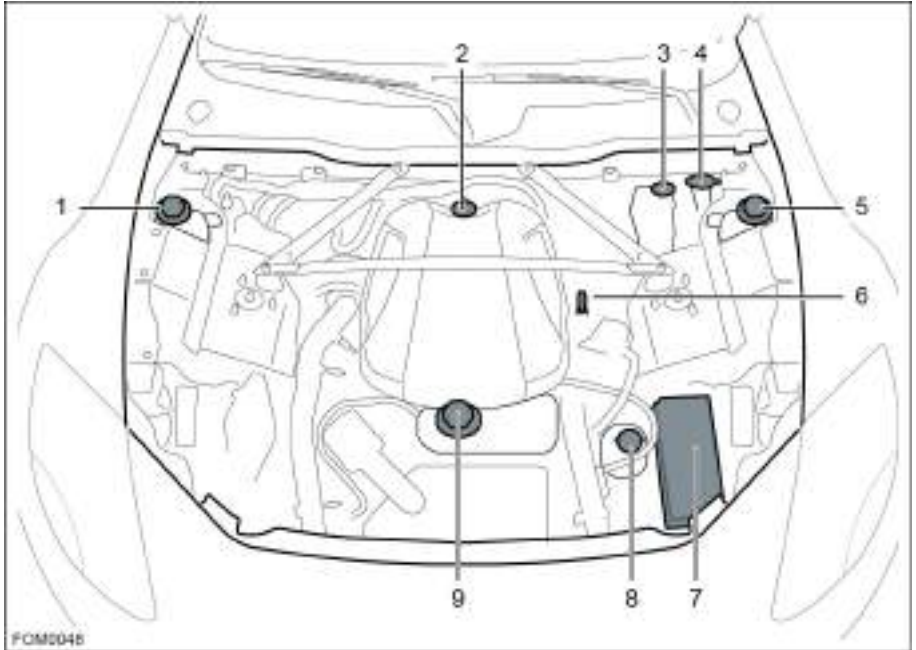

1. Coolant reservoir - Electric drive components
2. Engine oil filler cap
3. Brake fluid reservoir
4. Windshield washer reservoir

5. Coolant reservoir - Engine
6. Engine oil level dipstick
7. Engine compartment fuse box
8. Power steering reservoir
9. Coolant reservoir - Battery

⚠ WARNING: Before working in the engine compartment, ensure that the vehicle is OFF and the key fob is outside the vehicle.

⚠ WARNING: Your vehicle uses high voltage. System components can be hot to touch during and after starting and when the vehicle is shut off. Be careful of both the high voltage and the high temperature. Obey all labels that are attached to the vehicle.

⚠ WARNING: The vehicles high voltage system has no user serviceable parts. Disassembling, removing or replacing high voltage components, cables or connectors can cause severe burns or electric shock that may result in serious injury or death. High voltage cables are colored orange for easy identification.



ENGINE OIL

! **CAUTION:** It is recommended that the oil level is checked monthly. If any significant or sudden drop in oil level is noted you should seek qualified assistance immediately.

! **CAUTION:** Your vehicle's warranty may be invalidated if damage is caused by the use of improper engine oil. Low quality or obsolete oils do not provide the protection required by modern, high performance engines. Failure to use an oil that meets the required specification could cause excessive engine wear, a buildup of sludge and deposits and increased pollution. It could also lead to engine failure.

! **CAUTION:** Do not use oil additives of any type as engine damage could occur. Use only specified lubricants.

Checking the oil level

Note: If it is necessary to check the oil level when the engine is hot, switch off the vehicle and let it stand for five minutes to allow the oil to drain back into the sump.



1. Withdraw the dipstick and wipe the blade clean with a lint free cloth.
2. Fully re-insert the dipstick and withdraw again to check the oil level.

Never allow the oil level to fall below the lower mark on the dipstick.

As a general guide, if the level on the dipstick:

- Is nearer to the upper mark, add no oil.
- Is nearer to the lower mark than the upper, add one pint (half a liter) of oil.
- Is below the lower mark, add two pints (one liter of oil and re-check the level after a further five minutes.

Adding engine oil

! **CAUTION:** Overfilling with oil could result in severe engine damage. Oil should be added in small quantities and the level re-checked to ensure that the engine is not overfilled.



1. Unscrew the oil filler cap.
2. Add the recommended engine oil to maintain the level between the **MIN** and **MAX** marks on the dipstick. See [APPROVED FLUIDS AND CAPACITIES, page 7.11.](#)
3. Check the oil level again after five minutes.
4. Once the correct level is achieved, replace the filler cap and securely tighten by hand
5. Clean up any oil spilled during topping-up.



BRAKE FLUID

! WARNING: Brake fluid is highly toxic - keep containers sealed and out of the reach of children. If accidental consumption of fluid is suspected, seek medical attention immediately.

! WARNING: If the fluid comes into contact with the skin or eyes, rinse immediately with plenty of water.

! WARNING: Brake fluid is highly flammable. Do not allow brake fluid to come into contact with open flames or other sources of ignition (e.g. a hot engine).

! WARNING: Seek qualified assistance immediately if brake pedal travel is unusually long or if there is any significant loss of brake fluid. Driving under such conditions could result in extended stopping distances or complete brake failure.

! WARNING: Do not drive the vehicle with the fluid level below the MIN mark

Check the fluid level monthly. The level should be checked more frequently in high mileage conditions.

The fluid level may drop slightly during normal use, as a result of brake pad wear, but should not be allowed to drop below the **MIN** mark.

 If the quantity of fluid in the brake reservoir drops below the recommended level, an indicator lamp in the instrument cluster will illuminate.

Note: If the indicator lamp illuminates while the vehicle is being driven, stop the vehicle as soon as safety permits by gently applying the brakes. Check and fill the fluid reservoir if necessary.

Checking the fluid level

Check the fluid level with the vehicle standing on level ground.



The level of fluid can be seen through the translucent body of the reservoir. The fluid level should be between the **MIN** and the **MAX** marks

Filling up the brake reservoir

! CAUTION: Brake fluid will damage painted surface. Soak up any spillage with an absorbent cloth immediately and wash the area with a mixture of car shampoo and water.

! CAUTION: Only use new fluid from an airtight container. Fluid from open containers or fluid previously bled from the system, will have absorbed moisture, which will adversely affect performance, and must not be used

1. Clean the filler cap with a clean, dry cloth before removing, to prevent dirt or moisture from entering the reservoir.
2. Remove filler cap.
3. Fill the reservoir using an approved brake fluid until the fluid level is between the **MIN** and **MAX** marks. See APPROVED FLUIDS AND CAPACITIES, page 7.11.
4. Replace the filler cap



POWER STEERING FLUID

! **WARNING:** Power steering fluid is highly toxic - keep containers sealed and out of reach of children. If accidental consumption of fluid is suspected, seek medical attention immediately.

! **WARNING:** If the fluid comes into contact with the skin or eyes, rinse immediately with plenty of water.

! **WARNING:** Do not spill the fluid onto a hot engine - a fire may result

! **CAUTION:** Seek qualified assistance immediately if there is a sudden noticeable drop in the fluid level.

! **CAUTION:** If fluid loss is slow, the reservoir may be filled to the upper level mark to enable the vehicle to be driven to a repair facility for inspection. However, we do recommend you seek qualified assistance before driving the vehicle.

Checking the fluid level

Check the fluid with the vehicle OFF, standing on level ground and the system cold. Ensure that the steering wheel is not turned after stopping the engine.



The level of fluid can be seen through the translucent body of the reservoir. The fluid level should be between the **MIN** and the **MAX** marks.

Filling up the power steering reservoir

! **CAUTION:** It is imperative that the steering system does not become contaminated in any way. Always use new fluid and clean the area around the filler neck, both before removing the filler cap and after topping up. Never return drained fluid to the system.

! **CAUTION:** Power steering fluid will damage painted surfaces. Soak up any spillage with an absorbent cloth immediately and wash the area with a mixture of car shampoo and water.

1. Clean the filler cap before removing to prevent dirt from entering the reservoir.
2. Remove filler cap.
3. Fill the reservoir using an approved power steering fluid until the fluid level is between the **MIN** and **MAX** marks. See APPROVED FLUIDS AND CAPACITIES, page 7.11.
4. Replace the filler cap



COOLANT

! *WARNING: Never remove filler caps when the system is hot, as the reservoir will be pressurized. Coolant and steam can escape rapidly when the cap is removed, causing injury.*

! *WARNING: Antifreeze is highly inflammable. Do not allow antifreeze to come into contact with naked flames or other sources of ignition (e.g. a hot engine) - a fire may result.*

! *WARNING: Unscrew the filler cap slowly, allowing the pressure to escape before removing completely.*

Your vehicle is unique in that unlike a traditional vehicle, it has three separate cooling systems to cool the engine, electric drive components and the high voltage battery.

The coolant levels for each reservoir should be checked monthly. The levels should be checked more frequently in high mileage conditions. Always check the level when the system is cold.

Battery coolant level

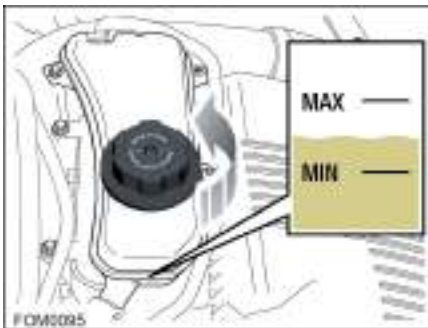

The level of fluid can be seen through the translucent body of the reservoir. The fluid level should be between the **MIN** and the **MAX** marks.

Electric drive components and the engine coolant levels

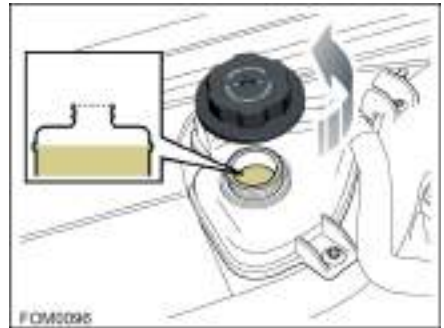

To check the coolant level, the filler cap must be removed.

The level of the fluid, visible in the filler neck, should be level with the seam molded into the body of the reservoir.

Ensure the cap is tightened fully after checking the reservoir by turning the cap until the ratchet cap clicks. Do not over tighten.

Filling up the coolant reservoirs

! *CAUTION: If persistent coolant loss is noticed, seek qualified assistance immediately*

Fill the reservoir to the upper level indicator mark using only a 50% mix of water and approved antifreeze. See *APPROVED FLUIDS AND CAPACITIES, page 7.11.*

Note: In an emergency, and only if the approved antifreeze is unavailable, fill the cooling system with clean water, but be aware of the resultant reduction in freeze protection.

Ensure the cap is tightened fully after top-up is completed by turning the cap until the ratchet cap clicks.



WASHER FLUID

! **WARNING:** Some screen wash products are flammable, particularly in undiluted concentrations. Do not allow screen wash fluid to come into contact with open flames or sources of ignition.

! **WARNING:** If the vehicle is operated in temperatures below 4°C (40°F), use a washer fluid with frost protection. In cold weather, failure to use a washer fluid with frost protection could result in impaired vision and an unsafe driving condition.

! **CAUTION:** Body panels may suffer discoloration as a result of screen wash spillage. Take care to avoid spillage, particularly if an undiluted or high concentration is being used. If spillage occurs, wash the affected area immediately with water

The washer reservoir supplies both the windshield and headlamp washer jets.

Check and fill up the reservoir level monthly or more frequently in high use conditions.



If the quantity of fluid remaining in the washer reservoir drops to less than one liter, a message will be displayed on the touch-screen diagnostic screen.

Operate the washers periodically to check that the nozzles are clear and properly directed

Filling up the washer reservoir

Note: National or local regulations may restrict the use of Volatile Organic Compounds (VOCs) which are commonly used as antifreeze agents in washer fluid. A washer fluid with limited VOC content should be used only if it provides adequate freeze resistance for all climates in which the vehicle is operated.

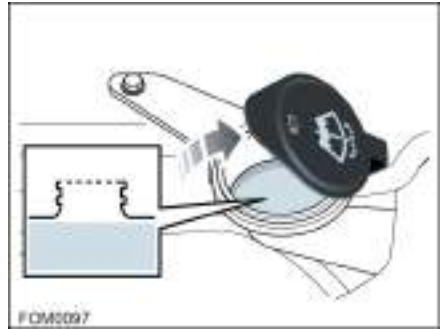

1. Clean the filler cap before opening to prevent dirt from entering the reservoir.
2. Open the filler cap.
3. Fill the reservoir with an approved fluid until the fluid is visible just below the filler neck. In cold climates, always fill up with windshield washer fluid to prevent freezing.
4. Install the filler cap.



APPROVED FLUIDS AND CAPACITIES

Fluid	Specification	Capacity
Engine oil	SAE 5W/30 meeting specification Dexos II, ACEA A5, ILSAC GF-5 or API SN/Resource Conserving. Fisker Automotive recommends Mobil 1.	5 qt (4.7 liters)
Brake fluid	You must use CCI 8070 type brake fluid. You can request either Fisker P/N C131125610000 or GM P/N 88863461.	1.6 qt (1.5 liters)
Power steering fluid	Pentosin CHF11S or CHF202	1.8 qt (1.7 liters)
Coolant - Engine	50/50 mix of DEX-COOL Extended life Antifreeze and clean drinkable water - preferably distilled water. Fisker Automotive recommends Havoline DEX-COOL or a coolant meeting specification GM 6277M.	12.7 qt (12.0 liters)
Coolant - Battery	50/50 mix of DEX-COOL Extended life Antifreeze and clean drinkable water - preferably distilled water. Fisker Automotive recommends Havoline DEX-COOL or a coolant meeting specification GM 6277M.	4.2 qt (4.0 liters)
Coolant - Electric drive components	50/50 mix of DEX-COOL Extended life Antifreeze and clean drinkable water - preferably distilled water. Fisker Automotive recommends Havoline DEX-COOL or a coolant meeting specification GM 6277M.	12.7 qt (12.0 liters)
Washer fluid	Any good quality screen wash.	4.2 qt (4.0 liters)
A/C Refrigerant	R134a. Fisker Automotive recommends KLEA 134a refrigerant. Note: If any oil needs adding to the system, only use an oil meeting ND 11 specification.	1.41 lb. (0.64 kg)
Differential oil	75W/90 synthetic axle lubricant meeting specification GM 9986115.	2.6 qt (2.5 liters)



CHECKING THE WIPER BLADES

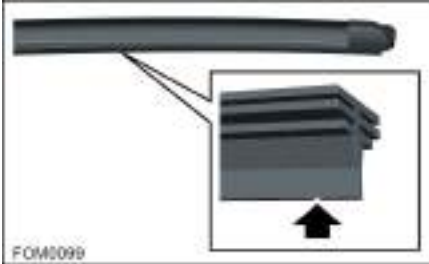

Only use cleaning products which have been approved for use on automotive glass and rubber. Inappropriate products may cause damage.

Periodically check and clean the wiping edge of the wiper blade. Clean the blade edge by wiping with a soft cloth or sponge, using warm soapy water.

Also, check the blade rubber for cracks, splits and roughness. If any damage is found, replace the blade immediately to prevent damage to the glass.

REPLACING THE WIPER BLADES

Install only replacement wiper blades that are the same length and identical to the original specification.



1. Release the locking lever securing the wiper blade to the wiper arm.

2. Lift the wiper arm away from the windshield.
3. Slide the wiper blade from the wiper arm and remove.

To install the new blade, position the new assembly on the wiper arm and close the locking lever to retain the wiper blade. Make sure the locking lever is securely closed.

WASHERS

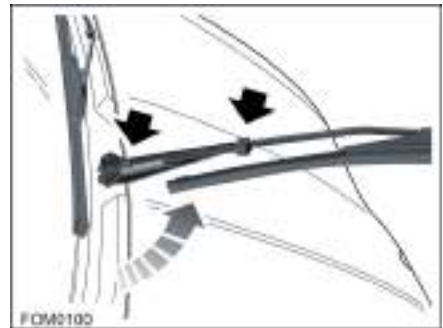

If a windshield washer becomes blocked, use a thin strand of wire to clear any blockages from the nozzle.

Note: The headlamp washers operate with every fifth operation of the windshield washer. If you have any problems with the headlamp washers, please consult a local Fisker Automotive Retailer.



CLEANING THE EXTERIOR

 It is illegal to pollute drains, rivers and waterways. Some cleaning products contain chemicals that are hazardous to the environment. Used toxic chemicals must be disposed of at authorized waste disposal sites only. Always take precautions to prevent fluids from spilling.

Hand washing

 **CAUTION:** Avoid using tight-napped or rough cloths, such as washing mitts. Care must be taken when removing caked-on dirt or other foreign substances so the paint surface is not scratched or damaged.



In order to maintain the appearance of your vehicle, observe the following:

- Do not wash the vehicle using hot water.
- Do not use detergents or washing up liquid.
- In hot weather, do not wash the vehicle in direct sunlight.
- Do not aim water hoses directly at window, door or hood seals, or through wheel apertures onto brake components.

Use a hose to flush grime and grit from the bodywork, before washing.

Only wash the bodywork using cold or lukewarm water containing a good quality wash and wax shampoo.

After washing, rinse with clean water and thoroughly wipe dry with a chamois. Do not allow cleaning agents to dry on the finish.

Automatic car washers or pressure washer

 **CAUTION:** Fisker Automotive recommends that you hand wash your vehicle. Do not use an automatic car washer or pressure washer as these may damage your vehicle's paint finish, solar roof, or other components.

Note: Vehicle or paint damage caused by using an automatic car washer will not be covered under the vehicle warranty.

Wheels

 **CAUTION:** Do not use chemical based wheel cleaners as these can damage the finish of the wheel.

Clean with warm, fresh water containing a good quality wash and wax shampoo. Thoroughly rinse the wheels to remove any residue.

Cleaning the underside

During winter months if salt has been used on the roads, use a hose to wash the underside of the car. Flush away accumulations of mud in those areas where debris easily collects (wheel arches and panel seams, for example).

Removing tar spots

Use denatured alcohol to remove tar spots and stubborn grease stains from paint. After cleaning, immediately wash the area with soapy water to remove all traces of alcohol.



CLEANING THE SOLAR ROOF

Clean the solar roof with a soft cloth and a mild solution of soap and water, or car shampoo. Do not scrape the glass or use any abrasive cleaning fluid.

If you notice any damage on the solar roof, please contact your local Fisker Automotive Retailer for advice.

UNDERHOOD CLEANING

 **CAUTION:** *Never use a pressure washer or a steam cleaner to clean components in the engine compartment, as it may damage critical seals on high voltage electrical components.*

Note: Vehicle or paint damage caused by using a pressure washer will not be covered under the vehicle warranty.

POLISHING THE BODY

 **CAUTION:** *Do not use cutting pastes, color restoration compounds, or polishes containing harsh abrasives. These can scour the surface and permanently damage the paintwork.*

 **CAUTION:** *Chrome polish, or other abrasive cleaners, must not be used on the vehicle's brightwork.*

To preserve the cosmetic appearance of the body, occasionally treat the paint surfaces with an approved polish containing the following properties:

- Very mild abrasive to remove surface contamination without removing or damaging the paint.
- Filling compounds that will fill scratches and reduce their visibility.
- Wax to provide a protective coating between the paint and the elements.

PAINT DAMAGE AND RECTIFICATION

Regularly inspect the paintwork for damage. Any stone chips, fractures or deep scratches in the paint/bodywork should be repaired promptly. Bare metal will corrode quickly and, if left untreated can result in expensive repairs.

Treat chips and scratches to the paint using a paint touch-up pen. Use the touch-up pen after washing but before polishing or waxing.

More extensive repairs to the body should only be carried out by a facility approved by Fisker Automotive. Contact your local Fisker Automotive Retailer for a list of approved body repair facilities.

USING A CAR COVER

 **CAUTION:** *Never use a car cover when the vehicle is plugged in, doing so can prevent the battery from being adequately cooled during charging.*

To preserve the cosmetic appearance of the body when the vehicle is not being used, you may want to use a car cover. Only a Fisker Automotive approved car cover should be used.



CLEANING THE INTERIOR

General cleaning

 **CAUTION:** Avoid using solvents (including alcohol), bleach, citrus, naphtha, silicone based products or additives on interior components as these can damage the appearance of the material.

To maintain the look and appearance of the interior of your vehicle, the interior should be inspected and cleaned frequently.

It is recommended that for general cleaning, materials and surfaces should be cleaned using a non solvent based cleaning (wet) wipe (e.g. a baby wipe), and a microfiber cloth.

If possible, try to wipe up spillages and clean marks as they happen. This will reduce the need for more expensive cleaning in the future.

Note: It is advisable to test all cleaners on a concealed area before use.

Glass and mirrors

The windshield, rear window and mirror glass should only be cleaned using soapy water and a soft cloth. This will avoid damaging the reflective surface of the mirror and heating elements in the rear window.

Air bag module covers

 **WARNING:** Air bag covers should only be cleaned using a slightly dampened cloth/cleaning wipe. Any substance which enters the air bag could prevent correct deployment.

 **WARNING:** Any damage, or cracks on an air bag cover, should be referred to a Fisker Automotive Retailer for inspection.

Plastic materials

Clean heavily soiled plastic surfaces using warm water and a non-detergent soap, then wipe clean with a soft cloth.

Chrome/metal surfaces

 **CAUTION:** Do not use metal polish, abrasive cleaners or hard cloths to clean chrome/metal surfaces as these can damage the surface finish.

Clean chrome surfaces using a soft cloth, warm water and a non-detergent soap. Wipe the surface dry using a microfiber cleaning cloth.

Lightly polish the surface using a spray furniture polish applied with a soft cloth. Polish using a linear motion along the surface and do not press too hard.

Leather

 **CAUTION:** Some materials/fabrics are prone to dye-transfer which can cause discoloration of lighter colored leathers. Affected areas should be cleaned as soon as possible using a cleaning wipe (e.g. a baby wipe).

To prevent ingrained dirt and staining, inspect the seat upholstery regularly and clean every one to two months, as follows:

- Wipe off fine dust from the seat surfaces using a clean, damp, non-colored cloth. Change frequently to a clean area of cloth, to avoid abrasive action on the leather surface. Avoid over-wetting.
- If this is not sufficient, use a non solvent based cleaning wipe containing aloe or lanolin (e.g. a baby wipe).

Note: Using soap or commercially available leather cleaners/conditioners is not recommended as this will dry out the leather.



Eco-Chic Suede

Note: Eco-Chic Suede requires little maintenance or cleaning in order to restore its overall appearance. The use of harsh or abrasive chemicals or scrubbing and brushing of the fabric is not recommended.

To preserve the look and feel of Eco-Chic Suede, it should be regularly cleaned to prevent any build up of dirt and contaminants from occurring, as follows:

- Vacuum the area to remove any loose dirt and debris. Avoid scrubbing the area to remove marks.
- Lightly soiled areas should be cleaned with a damp microfiber cloth. Lightly pat and wipe over the surface with the damp cloth. Regularly rinse the cloth in clean warm water.
- Heavily soiled areas should be cleaned with a damp microfiber cloth and warm, soapy water. Carefully pat and wipe the surface to remove any marks. Regularly rinse the cloth in clean warm water and repeat the process. Avoid over-wetting the surface or scrubbing.
- After cleaning, vacuum the area to remove any excess moisture and then lightly brush the surface to give it that as new look.

Carpets

Clean with warm water and a non-detergent soap. Avoid over-wetting the area.

For heavily soiled areas, use a diluted upholstery cleaner.

Seat belts

 **WARNING:** Do not allow any water, cleaners, or fabric from cloths to enter the seat belt mechanism. Any substance which enters the mechanism may affect the performance of the seat belt in an impact

Extend the belts and clean with warm, soapy, fresh water only. Do not use any type of detergent or chemical cleaning agent. Allow the belts to dry naturally while extended, preferably away from direct sunlight.

Touch-screen and instrument cluster

Clean the touch-screen and instrument cluster using a damp cloth/cleaning wipe. Do not use cleaning compounds or solutions.

FLOOR MATS

 **WARNING:** To avoid potential pedal interference that may result in a collision or injury, ensure that the driver's floor mat is securely retained.

 **WARNING:** Never place another floor mat on top of the driver's floor mat.

The use of genuine Fisker floor mats can extend the life of your vehicle carpet and make it easier to clean the interior. Mats should be maintained with regular cleaning and replaced if they become excessively worn.



VEHICLE STORAGE

! *WARNING: Always wear appropriate eye protection when working with the 12-volt battery. The battery contains acid, which is both corrosive and poisonous.*

! *WARNING: During normal use, the 12-volt battery emits explosive hydrogen gas - ensure sparks and naked lights are kept away from the battery.*

Vehicle preparation

Disconnect the 12-volt battery negative (-) cable connector under the hood to prevent the battery from becoming discharged. Alternatively, connect a battery trickle charger to maintain the battery voltage.

In addition, to avoid potential damage to the high voltage battery, perform the following recommended steps:

- Store the vehicle with the high voltage battery at 50% charge or less.
- Store the vehicle in an environment between 14°F (-10°C) and 86°F (30°C).

Note: Storing the battery at extreme temperatures can cause damage to the high voltage battery.

Remember to reconnect the 12-volt battery when ready to drive the vehicle.

Tire pressures during long term storage

To minimise the possibility and effects of flat spots during storage, the tires may be inflated to the maximum pressure indicated on the tire wall.

Note: The tire pressures should be reduced to the correct pressure before the vehicle is driven.



REPLACING A FUSE

! **WARNING:** Always make sure the affected electrical circuit is switched off and the vehicle is OFF, before replacing a fuse.

! **CAUTION:** Only use Fisker Automotive approved replacement fuses of the same rating and type, or fuses of matching specification. Using an incorrect fuse may result in damage to the vehicle's electrical system and can result in a fire

! **CAUTION:** If the replacement fuse blows after installation, the system should be checked by Fisker Automotive or your local Fisker Automotive Retailer.

Identify the fuse protecting the affected circuit, using the label on the inside of the fuse box cover or as shown on the following pages, and pull to remove. A break in the wire inside the fuse indicates that the fuse has blown.

Note: Fisker Automotive recommend that owners do not remove or replace relays. Failure of any of these items should be investigated by a qualified technician.

ENGINE COMPARTMENT FUSE BOX



Release the plastic cover by pressing the tab arrowed.

The fuse values and locations and the circuits protected are shown on the plastic cover.

FUSE SPECIFICATIONS

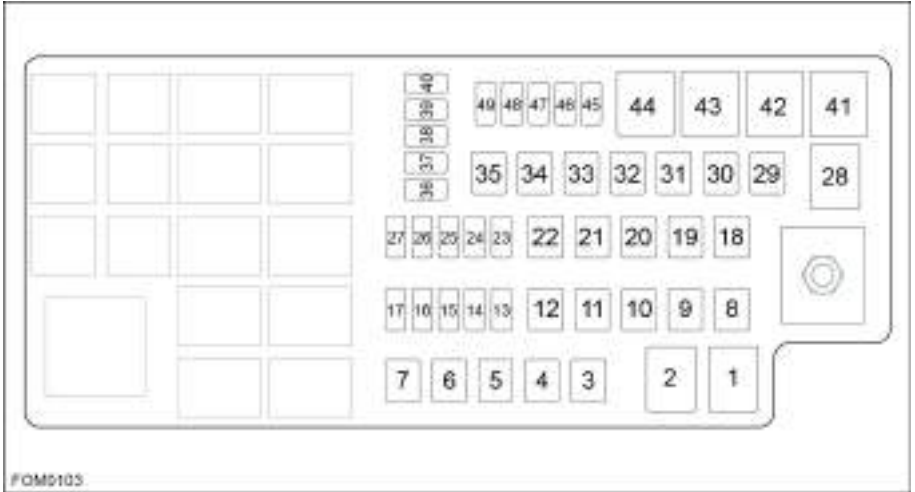

Fuse	Rating	Circuit protected
1	50 A	RH Cooling fan - Low temperature cooling system
2	50 A	LH Cooling fan - Low temperature cooling system
3	30 A	Windshield wipers and washers
4	25 A	Rear window defrost
5	20 A	Fuel pump relay
6	30 A	Subwoofer amplifier
7	25 A	Infotainment
8	30 A	Driver's power seat and seat memory
9	40 A	Passenger's power seat
10	40 A	Climate control
11	20 A	Coolant pump - Front
12	40 A	Power windows
13	15 A	Powertrain
14	15 A	Glove compartment, trunk and fuel filler cover switches. Evaporative emission control system.
15	20 A	Diagnostic socket
16	15 A	Air bag and Supplementary Restraint Systems (SRS)
17	10 A	Hybrid Control Unit



Fuse	Rating	Circuit protected
18	20 A	Coolant pump B - Rear
19	40 A	Vehicle Control Module (VCM) - Exterior lighting
20	40 A	Vehicle Control Module (VCM) - Exterior lighting
21	40 A	Vehicle Control Module (VCM) - Wipers, Fog lamp, Reversing lamp
22	40 A	Vehicle Control Module (VCM) - Interior lighting
23	10 A	Climate control
24	15 A	Electric drive components
25	20 A	Antilock Braking System (ABS), Power windows
26	20 A	Infotainment, Center channel amplifier
27	25 A	Solar roof
28	60 A	Antilock Braking System (ABS)
29	50 A	Antilock Braking System (ABS)
30	50 A	Cooling fan - Engine
31	30 A	Powertrain
32	20 A	Rear heated seats
33	20 A	Coolant pump A - Rear
34	20 A	Hybrid Control Unit (HCU), Power distribution
35	60 A	Feeds fuses 40, 46, 47, 48 and 49
36	15 A	Powertrain
37	10 A	Powertrain
38	20 A	Powertrain
39	10 A	Powertrain
40	20 A	Battery coolant pump
46	15 A	Exterior sound
47	10 A	Steering column adjustment, Exterior mirrors, Interior rear view mirror
48	30 A	High voltage charging
49	10 A	Hybrid Control Unit (HCU)



JACKING AND LIFTING THE VEHICLE

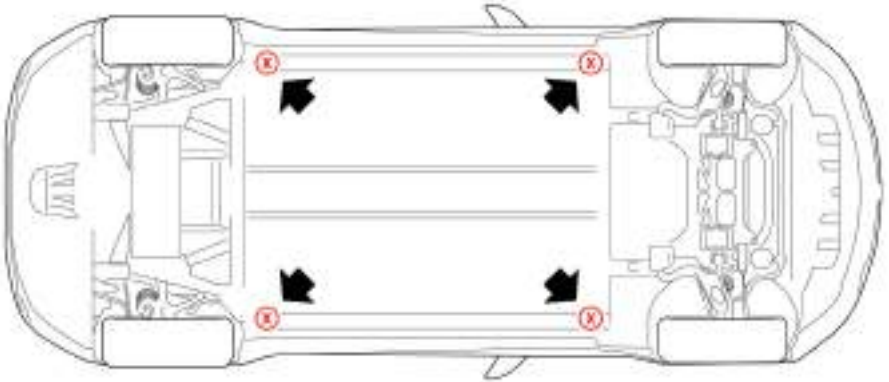

FCM5104

Refer to the illustration above to determine the correct position for lifting the vehicle with a jack or on a two post lift.

Please make sure that any non Fisker Automotive repair facility is aware of these lifting points.

! *CAUTION: These are the only approved lifting points for your vehicle. Lifting the vehicle at any other points may cause irreparable damage to the vehicle.*

! *CAUTION: The coolant lines for the electric drive system run in channels recessed into the floor of the vehicle. These channels are located approximately 2 inches (45 mm) from the lower edge of the rocker.*

! *CAUTION: Use a suitable rubber or wood pad to protect the body from surface damage.*

! *WARNING: Never raise the vehicle when the charge cable is connected, even if charging is not in progress. Always disconnect the charge cable before raising the vehicle.*



TRANSPORTING THE VEHICLE

! **CAUTION:** Towing the vehicle with the wheels on the ground, or on a suspended lift, may cause serious damage to the vehicle as well as generating high voltages in the vehicle's electrical components.

The only approved method of recovering or transporting your vehicle is using a flatbed trailer or transporter.

Note: Damage caused by any other recovery method will not be covered by the vehicle warranty.

ATTACHING THE VEHICLE RECOVERY EYE

! **CAUTION:** Under no circumstances should the vehicle be towed using the vehicle recovery eye. Doing so can cause significant damage to your vehicle.

A vehicle recovery eye can be attached to the front of the vehicle to allow the vehicle to be pulled onto a transporter in situations when the vehicle can roll freely.

The recovery eye is located in the under-floor storage area of the trunk.

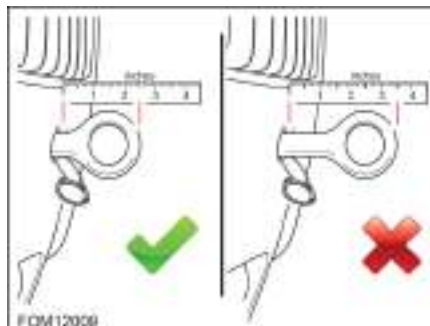

2. Locate the recovery eye through the bumper and screw into the fixing for 10 complete turns. Refer to the illustration above showing how the recovery eye should seat into the front of the vehicle.

Note: If the recovery eye cannot be rotated for 10 complete turns, remove the recovery eye and clean any debris from the threads before reinstalling.

! **CAUTION:** Failure to fit the recovery eye correctly, could result in the recovery eye pulling out of the front of the vehicle causing significant damage.

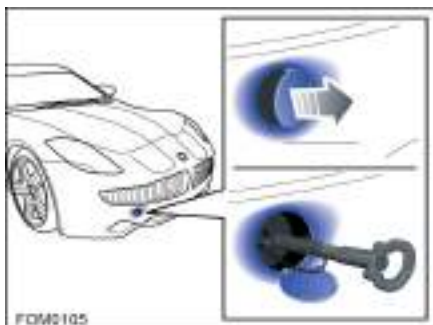

1. Using a flat bladed screwdriver, remove the cover in the front bumper.



SECURING THE WHEELS



When the vehicle is in position on the transporter or trailer, use chocks and tie down straps to secure the wheels.

To avoid damage:

- Ensure that metal parts on tie down straps do not contact the vehicle's painted surfaces or the face of any wheels.
- Do not place straps over or through the vehicle's body panels.

 **CAUTION:** *Attaching straps to the chassis, suspension or other parts of the body can damage the vehicle.*



Tire Care

- 8.2 INSPECTION AND MAINTENANCE
- 8.3 TIRE WEAR
- 8.4 TIRE PRESSURES
- 8.6 REPLACEMENT WHEELS AND TIRES
- 8.7 DRIVING IN LOW AMBIENT TEMPERATURES
- 8.7 WINTER TIRES AND TIRE CHAINS

Tire Pressure Monitoring System (TPMS)

- 8.8 TIRE PRESSURE MONITORING SYSTEM

Tire Repair Kit

- 8.10 TIRE REPAIR KIT
- 8.11 SAFETY PRECAUTIONS
- 8.11 USING THE TIRE REPAIR KIT
- 8.13 USING THE COMPRESSOR
- 8.13 REPLACING THE CANISTER/AIR HOSE ASSEMBLY

Tire Information

- 8.14 TIRE MARKINGS
- 8.16 UNIFORM TIRE QUALITY GRADING
- 8.17 LOADING THE VEHICLE
- 8.18 STEPS FOR DETERMINING CORRECT LOAD LIMIT

Glossary of Terms

- 8.20 WHEELS AND TIRES GLOSSARY



INSPECTION AND MAINTENANCE

! **WARNING:** *The tires should be regularly checked for wear and to make sure that there are no cuts, bulges or exposure of the ply/cord structure. Do not drive with tires which are worn, damaged or inflated to the incorrect pressure. The safety of the vehicle and occupants will be adversely affected.*

Always consider tire conditions when driving, and regularly inspect the tread and side walls for any sign of distortion (bulges), cuts or wear.

Good driving practice will improve the mileage you obtain from your tires, and avoid unnecessary damage.

- Always ensure that the tire pressures are correctly adjusted.
- Always observe the posted speed limits, and advisory speeds.
- Avoid pulling away quickly, or hard acceleration.
- Avoid making fast turns or braking sharply.
- Avoid potholes and objects in the road.
- Do not run over curbs or hit the tire against the curb when parking.

! **CAUTION:** *Avoid contaminating tires with vehicle fluids that can cause damage.*

Wheel alignment and tire balance

Unbalanced wheels (noticeable as vibration through the steering) may affect vehicle handling and tire life.

Note: If tire wear is uneven (on one side of the tire only) or becomes abnormally excessive, the wheel alignment should be checked.

Tire rotation

Because your vehicle is fitted with different size tires on the front and rear wheels, the tires can only be moved from side to side on the same axle pair (front or rear).

Punctured tires

! **WARNING:** *Do not drive the vehicle with a punctured tire. Even if the punctured tire has not deflated, it is unsafe to use as the tire may deflate suddenly at any time.*

Your vehicle is fitted with tubeless tires, which may not leak when penetrated, provided the object remains in the tire.

If, however, you feel a sudden vibration or ride disturbance while driving, or you suspect your tire or vehicle has been damaged, immediately reduce your speed. Drive slowly, while avoiding heavy braking or sharp steering and when safe to do so, stop the vehicle.

Inspect the tires for damage. If a tire is under-inflated and does not appear to have any damage to the sidewall, try to repair it using the tire repair kit. See *Tire Repair Kit, page 8.10*. If you cannot detect the cause or the tire is too heavily damaged, have the vehicle recovered to a tire repair center, or your local Fisker Retailer to have the vehicle inspected.

A puncture will eventually cause the tire to lose pressure, which is why frequent checking of tire pressures is important. Punctured or damaged tires must be permanently repaired or replaced as soon as possible.

Age degradation

Tires degrade over time due to the effects of ultraviolet light, extreme temperatures, high loads, and environmental conditions. It is recommended that tires are replaced every six years, but may require replacement more frequently.

TIRE WEAR

⚠ WARNING: *The tire wear indicators show the minimum tread depth recommended by the tire manufacturer. Tires which have worn to this point will have reduced grip and poor water displacement characteristics.*

The tires fitted to your Karma are moulded with a high grip compound and reduced tread depth to emphasise dry road traction and handling. The focus on dry road traction produces a tire that will not last as long as a general purpose tire. Drivers should expect significantly shorter tire life with these tires.



Tires fitted as original equipment have wear indicators moulded into the tread pattern.

As the tire tread wears down the indicators start appearing at the surface of the tread, producing the effect of a continuous band of rubber across the width of the tire.

A tire must be replaced as soon as an indicator band becomes visible or the tread depth reaches the minimum permitted by legislation.

Normal tire wear

The characteristics for normal tire wear on the Karma are defined as:

- A uniform thickness of usable rubber across the entire tread width of the tire.
- The tread depth at the shoulder 'rib' is reduced compared to the center of the tire. This helps the Karma achieve excellent steering and dry road handling performance.
- Under typical operating conditions, the shoulder rib may appear to be wearing at an accelerated rate. Depending on driving style, this may apply more to the front tires than the rear tires.

Note: Shoulder ribs will still have usable tread rubber, even though they appear worn.

⚠ CAUTION: *Karma tires are classified as a 'summer' tire and use a softer rubber compound for driving conditions above 50°F (10°C). Hard cornering and large steering angle manoeuvres will accelerate shoulder wear.*



Assessing tire wear



1. Locate wear indicator bars between adjacent tread ribs, they will align with one of the nine triangle indicators near the upper sidewall of the tire
2. Inspect the wear indicator bars closely, once they become flush with the road contact surface of the tire, replace tires immediately

Note: Your Fisker dealer will evaluate tire wear when servicing your vehicle.

TIRE PRESSURES

⚠ WARNING: *Tire pressures should be checked using an accurate pressure gauge when cold. Under-inflation is the most common cause of tire failures and may result in severe tire cracking, tread separation or “blowout”, with unexpected loss of vehicle control and increased risk of injury.*

Each tire, should be checked monthly when cold and inflated to the inflation pressure recommended by the vehicle manufacturer on the vehicle placard or tire inflation pressure label. (If your vehicle has tires of a different size than the size indicated on the vehicle placard or tire inflation pressure label, you should determine the proper tire inflation pressure for those tires).

⚠ As an added safety feature, your vehicle has been equipped with a tire pressure monitoring system (TPMS) that illuminates a low tire pressure telltale when one or more of your tires is significantly under-inflated. Accordingly, when the low tire pressure telltale illuminates, you should stop and check your tires as soon as possible, and inflate them to the proper pressure. See [TIRE PRESSURE MONITORING SYSTEM, page 8.8.](#)

Driving on a significantly under-inflated tire causes the tire to overheat and can lead to tire failure. Under-inflation also reduces Battery range and tire tread life, and may affect the vehicle’s handling and stopping ability.

Please note that the TPMS is not a substitute for proper tire maintenance, and it is the driver’s responsibility to maintain correct tire pressure, even if under-inflation has not reached the level to trigger illumination of the TPMS low tire pressure telltale.



Checking tire pressures

⚠ WARNING: *Pressure checks should only be carried out when the tires are cold and the vehicle has been stationary for more than three hours. A hot tire at or below recommended cold inflation pressure is dangerously under-inflated.*

⚠ WARNING: *If the vehicle has been parked in strong sunlight or used in high ambient temperatures, do not reduce the tire pressures. Move the vehicle into the shade and allow the tires to cool before checking.*

⚠ WARNING: *Do not exceed the maximum pressure stated on the sidewall of the tire. Over-inflation could cause the tire to fail suddenly.*

Check the pressures when the tires are cold. Air pressure increases in warm tires and it only takes 1 mile of driving to warm the tires sufficiently to affect the tire pressures. If it is necessary to check the tires when they are warm, you should expect the pressures to have increased. Do not let air out of warm tires in an attempt to match the recommended cold tire pressures.

Always inflate your tires to the pressures recommended by Fisker Automotive even if it is different from the maximum inflation pressure information found on the tire itself. For the correct tire pressures, refer to the [Tire and loading information label / vehicle placard, page 8.17.](#)

The following procedure should be used to check and adjust tire pressures:

1. Remove the cap from the valve, then firmly press the tire gauge onto the valve and measure the pressure.
2. If required add air to reach the required pressure.
3. Check the pressure by removing the tire gauge and then re-attaching it. Failure to remove and re-attach the gauge to the valve could cause the gauge to show an incorrect reading.
4. If the tire pressure is too high, remove the gauge and allow air out of the tire by pressing the center of the valve. Refit the gauge to the valve and check the pressure.
5. Repeat the process adding or removing air as required until the correct tire pressure is reached.
6. Refit the valve cap.

Note: It is an offense in certain countries to drive a vehicle with incorrect tire pressures.

Tire valves

Keep the valve caps screwed down firmly to prevent water or dirt entering the valve. Check the valves for leaks when checking the tire pressures.

Flat spots

If the vehicle is stationary for a long period, when the ambient temperature is high, the tires may form flat spots. When the vehicle is driven, these flat spots will cause a vibration which will steadily disappear as the tires warm up and regain their original shape.



REPLACEMENT WHEELS AND TIRES

! *WARNING: For your safety, it is recommended that only wheels and tires that match the original specification are used on the vehicle.*

! *WARNING: Operation of the TPMS may be affected if the tires are replaced with a different specification to the originals.*

Wheel rims and tires are matched to suit the handling characteristics of the vehicle. Always check that replacement tires comply with the original specification. If tires other than those specified are used, ensure that the load and speed ratings (shown on the tire side wall) equal or exceed those of the original specification.

For the specification of the original wheels and tires installed on the Karma, refer to [Wheels and Tires, page 9.5](#).

Ideally, tires should be replaced as sets of four. If this is not possible, replace the tires in pairs (front and rear). When tires are replaced, the wheels should always be re-balanced and alignment checked.

Asymmetric tires

! *WARNING: Road holding will be seriously impaired if the tires are incorrectly installed on the wheels.*



Your vehicle is fitted with asymmetric tires which must be mounted on the wheel with the correct sidewall facing outwards from the vehicle. In this case, the sidewall of the tire is marked with the words **THIS SIDE OUTWARDS**. Equally the inward facing sidewall is marked **THIS SIDE INWARDS**.

When new tires have been installed, always make sure that the tires are correctly orientated to the wheel.



DRIVING IN LOW AMBIENT TEMPERATURES

The tires fitted to your Karma are specially formulated summer tires that are not intended to be driven in near-freezing temperatures, through snow or on ice.

Tire performance reduces in low ambient temperatures, resulting in less grip and an increased susceptibility to damage from impacts. When driving in sustained temperatures below 50°F (10°C), it is recommended that winter tires are fitted.

WINTER TIRES AND TIRE CHAINS

Winter tires

 **WARNING:** Always adhere to the tire manufacturer's instructions, paying particular attention to the maximum speed at which the vehicle can be driven and the correct tire pressures.

 **CAUTION:** Winter tires should not be installed on the standard production wheels fitted to your vehicle. The installation of winter tires may cause interference issues with chassis and body components.

Fisker Automotive has designed a winter wheel and tire combination specifically for your vehicle. Please contact your local Fisker Retailer for information on how to purchase these wheels and tires.

Generally, winter tires have lower speed ratings than factory equipped tires and may not match the potential maximum vehicle speed. Never exceed the maximum speed rating of the tire.

If you install winter tires, they must be the same size, brand, construction and tread pattern for an axle pair (front and rear).

Tire chains

 **WARNING:** Tire chains must only be used in conjunction with the Fisker approved winter wheels and tires.

 **CAUTION:** To avoid possible damage to the vehicle, only use very low profile tire chains, or cable type chains. SAE class "S" chains are the largest style tire chains that should be used.

Use of tire chains may be prohibited according to location. Check the local laws before installing tire chains.

When installing tire chains, make sure they are the proper size for the tires on your vehicle and are installed according to the chain manufacturer's suggestions.

When using tire chains:

- Drive at a reduced speed.
- Avoid fully loading your vehicle as this will reduce the clearance between the body and the wheels.
- Avoid tire/vehicle damage by removing the tire chains as soon as the conditions allow.

Contact your local Fisker Retailer for a list of approved tire chains and manufacturers.



TIRE PRESSURE MONITORING SYSTEM

! *WARNING: The TPMS is not a substitute for manually checking tire pressures. The TPMS only provides a tire pressure warning and does not re-inflate the tires.*

! *WARNING: The TPMS cannot register damage to a tire. Regularly check the condition of your tires.*

! *WARNING: Do not use any tire liquid or aerosol tire sealant other than the one supplied with the vehicle, as this may cause a malfunction of the tire pressure sensors.*



The Tire Pressure Monitoring System (TPMS) monitors the pressure of the tires using sensors located in each wheel and receivers located within the vehicle. The sensors communicate with the receiver using Radio Frequency (RF) signals.

Note: Installing accessories that are not approved by Fisker Automotive may interfere with the TPMS system.

(U) Tire pressure warnings are displayed on the instrument panel using an amber warning indicator (telltale).

The tire pressure warning indicator will illuminate if a tire is under or over inflated.

If the tire pressure warning indicator illuminates, stop and check your tires as soon as possible and inflate them to the correct pressure. If the tire pressure warning occurs frequently, the cause must be determined and rectified.

Determining which tire is incorrectly inflated

When the tire pressure warning indicator is illuminated, you can use the vehicle's touch-screen to determine which tire sensor has reported the problem.

 To view the tire pressure information, touch the **SYSTEM** icon on the touch-screen.

 Then touch the **DIAG** icon on the touch-screen.



Touch the **TIRES** icon.



The incorrectly inflated tire will be highlighted in Orange.



TPMS malfunction

Your vehicle has also been equipped with a TPMS malfunction indicator to indicate when the system is not operating properly

The TPMS malfunction indicator is combined with the tire pressure telltale. When the system detects a malfunction, the indicator will flash for approximately one minute and then remain continuously illuminated. This sequence will continue upon subsequent vehicle start-ups as long as the malfunction exists.

When the malfunction indicator is illuminated, the system may not be able to detect or signal low tire pressure as intended. TPMS malfunctions may occur for a variety of reasons, including the installation of replacement or alternate tires or wheels on the vehicle that prevent the TPMS from functioning properly. Always check the TPMS malfunction indicator after replacing one or more tires or wheels to ensure that the replacement or alternate tires and wheels allow the TPMS to function properly.

Note: If a tire has been replaced, or repaired using a different tire sealant from the one supplied with the vehicle, and a low tire pressure is detected, it is possible that the tire sensor has been damaged. Please contact your local Fisker Retailer to have the fault rectified as soon as possible.

Tire pressure correction

The tire pressure indicator light does not automatically turn off when the tire pressure is adjusted for all 4 tires.

After the tires are inflated to the correct pressures, the vehicle must be driven above 19 mph (30 km/h) for more than 10 minutes to activate the TPMS and turn off the low tire pressure indicator light.

Tire changing

Always have your tires serviced or changed by a qualified technician.

Care must be taken to avoid contact between the bead of the tire and the sensor during removal and refitting of the tire, otherwise the sensor may become damaged and or inoperable.

Replacing a tire sensor

If you are experiencing frequent low tire pressure warnings and the tire pressures are correct, the system should be checked by your local Fisker Retailer to determine if a tire sensor requires replacement.

If a tire sensor is replaced, it must be programmed to the vehicle before it will register the correct tire pressure on the system.

Type approval

The TPMS devices comply with Part 15 of the FCC rules and RSS-210. Operation is subject to the following two conditions:

1. This device may not cause harmful interference.
2. This device must accept interference received, including interference that may cause undesired operation.

USA FCC ID:	KOBET11TPM
Canada IC:	3521A-ET11TPM



TIRE REPAIR KIT

Your vehicle has no spare tire. Instead, you have been provided with a tire repair kit located in the storage space beneath the trunk floor.



The tire repair kit consists of a canister of tire sealant and a compressor.

Note: The canister only contains enough sealant to seal one tire.

The tire sealant contains liquid latex and a propellant. When injected into the tire through the valve, the liquid latex penetrates the puncture site and cures to form a temporary repair.

Note: The kit can only be used to repair small punctures in the tire tread. In the event of punctures larger than 1/4 inch (6 mm), severe tread damage, a damaged sidewall, ripped tires or tires that have come off the rim, please contact your Roadside Assistance provider.

You are advised to have the tire repaired or replaced as soon as possible.

! *CAUTION: Do not drive on a deflated tire as this can cause serious damage to the wheel and the vehicle. If the tire is too badly damaged, call Roadside Assistance to have the vehicle transported to a repair facility.*

Tire sealant

! *WARNING: Always read and follow the safety and handling instructions on the label adhered to the sealant canister.*

The tire sealant supplied as part of the tire repair kit has an expiration date printed on the outside of the canister. Always replaced an expired tire sealant canister. If the tire sealant has passed its expiration date, it may not work as expected when you need to use it in an emergency.

The tire sealant should always be replaced with one of the same type and capacity. This tire sealant has been approved for use with your vehicle and will not damage the TPMS sensors.

Tire sealant canisters are available from all Fisker Automotive Retailers.

Note: The sealant/air hose assembly will need to be replaced after each use. See [REPLACING THE CANISTER/AIR HOSE ASSEMBLY, page 8.13.](#)



SAFETY PRECAUTIONS

⚠ WARNING: Under no circumstances should speeds of 55 mph (90 km/h) be exceeded while driving with a repaired tire.

⚠ WARNING: Never drive with a deflated tire, vehicle handling and braking will be compromised.

⚠ WARNING: Always read the directions and warnings on the tire sealant before starting a repair. Follow the directions on the canister exactly and pay attention to the following precautions.

⚠ WARNING: Always keep the tire sealant out of the reach of children.

⚠ WARNING: The tire sealant contains components which are harmful if consumed or inhaled:

- If swallowed, do not induce vomiting. Seek medical assistance immediately.
- If inhaled, breathe fresh air. If breathing is affected, seek medical assistance immediately.
- If the sealant comes into contact with the eyes, immediately flush the eyes with water. If irritation persists, seek medical assistance.
- Do not breathe gas, fumes, vapor or spray that may be emitted from the tire sealant. Inhalation can cause drowsiness and dizziness.

⚠ WARNING: Store the tire sealant in its correct location in the trunk. Temperatures in other locations may exceed safe storage conditions.

USING THE TIRE REPAIR KIT

If possible, stop in a safe place away from traffic. Always ask passengers to wait in a safe area away from traffic. Switch on the hazard warning flashers to alert other road users, then follow these steps.

1. If possible, position the wheel with puncture at the bottom.



2. Release the clear plastic hose from around the base of the tire compressor taking care to ensure the sealant canister remains in place.
3. Detach the 12V power supply connector and plug into one of the vehicle's accessory power supply sockets.



4. Screw the end of the hose to the tire valve.



5. Ensure the compressor is standing upright with the pressure gauge facing up.



11. Check the tire pressure once again and inflate if necessary using the black hose located in the bottom of the compressor.



6. Turn on the compressor to inject sealant and air into the tire.

Note: The pressure gauge will initially show a high pressure while the compressor pushes the sealant into the tire. Once the sealant is completely dispersed into the tire, the pressure will quickly drop and start to rise again as the tire inflates with air only.

7. Monitor the tire pressure gauge and inflate the tire to the recommended tire pressure.
8. Turn off the compressor and remove the hose from the tire valve.
9. Wipe of any excess sealant from the tire valve and wheel rim.
10. If the wheel rim has lifted from the ground, drive immediately for 5 miles (8 km) to distribute the sealant around the tire. Do not exceed 25 mph (40 km/h).

12. Apply the warning label supplied with the tire repair kit to a prominent area in the vehicle to remind you not to exceed 55 mph (90 km/h) until the tire has been professionally repaired or replaced.

13. Dispose of the used sealant canister and sealant/air hose assembly at a local Fisker Automotive Retailer.

14. Replace the tire sealant canister and sealant/air hose assembly. See [REPLACING THE CANISTER/AIR HOSE ASSEMBLY, page 8.13.](#)

⚠ WARNING: *If the required pressure cannot be reached after approximately 25 minutes, or the wheel rim has not risen from the ground, then the tire is too severely damaged for a safe repair. Call Roadside Assistance to have the vehicle transported. Do not drive!*



USING THE COMPRESSOR

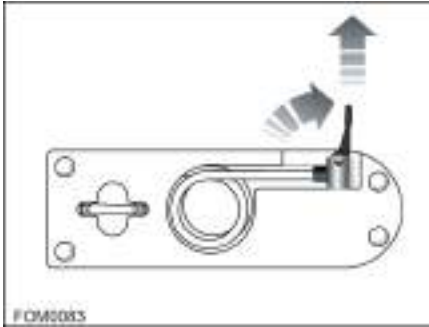

1. Release the black air only hose from the sealant canister on the base of the tire compressor.
2. Detach the 12V power supply connector and plug into one of the vehicle's accessory power supply sockets.



3. Attach the air only hose to the tire valve and press the lever down to secure it in place.
4. Ensure the compressor is standing upright with the pressure gauge facing up.
5. Turn on the compressor to inflate the tire.

REPLACING THE CANISTER/AIR HOSE ASSEMBLY

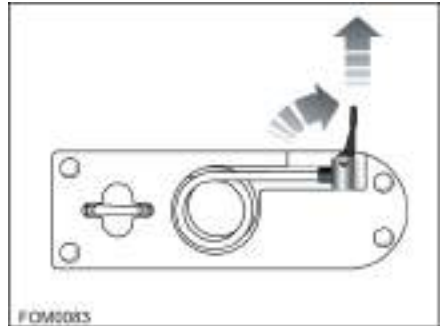

1. Release the black air only hose from the sealant canister on the base of the tire compressor.
2. Unwrap the clear sealant/air hose from the compressor.

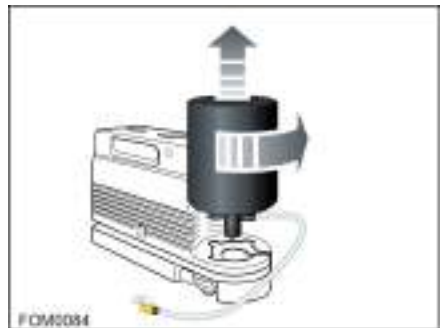

3. Rotate the sealant canister so the clear sealant/air hose is aligned with the slot in the compressor.
4. Lift the canister/air hose assembly from the compressor.

Note: Installation of the new canister is the reverse of the removal process.



TIRE MARKINGS



Federal law requires tire manufacturers to place standardized information on the sidewall of all tires. This information identifies and describes the fundamental characteristics of the tire and also provides the tire identification number (TIN) for safety standard certification and in case of a recall.

1. Tire category

P indicates that the tire is for passenger vehicles

2. Tire width

This three digit number gives the width in millimeters of the tire from sidewall edge to sidewall edge.

3. Aspect ratio

This two digit number, known as the aspect ratio or profile, gives the sidewall height as a percentage of the tread width. So, if the tread width is 205 mm, and the aspect ratio is 50, the sidewall height will be 102 mm.

4. Tire construction

R indicates that the tire is of Radial ply construction.

5. Wheel diameter

This two digit number is the diameter of the wheel rim in inches.



6. Load index

This two or three digit number is the tire's load index. It is a measurement of how much weight each tire can support. This number is not always shown.

7. Speed rating

The speed rating, when stated, denotes the maximum speed at which the tire should be used for extended periods. The ratings range from 99 mph to 186 mph. These ratings are listed in the following table.

Rating	Speed mph (km/h)
Q	99 (160)
R	106 (170)
S	112 (180)
T	118 (190)
U	124 (200)
H	130 (210)
V	149 (240)
W	168 (270)
Y	186 (300)

8. U.S DOT Tire Identification Number (TIN)

This begins with the letters **DOT** and indicates that the tire meets all federal standards. The next two numbers or letters are the plant code where it was manufactured, and the last four numbers represent the week and year the tire was built. For example, the numbers **1710** means the 17th week of 2010. The other numbers are marketing codes used at the manufacturer's discretion. This information can be used to contact consumers if a tire defect requires a recall.

9. Maximum permissible inflation pressure

The maximum inflation pressure for the tire. This pressure should not be used for normal driving.

10. Treadwear grade

This number indicates the tire's wear rate. The higher the treadwear number is, the longer it should take for the tread to wear down. A tire rated at **400** for example, will last twice as long as a tire rated at **200**.

11. Traction grade

This letter indicates a tire's ability to stop on wet pavement. A higher graded tire should allow you to stop your vehicle on wet roads in a shorter distance than a tire with a lower grade.

Traction is graded from highest to lowest as **AA, A, B, and C**.

12. Temperature grade

Heat resistance grading. The tires resistance to heat is grade **A, B, or C**, with **A** indicating the greatest resistance to heat. This grading is provided for a correctly inflated tire, which is being used within its speed and loading limits.

13. Tire composition and materials

The number of plies in both the tread area, and the sidewall area, indicates how many layers of rubber coated material make up the structure of the tire. Information is also provided on the type of materials used.

14. Maximum tire load

The maximum load which can be carried by the tire.



UNIFORM TIRE QUALITY GRADING

United States Department of Transportation/Uniform Tire Quality Grade

The following information relates to the tire grading system developed by the National Highway Traffic Safety Administration (NHTSA) which will grade tires by tread wear, traction and temperature performance.

Note: Tires that have deep tread, and winter tires, are exempt from these marking requirements.

Quality grades, where applicable, can be found on the tire sidewall between the tread shoulder and maximum section width.

For example:

Treadwear	Traction	Temperature
200	AA	A

In addition to the marking requirements, passenger car tires must conform to Federal Safety Requirements.

Treadwear

The treadwear grade is a comparative rating based on the wear rate of the tire when tested under controlled conditions on a specified government test course.

For example; a tire graded **150** would wear one and a half (1.5) times as well on a government test course as a tire graded **100**. The relative performance of tires depends on the actual conditions of their use, however, and may depart significantly from the norm due to variations in driving habits, service practices, and differences in road characteristics and climate.

Traction

! *WARNING: The traction grade assigned to this tire is based on straight-ahead braking traction tests, and does not include; acceleration, cornering, hydroplaning or peak traction characteristics.*

The traction grades, from highest to lowest, are; **AA, A, B,** and **C**. These grades represent a tire's ability to stop on a wet pavement as measured under controlled conditions on specified government test surfaces of asphalt and concrete. A tire marked **C** may have poor traction performance.

Temperature

! *WARNING: The temperature grade for this tire is established for a tire that is properly inflated and not overloaded. Excessive speed, under-inflation, or excessive loading, either separately or in combination, can cause heat buildup and possible tire failure.*

The temperature grades are **A** (the highest), **B,** and **C,** representing the tire's resistance to the generation of heat and its ability to dissipate heat when tested under controlled conditions on a specified indoor laboratory test wheel.

Sustained high temperature can cause the material of the tire to degenerate and reduce tire life, and excessive temperature can lead to sudden tire failure.

The grade **C** corresponds to a level of performance which all passenger car tires must meet under the Federal Motor Safety Standard (FMVSS) No. 109.

Grades **B** and **A** represent higher levels of performance on the laboratory test wheel than the minimum required by law.



LOADING THE VEHICLE

⚠ WARNING: *Overloading the vehicle will have an adverse effect on braking and handling characteristics, which could compromise your safety or damage the vehicle.*

It is important to understand how much weight your vehicle can safely carry. This weight is called the vehicle capacity weight and includes the weight of all occupants, cargo and any additional equipment fitted to the vehicle since it was manufactured.



There are two labels affixed to your vehicle that state how much weight your vehicle can safely carry:

1. Tire and loading information label.
2. Vehicle certification label.

With the driver's door open, these labels are located on the center door post.

Tire and loading information label / vehicle placard



The tire and loading information label contains the following information:

- The maximum number of occupant seating positions.
- The maximum vehicle capacity weight in kilograms (kg) and pounds (lbs).
- The size of the tires originally fitted to the vehicle.
- The cold inflation pressures for the original specification of front and rear tires.

The stated tire pressures provide optimum ride and handling characteristics for all normal operating conditions.

Note: This label must not be changed, even if different wheels are fitted at a later stage.



Vehicle certification label

! *CAUTION: To prevent serious damage to the vehicle, never load the vehicle so that it is heavier than GVWR or exceed the individual GAWR weights. Heavy loads should be evenly distributed throughout the vehicle.*



The vehicle certification label contains the following information:

- **GVWR - Gross Vehicle Weight Rating.**
The GVWR is the maximum allowable total mass of the vehicle. This is calculated as the weight of the vehicle, all passengers, fuel and cargo.
- **GAWR FR and GAWR RR - Gross Axle Weight Rating for the front and rear axles.**
The GAWR is the maximum distributed weight that may be supported by an axle on the vehicle.

Carrying items

! *WARNING: The trunk is the preferred place to carry objects. In an accident, during hard braking, or sudden maneuvers, loose items carried in the vehicle's cabin area can be thrown around, and cause injury to occupants unless securely fastened.*

Towing a trailer

! *WARNING: Do not tow a trailer with your vehicle. The Karma has not been designed to have a trailer hitch fitted to it. The installation of a trailer hitch may cause serious damage to the vehicle which could result in an accident or serious injury.*

STEPS FOR DETERMINING CORRECT LOAD LIMIT



1. Locate the statement "The combined weight of occupants and cargo should never exceed XXX kg or XXX lbs" on your vehicle's placard (Tire information and loading label).
2. Determine the combined weight of the driver and passengers that will be riding in your vehicle.
3. Subtract the combined weight of the driver and passengers from XXX kg or XXX lbs.
4. The resulting figure equals the available amount of cargo and luggage load capacity. For example, if the "XXX" amount equals 1400 lbs, and there will be five 150 lb passengers in the vehicle, the amount of available cargo and luggage capacity is 650 lbs. ($1400 - 750 (5 \times 150) = 650$ lbs)
5. Determine the combined weight of luggage and cargo being loaded on the vehicle. That weight may not safely exceed the available cargo and luggage load capacity calculated in Step 4.





Example load limit calculations

The number and weight of passengers will affect the cargo and luggage load capacity. The following are typical examples of calculated load limits.

Example 1:

Item	Description	Total
	Vehicle Capacity Weight =	750 lbs
	Subtract Occupant Weight (2 x 150 bs) =	300 lbs
	Available Cargo or Occupant Weight =	450 lbs

Example 2:

Item	Description	Total
	Vehicle Capacity Weight =	750 lbs
	Subtract Occupant Weight (4 x 150 bs) =	600 lbs
	Available Cargo or Occupant Weight =	150 lbs

Note: If the passengers weigh more, the available cargo capacity will decrease.



WHEELS AND TIRES GLOSSARY

Accessory weight

The combined weight (in excess of those items replaced) of items available as factory installed equipment.

Bead

The inner edge of a tire that is shaped to fit to the rim and form an air tight seal. The bead is constructed of steel wires which are wrapped, or reinforced, by the ply cords.

Cold tire pressure

The air pressure in a tire which has been standing in excess of three hours, or driven for less than one mile.

Curb weight

The weight of a standard vehicle, including a full tank of fuel, any optional equipment fitted, and with the correct fluid levels.

Gross vehicle weight

The maximum permissible weight of a vehicle with driver, passengers, load, luggage, and equipment.

kPa (kilo Pascal)

A metric unit used to measure pressure. One kilo Pascal equals approximately 0.145 psi.

Maximum inflation pressure

The maximum pressure to which the tire should be inflated. This pressure is given on the tire side wall in psi (lbf/in²) and kPa.

Note: This pressure is the maximum allowed by the tire manufacturer. It is not the pressure recommended for use.

Maximum loaded vehicle weight

The sum of curb weight, accessory weight, vehicle capacity weight, and production options weight.

Production options weight

The combined weight of options installed which weigh in excess of 3 lbs (1.4 kg) more than the standard items that they replaced, and are not already considered in curb or accessory weights.

PSI (lbf/in²)

Pounds per square inch, an imperial unit of measure for pressure.

Rim

The metal support for a tire, or tire and tube, upon which the tire beads are seated.

Vehicle capacity weight

The number of seats multiplied by 150 lbs (68 kg) plus the rated amount of load/luggage.



Vehicle and Component Identification

- 9.2 VEHICLE IDENTIFICATION NUMBER (VIN)
- 9.2 ENGINE IDENTIFICATION NUMBER

Vehicle Dimensions and Weights

- 9.3 DIMENSIONS
- 9.4 VEHICLE WEIGHTS

Wheels and Tires

- 9.5 WHEEL SPECIFICATIONS
- 9.5 TIRE SPECIFICATIONS
- 9.5 TIRE PRESSURES

Subsystem Specifications

- 9.6 ENGINE
- 9.6 TRACTION MOTORS
- 9.6 PROPULSION UNIT/DIFFERENTIAL
- 9.7 STEERING
- 9.7 FRONT SUSPENSION
- 9.7 REAR SUSPENSION
- 9.8 BRAKES
- 9.8 BATTERY - 12V
- 9.8 BATTERY - HIGH VOLTAGE



VEHICLE IDENTIFICATION NUMBER (VIN)

If you need to communicate with Fisker Automotive, you may be asked to quote the Vehicle Identification Number (VIN).

You can find the VIN in the following locations:



- Top of dashboard - the VIN is stamped on a plate which is visible through the lowest part of the left-hand side of the windshield.

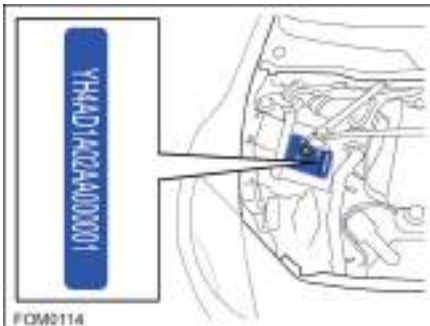

- Chassis - the VIN is stamped on the vehicle chassis, and is visible on the right-hand front suspension mounting in the engine compartment.

Note: The VIN is also displayed on the vehicle certification label. See [Vehicle certification label](#), page 8.18.

ENGINE IDENTIFICATION NUMBER

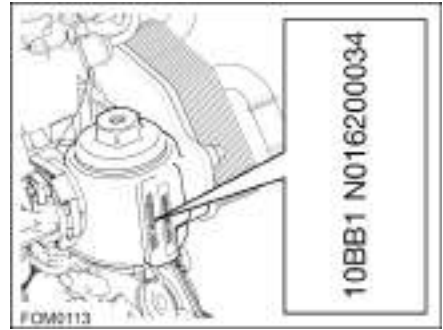

The engine identification number is located on the side of the engine oil filter housing.



DIMENSIONS



A	Overall length	196.8 in	4998 mm
B	Overall width (including mirrors)	84.0 in	2133 mm
C	Overall height	52.4 in	1330 mm
D	Wheel base	124.4 in	3160 mm
E	Front overhang	35.9 in	913 mm
F	Rear overhang	36.4 in	925 mm
G	Ground clearance	5.3 in	135 mm
H	Track - Front	66.6 in	1692 mm
	Track - Rear	67.0 in	1701 mm
	Approach angle	11.4°	
	Departure angle	20.0°	
	Breakover angle	9.9°	



VEHICLE WEIGHTS

Curb weight (full fuel tank, correct fluid levels, no occupants or cargo)	5300 lb.	2405 kg
Gross Vehicle Weight Rating	Refer to the vehicle certification label. See <i>Vehicle certification label, page 8.18.</i>	
Gross Axle Weight Rating - Front		
Gross Axle Weight Rating - Rear		
Trailer towing	Not permissible	



WHEEL SPECIFICATIONS

Wheel type	Location	Size
<i>Standard production wheels</i>		
5 Spoke, Cast Alloy	Front	8.5J x 22
	Rear	9.5J x 22
<i>Optional winter tire wheels</i>		
5 Spoke, Cast Alloy	Front	8.5J x 21
	Rear	9.0J x 21
Road wheel nut torque	190 Nm	140 lbf.ft
Note: For details on where to lift the vehicle, see Raising the Vehicle, page 7.21 .		

TIRE SPECIFICATIONS

Tire type	Location	Size
<i>Standard production tires</i>		
GOODYEAR EAGLE F1 SUPERCAR	Front	255/35 R22 99W
	Rear	285/35 R22 102W
<i>Optional winter tires</i>		
YOKOHAMA W* DRIVE	Front	245/40 R21
	Rear	265/40 R21

TIRE PRESSURES

Tire	Recommended cold inflation pressures	
<i>Standard production tires</i>		
Front	Refer to tire information label, see Tire and loading information label / vehicle placard, page 8.17 .	
Rear		
<i>Optional winter tires</i>		
Front	40 PSI	275 kPa (2.76 bar)
Rear	36 PSI	248 kPa (2.48 bar)



ENGINE

Type	GM L4 Ecotec engine. DOHC with variable valve timing. Turbocharged.
Displacement	122 ci (1998 cc)
Number of cylinders	4 in line
Firing order	1-3-4-2
Bore	3.39 in (86 mm)
Stroke	3.39 in (86 mm)
Compression ratio	9.25:1
Fuel system	Direct injection
Spark plug type	AC Delco IRIDIUM 41-108
Spark plug gap	0.035 in (0.90 mm)
Fuel	UNLEADED fuel. Refer to the label on the inside of the fuel filler cover for the Octane rating recommended for your vehicle.

TRACTION MOTORS

Type	2 x high voltage motors. Aluminum casings. Water cooled.
Rating	333 Volts
Maximum speed	6300 rpm

PROPULSION UNIT/DIFFERENTIAL

Type	Water cooled, single speed.
Reverse mode	Reverse direction of motors, limited to 30 mph (48 km/h)
Final drive ratio	4.1:1



STEERING

Type	Rack and pinion with electro hydraulic power steering system and variable sensitivity.
Number of turns lock to lock	2.8
Turning circle (curb to curb)	12.45 m (40 ft 10 in)

FRONT SUSPENSION

Type	Independent. Co-axial coil spring/telescopic damper. Sway bar.	
Alignment	optimum	0.1°
	tolerance	± 0.2°
Camber	optimum	-0.5° per side 0.0° side to side
	tolerance	± 0.5° per side ± 0.5° side to side
Caster	optimum	6.0° per side 0.0 side to side
	tolerance	± 0.5° per side ± 0.7° side to side

REAR SUSPENSION

Type	Independent. Co-axial coil spring/telescopic damper. Sway bar.	
Alignment	optimum	0.1°
	tolerance	± 0.2°
Camber	optimum	-1.25° per side 0.0° side to side
	tolerance	± 0.5° per side ± 0.5° side to side



BRAKES

Type	Electro hydraulic brake boost unit with integrated chassis control function. Anti-lock Braking System (ABS). Advanced regenerative blended brake system.
Calipers	Front: Six piston monoblock Rear: Four piston
Rotors	Ventilated front and rear rotors. Front: 370 mm diameter Rear: 365 mm diameter
Parking brake	Electrically actuated cable operation of parking brake.
Brake pedal free travel	Not adjustable

BATTERY - 12V

Type	VARTA E39. Maintenance free, sealed for life.
Rating	70 Amp/hr. Cold Cranking Amps (CCA): 760.
Voltage and polarity	12V. Negative (-) ground

BATTERY - HIGH VOLTAGE

Type	Lithium ion (Li-ion) with Nanophosphate™ technology
Weight	606 lb. (275 kg)
Rating	20 kWh (Peak)
Voltage and polarity	333V DC. Negative (-) ground



A

ABS 5.25
Accessing your vehicle 3.2
Accessory mode 5.20
Accessory power outlets 5.38
Air bags
 Deactivation 4.15
 Deployment effects 4.15
 Disposal information 4.17
 General information 4.13
 Locations in vehicle 4.13
 Obstruction of air bags 4.15
 Safety information 4.14
 Service information 4.17
 Vehicle modification information ... 4.17
 Warning indicator 4.16
 Warning labels 4.16
 Warnings 4.15
Air conditioning 5.16
Air distribution 5.14
Air recirculation 5.14
Air vents 5.18
Alternative fuels 6.11
Anti-lock braking (ABS) 5.25
Approved fluids and capacities 7.11
Attention symbols 1.2
Automatic climate control 5.15
Auxiliary input jack (AUX) 5.38

B

Battery charge level indicator 5.2
Battery range 5.2
Blower speed control 5.14
Brake fluid level 7.7
Brake fluid replacement 7.2
Brake warning indicator 5.27
Brakes
 Anti-lock (ABS) 5.25
 Emergency braking 5.26
 Parking brake 5.27
 Regenerative braking 5.26
 Specifications 9.8

C

Cabin air filter 5.18
California specific information
 Perchlorate advisory 1.4
 Proposition 65 1.4
Camera 5.33
Car covers 7.14
Car washes 7.13
Central door locking 3.5
Charging
 Charging cord 6.3
 Charging cord compliance 6.3
 Charging port 6.3
 Charging time 6.8
 Cold weather considerations 6.8
 Connecting the charge cord 6.6
 Electrical requirements 6.4
 EV charge station 6.8
 High voltage battery 6.2
 Status indicators 6.5
 Use of extension cords 6.4
Child passengers 4.9
Child restraint systems 4.10
Child restraints 4.9
 LATCH 4.10
 Non LATCH 4.10
 Top tether 4.11
Child safety locks 3.5
Child seat air bag hazard 4.16
Child seats 4.9
Cleaning
 Exterior 7.13
 Interior 7.15
 Rear view camera 5.33
 Removing tar 7.13
 Solar roof 7.14
 Underneath the vehicle 7.13
 Wheels 7.13
Climate control 5.14
Collision repairs 1.3
Compass 5.11
Connecting a media player 5.38



- Contact information
- Fisker Automotive 1.6
 - NHTSA 1.6
 - Transport Canada 1.6
- Coolant levels 7.9
- Coolant replacement 7.2
- Covering the vehicle 7.14
- Cruise control 5.29
- Curtain air bags 4.14
- Customer service 1.6
- D**
- Dashboard overview 2.3
- Data recording 1.5
- Daytime running lights 5.7
- Defrosting 5.18
- Dimensions 9.3
- Document applicability 1.2
- Doors
- Automatic locking 3.5
 - Exterior door release 3.5
 - Interior door release 3.5
 - Locking 3.5
 - Manual door release 3.6
 - Unlocking with key 3.6
- Drive away locking 3.5
- Drive mode 5.20
- Driver's seat memory 4.4
- Dual zone temperature control 5.16
- E**
- Emergency door opening 3.6
- Emergency flashers 5.8
- Emergency unlocking 3.6
- Engine compartment 7.5
- Engine identification number 9.2
- Engine oil level 7.6
- Entry Gates 5.37
- Ethanol fuels 6.11
- Event data recording 1.5
- Exterior
- Dimensions 9.3
 - Overview 2.2
- Exterior lights 5.7
- Exterior mirror fold 5.11
- Exterior mirrors 5.10
- Exterior sound 5.31
- External temperature gauge 5.2
- F**
- Flat tire repair 8.10
- Flatbed transporting 7.22
- Floor mats 7.16
- Fresh air 5.17
- Front suspension specifications 9.7
- Fuel filler 6.10
- Fuel gauge 5.2
- Fuel safety information 6.10
- Fuel specification 6.11
- Fuel tank capacity 6.11
- Fuse box 7.18
- Fuse specifications 7.19
- G**
- Garage door opener 5.36
- Glove compartment 3.8
- Ground clearance 9.3
- H**
- Hauling your vehicle 7.22
- Hazard warning lights 5.8
- Head lamp washers 5.6
- Heated rear window 5.18
- Heated seats
- Front 4.3
 - Rear 4.3
- Heater controls 5.14
- Heating and ventilation 5.14
- High voltage 1.3
- High voltage battery
- Charging 6.2
 - Specifications 9.8



HILL	5.24
HomeLink	5.36
Hood	
Closing	7.4
Opening	7.4
I	
Identification numbers	9.2
Important information	1.4
Indicator light	
Brake	5.25
Indicator lights	5.3
ABS	5.25
Air bag	4.16
Brake fluid	7.7
Charging	6.6
Cruise control	5.29
Depress brake pedal	5.20
ESC	5.28
ESC off	5.28
Exterior sound	5.31
Fuel filler	6.10
Head lamp high beam	5.7
Head lamp low beam	5.7
Key fob not detected	5.21
Low fuel	6.11
Low tire pressure	8.8
Parking brake	5.27
Ready	5.20
Rear fog	5.7
Seat belt	4.7
Turn signals	5.8
Instrument cluster	2.4
Instruments	
Battery charge level indicator	5.2
Battery range	5.2
Fuel level indicator	5.2
Odometer	5.2
Power meter	5.2
Speedometer	5.2
Interior	
Door release handle	3.5
Overview	2.3
J	
Jacking the vehicle	7.21
K	
Key fob	3.2
Battery replacement	3.4
Care instructions	3.4
Compliance	3.4
Low battery indicator	3.4
Not detected	5.21
Replacing	3.2
Using	3.2
Keyless start	5.20
Compliance	5.22
Keyless start backup procedure	5.21
Keys	3.2
Unlocking the passenger's door	3.6
Knee air bags	4.14
L	
Label	
Air bags	4.16
Fuel specification	6.11
Tire and loading information	8.17
Vehicle certification	8.18
LATCH child restraints	4.10
Lights	
Courtesy	5.7
Daytime running	5.7
Hazard warning	5.8
Head lamp high beams	5.7
Master switch	5.7
Rear fog	5.7
Load carrying	8.18
Locking your vehicle	3.2
Lost keys and key fobs	3.2



M

Maintenance	
Approved fluids	7.11
Brake fluid	7.7
Cleaning the exterior	7.13
Cleaning the interior	7.15
Coolant levels	7.9
Daily checks	7.2
Emission control system	7.3
Engine compartment	7.5
Engine oil	7.6
Fuel system	7.3
Monthly checks	7.2
Owner maintenance	7.2
Paint repair	7.14
Power steering fluid	7.8
Removing tar	7.13
Replacing a fuse	7.18
Scheduled maintenance	7.2
Washer fluid	7.10
Washer jets	7.12
Windshield wipers	7.12
Maintenance and servicing	1.3
Making a compliant	1.6
Master door locking switch	3.5
Media player connection	5.38
Medical Safety	
Radio Transmitters	3.3
Methanol fuels	6.11
Mirrors	5.10
Folding	5.10
Mode selector	5.23
Modifying your vehicle	1.4
Motor specifications	9.6

O

Odometer	5.2
Opening the doors	
Inside the vehicle	3.5
Outside the vehicle	3.5
Other documents	1.2

Overview

Exterior	2.2
Instrument cluster	2.4
Interior	2.3
Touch-screen	2.5

P

Paint code	9.2
Paint damage	7.14
Parking brake	5.27
Emergency use	5.27
Parking sensors	5.32
Passenger air bag deactivation	4.15
Polishing the bodywork	7.14
Power meter	5.2
Power mirrors	5.10
Power outlets	5.38
Power seats	4.3
Power steering fluid level	7.8
Power windows	5.9
Pre-delivery mileage	1.4
Pressure washers	7.13

R

Raising the vehicle	7.21
Rear suspension specifications	9.7
Rear view camera	5.33
Rear view mirror	5.10
Rear window switch deactivation	5.9
Reformulated gasoline	6.11
Regenerative braking	5.26
Remote window opening	5.9
Replacement keys and key fobs	3.2
Reporting safety defects	1.6
Restraints - child	4.10
Running out of fuel	6.11

**S**

Safety instructions

Child seats	4.9, 4.16
Engine compartment	7.5
Fuel filling	6.10
Jacking the vehicle	7.21
Obstruction of airbags	4.15
Rear window inhibit	5.9
Seat belts	4.5
Tire repair	8.11
Vehicle maintenance	7.3
Wearing seat belts when pregnant ..	4.7

Seat belts

Adjusting	4.6
Care	4.8
Cleaning	7.16
General information	4.5
Pre-tensioners	4.8
Reminder	4.7
Safety instructions	4.5
Testing	4.8
Wearing	4.6
Wearing when pregnant	4.7

Seat heaters

5.11

Seat position memory

4.4

Seats

Adjustment	4.3
Automatic movement	4.4
Child seats and restraints	4.9
Correct seating position	4.2
Heated	4.3

Service data recording

1.5

Side air bags

4.14

Solar roof

6.9

Specifications

12V battery	9.8
Brakes	9.8
Engine	9.6
Front suspension	9.7
Fuses	7.19
High voltage battery	9.8
Rear suspension	9.7
Steering	9.7
Tire pressures	9.5

Tires

9.5

Traction motors

9.6

Transmission and differential

9.6

Wheels

9.5

Speedometer

5.2

SPORT mode

5.24

Stability control

5.28

Starting the vehicle

5.20

STEALTH mode

5.24

Steering column adjustment

4.2

Steering specifications

9.7

Supplementary Restraint System (SRS) ...
4.13**T**

Temperature control

5.14, 5.16

Temperature display

5.17

Tire and loading information label

8.17

Tire care

8.2

Tire compressor

8.11

Tire Identification Number (TIN)

8.15

Tire pressure checking

8.5

Tire Pressure Monitoring System

Malfunction

8.9

Operation

8.8

Tire pressures

8.17

Tire repair kit

8.10

Compressor

8.13

Replacing the sealant

8.13

Tires

8.14

Asymmetric

8.6

Degradation

8.3

Flat spots

8.5

Grading

8.16

Markings

8.14

Pressure monitoring

8.8

Pressures

8.4

Quality

8.16

Replacement of

8.6

Replacing a tire sensor

8.9

Rotation

8.2

Specification

9.5

Tire chains

8.7



Tire sealant	8.10	Vehicle recovery eye	7.22
Wear	8.3	Vehicle settings	5.13
Wheel alignment	8.2	Vehicle weights	9.4
Winter tires	8.7	Ventilation	5.18
Touch-screen	2.5	VIN (Vehicle Identification Number)	9.2
Care points	5.13	Voice activation	5.34
Features	5.12	Voice commands	5.35
Operation	5.12	Voltage warning	1.3
Overview	5.11	Volume control	5.11
TPMS	8.8		
TPMS compliance	8.9	W	
Traction control	5.28	Washer fluid level	7.10
Trailer towing	8.18	Washing the solar roof	7.14
Transporting the vehicle	7.22	Washing the vehicle	7.13
Trip computer	5.5	Weekly checks	7.2
Trunk		Wheel replacement	8.6
Interior release handle	3.7	Wheel specifications	9.5
Opening and closing	3.7	Windows	5.9
Turn signals	5.8	Windshield defogger	5.18
Type approval		Windshield washer	5.6
Charging cord	6.3	Windshield washer jets	7.12
Key fob	3.4	Windshield wipers	5.6
Keyless start	5.22	Checking blade	7.12
TPMS	8.9	Wiper blade inspection	7.12
		Wipers	5.6
U			
Uniform tire quality grading	8.16		
Unleaded fuel	6.11		
Unlocking your vehicle	3.2		
USB audio	5.38		
USB charging port	5.38		
Used engine oil	7.3		
V			
Valet mode	3.8		
Vehicle certification label	8.18		
Vehicle Identification Number (VIN)	9.2		
Vehicle lashing	7.23		
Vehicle loading	8.17		
Determining correct load limit	8.18		
Example load calculations	8.19		
Vehicle modifications	1.4		