



Owner's Manual

VECTRA

Operation, Safety and Maintenance



VECTRA

VAUXHALL Vectra

Operation, Safety, Maintenance

Data specific to your vehicle

Please enter your vehicle's data here to keep it easily accessible.

This information is available under the section "Technical data" as well as on the identification plate and in the Service Booklet.

Fuel

Designation

Engine oil

Grade

Viscosity

Tyre pressure

	Tyre size	with up to 3 people		with full load	
Summer tyres	<input type="text"/>	Front <input type="text"/>	Rear <input type="text"/>	Front <input type="text"/>	Rear <input type="text"/>
Winter tyres	<input type="text"/>	Front <input type="text"/>	Rear <input type="text"/>	Front <input type="text"/>	Rear <input type="text"/>

Weights

Permissible Gross Vehicle Weight

- EC kerbweight

= Loading

Your Vectra

is an intelligent combination of forward-looking technology, impressive safety, environmental friendliness and economy.

It now lies with you to drive your vehicle safely and ensure that it performs perfectly. This Owner's Manual provides you with all the necessary information to that end.

Make sure your passengers are aware of the possible risk of accident and injury which may result from improper use of the vehicle.

You must always comply with the specific laws of the country that you are travelling through. These laws may differ from the information in this Owner's Manual.

When instructed to consult a workshop, we recommend that you consult your Vauxhall Authorised Repairer.

All Vauxhall Authorised Repairers provide first-class service at reasonable prices.

You will receive quick, reliable and individual service.

Experienced mechanics, trained by Vauxhall, work according to specific Vauxhall instructions.

The Owner's Manual should always be kept in the vehicle: Ready to hand in the glove compartment.

Make use of the Owner's Manual:

- The "In brief" section will give you an initial overview.
- The table of contents at the beginning of the Owner's Manual and within the individual chapters will show you where everything is.
- Its index will help you find what you want.
- It will familiarise you with the sophisticated technology.
- It will increase your pleasure in your vehicle.
- It will help you to handle your vehicle expertly.

The Owner's Manual is designed to be clearly laid-out and easily understood.

This symbol signifies:

► Continue reading on next page.

- ❖ The asterisk signifies equipment not fitted to all vehicles (model variants, engine options, models specific to one country, optional equipment, Genuine Vauxhall Parts and Accessories).

Warning

Text marked  **Warning** provides information on risk of accident or injury. Disregard of the instructions may lead to injuries or endanger life. Inform your passengers accordingly.

Yellow arrows in the illustrations serve as points of reference or indicate some action to be performed.

Black arrows in the illustrations indicate a reaction or a second action to be performed.

Directional data, e.g. left or right, or front or back, in the descriptions always relate to the direction of travel.

Thank you for choosing a Vauxhall. We wish you many hours of pleasurable driving.

Your Vauxhall Team

Contents

Commitment to customer satisfaction:

Our aim: to keep you happy with your vehicle. All Vauxhall Authorised Repairers offer first-class service at competitive prices. Experienced, factory-trained technicians work according to factory instructions. Your Authorised Repairer can supply you with GENUINE VAUXHALL-APPROVED PARTS, which have undergone stringent quality and precision checks, and of course useful and attractive VAUXHALL-APPROVED ACCESSORIES.

Our name is your guarantee!

For details of the

Vauxhall Authorised Repairer Network, please ring this number; 0845 090 2044

In brief	2
Keys, doors, windows, sunroof	26
Seats, interior	50
Instruments, controls	98
Lighting	128
Infotainment system	137
Climate control	140
Driving and operation	168
Self-help, vehicle care	228
Service, maintenance	268
Technical data	282
Index	314

In brief



16968 T

**To unlock and open vehicle:
Press button \geq , pull door handle**

- ▶ Door locks, child safety locks – see page 41,
- keys – see page 26,
- electronic immobiliser – see page 27,
- remote control – see page 28,
- central locking – see page 30,
- mechanical anti-theft locking system * – see page 30,
- Vauxhall alarm system * – see page 38.

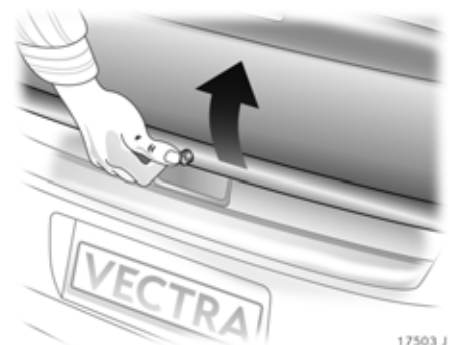

17503 J

**To unlock and open the luggage compartment:
Press button \geq on remote control,
press button \geq on boot lid/tailgate
and for Estate, pull catch
under handle**

- ▶ Remote control – see page 28,
- central locking – see page 30,
- Vauxhall alarm system * – see page 38,
- electrically operated tailgate * – see page 35.



S 12119

**To adjust front seats:
Pull handle, slide seat,
release handle**

► Seats – see page 50,
seat position – see page 52,
electrically adjustable front seats –
see page 52.

⚠ Warning

Important: Do not sit nearer than
10 inches (25 cm) from the steering
wheel, to permit safe airbag deployment.



S 12120

**To adjust front seat backrests:
Turn handwheel**

Move seat backrest to suit seating position.

Do not lean on seat backrest whilst
adjusting it.

► Seats – see page 50,
seat position – see page 52,
folding down front passenger's seat
backrest – see page 66,
electrically adjustable front seats –
see page 52.



S 12122

**To adjust front seat height*:
Operate lever on outboard side of
seat**

Pump action of lever

Upwards: Seat higher

Downwards: Seat lower

► Seats – see page 50,
seat position – see page 52,
electrically adjustable front seats –
see page 52.



S 12123

**Adjusting front seat inclination *:
Operate front lever on outboard
side of seat**

Pump action of lever

Upwards: Seat steeper

Downwards: Seat flatter

► Seats – see page 50,
seat position – see page 52,
electrically adjustable front seats –
see page 52.

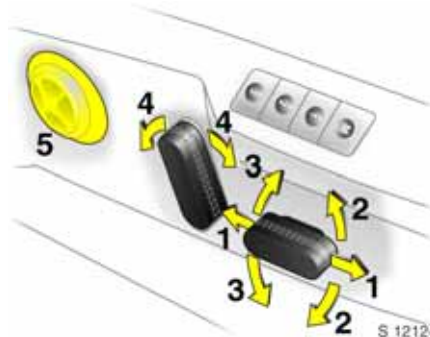

S 12124

**Electric seat adjustment *:
Operate switch on outboard side
of seat**

- 1 Adjusting the longitudinal position
- 2 Adjusting the inclination
- 3 Height adjustment
- 4 Seat backrest adjustment
- 5 Lumbar support *

► Seats – see page 52,
seat position – see page 52,
electrically adjustable front seats –
see page 52.

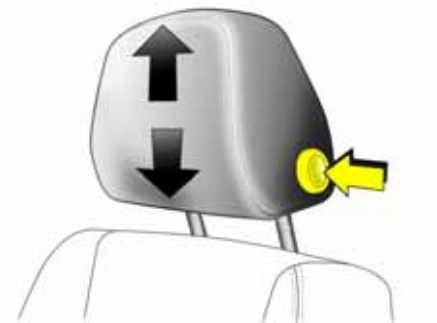

16976 T

**To adjust head restraint height *
of front and outboard rear seats:
Press button to release,
adjust height, engage in position**

► Head restraints – see page 55,
head restraint position – see page 56,
rear head restraints – see page 55.



To adjust head restraint angle * of front and outboard rear seats: Swivel bottom edge of head restraint forwards or backwards

► Head restraints – see page 55,
head restraint position – see page 56,
rear head restraints – see page 55.



To apply seat belt: Pull out seat belt smoothly from inertia reel, guide it over the shoulder and engage in the belt buckle

The seat belt must not be twisted at any point. The lap belt must lie snugly against the body. The backrests must not be tilted back too far (recommended maximum tilting angle approx. 25°).

To release belt, press red button on belt buckle.

► Three-point seat belts – see page 72,
airbag systems * – see page 81,
seat position – see page 52.



Adjusting interior mirror: Swivel mirror housing

Swivel lever on underside of mirror housing to reduce dazzle at night.

► Mirror – see page 44,
automatic anti-dazzle interior mirror * –
see page 44.

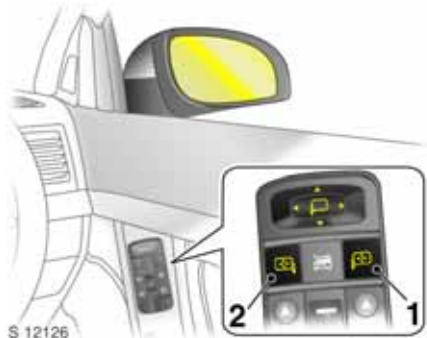

**To adjust exterior mirrors:
Four-way switch in driver's door**

If the outer mirror switch (1) is pressed, the four-way switch operates the driver's and front passenger's mirrors*, and if the inner mirror switch (2) is pressed, it only operates the front passenger's mirror.

- ▶ Mirrors – see page 43,
- aspherical exterior mirrors* – see page 43,
- automatic anti-dazzle exterior mirrors* – see page 43,
- heated exterior mirrors – see page 13,
- electric seat adjustment* – see page 54.

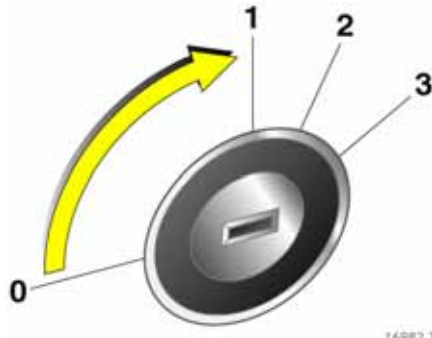

**Steering column lock and ignition:
Turn key to position 1.
Move steering wheel slightly to
release steering column lock**

Positions:

- 0 = Ignition off
- 1 = Steering free, ignition off
- 2 = Ignition on, for diesel engines:
Preheating
- 3 = Starting

- ▶ Starting – see page 15,
- electronic immobiliser – see page 27,
- parking the vehicle – see page 16.



**Steering wheel adjustment*:
Move lever down,
adjust height and distance,
move lever up,
engage**

Adjust steering wheel only when vehicle is stationary and steering column lock is released.

- ▶ Airbag systems* – see page 81.



16986 T

Turn light switch:

- 0** = Off
- ☞☛** = Parking lights
- ☞☛** = Dipped or main beam
- AUTO** = Automatic dipped beam activation *

Press button:

- ☞☛** = Front fog lights *
- ☞☛** = Fog tail light

► Lighting – see page 128,
head light control indicator –
see pages 100, 126, 128.

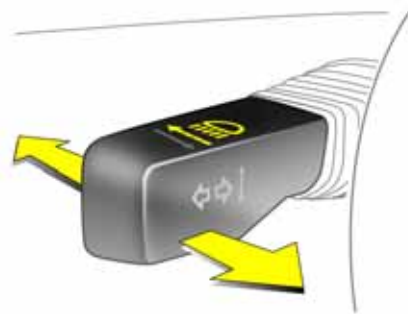

16987 T

Headlight flash, main beam and dipped beam:

- Headlight flash** = Pull stalk towards steering wheel
- Main beam** = Push stalk forwards
- Dipped beam** = Push stalk forwards again or pull towards steering wheel

► Main beam, headlight flash –
see page 129.

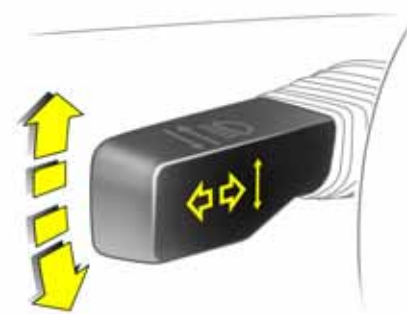

16989 T

Switch on turn signal lights:

- Right** = Stalk up
- Left** = Stalk down

► Turn signal lights – see page 130.

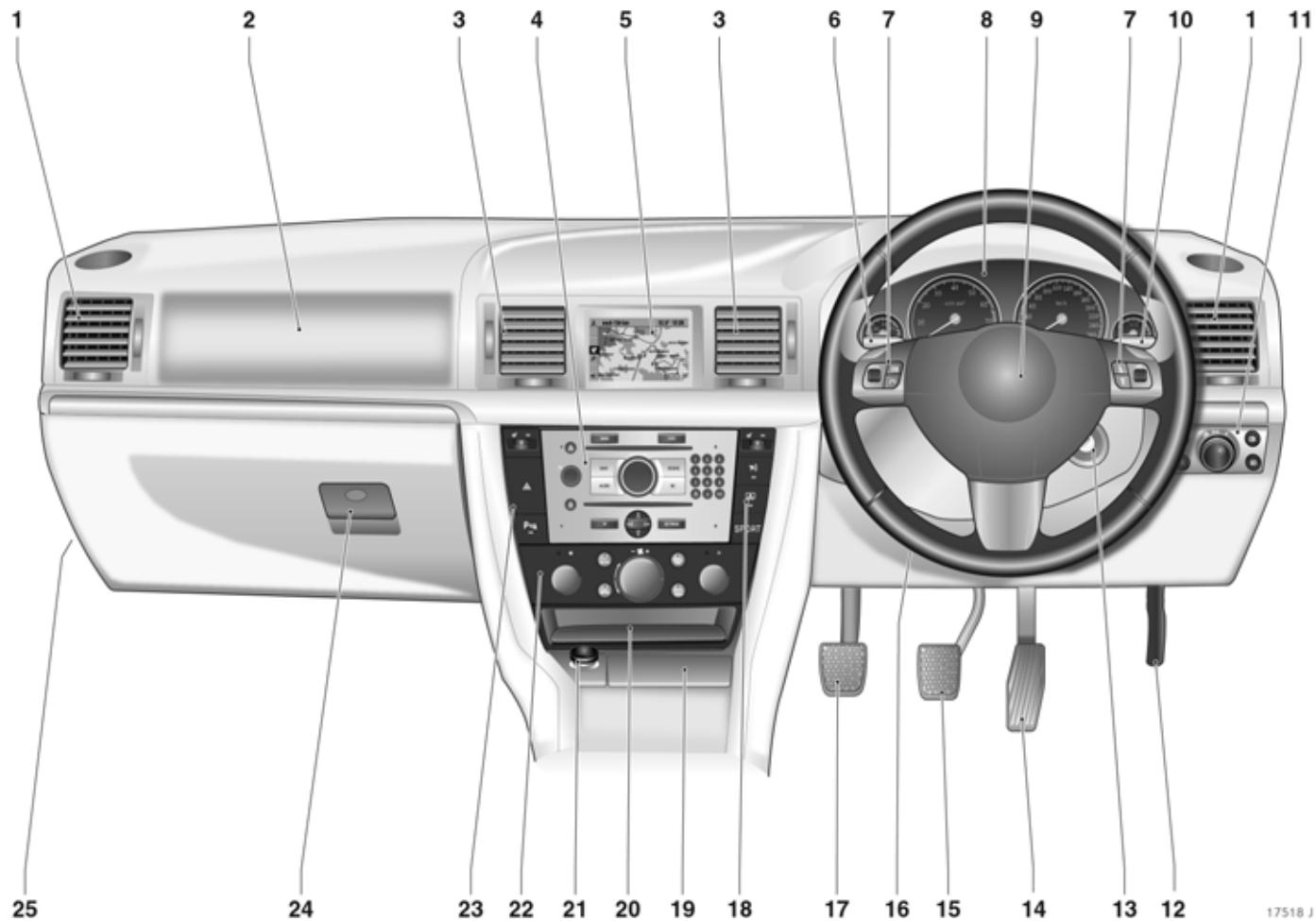























	Page
1 Side air vents	142
2 Front passenger's airbag	81
3 Centre air vents	142
4 Infotainment system *	137
5 Central information display for time, date, outside temperature, Infotainment system *, check control *, trip computer *, Electronic Climate Control *	108
6 Turn signal lights.....	7
Headlight flash, dipped beam and main beam	7
Door-to-door lighting *	133
Parking lights	134
Cruise control *	200
7 Steering wheel remote control * ..	137
8 Instruments	98
9 Horn	11
Driver's airbag	81











	Page
10 Windscreen wiper, windscreen wash system, headlight wash system * and rear window wash system *	11
11 Parking lights, dipped beam	128
Instrument illumination	134
Fog tail light	131
Front fog lights *	130
Headlight range adjustment *	131
12 Unlocking the bonnet	228
13 Starter switch with steering column lock	6
14 Accelerator pedal	184
15 Brake pedal	185, 208
16 Steering wheel adjustment	6
17 Clutch pedal *	185
18 Heated seat (right) * and seat climate control *	144
Vauxhall alarm system *	38
Rear window blind *	49
and Electronic Stability Programme *	196
SPORT mode *	198

	Page
19 Ashtrays	94
20 Stowage compartment with AUX input *	138
21 Cigarette lighter * or socket	93
22 Climate control	163
23 Heated seat (left) *	144
Hazard warning lights	131
Parking distance sensors *	202
24 Glove compartment	95, 135
25 Fusebox	246

Control indicators

-  Turn signal lights,
see pages 7, 98, 130.
-  Engine oil pressure,
see page 98.
-  Brake system, clutch system,
see pages 99, 209, 276.
-  Alternator,
see page 99.
-  Airbag systems *,
belt tensioners *,
see pages 74, 86.
-  Coolant temperature,
see pages 100, 106.
-  Exterior lights,
see pages 100, 128.
-  SPORT mode of automatic
transmission *,
see pages 100, 178, 179.
-  Winter programme of
automatic transmission * or
Easytronic *,
see pages 100, 172, 180.
-  Door open *,
see page 100.
-  Easytronic *,
starting the engine *,
see pages 100, 169.

-  Bulb replacement *,
see pages 100, 252.
-  Open luggage compartment,
see pages 34, 101.
-  Front fog lights *,
see pages 101, 130.
-  Main beam,
see pages 7, 101, 128.
-  Fog tail light,
see pages 101, 131.
-  Parking distance sensors *,
see pages 101, 202.
-  Continuous Damping Control *,
SPORT mode,
see pages 101, 198.
-  Seat belt *,
see page 101.
-  Engine electronics, transmission
electronics *, diesel fuel filter *,
see pages 27, 101, 192.
-  Preheating for diesel engines *,
diesel particulate filter *,
see pages 102, 194.
-  Coolant level,
see pages 102, 275.

-  Anti-lock Brake System (ABS),
see page 210.
-  Electro-hydraulic power
assisted steering,
see page 103.
-  Electronic Stability Programme
(ESP^{Plus}) *,
see pages 103, 196.
-  Seat occupancy recognition *,
see pages 87, 103.
-  Engine oil level *,
see pages 103, 272.
-  Cruise control *,
see page 200.
-  Fuel level,
see pages 103, 106, 228.
-  Exhaust gases *,
see pages 104, 192.
-  Tyre pressure monitoring
system *,
see pages 104, 204.
-  Adaptive Forward Lighting
(AFL) *,
see pages 104, 132.



Hazard warning lights:

On = Press 
Off = Press  again

► Hazard warning lights – see page 131.

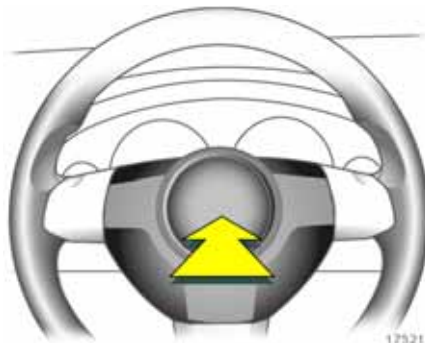

Activate horn:

Press  in centre of steering wheel

► Airbag systems * – see page 81,
 remote control on steering wheel * – see page 137.

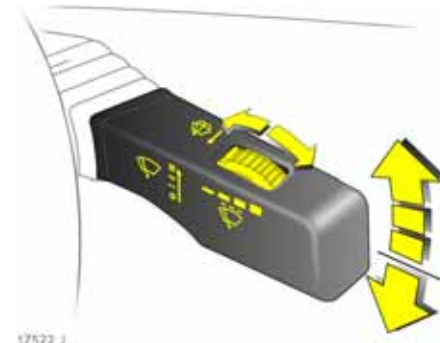

Windscreen wiper:

Gently push stalk upwards

 = Off
 -- = Adjustable timed interval wipe
 — = Slow
 == = Fast

Press the stalk down from position :
 Single swipe.

► Windscreen wiper – see page 126,
 adjustable wiper interval * – see page 126,
 wiper blades – see pages 277, 278,
 vehicle care – see page 264.

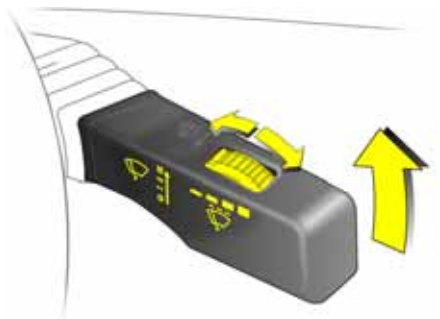

17523 J

Automatic wiping with rain sensor *:

Gently push stalk upwards

○ = Off

-- = Automatic wiping with rain sensor

Automatic wiping --:

Low sensitivity: Move adjuster wheel to the left

High sensitivity: Move adjuster wheel to the right

▶ Windscreen wiper – see page 126, wiper blades – see pages 277, 278, vehicle care – see page 264.



17524 J

Operating windscreen and headlight wash systems *:
Pull stalk towards steering wheel

▶ Windscreen wash system and headlight wash system * – see page 127, further information – see pages 264, 278.

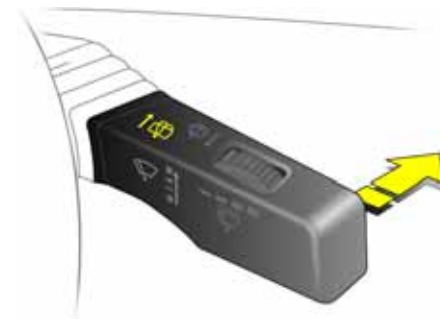

17525 J

Operating rear window wiper * and wash systems *:

Wiper on = Push stalk forwards

Wiper off = Push stalk forwards again

Wash = Hold stalk in fully forwards position

▶ Rear window wiper * and rear window wash * systems – see page 127, further information – see pages 264, 277, 278.



**Heated rear window,
heated exterior mirrors:**

On = Press

Off = Press again

► Air conditioning * – see page 140,
heated rear window, heated exterior
mirrors – see page 143.



To demist or defrost windows:
Set air distribution to ,
turn rotary knob for temperature
and airflow clockwise;

Air conditioning system *:
Press buttons and ;

**Automatic air conditioning
system *:**
Press buttons and ,
turn rotary knob for
temperature clockwise,
airflow to A;

Electronic Climate Control *:
Press button

► Climate control – see page 140.



**Setting automatic mode of
Electronic Climate Control *:**
Press **AUTO** button,
set temperature for driver's
and front passenger's sides using
left and right rotary knobs

► Electronic Climate Control * –
see page 156.



S 12130

Manual transmission:

Reverse gear: with vehicle stationary, pull the ring up three seconds after depressing clutch pedal and engage gear.

If the gear does not engage, set the lever in neutral, release the clutch pedal and depress again; then repeat gear selection.

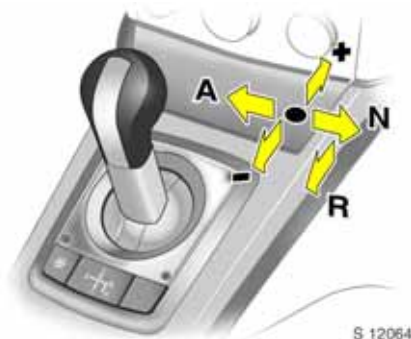

S 12064

Easytronic *:

- N** = Idling
- = Drive position
- +** = Higher gear
- = Lower gear
- A/M** = Switch between Automatic and Manual mode
- R** = Reverse gear (with selector lever lock)

The selector lever must always be moved in the appropriate direction as far as it will go. Upon release, it automatically returns to the centre position. Pay heed to the gear/mode indicator in the transmission display.

The footbrake must be depressed when starting.

► Easytronic * – see page 168.



S 12545

Automatic transmission *:

- P** = Park position
- R** = Reverse gear
- N** = Neutral position (idling)
- D** = Automatic gear selection

Selector lever in D to the left:
Manual mode

- +** = Higher gear
- = Lower gear

P or N must be engaged when starting.

In order to leave **P**, switch on ignition, depress footbrake and press button on selector lever.

To engage **P** or **R**, press button on selector lever.

P Only with vehicle stationary, apply handbrake beforehand.

R Only if vehicle is stationary.

► Automatic transmission * – see page 176.

Before starting-off, check:

- Tyre pressure and condition – see pages 204, 211, 299.
- Engine oil level and fluid levels in engine compartment – see pages 271 to 279.
- All windows, mirrors, exterior lighting and number plates are free from dirt, snow and ice and are operational.
- No objects are placed in front of the rear window, on the instrument panel or in the area in which the airbags inflate.
- Seats, seat belts and mirrors are correctly adjusted.
- Brake operation.

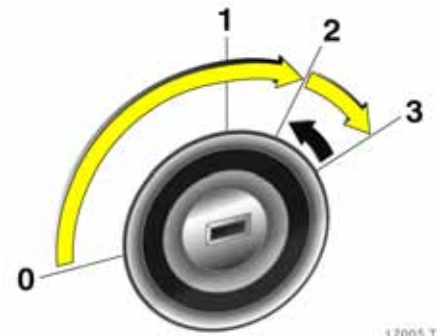

To start engine:

Operate clutch and brake pedals, automatic transmission *

in P or N,

Easytronic *: Depress brake, do not accelerate,

Petrol engines: Turn key to 3;

Diesel engines: Turn key to 2,

when control indicator  goes out¹⁾, turn key to 3;

release key once engine is running

To restart or switch off the engine, turn key back to 0.

To switch on the ignition, only turn the key to 2.

► Electronic immobiliser – see page 27, diesel fuel system – see page 228.

¹⁾ Preheating system switches on only if outside temperature is low.

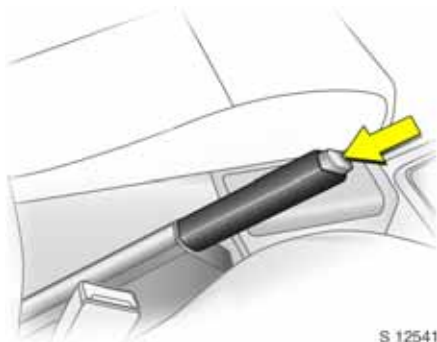

**Releasing the handbrake:
Raise lever slightly,
press release button,
lower lever fully**

► Handbrake – see page 209.

Parking the vehicle

■ Always apply the handbrake firmly without pressing the release button; to do this, fold up the armrest ✱. Apply handbrake as fully as possible on an uphill or downhill incline. To reduce the amount of force required to activate the handbrake, depress the footbrake at the same time.

■ Switch off the engine; to do this, turn the ignition key to 0. Remove the ignition key and turn the steering wheel until the steering column lock (anti-theft protection) engages. In vehicles with automatic transmission ✱, the key can only be removed when the selector lever is in P.

■ If the vehicle is parked on a flat surface or an uphill incline, engage first gear before switching off the ignition if you have manual transmission or Easytronic ✱; if the vehicle has automatic transmission ✱, place the selector lever in P. On an uphill incline, also turn the front wheels away from the kerb.

If the vehicle is on a downhill incline, engage reverse gear before switching off the ignition if you have manual transmission or Easytronic ✱; if the vehicle has automatic transmission ✱, place the selector lever in P. Also turn the front wheels towards the kerb.

■ Lock the doors and luggage compartment and activate the Vauxhall alarm system ✱ by pressing button = on the remote control.

To activate the mechanical anti-theft locking system ✱, press button = again no more than 15 seconds after locking.

Advice when parking:

■ Do not park vehicle on easily ignitable surfaces, since the hot exhaust system temperatures could cause the surface to ignite.

■ On vehicles with Easytronic ✱, control indicator (D) flashes for a few seconds after the ignition is switched off if the handbrake has not been applied – see page 174.

■ Close windows and sunroof ✱.

■ The engine cooling fans may run after the engine has been switched off – see page 271.

► Remote control – see page 28, central locking – see page 30, Vauxhall alarm system ✱ – see page 38, vehicle decommissioning – see page 281.

That was a brief overview of the most important information for your first drive in your vehicle.

The other pages of this chapter contain a summary of the interesting functions in your vehicle.

The remaining chapters of the Owner's Manual contain important information on operation, safety and maintenance as well as a complete index.

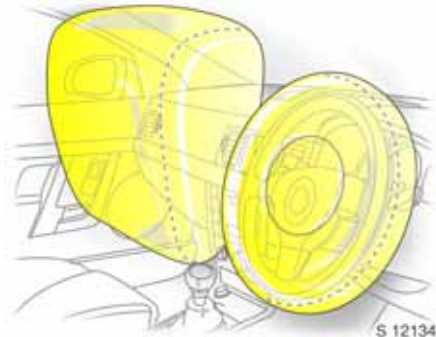

Airbag system

The airbag system consists of several separate systems.

Front airbag system

The front airbag system will be triggered in the event of a serious accident involving a frontal impact and forms safety cushions for the driver and front passenger.

The forward movement of the driver and front passenger is checked and the risk of injuries to the upper body and head are thereby substantially reduced.

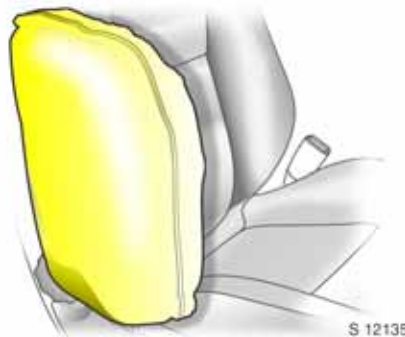

Side airbag system *

The side airbag system triggers when a side-on collision occurs and provides a safety barrier for the driver and/or front passenger in the respective front door area. This reduces the risk of injury to the upper body considerably, in the event of a side-impact.

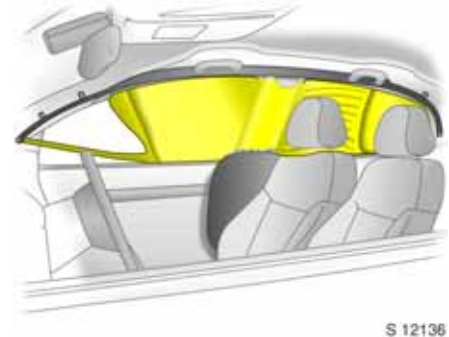

Curtain airbag system *

The curtain airbag system triggers in the event of a side-on collision and provides a safety barrier in the head area on the respective side of the vehicle. This reduces the risk of injury to the head considerably in the event of a side-on collision.

► Airbag systems * – see page 81.

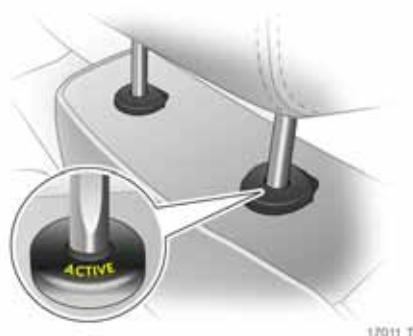

17011 T

Active head restraints * at front seats

In the event of a rear-impact, the active head restraints tilt forwards a little. The head is more effectively supported by the head restraint and the danger of injuries caused by whiplash in the neck area is reduced.

Active head restraints are identified by the lettering **ACTIVE** on the head restraint guide sleeves.

► Head restraints – see page 55.



17012 T

Operating menus in the information display *

Menu options are selected using menus and using the buttons/four-way button or the multi-function knob of the Infotainment system * or the left-hand adjuster wheel * on the steering wheel. The respective menu options are shown on the display.

To select with four-way button:
Press the four-way button up, down, right or left.



17013 T

Selection using multi-function knob:
Rotate and press multi-function knob.

To exit a menu, turn the multi-function knob left or right to **Return** or **Main** and select.



Selection using left-hand adjuster wheel on steering wheel:

Rotate and press adjuster wheel.

► Information display – see page 108.

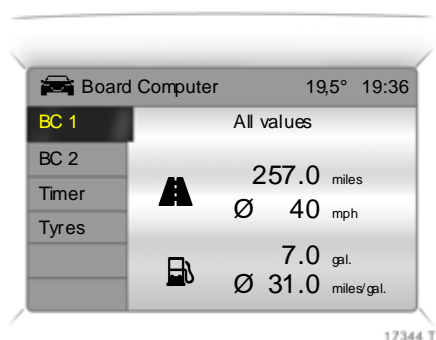

Trip computer *

The trip computer provides information on driving data, which is continually recorded and evaluated electronically.

Functions:

- Range,
- Instantaneous consumption,
- Distance travelled,
- Average speed,
- Effective consumption,
- Average consumption,
- Stop watch,
- Tyre pressure *

► Trip computer * – see pages 114, 120.

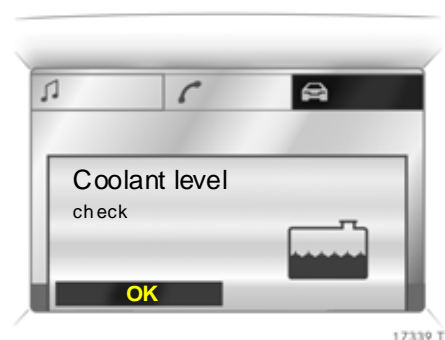

Check control *

The check control software monitors:

- Fluid levels,
- Tyre pressures *
- Remote control battery,
- Vauxhall alarm system *
- Important exterior lights, including cables and fuses.

► Check control * – see page 124.



Remote control on steering wheel *

The functions of the Infotainment system and the information display can be operated with the buttons and adjuster wheels on the steering wheel.

Further information is available in the Infotainment system operating instructions.

► Remote control on steering wheel * – see page 137, Infotainment system – see page 137.



Twin Audio *

Twin Audio provides rear seat occupants with the opportunity to listen to a different audio source than the one selected by the driver on the Infotainment system *.

Only an audio source that is not currently active on the Infotainment system can be controlled using Twin Audio.

Two headphone connections are available, with separate volume controls.

Further information is available in the Infotainment system operating instructions.

► Twin Audio * – see page 138.



FlexOrganizer *

The side walls contain retaining strips, where various components can be attached to divide the luggage compartment or fasten loads.

The system consists of:

- Variable partition net,
- Variable partition wall,
- Partition rod,
- Mesh pockets for the side walls,
- Hooks.

► FlexOrganizer * – see page 69.



17560 J

Travel Assistant *

The Travel Assistant contains:

- Arm rest,
- Stowage compartments,
- Waste container,
- Drink holders,
- Accessory sockets,
- Connection console
e.g. for DVD player *
- Electric cool box,
- Foldaway tables,
- Twin Audio (rear audio module) * or
stowage compartment.

The Travel Assistant is installed on a console above the centre seat in the rear.

► Travel Assistant * – see page 58.

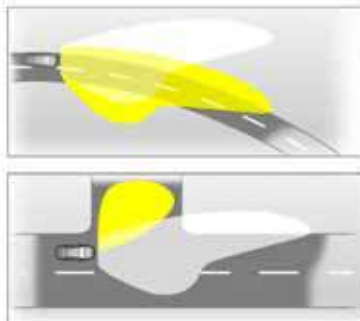

S 14736

Adaptive Forward Lighting (AFL) *

On vehicles with Bi-Xenon headlights, AFL improves illumination of:

- Curves (curve lighting),
- Intersections and tight turns (turn lighting).

Curve lighting

The Xenon light beam pivots based on steering wheel position and vehicle speed, from approx. 6 mph (10 km/h).

The headlights shine at an angle of up to 15° to the right or left of the direction of travel.

Turn lighting

An additional light illuminates at certain steering wheel settings (after approx. 90°), turn signal settings and speeds up to approx. 25 mph (40 km/h).

The light beam projects at a 90° angle to the left or right of the vehicle up to a distance of approx. 30 metres.

Motorway lighting

At higher speeds and continuous straight ahead travel, the dipped beam automatically raises slightly, thereby increasing headlight range.

► Adaptive Forward Lighting (AFL) * – see page 132.

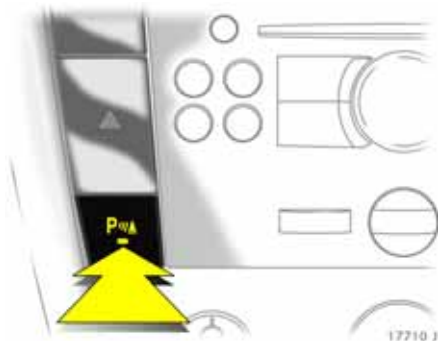

Parking distance sensors *

When reverse gear is selected, the parking distance sensors switch on automatically.

The parking distance sensors can also be activated at speeds of less than 15 mph (25 km/h) by pressing the **P** button on the instrument panel.

If the vehicle approaches an obstacle to the front or rear, a series of signals is audible in the vehicle interior. The interval between the signals becomes shorter as the distance is reduced. If the distance is less than 30 cm, the signal will be continuous.

► Parking distance sensors * – see page 202.

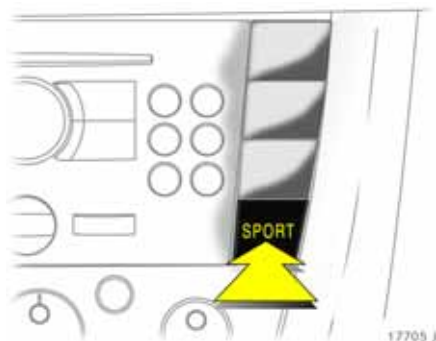

SPORT mode *

To activate

Press the **SPORT** button. The LED in the button illuminates.

SPORT mode is used to change damping *, steering *, throttle application and the shifting times and shifting points for Easytronic * and automatic transmission * whilst driving.

Damping and steering * become more direct and provide better contact with the road surface. The engine reacts more quickly to accelerator movements.

With automatic transmission *, the shift times are reduced and gear changes occur at higher engine speeds (not when cruise control * is active).

► SPORT mode * – see page 198.

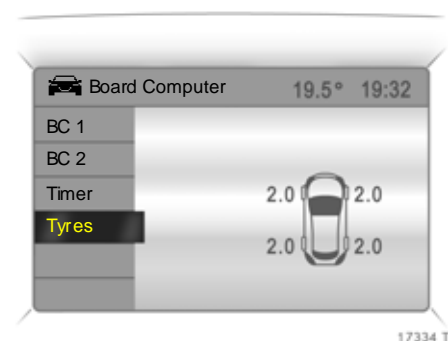

Tyre pressure monitoring system *

The tyre pressure monitoring system continuously monitors the pressure of all four tyres while the vehicle is being driven.

A pressure sensor is installed in each wheel. The tyre pressures of the individual tyres are transmitted to a controller, where they are compared.

The current tyre pressures can be displayed on the Graphical Information Display or the Colour Information Display *.

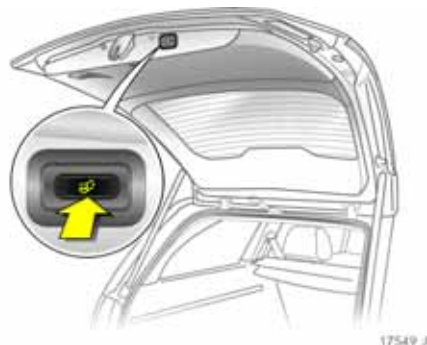

Deviating tyre pressures are displayed in the form of messages on the information display whilst driving.

► Tyre pressure monitoring system * – see page 204.





Electrically operated tailgate, Estate *

■ To open:

- Hold down remote control button  (see page 35, Fig. 17548 J) for a approx. 1 second.
- or -
- When the key is inserted in the starter switch and the handbrake is applied, hold down the  button in the driver's door for approx. 1 second.
- or -
- Unlock the tailgate and open by pulling the catch beneath the handle.

■ To close:

- Hold down the  button on the remote control until the tailgate is closed.
 - or -
 - When the key is inserted in the starter switch and the handbrake is applied, hold down the  button in the driver's door until the tailgate is shut.
 - or -
 - Press the  button in the tailgate.
- Electrically operated tailgate * – see page 35.



Towing equipment with pivoting coupling ball bar *

The release lever is in the left stowage compartment in the luggage compartment. Open cover.

■ Pull release lever downwards.

- The LED on the lever is illuminated while the coupling ball bar is not engaged.
- In addition, a warning buzzer sounds and the coupling ball bar pivots downwards.

■ Pivot the coupling ball bar backwards until it engages.

- LED must extinguish,
- Warning buzzer must cease,
- Otherwise, repeat the procedure.

► Towing equipment with pivoting coupling ball bar * – see page 222.

Diesel particle filter *

The diesel particle filter system removes polluting soot particles out of the engine exhaust gases. The system includes a self-cleaning function that operates automatically whilst driving. The filter is cleaned by burning the trapped soot particles at a high temperature. There may be an increase in fuel consumption, exhaust smell, and engine cooling fan operation * during the self-cleaning operation.

The self-cleaning function cannot operate automatically during certain driving situations where the engine does not reach its normal operating temperature. An example of this would be driving only short distances in cold weather.



If the filter needs cleaning and recent driving situations did not allow the function to automatically operate, then control indicator  will flash. If this occurs, then you may continue to drive the vehicle normally. The vehicle will not be damaged and does not require service.

The self-cleaning function will automatically operate whilst driving after the engine has reached its normal operating temperature. Control indicator  will continue to flash until the self-cleaning operation is complete. This may take up to 20 minutes of driving. The time will be shorter at higher vehicle speeds.

► Diesel particle filter * – see page 194.

Keys, doors, windows, sunroof

Replacement keys	26
Lock cylinders	26
Car Pass *.....	26
Key with foldaway key section *.....	26
Electronic immobiliser.....	27
Store and activate personal vehicle settings using the remote control....	28
Remote control	28
Central locking system	30
Fault when locking or unlocking.....	33
Luggage compartment	34
Vauxhall alarm system *.....	38
Child safety locks	41
Universal remote control in mirror housing *.....	41
Exterior mirrors.....	43
Interior mirror	44
Electric windows *.....	45
Windows in rear doors	47
Sunroof *.....	47
Electrically operated rear window blind *	49
Sunblinds for rear door windows *....	49

Replacement keys

The key number is specified in the vehicle documents and in the Car Pass *.

The key is a constituent of the electronic immobiliser. Ordering keys from a Vauxhall Authorised Repairer guarantees problem-free operation of the electronic immobiliser.

Keep the spare key in a safe place.

Locks - see page 266.

Lock cylinders

Designed to free-wheel if they are forcefully rotated without the correct key or if the correct key is not fully inserted.

To reset, turn cylinder with the correct key until its slot is vertical, remove key and then re-insert it. If the cylinder still free-wheels, turn the key through 180° and repeat operation.

Car Pass *

The Car Pass contains all of the vehicle's data and should therefore not be kept in the vehicle.

Have your Car Pass to hand when consulting a Vauxhall Authorised Repairer.



17027 T

Key with foldaway key section *

Press button to extend. Press button to retract and audibly engage key section.

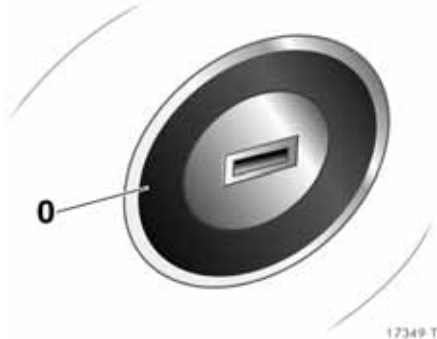

Electronic immobiliser

The system checks whether the vehicle may be started using the key that has been inserted. If the key is recognised as "authorised" the vehicle can be started. The check is carried out via a transponder in the key.

The electronic immobiliser activates automatically when the key is removed from the starter switch.

The code number of the electronic immobiliser is given in the Car Pass.



Control indicator for immobiliser

Control indicator  illuminates briefly when the ignition is switched on.

If the control indicator flashes when the ignition is on, there is a fault in the system; the engine cannot be started. Switch off the ignition and then repeat the start attempt.

If the control indicator  continues to flash, try to start the engine using the spare key and contact a workshop for assistance.

If control indicator  illuminates after the engine is started, there is a fault in the engine electronics or transmission electronics * (see pages 101, 174, 182, 192) or there is water in the diesel fuel filter * (see page 274).

Note

The immobiliser does not lock the doors. Therefore, after leaving the vehicle always lock it and switch on the Vauxhall alarm system * – see pages 30, 38.

Store and activate personal vehicle settings using the remote control

The last settings selected for:

- Instrument illumination,
- Central locking,
- Memory function * for driver's seat and mirror,
- Electronic Climate Control *

are automatically stored depending on the vehicle key used.

Different settings are stored for each remote control. Use of a remote control will activate the settings associated with it.

The settings for five remote controls can be stored.



17029 T

Remote control

The remote control is integrated in the key.

Used to operate:

- Central locking system,
- Mechanical anti-theft locking system *,
- Vauxhall alarm system *,
- Electrically operated tailgate, Estate *

In addition, electric windows * and electric sunroof * can be closed using the remote control.

The remote control has a range of approx. 5 metres. This range can be affected by outside influences. Aim the remote control at the vehicle to operate.

Handle the remote control with care, protect it from moisture and high temperatures and avoid unnecessary operation.

The hazard warning lights illuminate to indicate that the remote control is operational.

Central locking system,
see page 30.

Mechanical anti-theft locking system *,
see page 30.

Boot lid or tailgate,
see page 34.

Vauxhall alarm system *,
see page 38.

Electric windows *,
see page 45.

Electrically operated sunroof *,
see page 47.

Fault

If the central locking system cannot be operated with the remote control, it may be due to the following:

- The range of the remote control has been exceeded.
- Remote control battery voltage is too low. Battery replacement - see next column.
- Frequent, repeated operation of the remote control outside the reception range of the vehicle (e.g. too far from vehicle, remote control is then no longer recognised). Remote control synchronisation – see end column.
- If the central locking system is overloaded as a result of repeated operation at short intervals. The power supply is cut off for a brief period.
- Interference from higher-power radio waves from other sources.

To eliminate the cause of a fault, we recommend contacting a workshop for assistance.

Manual unlocking and locking using the vehicle key - see page 33.

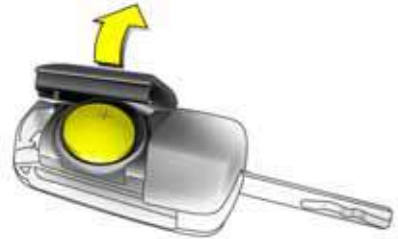

17031 T

Remote control battery replacement

Replace the battery as soon as the range of the remote control becomes reduced.

Extending the key – see page 26.

Open the remote control. Replace the battery (battery type – see page 307), noting installation position. Close the remote control.

Make sure that you dispose of old batteries in accordance with environmental protection regulations.

Remote control synchronisation

After a battery change, unlock door with key in lock - see page 33. Inserting the key into the lock synchronises the remote control.



16968 T

Central locking system

For doors, boot lid/tailgate and tank flap.

To unlock

Press button  on remote control.



17042 T

To lock

Press button  on remote control.

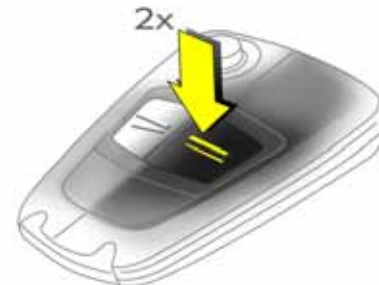

17043 T

Mechanical anti-theft locking system*

Warning



Do not use the system if there are people in the vehicle. The doors cannot be unlocked from inside.

All doors must be closed. Press button  on remote control again no more than 15 seconds after locking.



Lock buttons on all doors are positioned such that doors cannot be opened.

If the ignition was on, the driver's door must be opened and closed once so that the vehicle can be secured.



Programming unlocking mode *

When the vehicle is delivered from the factory, the remote control is preset so that a single press of the  button opens all of the doors and the luggage compartment. The unit can be configured so that a single press of the  button unlocks the entire vehicle or just the driver's door.

Change to presetting:

Hold button  on the remote control and button  in the driver's door depressed simultaneously until a double buzzer sounds. Afterwards, only the driver's door will be unlocked when button  is pressed once.

The entire vehicle is then unlocked by pressing button  on the remote control twice.



To restore the original settings, hold button  on the remote control and button  in the driver's door depressed simultaneously until a buzzer sounds.

The current setting is stored for the remote control - see page 28.



**Central locking switch for locking and unlocking the doors from inside the vehicle**

Press button  in the driver's door:
Doors and luggage compartment are locked.

Press button  in the driver's door:
Doors and luggage compartment are unlocked.



In the Estate with electrically operated tailgate , the doors and luggage compartment are locked and unlocked with button .



When the mechanical anti-theft locking system is active  (see page 30), the doors cannot be unlocked with this button.



If the vehicle is locked using the remote control, buttons  and  in the driver's door are inoperable.

Automatic locking *

The central locking can be set to lock automatically at a certain speed.

To activate the function, hold button  on the remote control and button  in the driver's door depressed simultaneously until a double buzzer sounds.

The doors and luggage compartment are unlocked by switching off the ignition or by pressing button  or, for Estate with electrically operated tailgate , by pressing button  in the driver's door. Individual doors can be unlocked by pulling the lock button.

To deactivate the function, hold button  on the remote control and button  in the driver's door depressed simultaneously until a buzzer sounds.

The current setting is stored for the remote control - see page 28.

Note

- If the driver's door is not closed properly, the central locking system will unlock again immediately after locking.
- 30 seconds after unlocking using the remote control, the doors automatically lock again * if neither a door nor the luggage compartment has been opened.
- To lock the doors from within (e.g. to prevent undesired access from outside), press the central locking button .
- If they are locked, the doors and the luggage compartment unlock automatically in the event of an accident of a certain severity (to permit outside assistance). Prerequisite: Ignition must not be switched off.



S 14738

Closing the windows * and sunroof * from outside using the remote control

Warning

Take care when operating the electric windows * and the sunroof *. Risk of injury, particularly to children.

Vehicle passengers must be informed accordingly.

Keep a close watch on the windows and sunroof when closing them. Ensure that nothing becomes trapped in them as they move.

The electric windows * can be closed from outside: hold down button  on the remote control until all windows are closed.

The sunroof * can be closed from outside: hold down button  on the remote control until the roof is fully closed.

Vehicle with electrically retractable exterior mirrors *:

When closing the windows using the remote control, the exterior mirrors will also be retracted. The mirrors will be folded back out when the vehicle is unlocked using the remote control.

If the mirrors are retracted using the button in the driver's door, they remain in this position when the doors are unlocked.

Automatic closing *

If the mechanical anti-theft locking system * is activated, the electric windows * and sunroof * are automatically closed and the electrically retractable exterior mirrors * are automatically retracted as soon as the rain sensor * detects water on the windscreen.

To safeguard the battery from discharge by the rain sensor *, after four hours the electric windows * and sunroof * are automatically closed and the electrically retractable exterior mirrors * are automatically retracted.

For further information on electric windows * and the sunroof * – see pages 47, 49.

Fault

If the central locking system cannot be operated with the remote control, it may be due to the following:

- The central locking system is overloaded as a result of repeated operation at short intervals. The power supply is cut off for a brief period.
- Defective fuse in fusebox – see page 246.

Seek the assistance of a workshop to rectify the cause of the fault. To open the driver's door with the key - see the following section.



S 11532

Fault when locking or unlocking**Remote control fault****To unlock:**

Insert key into lock in driver's door and turn towards front of vehicle as far as it will go. Turn key back to vertical position and remove from lock. Unlock driver's door with central locking switch - see page 31.

The mechanical anti-theft locking system * is deactivated when the key is inserted in the starter switch.

To lock:

Open front passenger's door, close driver's door, lock vehicle using central locking switch (see page 31), close front passenger's door.

Malfunction in central locking system**To unlock:**

Insert key into driver's door lock and turn towards front of vehicle as far as it will go. Turn key back to a vertical position and remove. The other doors can be unlocked by pulling the interior lock button (unless the mechanical anti-theft locking system * has been enabled). The luggage compartment and the tank flap remain locked.

To lock:

Lock front passenger's door and rear doors by pressing the interior lock button. Lock driver's door with key in lock. Turn key towards rear of vehicle as far as it will go, turn key to a vertical position and remove. The unlocked tank flap and the luggage compartment cannot be locked.



16968 T

Luggage compartment

To unlock

Press button  on remote control.

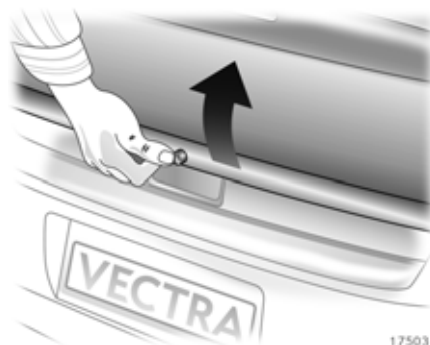

17503 J

To open

The luggage compartment of the Saloon / Hatch is opened by pressing the button, and the luggage compartment of the Estate is opened by pulling the catch beneath the handle.

Illumination of control indicator  indicates that the boot lid/tailgate is open.

For notes on open boot lid/tailgate - see page 37.

Electrically operated tailgate, Estate * – see next page.



17547 J

To close



There is a handle on the inside of the boot lid/tailgate for closing the luggage compartment.

With the Estate, do not operate the catch beneath the handle when closing, otherwise the luggage compartment will be unlocked again.



17042 T

To lock

Press button  on the remote control
 – or –
 Press central locking button  in driver's door when the doors are closed.

Electrically operated tailgate, Estate *

In Estate vehicles with an electrically operated tailgate, the tailgate can be electrically opened and closed after unlocking.

⚠ Warning

Make sure there is more than 2 metres clearance before operating the electric tailgate. Observe the pivoting zone of the tailgate during operation and do not enter the pivoting zone.

To open:

Unlock the vehicle by pressing button  on the remote control; the tailgate is opened electrically by pulling the catch beneath the handle.
 – or –



17548 J

Briefly press button  on the remote control to unlock the tailgate (the doors remain locked.) The tailgate is opened electrically by pulling the catch beneath the handle.



– or –
 Hold down button  on the remote control for more than 1 second (the doors remain locked); the tailgate is unlocked and opens electrically
 – or –







With the key in the starter switch and the handbrake applied, hold button  in the driver's door depressed for approx. 1 second; the tailgate opens electrically.

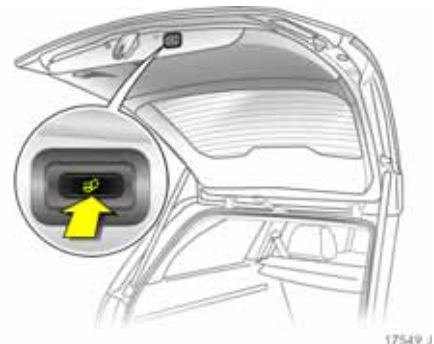

To close:
Hold down button  on the remote control until the tailgate is closed.
– or –
Hold down button  in the driver's door when the key is inserted in the starter switch until the tailgate is closed.
– or –



Press button  in the tailgate; the tailgate closes electrically.



To lock, press button  on the remote control.

Tailgate opening and closing is indicated by the rear turn signal lights flashing three times.

If the luggage compartment is not closed within 20 minutes of opening, the button in the tailgate is deactivated.

Interruption of tailgate opening/closing procedure



The opening or closing process is immediately interrupted by:

- briefly pressing button  in the driver's door,
- or –
- button  on the remote control,
- or –
- the external button beneath the handle,
- or –
- button  in the tailgate.

The tailgate remains in this position for 10 seconds and then slowly reopens.

Safety function

The tailgate has an obstruction detection facility. If the tailgate encounters resistance during the automatic closing movement, the closing procedure is stopped immediately and the tailgate is slowly opened again.

Vehicles with towing equipment :
When towing a caravan/trailer, the tailgate cannot be operated using button  on the remote control or button  in the driver's door.

Fault in electrically operated tailgate

If the electronic drive should fail, the tailgate can be opened and closed manually, although more force is required to close the tailgate.

Opening the tailgate when the doors are locked via the central locking system

If the doors are locked via the central locking system, the tailgate can be opened by pressing button  on the remote control and pulling the catch beneath the handle.

Open boot lid, open tailgate** Warning**

Do not drive with the boot lid or tailgate open or ajar, e.g. when transporting bulky objects, since toxic exhaust gas could penetrate the interior.

Also, the number plate of the Estate cannot be clearly read unless the luggage compartment is closed.

Fitting accessories to the boot lid/tailgate will increase its weight. If it becomes too heavy, the boot lid/tailgate will then not stay open.

Vauxhall alarm system *

Monitors:

- Doors, luggage compartment, bonnet,
- Passenger compartment,
- Vehicle tilt, e.g. if it is raised,
- Ignition.



17042 T

To activate

All doors, windows, the sunroof * and the bonnet must be closed. Press button  on the remote control.

If the ignition was switched on, the driver's door must be opened and closed again so that the anti-theft alarm system can be activated again.



17550 J

Activation without monitoring of passenger compartment and vehicle tilt

Activate e.g. when animals are left in the vehicle.

1. Close boot lid/tailgate and bonnet.
2. Press button ; LED in button flashes (maximum of 10 seconds).
3. Close doors.
4. Switch on anti-theft alarm system. LED illuminates. After approx. 10 seconds, the system is activated without monitoring of the passenger compartment or vehicle tilt. LED flashes until system is switched off.



Light emitting diode (LED)

During the first 10 seconds of anti-theft alarm system activation:

- LED illuminates = Test, switch-on delay.
- LED flashes quickly = Door, luggage compartment or bonnet open, or system fault.

After the first 10 seconds of anti-theft alarm system activation:

- LED flashes slowly = System switched on.
- LED illuminates = Switch-off function. for approx. 1 second

If a system fault occurs, contact a workshop for assistance.



To deactivate

Press button  on the remote control – or – turn on the ignition.

If there is a fault in the remote control, unlock vehicle as described on page 33.

If the alarm is triggered when the driver's door is opened, deactivate the anti-theft alarm system by switching on the ignition.



17548 J

Estates with electrically operated tailgate *:

To open and close the luggage compartment when the anti-theft alarm system is active:

1. Briefly press button  on the remote control – luggage compartment is unlocked (see page 34), and monitoring of the passenger compartment and vehicle tilt is disabled.
2. Open luggage compartment – see page 34.

3. After the luggage compartment is closed, monitoring of the passenger compartment, luggage compartment and vehicle tilt is reactivated after a 5 minute delay and the tailgate is locked. To override the delay, press button  on the remote control.

Note

- Changes to the vehicle interior, such as the use of extra seat covers, could impair the function of passenger compartment monitoring.
- Disable passenger compartment monitoring if the vehicle interior is being heated.

Alarm

An alarm can be triggered whilst the anti-theft alarm system is active, indicated by:

- an acoustic signal (horn) and
- a visual signal (hazard warning lights).

The number of alarms and the duration thereof are stipulated by law.

The alarm can be silenced by pressing a button on the remote control or by switching on the ignition. The anti-theft alarm system is deactivated at the same time.

Alarm siren with integrated battery *

The alarm siren monitors the on-board voltage network and triggers an alarm if this network is manipulated (e.g. if the vehicle's battery is disconnected by unauthorised persons). The alarm siren has its own power supply and is therefore not dependent on the vehicle's battery.

If the vehicle's battery is to be disconnected (e.g. for maintenance work), the alarm siren must be deactivated as follows: switch the ignition on then off, disconnect the vehicle's battery within 15 seconds.

To switch off alarm siren:

Switch ignition on then off.



Child safety locks

Warning

Use the child safety locks whenever children are occupying the rear seats. Disregard may lead to injuries or endanger life. Vehicle passengers must be informed accordingly.

Turn rotary knob near rear door lock from the vertical position using key; door cannot be opened from inside.



Universal remote control in mirror housing *

To operate up to 3 different remotely-operated systems (e.g. garage door, domestic alarm system, domestic exterior lighting).

The programmed universal remote control can replace the individual remote control units of the systems to be operated. Three buttons on the underside of the mirror housing can be used to operate various systems.

Consult your Vauxhall Authorised Repairer for details on compatible systems.

Warning

Ensure that no persons, animals or objects are in the movement zone of the system to be operated (e.g. a garage door). Vehicle passengers must be informed of the hazards.

Basic programming of the universal remote control system

1. Switch on ignition.
2. When programming for the first time, press both outer buttons on the mirror housing, until the control indicator alongside the buttons flashes rapidly (after approx. 20 seconds).
3. Hold the manual remote control unit at a distance of 0 to 30 cm from the control button area of the mirror housing.

4. Press the button on the manual remote control unit while pressing and holding the desired button of the universal remote control.
5. The control indicator in the mirror housing will flash slowly at first. As soon as it flashes rapidly, release both buttons. The universal remote control system is now programmed for the chosen system.
6. To programme other buttons with other systems, repeat steps 3 to 5.

If a system cannot be operated after repeated programming, and the control indicator flashes rapidly for a short time after the relevant button has been pressed and then illuminates for 2 seconds, the receiver may be equipped with a variable code system - see next column.

Programming the universal remote control system for variable code systems

1. Perform basic programming – see previous page.
2. Activate synchronisation mode of system (see system manufacturer's operating manual) and briefly press the pre-programmed button on the universal remote control three times within 30 seconds.
3. The universal remote control system is now programmed for variable code systems. To programme other systems for variable codes, repeat steps 1 and 2 for the other buttons on the universal remote control.

Using the universal remote control system

With the ignition on, press the required universal remote control button and the control indicator in the mirror housing will illuminate. The pre-programmed system can now be operated using the universal remote control system.

Reprogramming individual button settings

If a button that has already been programmed is to be used for a different system, repeat steps 3 to 5 of the basic programming procedure described previously.

Clearing all programmed button settings

Before selling the vehicle, it is a good idea to erase button settings.

Button settings can only be erased all at once. It is not possible to erase individual button settings. Buttons can, however, be individually reprogrammed - see "Reprogramming individual button settings".

In order to erase the programming of all 3 buttons, press both outer buttons and release as soon as the LED begins to flash (after approx. 20 seconds). All button settings have now been cleared and can be programmed anew at any time.

Note

Keep replaced manual transmitters for possible reprogramming. The manual transmitters can also continue to be used.

If, after repeated attempts at execution of the above steps, a system cannot be actuated with the universal remote control, seek the assistance of a workshop.

During programming, the vehicle should be within the range of the receiver. Under no circumstances should the vehicle be in the movement zone of a system (e.g. garage door).

Do not programme a system without an automatic safety stop (manufactured before April 1982).

Take note of the system manufacturer's safety instructions for drives and manual remote control units.

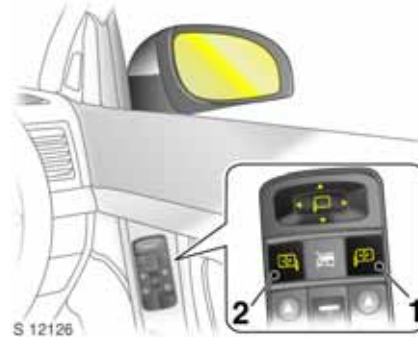

Exterior mirrors

Adjusting exterior mirrors *

Adjustment using the four-way switch in the driver's door. If the outer mirror switch (1) is pressed, the four-way switch operates the driver's and front passenger's mirrors *. If the inner mirror switch (2) is pressed, it only operates the front passenger's mirror.

The glass of the mirror is adjusted in the relevant direction in accordance with the operation of the four-way switch.

Electrical seat adjustment with Memory function *

If the inner mirror switch (2) is pressed, the front passenger-side exterior mirror is pointed automatically at the rear tyres after reverse gear is engaged, in order to assist parking (not if towing a caravan/trailer) *.

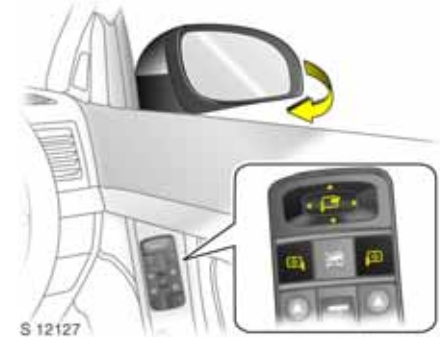

Swinging in exterior mirror

Manually: The exterior mirrors can be folded in by gently pressing the outer edge of the housing.

Electrically * (both mirror switches must not be latched into position):

Push four-way switch to the right: outside rear view mirrors swivel in.

Push four-way switch to the left: outside rear view mirrors swivel out.

Return the mirrors to the driving position before starting-off.

The mirrors can be retracted from the outside: Press button  on the remote control approx. 1 second. The mirrors will be extended the next time the vehicle is unlocked.

Swivelling only allowed at speeds of up to 4 mph (7 km/h).



For the safety of pedestrians, the exterior mirrors will swing out of their normal mounting position if they are bumped with sufficient force. Reposition the mirror by applying slight pressure to the mirror housing.

Aspherical exterior mirror ✳

The aspherical mirror glass makes the blind angle smaller. The curvature makes objects look smaller, making it more difficult to estimate how far away following vehicles are.

Automatic anti-dazzle exterior mirror ✳ on the driver's side

Dazzle from following vehicles at night is automatically reduced.

The mirror does not reduce dazzle when:

- the ignition is switched off,
- reverse gear is engaged or selector lever set to **R**,
- the interior lights are on,
- a door is open.



Interior mirror

To adjust, swivel mirror housing.

Swivel lever on underside of mirror housing to reduce dazzle from following vehicles at night.



S 12164

Automatic anti-dazzle interior mirror *
Dazzle from following vehicles at night is automatically reduced.

The sensor is located at the bottom of the housing. In the case of vehicles with a position memory for electrically operated front seats * or a universal remote control *, the sensor is located at the top right of the mirror glass.

The mirror does not reduce dazzle when:

- the ignition is switched off,
- reverse gear is engaged or selector lever set to R,
- the interior lights are on,
- a door is open.

Electric windows *

⚠ Warning

Take care when operating the electric windows. Risk of injury, especially for children. Vehicle occupants should be informed accordingly.

If there are children on the rear seat, switch on the child safety system * for the electric windows.

Keep a close watch on the windows when closing them. Ensure that nothing becomes trapped in them as they move.

The electric windows can be used:

- with ignition on,
- within 10 minutes of switching ignition off,
- within 10 minutes of opening or closing the driver's door,
- within 10 minutes of inserting or removing the ignition key.

Readiness for operation stops when the vehicle is locked.



S 12167

Operation via 2 rocker buttons in the driver's door. Additional rocker buttons in the front passenger's door and the rear doors *.

To operate window in stages, tap switch. For automatic opening or closing, keep switch pressed for slightly longer; to stop window movement, tap switch again.



Vehicles with rear electric windows ✳ have a slide switch between the buttons in the driver's door

- Up:
The front windows can be operated using the buttons.
- Down:
The rear windows can be operated using the buttons.

Safety function

If the window glass encounters resistance above the middle of the window during automatic closing, it is immediately stopped and the window opened again.

If the windows do not move easily (e.g. on account of frost), keep pressing the switch for the window in question until the window has been closed in stages.



Child safety system for rear windows ✳
Switch ✳ in the driver's door

- Press (switch ✳ illuminates in red): rear windows cannot be operated using the buttons in the rear doors,
- press again (switch ✳ no longer illuminates in red): rear windows can be operated using the buttons in the rear doors.

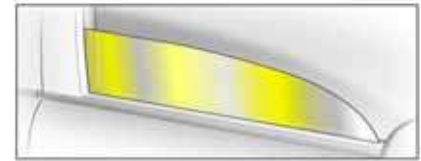

S 14738

Closing windows from outside using the remote control ✳

The windows can be closed from outside using the remote control:
Depress the = button until the windows are closed.

Automatic closing *

See page 33.

Overload

If the windows are repeatedly operated at short intervals, the power supply is briefly cut off.

The system is protected by fuses in the fusebox – see page 246.

Fault

If the windows cannot be opened and closed automatically, activate the window electronics as follows:

1. Close doors.
2. Switch on ignition.
3. Window completely open.
4. Close window and press on button for at least 3 seconds.
5. Repeat for each window.

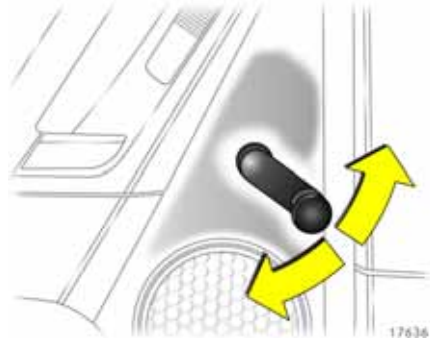
**Windows in rear doors**

Turn crank * towards the front or rear.

Sunroof *

 Warning
<p>Caution when operating the sunroof. Risk of injury, particularly to children. Vehicle passengers must be informed accordingly.</p> <p>Keep a close watch on the sliding roof when closing it. Ensure that nothing becomes trapped as it moves.</p>

Caution when operating the sunroof. Risk of injury, particularly to children. Vehicle passengers must be informed accordingly.

Keep a close watch on the sliding roof when closing it. Ensure that nothing becomes trapped as it moves.

The electric sunroof can be operated

- with ignition on,
- within 10 minutes of switching ignition off,
- within 10 minutes of opening or closing the driver's door,
- within 10 minutes of inserting or removing the ignition key.

Readiness for operation stops when the vehicle is locked.

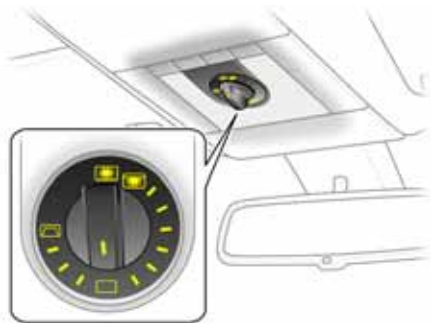

S 12169

Operated using rotary switch in the overhead control panel.

To open

Turn the rotary switch to any position between □ and ☒. The sunroof will automatically move to the desired position. When the switch is in position ☒, the sunroof is fully opened.

Comfort position

Set rotary switch to position ☒. With the roof in this position, wind noise is reduced.

To close:

Turn rotary switch to □.

To raise

Turn the rotary switch to any position between □ and ☒. The sunroof will automatically move to the desired position. When the rotary switch is in position ☒, the sunroof is fully raised.

To lower

Turn rotary switch to □.

Position memory

After the ignition has been switched on, the sunroof can be automatically returned to its last position by briefly pressing the rotary switch.

Safety function

If the sunroof encounters resistance during automatic closing, it is immediately stopped and opened again, as long as the vehicle is stationary.

Warning

If when the vehicle is being driven the sunroof encounters resistance during automatic closing, because of the higher closing forces involved the protective function cannot be guaranteed, and there is a risk of injury.

If the sunroof movement is stiff, e.g. due to frost, turn rotary switch to □ and keep it pressed until the sunroof is closed.



17638 J

Closing sunroof from outside

To close the sunroof from outside with the remote control: Press button = until the sunroof is closed.

If the electric windows * are to be closed from outside the vehicle, but the sunroof is to be left open, briefly press the rotary switch before switching off the ignition.

Automatic closing *

See page 33.

Sunshade

To reduce the sunlight in the interior with the sliding roof closed or raised.

Open or close sunshade as required.





When the sunroof is opened, the sunshade is also opened.

Overload

If the system is overloaded, the power supply is automatically cut off for a short time.



Fault

If the sunroof no longer assumes the desired position automatically, programme sunroof electronics as follows:

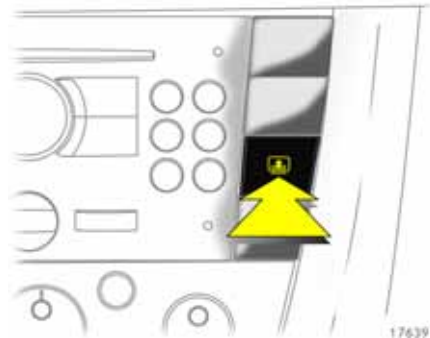
1. Switch on ignition.
2. Press the rotary switch until the sunroof is shut, then keep it pressed for at least a further 3 seconds.
3. Turn rotary switch to  and keep it depressed until the sunroof is open.
4. Turn rotary switch to  and keep it depressed until the sunroof is closed.
5. Turn rotary switch to  and leave there until the sunroof is fully raised.
6. Turn rotary switch to  and keep it depressed until the sunroof is closed.

**Electrically operated rear window blind ***

Reduces intensity of sunlight shining on to rear seats. Operation with ignition switched on.

To raise = Press 
 To lower = Press  again

Do not operate blind if there are objects lying in front of the rear window.

**Sunblinds for rear door windows ***

To reduce sunlight at the rear seats.

Pull the blind upwards using the grip and engage it at the top in the door frame.

Seats, interior

Manually adjustable front seats	50
Electrically adjustable front seats * ..	52
Head restraints	55
Armrest * between the front seats....	57
Rear seat armrest	57
Travel Assistant *	58
Luggage compartment extension	65
Luggage compartment cover *.....	66
Safety net *, Estate	67
Lashing eyes	69
Reversible carpet *	69
FlexOrganizer *.....	69
Notes on loading the vehicle	71
Three-stage safety system.....	72
Three-point seat belts	72
Belt tensioners.....	73
Using the seat belts.....	76
Child restraint systems *	77
Airbag system	80
Cigarette lighter *.....	93
Accessory sockets *	93
Ashtray	94
Stowage compartments.....	95
Drink holders	97
Sunvisors.....	97



S 12119

Manually adjustable front seats

Warning

Never adjust seats during driving, as they can move uncontrollably.

Important: Do not sit nearer than 10 inches (25 cm) from the steering wheel, to permit safe airbag deployment.

Adjust seat longitudinally

To adjust seat position, pull handle at front of seat, move seat and then release handle.



S 12120

Adjusting the backrest

To adjust, turn side handwheel on the seat while releasing the load on the backrest.

Move backrest to suit seating position.



S 12122

Adjusting the seat height ✳

To adjust height of seat, operate rear lever on outboard side of seat.

Pump action of lever

Upwards: Seat higher

Downwards: Seat lower



S 12123

To adjust seat incline ✳

Pump action of lever

Upwards: Seat steeper

Downwards: Seat flatter



S 12121

Adjusting the lumbar support ✳

To adjust, activate the lever on the backrest, relieving pressure on the backrest as you do so.

Adjust lumbar support to suit personal requirements.

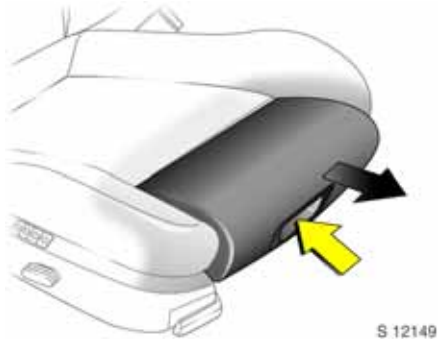

S 12149

To adjust thigh support * on the sports seats *

To adjust, press button in recessed grip located in the centre beneath the adjusting cushion and move the thigh support.

Adjust thigh support to suit personal requirements.

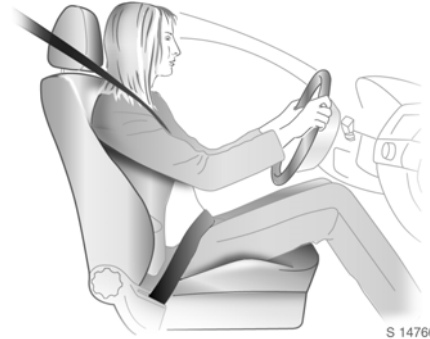

S 14766

Seat position

Adjust driver's seat such that with the driver sitting upright the steering wheel is held in the area of its upper spokes with the driver's arms slightly bent.

Push front passenger's seat as far back as possible.

The seat backrests must not be tilted too far back (recommended maximum tilting angle approx. 25°).

Warning

Failure to observe the descriptions could lead to injuries which could be fatal. Vehicle passengers must be informed accordingly before starting-off.

Electrically adjustable front seats *

Warning

Care must be taken when operating the electrically adjustable seats. There is a risk of injury, particularly for children, and a danger that articles could become trapped.

Keep a close watch on the seats when adjusting them.

Vehicle passengers must be informed accordingly.

Adjustment

The seat position can be adjusted by means of switches on the outboard side of the seats.

Adjusting the inclination

Move switch 1 upwards/downwards at front.

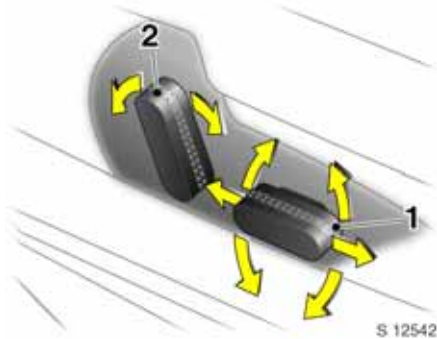

S 12542

Adjusting the longitudinal position

Move switch 1 forwards/backwards.

Height adjustment

Move switch 1 upwards/downwards at rear

Seat backrest adjustment

Turn switch 2 forwards/backwards.

Operate switch until desired seat position is reached. Seat position – see page 52.

After adjusting the seat, adjust height of seat belt – see page 76.

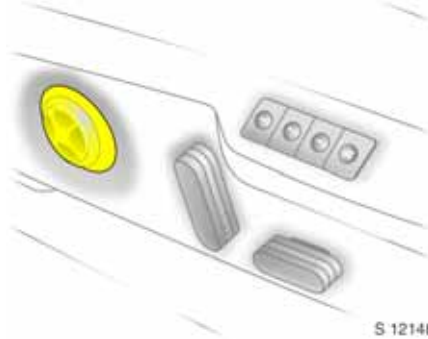

S 12146

Electrically operated lumbar support * on driver's seat

Adjust lumbar support using four-way switch on outboard side of driver's seat.

Adjust lumbar support to suit personal requirements.

Moving support up and down: press button up or down.

Increasing and decreasing support: press button forwards or backwards.

Thigh support * on driver's seat

See page 52.

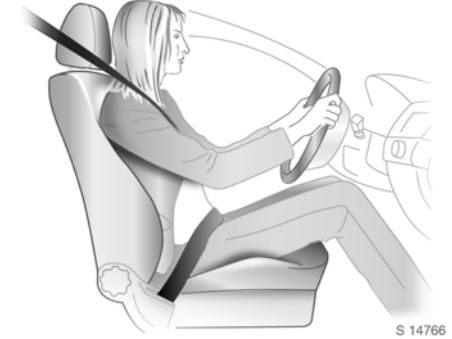

S 14766

Seat position

Adjust driver's seat such that with the driver sitting upright the steering wheel is held in the area of its upper spokes with the driver's arms slightly bent.

Push front passenger's seat as far back as possible.

The seat backrests must not be tilted too far back (recommended maximum tilting angle approx. 25°).

⚠ Warning

Failure to observe the descriptions could lead to injuries which could be fatal. Vehicle passengers must be informed accordingly before starting-off.

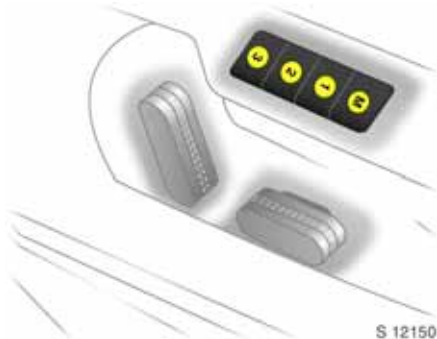

Memory function * for electrically adjustable driver's seat and exterior mirrors

Three different seat and mirror settings can be stored (e.g. for three drivers).

Readiness for operation

- With ignition on,
- within 10 minutes of switching ignition off,
- within 10 minutes of opening or closing the driver's door,
- within 10 minutes of inserting or removing the ignition key.

Readiness for operation stops when the vehicle is locked.

Storing settings

1. Adjust seat.
2. To adjust exterior mirror - see pages 6, 43.
3. Press memory button **M** and the position button to be used (**1**, **2** or **3**) simultaneously, and storage is acknowledged by an acoustic signal.

Retrieving settings

Keep position key **1**, **2** or **3** pressed until the stored seat and mirror positions have been reached.

For reasons of safety, seat adjustment stops immediately if the position button is released or one of the setting buttons is operated.

Adjustments may only be performed with vehicle stationary.

Store and activate the settings using the remote controls *

When the vehicle is locked using the remote control the current driver's seat and exterior mirror positions are stored - see page 28.

The seat adjusting procedure can be stopped immediately by operating a setting button.

Front passenger-side exterior mirror with mirror parking assistance *

See page 43.

Overload

If the seat setting is electrically overloaded, the power supply is automatically cut off for a short time.

The system is protected by fuses in the fusebox - see page 246.

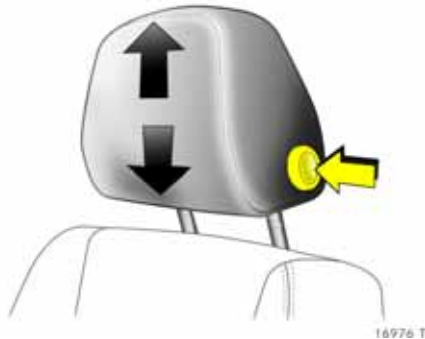

Head restraints

Adjusting the front seat head restraints and the outboard rear seat head restraints *

To adjust height, press button on side and adjust height.

In order to increase the size of the luggage compartment or if they are not being used, push rear head restraints down as far as possible - see page 65.

When the seats are occupied, adjust the height according to the body size of the occupant.



To adjust the incline, swivel the bottom edge of the head restraint forwards or backwards.

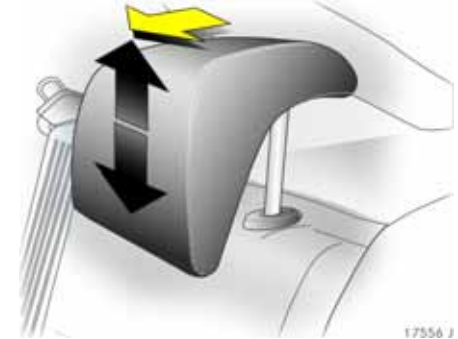

Adjusting the rear head restraints integrated in the rear seat backrest *

To adjust head restraints, pull forwards with both hands and slide up or down.

To increase the size of the luggage compartment or improve visibility, push head restraint down as far as possible if seat is unoccupied.

If seat is occupied, pull head restraint upwards.

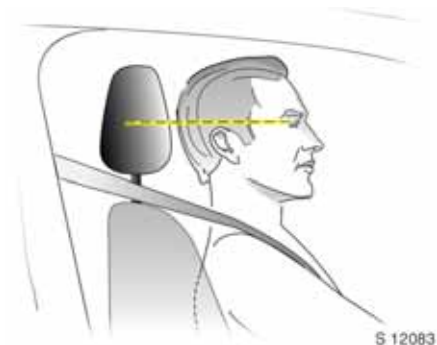

Head restraint position

The middle of the head restraint should be at eye level. If this is not possible for extremely tall persons, set to highest position, and set to lowest position for small persons.

Warning

Disregarding the instructions can lead to injuries which could be fatal. Vehicle passengers must be informed accordingly before setting off.



Active head restraints ✱

In the event of a rear-impact, the active head restraints tilt slightly forwards. The head is more effectively supported by the head restraint and the danger of whiplash in the neck area is reduced.

Active head restraints are identified by the lettering **ACTIVE** on the head restraint guide sleeves.



Removing the head restraints

Press and release the two catches. Pull and remove the head restraint.

In order to increase the size of the luggage compartment or if they are not being used, push rear head restraints down as far as possible - see page 65.

Note

Only approved objects or components should be attached to the head restraint of the unoccupied front passenger's seat.



Armrest* between the front seats

The armrest can be pushed forwards. If the armrest is not required, push it back and fold it up.

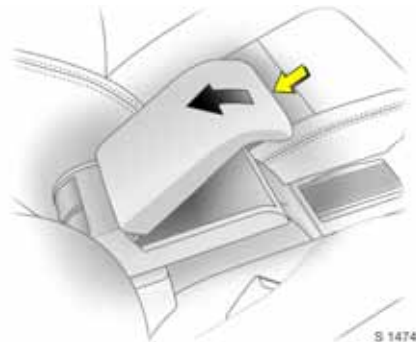

The armrest contains a stowage compartment: to open, slide armrest back, press button at front and lift.

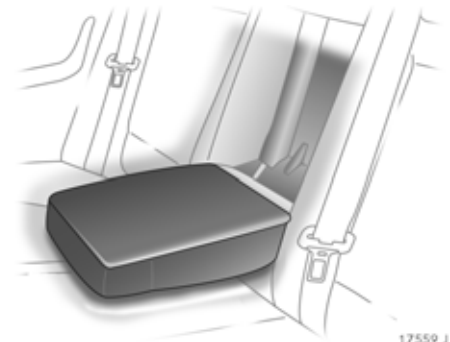

Rear seat armrest

The armrest can be folded down.

If the rear centre seat is being used or the rear seat backrests are being folded down, fold armrest upwards.



17560 J

Travel Assistant *

The Travel Assistant contains

- Arm rest
- Stowage compartments
- Waste container
- Drink holders
- Accessory sockets.
- Connection console
e.g. for DVD player *
- Electric cool box
- Foldaway tables
- Twin Audio (rear audio module) * or
stowage compartment.

The Travel Assistant is installed on a console above the centre seat in the rear.

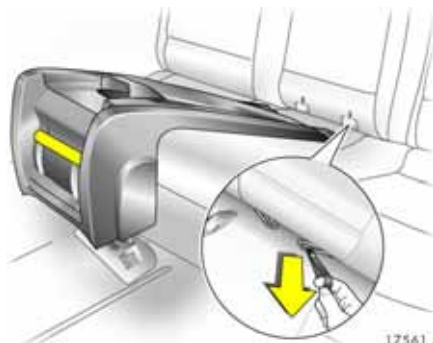

17561 J

Installing the Travel Assistant

Swivel out retaining device on seat with strap.

Insert the two rear retainers of the connecting console in the retaining device on the seat and engage.

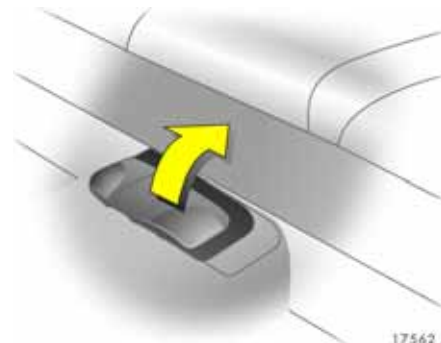

17562 J

Swivel open and hold cover of front attachment points in floor in front of console.

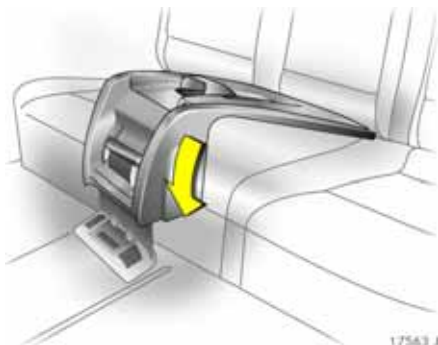

Swivel connecting console downwards and engage in attachment points.

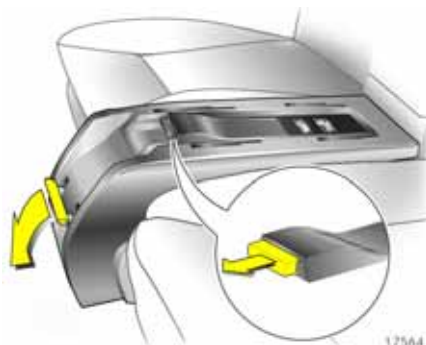

Swivel the locking lever downwards.
Check the locking position of the Travel Assistant: The red mark (see Fig. 17566 J on next page) must not be visible.
Otherwise, lock using the key – see page 63, Fig. 17575 J.

Remove cap ✱ from plug at securing bracket.



To lock, insert Travel Assistant into recesses in connecting console and slide back as far as possible.



If it is correctly locked, the red mark must no longer be visible in the window, otherwise the procedure must be repeated.

⚠ Warning

If it is not correctly locked, the Travel Assistant could be propelled forwards with considerable force when hard braking occurs, risk of injury.



Drink holder and accessory sockets
Open the drink holder by pressing the marking.

Only accessories with maximum power consumption of 120 Watts must be connected to the accessory sockets. For notes – see page 93.

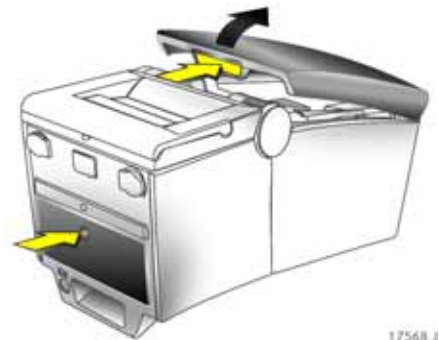

Stowage compartments
The lower stowage compartment is opened by pressing the mark. The underside of the compartment has an opening through which objects in the compartment can be raised.

The upper stowage compartment is located under the armrest. To open, press the button and fold the armrest upwards.

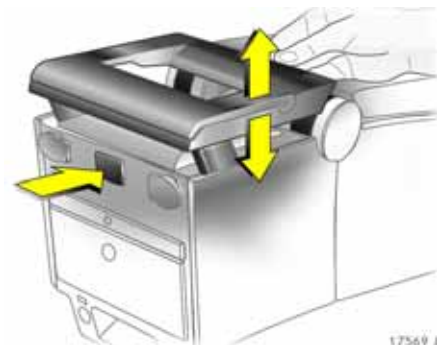

Connecting console for DVD player*
When not in use, pull connecting console upwards, press button and slide downwards.



Swivel up the display holder, slide DVD player display into bracket from below and fix in position with bracket.
Maximum load: 1 kg.

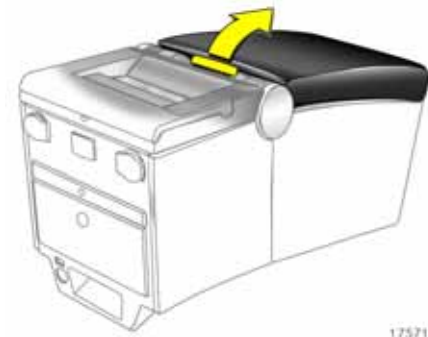

Electric cool box
To open, fold open the armrest together with the stowage compartment.

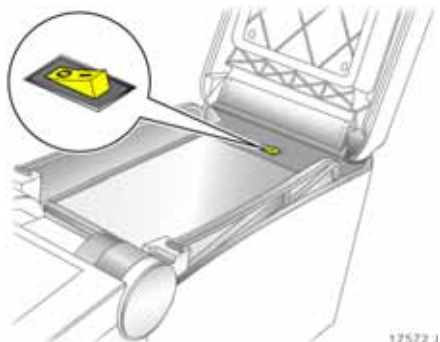

17572 J

Switch on the cool box as needed.

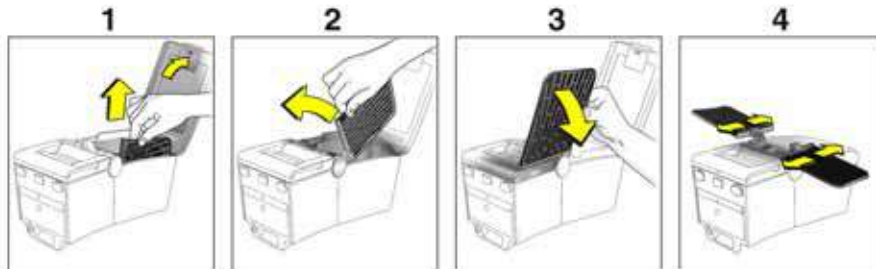

17573 J

Foldaway tables

Fold armrest upwards (1).

Use recessed grip to pull foldaway table upwards as far as it will go (1), swivel foldaway table forwards (2) and fold downwards (3).

Set required clearance by adjusting longitudinal position of foldaway table (4).

Swivel armrest down.



17574 J

To fold away the table, swivel the armrest up.

Push the table forwards as far as it will go (1).

Fold the table upwards past the resistance point (2), swivel it downwards and insert in the Travel Assistant (3).

Swivel armrest down.

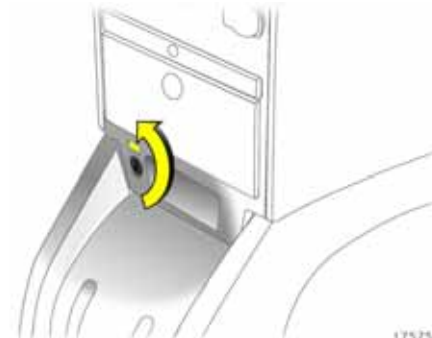

17575 J

Dismantling the Travel Assistant

Open catch using key, red mark appears in window.



Pull the Travel Assistant to the front on the connecting console and remove.

Fit cap * to plug on securing bracket.

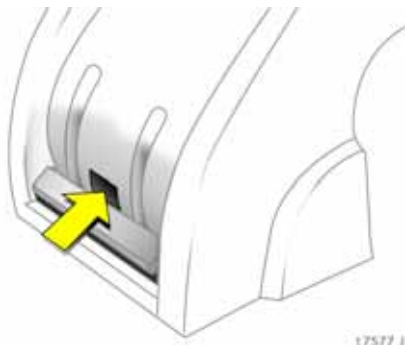

Press the locking lever down, press the button on the front of the connecting console and swivel the locking lever upwards.

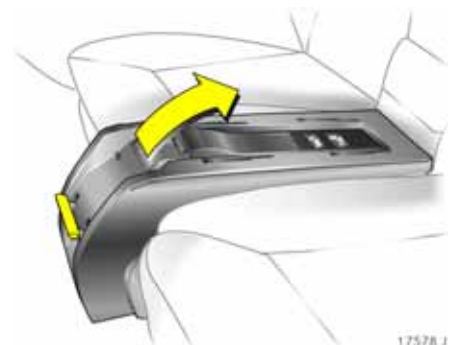

Swivel the connecting console upwards and pull it from the retaining device on the seat.

Swivel the retaining device back on the seat.



Luggage compartment extension

Fold down the cover behind the armrest

Fold down the armrest on to the seat cushion, pull the handle and tilt the cover forwards.

The outer seats can continue to be used for passengers.

Warning

The load must not obstruct operation of the pedals, handbrake and gearshift, or the freedom of movement of the driver. Do not leave unsecured objects in the interior. Note instruction on page 71.

Engage the cover behind the centre armrest audibly in position.

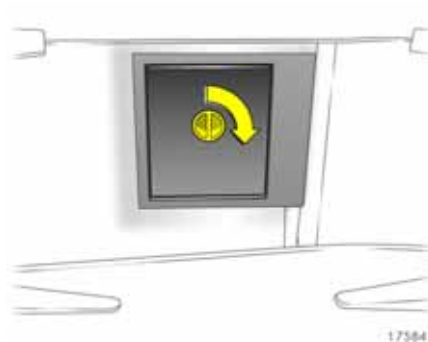

Cover behind armrest can be locked from luggage compartment * : turn handle 90°:

- Locked = Handle horizontal
- Unlocked = Handle vertical

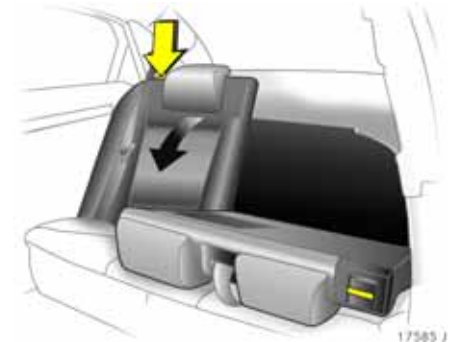

Folding down the rear seat backrests

Push the rear head restraints right down.

Place the belt buckles in storage pockets in the seat cushions.

Slide front seat forwards slightly.

Remove Travel Assistant * - see page 60.

Unlock one or both rear seat backrests by depressing pushbuttons and fold down on to seat cushion.

Return front seat to desired position.



Restoring backrest to an upright position
Audibly engage the rear seat backrests. There is a locking indicator on the release lever. If the rear seat backrests have been correctly locked the red indicator on the release levers must not be visible.

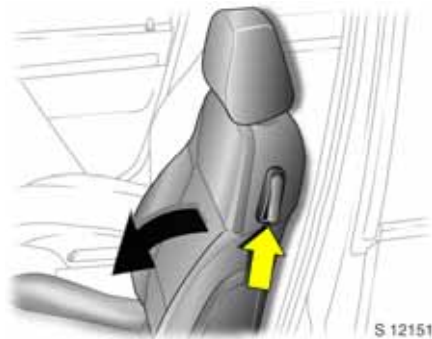

Folding down the front passenger's seat *
Push head restraint on front passenger's seat down as far as it will go.
Slide front passenger's seat backwards.
Fold front passenger's seat forwards by raising release lever.
To restore, raise the release lever, restore the front seat backrest to an upright position and audibly engage.

Notes on loading
See page 71.

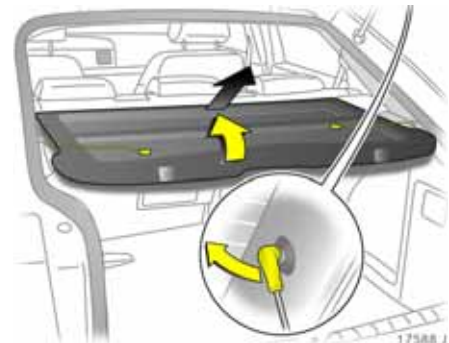

Luggage compartment cover *
5-door Hatch

Removing
Detach retaining straps from tailgate.
Pull cover from the side guides.

Fitting
Engage cover in side guides and fold down.
Attach retaining straps to tailgate.

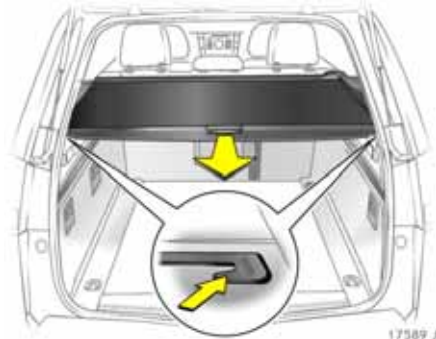
**Estate****To close**

Pull luggage compartment cover towards rear of vehicle using handle and hook into side retainers.

Do not place any heavy or sharp-edged objects on the cover.

To open

Remove luggage compartment cover from side brackets. It rolls up automatically.

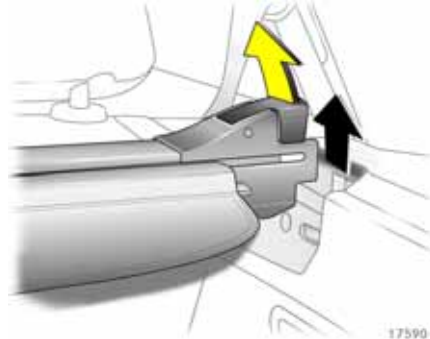
**Removing**

Open luggage compartment cover.

Raise the release lever on the right of the luggage compartment cover. Remove cover from the brackets by lifting first on the right, then on the left.

Fitting

Fit the luggage compartment cover in the bracket on the left-hand side, fold up the release lever on the right-hand side, fit the luggage compartment cover in the bracket on the right-hand side, engage and press the release lever closed.

**Safety net *, Estate**

The safety net can be fitted behind the rear seats or, with the rear seat backrests folded down, behind the front seats.

Passengers must not be carried behind the safety net.

Fitting behind the rear seats

Remove the luggage compartment cover - see left column.

Fit the cassette with rolled safety net into the side brackets and engage by twisting.



Extend the net from the cassette. The roof frame houses two installation openings. Fit the net rod in the installation opening on one side and then the other and engage by pushing forwards.

Fit the luggage compartment cover.

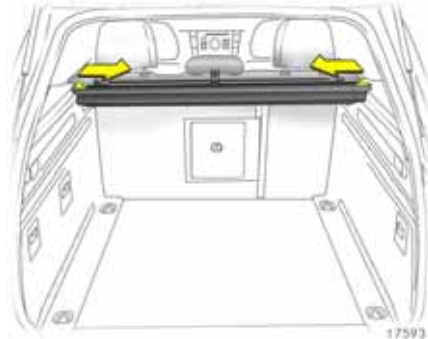

Removing

Remove the luggage compartment cover.

Detach the safety net rod from the brackets in the roof frame.

Slide both latches inwards; push the cassette with rolled net backwards in the bracket, twist and remove upwards.

Fitting behind front seats

Fold both rear seat backrests. Place the rolled net on the floor behind the front seats in such a way that the cog rail in the slit on the net is to the rear.

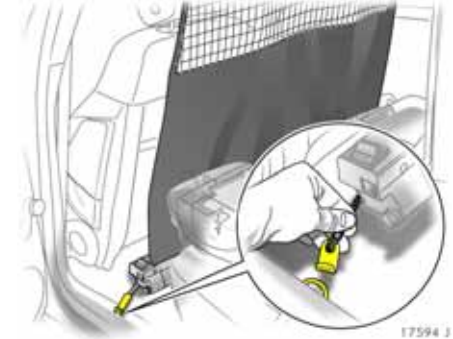

Pull each side hook from the cassette and attach it to an eye ❁ in the vehicle floor.

Extend the net from the cassette. The roof frame houses two installation openings. Fit the net rod in the installation opening on one side and then the other and engage by pushing forwards.

Removing

Detach the safety net rod from the brackets in the roof frame.

Undo the side hooks from the eyes ❁ in the vehicle floor.



Lashing eyes

In the luggage compartment, secure items being transported against slipping by attaching lashing straps * or a luggage net *.

Reversible carpet *

Folding floor covering with two different surfaces. When transporting objects in the luggage compartment, fold reversible carpet with appropriate surface on top.



FlexOrganizer *

Flexible system for dividing the luggage compartment or securing loads in an Estate.

The components are housed in a stowage compartment at the rear in the load floor - see page 96.

The system consists of:

- Variable partition net,
- Variable partition wall,
- Partition rod,
- Mesh pockets for the side walls,
- Hooks.

The components can be mounted in the two guide rails in the side walls of the luggage compartment.



The illustrations show some possible uses.

Variable partition wall

See Fig. 17596 J. Press the rods of the partition wall together slightly and engage in the desired guide rail openings in the side walls. The rods can be engaged in various positions.

Variable partition net

See Fig. 17597 J. Push rods of partition net together a little and insert into relevant openings in side wall guide rails. The rods can be engaged in various positions. The partition net can be installed horizontally or vertically at different heights.

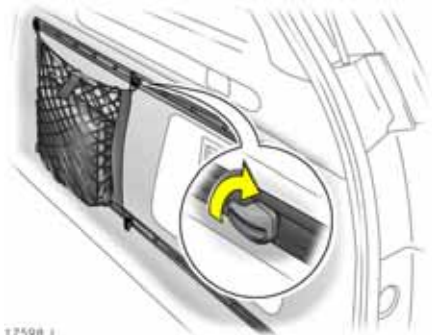

17598 J

Hooks and mesh pockets for the side walls
See Fig. 17598 J. Engage the hooks in the openings of the guide rails in the side walls as indicated in the illustration and turn 90°. The mesh pockets can be hung from the hooks.



17599 J

Removing
Press together the rods of the partition wall/net or the telescopic rods and remove from the guide rails. Turn the hooks 90° and remove.

FlexOrganizer stowage

The FlexOrganizer components are housed in a stowage compartment at the rear in the load floor. To open, raise the handle and open the flap – see page 96, Fig. 17611 J.



17600 J

To stow away, pull partition rods, partition net rods and separate telescopic rod apart in the middle and fold the two halves together - see Fig. 17599 J. Roll up partition and partition net and place in compartment with other components. Close lid.

Notes on loading the vehicle

- Heavy objects in the luggage compartment should be placed against the engaged rear seat backrests or, if the rear seat backrests are folded down, against the front seat backrests. If objects are to be stacked, the heavier objects should be placed at the bottom. Unsecured objects in the luggage compartment would be thrown forwards with great force in the event of heavy braking, for example.
- Secure objects with lashing straps * attached to lashing eyes – see page 69. If heavy loads slip when the vehicle is braked heavily or driven around a bend, the handling of the vehicle may change.
- Saloon / Hatch: loose objects in the luggage compartment should be secured against slipping using a luggage net * – see page 69.
- Estate: mount the safety net * when transporting objects in the luggage compartment - see page 67.
- Estate: Close luggage compartment cover - see page 67.
- When transporting objects in the luggage compartment the rear seats must be engaged - see page 65.

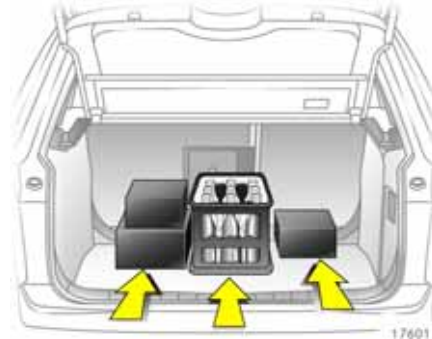

- Do not allow the load to protrude above the upper edge of the rear seat backrests, or above the upper edge of the front seat backrests if the rear seat backrests are folded down.
- The warning triangle * and first-aid kit * must always be freely accessible.
- Do not place any objects in front of the rear window or on the instrument panel. They are reflected in the glass, obstruct the driver's view and will be thrown through the vehicle, for instance in the event of heavy braking.
- Objects must not be stored in the airbag inflation area, because they could cause injury if the airbag inflates.
- The load must not obstruct the operation of the pedals, the handbrake or the gears or restrict the driver's freedom of movement. Do not place loose objects in the interior.
- Do not drive with luggage compartment open when transporting bulky objects, for example, since toxic exhaust fumes could penetrate the interior.
- Weights, payload and roof load - see page 293.
- Driving with a roof load - see pages 184, 187, 218. A roof load increases the sensitivity of the vehicle to crosswinds and has a detrimental effect on vehicle handling owing to the vehicle's higher centre of gravity.

Warning

Failure to observe these descriptions can lead to injuries which may be fatal. Vehicle passengers must be informed accordingly.

Three-stage safety system

Comprising:

- Three-point seat belts.
- Belt tensioners at the front seats.
- Airbag systems for driver, front passenger and outboard rear seat occupants ✱.

The three stages are activated in sequence depending on the severity of the accident:

- The automatic seat belt locking devices prevent the belt strap from being pulled out and thus ensure that the vehicle occupants are retained in their seats.
- The front seat belts are pulled down at the belt buckles. This means the belts fit snugly, the occupants are decelerated early with the vehicle and the body loading is reduced.
- The airbag systems are also triggered in the event of serious accidents and form a safety cushion for the occupants. Depending on the severity of the accident, the front airbags inflate in two stages.

Warning

The airbag systems serve to supplement the three-point seat belts and belt tensioners. The seat belts must therefore always be worn. Disregard of these instructions may lead to injuries or endanger life. Vehicle passengers must be informed accordingly.

Please read the instructions provided with the child restraint system.



Three-point seat belts

The vehicle is equipped with three-point seat belts with automatic retractors and locking devices, allowing full freedom of body movement although the spring tensioned seat belts always ensure a snug fit.

For information on correct seating position – see pages 52, 77, 82.

The seat belts lock during heavy acceleration or deceleration.

Warning

Always wear your seat belt, and that means also in urban traffic and when you are a rear seat passenger. It can save your life.

Also, pregnant women must always wear a seat belt – see page 76.

In the event of an accident, persons not wearing seat belts endanger their fellow occupants and themselves.

Control indicator  for the seat belt – see page 101.

Seat belts are only intended for one person. They are not suitable for anyone under 12 years of age or under 150 cm tall.

For children up to 12 years of age, we recommend the Vauxhall child restraint system – see page 77.

Belt force limiters

on the front seat belts reduce stresses on the body by releasing the seat belt gently during an impact. This allows the body to move slightly in anticipation of the impact.

Testing the seat belts

Check all parts of the belt system from time to time for damage and to ensure function. Replace damaged parts. Following an accident, have the seat belts and actuated belt tensioners replaced by a workshop.

Do not make alterations to the seat belts, their anchorages, their automatic retractors and the belt buckles.

Do not damage the seat belt with sharp objects, and do not get it trapped.

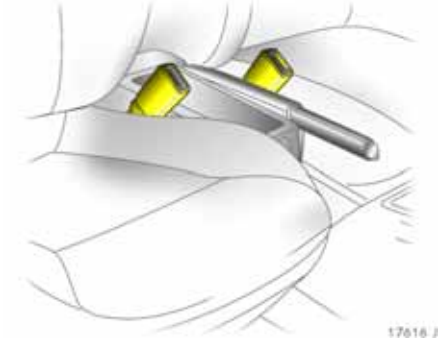

Belt tensioners

The front seat belt systems are fitted with belt tensioners. The seat belts are pulled down and tensioned at the belt buckles in the event of frontal and rear collisions, depending on the severity of the accident. This tensions the seat belts.

Actuation of belt tensioners

Actuation of belt tensioners is indicated by continuous illumination of control indicator  - see next column.

If the belt tensioners are triggered, they must be replaced by a workshop.

Important information - see page 73.



Control indicator for belt tensioners

The operation of the belt tensioners is electronically monitored together with the airbag systems and indicated on the instrument cluster by the control indicator . When the ignition is switched on, the control indicator illuminates for approx. 4 seconds. If it does not illuminate, does not go off after 4 seconds or illuminates whilst driving, there is a fault in the belt tensioner system or the airbag systems - see page 86. The belt tensioner or the airbag systems may not activate if an accident occurs.

Deployment of the belt tensioners is indicated by continuous illumination of .

Warning

Have the cause of the fault eliminated immediately by a workshop.

The system's integrated self-diagnostics allows faults to be quickly remedied.

If control indicator  in the instrument cluster fails, for reasons of safety, the text **AirBAG** appears on the odometer display. Pressing the reset button will cause the text to disappear. It then reappears on the odometer display 10 seconds later.

Important

- Do not fit accessories not specifically released for your vehicle type or store objects in the belt tensioner operating area (in the area of the belt buckles) due to the risk of injury in the event the belt tensioners are triggered.
- Do not make any modifications to the components of the belt tensioners, as this will render the vehicle unroadworthy.

 **Warning**

Incorrect handling (e.g. removal or fitting of seat belts or belt buckles) can trigger the belt tensioners with risk of injury.

- The belt tensioner and airbag system control electronics can be found in the centre console area. In order to avoid malfunctions, do not store magnetic objects in this area.
- When using the rear seats, make sure that the components of the front seat belts are not damaged by shoes or other objects. Do not allow dirt to enter the automatic seat belt retractor.
- We recommend that you have the front seats removed by a workshop in the event of actuation of the belt tensioners.
- The belt tensioners trigger once only, indicated by the lighting of the control indicator . Have a workshop replace triggered belt tensioners.
- When disposing of the vehicle, the safety instructions given for this must be observed. Take the vehicle to a recycling company for disposal.



S 11541



S 11542



S 12158

Using the seat belts

Fitting seat belts

Pull the seat belt out of the retractor and place it across the body, making sure it is not twisted.

Insert the latch plate into the buckle. The front seat backrest must not be tilted back too far or the seat belt will not operate properly. The recommended angle of inclination is 25°. Make sure that the lap belt is not twisted and that it fits snugly across the body. Tension the belt frequently whilst driving by tugging the diagonal part of the belt.

Warning

On pregnant women in particular, the lap belt must be positioned as low as possible across the pelvis so as not to put too much pressure on the abdomen.

Bulky clothing will impede the snug fit of the seat belt. The seat belt must not be placed over hard or breakable objects in the pockets of your clothing (e.g. pens, keys, spectacles) as this may cause injury. Do not place any objects, such as handbags or mobile telephones, between the seat belt and your body.

Height adjustment

Height adjustment of upper anchorage point for front seat belts:

1. Pull out the seat belt slightly.
2. Front seat belts: Push the button down or push the belt guide up.

Rear seat belts: Press the belt guide and push up or down.

3. Set desired height.
4. Allow belt guide to audibly engage.

Do not adjust height whilst driving.



S 14767

Adjust height such that the seat belt passes over the wearer's shoulder and rests against the shoulder. It must not pass over the neck or upper arm.



S 11542

Removing the belt

To remove the seat belt, press the red button on the catch; the seat belt retracts by itself.

Child restraint systems *

When using a child restraint system, follow the instructions for installation and use.

The country in which you are travelling may not permit the use of child restraint systems on certain seats. Always comply with the local or national regulations.

Selecting the right system

Your child should travel facing backwards in the vehicle for as long as possible. A child has a very weak cervical spinal column and in the event of an accident is less likely to suffer injury in a rear-facing, semi-lying position than if seated upright.

Warning

Never carry child restraint systems on your lap, risk of fatal injury.

Permissible options for fitting a child restraint¹⁾

Weight and age class ²⁾	On front passenger's seat	On outboard rear seats	On centre rear seat
Group 0: up to 10 kg or approx. 10 months	B ¹ , +	U, +	U
Group 0+: up to 13 kg or approx. 2 years			
Group 1: 9 to 18 kg or approx. 8 months to 4 years	B ² , +	U, +	U
Group II: 15 to 25 kg or approx. 3 to 7 years	X	U	U
Group III: 22 to 36 kg or approx. 6 to 12 years			

B¹ = Limited, only with seat occupancy recognition and Vauxhall child restraint system with transponders.

If the child restraint system is being secured using a three-point seat belt, move seat height adjustment* to uppermost position. Move front passenger's seat as far back as possible and move front passenger's seat belt anchorage point to lowest position.

B² = Limited, only with seat occupancy recognition and Vauxhall child restraint system with transponders.

If the child restraint system is being secured using a three-point seat belt, move seat height adjustment* to uppermost position. Move front passenger's seat as far back as possible so that vehicle safety belt runs from anchorage point towards the front.

¹⁾ For reasons of safety, we recommend that the child restraint be installed on one of the outboard rear seats.

²⁾ We recommend the use of each system until the child reaches the upper weight limit.

- U = Can be used universally in combination with a three-point seat belt.
- + = Vehicle seat available with ISOFIX fixings. When using ISOFIX, only ISOFIX child restraint systems approved for the vehicle may be used.
- X = No child restraint system permitted in this weight class.

Note

- Children under 12 years or under 150 cm tall should only travel in an appropriate child restraint.
- When transporting children, use the child restraint systems suitable for the child's weight.
- Ensure that the child restraint system has been correctly fitted - see instructions provided with child restraint system.
- The covers of the Vauxhall child restraint system can be wiped clean.
- Do not stick anything on the child restraint systems and do not cover them with any other materials.
- Only allow the child to enter and exit on the side of the vehicle facing away from the road.
- A child restraint system which has been subjected to stress in an accident must be replaced.
- Secure or remove child restraint systems carried in the vehicle when not in use.

Mounting brackets * for ISOFIX child restraint systems

The brackets located between the backrest and seat cushion are used for mounting ISOFIX child restraint systems.

Please follow the instructions accompanying the ISOFIX child restraint system.

Only ISOFIX child restraint systems approved for the vehicle may be used.

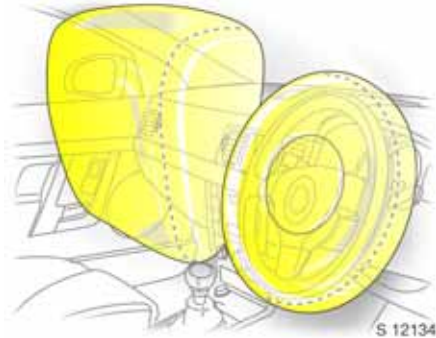

Airbag system

The airbag system consists of several separate systems.

Front airbag system

The front airbag system will be triggered in the event of a serious accident involving a frontal impact and forms safety cushions for the driver and front passenger. The forward movement of the driver and front passenger is checked and the risk of injuries to the upper body and head are thereby substantially reduced.

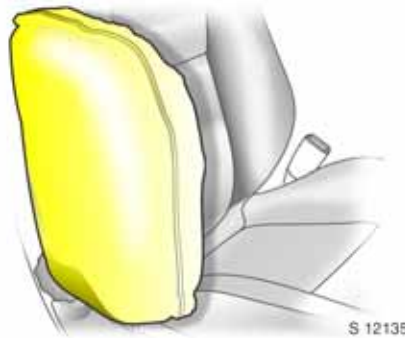

Side airbag system *

The side airbag is triggered in the event of a side-on collision to form a safety cushion for the driver or front passenger in the respective door area. This substantially reduces the risk of injury to the upper body and pelvis.

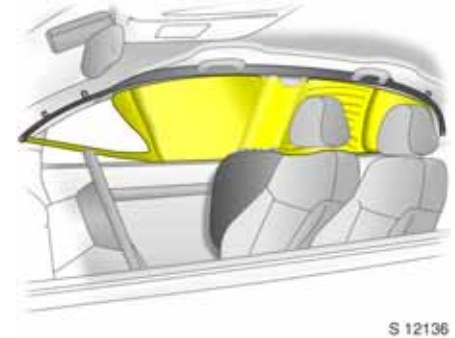

Curtain airbag system *

The curtain airbag system triggers in the event of a side-on collision and provides a safety barrier in the head area on the respective side of the vehicle. This reduces the risk of injury to the head considerably in the event of a side-on collision.



17111 T

Airbag system

Front airbag



The front airbag system is identified by the word **AIRBAG** on the steering wheel and above the glove compartment.

The front airbag system comprises:

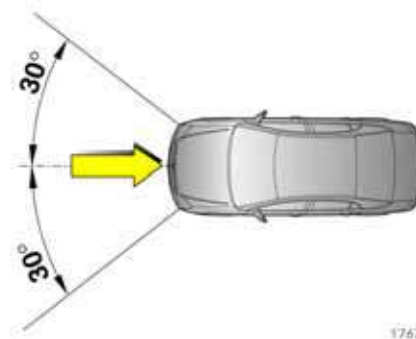
- an airbag with inflator in the steering wheel and a second one behind the trim panel above the glove compartment,
- control electronics with impact sensors,
- control indicator for airbag systems  in instrument cluster,







17621 J

- seat occupancy recognition ,
- the control indicator for Vauxhall child restraint systems  with transponders  in the odometer display.

The front airbag system will be triggered:

- depending on the severity of the accident,
- depending on the type of impact,
- within the range shown in the illustration,
- independent of side airbag and curtain airbag system .

Exception:

Front passenger's seat with seat occupancy recognition system . The seat occupancy recognition system deactivates the front and side airbags  on the front passenger's side if the front passenger's seat is unoccupied or a Vauxhall child restraint system with transponders  has been fitted to the front passenger's seat. Seat occupancy recognition - see page 87. Vauxhall child restraint system with transponders  - see page 78.

Examples of events triggering the front airbag system:

- Impact against a non-yielding obstacle: the front airbags are triggered at low vehicle speed.
- Impact against a yielding obstacle: (such as another vehicle): the front airbags are only triggered at a higher vehicle speed.

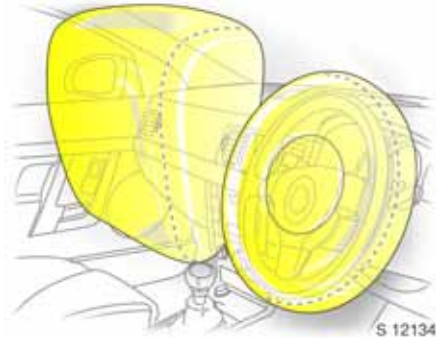

When triggered, the front airbags inflate in milliseconds to form a safety cushion for the driver and front passenger. The forward movement of the front seat occupants is checked, thereby substantially reducing the risk of injury to the upper body and head.

No impairment of view will occur, because the airbags inflate and deflate so quickly.

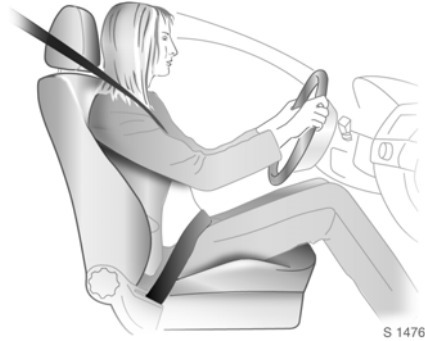

Warning

The front airbag system provides optimum protection when the seat, backrest and head restraint are correctly adjusted: Adjust the driver's seat according to the occupant's height such that with the driver sitting upright the steering wheel is held in the area of its upper spokes with the driver's arms slightly bent. The front passenger's seat should be as far back as possible, with the backrest upright – see pages 3, 52. Do not place the head, body, hands or feet on the covers of the airbag systems.

Do not place any objects in the area in which the airbags inflate. Important information - see page 89.



Warning

The three-point seat belt must be correctly fitted – see page 76.

The front airbag system will not be triggered in the event of:

- the ignition being switched off,
- minor frontal collisions,
- accidents in which the vehicle overturns,
- collisions involving a side or rear-impact, that is to say, if it would not be of benefit to the occupants.

Warning

Seat belts must therefore always be worn. The front airbag system serves to supplement the three-point seat belts. If you do not wear your seat belt you risk being seriously injured, or even thrown from the vehicle, in the event of an accident.

In the event of an accident the seat belt helps to keep you in the correct seating position, so that the front airbag system can provide you with effective protection.

In addition, the front airbag system will not be triggered for the front passenger's seat in model variants with seat occupancy recognition * if:

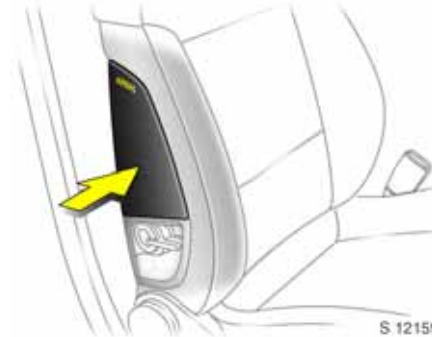

- the front passenger's seat is unoccupied,
 - there is a properly fitted Vauxhall child restraint system with transponders *.
- Seat occupancy recognition – see page 87. Vauxhall child restraint system with transponders * – see page 77.



Side airbag *

The side airbag system is identified by the word **AIRBAG** on the outboard sides of the front seat backrests.

The side airbag system comprises:

- an airbag with inflator in the back of the driver's and front passenger's seat respectively,
- the control electronics,
- the side-impact sensors,
- control indicator for airbag systems  in instrument cluster,
- seat occupancy recognition *,
- the control indicator for Vauxhall child restraint systems  with transponders * in the odometer display.

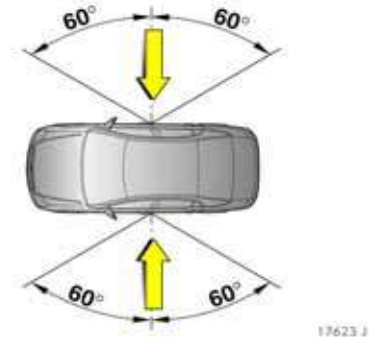

The side airbag system will be triggered:

- depending on the severity of the accident,
- depending on the type of impact,
- within the range shown in the illustration on the centre door pillar of the driver's or front passenger's side,
- independently of the front airbag system.

Exception:

Front passenger's seat with seat occupancy recognition system *. The seat occupancy recognition system deactivates the front and side airbags * on the front passenger's side if the front passenger's seat is unoccupied or a Vauxhall child restraint system with transponders * has been fitted to the front passenger's seat. Seat occupancy recognition - see page 87. Vauxhall child restraint system with transponders * - see page 78.

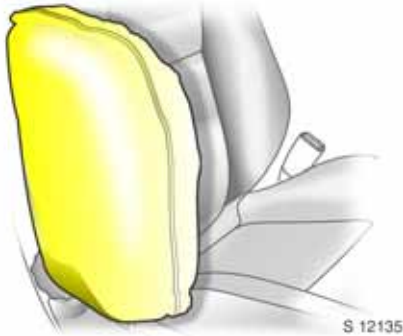

S 12135

When triggered, the side airbag inflates within milliseconds to form a safety cushion for the driver or front passenger in the respective door area. This substantially reduces the risk of injury to the upper body and pelvis in the event of a side-on collision.

Warning

There must be no objects in the area in which the airbag inflates or in the area between the backrests and the vehicle body. Do not place the hands or arms on the covers of the airbag systems.

Important information – see page 89.

The three-point seat belt must always be correctly fitted – see page 76.

The side airbags will not be triggered in the event of:

- the ignition being switched off,
- frontal collisions,
- accidents in which the vehicle overturns,
- collisions involving a rear-impact,
- collisions involving a side-impact outside the passenger cell.

In addition, the side airbag system will not be triggered for the front passenger's seat in model variants with seat occupancy recognition * if:

- the front passenger's seat is unoccupied,
- there is a properly fitted Vauxhall child restraint system with transponders *.

Seat occupancy recognition – see page 87.

Vauxhall child restraint system with transponders * – see page 77.



17624 J

Curtain airbag

The curtain airbag system is identified by the word **AIRBAG** on the roof pillar trim.

The curtain airbag system comprises:

- an airbag with inflator in the roof frame on the driver's and front passenger's side respectively,
- the control electronics,
- the side-impact sensors,
- the control indicator for airbag systems  in the instrument.

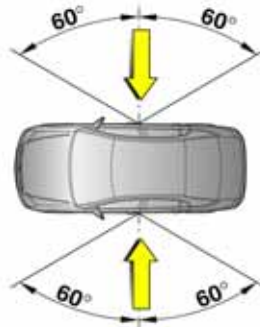

17623 J

The curtain airbag system will be triggered:

- depending on the severity of the accident,
- depending on the type of impact,
- within the range shown in the illustration on the centre door pillar of the driver's or front passenger's side,
- together with the side airbag system,
- irrespective of seat occupancy recognition,
- independently of the front airbag system.

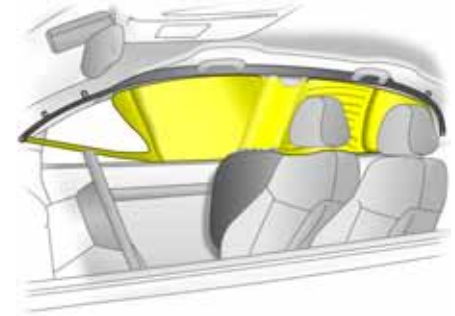

S 12136

When the curtain airbag is triggered it inflates within milliseconds and provides a safety barrier in the head area on the respective side of the vehicle. This reduces the risk of injury to the head considerably in the event of a side-impact.

⚠ Warning

There must be no objects in the area in which the airbag inflates. Do not place the hands or arms on the covers of the airbag systems. Important information – see page 89.

The three-point seat belt must always be correctly fitted – see page 76.

The curtain airbags will not be triggered in the event of:

- the ignition being switched off,
- frontal collisions,
- accidents in which the vehicle overturns,
- collisions involving a rear-impact,
- collisions involving a side-impact outside the passenger cell.



Control indicator ⚠ for airbag systems

The operation of the airbag systems is electronically monitored together with the seat occupancy recognition systems ⚠ and the belt tensioners and indicated on the instrument cluster by the control indicator ⚠. When the ignition is switched on, the control indicator illuminates for approx. 4 seconds. If it does not illuminate, does not go off after 4 seconds or illuminates whilst driving, there is a fault in the airbag systems, the seat occupancy recognition system ⚠ or the belt tensioners - see page 74. The systems may not activate if an accident occurs.

Deployment of the airbags is indicated by continuous illumination of ⚠.

⚠ Warning

Have the cause of the fault eliminated immediately by a workshop.



The system's integrated self-diagnostics allows faults to be quickly remedied.

If control indicator ⚠ in the instrument cluster fails, for reasons of safety, the text **AirBAG** appears on the odometer display.

The text is acknowledged by pressing the reset button. It then disappears from the odometer display 10 seconds later.

Seat occupancy recognition *

The seat occupancy recognition system deactivates the front and side airbags for the front passenger's seat if the front passenger's seat is not occupied or a Vauxhall child restraint system with transponders * is fitted on the front passenger's seat. The curtain airbag system * remains activated.

The control indicator for seat occupancy recognition  is located in the odometer display. If control indicator  illuminates for approx. 4 seconds when the ignition is switched on, the vehicle is equipped with seat occupancy recognition; see next page, Fig. S 14742.

If a Vauxhall child restraint system with transponders * is fitted, the control indicator  illuminates continuously after the ignition is switched on as soon as the system has detected the child restraint system. Only then may the child restraint system with transponders * be used on the passenger's seat.



17625 J

Vehicles with seat occupancy recognition can also be identified by the sticker on the side of the instrument panel - see illustration above.

Vauxhall child restraint systems with transponders * are automatically detected if correctly fitted to the front passenger's seat. When these child restraint systems are being used on the front passenger's seat, the front and side airbag systems for the front passenger's seat are deactivated. The curtain airbag system remains activated. Pay attention to control indicator seat  for occupancy recognition * - see page 88.

Warning

Only Vauxhall child restraint systems with transponders * can be fitted on the front passenger's seat. Use of systems without transponders poses a risk of fatal injury.

Vauxhall child restraint systems with transponders * can be identified by a sticker.

Control indicator  for Vauxhall child restraint systems with transponders *

The presence of a Vauxhall child restraint system with transponders * is indicated after the ignition has been switched on by continuous illumination of the control indicator  in the odometer display, as soon as the seat occupancy recognition system has detected the child restraint system.



If control indicator  does not illuminate whilst driving, the front and side airbags for the front passenger's seat are not deactivated and there is a risk of fatal injury to the child. Fit the child restraint systems on the rear seat. Have the cause of the fault eliminated by a workshop.

If the child restraint system is not correctly fitted or the transponders are defective, the control indicator flashes. Check that child restraint system is correctly fitted. For fitting child restraint system with transponders * - see instructions provided with child restraint system.

If the control indicator flashes when the child restraint system with transponders * is correctly fitted, there is a fault with risk of injury to the child. Fit the child restraint system on the rear seat. Have the cause of the fault eliminated by a workshop.

If no Vauxhall child restraint system with transponders * is fitted, the control indicator must not illuminate or flash, as the front passenger's airbag systems would not deploy. Have the cause of the fault eliminated by a workshop.

 Warning

If the Vauxhall child restraint system with transponders * has been fitted according to the instructions, control indicator  for Vauxhall child restraint systems with transponders must illuminate in the odometer display when the ignition is switched on.

If the control indicator does not illuminate whilst driving, the front passenger's airbag systems are not deactivated and there is a risk of fatal injury. In this case fit child restraint systems on the rear seat. Have the cause of the fault eliminated by a workshop.

Important

- Do not fit accessories or place objects in the expansion zone of the airbag systems - risk of injury if airbags are deployed.
- Do not place any objects between the airbag systems and the vehicle occupants; risk of injury.

 Warning
Never carry child restraint systems or other objects on your lap - risk of fatal injury.

Never carry child restraint systems or other objects on your lap - risk of fatal injury.

- Use the hooks in the roof frame only to hang up light articles of clothing or coat hangers. Do not place any objects in the pockets of the hanging items – risk of injury.

- The airbag systems and belt tensioner control electronics can be found in the centre console area. In order to avoid malfunctions, do not store magnetic objects in this area.
- Do not stick anything on the steering wheel, instrument panel, front seat backrests or roof frame in the vicinity of the airbags, or on the front passenger's seat cushion, or cover any of those areas with other materials.
- Use only a dry cloth or Interior/ Upholstery Cleaner to clean the steering wheel, instrument panel, front seat backrests, roof frame and seat cushion of the front passenger's seat. Do not use any aggressive cleaning agents.
- Only protective covers which are approved for your vehicle with side airbag ✱ may be fitted on the front seats. When fitting the protective covers, make sure that the airbag units on the outboard sides of the front seat backrests are not covered.
- The airbag systems are triggered independently of each other based on the severity of the accident and the type of impact. The side airbag system ✱ and the curtain airbag system ✱ are triggered together. See seat occupancy recognition on page 87 for exceptions.
- Each airbag deploys once only. Have a workshop replace deployed airbags immediately.
- The speeds, directions of movement and deformation properties of the vehicles, and the properties of the obstacle concerned, determine the severity of the accident and triggering of the airbags. The degree of damage to your vehicle and the resulting repair costs alone are not indicative that the criteria for triggering of the airbags were met.

- Do not perform any alterations on the components of the airbag system, as this would render the vehicle unroadworthy.

Warning

The systems can be triggered abruptly and cause injury if they are handled im properly.

- We recommend having the steering wheel, the instrument panel, all panelling parts, the door seals, the handles and the seats removed by a workshop.
- When disposing of the vehicle, the safety instructions given for this must be observed. Take the vehicle to a recycling company for disposal.
- Persons weighing less than 35 kg should only travel on the rear seats. This does not apply to children who are travelling in child restraint systems with transponders *.

- In vehicles with seat occupancy recognition *, do not place any heavy objects on the front passenger's seat otherwise the airbag systems for the front passenger's seat may be triggered in the event of an accident.

- In vehicles with seat occupancy recognition *, to prevent malfunctions do not use protective covers or extra seat cushions on the front passenger's seat.

- In order to prevent malfunctions when using a Vauxhall child restraint system with transponders * on the front passenger's seat, no objects (e.g. plastic sheet, stickers or heated mats) may be placed under the child restraint system.

Warning

Child restraint systems as well as other objects must never be carried on the lap of passengers; risk of fatal injury. If carried in this way, child restraint systems with transponders * in vehicles with seat occupancy recognition * could lead to front passenger's airbag systems not being triggered in the event of an accident.



17424 T

Use of child restraint systems * on the front passenger's seat in vehicles with airbag systems, but without seat occupancy recognition *

⚠ Warning

Vehicles with front passenger's airbag and no side airbag ✳:
Child restraints facing the rear of the vehicle must not be fitted to the front passenger's seat; risk of fatal injury.

Child restraints facing the front (child restraints for weight ranges I, II and III – see page 77) are permitted on the front passenger's seat, providing that it is pushed back as far as possible and the backrest has been adjusted so that the lap belt fits snugly.



17118 T

Vehicles with front passenger's airbag can be recognised by the word **AIRBAG** above the glove compartment and the warning sticker on the sunvisor on the front passenger's side - see Fig. 17424 T on previous page. In some model variants, the warning sticker may be on the side of the instrument panel - see Fig. 17118 T.

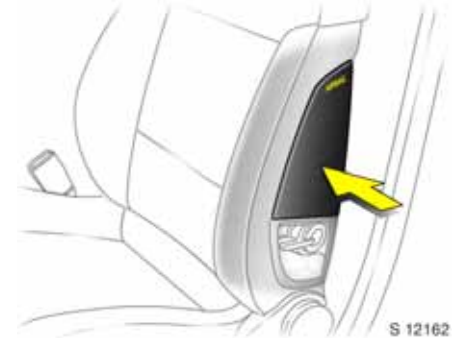

S 12162

⚠ Warning

Vehicles with side airbag ✳: No child restraint system ✳ may be fitted on the front passenger's seat; risk of fatal injury.

A vehicle with side airbags can be identified by the word **AIRBAG** on the outboard sides of the front seat backrests.

Seat occupancy recognition ✳ – see page 87.



17625 J

Use of child restraint systems * on front passenger's seat in vehicles with airbag systems * and with seat occupancy recognition *

Warning

Only Vauxhall child restraint systems with transponders * can be fitted on the front passenger's seat. Use of systems without transponders poses a risk of fatal injury.



S 14742

Vehicles with seat occupancy recognition can be identified by control indicator  in the odometer display. If the control indicator illuminates for approx. 4 seconds when the ignition is switched on, the vehicle is equipped with seat occupancy recognition - see page 87.

Vehicles with seat occupancy recognition can also be identified by the sticker on the side of the instrument panel - see Fig. 17625 J.

The seat occupancy recognition system detects Vauxhall child restraint systems with transponders * and switches off the front and side airbag systems for the front passenger's seat. The curtain airbag system remains activated. Seat occupancy recognition - see page 87.



17424 T

Vauxhall child restraint systems with transponders * can be identified by a sticker or badge - see illustration.



Cigarette lighter *

The cigarette lighter is in the front centre console.

Press in cigarette lighter with ignition switched on. Switches off automatically when element is glowing. Withdraw cigarette lighter.



Accessory sockets *

The socket in the centre console and the cigarette lighter socket can be used to connect electrical accessories. The sockets are ready for operation when the ignition is switched on. If the engine is not running the battery will be discharged. More accessory sockets * can be found in the centre console beneath the rear air vents* and in the Travel Assistant*.

Estates have an additional accessory socket * to the left in the luggage compartment next to the luggage compartment lighting.

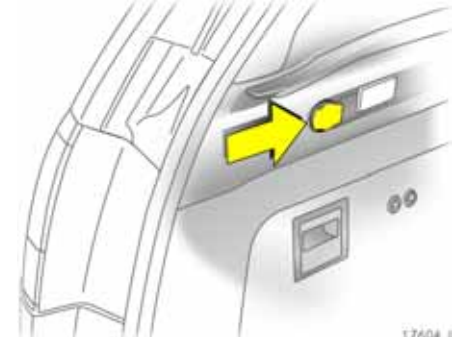

Do not damage the sockets by using unsuitable plugs.

The maximum power consumption of electrical accessories must not exceed 120 watts.

Do not connect any current-delivering accessories, e.g. electrical charging devices or batteries.

Electrical accessories connected to the socket must comply with the electromagnetic compatibility requirements laid down in DIN VDE 40 839, otherwise vehicle malfunctions may occur.

Accessory sockets in the Travel Assistant * – see page 60.



Ashtray

To be used only for ash and not for combustible rubbish.

Warning

Failure to observe these descriptions can lead to injuries which may be fatal. Vehicle passengers must be informed accordingly.

Front ashtray

The ash tray is in the front centre console beneath a cover.

The cover opens when pressed at the point indicated.



To empty, grip both sides of the ashtray insert at the points illustrated and pull upwards.

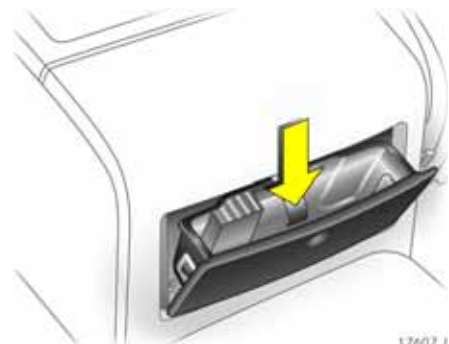

Rear ashtray*

The ash tray is in the rear centre console.

The cover opens when pressed at the point indicated.

To empty, open the ashtray, press the spring (arrow) and pull out the ashtray.

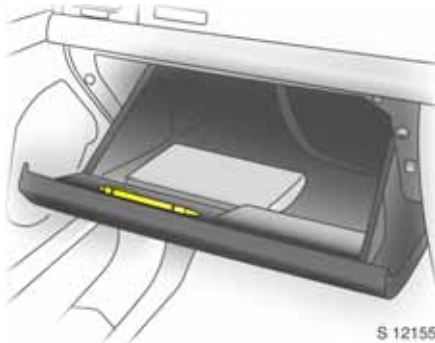

S 12155

Stowage compartments

Glove compartment

To open, pull handle upwards.

At the front of the opened cover there is a pen holder.

The glove compartment should remain closed whilst driving.

Cooled glove compartment * – see page 143.

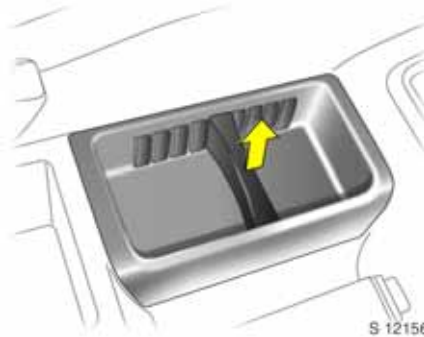

S 12156

Centre console stowage compartment *

Division of the stowage compartment can be changed by moving the partition in the side guides.

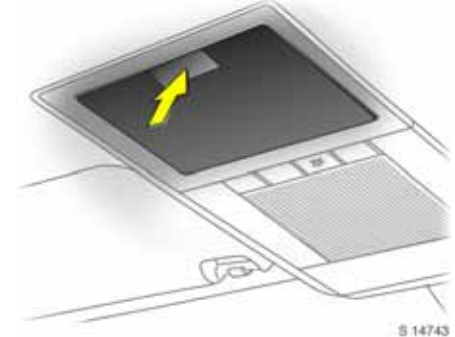

S 14743

Stowage compartment in the roof lining *

To open, press the point indicated.

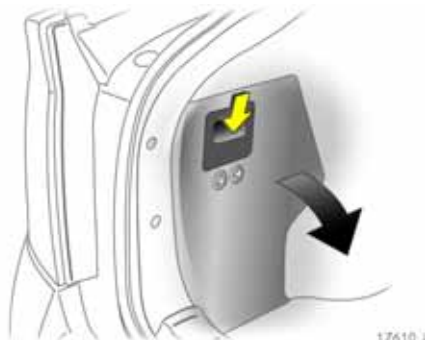

The maximum permitted load on the stowage compartment is 0.4 kg.

The stowage compartment must be closed whilst driving.



Storage compartments in the luggage compartment

To access press down bar and open the cover.

Warning triangle * and first-aid kit * storage – see page 234.

Stowing the spare wheel – see page 236.

Jack and vehicle tools storage – see page 238.



Estates have an additional storage compartment in the load compartment floor.

To open, pull the release lever and open the flap.

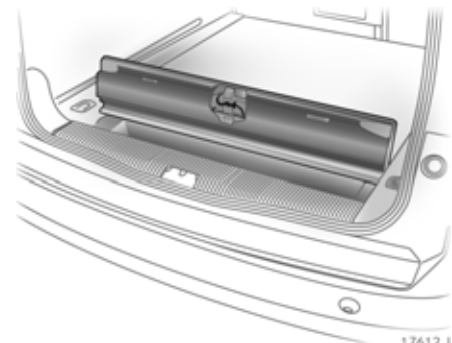

When opening, ensure that the hinge at the fold is opened and that the entire floor covering is not raised.



S 12157

Drink holders

Drink holders, front ❄

The drink holder can be found between the front seats in the centre console: slide cover ❄ open.

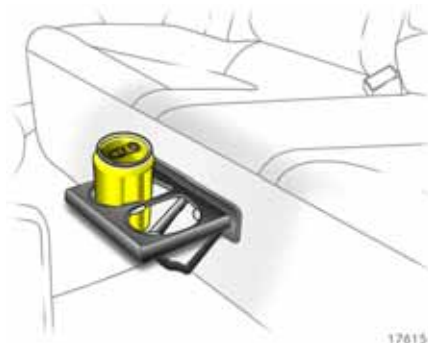

17615 J

Drinks holders, rear ❄

The drink holder can be found beneath the centre seat: pressing front edge moves drink holder out.

Drink holder in Travel Assistant ❄ – see page 60.

Sunvisors

Use the sunvisor to protect from glare by pulling it down and swivelling it to the side.

During driving, the mirrors ❄ in the sunvisors should be covered.

Instruments, controls

Control indicators	98
Instrument display	105
Information display	108
Warning buzzers.....	126
Windscreen wiper	126

Control indicators

The control indicators described here are not present in all vehicles. The descriptions however, apply to all instrument versions.

The control indicator colours mean:

- Red Danger, important reminder
- Yellow Warning, note, fault
- Green On confirmation
- Blue On confirmation



Turn signal lights

Control indicator flashes green.

The control indicator flashes on the respective side.

Both control indicators flash with the hazard warning lights on.

Rapid flashes: A turn signal light or the related fuse has failed, failure of turn signal light on the caravan/trailer *.

Turn signal lights – see page 130.

Change bulbs - see page 252.

Fuses - see page 246.



Engine oil pressure

Control indicator illuminates red.

It illuminates when the ignition is switched on and extinguishes shortly after the engine starts.

Illuminates when the engine is running: Engine lubrication may be interrupted. This may result in damage to the engine and/or locking of the drive wheels:

1. Move out of the flow of traffic as quickly as possible without impeding other vehicles.
2. Depress clutch.
3. Shift manual transmission or Easytronic * into neutral; for automatic transmission *, set selector lever to **N**.
4. Switch off ignition.

Warning

When the engine is off, considerably more force is needed to brake and steer.

Do not remove key until vehicle has come to a standstill, otherwise the steering column lock could engage unexpectedly.

Check oil level before contacting a workshop.



Brake system, clutch system

Control indicator illuminates or flashes red.

It illuminates when the ignition is switched on if the handbrake is applied or if the brake and clutch fluid level is too low. For further instructions – see pages 209, 276.

For vehicles with Easytronic*, the control indicator flashes for a few seconds when the ignition is turned off if the handbrake is not applied.

Warning

Illuminate if the handbrake has been released: stop vehicle and interrupt journey immediately. Contact a workshop for assistance.



Alternator

Control indicator illuminates or flashes red.

It illuminates when the ignition is switched on and extinguishes shortly after the engine starts.

Flashes while starting:

Battery voltage too low. Have electrical system tested by a workshop.

Illuminates when the engine is running:

Stop and switch engine off. Battery will not be charged. Engine cooling may be interrupted. Effect of brake servo unit may stop in vehicles with diesel engines.

Check drive belt condition and tensioning before contacting a workshop for assistance.



Airbag systems*, belt tensioners*

Control indicator illuminates red.

Illuminates when the engine is running:

Fault in the airbag systems, seat occupancy recognition* or belt tensioners - see pages 74, 86.



Coolant temperature

Control indicator illuminates red.

Illuminates when the engine is running:
 Stop and turn engine off, coolant temperature is too high. Risk of engine damage. For coolant temperature display - see page 106. Check coolant level - see page 275.



Exterior lights

Control indicator illuminates green.

It is illuminated when the exterior lighting is on – see page 128.



SPORT mode of automatic transmission*

Control indicator is illuminated in the transmission display if the SPORT mode* is selected.

Further information - see pages 178, 179.



Winter programme of automatic transmission* or Easytronic*

Control indicator illuminates in transmission display with Winter programme engaged.

Further information – see pages 172, 180.



Door open

Control indicator illuminates red.

It illuminates with the doors open.



Easytronic*, starting the engine

Control indicator illuminates yellow.

It illuminates if the footbrake is not depressed. The indicator extinguishes as soon as the footbrake is depressed. The engine can only be started with the footbrake depressed - see page 169.



Bulb replacement*

Control indicator illuminates red.

It illuminates if a bulb is defective. Check the lights and replace any defective bulbs. Replacing bulbs - see page 252.

**Open luggage compartment**

Control indicator illuminates red.

It illuminates with the luggage compartment open, to close luggage compartment – see page 34.

**Front fog lights ***

Control indicator illuminates green.

It is illuminated when the front fog lights are on – see page 130.

**Main beam**

Control indicator illuminates blue.

It is illuminated when main beam is on and during headlight flash – see pages 7, 128.

**Fog tail light**

Control indicator illuminates yellow.

It is illuminated when the fog tail light is on – see page 131.

**Parking distance sensors ***

Control indicator illuminates yellow.

Fault in system. Contact a workshop for help.

Parking distance sensors * – see page 202.

**Continuous Damping Control *, SPORT mode**

Control indicator illuminates yellow.

Fault in system. Contact a workshop for help.

Further information – see page 198.

**Seat belt ***

Control indicator illuminates red.

It illuminates once the ignition has been switched on until the seat belt is applied. A warning buzzer also sounds once the vehicle has started moving.

Putting on a seat belt – see page 76.

**Engine electronics *, diesel fuel filter *, immobiliser**

Control indicator illuminates or flashes yellow.

It illuminates for a few seconds when the ignition is switched on.

Illuminates when the engine is running:
Fault in engine or gearbox electronic system. Electronics have switched on emergency running programme; fuel consumption may be increased and the vehicle's driveability reduced - see page 192. Contact a workshop immediately.

Diesel engines¹⁾ Z 19 DTL, Z 19 DT, Z 19 DTH: Have water drained from diesel fuel filter - see page 274.

Flashes when the ignition is on:
Fault in the electronic immobiliser system; the engine cannot be started - see page 27.

¹⁾ Sales designation – see page 284, 285.



Preheating for diesel engines ❄️, diesel particle filter ❄️

Control indicator illuminates or flashes yellow.

Illuminates:

Preheating system active, switches on only if outside temperature is low.

Flashes:

(in vehicles with diesel particle filter)

The driving situation is such that the diesel particle filter self-cleaning function cannot operate automatically. You may continue to drive the vehicle normally. The vehicle will not be damaged and does not require service.

The self-cleaning function will automatically operate whilst driving after the engine has reached its normal operating temperature. The control indicator ❄️ will continue to flash until the self-cleaning operation is complete. This may take up to 20 minutes of driving. The time will be shorter at higher vehicle speeds.

Further information – see page 194.



Coolant level

Control indicator illuminates yellow.

Illuminates when the engine is running:
Coolant fluid level too low. Stop, turn off engine. Check coolant fluid level - see page 275.



Anti-lock Brake System (ABS)

Control indicator illuminates red.

Illuminates whilst driving:

Fault in Anti-lock Brake System - see page 210.

**Electro-hydraulic power assisted steering**

Control indicator illuminates red.

Fault in electro-hydraulic power assisted steering system. The power assisted steering may have failed. The vehicle can be steered but considerably more force is required. Contact a workshop for assistance.

**Electronic Stability Programme (ESP® Plus) ***

Control indicator flashes or lights yellow.

Flashes whilst driving:

System actively engaged - see page 196.

Illuminates whilst driving:

System switched off or fault in the Electronic Stability Programme - see page 196.

**Seat occupancy recognition ***

Control indicator illuminates or flashes on the odometer display.

Illuminates:

Seat occupancy recognition has detected a child restraint system with transponders. Airbag systems for the front passenger's seat are deactivated - see page 87.

Flashes:

Fault in the system or child restraints with transponder fitted incorrectly - see page 87.

**Engine oil level ***

Control indicator illuminates yellow.

The engine oil level is checked automatically.

Illuminates when the engine is running:

Engine oil level too low. Check engine oil level and top up engine oil if necessary - see page 272.

**Cruise control ***

Control indicator illuminates green.

It is illuminated when the system is on - see page 200.

**Fuel level**

Control indicator illuminates or flashes yellow.

Illuminates:

Low fuel level, fuel gauge in reserve area.

Flashes:

Fuel supply exhausted, refuel immediately.

Never let the tank run dry.

Erratic fuel supply can cause catalytic converter to overheat - see page 190.

Diesel engines: If the tank is run dry, bleed the fuel system as described on page 228.



S 14744



Exhaust gases *

Control indicator illuminates or flashes yellow.

It illuminates when the ignition is switched on and extinguishes shortly after the engine starts.

Illuminates when the engine is running:

Fault in emission control system. The permitted emissions may be exceeded. Contact a workshop immediately.

If it flashes when the engine is running:

Fault that may cause damage to the catalytic converter – see page 192. Contact a workshop for assistance immediately.



Tyre pressure monitoring system *

Control indicator illuminates red:

Tyre pressure difference, check tyre pressure at next opportunity.

Control indicator flashes red:

Considerable pressure difference or direct loss of pressure, stop immediately and check tyres and tyre pressure.

Control indicator illuminates yellow:

Fault in system. Contact a workshop for help.

Tyre pressure monitoring system – see page 204.



Adaptive Forward Lighting (AFL) *

Control indicator flashes yellow.

Flashing:

Fault in system. Contact a workshop for help.

Flashing for 4 seconds when the ignition is switched on:

System adjusted for driving abroad.

AFL - see page 132.



S 14745

Instrument display

In some model variants the pointers of the tachometer, the speedometer, the coolant temperature gauge and the fuel gauge briefly go to the end stop as a functionality check.

Tachometer

Indicates engine speed.

Warning zone: Maximum permissible engine speed exceeded; danger to engine.

Speedometer

Speed display.

Odometer

Records the miles (kilometres) counted.

Display in the event of airbag system malfunction – see page 86.

Trip odometer

Display of miles (kilometres) covered since reset.

To set to zero, hold reset knob down for approx. 2 seconds with ignition switched on.



Coolant temperature display



- Pointer in zone at left = Engine operating temperature not yet reached
- Pointer between the zones = Normal operating temperature
- Pointer in warning zone at right or  is illuminated = Temperature too high: Stop. Switch off engine. Risk of engine damage. Check coolant level - see page 275.

For physical reasons, the engine temperature gauge shows the coolant temperature only if the coolant level is adequate.

During operation the system is pressurised. The temperature may therefore rise briefly to over 100 °C.



Fuel gauge

- Pointer in left zone or  illuminated = Reserve area
- Pointer in left zone or  flashing = Refuelling - see page 189

Never let the tank run dry.

Diesel engines: If the tank is run dry, bleed the fuel system as described on page 228.

Because of the fuel remaining in the tank, the amount of fuel required to fill the tank may be less than the specified tank capacity.



17536

Transmission display*

Display of gear selected for automatic transmission* or current gear or mode for Easytronic*.

- P** Automatic transmission park position
- R** Reverse gear
- N** Neutral
- A** Automatic mode on Easytronic
- M** Manual mode on Easytronic
- D** Automatic mode on automatic transmission
- 1-5** Manual mode, current gear on Easytronic
- 1-5** Manual mode, selected gear on 1-6*
- 1-6*** automatic

For Easytronic*, the display flashes for a few seconds if **A**, **M** or **R** is selected when the engine is running but the footbrake is not depressed.



S 14747

InSP Service interval display*

When InSP appears on the odometer display, make an appointment with a workshop for servicing as soon as possible. We recommend your Vauxhall Authorised Repairer.

Service, maintenance – see page 268.



Information display

Triple Information Display

Display of time, outside temperature and date/Infotainment system * (when it is on).

When the ignition is off, the time, date and outside temperature can be presented for 15 seconds by briefly pressing one of the two buttons below the display.

Display **F** in the display indicates a fault. Have the cause eliminated by a workshop.



Board Information Display *

Display of time, outside temperature and date/Infotainment system * (when it is on).

Display **F** in the display indicates a fault. Have the cause eliminated by a workshop.

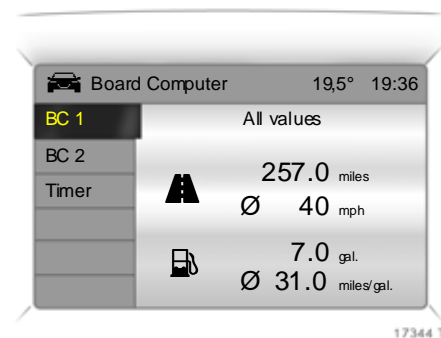

Graphical Information Display *, Colour Information Display *

Display of time, outside temperature, date/Infotainment system * (when it is on) and Electronic Climate Control *.

The Graphical Information Display presents the information in monochrome. The Colour Information Display presents the information in colour.

The type of information and how it is displayed depends on the equipment of the vehicle and the Infotainment system \ast , trip computer \ast and Electronic Climate Control \ast settings.

Some information appears on the display in an abbreviated form.

For Infotainment system - see Infotainment system instructions.

For Electronic Climate Control \ast - see page 156.

Display **F** in the display indicates a fault. Have the cause eliminated by a workshop.



Outside temperature

A fall in temperature is indicated immediately and a rise in temperature after a time delay.

If outside temperature drops to 3 °C, the symbol \ast illuminates in the Triple Information Display or the Board Information Display \ast as a warning for icy road surfaces. \ast remains illuminated until temperatures reach at least 5 °C.



In vehicles with Graphical Information Display \ast or Colour Information Display \ast , an icy road surface warning message appears on the display. No message is displayed if the temperature is less than -5 °C.

Warning

Caution: The road surface may already be icy even though the display indicates a few degrees above 0 °C.

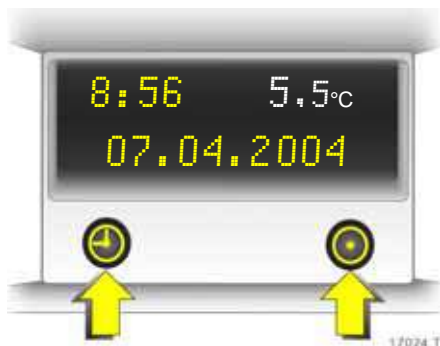

Triple Information Display

Set date and time

Infotainment system off: press and below the display as follows:

Press for approx. 2 seconds:

- Day flashes
- : Set day
- : Month flashes
- : Set month
- : Year flashes
- : Set year
- : Hours flash
- : Set hours
- : Minutes flash
- : Set minutes
- : Clock is started.

Correcting time *

Some RDS transmitters do not send a correct time signal. If the incorrect time is continually displayed, deactivate automatic time synchronisation * - see next column, and set the time manually.

The automatic setting is indicated by in the display.

Deactivating/activating automatic time synchronisation: Infotainment system off, press and below the display:

Hold down for approx. 2 sec., clock display is now in setting mode,

Press twice (until year flashes).

Press and hold down for approx. 3 seconds until flashes in display * and text "RDS TIME" appears (years flash during this time),

Press ; display shows:
RDS TIME 0 = Off

Press ; display shows:
RDS TIME 1 = On

Press three times.

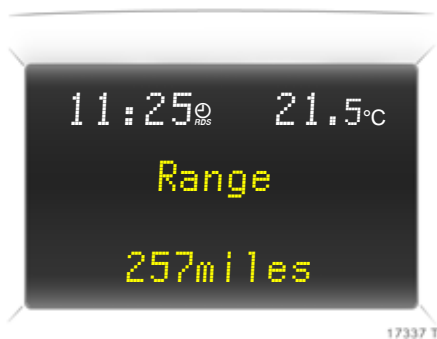

Board Information Display *, selecting functions

Functions and settings of some equipment * can be accessed via the Board Information Display.

This is done using the menus and the buttons/four-way button on the Infotainment system * or the left-hand adjuster wheel * on the steering wheel. The respective menu options are then shown in the following lines on the display.

If check control warning messages * are displayed, the display is blocked to other displays. Confirm the warning message. If there are several warning messages, confirm one after the other.



To select with four-way button:
Select options via the menus and with the buttons/four-way button on the Infotainment system *.



To select using the left adjuster wheel * on the steering wheel

Scroll upwards
Previous menu item.

Scroll downwards
Next menu item.

Press
Selection of highlighted item, confirmation of commands.

System settings - see page 112.

Trip computer * - see page 114.



Board Information Display *, System settings

Press the **Settings** button of the Infotainment system. Menu item **Audio** or **System** will appear.

Press the lower button of the four-way button to reach menu item **System**. After pressing the right-hand part of the four-way button, the first function of the **System** menu is shown.

Some information appears on the display in an abbreviated form.

The functions are displayed in the following order:

- Time synchronisation,
- Time, setting hours,
- Time, setting minutes,
- Date, setting day,
- Date, setting month,
- Date, setting year,
- Ignition logic,
- Language selection,
- Setting units of measure.

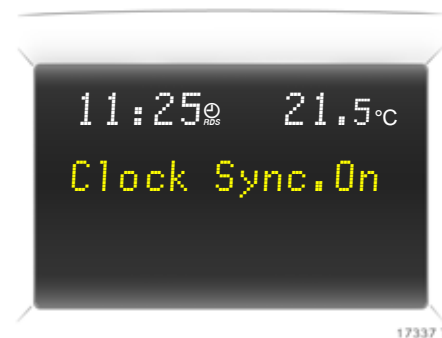

Correcting time *

Some RDS transmitters do not send a correct time signal. If the incorrect time is continually displayed, deactivate automatic time synchronisation * and set the time manually - see next page.

The automatic setting is indicated by  in the display.

To correct time with the help of RDS, select the menu item for time synchronisation from the **Settings** menu.

Make the desired setting.

Setting date and time

Select the menu item for time and date setting from the **Settings** menu.

Make the desired setting.

The setting is executed upon exit from the menu item.

Ignition logic *

Adjustment - see Infotainment system instructions.



Language selection

You can select the display language for some functions.

Select the menu item for language from the **Settings** menu and make the desired setting.

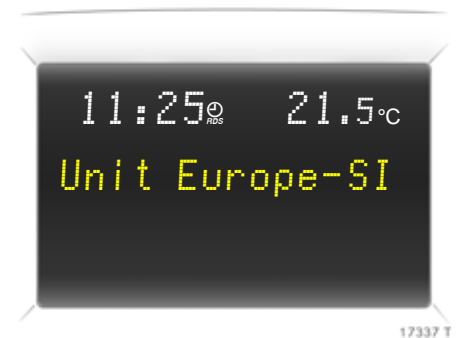

Setting units of measure

You can select which units of measure are to be used.

Select the menu item for units of measure from the **Settings** menu and make the desired setting.

Board Information Display *, trip computer *

The trip computer provides information on driving data, which is continually recorded and evaluated electronically.

Access trip computer vehicle data by pressing the **BC** button on the Infotainment system or the left adjuster wheel * on the steering wheel.

Some information appears on the display in an abbreviated form.

Once an audio function has been selected, the subsequent rows of the trip computer function are displayed.

The functions are displayed in the following order:

- Instantaneous consumption,
- Average consumption,
- Effective consumption,
- Average speed,
- Distance travelled,
- Range,
- Stop watch.



Instantaneous consumption

Display changes depending on speed:

- Display in gal/h below 8 mph (13 km/h)
- Display in mpg above 8 mph (13 km/h)

Average consumption

Average consumption display.

Measurement may be reset to zero at any time and restarted - see "Resetting the trip computer information".

Effective consumption

Fuel consumption display.

Measurement may be reset to zero at any time and restarted - see "Resetting the trip computer information".

Average speed

Average speed display.

Measurement may be reset to zero at any time and restarted - see "Resetting the trip computer information".

Stoppages in the journey with the ignition off are not included in the calculations.

Distance travelled

Distance travelled display.

Measurement may be reset to zero at any time and restarted - see "Resetting the trip computer information".

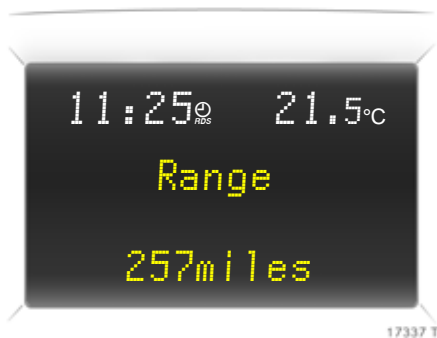

Range

Range is calculated from current fuel tank content and instantaneous consumption. The display shows average values.

After refuelling, the vehicle updates the range automatically after a brief delay.

If less than 30 miles (50 km) can be driven with the fuel remaining in the tank, the warning "Range" appears on the display.

If less than 20 miles (30 km) can be driven with the fuel remaining in the tank, the warning "Refuel!" * appears on the display.

Acknowledge the menu item as described on page 111.

Resetting the trip computer information

The following trip computer information can be reset (reset to zero and measurements/calculations restarted):

- Average consumption,
- Effective consumption,
- Average speed,
- Distance travelled.

Select the desired trip computer information.

Reset using the left wheel on the steering wheel or the right/left button of the four-way button:

- Press for more than 2 seconds: Current value.
- Press for more than 4 seconds: All values.



Stop watch

Operation with the four-way button:

- Press right button: Start/Stop.
- Press left button for more than 2 seconds: Reset.

Operating using the left adjuster wheel * on the steering wheel:

- Press: Start/Stop.

Interruption of power supply

If the power supply has been interrupted or if the battery voltage has dropped too low, the values stored in the trip computer will be lost.



Graphical Information Display * or Colour Information Display *, selecting functions

The functions and settings of some equipment * can be accessed via the Graphical Information Display or the Colour Information Display.

Functions are selected and executed in the menu on the display using the four-way button, the multi-function knob * on the Infotainment system or the left wheel * on the steering wheel.

If check control warning messages * are displayed, the display is blocked to other displays. Confirm the warning message. If there are several warning messages, confirm one after the other.



To select with four-way button:
Select menu items via menus and with the buttons/four-way button of the Infotainment system.



To select using the multi-function knob:
Turn
Highlighting of menu options or commands, selection of function ranges,
Press
Selection of highlighted option, confirmation of commands.
To exit a menu, turn the multi-function knob left or right to **Return** or **Main** and select.



To select using the left adjuster wheel *
on the steering wheel

Scroll upwards

Previous menu item.

Scroll downwards

Next menu item.

Press

Selection of highlighted item, confirmation
of commands.

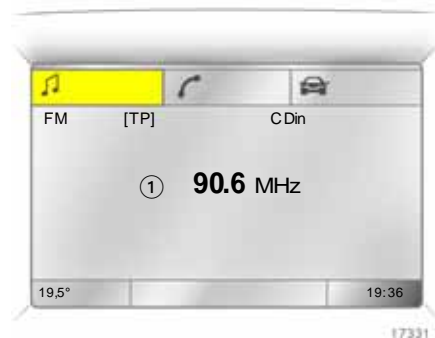

Function ranges

For each functional area there is a main page (Main), which is selected at the top edge of the display (not with Infotainment system CD 30 without the hands-free mobile phone system):

- Audio,
- Navigation *,
- Telephone *,
- Trip computer *.

For audio, navigation * and telephone functions * - see Infotainment system instructions.

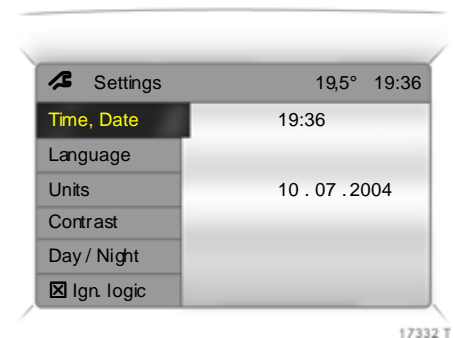

System settings

The settings are accessed via the **Settings** menu.

Press the **Main** button * (not found on all Infotainment systems) on the Infotainment system (call up main display).

Press the **Settings** button of the Infotainment system. No menu may be selected with Infotainment System CD 30.

The **Settings** menu is displayed.

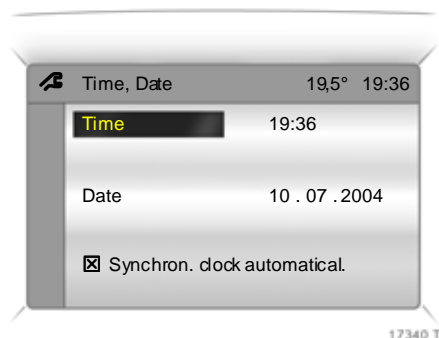

Setting the date and time ✱

Select menu item **Time, Date** from the **Settings** menu.

The menu for **Time, Date** is displayed.

Select the menu items required:

Make the desired setting.

Correcting time ✱

For systems with GPS receiver¹⁾, time and date are automatically set up on receipt of a GPS satellite signal. If the displayed time does not correspond to local time, time can be manually corrected in 30-minute increments or automatically corrected via receipt of an RDS time signal²⁾ ✱.

Some RDS transmitters do not send correct time signals. If the incorrect time is displayed often, deactivate automatic time synchronisation ✱ and set the time manually.

To correct time with the help of RDS, select menu item **Synchron. clock automatical.** from the **Time, Date** menu.

The box in front of **Synchron. clock automatical.** will be ticked; see Fig. 17340 T.



Language selection

You can select the display language for some functions.

Select menu item **Language** from the **Settings** menu.

The available languages are displayed.

¹⁾ **GPS** = **G**lobal **P**ositioning **S**ystem,
Satellite system for world-wide positioning.
²⁾ **RDS** = **R**adio **D**ata **S**ystem.



Select the desired language.

Selections are indicated by a ► in front of the menu item.

In systems with voice output ✳, when the language setting of the display is changed the system will ask whether the announcement language should also be changed – see Infotainment system instructions.

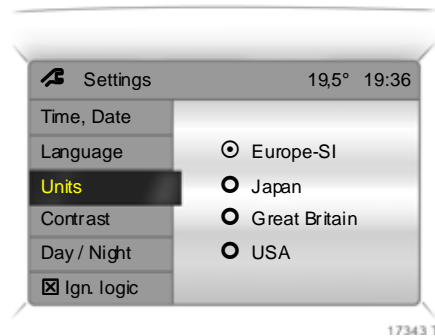

Setting units of measure

You can select which units of measure are to be used.

Select menu item **Units** from the **Settings** menu.

The available units are displayed.

Select the desired unit.

Selections are indicated by a ● in front of the menu item.

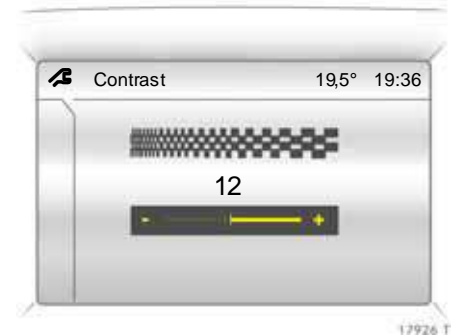

Adjusting contrast ✳ (Graphical Information Display)

Select menu item **Contrast** from the **Settings** menu.

The menu for **Contrast** is displayed.

Confirm the required setting.

Setting display mode *

The display can be adjusted to suit the light conditions, black or coloured text on a light background or white or coloured text on a dark background.

Select menu item **Day / Night** from the **Settings** menu.

The options are displayed.

Automatic: adapted based on vehicle lighting.

Always day design: black or coloured text on light background.

Always night design: white or coloured text on dark background.

Selections are indicated by a ● in front of the menu item.

Ignition logic *

Adjustment - see Infotainment system instructions.

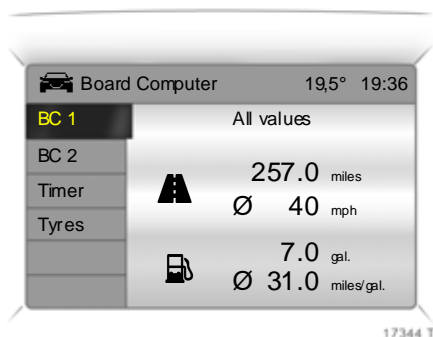

Graphical Information Display * or Colour Information Display *, trip computer *

The trip computers provide information on driving data, which is continually recorded and evaluated electronically.

The trip computer main page (Main) provides information about range, average fuel consumption * and instantaneous consumption.

To display other trip computer data, press the **BC** button on the Infotainment system *, select the trip computer menu on the display or press the left adjuster wheel * on the steering wheel.



Range

Range is calculated from current fuel tank content and instantaneous consumption. The display shows average values.

After refuelling, the vehicle updates the range automatically after a brief delay.



17345 T

If less than 30 miles (50 km) can be driven with the fuel remaining in the tank, the warning "Range" appears on the display.

If less than 20 miles (30 km) can be driven with the fuel remaining in the tank, the warning "Please refuel!" * appears on the display. At that point "Please refuel!" * will also be displayed on the trip computer main page (Main) instead of "Range".

Acknowledge the menu item as described on page 116.

Instantaneous consumption

Display changes depending on speed:

Display in gal/h below 8 mph (13 km/h)

Display in mpg above 8 mph (13 km/h)

Distance travelled

Distance travelled display.

Measurement may be reset to zero at any time and restarted - see "Resetting the trip computer information".

Average speed

Average speed display.

Measurement may be reset to zero at any time and restarted - see "Resetting the trip computer information".

Stoppages in the journey with the ignition off are not included in the calculations.

Effective consumption

Fuel consumption display.

Measurement may be reset to zero at any time and restarted - see "Resetting the trip computer information".

Average consumption

Average consumption display.

Measurement may be reset to zero at any time and restarted - see "Resetting the trip computer information".

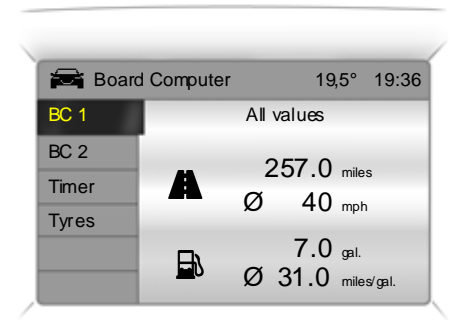

17344 T

Resetting the trip computer information

The following trip computer information can be reset (restart measurements):

- Distance travelled,
- Average speed,
- Effective consumption,
- Average consumption.

Select **BC 1** or **BC 2** from the trip computer menu.

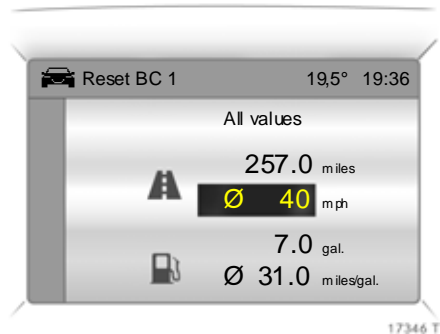

The information from both trip computers can be reset separately, making it possible to evaluate data over different time periods.

Select the desired trip computer information.

The value for the selected function will be reset and recalculated.

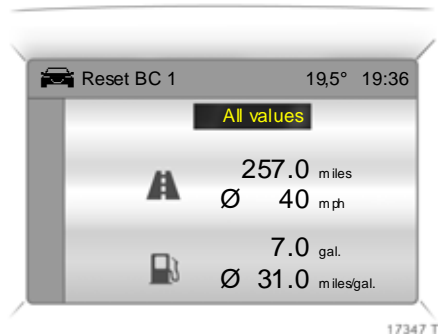

To reset all information of a trip computer, select menu item **All values**.

If trip computer information has been selected, "---" is displayed after a reset. The recalculated values are displayed after a brief delay.

Interruption of power supply

If the power supply has been interrupted or if the battery voltage has dropped too low, the values stored in the trip computer will be lost.



Stop watch

Select menu item **Timer** from the **Board Computer** menu.

The **Timer** menu is displayed.

To start, select menu item **Start**.

To reset, select menu item **Reset**.

The desired stop watch display can be selected from the **Options** menu ✱:

Driving Time excl. Stops

The time the vehicle is in motion is recorded. Stationary time is not included.

Driving Time incl. Stops

The time the vehicle is in motion is recorded. The time the vehicle is stationary with the key in the starter switch is included.

Travel Time

Measurement of the time from manual activation via **Start** to manual deactivation via **Reset**.

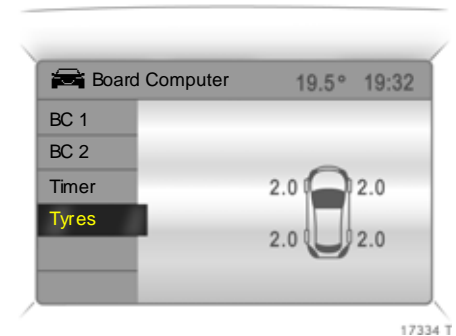

Display of current tyre pressure ✱

Select menu item **Tyres** from the **Board Computer** menu.

The current pressure of each tyre is displayed.

Further information – see page 204.

Check control*

Check control monitors several fluid levels, the tyre pressure*, the remote control batteries, Vauxhall alarm system* and the main vehicle lighting systems, including the cables and fuses. When towing, the caravan/trailer lighting system is also monitored.

Once the ignition has been switched on, all check control functions are automatically verified.

Warning messages appear on the display. If there are several warning messages, they are displayed one after the other.

Some information appears on the display in an abbreviated form.

Examples of warning messages for the Graphical Information Display* and Colour Information Display* are shown. On the Board Information Display, messages appear in an abbreviated form.

Acknowledge warning messages as described on pages 111, 116.

Unacknowledged warning messages can be re-displayed later.

Warning messages:

Remote Control Battery check

Remote control battery voltage is too low – see page 29.

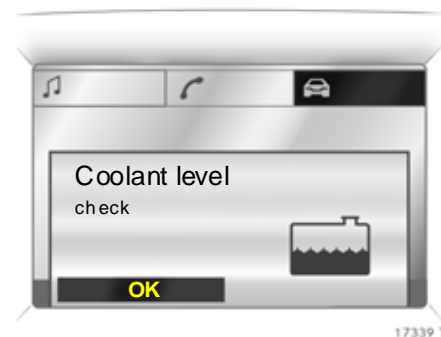

Brake light switch check

Fault. Brake light not illuminating when braking occurs. Have cause of fault remedied by a workshop immediately.

Safeguard check

Fault. System fault in Vauxhall alarm system. Have the cause of the fault rectified straight away by a workshop.

If there is a fault in the vehicle lighting system, the respective location of the fault is displayed as text, e.g.:

**Brakelight
check right**

If brake light is defective, the relevant tail light takes over the brake light function.

In vehicles with tyre pressure monitoring system ✱, if tyre pressure is too low, the display indicates which tyre to check, e.g.:

**Tyre pressure
check rear
right
(value in bar)**

Check tyre pressure at next opportunity using suitable gauge. Tyre pressure monitoring system ✱ – see page 204.
Checking tyre pressure – see page 299.

In vehicles with tyre pressure control system ✱, if there is major loss of pressure in a tyre, the display indicates the tyre at fault, e.g.:

**Attention!
Rear left tyre
pressure loss
(value in bar)**

Stop immediately and check tyre and tyre pressure. For tyre pressure monitoring system ✱ – see page 204.

**Washer
Fluid Level
check**

Fluid level in windscreen wash system too low. Topping up wash fluid – see page 279.

Rear window wash system and headlight wash system ✱ are deactivated if wash fluid level is low.

**Coolant level
check**

Fluid level in engine cooling system is low. Check coolant level immediately – see page 274.

Interruption of power supply

Stored warning messages appear on the display one after the other.

Warning buzzers

When starting the engine or whilst driving:

- If seat belt is not fastened ✱.
- When driving with a door open or the luggage compartment ajar.
- Once you have reached a certain speed if the handbrake is applied ✱.
- If a specified maximum speed is exceeded ✱.
- In the case of Easytronic ✱ if **A**, **M** or **R** is selected while the engine is running and the driver's door is opened but the footbrake is not depressed.

When the vehicle is parked and the driver's door is opened:

- When the key is in the starter switch ✱.
- With parking lights or dipped beam switched on.
- In the case of Easytronic ✱, if the handbrake is not applied and no gear is engaged when the engine is off.

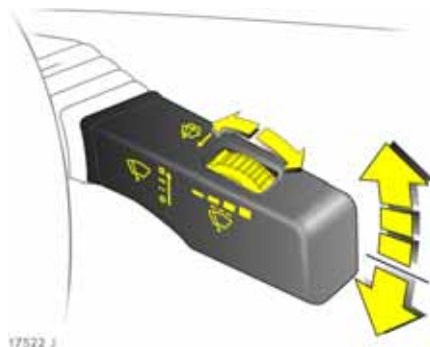

Windscreen wiper

To activate, gently push stalk upwards.

- = Off
- = Adjustable timed interval wipe
- = Slow
- ≡ = Fast

The stalk always moves back to the starting position. To select next higher or lower stage: move stalk slightly.

Push stalk past resistance point and hold: the windscreen wiper stages are run through; an acoustic signal sounds at position ○.

Adjustable timed interval wipe --:
 Adjuster wheel right = short intervals
 Adjuster wheel left = long intervals

Press the stalk down from position ○:
 Single swipe.

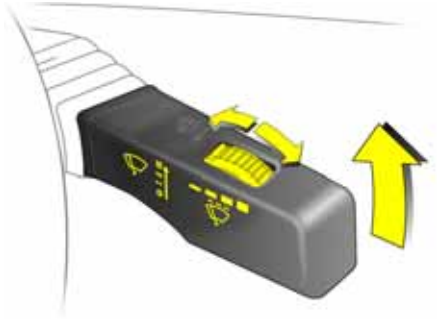

17523 J

Automatic wiping with rain sensor *

To activate, gently push stalk upwards.

○ = Off

-- = Automatic wiping with rain sensor

The rain sensor detects the amount of water on the windscreen and automatically controls the windscreen wiper. Adjust the sensitivity of the system using the adjuster wheel:

Adjuster wheel right = High sensitivity

Adjuster wheel left = Low sensitivity

Keep sensor area of rain sensor clean by operating the windscreen wash system.



17524 J

Windscreen wash system and headlight wash system *

To activate, pull stalk towards steering wheel.

The wiper is switched on for several wipe operations. A single after-wipe occurs at speeds of up to 80 mph (130 km/h).

The headlight wash system * is ready for operation when the headlights are switched on. Wash fluid is sprayed onto the headlights once. Then the headlight wash system is disabled for 2 minutes.

On vehicles fitted with rain sensor *, keep the sensor area clean by operating the wash system regularly.

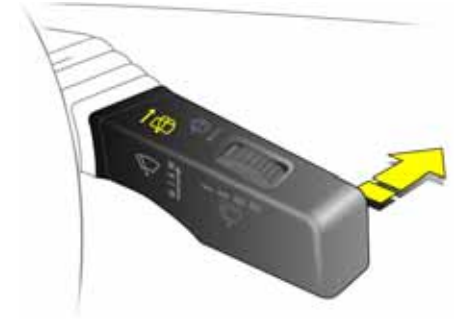

17525 J

Rear window wiper * and rear window wash systems *

Push stalk forwards to switch on.

The rear window wiper swipes in timed interval mode.

The tailgate wiper switches on automatically when the windscreen wiper is switched on and reverse gear is engaged.

Push stalk forwards again to switch off.

The rear window wash system will remain on for as long as the stalk is held in the forward position.

The rear window wash system is deactivated when the fluid level is low.

Lighting

Exterior lights	128
Main beam, headlight flash	129
Automatic dipped beam activation *	129
Turn signal lights	130
Front fog lights \mathcal{D} *	130
Fog tail light \mathcal{Q}	131
Reversing lights.....	131
Hazard warning lights.....	131
Headlight range adjustment \mathcal{D}	131
Adaptive Forward Lighting (AFL) *	132
Door-to-door lighting *	133
Parking lights	134
Instrument illumination \mathcal{Q} , information display illumination	134
Courtesy light	134
Battery discharge protection.....	136
Light covers.....	136
Headlights when driving abroad	136



Exterior lights

Turn light switch:

- 0** = Off
- \mathcal{D} = Parking lights
- \mathcal{D} = Dipped or main beam

In positions \mathcal{D} and \mathcal{D} , the tail lights and number plate lights are also on.

Control indicator \mathcal{D} – see page 100.

If the ignition is switched off with the dipped beam or main beam on, the parking lights illuminate *.

Model variants with daytime running lights *: Parking lights are on when the ignition is switched on and the light switch is set to **0** or **AUTO**. Dipped beam is on when the engine is running.

The daytime running lights switch off when the ignition is switched off.

Follow the regulations of the country in which you are driving when using daytime running lights and front fog lights *.

The rear lights of the Estate automatically switch themselves off after 10 minutes if the luggage compartment is open and the vehicle is stationary.

Driving abroad – see page 136.

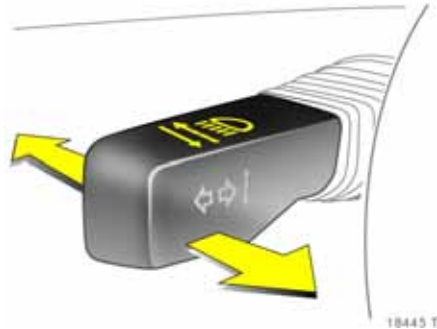

Main beam, headlight flash

To switch from dipped to main beam, press stalk forwards.

To switch to dipped beam, push stalk forwards again or pull towards steering wheel.

To activate the headlight flash, pull stalk towards steering wheel. Main beam is engaged for the duration of activation.

The blue control indicator  is illuminated when main beam or headlight flash is on.



Automatic dipped beam activation *

Light switch to **AUTO**: Dipped beam switches on or off automatically when the engine is running based on outside light conditions.

The exterior lights are turned off by removing the ignition key.

For reasons of safety, the light switch should always remain in the **AUTO** position.

In poor visibility such as fog, turn the light switch to .

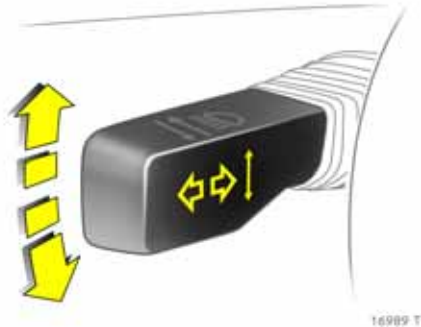

Turn signal lights

To activate, press stalk up or down.

Stalk up = Right

Stalk down = Left

After operation, the turn signal stalk returns to its starting position.

If the stalk is moved past the resistance point, the turn signal light remains on. When the steering wheel moves back towards the straight-ahead position, the turn signal light is automatically deactivated.

Tap signal: Move stalk to resistance point and release to activate three flashes from the turn signals when changing lanes or the like.

Move the stalk to the resistance point and hold for the turn signals to flash longer.

Switch the turn signal off manually by moving the stalk slightly.



Front fog lights D *



The front fog lights can only be switched on when both the ignition and lights are on.

On = Press D , D illuminates in instrument cluster

Off = Press D again or switch off ignition or light.

Fog tail light

The fog tail light can only be switched on when the ignition is on and dipped beam or parking lights are on or if the light switch is in the **AUTO**  position and dipped beam is active.

- On = Press ,  illuminates in instrument cluster
- Off = Press  again or switch off ignition or light.



The fog tail light on the vehicle is deactivated when towing a caravan/trailer.

Reversing lights

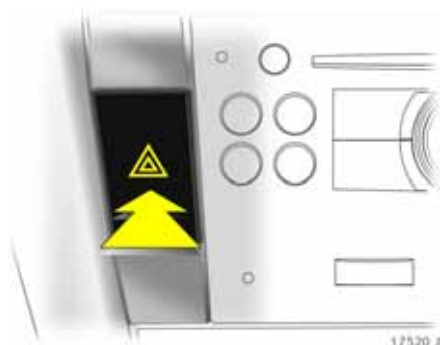
Illuminate when reverse gear is engaged and ignition is switched on.



Hazard warning lights

To activate, press button , to deactivate press button  again.

To aid location of the pushbutton, the red surface is illuminated when the ignition is switched on. When the button is pressed, its control indicator flashes in time with the hazard warning lights.

The hazard warning lights switch on automatically when the airbags are triggered, and the central locking unlocks all doors. Switch off hazard warning lights with button .



Headlight range adjustment

Manual headlight range adjustment

With dipped beam switched on, adjust headlight range in four steps to suit vehicle load. Turn wheel against resistance and click it to the required position.

Correct adjustment of the headlight range reduces dazzle for other road users.

Automatic level control system  - see page 204.



Vehicles without automatic level control system

- 0 = Front seats occupied
- 1 = All seats occupied
- 2 = All seats occupied and luggage compartment load
- 3 = Driver's seat occupied and luggage compartment load

Vehicles with automatic level control system *

- 0 = Front seats occupied
- 1 = All seats occupied
- 1 = All seats occupied and luggage compartment load
- 2 = Driver's seat occupied and luggage compartment load

Automatic headlight range adjustment *

On vehicles with Xenon headlights, the range of the headlights is adjusted automatically based on vehicle load.

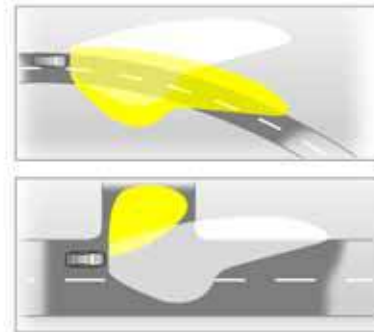

1

2

S 12137

Adaptive Forward Lighting (AFL) *

On vehicles with Bi-Xenon headlights, AFL improves illumination of:

- Curves (curve lighting),
- Intersections and tight turns (turn lighting).

Curve lighting

The Xenon light beam pivots based on steering wheel position and speed (from approx. 6 mph / 10 km/h).

The headlights shine at an angle of up to 15° to the right or left of the direction of travel.

Turn lighting

An additional light illuminates at certain steering wheel settings (after approx. 90°), turn signal settings and speeds (up to approx. 25 mph / 40 km/h).

The light shines approx. 90° to the left or right of the vehicle and approx. 30 metres to the front.

Motorway lighting

At higher speeds and continuous straight ahead travel, the dipped beam automatically raises slightly, thereby increasing headlight range.

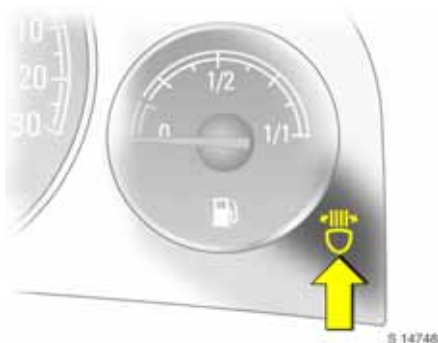

Control indicator

Flashing: Fault in system. The system is not ready for operation.

If the curve lighting swivelling device fails, the relevant dipped beam is switched off. The corresponding fog light is automatically switched on for reasons of safety.

Contact a workshop.

Flashing of control indicator  for approx. 4 seconds after switching on the ignition reminds you that the headlights have been adjusted - see "Headlights when driving abroad" on page 136.



Door-to-door lighting *

The dipped beam and the reversing lights illuminate for approx. 30 seconds after the driver has exited the vehicle and closed his door.

To activate

1. Switch off ignition.
2. Remove ignition key.
3. Open driver's door.
4. Pull turn signal stalk towards steering wheel.
5. Close driver's door.

If the driver's door is left open, the lights will go out after two minutes.

The light is switched off immediately by inserting the key into the ignition or pulling the turn signal stalk again with the driver's door open.

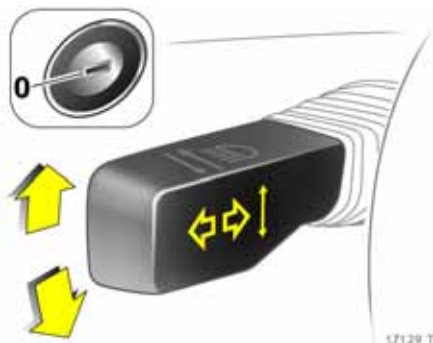

Parking lights

The front parking light and tail light of one side of the vehicle can be activated when parking:

1. Set light switch to **0** or **AUTO** *.
2. Ignition off.
3. Move turn signal stalk all the way up (right parking light) or down (left parking light).

An acoustic signal sounds and control indicator  illuminates briefly in the instrument cluster to indicate activation.

Remove the ignition key before leaving the vehicle.

To switch it off, switch on the ignition or move the turn signal stalk in the opposite direction.



Instrument illumination , information display illumination

Brightness can be adjusted when the exterior lights are on:
Press to release knob  and then turn it clockwise or anticlockwise and hold until the desired brightness is obtained.

Display mode * – see page 120.

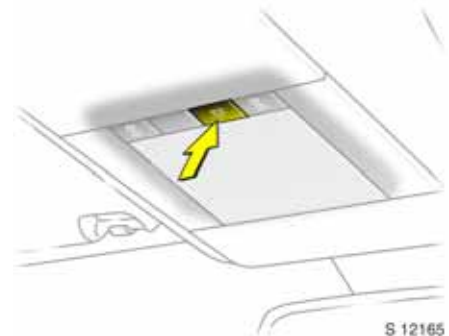

Courtesy light



Front courtesy light

Illuminates automatically when the vehicle is unlocked with the remote control, when a door is opened or when the key is removed from the starter switch after the ignition is switched off.

Extinguishes automatically with delay after the doors are closed or immediately when the ignition is switched on or the doors are locked.

Front courtesy light

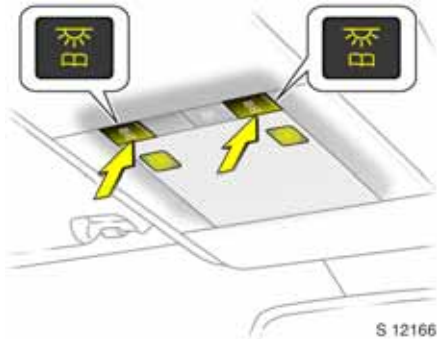

Manual operation from inside with doors closed:

- On = Press button 
Off = Press button  again



Front reading lights *

Left and right reading lights are individually operable. With ignition on:

- On = Press button 
- Off = Press button  again



Courtesy lights and rear reading lights *

Centre switch position: The rear courtesy light illuminates together with the front one when a door is opened.

The rear reading lights on the left and right can be switched on separately. With ignition on:

- On = Switch position **I**
- Off = Switch position **0**

Entry lighting *

After unlocking the vehicle, the instrument and switch illumination as well as the courtesy lights illuminate for a few seconds.

Illuminated mirror in the sunvisors *

The lighting switches on when the cover is opened.

Glove compartment lighting

Glove compartment is illuminated when lid is open and ignition on.

Cigarette lighter and ashtray illumination *

Illuminates when ignition is switched on.

Luggage compartment lighting *

Illuminates when the luggage compartment/tailgate is opened.

Automatically regulated centre console lighting *

Spotlight in housing of interior mirror.

Daylight-dependent, automatically regulated centre console lighting with ignition switched on.

Battery discharge protection

To prevent the battery from becoming discharged, the courtesy light, reading lights, luggage compartment lighting and glove compartment lighting switch off automatically 5 minutes after the ignition is switched off.

Light covers

The inside of the light covers may become misted up for a short period during unfavourable weather conditions, heavy rain or after washing the vehicle. The misting disappears automatically after a short time, but can be speeded up by switching the lights on.

Headlights when driving abroad

The asymmetrical dipped beam increases the field of vision on the passenger side of the lane.

This causes glare for oncoming traffic if the vehicle is driven in countries where traffic drives on the opposite side of the road.

Do as follows to prevent glare:

Vehicles with halogen - headlight system or Xenon headlight system without Adaptive Forward Lighting (AFL) *

Have the workshop convert the headlights.

Vehicles with Adaptive Forward Lighting (AFL) *

1. Open fusebox cover in engine compartment - see page 250.
2. Insert any fuse (maxi-fuse) * in slot 37. Fuse assignment – see page 251.
3. Close fusebox.
4. Switch on ignition.

Then the AFL control indicator  flashes for 4 seconds whenever the ignition is switched on.

Control indicator  - see pages 104, 133.

Infotainment system

Radio reception *..... 137
 Infotainment system *..... 137
 Remote control on steering wheel *.. 137
 Twin Audio *..... 138
 AUX input *..... 138
 Electronic data acquisition at toll systems *..... 138
 Mobile telephones and radio equipment *..... 139

Radio reception *

Vehicle radio reception differs from domestic radio reception:

As the vehicle antenna is relatively near the ground, the broadcasting companies cannot guarantee the same quality of reception as obtained with a domestic radio using an overhead antenna.

- Changes in distance from the transmitter,
 - multi-path reception due to reflection and
 - shadowing
- may cause hissing, noise, distortion or loss of reception altogether.

Infotainment system *

The Infotainment system is operated as described in the operating instructions.



Remote control on steering wheel *

The functions of the Infotainment system * and the information display can be operated with the adjuster wheels and buttons on the steering wheel.

Further information – see pages 111, 116 and the relevant operating instructions.



S 17542 J

Twin Audio *

Twin Audio provides rear seat occupants with the opportunity to listen to a different audio source than the one selected by the driver on the Infotainment system *.

Only an audio source that is not currently active on the Infotainment system can be controlled using Twin Audio.

Two headphone connections are available, with separate volume controls.

Further information is available in the Infotainment system operating instructions.



S 14749

AUX input *

The AUX input is in the stowage compartment in the centre console.

An external audio source such as a portable CD player can be connected via the AUX input using a 3.5 mm jack.

Keep AUX input clean and dry at all times.

Further information is available in the Infotainment system operating instructions.

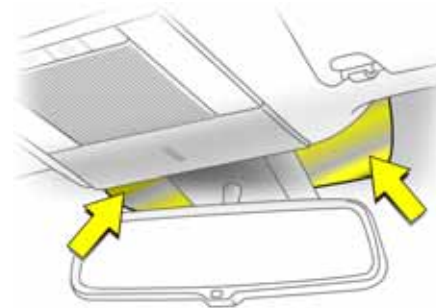

S 12140

Electronic data acquisition at toll systems *

In vehicles with heat-reflecting windscreen¹⁾ * attach chipcard * for electronic data recording and fee payment in black area of windscreen on left or right-hand side behind the interior mirror - see arrows in illustration. Attaching the chipcard outside this area may cause data recording malfunctions.

¹⁾ Solar Reflect.

Mobile telephones and radio equipment *

The Vauxhall installation instructions and the operating guidelines provided by the telephone manufacturer must be observed when fitting and operating a mobile telephone. Failure to do so could invalidate the vehicle's operating permit (EU Directive 95/54/EG).

Recommended prerequisites for fault-free operation:

- Professionally installed exterior antenna to obtain the maximum range possible.
- Maximum transmission power 10 Watt.
- Installation of the telephone in a suitable spot (see information on page 89).

Obtain advice on predetermined installation locations for the external antenna and equipment holder and ways of using devices with transmission power of more than 10 Watts. We recommend that you consult your Vauxhall Authorised Repairer, who will have brackets and various installation kits available as accessories and will install them in accordance with regulations.

A hands-free attachment without an external antenna in mobile phone standards GSM 900/1800/1900 and UMTS must only be operated if the maximum transmission power of the mobile phone does not exceed 2 Watts with GSM 900 and 1 Watt in other cases. The operating regulations stipulated by the manufacturer of the telephone and the hands-free attachment must be complied with.

For reasons of safety, we recommend that you do not use the phone whilst driving. Even use of a hands-free set can be a distraction whilst driving. Be sure to observe any country-specific regulations.

Warning

Mobile phones and radio equipment may cause malfunctions in the vehicle electronics if they are operated in the vehicle without the external antenna unless the above-mentioned regulations are complied with.

Mobile phones that do not comply with the above-mentioned mobile phone standard and radio equipment must only be operated using an antenna that is attached to the exterior of the vehicle.

Climate control

Heating and ventilation system, air conditioning system *	140
Automatic air conditioning system *	141
Electronic Climate Control *	141
Air vents	142
Cooled glove compartment *	143
Heated rear window, heated exterior mirrors	143
Heated front seats *	144
Heated rear seats *	144
Driver's seat with climate control *	144
Heating and ventilation system	145
Air conditioning system *	148
Automatic air conditioning system *	150
Electronic Climate Control *	156
Auxiliary heating/ventilation *	163
Air intake	166
Air outlet	166
Pollen filter	166
Note	166
Maintenance	167



Heating and ventilation system, air conditioning system *

Ventilation, heating and cooling * are combined into one unit that is designed to provide comfort regardless of the season, weather or outside temperature.

When cooling * is activated, the air is cooled and dried.

The heating unit heats the air as required in all operating modes depending on the position of the temperature rotary knob. The air supply can be adjusted to suit requirements by means of the fan.



Vehicles without an air conditioning system do not have buttons for cooling ⚙️, air recirculation 🔄 or demisting and defrosting 🌬️.

Air conditioning system * – see page 148.



Automatic air conditioning system ✱

Provides a comfortable interior regardless of the weather, outside temperature or season.

When an interior temperature is set with the temperature control, the temperature and amount of inflowing air are automatically regulated. A uniform, comfortable climate in the vehicle is thereby automatically obtained based on outside climate conditions.

Automatic air conditioning system ✱ – see page 150.



Electronic Climate Control ✱

Offers the greatest comfort in the vehicle interior regardless of the conditions outside.

To ensure a uniform and comfortable climate in the vehicle, the temperature of inflowing air, air-flow rate and air distribution are automatically adapted based on the climate conditions outside the vehicle and the current temperature of the vehicle interior.

The set values appear on the information display.

Electronic Climate Control ✱ – see page 156.



Air vents

Pleasant ventilation to the head area controlled by the position of the temperature rotary knob.

To increase the air supply, set the fan to a higher speed and set the air distribution rotary knob to .

Centre and side air vents (1)

To open air vent: Turn vertical adjuster wheel up.

Adjust the direction of airflow by turning the horizontal and vertical adjuster wheels.

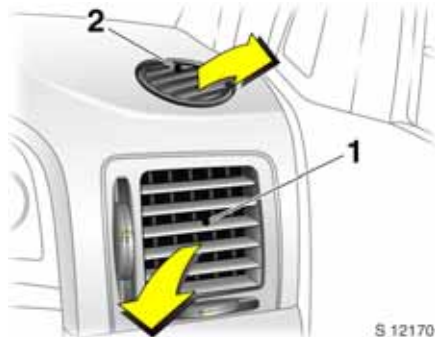

To close the air vents, turn the adjustment wheel fully downwards.

Windscreen defroster nozzles (2)

Air distribution rotary knob to or : Air flows onto windscreen and door windows.

Additional air vents

Additional air vents can be found beneath the windscreen and the door windows, and also in the footwell.

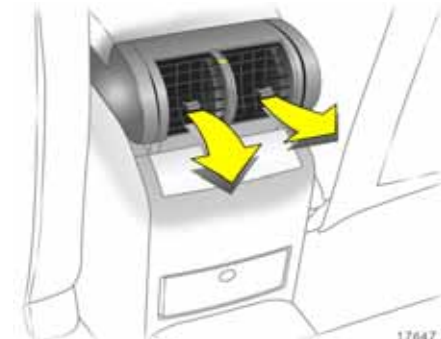

Rear air vents ❄️

To open air vent: Turn vertical adjuster wheel all the way up.

Adjust quantity of air by rotating the control wheel.

The airflow can be directed as desired by tilting and swivelling the slats.

To close the air vents turn the adjustment wheel fully downwards.

If the rear seats are unoccupied close the rear nozzles to increase the air supply at the front.

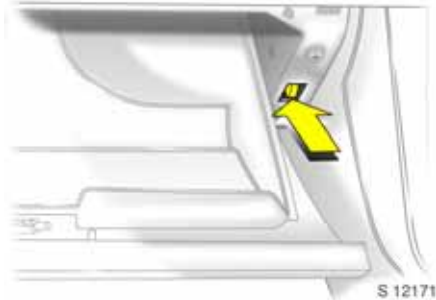

Cooled glove compartment*

Cooled air is fed into the glove compartment through a nozzle.

If glove compartment cooling is not needed, turn the wheel downwards.



Heated rear window, heated exterior mirrors

With the ignition on, the rear window and exterior mirror heating is switched on by pressing button :

LED in the button  illuminated:

Rear window and exterior mirror heating turned on.

LED in the button  extinguished:

Rear window and exterior mirror heating turned off.

Heating takes place with the engine running and is switched off automatically after approximately 15 minutes.

The heated rear window automatically switches on if the diesel particle filter* is being cleaned.



Heated front seats *

Two knurled wheels beneath the centre air vent for the left and right-hand seats.

Turn relevant wheel to set required heating level.

Control indicator above adjustment wheel.

We do not recommend prolonged use of the highest level for people with sensitive skin.

To switch off, set wheel to **0**.

Seat heating is operational when the ignition is on.

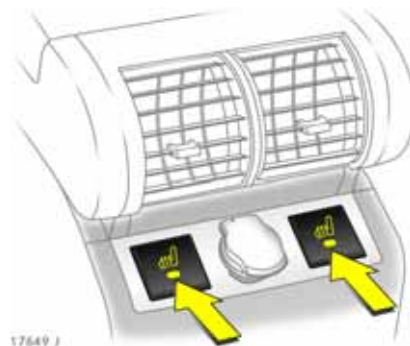

Heated rear seats *

Two buttons at rear of centre console in front of the rear seats.

When the ignition is switched on, the heating of the corresponding seat is activated by pressing the button .

LED in the button  on: Seat heating on.

LED in the button  off: Seat heating off.

The outboard rear seats are heated.



Driver's seat with climate control *

Knurled wheel at driver's side below centre air vents.

Move knurled wheel to required ventilation or heating setting as per requirements.

Control indicator above adjustment wheel.

We do not recommend prolonged use of the highest heating level for people with sensitive skin.

To switch off, set wheel to **0**.





Function only available with ignition switched on.





Heating and ventilation system

Air distribution

Setting with the left rotary knob.

-  To head area via adjustable air vents, to footwell
-  To head area via adjustable air vents
-  To windscreen and front door windows
-  To windscreen, front door windows and footwell
-  To footwell

Open the air vents when the rotary knob is set to  or .



Temperature

Setting with the central rotary knob.

- Red area = Warm
- Blue area = Cold

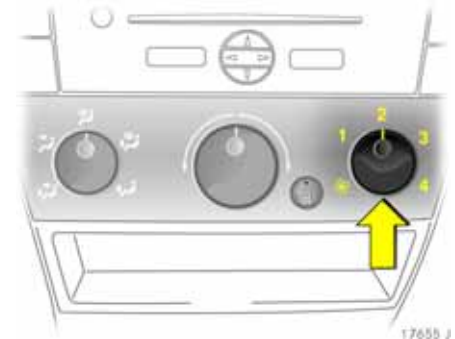

Airflow

Setting with the right rotary knob.

Four fan speeds:

-  Off
- 1-4** Selected fan speed

The rate of airflow is determined by the fan. The fan should therefore also be switched on during a journey.



Ventilation

- For maximum ventilation in head area: Set air distribution rotary knob to , open all vents.
- For ventilation to footwell: Set air distribution rotary knob to .
- For simultaneous ventilation to the head area and the footwell: set air distribution rotary knob to .
- Set the temperature to the desired setting.
- Switch fan on, adjust fan setting as desired.

Heating

The amount of heat is dependent on the coolant temperature and is thus not fully attained until the engine is warm.

For rapid warming of the passenger compartment:

- Set air distribution rotary knob to desired position, preferably position - see page 145.
- Turn the temperature rotary knob clockwise as far as it will go (warm).
- Set the fan to speed 3.
- Open air vents.

Vehicles with Quickheat

Depending on the outside temperature and engine temperature, the passenger compartment can be heated more quickly by means of supplementary electrical heating.

The auxiliary electric heater switches itself on automatically.

The comfort and general well-being of the vehicle occupants are to a large extent dependent on a suitable ventilation and heating setting.

To obtain temperature stratification in the vehicle with a pleasant "cool head and warm feet" effect, move the rotary air distribution rotary knob to or , move the temperature rotary knob to the central position and open the centre air vents.

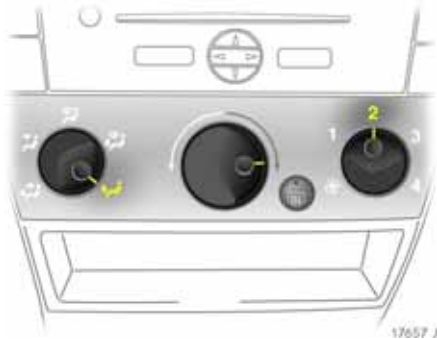

Heating the footwell

- Set air distribution rotary knob to 1.
- Set the temperature rotary knob to the red zone.
- Switch on fan.



Window demisting and defrosting

Warning

Disregard of the instructions could lead to misting or icing of the windows and subsequent accidents due to impaired visibility.

Misted or icy windows, such as in damp weather, from wet clothes or when outside temperatures are low:

- Move air distribution rotary knob to 3.
- For simultaneous warming of the footwell, set air distribution rotary knob to 1.

- Turn the temperature rotary knob clockwise as far as it will go (warm).
- Set the fan rotary knob to 3 or 4.
- Activate heated rear window .
- Open side air vents as required and direct them towards the door windows.

Air conditioning system *

As a supplement to the heating and ventilation system, the air conditioning system cools and dehumidifies (dries) inflowing air.

If cooling or dehumidification is not desired, switch off cooling in order to save fuel.

Cooling switches off automatically at low outside temperatures.



Cooling ☼

Operation only with engine running and fan switched off.

On = Press ☼

Off = Press ☼ again

Control indicator in the button.



Air recirculation system 🔄

The air recirculation button 🔄 is used to set the ventilation system in air recirculation mode (control indicator in the button).

If fumes or unpleasant odours penetrate from outside: temporarily switch on air recirculation system 🔄.

The switched-on air recirculation system reduces air replacement. The humidity increases and the windows may mist up. The quality of the interior air deteriorates over time, which may cause drowsiness.



Comfort setting

- Set cooling as desired.
- Air recirculation system off.
- Set air distribution rotary knob to or .
- Set temperature rotary knob as desired.
- Switch on fan at desired speed
- Open air vents as required.

Temperature rotary knob in centre of adjustment range: warmer air will flow into the footwell and cooler air into the upper zone, with warmer air coming from the side air vents and cooler air from the centre air vents.



Maximum cooling

Open windows and sunroof briefly so that warm air can escape rapidly.

- Cooling on.
- Set air distribution rotary knob to .
- Turn the temperature rotary knob anticlockwise as far as it will go (cold).
- Set fan rotary knob to **4**.
- Open all air vents.

The system will switch automatically to a air recirculation mode.





Window demisting and defrosting

⚠ Warning

Failure to follow the instructions could lead to misted or icy windows and accidents stemming from impaired visibility.

Misted or icy windows, such as in damp weather, from wet clothes or when outside temperatures are low:

- Cooling ☀ on, the air conditioning compressor automatically switches itself off at low outside temperatures (icing).
 - Press button : The fan will automatically switch to 4, air distribution directed on to the windscreen.
 - Turn the temperature rotary knob clockwise.
 - Open side air vents as required and direct them towards door windows.
 - Switch on heated rear window .
- To switch off, press button  again; the air conditioning will operate at the settings selected previously.

Automatic air conditioning system ☀

Provides a uniformly comfortable interior regardless of the weather, outside temperature or season.

To ensure a constant and comfortable climate in the vehicle, the temperature of the inflowing air and the air-flow rate are changed automatically based on climate conditions outside the vehicle.

Temperature changes due to external influences, such as direct sunlight, are automatically compensated.



Automatic mode

Basic setting for maximum comfort:





- Set fan rotary knob to **A**.
- Set air distribution rotary knob to desired position – see next column.
- Use rotary knob to set temperature to 22 °C (a higher or lower temperature can be set as desired).
- Air conditioning compressor activation – see page 152.
- All front air vents open. If desired, the rear air vents also .

Deactivation of the air conditioning compressor can reduce the level of comfort and safety – see page 152.





Air distribution

Setting with the left rotary knob.

-  To head area via adjustable air vents, to footwell
-  To head area via adjustable air vents
-  To windscreen and front door windows
-  To windscreen, front door windows and footwell
-  To footwell

Intermediate settings are possible.

Open the air vents when the air distribution rotary knob is set to  or .



Temperature preset

Setting with the centre rotary knob.

Set the rotary knob to a value between 17 °C and 27 °C. Intermediate settings are possible.

The selected temperature is maintained.

For reasons of comfort, temperature can only be changed in small increments.

There is no temperature control for settings below 17 °C (all the way left) or above 27 °C (all the way right). The air conditioning system works at maximum cooling or heating.

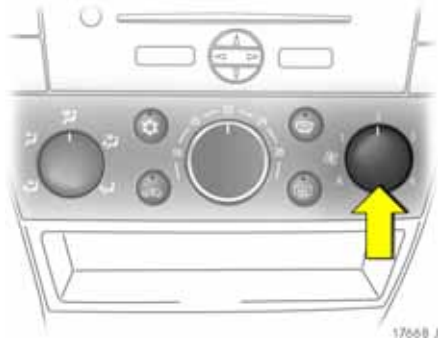

Airflow

Setting with the right rotary knob.

1 - 4 Manual fan speed setting, intermediate settings are possible

A Automatic fan speed control

✱ Fan off

The fan speed regulates the rate of airflow that is needed to maintain the preselected temperature.

Select automatic mode for the highest level of comfort.

When the fan is off, the air conditioning compressor is also off.



To activate/deactivate air conditioning compressor (cooling) ⚙

Operation only with engine running and fan switched off:

On = Press ⚙

Off = Press ⚙ again

Control indicator in the button.

When the cooling (air conditioning compressor) is active, the air is cooled and dehumidified. If cooling or dehumidification is not desired, switch off cooling in order to save fuel.

Cooling switches off automatically at low outside temperatures.



Manual air recirculation mode

The air recirculation system minimises the entry of outside air and the air in the passenger compartment is circulated.



Press button , control indicator in button.

The exchange of fresh air is reduced in air recirculation mode. The quality of the passenger compartment air deteriorates which may cause the vehicle occupants to feel drowsy. In operation without cooling, the air humidity increases, so the windows may mist up. Consequently, manual air recirculation should only be run for short periods of time.

To deactivate manual air recirculation: Press button  again. The control indicator in the button extinguishes.



Ventilation

- For maximum ventilation in head area: set air distribution rotary knob to  and open all air vents.
- For ventilation to footwell: Set air distribution rotary knob to .
- For simultaneous ventilation to the head area and the footwell: set air distribution rotary knob to .
- Set desired temperature.
- Set fan rotary knob to **A**. The fan can also be manually set: Set the rotary knob to position **1 - 4**. Intermediate settings are also possible.

Heating

The amount of heat is dependent on the coolant temperature and is thus not fully attained until the engine is warm.

For rapid warming of the passenger compartment:



- Set the air distribution rotary knob to the desired position – see page 145.
- Set the centre rotary knob to the desired temperature. We recommend a value of about 22 °C.
- Set fan rotary knob to **A**. The fan can also be manually set: Set the rotary knob to position **1 - 4**. Intermediate settings are also possible.

Vehicles with Quickheat

Depending on the outside temperature and engine temperature, the passenger compartment can be heated more quickly by means of supplementary electrical heating.

The auxiliary electric heater switches itself on automatically.



The comfort and general well-being of the vehicle occupants are to a large extent dependent on a suitable ventilation and heating setting.

To obtain temperature stratification in the vehicle with a pleasant "cool head and warm feet" effect, move the rotary air distribution rotary knob to  or , move the rotary temperature rotary knob to approx. 22° and open the centre air vents.



Maximum cooling for very hot interior

Open windows and sunroof  briefly so that warm air can escape rapidly.

- Cooling  on.
- Set air distribution rotary knob to .
- Set the temperature rotary knob to the desired temperature.
- Set fan rotary knob to **A**.
- Open all air vents.

The automatic air conditioning system provides maximum cooling down to the set value.

At settings below 17 °C (rotary knob all the way to the left), the system continually runs with maximum cooling. When the air conditioning compressor is running, air recirculation is automatically switched on.





Demisting and defrosting the windows

Warning

Failure to follow the instructions could lead to misted or icy windows and accidents stemming from impaired visibility.

Misted or icy windows, such as in damp weather, from wet clothes or when outside temperatures are low:

- Cooling  on - the AC compressor deactivates automatically when outside temperatures are low (icing).

- Press button : In fan rotary knob position **A**, the fan automatically switches to the highest speed and air is directed to the windscreen.

- Set temperature to maximum heating, i.e. turn the centre rotary knob all the way to the right (28 °C).

- Switch on heated rear window .

To switch off, press button  again; the automatic air conditioning system will operate at the settings selected previously.

Electronic Climate Control *

Provides the greatest amount of comfort in the interior regardless of the weather, outside temperature or season.

To ensure constant and comfortable climate in the vehicle, the temperature of the inflowing air, the air-flow rate and the air distribution are changed automatically according to climatic conditions outside the vehicle.

The air is automatically regulated in accordance with the settings personally selected for the driver's and front passenger's sides.

Temperature changes due to external influences, such as direct sunlight, are automatically compensated.

Data is shown on the information display. Setting modifications are briefly shown in the information display, superimposed over the currently displayed menu.

The display can vary according to the type of presentation – see page 108.

Electronic Climate Control settings are stored in the vehicle key when the vehicle is locked - see "Storing custom vehicle settings in the vehicle key" - see page 28.

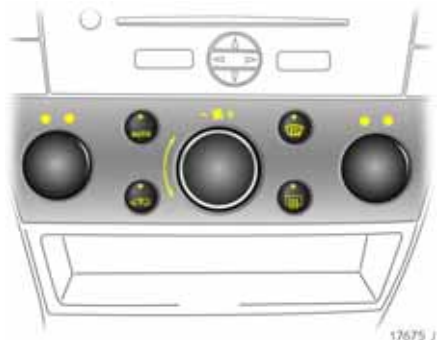

Different settings are stored for each remote control. Use of a remote control will activate the settings associated with it.

Manual settings e.g. operating without cooling and air distribution can be selected using the menu - see page 158.

When cooling (air conditioning compressor) is active, air is cooled and dehumidified.

The pollen filter removes dust, soot, pollen and spores from the inflowing outside air.



The automatic air recirculation system * has an air quality sensor * to detect harmful ambient gases, in which case it will switch automatically to air recirculation.

When set to automatic mode, Electronic Climate Control provides the optimal settings for almost all conditions. If necessary, Electronic Climate Control settings can be modified manually.

The Electronic Climate Control is only operational when the engine is running.

Cooling (air conditioning compressor) switches off automatically at low outside temperatures.



Automatic mode

Basic setting for maximum comfort:

- Press **AUTO** button.
- Open all front air vents. If desired, the rear air vents also ✱.
- Air conditioning compressor activation – see page 160.
- Individually set temperature for the driver's and front passenger's side to 22 °C using the outer knobs.

The temperature can be set higher or lower as desired.

Different temperatures can be set for the driver's and front passenger's sides.

Switching off the air conditioning compressor (**Eco** appears on the display) can have a detrimental effect on comfort and safety - see page 160.

All air vents (except the rear air vents ✱) are controlled automatically in automatic mode. The front air vents should therefore always be open.

Automatic air recirculation system ✱

The ventilation system is set to air recirculation mode and interior air is recirculated.

The automatic air recirculation system has an air quality sensor to detect harmful gases in the outside air, in which case it will switch automatically to air recirculation.

At low outside temperatures and with the cooling (air conditioning compressor) switched off, automatic air recirculation operation will be disabled. This prevents the windows from misting up. Switch manually to air recirculation as necessary.

Activating/deactivating automatic air recirculation system – see page 161.

Manual air recirculation mode – see page 162.

Temperature preset

Using the outer knobs, temperatures can be individually set to values between 16 °C and 28 °C.

For reasons of comfort, temperature can only be changed in small increments.

Vehicles with Quickheat *:

Depending on the outside temperature and engine temperature, the passenger compartment can be heated more quickly by means of supplementary electrical heating.

The auxiliary electric heater switches itself on automatically.

If a temperature below 16 °C is set,

Lo appears on the display: the Electronic Climate Control system runs constantly at maximum cooling power. The temperature is not regulated.

If a temperature above 28 °C is set,

Hi appears on the display: the Electronic Climate Control runs constantly at maximum heating power. The temperature is not regulated.

Temperature settings are stored when the ignition is switched off.



Common temperature setting

Press the knob for the driver's side. The temperature for both the driver's and front passenger's side can be set together using the knob on the driver's side.

Individual temperature settings

Press the knob for the front passenger's side. Temperatures can be set independently of each other using the knobs on the driver's and front passenger's sides.

The temperature on both the driver's and front passenger's side are shown in the display.

For reasons of comfort, the temperatures cannot differ by more than 2 °C.



Manual settings

Under certain circumstances (e.g. iced or misted windows), the functions of the Electronic Climate Control can be modified manually.

Electronic Climate Control system settings can be changed via the centre knob, the buttons and the menus shown on the display.

Press the centre knob to call up the menu. The menu for manual Electronic Climate Control system settings appears on the display.



The individual menu items are highlighted by rotating the centre knob and selected by pressing it. Selecting certain menus by pressing the knob will open a submenu.

To exit a menu, turn the centre knob left or right to **Return** or **Main** and select.

Manual settings are stored when the ignition is switched off.



Window demisting and defrosting

Warning

Failure to follow the instructions could lead to misted or icy windows and accidents stemming from impaired visibility.

Misted or icy windows, such as in damp weather, from wet clothes or when outside temperatures are low:

Press button , control indicator in button.

Temperature and air distribution settings are made automatically, the fan runs at a high speed (fan speed is indicated on the display) and the windows are quickly cleared of moisture and ice.

The airflow can be increased or decreased by turning the central knob.

To return to automatic mode: press button  or **AUTO**.

Heated rear window - see page 143.
Auxiliary heating  - see page 163.

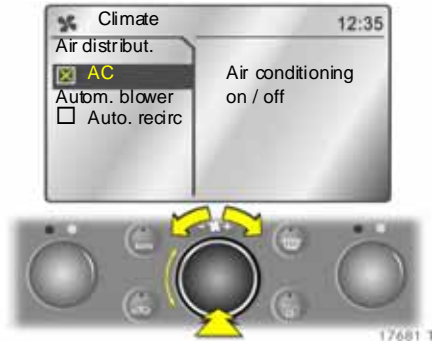

Activating and deactivating air conditioning compressor

If no cooling or dehumidification is required, switch the air conditioning compressor off (maximum energy savings): Highlight menu item **AC** from the manual settings menu and select by pressing the knob. **Eco** appears on the display.

Inflowing air is neither cooled nor dehumidified. This restricts the level of comfort provided by the Electronic Climate Control system. This may cause the windows to mist up, for example.

To activate cooling: Select menu item **AC** from the manual settings menu and press to activate cooling.



Air distribution

Select menu item **Air distribut.** from the manual settings menu.

Make the desired settings in the **Air distribut.** menu:

- Up Air distribution towards windscreen and front door windows
- Middle Air distribution to vehicle occupants via adjustable air vents at front
- Down Air distribution towards footwell

Return to automatic air distribution: deactivate relevant setting or press button **AUTO**.



Airflow

Turn the centre rotary knob clockwise or anticlockwise (if no menu for manual settings is displayed). The selected fan level is indicated by **✱** and numbers in the display.

At speed **0** both the fan and cooling (air conditioning compressor) are switched off.

To return to automatic mode: Press **AUTO** button.



Fan control in automatic mode ✱

Fan regulation in a automatic mode can be modified.

Select menu item **A automatic blower** from the manual settings menu and select the desired fan control.

Depending on the setting, the maximum airflow, and thereby the noise level, will increase.



Switching automatic air recirculation ✱ on or off

The automatic air recirculation system has an air quality sensor to detect harmful gases in the outside air, in which case it will switch automatically to a air recirculation.

Select menu item **Auto. recirc** from the manual settings menu and switch it on or off by pressing.

Switch to manual air recirculation as necessary.



Manual air recirculation mode

The air recirculation system minimises the entry of outside air and the air in the passenger compartment is circulated.

Press button , control indicator in button.

The exchange of fresh air is reduced in air recirculation mode. The quality of the passenger compartment air deteriorates which may cause the vehicle occupants to feel drowsy. In operation without cooling, the air humidity increases, so the windows may mist up. Consequently, manual air recirculation should only be run for short periods of time.

To deactivate manual air recirculation: Press button  again. The control indicator in the button extinguishes.



Air conditioning with the engine not running

When the vehicle is stopped and the ignition is off, the heat or cooling power still in the system can be used to condition the passenger compartment, for example when stopped at a level crossing.

Press **AUTO** button with the ignition off.

Residual air conditioning on will appear briefly in the display.

The air conditioning will operate for a limited period of time.

If necessary, the auxiliary heating  also automatically switches on. Observe notes on page 163.

To cancel air conditioning, press the **AUTO** button.

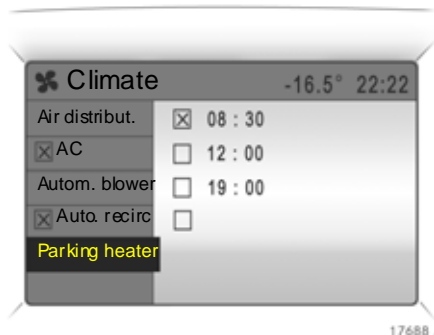

Auxiliary heating/ventilation *

If the engine is switched off, the interior is heated or ventilated depending on the values that have been set and the interior temperature.

The regulation is in accordance with the most recent temperature settings in the Electronic Climate Control system – see page 158. When the system is switched on, the temperature setting can be varied using the outer rotary knobs.

The air is directed to the windscreen and the front door windows if the  button is pressed before switching the ignition off.

Warning

Do not switch auxiliary heater on in filling stations or closed spaces – risk of fire or injury.

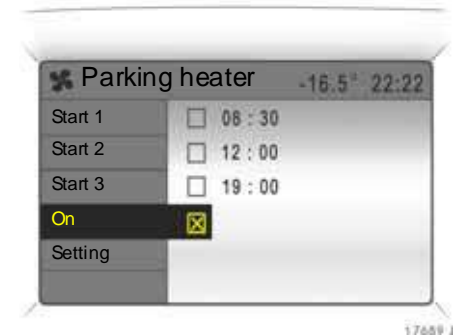

Direct activation

For immediate activation with the ignition on, select menu item **Parking heater** and then menu item **On** from the manual settings menu.

When the system is activated, the control indicator in the **AUTO** button will illuminate.

The system switches itself off automatically after a maximum of 60 minutes, depending on the values that have been set and the interior temperature.

For early deactivation, press the **AUTO** button or select menu item **Parking heater** and then menu item **On** once again.



Switching on at a programmed time

Three programmed times can be stored for switching on.

For safety reasons only one programmed time for switching on can be active at any one time. After the heating cycle has been completed, the next required time for switching on must be activated afresh.

To store a programmed time for activation, select menu item **Parking heater** from the manual settings menu.

After menu item **Parking heater** the current status will be shown.

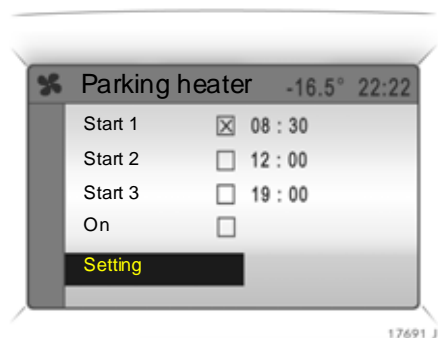

To set a time, select menu item **Setting**.

Then select menu item **Start 1**, **Start 2** or **Start 3** and set the desired time.

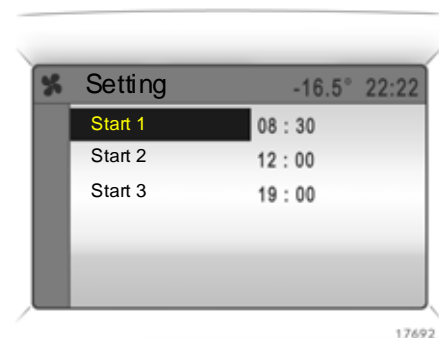

Select the required time for programmed switching on.

When the system is activated, the control indicator in the **AUTO** button will illuminate.

The system switches itself off automatically after a maximum of 60 minutes depending on the values that have been set and the interior temperature.

To cancel air conditioning, press the **AUTO** button.

To perform settings, the **Parking heater** menu can be called up within 2 hours of switching the ignition off by pressing on the central rotary knob.



17693 J

Remote control

The system can also be switched on and off directly using the remote control:

- On = Press button ①, the control indicator in the remote control will illuminate.
- Off = Press button ②, the control indicator in the remote control will illuminate

Whilst the control indicator is illuminated, no further signal can be sent.

When the system is activated, the control indicator in the **AUTO** button will illuminate.

The remote control has a range of approx. 600 m. The range can be reduced by obstructions between the sender and receiver (e.g. walls) and by low power in the battery.

The system switches itself off automatically after a maximum of 60 minutes depending on the values that have been set and the interior temperature.

The auxiliary heating can be switched off at any time by pressing the button ③.

Deactivating an activated switch-on time:

1. Press button ③.
2. Delay of at least 3 seconds.
3. Press button ③ again.

If required, up to three additional remote control units can be programmed. We recommend that you consult your Vauxhall Authorised Repairer.



17694 J

Changing the remote control battery

Replace the battery immediately if the range of the remote control starts to become reduced.

Insert a pointed object into the opening in the underside of the remote control and flip open the cover. Replace batteries observing installation position. For battery type – see page 307.

Always exchange all batteries at the same time.

Make sure that you dispose of old batteries in accordance with environmental protection regulations.

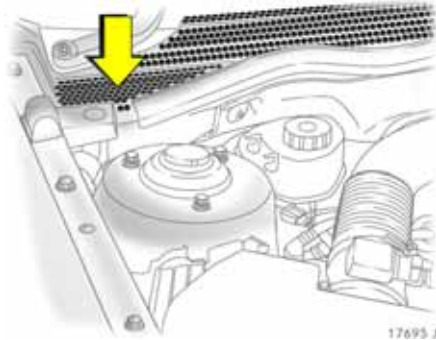

Air intake

The air intakes in front of the wind screen on the far right and left sides of the engine compartment must be kept clear to allow air intake. Remove any leaves, dirt or snow.

Air outlet

Do not cover the air outlets when storing items in the luggage compartment storage compartments.

Pollen filter

The pollen filter cleans dust, soot, pollen and spores from the air entering from outside. The active carbon layer * eliminates most odours and harmful ambient gases from the air.

Have the pollen filter replaced by a workshop at the replacement intervals specified in the Service Booklet.

Note

If the windscreen is misted due to damp weather, temporarily set the system as described under "Window demisting and defrosting" - see pages 147, 150, 159.

The cooling system * operates most effectively with the windows and sunroof * closed. If the passenger compartment has heated up considerably after a long period in direct sunlight, briefly open the windows and sunroof * so that the hot air can escape quickly.

When cooling * (air conditioning compressor) is switched on, condensation forms, which is expelled from the underside of the vehicle.

At least one air vent must be open while cooling * (air conditioning compressor) is on in order to prevent the evaporator from icing up due to lack of air movement.

Cooling switches off automatically at low outside temperatures.

When the auxiliary heating/auxiliary ventilation * is switched on, the Vauxhall alarm system monitoring of the vehicle interior * is deactivated.

Auxiliary heating * consumes fuel (approx. 0.3 litres per heating process on average).

When the auxiliary heating * is switched on, there may briefly be some smoke and noise.

The auxiliary heating * only switches itself on at outside temperatures of less than approx. 20 °C and at coolant temperatures of less than approx. 80 °C.

In order to improve heating power and ensure that the engine operating temperature is reached quickly, auxiliary heating * also switches on automatically when driving if the outside temperature is less than approx. 8 °C. This occurs irrespective of stored auxiliary heating switch-on times. Auxiliary heating switches itself off automatically when the engine is switched off, while the combustion air fan continues running for approx. 2 minutes (humming noise).

Maintenance

In order to ensure consistently good operation, the air conditioning compressor * must be switched on for several minutes once per month irrespective of the weather or time of year. If the vehicle has an Electronic Climate Control system, this is done automatically during travel. Operation with cooling (air conditioning compressor) is not possible when outside temperatures are low. Every 6 months, the auxiliary heating * should be operated for a few minutes at a preset temperature above 22 °C.

On faults, contact a workshop.

Driving and operation

Easytronic *	168
Automatic transmission *	176
Driving hints	184
Saving fuel, protecting the environment	186
Fuels, refuelling	188
Catalytic converter, exhaust gases....	190
Drive Control Systems	196
Brake system	208
Anti-lock Brake System (ABS).....	210
Wheels, tyres	211
Roof racks *.....	218
Towing equipment *.....	219
Towing equipment with removable coupling ball bar *, Saloon / Hatch *.....	219
Towing equipment with pivoting coupling ball bar *	222
Caravan/trailer towing	223

Easytronic *

The automatic Easytronic transmission permits manual (**Manual mode**) or automatic gearshifting (**Automatic mode**), both with automatic clutch control.

Warning

Disregard of these instructions may lead to injuries or endanger life.



17924 J

Transmission display
Shows the mode or current gear.



Starting the engine

Depress footbrake when starting the engine. The engine can only be started with the footbrake depressed. "N" appears on the transmission display. If the footbrake is not depressed the control indicator  illuminates in the instrument cluster, and "N" flashes in the transmission display - the engine cannot be started.

Also the vehicle cannot be started if all brake lights have failed.

It is not necessary to select the neutral position before starting. If no gear is engaged, the transmission automatically shifts into neutral position (N) before starting the engine. This can lead to a slight delay when starting.

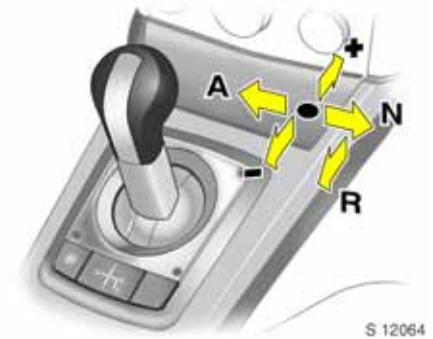

Easytronic operation via the selector lever

Always move the selector lever in the appropriate direction as far as it will go. Upon release, it automatically returns to the centre position. Pay heed to the gear/mode indicator in the transmission display.

Move selector lever towards N

Neutral.



S 12096

Starting-off

Depress the footbrake, release the handbrake, move the selector lever to **A**, **+** or **-**. Easytronic is in Automatic mode and first gear is engaged (second gear if the Winter programme is active). "A" appears on the transmission display.

The vehicle begins to "creep" when the footbrake is released.

It is also possible to start-off without depressing the footbrake if the accelerator pedal is operated directly after moving the selector lever. If there is no immediate acceleration or the footbrake is not depressed, no gear is engaged and "A" flashes. After a few seconds, the display reverts to "N". Repeat previously described starting procedure.

In Automatic mode, selection of other gears is automatic irrespective of driving conditions.

Move selector lever towards A

Switch between Automatic and Manual mode.

Manual gearshifting is possible in Manual mode. The currently engaged gear appears on the display.

If the engine speed is too low the Easytronic will automatically shift to a lower gear even in Manual mode. This prevents the engine from stalling.



S 12064

Move selector lever towards + or -

- + Shift to a higher gear
- Shift to a lower gear

If a higher gear is selected when the running speed is too low, or a lower gear when the speed is too high, no shift is effected. This prevents the engine from running at too low or too high revs.

Gears can be skipped by moving the selector lever repeatedly at short intervals.

If the vehicle is in Automatic mode, on movement of the selector lever to + or - Easytronic shifts to Manual mode and changes up or down. The transmission display shows the currently selected gear.

Move selector lever towards R

Reverse gear. Engage only when vehicle is stationary.

Depress the footbrake, release the handbrake and move the selector lever to R. Reverse gear is engaged. "R" appears on the transmission display.

The vehicle begins to "creep" when the footbrake is released.

It is also possible to start-off in reverse without depressing the footbrake if the accelerator pedal is operated directly after moving the selector lever. If there is no immediate acceleration or the footbrake is not depressed, no gear is engaged and "R" flashes. After a few seconds, the display reverts to "N". Repeat previously described starting procedure.

Electronically controlled driving programmes

- By means of delayed gear changing (higher engine speeds) following a cold start, the operating temperature programme in Automatic mode quickly and automatically brings the catalytic converter to the temperature required for optimum pollutant reduction.
- Adaptive programmes automatically adapt gearshifting in Automatic mode to suit the driving conditions, such as if the vehicle is towing a caravan/trailer, has a high payload, or is being driven on inclines.
- Winter programme: Press button ❄ – see next page.



Winter programme ❄️

In the event of difficulties starting-off on slippery roads, press button ❄️ ("A" and ❄️ appear in the transmission display).

Easytronic switches to Automatic mode and the vehicle sets off in second gear.

The Winter programme is switched off by:

- Pressing button ❄️ again.
- Turning off the ignition.

In order to protect the Easytronic the Winter programme automatically switches itself off at extremely high clutch temperatures.

If the vehicle is switched to Manual mode while the Winter programme is active, the Winter programme is interrupted. The Winter programme resumes upon return to Automatic mode.

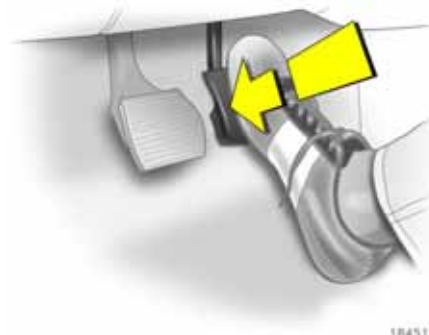

Kickdown

Depress accelerator past resistance point: transmission shifts to a lower gear depending on engine speed. Full engine power is available for acceleration.

During kickdown no manual gearshifting is possible.

When the engine speed approaches its upper limit, the transmission shifts to a higher gear during kickdown even in Manual mode.

Without kickdown this automatic shift is not effected in Manual mode.

Engine braking

Automatic mode:

When driving downhill, Easytronic does not shift into higher gears until a fairly high engine speed has been reached. When braking, Easytronic shifts down in good time.

Manual mode:

To utilise the engine braking effect, select a lower gear in good time when driving downhill.

"Rocking" the vehicle

If it becomes necessary to rock the vehicle to free it from sand, mud, snow or a hole, move the selector lever between **R** and **A** (or + or -) in a repeat pattern while applying light pressure to the accelerator pedal. Do not race the engine and avoid sudden acceleration.

This applies only to the exceptional circumstances mentioned above.

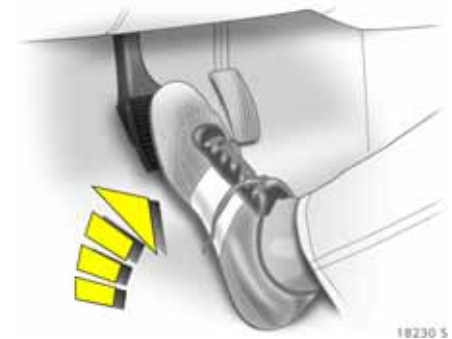

Manoeuvring the vehicle

To manoeuvre the vehicle back and forth during attempts to park or in garage entrances the creeping movement can be utilised by releasing the footbrake.

Never actuate accelerator and brake pedals simultaneously.

To prevent damage, Easytronic disengages the "creep function" at extremely high automatic clutch temperatures.

Stopping the vehicle

In Automatic or Manual mode, when the vehicle has stopped first gear (with Winter mode engaged, second gear) is engaged automatically and the clutch released. In R reverse remains engaged.

When the engine is running, a gear is engaged and the footbrake is not depressed, a warning buzzer sounds when the driver's door is opened and the gear shown in the transmission display flashes at a rapid rate. If the handbrake is not applied, the vehicle creeps. Move the selector lever to N and apply the handbrake.

When stopping on gradients, apply the handbrake or depress the brake pedal. To prevent overheating of the clutch, do not increase engine speed to ensure smooth idling when in gear.

In order to prevent damage to the Easytronic the clutch is automatically engaged at extremely high clutch temperatures.

Switch off engine if stopping for a lengthy period, e.g. in traffic jams or at level crossings.

Vehicle storage

Before leaving the vehicle:

- Apply handbrake,
- Remove ignition key.

The most recently engaged gear (indicator in transmission display) remains engaged. With N, no gear is engaged.

When the ignition is switched off the Easytronic no longer responds to movement of the selector lever.

Lock the vehicle. Otherwise the battery may become discharged if the vehicle is parked for long periods.

If the handbrake has not been applied, the control indicator (D) flashes for a few seconds after the ignition is switched off.

With the engine off and the handbrake not applied, when the driver's door is opened a warning buzzer sounds and the control indicator (D) flashes; switch on ignition, engage gear, switch off ignition and apply handbrake.



S 14751

Fault

Control indicator (D) illuminates in the event of a fault in the Easytronic system. In the event of serious faults, "F" also appears on the transmission display.

It is possible to continue driving if only control indicator (D) illuminates. Manual mode can then no longer be selected.

If "F" also appears on the transmission display, continued driving is not possible.

Have the cause of the fault eliminated by a workshop. The self-diagnosis integrated into the system allows rapid fault identification.

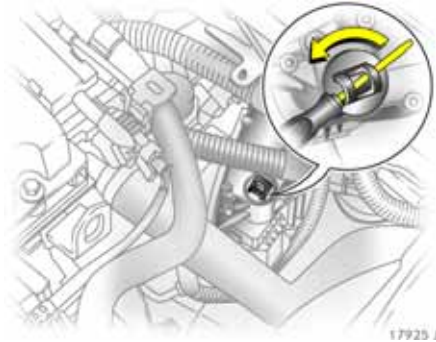

Interruption of power supply

The clutch is not disengaged if the vehicle battery is discharged and a gear has been selected. The vehicle cannot move.

If the battery is flat, start the vehicle using jump leads – see page 230.

If the cause of the power failure is not a discharged battery, contact a workshop. If the vehicle must be removed from flowing traffic, release the clutch as follows:

1. Apply handbrake and switch off ignition.
2. Opening and propping up the bonnet - see page 228.
3. Clean Easytronic around the cap (see Fig. 17925 J) so that no dirt can get into the opening when the cap is removed.
4. Rotate cap to slacken and remove by lifting upwards – see illustration.
5. Turn the adjusting screw clockwise using a flat-head screwdriver (vehicle tools* – see page 238) until clear resistance can be felt. The clutch has now been disengaged.

Do not turn beyond the resistance, since this can damage the Easytronic.

6. Fit cleaned cap again. The cap must be in full contact with the housing.

Towing the vehicle and starting the engine is not permitted when the clutch has been released in this way, although the vehicle can be moved a short distance.

Contact a workshop immediately.

Automatic transmission *

The automatic transmission allows automatic shifting (**Automatic mode**) or manual shifting (**Manual mode**) to take place.

The engine can only be started with the selector lever in **P** or **N**. When starting in **N**, depress the footbrake or apply the handbrake. After the engine has started, depress the footbrake before engaging a gear. Do not accelerate while selecting a gear. Once a gear is engaged and the footbrake is released, the vehicle "creeps". Never depress the footbrake and the accelerator pedal simultaneously. The selected gear is shown in the transmission display - see end column.

Warning

Disregard of these instructions may lead to injuries or endanger life.

Selecting **D** puts the transmission in Automatic mode.

If the selector lever is moved to the left from the **D** position, Manual mode is activated. Gear changes can then be made manually by moving the selector lever towards + or -.



Transmission display

Display of selector lever setting, gear and mode.

- P** Park position
- R** Reverse gear
- N** Neutral
- D** Automatic mode
- 1-6** Manual mode showing the gear selected



Selector lever settings P, R, N and D (Automatic mode)

- P** Park position, front wheels blocked. Only select with vehicle stationary and handbrake applied. "P" appears on the transmission display.
- R** Reverse gear. Only select when vehicle is stationary. "R" appears on the transmission display.
- N** Neutral or idling position. "N" appears on the transmission display.
- D** Drive position for normal driving in 1st to highest gear. "D" appears on the transmission display.

The selector lever can only be moved out of position **P** or **N** with the ignition switched on and the footbrake depressed (selector lever lock). In selector lever position **N** the selector lever lock is activated after a delay and only if the vehicle is stationary.

In positions **P** or **N**, the control indicator  illuminates red in the selector lever indicator, the selector lever is blocked - see Fig. S 12547.

To engage **P** or **R**, press button on selector lever.



The engine can only be started with lever in position **P** or **N**. When position **N** is selected, depress footbrake or apply handbrake before starting.

Do not accelerate during the selection procedure.

If the transmission fluid temperature is less than $-25\text{ }^{\circ}\text{C}$, the selector lever cannot be moved until the fluid temperature reaches $-25\text{ }^{\circ}\text{C}$ with the engine running (**P** or **N** flashes in the transmission display for as long as the selector lever is locked).



S 12549

ActiveSelect (Manual mode)

Shift the selector lever from **D** first to the left and then forwards or backwards.

- + Shift to a higher gear
- Shift to a lower gear

If a higher gear is selected at too low a speed or a lower gear selected at too high a speed, there is no change. This avoids revs that are too low or too high.

If the engine speed is too slow, the transmission automatically shifts to a lower gear, but not if the gear was selected below a certain speed.

If a higher gear is selected below a certain speed a downshift does not take place.

When engine speed is high, there is no automatic shift to a higher gear.

For reasons of safety, kickdown also functions in Manual mode – see page 180.

The selected gear is shown in the transmission display – see page 176.

Electronically controlled driving programmes

■ With adaptive programmes, shifting into other gears is handled automatically based on the driving style, e.g.:

- Economical driving style: at slower engine speeds.
- Adaptation to special driving conditions still takes place, such as: driving up and down hills, towing a caravan/trailer, and with a heavy load.

- Automatic neutral shift function automatically sets the transmission to **N** to reduce fuel consumption, e.g. at traffic lights.



The automatic neutral shift function is activated when the following occurs simultaneously:

- The selector lever is in Automatic or Manual mode.
- The footbrake is depressed.
- The vehicle is stationary.
- The accelerator pedal is not actuated.
- The transmission fluid temperature is above 0 °C.

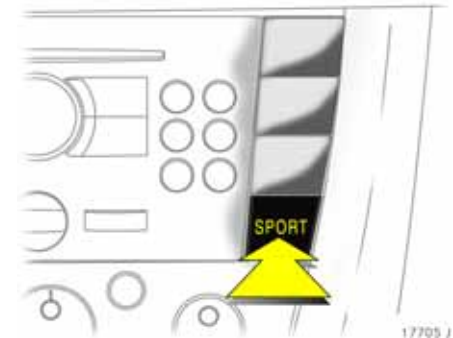

As soon as the footbrake is released and the accelerator pedal is depressed, the vehicle starts off in the usual manner.

- After a cold start, the operating temperature programme ensures that the correct gear (increased engine speed) is selected to quickly bring the catalytic converter to the temperature required for optimum pollutant reduction.



- If the Continuous Damping Control is set to SPORT mode , the shift times are reduced and gear changes occur at higher engine speeds (not when cruise control is active). The control indicator  also illuminates in the transmission display - see page 176.

Continuous Damping Control, SPORT mode  - see page 198.

- Winter programme: Press button . Control indicator  appears on the transmission display - see next page and page 176.



Winter programme ❄️

Press button ❄️ if you are having problems starting-off on a slippery road surface.

To activate

The Winter programme can be switched in Automatic mode (❄️ illuminates in the transmission display - see page 176). The vehicle shifts to 4th gear.

To deactivate

The Winter programme is switched off by:

- pressing button ❄️ again,
- switching off the ignition,
- switching to Manual mode.

To protect against damage, the starting-off aid automatically cuts out at very high transmission fluid temperatures.

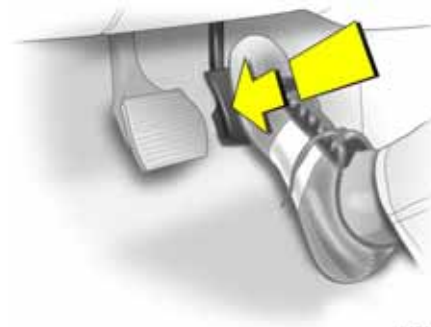

Kickdown

Depress accelerator past resistance point: transmission shifts to a lower gear depending on engine speed. Full engine power is available for acceleration.

For safety reasons, kickdown is available in both Automatic mode and Manual mode.

Engine braking

The automatic transmission automatically selects the driving programme with optimal engine braking effect.

As needed, lower gears can also be selected in Manual mode to increase engine braking effect. 1st gear has the greatest braking effect.

"Rocking" the vehicle

If it becomes necessary to rock the vehicle to free it from sand, mud, snow or a hole, move the selector lever from **D** to **R** in a repeat pattern while simultaneously applying light pressure to the accelerator pedal. Do not race the engine and avoid sudden acceleration.

This applies only to the exceptional circumstances mentioned above.

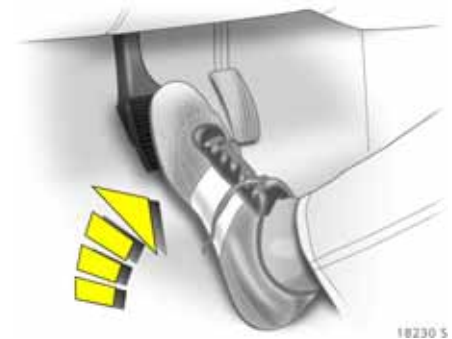
**Manoeuvring the vehicle**

To manoeuvre the vehicle back and forth during attempts to park or in garage entrances, the vehicle's creeping movement can be utilised by releasing the footbrake.

Never actuate accelerator and brake pedals simultaneously.

Stopping the vehicle

The selector lever can be left in the chosen gear with the engine running.

When stopping on gradients apply handbrake or depress brake pedal. To prevent overheating of the transmission, do not increase engine revolutions to ensure smooth idling while standing if a gear has been selected.

Switch off engine if stopping for a lengthy period, e.g. in traffic jams or at level crossings.

Before leaving the vehicle, apply handbrake, then place selector lever in position **P** and remove ignition key.

The ignition key can only be removed when the selector lever is in position **P**.

If the selector lever is not in the **P** position when the ignition is switched off, control indicator  in the selector lever indicator strip flashes – see page 177, Fig. S 12547. Shift the selector lever to **P**.

If the ignition key is not removed, the battery may be discharged if the vehicle is then left to stand for a lengthy period of time.



S 14751

Fault

In the event of a fault in the automatic transmission, control indicator  illuminates. The transmission no longer shifts automatically. Driving can be continued.

In Manual mode, 2nd gear and the highest gear can be engaged. For some faults, only the highest gear is available.

Only the highest gear is available in **D** Automatic mode.

Illumination of control indicator  can also indicate a fault in the engine electronics – see page 192.

For diesel engines¹⁾ Z 19 DTL, Z 19 DT, Z 19 DTH illumination of control indicator  could also indicate that the diesel fuel filter must be drained of water – see page 274.

Have the cause of the fault eliminated by a workshop.

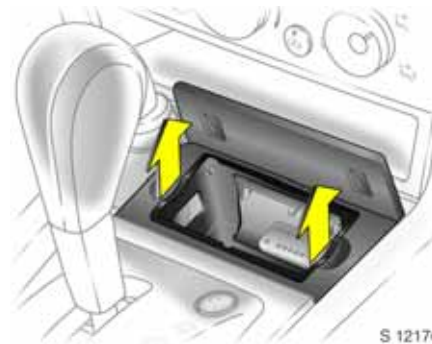

Interruption of power supply

If the vehicle battery is flat, the selector lever cannot be moved out of position **P** or **N**.

If the battery is flat, start the vehicle using jump leads – see page 230.

If the cause is not a discharged battery, unlock selector lever:

1. Apply handbrake.
2. Remove the ashtray – see page 94.
3. Pull out ashtray socket upwards.



4. Press the yellow catch downwards with a screwdriver and move the selector lever out of **P**.
5. Refit ashtray socket in centre console and latch into position.
6. Refit ashtray.

Selecting **P** or **N** again effects locking again. Have the cause of the interruption of power supply rectified by a workshop.

¹⁾ Sales designation – see page 284, 285.

Driving hints

The first 600 miles (1000 km)

Drive your vehicle at various speeds. Do not use full throttle. Never allow the engine to labour at low revs.

Make good use of all gears. Depress the accelerator pedal a maximum of around three quarters of the available pedal travel in all gears.

Do not drive faster than three quarters of maximum speed.

Do not brake unnecessarily hard for the first 125 miles (200 km).

Never coast with engine not running

Many units will not function in this situation (e.g. brake servo unit, electro-hydraulic power steering). Driving in this manner is a danger to yourself and others.

Brake servo unit

When the engine is not running, the brake servo unit is no longer effective once the footbrake has been depressed once or twice. Braking effect is not reduced, but significantly greater force is required for braking.

Electro-hydraulic power assisted steering

If the power-assisted steering fails when being towed with the engine switched off, the vehicle can still be steered, but considerably more force is required.

Driving in mountainous terrain or with a caravan/trailer

The cooling fan is electrically operated. Its cooling power is therefore independent of the engine speed.

Since a considerable amount of heat is generated at high engine speeds and less at slower speeds, do not shift down when climbing hills whilst the vehicle is still coping with the gradient in the higher gear.

Diesel engines: On rising gradients of 10% or more, do not drive faster than 20 mph (30 km/h) in 1st gear or 30 mph (50 km/h) in 2nd gear; with automatic transmission ⚠, do not exceed 25 mph (40 km/h) in position 1.

Driving with a roof load

Do not exceed the permissible roof load – see pages 218, 293. For reasons of safety, distribute the load evenly and secure it properly with retaining straps. Adjust the tyre pressure to the load conditions. Do not drive faster than 75 mph (120 km/h). Check and retighten the straps frequently. Observe country-specific regulations.

Switching off the engine

When you switch off, fans in the engine compartment may continue running for a time to cool the engine.

If the engine temperature is very high, e.g. after driving in mountainous terrain: allow the engine to idle for approximately two minutes in order to prevent heat accumulation.

Vehicles with turbocharged engine ⚠

After running at high engine speeds or high engine loads, operate the engine briefly at a low load or run in neutral for approx. 30 seconds before switching off in order to protect the turbocharger.

Save energy – more miles / kilometres

Please observe the running-in hints on the previous page and the tips for energy saving on the following pages.

Good, technically correct and economical driving ensures maximum durability and performance for your vehicle.

Overrun

The fuel supply is automatically shut off during overrun, e.g. when the vehicle is being driven down long gradients or when braking. To enable the overrun cut-off to take effect, do not accelerate during overrun and, if in manual transmission mode, do not depress clutch pedal. To prevent damage to the catalytic converter, overrun cut-off is temporarily deactivated when the catalytic converter temperature is high.

Vehicles with turbocharged engine *

Flow-generated noises may be audible if the accelerator is released quickly on account of airflow in the turbocharger.

Engine speed

Drive in a low engine speed range for each gear as much as possible.

Warming up

Allow the engine to warm up whilst driving. Do not warm it up by letting it run at idling speed. Do not apply full throttle until the engine has reached operating temperature.

After a cold start, the automatic transmission * or Easytronic * in Automatic mode shifts into higher gears at higher rpm. This allows the catalytic converter to quickly reach the temperature required for optimum pollutant reduction.

Correct gear selection

Transmission in neutral and without revving in the lower gears. Stop-and-go traffic and driving at a speed too high for the selected gear or transmission ratio increases wear and fuel consumption.

Change down

When decreasing speed, shift down into the next lowest gear. Do not slip the clutch with a high-revving engine. This is especially important when hill climbing.

Clutch operation

Always depress the clutch pedal hard to the floor to prevent shifting difficulties and transmission damage.

When driving do not use the pedal as a footrest; this will cause substantial clutch wear.

Cooling fan

The cooling fan is controlled via a thermostat and therefore only runs if necessary.

The cooling fan automatically switches on when the diesel particle filter * is being cleaned depending on the engine.

Pedals

Do not place any objects in the footwell which could slip under the pedals and inhibit the pedal travel.

To ensure the pedal travel is uninhibited, there must be no mats in the area of the pedals.

Battery care

When driving slowly or when the vehicle is stationary, e.g. in slow urban traffic, stop-and-go traffic or traffic jams, turn off all unnecessary electrical loads where possible (e.g. heated rear window, heated seats *).

Depress clutch pedal when starting in order to relieve the strain on the starter and the battery.

Saving fuel, protecting the environment

Trend-setting technology

In the development and manufacture of your vehicle, environment-friendly and in the main recyclable materials were used. The production methods used to make your vehicle are likewise environmentally-compatible.

Recycling of production wastes keeps the circulation of material closed. Reduction of energy and water requirements also helps to conserve natural resources.

A highly advanced design means that your vehicle can be easily disassembled at the end of its working life, and the individual materials separated for subsequent re-use.

Materials such as asbestos and cadmium are not used. The refrigerant in the air conditioning system * is CFC-free.

New painting techniques employ water as a solvent.

End-of-life vehicle recovery

For detailed information on Vauxhall's on-going commitment to achieving an environmentally sustainable future, including; design for recycling, take back of End-of-Life Vehicle's (ELVs) and the recycling of ELVs, view www.vauxhall.co.uk/recycling for details.

Energy and environment-conscious driving

■ High noise levels and exhaust emissions are often a result of driving without due attention to saving energy and protecting the environment.

■ You should therefore drive with energy in mind "more miles / kilometres – less fuel".

Reduce the noise level and exhaust emissions by adopting an environment-conscious driving style. This is extremely worthwhile and improves the quality of life.

Fuel consumption depends to a great extent on your own personal driving style. The following hints are intended to help you consume fuel at a rate that is as close as possible to the specified levels – see page 287.

Check your vehicle's fuel consumption every time you refuel. This facilitates early detection of any irregularities causing increased fuel consumption.

Warming up

- Full throttle and warming up at idle speed increase wear, fuel consumption, exhaust emission, the amount of pollutant in the exhaust and the amount of noise.
- Drive off as soon as possible after starting.

Uniform speed

- Hectic driving significantly increases fuel consumption, the exhaust emissions, the proportion of pollutant in the exhaust gas and the noise level.
- Do not accelerate and brake unnecessarily. Drive at uniform speed, watching the road.

Avoid frequent starting-off and stopping e.g. at traffic lights, in short distance traffic and in queues of traffic by means of clever planning. Select roads with good traffic flow.

Idling

- The engine also consumes fuel when idling.
- If you have to wait for more than one minute, it is worthwhile switching off the engine. Five minutes of idling corresponds to approximately 0.6 miles (1 km) of driving.

Overrun

- The fuel supply is automatically shut off during overrun, e.g. when the vehicle is being driven down long gradients or when braking – see page 185.
- To enable the overrun cut-off to come into action and save fuel, do not accelerate or depress clutch pedal during overrun.

Correct gear selection

- High revs increase engine wear and fuel consumption.
- Do not race your engine. Avoid driving at high engine speeds.

Making use of the tachometer helps to save fuel. Drive in a low engine speed range for each gear as much as possible with uniform engine speeds. Drive as often as possible in top gear, select the next higher gear as soon as possible, and only change down when the engine is no longer running perfectly smoothly.

High speed

- The higher the speed, the higher the consumption and the noise level. At top speed, you consume a great deal of fuel and produce excessive noise and exhaust emissions.

- Slightly releasing the accelerator pedal results in distinct fuel savings with no major loss of speed.

Drive at no more than around three quarters of maximum speed and you will use up to 50% less fuel, without losing a great deal of time.

Tyre pressure

- Inadequate tyre pressure, leading to higher road resistance, costs money in two ways: for more fuel and increased tyre wear.
- Regular checks (every 14 days) pay off.

Electrical loads

- The power consumption of electrical equipment increases fuel consumption.
- Switch off all auxiliary electrical loads (e.g. air conditioning ✱, heated rear window) when not needed.

Roof racks, ski-holders

- Due to air resistance, a roof load can increase fuel consumption by approx. 3.5 gal./1000 miles (1 l/100km).
- Remove them if they are not being used.

Repair and maintenance

- Improper repairs or adjustment and maintenance work can increase fuel consumption. Do not carry out work on the engine yourself.

You may out of ignorance infringe environmental laws by not disposing of materials properly.

Appropriate parts might not be recycled.

Contact with some of the materials involved may pose a health hazard.

- We recommend that repair and maintenance be entrusted to your Vauxhall Authorised Repairer.

Extreme driving conditions

- Going up steep slopes, cornering, driving on poor roads and winter driving all increase fuel consumption.

Fuel consumption increases dramatically in urban traffic and at winter temperatures, especially on short trips when the engine operating temperature is not reached.

- Follow the hints given above to keep consumption to a minimum under such conditions.

Fuels, refuelling

Fuel consumption

Fuel consumption is determined under specific driving conditions – see page 287.

Special equipment increases the weight of the vehicle. As a result, they can increase fuel consumption and reduce the specified maximum speed.

For the first few thousand miles / kilometres, friction between the engine and transmission components is higher. This increases fuel consumption.

Fuel for petrol engines

Normal commercial high-quality fuels with a maximum ethanol content of 5% in accordance with DIN EN 228 are suitable (for catalytic converter see page 190, for octane numbers - see pages 284, 285). The quality thereof has considerable effect on the performance, running and service life of the engine. The additives mixed with the fuel are extremely important. For this reason you must only refuel with high-quality fuels containing additives.

Fuels with ethanol content greater than 5% do not comply with DIN EN 228 and must not be used unless the vehicle has been specifically developed and approved for these fuels.

Fuel with too low an octane number can cause pinking. Vauxhall cannot be held liable for resulting damage.

Petrol with a higher octane number can always be used.

The use of 91 octane fuel is not permitted in vehicles with the Z 22 YH¹⁾ engine or the Vectra VXR.

The ignition timing adjusts automatically to the grade of fuel used (octane number) – see pages 284, 285.

Use of petrol with an octane rating of 95 will ensure economical driving.

Fuel with 95 RON will result in less power and torque with the Vectra VXR.

Fuel for diesel engines

Diesel engines must be operated only on commercially available diesel fuel meeting the specifications of DIN EN 590.

Since January 2004, some oil companies have mixed their diesel fuel with up to 5% Bio fuel (FAME = Fatty Acid Methyl Esters) like RME (Rape-Oil Methyl Ester). This is in accordance with the current DIN EN 590 and does not harm the fuel/injection system. The characteristics of a diesel fuel mixed up with 5% Bio fuel (FAME) do not differ from conventional diesel fuel and do not influence the vehicle's driveability.

Important: Diesel fuel mixed with 5% FAME according to DIN EN 590 must not be confused with 100% Bio Diesel, which is not to be used in Vauxhall engines.

The flow and filterability of diesel fuel are temperature-dependent.

Diesel fuels with improved low temperature properties are therefore available on the market during the winter months. Make sure that you fill the tank with winter fuel before the start of the cold weather season.

Additives can be used with diesel fuels with winter properties that are guaranteed by the manufacturer and when using diesel fuel filters that are heated depending on the outside temperature.

Diesel fuels must not be diluted with fuels that are intended for petrol engines.

Fuel filler cap

When replacing the fuel filler cap, be sure to use a genuine fuel filler cap for your model to ensure full functionality. Diesel-engined vehicles have special fuel filler caps.

¹⁾ Sales designation – see page 284, 285.



Refuelling

⚠ Warning

Care must be taken when handling fuel.

Before refuelling, turn off engine and also shut off external heaters with combustion chambers (identified by stickers on tank flap). Switch off mobile phones.

The tank display updates more quickly if the ignition is switched off during refuelling.

⚠ Warning

Fuel is flammable and explosive. When handling fuel or in the immediate vicinity, avoid naked flames or sparks. Do not smoke. This also applies where the presence of fuel is revealed by its characteristic smell. If fuel odours occur in the vehicle, have a workshop eliminate the fault immediately.

Fuel filler neck at right rear side of vehicle.

The tank flap is locked together with the doors – see page 30.

Open the tank flap.

Unscrew the fuel filler cap, remove and suspend from the tank flap.

The fuel tank has a limiting system which prevents overfilling of the tank.

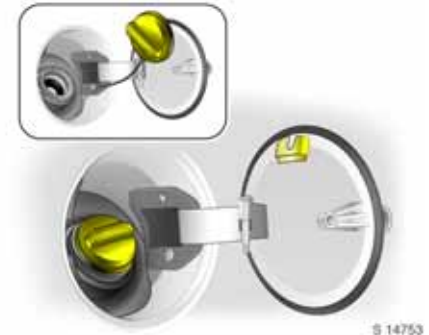

Correct filling depends to a large extent on proper operation of the fuel dispensing pump:

1. Fully insert the pump nozzle and switch it on.
2. After an automatic shut-off, the nominal capacity of the fuel tank is reached by means of two metered top-ups. Insert fuel dispensing pump as far as it will go.

To close, position the fuel filler cap and rotate past the resistance until the cap audibly clicks over the retainer.

Close fuel tank flap.

Wipe off any overflowing fuel immediately.

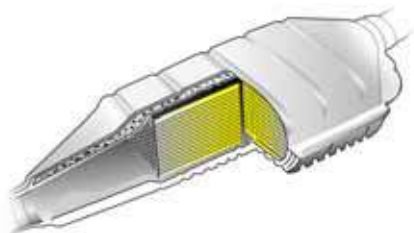

Catalytic converter, exhaust gases

Catalytic converter for petrol engines

Leaded fuel will damage the catalytic converter and parts of the electronic system, rendering them inoperative.

Use of high-quality fuels other than those specified on page 188 (e.g. LRP¹⁾) could damage the catalytic converter.

Damage to the catalytic converter or the vehicle may result if the following points are not observed:



- On ignition faults, uneven running after cold start, a clear drop-off in engine power or other unusual operating symptoms which could indicate a fault in the ignition system, contact a workshop immediately. Continue driving if necessary for a short time at low speed and low revs.

Irregular engine running and a loss of engine power when the Electronic Stability Programme (ESP^{PLUS}*) comes into action are the result of operating conditions and are therefore of no significance – see page 196.

- If unburned fuel enters the catalytic converter, this may result in overheating and irreparable damage to the catalytic converter.

You should therefore avoid unnecessarily long use of the starter when starting-off, running the tank dry (an irregular fuel supply will lead to overheating) and starting the engine by pushing or towing.

1) LRP = Lead Replacement Petrol.

- If the control indicator  for exhaust gases flashes, slow down until the flashing stops and the control indicator illuminates. Contact a workshop for assistance immediately. Control indicator  for exhaust gases – see page 192.

Catalytic converter for diesel engines

Damage to the catalytic converter or the vehicle may result if the following points are not observed:

- On uneven running, a clear drop-off in engine power or other unusual operating symptoms, contact a workshop immediately. Continue driving if necessary for a short time at low speed and low revs.

Irregular engine running and a loss of engine power when the Electronic Stability Programme (ESP®^{PLUS} ) comes into action are the result of operating conditions and are therefore of no significance – see page 196.

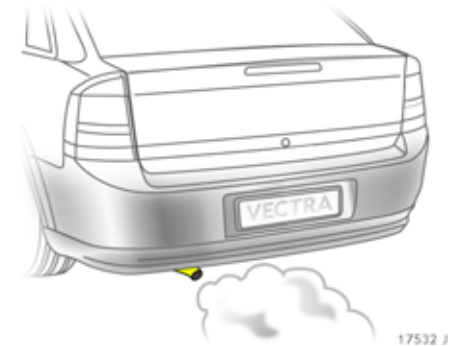

Controlling exhaust emission

Some of the damaging substances in the exhaust such as carbon monoxide (CO), hydrocarbons (HC) and nitrous oxides (NO_x) are reduced to a minimum by making structural changes – mainly in the injection system and the ignition system in conjunction with the catalytic converter.

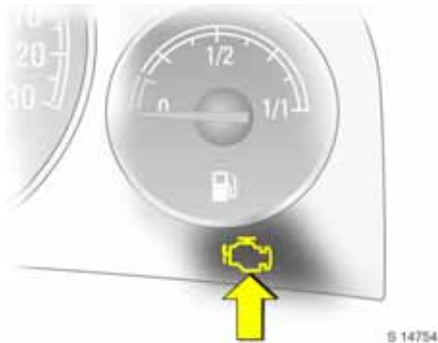

Control indicator  for exhaust
illuminates when the ignition is switched on
and during the start attempt. Extinguishes
shortly after the engine starts running.

Illuminated with the engine running
indicates a fault in the exhaust gas
cleaning system. The permitted emissions
may be exceeded. Contact a workshop
immediately.

Flashing with the engine running indicates
a fault which could lead to catalytic
converter damage. You may continue
driving without damage if you back off
until flashing stops and the control
indicator illuminates. Contact a workshop
immediately.



Control indicator  for engine electronics
illuminates for a few seconds after the
ignition is switched on.

If it illuminates when the engine is running,
there is a fault in engine or transmission
electronics. The electronic system switches
to an emergency running programme. Fuel
consumption may be increased and the
driveability of the vehicle may be impaired.

In some cases, faults can be eliminated by switching off the engine and restarting. If the control indicator illuminates again when the engine is running, contact a workshop to eliminate the cause of the fault.

If it illuminates briefly, but does not recur, it is of no significance.

If  illuminates, this may also mean water in the diesel fuel filter in the engines¹⁾ Z 19 DTL, Z 19 DT and Z 19 DTH. Where necessary, have the fuel filter inspected by a workshop for any residual water.

If it flashes after the ignition is switched on, there is a fault in the immobiliser system.

The engine cannot be started.

See page 27.

Exhaust gases

Warning

Engine exhaust gases contain poisonous carbon monoxide, which is colourless and odourless and could be fatal if inhaled.

If exhaust gases penetrate the vehicle interior, open a window and contact a workshop.

Avoid driving with an open luggage compartment. Otherwise, exhaust gases could penetrate the interior.

During the first drive smoke may develop because of wax and oil evaporating on the exhaust system. Park the vehicle in the open for a while after the first drive and avoid inhaling the fumes.

¹⁾ Sales designation – see page 284, 285.

Diesel particle filter *

The diesel particle filter system removes polluting soot particles out of the engine exhaust gases. The system includes a self-cleaning function that operates automatically whilst driving. The filter is cleaned by burning the trapped soot particles at a high temperature. There may be an increase in fuel consumption, exhaust smell, and engine cooling fan operation * during the self-cleaning operation.



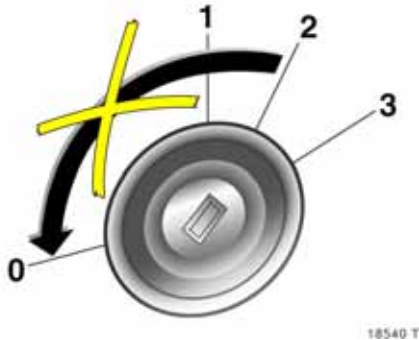

The self-cleaning function cannot operate automatically during certain driving situations where the engine does not reach its normal operating temperature. An example of this would be driving only short distances in cold weather. If the filter needs cleaning and recent driving situations did not allow the function to automatically operate, then the control indicator will flash. If this occurs, then you may continue to drive the vehicle normally. The vehicle will not be damaged and does not require service.

The self-cleaning function will automatically operate whilst driving after the engine has reached its normal operating temperature. The control indicator will continue to flash until the self-cleaning operation is complete. This may take up to 20 minutes of driving. The time will be shorter at higher vehicle speeds. If the vehicle is not moving for more than a few minutes, then the self-cleaning function will not operate. Operation will continue when driving resumes.

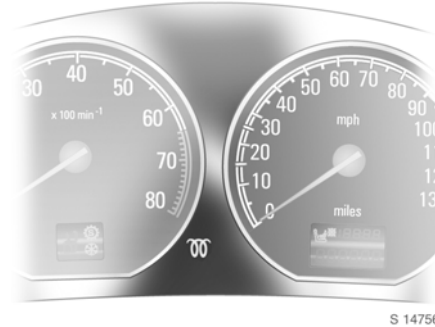

We recommend that you do not turn the ignition off until the self-cleaning operation is complete. If you must turn the ignition off before the operation is complete, then the operation will automatically resume when driving the next time and after the engine has reached its normal operating temperature.



The control indicator  extinguishes as soon as the self-cleaning operation is complete.

Maintenance

Have all maintenance work carried out at the intervals specified. We recommend that you entrust this work to your Vauxhall Authorised Repairer, who has proper equipment and trained personnel available. Electronic testing systems permit rapid diagnosis and remedy of faults. This way you can be certain that all components of the vehicle's electrical, injection and ignition systems operate correctly, that your vehicle has a low level of pollutant emission and that the catalytic converter system will have a long service life.

You are thereby making an important contribution towards keeping the air clean and compliance with emissions legislation.

Checking and adjustment of the fuel-injection and ignition systems is part of the scope of inspection. For this reason you should have all maintenance work carried out at the intervals specified in your Service Booklet.

Drive Control Systems

Interactive Driving System (IDS+) *

The IDS+ combines the sensors and control units of the Electronic Stability Programme (ESP®^{Plus}), the Anti-lock Brake System (ABS) and Continuous Damping Control (CDC). This provides both excellent driving dynamics and greater safety.

Electronic Stability Programme

(ESP®^{Plus}) *

ESP®^{Plus} improves driving stability when necessary in any driving situation regardless of the type of road surface or tyre grip. It also prevents the drive wheels from spinning.

The system monitors vehicle movements. As soon as the vehicle starts to swerve (understeers/oversteers) engine output is reduced (the sound of the engine changes) and individual wheels are specifically braked. This considerably improves the driving stability of the vehicle on snow and ice and on wet or slippery road surfaces.

ESP®^{Plus} is ready for operation as soon as the ignition is switched on and control indicator  extinguishes.

Control indicator  flashes when ESP®^{Plus} is in action.

The vehicle is now in a critical situation; ESP®^{Plus} allows you to keep control of the vehicle and reminds you to match your speed to the road conditions.

Warning

Do not let this special safety feature tempt you into taking risks when driving.

Traffic safety can only be achieved by adopting a responsible driving style.

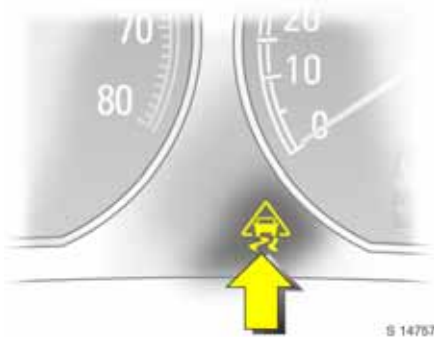

Control indicator

Illuminates for a few seconds when the ignition is switched on. The system is now ready for operation.

Flashing during driving:

This shows the system has come into action. The engine output may be reduced (the sound of the engine changes) and the vehicle may be braked automatically to a small degree.



Illuminates whilst driving:

The system is switched off or a fault has occurred. The vehicle can continue to be driven. However, driving stability may worsen depending on the nature of the road surface.

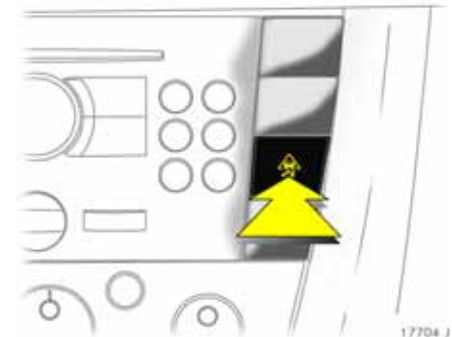
Switch on ESP^{Plus} again, or have the cause of the fault rectified by a workshop. The system's integrated self-diagnostics allows faults to be quickly remedied.



Switching off

ESP^{Plus} can be deactivated by pressing button  .

Deactivation is only possible up to a speed of 40 mph (60 km/h) and is indicated by illumination of control indicator  in the instrument cluster.

Pressing the  button again or turning on the ignition switches ESP^{Plus} on again.

Continuous Damping Control * (CDC)

Normal mode

CDC automatically adapts vehicle damping to the current driving situation and road conditions.

The system continually monitors wheel and vehicle movements and immediately modifies the damping of each shock absorber. Chassis calibration is optimally adapted to the driving situation and road conditions.

Continuous Damping Control is always in normal mode with the ignition is switched on. If desired, the system can be switched to SPORT mode.

In SPORT mode, the damping control is adapted to a sportier driving style, among other things. This adaptation results in a "harder" suspension setting.

SPORT mode

When driving in SPORT mode, the damping, steering * (not for engines Z 28 NEL/NET)¹⁾, throttle application and - for automatic transmissions * - the shifting points are changed.

Damping and steering * become more direct and provide better contact with the road surface. The engine reacts more quickly to accelerator movements.

With automatic transmission * the shift times are reduced and gear changes occur at higher engine speeds (not when cruise control * is active).

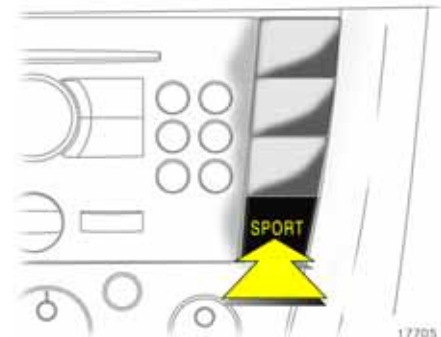

Activating SPORT mode

Press the **SPORT** button. The LED in the button illuminates.

In vehicles with automatic transmission * the control indicator ⚙️ also illuminates in the transmission display.

If the Winter programme * has been switched on (vehicles with automatic transmission *) SPORT mode cannot be activated.

Winter programme - see page 180.

¹⁾ Sales designation – see pages 284, 285.

Deactivating SPORT mode

Briefly press the **SPORT** button again. The LED in the button extinguishes. The Continuous Damping Control system resumes Normal mode.

SPORT mode is switched off by switching off the ignition or switching off the Winter programme ❄ (vehicles with automatic transmission ❄).

Winter programme - see page 180.





Control indicator  for Continuous Damping Control or SPORT mode fault
Illuminates for a few seconds after the ignition is switched on. If the control indicator does not go out, or if it illuminates whilst driving, there is a fault in the Continuous Damping Control system or SPORT mode. The system is not ready for operation. Have the cause of the fault rectified by a workshop.

The system's integrated self-diagnostics allows faults to be quickly remedied.

Cruise control *

Cruise control can store and maintain speeds of approx. 20 to 125 mph (30 to 200 km/h). Deviation from the saved speed is possible on uphill or downhill inclines.

For safety reasons the cruise control cannot be activated until the footbrake has been depressed once.

Cruise control is operated with buttons , , and  on the turn signal stalk.

Do not use the cruise control if it is not advisable to maintain a constant speed (e.g. in situations presenting a danger to yourself and other road users, in heavy traffic or on winding, slippery or greasy roads).

With automatic transmission *, only use cruise control in **D** or in Automatic mode with Easytronic *.

When the cruise control is active, reaction times may be increased due to the different position of the feet.

Warning

Even with cruise control activated, the driver has full responsibility for maintaining an appropriate speed. Disregard of these instructions could lead to injury or danger to life.



S 14759

Control indicator 

Illuminates for a few seconds when the ignition is switched on. The system is now ready for operation.

When driving, control indicator  will illuminate as soon as the system is switched on.

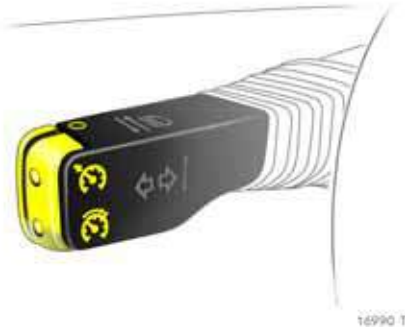



To activate

Briefly press button : the current speed is stored and maintained. The accelerator pedal can be released.

Vehicle speed can be increased by depressing the accelerator pedal. When the accelerator pedal is released, the previously stored speed is resumed.

Increase

With cruise control active, hold down button  or briefly press it repeatedly: speed is increased continuously or in steps of 1.2 mph (2 km/h) without using the accelerator pedal.



When button  is released the current speed is stored and maintained.

Decelerate

With cruise control active, hold down button  or briefly press it repeatedly: speed is reduced continuously or in steps of 1.2 mph (2 km/h).



When button  is released the current speed is stored and maintained.

To deactivate

Briefly press button : Cruise control is switched off, control indicator  extinguishes and the vehicle slowly decelerates. To continue driving, depress the accelerator pedal in the usual manner.

For reasons of safety, cruise control deactivates under certain driving conditions.

For example:

- if the vehicle's speed drops below approx. 20 mph (30 km/h), or
- if the brake pedal is depressed, or
- if the clutch pedal is depressed, or
- if the selector lever of automatic transmission  or Easytronic  is in N.

Resuming the stored speed

Briefly press button  at a speed above 20 mph (30 km/h): the speed selected before the cruise control was switched off is resumed.

The stored speed value is deleted when the ignition is switched on.

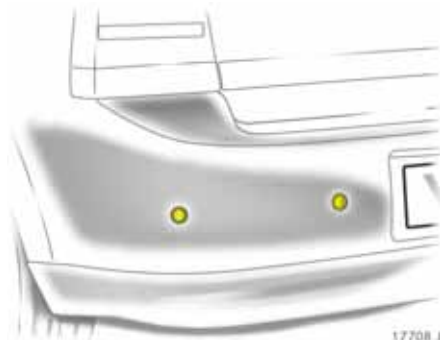

Parking distance sensors *

The parking distance sensors make reverse parking easier by measuring the distance between the vehicle and an obstacle, and giving an acoustic signal in the passenger compartment.



The system registers distance by means of four sensors in each of the front and rear bumpers.

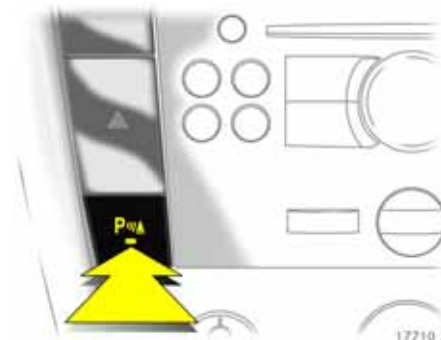

To activate

With the ignition switched on, the front and rear parking distance sensors are automatically activated when reverse gear is engaged.

The parking distance sensors can also be activated at speeds of less than 15 mph (25 km/h) by pressing the **P** button on the instrument panel.

An illuminated LED and an acoustic signal indicate that it is ready for operation.

If the vehicle approaches an obstacle to the front or rear, a series of signals is audible in the vehicle interior. The interval between the signals becomes shorter as the distance is reduced. If the distance is less than 30 cm, the signal will be continuous.

Warning

Under certain circumstances, various reflective surfaces on objects or clothing as well as external noise sources may cause the system to fail to detect obstacles. For this reason, care must be taken when reversing even if the parking distance sensors are operational. This is of particular importance when in the vicinity of pedestrians.

To deactivate

To deactivate the system, press button **P** again, the LED in the button will go dark.

The system switches itself off automatically when the forwards speed exceeds approx. 15 mph (25 km/h).



Control indicator **P**

Illuminates:

Fault in system. The system is not operational. Have cause of fault remedied by a workshop. The system's integrated self diagnostics allows faults to be quickly remedied.

Flashes:

The fault is due to sensors obstructed with snow or ice. The sensors must be undamaged and free of dirt, snow and ice.

Interference due to external sources of ultra sound (e.g. pneumatic drills, rotary machines). Once the source of interference is removed, the system will operate normally.

Caravan/trailer towing equipment ,

caravan/trailer towing

The system automatically detects if a towbar is properly fitted to the vehicle.

When towing, inserting the caravan/trailer plug in the socket automatically switches off the parking distance sensors for the rear.

Fitting rear load racks

Rear load racks, e.g. bicycle racks, fitted near the sensors could disrupt the system.



17712 J

Automatic level control *

Automatic level control makes it possible to keep the height of the vehicle constant when subjected to different loads in the rear (e.g. when towing a caravan/trailer). This significantly improves driving conditions.

The vehicle is automatically raised at the rear, increasing the spring travel and ground clearance.

The automatic level control system is activated after approx. 2 miles (3 km), depending on the vehicle loading and the nature of the road surface.

Head light range adjustment – see page 131.

Do not use full load in the event of faults. Have the cause of the fault rectified straight away by a workshop.

Tyre pressure monitoring system *

The tyre pressure monitoring system continuously monitors the pressure of all four tyres while the vehicle is being driven.

A pressure sensor is integrated in each wheel. Once each minute, the pressure of each tyre is sent to a control unit for comparison. If the system detects one or more pressure differences, control indicator (⚠) illuminates or flashes red. In vehicles with check control *, the exact pressure of the tyre in question appears on the information display.

In vehicles with Graphical Information Display * or Colour Information Display * and trip computer *, current tyre pressures can be shown in the information display.

For the system to be operational, all wheels must be equipped with pressure sensors and all tyres must be inflated to the prescribed pressure. The tyre pressure monitoring system automatically detects if the vehicle is being driven with a load of up to 3 persons or a full load.

Once the ignition is switched on, the system is operational and will continuously monitor the tyre pressures at speeds of approx. 20 mph (30 km/h) and above.

Warning

The tyre pressure monitoring system does not replace manual checks with a suitable gauge.

Check tyre pressures at least every 14 days and prior to any long journey; the tyres should be checked when cold. Don't forget to check the spare ❄️.

Tyre pressure – see pages 213, 299.

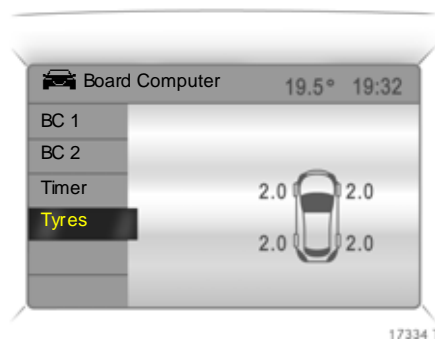

Display of current tyre pressure ❄️
Select menu item **Tyres** from the **Board Computer** menu.

The current pressure of each tyre is displayed.

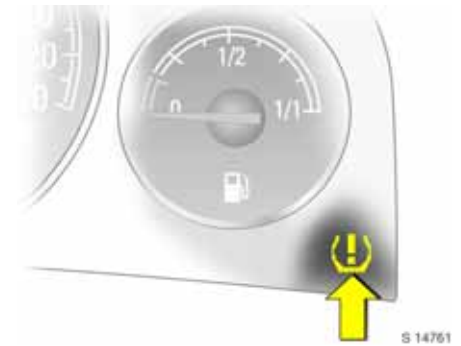

Control indicator  in red as warning message
Illumination in red whilst driving indicates deviating tyre pressure.

Indicator illuminates red:
Minor tyre pressure difference; slow down.
Check tyre pressure at next opportunity with a suitable gauge and correct if necessary.

Indicator flashes red:
Considerable pressure difference or direct loss of pressure. Stop immediately and check tyre and tyre pressure. Fit spare wheel if necessary - see pages 236, 238.

Warning messages in the Graphical Information Display * or Colour Information Display *

In the model variant with check control * differing tyre pressures whilst driving are indicated by messages on the information display. The message appears in abbreviated form depending on the model variant.

For example, the following messages can be displayed:



A graphic * indicating the left rear tyre is shown together with the current tyre pressure: Slight pressure deviation. Reduce speed. Check pressure at next opportunity with appropriate gauge and correct if necessary.

On the Colour Information Display this report will appear in yellow.



A diagram * appears at the same time, marking the front left tyre and showing the current tyre pressure: Considerable pressure difference or direct loss of pressure. Exit flow of traffic as soon as possible without obstructing other vehicles, stop and check tyre and tyre pressure. Fit spare wheel if necessary - see pages 236, 238.

On the Colour Information Display this report will appear in red.

Acknowledgement of warnings – see page 116.

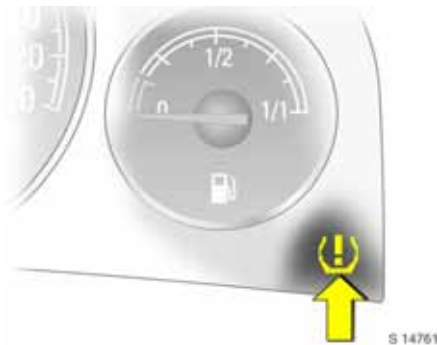

Control indicator (T) in yellow as fault message

If control indicator (T) illuminates yellow whilst driving, there is a fault in the tyre pressure monitoring system. Fitting a wheel without a pressure sensor (e.g. the spare wheel *) will also generate a fault in the system. Have the cause of the fault remedied by a workshop. The system's integrated self-diagnostics allows faults to be quickly remedied.

General information

The tyre pressure monitoring system is not ready for operation if the emergency/spare wheel is used and is not fitted with a pressure sensor; the control indicator (T) illuminates yellow. The tyre pressure monitoring system remains operational for the other three wheels.

If you use a complete set of wheels which are not fitted with sensors for the tyre pressure monitoring system, e.g. four winter tyres or aftermarket tyres of a different size, no fault message will be displayed. The tyre pressure monitoring system is not ready for operation.

Sensors for the tyre pressure monitoring system can be retro-fitted by a workshop upon request.

When manually checking tyre pressure with a pressure gauge, screw the adapter onto the valve. Tyre pressure – see page 213.

Every time a tyre is changed, the valve inserts and tyre pressure monitoring system sealing rings must be replaced by a workshop.

The use of commercially available liquid filled run-flat systems or repair kits can impair the function of the system. Vauxhall-approved systems can be used.

Radio transmitters (e.g. radio headphones, walkie-talkies) operated in the area could cause interference in the tyre pressure monitoring system.

Brake system

The effectiveness of the brakes is an important factor for traffic safety.

To improve effectiveness, do not brake unnecessarily hard for the first 125 miles (200 km) after new brake pads have been fitted.

Brake pad wear must not exceed a specified limit. Regular maintenance as detailed in the Service Booklet is therefore of the utmost importance for traffic safety.

Have worn brake pads replaced by a workshop.

Pads that have been tested and approved guarantee optimum brake performance.

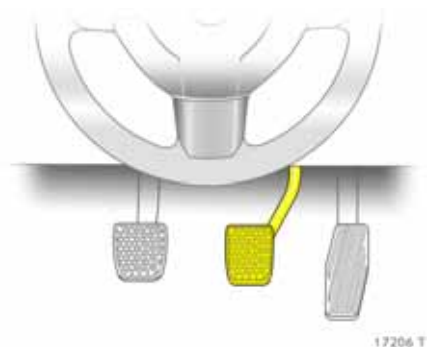

Brake assist

If the brake pedal is slammed on, the vehicle is automatically braked with maximum brake force amplification in order to achieve the shortest possible braking distance when full-on braking occurs (braking assist).

Maintain steady pressure on the brake pedal for as long as full-on braking is to continue. When the brake pedal is released, the maximum brake force amplification is taken away.

Adaptive brake light

During full-on braking, all three brake lights flash for the duration of ABS control.

Footbrake

The footbrake comprises two independent brake circuits.

If one brake circuit faults, the vehicle can still be braked with the other brake circuit. However the braking effect will occur at a lower pedal position and considerably more force is required. The braking distance is longer. Contact a workshop before continuing to drive.

To ensure that full pedal travel – can be utilised, particularly if there is a fault in one of the brake circuits, there must be no mats in the pedal area - see page 185.

When the engine is not running, the assistance of the brake servo unit disappears once the brake pedal has been depressed once or twice. Braking effect is not reduced, but braking requires significantly greater force. This is especially important to bear in mind when towing.

Check the brake lights before starting out on a journey. On vehicles with check control ✱ the brake lights are checked automatically – see page 124.

Shortly after starting each journey the effectiveness of the brake system should be tested at low speed and without inconveniencing other traffic, especially if the brakes are wet, e.g. after the vehicle has been washed.

The brake fluid level should be checked regularly. If the brake fluid level is too low and the handbrake is not applied, control indicator ① in the instrument cluster illuminates – see page 99.

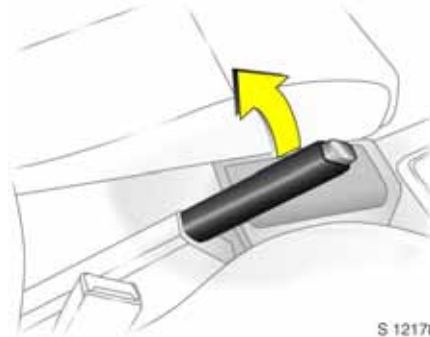

Handbrake

Always apply the handbrake firmly without actuating the release button; to do this fold up the armrest ✱. Apply as fully as possible on uphill or downhill inclines.

The mechanical handbrake acts on the brakes on the rear wheels. It engages automatically when applied.

To release the handbrake pull the lever up slightly, press the ratchet knob, and fully lower the lever.

To reduce the operating forces of the handbrake, depress the footbrake at the same time.



Brake system control indicator ①

The control indicator illuminates when the ignition is switched on if the handbrake is applied or if the brake or clutch fluid level is too low. Brake fluid – see page 276.

Warning

If the control indicator illuminates when the handbrake is released, stop driving immediately. Contact a workshop.

Anti-lock Brake System (ABS)

ABS continually monitors the brake system and prevents the wheels from locking regardless of the type of road surface or tyre grip.

It starts to regulate the braking pressure as soon as a wheel shows a tendency to lock. The vehicle remains steerable, even in the event of very heavy braking, for instance on bends or when swerving to avoid an obstacle. Even in the case of full-on braking, the ABS makes it possible to drive round an obstacle without releasing the brakes.

ABS control is made apparent through a pulse in the brake pedal and the noise of the regulation process.

Warning

For optimum braking, keep the brake pedal fully depressed throughout the braking process, despite the fact that the pedal is pulsating. Do not reduce the pressure on the pedal.

Do not let this special safety feature tempt you into taking risks when driving.

Traffic safety can only be achieved by adopting a responsible driving style.



Control indicator for ABS

It illuminates for a few seconds after the ignition is turned on. The system is ready for operation when the control indicator extinguishes.

If the control indicator does not go out after a few seconds, or if it illuminates whilst driving, there is a fault in the ABS. The brake system remains operational without ABS regulation.

Self-check

Each time the ignition is turned on and the engine started, after moving away from a speed of around 2 mph (3 km/h) the system performs a self-check which may be audible.

Fault

Warning

If there is a fault in ABS, the wheels may be subject to locking due to braking that is heavier than normal. The advantages of ABS are no longer operational.

You can continue driving, provided you drive with care and anticipation.

Have the cause of the fault eliminated by a workshop. The self-diagnosis integrated into the system allows rapid fault identification.

Wheels, tyres

See page 297 for suitable tyres and restrictions.

Tyres fitted in the factory are adapted to the chassis and provide optimum driving comfort and safety.

Changing tyre/wheel type

Before changing to other tyres or wheels, note the necessary changes.

If tyres of a different size than those fitted at the factory are used, the electronic speedometer may require reprogramming to ensure that the correct speed is displayed.

Warning

Use of unsuitable tyres or wheels may lead to accidents and render the vehicle unroadworthy.

Vehicles with tyre pressure monitoring system *

If you have winter tyres or aftermarket tyres of a different size fitted, sensors for the tyre pressure monitoring system can be retro-fitted by a workshop upon request. Otherwise the system will not display tyre pressure deviations.

Tyre pressure monitoring system * – see page 204.

Fitting new tyres

Fit tyres in pairs or in sets, which is even better. Ensure that tyres on one axle are:

- the same size,
- the same design,
- the same make,
- and have the same tread pattern.

Fit directional tyres such that they roll in the direction of travel. The rolling direction is indicated by a symbol (e.g. an arrow) on the sidewall.

Tyres fitted opposing the rolling direction (e.g. when a tyre is changed) should be refitted as soon as possible. This is the only way to obtain full benefit from the design properties of the tyre.

Some brands of tyres have a beaded edge for alloy wheels to protect against damage. If wheel trim is used on steel wheels with beaded-edge tyres, the following procedure must be followed:

- Use wheel trims and tyres that are approved by Vauxhall for the vehicle in question and therefore meet all the requirements pertaining to the respective wheel/tyre combination.
- If the wheel trims and tyres used are not Vauxhall-approved, the tyres must not have a beaded edge.

Warning

Use of unsuitable tyres or wheel trims could lead to sudden loss of air and thereby accidents.

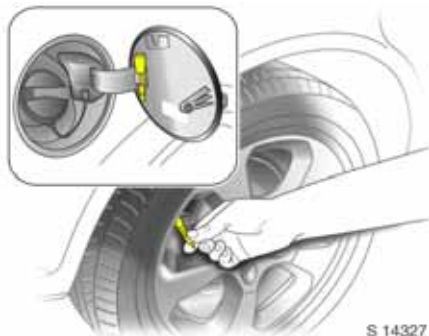

S 14327

Tyre pressure

Check tyre pressures, including the spare wheel, at least every 14 days and prior to any long journey; the tyres should be checked when cold. Don't forget to check the spare.

Use the valve cap key to make unscrewing the valve caps easier. The key is located on the inside of the tank flap.

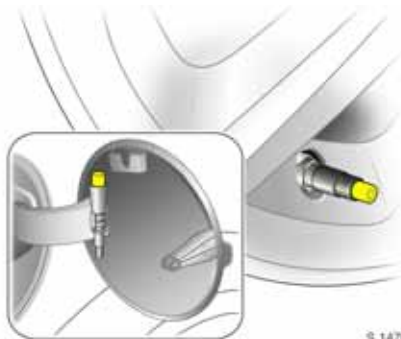

S 14763

In vehicles with tyre pressure monitoring system * there is an adapter in the valve cap key. Screw adapter to valve before attaching tyre pressure gauge - see page 204.

Tyre pressure - see page 299.

Do not reduce tyre pressure when the tyres are warm. Otherwise the pressure may drop below the permissible minimum when the tyres cool down.

After having checked the tyre pressures, tighten the valve caps using the valve cap key.



17213 T

Incorrect tyre pressures will impair safety, vehicle handling, comfort and fuel economy and will increase tyre wear.

If the pressure is too low, this can result in considerable tyre warm-up and internal damage, leading to tread separation and even to tyre blow-out at high speeds.

Hidden tyre damage is not eliminated by adjusting the tyre pressure.

Warning

Incorrect tyre pressure could lead to a flat tyre.

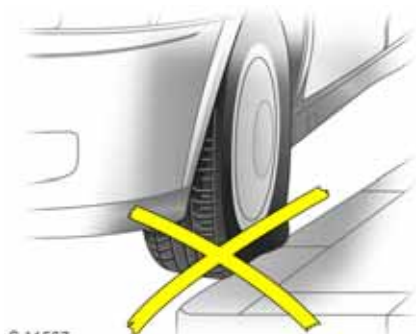

S 11567

Tyre condition, wheel condition

Drive over edges slowly and at a right angle if possible. Driving over sharp edges can lead to hidden tyre damage and wheel damage which is only noticed later on.

When parking, ensure that the tyres are not pressed against the edge of the kerb.

Check tyres regularly for damage (penetrated foreign bodies, punctures, cuts, cracks, bulges in side walls). Check wheels for damage. If damage or unusual wear is found, contact a workshop.

Warning

Damage may lead to tyre blow-out.

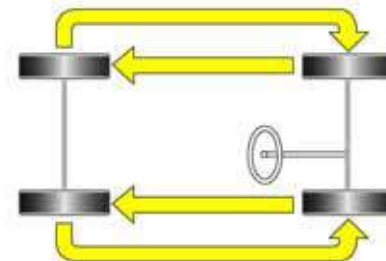

S 11568

Tread depth

Check tread depth regularly.

If wear in the front is greater than that in the rear, move the rear wheels to the front axle and vice versa.

Correct tyre pressure.

For reasons of safety, tyres should be replaced when their tread depth has worn down to 2 to 3 mm (winter tyres: 4 mm).



The legally permissible minimum tread depth (1.6 mm) has been reached when the tread has worn down as far as one of the wear indicators (TWI¹⁾). A number of wear indicators are spaced at equal intervals around the tyre within the tread. Their position is indicated by markings on the tyre sidewall.

General information

- The danger of aquaplaning is greater if the tyres are worn.
- Tyres age, even if they are used only very little or not at all. A spare wheel which has not been used for six years should be used with care.
- Never fit used tyres the previous history and use of which you do not know.
- So as not to impair brake cooling, use only wheel trims approved for use on your vehicle.

Tyre designations

Meaning:

e.g. **195/65 R 15 91 H**

- 195** = Tyre width in mm
- 65** = Cross-section ratio (tyre height to width) in %
- R** = Belt type: Radial
- 15** = Wheel diameter in inch
- 91** = Load index e.g. 91 corresponds to 618 kg
- H** = Speed code letter

Speed code letters:

- Q** up to 100 mph (160 km/h)
- S** up to 112 mph (180 km/h)
- T** up to 118 mph (190 km/h)
- H** up to 130 mph (210 km/h)
- V** up to 150 mph (240 km/h)
- W** up to 168 mph (270 km/h)

¹⁾ **TWI** = Tread Wear Indicator.

Winter tyres ❄

For notes on fitting new tyres – see page 212.

See page 299 for restrictions.

Winter tyres improve safety at temperatures below 7 °C and should therefore be fitted on all the wheels.

The design of summer tyres means they have limited qualities for winter driving.

If the maximum permissible speed for the winter tyres is less than that of the vehicle, a notice indicating the maximum permissible speed for the tyres must be affixed within the driver's field of vision¹⁾.

If you use the spare wheel when it is fitted with a summer tyre, the vehicle's driveability may be affected, especially on slippery road surfaces. Obtain a replacement for the faulty tyre as soon as possible, and have the wheel balanced and fitted to the vehicle.

Wheel trims ❄

If the wheel trims and tyres used are not Vauxhall-approved, make sure that the tyres do not have a beaded edge - see page 212.

¹⁾ Varies from country to country on account of national regulations.

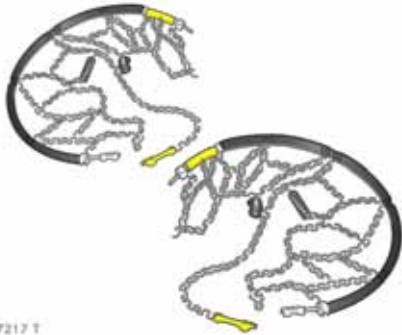

17217 T

Tyre chains ❄️

Restrictions and further information – see page 299.

Tyre chains are only permitted on the drive wheels (front axle). They must be fitted to the tyres symmetrically in order to achieve a concentric fit.

Always use fine mesh chains that add no more than 10 mm to the tyre tread and the inboard sides (including chain lock).

Wheel trim on steel wheels could come into contact with parts of the chain and be damaged. Remove the wheel trim – see page 239.

Tyre chains may only be used at speeds up to 30 mph (50 km/h)¹⁾ and, when travelling on roads that are free of snow, they may be used for brief periods only since they are subject to rapid wear on a hard road and may snap.

Temporary wheel ❄️

Tyre chains must not be used on the temporary spare wheel. If you need to use tyre chains after suffering a flat front tyre, fit the temporary spare on the rear axle and transfer one of the rear wheels to the front axle.

For notes on the temporary spare wheel – see page 237.

Wheel changing – see page 238.

Correct tyre pressure.

Tyre pressure monitoring system ❄️ – see page 204.

¹⁾ Varies from country to country on account of national regulations.

Roof racks *

Warning

Disregard of these notes can lead to injuries which may be fatal. Vehicle passengers must be informed accordingly.

For safety reasons and to avoid roof damage, we recommend using the Vauxhall roof rack system approved for your vehicle.

Fasten the roof rack following the instructions that accompany the system.

Driving hints – see page 184.

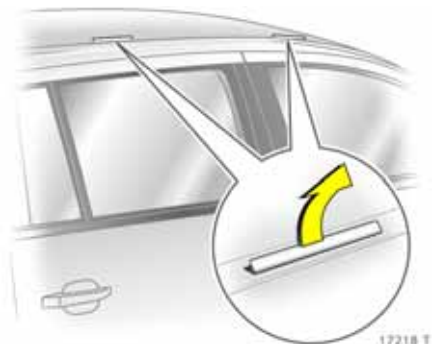

Version without roof railing

Fold covers of installation openings upwards.

Attach roof rack at appropriate points - see enclosed roof luggage rack system instructions.

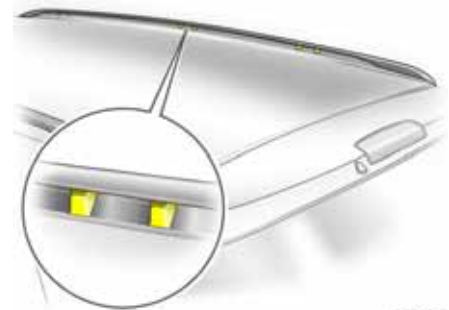

Version with roof railing *

Attach roof rack to roof railing at points shown in illustration - see enclosed roof luggage rack system instructions.

Towing equipment ***⚠ Warning**

Disregard of these notes can lead to injuries which may be fatal. Vehicle passengers must be informed accordingly.

Only use a caravan/trailer towing device approved for the vehicle. Have a towing device fitted by workshop, who will inform you of any possible caravan/trailer load increases. They will have the instructions for fitting the device and any necessary changes to the vehicle concerning cooling, heat shields or other devices.

⚠ Warning

The coupling ball bar is to be removed when not towing.

For installation dimensions of the caravan/trailer towing equipment – see pages 311, 312.



17729 J

Towing equipment with removable coupling ball bar *, Saloon / Hatch ***Storage of coupling ball bar**

The coupling ball bar is stored in a bag strapped to the spare wheel.



17717 J

Fitting the coupling ball bar

Compress the sealing plugs at the ends and pull out of the opening for the coupling ball bar. Stow the sealing plugs in the luggage compartment. Disengage socket and fold down *.





Checking the tensioning of the coupling ball bar:

- Red marking on turn knob points towards green marking on coupling ball bar.
- Gap of approx. 6 millimetres between rotary knob and coupling ball bar.
- Key is in lock.

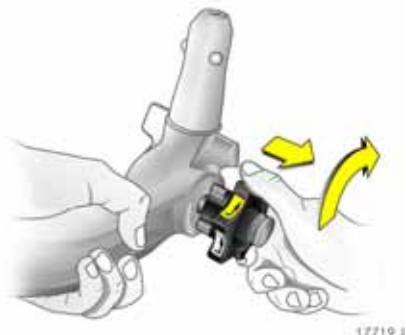

Otherwise, the coupling ball bar must be tensioned before it is inserted into the coupling housing:

- Open coupling ball bar,
- Pull turn knob out and then turn it clockwise as far as it will go – see illustration.

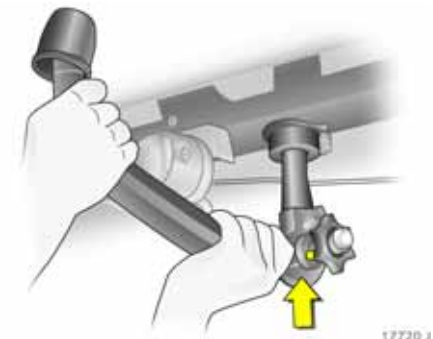

Inserting the coupling ball bar

Insert the tensioned coupling ball bar in the coupling housing and push firmly upwards until you hear the coupling ball bar engaging.

The turn knob snaps back into its home position resting against the coupling ball bar.

⚠Warning

Do not touch the turn knob when inserting the coupling ball bar – risk of injury.

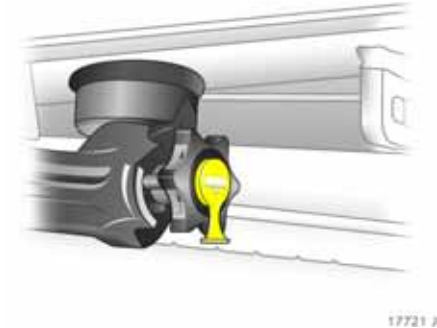

Open coupling ball bar. Remove key and put on provided protective clip.

When the coupling ball bar is locked the turn knob can no longer be pulled out.

Important

Check that the coupling ball bar is correctly installed:

- Red marking on turn knob points towards white marking on coupling ball bar.
- No gap between turn knob and coupling ball bar.
- Coupling ball bar must be seated firmly in coupling housing.
- Coupling ball bar must be locked and key must be removed.

⚠ Warning

Towing is permitted only with a correctly fitted towbar. If the towbar cannot be fitted correctly, contact a workshop.

Eye for break-away stopping cable

In the case of caravans/trailers with brake, attach the break-away stopping cable to the eye. Eye - see Fig. 17721 J.

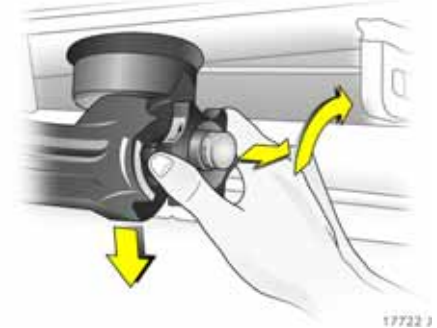

Dismounting the coupling ball bar

Close coupling ball bar.

Pull the turn knob out and then turn it clockwise as far as it will go. Pull the coupling ball bar downwards out of the coupling housing and stow it in the luggage compartment – see page 219, Fig. 17729 J.

Insert the sealing plug in the hole for the coupling ball bar. Fold away the socket – see page 219, Fig. 17717 J.

Do not use steam-jet cleaners or other high-pressure cleaners to clean the coupling ball bar.



Towing equipment with pivoting coupling ball bar ✳

Folding out the coupling ball bar

The release lever is in the stowage compartment to the left in the luggage compartment.

To open the stowage compartment, push both latches down and open the cover.

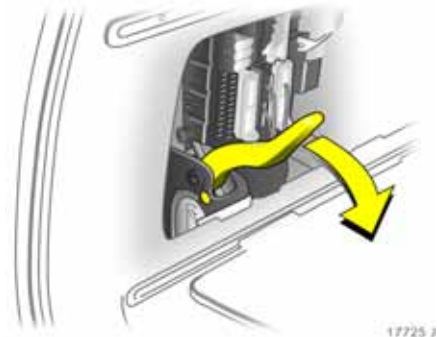

Push the release lever down; the LED on the lever is illuminated while the coupling ball bar is not engaged. A warning buzzer also sounds and the coupling ball bar pivots down.

Warning

Make sure that no one is in the pivot zone of the coupling ball bar. Risk of bodily injury.

Swivel the coupling ball bar backwards until it engages (see Fig. 17726 J). The LED must go out and the warning buzzer must cease. Otherwise, repeat the procedure.



Important

Check that the coupling ball bar is correctly engaged:

- LED is not illuminated.
- No warning buzzer.

Warning

Caravan/trailer towing is permissible only when the coupling ball bar is engaged correctly. If the coupling ball bar cannot be engaged correctly, the LED does not go out or the warning buzzer does not go off. Seek the assistance of a workshop.

Caravan/trailer with break-away cable *

For caravans/trailers with brakes, loop break-away cable around coupling ball bar.



Stowing the coupling ball bar

Open the stowage compartment – see page 222.

Push the release lever down; the LED on the lever remains illuminated as long as the coupling ball bar is not engaged.

A warning buzzer also sounds and the coupling ball bar pivots down.

Pivot the coupling ball bar to the right and up. The LED must go out and the warning buzzer must cease, otherwise repeat the procedure.

Caravan/trailer towing

Caravan and trailer loads¹⁾

The permissible caravan/trailer loads are vehicle-dependent and engine-dependent maximum values which must not be exceeded. The actual caravan/trailer load is the difference between the actual gross weight of the caravan/trailer and the actual coupling socket load with the caravan/trailer attached. When the caravan/trailer load is being checked, therefore, only the caravan/trailer wheels – and not the jockey wheel – must be standing on the weighing apparatus.

The permissible caravan/trailer loads for your vehicle are given in the vehicle documents. Unless otherwise stated, they are valid for gradients up to max. 12%.

¹⁾ Observe national regulations.

The permissible caravan/trailer load should be fully utilised only by drivers who are adequately experienced in towing large or heavy caravans/trailers.

The permitted caravan/trailer load applies up to the specified incline and up to an altitude of 1000 metres above sea-level. Since engine power decreases as altitude increases because of the air becoming thinner, therefore reducing climbing ability, the permitted towing weight also decreases by 10% for every 1000 metres of additional altitude. The towing weight does not have to be reduced when driving on roads with slight inclines (less than 8%, e.g. motorways).

The actual caravan/trailer load plus the actual gross weight of the towing vehicle must not exceed the maximum permitted towing weight. For example, if the permitted Gross Vehicle Weight is utilised, the caravan/trailer load must only be used until the maximum permitted towing weight is reached. The maximum permitted towing weight is shown on the identification plate - see page 282.

Coupling socket load

The coupling socket load is the load exerted by the caravan/trailer on the coupling ball. It can be varied by changing the weight distribution when loading the caravan/trailer.

The maximum permissible coupling socket load (Saloon / Hatch: 78 kg, Estate: 85 kg) is specified on the towing equipment identification plate and in the vehicle documents. Always aim for the maximum load, especially in the case of heavy caravans/trailers. The coupling socket load should never fall below 25 kg.

When measuring the coupling socket load, make sure that the drawbar of the loaded caravan/trailer is at the same height as it will be when the caravan/trailer is coupled with the towing vehicle loaded. Particularly important for caravans/trailers with tandem axle.

Rear axle load during towing

When the caravan/trailer is coupled up and the towing vehicle is fully loaded, including all occupants, the permissible rear axle load (for information - see the identification plate or vehicle documentation) may be exceeded by 50 kg. The Gross Vehicle Weight rating must not be exceeded in the process.

On the increased payload version *, the permissible rear axle load may be exceeded by 65 kg.

If the permissible rear axle load is exceeded, a maximum speed of 60 mph (100 km/h) must be applied. If lower national speed limits are prescribed for vehicles towing caravans/trailers, these must be observed.

**Tyre pressure**

Adjust the tyre pressure on the towing vehicle to the value specified for a full load - see page 299. Also check the pressure of the caravan/trailer wheels and the spare wheel.

Trailer Stability Assist * (TSA)

TSA monitors vehicle movements when towing a caravan/trailer. If the system detects lurching movements, engine power is reduced while the vehicle and caravan/trailer combination is selectively braked until the lurching ceases.

TSA is a function of the Electronic Stability Programme (ESP^{Plus}) - see page 196.

Driving characteristics, towing tips

For caravans/trailers with brakes, attach break-away cable to eye * or loop around coupling ball bar if no eye available.

Before attaching the caravan/trailer, lubricate the ball of the caravan/trailer towing device. However, do not lubricate the ball if a stabiliser, which acts on the coupling ball, is being used to damp snaking.

Check caravan/trailer lighting before starting to drive. The fog tail light on the vehicle is deactivated when towing a caravan/trailer.

Caravan/trailers with LED turn signals must have a provision that makes it possible to monitor standard light bulbs.

Turn signal control indicator – see page 98.

The parking distance sensors at the rear * are deactivated when towing a caravan/trailer.

Handling is greatly influenced by the loading of the caravan/trailer. Loads should therefore be secured so that they cannot slip and be placed in the centre of the caravan/trailer if possible, i.e. above the axle.

In the case of trailers with low driving stability or caravans with a permitted Gross Vehicle Weight of 1400 kg (Saloon / Hatch)/1500 kg (Estate), do not exceed a speed of 50 mph (80 km/h); the use of a friction-type stabiliser is highly recommended.

Do not drive faster than 50 mph (80 km/h) if possible, even in countries where higher speeds are permitted.

Make sure that you have enough room when cornering and avoid sudden manoeuvres.

If the caravan/trailer starts to sway, drive more slowly, do not attempt to correct the steering and brake sharply if necessary.

If it is necessary to apply the brakes fully, depress the brake pedal as hard as possible.

Remember that the braking distance for vehicles towing caravans/trailers with and without brake is always greater than that for vehicles not towing a caravan/trailer.

When driving downhill, the brakes are under considerably more load when towing a caravan/trailer. For this reason, drive in the same gear as if driving uphill and drive at a similar speed.

Automatic transmission * or Easytronic * in Automatic mode will automatically select the driving programme with the optimum engine braking effect.

If necessary, the gears can also be selected manually.

The cooling fan is electrically operated. Its cooling power is therefore independent of the engine speed.

Since a considerable amount of heat is generated at high engine speeds and less at slower speeds, do not shift down when climbing hills whilst the vehicle is still coping with the gradient in the higher gear.

Diesel engines: On rising gradients of 10% or more, do not drive faster than 20 mph (30 km/h) in 1st gear or 30 mph (50 km/h) in 2nd gear; with automatic transmission ✱, do not exceed 25 mph (40 km/h) in position 1.



17730 J



Starting on inclines

For vehicles with manual transmission, the most favourable engine speed when starting-off on an incline is between 2500 and 3000 rpm for petrol engines and between 2000 and 2200 rpm for diesel engines. Hold engine speed constant, engage clutch gradually (let slip), release handbrake and open throttle. If possible, the engine speed should not drop during this procedure.

For vehicles with a automatic transmission ✱ or Easytronic ✱ in Automatic mode it is sufficient to apply full throttle.

Before starting-off under extreme conditions (high combination weight, mountainous terrain with steep inclines), switch off all unnecessary electrical loads (e.g. heated rear window, air conditioning system ✱, heated seats ✱).

Self-help, vehicle care

Diesel fuel system, bleeding	228
Bonnet	228
Starting	229
Towing	232
Warning triangle  *, first-aid kit  *	234
Spare wheel *	236
Jack  * and vehicle tools *	238
Changing wheels	238
Tyre repair kit *	242
Electrical system	246
Fuses and the most important circuits they protect	248
Bulb replacement	252
Halogen headlight system, dipped and main beam	253
Xenon headlight system, dipped and main beam	255
Adaptive Forward Lighting (AFL) system *	257
Halogen headlight system, Xenon headlight system, parking lights	257
Tail lights	258
Number plate light	261
Courtesy light	262
Vehicle care	264

Warning

Disregard of these notes can lead to injuries which may be fatal. Vehicle passengers must be informed accordingly.

Diesel fuel system, bleeding

Never let the tank run dry. If control indicator  illuminates, refuel as soon as possible. Refuel immediately if it flashes.

Restarting after running out of fuel is possible, but starting behaviour will be delayed. Turn on the ignition three times for 15 seconds each time. Then start the engine for a maximum of 40 seconds. If it does not start, repeat the process after waiting at least 5 seconds. If the engine still does not start, contact a workshop.

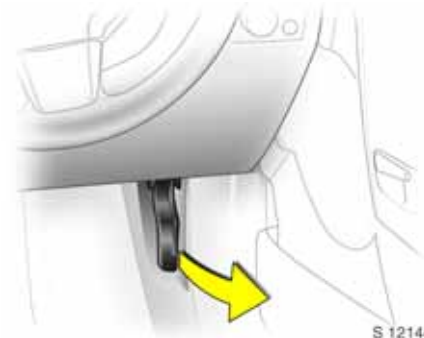

S 12144

Bonnet

To open the bonnet, pull the release lever located on the driver's side below the instrument panel. The bonnet will then be unlocked and will partially open. Return release lever to its original position.

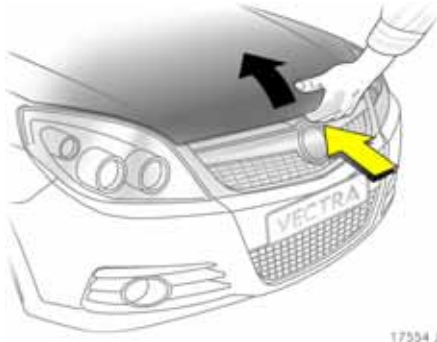

There is a safety catch on the underside of the bonnet: lift this upwards and open the bonnet.

Dirt or snow on the bonnet may drop onto the windscreen when the bonnet is opened and block the air intake.

Air intake – see page 166.

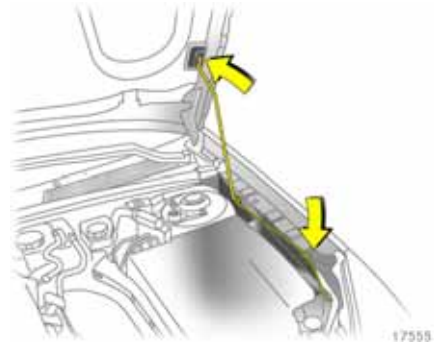

To hold the bonnet open, insert the support located at the side in the small slot on the underside of the bonnet.

Before closing, fasten the support in its retainer. Lower the bonnet and allow it to fall into its catch.

Check that the bonnet is locked in position by pulling at its front edge. If it is not engaged, repeat the procedure.

Starting

Do not start with quick charger

This prevents damage to electronic components.

Do not start by pushing or towing

Because your vehicle is fitted with a catalytic converter, it must not be started by pushing or towing – see page 190.

The vehicle can only be started using jump leads – see following page.

Starting the engine with jump leads *

A vehicle with a discharged battery can be started using jump leads and the battery of another vehicle.

Attempts to start the vehicle should be made at intervals of one minute and should not last longer than 15 seconds

⚠ Warning

Be extremely careful when starting with jump leads. Any deviation from the following instructions can lead to injuries or damage caused by battery explosion or damage to the electrical systems of both vehicles.

- Never expose the battery to naked flames or sparks.
- A discharged battery can freeze at temperatures of around 0 °C. Always thaw out a frozen batteries in a warm room before attaching jump leads.
- Do not allow battery fluid to come into contact with eyes, skin, fabrics or painted surfaces. The fluid contains sulphuric acid which can cause injuries and damage in the event of direct contact.

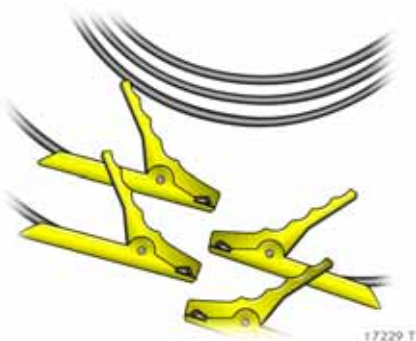

- Wear eye protection and protective clothing when handling a battery.
- Use auxiliary battery with same voltage (12 volts). Its capacity (Ah) must not be considerably less than that of the discharged battery. Voltage and capacity information can be found on the batteries.
- Use jump leads with insulated terminals and a cross section of at least 16 mm² (25 mm² for diesel engines).
- Do not disconnect the discharged battery from the vehicle.



- Switch off all unnecessary electrical consumers.
- Do not lean over the battery during jump starting.
- Do not allow the terminals of one lead to touch those of the other lead.
- Do not allow the vehicles to touch while jump starting.
- Apply handbrake. Manual transmission or Easytronic * in neutral, automatic transmission * in P.

The battery is in a box at the front of the engine compartment, on the right-hand side as viewed from the front. To open the box, pull the cover forwards and swing it upwards.

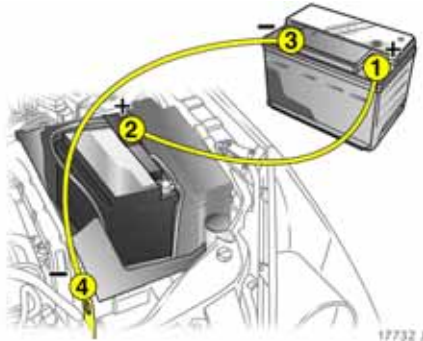

Connect the leads in the order shown in the illustration:

1. Connect one end of the first jump lead to the positive terminal 1 of the battery providing the jump start (identified by "+" sign on battery case or terminal).
2. Connect the other end of this lead to the positive terminal 2 of the discharged battery ("+" sign).
3. Connect the first end of the other jump lead to the negative terminal 3 of the battery providing the start ("- " sign).
4. Connect the other end of the second jump lead 4 to ground on the other vehicle, e.g. engine block or screw connection in the engine suspension.

- Do not connect leads to negative terminal of discharged battery.
- The connection point should be as far away from the discharged battery as possible.
- Route the leads so that they cannot catch on rotating parts in the engine compartment.

- Start the engine of the vehicle providing the jump start.
- After 5 minutes, start the other engine. Start attempts should be made at intervals of 1 minute and should not last longer than 15 seconds.
- After starting, allow both engines to idle for approx. 3 minutes with the leads connected.
- In order to avoid excess voltage in the electrical system, before removing a lead, switch on an electrical consumer (e.g. light, heated rear window) in the vehicle receiving the jump start.
- Reverse above sequence exactly when removing leads.

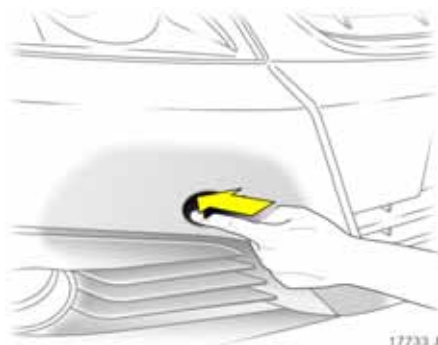

Towing

Towing your own vehicle

To open the cover concealing the towing eye socket at the front right of the vehicle: disengage the cover at the bottom and pull it off downwards.

The front towing eye is located in the compartment containing the jack and vehicle tools underneath the spare wheel in the luggage compartment. Jack and vehicle tools – see page 238.

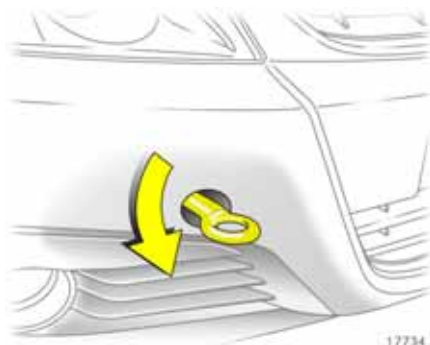

Screw in the front towing eye anticlockwise as far as it will go until it stops in a horizontal position.

Attach a tow rope * – or better still a tow rod * – to the eye.

The front towing eye may be used only for towing the vehicle, not for rescuing it.

Switch on ignition to release steering column lock and to permit operation of brake lights, horn and windscreen wiper.

Manual transmission or Easytronic * in neutral, automatic transmission * in **N**.

Drive slowly. Do not drive jerkily. Excessive tractive force can damage the vehicle.

Warning

For braking and steering, significantly higher forces are required: brake assistance and steering assistance are effective only with the engine running.

To prevent the entry of exhaust fumes from the towing vehicle, switch on the air recirculation * and close the windows.

Vehicles with automatic transmission * should be towed facing forwards only and must not be towed faster than 50 mph (80 km/h) or further than 60 miles (100 km). If the transmission is defective, or if the above speed or distance is to be exceeded, the front axle must be raised off the ground.

Contact a workshop.

If the automatic clutch is released manually after a power failure on vehicles with Easytronic *, towing is not permitted - see page 175. In this case, contact a workshop immediately.

After towing, unscrew front towing eye by rotating clockwise and insert and close the cap.

Towing service

Entrust your vehicle only to the towing service of your choice and obtain an estimate on towing costs before employing any towing service. In this way you avoid unnecessary costs and possible insurance problems during claim processing.



Towing another vehicle

To open the cover concealing the towing eye socket at the rear right of the vehicle: disengage the cover at the bottom and pull it off downwards.

The rear towing eye is located in the compartment containing the jack and vehicle tools underneath the spare wheel in the luggage compartment. Jack and vehicle tools - see page 238.

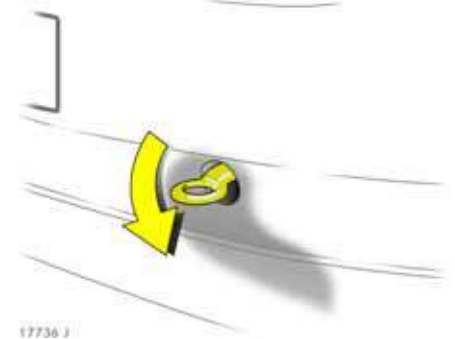

Screw in the rear towing eye anticlockwise as far as it will go until it stops in a horizontal position.

Attach a tow rope * - or better still a tow rod * - to the eye.

The rear towing eye may be used only for towing the vehicle, not for rescuing it.

Drive slowly. Do not drive jerkily. Excessive tractive force can damage the vehicle.

After towing, unscrew rear towing eye by rotating clockwise and insert and close the cap.

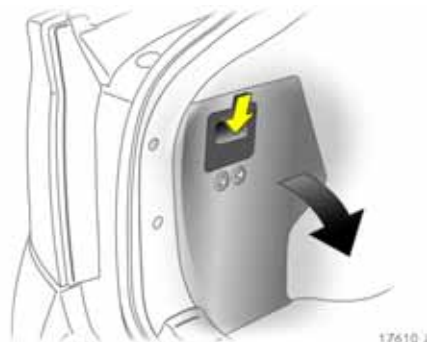

**Warning triangle ▲ ❄️,
first-aid kit ☹️ ❄️**

Saloon / Hatch

The warning triangle and first-aid kit/
cushion are stowed in the side panel trim
on the left-hand side.

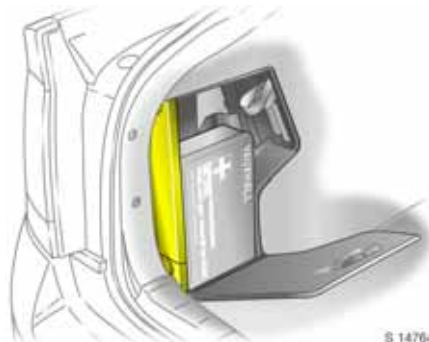

To access press down bar and open the
cover.

Depending on the warning triangle version,
move locking lever upwards and therefore
clamp warning triangle in position.



When loading vehicle, always ensure that
first-aid cushion or first-aid kit is a ccessible.

**Estate**

The warning triangle and first-aid kit/cushion are stowed in the side panel trim on the left-hand side.

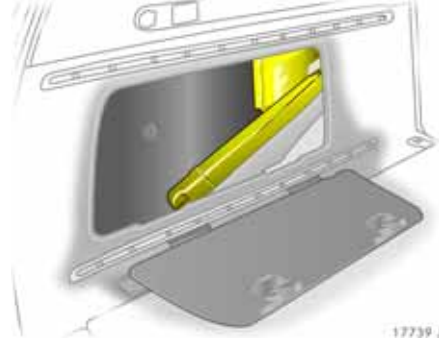

To open, push both bars down and open the flap.

When loading vehicle, always ensure that warning triangle and first-aid cushion or first-aid kit are accessible.

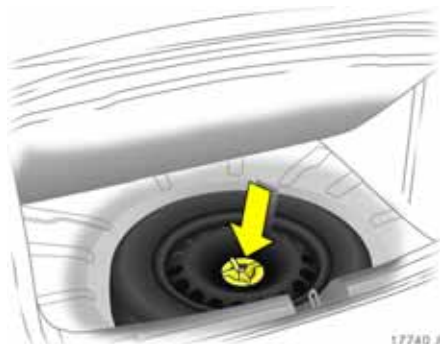

Spare wheel *

Some vehicles are equipped with a tyre repair kit instead of a spare wheel. See page 242.

Saloon / Hatch

The spare wheel is located in the luggage compartment under the floor cover. It is secured with a plastic wing nut.

To open the floor cover, pull up the handle or strap.

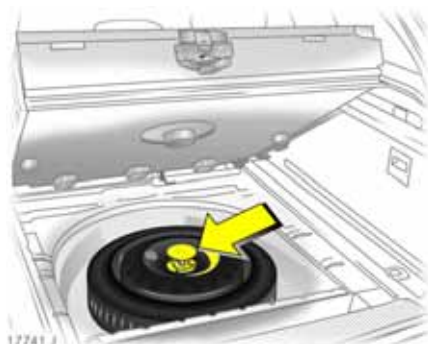

Estate

The spare wheel is located in the luggage compartment under the load floor. It is secured with a plastic wing nut.

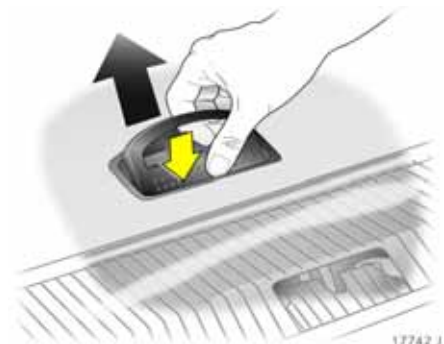

To open the loading floor, fold out release lever by pushing at the marked point and raise up the loading floor all the way.

Stowing standard size tyres in the spare wheel well

The spare wheel well is not designed for all sizes of permissible tyres. If a larger wheel must be stowed in the spare wheel well after changing wheels, place the floor cover on the protruding wheel.

General information

Depending on the model variant, the spare wheel is in the form of an temporary spare wheel ✱. Please pay attention to instructions concerning temporary spare wheel in the next column and on pages 217, 242, 299.

On vehicles with alloy wheels ✱ the spare wheel may have a steel rim.

If you use winter tyres ✱, the spare wheel may still be fitted with a summer tyre. If you use the spare wheel the vehicle's handling may be altered. Obtain a replacement for the faulty tyre as soon as possible, and have the wheel balanced and fitted to the vehicle.

The spare wheel may have a smaller tyre and a smaller rim than the wheels mounted on the vehicle¹⁾: Using the spare wheel may alter vehicle handling. Have the defective tyre replaced as soon as possible, balance the wheel and have it mounted on the vehicle.

Notes on temporary spare wheel ✱

- Using a temporary spare wheel may change the driving behaviour of the vehicle, particularly if using winter tyres ✱. Replace defective tyre as quickly as possible, balance wheel and fit to vehicle.
- Fit only one temporary spare wheel.
- Do not drive faster than 50 mph (80 km/h).
- Take curves slowly.
- Do not use the temporary spare wheel for a lengthy period.
- Replace temporary spare wheel with full specification wheel without delay.
- Tyre chains are not permitted on the temporary spare wheel. If tyre chains have to be used after a front wheel puncture, fit temporary spare wheel to the rear axle and fit a rear wheel to the front axle. Check tyre pressure and correct if necessary - see page 299.
- Please follow instructions concerning temporary spare wheel on pages 217 and 299.

Notes on directional tyres ✱

Directional tyres only achieve their full performance potential when mounted in the prescribed direction of rotation. If after a flat tyre the tyre or spare wheel is mounted against the prescribed direction of rotation, observe the following:

- Driving conditions may be altered. Replace the defective tyre as soon as possible, balance the wheel and mount it on the vehicle.
- Do not drive faster than 50 mph (80 km/h).
- Drive especially carefully in wet or snowy weather.

For further information on directional tyres – see page 211.

¹⁾ Country-specific version: The spare wheel is only to be used as a temporary spare wheel.

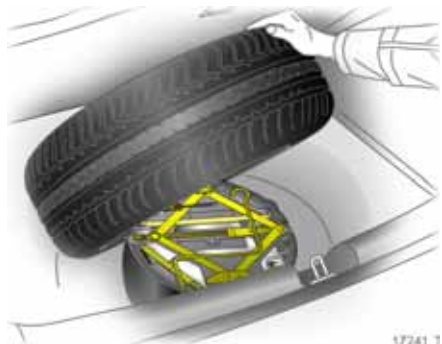

Jack and vehicle tools

The jack and the vehicle tools have been specially developed for your vehicle and must only be used on that vehicle. Only use jack for changing wheels.

Vehicles with tyre repair kit

The vehicle tools are stored in the luggage compartment together with the tyre repair kit in a compartment beneath the floor cover.

Vehicles with spare wheel

The jack and vehicle tools are located in a compartment in the luggage compartment, beneath the spare wheel. To remove the spare wheel - see page 236.

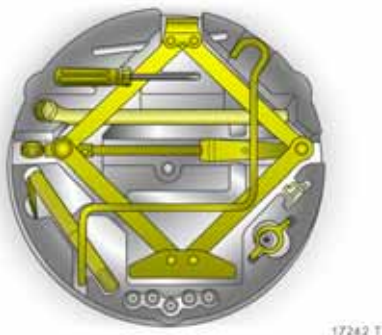



After use, stow away the jack and tools in the compartment as shown in illustration.

Changing wheels

There may be a tyre repair kit instead of a spare wheel – see page 242.

To ensure your safety, make the following preparations and observe the following information when changing wheels:

- Park the vehicle on a level, firm and non-skid surface.
- Switch on hazard warning lights, apply hand brake, automatic transmission  - selector lever in **P**, manual transmission or Easytronic  - engage 1st or reverse gear.
- Correctly set up the warning triangle. Warning triangle – see page 234.

- Remove spare wheel from luggage compartment - see page 236.
- Before raising the vehicle, set the front wheels to the straight-ahead position.
- Slacken the wheel bolts one half turn before raising the vehicle, but do not totally unscrew the bolts.
- Never change more than one wheel at once.
- Block the wheel diagonally opposite the wheel to be changed by placing wedge blocks or equivalent in front and behind the wheel.
- Use the jack only to change wheels.

- If the ground on which the vehicle is standing is soft, a solid board (max. 1 cm thick) should be placed under the jack ✱. Using a thicker board could damage the jack ✱ and the vehicle.
- No people or animals may be in the vehicle when it is jacked-up.
- Never crawl under a jacked-up vehicle.
- Do not start or run the engine while the vehicle is on the jack.
- Before inserting the wheel bolts when changing wheels, lightly grease the cone of each bolt. For this reason, carry some conventional grease.



1. Prise off the wheel trim using the hook included with the vehicle tools ✱. For vehicle tools - see page 238.

If the wheel trim has visible wheel bolts ✱, the trim can remain on the wheel. The retaining washers ✱ on the wheel bolts must not be removed.



Alloy wheels ✱: Disengage the wheel bolt caps with a screwdriver and remove. Protect the wheel by inserting a soft cloth between the screwdriver and alloy wheel.



2. Turn wheel bolts half a turn using the wheel bolt wrench ✱, pushing the wrench ✱ on as far as possible.

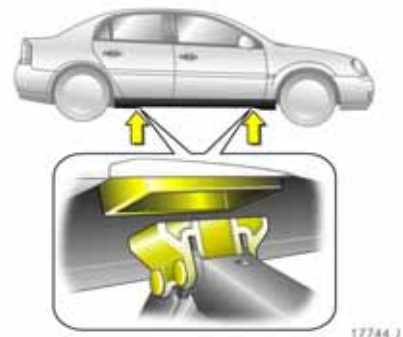

3. There are plastic retainers at the front and rear of the vehicle underbody for positioning the jack. The location of each retainer is indicated by a mark on the bottom edge of the vehicle.

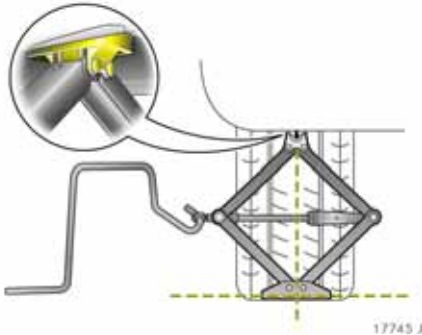

4. Before attaching jack * set to required height by turning the eye by hand. Fit the jack * at the front – or rear – in such a way that the jack head engages in the plastic retainer beneath the vehicle. Check that it is properly engaged.

The jack base must be on the ground directly below the jacking point in a manner that prevents it from slipping.

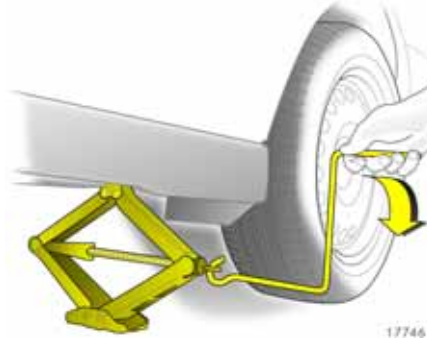

Attach crank to eye of threaded rod and turn crank to raise vehicle.

If this is not the case, carefully lower the vehicle immediately and reposition the jack.

5. Unscrew wheel bolts and wipe clean with a cloth. Then apply a light coating of grease to the wheel bolts. Do not grease the thread of the bolts. Do not put the wheel bolts down in a location where they may become soiled.

If the wheel bolts have retaining washers *, they must not be removed.

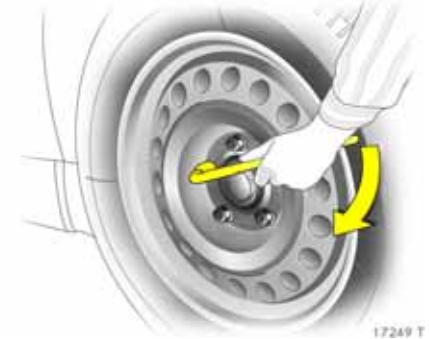

6. Change the wheel. Notes on spare wheel – see page 236, notes on temporary spare wheel – see page 237.
7. Screw in wheel bolts and tighten slightly, inserting the wheel bolt wrench * as far as possible.
8. Lower vehicle.
9. Tighten wheel bolts crosswise, putting on wheel bolt wrench * as far as possible.



10. Before refitting the wheel trim, clean the wheel around the retaining clips. Valve symbol * on back of wheel trim must point towards valve on wheel.

Align and refit wheel trim or wheel bolt caps *.

Alloy wheels *: Align and refit wheel bolt caps *.

11. Stow away replaced wheel, tools and warning triangle in the luggage compartment - see page 238.
12. Check the tyre pressure of the newly mounted wheel. Correct if necessary.
13. Have the tightening torque of the wheel bolts on the new wheel checked on the vehicle using a torque wrench as soon as possible and, if necessary, corrected. Tightening torque – see page 299.
14. Replace the faulty tyre on the wheel that was removed.
15. Replace temporary spare wheel * with a full specification wheel without delay.

Tyre repair kit *

Minor damage to the tyre tread or side wall, e.g. from foreign bodies, can be repaired using the tyre repair kit.

Do not remove the foreign body from the tyre.

Tyre damage exceeding 4 mm or that is on the rim cannot be repaired with the tyre repair kit.

Warning

Driving with tyre pressures too low or tyres deflated can cause invisible damage to the tyre. This damage cannot be eliminated with a tyre repair kit. Park the vehicle and contact a workshop.

Important information – see page 246.

In the event of a flat tyre:

- Switch on hazard warning lights, apply handbrake; for automatic transmission *, move selector lever to P; for manual transmission or Easytronic *, select 1st or reverse gear.
- Correctly set up the warning triangle. Warning triangle – see page 234.



The tyre repair kit is in a compartment in the spare wheel well of the luggage compartment.

1. Take the pouch with the tyre repair kit from the compartment. Carefully remove the components from the pouch.
2. Remove the compressor.



3. Remove the electrical connection cable and air hose from the stowage compartments on the underside of the compressor.



4. Screw the compressor air hose to the connection on the sealant bottle.
5. Fit the sealant bottle in the retainer on the compressor.
Set the compressor near the tyre in such a way that the sealant bottle is upright.
6. Remove the valve cap from the defective tyre.

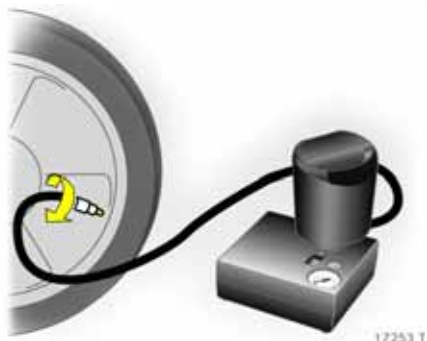

7. Screw the filler hose to the tyre valve.
8. The switch on the compressor must be set to O.
9. Connect the compressor plug to the accessory socket or cigarette lighter socket. Accessory socket – see page 93.
10. Switch on ignition.
To prevent battery discharge, we recommend that you leave the engine running.



11. Set the rocker switch on the compressor to I. The tyre is filled with sealant.
12. While the sealant bottle drains (approx. 30 seconds) the pressure indicator on the compressor briefly points to 6 bar (87 psi). Pressure then sinks again.
13. All of the sealant is pumped into the tyre. Afterwards, the tyre is filled with air.
14. The prescribed tyre pressure – see page 299 should be reached within 10 minutes. Switch off the compressor when the correct pressure is obtained.



If the specified tyre pressure is not reached within 10 minutes, remove the tyre repair kit. Move the vehicle through one tyre rotation, approx. 2 metres, in either direction. Reconnect the tyre repair kit and continue the filling process for 10 minutes. If the specified tyre pressure is still not reached, the tyre is too badly damaged. Park the vehicle and contact a workshop.

Drain excess tyre pressure with the button over the pressure indicator.

Do not run the compressor for more than 10 minutes - see "Important information" on page 246.

15. Detach the tyre repair kit. Screw the filler hose to the free connection on the sealant bottle. This prevents sealant leakage. Stow the tyre repair kit in the luggage compartment.
16. Wipe away any sealant spill with a cloth.
17. Dismantle the warning triangle and stow it in the luggage compartment – see page 234.

18. The enclosed sticker shows the maximum permitted speed at which the tyre repair may be used. Apply sticker in the driver's field of vision.

19. Continue driving immediately to allow the sealant to distribute evenly throughout the tyre. Stop after approx. 6 miles / 10 km (but no more than 10 minutes) and check tyre pressure. Screw the compressor air hose directly onto the tyre valve (see Fig. 17256 T).

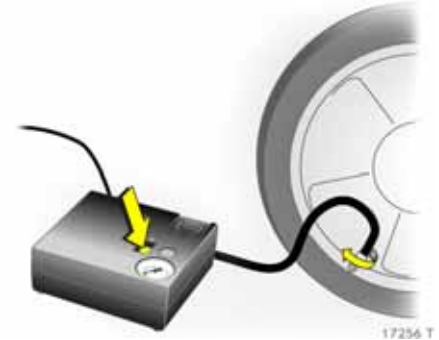

As long as the tyre pressure is more than 1.3 bar (19 psi), it may be adjusted to the prescribed value. Repeat the procedure until there is no more pressure loss.

If the tyre pressure has fallen below 1.3 bar (19 psi), the vehicle may no longer be used. Contact a workshop.

20. Stow the tyre repair kit in the luggage compartment – see page 242.

Important

⚠ Warning

Do not drive faster than 50 mph (80 km/h).

Do not use the temporary spare wheel for a lengthy period.

Steerability and driving behaviour may be impaired.

The driving characteristics of the repaired tyre is severely affected, therefore have this tyre replaced.

If the compressor makes abnormal noises or heats up greatly, switch it off for at least 30 minutes.

The integrated safety valve opens at a pressure of 7 bar (102 psi).

Protect the compressor from moisture and rain.

The sealant can only be stored for approx. 4 years. After this time, the sealing properties can no longer be guaranteed. Heed the expiration date on the sealant bottle.

The sealant bottle can only be used once. Replace a used sealant bottle.

The compressor and sealant can be used from approx. -30 °C.

Dispose of a used tyre repair kit in accordance with applicable legislation.

The adapter  supplied may be used to pump up other objects, such as balls, airbeds, dinghies.

This is located on the underside of the compressor. To remove, unscrew the compressor air hose and pull out the adapter.

When using the tyre repair kit, no consumer may be connected to the front accessory socket at the same time.

Electrical system

⚠ Warning

Electronic ignition systems generate very high voltages. Do not touch the ignition system; high voltage can be fatal.

Fuses

There are three fuseboxes in the vehicle: In the passenger compartment on the far left of the instrument panel, in the stowage compartment on the left in the luggage compartment, and at the front of the engine compartment.

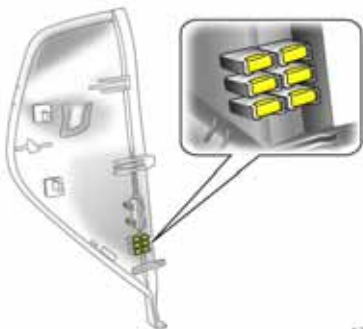

17747 J

We recommend carrying a complete set of fuses.

Spare fuses are kept on back of fusebox cover in the instrument panel. For opening cover – see next page.

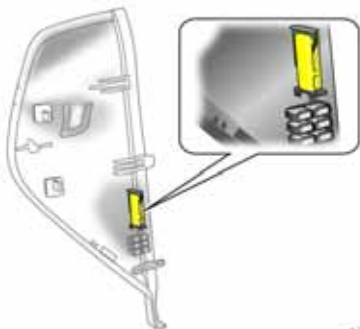

17748 J

Before replacing a fuse, turn off the respective switch and the ignition.

A defective fuse (Fig. 17259 T) can be recognised by its melted wire. A new fuse should only be installed after the cause of the fault has been rectified.

There is a fuse extractor on the rear of the fusebox cover in the instrument panel for changing fuses – see illustration above.

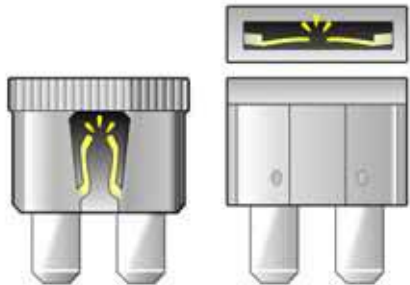

17259 T

Only install fuses of the specified rating. Each fuse has its rating written on it, in addition the fuses are colour coded.

Fuse, colour	Fuse, rating
Light brown	5 A
Dark brown	7.5 A
Red	10 A
Light blue	15 A
Yellow	20 A
White	25 A
Light green	30 A
Orange	40 A
Dark blue	60 A



Fuses and the most important circuits they protect

Fusebox in passenger compartment

The fusebox is on the left, on the outside of the instrument panel. Open door. Disengage cover by pulling firmly and remove.

Spare fuses, fuse extractor – see page 246.



Some circuits may be protected by several fuses.

No.	Circuit	Rating
1	Infotainment system, radio transport fuse	20 A
2	Interior fan, heating, air conditioning system	7.5 A
3	Sunroof	20 A
4	–	–
5	Door module control unit	7.5 A
6	Brake light	7.5 A
7	Bodywork module control unit	30 A
8	Front passenger's door module control unit	30 A
9	Central control unit	7.5 A

No.	Circuit	Rating
10	Steering column module control unit	7.5 A
11	Diagnostics plug	7.5 A
12	Battery overload protection	10 A
13	–	–
14	–	–
15	Door module control unit	30 A
16	–	–
17	Instruments, information display	15 A
18	–	–
19	–	–
20	Yaw rate sensor (ESP® ^{Plus})	7.5 A
21	–	–
22	Cigarette lighter	30 A
23	Interior fan, air conditioning, Electronic Climate Control	30 A 40 A
24	–	–
25	Heating, air conditioning system	7.5 A
26	Instruments, information display	7.5 A

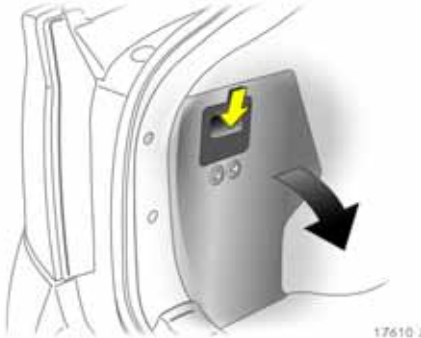

17610 J

Fusebox in luggage compartment

The fusebox is located on the left side of the luggage compartment, in the stowage compartment.

Saloon / Hatch:

Press the latch down and open the cover.

Estate:

Press both latches down and open the cover and interior trim.

Spare fuses, fuse extractor – see page 246.



17751 J

Some circuits may be protected by several fuses.

No.	Circuit	Rating
1	–	–
2	–	–
3	Electric seat adjustment, driver's seat	40 A
4	Heated rear window	40 A
5	Electric seat adjustment, front passenger's seat	40 A
6	Electric window operation, right rear	30 A
7	Electric window operation, left rear	30 A
8	Seat heating, rear right	15 A
9	Horn, Vauxhall alarm system	15 A
10	Fuel pump	20 A

No.	Circuit	Rating
11	Battery voltage	25 A
12	Seat heating, rear left	15 A
13	Towing equipment	20 A
14	Tailgate wiper	15 A
15	Heated seats, seat climate control, left front	15 A
16	Seat heating, front right	15 A
17	Accessory socket	15 A
18	Tailgate locking, Estate	30 A
19	Terminal 30, Twin Audio	10 A
20	Tank flap locking	7.5 A
21	Ultrasonic sensor, Vauxhall alarm system	5 A
22	Electrically operated tailgate	30 A
23	Glass breakage sensor (Vauxhall alarm system)	7.5 A
24	Battery voltage	25 A
25	Electronic chassis	10 A
26	Terminal 15 (starter switch), Twin Audio	25 A
27	Seat occupancy recognition, tyre pressure monitoring system, rain sensor, air conditioning system	5 A
28	Parking distance sensors	7.5 A
29	–	–



Fusebox in engine compartment

The fusebox is in the box at the front of the engine compartment.

⚠ Warning

Switch off engine before opening the fusebox in the engine compartment, risk of injury.

To open, disengage front battery cover and tilt upwards.



Disengage the bar at the front of the cover of fusebox and swing it upwards.

Spare fuses, fuse extractor – see page 246.

Some circuits may be protected by several fuses.

No.	Circuit	Rating
1	Engine electronics, transmission electronics	20 A
2	Starter	25 A
3	Horn	20 A
4	Air conditioning system, Electronic Climate Control	10 A
5	Windscreen wash system, front and rear	15 A
6	Diesel fuel filter heating	30 A

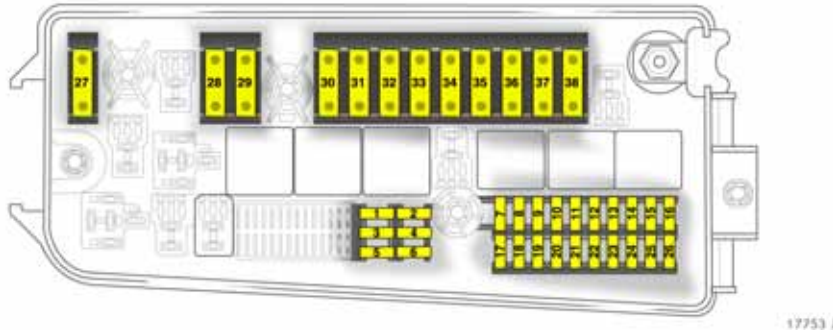

No.	Circuit	Rating
7	Central control unit, ESP® ^{Plus}	15 A
8	Headlights, windscreen wash nozzles	10 A
9	Power steering, brake servo	7.5 A
10	Adaptive Forward Lighting	10 A
11	Windscreen wiper	30 A
12	Central control unit, ESP® ^{Plus}	7.5 A
13	Headlight wash system	30 A
14	Oxygen sensor	10 A
15	Engine control unit ¹⁾	10 A
16	ABS	5 A

No.	Circuit	Rating
17	–	–
18	–	–
19	Adaptive Forward Lighting, headlight range adjustment	15 A 5 A
20	Headlight range adjustment	5 A
21	–	–
22	Windscreen wiper	30 A
23	Auxiliary heating	20 A
24	Battery voltage, terminal 30	30 A
25	Battery voltage, terminal 30	30 A
26	–	–

No.	Circuit	Rating
27	Easytronic	30 A
28	Tailgate module control unit	60 A
29	ABS	40 A
30	Tailgate module control unit	60 A
31	Vehicle interior module control unit	60 A
32	ABS	40 A
33	Vehicle interior module control unit	60 A
34	Tailgate module control unit	60 A
35	Cooling fan ¹⁾	30 A 40 A
36	Cooling fan ¹⁾ Brake servo	20 A 30 A 30 A
37	Adaptive Forward Lighting: Slot for changing to symmetrical dipped beam for driving abroad - see page 136	Insert any maxi-fuse
38	–	–

¹⁾ The brake lights are on all the time if the fuse is defective and the ignition is switched on.

¹⁾ Depending on engine.

Bulb replacement

Before replacing a bulb, switch ignition off and switch relevant switch off.

Only hold new bulb at base. Do not touch the bulb glass with bare hands, otherwise fingerprints on the glass evaporate. Residue builds up on the reflector eventually resulting in a dull reflector. Inadvertently stained bulbs may be cleaned with a clean non-fluffy cloth, using alcohol or white spirits.

Replacement bulb must be in accordance with data on base of defective bulb. Do not exceed wattage given on bulb base.

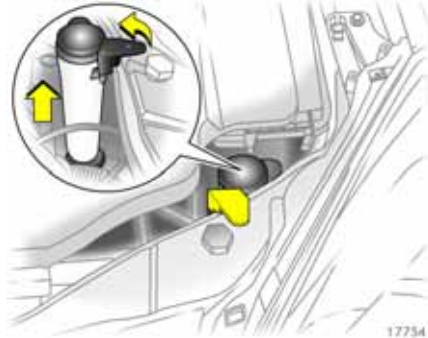

To change the lights on the left-hand side, remove filler neck from windscreen wash system fluid container to gain better access: disengage retaining clamp and withdraw filler neck by pulling upwards. Wash fluid may escape if the bottle is full.

Warning

Protect the environment. Do not allow wash fluid to seep into the ground or drain into the sewage system.

As the headlight has to be removed, have the bulb on the right changed by a workshop.

Headlight aiming

We recommend that headlight adjustment be carried out by a workshop which will have special equipment.

Manual headlight range adjustment * must be set to **0** when adjusting the headlights.

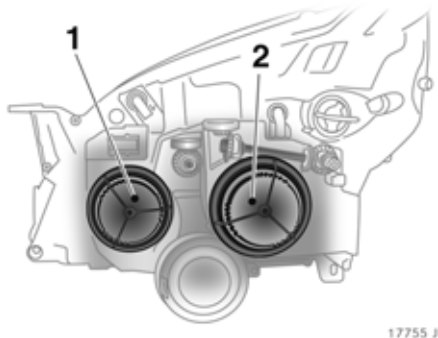

Halogen headlight system, dipped and main beam

Headlights with separate systems for main beam 1 (inner bulbs) and dipped beam 2 (outer bulbs).

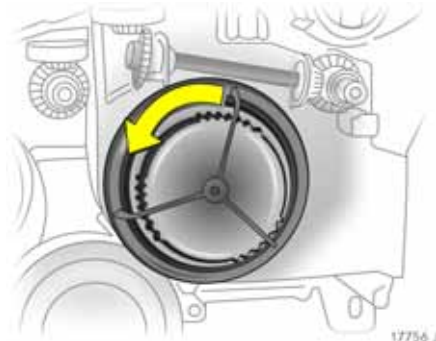

Dipped beam

1. Open bonnet.
2. To change the bulb on the left, remove filler neck from windscreen wash system fluid container - see page 252. As the headlight has to be removed, have the bulb on the right changed by a workshop.
3. Turn the headlight cover anticlockwise and remove.

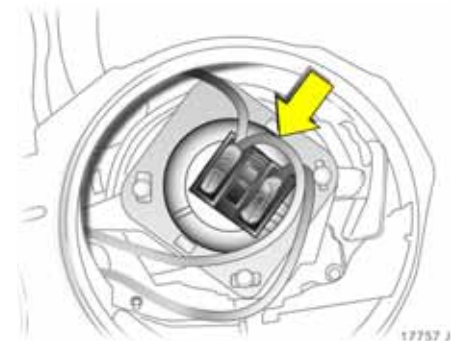

4. Push down bulb at bulb holder.





5. Remove the bulb holder with bulb from the reflector.

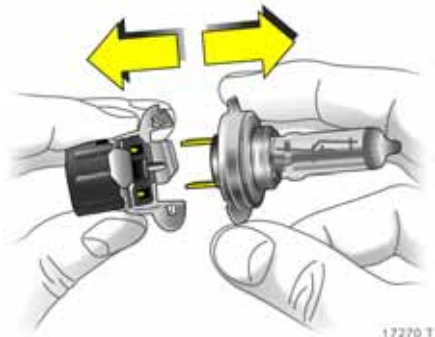

6. Detach bulb from bulb mounting.
7. Insert new bulb into bulb mounting, without touching the glass.
8. Insert new bulb so that the two lugs on the bulb mounting engage in the recesses in the reflector.
9. Engage the bulb holder.
10. Reposition the headlight cover and turn it clockwise.
11. After changing the bulb on the left, insert and engage filler neck for windscreen wash system fluid container - see page 252.



Main beam

1. Open bonnet.
2. To change the bulb on the left, remove filler neck from windscreen wash system fluid container - see page 252. As the headlight has to be removed, have the bulb on the right changed by a workshop.
3. Turn the headlight cover anticlockwise and remove.
4. Detach plug connector from bulb.

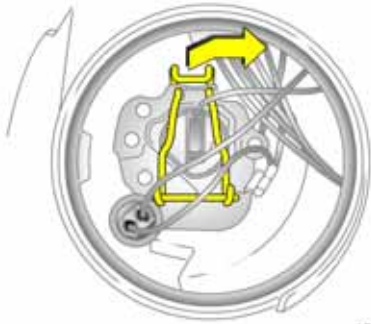

17760 J

5. Press spring wire clip forwards, disengage to the right and open.

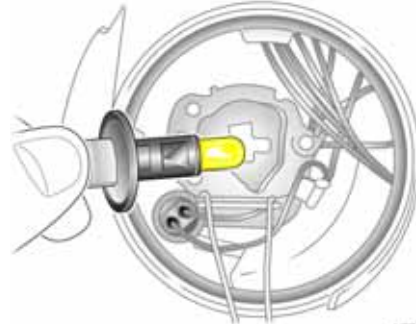

17761 J

6. Remove bulb from reflector housing.
7. When fitting a new bulb, engage the lugs in the recesses on the reflector without touching the glass.
8. Engage spring wire clip, plug connector onto bulb.
9. Reposition the headlight cover and turn it clockwise.
10. After changing the bulb on the left, insert and engage filler neck for windscreen wash system fluid container - see page 252.

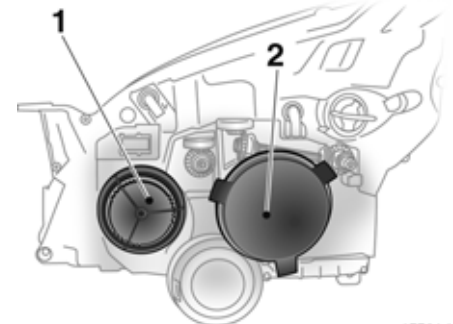

17764 J

Xenon headlight system, dipped and main beam

Headlights with separate systems for main beam 1 (inner bulbs) and dipped beam 2 (outer bulbs).

Dipped beam

Warning

The dipped beam works with very high electrical voltage. Do not touch, risk of fatal injury. Have bulbs changed by a workshop.



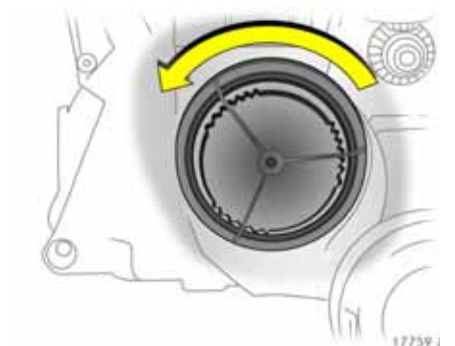

Main beam

1. Open bonnet.
2. To change the bulb on the left, remove filler neck from windscreen wash system fluid container - see page 252. As the headlight has to be removed, have the bulb on the right changed by a workshop.
3. Turn the headlight cover anticlockwise and remove.
4. Detach plug connector from bulb.

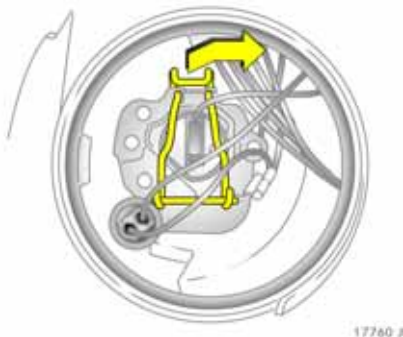

5. Press spring wire clip forwards, disengage to the right and open.

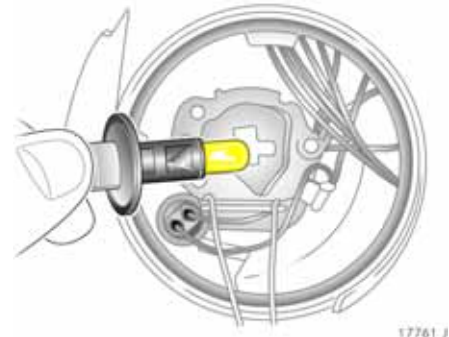

6. Remove bulb from reflector housing.
7. When fitting a new bulb, engage the lugs in the recesses on the reflector without touching the glass.
8. Engage spring wire clip, plug connector onto bulb.
9. Reposition the headlight cover and turn it clockwise.
10. After changing the bulb on the left, insert and engage filler neck for windscreen wash system fluid container - see page 252.

Adaptive Forward Lighting (AFL) system *

Xenon headlight system for main and dipped beam together with curve illumination based on steering angle.

⚠ Warning

Xenon headlights operate at very high voltage. Do not touch, risk of fatal injury. Only have bulbs for dipped beam, main beam, turn lighting, parking lights and turn signal lights changed by a workshop.



Halogen headlight system, Xenon headlight system, parking lights

1. Open bonnet.
2. To change the bulb on the left, remove filler neck from windscreen wash system fluid container - see page 252. As the headlight has to be removed, have the bulb on the right changed by a workshop.
3. Turn the headlight cover anticlockwise and remove.

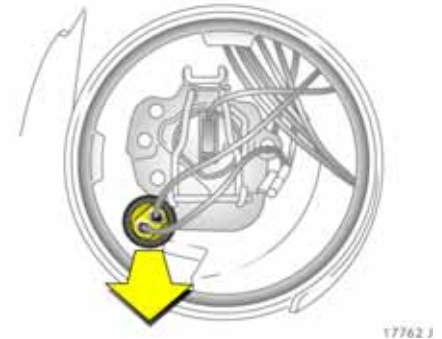

4. Remove parking light bulb holder from reflector.



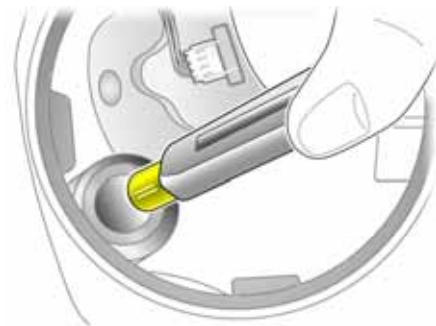

5. Remove bulb from socket.
6. Insert new bulb, without touching the glass.
7. Insert socket in reflector, position headlight cover and turn clockwise.
8. After changing the bulb on the left, insert and engage filler neck for windscreen wash system fluid container - see page 252.

**Halogen headlight system,
Xenon headlight system,
front turn signal lights**

Have bulbs changed by a workshop.

Side turn signal lights

Have bulbs changed by a workshop.

Front fog lights *

Have bulbs changed by a workshop.



Tail lights

Saloon / Hatch

1. To open the stowage compartment, press down bar and open the cover.

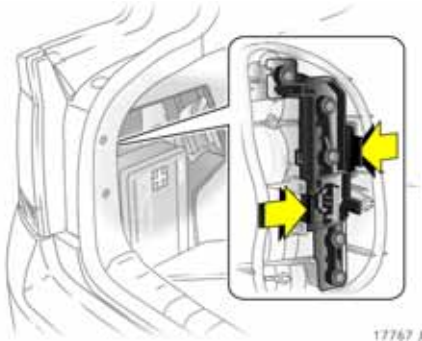

2. Detach plug connector from bulb mounting.
3. Press the two retaining lugs on outer edges of bulb mounting towards each other and remove bulb mounting.

Lights from top to bottom:

Turn signal light
 Tail light/brake light
 Tail light
 Fog tail light
 Reversing light

4. Remove bulb from socket.
5. Insert new bulb without touching the glass. Fit bulb mounting into bulb housing. Connect plug. Close stowage compartment.

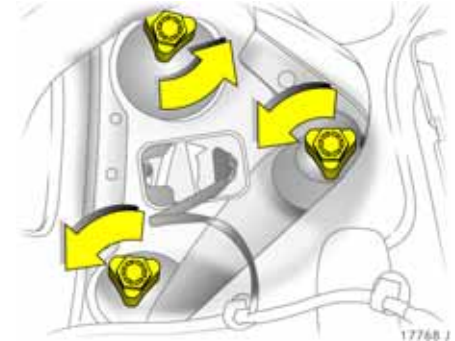

Estate

1. Open the compartment on the left or right-hand side by pressing the latch down – see page 235.
2. Hold the bulb housing from the outside, use a wheel bolt spanner * to loosen the retaining nuts and unscrew them by hand. Remove the bulb housing to the rear. Wheel bolt spanner * – see vehicle tools on page 238.
3. Detach the cable from the bulb housing.



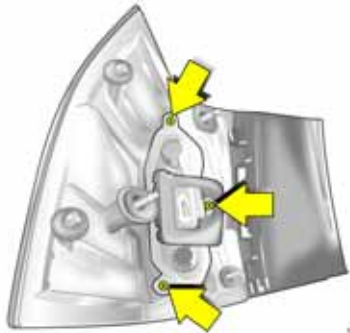

17769 J

4. Undo the three screws using a screwdriver and detach the bulb mounting.

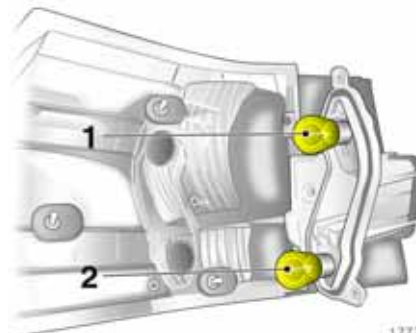

17770 J

5. Remove bulb from socket. Bulbs in bulb holder:

- 1 = Brake/tail light
- 2 = Turn signal light

6. Fit a new bulb without touching the glass. Refit the bulb mounting and screw it into place. Position the bulb housing in the vehicle body and screw it into place. Close the compartment in the side trim.

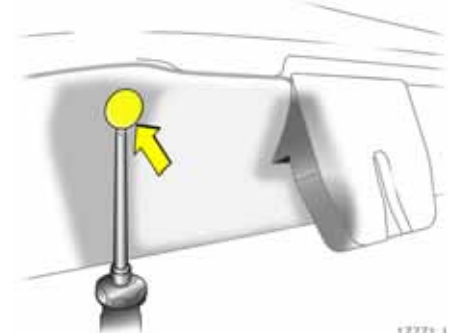

17771 J

Tailgate lights

Due to the large amount of effort required, bulbs should be replaced by a workshop.

1. Use a screw driver to prise off the plastic plugs in the tailgate panelling to the right and left of the tailgate lock.



17772 J

2. Undo screws in handle of inner panelling with torx screwdriver.
3. Remove the inner panelling and clips from the tailgate.

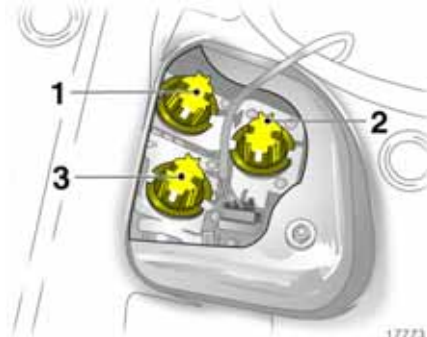

17773 J

4. Unscrew corresponding holder:

- 1 = Reversing light
- 2 = Fog tail light
- 3 = Reversing light

5. Remove bulb from socket.
6. Fit a new bulb without touching the glass. Refit the mounting in the tailgate.
7. Refit the inner panelling to the tailgate using the clips. Tighten the screw in the handle. Refit the plastic plugs in the openings.

Lights in electrically operated tailgate*
Have bulbs replaced by a workshop.



17297 T

Number plate light

1. Insert screw driver vertically in bulb insert as shown in illustration. Press to the side and release spring.



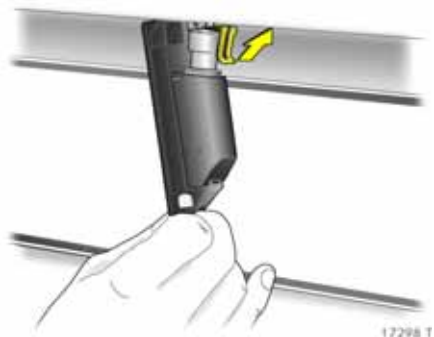

2. Remove bulb housing downwards, taking care not to pull on the cable.
3. Lift flap and disconnect plug from bulb socket.



4. Rotate bulb holder to left and disengage.
5. Remove bulb from socket.
6. Insert new bulb, without touching the glass.
7. Insert light holder in bulb housing and engage by rotating clockwise.
8. Connect plug to bulb socket.
9. Insert and engage bulb housing.

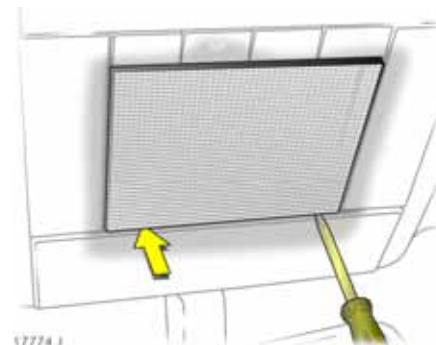

Courtesy light

Front courtesy light, reading lights ✳

To ensure that no power is supplied to the lights, close the doors before removing.

1. Lever the lens out of the housing recesses.



17775 J

2. Remove bulb from socket.
3. Insert new bulb, without touching the glass.
4. Mount lens and engage in position.

**Rear courtesy lights ✳,
rear reading lights ✳**

Have bulbs changed by a workshop.

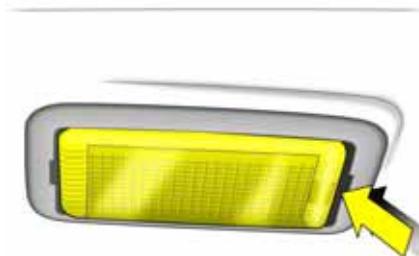

17301 T

**Glove compartment lighting,
luggage compartment lighting,
footwell lighting ✳**

To ensure that no power is supplied to the lights, close the doors or hold the contact switch depressed before removing.

1. Prise the light out with a screwdriver.



17302 T

2. Press bulb slightly towards spring clip and remove.
3. Insert new bulb, without touching the glass.
4. Insert light in opening and engage in position.

**Instrument illumination,
information display illumination ✳**

Have bulbs changed by a workshop.

Vehicle care

When caring for your vehicle, observe all national environmental regulations, particularly when washing it.

Regular, thorough care helps to improve the appearance of your vehicle and maintain its value over the years. It is also a prerequisite for warranty claims for any paint or corrosion damage. The following pages contain tips for vehicle care which, if used properly, will help combat the unavoidable damaging effects of the environment.

Vehicle care aids *

Vehicle wash:

- Wash brush,
- Car Shampoo,
- Car Sponges,
- Insect Removal Sponge,
- Wheel Cleaners,
- Engine Cleaners,
- Glass Cleaners,
- Chamois Leather.

Vehicle care:

- Paintwork Cleaner,
- Paintwork Polish,
- Cream Polish,
- Metallic Paintwork Wax,
- Hard wax,
- Touch-up pens,
- Touch-Up/Aerosol Paint,
- Wheel Preserver,
- Insect Remover,
- Window Cleaning Spray,
- Lock Cylinder Grease,
- Alloy Wheel Cleaner,
- Alloy Wheel Preserver,
- Rust Preventative,
- Vauxhall De-icer Spray,
- Vauxhall Windscreen Wash Solvent,
- Silicone Oil for Rubber Seals.

Interior care:

- Interior/Upholstery Cleaner.

Washing

The paintwork of your vehicle is exposed to environmental influences, e.g. continuous changes in weather conditions, industrial waste gases and dust or thawing salts, so wash and wax your vehicle regularly. When using automatic car washes, select a programme which includes waxing.

Bird droppings, dead insects, resin, pollen and the like should be cleaned off immediately, as they contain aggressive constituents which can cause paint damage.

Please follow the wash system manufacturer's instructions when using wash systems. The windscreen wiper and the automatic wiper with rain sensor * and the rear window wiper * must be switched off - see pages 11, 126. Unscrew the antenna rod * and the roof rack *, standing on the door sill to make them easier to reach.

If you wash your vehicle by hand, make sure that the insides of the wings are also thoroughly rinsed out.

Clean edges and folds on opened doors and flaps as well as the areas they cover.

Thoroughly rinse off and leather-off the vehicle. Rinse leather frequently. Use separate leathers for paint and window surfaces: remnants of wax on the windows will impair vision.

Observe national regulations.

Waxing

Wax your vehicle regularly, in particular after it has been washed using Car Shampoo and at the latest when water no longer forms beads on the paintwork, otherwise the paintwork will dry out.

Also wax edges and folds on opened doors and flaps as well as the areas they cover.

Polishing

Polishing is necessary only if the paint has become dull or if solid deposits have become attached to it.

Paintwork polish with silicone forms a protective film, making waxing unnecessary.

Plastic body parts should not be treated with wax and polish.

Use Metallic Paintwork Wax on vehicles with a metallic-effect paint finish.

Wheels

Use a pH-neutral wheel cleaning agent to clean the wheels.

Wheels are painted and can be treated with the same agents as the body. For alloy wheels we recommend use of Alloy Wheel Preserver.

Paintwork damage

Repair minor paintwork damage such as stone chips, scratches etc. immediately using the Touch-up pen or Touch-Up/ Aerosol Paint before rust forms. If rust has already formed, have a workshop eliminate the cause. Also check the surfaces and edges facing the road surface on which rust may have developed for some time unnoticed.

Exterior lights

Headlight and other protective light bezels are made of plastic. If they require additional cleaning after the vehicle has been washed, clean them with Car Shampoo. Do not use any abrasive or caustic agents, do not use an ice scraper, and do not clean them dry.

Plastic and rubber parts

For additional cleaning of plastic and rubber parts use Interior/Upholstery Cleaner. Do not use any other agent, and in particular do not use solvents or petrol.

Do not use high-pressure jet cleaners on plastic and rubber parts.

Wheels and tyres

Do not use high-pressure jet cleaners on wheels and tyres.

Interior and upholstery

Clean the vehicle interior, including the instrument panel fascia, using Interior/Upholstery Cleaner.

The instrument panel should only be cleaned using a soft damp cloth.

Clean fabric upholstery with a vacuum cleaner and brush. To remove stains, use Interior/Upholstery Cleaner that is suitable for both fabrics and vinyl.

Do not use cleaning agents such as acetone, tetrachloride, paint thinner, paint remover, nail varnish remover, washing powder or bleach. Petrol is also unsuitable. Open Velcro fasteners on clothing could damage seat upholstery. Make sure that Velcro fasteners are closed.

Seat belts

Always keep seat belts clean and dry.

Clean only with lukewarm water or Interior/Upholstery Cleaner.

Windows

When cleaning the heated rear window, make sure that the heating element on the inside of the window is not damaged.

Use a soft lint-free cloth or chamois leather in conjunction with Window Cleaning Spray and Insect Remover.

Vauxhall Windscreen Wash Solvent is suitable for de-icing windows.

For mechanical removal of ice, use a commercially available sharp-edged ice scraper. Press the scraper firmly against the glass so that no dirt can get under it and scratch the glass.

Windscreen wiper blades

Wax, such as that used in car washes, can cause streaking on the windscreen when the wiper is used.

Smearing wiper blades can be cleaned with a soft cloth and Vauxhall Windscreen Wash Solvent, and replaced if necessary – see page 277.

Locks

The locks are lubricated with a high-quality Lock Cylinder Grease in the factory. Only use de-icer in urgent cases, since it has a de-greasing effect and affects the operation of the locks. Have the locks regreased in a workshop after using de-icer.

Engine compartment

Areas of the engine compartment that are painted in the same colour as the vehicle must be looked after like any other painted surface.

It is advisable to wash the engine compartment before and after winter and preserve it with wax. Cover alternator and brake fluid reservoir with plastic sheets before washing the engine.

When washing the engine with a steam jet, do not direct the jet at components of the Anti-lock Brake System (ABS), the air conditioning system ✱, the Electronic Climate Control system ✱, the auxiliary heater ✱ or the belt drive or its components.

Engine washing also removes subsequently applied protective wax. Therefore after washing, have a workshop protect the engine, parts of the braking system in the engine bay, axle elements with steering, body elements and cavities, thoroughly with protective wax.

An engine wash can be performed in the spring in order to remove dirt that has adhered to the engine compartment, which may also have a high salt content. Check protective wax layer and make good if necessary.

Do not use high-pressure jet cleaners in the engine compartment.

Underbody

Your vehicle has a factory-applied PVC undercoating in the wheel arches (including the longitudinal members) which provides permanent protection and needs no special maintenance.

The surfaces of the vehicle underbody not covered by PVC are provided a durable protective wax coating in critical areas.

On vehicles which are washed frequently in automatic car washes with underbody washing facility, the protective wax coating may be impaired by dirt-dissolving additives, so check the underbody after washing and have it waxed if necessary.

Before the start of the cold weather season, check the PVC coating and protective wax coating and, if necessary, have them restored to perfect condition.

Caution - commercially available bitumen/rubber materials can damage the PVC coating. We recommend that you have underbody work carried out by a workshop which knows the prescribed materials and has experience in the use thereof.

The underbody should be washed following the end of the cold weather season to remove any dirt adhering to the underbody since this may also contain salt. Check protective wax coating and, if necessary, have it restored to perfect condition.

Service, maintenance

Inspection system	270
Genuine Vauxhall Parts and Accessories	271
A note on safety	271
Checking and topping up fluids	271
Engine oil	272
Diesel fuel filter	274
Coolant	274
Brake fluid	276
Windscreen wiper	277
Windscreen and headlight wash systems *.....	279
Battery	280
Protecting electronic components	280
Vehicle decommissioning.....	281
Vehicle recommissioning.....	281

In our experience, the most common cause of all complaints is the result of misunderstanding or lack of communication between the customer and the Vauxhall Authorised Repairer.

We sincerely hope you will never have cause to complain about your vehicle. However, if things do go wrong, the best course of action for you to take is to contact your Vauxhall Authorised Repairer's Service Reception Staff and explain the difficulty you are having. We are confident they will do their utmost to resolve the problem to your complete satisfaction.

Sometimes, however, despite the best of intentions of all concerned, misunderstandings can occur. If your problem has not been resolved to your satisfaction, please make an appointment to discuss the matter with the Manager of the department concerned.

The majority of areas of concern can be quickly resolved in this way.

Should you wish to pursue the matter further, the Principal of the Vauxhall Authorised Repairer should be made aware of your concern. It is advisable in cases such as this to write to him to confirm your problem and the solutions that have been offered.

You can be assured the Authorised Repairer's Principal will only be too anxious to fully investigate your problems and correct any errors made. After all, he has a

large investment in his business and is proud of his reputation and professionalism and fully realises that satisfied customers are his key to success.

In the unlikely event that you are still not happy with the answer your Vauxhall Authorised Repairer has given, or the action he proposes to correct the problem, you may contact the Customer Care Department¹⁾ where a team of Customer Care Consultants will spare no effort to ensure your complete satisfaction.

Vauxhall Motors Ltd.

Customer Care,
Griffin House,
Osborne Road
LUTON,
Beds., LU1 3YT
Telephone: 0845 090 2044

They will review all the facts involved. Then if it is felt some further action can be taken, the Vauxhall Authorised Repairer will be advised accordingly. In any case, your contact will be acknowledged confirming Vauxhall Motors' position in the matter.

If you are not satisfied with the outcome, you can if you wish, seek advice from an independent third party such as:

Automobile Association (A.A.)

Fanum House, Basing View,
BASINGSTOKE,
Hants., RG21 4EA

¹⁾ Calls may be monitored and recorded for training purposes.

Royal Automobile Club (R.A.C.),
R.A.C. Motoring Services Ltd.
89-91 Pall Mall,
LONDON, SW1Y 5HS

The Customer Relations Department,
Society of Motor Manufacturers and Traders Ltd. (S.M.M.T.),
Forbes House, Halkin Street,
LONDON, SW1X 7DS

Customer Complaints Service,
Scottish Motor Trade Association,
(S.M.T.A.),
3 Palmerston Place,
EDINBURGH, EH12 5AQ

The National Conciliation Service,
Retail Motor Industry Federation,
9 North Street,
RUBGY, CV21 2AB

If you have a problem whilst abroad:

The Service Departments of Adam Opel GmbH and General Motors branches everywhere will provide information and assistance:

In **Luxembourg** please contact the General Motors Service Department in Antwerp – Belgium
Telephone: 00 32-34 50 63 29

General Motors Austria GmbH
Groß-Enzersdorfer Str. 59
1220 Vienna – Austria
Tel. 00 43-1-2 88 77 444 or
00 43-1-2 88 77 0

General Motors Belgium N.V.
Noordelaan 401 - Haven 500
2030 Antwerp – Belgium
Tel. 00 32-34 50 63 29

General Motors Southeast Europe
org. složka
Olbrachtova 9
140 00 Prague – Czech Republic
Tel. 00 420-2 39 004 321

General Motors Danmark
Jaegersborg Alle 4
2920 Charlottenlund – Denmark
Tel. 00 45-39 97 85 00

Vauxhall Motors Ltd.
Customer Care
Griffin House, Osborne Road
Luton, Bedfordshire, LU1 3YT – England
Tel. 00 44-845 090 2044

General Motors Finland Oy
Pajuniityntie 5
00320 Helsinki – Finland
Tel. 00 358-9 817 101 47

General Motors France
1 – 9, avenue du Marais
Angle Quai de Bezons
95101 Argenteuil Cedex – France
Tel. 00 33-1-34 26 30 51

ADAM OPEL GmbH
Bahnhofspatz 1
65423 Rüsselsheim – Germany
Tel. 00 49-61 42-77 50 00 or
00 49-61 42-7 70

General Motors Hellas S.A.
56 Kifisias Avenue & Delfon str.
Amarousion
151 25 Athens – Greece
Tel. 00 30-1-6 80 65 01

General Motors Southeast Europe Ltd.
Szabadsag utca 117
2040 Budaörs – Hungary
Tel. 00 36-23 446 100

General Motors India
Sixth Floor, Tower A
Global Business Park
Mehrauli – Gurgaon Road
Gurgaon 122 022, Haryana – India
Tel. 00 91-124 280 3333

General Motors Ireland Ltd.
Opel House, Unit 60, Heather Road
Sandyford, Dublin 18 – Ireland
Tel. 00 353 1-216 10 00

General Motors Italia Srl
Piazzale dell'Industria 40
00144 Rome – Italy
Tel. 00 39-06-5 46 51

General Motors Nederland B.V.
Lage Mosten 49 – 63
4822 NK Breda – Netherlands
Tel. 00 31-76-5 44 83 00

General Motors Norge AS
Kjeller-Vest 6
2027 Kjeller – Norway
Tel. 00 47-23 50 01 04

General Motors Poland Sp. z o.o.
Wolaska 5
06-675 Warsaw – Poland
Tel. 00 48-22-606 17 00

General Motors Portugal
Quinta da Fonte
Edifício Femão Magalhães, Piso 2
2780-190 Paço d'Arcos – Portugal
Tel. 00 351- 21 440 75 00

General Motors Southeast Europe
org. zložka
Apollo Business Centre
Mlynské Nivy 45
821 09 Bratislava - Slovakia
Tel. 00 421-2 58 275 543

General Motors España S.L.
Paseo de la Castellana, 91
28046 Madrid – Spain
Tel. 00 34-902 25 00 25

General Motors Norden AB
Årstaångvägen 17
100 73 Stockholm – Sweden
Tel. 00 46-20 333 000

General Motors Suisse S.A.
Stelzenstraße 4
8152 Glattbrugg – Switzerland
Tel. 00 41-44 828 28 80

General Motors Türkiye Ltd. Sti.
Kemalpaşa yolu üzeri
35861 Torbalı / Izmir – Turkey
Tel. 00 90-2 32-8 53-14 53

In **Albania, Bosnia-Herzegovina, Bulgaria, Croatia, Estonia, Latvia, Lithuania, Macedonia, Romania, Serbia-Montenegro and Slovenia** please contact the General Motors Service Department in Budaörs – Hungary
Tel. 00 36-23 446 100



Inspection system

In order to guarantee economical and safe vehicle operation and to maintain the value of your vehicle, it is of vital importance that all maintenance work is carried out at the proper intervals.

For vehicles with strict engine oil change and service intervals, before servicing is due the display **InSP** appears on the odometer display after the ignition has been switched on and off: Have your next service carried out by a workshop within one week or 300 miles (500 km).

The service interval display takes account of off-the-road periods during which the battery is disconnected.

For vehicles with flexible oil change and service intervals, the length of these intervals is based on several parameters stemming from usage.

For this reason, various engine-specific

data is continually gathered and is used to calculate the remaining distance until the next service.

The remaining distance can be seen in the odometer display when the ignition is off. Press the reset button next to the trip odometer. **InSP** and the remaining distance will be displayed.

If the remaining distance is less than 1000 miles (1500 km), **InSP** is displayed with a remaining distance of 600 miles (1000 km) when the ignition is switched on. **InSP** is displayed for several seconds if the remaining distance is less than 300 miles (500 km). Have service work that is due carried out within one week or 300 miles (500 km). Have this work carried out by a Vauxhall Authorised Repairer in order to avoid invalidation of warranty claims.

Further information on maintenance and the inspection system can be found in the Service Booklet, found in the glove compartment.

Have maintenance work – and repair work on the body and the equipment – carried out professionally by a workshop. We recommend using your Vauxhall

Authorised Repairer, who has excellent knowledge of Vauxhall vehicles and has the necessary special tools and up-to-date Service Instructions from Vauxhall. It is particularly advisable to use a Vauxhall Authorised Repairer during the warranty period in order to prevent loss of warranty. Further information can be found in the Service Booklet.

Separate anti-corrosion service

Have this work carried out according to the intervals specified in the Service Booklet.

Genuine Vauxhall Parts and Accessories

We recommend that you use "Genuine Vauxhall Parts and Accessories" and conversion parts approved expressly for your vehicle type. These parts have undergone special tests to establish their reliability, safety and specific suitability for Vauxhall vehicles. Despite continuous market monitoring, we cannot assess or guarantee these attributes for other products, even if they have been granted approval by the relevant authorities or in some other form.

"Genuine Vauxhall Parts and Accessories" and conversion parts approved by Vauxhall can be obtained from your Vauxhall Authorised Repairer, who can provide expert advice on permitted technical changes and ensure correct installation.

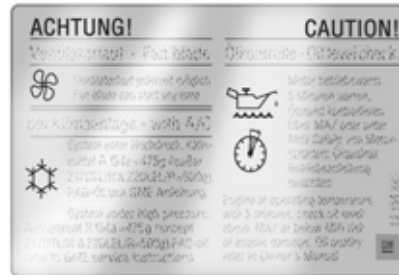

17304 T

A note on safety

To avoid injury from moving parts and cables conducting ignition voltage, only carry out engine compartment checks (e.g. checking brake fluid or engine oil level) when the ignition is switched off.

Warning

The cooling fan is controlled by a thermoswitch and can therefore start unexpectedly even if the ignition is switched off. Risk of injury.

Electronic ignition systems generate very high voltages. Do not touch the ignition system; high voltage can be fatal.

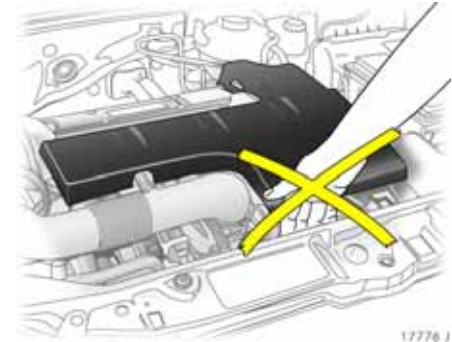

17776 J

Never carry out any repairs or adjustment and maintenance work on the vehicle yourself. This especially applies to the engine, chassis and safety parts. You may unwittingly infringe the provisions of the law and, by not performing the work properly, endanger yourself and other road users.

Checking and topping up fluids

To aid identification, the caps used when topping up engine oil, coolant and wash fluid as well as the oil dipstick handle may be coloured yellow.

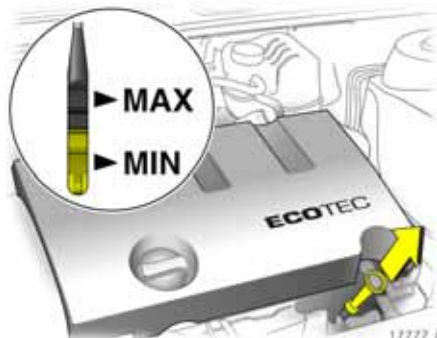

Engine oil

Information on engine oils is found in the Service Booklet.

Engine oil level and consumption

Every engine consumes engine oil for technical reasons. The engine oil consumption cannot be assessed until a fairly long distance has been driven, and may be above the specified value when the vehicle is first being driven (run-in period). Frequent driving at high revs increases engine oil consumption.

Warning

Do not allow the engine oil to drop below the minimum level.

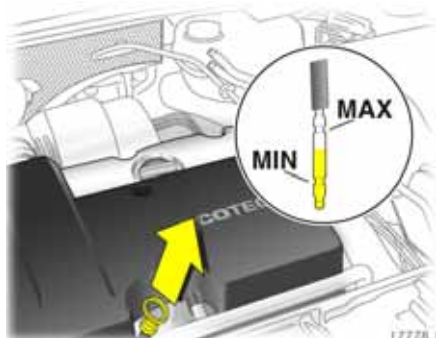

In vehicles with engine oil level monitoring , the engine oil level is monitored automatically - see page 103. It is advisable to check the oil level before setting out on long journeys.

Warning

Important: It is the owner's responsibility to maintain the correct level of an appropriate quality oil in the engine.

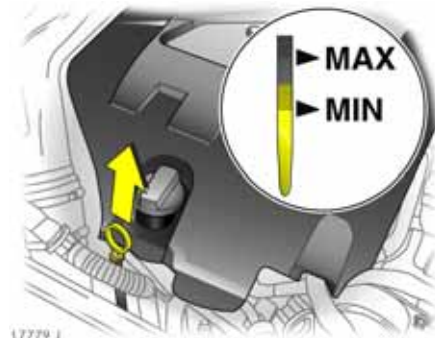

Engine oil level check, topping up engine oil

The illustrations on this page show examples of the checks for various petrol and diesel engines. Fig. 17780 J on the next page shows the checks for engine Z 30 DT¹⁾.

The oil level must be checked with the vehicle on a level surface and with the engine (which must be at operating temperature) switched off. Wait at least 5 minutes before checking the level to allow the normal engine oil accumulation in the engine to drain into the oil pan.

¹⁾ Sales designation – see page 284, 285.

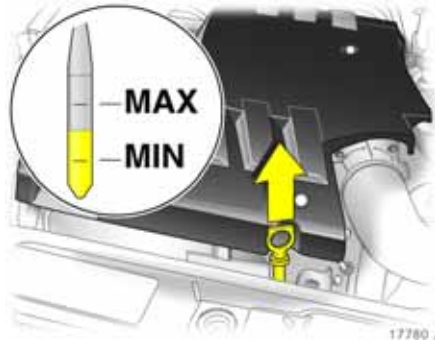

To check the engine oil level, insert wiped oil dipstick into dipstick tube as far as it will go. Top engine oil up if the level has dropped into the range of the top-up mark **MIN**.

The engine oil level must not exceed the upper mark **MAX** on the dipstick. Excess engine oil must be drained off or extracted. If the engine oil level is above the **MAX** mark there is a risk of damage to the engine or the catalytic converter.

The amount filled must be between the **MIN** and **MAX** marks – see page 308.

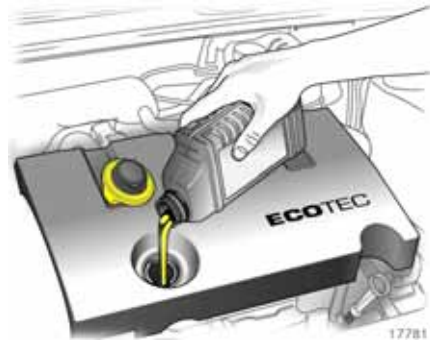

Top up with the same brand of engine oil that was used during the previous oil change, following the instructions in the Service Booklet.

To close, position the cap and screw it into place.

Capacities – see page 308.

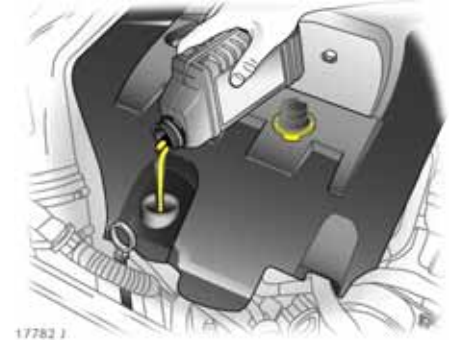

Engine oil change, oil filter change
Change oil at a workshop according to the service interval shown on the display.

We recommend that you use genuine engine oil filters.

Warning

Waste engine oil cannot be disposed of with domestic refuse. Observe the legal requirements for disposal of old oil and filters to protect the environment and your health.

Diesel fuel filter

On each engine oil change, have the fuel filter checked for any water residue by a workshop.

For engines¹⁾ Z 19 DT, Z 19 DTL and Z 19 DTH, control indicator  illuminates if there is water in the diesel fuel filter.

Have fuel filter checked at shorter intervals if the vehicle is subjected to extreme operating conditions such as high humidity (primarily in coastal areas), extremely high or low outside temperatures and substantially varying daytime and nighttime temperatures.

¹⁾ Sales designation – see page 284, 285.

Coolant

The glycol-based coolant provides excellent corrosion protection for the heating and cooling systems as well as anti-freeze protection down to approx. -28 °C. It remains in the cooling system throughout the year and need not be changed.

Use of certain anti-freezes can lead to engine damage. We therefore recommend that you use only approved anti-freezes.

Warning

Anti-freeze is a danger to health; it must therefore be kept in the original container and out of the reach of children.

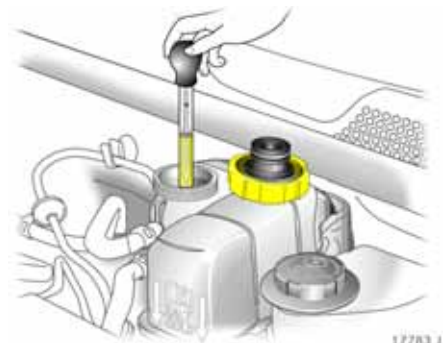

Anti-freeze and corrosion protection

Before the start of winter, have a workshop check the anti-freeze protection. The anti-freeze level must guarantee protection down to approx. -28 °C. Insufficient anti-freeze will reduce the frost protection level and the corrosion protection. If necessary add anti-freeze.

If coolant loss is topped up with water, have concentration checked and add anti-freeze if necessary.

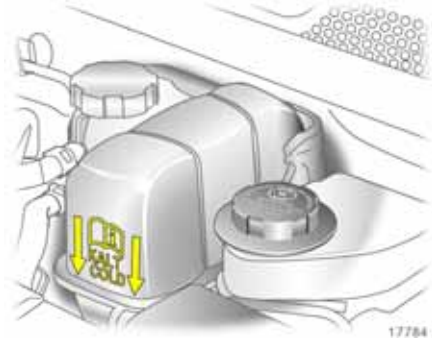

Coolant level

Hardly any losses occur since the cooling system is sealed and it is thus rarely necessary to top up the coolant.

4-cylinder petrol and diesel engines: When the cooling system is cold, the coolant level in the expansion tank should be slightly above the **KALT/COLD** mark. Coolant level can be read off from the outside of the expansion tank.

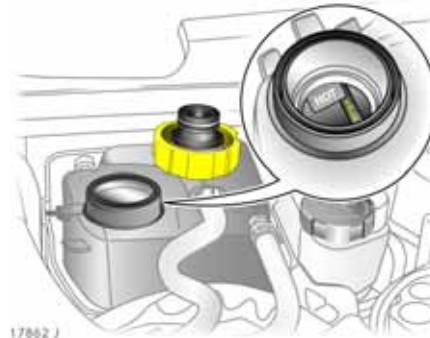

For V6 petrol and diesel engines, the expansion tank must be opened in order to check coolant level. When the cooling system is cold, the coolant should be up to the **COLD** mark on the filler opening.

Warning

Allow engine to cool down before removing coolant filler cap. Remove filler cap carefully so that pressure can escape slowly, otherwise there is a risk of scalding.

When the engine is at operating temperature, coolant level rises. It falls again when the system cools. If it falls below the **KALT/COLD** mark when the system is cold, top up to the mark.

Top up anti-freeze. If no anti-freeze is available, top up with clean tap water. If tap water is unavailable, distilled water can be used.

After filling with tap water or distilled water, measure the anti-freeze concentration and add anti-freeze if required. Have a workshop establish the cause of the coolant loss.

Too low a coolant level can cause engine damage.

To close, position the cap and screw it into place.

Coolant temperature

If the temperature gauge enters the right-hand (warning) zone or control indicator  illuminates, check the coolant level immediately.

■ Coolant level too low:

Top up coolant, noting the instructions given under "Anti-freeze and corrosion protection" and "Coolant level". Have the cause of the coolant loss rectified by a workshop.

■ Coolant level OK:

Have the cause of the elevated coolant temperature rectified. Contact a workshop.



Brake fluid

Brake fluid level

 **Warning**

Brake fluid is poisonous and corrosive. Do not allow it to come into contact with eyes, skin, fabric or painted surfaces. Direct contact could cause injury and damage.

The fluid level in the reservoir must be neither higher than the **MAX** mark nor lower than the **MIN** mark.

Use of certain brake fluids can lead to damage or reduced braking effect. We therefore recommend that you use only high performance approved brake fluid.

Extreme cleanliness is needed when topping up, since contamination in the brake fluid can cause brake system malfunctions.

After correcting the brake fluid level, have a workshop eliminate the cause of the brake fluid loss.

Brake fluid change

Brake fluid is hygroscopic, i.e. it absorbs water. If the brakes become hot, such as when driving on long downhill stretches, vapour bubbles can occur in the water, which can have an extremely adverse effect on braking power (depending on the proportion of water).

The fluid change intervals specified in the Service Booklet must therefore be observed.

 **Warning**

Have the brake fluid changed by a workshop. Observe the legal requirements for disposal of brake fluid to protect the environment and your health.

Windscreen wiper

Clear vision is essential for safe driving.

Perform regular checks on the windscreen wiper and headlight wash system * to ensure they are operating correctly. We recommend wiper blade replacement at least once a year.

If the windscreen is dirty, operate the windscreen wash system before switching on the windscreen wiper or setting the wiper to automatic operation with the rain sensor *. This will avoid wiper blade wear.

Do not switch on the windscreen wiper or set the wiper to automatic operation with the rain sensor * if the windscreen is iced up as this could damage the wiper blades or the wiper system.

If the wiper becomes frozen on to the glass, we recommend that it be released with the aid of De-icer Spray.

Smearing wiper blades can be cleaned with a soft cloth and Vauxhall Windscreen Wash Solvent.

Wiper blades whose lips have become hardened, cracked or covered with silicone must be replaced. This may be necessary as a result of the effects of ice, thawing salt or heat, or the incorrect use of cleaning agents.

Switch off the windscreen wiper or automatic wiper with rain sensor * in car washes - see pages 11, 264.

Windscreen wiper blade maintenance - see page 266.



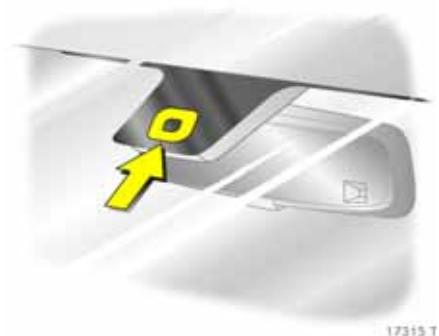

To ensure proper operation of the rain sensor ❄️, the sensor area must be free from dust, dirt and ice. The windscreen wash system must also be operated at regular intervals and the sensor area must be de-iced. Vehicles with rain sensor can be identified by the sensor area near the top of the windscreen.



Service setting for front windscreen wiper (e.g. for changing or cleaning the front wiper blades).

Within 8 seconds of switching off the engine but with the key in the starter switch, press the windscreen wiper stalk downwards. Release the stalk as soon as the wiper blades are vertical.

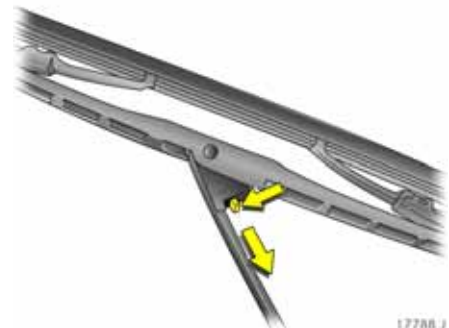

Wiper blades on the windscreen
Activating service position - see preceding column. Lift wiper arm. Press the release lever and detach the wiper blade.

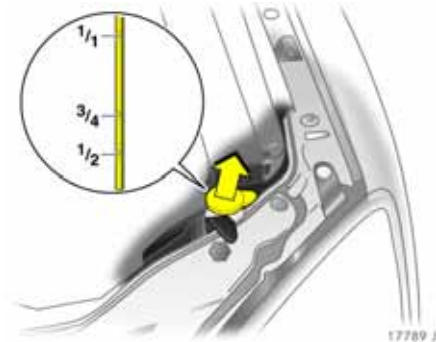

Windscreen and headlight wash systems ✱

The filler neck of the windscreen wash system and headlight wash system fluid container ✱ is at the front left of the engine compartment next to the battery. The fluid level in the reservoir can be read off from the level indicator. Do not fill above $\frac{1}{4}$.

Capacities – see page 308.

Fill only with clean water to prevent the nozzles from clogging. To improve cleaning efficiency, we recommend that you add a little Vauxhall Windscreen Wash Solvent.

The windscreen wash system and headlight wash system will not freeze in winter:

Frost protection down to	Mixture ratio of Vauxhall Windscreen Wash Solvent to Water
- 5 °C	1 : 3
- 10 °C	1 : 2
- 20 °C	1 : 1
- 30 °C	2 : 1

When closing the reservoir, press the lid firmly over the beaded edge all the way round.

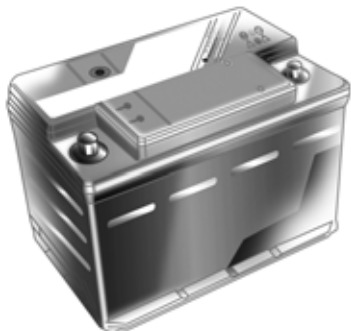

17320 T

Battery

The battery is maintenance-free.

Warning

Have the battery changed by a workshop. Observe the legal requirements for disposal of old batteries to protect the environment and your health.

Retro-fitting of electrical or electronic accessories can discharge or add extra load to the battery. Take advice on the technical possibilities, e.g. use of a more powerful battery.

Laying up the vehicle for more than 4 weeks can lead to battery discharge, which may reduce the service life of the battery. Disconnect battery from on-board power supply by detaching negative terminal.

The Vauxhall alarm system *siren must be deactivated as follows: switch the ignition on then off, disconnect the vehicle's battery within 15 seconds.

Ensure that ignition is switched off before connecting battery. Then perform the following actions:

- Setting date and time in the information display – see pages 110, 113, 118.
- Activate window and sunroof electronics *if necessary – see pages 47, 49.

In order to prevent the battery from discharging, some consumers such as the courtesy light automatically switch off after approx. 20 minutes.

Disconnecting/connecting the battery from/to the electrical system

Disconnect battery from vehicle power supply before charging: disconnect negative cable first, then the positive cable.

The polarity of the battery, i.e. the positive and negative terminal connections, must not be switched. Always connect the positive cable first, then the negative cable.

Protecting electronic components

In order to prevent faults in electronic components in the electrical system, never connect or disconnect battery with engine running or ignition switched on. Never start engine with battery disconnected, e.g. when starting using jump leads.

To avoid damaging the vehicle, do not make any modifications to the electrical system, e.g. connecting additional consumers or tampering with electronic control units (chip tuning).

Warning

Electronic ignition systems generate very high voltages. Do not touch the ignition system; high voltage can be fatal.

Vehicle decommissioning

Observe national regulations.

If the vehicle is to be parked for several months, to avoid damage have the following work performed by a workshop.

- Wash and preserve the vehicle – see page 264.
- Check corrosion protection in engine compartment and on underbody and repair if necessary.
- Clean and preserve rubber seals on bonnet and doors.
- Change engine oil – see page 273.
- Check anti-freeze and corrosion protection – see page 274.
- Check the coolant level, top up with anti-freeze if necessary – see page 275.
- Empty windscreen wash system and headlight wash system ✱.
- Increase tyre pressure to value specified for full load – see page 299.

Vehicle storage

- Park vehicle in dry, well ventilated place. With manual transmission or Easytronic ✱, engage 1st or reverse gear. With automatic transmission ✱, selector lever in P. Use chocks or the like to prevent the vehicle from rolling.
- Do not apply handbrake.
- Disconnect battery by disengaging negative terminal from vehicle electrical system – see page 280.

Vehicle recommissioning

Observe national regulations.

Perform the following work before recommissioning the vehicle:

- Connect battery – see page 280.
- Check tyre pressure and correct if necessary – see page 299.
- Fill up windscreen wash system and headlight wash system ✱ – see page 279.
- Check engine oil level – see page 272.
- Check the coolant level; top up with anti-freeze if necessary – see page 275.
- Fit the number plate if necessary.

Technical data

Vehicle documents, identification plate.....	282
Vehicle identification data.....	283
Coolant, brake fluid, oils.....	283
Engine data.....	284
Performance.....	286
Fuel consumption, CO ₂ emissions.....	288
Weights, payload and roof load.....	293
Tyres.....	299
Electrical system.....	307
Capacities.....	308
Dimensions.....	310



Vehicle documents, identification plate

The technical data is determined in accordance with European Community standards. We reserve the right to make modifications. Specifications in the vehicle documents always have priority over those given in this manual.

The identification plate is affixed to the front right door frame.



Information on identification plate:

- 1 Manufacturer
- 2 Type approval number
- 3 Vehicle Identification Number
- 4 Gross Vehicle Weight rating
- 5 Permissible Gross Train Weight
- 6 Maximum permissible front axle load
- 7 Maximum permissible rear axle load
- 8 Vehicle-specific or country-specific data



Vehicle identification data

The Vehicle Identification Number is stamped on the identification plate and beneath a cover on the floor of the vehicle between the front door and driver's seat.

In other model variants, the identification plate may also be affixed to the instrument panel.

Engine code and engine number: stamped on left-hand side of engine on crankcase.

Coolant, brake fluid, oils

Only use approved fluids.

Use of unsuitable fluids can cause serious damage to the vehicle.

Engine oils

Information on engine oils is found in the Service Booklet.

Engine data

Sales designation Engine identifier code	1.8 Z 18 XE	1.8 Z 18 XER	2.0 Turbo Z 20 NET	2.2 Z 22 SE	2.2 DIRECT Z 22 YH	2.8 V6 Z 28 NEL
Number of cylinders	4	4	4	4	4	6
Piston displacement (cm ³)	1796	1796	1998	2198	2198	2792
Engine power (kW) at rpm	90 6000	103 6300	129 5500	108 5600	114 5600	169 5500
Torque (Nm) at rpm	167 3800	175 3800	265 2500 to 3800	203 4000	220 3800	330 1800 to 4500
Type of fuel	Petrol	Petrol	Petrol	Petrol	Petrol	Petrol
Octane requirement (RON) ¹⁾ unleaded or unleaded or unleaded	95 98 ²⁾ 91 ²⁾³⁾	95 98 ²⁾ 91 ²⁾³⁾	95 98 ²⁾ 91 ²⁾⁴⁾	95 98 ²⁾ 91 ²⁾⁴⁾	95 ⁵⁾ 98 ²⁾ _6 ⁶⁾	95 98 ²⁾ 91 ²⁾³⁾
Max. permissible engine speed, continuous operation (rpm) approx.	6500	6500	6200	6500	6500	6700
Engine oil consumption (l/1 000 km)	0.6	0.6	0.6	0.6	0.6	0.6

¹⁾ Standard high-quality fuels, e.g. unleaded DIN EN 228; value printed in bold: recommended fuel.

²⁾ Knock control system automatically adjusts ignition timing according to type of fuel used (octane number).

³⁾ Slight reduction in engine output and torque if 91 RON is used.

⁴⁾ If no unleaded Premium fuel is available, 91 RON can be used taking care to avoid high engine load or full load as well as for driving in mountainous terrain with a caravan/trailer load or high payload.

⁵⁾ The use of fuel that is at least 95 RON is prescribed.

⁶⁾ 91 octane fuel must not be used.

Engine data

Sales designation Engine identifier code	2.8 V6 Z 28 NET	VXR Z 28 NET	1.9 CDTI Z 19 DTL	1.9 CDTI Z 19 DT	1.9 CDTI Z 19 DTH	3.0 CDTI Z 30 DT
Number of cylinders	6	6	4	4	4	6
Piston displacement (cm ³)	2792	2792	1910	1910	1910	2958
Engine power (kW) at rpm	184 5500	206 5500	74 3500	88 3500 to 4000	110 4000	135 4000
Torque (Nm) at rpm	350 1800 to 4500	355 1800 to 4500	260 1700 to 2500	280 2000 to 2750	320 2000 to 2750	400 1900 to 2700
Type of fuel	Petrol	Petrol	Diesel	Diesel	Diesel	Diesel
Octane requirement (RON) ¹⁾ unleaded or unleaded or unleaded	95 98 ²⁾ 91 ²⁾³⁾	95 ⁴⁾ 98 ²⁾ _ ⁵⁾	– – –	– – –	– – –	– – –
Cetane requirement (CN) ¹⁾	–	–	49 (D) ⁶⁾	49 (D) ⁴⁾	49 (D) ⁴⁾	49 (D) ⁴⁾
Max. permissible engine speed, continuous operation (rpm) approx.	6700	6700	5100	5100	5100	5000
Engine oil consumption (l/1000 km)	0.6	0.6	0.6	0.6	0.6	0.6

¹⁾ Standard high-quality fuels, e.g. unleaded DIN EN 228, Diesel DIN EN 590; D = Diesel; value printed in bold: recommended fuel.

²⁾ Knock control system automatically adjusts ignition timing according to type of fuel used (octane number).

³⁾ Slight reduction in engine output and torque if 91 RON is used.

⁴⁾ Slight reduction in engine output and torque if 95 RON is used.

⁵⁾ 91 octane fuel must not be used.

⁶⁾ A lower value is possible with winter fuels.

Performance

(approx. mph / km/h), Saloon / Hatch

Engine ¹⁾	Z 18 XE	Z 18 XER	Z 20 NET	Z 22 SE	Z 22 YH	Z 28 NEL
Maximum speed ²⁾						
Manual transmission	126/203	130/210	–	134/216	135/218	155/250
Sports transmission	127/205	130/210	143/230	–	135/218	–
Easytronic	–	129/207	–	–	–	–
Automatic transmission	–	–	–	130/210	130/210	155/250
Engine ¹⁾	Z 28 NET	Z 28 NET VXR	Z 19 DTL	Z 19 DT	Z 19 DTH	Z 30 DT
Maximum speed ²⁾						
Manual transmission	155/250 ³⁾	155/250 ³⁾	116/186	124/200	135/217	143/230
Sports transmission	–	–	–	–	–	–
Easytronic	–	–	–	–	–	–
Automatic transmission	155/250 ³⁾	155/250 ³⁾	–	–	130/210	140/226

1) Sales designation – see pages 284, 285.

2) The maximum speed indicated is achievable at kerbweight (without driver) plus 200 kg payload. Optional equipment could reduce the specified maximum speed of the vehicle.

3) The maximum speed is limited electronically.

Performance

(approx. mph / km/h), Estate

Engine ¹⁾	Z 18 XE	Z 18 XER	Z 20 NET	Z 22 YH	Z 28 NEL
Maximum speed ²⁾					
Manual transmission	–	126/203	–	130/210	152/245
Sports transmission	124/199	130/209	139/224	130/210	–
Easytronic	–	128/207	–	–	–
Automatic transmission	–	–	–	129/208	152/245

Engine ¹⁾	Z 28 NET	Z 28 NET VXR	Z 19 DTL	Z 19 DT	Z 19 DTH	Z 30 DT
Maximum speed ²⁾						
Manual transmission	155/250 ³⁾	155/250 ³⁾	113/182	121/195	130/210	140/225
Sports transmission	–	–	–	–	–	–
Easytronic	–	–	–	–	–	–
Automatic transmission	155/250 ³⁾	155/250 ³⁾	–	–	129/208	137/221

¹⁾ Sales designation – see pages 284, 285.

²⁾ The maximum speed indicated is achievable at kerbweight (without driver) plus 200 kg payload. Optional equipment could reduce the specified maximum speed of the vehicle.

³⁾ The maximum speed is limited electronically.

Fuel consumption, CO₂ emissions

Directive 80/1268/EEC (last changed by 2004/3/EC) has applied for the measurement of fuel consumption since 1996.

The directive is oriented to actual driving practices: Urban driving is rated at approx. $\frac{1}{3}$ and extra-urban driving with approx. $\frac{2}{3}$ (urban and extra-urban consumption). Cold starts and acceleration phases are also taken into consideration.

The specification of CO₂ emission is also a constituent of the directive.

The figures given must not be taken as a guarantee for the actual fuel consumption of a particular vehicle.

All values are based on the EU base model with standard equipment.

The calculation of fuel consumption as specified by directive 2004/3/EC takes account of the vehicle's kerbweight, ascertained in accordance with these regulations. Optional extras may result in slightly higher fuel consumption and CO₂ emission levels than those quoted.

To convert l/100 km into mpg, divide 282 by number of litres/100 km.

Saving fuel, protecting the environment – see page 186.

Fuel consumption (approx. l/100 km), **CO₂ emissions** (approx. g/km), **Saloon 4-door** (tyre width up to 225 mm)

Engine ¹⁾	Z 18 XE	Z 18 XER	Z 20 NET	Z 22 SE	Z 22 YH	
Manual/sports/Easytronic/automatic transmission						
urban	10.4/10.7/-/-	10.1/ 9.9/ 9.7/-	-/12.5/-/-	- /11.4/-/13.3	10.3/10.3/-/11.3	
extra-urban	5.5/ 5.8/-/-	5.5/ 5.6/ 5.4/-	-/ 6.3/-/-	- / 6.2/-/ 6.5	6.0/ 5.9/-/ 6.1	
total	7.3/ 7.6/-/-	7.2/ 7.2/ 7.0/-	-/ 8.6/-/-	- / 8.1/-/ 9.0	7.6/ 7.5/-/ 8.0	
CO ₂	175/ 182/-/-	173/173/168/-	-/ 206/-/-	- / 194/-/ 216	182/ 180/-/ 192	
Engine ¹⁾	Z 28 NEL	Z 28 NET	Z 19 DTL	Z 19 DT	Z 19 DTH	Z 30 DT
Manual/sports/Easytronic/automatic transmission						
urban	15.4/-/-/17.1	15.4/-/-/17.1	7.4/-/-/-	7.4/-/-/-	7.4/-/-/ 9.4	9.8/-/-/10.2
extra-urban	7.3/-/-/ 7.3	7.3/-/-/ 7.3	4.7/-/-/-	4.7/-/-/-	4.7/-/-/ 5.3	5.2/-/-/ 5.3
total	10.3/-/-/10.9	10.3/-/-/10.9	5.7/-/-/-	5.7/-/-/-	5.7/-/-/ 6.8	6.9/-/-/ 7.1
CO ₂	247/-/-/ 262	247/-/-/ 262	154/-/-/-	154/-/-/-	154/-/-/184	186/-/-/ 192

Fuel consumption (approx. l/100 km), **CO₂ emissions** (approx. g/km), **Saloon 4-door** (tyre width up to 235 mm)

Engine ¹⁾	Z 18 XE	Z 18 XER	Z 20 NET	Z 22 SE	Z 22 YH	
Manual/sports/Easytronic/automatic transmission						
urban	10.5/10.8/-/-	10.2/10.0/9.8/-	-/12.6/-/-	- /11.5/-/13.4	10.4/10.4/-/11.4	
extra-urban	5.6/ 5.9/-/-	5.6/ 5.7/ 5.5/-	-/ 6.4/-/-	- / 6.3/-/ 6.6	6.1/ 6.0/-/ 6.2	
total	7.4/ 7.7/-/-	7.3/ 7.3/ 7.1/-	-/ 8.7/-/-	- / 8.2/-/ 9.1	7.7/ 7.6/-/ 8.1	
CO ₂	178/ 185/-/-	175/ 175/170/-	-/209/-/-	- / 197/-/ 218	185/ 182/-/194	
Engine ¹⁾	Z 28 NEL	Z 28 NET	Z 19 DTL	Z 19 DT	Z 19 DTH	Z 30 DT
Manual/sports/Easytronic/automatic transmission						
urban	15.5/-/-/17.2	15.5/-/-/17.2	7.5/-/-/-	7.5/-/-/-	7.5/-/-/ 9.5	9.9/-/-/10.3
extra-urban	7.4/-/-/ 7.4	7.4/-/-/ 7.4	4.8/-/-/-	4.8/-/-/-	4.8/-/-/ 5.4	5.3/-/-/ 5.4
total	10.4/-/-/11.0	10.4/-/-/11.0	5.8/-/-/-	5.8/-/-/-	5.8/-/-/ 6.9	7.0/-/-/ 7.2
CO ₂	250/-/-/264	250/-/-/264	157/-/-/-	157/-/-/-	157/-/-/186	189/-/-/ 194

¹⁾ Sales designation – see pages 284, 285.

Fuel consumption (approx. l/100 km), **CO₂ emissions** (approx. g/km), **Hatch 5-door** (tyre width up to 225 mm)

Engine¹⁾	Z 18 XE	Z 18 XER	Z 20 NET	Z 22 SE
Manual/sports/Easytronic/automatic transmission				
urban	10.4/10.7/-/-	10.1/9.9/9.7/-	-/12.5/-/-	-/11.4/-/13.3
extra-urban	5.5/ 5.8/-/-	5.5/ 5.6/5.4/-	-/ 6.3/-/-	-/ 6.2/-/ 6.5
total	7.3/ 7.6/-/-	7.2/ 7.2/7.0/-	-/ 8.6/-/-	-/ 8.1/-/ 9.0
CO ₂	175/ 182/-/-	173/173/168/-	-/206/-/-	-/ 194/-/ 216
Engine¹⁾	Z 22 YH	Z 28 NEL	Z 28 NET	Z 28 NET VXR
Manual/sports/Easytronic/automatic transmission				
urban	10.3/10.3/-/11.3	15.4/-/-/17.1	15.4/-/-/17.1	15.4/-/-/2)
extra-urban	6.0/ 5.9/-/ 6.1	7.3/-/-/ 7.3	7.3/-/-/ 7.3	7.3/-/-/2)
total	7.6/ 7.5/-/ 8.0	10.3/-/-/10.9	10.3/-/-/10.9	10.3/-/-/2)
CO ₂	182/ 180/-/ 192	247/-/-/ 262	247/-/-/262	247/-/-/2)
Engine¹⁾	Z 19 DTL	Z 19 DT	Z 19 DTH	Z 30 DT
Manual/sports/Easytronic/automatic transmission				
urban	7.4/-/-/-	7.4/-/-/-	7.4/-/-/ 9.5	9.8/-/-/10.2
extra-urban	4.7/-/-/-	4.7/-/-/-	4.7/-/-/ 5.4	5.2/-/-/ 5.3
total	5.7/-/-/-	5.7/-/-/-	5.7/-/-/ 6.9	6.9/-/-/ 7.1
CO ₂	154/-/-/-	154/-/-/-	154/-/-/186	186/-/-/ 192

¹⁾ Sales designation – see pages 284, 285.

²⁾ Values not available at time of printing.

Fuel consumption (approx. l/100 km), **CO₂ emissions** (approx. g/km), **Hatch 5-door** (tyre width up to 235 mm)

Engine ¹⁾	Z 18 XE	Z 18 XER	Z 20 NET	Z 22 SE
Manual/sports/Easytronic/automatic transmission				
urban	10.5/10.8/-/-	10.2/10.0/9.8/-	-/12.6/-/-	-/11.5/-/13.4
extra-urban	5.6/ 5.9/-/-	5.6/ 5.7/5.5/-	-/ 6.4/-/-	-/ 6.3/-/ 6.6
total	7.4/ 7.7/-/-	7.3/ 7.3/7.1/-	-/ 8.7/-/-	-/ 8.2/-/ 9.1
CO ₂	178/ 185/-/-	175/ 175/170/-	-/ 209/-/-	-/ 197/-/ 218
Engine ¹⁾	Z 22 YH	Z 28 NEL	Z 28 NET	Z 28 NET VXR
Manual/sports/Easytronic/automatic transmission				
urban	10.4/10.4/-/11.4	15.5/-/-/17.2	15.5/-/-/17.2	15.4/-/- ²⁾
extra-urban	6.1/ 6.0/-/ 6.2	7.4/-/-/ 7.4	7.4/-/-/ 7.4	7.3/-/- ²⁾
total	7.7/ 7.6/-/ 8.1	10.4/-/-/11.0	10.4/-/-/11.0	10.3/-/- ²⁾
CO ₂	185/ 182/-/ 194	250/-/-/ 264	250/-/-/ 264	247/-/- ²⁾
Engine ¹⁾	Z 19 DTL	Z 19 DT	Z 19 DTH	Z 30 DT
Manual/sports/Easytronic/automatic transmission				
urban	7.5/-/-/-	7.5/-/-/-	7.5/-/-/ 9.6	9.9/-/-/10.3
extra-urban	4.8/-/-/-	4.8/-/-/-	4.8/-/-/ 5.5	5.3/-/-/ 5.4
total	5.8/-/-/-	5.8/-/-/-	5.8/-/-/ 7.0	7.0/-/-/ 7.2
CO ₂	157/-/-/-	157/-/-/-	157/-/-/189	189/-/-/ 194

¹⁾ Sales designation – see pages 284, 285.

²⁾ Values not available at time of printing.

Fuel consumption (approx. l/100 km), **CO₂ emissions** (approx. g/km), **Estate** (tyre width up to 225 mm)

Engine ¹⁾	Z 18 XE	Z 18 XER	Z 20 NET	Z 22 YH	Z 28 NEL	
Manual/sports/Easytronic/automatic transmission						
urban	-/11.0/-/	10.3/10.4/10.0/-	-/12.7/-/	10.6/10.6/-/11.5	15.5/-/17.4	
extra-urban	-/ 6.1/-/	5.9/ 6.1/ 5.7/-	-/ 6.5/-/	6.3/ 6.2/-/ 6.3	7.4/-/ 7.6	
total	-/ 7.9/-/	7.5/ 7.7/ 7.3/-	-/ 8.8/-/	7.9/ 7.8/-/ 8.2	10.4/-/11.2	
CO ₂	-/ 190/-/	180/ 185/ 175/-	-/ 211/-/	190/ 187/-/ 197	250/-/269	
Engine ¹⁾	Z 28 NET	Z 28 NET VXR	Z 19 DTL	Z 19 DT	Z 19 DTH	Z 30 DT
Manual/sports/Easytronic/automatic transmission						
urban	15.5/-/17.4	15.5/-/2)	7.5/-/	7.5/-/	7.5/-/9.6	9.8/-/10.3
extra-urban	7.4/-/ 7.6	7.4/-/2)	4.8/-/	4.8/-/	4.8/-/5.5	5.2/-/ 5.4
total	10.4/-/11.2	10.4/-/2)	5.8/-/	5.8/-/	5.8/-/7.0	6.9/-/ 7.2
CO ₂	250/-/269	250/-/2)	157/-/	157/-/	157/-/189	186/-/ 194

Fuel consumption (approx. l/100 km), **CO₂ emissions** (approx. g/km), **Estate** (tyre width up to 235 mm)

Engine ¹⁾	Z 18 XE	Z 18 XER	Z 20 NET	Z 22 YH	Z 28 NEL	
Manual/sports/Easytronic/automatic transmission						
urban	-/11.1/-/	10.4/10.5/10.1/-	-/12.8/-/	10.7/10.7/-/11.6	15.6/-/17.5	
extra-urban	-/ 6.2/-/	6.0/ 6.2/ 5.8/-	-/ 6.6/-/	6.4/ 6.3/-/ 6.4	7.5/-/ 7.7	
total	-/ 8.0/-/	7.6/ 7.8/ 7.4/-	-/ 8.9/-/	8.0/ 7.9/-/ 8.3	10.5/-/11.3	
CO ₂	-/ 192/-/	182/ 187/ 178/-	-/ 214/-/	192/ 190/-/ 199	252/-/271	
Engine ¹⁾	Z 28 NET	Z 28 NET VXR	Z 19 DTL	Z 19 DT	Z 19 DTH	Z 30 DT
Manual/sports/Easytronic/automatic transmission						
urban	15.6/-/17.5	15.5/-/2)	7.6/-/	7.6/-/	7.6/-/9.7	9.9/-/10.4
extra-urban	7.5/-/ 7.7	7.4/-/2)	4.9/-/	4.9/-/	4.9/-/5.6	5.3/-/ 5.5
total	10.5/-/11.3	10.4/-/2)	5.9/-/	5.9/-/	5.9/-/7.1	7.0/-/ 7.3
CO ₂	252/-/271	250/-/2)	159/-/	159/-/	159/-/192	189/-/ 197

¹⁾ Sales designation – see pages 284, 285.

²⁾ Values not available at time of printing.

Weights, payload and roof load

The payload is the difference between the permitted Gross Vehicle Weight (see identification plate on page 282) and the EC kerbweight.

To calculate the kerbweight, enter the data for your vehicle below:

- Kerbweight from Table 1, pages 294 to 296 + kg
 - Additional weight of equipment versions from Table 2, page 297 + kg
 - Weight of heavy accessories from Table 3, page 298 + kg
- Total = kg

is the EC kerbweight.

Optional equipment and accessories increase the kerbweight, which means that the payload will also change slightly.

Pay attention to weight ranges in vehicle documents and on identification plate.

The combined total of front and rear axle loads must not exceed the permissible Gross Vehicle Weight. For example, if the front axle is bearing its maximum permissible load, the rear axle can only bear a load that is equal to the Gross Vehicle Weight minus the front axle load.

When the caravan/trailer is coupled and the towing vehicle fully loaded (including all occupants), the permissible rear axle load (see identification plate or vehicle documents) may be exceeded by 40 kg. If the permissible rear axle load is exceeded, a maximum speed of 60 mph (100 km/h) applies. If national regulations specify a lower maximum speed for vehicles towing a caravan/trailer, this must be observed.

See the identification plate or vehicle documents for permissible axle loads.

Roof load

The permissible roof load is 90 kg, and 100 kg for Estate with roof railing*. The roof load is the combined weight of the roof rack and the load.

Driving hints – see page 184.

Roof rack – see page 218.

Weights (kg): Table 1, Kerbweight¹⁾, Saloon

Model	Engine ²⁾	4-door		
		Manual transmission	Easytronic	Automatic transmission
Vectra with Electronic Climate Control ✱	Z 18 XE	1395	–	–
	Z 18 XER	1395	1395	–
	Z 20 NET	1505	–	–
	Z 22 SE	1460	–	1490
	Z 22 YH	1460	–	1490
	Z 28 NEL	1565	–	1590
	Z 28 NET	1565	–	1590
	Z 19 DTL	1505	–	–
	Z 19 DT	1505	–	–
	Z 19 DTH	1503	–	1523
	Z 30 DT	1635	–	1660

¹⁾ According to EC Directive, including assumed weights for driver (68 kg), luggage (7 kg) and all fluids (tank 90% full).

²⁾ Sales designation – see pages 284, 285.

Weights (kg): Table 1, Kerbweight¹⁾, Hatch

Model	Engine ²⁾	5-door		
		Manual transmission	Easytronic	Automatic transmission
Vectra with Electronic Climate Control*	Z 18 XE	1393	–	–
	Z 18 XER	1393	1393	–
	Z 20 NET	1503	–	–
	Z 22 SE	1475	–	1505
	Z 22 YH	1475	–	1505
	Z 28 NEL	1580	–	1605
	Z 28 NET	1580	–	1605
	Z 19 DTL	1503	–	–
	Z 19 DT	1503	–	–
	Z 19 DTH	1523	–	1548
	Z 30 DT	1650	–	1675

¹⁾ According to EC Directive, including assumed weights for driver (68 kg), luggage (7 kg) and all fluids (tank 90% full).

²⁾ Sales designation – see pages 284, 285.

Weights (kg): Table 1, Kerbweight¹⁾, Estate

Model	Engine ²⁾	Estate		
		Manual transmission	Easytronic	Automatic transmission
Vectra with Electronic Climate Control *	Z 18 XE	1475	–	–
	Z 18 XER	1475	1475	–
	Z 20 NET	1570	–	–
	Z 22 YH	1523	–	1553
	Z 28 NEL	1613	–	1638
	Z 28 NET	1613	–	1638
	Z 19 DTL	1585	–	–
	Z 19 DT	1585	–	–
	Z 19 DTH	1600	–	1613
	Z 30 DT	1685	–	1710

¹⁾ According to EC Directive, including assumed weights for driver (68 kg), luggage (7 kg) and all fluids (tank 90% full).

²⁾ Sales designation – see pages 284, 285.

Weights (kg): Table 2, Additional weight of equipment versions
Saloon / Hatch

Engine¹⁾	Z 18 XE, Z 18 XER	Z 20 NET	Z 22 SE	Z 22 YH	Z 28 NEL	Z 28 NET
Life	16	16	16	16	16	16
Exclusiv	32	32	32	32	32	32
Design/Elite	31	31	31	31	31	31
SRi	28	28	28	28	28	28

Engine¹⁾		Z 19 DTL	Z 19 DT	Z 19 DTH	Z 30 DT
Life		16	16	16	6
Exclusiv		32	32	32	22
Design/Elite		31	31	31	21
SRi		28	28	28	26

Estate

Engine¹⁾	Z 18 XE, Z 18 XER	Z 20 NET	Z 22 YH	Z 28 NEL	Z 28 NET	Z 19 DTL	Z 19 DT	Z 19 DTH	Z 30 DT
Life	5	5	5	5	5	5	5	5	3
Exclusiv	22	22	22	22	22	22	22	22	20
Design/Elite	27	27	27	27	27	27	27	27	25
SRi	23	23	23	23	23	23	23	23	26

¹⁾ Sales designation – see pages 284, 285.

Weights (kg), Table 3, Heavy accessories

Saloon / Hatch

Accessories	Sunroof	Towing equipment
Weight	17	23

Estate

Accessories	Sunroof	Towing equipment
Weight	18	33

Tyres

Not all tyres available on the market currently meet the structural requirements. We recommend that you consult a Vauxhall Authorised Repairer concerning suitable tyre makes.

These tyres have undergone special tests to establish their reliability, safety and specific suitability for Vauxhall vehicles.

Despite continuous market monitoring, we are unable to assess these attributes for other tyres, even if they have been granted approval by the relevant authorities or in some other form.

Further information – see page 211.

Winter tyres *

Tyres of size 215/50 R 17, 225/45 R 18 and 235/35 R 19 are not to be used as winter tyres.

Only the winter tyres specified on page 306 may be used on vehicles factory-fitted with 235/35 R 19 tyres.

For Vectra VXR, tyres of size 225/45 R 17 on a Vauxhall-approved alloy wheel with designation 7x17, ET39 as well as tyres of size 235/40 R 18 are permissible as winter tyres.

If winter tyres are in use, the spare wheel may still be fitted with a summer tyre. Use of the spare wheel may alter vehicle handling. Obtain a replacement for the faulty tyre as soon as possible, and have the wheel balanced and fitted to the vehicle.

Further information – see page 216.

Tyre chains *

Tyre chains may be used on the front wheels only.

We recommend the use of fine-link tyre chains which amount to max 10 mm on the tread and tyre inner wall with chain lock

Tyre chains are not permitted on tyre sizes 115/70 R 16, 215/50 R 17, 225/45 R 18, 235/40 R 18 and 235/35 R 19.

Further information – see page 217.

Wheels

Wheel bolt tightening torque: 110 Nm.

Spare wheel *

On vehicles with alloy wheels * the spare wheel may have a steel rim.

Depending on the model variant, the spare wheel is designed to be an emergency wheel *: Using a spare wheel may change the vehicle's handling. Replace defective tyres as quickly as possible, balance wheel and fit to vehicle.

The spare wheel may be fitted with a smaller tyre¹⁾ and a smaller rim than the wheels fitted to the vehicle: Using the spare wheel may change the vehicle's handling.

Tyre pressure in psi/bar²⁾

The specified tyre pressures are valid for cold tyres. The increased tyre pressure resulting from extensive driving must not be reduced. The tyre pressures specified on the following pages apply to both summer and winter tyres.

Always inflate the spare wheel to the tyre pressure for full load - see tables on following pages.

Temporary spare wheel tyre pressure * – see tables on the following pages.

In vehicles with tyre pressure monitoring system * there is an adapter in the valve cap key. Screw a dapter to valve before attaching tyre pressure gauge – see page 213.

Further information – see pages 211 to 217.

¹⁾ Country-specific version: The spare wheel is only to be used as a temporary spare wheel.
²⁾ 1 bar corresponds to 100 kPa / 14.5 psi.

(ctd.)
Tyre pressure in psi/bar

Saloon / Hatch		Tyre pressure for load of up to 3 people		Tyre pressure ECO ¹⁾ loaded with up to 3 people		Tyre pressure for full load	
Engine ²⁾	Tyres	Front	Rear	Front	Rear	Front	Rear
Z 18 XE, Z 18 XER	195/65 R 15, 205/55 R 16, 215/55 R 16, 215/50 R 17, 225/45 R 17, 225/45 R 18	29/2.0	32/2.2	35/2.4	38/2.6	35/2.4	42/2.9
Z 20 NET	205/55 R 16 ³⁾	35/2.4	35/2.4	–	–	36/2.5	44/3.0
	215/55 R 16, 215/50 R 17, 225/45 R 17, 225/45 R 18	33/2.3	33/2.3	38/2.6	38/2.6	35/2.4	42/2.9
Z 22 SE, Z 22 YH	195/65 R 15, 205/55 R 16	33/2.3	33/2.3	–	–	35/2.4	42/2.9
	215/55 R 16, 215/50 R 17, 225/45 R 17, 225/45 R 18	32/2.2	32/2.2	36/2.5	36/2.5	33/2.3	41/2.8
all	T 115/70 R 16 ⁴⁾	61/4.2	61/4.2	–	–	61/4.2	61/4.2

1) To reduce fuel consumption as much as possible.

2) Sales designation – see pages 284, 285.

3) Only permitted as winter tyres.

4) For notes on the temporary spare wheel – see page 237.

(ctd.)
Tyre pressure in psi/bar

Saloon / Hatch		Tyre pressure for load of up to 3 people		Tyre pressure for full load	
Engine ¹⁾	Tyres	Front	Rear	Front	Rear
Z 28 NEL, Z 28 NET	215/55 R 16 ²⁾	35/2.4	35/2.4	38/2.6	45/3.1
	215/50 R 17 ²⁾ , 225/45 R 17 ²⁾ , 225/45 R 18 ²⁾	38/2.6	35/2.4	41/2.8	48/3.3
	215/55 R 16 ³⁾	36/2.5	33/2.3	39/2.7	46/3.2
	215/50 R 17 ³⁾ , 225/45 R 17 ³⁾ , 225/45 R 18 ³⁾	39/2.7	35/2.4	42/2.9	49/3.4
Vectra VXR	235/35 R 19, 235/40 R 18	42/2.9	38/2.6	45/3.1	51/3.5
	225/45 R 17 ⁴⁾	41/2.8	36/2.5	44/3.0	51/3.5
all	T 115/70 R 16 ⁵⁾	61/4.2	61/4.2	61/4.2	61/4.2

1) Sales designation – see pages 284, 285.

2) Version with manual transmission.

3) Version with automatic transmission.

4) Only permitted as winter tyres on Vauxhall-approved alloy wheels.

5) For notes on the temporary spare wheel – see page 237.

(ctd.)
Tyre pressure in psi/bar

Saloon / Hatch		Tyre pressure for load of up to 3 people		Tyre pressure ECO ¹⁾ loaded with up to 3 people		Tyre pressure for full load	
Engine ²⁾	Tyres	Front	Rear	Front	Rear	Front	Rear
Z 19 DTL, Z 19 DTH	195/65 R 15, 205/55 R 16	35/2.4	35/2.4	–	–	36/2.5	44/3.0
	215/55 R 16, 215/50 R 17, 225/45 R 17, 225/45 R 18	33/2.3	33/2.3	38/2.6	38/2.6	35/2.4	42/2.9
Z 19 DT	195/65 R 15, 205/55 R 16	33/2.3	33/2.3	–	–	35/2.4	42/2.9
	215/55 R 16, 215/50 R 17, 225/45 R 17, 225/45 R 18	32/2.2	32/2.2	36/2.5	36/2.5	33/2.3	41/2.8
Z 30 DT	215/55 R 16,	36/2.5	33/2.3	–	–	39/2.7	46/3.2
	215/50 R 17, 225/45 R 18	38/2.6	35/2.4	–	–	39/2.7	46/3.2
	225/45 R 17	39/2.7	35/2.4	–	–	41/2.8	48/3.3
all	T 115/70 R 16 ³⁾	61/4.2	61/4.2	–	–	61/4.2	61/4.2

1) To reduce fuel consumption as much as possible.

2) Sales designation – see pages 284, 285.

3) For notes on the temporary spare wheel – see page 237.

(ctd.)
Tyre pressure in psi/bar

Estate		Tyre pressure for load of up to 3 people		Tyre pressure ECO ¹⁾ loaded with up to 3 people		Tyre pressure for full load	
Engine ²⁾	Tyres	Front	Rear	Front	Rear	Front	Rear
Z 18 XE, Z 18 XER	195/65 R 15, 205/55 R 16, 215/55 R 16, 215/50 R 17, 225/45 R 17, 225/45 R 18	29/2.0	32/2.2	35/2.4	38/2.6	35/2.4	42/2.9
Z 20 NET	205/55 R 16 ³⁾	35/2.4	35/2.4	–	–	36/2.5	44/3.0
	215/55 R 16, 215/50 R 17, 225/45 R 17, 225/45 R 18	33/2.3	33/2.3	38/2.6	38/2.6	35/2.4	42/2.9
Z 22 YH, Z 22 SE	195/65 R 15 ³⁾ , 205/55 R 16	33/2.3	33/2.3	–	–	35/2.4	42/2.9
	215/55 R 16, 215/50 R 17, 225/45 R 17, 225/45 R 18	32/2.2	32/2.2	36/2.5	36/2.5	33/2.3	41/2.8
all	T 115/70 R 16 ⁴⁾	61/4.2	61/4.2	–	–	61/4.2	61/4.2

1) To reduce fuel consumption as much as possible.

2) Sales designation – see pages 284, 285.

3) Only permitted as winter tyres.

4) For notes on the temporary spare wheel – see page 237.

(ctd.)
Tyre pressure in psi/bar

Estate	Engine ¹⁾	Tyres	Tyre pressure for load of up to 3 people		Tyre pressure for full load	
			Front	Rear	Front	Rear
Z 28 NEL, Z 28 NET		215/55 R 16 ²⁾	36/2.5	33/2.3	39/2.7	46/3.2
		215/50 R 17 ²⁾ , 225/45 R 17 ²⁾ , 225/45 R 18 ²⁾	39/2.7	35/2.4	42/2.9	49/3.4
		215/55 R 16 ³⁾	38/2.6	35/2.4	41/2.8	48/3.3
		215/50 R 17 ³⁾ , 225/45 R 18 ³⁾	39/2.7	35/2.4	42/2.9	49/3.4
		225/45 R 17 ³⁾	41/2.8	36/2.5	44/3.0	51/3.5
Vectra VXR		235/35 R 19, 235/40 R 18	42/2.9	38/2.6	45/3.1	51/3.5
		225/45 R 17 ⁴⁾	41/2.8	36/2.5	44/3.0	51/3.5
all		T 115/70 R 16 ⁵⁾	61/4.2	61/4.2	61/4.2	61/4.2

1) Sales designation - see pages 284, 285.

2) Version with manual transmission.

3) Version with automatic transmission.

4) Only permitted as winter tyres on Vauxhall-approved alloy wheels.

5) For notes on the temporary spare wheel - see page 237.

(ctd.)
Tyre pressure in psi/bar

Estate		Tyre pressure for load of up to 3 people		Tyre pressure ECO ¹⁾ loaded with up to 3 people		Tyre pressure for full load	
Engine ²⁾	Tyres	Front	Front	Rear	Rear	Front	Rear
Z 19 DTL, Z 19 DTH	195/65 R 15, 205/55 R 16	35/2.4	35/2.4	–	–	36/2.5	44/3.0
	215/55 R 16, 215/50 R 17, 225/45 R 17, 225/45 R 18	33/2.3	33/2.3	38/2.6	38/2.6	35/2.4	42/2.9
Z 19 DT	195/65 R 15, 205/55 R 16	33/2.3	33/2.3	–	–	35/2.4	42/2.9
	215/55 R 16, 215/50 R 17, 225/45 R 17, 225/45 R 18	32/2.2	32/2.2	36/2.5	36/2.5	33/2.3	41/2.8
Z 30 DT	215/55 R 16	36/2.5	33/2.3	–	–	39/2.7	46/3.2
	215/50 R 17, 225/45 R 18	38/2.6	35/2.4	–	–	39/2.7	46/3.2
	225/45 R 17	39/2.7	35/2.4	–	–	41/2.8	48/3.3
all	T 115/70 R 16 ³⁾	61/4.2	61/4.2	61/4.2	61/4.2	61/4.2	61/4.2

1) To reduce fuel consumption as much as possible.

2) Sales designation – see pages 284, 285.

3) For notes on the temporary spare wheel - see page 237.

(ctd.)
Tyre pressure in psi/bar

Saloon / Hatch, Estate with 19-inch wheels		Tyre pressure for load of up to 3 people		Tyre pressure for full load	
Engine ¹⁾	Tyres	Front	Rear	Front	Rear
Z 18 XE, Z 18 XER, Z 22 SE, Z 22 YH	235/35 R 19	39/2.7	35/2.4	41/2.8	48/3.3
	215/55 R 16 ²⁾ , 225/45 R 17 ²⁾ , 205/50 R 17 ²⁾	33/2.3	33/2.3	36/2.5	44/3.0
Z 20 NET, Z 19 DTL, Z 19 DTH	235/35 R 19	39/2.7	35/2.4	41/2.8	48/3.3
	215/55 R 16 ²⁾ , 225/45 R 17 ²⁾	33/2.3	33/2.3	36/2.5	44/3.0
	205/50 R 17 ²⁾	39/2.7	35/2.4	41/2.8	48/3.3
Z 28 NEL, Z 28 NET	235/35 R 19	42/2.9	38/2.6	45/3.1	51/3.5
	215/55 R 16 ²⁾ , 225/45 R 17 ²⁾	41/2.8	36/2.5	44/3.0	51/3.5
	205/50 R 17 ²⁾	42/2.9	38/2.6	45/3.1	51/3.5
Z 30 DT	235/35 R 19	42/2.9	38/2.6	45/3.1	51/3.5
	215/55 R 16 ²⁾ , 225/45 R 17 ²⁾	39/2.7	36/2.5	42/2.9	49/3.4
	205/50 R 17 ²⁾	42/2.9	38/2.6	45/3.1	51/3.5
all	T 115/70 R 16 ³⁾	61/4.2	61/4.2	61/4.2	61/4.2

1) Sales designation - see pages 284, 285.

2) Only permitted as winter tyres.

3) For notes on the temporary spare wheel - see page 237.

Electrical system

Battery	Voltage	12 Volt
	Amp hours	55 Ah / 60 Ah * / 66 Ah * / 70 Ah * / 72 Ah * / 85 Ah *

Battery for remote control of central locking system	CR 20 32
--	----------

Battery for remote control of auxiliary heater/ventilation	AAA LR 06
--	-----------

308 Technical data

Capacities

(approx. litres)

Engine ¹⁾	Z 18 XE	Z 18 XER	Z 20 NET	Z 22 SE	Z 22 YH	Z 28 NEL, Z 28 NET
Fuel tank (nominal content)						
Saloon / Hatch	61	61	61	61	61	61
Estate	60	60	60	60	60	60
Engine oil with filter change	4.25	4.5	6.0	4.75	5.0	6.0
between MIN and MAX on dipstick	1.0	1.0	1.0	0.75	1.0	1.0
Windscreen wash reservoir	2.9	2.9	2.9	2.9	2.9	2.9
with headlight wash system	5.6	5.6	5.6	5.6	5.6	5.6

¹⁾ Sales designation – see pages 284, 285.

Capacities

(approx. litres)

Engine ¹⁾	Z 19 DTL	Z 19 DT	Z 19 DTH	Z 30 DT
Fuel tank (nominal content)				
Saloon / Hatch	61	61	61	61
Estate	60	60	60	60
Engine oil with filter change	4.3	4.3	4.3	7.5
between MIN and MAX on dipstick	1.0	1.0	1.0	1.0
Windscreen wash reservoir	2.9	2.9	2.9	2.9
with headlight wash system	5.6	5.6	5.6	5.6

¹⁾ Sales designation – see pages 284, 285.

310 Technical data

Dimensions

(approx. mm)

	Saloon / Hatch	Estate	Saloon / Hatch VXR	Estate VXR
Overall length	4611	4839	4642	4870
Overall width	1798	1798	1798	1798
Width with two exterior mirrors	2036	2036	2036	2036
Overall height ¹⁾	1460	1500	1460	1500
Length of luggage compartment floor	1047	1176	1047	1176
Luggage compartment width				
maximum	1396	1079	1396	1079
between the wheel arches	972	1060	972	1060
Height of luggage compartment opening	614 ²⁾	767	614	767
Wheelbase	2700	2830	2700	2830
Turning circle diameter ³⁾	11.50	11.50	11.50	11.50

¹⁾ At kerbweight with driver.

²⁾ 4-door Saloon 324 mm.

³⁾ In metres.

Installation dimensions of caravan/trailer towing equipment with removable coupling ball bar*, Saloon / Hatch

All dimensions refer to factory-fitted towing equipment.

Dimension	mm
A	334
B	1061
C	492.5
D	486.5
E	218
F	495
G	492.5
H	201

Warning

Only use towing equipment approved for your vehicle. We recommend entrusting retro-fitting of towing equipment to a workshop.

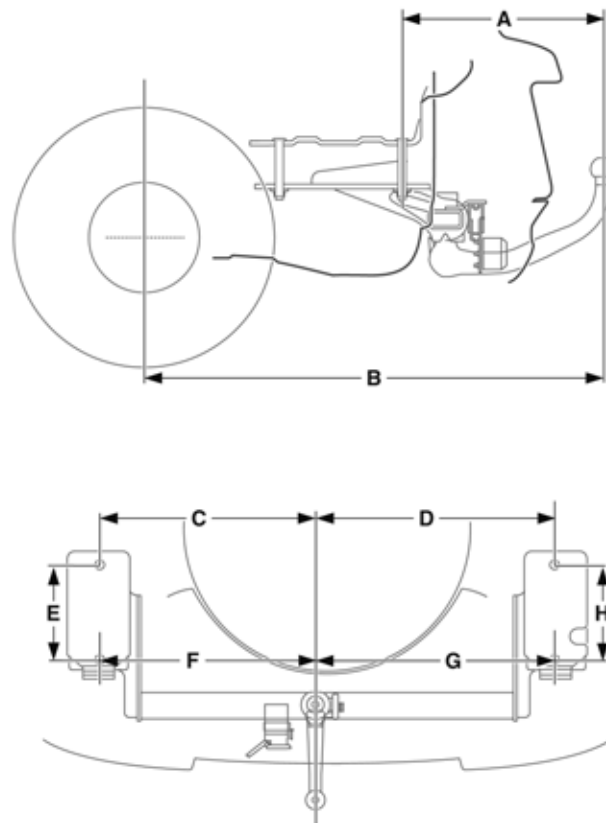

Installation dimensions of caravan/trailer towing equipment with pivoting coupling ball †, Estate

All dimensions refer to factory-fitted towing equipment.

Dimension	mm
A	396.5
B	157.5
C	386
D	74
E	630
F	590
G	491
H	486
I	480
J	379.5

Warning

Only use towing equipment approved for your vehicle. We recommend entrusting retro-fitting of towing equipment to a workshop.

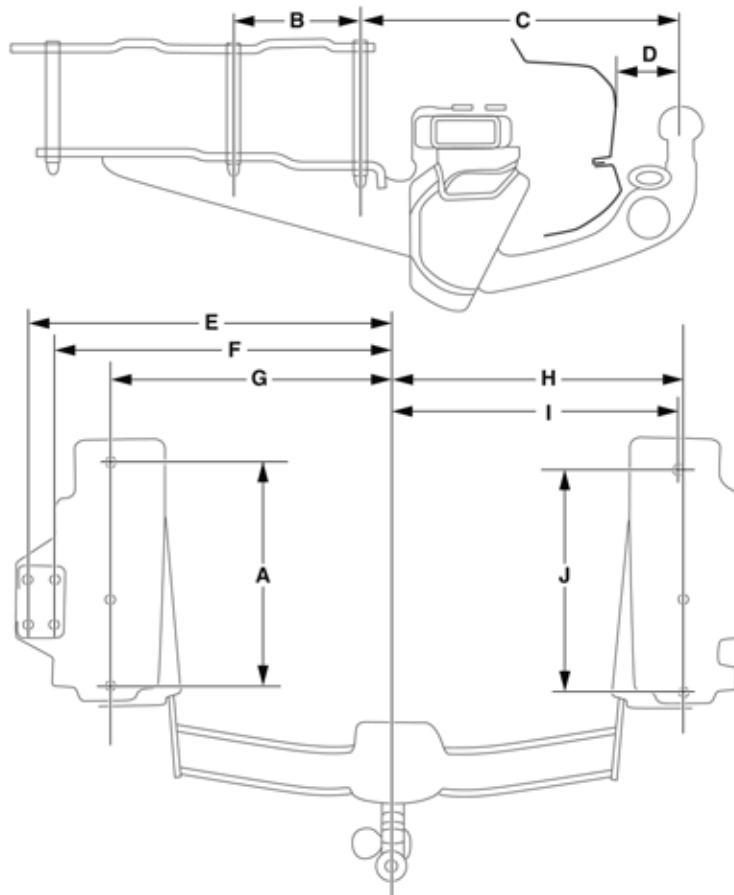

Index

A

- Accessories..... 77, 234
- Accessory socket 60, 93
- Adaptive brake light..... 208
- Adaptive Forward Lighting (AFL) 132, 133
 - Bulb replacement 257
 - Driving abroad..... 136
- Adjusting the incline
 - Seats 51
- Air conditioning system 140
- Air intake..... 166
- Air outlet 166
- Air quality sensor 157
- Air recirculation system 148, 153, 161
- Air vents 142
- Airbags..... 81
- Alarm 40
- Alarm system 38
- Alternator 99
- Antenna 137
- Anti-corrosion service..... 271
- Anti-freeze 274
- Anti-freeze protection..... 274, 279
- Anti-knock quality of fuel 188
 - Octane number..... 284, 285
- Anti-lock Brake System (ABS)..... 210
- Anti-theft alarm system 38
- Anti-theft locking system 30
- Anti-theft protection 16
- Aquaplaning..... 215
- Armrest 57
- Ashtray..... 94, 135
- Automatic air recirculation mode..... 161
- Automatic anti-dazzle interior mirror... 44
- Automatic level control system..... 204
- Automatic transmission..... 14
 - Automatic mode 177
 - Driving programmes 178
 - Fault 182
 - Interruption of power supply..... 183
 - Kickdown..... 180
 - Manual mode 178
 - Selector lever..... 14, 177, 178
 - Selector lever lock..... 177
 - Winter programme 180
- Automatic wiping 12, 127
- Auxiliary heating 163
 - Programming..... 164
 - Remote control 165

B

Battery	185, 280, 307
Interruption of	
power supply	47, 175, 183
Battery discharge protection.....	136
Before starting-off	15, 16, 126
Belt force limiters	73
Belt tensioners.....	73
Bleeding, diesel fuel system.....	228
Board Information Display	108
Bonnet	228
Boot, see Luggage compartment	34, 65
Brake assist	208
Brake light	208
Brake system	99
Brakes	
ABS	210
Brake assist	208
Brake fluid	276
Brake lights.....	258
Brake servo unit	184
Footbrake	208
Handbrake	209
Bulb replacement	252
Bulbs	252

C

Capacities	308
Car Pass	26
Caravan/trailer towing	184
Care	264
Catalytic converter.....	195, 229
CDC (Continuous Damping Control)....	198
Central locking system	30
Centre console lighting	135
Changing the battery	
Remote control	29, 165, 307
Changing tyre/wheel type	211
Changing wheels	238
Chassis number,	
see Vehicle Identification Number	283
Check control	20, 124
Child restraint system.....	77
Child safety locks.....	41, 46
Cigarette lighter	93, 135
Climate control	140
Climate control system	156
Clutch operation.....	185
CO ₂ emissions	287, 288
Cold start	185
Colour Information Display	108
Continuous Damping Control (CDC)....	198
Contrast.....	119

Control indicators.....	10, 98
Adaptive Forward Lighting	104, 133
Airbag	86
Anti-lock Brake System (ABS).....	210
Belt tensioners	74
Brake system.....	209
Engine electronics.....	192
Electronic Stability Programme	196
Exhaust.....	192
IDS+	199
Immobiliser.....	27
Parking distance sensors ..	202 133, 203
Tyre pressure monitoring system	207
Cool box.....	61
Coolant	274
Coolant level.....	275
Coolant temperature display.....	106
Cooled glove compartment	143
Cooling	149, 154
Correcting time.....	112, 118
Coupling socket load	224
Courtesy light	134
Courtesy lights	
Bulb replacement	262
Cruise control.....	200
Curtain airbags	85
Curve lighting (AFL)	22, 132

D

Dashboard, see Instrument panel 6
 Data 26, 282
 Date 110, 113
 Daytime running lights 128
 Decommissioning 281
 Demisting and defrosting
 Windows 147
 With climate control system..... 159
 With air conditioning system 150, 155
 Diesel fuel filter 274
 Diesel fuel system 228, 274
 Diesel particle filter..... 102, 143, 185, 194
 Dimensions..... 310
 Dipped beam 7
 Bulb replacement 253, 255
 Display 107, 108
 Display mode 120
 Door locks..... 26, 266
 Doors 100
 Door-to-door lighting..... 133
 Drink holders 97
 Driver's seat with climate control 144
 Driving abroad 188, 269
 Headlights 136
 Toll system 138
 Driving hints 184

E

Easytronic 14, 168
 Driving programmes 171
 Interruption of power supply 175
 Kickdown 172
 Selector lever..... 14
 Starting-off..... 170
 Winter programme..... 172
 Economical driving..... 186
 Electric seat adjustment..... 52
 Electric sunroof 47
 Electric windows 45
 Electrical system 246, 280, 307
 Electro-hydraulic power-assisted
 steering..... 10, 103, 184
 Electronic components 280
 Electronic immobiliser 27
 Electronic Stability Programme 196
 Engine code 283, 284, 285
 Engine control indicator..... 192
 Engine oil 272
 Engine oil change 273
 Engine oil level and consumption 103, 272
 Engine oil filter 273
 Engine oil pressure 98
 Engine speed 185
 Engine wash 266

Environmental protection 264, 273
 ESP (Electronic Stability Programme) .. 196
 Exhaust control indicator 192
 Exhaust gases..... 193
 Exhaust system 193
 Exterior mirrors 6, 43, 143

F

Fan..... 145, 152, 271
 Filling station
 Capacities..... 308, 309
 Engine oil level 272
 Fuel 188, 284, 285
 Opening the bonnet 228
 Tyre pressure..... 187, 299
 Vehicle data 283
 Windscreen wash system..... 279
 First-aid kit, 234
 Flat tyre 242
 FlexOrganizer 69
 Fog tail light..... 131
 Bulb replacement. 258
 Footbrake..... 208
 Front fog lights 130
 Bulb replacement. 258
 Front passenger's airbag..... 81
 Fuel 188, 284, 285
 Fuel consumption 186, 188, 287, 288
 Fuel filter..... 274
 Fuel gauge 106
 Fuel system, diesel..... 228
 Fuses 246

G

Gears 14
 Generator, see Alternator..... 99
 Genuine Vauxhall Parts
 and Accessories 271
 Glove compartment 95
 Cooled 143
 Glove compartment lighting 135
 Bulb replacement 263
 Graphical Information Display 108
 Gross Vehicle Weight 293

H

Halogen headlight system 253
 Bulb replacement..... 253
 Driving abroad 136
 Handbrake..... 16, 209
 Hazard warning lights 131
 Head restraints..... 5, 19, 55, 56
 Headlight flash..... 129
 Headlight range adjustment..... 131, 252
 Headlight switch 7, 128, 129
 Headlight wash system 12, 127, 279
 Headlights 7
 Daytime running lights..... 128
 Driving abroad 136
 Front fog lights 130
 Reversing lights..... 131
 Warning device..... 126
 Heated exterior mirrors 13, 143
 Heated front seats 144
 Heated rear seats 144
 Heated rear window 13, 143
 Heating 140, 146, 154
 Seats..... 144
 With climate control system 158
 With air conditioning system.... 150, 155
 Height adjustment
 Seat belts 76
 Steering wheel 6
 High-pressure cleaners 221, 266, 267
 Horn..... 11

I

Identification plate 282
IDS+ (Interactive Driving System). 196, 198
Ignition logic 113, 120
Ignition system 271, 280
Immobiliser 27
Information display 108
Infotainment system 137
Inspection system 268
Instrument display 105
Instrument illumination 134
 Bulb replacement 263
Instrument panel 6
Instruments 98, 105, 137
Interactive Driving System (IDS+). 196, 198
Interior mirror 5, 44
 Universal remote control 41
Interruption of power supply .. 47, 122, 125
 Easytronic 175
 Electric windows 47
 Selector lever lock 183
ISOFIX 79

J

Jack 238
Jump starting 230

K

Keys
 Extending 26
 Ignition lock 6, 15, 27
 Locking doors 30
 Remove 16
 Starting the engine 6, 15, 27

L

- Language selection 113, 118
- Lashing eyes 69
- Leather trim 266
- Level control system 204
- Light switch 7
- Lighting 7, 100, 128
 - Driving abroad 136
- Loading 223
- Locking doors 2, 30
- Locking from the inside 31
- Locks 266
- Lubricants 272, 283
- Luggage compartment
 - Bulb replacement 263
 - Extension 65
 - FlexOrganizer 69
 - Lashing eyes 69
 - Lighting 135
 - Loading 223, 293
 - Locking 34
 - Safety net 67
- Luggage compartment cover 66
- Lumbar support 51, 53

M

- Main beam 7, 129
 - Bulb replacement 254, 256
 - Control indicator 101
- Maintenance 268
 - Air conditioning system 167
 - Anti-freeze protection 274
 - Brake fluid 276
 - Brakes 208
 - Catalytic converter 195
 - Engine oil 272, 273
 - Fuel consumption 187
 - Tyre pressure 213
 - Tyres 214
 - Windscreen wiper 277
- Manual transmission 14
- Mirrors 5, 43, 44
- Misted windows 13, 147, 159
- Mobile telephone 139
- Motorway lighting (AFL) 22, 132
- Muffler, see Exhaust system 193

N

- Number plate lights
 - Bulb replacement 261
- Number plate lighting 261
- Number plates 281

O

Octane numbers..... 188, 284, 285
Odometer 105
Oil change..... 273
Oil filter change 273
Oil level and consumption 272
Oil pressure 98
Oils 272
Operating temperature..... 185
Outside temperature gauge 109
Overrun..... 185, 187

P

Paintwork damage..... 265
Parking 16, 202
Parking distance sensors 202
Parking lights 7, 134
 Bulb replacement 257
Parts 271
Pedals 185
Performance 287, 288
Petrol 188, 284, 285
Pinking 188
Pollen filter 166
Position memory 43, 54
Power steering, see electro-hydraulic
 power-assisted steering 184
Preheating..... 102
Pushing, towing..... 229

Q

Quickheat 146, 154, 158

R

Radio	137
Radio equipment (CB).....	139
Radio reception	137
Rain sensor.....	12, 47, 48, 127, 264, 277
Reading lights.....	135
Rear light cluster.....	128
Bulb replacement.....	258
Rear window	
wash system.....	12, 127, 264, 279
Refuelling.....	189
Fuel filler cap.....	188
Remote control	
Auxiliary heating.....	165
Central locking system	28
Steering wheel.....	21, 137
Universal remote control	41
Replacement keys	26
Reversible carpet	69
Reversing lights	
Bulb replacement.....	258
Roof load.....	71, 184, 187
Roof rack	187, 218
Running-in	
Brakes	208

S

Safeguard against unauthorised use	6, 16
Safety accessories	77, 234
Safety net.....	67
Saving energy	186
Seat adjustment.....	3, 50, 52
Seat belts	72, 76, 266
Seat height adjustment	3, 51
Seat occupancy recognition	87
Seat position	52, 53
Seats	3, 50, 51
Extending the luggage compartment	65
Heated.....	144
With climate control	144
Selector lever.....	169, 177
Selector lever lock.....	14, 177
Self-diagnosis	74, 86
Self-help	228
Central locking system	33
Electric sunroof	49
Electric windows.....	47
Information display.....	110
Remote control	29
Service interval display	270
Service work	270
Side airbags	83
Spare fuses.....	247
Spare keys.....	26
Spare wheel	236, 238

Speed	186
Fuel consumption	186, 187
Speedometer	105
Sport mode	101, 198
Starter switch.....	6, 15, 27
Starting the engine	6, 15, 27, 229
Self-help	229
Steam-jet cleaners	221, 266, 267
Steering column lock.....	6, 16
Steering wheel adjustment	6
Steering wheel remote control	21, 137
Stowage compartments	57, 95, 96
Sunblind	49
Sunroof.....	47
Sunshade	49
System settings.....	112, 117

T

Tables.....	62
Tachometer.....	105
Tail lights.....	128
Bulb replacement.....	258
Tailgate.....	34
Tailgate wiper.....	127
Technical data.....	282
Telephone, see Mobile telephone.....	139
Temperature regulation.....	145, 158
Temporary spare wheel.....	217, 237
The first 600 miles.....	184
Thigh support.....	53
Tightening torque.....	242, 299
Time.....	110, 113
Toll systems.....	138
Tools.....	238
Towing.....	232
Towing equipment.....	219
Towing eye.....	232, 233
Trailer/caravan towing.....	184
Trailer Stability Assist (TSA).....	225
Transmission display.....	168, 176

Transmission, automatic.....	14
Automatic mode.....	177
Driving programmes.....	178
Fault.....	182
Interruption of power supply.....	183
Kickdown.....	180
Selector lever.....	177, 178
Selector lever lock.....	177
Winter programme.....	180
Transmission, Easytronic.....	168
Driving programmes.....	171
Interruption of power supply.....	175
Kickdown.....	172
Selector lever.....	14, 170
Winter programme.....	172
Transmission, manual.....	14
Travel Assistant.....	22, 58
Tread depth.....	214
Trip computer.....	20, 114, 120
Trip odometer.....	105
Triple Information Display.....	108
TSA (Trailer Stability Assist).....	225
Turn lighting (AFL).....	22, 132
Turn signal lights.....	7
Bulb replacement.....	258
Twin Audio.....	21, 138
Tyre chains.....	217, 299
Tyre condition.....	214
Tyre pressure.....	204, 213, 299
Tyre pressure monitoring system.....	204
Tyre repair kit.....	242

U

Units of measure.....	113, 119
Unleaded fuel.....	188, 190, 284, 285
Used oil.....	273

V

Valve cap key.....	213
Vauxhall alarm system.....	38
Vauxhall Service.....	268
Vehicle care.....	264
Vehicle decommissioning.....	281
Vehicle Identification Number.....	283
Vehicle keys, see Keys.....	26
Vehicle recommissioning.....	281
Vehicle tools.....	238
Ventilation.....	140, 146, 153, 160

W

- Warning buzzers..... 126
- Warning messages 111, 116
- Warning triangle, 234
- Wash fluid reservoir,
 - windscreen wash system..... 279
- Wheels, tyres 211
- Windows
 - Demisting
 - and defrosting 13, 147, 150, 155, 159
- Windscreen wash system 12, 127
 - Anti-freeze protection 279
 - Capacities..... 308, 309
 - Wash fluid reservoir..... 279
- Windscreen wiper 11, 126, 277
- Winter mode
 - Starting-off aid 172
- Winter operation
 - Battery 185
 - Coolant, anti-freeze..... 274
 - Fuel consumption 187
 - Fuel for diesel engines..... 188
 - Heating 140, 150, 155
 - Locks 266
 - Tyre chains 217, 299
 - Window demisting and defrosting ... 147
 - Windscreen wash system,
 - anti-freeze protection..... 279
- Winter programme 172
- Winter tyres..... 216, 299

X

- Xenon headlight system..... 255
 - Bulb replacement 255
 - Driving abroad..... 136



©Copyright by Vauxhall Motors Ltd., England.

Reproduction or translation, in whole or in parts, is not permitted without prior written consent from Vauxhall Motors Ltd.

All rights as understood under the copyright laws are explicitly reserved by Vauxhall Motors Ltd.

All information, illustrations and specifications contained in this manual are based on the latest production information available at the time of publication.

The right is reserved to make changes at any time without notice.

Edition: July 2007.

TS 1557-A-08

