



# Movano

Owner's Manual



# Contents

<b>Emergency numbers</b>		
<b>For emergency service call the Vauxhall Incident Manager</b>		<b>0800 55 33 88 (Free Linkline)*</b>
<b>Vauxhall Assistance General Enquiries</b>		<b>0845 7565 565</b>
<b>You will need to provide:</b>	Vehicle registration number	Model and colour of your Vauxhall
	Contact telephone number	Details of your precise location

\* Calls may be chargeable from mobile phones

Introduction .....	2
Keys, doors and windows .....	4
Seats, restraints .....	18
Storage .....	36
Instruments and controls .....	44
Lighting .....	67
Climate control .....	75
Driving and operating .....	86
Vehicle care .....	140
Service and maintenance .....	180
Technical data .....	184
Customer information .....	188
Body conversions .....	194
Index .....	200

# Introduction

## Introduction

Your vehicle is a designed combination of advanced technology, safety, environmental friendliness and economy.

This Owner's Manual provides you with all the necessary information to enable you to drive your vehicle safely and efficiently.

Some functions are only operational when ignition is switched on, when combustion engine is running or when electric engine is ready.

Make sure your passengers are aware of the possible risk of accident and injury which may result from improper use of the vehicle.

You must always comply with the specific laws and regulations of the country that you are in. These laws may differ from the information in this Owner's Manual.

Disregarding the description given in this manual may affect your warranty.

When this Owner's Manual refers to a workshop visit, we recommend your Vauxhall Authorised Repairer.

All Vauxhall Authorised Repairers provide first-class service at reasonable prices. Experienced mechanics trained by Vauxhall work according to specific Vauxhall instructions.

The customer literature pack should always be kept ready to hand in the vehicle.

## Using this manual

- This manual describes all options and features available for this model. **Certain descriptions, including those for display and menu functions, may not apply to your vehicle due to model variant, country specifications, special equipment or accessories.**
- The table of contents at the beginning of this manual and within each section shows where the information is located.

- The index will enable you to search for specific information.
- This Owner's Manual depicts left-hand drive vehicles. Operation is similar for right-hand drive vehicles.
- The Owner's Manual uses the engine identifier code. The corresponding sales designation and engineering code can be found in the section "Technical data".
- Directional data, e.g. left or right, or front or back, always relate to the direction of travel.
- Displays may not support your specific language.
- Display messages and interior labelling are written in **bold** letters.

## Danger, Warnings and Cautions

### **⚠ Danger**

Text marked **⚠ Danger** provides information on risk of fatal injury. Disregarding this information may endanger life.

### **⚠ Warning**

Text marked **⚠ Warning** provides information on risk of accident or injury. Disregarding this information may lead to injury.

### **Caution**

Text marked **Caution** provides information on possible damage to the vehicle. Disregarding this information may lead to vehicle damage.

## Symbols

Page references are indicated with ⇨. ⇨ means "see page".

Page references and index entries refer to the indented headings given in the section table of content.

Thank you for choosing a Vauxhall.

We wish you many hours of pleasurable driving.

**Your Vauxhall Team**

## Keys, doors and windows

<b>Keys, locks</b> .....	<b>4</b>
Keys .....	4
Radio remote control .....	5
Central locking system .....	7
Automatic locking .....	9
Child locks .....	9
<b>Doors</b> .....	<b>9</b>
Sliding door .....	9
Rear doors .....	10
<b>Vehicle security</b> .....	<b>12</b>
Anti-theft locking system .....	12
Anti-theft alarm system .....	12
Immobiliser .....	13
<b>Exterior mirrors</b> .....	<b>14</b>
Convex shape .....	14
Electric adjustment .....	14
Folding mirrors .....	15
Heated mirrors .....	15
<b>Interior mirrors</b> .....	<b>16</b>
Manual anti-dazzle .....	16
<b>Windows</b> .....	<b>16</b>
Windscreen .....	16
Power windows .....	17

Heated rear window .....	17
Sun visors .....	17

## Keys, locks

### Keys

#### Caution

Do not attach heavy or bulky items to the ignition key.

#### Danger

Never remove the key from ignition switch during driving as this will cause steering wheel lock.

### Lock cylinders

Designed to free-wheel if they are forcefully rotated without the correct key or if the correct key is not fully inserted. To reset, insert the correct key only half way and turn cylinder until its slot is vertical, remove key then re-insert it. If the cylinder still free-wheels, insert the key only half way and turn the key through 180° and repeat operation.

## Replacement keys

The key number is specified on a detachable tag.

The key number must be quoted when ordering replacement keys as it is a component of the immobiliser system.

Locks ⇨ 177.

Central locking ⇨ 7.

Starting the engine ⇨ 88.

Radio remote control ⇨ 5.

## Mechanical key



The key locks and unlocks the doors, the fuel filler flap and is used for the ignition lock.

## Key with foldaway key section







Press button to extend. To fold the key, first press the button.

## Radio remote control



Depending on model, the vehicle may use a 2-button or 3-button remote control.



-  : unlocks the vehicle
-  : unlocks the front doors
-  : unlocks the load compartment
-  : locks the vehicle

Enables operation of the following functions via the use of the remote control buttons:

- central locking system ⇨ 7
- anti-theft locking system ⇨ 12
- anti-theft alarm system ⇨ 12

The remote control has a range of up to 50 m, but may also be much less due to external influences. The hazard warning flashers confirm operation.

Handle with care, protect from moisture and high temperatures and avoid unnecessary operation.

### Replacing battery in radio remote control

Replace the battery as soon as the system no longer operates properly or the range is reduced.



Batteries do not belong in household waste. They must be disposed of at an appropriate recycling collection point.

1. Extend the key.

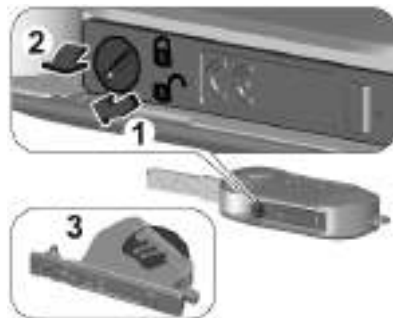

2. Turn with a fine screwdriver the screw from the lock to the open position.
3. Extract the battery holder from the housing.
4. Extract the flat battery from its location.
5. Replace battery with a battery of the same type. Pay attention to the installation position.
6. Attach battery holder and turn the screw to the lock position.



## Fault

If the central locking system cannot be operated with the radio remote control, the cause may be one of the following:

- Fault in radio remote control.
- The battery voltage is too low.
- Interference from higher-power radio waves from other sources.

Manual unlocking ⇨ 7.

## Central locking system

Unlocks and locks doors, load compartment and fuel filler flap.

A pull on an interior door handle opens the respective door.

## Remote control operation

### Unlocking



Press .

### Locking

Close doors, load compartment and fuel filler flap.



Press .

If the vehicle is not closed properly, the central locking system will not work.

### Cab



Press  to lock.

### Load compartment



Press  to unlock.



Press  to lock or unlock. The LED illuminates when locked.

### Confirmation

Operation of the central locking system is confirmed by the hazard warning flashers.

### Central locking button

Locks or unlocks all doors, the load compartment and fuel filler flap from inside the passenger compartment.



Press  to lock. The LED in the button illuminates with ignition on and flashes with ignition off.

Press  again to unlock. The LED in the button extinguishes.

### Operation with the key

Insert key into driver's door lock to lock or unlock the vehicle. When vehicle battery is down or in case of a central locking system fault, only the driver's door is locked or unlocked.

The front passenger door can be locked by inserting the key and moving it upward.



Operate inside handle to unlock the passenger door.

## Automatic locking

This system allows automatic locking of the doors and tailgate as soon as the speed of the vehicle exceeds a certain speed.

If one of the doors or the tailgate is open, the automatic central locking does not take place. This is signalled by the sound of the locks rebounding.

## Child locks

### ⚠ Warning

Use the child locks whenever children are occupying the rear seats.

Move down the locking device located at the rear edge of the door. The door cannot be opened from the inside.

To deactivate, move the locking device up.

## Doors

### Sliding door

Open and close the sliding side door only when the vehicle is at a standstill with the parking brake applied.

Open the door from outside by pulling the handle and sliding the door towards the rear.



Open the door from inside by pushing the handle and sliding the door towards the rear.

The fully opened sliding side door is locked. Operate handle to unlock and slide the door towards the front.

**⚠ Warning**

Take care when operating the sliding side door. Risk of injury. Ensure that nothing becomes trapped during operation and no-one is standing within the moving area.

If the vehicle is parked on a slope, open sliding doors may move accidentally on account of their weight.

Close the sliding doors before driving off.

**⚠ Danger**

Do not drive with the sliding side door open or ajar, e.g. when transporting bulky objects, since toxic exhaust gases, which cannot be seen or smelled, could enter the vehicle. This can cause unconsciousness and even death.

Central locking system ⇨ 7.

**Side step****⚠ Warning**

Take care when using the step, particularly in wet and cold weather conditions.



The side step operates automatically when the sliding door is opened or closed.

**Rear doors**

Lock and unlock the rear doors with the remote control or key.

Central locking system ⇨ 7.

To open the right-hand rear door, pull the exterior handle.



The right-hand door can also be opened from inside the vehicle by pulling the interior handle on it.



The left-hand rear door is then released using the lever on it.

### **⚠ Warning**

The rear lights may be obscured if the rear doors are open and the vehicle is parked on the roadside.

Make other road users aware of the vehicle, by using a warning triangle or other equipment specified in the road traffic regulations.

The doors are retained in the 90° position by locking stays.



To open the doors to 180° or further (depending on model) release locking stays by pressing the button. Swing doors open to the desired position.

When opening the doors to 270°, the doors are retained in the fully open position by magnets on the body side.

### **⚠ Warning**

Ensure extended opening doors are secured when fully opened.

Opened doors may slam due to the force of the wind!

Always close the left-hand door before the right-hand door.

### **⚠ Danger**

Do not drive with the rear doors open or ajar, e.g. when transporting bulky objects, since toxic exhaust gases, which cannot be seen or smelled, could enter the vehicle. This can cause unconsciousness and even death.

### **Rear step**

### **⚠ Warning**

Take care when using the step, particularly in wet and cold weather conditions.

Slide out the rear step when needed, slide in when not in use.

## Vehicle security

### Anti-theft locking system

#### ⚠ Warning

Do not use the system if there are people in the vehicle! The doors cannot be unlocked from the inside.

The system deadlocks all the doors. All doors must be closed otherwise the system cannot be activated.

Unlocking the vehicle disables the mechanical anti-theft locking system. This is not possible with the central locking button.

#### Activating



Press  on the radio remote control twice within 3 seconds.

Activation is confirmed by three times flashing of the hazard warning flashers and the LED in the central locking button in the passenger compartment.

#### Anti-theft alarm system

The anti-theft alarm system monitors:

- doors, bonnet
- vehicle inclination, e.g. if it is raised
- ignition

#### Activation

All doors, the load compartment and the engine compartment must be closed.



Press  on the radio remote control.

#### Indication

An acoustic signal indicates if the anti-theft alarm system is activated.

#### Deactivation

Unlocking the vehicle deactivates the anti-theft alarm system.

The system is not deactivated by unlocking the front door with the key or with the central locking button in the passenger compartment.

## Alarm

When triggered, the alarm siren sounds and the hazard warning lights flash simultaneously. The number and duration of alarm signals are stipulated by legislation.

The anti-theft alarm can be deactivated by pressing  or switching on the ignition.

A triggered alarm, which has not been interrupted by the driver, will be indicated by illuminating  for about 10 seconds when the ignition is switched on.

## Fault

If another acoustic signal is given after activation with properly closed doors and bonnet, seek the assistance of a workshop.

## Locking the vehicle without activation of the anti-theft alarm

Lock the vehicle by locking the front door with the key.

## Immobiliser

### Notice

The immobiliser does not lock the doors. Always lock the vehicle after leaving it  7.

Switch on the anti-theft alarm system  12.

## Key-integrated immobiliser

The system is part of the ignition switch and checks whether the vehicle is allowed to be started with the key being used.

The immobiliser is activated automatically.

### Notice

Radio Frequency Identification (RFID) tags may cause interference with the key. Do not have it placed near the key when starting the vehicle.

## Immobiliser with separate transponder



The system prevents unauthorised starting of the vehicle.

The immobiliser is activated automatically when the transponder is out of the detection range. The transponder has a range of up to 5 m.

The immobiliser is deactivated automatically when the transponder is detected.

The rear view mirror display shows **RESTART** when the transponder is not detected during vehicle start. Restart the vehicle when the transponder is detected.

In case the transponder is moved out of the detection range while the engine is running, the immobiliser is only activated when the ignition key is removed from the ignition switch.

Rear view mirror display ⇨ 98.

### Status LED



Flashes red: the system is active.

LED is off: the transponder is detected and the vehicle can be started.

## Exterior mirrors

### Convex shape

The shape of the mirror makes objects appear smaller, which will affect the ability to estimate distances.

Side blind spot alert ⇨ 117.

### Electric adjustment



Select the relevant exterior mirror.

No mirror is selected when the control is in the centre position.





Then swivel the control to adjust the mirror.

## Folding mirrors



For pedestrian safety, the exterior mirrors will swing out of their normal mounting position if they are struck with sufficient force. Reposition the mirror by applying slight pressure to the mirror housing.

## Electric folding



Push . Both exterior mirrors are folded.

Push . Both exterior mirrors return to their original position.

An electrically folded mirror should be only unfolded electrically. To unfold manually folded mirrors, push  until a click sound is heard and then push .

## Heated mirrors



Operated by pressing .

Heating is switched off automatically after a short time.

Heated rear window  17.

## Interior mirrors



To adjust the mirror, move the mirror housing in the desired direction.

## Manual anti-dazzle



To reduce dazzle, adjust the lever on the underside of the mirror housing.

## Windows

### Windscreen

#### Windscreen stickers

Do not attach stickers such as toll road stickers or similar on the windscreen in the area of the interior mirror. Otherwise the detection zone of the sensor and the view area of the camera in the mirror housing could be restricted.

#### Windscreen replacement

##### Caution

If the vehicle has a front-looking camera sensor for the driver assistance systems, it is very important that any windscreen replacement is performed accurately according to Vauxhall specifications. Otherwise, these systems may not work properly and there is a risk of unexpected behaviour and / or messages from these systems.

## Power windows

### ⚠ Warning

Take care when operating the power windows. Risk of injury, particularly to children.

Keep a close watch on the windows when closing them. Ensure that nothing becomes trapped in them as they move.



Operate the switch for the respective window by pushing to open or pulling to close.

Pushing for longer than approx. half a second starts the automatic opening operation. To stop movement, push the switch again.

## Heated rear window



Operated by pressing .

Heating is switched off automatically after a short time.

Heated mirrors ⇨ 15.

## Sun visors

The sun visors can be folded down or swivelled to the side to prevent dazzling.

If the sun visors have integral mirrors, the mirror covers should be closed when driving.

A ticket holder is located on the backside of the sun visor.

## Seats, restraints

<b>Head restraints</b> .....	<b>18</b>
<b>Front seats</b> .....	<b>19</b>
Seat position .....	19
Seat adjustment .....	20
Armrest .....	22
Heating .....	23
<b>Seat belts</b> .....	<b>23</b>
Three-point seat belt .....	24
<b>Airbag system</b> .....	<b>26</b>
Front airbag system .....	29
Side airbag system .....	29
Curtain airbag system .....	30
Airbag deactivation .....	30
<b>Child restraints</b> .....	<b>31</b>
Child restraint systems .....	31
Child restraint installation locations .....	34

## Head restraints

### Position

#### ⚠ Warning

Only drive with the head restraint set to the proper position.



The upper edge of the head restraint should be at upper head level. If this is not possible for extremely tall people, set to highest position, and set to lowest position for small people.

### Adjustment



Pull up to raise or press button and lower head restraint. Ensure the head restraint engages.

## Removal



E.g. when using a child restraint system ↪ 31.

Pull up head restraint to uppermost position. Press both release buttons and pull the head restraint upwards to remove.

Stow head restraints securely in load compartment.

Do not drive with head restraints removed if the seat is occupied.

## Installation

Insert the rods of the head restraint into their holes.

Lower head restraint as far as possible, then raise head restraint (press both release buttons first, if necessary) until it engages securely in desired position.

## Front seats

### Seat position

#### ⚠ Warning

Only drive with the seat correctly adjusted.

#### ⚠ Danger

Do not sit closer than 25 cm to the steering wheel, to permit safe airbag deployment.

#### ⚠ Warning

Never adjust seats while driving as they could move uncontrollably.

#### ⚠ Warning

Never store any loose objects under the seats.

Underseat storage, storage box  
↪ 38.



- Sit with buttocks as far back against the backrest as possible. Adjust the distance between the seat and the pedals so that legs are slightly angled when pressing the pedals. Slide the front passenger seat as far back as possible.
- Set seat height high enough to have a clear field of vision on all sides and of all display instruments. There should be at least one hand of clearance between head and the roof frame. Thighs should rest lightly on the seat without pressing into it.

- Sit with shoulders as far back against the backrest as possible. Set the backrest rake so that it is possible to reach the steering wheel with arms slightly bent. Maintain contact between shoulders and the backrest when turning the steering wheel. Do not angle the backrest too far back. We recommend a maximum rake of approx. 25°.
- Adjust seat and steering wheel in a way that the wrist rests on top of the steering wheel while the arm is fully extended and shoulders on the backrest.
- Adjust the steering wheel ↻ 47.
- Adjust the head restraint ↻ 18.
- Adjust the height of the seat belt ↻ 24.
- Adjust the lumbar support so that it supports the natural shape of the spine ↻ 20.

### Seat adjustment

Drive only with engaged seats and backrests.

### Longitudinal adjustment



Pull handle, slide seat, release handle. Try to move the seat back and forth to ensure that the seat is locked in place.

### Backrest inclination



Turn handwheel. Do not lean on backrest when adjusting.

### Seat height



Pull up front release lever up to adjust height of front part of seat.

Pull up rear release lever to adjust height of rear part of seat.

### Lumbar support



Adjust lumbar support to suit personal requirements.

Increasing and decreasing support: turn the handwheel while relieving the load on the backrest.

### Suspension seat sensitivity



Rotate knob to adjust the sensitivity of the suspension seat to the driver's weight.

### Swivelling the seat

The seat can be swivelled up to 180° from the forward-facing position.

Before swivelling the seat, slide seat forth. Slide the seat only in the forward-facing position.



Press the control and swivel seat.

Always return the seat to the forward-facing position before driving and ensure the seat is locked in place before starting off.

### Armrest



Armrests can be folded up when not required.

Operate the wheel to adjust the lower position.



## Heating



Press button to switch on or off.

Prolonged use for people with sensitive skin is not recommended.

## Seat belts



The seat belts are locked during heavy acceleration or deceleration of the vehicle, holding the occupants in the seat position. Therefore the risk of injury is considerably reduced.

### **⚠ Warning**

Fasten seat belt before each trip.

In the event of an accident, people not wearing seat belts endanger their fellow occupants and themselves.

Seat belts are designed to be used by only one person at a time.

Child restraint system ⇨ 31.

Periodically check all parts of the belt system for damage, soiling and proper functionality.

Have damaged components replaced. After an accident, have the seat belts and triggered belt pretensioners replaced by a workshop.

### **Notice**

Make sure that the belts are not damaged by shoes or sharp-edged objects or are trapped. Prevent dirt from getting into the belt retractors.

### **Notice**

Use the belt buckle intended for the respective seat belt when fastening in order to ensure proper functionality.

### **Seat belt reminder**

Each seat is equipped with a seat belt reminder, indicated by a control indicator  for the respective seat ⇨ 55.

### Belt force limiters

On the front seats, stress on the body is reduced by the gradual release of the belt during a collision.

### Belt pretensioners

In the event of a head-on or side-on collision of a certain severity, the front seat belts are tightened.

#### ⚠ Warning

Incorrect handling (e.g. removal or fitting of belts) can trigger the belt pretensioners.

Deployment of the belt pretensioners is indicated by continuous illumination of control indicator  ↻ 55.

Triggered belt pretensioners must be replaced by a workshop. Belt pretensioners can only be triggered once.

#### Notice

Do not affix or install accessories or other objects that may interfere with the operation of the belt pretensioners. Do not make any

modifications to belt pretensioner components as this will invalidate the operating permit of your vehicle.

### Three-point seat belt

#### Fasten



Withdraw the seat belt from the retractor, guide it untwisted across the body and insert the latch plate into the buckle. Make sure the belt fits tightly to the body while driving.



Loose or bulky clothing prevents the belt from fitting snugly. Do not place objects such as handbags or mobile phones between the belt and your body.

#### ⚠ Warning

The seat belt must not rest against hard or fragile objects in the pockets of your clothing.

Seat belt reminder  ↻ 55.

## Height adjustment



Press the button to disengage and adjust the seat belt height.



Adjust the height so that the belt lies across the shoulder. It must not lie across the throat or upper arm.  
Do not adjust while driving.

## Unfasten



To release seat belt, press red button on seat belt buckle and guide the seat belt back.

## Using seat belts while pregnant



### Warning

The lap belt must be positioned as low as possible across the pelvis to prevent pressure on the abdomen.

## Airbag system

The airbag system consists of a number of individual systems.

When triggered, the airbags inflate within milliseconds. They also deflate so quickly that it is often unnoticeable during the collision.

### ⚠ Warning

The airbag system deploys in an explosive manner, repairs must be performed by skilled personnel only.

### ⚠ Warning

Adding accessories that change the vehicle's frame, bumper system, height, front end or side sheet metal, may keep the airbag system from working properly. The operation of the airbag system can also be affected by changing any parts of the front seats, seat belts, airbag sensing and diagnostic module, steering wheel,

instrument panel, inner door seals including the speakers, any of the airbag modules, ceiling or pillar trim, front sensors, side impact sensors or airbag wiring.

### ⚠ Warning

Keep the area in which the airbag inflates clear of obstructions.



### Notice

The airbag systems and belt pretensioner control electronics are located in the centre console area. Do not put any magnetic objects in this area.

Do not affix any objects onto the airbag covers and do not cover them with other materials. Have damaged covers replaced by a workshop.

Each airbag is triggered only once. Have deployed airbags replaced by a workshop. Furthermore, it may be necessary to have the steering wheel, the instrument panel, parts of the panelling, the door seals, handles and the seats replaced.

Do not make any modifications to the airbag system as this will invalidate the vehicle operating permit.

Control indicator  for airbag systems  55.

## Child restraint systems on front passenger seat with airbag systems



**EN:** NEVER use a rearward-facing child restraint on a seat protected by an ACTIVE AIRBAG in front of it; DEATH or SERIOUS INJURY to the CHILD can occur.

**DE:** Nach hinten gerichtete Kindersitze NIEMALS auf einem Sitz verwenden, der durch einen davor befindlichen AKTIVEN AIRBAG geschützt ist, da dies den TOD oder SCHWERE VERLETZUNGEN DES KINDES zur Folge haben kann.

**FR:** NE JAMAIS utiliser un siège d'enfant orienté vers l'arrière sur un siège protégé par un COUSSIN GONFLABLE ACTIF placé devant lui, sous peine d'infliger des BLESSURES GRAVES, voire MORTELLES à l'ENFANT.

**ES:** NUNCA utilice un sistema de retención infantil orientado hacia atrás en un asiento protegido por un AIRBAG FRONTAL ACTIVO. Peligro de MUERTE o LESIONES GRAVES para el NIÑO.

**RU:** ЗАПРЕЩАЕТСЯ устанавливать детское удерживающее устройство лицом назад на сиденье автомобиля, оборудованном фронтальной подушкой безопасности, если ПОДУШКА НЕ ОТКЛЮЧЕНА! Это

может привести к СМЕРТИ или СЕРЬЕЗНЫМ ТРАВМАМ РЕБЕНКА.

**NL:** Gebruik NOOIT een achterwaarts gericht kinderzitje op een stoel met een ACTIEVE AIRBAG ervoor, om DODELIJK of ERNSTIG LETSEL van het KIND te voorkomen.

**DA:** Brug ALDRIG en bagudvendt autostol på et forsæde med AKTIV AIRBAG, BARNET kan komme i LIVSFARE eller komme ALVORLIGT TIL SKADE.

**SV:** Använd ALDRIG en bakåtvänd barnstol på ett säte som skyddas med en framförvarande AKTIV AIRBAG. DÖDSFALL eller ALLVARLIGA SKADOR kan drabba BARNET.

**FI:** ÄLÄ KOSKAAN sijoita taaksepäin suunnattua lasten turvaistuinta istuimelle, jonka edessä on AKTIIVINEN TURVATYYNYY, LAPSI VOI KUOLLA tai VAMMAUTUA VAKAVASTI.

**NO:** Bakovervendt barnesikringsutstyr må ALDRI brukes på et sete med AKTIV KOLLISJONSPUTE foran, da det kan

føre til at BARNET utsettes for LIVSFARE og fare for ALVORLIGE SKADER.

**PT:** NUNCA use um sistema de retenção para crianças voltado para trás num banco protegido com um AIRBAG ACTIVO na frente do mesmo, poderá ocorrer a PERDA DE VIDA ou FERIMENTOS GRAVES na CRIANÇA.

**IT:** Non usare mai un sistema di sicurezza per bambini rivolto all'indietro su un sedile protetto da AIRBAG ATTIVO di fronte ad esso: pericolo di MORTE o LESIONI GRAVI per il BAMBINO!

**EL:** ΠΟΤΕ μη χρησιμοποιείτε παιδικό κάθισμα ασφαλείας με φορά προς τα πίσω σε κάθισμα που προστατεύεται από μετωπικό ΕΝΕΡΓΟ ΑΕΡΟΣΑΚΟ, διότι το παιδί μπορεί να υποστεί ΘΑΝΑΣΙΜΟ ή ΣΟΒΑΡΟ ΤΡΑΥΜΑΤΙΣΜΟ.

**PL:** NIE WOLNO montować fotelika dziecięcego zwróconego tyłem do kierunku jazdy na fotelu, przed którym znajduje się WŁĄCZONA PODUSZKA POWIETRZNA. Niezastosowanie się do tego

zalecenia może być przyczyną ŚMIERCI lub POWAŻNYCH OBRAŻEŃ u DZIECKA.

**TR:** Arkaya bakan bir çocuk emniyet sistemini KESİNLİKLE önünde bir AKTİF HAVA YASTIĞI ile korunmakta olan bir koltukta kullanmayınız. ÇOCUK ÖLEBİLİR veya AĞIR ŞEKİLDE YARALANABİLİR.

**UK:** НИКОЛИ не використовуйте систему безпеки для дітей, що встановлюється обличчям назад, на сидінні з УВІМКНЕНОЮ ПОДУШКОЮ БЕЗПЕКИ, інакше це може призвести до СМЕРТІ чи СЕРІОЗНОГО ТРАВМУВАННЯ ДИТИНИ.

**HU:** SOHA ne használjon hátrafelé néző biztonsági gyerekülést előlről AKTÍV LÉGZSÁKKAL védett ülésen, mert a GYERMEK HALÁLÁT vagy KOMOLY SÉRÜLÉSÉT okozhatja.

**HR:** NIKADA nemojte koristiti sustav zadržavanja za djecu okrenut prema natrag na sjedalu s AKTIVNIM ZRAČNIM JASTUKOM ispred njega, to bi moglo dovesti do SMRTI ili OZBILJNIH OZLJEDA za DIJETE.

**SL:** NIKOLI ne nameščajte otroškega varnostnega sedeža, obrnjenega v nasprotni smeri vožnje, na sedež z AKTIVNO ČELNO ZRAČNO BLAZINO, saj pri tem obstaja nevarnost RESNIH ali SMRTNIH POŠKODB za OTROKA.

**SR:** NIKADA ne koristiti bezbednosni sistem za decu u kome su deca okrenuta unazad na sedištu sa AKTIVNIM VAZDUŠNIM JASTUKOM ispred sedišta zato što DETE može da NASTRADA ili da se TEŠKO POVREDI.

**MK:** НИКОГАШ не користете детско седиште свртено наназад на седиште заштитено со АКТИВНО ВОЗДУШНО ПЕРНИЧЕ пред него, затоа што детето може ДА ЗАГИНЕ или да биде ТЕШКО ПОВРЕДЕНО.

**BG:** НИКОГА не използвайте детска седалка, гледаща назад, върху седалка, която е защитена чрез АКТИВНА ВЪЗДУШНА ВЪЗГЛАВНИЦА пред нея - може да се стигне до СМЪРТ или СЕРИОЗНО НАРАНЯВАНЕ на ДЕТЕТО.

**RO:** Nu utilizați NICIODATĂ un scaun pentru copil îndreptat spre partea din spate a mașinii pe un scaun protejat de un AIRBAG ACTIV în fața sa; acest lucru poate duce la DECESUL sau VĂTĂMAREA GRAVĂ a COPILULUI.

**CS:** NIKDY nepoužívejte dětský zádržný systém instalovaný proti směru jízdy na sedadle, které je chráněno před sedadlem AKTIVNÍM AIRBAGEM. Mohlo by dojít k VÁŽNĚMU PORANĚNÍ nebo ÚMRTÍ DÍTĚTE.

**SK:** NIKDY nepoužívajte detskú sedačku otočenú vzad na sedadle chránenom AKTÍVNYM AIRBAGOM, pretože môže dôjsť k SMRTI alebo VÁŽNYM ZRANENIAM DIEŤAŤA.

**LT:** JOKIU BŪDU nemontuokite atgal atgręžtos vaiko tvirtinimo sistemas sėdynėje, prieš kurią įrengta AKTYVI ORO PAGALVĖ, nes VAIKAS GALI ŽŪTI arba RIMTAI SUSIŽALOTI.

**LV:** NEKĀDĀ GADĪJUMĀ neizmantojiet uz aizmuguri vērstu bērnu sēdekļi sēdvietā, kas tiek aizsargāta ar tās priekšā uzstādītu

AKTĪVU DROŠĪBAS SPILVENU, jo pretējā gadījumā BĒRNS var gūt SMAGAS TRAUMAS vai IET BOJĀ.

**ET:** ĀRGE kasutage tahapoole suunatud lapseturvaistet istmel, mille ees on AKTIIVSE TURVAPADJAGA kaitstud iste, sest see vōib pōhjustada LAPSE SURMA vōi TÕSISE VIGASTUSE.

**MT:** QATT tuža tražžin għat-*tfal* li jħares lejn in-naħa ta' wara fuq sit protett b'AIRBAG ATTIV quddiemu; dan jista' jikkawħa l-MEWT jew ĠRIEHI SERJI lit-TFAL.

**GA:** Nā húsáid srian sábháilteachta linbh cúil RIAMH ar shuíochán a bhfuil mála aeir ag feidhmiú os a chomhair. Tá baol BÁIS nó GORTÚ DONA don PHÁISTE ag baint leis.

Additionally, for safety reasons a forward-facing child restraint system must only be used subject to the instructions and restrictions in the table ⇨ 34.

The airbag label is located on both sides of the front passenger sun visor. Airbag deactivation ⇨ 30.

## Front airbag system

The front airbag system consists of one airbag in the steering wheel and one in the instrument panel on the front passenger side. These can be identified by the word **AIRBAG**.

The front airbag system is triggered in the event of a front-end impact of a certain severity. The ignition must be switched on.

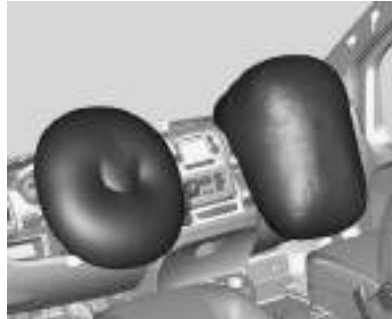

The inflated airbags cushion the impact, thereby reducing the risk of injury to the upper body and head of the front seat occupants considerably.

## ⚠ Warning

Optimum protection is only provided when the seat is in the proper position.

Seat position ⇨ 19.

Fasten the seat belt correctly and engage securely. Only then is the airbag able to protect.

## Side airbag system

The side airbag system consists of airbags in the outer front seat backrests. This can be identified by the word **AIRBAG**.

The side airbag system is triggered in the event of a side impact of a certain severity. The ignition must be switched on.



The inflated airbags cushion the impact, thereby reducing the risk of injury to the upper body and pelvis in the event of a side-on collision considerably.

#### Notice

Only use protective seat covers that have been approved for the vehicle. Be careful not to cover the airbags.

### Curtain airbag system

The curtain airbag system consists of an airbag in the roof frame on each side. This can be identified by the word **AIRBAG** on the roof pillars.

The curtain airbag system is triggered in the event of a side-on impact of a certain severity. The ignition must be switched on.



The inflated airbags cushion the impact, thereby reducing the risk of injury to the head in the event of a side-on impact considerably.

### Airbag deactivation

The front passenger airbag system must be deactivated for child restraint system on the passenger seat according to the instructions in the table ↗ 34.

The curtain airbag system, the belt pretensioners and all driver airbag systems will remain active.

The front passenger airbag system can be deactivated via the Driver Information Centre.

Depending on version, it can also be deactivated via the Info Display.

- OFF : front passenger airbag is deactivated and will not inflate in the event of a collision.
- ON : front passenger airbag is active.

#### **⚠ Danger**

Deactivate passenger airbag only in combination with the use of a child restraint system, subject to the instructions and restrictions in the table ↗ 34.

Otherwise, there is a risk of fatal injury for a person occupying a seat with a deactivated front passenger airbag.





If the control indicator  illuminates approx. eight seconds after the ignition is switched on, the front passenger airbag system is deactivated. It stays on while the airbag is deactivated. During the first eight seconds the LED will illuminate as a functionality test.

Status remains until the next change.  
Driver Information Centre ⇨ 61.

## Child restraints

### Child restraint systems

#### Danger

Make sure that children below sufficient size and weight are protected using a suitable child restraint system. Never place a child on the lap.

#### Danger

If using a rear-facing child restraint system on the front passenger seat, the airbag system for the front passenger seat must be deactivated. This also applies to certain forward-facing child restraint systems as indicated in the tables ⇨ 34.

Airbag deactivation ⇨ 30.

Airbag label ⇨ 26.

We recommend a child restraint system which is tailored specifically to the vehicle.

In case of any interference of the child restraint system with vehicle seat head restraint, adjust or remove the corresponding head restraint ⇨ 18.

When a child restraint system is being used, pay attention to the following usage and installation instructions and also those supplied with the child restraint system. The given restrictions in the table refer to a test body, which is the maximum envelope of all existing child restraint systems. Make sure that the seats do not interfere with the used child restraint system.

Always comply with local or national regulations. In some countries, the use of child restraint systems is forbidden on certain seats.

Only drive with the driver seat correctly adjusted ⇨ 19.

Child restraint systems can be fastened with:

- Three-point seat belt
- ISOFIX brackets
- Top-tether

### Three-point seat belt

Child restraint systems can be fastened by using a three-point seat belt. After fastening the child restraint system the seat belt has to be tightened.

### ISOFIX brackets



Fasten vehicle-approved ISOFIX child restraint systems to the ISOFIX brackets. Specific vehicle ISOFIX child restraint system positions are marked in the table ↗ 34.

ISOFIX brackets are indicated by a label on the backrest.

When fastening ISOFIX child restraint systems on adjustable passenger seats, such as the front passenger seat, first incline the backrest as far as necessary backwards in order to get access to the ISOFIX brackets. After the proper fastening of the ISOFIX child restraint system, incline the backrest forward again.

An i-Size child restraint system is an universal ISOFIX child restraint system according UN Regulation No. 129.

All i-Size child restraint systems can be used on any vehicle seat suitable for i-Size, table ↗ 34.

Either a Top-tether strap or a support leg must be used in addition to the ISOFIX brackets.



i-Size child seats and vehicle seats with i-Size approval are marked with i-Size symbol, see illustration.

### Top-tether anchors



Top-tether anchors are marked with the symbol  for a child seat.

In addition to the ISOFIX brackets, fasten the Top-tether strap to the Top-tether anchors.

ISOFIX child restraint systems of universal category positions are marked in the table by IUF ↗ 34.

### Selecting the right system

The rear seats are the most convenient location to fasten a child restraint system.

Children should travel facing rearwards in the vehicle as long as possible. This makes sure that the child's backbone, which is still very weak, is under less strain in the event of an accident. Do not use forward facing child restraint system at all seats when child's weight is below 13 kg.

Suitable are child restraint systems that comply with valid UN ECE regulations. Check local laws and regulations for mandatory use of child restraint systems.

The following child restraints are recommended for the following weight classes:

- **Group 0+:**  
Römer Baby-Safe Plus installed in the rearward facing position with or without ISOFIX base for children up to 13 kg
- **Group I:**  
RÖMER Duo Plus ISOFIX with or without ISOFIX and Top-tether for children from 9 kg to 18 kg
- **Group II, Group III:**  
Römer Kidfix XP /  
Römer Kidfix 2R with or without

ISOFIX for children from 15 kg to 36 kg,

Graco Booster for children from 15 kg to 36 kg.

Ensure that the child restraint system to be installed is compatible with the vehicle type.

Child seat at the single passenger seat: Adjust the front passenger seat to the highest and fully back longitudinal position with the backrest straightened.

Do not use forward facing child restraints system when child's weight is below 13 kg at all seats.

Follow child restraint manufacturer's instructions to install corresponding child restraints in vehicle.

For semi-universal or vehicle specific child restraint system (ISOFIX or belted child restraint system), see the vehicle list provided in the user manual of the child restraint system.

Ensure that the mounting location of the child restraint system within the vehicle is correct, see following table.

Allow children to enter and exit the vehicle only on the side facing away from the traffic.

When the child restraint system is not in use, secure the seat with a seat belt or remove it from the vehicle.

#### **Notice**

Do not affix anything on the child restraint systems and do not cover them with any other materials.

A child restraint system which has been subjected to stress in an accident must be replaced.

## Child restraint installation locations

### Installation of universal, ISOFIX and i-Size child seats

As required by European regulations, this table gives the options for installing child seats secured using the seat belt and universally approved as well as the larger ISOFIX and i-Size child seats on seat positions equipped with ISOFIX mountings in the vehicle.

Yes : Suitable for fitment of the designated category of the child restraint system.

No : Not suitable for fitment of the designated category of the child restraint system.

<b>Child restraint system categories</b>	<b>Centre front passenger seat</b>	<b>Outer front passenger seat with activated airbag ON</b>	<b>Outer front passenger seat with deactivated airbag OFF</b>	<b>Rear seats</b>
Universal belted child restraint system <sup>1)</sup>	NO	NO	Yes <sup>2) 3)</sup>	NO
i-size child restraint system	NO	NO	NO	NO
Position equipped with a Top-tether fixing	NO	NO	NO	NO
Carry-cot (ISOFIX lateral facing child restraint system)	NO	NO	NO	NO
ISOFIX child restraint fixture: L1, L2				
ISOFIX rearward facing child restraint system	NO	NO	NO	NO
ISOFIX child restraint fixture: R1, R2, R3				

Child restraint system categories	Centre front passenger seat	Outer front passenger seat with activated airbag ON	Outer front passenger seat with deactivated airbag OFF	Rear seats
ISOFIX forward facing child restraint system	NO	NO	NO	NO
ISOFIX child restraint fixture: F2, F2X, F3				
Booster seat: B2, B3	NO	NO	NO	NO

- 1) Universal child seat: child seat that can be installed in all vehicles using the seat belt. Applies to all stature and mass groups.
- 2) Only rearward facing child restraint system
- 3) To install a rearward facing child restraint system at this seat position, the front passenger's airbag must be deactivated OFF.

Size of child restraint fixture (1, 2, 3):

- R1 means rearward facing child restraint fixture for mass group 0 up to 10 kg and mass group 0+ up to 13 kg, age around 0-1 year.
- R2 means reduced size of rearward facing child restraint fixture for mass group 0+ up to 13 kg and mass group 1 from 9 to 18 kg, age around 2-4 years.
- R3 means full size of rearward facing child restraint fixture for mass group 0+ up to 13 kg and mass group 1 from 9 to 18 kg, age around 2-4 years.
- F2, F2X mean reduced height of forward facing child restraint fixture for mass group 1 from 9 to 18 kg, age around 6-7 years.
- F3 means full height of forward facing child restraint fixture for mass group 1 from 9 to 18 kg, age around 7-10 years.

## Storage

<b>Storage compartments</b> .....	<b>36</b>
Glovebox .....	36
Cupholders .....	37
Front storage .....	37
Overhead console .....	37
Underseat storage .....	38
Centre console storage .....	39
Overcab storage .....	39
<b>Load compartment</b> .....	<b>40</b>
Lashing eyes .....	40
Cargo management system .....	40
Load compartment grille .....	40
Warning triangle .....	40
First aid kit .....	40
<b>Additional storage features</b> .....	<b>41</b>
Folding tray .....	41
<b>Roof rack system</b> .....	<b>42</b>
Roof rack .....	42
<b>Loading information</b> .....	<b>42</b>

## Storage compartments

### ⚠ Warning

Do not store heavy or sharp objects in the storage compartments. Otherwise, the storage compartment lid could open and vehicle occupants could be injured by objects being thrown around in the event of hard braking, a sudden change in direction or an accident.

Close all storage compartments whilst driving.

## Glovebox



To open the glovebox pull the handle.

## Cupholders

### Front cupholder



A cup holder is located at the side of the instrument panel.



Cupholders may be located in the centre console.



Cupholders may be located in a folding tray in the backrest of the passenger seatback. Pull the loop to fold down the tray.

### Front storage



Glovebox cooler ⇨ 84.

### Overhead console

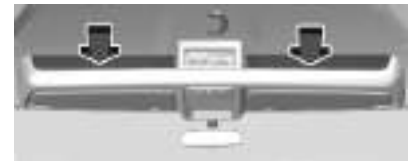

## 38 Storage

Store only lightweight items such as paperwork or maps.

The maximum permitted load is 20 kg.

### **⚠ Warning**

Secure objects to prevent them from falling out and causing injury.

### Underseat storage



There may be a fixed storage tray under the driver seat.



There is a storage box under the passenger seat.

Release the storage cover.



Turn the rotary knob a quarter turn to release the storage box.

Move the box out of its position.



The box is meant to storage tools for wheel changing, bulb replacement or towing.

Do not forget to turn the rotary knob a quarter turn back to fix the storage box after putting back. ↪ 160





There may be a storage box under the centre bench seat.

Pull the seat cushion forwards to gain access.

## Centre console storage

### Variant with a lid



The storage compartment is lockable with the key.

Pull the handle to open it.

### Open variant



A smartphone holder may be located.

## Overcab storage

Light objects can be stored in this storage compartment located in the loading area above the cab.

The total weight must not exceed 20 kg evenly distributed.

## Load compartment

Depending on version, the load compartment area can be increased by folding up or removing the seats in the second and third row.

## Lashing eyes



The lashing eyes are designed to secure items against slippage, e.g. using lashing straps or luggage net.

Lashing eyes may be located on the vehicle floor and / or in the sidewall. The number and location of the lashing eyes may vary depending on version.

The maximum force applied to the lashing eyes should not exceed 500 daN / 5 kN / 5000 N.

Depending on country, the maximum force may be shown on a label.

### Notice

Specifications on the label always have priority over those given in this manual.

## Cargo management system

Depending on version, a partition behind the front seats protects the driver and front passengers against the risk of load movement.

## Load compartment grille

Depending on version a partition protects the driver against the risk of load movement.

The partition can be placed behind the driver seat.

## Warning triangle

Depending on version, the warning triangle can be stored in the load compartment. Secure it with the elastic straps.

## First aid kit

Depending on version, the first aid kit can be stored in the storage compartment of the doors.

## Additional storage features

### Folding tray

#### Writing pad



Pull or push above the writing pad to fold or unfold the writing pad.

The paperclip serves to fix documents, papers, etc.

#### Holder for mobile devices

This holder is used to fix portable devices in position: smartphones in vertical position, tablets in horizontal position.



- Pull the holder above to fold forwards.
- Pull the lever to release the two brackets.



- Slide up, slide down the two brackets.
- Push the lever to fix the brackets.

### Document tray in the front centre passenger seat backrest



The front centre passenger seat backrest may contain a document tray.

Pull the loop to fold down the tray. The document tray contains cup holders and a swivelling shelf.

Return the swivelling shelf to its normal position before raising the tray.

## Roof rack system

### Roof rack

For safety reasons and to avoid damage to the roof, a vehicle approved roof rack system is recommended. For further information contact your workshop.

Follow the installation instructions and remove the roof rack when not in use.

The roof load is the combined weight of the roof rack and the load.

Loading information ⇨ 42.

### Mounting

Fasten the roof rack according to the installation instructions delivered with the roof rack.

The number and location of the mounting points vary depending on version.

Permissible roof load max. 150 kg.



Mount the roof rack using the mounting points marked in the picture.

## Loading information

### ⚠ Warning

Always make sure that the load in the vehicle is securely stowed. Otherwise objects can be thrown around inside the vehicle and cause personal injury or damage to the load or car.

- Heavy objects in the load compartment should be placed against the seat backrests. Make sure that the backrests are securely engaged. If objects can be stacked, heavier objects should be placed at the bottom.
- Prevent sliding of loose objects by securing them with straps attached to the lashing eyes.
- Do not allow the load to protrude above the upper edge of the backrests.

- Do not place any objects on the rear luggage cover or the instrument panel, and do not cover the sensor on top of the instrument panel.
- The load must not obstruct the operation of the pedals, parking brake and gear selector, or hinder the freedom of movement of the driver. Do not place any unsecured objects in the interior.
- Do not drive with an open load compartment.
- The payload is the difference between the permitted gross vehicle weight (see identification plate ↻ 185) and the EC kerb weight.

To calculate the payload, enter the data for your vehicle in the weights table at the front of this manual.

The EC kerb weight includes weights for the driver (68 kg), luggage (7 kg) and all fluids (fuel tank 90% full).

Optional equipment and accessories increase the kerb weight.

- Driving with a roof load increases the sensitivity of the vehicle to cross-winds and has a detrimental effect on vehicle handling due to the vehicle's higher centre of gravity. Distribute the load evenly and secure it properly with retaining straps. Adjust the tyre pressure and vehicle speed according to the load conditions. Check and retighten the straps frequently. Do not drive faster than 75 mph. The permissible roof load is 150 kg. The roof load is the combined weight of the roof rack and the load.

# Instruments and controls

## Instrument panel overview ..... 45

## Controls ..... 47

Steering wheel adjustment ..... 47

Steering wheel controls ..... 47

Horn ..... 47

Windscreen wiper and washer .. 48

Outside temperature ..... 48

Clock ..... 49

Power outlets ..... 49

Cigarette lighter ..... 50

Ashtrays ..... 50

## Warning lights, gauges and indicators ..... 51

Speedometer ..... 51

Odometer ..... 51

Tachometer ..... 52

Fuel gauge ..... 52

High voltage battery gauge ..... 52

Engine coolant temperature gauge ..... 53

Service display ..... 53

Control indicators ..... 54

Turn lights ..... 55

Seat belt reminder ..... 55

Airbag and belt tensioners ..... 55

Charging system ..... 55

Malfunction indicator light ..... 56

Service vehicle soon ..... 56

Brake system ..... 56

Brake pad wear ..... 56

Parking brake ..... 56

Antilock brake system (ABS) ..... 56

Gear shifting ..... 57

Air suspension ..... 57

Power steering ..... 57

Lane departure warning ..... 57

Electronic Stability Control and Traction Control system ..... 57

Engine coolant temperature ..... 57

Preheating ..... 58

Diesel particle filter ..... 58

AdBlue ..... 58

Tyre pressure monitoring system ..... 58

Engine oil pressure ..... 58

Low fuel ..... 59

Drain fuel filter ..... 59

Immobiliser ..... 59

Stop-start system ..... 59

Low beam ..... 59

High beam ..... 59

High beam assist ..... 59

Headlight levelling system ..... 59

Front fog lights ..... 60

Rear fog light ..... 60

Cruise control ..... 60

Vehicle detected ahead ..... 60

Active emergency braking ..... 60

Speed limiter ..... 60

Door open ..... 60

## Displays ..... 61

Driver Information Centre ..... 61

Info Display ..... 62

## Vehicle messages ..... 63

Warning chimes ..... 63

## Trip computer ..... 64

## Tachograph ..... 65

## Vehicle personalisation ..... 65

## Telematics services ..... 66

Emergency call ..... 66

## Instrument panel overview

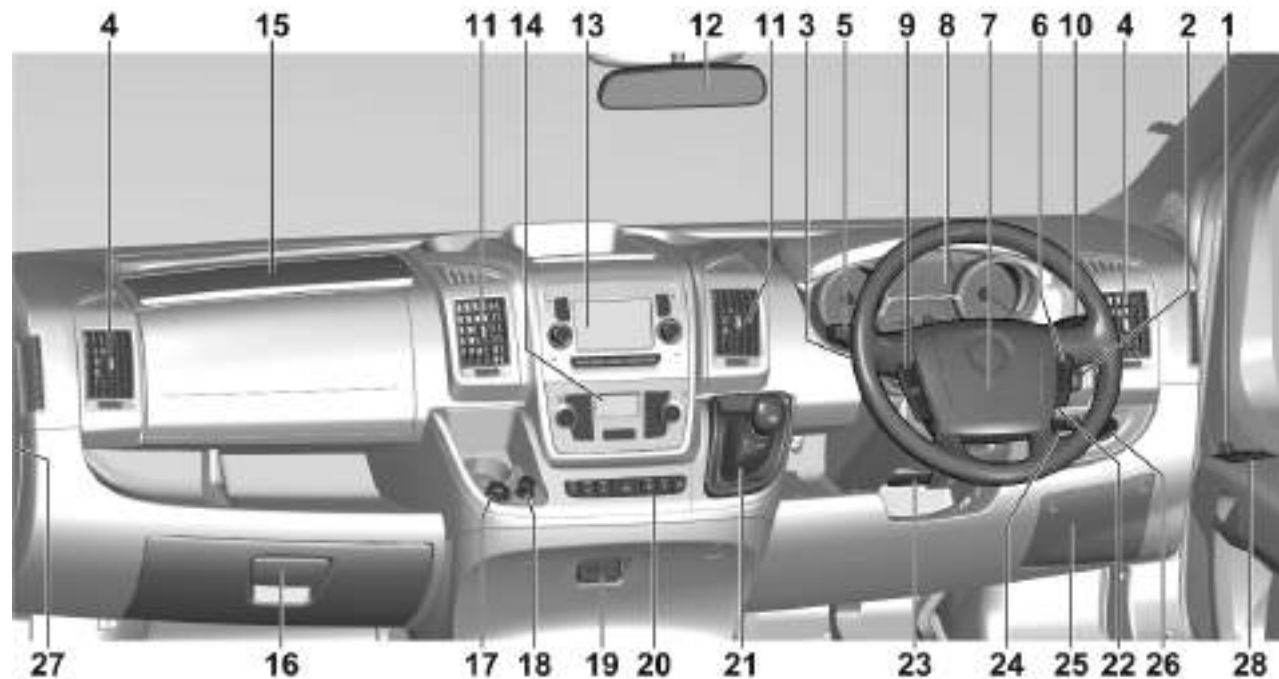

## 46 Instruments and controls

---

1	Exterior mirrors .....	14	12	Interior mirror .....	16	Descent control system .....	104	
2	Stop-start system .....	89		Rear view mirror display .....	61	Electronic Stability Control and Traction Control system .....	102	
	Front fog lights .....	71	13	Info Display .....	62	21	Electric drive unit .....	98
	Rear fog light .....	72	14	Heating and ventilation system .....	75		Selector lever .....	99
	Headlight range adjustment ..	70		Air conditioning system .....	76	22	Ignition switch .....	87
	Buttons for Driver Information Centre .....	61		Electronic climate control system .....	78	23	Steering wheel adjustment ...	47
3	Cruise control .....	106	15	Front storage .....	37	24	Air suspension .....	92
	Speed limiter .....	109	16	Glovebox .....	36	25	Instrument panel fuse box	
4	Side air vents .....	83	17	12 V power outlet .....	49	26	Auxiliary heater .....	80
5	High beam .....	68	18	USB port .....	49		Parking heater .....	81
	High beam assist .....	68		Cigarette lighter .....	50	27	Bonnet release lever .....	145
	Turn lights .....	71	19	USB port .....	49	28	Power windows .....	17
	Parking lights .....	72		AUX port .....	49		Load compartment locking button .....	7
6	Steering wheel controls .....	47	20	Airbag deactivation .....	30			
7	Horn .....	47		Heated rear window .....	17			
8	Driver Information Centre .....	61		Central locking button .....	7			
9	Steering wheel controls .....	47		Hazard warning flashers .....	70			
10	Windscreen wiper and washer .....	48		Lane departure warning .....	124			
11	Air vents .....	83						



## Controls

### Steering wheel adjustment



Unlock lever, adjust steering wheel, then engage lever and ensure it is fully locked.

Do not adjust steering wheel unless vehicle is stationary and steering wheel lock has been released.

### Steering wheel controls



The controls on the steering wheel can be used for audio and phone functions.

For more information, refer to the Infotainment manual.

### Horn



Press .

## Windscreen wiper and washer

### Windscreen wiper



The following settings are selectable:

- one notch down : intermittent wiping with activation of the rain sensor
- two notches down : slow continuous wiping
- three notches down : fast continuous wiping
- up : single wipe

When intermittent wiping is selected, it is possible to select four frequency levels by turning the ring.

The rain sensor detects the amount of water on the windscreen and automatically regulates the frequency of the windscreen wipers.

The rain sensor must be reactivated each time the ignition is switched on.

#### Notice

During extreme weather conditions, e.g. fog or snow, automatic wiping with rain sensor may become unavailable. If required, select another wiper position.



Keep the sensor free from dust, dirt and ice.

Do not use the windscreen wiper if the windscreen is frozen.

Switch off in car washes.

### Windscreen washer



Pull lever. Washer fluid is sprayed onto the windscreen.

### Outside temperature

The outside temperature is displayed in the Driver Information Centre or in the Info Display. A drop or a rise in temperature might be indicated after a time delay.

If the climate conditions can lead to black ice on the road,  will illuminate in the Driver Information Centre. Drive carefully and avoid sudden braking.



The unit for the outside temperature indication can be set in the Driver Information Centre ↷ 61.

To set the unit for the outside temperature indication in the Info Display, refer to the Infotainment manual.

### Warning

The road surface may already be icy even though the display indicates a few degrees above 0 °C.

## Clock

To set the time and the date in the Driver Information Centre, use the buttons **MODE**,  and  next to the steering wheel.

Driver Information Centre ↷ 61.

To set the time and the date in the Info Display, refer to the Infotainment manual.

## Power outlets



A 12 V power outlet is located on the instrument panel.

Connecting electrical accessories while the engine is off will discharge the vehicle battery. Do not exceed the maximum power consumption of 180 W.

### Danger

To avoid the risk of fire, if multiple power outlets are used simultaneously, the total power

consumption of connected accessories must not exceed 180 W.

With the ignition off, the power outlet may be deactivated.

Additionally, the power outlet may be deactivated in case of low battery voltage.

Electrical accessories that are connected must comply with the electromagnetic compatibility requirements laid down in DIN VDE 40 839.

### Caution

Do not connect any current-delivering accessories, e.g. electrical charging devices or batteries.

Do not damage the outlets by using unsuitable plugs.

### USB ports



A USB port to charge external devices is located on the instrument panel.



A USB port to connect external devices to the Infotainment system is located in the central storage space.

### AUX port



An AUX port is located in the central storage space.

#### Notice

The sockets must always be kept clean and dry.

### Cigarette lighter



Press in cigarette lighter. It switches off automatically once the element is glowing. Pull out lighter.

### Ashtrays

Caution
To be used only for ash and not for combustible rubbish.

### Portable ashtray



Ashtray container for mobile use in the vehicle. To use, open cover.

## Warning lights, gauges and indicators

### Speedometer

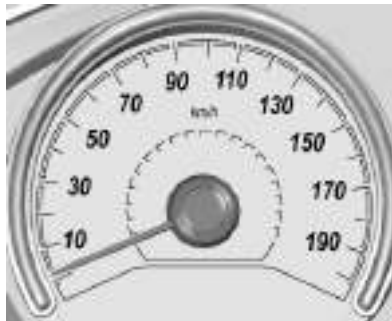

Indicates vehicle speed.

Speed limiter ⇨ 109.

Cruise control ⇨ 106.

### Odometer



Depending on version, two variants are available.

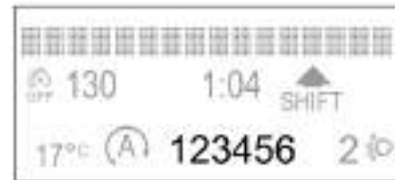

Displays the recorded distance in miles.

### Notice

When a tachograph is fitted, the total distance travelled may be shown only on the tachograph.

Tachograph ⇨ 65.

### Tachometer

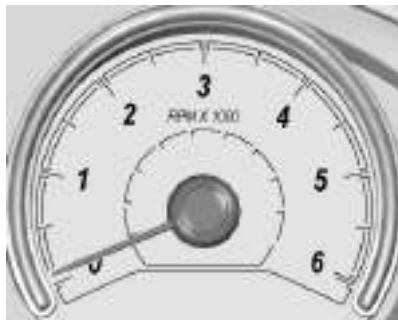

Displays the engine speed.

Drive in a low engine speed range for each gear as much as possible.

### Caution

When the engine speed is too high, the engine can be damaged.

### Fuel gauge



Displays fuel level in the tank.

When the low fuel tank level **E** is reached, the control indicator ● illuminates. Refuel immediately ⇨ 134.

Never run the tank dry.

Diesel fuel system bleeding ⇨ 151.

Because of the fuel remaining in the tank, the top-up quantity may be less than the specified tank capacity.

### High voltage battery gauge



Displays the high voltage battery state of charge.

## Engine coolant temperature gauge



Displays the coolant temperature. If the needle enters the red zone or if the control indicator ● illuminates red, the temperature is too high ⇨ 57.

### Caution

If engine coolant temperature is too high, stop vehicle, switch off engine. Danger to engine. Check coolant level.

For physical reasons, the coolant temperature gauge shows the coolant temperature only if the coolant level is adequate.

## Service display

For a few seconds after the ignition is switched on, information on when the next service is due is displayed in the Driver Information Centre.

Next, the engine oil level will be displayed on a scale of 1 (**MIN**) to 5 (**MAX**). If no scale is displayed, the engine oil level is insufficient. It is essential to top it up to prevent engine damage. For the measurement of this level to be valid, the vehicle must be parked on horizontal ground, with the engine having been off for more than 30 minutes.



To access the service indications at any time, briefly press **MODE**. Use ⇨ and ⇩ to view service intervals and engine oil quality. The remaining range before the next service and the next oil change will be displayed.

Based on driving conditions, the interval at which a service will be indicated can vary considerably.

If the vehicle needs a service, seek the assistance of a workshop.

## Resetting the service display

After a service or an engine oil change, the values must be reset. To reset, switch on the ignition and depress the brake and accelerator pedals for more than 15 seconds.

Trip computer ⇨ 64.

Driver Information Centre ⇨ 61.

Service information ⇨ 180.

## Control indicators

The control indicators described are not available in all vehicles. This description applies to all instrument versions. Depending on the equipment, the position of the control indicators may vary. When the ignition is switched on, most control indicators will illuminate briefly to test the functionality.

The control indicator colours mean:















red : danger, important reminder















yellow : warning, information, fault

green : confirmation of activation









blue : confirmation of activation

## Overview

-  Outside temperature ⇨ 48
-  Turn lights ⇨ 55
-  Seat belt reminder ⇨ 55
-  Airbag and belt tensioners ⇨ 55
-  Charging system ⇨ 55
-  Malfunction indicator light ⇨ 56
-  Service vehicle soon ⇨ 56
-  Brake system ⇨ 56
-  Parking brake ⇨ 56
-  Brake pad wear ⇨ 56
-  Antilock brake system (ABS) ⇨ 56
-  Gear shifting ⇨ 57
-  Air suspension ⇨ 57
-  Power steering ⇨ 57

-  Lane departure warning ⇨ 57
-  Electronic Stability Control and Traction Control system ⇨ 57
-  Engine coolant temperature ⇨ 57
-  Preheating ⇨ 58
-  Diesel particle filter ⇨ 58
-  AdBlue ⇨ 58
-  Tyre pressure monitoring system ⇨ 58
-  Engine oil pressure ⇨ 58
-  Low fuel ⇨ 59
-  Drain fuel filter ⇨ 59
-  Immobiliser ⇨ 59
-  Stop-start system ⇨ 59
-  Low beam ⇨ 59
-  High beam ⇨ 59
-  High beam assist ⇨ 59



-  Headlight levelling system  
⇨ 59
-  Front fog lights ⇨ 60
-  Rear fog light ⇨ 60
-  Cruise control ⇨ 60
-  Vehicle detected ahead  
⇨ 60
-  Active emergency braking  
⇨ 60
-  Speed limiter ⇨ 60
-  Door open ⇨ 60

## Turn lights

← or → flashes green.

Flashes if a turn light is activated.

An audible warning can be heard when the turn lights are on.

Bulb replacement ⇨ 151.

Turn lights ⇨ 71.

## Seat belt reminder

### Front seats

 illuminates or flashes red.

Depending on the vehicle, the control indicator flashes if the front passenger seat is occupied and seat belt is not fastened.

If the seat belt is fastened, the control indicator extinguishes.

 **Illuminates accompanied by an audible signal**

The vehicle is moving with the driver's seat belt unfastened.

 **flashes**

The driver has not fastened the seat belt.

### Airbag and belt tensioners

 illuminates red.

When the ignition is switched on, the control indicator illuminates briefly. If it does not illuminate or illuminates whilst driving, there is a fault in the airbag system. Seek the assistance

of a workshop. The airbags and belt pretensioners may fail to trigger in the event of an accident.

Deployment of the belt pretensioners or airbags is indicated by continuous illumination of .

### Warning

Have the cause of the fault remedied immediately by a workshop.

Belt pretensioners ⇨ 23.

Airbag system ⇨ 26.

## Charging system

 illuminates red.

Illuminates when the ignition is switched on and extinguishes shortly after the engine starts.

### Illuminates or flashes when the engine is running

Stop, switch off engine. Vehicle battery is not charging. Engine cooling may be interrupted. The brake servo unit may cease to be effective. Seek the assistance of a workshop.

### Malfunction indicator light



 illuminates yellow.

Fault in the emission control system. The permitted emission limits may be exceeded. Stop the vehicle and switch off the engine as soon as possible.

#### Warning

Have the cause of the fault remedied immediately by a workshop.

### Service vehicle soon

 illuminates in the Driver Information Centre or  illuminates yellow.

The vehicle needs a service.

May illuminate in combination with another control indicator or a message in the Driver Information Centre.

If  illuminates, a minor fault has been detected.

If  illuminates and a corresponding message is displayed, a major fault has been detected.



#### Warning

Have the cause of the fault remedied immediately by a workshop.

### Brake system

 illuminates red.

Illuminates briefly when the ignition is switched on.

 illuminates if the brake fluid level is too low ⇨ 148.  and  illuminate if the brake system has a fault.

#### Warning

Stop. Do not continue your journey. Consult a workshop.

Brake system ⇨ 100.

### Brake pad wear

 illuminates yellow.

The front brake pads are worn.

Seek the assistance of a workshop.

### Parking brake

 illuminates red.

Control indicator  remains illuminated when the parking brake is applied and extinguishes when the parking brake is released ⇨ 101.

### Antilock brake system (ABS)

 illuminates yellow.

Illuminates briefly when the ignition is switched on. The system is ready for operation when  extinguishes.

Illuminates during driving when there is a fault in the ABS. The brake system remains operational but without ABS regulation.

Antilock brake system ⇨ 100.

## Gear shifting

 illuminates in the Driver Information Centre.

Gear shifting is recommended for fuel saving reasons.

## Air suspension

 illuminates red.

The system has a fault.

Seek the assistance of a workshop.



Air suspension ⇨ 92.

## Power steering

 illuminates red.

The power steering has a fault. Drive carefully at a moderate speed and consult a workshop.

## Lane departure warning

 or  flashes yellow.

An unintended lane change has been detected on the left side or on the right side.

Turn the steering wheel in the opposite direction to return to the correct trajectory.

If  illuminates yellow, the lane departure warning system is faulty. Clean the windscreen. If the problem persists, seek the assistance of a workshop.

## Electronic Stability Control and Traction Control system

 illuminates or flashes yellow.

### Illuminates

A fault has been detected.

Additionally, a warning message might be displayed in the Driver Information Centre.

In case of a system fault, seek the assistance of a workshop.

## Flashes

The system is operating and optimises traction and improves the directional stability of the vehicle.

Electronic Stability Control and Traction Control system ⇨ 102.

Descent control system ⇨ 104.

Hill start assist ⇨ 101.

## Engine coolant temperature

 illuminates red.

Illuminates briefly red when the ignition is switched on.

### Illuminates when the engine is running

If  illuminates red, stop the vehicle and switch off the engine.

#### Caution

Coolant temperature too high.

Wait for the engine to cool down to check the coolant level.

Check coolant level ⇨ 147.

If there is sufficient coolant, consult a workshop.

## Preheating

 illuminates yellow.

Preheating is activated. Only activates when outside temperature is low.

Wait until  goes off before starting the engine.

## Diesel particle filter

 illuminates yellow.

The particle filter is regenerating itself. Leave the engine running until  goes off so that regeneration can be completed.

## AdBlue

 illuminates yellow.

AdBlue level is low. Refill AdBlue as soon as possible to avoid prevention of engine starts.



A corresponding message may appear in the Driver Information Centre.

AdBlue  94.

## Tyre pressure monitoring system

 illuminates yellow.

Tyre pressure loss. Stop immediately and check tyre pressure.

If  illuminates together with , a sensor is faulty.

Consult a workshop.

Tyre pressure monitoring system  162.

## Engine oil pressure

 illuminates red.

Illuminates briefly when the ignition is switched on.

## Illuminates when the engine is running

### Caution

Engine lubrication may be interrupted. This may result in damage to the engine and / or locking of the drive wheels.

Park the vehicle and check the engine oil level  146.

### Warning

When the engine is off, considerably more force is needed to brake and steer. During an Autostop the brake servo unit will still be operational.

Do not remove key until vehicle is stationary, otherwise the steering wheel lock could engage unexpectedly.

Keep engine turned off and let the vehicle be towed to a workshop.

### Flashes when the engine is running

The engine oil quality is deteriorated. Change the engine oil as soon as possible.

The engine performance might be limited.

Keep engine turned off and let the vehicle be towed to a workshop.

### Low fuel

● illuminates yellow.

Fuel level in the tank is too low. Refuel immediately.

Never run the tank dry.

If  flashes, the system has a fault. Seek the assistance of a workshop.

Catalytic converter ⇨ 94.

Refuelling ⇨ 134.

Bleeding the diesel fuel system ⇨ 151.

### Drain fuel filter

 illuminates yellow.

The diesel filter contains water. Risk of damage to the injection system. Seek the assistance of a workshop.

### Immobiliser

 illuminates yellow.

The ignition key inserted has not been recognised. The engine cannot start. Change the key and have the faulty key checked.

If  illuminates for about 10 seconds when the ignition is switched on, the alarm has been triggered.

Seek the assistance of a workshop to have the locks checked.

Immobiliser ⇨ 13.

### Stop-start system

 illuminates or flashes in the Driver Information Centre.

### Illuminates

An Autostop has been executed.

### Flashes

The stop-start system is currently unavailable.

Stop-start system ⇨ 89.

### Low beam

 illuminates green.

Low beam is on ⇨ 67.

### High beam

 illuminates blue.

The high beam is on ⇨ 68.

### High beam assist

 illuminates blue.

The high beam assist is on ⇨ 68.

### Headlight levelling system

 illuminates together with the headlight position number in the Driver Information Centre.

Headlight range adjustment ⇨ 70.

## Front fog lights

 illuminates green.

Illuminated when the front fog lights are on ⇨ 71.

## Rear fog light

 illuminates yellow.

Illuminated when the rear fog light is on ⇨ 72.

## Cruise control

 illuminates green.

The system is on.

Cruise control ⇨ 106.

## Vehicle detected ahead

 illuminates or flashes yellow or red.

 illuminates yellow and a warning message is displayed in the Driver Information Centre when the distance to the vehicle ahead gets to small.

 illuminates red and a warning message is displayed in the Driver Information Centre and a warning

chime sounds when a collision is imminent and immediate driver's action is required.

Forward collision alert ⇨ 114.

## Active emergency braking

 illuminates or flashes yellow.

### Illuminates

The system has been deactivated or a fault has been detected.

If a fault has been detected,  might illuminate in addition.

Additionally, a warning message is displayed in the Driver Information Centre.

In case of a system fault, seek the assistance of a workshop.

### Flashes

The system is actively engaged.

Depending on the situation, the vehicle may automatically brake moderately or hard.

Forward collision alert ⇨ 114.

Active emergency braking ⇨ 112.

## Speed limiter

 illuminates in the Driver Information Centre.

The speed limiter is activated.

If  illuminates, the speed limiter is selected but not activated.

Speed limiter ⇨ 109.

## Door open

 illuminates.

Illuminates with the ignition switched on when a door or the load compartment is open.

## Displays

### Driver Information Centre



The Driver Information Centre is located in the instrument cluster.

1:04	/i\	Trip A
17°C	Distance A 205.2	
▲ SHIFT	⊕	123456

Depending on version, two variants are available.

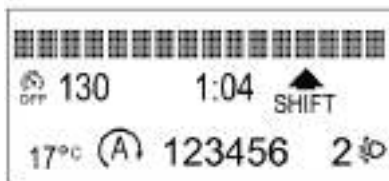

In addition to warning lights, gauges and indicators, the following information is available:

- trip odometer
- gear shift indication
- service information
- vehicle and warning messages
- driver assistance messages
- pop-up messages
- Infotainment information

Vehicle messages ⇨ 63.

### Selecting menus and functions



Press **MODE** to do the following:

- access menus and submenus
- confirm a selection within a menu
- exit menu

A long press will display the home screen.



Press or to scroll within a menu or to increase or decrease a value.

### Rear view mirror display

The rear view mirror display shows information about the high voltage battery for electric vehicles.



The rear view mirror display will be switched on when the ignition is switched on and when the vehicle is being charged. It can be switched off temporarily by pressing .

The rear view mirror display indicates the following information:

- charge level
- remaining range or remaining time before the charging process is completed
- voltage
- incoming and outgoing current
- position of the electric drive unit

- vehicle status
- information messages and alerts

Charging 125.

### Info Display



The illustrations show different variants of the Infotainment system.





The Info Display can indicate:

- time ↪ 49
- outside temperature ↪ 48
- date ↪ 49
- Infotainment system, see description in the Infotainment Manual
- indication of rear view camera ↪ 120
- navigation, see description in the Infotainment Manual
- vehicle and system messages ↪ 63
- settings for vehicle personalisation ↪ 65

For further information, see Infotainment Manual.

### Selecting menus and settings

There are three options to operate the display:

- via buttons next to the display
- by touching the touchscreen with the finger
- via speech recognition

## Vehicle messages

Messages are indicated in the Driver Information Centre, in some cases together with a warning chime.

Messages can also be indicated in the rear view mirror display, if available.

### Vehicle and service messages

The vehicle messages are displayed as text. Follow the instructions given in the messages.

### Messages in the Info Display

Some important messages may appear additionally in the Info Display. Some messages only pop-up for a few seconds.

## Warning chimes

The warning chime regarding not fastened seat belts has priority over any other warning chime.

### When starting the engine or whilst driving

A warning chime might sound when

- a seat belt is not fastened
- a door or the tailgate is not fully closed
- a certain speed is exceeded with parking brake applied
- cruise control deactivates automatically
- a programmed speed or speed limit is exceeded
- a warning message appears in the Driver Information Centre
- the parking assist detects an object
- an unintended lane change occurs
- hands-off driving is recognised
- the exhaust filter has reached the maximum filling level

If several warnings appear at the same time, only one warning chime will sound.

### When the vehicle is parked and / or the driver's door is opened

- With exterior lights on.

### During an Autostop

- If the driver's door is opened.
- If any condition for a restart of the engine is not fulfilled.

## Trip computer

The trip computer displays current trip information since the last reset.



To view the current trip information, press **TRIP**.

The following information will be displayed:

- range
- distance
- average consumption
- current consumption
- average speed
- duration

Additionally, **Trip B** can be activated via the Driver Information Centre or Info Display.

To reset the trip computer, select the respective entry in the Driver Information Centre via the **MODE** button.

The trip computer screen can be closed by pressing **TRIP** for more than a second.

### Trip computer with touchscreen audio system

The trip computer can also be reset via the Info Display. Press **MORE** on the Infotainment panel, open the menu for trip information and touch and hold **Trip A** or **Trip B** until the value resets to **0**.

## Tachograph



If the vehicle is equipped with a tachograph, it will be located in the overhead console.

## Vehicle personalisation

The vehicle's behaviour can be personalised by changing the settings in the Driver Information Centre.

Some functions are only displayed or active when the engine is running.



The vehicle settings can be adjusted via the **MODE** menu in the Driver Information Centre.

Lighting, safety, audio and display settings are adjustable.

Driver Information Centre ⇨ 61.

## Vehicle personalisation with touchscreen audio system

The vehicle settings can be adjusted via the settings menu  in the Info Display.



Info Display  62.

## Telematics services

### Emergency call

#### Notice

In order to be available and operational, the system requires functioning vehicle electrics, mobile service and GPS or GLONASS satellite link. Depending on equipment, a backup battery is used.

#### Notice

The service is only available for markets where it is legally required. Furthermore, it depends on the availability of the emergency centres and the infrastructure in the country.

### Status LED in the overhead console

Illuminates green and red and extinguishes after a short time, when the ignition is switched on: the system works properly.

Illuminates red: fault in the system. Contact a workshop.

Flashes red: backup battery needs replacement. Contact a workshop.

### Emergency call

The emergency call function will establish a connection to the nearest public safety answering point (PSAP). A minimum set of data including vehicle and location information will be sent to the PSAP.

In case of an emergency, press the red **SOS** button in the overhead console for more than two seconds. The LED flashes green to confirm that a connection to the nearest PSAP is being established. The LED illuminates steadily as long as the call is active.

Pressing the **SOS** button immediately a second time will terminate the call. The LED switches off.

### Automatic crash notification

In case of an accident with airbag deployment and without damage of needed hardware, an automatic emergency call is established and an automatic crash notification will be transmitted to the next PSAP.

## Lighting

<b>Exterior lighting</b> .....	<b>67</b>
Light switch .....	67
Automatic light control .....	68
High beam .....	68
High beam assist .....	68
Headlight flash .....	69
Headlight range adjustment .....	70
Headlights when driving abroad .....	70
Daytime running lights .....	70
Hazard warning flashers .....	70
Turn lights .....	71
Front fog lights .....	71
Rear fog light .....	72
Parking lights .....	72
Reversing lights .....	72
Misted light covers .....	72
<b>Interior lighting</b> .....	<b>73</b>
Instrument panel illumination control .....	73
Interior lights .....	73
Load compartment lighting .....	73
<b>Lighting features</b> .....	<b>74</b>
Centre console lighting .....	74

Exit lighting .....	74
Battery discharge protection .....	74

## Exterior lighting

### Light switch



Turn the adjuster wheel until the white mark matches the symbol:

- : off (ignition on) / daytime running light (ignition off)
- ☰ : low beam / high beam
- Ⓜ : automatic light control switches automatically between daytime running light and headlight

Control indicator ☞ ☞ ☞ 59.

## Tail lights

The tail lights are illuminated together with the low / high beam and the sidelights.

## Automatic light control



When the automatic light control function is switched on and the engine is running, the system switches between daytime running lights and headlights automatically depending on the external lighting conditions.

### Notice

Do not cover the light sensor otherwise the automatic mode will not operate properly.

Make sure the sensor is not blocked.

Regulate the sensitiveness of the sensor in the vehicle settings. For further information please refer to the Infotainment manual.

Daytime running light ⇨ 70.

### Automatic headlight activation

Turn the adjuster wheel in position:



During poor lighting conditions the headlights are switched on.

The headlights go out:

- if the lighting conditions permit.
- if the ignition is switched off.

## High beam



To change between low and high beam, pull the lever beyond the resistance point.

### High beam assist

The system switches from low beam to high beam and vice versa to prevent glaring. Once activated, high beam assist remains active and switches high beam on and off depending on surrounding conditions.

It switches automatically back to low beam when

- a sensor detects the lights of oncoming or preceding vehicles.
- driving in urban areas.
- the vehicle is slower than 9 mph.
- it is foggy or snowy.
- front or rear fog lights are switched on.

If there are no restrictions detected and the vehicle is faster than 25 mph, the system switches back to high beam.

### Activating



Turn the adjuster wheel in position  to switch on the system.





Press the button **MODE** and select the the required settings.

Vehicle personalisation ⇨ 65.

Driver Information Centre ⇨ 61.

Activate the high beam assist by pulling the indicator lever.

The green control indicator  illuminates continuously when the assist is activated, the blue one  illuminates when the high beam is on.

### Deactivating

To deactivate the high beam assist, pull the indicator lever again.

If a headlight flash is activated when the high beam assist is activated and the low beam is on, the high beam assist will be deactivated. The system changes to high beam.

If a headlight flash is activated when the high beam assist is activated and the high beam is on, the high beam assist will be deactivated. The system changes to low beam.

### Headlight flash

To activate the headlight flash, pull the lever briefly without passing the resistance point.

High beam ⇨ 68.

## Headlight range adjustment

### Manual headlight range adjustment



To adapt the headlight range to the vehicle load to prevent dazzling: push button  $\text{D}^{\uparrow}$  or  $\text{D}^{\downarrow}$  a few times to achieve the required position.

The position is indicated through the control indicator in the center console:

- 0 : front seats occupied
- 1 : all seats occupied

- 2 : all seats occupied and load compartment laden
- 3 : driver's seat occupied and load compartment laden

### Headlights when driving abroad

When driving in countries where traffic drives on the opposite side of the road, the headlights do not have to be adjusted.

### Daytime running lights

Daytime running lights increase visibility of the vehicle during daylight.

They are switched on automatically when the engine is running.

If the sidelights, high beam or low beam are turned on manually or automatically, the daytime running lights are turned off.

## Hazard warning flashers



Operated by pressing  $\triangle$ .

When braking in an emergency, the hazard warning flashers are switched on automatically, depending on the force of deceleration. They are switched off automatically, as soon as the vehicle is accelerated again.



## Turn lights



up : right turn lights  
down : left turn lights

A resistance point can be felt when moving the indicator lever.

Constant flashing is activated when the indicator lever is being moved beyond the resistance point. It is deactivated when the steering wheel is moved in the opposite direction or the indicator lever is manually moved back to its neutral position.

Activate temporary flashing by holding the indicator lever just before the resistance point. Turn lights will flash until the indicator lever is being released.

To activate five flashes, tap the indicator lever briefly without passing the resistance point.

## Front fog lights



Turn the adjuster wheel in position .

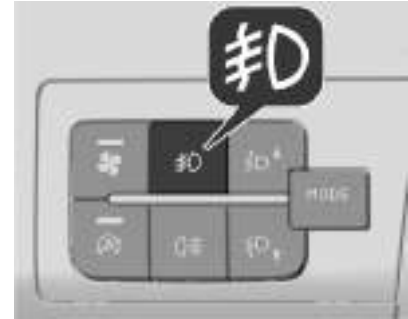

Operated by pressing .

Light switch in position : switching on the front fog lights will switch the headlights on automatically.

## Rear fog light



Turn the adjuster wheel in position .





Operated by pressing .

Light switch in position : switching on the rear fog light will switch the headlights on automatically.

The vehicle rear fog light is deactivated when towing a trailer or a plug is connected with the socket, e.g. when a bicycle carrier is used.

## Parking lights

When the vehicle is parked, the parking lights can be activated:

1. Switch off the ignition.
2. First turn the adjuster wheel of the indicator lever to position: 
3. Then turn the adjuster wheel to position: 

The control indicator  illuminates continuously in the centre console.

## Reversing lights

The reversing light comes on when the ignition is on and the reverse gear is selected.

## Misted light covers

The inside of the light housing may mist up briefly in poor, wet and cold weather conditions, in heavy rain or after washing. The mist disappears quickly by itself; to help switch on the headlights.

## Interior lighting

### Instrument panel illumination control

Brightness of the following lights can be adjusted when the parking lights are on:

- instrument panel illumination
- Info Display
- illuminated switches and operation elements

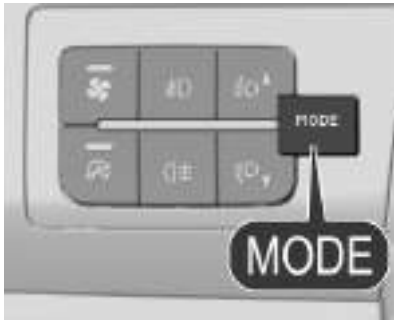

Press the button **MODE** and select the required settings.

Driver Information Centre ↗ 61.

### Interior lights

The front courtesy light comes on:

- by opening or closing the door.
- by unlocking and locking the door.

It switches off:

- if the switches are in its central position: automatically.
- if the doors are open: after a delay of 15 minutes.
- if the ignition is switched on.

### Front courtesy light



- |                   |                       |
|-------------------|-----------------------|
| press             | : switching off both  |
| <b>AUTO / OFF</b> | lights                |
| press             | : switching on both   |
|                   | lights                |
| press             | : switching on driver |
|                   | side light            |
| press             | : switching on        |
|                   | passenger light       |

### Load compartment lighting

If available there are one or two lights above the rear doors and sliding doors.

Load compartment lighting can be set to illuminate when the side and rear doors are opened, or switched on constantly.

With the switch in its central position, the light functions as a courtesy light. It switches off after a few minutes, if the doors are open.



- Operated by pressing on the left part of the light: on constantly.
- Operated by pressing on the right part of the light: off constantly.

## Lighting features

### Centre console lighting

A spotlight integrated in the overhead console illuminates the centre console when headlights are switched off.

The intensity can be adjusted in the vehicle personalisation ↗ 65.

### Exit lighting

#### Path lighting

The headlight illuminate the surrounding area for about 30 seconds after leaving the vehicle.

#### Activating

1. Switch the ignition off and turn the key into position: **STOP**.
2. Pull the light switch in the direction of the steering wheel.

3.  illuminates.

Every pull extends the afterglow by 30 seconds up to 3 minutes.

4. The light goes out after expiration of period.

#### Deactivating

Pull the light switch in direction of the steering wheel for more than 2 seconds.

### Battery discharge protection

To prevent discharge of the vehicle battery when the ignition is switched off, some interior lights are switched off automatically after some time.

## Climate control

<b>Climate control systems</b> .....	<b>75</b>
Heating and ventilation system .	75
Air conditioning system .....	76
Electronic climate control system .....	78
Auxiliary heater .....	80
Parking heater .....	81
<b>Air vents</b> .....	<b>83</b>
Adjustable air vents .....	83
Fixed air vents .....	84
Glovebox cooler .....	84
<b>Maintenance</b> .....	<b>85</b>
Air intake .....	85
Air conditioning regular operation .....	85
Service .....	85

## Climate control systems

### Heating and ventilation system



Controls for:

- temperature
- fan speed
- air distribution
- air recirculation

### Notice

Electric vehicles: The control panel for heating the interior of electric vehicles is located next to the steering wheel, below the **Mode** control panel.

Auxiliary heater ⇨ 80.

### Temperature

Adjust the temperature by turning temperature control to the desired temperature.

blue : cold

red : warm

Heating will not be fully effective until the engine has reached normal operating temperature.

### Electric vehicles





For heating the interior of electric vehicles: Switch on auxiliary heater, turn temperature setting to highest (red zone) and adjust air flow.

Auxiliary heater ⇨ 80.

### Fan speed

Adjust the air flow by turning  to the desired speed.

### Air distribution

-  : to head area
-  : to head area and foot well
-  : to foot well
-  : to foot well, windscreen and front door windows
-  : to windscreen and front door windows

### Air recirculation system

Turn control to  to activate air recirculation mode.





Press  to deactivate recirculation mode.

#### Warning

The exchange of fresh air is reduced in air recirculation mode. In operation without cooling the air humidity increases, so the windows may mist up from inside. The quality of the passenger compartment air deteriorates, which may cause the vehicle occupants to feel drowsy.

In warm and very humid ambient air conditions, the windscreen may mist up from outside when cold air is directed towards it. If windscreen mists up from outside, activate windscreen wiper and deactivate .

### Demisting and defrosting

- Set temperature control to warmest level.
- Set fan speed  to highest level.
- Set air distribution control to .
- Switch on heated rear window  in centre console .
- Open side air vents as required and direct them towards the door windows.
- For simultaneous warming of the foot well, set air distribution control to .

Heated rear window  ⇨ 17.

### Air conditioning system



Controls for:

- cooling 
- temperature
- fan speed
- air distribution
- air recirculation

#### Notice

Electric vehicles: The control panel for heating the interior of electric vehicles is located next to the steering wheel, below the **Mode** control panel.

Auxiliary heater ⇨ 80.

## Cooling

Press  to switch on cooling. The LED in the button illuminates to indicate activation. Cooling is only functional when the engine is running and fan is switched on.

Press  again to switch off cooling.

The air conditioning system cools and dehumidifies (dries) as soon as the outside temperature is slightly above the freezing point. Therefore, condensation may form and drip from under the vehicle.

If no cooling or drying is required, switch off the cooling system for fuel saving reasons.

Activated cooling may inhibit Autostops.

Stop-start system ⇨ 89.

## Temperature

Adjust the temperature by turning temperature control to the desired temperature.

blue : cold  
red : warm

Heating will not be fully effective until the engine has reached normal operating temperature.

### Electric vehicles





For heating the interior of electric vehicles: Switch on auxiliary heater, turn temperature setting to highest (red zone) and adjust air flow.

Auxiliary heater ⇨ 80.

### Fan speed

Adjust the air flow by turning  to the desired speed.

### Air distribution

-  : to head area
-  : to head area and foot well
-  : to foot well
-  : to foot well, windscreen and front door windows
-  : to windscreen and front door windows

### Air recirculation

Turn control to  to activate air recirculation mode.

Press  to deactivate recirculation mode.



### Warning

The exchange of fresh air is reduced in air recirculation mode. In operation without cooling the air humidity increases, so the windows may mist up from inside. The quality of the passenger compartment air deteriorates, which may cause the vehicle occupants to feel drowsy.

In warm and very humid ambient air conditions, the windscreen may mist up from outside when cold air is directed towards it. If windscreen mists up from outside, activate windscreen wiper and deactivate .





### Maximum cooling

Briefly open the windows so that hot air can disperse quickly.

- Switch on cooling .
- Press  for air distribution.
- Set temperature control to coldest level.

- Set fan speed to highest level.
- Open all vents.

### Demisting and defrosting

- Set temperature control to warmest level.  
Electric vehicles: activate auxiliary heater.  
Auxiliary heater ⇨ 80.
- Set fan speed  to highest level.
- Switch on cooling , if required.
- Set air distribution control to .
- Switch on heated rear window  in centre console .
- Open side air vents as required and direct them towards the door windows.
- For simultaneous warming of the foot well, set air distribution control to .

Heated rear window  ⇨ 17.

#### Notice

If the settings for demisting and defrosting are selected, an Autostop may be inhibited.



If the settings for demisting and defrosting are selected while the engine is in an Autostop, the engine will restart automatically.



Stop-start system ⇨ 89.

### Electronic climate control system



Controls for:

- automatic mode **AUTO**
- temperature
- air distribution ▲, ► or ▼
- fan speed 
- cooling 
- complete system off **OFF**

- demisting and defrosting 
- air intake / air recirculation 

Activated functions are indicated by the LED in the respective control or by a symbol shown in the display.

The electronic climate control system is only fully operational when the engine is running.

#### Notice

Electric vehicles: The control panel for heating the interior of electric vehicles is located next to the steering wheel, below the **Mode** control panel.

Auxiliary heater ⇨ 80.

### Automatic mode

Basic setting for maximum comfort:

- Press **AUTO (FULL AUTO)** appears in the display).
- Set desired temperature by turning the ring around **AUTO** according to a scale between **HI** (approx. 32 °C) and **LO** (approx. 16 °C).



- Open all air vents to allow optimised air distribution.
- Air conditioning must be activated for optimal cooling and demisting. Press  to switch on air conditioning. The symbol in the display indicates activation.

During full automatic mode, the settings for fan speed, air distribution, air conditioning and air recirculation are automatically regulated by the system. The preselected temperature is maintained automatically.

For correct operation, do not cover the sensor on the instrument panel.

## Manual settings

Climate control system settings can be manually adapted by use of air distribution, fan speed and air recirculation controls. The display changes from **FULL AUTO** to **AUTO**.

When the system cannot maintain preselected temperature with manual settings, temperature display will flash and **AUTO** will disappear from screen.

To return to full automatic mode, press **AUTO**.

### Air distribution

Press ,  or .



 : to windscreen and front door windows

 : to head area

 : to front and rear foot well

To return to automatic air distribution, press **AUTO**.

### Fan speed

Press  or  to adjust the air flow.

To return to automatic mode, press **AUTO**.

### Air conditioning

Press  to switch on cooling. The symbol on the display indicates activation. Cooling is only functional when the engine is running and climate control fan is switched on.

Press  again to switch off cooling.

The air conditioning system cools and dehumidifies (dries) when outside temperature is above a specific level. Therefore, condensation may form and drip from under the vehicle.

If no cooling or drying is required, switch off the cooling system for fuel saving reasons.

### Notice

If **A/C** is switched on, reducing the set cabin temperature can cause the engine to restart from an Autostop or inhibit an Autostop.

### Manual air recirculation

Press  to activate the air recirculation mode. The LED in the button illuminates to indicate activation.

Press  again to deactivate recirculation mode.





### Warning

The exchange of fresh air is reduced in air recirculation mode. In operation without cooling, the air humidity increases, so the



windows may mist up from inside. The quality of the passenger compartment air deteriorates, which may cause the occupants to feel drowsy.

In warm and very humid ambient air conditions, the windscreen may mist up from outside, when cold air is directed towards it. If windscreen mists up from outside, activate windscreen wiper and deactivate ▲.

### Demisting and defrosting the windows

- Press . The LED in the button illuminates to indicate activation.
- Temperature and air distribution are set automatically and the fan runs at high speed.
- Switch on air conditioning by pressing , if required.
- Switch on heated rear window . Heated rear window ⇨ 17.
- To return to previous mode, press  again. To return to automatic mode, press **AUTO**.

### Notice

If  is pressed while the engine is running, an Autostop will be inhibited until  is pressed again.

If  is pressed while the engine is in an Autostop, the engine will restart automatically.

Stop-start system ⇨ 89.

### Deactivation of electronic climate control system

Press **OFF**.

### Auxiliary heater

The control panel for heating the interior of electric vehicles is located next to the steering wheel, below the **Mode** control panel.

### Notice

This control panel is for heating only. To distribute cold air, use the standard controls on the centre console.



- 1 : heating on/off
- 2 : heating status
- 3 : temperature setting
- 4 : increase temperature
- 5 : reduce temperature
- 6 : access temperature settings



### Heating status

OUT1 is displayed permanently: heating is in operation.

OUT1 flashing: temperature adjustment in progress.

OUT1 off: selected temperature has been reached.

## Activation

- Switch on ignition.
- Press  to switch on heater.
- Press **set**.
- Press  or  to reduce or increase temperature setting
- Press **set** to confirm temperature setting.
- On standard heating and ventilation control in middle console:

Turn temperature setting to highest to avoid entry of cold air and for the selected temperature to be reached quickly without consuming too much energy.

Adjust air flow.

Heating will start after two to three minutes.

Temperature settings will be stored when engine is switched off.

### Notice

If the charging level of the high voltage battery is below 15%, heating is switched off automatically.

It is recommended to select a temperature between 16°C and 22°C in order to preserve the high voltage battery's range.

Heating can be switched on while charging the vehicle. In this case, the vehicle is heated using the electricity supply.

## Deactivation

Press  to switch off heating.

## Parking heater

### Warning

Do not operate the system when refuelling, when dust or combustible vapours are present or in enclosed spaces (e.g. garage).

The programmable heater gradually brings the engine to a good temperature to facilitate its starting. A built-in clock allows time presets for delayed start of heating. The passenger compartment will warm up

faster. The warming-up of the passenger compartment, de-icing and demisting are facilitated.

Heating switches off when the battery voltage is low, so as to allow engine starting. The heater is fed by the vehicle's fuel tank. Ensure that the low fuel warning lamp is not on.

The heater is fitted with a temperature limiter which cuts off the combustion in the event of engine overheating due to a lack of coolant. Check the level and top up if necessary. Then press **set** before switching the heating on again. Engine coolant  147.

### Notice

Have the additional heating checked at least once a year at the beginning of winter. Maintenance and repairs should only be carried out by a qualified workshop. Use only genuine replacement parts.



- 1 : time setting
- 2 : heating indicator
- 3 : time display
- 4 : ventilation indicator
- 5 : **set**
- 6 : preset numbers
- 7 : timer indicator
- 8 : immediate heating

### Setting system clock time

Set the clock of the parking heater before setting up time presets for heating.

- Press and hold **set**. The display and the timer indicator will come on.

- Within 10 seconds, while still holding **set**, press < or > to decrease or increase hours until correct time is displayed. Press and hold < or > to decrease or increase hours faster.
- Release **set**.

When the display switches off, the time is stored.

### Display time

Press < or >.

Timer indicator will come on and the time will be displayed for approx. ten seconds.

### Immediate start of heating system

- Before turning on the heating, check that in the centre console temperature is set to warm / high and air flow control knob is in position two.
- Press button for immediate heating (8) to start heating.

The display and the heating indicator will come on and stay on for the entire operating time.

### Preset start of heating

The start time can be preset between 1 minute and 24 hours in advance. Up to three different start times can be stored, but only a single preset start can be programmed.

To perform a daily start at a fixed time, reprogramme the stored time each day.

- Press **set**. The display will switch on.  
--:-- or the previous stored time and corresponding preset number (1, 2 or 3) are displayed for 10 seconds.
- To recall other preset times, press **set** several times before the end of the 10 seconds.
- Within 10 seconds, press < or > to select the desired start time.

When the new preset time is stored display of start time and preset number will disappear and display lighting will switch off.

By default, preset times are already stored in the system (1 = 06:00, 2 = 16:00, 3 = 22:00). Any change

cancels and replaces the previous preset time. If the battery is disconnected, the default preset times will be restored.

### Cancel preset heating

To delete the preset start time, briefly press **set**.

Display and preset number will go off.

### Recalling one of the preset start times

Press **set** as many times as necessary until the number corresponding to the desired preset start time (1, 2 or 3) appears.

After ten seconds, timer display disappears but remains stored while the corresponding number (1, 2 or 3) and the display remain on.

### Setting operating duration

The operating duration can be set between 10 and 60 minutes

- Press and hold **set**.
- Press simultaneously **<** or **>**.

The display and the timer indicator will come on.

- Press and hold **set** and **<** or **>** again.

The programmed operating duration is displayed and the heating or ventilation indicator flashes.

- Adapt the duration by pressing **<** or **>**.

New duration is stored and confirmed by the disappearance of the duration display or by pressing **set** again.

### Switching off heating

In the event of a preset start, the heating switches off automatically at the end of the programmed duration.

In the event of an immediate start, press button for immediate heating (8) again to switch it off manually.

The heating indicator and the display go off.

## Air vents

### Adjustable air vents

#### Air vents in the instrument panel

At least two air vent must be open while the cooling is on.



Direct the flow of air by tilting and swivelling the slats.



Adjust the air amount at the vent outlet by turning the adjuster wheel. The vent is closed when the adjuster wheel is turned close to the left or right.

### Outer air vents in the instrument panel



Direct the flow of air by tilting and swivelling the slats.

Adjust the air amount at the vent outlet by turning the adjuster wheel. The vent is closed when the adjuster wheel is turned close to the left or right.

At least two air vents must be open while cooling is on.

### Warning

Do not attach any objects to the slats of the air vents. Risk of damage and injury in case of an accident.

### Fixed air vents

Additional air vents are located beneath the windscreen, the door windows and in the foot wells.

### Glovebox cooler

The front storage provides an air vent which can be closed ↪ 37.

## Maintenance

### Air intake

The air intake in front of the windscreen in the engine compartment must be kept clear to allow air intake. Remove any leaves, dirt or snow.

### Air conditioning regular operation

In order to ensure continuously efficient performance, cooling must be operated for a few minutes once a month, irrespective of the weather and time of year. Operation with cooling is not possible when the outside temperature is too low.

### Service

For optimal cooling performance, it is recommended to annually check the climate control system, starting three years after initial vehicle registration, including:

- functionality and pressure test
- heating functionality

- leakage check
- check of drive belts
- cleaning of condenser and evaporator drainage
- performance check

## Driving and operating

<b>Driving hints</b> .....	<b>86</b>
Control of the vehicle .....	86
Steering .....	87
<b>Starting and operating</b> .....	<b>87</b>
New vehicle running-in .....	87
Ignition switch positions .....	87
Starting the engine .....	88
Stop-start system .....	89
Parking .....	91
Air suspension .....	92
<b>Engine exhaust</b> .....	<b>93</b>
Exhaust filter .....	93
Catalytic converter .....	94
AdBlue .....	94
<b>Electric drive unit</b> .....	<b>98</b>
<b>Manual transmission</b> .....	<b>99</b>
<b>Brakes</b> .....	<b>100</b>
Antilock brake system .....	100
Parking brake .....	101
Brake assist .....	101
Hill start assist .....	101
Regenerative braking .....	102

<b>Ride control systems</b> .....	<b>102</b>
Electronic Stability Control and Traction Control system .....	102
Descent control system .....	104
<b>Driver assistance systems</b> .....	<b>106</b>
Cruise control .....	106
Speed limiter .....	109
Active emergency braking .....	112
Forward collision alert .....	114
Parking assist .....	116
Side blind spot alert .....	117
Rear view camera .....	120
Rear cross traffic alert .....	121
Traffic sign assistant .....	123
Lane departure warning .....	124
<b>Charging</b> .....	<b>125</b>
General information .....	125
Charging types .....	126
Charging cable .....	127
Charging status .....	132
<b>Fuel</b> .....	<b>133</b>
Fuel for diesel engines .....	133
Refuelling .....	134
<b>Trailer hitch</b> .....	<b>136</b>
General information .....	136
Driving characteristics and towing tips .....	136
Trailer towing .....	136
Towing equipment .....	137

## Driving hints

### Control of the vehicle

#### Never coast with engine not running

Many systems will not function in this situation (e.g. brake servo unit, power steering). Driving in this manner is a danger to yourself and others.

All systems function during an Autostop.

Stop-start system ⇨ 89.

#### Pedals

To ensure the pedal travel is uninhibited, there must be no mats in the area of the pedals.

Use only floor mats, which fit properly and are fixed by the retainers on the driver side.



## Steering

If power steering assist is lost because the engine stops or due to a system malfunction, the vehicle can be steered but may require increased effort.

## Starting and operating

### New vehicle running-in

Do not brake unnecessarily hard for the first few journeys and after new disc brake pads have been fitted.

During the first drive, smoke may occur because of wax and oil evaporating off the exhaust system. Park the vehicle in the open for a while after the first drive and avoid inhaling the fumes.

During the running-in period, fuel and engine oil consumption may be higher.

Additionally, the cleaning process of the exhaust filter may take place more often.

Exhaust filter ⇨ 93.

### Ignition switch positions

Turn key:

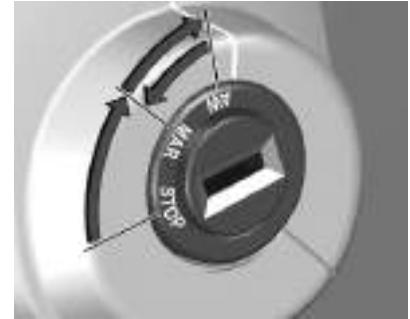

**STOP** : ignition off: some functions may remain active for some time

**MAR** : ignition on power mode: ignition is on, diesel engine is preheating, control indicators illuminate and most electrical functions are operable

**AVW** : engine start: release key after engine has been started

### Steering wheel lock

Remove key from ignition switch and turn steering wheel until it engages.

**⚠ Danger**

Never remove the key from ignition switch during driving as this will cause steering wheel lock.

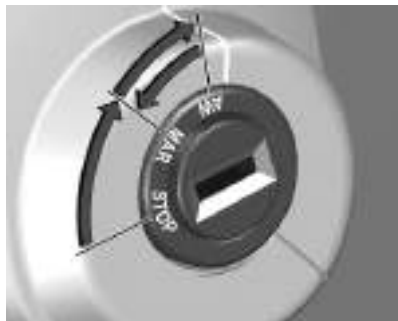
**Starting the engine****Combustion engine vehicle**

Turn key to position MAR to release the steering wheel lock.

Operate clutch and brake pedal.

Do not operate accelerator pedal.

Wait until control indicator  extinguishes.

Turn key briefly to position AVV and release after the engine has been started.

During an Autostop, the engine can be started by depressing the clutch pedal ⇨ 89.

**Starting the vehicle at low temperatures**

Starting the engine without additional heaters is basically possible.

Required is an engine oil with the correct viscosity, the correct fuel, performed services and a sufficiently charged vehicle battery. At low temperatures, the automatic transmission requires a warming phase of approx. 5 minutes. The selector lever must be in position **N** and the parking brake applied.

**Turbo engine warm-up**

Upon start-up, engine available torque may be limited for a short time, especially when the engine temperature is cold. The limitation is to allow the lubrication system to fully protect the engine.

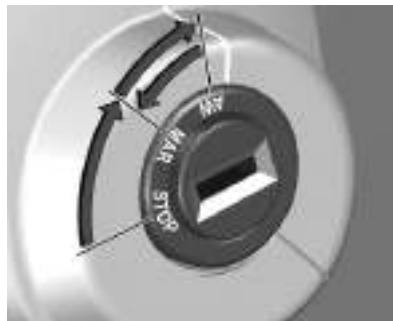
**Electric vehicle**

- Operate the brake pedal and with the parking brake applied, turn key briefly to position AVV and release it. A corresponding message appears in the rear view mirror display.
- Do not operate the accelerator pedal.
- Depress the brake pedal completely, then press **D** or **R** on the gear selector ⇨ 98.
- Release the parking brake.

## Stop-start system

The stop-start system helps to save fuel and to reduce the exhaust emissions. When conditions allow, it switches off the engine as soon as the vehicle is at a low speed or at a standstill, e.g. at a traffic light or in a traffic jam.

### Activation

The stop-start system is available as soon as the engine is started, the vehicle starts-off and the conditions as stated below in this section are fulfilled. As soon as the ignition has been switched on, the system is activated by default.



Press  to activate the system when it has been deactivated before.

The activation is indicated when the LED in the button is not illuminated. Additionally, a message is displayed in the Driver Information Centre.

### Deactivation



Press  to deactivate the system. The deactivation is indicated when the LED in the button illuminates. Additionally, a message is displayed in the Driver Information Centre.

If the system is deactivated during an Autostop, the engine restarts immediately.

### Autostop

The automatic engine shutdown is only possible when the speed of the vehicle has exceeded 6 mph, in order to avoid repeated engine shutdowns when driving slowly.

Activate an Autostop as follows:

- Depress the clutch pedal.
- Set the selector lever to neutral.
- Release the clutch pedal.

The engine will be switched off while the ignition stays on.

### Caution

Performing engine compartment checks with activated stop-start system increases the risk of injuries caused by a possible automatic restart of the engine.

Only perform engine compartment checks when the stop-start system is deactivated.

### Indication



An Autostop is indicated by control indicator (A).

During an Autostop, the heating and brake performance will be maintained.

### Conditions for an Autostop

The stop-start system checks if each of the following conditions is fulfilled.

- The stop-start system is not manually deactivated.
- The driver's door is closed or the driver's seat belt is fastened.
- The reverse gear is not engaged.
- The vehicle battery is sufficiently charged and in good condition.
- The engine is warmed up.
- The ambient temperature is between 0 °C and 35 °C.
- The engine coolant temperature is not too high.
- The engine exhaust temperature is not too high, e.g. after driving with high engine load.
- The air conditioning is switched off.
- The rear window heating is switched off.

- The windscreen wipers are not in fast wiping mode.
- The brake vacuum is sufficient.
- The self-cleaning function of the exhaust filter is not active.
- The vehicle was driven at least at walking speed since the last Autostop.

Otherwise an Autostop will be inhibited.

### Notice

The Autostop may be inhibited for several hours after a battery replacement or reconnection.

Certain settings of the climate control system may inhibit an Autostop.

Climate control ⇨ 76.

Immediately after higher speed driving an Autostop may be inhibited.

New vehicle running-in ⇨ 87.

### Vehicle battery discharge protection

To ensure reliable engine restarts, several vehicle battery discharge protection features are implemented as part of the stop-start system.

## Restart of the engine by the driver

With a gear engaged, depress the clutch pedal without depressing the brake pedal to restart the engine.

Control indicator (A) extinguishes when the engine restarts.

If no actions are performed within 3 minutes after an automatic restart, the engine is switched off permanently. To restart the engine, use the ignition key.

Starting the engine ⇨ 88.

## Restart of the engine by the stop-start system

If one of the following conditions occurs during an Autostop, the engine will be restarted automatically by the stop-start system:

- the vehicle is free-wheeling on a slope
- windscreen wipers are in fast wiping mode **HI**
- engine temperature too low
- charging level of vehicle battery below defined level

- brake vacuum not sufficient
- climate control system requests engine start
- air conditioning manually switched on
- engine has been switched off for around 3 minutes by the system

If one of these conditions occur, (A) flashes for some seconds and a message is displayed in the Driver Information Centre.

## Fault

In the event of a fault, the stop-start system is deactivated, a warning light is illuminated and a message is displayed in the Driver Information Centre.

Have the system checked by a qualified workshop.

In the event of a fault in Autostop, the engine can be restarted by fully depressing the clutch pedal or setting the selector lever to neutral.

## Parking

### ⚠ Warning

- Do not park the vehicle on an easily ignitable surface. The high temperature of the exhaust system could ignite the surface.
- Apply the parking brake.
- If the vehicle is on a level surface or uphill slope, engage first gear or set the selector lever to position **N** (electric vehicle). On an uphill slope, turn the front wheels away from the kerb.  
  
If the vehicle is on a downhill slope, engage reverse gear or set the selector lever to position **N** (electric vehicle). Turn the front wheels towards the kerb.
- Close the windows.

- Switch off the engine.
  - Remove the ignition key from the ignition switch. Turn the steering wheel until the steering wheel lock is felt to engage.
- Lock the vehicle.
  - Activate the anti-theft alarm system.
  - The engine cooling fans may run after the engine has been switched off ⇨ 144.

### Notice

In the event of an accident with airbag deployment, the engine is switched off automatically if the vehicle comes to a standstill within a certain time.

In countries with extremely low temperatures it may be necessary to park the vehicle without applied parking brake. Make sure to park the vehicle on a level surface.

## Air suspension

### Caution

Components under the body may be damaged when driving with the air suspension set too high or too low, respectively.

The height may be adjusted automatically to take account of changes in temperature or loading.

Do not adjust the height of the sill level manually if somebody is working underneath the vehicle, if a wheel is being changed or if the vehicle is being transported by a lorry, train, ferry, boat, etc.

In order to avoid injuries or damages, always check that nobody or nothing is underneath the vehicle before adjusting the height of the air suspension.



To facilitate the loading or unloading of the vehicle, the height of the rear loading sill can be adjusted.

### Manual adjustment

The system provides seven preset loading heights:

- Normal sill level 0
- Three higher sill levels from +1 to +3
- Three lower sill levels from -1 to -3



With the vehicle stationary, briefly press to select the next higher sill level.

Briefly press to select the next lower sill level.

Press and hold or to select the highest or lowest sill level, respectively.

The current sill level will be displayed in the Driver Information Centre. The LED in the respective button illuminates after each press.

### Caution

Ensure there is adequate clearance and that there are no obstructions when adjusting the suspension height.

### Deactivation / reactivation

Press and hold and simultaneously to deactivate or reactivate the system. The deactivation is confirmed by the illumination of the LEDs in both buttons.

If the vehicle's speed exceeds 3 mph, the system is reactivated automatically.

### Automatic adjustment

If the vehicle's speed exceeds 12 mph, the normal sill level **0** will be set automatically by the system.

### Fault

If a fault is detected, illuminates. Seek the assistance of a workshop.

## Engine exhaust

### Danger

Engine exhaust gases contain poisonous carbon monoxide, which is colourless and odourless and could be fatal if inhaled.

If exhaust gases enter the interior of the vehicle, open the windows. Have the cause of the fault rectified by a workshop.

Avoid driving with an open load compartment, otherwise exhaust gases could enter the vehicle.

## Exhaust filter

### Automatic cleaning process

The exhaust filter system filters soot particles out of the exhaust gases.

The start of saturation of the exhaust filter is indicated by the illumination of accompanied by a message in the Driver Information Centre.

As soon as the traffic conditions permit, regenerate the filter by driving at a vehicle speed of at least 40 mph with an engine speed of 2,000 rpm until the control indicator extinguishes.

This procedure can last up to 15 minutes.

Avoid switching off the engine before the filter regeneration has been finished. Repeated interruptions can lead to early deterioration of the engine oil.

It is not recommended to terminate the filter regeneration with the vehicle stationary.

#### Notice

On a new vehicle, the first exhaust filter regeneration operations may be accompanied by a burning smell, which is normal. Following prolonged operation of the vehicle at very low speed or at idle, water vapour can be emitted at the exhaust on acceleration. This does not affect the behaviour of the vehicle or the environment.

#### Fault

In the event of a fault,  and the message in the Driver Information Centre persist.

Seek the assistance of a workshop.

#### Catalytic converter

The catalytic converter reduces the amount of harmful substances in the exhaust gases.

#### Caution

Fuel grades other than those listed on page  133 could damage the catalytic converter or electronic components.

Unburnt fuel will overheat and damage the catalytic converter. Therefore avoid excessive use of the starter, running the fuel tank dry and starting the engine by pushing or towing.

In the event of misfiring, uneven engine running, a reduction in engine performance or other unusual problems, have the cause of the fault

rectified by a workshop as soon as possible. In an emergency, driving can be continued for a short period, keeping vehicle speed and engine speed low.

#### AdBlue

##### General information

The selective catalytic reduction (BlueInjection) is a method to substantially reduce the nitrogen oxides in the exhaust emission. This is achieved by injecting a Diesel Exhaust Fluid (DEF) into the exhaust system. The ammonia released by the fluid reacts with nitrous gases (NO<sub>x</sub>) from the exhaust and turns it into nitrogen and water.

The designation of this fluid is AdBlue®. It is a non-toxic, non-flammable, colourless and odourless fluid which consists of 32% urea and 68% water.



**⚠ Warning**

Avoid contact of your eyes or skin with AdBlue.

In case of eye or skin contact, rinse off with water.

**Caution**

Avoid contact of the paintwork with AdBlue.

In case of contact, rinse off with water.

AdBlue freezes at a temperature of approx. -11 °C. As the vehicle is equipped with an AdBlue pre-heater, the emissions reduction at low temperatures is ensured. The AdBlue pre-heater works automatically.

In some circumstances below the mentioned temperature, an error message appears in the Driver Information Centre. In this event, park the vehicle in a space with a higher ambient temperature until AdBlue is liquefied.

**Notice**

Frozen and again liquefied AdBlue is usable without quality loss.

**Warning levels**

Depending on the calculated range of AdBlue, different messages are displayed in the Driver Information Centre. The messages and the restrictions are a legal requirement.

1. When switching on the ignition, a warning message with the calculated range will be displayed in the Driver Information Centre. Additionally, the control indicator  flashes accompanied by a warning chime. Although driving is possible without any restrictions, it is recommended to top up AdBlue as soon as possible.
2. As soon as the threshold value of 372 miles has been reached, the next warning level is activated. When switching on the ignition, a warning message with the calculated range will be displayed in the Driver Information Centre. Additionally, the control indicator

 flashes accompanied by a warning chime. Refill AdBlue as soon as possible before the AdBlue tank is completely empty. Otherwise, a restart of the engine will not be possible.

When driving, the chime sounds and the message is displayed every 31 miles until the AdBlue tank has been topped-up.

3. The last warning level is entered when the AdBlue tank is empty. Restart of the engine is not possible. A warning message will be displayed in the Driver Information Centre.

Refill the tank to a level of at least 4 l of AdBlue, otherwise restarting of the engine is not possible.

**High emission warnings**

In the event of a fault with the emissions control system, different messages are displayed in the Driver Information Centre. The messages and the restrictions are a legal requirement.

1. If a fault is detected for the first time, the control indicator  will illuminate, a warning message is displayed accompanied by a warning chime. Driving is possible without any restrictions.

If it is a temporary fault, the alert disappears during the next journey, after self-diagnosis of the emissions control system.

2. If the fault persists and it is confirmed by the emission control system, the message is displayed every 30 s.

The control indicator  continues to illuminate accompanied by a warning chime. Additionally, the remaining range until the start of the engine start prevention system will be displayed.

Seek the assistance of a workshop!

3. Once the permissible range has been exceeded, each engine starting attempt is prevented by the system.

Additionally, the control indicator  will illuminate accompanied by a warning chime.

Seek the assistance of a workshop!

### Refilling AdBlue

#### Caution

Only use AdBlue that complies with European standards DIN 70 070 and ISO 22241-1.

Do not use additives.

Do not dilute AdBlue.

Otherwise the selective catalytic reduction system could be damaged.

#### Notice

Whenever a filling pump with a nozzle for passenger cars is not available at a filling station, use only AdBlue bottles or canisters with a sealed refill adapter for refilling, to prevent splashback and overflow, and in order to ensure that the fumes from the AdBlue tank are captured and do not emerge. AdBlue in

bottles or canisters is available in many filling stations and can be purchased e.g. at Vauxhall dealers and other retail outlets.

Since AdBlue has a limited durability, check the date of expiry before refilling.

#### Notice

Refill the AdBlue tank to a level of at least 4 l to ensure that the new AdBlue level is being detected.

In case AdBlue refill is not successfully detected:

1. Continuously drive the vehicle for 10 min making sure that vehicle speed is always higher than 12 mph.
2. If AdBlue refill is detected successfully, AdBlue supply-driven warnings or limitations will disappear.

If AdBlue refill is still not detected, seek the assistance of a workshop.

If AdBlue must be refilled at temperatures below -11 °C, the refilling of AdBlue may not be detected by the system. In this

event, park the vehicle in a space with a higher ambient temperature until AdBlue is liquified.

**Notice**

When unscrewing the protective cap from the filler neck, ammonia fumes may emerge. Do not inhale as the fumes have a pungent smell. The fumes are not harmful by inhalation.

The AdBlue tank should be filled completely. This must be done if the warning message regarding prevention of an engine restart is already displayed.

The vehicle must be parked on a level surface.

1. Remove key from ignition switch.



2. Open the fuel filler flap.

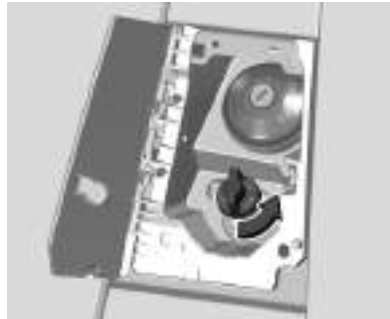

3. Turn the protective cap of the AdBlue tank a 6th of a turn anti-clockwise and remove it.

4. Open AdBlue canister.
5. Mount one end of the hose on the canister and screw the other end on the filler neck.
6. Lift the canister until it is empty, or until the flow from the canister has stopped. This can take up to 5 minutes.
7. Place the canister on the ground to empty the hose, wait 15 seconds.
8. Unscrew the hose from the filler neck.
9. Mount the protective cap and turn it clockwise until it engages.

**Notice**

Dispose of AdBlue canister according to environmental requirements. Hose can be reused after flushing with clear water before AdBlue dries out.

## Electric drive unit

The vehicle is equipped with an electric drive unit that contains a 1-gear transmission. The drive selector is located on the centre console next to the steering wheel.

### Caution

Spinning the tyres or holding the vehicle in one place on a hill using only the accelerator pedal may damage the electric drive unit. If you are stuck, do not spin the tyres. When stopping on a hill, use the brakes to hold the vehicle in place.



**D** : drive mode

**N** : neutral

**R** : reverse gear, engage only when the vehicle is stationary

### Shifting

Shifting always starts from **N** and is operated by pushing the respective button. Once operated, the button of the selected gear is illuminated.



The selected gear is indicated in rear view mirror display.

### Neutral N

In this position, the propulsion system does not transfer torque to the wheels. When the ignition has been switched on, the drive selector is always in mode **N**.

The electric drive unit will shift to **N** automatically if the driver's door is opened.

A message is displayed in the Driver Information Centre accompanied by a warning chime.

### ⚠ Warning

It is dangerous to get out of the vehicle if the parking brake is not firmly applied. The vehicle can roll. Do not leave the vehicle when the propulsion system is running, the vehicle may move suddenly. You or others can be injured. To be sure the vehicle will not move, even if the vehicle is on a level surface, always apply the parking brake and select **N**.

### Reverse gear R

Use this gear to reverse.

To shift into and out of **R**:

1. Bring the vehicle to a complete stop.
2. To shift into **R**, depress the brake pedal and press **R**.

To shift out of **R**, depress the brake pedal and shift into the desired gear.

### Caution

Shifting into **R** while the vehicle is moving forward could damage the electric drive unit. Only shift into **R** after the vehicle has been stopped.

### Drive mode D

This position is for forward driving.

### Caution

If the vehicle seems to accelerate slowly or not respond when trying to go faster, do not continue the journey. The electric drive unit could be damaged. Consult a workshop as soon as possible.

## Manual transmission



To engage reverse, depress the clutch pedal, pull the ring under the selector lever and move the selector lever quite to the left and front.

If the gear does not engage, set the selector lever to neutral, release the clutch pedal and depress again. Then repeat gear selection.

Do not slip the clutch unnecessarily.

When operating, depress the clutch pedal completely. Do not use the pedal as a foot rest.

**Caution**

It is not advisable to drive with the hand resting on the selector lever.

Gear shift indication ⇨ 57.

Stop-start system ⇨ 89.

**Brakes**

The brake system comprises two independent brake circuits.

If a brake circuit fails, the vehicle can still be braked using the other brake circuit. However, braking effect is achieved only when the brake pedal is depressed firmly. Considerably more force is needed for this. The braking distance is extended. Seek the assistance of a workshop before continuing the journey.

When the engine is not running, the support of the brake servo unit disappears once the brake pedal has been depressed once or twice. Braking effect is not reduced, but braking requires significantly greater force. It is especially important to bear this in mind when being towed.

**Antilock brake system**

Antilock brake system (ABS) prevents the wheels from locking.

ABS starts to regulate brake pressure as soon as a wheel shows a tendency to lock. The vehicle remains steerable, even during hard braking.

ABS control is made apparent through a pulse in the brake pedal and the noise of the regulation process.

For optimum braking, keep the brake pedal fully depressed throughout the braking process, despite the fact that the pedal is pulsating. Do not reduce the pressure on the pedal.



Control indicator  ⇨ 56.

## Fault

### ⚠ Warning

If there is a fault in the ABS, the wheels may be liable to lock due to braking that is heavier than normal. The advantages of ABS are no longer available. During hard braking, the vehicle can no longer be steered and may swerve.

Have the cause of the fault remedied by a workshop.

## Parking brake

### ⚠ Warning

Before leaving the vehicle, make sure the parking brake is applied. Control indicator (ⓘ) illuminates constantly when parking brake is applied.



### ⚠ Warning

Always apply parking brake firmly without operating the release button, and apply as firmly as possible on a downhill or uphill slope.

To release the parking brake, pull the lever up slightly, press the release button and fully lower the lever.

To reduce the operating forces of the parking brake, depress the foot brake at the same time.

## Brake assist

If brake pedal is depressed quickly and forcefully, maximum brake force is automatically applied.

Operation of brake assist might become apparent by a pulse in the brake pedal and a greater resistance when depressing the brake pedal.

Maintain steady pressure on the brake pedal as long as full braking is required. Maximum brake force is automatically reduced when brake pedal is released.

## Hill start assist

The system helps prevent unintended movement when driving away on inclines.

When releasing the brake pedal after stopping on an incline, brakes remain on for further 2 seconds.

The brakes release automatically when:

- the clutch pedal is released.
- the parking brake is applied.

- the engine is switched off.
- the engine stalls.

### System limits

- The vehicle must be stationary, the engine running and the brake pedal depressed.
- The incline of the road must be steeper than 5%.
- The selector lever must be set to neutral or another than reverse when standing uphill.
- The selector lever must be set to reverse when standing downhill.

### Fault

In the event of a fault,  illuminates and a warning message is displayed in the Driver Information Centre accompanied by a warning chime. Seek the assistance of a workshop.

## Regenerative braking

### Warning

In the case of extreme temperatures or if the high voltage battery is almost fully charged, the brake force of the engine braking may be temporarily reduced. If the braking force is not sufficient, the driver has to be prepared to use the brake pedal.

### Warning

Depending on the engine braking force the brake lights are illuminated.

Regenerative braking generates electrical energy resulting from engine braking to charge the high voltage battery.

Electric drive unit ⇨ 98.

## Ride control systems

### Electronic Stability Control and Traction Control system

### Warning

Do not let this special safety feature tempt you into taking risks when driving.  
Adapt speed to the road conditions.

Electronic Stability Control (ESC) improves driving stability when necessary, regardless of the type of road surface or tyre grip.

As soon as the vehicle start to swerve (understeer / oversteer), engine output is reduced and the wheels are braked individually.

ESC consists of several subsystems:

- Antilock brake system (ABS)  
⇨ 100
- Brake assist ⇨ 101
- Traction control system (TC)



- Dynamic stability control
- Load inertia control

### Traction control system (TC)

The TC prevents the driven wheels from spinning.

Traction Control improves driving stability when necessary, regardless of the type of road surface or tyre grip, by preventing the driven wheels from spinning.

As soon as the driven wheels starts to spin, engine output is reduced and the wheel spinning the most is braked individually. This considerably improves the driving stability of the vehicle on slippery road surfaces.

ESC and TC are operational after each engine start as soon as the control indicator  extinguishes.

When ESC and TC operate,  flashes.

### Warning

Do not let this special safety feature tempt you into taking risks when driving.

Adapt speed to the road conditions.

Control indicator   57.

### Deactivation



TC can be deactivated, everytime it is required: press **ASR OFF**.

The LED in the button **ASR OFF** illuminates.

A status message appears in the Driver Information Centre when TC is deactivated.

TC is reactivated by pressing the **ASR OFF** button again.

The LED in the button **ASR OFF** extinguishes when TC is reactivated.

TC is also reactivated the next time the ignition is switched on.

Reactive the system as soon as the level of grip permits.

### Intelligent traction control system



The system operates on roads with low grip (e.g. snow, ice, mud, etc.). It enables the detection of situations of precarious grip which can complicate the starting and the progress of the vehicle.

In these situations, the intelligent traction control system overrides the TC by transferring the driving force to the wheel with the greatest contact with the ground to optimise traction and trajectory tracking.



Intelligent traction control is deactivated after each engine start.

## Activation / Deactivation



At speeds below approx. 19 mph, press . The LED in the button  is illuminated to confirm the activation of the system.

If the speed exceeds 19 mph, the system is paused. The LED in the button  is still illuminated. The system is automatically resumed if the speed falls below 19 mph.

To deactivate the system, press . The LED in the button  extinguishes to confirm the deactivation of the system.

## Dynamic stability control

Dynamic stability control monitors each wheel and automatically acts on the brake of one or more wheels and on the engine to return the vehicle to the required path, within the limits of the laws of physics, when it detects a difference between the path followed by the vehicle and that required by the driver.

Dynamic stability control is operational after each engine start as soon as the control indicator  extinguishes.

When dynamic stability control operates, the control indicator  flashes.

## Load inertia control

The actual total weight of a commercial vehicle can vary considerably depending on its load. The centre of gravity of the vehicle can therefore move in the longitudinal direction and even in height.

Each of these variations has repercussions on braking, traction, cornering behaviour and overturning.

The load inertia control estimates the actual total weight of the vehicle by analysing its behaviour, during acceleration and braking phases.

This system then adapts the intervention of the dynamic stability control and TC according to the weight distribution of the vehicle. In critical situations, the vehicle therefore remains more safely on its trajectory.

## Fault

If there is a fault in the ESC or in the respective subsystems, the control indicator  illuminates and a message is displayed in the Driver Information Centre accompanied by a warning chime. The system is not operational.

Seek the assistance of a workshop.

## Descent control system

The descent control system allows the vehicle to travel at a low speed without depressed brake pedal. The vehicle will automatically decelerate to a low speed and remain at that

speed when the system is activated. Some noise or vibration from the brake system may be apparent when the system is active.

Do not use the system with the selector lever set to neutral.

Engage an appropriate gear for the corresponding speed, in order to prevent engine stalling.

### Caution

Use only when descending steep grades while driving off-road. Do not use when driving on normal road surfaces. Unnecessary usage of the dynamic stability function, such as while driving on normal roads, may damage the brake system and the ESC function.



### Caution

The function may be unavailable if the vehicle brakes overheat. Wait a few minutes.

## Activation

The system is only available for slopes greater than 8%.



At speeds below approx. 15 mph, press . The system can also be activated when the vehicle is stationary with the engine running. The LED in the button  is illuminated and a message in the Driver Information Centre is displayed to confirm the activation of the system.

When the vehicle starts its descent, the system controls the speed of the vehicle; accelerator and brake pedals can be released. The LED in the button  flashes.

However, accelerator and brake pedal maintain operational if an increase or decrease of the vehicle's speed is desired.

If the system is operating, the brake lights automatically come on.

If the speed exceeds 15 mph, regulation is paused. The LED of the  button is still illuminated.

Regulation is automatically resumed if the speed falls below 15 mph and the slope is greater than 8%.

## Deactivation

Press  again until the LED in the button extinguishes.

If the speed exceeds 31 mph, the system is automatically deactivated. The LED in the button extinguishes.

## Fault

In the event of a fault,  illuminates in the Driver Information Centre.

Seek the assistance of a workshop.

## Driver assistance systems

### Warning

Driver assistance systems are developed to support the driver and not to replace the driver's attention.

The driver accepts full responsibility when driving the vehicle.

When using driver assistance systems, always take care regarding the current traffic situation.

## Cruise control

The cruise control can store and maintain speeds above 19 mph. Additionally at least the second gear must be engaged on manual transmission.

Deviations from the stored speeds may occur when driving uphill or downhill.

The system maintains the vehicle speed at the preset speed by the driver, without any action on the accelerator pedal.

The preset speed can be exceeded temporarily by pressing the accelerator pedal firmly.

The status and preset speed is displayed in the Driver Information Centre.

Do not use the cruise control if it is not advisable to maintain a constant speed.

Control indicator  ⇨ 60.

Depending on version, there are two different levers to use the system.

## Switching on the system

### Lever type A



Turn the adjuster wheel to . The control indicator is illuminated and a message is displayed in the Driver Information Centre.

The system is still not active.

### Lever type B



Turn the adjuster wheel to **ON**. The control indicator is illuminated and a message is displayed in the Driver Information Centre.

The system is still not active.

## Activation of the functionality

### Lever type A



Accelerate to the desired speed and move the control lever upwards **+** or downwards **-**. The current speed is stored and maintained. Accelerator pedal can be released.

The preset speed can then be changed by moving the control lever upwards **+** to increase or downwards **-** to decrease the speed.

Briefly press increases or decreases the speed by 1 mph, a long press by 5 mph.

Speed value is indicated in the Driver Information Centre.

### Lever type B



Accelerate to the desired speed and move the control lever upwards + for about 1 second. The current speed is stored and maintained. Accelerator pedal can be released.

The preset speed can then be changed by moving the control lever upwards + to increase or downwards - to decrease the speed.

Briefly press increases or decreases the speed in small steps, a long press in larger steps.

Speed value is indicated in the Driver Information Centre.

### Exceeding the set speed

Vehicle speed can be increased by depressing the accelerator pedal. When the accelerator pedal is released, the previously stored speed is resumed.

### Deactivation of the functionality



Depress the brake, the clutch pedal or press button. The cruise control is in pause mode. The vehicle is driven without cruise control.

Cruise control is deactivated, but not switched off. The last stored speed remains in memory for later speed resume.

When the dynamic stability control system is active, the cruise control is temporarily deactivated.

Electronic stability control and traction control system ↗ 102.

### Resume stored speed

#### Lever type A



Press the button at a speed above 19 mph to return to the stored speed.

A message is displayed in the Driver Information Centre.

### Lever type B



Press the button at a speed above 19 mph to return to the stored speed. The control indicator  illuminates green and a message is displayed in the Driver Information Centre.

### Switching off the system

#### Lever type A



Turn adjuster wheel to **0** to switch off the system.

#### Lever type B



Turn adjuster wheel to **OFF** to switch off the system.

### Fault

In the event of a cruise control fault, the system is switched off and the indicator light  extinguishes.

Seek the assistance of a workshop.

### Speed limiter

The speed limiter prevents the vehicle exceeding a preset maximum speed.

The maximum speed can be set at speeds above 18 mph.

The driver can accelerate the vehicle up to the preset speed. Deviations from the limited speed may occur when driving downhill.

The preset speed can be exceeded temporarily by pressing the accelerator pedal firmly.

The status and preset speed limit are displayed in the Driver Information Centre.

### Switching on the system



Turn the adjuster wheel to the last programmed speed and a message are displayed in the Driver Information Centre.

The system is still not active.

### Activation of the functionality



Press the button to activate the system with the last programmed speed.

Press the button once again to pause the activation of the system.

### Setting speed

To set the speed, the system does not have to be activated.



Move the control lever upwards + or downwards -. The chosen speed is set.

The preset speed can then be changed by moving the control lever upwards + to increase or downwards - to decrease the speed.

Briefly press increases or decreases the speed by 1 mph, a long press by 5 mph.

The speed value is indicated in the Driver Information Centre.



### Exceeding the speed limit

In the event of an emergency, it is possible to exceed the speed limit by depressing the accelerator pedal firmly nearly to the final point.

Release the accelerator pedal and the speed limiter function is reactivated once a speed lower than the limit speed is obtained.

### Deactivation of the functionality



Press the button to deactivate the functionality. The speed limiter is in pause mode and a message is displayed.

The speed limiter is deactivated, but not switched off. The last stored speed remains in memory for later speed resume.

### Resume limit speed



Press the button to return to the stored speed limit.

### Switching off the system



Turn adjuster wheel to 0 to switch off the system.

The last set speed remains in the memory.

### Fault

In the event of a speed limiter fault, the speed is cleared resulting in flashing of the dashes.

### Fixed speed limiter

Depending on version and country, the maximum speed is set by default.



A label located in the passenger compartment indicates the maximum speed.

The fixed speed limiter can not be activated or deactivated by the driver.

## Active emergency braking

Active emergency braking can help to reduce the damage and injury from crashes with vehicles and obstacles directly ahead, when a collision can no longer be avoided either by manual braking or by steering.

Active emergency braking consists of several subsystems:

- Forward collision alert ⇨ 114
- Emergency automatic braking
- Smart brake assist

Before the active emergency braking applies, the driver is warned by the forward collision alert.

The system uses various inputs, such as a front camera located at the top of the windscreen, but also brake pressure or vehicle speed, to calculate the probability of a frontal collision.



### ⚠ Warning

This system is not intended to replace the driver responsibility for driving the vehicle and looking ahead. Its function is limited to supplemental use only to reduce the vehicle speed before a collision.

The system may not react to animals. After a sudden lane change, the system needs a certain time to detect the next preceding vehicle.

The driver must always be ready to take action and apply the brakes and steer to avoid collisions.

Active emergency braking can be deactivated in the vehicle personalisation ⇨ 65. If deactivated, (Ⓢ) illuminates and a message is displayed the Driver Information Centre.

When ignition is switched on next time, system is activated by default.

## Functionality

Active emergency braking operates in forward gear above 3 mph up to 53 mph when a moving vehicle is detected. The system detects stationary vehicles only if the speed does not exceed 50 mph.

A precondition is that active emergency braking is not deactivated in the vehicle personalisation menu.

## Smart brake assist

If the driver brakes, but not sufficiently to avoid a collision, this system will supplement the braking. This assistance will only be provided if the driver presses the brake pedal.

Smart brake assist will automatically disengage when the brake pedal is released.

## Emergency automatic braking

Just before the imminent collision, this function automatically applies limited braking to reduce the impact speed of the collision or prohibit a crash.

If active emergency braking is applied,  flashes in the Driver Information Centre.

Depending on the situation, the vehicle may automatically brake moderately or hard.

Emergency automatic braking may slow the vehicle to a complete stop trying to avoid a potential crash. If the vehicle comes to a complete stop, automatic braking is maintained for up to 2 seconds.

If the vehicle comes to a complete stop, the engine may stall.

Operation of the function may be felt by a slight vibration in the brake pedal.

### Warning

Emergency automatic braking is an emergency crash preparation feature and is not designed to avoid crashes. Do not rely on the system to brake the vehicle. Emergency automatic braking will not brake outside of its operating

speed range and only responds to detected vehicles and pedestrians.

## Operation conditions and system limitations

In some cases, the active emergency braking system may provide an automatic braking in situations that seem to be unnecessary, for instance in parking garages, due to traffic signs in a curve or due to vehicles in another lane. This is a normal operation, the vehicle does not need service. Firmly apply the accelerator pedal to override the automatic braking if the situation and the surroundings permit.

The system is only operational when the ESC is not faulty, TC is activated and all passenger seat belts are fastened.

ESC and TC ⇨ 102.

Driving at a steady speed on roads with few bends is required.

Cases of non-detection by the system:

- Pedestrians, cyclists, animals, objects on the road.
- Vehicles crossing the lane.
- Vehicles driving in the opposite direction.

Pay particular attention when narrow vehicles (e.g. motorcycles) are present, there are vehicles staggered across the traffic lane and / or when entering a tunnel or crossing a bridge.

Suspend the system when:

- there are vehicles in a tight bend.
- approaching a roundabout.
- a vehicle cuts in sharply between your vehicle and the one in front.

In the following cases, active emergency braking performance is limited:

- Driving on winding or hilly roads.
- Detecting all vehicles, especially vehicles with a trailer, tractors, muddy vehicles, etc.
- Detecting a vehicle when weather limits visibility, such as in fog, rain, or snow.

- Driving during nighttime.
- The windscreen is damaged or stickered.

Complete attention is always required while driving, and the driver should be ready to take action and apply the brakes and / or steer the vehicle to avoid crashes.

We recommend to deactivate the system in the vehicle personalisation in the following cases:

- when towing a trailer or caravan
- when carrying long objects on roof bars or a roof rack
- when the vehicle is being towed with the engine running
- when tyre chains are fitted
- when a spare wheel is fitted that is smaller than the other wheels
- before using an automatic car wash with the engine running
- before placing the vehicle on a rolling road in a workshop
- if the windscreen has been damaged close to the camera
- if the brake lamps are not working

### Fault

If there is a fault,  illuminates and a message is displayed in the Driver Information Centre accompanied by a warning chime.

If the system does not work properly, vehicle messages are displayed in the Driver Information Centre.

Vehicle messages ⇨ 63.

Seek the assistance of a workshop.

### Forward collision alert

The forward collision alert may help to avoid or reduce the harm caused by front-end crashes.



The forward collision alert uses the front camera in the windscreen to detect a preceding vehicle directly ahead, in the vehicle's path.

If a vehicle directly ahead is approached too quickly, a warning chime and alert in the Driver Information Centre is provided.

### Warning

Forward collision alert is just a warning system and does not apply the brakes. When approaching a vehicle ahead too rapidly, there may not be enough time to avoid a collision.

The driver accepts full responsibility for the appropriate following distance based on traffic, weather and visibility conditions.

The complete attention of the driver is always required while driving. The driver must always be ready to take action and apply the brakes.



### Activation

Forward collision alert detects vehicles and operates automatically at all speeds above 3 mph and 53 mph. The system detects stationary vehicles if the speed does not exceed 50 mph.

### Alerting the driver

Depending on the degree of collision risk detected by the system and the chosen alert sensitivity by the driver, several alert levels may be triggered and displayed in the Driver Information Centre.

The driver is warned by following alerts:

- Symbol  illuminates yellow and a warning message is displayed in the Driver Information Centre when the distance to the vehicle ahead gets to small.
- Symbol  illuminates red, a warning message is displayed in the Driver Information Centre and a warning chime sounds, when a

collision is imminent and immediate driver's action is required.

- A haptic alert in the form of micro-braking can be given, in order to confirm the risk of collision. This is the last possible alert.

### Warning

Forward collision alert is just a warning system and does not apply the brakes. When approaching a vehicle ahead too rapidly, there may not be enough time to avoid a collision.

The driver accepts full responsibility for the appropriate following distance based on traffic, weather and visibility conditions.

The complete attention of the driver is always required while driving. The driver must always be ready to take action and apply the brakes.

**Caution**

The colour lighting of this control indicator does not correspond to local traffic laws on following distance. The driver bears full responsibility for maintaining safe following distance according to applicable traffic rules, weather and road conditions etc. at all times.

**Selecting the alert sensitivity**

The alert sensitivity has to be set to close, normal or distant in the vehicle personalisation menu ↻ 65.

The chosen setting will remain until it is changed. The alert timing will vary based on vehicle speed. The faster the vehicle speed, the farther away the alert will occur. Consider traffic and weather conditions when selecting the alert timing.

**Deactivation**

The system can only be deactivated by deactivating the active emergency braking in the vehicle personalisation ↻ 65.

**System limitations**

Forward collision alert is designed to warn on vehicles only, but may react also to other objects.

In the following cases, forward collision alert may not detect a vehicle ahead or sensor performance is limited:

- driving on winding or hilly roads
- driving during nighttime
- weather limits visibility, such as fog, rain, or snow
- the sensor in the windscreen is blocked by snow, ice, slush, mud, dirt etc.
- the windscreen is damaged or affected by foreign objects, e.g. stickers

**Parking assist****General information**

When attaching a trailer or bicycle carrier to the trailer hitch, the parking assist is deactivated.

**⚠ Warning**

The driver bears full responsibility for the parking manoeuvre.

Always check the surrounding area when driving backwards or forwards while using parking assist system.



The system warns the driver with acoustic signals against potentially hazardous obstacles behind the vehicle while reverse gear is engaged.

The system operates with ultrasonic parking assist sensors in the rear bumper.

The system warns people outside the vehicle with an acoustic signal.

### Activation

Rear parking assist is activated when reverse gear is engaged and ignition is switched on.

### Indication

The interval between the sounds becomes shorter as the vehicle gets closer to that obstacle. When the distance is less than approx. 30 cm, the sound is continuous.

### Deactivation

Disengage reverse gear and shift to neutral.

## System limitations

### ⚠ Warning

Under certain circumstances, various reflective surfaces on objects or clothing as well as external noise sources may cause the system to fail to detect obstacles.

Special attention must be paid to low obstacles which can damage the lower part of the bumper.

### Caution

Performance of the system can be reduced when sensors are covered, e.g. by ice or snow.

Performance of the parking assist system can be reduced due to heavy loading.

Special conditions apply if there are taller vehicles in the vicinity (e.g. off-road vehicles, mini vans, vans). Object identification and

correct distance indication in the upper part of these vehicles cannot be guaranteed.

Objects with a very small reflection cross-section, e.g. objects of narrow size or soft materials, may not be detected by the system.

Parking assist systems do not detect objects outside the detection range.

In the event of a fault or if the system does not work temporarily, e.g. because of high external noise level or other interference factors,  illuminates in the instrument cluster. A message is displayed in the Driver Information Centre.

Seek the assistance of a workshop.

## Side blind spot alert

The side blind spot alert system detects and reports objects on either side of the vehicle, within a specified blind spot zone. The system displays a visual alert in each exterior mirror, when detecting objects that may not

be visible in the interior and exterior mirrors. Additionally, a warning chime may sound whenever the lane is changed and an object is detected in the blind spot zone.

Side blind spot alert uses two radar sensors which are located in the rear bumper on each side of the vehicle.

When the vehicle is started, both LEDs on the exterior mirrors will briefly come on to indicate that the system is operating.

### **⚠ Warning**

Side blind spot alert does not replace driver vision.

The system does not detect:

- vehicles outside the side blind zones which may be rapidly approaching
- pedestrians, cyclists or animals

Before changing a lane, always check all mirrors, look over the shoulder and use the turn signal.

### **Activation**

Activate the function in the vehicle personalisation.

Two different modes are available:

- Visual mode
- Visual and audible mode

Vehicle personalisation ⇨ 65.

### **Functionality**

The system provides different warning signals, depending on which mode has been selected.

Either the system warns the driver by giving only a visual alert or a warning chime sounds additional to that.



- When the visual mode has been selected, a LED will illuminate in the relevant exterior mirror, as soon as the system detects a vehicle in the side blind zone while driving forwards.
- When the visual and audible mode has been selected, a LED will illuminate in the relevant exterior mirror, as soon as the system detects a vehicle in the side blind zone while driving forwards. In addition, a warning chime sounds, as soon as the indicator lever has been set for the side in which the system has detected a vehicle in the side blind zone while driving forwards.

### **Notice**

If rear cross traffic alert is activated, the system still provides visual and audible warning signals, even if the side blind spot alert is deactivated or only in visual mode.

Rear cross traffic alert ⇨ 121.



## Lane change alert

Additional to the side blind spot alert, lane change alert recognises rapidly approaching vehicles from behind on parallel lanes next to your vehicle.



The system alerts visually in each exterior mirror when detecting rapidly approaching vehicles from behind.

## Trailer detection

If a trailer is hitched to the vehicle, the detection area is enlarged by the length of the trailer.

Two different length settings can be set in the vehicle personalisation  $\diamond$  65:

- Maximum length: for trailers with a length of more than 9 metres.
- Automatic length detection: the system detects the trailer length automatically (3 metres, 6 metres and 9 metres).

When automatic detection has been set, the respective length icon is displayed in the Driver Information Centre.

In order to enable the automatic length detection, it may be necessary to make a 90° turn.

The rear cross traffic alert is deactivated, as soon as the trailer detection has been activated.

Rear cross traffic alert  $\diamond$  121.

## Operation conditions

The following conditions must be fulfilled for proper operation:

- all vehicles are moving in the same direction and in adjacent lanes
- the speed of your vehicle is higher than approx. 6 mph.
- passing a vehicle with a speed difference of less than 16 mph
- another vehicle is passing with a speed difference of less than 30 mph
- the traffic flow is normal
- driving on a straight or slightly curved road
- the sensors are not covered by mud, ice or snow
- the warning zones in the exterior mirrors or the detection zones on the rear bumper are not covered

No alert will be given in the following situations:

- in the presence of non-moving objects, e.g. parked vehicles, barriers, street lamps, road signs
- in very dense traffic, when moving vehicles might be confused with a stationary object
- with vehicles moving in the opposite direction
- driving on a winding road or a sharp corner
- when passing or being passed by a very long vehicle, e.g. lorry, coach, which is at the same time detected at the rear in the blind spot angle and present in the driver's forward field of vision
- when passing too quickly

### Deactivation

The system can be deactivated in the vehicle personalisation.

Vehicle personalisation ⇨ 65.

The state of the system is stored when switching off the ignition.

Due to adverse weather conditions such as heavy rain, false detections may occur.

### Fault

In the event of a fault, the LEDs in the exterior mirrors are either illuminated continuously or extinguished. Additionally, a warning message is displayed in the Driver Information Centre and a warning chime may sound.

Seek the assistance of a workshop.

### Rear view camera

The rear view camera assists the driver when reversing by displaying a view of the area behind the vehicle.

#### Warning

The rear view camera does not replace driver vision. Note that objects that are outside the camera's field of view, e.g. below the bumper or underneath the vehicle, are not displayed.

Do not reverse the vehicle by only looking at the display and check the surrounding area behind and around the vehicle before and during reversing.



The view of the camera is displayed in the Info Display ⇨ 62.

The area displayed by the camera is limited. The distance of the image that appears on the display differs from the actual distance.

### Switching on

The rear view camera is automatically activated when reverse gear is engaged and it remains active up to approx. 9 mph.

The rear view camera will also be activated with the vehicle stationary, when the rear doors are opened.

### Switching off

The camera is switched off when a forward gear is engaged.

### Guidelines

The area behind the vehicle is displayed in the screen. The vertical lines represent the width of the vehicle with mirrors unfolded.

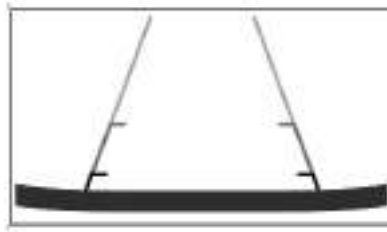

The first horizontal line represents a distance of about 30 cm beyond the edge of vehicle's rear bumper. The upper horizontal line represents a distance of about 1 m beyond the edge of the vehicle's rear bumper.

The guidelines can be deactivated in the vehicle personalisation ↻ 65.

### System limitations

The rear view camera may not operate properly when:

- the surrounding is dark
- the beam of headlights is shining directly into the camera lenses

- weather limits visibility such as fog, rain or snow
- the camera lenses are blocked by snow, ice, slush, mud, dirt. Clean the lense, rinse with water, and wipe with a soft cloth
- the tailgate will be opened
- the vehicle is towing an electrically connected trailer, bicycle carrier etc.
- the vehicle had a rear end accident
- there are extreme temperature changes

### Rear cross traffic alert

Additional to the side blind spot alert ↻ 117, rear cross traffic alert warns of cross traffic from left or right side when driving rearwards.

The radar distance sensors used to monitor the area left and right behind the vehicle are located in the rear bumper.

**⚠ Warning**

The rear cross traffic alert does not replace driver vision. Note that objects that are outside sensor's range, e.g. below the bumper or underneath the vehicle, are not detected.

Pedestrians, children or animals may not be detected.

Do not reverse the vehicle by only looking at the Info Display and check the surrounding behind and around the vehicle before reversing.

**Activation**

Rear cross traffic alert is automatically activated when reverse gear is engaged.

**Detection zone**

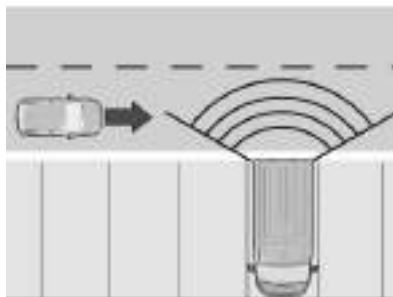

The system detects vehicles moving towards both sides behind the vehicle at speeds from 1 mph to approx. 22 mph.

**Functionality**



A LED will illuminate in the relevant exterior mirror accompanied by a warning chime, as soon as the system detects a vehicle in the detection zone.

**Deactivation**

Rear cross traffic alert is deactivated when a certain forward speed is exceeded or if reverse gear is not engaged.

The system is deactivated if the vehicle is towing a trailer.

Side blind spot alert ⇨ 117.

## System limitations

The system may not operate properly when:

- ice, snow, mud, stickers, magnets, metal plates, or anything else covers the sensors
- driving in heavy rainstorms
- the vehicle had an accident or if the area surrounding the detection sensor is damaged or not properly repaired

In the event of a fault, seek the assistance of a workshop.

## Traffic sign assistant

The traffic sign assistant uses the camera at the top of the windscreen to detect the speed limit indications, overtaking prohibitions and signs indicating the end of implementation of the signs previously mentioned. The detected signs are displayed in the Info Display first and then in the Driver Information Centre.

The system detects signs on the left-hand side and right-hand side, high and low, as well as overlapping signs.

The system only detects circular signs.

The system can display two road signs (speed limit and no overtaking / end of no overtaking) simultaneously in the Driver Information Centre.

If an additional road sign is detected, such as a reduced speed limit for wet road sign, it is displayed in an empty window below the corresponding sign.

Additional signs are filtered as follows:

- Signs for snow or ice only appear if the outside temperature is below 3° C.
- Signs concerning heavy goods vehicles are not displayed if they concern a vehicle weighing less than 4 tonnes.
- Signs concerning farm equipment are not displayed.
- Signs such as no overtaking go out after about 40 seconds on the instrument panel.

Signs such as no overtaking go out after about 40 seconds in the Driver Information Centre.

## ⚠ Warning

The actual traffic sign always takes priority over the traffic sign displayed in the Driver Information Centre.

Info Display ⇨ 62

Driver Information Centre ⇨ 61

## Activation / Deactivation

The system can be activated or deactivated in the vehicle personalisation.

Vehicle personalisation ⇨ 65.

## System limitations

The system does not take account of reduced speed limits, especially those imposed in the following cases:

- Poor weather (rain, snow).
- Atmospheric pollution.
- Towing.
- Driving with a temporary spare wheel or tyre chains fitted.
- Driving with a non-standard suspension kit.

- Tyre repaired using the tyre repair kit.
- Young drivers.

The system may not display the speed limit if it does not detect a speed limit sign within a preset period and in the following situations:

- Road signs that are obstructed, non-standard, damaged or bent.
- Obsolete or incorrect maps.
- Road incline causing the sign to be out of the camera field of vision (on a slope, e.g.).
- Change in the vehicle load that causes the camera to tilt significantly (system operation may temporarily be suspended to enable camera self-calibration).



## Lane departure warning

The lane departure warning system observes the lane markings between which the vehicle is driving via a front camera. The system detects lane changes and warns the driver in the event of an unintended lane change via visual and acoustic signals.

## Functionality

The system is only operable at vehicle speeds above 37 mph and if lane markings are available.

The system starts automatically when moving off.

The operating conditions are checked by the system. Therefore, both control indicators  are illuminated first in the Driver Information Centre. When these conditions are met, both control indicators  extinguish. The system is activated.

If the operating conditions are not met, both control indicators  remain illuminated. The system is activated, but is no longer effective.

## Deactivation / Reactivation





Press  to deactivate / reactivate the system.

The LED in the button  is illuminated and a message in the Driver Information Centre is displayed to confirm the deactivation of the system.

Upon reactivation, both control indicators  remain illuminated until the speed reaches 37 mph.

The state of the system remains in the memory when switching off the ignition.

## Detection

When the system recognises an unintended lane change, the control indicator  or  flashes yellow. Simultaneously, a chime sounds.

No warning is transmitted while the turn light is activated and for approximately 20 seconds after the turn light is switched off. A warning may be transmitted if a direction marking (arrow) or non-standard marking is crossed.

## Operating conditions

Once engaged, the system is only active when the following operating conditions are met:

- The vehicle is moving forwards.
- No malfunction of the vehicle is detected.
- The longitudinal marking of the traffic lanes is clearly visible.
- The visibility conditions are clear.
- The trajectory is in a straight line (or in the case of bends, they are wide).

- The field of vision is sufficiently clear.
- In the event of a lane departure, the turn light corresponding to the direction (right or left) of the departure has not been operated.
- The trajectory of the vehicle is consistent with the road layout.

## Fault

The control indicator  flashes and a message is displayed in the Driver Information Centre accompanied by a warning chime.

Seek the assistance of a workshop.

The system cannot operate when no lane marking is detected.

## Charging

### General information

#### Warning

Persons with a pacemaker should consult a doctor for possible precautions.

Charging the vehicle's high voltage battery depends upon several factors:

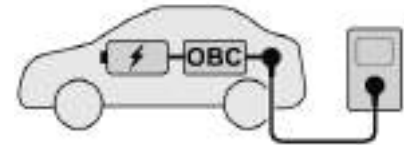

- high voltage battery of the vehicle
- internal on-board charger (OBC)
- external charging device
- charging cable

The charging cable connects the vehicle's high voltage battery with an external charging device providing

electric power. This may be a domestic electrical outlet, a wall box or a public charging station.

The high voltage battery can be charged with direct current (DC) only. When charging from a domestic electrical outlet, a wall box or an alternating current (AC) charging station, AC has to be converted into DC. This is done by the vehicle's onboard charger.

If the vehicle is charged at a public DC charging station, no DC conversion is required. The high voltage battery can be directly charged with DC provided by the DC charging station.

The speed of charging the vehicle's high voltage battery depends upon the weakest element of the charging chain. To achieve the maximum charging speed, charging cable and charging device have to be attuned to each other.

#### Notice

Make sure that the charging cable used fits to the vehicle's onboard charger.

Charging types ⇨ 126.

Charging cable ⇨ 132.

### Charging types

There are different types of charging the vehicle's high voltage battery.

#### Charging at wallboxes



A wallbox is a charging unit for private households. It provides a charging cable which has to be connected to the vehicle's charging port. Some wallboxes do not provide a charging cable. In this case, a separate charging cable is required which has to be connected to both the wallbox and the charging port of the vehicle.

#### Charging at charging stations



Charging stations may provide alternating current (AC) or direct current (DC).



Charging time may vary depending on the charging station, DC charging stations provide the fastest charging. To charge the vehicle's battery, the charging cable of the charging station has to be connected to the charging port of the vehicle.



## Charging at domestic electrical outlets



The vehicle's high voltage battery can be charged at a domestic electrical outlet. Connect the charging cable to the vehicle's charging port and to the domestic electrical outlet.

However, this type of charging is not recommended.

## Charging cable

Depending on the charging type, different charging cables are used.

### **⚠ Warning**

Improper use of portable charging cables may cause a fire, electrical shock, or burns, and may result in damage to property, serious injury, or death.

- Do not use extension cables, multi-outlet power strips, splitters, grounding adaptors, surge protectors, or similar devices.
- Do not use an electrical socket that is worn or damaged, or one that will not hold the plug firmly in place.
- Do not immerse the charging cable into any liquid.
- Do not use an electrical socket that is not properly grounded.
- Do not use an electrical socket that is on a circuit with other electrical loads.

### **⚠ Warning**

Read all the safety warnings and instructions before using this product. Failure to follow the warnings and the instructions may result in electric shock, fire, and / or serious injury.

Never leave children unattended near the vehicle while the vehicle is charging and never allow children to play with the charging cable.

If the plug provided does not fit the electrical outlet, do not modify the plug. Arrange for a qualified electrician to inspect the electrical outlet.

Do not put fingers into the electric vehicle connector.

### **⚠ Danger**

There is a risk of electric shock that may cause personal injury or death.

Do not use the charging cable if any part of the charging cable is damaged.

Do not open or remove the charging cable cover.

Service by qualified personnel only. Connect the charging cable to a properly grounded outlet with cables that are not damaged.

## Basic domestic cable (mode 2) / enhanced domestic cable (mode 2)



1. Vehicle plug
2. Status indicators
3. Wall plug

Basic domestic cables (mode 2) are used for charging at domestic electrical outlets. A basic domestic cable (mode 2) consists of a vehicle plug, a control box and a plug for the domestic electrical outlet. The control box has an intergrated charge controller and several LEDs indicating the charging status.

Enhanced domestic cables (mode 2) are similar to basic domestic cables (mode 2). However, the charging performance of enhanced domestic cables (mode 2 charging) is better than the charging performance of basic domestic cables (mode 2). Enhanced domestic cables (mode 2) are used at Green'Up sockets which have to be installed by a certified electrician at the customer's site.

### Charging cable status indicators

After plugging in the charging cable, it will perform a quick self test and all status indicators illuminate for a moment. For the functions of the status indicators, refer to the manual of the charging cable manufacturer.

### Important information about portable electric vehicle charging

- Charging an electric vehicle can stress a building's electrical system more than a typical household appliance.
- Before you plug in to any electrical outlet, have a qualified electrician inspect and verify the

electrical system (electrical outlet, wiring, junctions and protection devices) for heavy-duty service at a 10 A continuous load.

- Electrical outlets may wear out with normal usage or be damaged over time, making them unsuitable for electric vehicle charging.
- Check the electrical outlet / plug while charging and discontinue use if the electrical outlet / plug is hot, then have the electrical outlet serviced by a qualified electrician.
- When outdoors, plug into an electrical outlet that is weather-proof while in use.
- Mount the charging cable to reduce strain on the electrical outlet / plug.

## Mode 3 charging cable



1. Vehicle plug
2. Plug for wall box / AC charging station

Mode 3 charging cables are used for charging at wall boxes and AC charging stations. A mode 3 charging cable provides a vehicle plug and a plug for the wall box / AC charging station. Wall boxes / AC charging stations may provide an integrated mode 3 charging cable. For more information on the mode 3 charging cable, refer to the manual of the charging cable manufacturer.

## Mode 4 charging cable

### Notice

Only use DC charging cables shorter than 30 metres.

Mode 4 charging cables are used for DC charging. Since mode 4 charging cables are integrated within DC charging stations, they only provide a vehicle plug.

## Charging

### ⚠ Warning

Persons with a pacemaker or similar devices should consult a doctor for possible precautions. If in doubt, during charging do not remain inside or near the vehicle, near the charging cable or the charging unit.

In order to ensure the compatibility of plug and outlet, different labels are used. The labels are located on the inside of the vehicle's charging port flap. Make sure to connect only a cable of the same type.



Type 2 plug or outlet used for AC charging



FF plug or outlet used for DC charging

### ⚠ Warning

Avoid any entry of fluids into the charging port of the vehicle, the vehicle plug of the charging cable and the domestic electrical outlet.

When charging at a public AC charging station / public DC charging station, follow the instructions for the use of the respective charging station. Public AC charging stations

may not provide an integrated charging cable. In this case, a portable mode 3 charging cable is required.

**⚠ Warning**

When charging at a domestic electrical outlet, only use an outlet which is properly grounded and protected by a 30 mA differential switch.

Only use a domestic electrical outlet protected by a circuit breaker adapted to the amperage of the electrical circuit.

Have a qualified electrician check the electrical installation to be used. The installation has to be in compliance with national standards and compatible with the vehicle.

When using a dedicated domestic electrical outlet, have it installed by a qualified electrician.

Make sure that the electrical outlet, the plug and the cable do not support the weight of the control box.

1. Shift into **N**, apply the parking brake and switch off the vehicle.



2. Pull the charging port flap to release it.
3. If necessary, take the charging cable out of the load compartment.
4. If necessary, plug in the plug of the charging cable into the corresponding port of the external power source.

Charging cable ⇨ 132.



5. Remove the protective cover and plug in the vehicle plug of the charging cable into the charging port of the vehicle.

Charging status ⇨ 132.



The LED located above the charging port illuminates to indicate that the vehicle plug is locked.



The start of charging is indicated by a message in the rear view mirror display.

Once charging, the vehicle plug will be locked to the charging port and cannot be disconnected while charging is active.

Driver Information Centre ⇨ 61.

Charging types ⇨ 126.

### Cancelling the charging process

#### Notice

At public charging stations, the cancelling and subsequent resuming of the charging process may cause additional costs.

Once the charging process has started, only the driver's door can be unlocked without cancelling the charging process. Therefore, activate the driver's door only function in the vehicle personalisation.

Press  for 5 seconds on the remote control to cancel the charging process at any time.

If the vehicle plug of the charging cable is not removed within 30 seconds after the cancellation of the charging, the charging will be resumed.

Central locking system ⇨ 7.

Vehicle personalisation ⇨ 65.

### Stop charging



A message displayed on the rear view mirror display indicates when the high voltage battery is fully charged.

1. Press  for 5 seconds on the remote control to stop the charging.

The LED located above the charging port extinguishes to indicate that the vehicle plug is unlocked.



2. Disconnect the vehicle plug of the charging cable from the charging port within 30 seconds after unlocking.
3. Close the charging port flap by pressing firmly to latch properly.
4. Reinsert the protective cover into the charging port.
5. Disconnect the charging cable from the external power source.
6. If necessary, store the charging cable in the load compartment.

While the charging cable is plugged into the vehicle, the vehicle cannot be driven.

### Charging status



If the vehicle is plugged in, the LED located above the charging port indicates the following:

- Illuminates: the vehicle plug of the charging cable is locked.

- Flashes: the vehicle plug of the charging cable has been inserted, but the ignition is still switched on. Switch off ignition and try it again.
- Off: the vehicle plug of the charging cable is unlocked and can be disconnected.

Further charging status indicators are located on the control box of the basic domestic cable (mode 2) / enhanced domestic cable (mode 2).

Further information regarding the charging is displayed on the rear view mirror display.

Charging cable ↗ 127.

Driver Information Centre ↗ 61.

## Fuel

### Fuel for diesel engines

The Diesel engines are compatible with bio-fuels that conform to current and future European standards and can be obtained from filling stations:



Diesel fuel that meets standard EN590 mixed with a biofuel that meets standard EN14214 (possibly containing up to 7% Fatty Acid Methyl Ester)



Diesel fuel that meets standard EN16734 mixed with a biofuel that meets standard EN14214 (possibly containing up to 10% Fatty Acid Methyl Ester)



Paraffinic Diesel fuel that meets standard EN15940 mixed with a biofuel that meets standard EN14214 (possibly containing up to 7% Fatty Acid Methyl Ester).



The use of B20 or B30 fuel meeting standard EN16709 is possible. However, this use, even occasional, requires strict application of the special servicing conditions referred to as "Arduous conditions".

For more information, contact a dealer or a qualified workshop.

#### Caution

The use of any other type of (bio) fuel (vegetable or animal oils, pure or diluted, domestic fuel etc.) is strictly prohibited (risk of damage to the engine and fuel system).

#### Notice

The only Diesel additives authorised for use are those that meet the B715000 standard.

#### Low temperature operation

At temperatures below 0 °C, some diesel products with biodiesel blends may clog, freeze or gel, which may affect the fuel supply system. Starting and engine operation may not work properly. Make sure to fill winter grade diesel fuel at ambient temperatures below 0 °C.

Arctic grade diesel fuel can be used at extremely low temperatures below -20 °C. Using this fuel grade in warm or hot climates is not recommended

and may cause engine stalling, poor starting or damage on the fuel injection system.

### Fuel system cut-off

In the event of an impact, the fuel cut-off system, automatically cuts off the fuel supply to the engine and the vehicle's power supply.

As soon as the system cuts off the fuel supply, the hazard warning flashers, the side lights and the interior lights are switched on and the doors are unlocked.

#### Caution

After an impact and before restoring these power supplies, check that there are no fuel leaks or sparks to avoid any risk of fire.

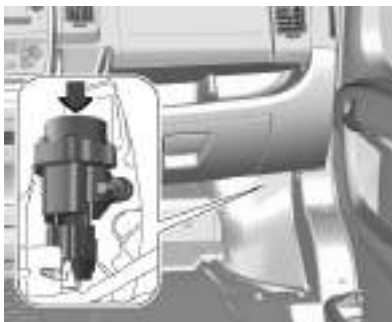

To restore the fuel supply, press the button on the fuel supply cut-off device.

It is located in the passenger compartment.

Depending on version, there is an additional safety relay that is activated after an impact. This safety relay cuts off the electrical supply.

Seek the assistance of a workshop!

### Refuelling

#### ⚠ Danger

Before refuelling, switch off ignition and any external heaters with combustion chambers.

Follow the operating and safety instructions of the filling station when refuelling.

#### ⚠ Danger

Fuel is flammable and explosive. No smoking. No naked flames or sparks.

If a smell of fuel can be noticed inside the vehicle, have the cause of this remedied immediately by a workshop.

A label with symbols at the fuel filler flap is indicating the allowed fuel types. In Europe the pump nozzles of the filling stations are marked with these symbols. Refuel only the allowed fuel type.



<b>Caution</b>
----------------

In case of misfueling, do not switch on ignition.
---

Fuel filler flap is located at the front left side of vehicle.



Release the fuel filler flap by pulling the flap.

Place the key in the lock and unlock the cap.

To open, turn the cap slowly anti-clockwise.

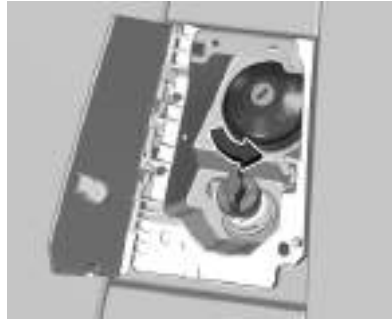

The fuel filler cap can be attached to the hook on the fuel filler flap.

Place the nozzle in straight position to the filler neck and press with slight force to insert.

To refuel, switch on pump nozzle.

After the automatic cut-off, the tank can be topped up by operating the pump nozzle a maximum of two more times.

<b>Caution</b>
----------------

Wipe off any overflowing fuel immediately.
--

To close, turn the fuel filler cap clockwise until it clicks.

Close the flap and allow it to engage.

### Fuel filler cap

Only use genuine fuel filler caps.

## Trailer hitch

### General information

Only use towing equipment that has been approved for the vehicle.

Entrust retrofitting of towing equipment to a workshop. It may be necessary to make changes that affect the cooling system, heat shields or other equipment.

### Driving characteristics and towing tips

Before attaching a trailer, lubricate the coupling ball. However, do not do so if a stabiliser, which acts on the coupling ball, is being used to reduce snaking movements. It is advisable to use a stabiliser.

During trailer towing do not exceed a speed of 50 mph. A maximum speed of 60 mph is only appropriate if an oscillation damper is used and the permissible gross trailer weight does not exceed the vehicle's curb weight.

For trailers with low driving stability and caravan trailers, the use of an oscillation damper is strongly recommended.

If the trailer starts snaking, drive more slowly, do not attempt to correct the steering and brake sharply if necessary.

When driving downhill, drive in the same gear as if driving uphill and drive at a similar speed.

If the outside temperature exceeds 37 °C, reduce the load on the trailer to protect the engine of the vehicle.

At high outside temperatures it is recommended to leave the engine running for one or two minutes after having stopped the vehicle in order to facilitate cooling.

Adjust tyre pressure to the value specified for full load.

Towing a trailer increases the braking distance of the vehicle. To limit the heating of the brakes, it is recommended to use the braking effect of the engine.

By driving uphill, the temperature of the coolant is increased. To reduce heating, drive at a reduced speed and pay attention to the coolant temperature. If the control indicator of the engine coolant temperature gauge illuminates, stop the vehicle and switch off engine as soon as possible.

## Trailer towing

### Trailer loads

The permissible trailer loads are vehicle and engine-dependent maximum values which must not be exceeded. The actual trailer load is the difference between the actual gross weight of the trailer and the actual coupling socket load with the trailer coupled.

The permissible trailer loads are specified in the vehicle documents. In general, they are valid for inclines up to 12%.

The permissible trailer load applies up to the specified incline and at sea level. Since engine power decreases as altitude increases due to the air

becoming thinner, therefore reducing climbing ability, the permissible gross train weight also decreases by 10% for every 1000 m of altitude. The gross train weight does not have to be reduced when driving on roads with slight inclines (less than 8%, e.g. motorways).

The permissible gross train weight must not be exceeded. This weight is specified on the identification plate  
⇨ 185.

### Vertical coupling load

The vertical coupling load is the load exerted by the trailer on the coupling ball. It can be varied by changing the weight distribution when loading the trailer.

The maximum permissible vertical coupling load (70 kg) is specified on the towing equipment identification plate and in the vehicle documents.

Always aim for the maximum vertical coupling load, especially in the case of heavy trailers. The vertical coupling load should never fall below 25 kg.

### Rear axle load

When the trailer is coupled and the towing vehicle fully loaded, the permissible rear axle load (see identification plate or vehicle documents) may be exceeded by 60 kg, the gross vehicle weight rating must not be exceeded. If the permissible rear axle load is exceeded, a maximum speed of 60 mph applies.

### Towing equipment

Depending on version the vehicle can be fitted with a detachable or a fixed coupling ball bar.

Caution
When operating without a trailer, remove the coupling ball bar.

### Fitting the coupling ball bar



Remove the sealing plug from the opening for the coupling ball bar and store it.

### Checking the tensioning of the coupling ball bar



- Red marking on rotary knob must point towards green marking on coupling ball bar.
- The gap between the rotary knob and the coupling ball bar must be approx. 6 mm.



- Remove the cover from the lock of the rotary knob and verify whether the rotary knob is locked. If the rotary knob cannot be turned, it is locked.

Otherwise, the coupling ball bar must be tensioned before being inserted:

- Unlock coupling ball bar by turning key to position .



- Pull out rotary knob and turn clockwise as far as it will go.

### Inserting the coupling ball bar



Insert the tensioned coupling ball bar in the opening and push firmly upwards until it audibly engages.

The rotary handle snaps back into its original position resting against the coupling ball bar without a gap.

### ⚠ Warning

Do not touch rotary handle during insertion.

Lock the coupling ball bar by turning the key to position . Remove the key and close the protective flap.

### Eye for break-away stopping cable



Attach breakaway stopping cable to eye.

### Check that the coupling ball bar is correctly installed

- Green marking on rotary knob must point towards green marking on coupling ball bar.
- There must be no gap between the rotary handle and the coupling ball bar.
- The coupling ball bar must be firmly engaged in the opening.
- The coupling ball bar must be locked and the key removed.

### ⚠ Warning

Towing a trailer is permitted only when a coupling ball bar is fitted correctly. If the coupling ball bar does not engage correctly, seek the assistance of a workshop.

### Dismounting the coupling ball bar



Open the protective flap and turn the key to position  to unlock the coupling ball bar.

Pull out rotary handle and turn clockwise as far as it will go. Pull out coupling ball bar downwards.

Insert sealing plug in opening. Fold away socket.

## Vehicle care

<b>General Information</b> .....	<b>140</b>
Accessories and vehicle modifications .....	140
Vehicle storage .....	142
End-of-life vehicle recovery .....	144
<b>Vehicle checks</b> .....	<b>144</b>
Performing work .....	144
Bonnet .....	145
Engine oil .....	146
Engine coolant .....	147
Washer fluid .....	148
Brakes .....	148
Brake fluid .....	148
Vehicle battery .....	148
High voltage battery .....	150
Diesel fuel system bleeding .....	151
Wiper blade replacement .....	151
<b>Bulb replacement</b> .....	<b>151</b>
Halogen headlights .....	151
Front fog lights .....	154
Front turn lights .....	155
Tail lights .....	156
Side turn lights .....	157
Exterior lighting .....	158

Centre high-mounted brake light .....	158
Number plate light .....	159
<b>Electrical system</b> .....	<b>159</b>
Fuses .....	159
<b>Vehicle tools</b> .....	<b>160</b>
Tools .....	160
<b>Wheels and tyres</b> .....	<b>161</b>
Winter tyres .....	161
Tyre designations .....	161
Tyre pressure .....	161
Tyre pressure monitoring system .....	162
Tread depth .....	163
Changing tyre and wheel size .....	164
Wheel covers .....	164
Tyre chains .....	165
Tyre repair kit .....	165
Wheel changing .....	168
Spare wheel .....	168
<b>Jump starting</b> .....	<b>173</b>
<b>Towing</b> .....	<b>175</b>
Towing the vehicle .....	175
Towing another vehicle .....	176
<b>Appearance care</b> .....	<b>177</b>
Exterior care .....	177
Interior care .....	178

## General Information

### Accessories and vehicle modifications

We recommend the use of genuine parts and accessories and factory approved parts specific for your vehicle type. We cannot assess or guarantee reliability of other products - even if they have a regulatory or otherwise granted approval.

Any modification, conversion or other changes made to standard vehicle specifications (including, without limitation, software modifications, modifications of the electronic control units) may invalidate the warranty offered by Vauxhall. Furthermore, such changes may affect driver assistance systems, may impact fuel or electric power consumption, CO<sub>2</sub> emissions and other emissions of the vehicle and cause the vehicle to no longer conform to the operating permit, impacting the validity of your vehicle registration.

**Caution**

Access to the diagnostic socket associated with the on-board electronics is reserved for qualified technicians and approved tools.

**Caution**

When transporting the vehicle on a train or on a recovery vehicle, the mud flaps might be damaged.

**Cold protection covers**

In order to prevent the accumulation of snow or ice in the upper engine compartment, it is recommended to install removable protection covers.

The protection covers must be professionally installed, consult a workshop.

**Mobile phones and CB radio equipment**

The vehicle specific installation instructions and the operating guidelines of the mobile phone and hands-free manufacturer must be observed when installing and operating a mobile telephone. Failure to do so could invalidate the vehicle type approval (EU directive 95/54/EC).

Recommendations for fault-free operation:

- Professionally installed exterior antenna to obtain the maximum range possible.
- Maximum transmission power 10 W.
- Installation of the phone in a suitable spot, consider the area in which the airbag inflates ↷ 29.

Seek advice on predetermined installation points for the external antenna or equipment holder and ways of using devices with a transmission power exceeding 10 W.

Use of a hands-free attachment without external antenna with mobile telephone standards GSM 900/1800/1900 and UMTS is only permitted if the maximum transmission power of the mobile telephone is 2 W for GSM 900 or 1 W for the other types.

For reasons of safety, do not use the phone while driving. Even use of a hands-free set can be a distraction while driving.

**⚠ Warning**

Operation of radio equipment and mobile telephones which fail to meet above mentioned mobile telephone standards is only permitted using an antenna located outside of the vehicle.

**Caution**

Mobile telephones and radio equipment may lead to malfunctions in the vehicle electronics when operated inside

the vehicle with no exterior antenna, unless the above mentioned regulations are observed.

## Vehicle storage

### Storage for a long period of time (non-electric vehicle)

If the vehicle is to be stored for several months:

- Wash the vehicle.
- Have the wax in the engine compartment and underbody checked.
- Clean and preserve the rubber seals.
- Fill up fuel tank completely.
- Change the engine oil.
- Drain the washer fluid reservoir.
- Check the coolant antifreeze and corrosion protection.
- Adjust tyre pressure to the value specified for full load.

- Park the vehicle in a dry, well ventilated place. Engage first or reverse gear or set selector lever to **P**. Prevent the vehicle from rolling.
- Do not apply the parking brake.
- Open the bonnet, close all doors and lock the vehicle.
- Activate the battery standby mode. Note that all systems are not functional, e.g. anti-theft alarm system.

### Storage for a long period of time (electric vehicle)

If the vehicle is to be stored for several months:

- Wash the vehicle.
- Have the wax in the engine compartment and underbody checked.
- Clean and preserve the rubber seals.
- Drain the washer fluid reservoir.
- Check the coolant antifreeze and corrosion protection.

- Adjust tyre pressure to the value specified for full load.
- Park the vehicle in a dry, well ventilated place. Engage first or reverse gear or set selector lever to **P**. Prevent the vehicle from rolling.
- Do not apply the parking brake.
- Open the bonnet, close all doors and lock the vehicle.

### Up to four weeks

Plug in the charging cable.

### Four weeks to twelve months

- Discharge the high voltage battery until 30 percent remain on the battery range indicator (battery symbol) on the instrument cluster.
- Do not plug in the charging cable.
- Always store the vehicle in a place with temperatures between  $-10\text{ }^{\circ}\text{C}$  and  $30\text{ }^{\circ}\text{C}$ .
- Vehicle storage at extreme temperatures may cause damage to the high voltage battery.



- Remove the black negative (-) cable from the 12 V vehicle battery and attach a trickle charger to the vehicle battery terminals or keep the 12 V vehicle battery cables connected and trickle charge from the positive (+) and negative (-) terminals in the engine compartment.
- Every three months, check the battery's state of charge. If the state of charge is below 30 percent, recharge the battery to 30 percent.

### Putting back into operation (non-electric vehicle)

When the vehicle is to be put back into operation:

- Deactivate the battery standby mode.
- Check tyre pressure.
- Fill up the washer fluid reservoir.
- Check the engine oil level.
- Check the coolant level.
- Fit the number plates if necessary.

### Putting back into operation (electric vehicle)

When the vehicle is to be put back into operation:

- Connect the clamp to the negative terminal of the 12 V vehicle battery.
- Check tyre pressure.
- Fill up the washer fluid reservoir.
- Check the coolant level.
- Fit the number plate if necessary.

### Battery standby mode

In order to protect the 12 V vehicle battery, it is possible to activate the battery standby mode.

#### Activation

1. Switch off engine.

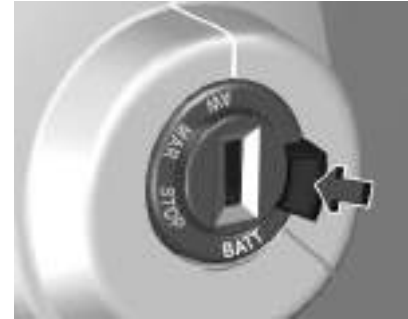

2. Press the red button, then turn key to position **BATT**.

The battery goes into standby mode approx. 7 minutes later. In this time period the vehicle should be left and locked by using the remote control.

Ensure that all vehicle electrical systems are deactivated.

#### Caution

When the battery is in standby mode, the driver's door can only be unlocked by unlocking the mechanical lock.

**Notice**

After a battery standby, several settings of the infotainment system (e.g. time, date, radio stations, etc.) are memorised.

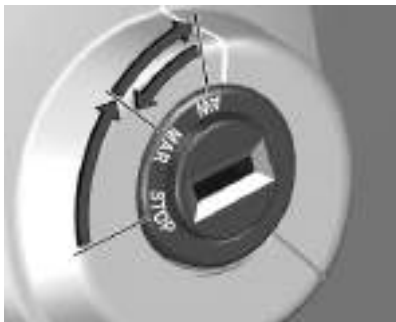
**Deactivation**

1. Turn key to position **MAR**.
  2. Turn key briefly to position **AVV** to start the engine.
- Starting the engine ⇨ 88.

**End-of-life vehicle recovery**

Information on end-of-life vehicle recovery centres and the recycling of end-of-life vehicles is available on our website, where legally required. Only entrust this work to an authorised recycling centre.

**High voltage battery**

The high voltage battery is designed for the life of the vehicle if the recommendations are followed. If it becomes necessary to replace the high voltage battery, contact a workshop for instructions on its disposal. Improper disposal carries the risk of severe burns, electric shock, and damage to the environment.

Recommendations ⇨ 150.

**Vehicle checks****Performing work****⚠ Warning**

Only perform engine compartment checks when the ignition is off.

The cooling fan may start operating even if the ignition is off.

**⚠ Danger**

The ignition system uses extremely high voltage. Do not touch.

**Electric vehicle**

**⚠ Danger**

Never try to perform maintenance work on high voltage components yourself. You may be injured and the vehicle may be damaged. Service and repair of these high voltage components should only be performed by a trained service technician with proper knowledge and tools. Exposure to high voltage may cause shock, burns, and even death. The high voltage components in the vehicle can only be serviced by technicians with special training.

High voltage components are identified by labels. Do not remove, open, take apart, or modify these components. High voltage cable or wiring has orange covering. Do not probe, tamper with, cut, or modify high voltage cable or wiring.

**Caution**

Even small amounts of contamination to the liquids can cause damage to vehicle systems. Do not allow contaminants to contact the fluids, reservoir caps, or dipsticks.

**Bonnet****Opening**

Open the driver's door.



Pull the release lever and return it to its original position.



Push the safety catch upwards and open the bonnet.



Secure the bonnet support.

## Closing

Before closing the bonnet, press the support into the holder.

Lower the bonnet and let it fall into the latch from a low height (20-25 cm). Check that the bonnet is engaged.

### Caution

Do not press the bonnet into the latch to avoid dents.

## Engine oil

Check the engine oil level manually on a regular basis to prevent damage to the engine. Ensure that the correct specification of oil is used.

Recommended fluids and lubricants  
⇨ 182.

Check with the vehicle on a level surface. The engine must be at operating temperature and switched off for at least five minutes.

It is recommended to check the engine oil level, and top up if necessary, every 3,000 miles.

### Caution

It is the owner's responsibility to maintain the proper level of an appropriate quality oil in the engine.

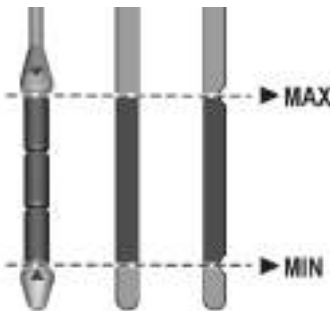

Different dipsticks are used depending on engine variant.

Pull out the dipstick, wipe it clean, reinsert it fully, pull out and read the engine oil level.

When the engine oil level has dropped to the **MIN** mark, top up the engine oil.



We recommend the use of the same grade of engine oil that was used at last change.

The engine oil level must not exceed the **MAX** mark on the dipstick.

### Caution

Overfilled engine oil must be drained or suctioned out. If the oil exceeds the maximum level, do not start the vehicle and contact a workshop.

Capacities ⇨ 186.

Fit the cap on straight and tighten it.

## Engine coolant

The factory filled coolant provides freeze protection down to approx.  $-37^{\circ}\text{C}$ .

### Caution

Only use approved antifreeze.

Coolant and antifreeze ↪ 182.

## Coolant level

### Caution

Too low a coolant level can cause engine damage.

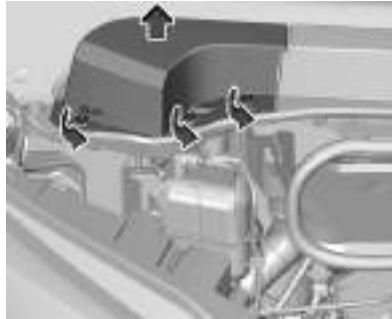

To gain access to the tank cap, remove the protective cover by turning the three fixing screws a quarter of a turn.



If the cooling system is cold, the coolant level should be above the **MIN** mark. Top up if the level is low.

### ⚠ Warning

Allow the engine to cool before opening the cap. Carefully open the cap, relieving the pressure slowly.

To top up, use a 1:1 mixture of released coolant concentrate mixed with clean tap water. If no coolant concentrate is available, use clean tap water. Install the cap tightly. Have the coolant concentration checked and have the cause of the coolant loss remedied by a workshop.

## Washer fluid



To access the filler cap, pull the telescope filler neck and unclip the cap.

Fill with clean water mixed with a suitable quantity of approved windscreen washer fluid which contains antifreeze.

### Caution

Only washer fluid with a sufficient antifreeze concentration provides protection at low temperatures or a sudden drop in temperature.

Washer fluid ⇨ 182.

## Brakes

Depending on the driving style, the brake wear may vary significantly. The brake wear may increase when the vehicle is driven over short distances, e.g. in the city.

It may be necessary to have the condition of the brakes checked, even between vehicle services.

Unless there is a leak in the circuit, a drop in the brake fluid level indicates that the brake pads are worn.

Once new brake linings are installed, do not brake unnecessarily hard for the first few journeys.

## Brake fluid

### ⚠ Warning

Brake fluid is poisonous and corrosive. Avoid contact with eyes, skin, fabrics and painted surfaces.



The brake fluid level must not exceed the **MAX** mark.

If the brake fluid level is not close to the **MAX** mark, seek the assistance of a workshop.

Brake and clutch fluid ⇨ 182.

## Vehicle battery

The vehicle battery is maintenance-free provided that the driving profile allows sufficient charging of the battery. Short-distance-driving and frequent engine starts can discharge the battery. Avoid the use of unnecessary electrical consumers.



Batteries do not belong in household waste. They must be disposed of at an appropriate recycling collection point.

Laying up the vehicle for more than four weeks can lead to battery discharge. Activate the battery standby mode or disconnect the clamp from the negative terminal of the vehicle battery.

Battery standby mode ⇨ 142.

Ensure the ignition is switched off before connecting or disconnecting the vehicle battery.

Battery discharge protection ⇨ 74.

## Battery access

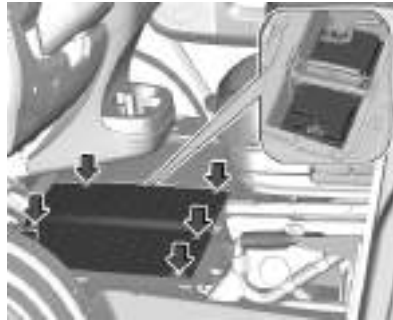

The battery is located under the left-hand front floor. Remove the panel to access the battery.

## Replacing the vehicle battery

### Notice

Any deviation from the instructions given in this section may lead to temporary deactivation or disturbance of the stop-start system.

When the vehicle battery is being replaced, please ensure that there are no open ventilation holes in the vicinity of the positive terminal. If a ventilation hole is open in this area, it

must be closed off with a dummy cap, and the ventilation in the vicinity of the negative terminal must be opened.

Ensure that the battery is always replaced by the same type of battery.

The vehicle battery has to be replaced by a workshop.

Stop-start system ⇨ 89.

## Charging the vehicle battery

### ⚠ Warning

On vehicles with stop-start system, ensure that the charging potential does not exceed 14.6 V when using a battery charger. Otherwise the vehicle battery may be damaged.

Jump starting ⇨ 173.

## Warning label



## Meaning of symbols:

- No sparks, naked flames or smoking.
- Always shield eyes. Explosive gases can cause blindness or injury.
- Keep the vehicle battery out of reach of children.
- The vehicle battery contains sulphuric acid which could cause blindness or serious burn injuries.

- See the Owner's Manual for further information.
- Explosive gas may be present in the vicinity of the vehicle battery.

## High voltage battery

To preserve the range and the durability of the high voltage battery, the following is recommended:

- Whenever possible do not charge the high voltage battery more than 80%.
- Do not completely discharge the high voltage battery.
- Do not store the vehicle for a long period of non-use (more than twelve hours) when the high voltage battery has a low or high charge level. Prefer a charge level between 20 and 40%.
- Limit the use of fast charging.
- Do not expose the vehicle to temperatures below  $-30\text{ }^{\circ}\text{C}$  and above  $60\text{ }^{\circ}\text{C}$  for more than 24 hours.

- Avoid charging the vehicle at low temperatures (except if the vehicle ran more than 20 minutes) or above  $30\text{ }^{\circ}\text{C}$ .
- Do not use the high voltage battery as a generator of energy.
- Do not use a generator to recharge the high voltage battery.

Vehicle storage ↗ 142.

## Leakage

Damage to the high voltage battery could result in the leakage of toxic gases or fluids either immediately or later. The following is recommended:

- Always inform the fire and emergency services in the event of an incident, that the vehicle is equipped with a high voltage battery.
- Never touch the liquids leaking from the high voltage battery.
- Do not inhale the gases emitted by the high voltage battery which are toxic.



- Move away from the vehicle in the event of incident or accident, the gases emitted being flammable and could cause a fire.
- Too low a coolant level must be topped up and the cause of the coolant loss remedied by a workshop.

## Diesel fuel system bleeding

If the tank has been run dry, the diesel fuel system must be bled. Refuel at least five litres diesel. Switch on the ignition for about 60 seconds and switch off again. Then crank the engine. If the engine does not start directly, repeat this process a few times. If the engine then fails to start, seek the assistance of a workshop.

## Wiper blade replacement

### Windscreen



Switch off the ignition.

Lift the wiper arm until it stays in the raised position, press the button to unclip the wiper blade and remove it.

Attach the wiper blade to the wiper arm and push until it engages.

Lower the wiper arm carefully.

## Bulb replacement

Before replacing a bulb, ensure that all exterior and interior lights and the ignition are switched off. All doors have to be closed.

Only hold a new bulb at the base. Do not touch the bulb glass with bare hands.

Use only the same bulb type for replacement.

Replace headlight bulbs from within the engine compartment.

In case of defective LEDs, have them replaced by a workshop.

### Bulb check

After a bulb replacement switch on the ignition, operate and check the lights.

## Halogen headlights

Halogen headlights with separate bulbs for low beam, high beam and sidelights / daytime running lights.

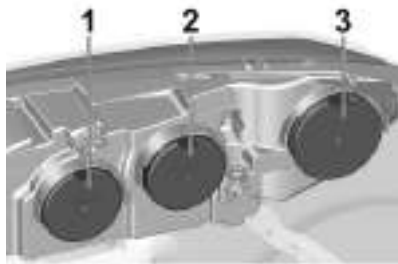

High beam (1) inner bulb  
Low beam (2) middle bulb  
Sidelights / daytime running lights (3)  
outer bulbs

### High beam (1)



1. Remove the protective cover by pulling.



2. Disconnect the electrical connector.  
Release the locking spring by pressing the central clamp.  
Withdraw the bulb socket from the reflector housing.



3. Detach the bulb from the bulb socket and replace the bulb.  
4. Insert the bulb socket into the reflector housing.  
5. Fit the protective cover on.

**Low beam (2)**

1. Remove the protective cover by pulling.



2. Disconnect the electrical connector.  
Release the locking spring by pressing the central clamp.  
Withdraw the bulb socket from the reflector housing.



3. Detach the bulb from the bulb socket and replace the bulb.
4. Insert the bulb socket into the reflector housing.
5. Fit the protective cover on.

**Sidelight / daytime running lights (3) with bulbs**

1. Remove the protective cover by pulling.



2. Rotate the bulb socket anticlockwise to disengage and withdraw from the reflector.



3. Remove the bulb from the bulb socket by pulling.
4. Replace and insert the new bulb into the bulb socket.
5. Insert the bulb socket into the light assembly and turn clockwise.

### Sidelight / daytime running light with LEDs

In case of defective LEDs, have them replaced by a workshop.

### Front fog lights

1. Turn the steering wheel so that the access to fog lights is given.



2. Unscrew and remove the protective flap.



3. Turn the bulb socket anticlockwise and remove it from the light assembly.



4. Disengage the plug connector by pulling the retaining lug.

5. Remove and replace the bulb unit and attach the plug connector. Note that the bulb and the socket are one unit and have to be changed together.
6. Insert the bulb socket into the light assembly by turning clockwise and engage.
7. Reinstall the protective flap.

## Front turn lights



Turn light (1) outer bulb



1. Remove the protective cover by pulling.



2. Rotate the bulb socket anticlockwise to disengage and withdraw from the reflector.



3. Remove the bulb from the bulb socket by pulling.
4. Replace and insert the new bulb into the bulb socket.
5. Insert the bulb socket into the light assembly and turn clockwise.

## Tail lights

### Tail light assembly

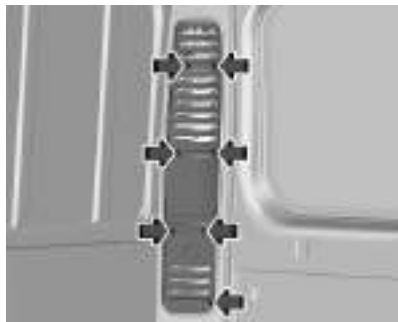

1. Unscrew the seven fixing screws with a screwdriver and remove cover afterwards.



2. Disconnect the electrical connector by pressing on its central tab. Remove the two fixing nuts from the lens unit. From the outside, remove the lens unit.



3. Remove the six fixing screws from the bulb carrier. Open the three retaining tabs and pull the bulb carrier out of his housing.

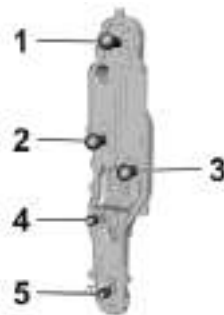

4. Replace the respective bulb:  
 Brake light (1)  
 Brake light / parking light (2)  
 Turn light / hazard warning flasher (3)  
 Reverse light (4)  
 Rear fog light (5)

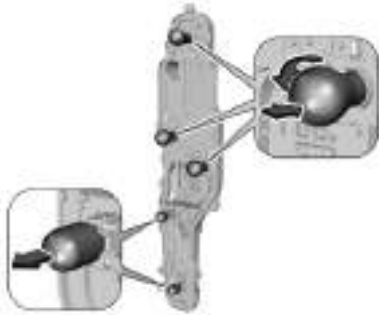

**5. To replace bulbs 1 to 3:**

Turn the bulb anticlockwise and remove it.

Replace and insert the new bulb into the bulb socket.

**To replace bulbs 4 and 5:**

Remove the bulb from the bulb socket by pulling.

Replace and insert the new bulb into the bulb socket.

**Body conversion variants**

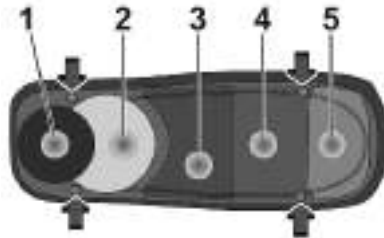

1. Remove the four fixing screws.  
Pull out lens unit.
2. Replace the respective bulb:  
Turn light / hazard warning flasher (1)  
Brake light (2)  
Parking light (3)  
Reverse light (4)  
Rear fog light (5)
3. To replace bulbs 1 and 2:  
Turn the bulb anticlockwise and remove it.

Replace and insert the new bulb into the bulb socket.

**To replace bulbs 3 to 5:**

Remove the bulb from the bulb socket by pulling.

Replace and insert the new bulb into the bulb socket.

**Side turn lights**

To replace the bulb, remove the light housing:



1. Remove the two fixing screws.
2. Pull the bulb carrier to release it from the pins.



3. Remove the bulb from the bulb socket by pulling.
4. Replace and insert the new bulb into the bulb socket.

## Exterior lighting

### Side marker lights

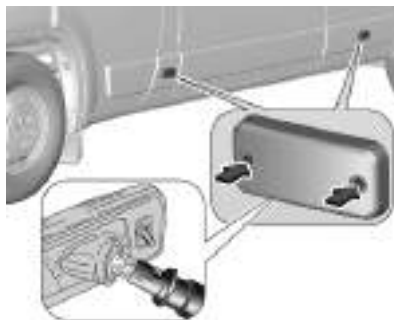

1. Remove the two fixing screws.
2. Pull the bulb carrier to release it from the pins.



3. Remove the bulb from the bulb socket by pulling.
4. Replace and insert the new bulb into the bulb socket.

## Centre high-mounted brake light

1. Remove the two fixing screws from the brake light assembly.





2. Pull the brake light assembly out carefully.
3. Remove the bulb carrier by pinching the two tabs inwards.
4. Remove the faulty bulb by pulling on it.
5. Renew bulb.
6. Install brake light assembly like explained above, in reversed order.

## Number plate light



1. Insert a screwdriver in one of the recesses of the cover and lever it out. Remove the cover.
2. Pull the bulb from the bulb holder and replace it.
3. Attach the cover.

## Electrical system

### Fuses

A defective fuse must be replaced by a workshop.

## Vehicle tools

### Tools



The tools are located in the storage box underneath the front passenger seat.

Underseat storage ↗ 38.

### Vehicles with spare wheel



The box includes:

- Extended socket
- Wheel bar
- Jack
- Wheelbrace
- Screwdriver (handle and bits)
- Towing eye
- Depending on version a kit for storing a damaged alloy wheel rim

### Vehicles without spare wheel

The box contains the tools and the tyre repair kit.

Tyre repair kit ↗ 165.

## Wheels and tyres

### Tyre condition, wheel condition

Drive over edges slowly and at right angles if possible. Driving over sharp edges can cause tyre and wheel damage. Do not trap tyres on the kerb when parking.

Regularly check the wheels for damage. Seek the assistance of a workshop in the event of damage or unusual wear.

### Winter tyres

Winter tyres improve driving safety at temperatures below 7 °C and should therefore be fitted on all wheels.

In accordance with country-specific regulations, affix the speed sticker in the driver's field of view, if the tyre speed code is below the maximum speed of the vehicle.

### Tyre designations

E.g. **225/55 R 18 98 V**

- 225** : tyre width, mm
- 55** : cross-section ratio (tyre height to tyre width), %
- R** : belt type: Radial
- RF** : type: RunFlat
- 18** : wheel diameter, inches
- 98** : load index e.g. 98 is equivalent to 750 kg
- V** : speed code letter

Speed code letter:

- Q** : up to 100 mph
- S** : up to 112 mph
- T** : up to 118 mph
- H** : up to 130 mph
- V** : up to 150 mph
- W** : up to 168 mph

Choose a tyre appropriate for the maximum speed of your vehicle. Refer to the EEC Certificate of Conformity provided with your vehicle or other national registration documents. Optional equipment could reduce the maximum speed of the vehicle.

### Directional tyres

Directional tyres should be mounted so that they rotate in the correct direction. The proper rotation direction is indicated by a symbol (e.g. an arrow) on the sidewall.

### Tyre pressure

Check the pressure of cold tyres at least every 14 days and before any long journey. Do not forget the spare wheel. This also applies to vehicles with tyre pressure monitoring system.



The tyre pressure information label on the left door frame indicates the original equipment tyres and the correspondent tyre pressures.

The tyre pressure data refers to cold tyres. It applies to summer and winter tyres.

Always inflate the spare tyre to the pressure specified for full load.

Incorrect tyre pressures will impair safety, vehicle handling, comfort and fuel economy and will increase tyre wear.

For the tyres approved for your vehicle, refer to the EEC Certificate of Conformity provided with your vehicle or other national registration documents.

The driver is responsible for correct adjustment of tyre pressure.

**⚠ Warning**

If the pressure is too low, this can result in considerable tyre warm-up and internal damage, leading to tread separation and even to tyre blow-out at high speeds.

**Temperature dependency**

The tyre pressure depends on the temperature of the tyre. During driving, tyre temperature and pressure increase. Tyre pressure values provided on the tyre information label and tyre pressure chart are valid for cold tyres, which means at 20 °C.

The pressure increases by nearly 1.5 psi for a 10 °C temperature increase. This must be considered when warm tyres are checked.

**Tyre pressure monitoring system**

The tyre pressure monitoring system checks the pressure of all four tyres once a minute when vehicle speed exceeds a certain limit.

**Caution**

Tyre pressure monitoring system warns only about low tyre pressure condition and does not replace regular tyre maintenance by the driver.

All wheels must be equipped with pressure sensors and the tyres must have the prescribed pressure.

**Notice**

In countries where the tyre pressure monitoring system is legally required, the use of wheels without pressure sensors will invalidate the vehicle operating permit.

If a tyre loses pressure the control indicator (⚠) illuminates and a warning chime is given. Depending on version, a warning message is displayed in the Driver Information Centre.

Depending on version and if only one tyre is affected, the tyre can be identified by the system and is displayed by the symbol and the message.

The system considers the tyre temperature for the warnings.

Temperature dependency ⇨ 161.

If the control indicator (⚠) illuminates continuously the tyre pressure has to be adjusted ⇨ 58.

In this case reduce speed, avoid sharp cornering and strong braking. Stop at next safe opportunity, check tyre pressure to the prescribed pressure.

After inflating, some driving may be required to update the tyre pressure values in the Driver Information Centre. It might take about 20 minutes until (⚠) extinguishes.

If the failure continues to be displayed, contact a workshop. The system is inoperable when ABS or ESC has a malfunction or a temporary spare wheel is used. Once the road tyre has been refitted, check the tyre pressure with cold tyres and initialise the system.

Only mount wheels with pressure sensors, otherwise the tyre pressure will not be displayed and (⚠) illuminates continuously.

A spare wheel or temporary spare wheel is not equipped with pressure sensors. The tyre pressure monitoring system is not operational for these tyres. Control indicator (⚠) illuminates. For the further three tyres, the system remains operational.

The use of commercially-available liquid tyre repair kits can impair the function of the system. Factory-approved repair kits can be used.

Operating electronic devices or being close to facilities using similar wave frequencies could disrupt the tyre pressure monitoring system.

Each time the tyres are replaced, tyre pressure monitoring system sensors must be dismantled and serviced.

### Auto learn function

After changing wheels or wheel positions the vehicle must be stationary for approx. 20 minutes, before the system recalculates. The following relearn process takes up to 10 minutes of driving in a speed range of 25 to 60 mph. Avoid to drive outside

of this range for a longer time. If possible, use a country road or similar which allows continuous driving.

Ensure the tyre loading status is set according to the selected pressure ⇨ 61.

If problems occur during the relearn process, a failure message is displayed in the Driver Information Centre. (⚠) will flash for 75 seconds and then illuminates continuously.

If this happens, repeat learning process. Keep your vehicle stationary for approx. 20 minutes and then drive again for 10 minutes as described above.

### Tread depth

Check tread depth at regular intervals.

For safety reasons, it is recommended that the tread depth of the tyres on one axle should not vary by more than 2 mm.



The legally permissible minimum tread depth (1.6 mm) has been reached when the tread has worn down as far as one of the tread wear indicators (TWI). Their position is indicated by markings on the sidewall.

If there is more wear at the front than the rear, swap round front wheels and rear wheels periodically. Ensure that the direction of rotation of the wheels remains the same.

Tyres age, even if they are not used. We recommend tyre replacement every six years.

## Changing tyre and wheel size

If tyres of a different size than those fitted at the factory are used, it may be necessary to reprogramme the nominal tyre pressure and make other vehicle modifications.

After converting to a different tyre size, have the label with tyre pressures replaced and the tyre pressure monitoring system reinitialised ↻ 162.

### ⚠ Warning

The use of unsuitable tyres or wheels may lead to accidents and will invalidate the vehicle operating permit.

## Wheel covers

Wheel covers and tyres that are factory approved for the respective vehicle and comply with all of the relevant wheel and tyre combination requirements must be used.

If the wheel covers and tyres used are not factory approved, the tyres must not have a rim protection ridge.

Wheel covers must not impair brake cooling.

### ⚠ Warning

Use of unsuitable tyres or wheel covers could lead to sudden pressure loss and thereby accidents.

Vehicles with steel wheels: When using locking wheel nuts, do not attach wheel covers.

## Tyre chains



Tyre chains are only permitted on the front wheels.

Always use fine mesh chains that add no more than 9 mm to the tyre tread and the inboard sides (including chain lock).

### ⚠ Warning

Damage may lead to tyre blowout.

Tyre chains are permitted on tyres of size 205/70R15, 215/70 R15, 225/70 R15, 215/75 R16 and 225/75 R16.

## Temporary spare wheel

The use of tyre chains is not permitted on the temporary spare wheel.

## Tyre repair kit

Minor damage to the tyre tread can be repaired with the tyre repair kit.

Do not remove foreign bodies from the tyres.

Tyre damage exceeding 4 mm or that is at tyre's sidewall cannot be repaired with the tyre repair kit.

### ⚠ Warning

Do not drive faster than 50 mph.  
Do not use for a lengthy period.  
Steering and handling may be affected.

In the case of a flat tyre:

Apply the parking brake and engage first gear, reverse gear or **P**.

The tyre repair kit is stored in a bag, placed in one of the front doors.

It includes:

- a quick user guide for the repair kit
- a cartridge, containing the sealant
- a compressor equipped with a pressure gauge and connectors
- adapters for the inflation of various components



1. Filler hose with a ring at the end.
2. Compressor
3. Switch with position (off/on): O / I
4. Pressure gauge

5. Cartridge, containing the sealant; sticker on the top marked with 50 mph to affix after the repairing on the instrument panel.
6. Hose to check and restore tyre pressure

### Repair the tyre



1. Unscrew the valve cap from the defective tyre.
2. Take out the filler hose and screw the ring nut onto the tyre valve.
3. The switch on the compressor must be set to O.

4. Connect the compressor plug to the power outlet or cigarette lighter socket.

The tyre repair kit may only be plugged in to the front 12 V power outlet, in order to work properly.

To avoid discharging the battery, we recommend running the engine.

5. Set the rocker switch on the compressor to I. The tyre is filled with sealant.
6. The compressor pressure gauge briefly indicates up to 600 kPa (6 bar) whilst the sealant cartridge is emptying (approx. 30 s). Then the pressure starts to drop.
7. All of the sealant is pumped into the tyre. Then the tyre is being inflated.
8. The prescribed tyre pressure should be obtained within 10 minutes.

When the correct pressure is obtained, switch off the compressor.

If the prescribed tyre pressure is not obtained within 10 minutes, remove the tyre repair kit. Move the vehicle forwards by about 10 m to distribute the sealing fluid inside the tyre evenly. Reattach the tyre repair kit and continue the filling procedure for 10 minutes. If the prescribed tyre pressure is still not obtained, the tyre is too badly damaged. Seek the assistance of a workshop.

Do not run the compressor longer than 10 minutes.

9. Detach the tyre repair kit. Store the tyre repair kit back in the storage compartment of the door.
10. Remove any excess sealant using a cloth.
11. Continue driving immediately so that sealant is evenly distributed in the tyre. After driving approx. 3 miles but no more than 10 minutes, stop and check tyre pressure. Screw compressor air hose directly onto tyre valve when doing this. Fill tyre as described before. Drain excess tyre



pressure with the button on the air hose.

If tyre pressure hasn't decreased under 150 kPa (1.5 bar), set it to the correct value. Otherwise the vehicle must not be used. Seek assistance of a workshop.

Repeat the checking procedure once more after driving further 6 miles but no more than 10 minutes to check that there is no more loss of pressure.

If the tyre pressure has fallen below 150 kPa (1.5 bar), the vehicle must not be used. Seek the assistance of a workshop.

#### Notice

The driving characteristics of the repaired tyre are severely affected, therefore have this tyre replaced.

If unusual noise is heard or the compressor becomes hot, turn compressor off for at least 30 min.

The built-in safety valve opens at a pressure of seven bar (102 psi).

Note the expiry date of the kit. After this date its sealing capability is no longer guaranteed. Pay attention to storage information on sealant bottle.

Replace the used sealant bottle. Dispose of the bottle as prescribed by applicable laws.

The compressor and sealant can be used from approx. -30 °C.

### Checking and restoring pressure



1. Unscrew the valve cap from the tyre.
2. Take out the pressure hose and connect it to the tyre valve.

The cartridge will be connected to the compressor and the tyre is inflated, but no sealant will be injected.

To deflate the tyre, press the yellow button located on the centre of the compressor switch.

3. Detach the tyre repair kit. Store the tyre repair kit back in the storage compartment of the door.

### Replacing the sealant cartridge

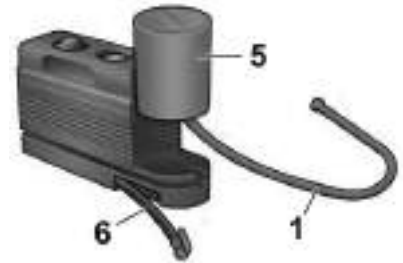

1. Turn the cartridge to be replaced anti-clockwise and lift it.
2. Insert the new cartridge and turn it clockwise.

## Wheel changing

Make the following preparations and observe the following information:

- Park the vehicle on a level, firm and non-skid surface. The front wheels must be in the straight-ahead position.
- If necessary, place a chock under the wheel diagonally opposite the wheel to be changed.
- Apply the parking brake and engage first gear, reverse gear or **P**.
- If the ground on which the vehicle is standing is soft, a solid board (max. 1 cm thick) should be placed under the jack.
- Take heavy objects out of the vehicle before jacking up.
- No people or animals may be in the vehicle when it is jacked-up.
- Never crawl under a jacked-up vehicle.
- Do not start the vehicle when it is raised on the jack.
- Before screwing in the wheel bolts, clean them.

### ⚠ Warning

Do not grease wheel bolts.

### Tightening torques

The tightening torque for 15 inches wheels is 160 Nm.

The tightening torque for 16 inches wheels is 180 Nm.

Use the correct wheel bolts for the respective wheels.

### Spare wheel

The spare wheel can be classified as a temporary spare wheel depending on the size compared to the other mounted wheels and country regulations. In this case a permissible maximum speed applies, even though no label at the spare wheel indicates this.

Only mount one temporary spare wheel. Do not drive faster than 50 mph. Take curves slowly. Do not use for a long period of time.

### Caution

The use of a spare wheel that is smaller than the other wheels or in combination with winter tyres could affect driveability. Have the defective tyre replaced as soon as possible.

The spare wheel is located underneath the vehicle.

The vehicle tools extended socket, wheelbrace and wheel bar are needed to get access.

If equipped with alloy wheel rims, the provided kit is also needed. ⇨ 160

1. Lift the rear of the vehicle to facilitate the access.



2. Assemble the extended socket, wheelbrace and wheel bar correctly to a wrench and install it on the retaining bolt.

Turn the wrench anti-clockwise to lower the spare wheel.

Continue turning anti-clockwise until the resistance point, indicated by the stiffening at turning or a click from the clutch present in the device.

3. Unwind the whole cable of the spare wheel lifting device



4. Unscrew the retaining knob.  
Remove the support by tilting one side.
5. Remove the spare wheel.
6. Change the wheel.



7. If the damaged wheel has an alloy rim, follow these steps:
- Position the support (3) inside the bracket of the tool kit (2).
  - Position the bracket (2) on the inside of the alloy wheel rim.
  - Tighten the retaining knob (1) on the bracket (2).
  - Tighten the three special screws (4) from under the damaged wheel to the nuts of the bracket (4), using the allen spanner.



8. If the damaged wheel has a steel rim, follow these steps:

- Position the support on the inside of the steel wheel rim and reattach it by tilting in.
- Tighten the retaining knob.



9. Position the wrench on the screw of the support and turn clockwise until the wheel is lifted up completely.

Check the correct position of the wheel under the platform.

10. Put the tools back in the storage. Only mount one temporary spare wheel. The permissible maximum speed on the label on the temporary spare wheel is only valid for the factory-fitted tyre size.

### Fitting the spare wheel

Make the following preparations and observe the following information:

- Park the vehicle on a level, firm and non-skid surface. The front wheels must be in the straight-ahead position.
- If necessary, place a chock under the wheel diagonally opposite the wheel to be changed.
- Apply the parking brake and engage first gear, reverse gear or P.
- Remove the spare wheel.
- Never change more than one wheel at once.
- Use the jack only to change wheels in case of puncture, not for seasonal winter or summer tyre change.
- The jack is maintenance-free.
- If the ground on which the vehicle is standing is soft, a solid board (max. 1 cm thick) should be placed under the jack.
- Take heavy objects out of the vehicle before jacking up.

- No people or animals may be in the vehicle when it is jacked-up.
- Never crawl under a jacked-up vehicle.
- Do not start the vehicle when it is raised on the jack.
- Before screwing in the wheel bolts, clean them.

### **⚠ Warning**

Do not grease wheel bolts.

1. Disengage wheel bolt caps with the wheel bolt cover remover  
↪ 160.  
Steel wheel rims with cover: Pull off the wheel cover.  
Alloy wheel rims: Disengage wheel bolt caps with the wheel bolt cover remover.



2. Attach the wheel wrench and loosen each wheel bolt by half a turn.

The wheels might be protected by locking wheel nuts. To loosen these specific nuts first attach the adapter onto the head of the nut before installing the wheel wrench. The adapter is located in the tool box. ↪ 160



3. Ensure the jack is correctly positioned under the relevant vehicle jacking point near the front wheel.



4. Ensure the jack is correctly positioned under the relevant vehicle jacking point near the rear wheel.



5. Ensure the notch of the jack fits in the intended hole.



Set the jack to the necessary height. Position it directly below the jacking point in a manner that prevents it from slipping.



With the jack correctly aligned rotate the wheel wrench until the wheel is clear of the ground.



6. If equipped with a side step the jack has to be positioned at 45° to not interfere with the side step.
7. Unscrew the wheel nuts.
8. Change the wheel.
9. Screw on the wheel nuts.
10. Lower the vehicle and remove the jack.
11. Install the wheel wrench ensuring that it is located securely and tighten each bolt in a crosswise

sequence. The tightening torque is 160 Nm for 15 inches wheels and 180 Nm for 16 inches wheels.

12. Align the valve hole in the wheel cover with the tyre valve before installing.  
Install the wheel nut caps.
13. Store the replaced wheel, the vehicle tools  $\rightarrow$  160 and the adapter for the locking wheel nuts.
14. Check the tyre pressure of the installed tyre and the wheel nut torque as soon as possible.

## Jump starting

Do not start with quick charger.

A vehicle with a discharged vehicle battery can be started using jump leads and the vehicle battery of another vehicle.

### Caution

Never jump start another vehicle with an electric vehicle.

### ⚠ Warning

Be extremely careful when starting with jump leads. Any deviation from the following instructions can lead to injuries or damage caused by battery explosion or damage to the electrical systems of both vehicles.

### ⚠ Warning

Avoid contact of the battery with eyes, skin, fabrics and painted surfaces. The fluid contains sulphuric acid which can cause injuries and damage in the event of direct contact.

- Never expose the vehicle battery to naked flames or sparks.
- A discharged vehicle battery can already freeze at a temperature of 0 °C. Defrost the frozen battery before connecting jump leads.
- Wear eye protection and protective clothing when handling a battery.
- Use a booster battery with the same voltage (12 V). Its capacity (Ah) must not be much less than that of the discharged vehicle battery.
- Use jump leads with insulated terminals and a cross section of at least 16 mm<sup>2</sup> (25 mm<sup>2</sup> for diesel engines).

- Do not disconnect the discharged vehicle battery from the vehicle.
- Switch off all unnecessary electrical consumers.
- Do not lean over the vehicle battery during jump starting.
- Do not allow the terminals of one lead to touch those of the other lead.
- The vehicles must not come into contact with each other during the jump starting process.
- Apply the parking brake, transmission in neutral, automatic transmission in **P**.



Open the positive terminal protection caps of both vehicle batteries.

Lead connection order:

1. Connect the red lead to the positive terminal of the booster battery.
2. Connect the other end of the red lead to the positive terminal of the discharged battery.
3. Connect the black lead to the negative terminal of the booster battery.
4. Connect the other end of the black lead to a vehicle grounding point of your vehicle in the engine compartment.

Route the leads so that they cannot catch on rotating parts in the engine compartment.

To start the engine:

1. Start the engine of the vehicle providing the jump.
2. After five minutes, start the other engine. Start attempts should be made for no longer than 15 s at an interval of 1 min.

3. Allow both engines to idle for approx. three minutes with the leads connected.
4. Switch on electrical consumers e.g. headlights, heated rear window of the vehicle receiving the jump start.
5. Reverse above sequence exactly when removing leads.



## Towing

### Towing the vehicle



Release the cap carefully with a flat tool.

The towing eye is stored with the vehicle tools ⇨ 160.



Screw in the towing eye as far as it will go until it stops in a horizontal position.

Attach a tow bar to the towing eye.

The towing eye must only be used for towing and not for recovering the vehicle.

Switch on ignition to release steering wheel lock and to permit operation of brake lights, horn and windscreen wiper.

#### Caution

Deactivate the driver assistance systems like active emergency braking ⇨ 112, otherwise the vehicle may automatically brake during towing.

Switch the selector lever to position **N**.

Release the parking brake.

#### Caution

Never tow a vehicle equipped with All Wheel Drive (AWD) with the front or rear tyres on the road. If towing a vehicle equipped with AWD while the front or rear tyres are rolling on the road, the drive system in the vehicle could be severely damaged. When towing vehicles equipped with AWD, all four tyres must not be in contact with the road.

**Caution**

Drive slowly. Do not drive jerkily. Excessive tractive force can damage the vehicle.

When the engine is not running, considerably more force is needed to brake and steer.

To prevent the entry of exhaust gases from the towing vehicle, switch on the air recirculation and close the windows.



When towing an electric vehicle or a vehicle equipped with an automatic transmission, transport the vehicle on a platform or tow it with the front wheels lifted.

Seek the assistance of a workshop. After towing, unscrew the towing eye. Insert cap with the flange into the recess and fix cap by pushing.

**Towing another vehicle**



The fixed towing eye is located under the bumper, on the right side. Attach a tow bar to the towing eye.

The towing eye must only be used for towing and not for recovering a vehicle.

**Caution**

Drive slowly. Do not drive jerkily. Excessive tractive force can damage the vehicle.

## Appearance care

### Exterior care

#### Locks

The locks are lubricated at the factory using a high quality lock cylinder grease. Use a de-icing agent only when absolutely necessary, as this has a degreasing effect and impairs lock function. After using a de-icing agent, have the locks regreased by a workshop.

#### Washing

The paintwork of the vehicle is exposed to environmental influences. Bird droppings, dead insects, resin, pollen and the like should be cleaned off immediately, as they contain aggressive constituents which can cause paint damage.

If using a vehicle wash, comply with the vehicle wash manufacturer's instructions. The windscreen wiper and rear window wiper must be

switched off. Remove antenna and external accessories such as roof racks etc.

If washing the vehicle by hand, make sure that the insides of the wheel housings are also thoroughly rinsed out.

Clean edges and folds on opened doors and the bonnet as well as the areas they cover.

Clean bright metal mouldings with a cleaning solution approved for aluminium to avoid damages.

Caution
<p>Always use a cleaning agent with a pH value of 4 to 9.</p> <p>Do not use cleaning agents on hot surfaces.</p>

Always use a cleaning agent with a pH value of 4 to 9.

Do not use cleaning agents on hot surfaces.

Do not clean the engine compartment with a steam-jet or high-pressure jet cleaner.

Thoroughly rinse and leather-off the vehicle. Rinse leather frequently. Use separate leathers for painted and glass surfaces: remnants of wax on the windows will impair vision.

Have the door hinges of all doors greased by a workshop.

#### Exterior lights

Headlight and other light covers are made of plastic. Do not use any abrasive or caustic agents, do not use an ice scraper, and do not clean them dry.

#### Polishing and waxing

Polishing is necessary only if the paint has become dull or if solid deposits have become attached to it.

Plastic body parts must not be treated with wax or polishing agents.

#### Windows and wiper blades

Switch off wipers before handling in their areas.

Use a soft lint-free cloth or chamois leather together with window cleaner and insect remover.

When cleaning the rear window from inside, always wipe in parallel to the heating element to prevent damage.

For mechanical removal of ice, use a sharp-edged ice scraper. Press the scraper firmly against the glass so that no dirt can get under it and scratch the glass.

Clean smearing wiper blades with a soft cloth and window cleaner. Also make sure to remove any residues such as wax, insect residues and similar from the window.

Ice residues, pollution and continuous wiping on dry windows will damage or even destroy the wiper blades.

### Glass panel

Use a soft lint-free cloth or chamois leather together with window cleaner to clean the glass panel.

### Wheels and tyres

Do not use high-pressure jet cleaners.

Clean rims with a pH-neutral wheel cleaner.

Rims are painted and can be treated with the same agents as the body.

### Paintwork damage

Rectify minor paintwork damage with a touch-up pen before rust forms. Have more extensive damage or rust areas repaired by a workshop.

### Underbody

Some areas of the vehicle underbody have a PVC undercoating while other critical areas have a durable protective wax coating.

After the underbody is washed, check the underbody and have it waxed if necessary.

Bitumen / rubber materials could damage the PVC coating. Have underbody work carried out by a workshop.

Before and after winter, wash the underbody and have the protective wax coating checked.

### Liquid gas system

**⚠ Danger**

Liquid gas is heavier than air and can collect in sink points.

Take care when performing work at the underbody in a pit.

For painting work and when using a drying booth at a temperature above 60 °C, the liquid gas tank must be removed.

Do not make any modifications to the liquid gas system.

### Towing equipment

Do not clean the coupling ball bar with a steam-jet or high-pressure jet cleaner.

### Interior care

#### Interior and upholstery

Only clean the vehicle interior, including the instrument panel fascia and panelling, with a dry cloth or interior cleaner.

Clean the leather upholstery with clear water and a soft cloth. In case of heavy soiling, use leather care.

The Driver Information Centre and the displays should only be cleaned using a soft damp cloth. If necessary use a weak soap solution.

Clean fabric upholstery with a vacuum cleaner and brush. Remove stains with an upholstery cleaner.

Clothing fabrics may not be colourfast. This could cause visible discolourations, especially on light-coloured upholstery. Removable stains and discolourations should be cleaned as soon as possible.

Clean seat belts with lukewarm water or interior cleaner.

### Caution

Close Velcro fasteners as open Velcro fasteners on clothing could damage seat upholstery.

The same applies to clothing with sharp-edged objects, like zips or belts or studded jeans.

### Plastic and rubber parts

Plastic and rubber parts can be cleaned with the same cleaner as used to clean the body. Use interior cleaner if necessary. Do not use any other agent. Avoid solvents and petrol in particular. Do not use high-pressure jet cleaners.

## Service and maintenance

<b>General information</b> .....	<b>180</b>
Service information .....	180
<b>Recommended fluids, lubricants and parts</b> .....	<b>182</b>
Recommended fluids and lubricants .....	182

## General information

### Service information

In order to ensure economical and safe vehicle operation and to maintain the value of your vehicle, it is of vital importance that all maintenance work is carried out at the proper intervals as specified.

The detailed, up-to-date service schedule for your vehicle is available at the workshop.

Severe operating conditions exist if one or more of the following circumstances occur frequently: Cold starting, stop and go operation, e.g. for taxis and police vehicles, trailer operation, mountain driving, driving on poor and sandy road surfaces, increased air pollution, presence of airborne sand and high dust content, driving at high altitude and large variations of temperature.

Service display ⇨ 53.

## Service intervals

Engine	DW12	DW12 <sup>1)</sup>	Electric vehicle
Country group 1	32,000 miles / 2 years <sup>2)</sup>	12,500 miles / 1 year	12,500 miles / 1 year
Country group 2	12,500 miles / 1 year	12,500 miles / 1 year	12,500 miles / 1 year

1) Severe operating conditions

2) Unless otherwise indicated in the service display

### Country group 1:

Andorra, Austria, Belgium, Bosnia-Herzegovina, Bulgaria, Croatia, Cyprus, Czech Republic, Estonia, Denmark, Finland, France, Germany, Greece, Hungary, Iceland, Italy, Latvia, Liechtenstein, Lithuania, Luxembourg, Malta, Monaco, Netherlands, North Macedonia, Norway, Poland, Portugal, Republic of Ireland, Romania, San Marino, Slovakia, Slovenia, Spain, Sweden, Switzerland, United Kingdom.

### Country group 2:

All other countries which are not listed in country group 1.

### Confirmations

Confirmation of service is recorded in the Service and warranty booklet. The date and mileage is completed with the stamp and signature of the servicing workshop.

Make sure that the Service and warranty booklet is completed correctly as continuous proof of service is essential if any warranty or goodwill claims are to be met, and is also a benefit when selling the vehicle.

## Recommended fluids, lubricants and parts

### Recommended fluids and lubricants

Only use products that meet the recommended specifications.

#### Warning

Operating materials are hazardous and could be poisonous. Handle with care. Pay attention to information given on the containers.

### Engine oil

Engine oil is identified by its quality and its viscosity. Quality is more important than viscosity when selecting which engine oil to use. The oil quality ensures e.g. engine cleanliness, wear protection and oil aging control, whereas viscosity grade gives information on the oil's thickness over a temperature range.

The required engine oil quality for the diesel engine DW12 is B71 2312. The engine oil viscosity grade is SAE 0W-30.

For diesel engine with severe operating conditions the required engine oil quality is B71 2297 and the engine oil viscosity grade is SAE 5W-30.

### Topping up engine oil

#### Caution

In case of any spilled oil, wipe it up and dispose it properly.

Engine oils of different manufacturers and brands can be mixed as long as they comply with the required engine oil quality and viscosity.

### Additional engine oil additives

The use of additional engine oil additives could cause damage and invalidate the warranty.

### Engine oil viscosity grades

The SAE viscosity grade gives information of the thickness of the oil. The recommended viscosity grade is suitable for high ambient temperatures.

Multigrade oil is indicated by two figures, e.g. SAE 5W-30. The first figure, followed by a W, indicates the low temperature viscosity and the second figure the high temperature viscosity.

### Coolant and antifreeze

Use only antifreeze approved for the vehicle. Consult a workshop.

The system is factory filled with coolant designed for excellent corrosion protection and frost protection down to approx.  $-28^{\circ}\text{C}$ . In cold regions with very low temperatures the factory filled coolant provides frost protection down to approx.  $-37^{\circ}\text{C}$ . This concentration should be maintained all year round. The use of additional coolant additives that intend to give additional corrosion protection or seal against



minor leaks can cause function problems. Liability for consequences resulting from the use of additional coolant additives will be rejected.

### **Washer fluid**

Use only washer fluid approved for the vehicle to prevent damage of wiper blades, paintwork, plastic and rubber parts. Consult a workshop.

### **Brake fluid**

Over time, brake fluid absorbs moisture which will reduce braking effectiveness. The brake fluid should therefore be replaced at the specified interval.

Use only brake fluid approved for the vehicle. Consult a workshop.

### **AdBlue**

Only use AdBlue to reduce the nitrogen oxides in the exhaust emission ⇨ 94.

## Technical data

<b>Vehicle identification</b> .....	<b>184</b>
Vehicle identification number ..	184
Identification plate .....	185
Engine identification .....	185
<b>Vehicle data</b> .....	<b>186</b>
Vehicle dimensions .....	186
Capacities .....	186

## Vehicle identification

### Vehicle identification number



The vehicle identification number is embossed on the instrument panel, visible through the windscreen.



The vehicle identification number is also displayed behind a removable plastic cover. Unclip the cover using a flat blade screwdriver to access.

## Identification plate



The identification plate is located in the engine compartment. The layout and position differ for some export countries.

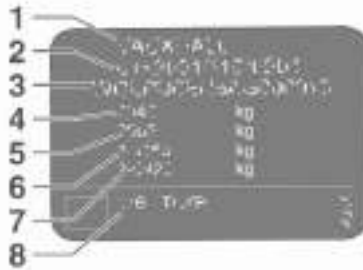

Information on identification plate:

- 1 : manufacturer
- 2 : type approval number
- 3 : vehicle identification number
- 4 : permissible gross vehicle weight rating in kg
- 5 : permissible gross train weight in kg
- 6 : maximum permissible front axle load in kg
- 7 : maximum permissible rear axle load in kg
- 8 : manufacturer address, vehicle-specific or country-specific data

The combined total of front and rear axle loads must not exceed the permissible gross vehicle weight.

Vehicle's kerb weight depends on the specification of the vehicle, e.g. optional equipment and accessories. Refer to the EEC Certificate of Conformity provided with your vehicle or other national registration documents.

The technical data is determined in accordance with European Community standards. We reserve the right to make modifications. Specifications in the vehicle documents always have priority over those given in this manual.

## Engine identification

Movano has 2.2 litre diesel engines with four cylinders with differing power and torque.

The electric motor has a power of 90 kW and a torque of 260 Nm.

For further information, refer to the EEC Certificate of Conformity provided with your vehicle or other national registration documents.

## Vehicle data

### Vehicle dimensions

Length [mm]	4963 / 5413 / 5998 / 6363
Width without exterior mirrors [mm]	2050
Width with two exterior mirrors [mm]	2508
Height [mm]	2254 / 2524 / 2764
Maximum load compartment width [mm]	1870
Load compartment width between wheel arches [mm]	1422
Wheelbase [mm]	3000 / 3450 / 3800 / 4035 / 4300
Turning circle diameter [m]	11.06 / 12.46 / 13.54 / 14.28 / 15.30

---

Other values are possible for conversions and chassis versions.

## Capacities

### Engine oil

<b>Engine</b>	<b>DW12</b>
including filter [l]	6.6
between MIN and MAX [l]	1.5

---

---

**Fuel tank**

Diesel, refilling quantity [l] 60 / 75 / 90

---

**AdBlue tank**

AdBlue, refilling quantity [l] 19

---

**High voltage battery**

Battery capacity [kWh] 37 / 70 / 75

---

## Customer information

<b>Customer information</b> .....	<b>188</b>
Declaration of conformity .....	188
REACH .....	188
Software update .....	188
Registered trademarks .....	190
<b>Vehicle data recording and privacy</b> .....	<b>190</b>
Event data recorders .....	190
Radio Frequency Identification (RFID) .....	193

## Customer information

### Declaration of conformity

#### Radio transmission systems

This vehicle has systems that transmit and / or receive radio waves subject to Directive 2014/53/EU and The Radio Equipment Regulations 2017 by the United Kingdom. The manufacturers of the systems declare conformity with

Directive 2014/53/EU and The Radio Equipment Regulations 2017. The full text of the EU declaration of conformity and information about operation frequency with maximum power for each system are available at the following internet address:  
[www.opel.com/conformity](http://www.opel.com/conformity).

Importer is Vauxhall Motors Limited, MP UK 1-101-135, Chalton House, Luton Road, Chalton, Luton, Bedfordshire, LU4 9TT, United Kingdom.

## REACH

Registration, Evaluation, Authorisation and Restriction of Chemicals (REACH) is a European Union regulation adopted to improve the protection of human health and the environment from the risks that can be posed by chemicals. Visit [www.opel.com](http://www.opel.com) for further information and for access to the Article 33 communication.

### Software update

The Infotainment system can download and install selected software updates over a wireless connection.

#### Notice

The availability of these over-the-air vehicle software updates varies by vehicle and country. Find more information on our website.

## Remote device management and remote software and firmware updates

As an integral part of the service related to the performance of subscribed connected service contracts, necessary device management and necessary software and firmware updates related to the software and firmware for the named connected service will be performed remotely, in particular by using over-the-air technology.

For this, a secure radio network connection between the vehicle and the device management server will be established when ignition is switched on and a mobile network is available. Depending on the equipment of the vehicle, connection configuration must be set to **Connected vehicle** to allow the establishment of the radio network connection.

Irrespective of a valid connected service subscription, remote product security or product safety related device management and software and firmware updates will be performed when the processing is

necessary for the compliance with a legal obligation to which the manufacturer is subject (e.g. applicable product liability law, emergency call regulation) or when the processing is necessary in order to protect the vital interests of the respective vehicle users and passengers.

The establishment of a secure radio network connection and the related remote updates are not affected by privacy settings and will be performed in principal after an initiation by the vehicle user following a respective notification.

The system is able to notify receipt of an update as soon as it is connected to an exterior Wi-Fi network or a mobile network. Large updates are downloaded only via the Wi-Fi network.

The availability of an update is notified on the Info Display at the end of a trip with an option of immediate installation or postponement of installation.

The installation time is variable and can take several minutes with a maximum of about 30 minutes. A notification will give an estimate of the duration and a description of the update.

Updates can be checked manually via the Info Display. Follow the on-screen prompts in the respective menu.

Info Display ⇨ 62.

### Notice

Steps for downloading and installing updates may vary by vehicle.

For safety reasons and because it requires sustained attention by the driver, the installation must be carried out with the ignition on without starting the engine. The installation cannot be carried out in the following cases:

- engine running
- emergency call in progress
- insufficient vehicle battery charge
- charging the vehicle's high voltage battery

### Notice

During the installation process, the vehicle may not be operational.

If the update has failed, seek the assistance of a workshop.

## Registered trademarks

### Apple Inc.

Apple CarPlay™ is a trademark of Apple Inc.

App Store® and iTunes Store® are registered trademarks of Apple Inc.

iPhone®, iPod®, iPod touch®, iPod nano®, iPad® and Siri® are registered trademarks of Apple Inc.

### Bluetooth SIG, Inc.

Bluetooth® is a registered trademark of Bluetooth SIG, Inc.

### DivX, LLC

DivX® and DivX Certified® are registered trademarks of DivX, LLC.

### Google Inc.

Android™ and Google Play™ Store are trademarks of Google Inc.

### Velcro Companies

Velcro® is a registered trademark of Velcro Companies.

### Verband der Automobilindustrie e.V.

AdBlue® is a registered trademark of the VDA.

## Vehicle data recording and privacy

### Event data recorders

Electronic control units are installed in your vehicle. Control units process data which is received by vehicle sensors, for example, or which they generate themselves or exchange amongst themselves. Some control units are necessary for the safe functioning of your vehicle, others assist you while you drive (driver assistance systems), while others provide comfort or infotainment functions.

The following contains general information about data processing in the vehicle. You will find additional information as to which specific data is uploaded, stored and passed on to third parties and for what purpose in your vehicle under the key word Data Protection closely linked to the references for the affected functional characteristics in the relevant owner's manual or in the general terms of sale. These are also available online.



## Operating data in the vehicle

Control units process data for operation of the vehicle.

This data includes, for example:

- vehicle status information (e.g. speed, movement delay, lateral acceleration, wheel rotation rate, "seat belts fastened" display)
- ambient conditions (e.g. temperature, rain sensor, distance sensor)

As a rule such data is transient and is not stored for longer than an operational cycle, and only processed on board the vehicle itself. Often control units include data storage (including the vehicle key). This is used to allow information to be documented temporarily or permanently on vehicle condition, component stress, maintenance requirements and technical events and errors.

Depending on technical equipment levels, the data stored is as follows:

- system component operating states (e.g. fill level, tyre pressure, battery status)
- faults and defects in important system components (e.g. lights, brakes)
- system reactions in special driving situations (e.g. triggering of an airbag, actuation of the stability control systems)
- information on events damaging the vehicle
- for electric vehicles the amount of charge in the high-voltage battery, estimated range

In special cases (e.g. if the vehicle has detected a malfunction), it may be necessary to save data that would otherwise just be volatile.

When you use services (e.g. repairs, maintenance), the operating data saved can be read together with the vehicle identification number and used where necessary. Staff working for the service network (e.g. garages, manufacturers) or third parties (e.g.

breakdown services) can read the data from the vehicle. The same applies to warranty work and quality assurance measures.

Data is generally read via the OBD (On-Board Diagnostics) port prescribed by law in the vehicle. The operating data read documents the technical condition of the vehicle or individual components and assists with fault diagnosis, compliance with warranty obligations and quality improvement. This data, in particular information on component stress, technical events, operator errors and other faults, is transmitted to the manufacturer where appropriate, together with the vehicle identification number. The manufacturer is also subject to product liability. The manufacturer potentially also uses operating data from vehicles for product recalls. This data can also be used to check customer warranty and guarantee claims.

Fault memories in the vehicle can be reset by a service company when carrying out servicing or repairs or at your request.

## Comfort and infotainment functions

Comfort settings and custom settings can be stored in the vehicle and changed or reset at any time.

Depending on the equipment level in question, these include

- seat and steering wheel position settings
- chassis and air conditioning settings
- custom settings such as interior lighting

You can input your own data in the infotainment functions for your vehicle as part of the selected features.

Depending on the equipment level in question, these include

- multimedia data such as music, videos or photos for playback in an integrated multimedia system
- address book data for use with an integrated hands-free system or an integrated navigation system

- input destinations
- data on the use of online services

This data for comfort and infotainment functions can be stored locally in the vehicle or be kept on a device that you have connected to the vehicle (e.g. a smartphone, USB stick or MP3 player). Data that you have input yourself can be deleted at any time.

This data can only be transmitted out of the vehicle at your request, particularly when using online services in accordance with the settings selected by you.

### Smartphone integration, e.g. Android Auto or Apple CarPlay

If your vehicle is equipped accordingly, you can connect your smartphone or another mobile device to the vehicle so that you can control it via the controls integrated in the vehicle. The smartphone image and sound can be output via the multimedia system in this case. At the same time, specific information is transmitted to your smartphone. Depending on the type of integration,

this includes data such as position data, day / night mode and other general vehicle information. For more information, please see the operating instructions for the vehicle / infotainment system.

Integration allows selected smartphone apps to be used, such as navigation or music playback. No further integration is possible between smartphone and vehicle, in particular active access to vehicle data. The nature of further data processing is determined by the provider of the app used. Whether you can define settings, and if so which ones, is dependent on the app in question and your smartphone's operating system.

## Online services

If your vehicle has a radio network connection, this allows data to be exchanged between your vehicle and other systems. The radio network connection is made possible by means of a transmitter device in your vehicle or a mobile device provided by you (e.g. a smartphone). Online functions can be used via this radio network connection. These include online services and applications / apps provided to you by the manufacturer or other providers.

## Proprietary services

In the case of the manufacturer's online services, the relevant functions are described by the manufacturer in an appropriate location (e.g. Owner's Manual, the manufacturer's website) and the associated data protection information is provided. Personal data may be used to provide online services. Data exchange for this purpose takes place via a protected connection, e.g. using the manufacturer's IT systems provided for the purpose. Collection,

processing and use of personal data for the purposes of preparation of services take place solely on the basis of legal permission, e.g. in the case of a legally prescribed emergency communication system or a contractual agreement, or by virtue of consent.

You can activate or deactivate the services and functions (which are subject to charges to some extent) and, in some cases, the vehicle's entire radio network connection. This does not include statutory functions and services such as an emergency communication system.

## Third party services

If you make use of online services from other providers (third parties), these services are subject to the liability and data protection and usage conditions of the provider in question. The manufacturer frequently has no influence over the content exchanged in this regard.

Therefore, please note the nature, scope and purpose of the collection and use of personal data within the scope of third party services provided by the service provider in question.

## Radio Frequency Identification (RFID)

RFID technology is used in some vehicles for functions such as tyre pressure monitoring and immobiliser. It is also used in connection with conveniences such as radio remote controls for door locking / unlocking and starting. RFID technology in Vauxhall vehicles does not use or record personal information or link with any other Vauxhall system containing personal information.

## Body conversions

<b>Tipper and dropside</b> .....	<b>194</b>
Loading information .....	194
Tailboard .....	195
Sideboards .....	195
Lashing eyes .....	195
Tipper operation .....	196
Safety prop .....	197
Hydraulic oil level .....	198
Ladder .....	198
Toolbox .....	198
Cleaning .....	198
Vehicle checks .....	199
Declaration of conformity .....	199

## Tipper and dropside

### Loading information

The tipper and dropside are not designed for carrying people or unsuitable / unsafe materials.

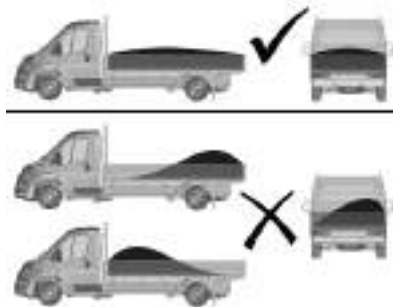

- Load the vehicle evenly, distributing the load across the body.
- Ensure the vehicle tailboard and sideboards are securely closed before loading.
- Ensure the tipper is completely lowered and fixed before loading.

- Secure any solid loads with additional lashing equipment.
- Place loads from the minimum practicable height. Do not drop loads onto the body.
- Do not overload the body.
- The rack supports a load of 300 kg.
- Ensure the load will not fall out or endanger other road users.
- Do not drive with the body tipped.
- Do not drive with the tailboard or sideboards down.
- Do not attempt to tip loads from the body when body sides or tailboard are closed.
- Do not attempt to tip loads unless the vehicle is on solid and flat ground.
- The isolation switch must be in the **OFF** position when tipping function is not in use.

## Tailboard

### Opening

Pull up the release levers to disengage the locks and lower the tailboard fully.

#### Caution

Do not operate tipping with lowered tailboard.

### Step

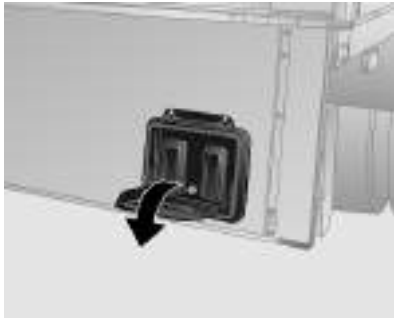

With the tailboard lowered, fold down the step. Fold up when not required.

### Closing

Raise the tailboard and push firmly into position. Push down the release levers ensuring locks engage fully.

### Swinging

The tailboard lower hooks are automatically released to allow the tailboard to swing from its upper hinges during tipping operations.

#### Warning

To prevent the tailboard becoming detached from the vehicle, ensure that the upper hinges are engaged with the release levers in the locked position.

Check that the tailboard is securely locked by the lower hooks after tipping.

### Version for rear tipper

Hook the chain to the bolt to use the tailboard in a horizontal position.

The maximum load is 150 kg.

## Sideboards

#### Warning

The sideboards are heavy. Take care when lowering the sideboards, do not allow them to drop down unassisted.

To open, pull up the release levers to disengage the locks.

The sideboards may have a horizontal position. To open fully, pull to the outside at the 45° position and lower the sideboard.

To close, raise the sideboard and push firmly into position. Push down the release levers ensuring locks engage fully.

### Lashing eyes

Secure objects with lashing straps attached to the lashing eyes.

**Caution**

The maximum force applied to the lashing eyes must not exceed 8000 N. Ensure a lashing angle of at least 30°.

Refer to the safety warning labels located on the tipper or dropside body.

**Tipper operation**

**⚠ Danger**

Don't be under a raised tipper without using the safety prop ⇨ 197.

**⚠ Warning**

Before operating the tipper, apply the parking brake and select neutral gear position.

The operator must remain at the control to ensure tipping and lowering are performed correctly.

Keep other people away when tipping function is in use. Ensure the vehicle is on solid ground and that the tipper body can be raised to the maximum height without touching overhead obstructions.

If the tipper is prolonged raised, use a support prop in the front area.

**Locking pins**

The tipper body has two different locking pins which must be always attached while operating. The locking pins are used to obtain any one of the three tipping positions.

**Caution**

The tipper must not be operated with locking pins incorrectly installed.

Pins installed diagonally opposite or in both front pivot positions will result in damage if tipping is attempted.

Insert locking pins into the pivots.

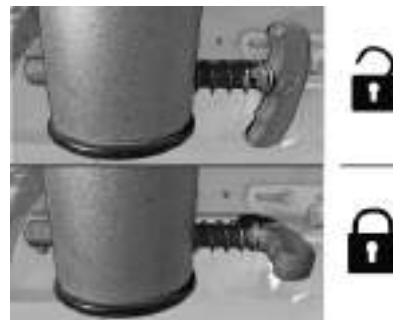

In the end stop position rotate both locking pins.

**Tipping to the side**

Insert locking pins into the front and rear pivots on the same side. Lower the sideboard fully.

**Tipping to the rear**

**⚠ Warning**

To prevent the tailboard becoming detached from the vehicle, ensure that the upper hinges are engaged

and push the release levers downwards to engage the locks fully.

Insert locking pins into the left and right rear pivots.

### Isolation switch



The system must be activated using the isolation switch located on the left-hand side of the chassis. Insert the key after removing the protective cap. When the tipper is not in use, remove the key and attach the protective cap.

### Raising and lowering the tipper

The tipper is operated using the remote control located by the front seats.

The remote control enables the user to supervise the operation of the tipper from outside the vehicle.

Press switch:

- ↑ : raise
- ↓ : lower

When the tipper is active an acoustic signal sounds.

The tipper can be stopped at any time by releasing the switch.

The tipper body will cease moving automatically when it reaches the maximum height.

Store the remote control in the holder when not in use.

### Safety prop

The safety prop is located under the tipper body and is provided only to assist in supporting the empty tipper body when tipped to the rear, for carrying out visual inspection of the vehicle components.

### Using the safety prop

1. Prepare the tipper body for tipping to the rear.
2. Raise the tipper fully.
3. Raise the safety prop to align with support on the tipper.
4. Lower the tipper body until the safety prop is in contact with the tipper.

### Stowing the safety prop:

1. Raise the tipper body sufficiently to release the safety prop from its support.
2. Lower the safety prop into the stowed position.
3. Lower the tipper body.

## Hydraulic oil level

### Caution

Before any inspection work can be carried out the safety prop must be in position.

With the tipper fully raised, the hydraulic oil level must be between the **MIN** and **MAX** marks.

### Caution

Only use products that have been tested and approved. Damage resulting from the use of nonapproved materials will not be covered by the warranty.

The use of additives could cause damage and invalidate the warranty.

Check the hydraulic oil level after long driving on bumpy or steep roads.

Have the cause of the loss of hydraulic oil remedied by a workshop.

Use only hydraulic oil type ISO H46 or equivalent.

## Ladder

To lower the ladder, push down latch to release and pull the ladder out.

### ⚠ Warning

The ladder must be stowed securely before driving.

## Toolbox



Unlock using the key provided and turn latches to open.

Close the door and turn both latches, then lock with the key.

### Caution

Ensure the toolbox door is properly secure before setting off.

Permissible load per shelf of the toolbox in front of the tipper is 35 kg.

Permissible load of the plastic toolbox under the tipper is 25 kg.

Permissible load of the stainless steel toolbox under the tipper is 7 kg.

## Cleaning

Clean the tipper or dropside immediately after transporting corrosive products.

Dirt or mud which remains dry on the body may become abrasive and can damage paint, seals, locks and hinges.

Clean the following parts if they become contaminated with dirt:

- Sideboard and tailboard locking latches and hinges.
- Tipper body pivot pins and locating holes.



**Caution**

Do not spray high-pressure water directly at the hydraulic seals, pump, reservoir, hydraulic ram ball joints, or guide clamps.

After cleaning, check, and if necessary lubricate the components listed in the vehicle checks.

**⚠ Warning**

Do not venture under the tipper body when raised.

**Vehicle checks**

Check regularly the following items:

- Visually check the subframe mountings, the safety cables and the hydraulic system. If any of the components appear loose, defective or leaking, seek the assistance of a workshop to rectify the cause of the fault.

- The tipper has an operating angle of 45° - 50°. If this limit is exceeded, seek the assistance of a workshop to rectify the cause of the fault.
- Do not operate the tipper if the acoustic signal doesn't sound. Seek the assistance of a workshop.
- Lubricate every month the tipper body pivots and hinges with high-pressure grease.
- Check every month the hydraulic oil level in the reservoir.

**Declaration of conformity**

All devices are compliant with directive 2004/108/CE or UN regulation R10.

# Index

## A

Accessories and vehicle modifications .....	140
Active emergency braking....	60, 112
AdBlue.....	58, 94
Adjustable air vents .....	83
Airbag and belt tensioners .....	55
Airbag deactivation .....	30
Airbag label.....	26
Airbag system .....	26
Air conditioning regular operation	85
Air conditioning system .....	76
Air intake .....	85
Air suspension.....	57, 92
Air vents.....	83
Antilock brake system .....	100
Antilock brake system (ABS) .....	56
Anti-theft alarm system .....	12
Anti-theft locking system .....	12
Appearance care.....	177
Armrest .....	22
Ashtrays .....	50
Automatic crash notification.....	66
Automatic light control .....	68
Automatic locking .....	9
Autostop.....	89
Auxiliary heater.....	80

## B

Battery.....	148
Battery discharge protection .....	74
BlueInjection.....	94
Bonnet .....	145
Brake assist .....	101
Brake fluid .....	148, 182
Brake pad wear.....	56
Brakes .....	100, 148
Brake system .....	56
Breakdown.....	175
Bulb replacement .....	151

## C

Capacities .....	186
Cargo management system .....	40
Catalytic converter .....	94
Central locking system .....	7
Centre console lighting .....	74
Centre console storage .....	39
Centre high-mounted brake light	158
Changing tyre and wheel size ...	164
Charging.....	129
Charging cable.....	127
Charging status.....	132
Charging system .....	55
Charging types.....	126
Child locks .....	9
Child restraint installation locations .....	34

Child restraints.....	31
Child restraint systems .....	31
Cigarette lighter .....	50
Cleaning.....	198
Climate control systems.....	75
Clock .....	49
Control indicators.....	54
Control of the vehicle .....	86
Controls.....	47
Convex shape .....	14
Coolant and antifreeze.....	182
Cruise control .....	60, 106
Cupholders .....	37
Curtain airbag system .....	30

**D**

Danger, Warnings and Cautions ...	3
Daytime running lights .....	70
Declaration of conformity....	188, 199
DEF.....	94
Descent control system.....	57, 104
Diesel exhaust fluid.....	94
Diesel fuel system bleeding .....	151
Diesel particle filter.....	58
Door open .....	60
Doors.....	9
Drain fuel filter .....	59
Driver assistance systems.....	106
Driver Information Centre.....	61

Driving characteristics and towing tips .....	136
Driving hints.....	86
Dynamic stability control.....	102

**E**

Electric adjustment .....	14
Electrical accessories.....	49
Electrical system.....	159
Electric drive unit.....	98
Electric power consumption.....	125
Electric range.....	125
Electric Vehicles	
Heating and ventilation.....	80
Electronic climate control system	78
Electronic Stability Control and Traction Control system....	57, 102
Emergency call.....	66
End-of-life vehicle recovery .....	144
Engine coolant .....	147
Engine coolant temperature .....	57
Engine coolant temperature gauge .....	53
Engine exhaust .....	93
Engine identification.....	185
Engine oil .....	146, 182
Engine oil pressure .....	58
Event data recorders.....	190
Exhaust filter.....	93
Exit lighting .....	74

Exterior care .....	177
Exterior lighting.....	67, 158
Exterior mirrors.....	14

**F**

First aid kit .....	40
Fixed air vents .....	84
Fixed speed limiter.....	109
Folding mirrors .....	15
Folding tray .....	41
Forward collision alert.....	114
Front airbag system .....	29
Front fog lights .....	60, 71, 154
Front seats.....	19
Front storage.....	37
Front turn lights .....	155
Fuel for diesel engines .....	133
Fuel gauge .....	52
Fuel system cut-off.....	133
Fuses .....	159

**G**

Gauges.....	54
Gear shifting.....	57
General information.....	125, 136
Glovebox .....	36
Glovebox cooler .....	84
Ground clearance.....	92

**H**

Halogen headlights .....	151
Hand brake.....	101
Hazard warning flashers .....	70
Headlight flash .....	69
Headlight levelling system.....	59
Headlight range adjustment .....	70
Headlights.....	67
Headlights when driving abroad ..	70
Head restraints .....	18
Heated mirrors .....	15
Heated rear window .....	17
Heating .....	23
Heating and ventilation system ...	75
Heating electric vehicles.....	80
High beam .....	59, 68
High beam assist.....	59, 68
High voltage battery.....	144, 150
High voltage battery gauge.....	52
Hill start assist.....	57, 101
Horn .....	47
Hydraulic oil level.....	198

**I**

Identification plate .....	185
Ignition switch positions .....	87
Immobiliser .....	13, 59
Indicators.....	54
Info Display.....	62

**Instrument panel illumination**

control .....	73
Instrument panel overview .....	45
Interior care .....	178
Interior lighting.....	73
Interior lights .....	73
Interior mirrors.....	16
Introduction .....	2
Isolation switch.....	196

**J**

Jump starting .....	173
---------------------	-----

**K**

Keys .....	4
Keys, locks.....	4

**L**

Ladder.....	198
Lane change alert.....	117
Lane departure warning.....	57, 124
Lashing eyes .....	40, 195
Light switch .....	67
Load compartment .....	40
Load compartment grille.....	40
Load compartment lighting.....	73
Load inertia control.....	102
Loading information .....	42, 194
Low beam.....	59
Low fuel .....	59

**M**

Malfunction indicator light .....	56
Manual anti-dazzle .....	16
Manual transmission .....	99
Mirrors.....	14
Misted light covers .....	72

**N**

New vehicle running-in .....	87
Number plate light .....	159

**O**

Object detection systems.....	116
Odometer .....	51
Oil, engine.....	182
Oil pressure.....	58
Outside temperature .....	48
Overcab storage .....	39
Overhead console .....	37

**P**

Parking .....	91
Parking assist .....	116
Parking brake.....	56, 101
Parking heater.....	81
Parking lights .....	72
Particulate filter.....	93
Performing work .....	144
Power outlets .....	49
Power steering.....	57
Power windows .....	17

Preheating .....	58
Puncture.....	168

## R

Radio Frequency Identification (RFID).....	193
Radio remote control .....	5
Rain sensor.....	48
REACH.....	188
Rear cross traffic alert.....	121
Rear doors .....	10
Rear fog light .....	60, 72, 156
Rear step.....	10
Rear view camera .....	120
Rear view mirror display.....	61
Recommended fluids and lubricants .....	182
Refuelling .....	134
Regenerative braking.....	102
Registered trademarks.....	190
Reversing lights .....	72
Ride control systems.....	102
Roof bars.....	42
Roof load.....	42
Roof rack .....	42

## S

Safety prop.....	197
Seat adjustment .....	20
Seat belt reminder .....	55
Seat belts .....	23

Seat heating.....	23
Seat position .....	19
Selective catalytic reduction.....	94
Service .....	85
Service display .....	53, 56
Service information .....	180
Service interval.....	180
Service vehicle soon .....	56
Side airbag system .....	29
Side blind spot alert.....	117, 121
Sideboards.....	195
Sidelights.....	67
Side marker lights.....	157, 158
Side step.....	9
Side turn lights .....	157
Sliding door .....	9
Software update.....	188
SOS.....	66
Spare wheel .....	168
Speed limiter.....	60, 109
Speed limit recognition.....	106
Speedometer .....	51
Starting and operating.....	87
Starting the engine .....	88
Steering.....	87
Steering wheel adjustment .....	47
Steering wheel controls .....	47
Stop-start system.....	59, 89
Storage.....	36
Storage compartments.....	36

Sun visors .....	17
Suspension seat.....	20
Symbols .....	3

## T

Tachograph.....	65
Tachometer .....	52
Tailboard.....	195
Tail lights .....	156
Three-point seat belt .....	24
Tipper operation.....	196
Toolbox.....	198
Tools .....	160
Tow bar.....	136
Towing.....	136, 175
Towing another vehicle .....	176
Towing equipment .....	137
Towing the vehicle .....	175
Traffic sign assistant.....	123
Trailer coupling.....	136
Trailer towing .....	136
Tread depth .....	163
Trip computer .....	64
Turn lights .....	55, 71
Tyre chains .....	165
Tyre designations .....	161
Tyre pressure .....	161
Tyre pressure monitoring system.....	58, 162
Tyre repair kit .....	165

**U**

Ultrasonic parking assist.....	116
Underseat storage .....	38
Upholstery.....	178
USB socket.....	49
Using this manual .....	2

**V**

Vehicle battery .....	148
Vehicle checks.....	144, 199
Vehicle data recording and privacy.....	190
Vehicle detected ahead.....	60
Vehicle dimensions .....	186
Vehicle identification number ....	184
Vehicle jack.....	160
Vehicle messages .....	63
Vehicle personalisation .....	65
Vehicle security.....	12
Vehicle storage.....	142
Vehicle tools.....	160
Ventilation.....	81

**W**

Warning chimes .....	63
Warning lights.....	54
Warning triangle .....	40
Washer fluid .....	148
Wheel changing .....	168
Wheel covers .....	164
Wheels and tyres .....	161
Windows.....	16
Windscreen.....	16
Windscreen wiper and washer ....	48
Winter tyres .....	161
Wiper blade replacement .....	151

Copyright by Vauxhall Motors Ltd.

The information contained in this publication is effective as of the date indicated below. Vauxhall Motors Ltd. reserves the right to make changes to the technical specifications, features and design of the vehicles relative to the information contained in this publication, as well as changes to the publication itself.

Edition: July 2022, Vauxhall Motors Ltd.

Printed on chlorine-free bleached paper.

**ID-VMVCORIE2207-en**

