

## Side view

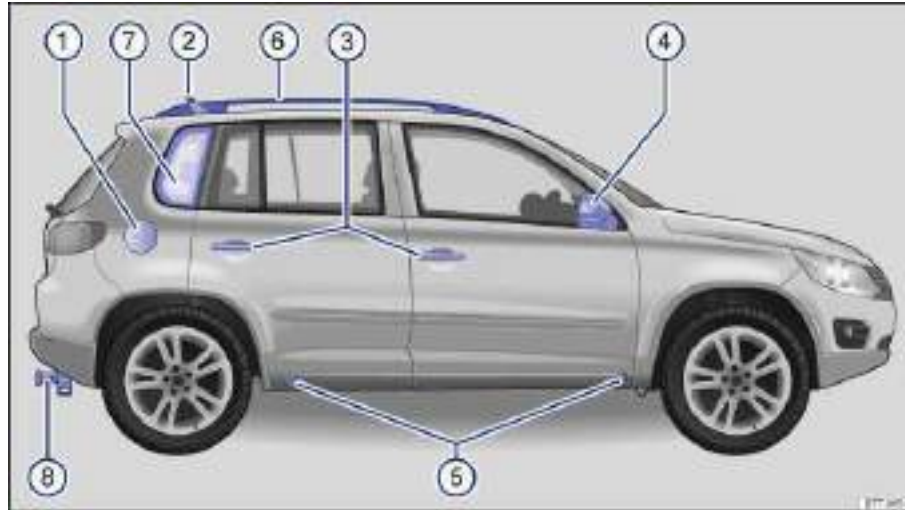

**Fig. 1** Vehicle side overview.

Key to **fig. 1**:

- (1) Fuel filler flap
- (2) Roof antenna for:
  - Mobile phone
  - Navigation
- (3) Outside door handles
- (4) Outside mirror
  - Additional turn signal light
- (5) Lift points for the jack
- (6) Roof rack
- (7) Side window with integrated antenna
- (8) Trailer hitch/ball mount receiver

## Front view

---

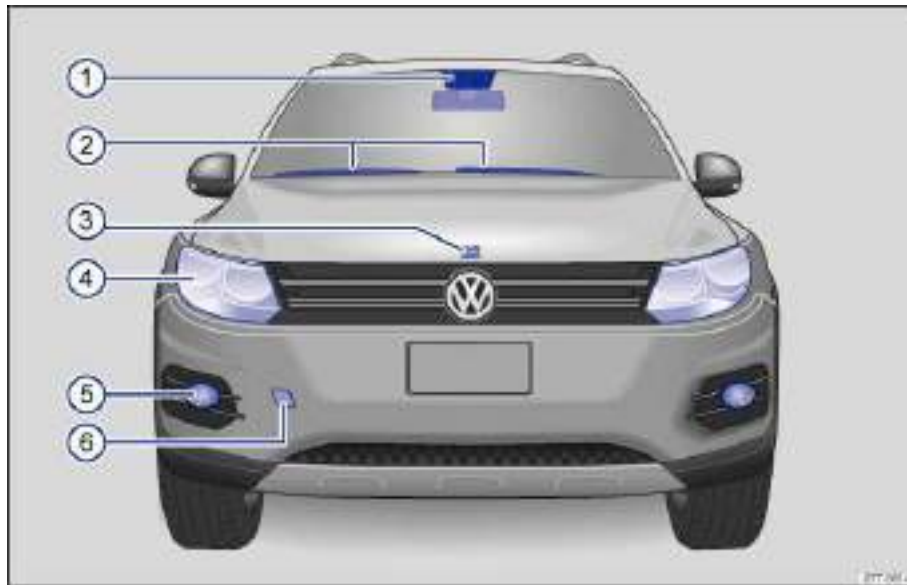

**Fig. 2** Vehicle front overview.

Key to **fig. 2**:

- (1) Sensor on mirror base for:
  - Low-light sensor
  - Rain sensor
- (2) Windshield wipers
- (3) Engine hood release
- (4) Headlights (on both left and right) ,
- (5) Fog lights/static cornering lights (on both left and right) ,
- (6) Threaded hole for the front towing eye (behind cover)

## Rear view



**Fig. 3** Vehicle rear overview.

Key to **fig. 3**:

- (1) Rear window:
  - Rear window defroster
  - Rear window wiper
- (2) High-mounted brake light
- (3) Taillights (on both left and right)
- (4) Area of:
  - Rear hatch release
  - Rear Assist camera
- (5) License plate lighting
- (6) Threaded hole for the rear towing eye (behind cover)
- (7) Roof antenna:
  - Mobile phone
  - Navigation
- (8) Trailer hitch/ball mount receiver
- (9) Backup lights and rear reflectors (on both left and right)

## Driver door overview

---

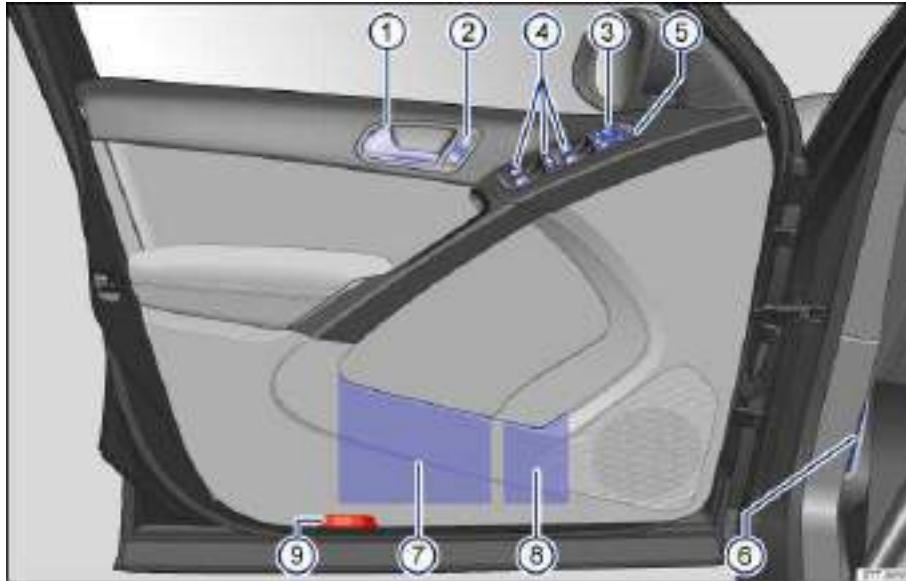





Fig. 4 Overview of controls in the driver door.

Key to fig. 4:

- (1) Door handle
- (2) Power locking button for locking and unlocking the vehicle 
- (3) Switch for adjusting the outside mirror:
  - Adjusting outside mirrors L – 0 – R
  - Outside mirror heating 
- (4) Buttons for operating the power windows:
  - Power windows 
  - Safety switch for rear power windows 
- (5) Indicator light for power locking system
- (6) Lever for releasing the engine hood
- (7) Storage compartment
- (8) Bottle holder
- (9) Reflector

## Driver side overview

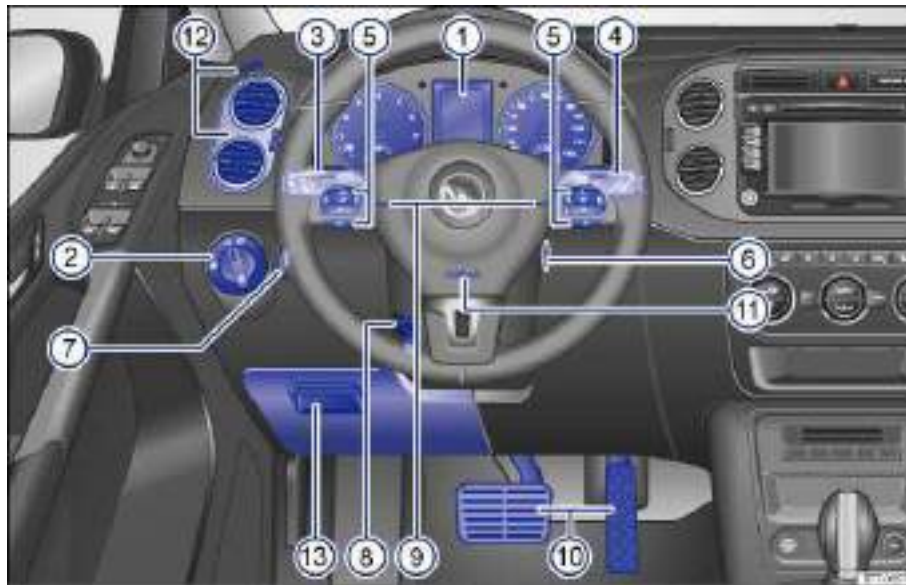









Fig. 5 Driver side overview.

Key to fig. 5:

- (1) Instrument cluster:
  - Instruments
  - Display
  - Warning and indicator lights
- (2) Headlight switch ☼:
  - Off position -0-
  - Low beams ☼
  - Fog lights ☼
- (3) Lever for:
  - High beams ☼
  - Headlight flasher ☼ 1x
  - Turn signal ☼
  - Cruise Control System (CCS) ON – CANCEL – OFF – RES/+ – SET/-
- (4) Windshield wiper and washer lever:
  - Windshield wiper **HIGH – LOW**
  - Intermittent operation for windshield wipers ...■
  - "One-tap wiping" 1x
  - Windshield wiper ☼
  - Automatic wipe/wash for windshield ☼
  - Rear window wiper ☼
  - Automatic wipe/wash for rear window ☼
  - Lever with buttons for the Volkswagen Information System (Basic version) **TRIP**, **OK/RESET**
- (5) Multi-function steering wheel controls
  - Volume setting for radio programs, navigation system notifications, or telephone calls ☼

- Mute switching for radio or activation of voice control 
  - Display Phone main menu or accept telephone calls 
  - Audio, Navigation <->
  - Control switches for the Volkswagen Information System (Premium version)   -  
 - 
- (6) Ignition switch (vehicles without Keyless Access)
  - (7) Dimmer control for the instrument and switch illumination 
  - (8) Lever for adjustable steering wheel
  - (9) Horn (only works when the ignition is switched on)
  - (10) Pedals
  - (11) Driver front airbag
  - (12) Air vents
  - (13) Storage compartment

## Center console overview



### Upper center console

---



Fig. 6 Overview of upper center console.

Key to fig. 6:

- (1) Switch for emergency flashers 
- (2) PASSENGER AIR BAG OFF , light (front airbag for front seat passenger)
- (3) Radio or Radio & Navigation system (factory-installed) ⇒ Booklet *Radio* or ⇒ Booklet *Navigation system*
- (4) Controls for:
  - Manual A/C
  - Climatronic
- (5) Air vent for indirect ventilation
- (6) Seat heating buttons 
- (7) Storage compartment
- (8) Card holder

## Lower center console

---

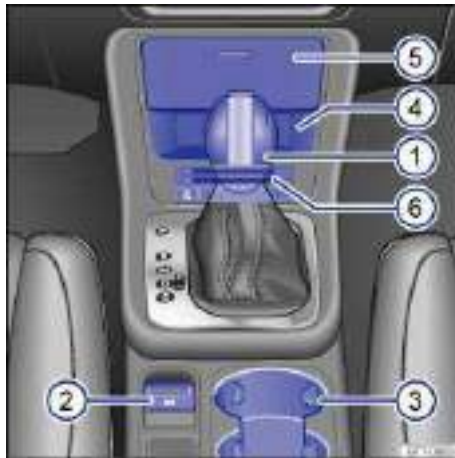

Fig. 8 Vehicles without Keyless Access: Overview of center console lower section.

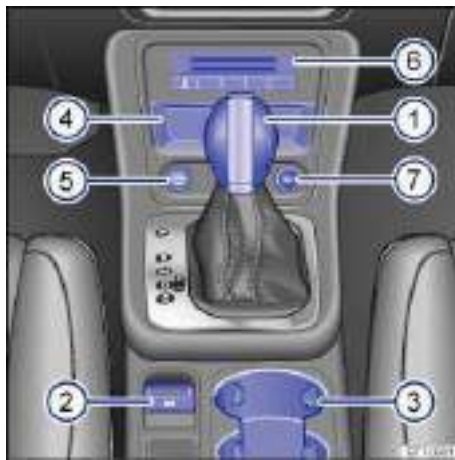



Fig. 9 Vehicles with Keyless Access: Overview of center console lower section.

Key to fig. 8 :

- (1) Levers for:
  - Manual transmission
  - Automatic transmission
- (2) Button for:
  - Electronic parking brake 
- (3) Cup holders
- (4) Storage compartment in the center console
- (5) Storage compartment with 12 Volt socket
- (6) Card holder



Key to [fig. 9](#):

- (1) Levers for:
  - Manual transmission
  - Automatic transmission
- (2) Button for:
  - Electronic parking brake 
- (3) Cup holders
- (4) Storage compartment in the center console
- (5) Starter button for Keyless Access locking and starting system **START – STOP**
- (6) Card holder
- (7) 12 Volt socket

## Front passenger side overview

---

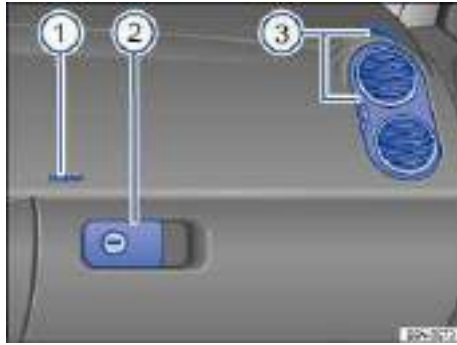

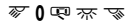

**Fig. 10** Overview of the front passenger side.

Key to fig. 10:

- (1) Passenger front airbag location in the instrument panel (approximate)
- (2) Opening handle for the lockable glove compartment
- (3) Air vents

## Symbols on the roof console

---

Symbol	Meaning
	Interior and reading lights
	Power sunroof
	Three-button module => booklet <i>Mobile phone package</i>

## Instrument cluster

### Introduction

---

In this section you'll find information about:

Instrument overview  
Instrument overview  
Displays  
Displays  
Compass  
Service reminder display

#### More information:

- Warning and indicator lights
- Volkswagen Information System
- Shifting
- Service reminder information ⇒ booklet *Warranty and Maintenance*

### WARNING

Driving on today's roads demands the full attention of the driver at all times. Driver distraction causes accidents, collisions and serious personal injury!

- Never use the buttons in the instrument cluster while driving.

### Instrument overview







---



Fig. 11 Instrument cluster in the instrument panel.

 Please first read and note the introductory information and heed the WARNINGS 

Instrument explanations ⇒ [fig. 11](#):

- (1) **Speedometer.**
- (2) **Tachometer** (shows engine revolutions per minute in thousands). The red zone at the end of the scale indicates maximum permissible engine rpm (revolutions per minute) for all gears after the break-in period. Before reaching the red zone, select the next higher gear or selector level position Drive (**D**), or ease your foot off the accelerator ⇒ .
- (3) **Displays** 13.
- (4) **Reset button** for the trip odometer display **trip**.
  - Push and hold the  button about one second in order to reset to zero.
  - Push and hold the  button for more than 10 seconds to display the vehicle's engine code. You must do this when the ignition is on, but the engine is not running.
- (5) **Fuel gauge** 272.
- (6) **Button for setting the instrument cluster clock, the Radio or Radio & Navigation system clock<sup>1</sup>.**
  - With the ignition on, push the  button to highlight the hour or the minutes in the clock display.
  - To advance the clock, push the  button (7). Press and hold the button to fast forward.
  - Push the  button again to finish setting the clock.
- (7) **Engine coolant temperature display** 



## NOTICE

- To help prevent engine damage, always avoid high engine speeds, full throttle acceleration and heavy engine loads when the engine is cold.
- To help prevent engine damage, the tachometer needle should only enter the red zone (warning zone) briefly.



Upshifting early into the next higher gear saves fuel and reduces engine noise.

---

<sup>1</sup> On appropriately equipped vehicles, the clocks can also be set via the **Settings** menu in the instrument cluster display ⇒ *Settings menu*.

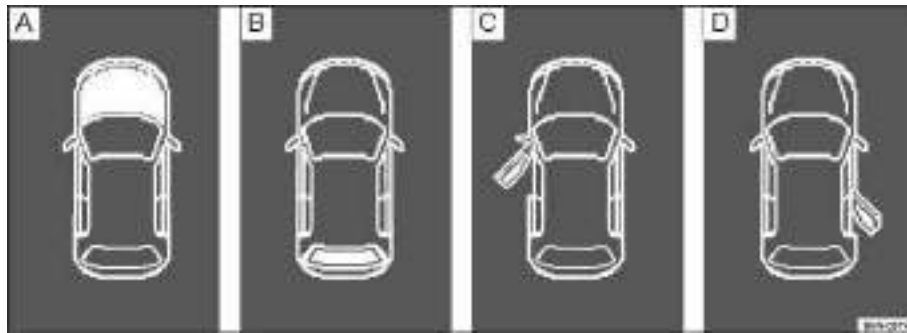

**Fig. 13** In the instrument cluster display: A: Open engine hood, B: Open rear hatch, C: Open front driver side door, D: Open rear passenger side door.

**ⓘ Please first read and note the introductory information and heed the WARNINGS ⚠**

Depending on the vehicle model, different information may be shown in the instrument cluster display  
 ⇒ [fig. 11 \(4\)](#) ⇒ [fig. 12 \(4\)](#).

- Warning and information texts
- Odometer displays
- Time
- Outside temperature
- Compass display
- Selector lever position
- Gear recommendation (manual transmission)
- Multi-Function Indicator (MFI) and menus for different settings
- Service reminder display

### Warning and information texts

The status of various vehicle functions and components is monitored when the ignition is switched on and while driving. Malfunctions are indicated by red and yellow warning symbols with text messages in the instrument cluster display (⇒ *Warning and indicator lights*). In some cases, they may also be signaled acoustically. The display can vary depending on the instrument cluster model.

Type of notification	Symbol color	Explanation
Priority 1 warning message	Red	Symbol flashing or lit – sometimes with acoustic warnings. 🛑 <b>Stop!</b> Check malfunction and take corrective action. Contact an authorized Volkswagen dealer or an authorized Volkswagen Service Facility for assistance if necessary. Menus cannot be accessed when a priority 1 warning message is displayed. The warning message will turn off automatically after a few seconds. You can confirm and turn off some warning messages using the <b>OK</b> button.

Type of notification	Symbol color	Explanation
Priority 2 warning message	Yellow	Symbol flashing or continuously lit – sometimes with acoustic warnings. Malfunctions or low operating fluid levels may cause vehicle damage and vehicle breakdown ⇒  . Check malfunction as soon as possible. Contact an authorized Volkswagen dealer or an authorized Volkswagen Service Facility for assistance if necessary.
Information text	–	Information about various vehicle situations.

### Odometer displays

The *odometer* indicates the distance driven by the vehicle.

The *trip odometer (Trip)* shows the distance driven since the last time the trip odometer was reset. The last digit indicates 1/10 mile (100 meters).

### Outside temperature display

At outside temperatures below about +39 °F (+4 °C), a “snowflake symbol” (icy road warning) appears in the display. The symbol flashes at first, then stays on until the outside temperature rises above +43 °F (+6 °C) ⇒ .

When the vehicle is not moving, is operating, or when you are driving at very low speeds, the temperature displayed may be slightly higher than the actual outside temperature.

The measurement range is from -40 °F (-40 °C) to +122 °F (+50 °C).

### Compass display

On vehicles equipped with compass display, the current compass direction is indicated in the instrument cluster display when the ignition and navigation system are switched on ⇒ *Compass*.

### Selector lever positions

The selector lever position is shown both on the side of the selector lever and in the instrument cluster display. The respective gear may also be shown in the instrument cluster display in Drive (**D**) and Sport Drive (**S**), as well as in Tiptronic® mode.

### Gear recommendation (manual transmission)

While the vehicle is moving, a fuel economy gear recommendation is indicated in the instrument cluster display ⇒ *Shifting*.

 <b>WARNING</b>
<p><b>Failure to heed warning lights and instrument cluster text messages can cause the vehicle to break down in traffic and result in a collision and serious personal injury.</b></p> <ul style="list-style-type: none"> <li>• <b>Never ignore warning lights or text WARNINGS.</b></li> <li>• <b>Always stop the vehicle as soon as it is safe to do so.</b></li> <li>• <b>Park the vehicle at a safe distance from moving traffic and where no part of the hot catalytic converter and exhaust system can come into contact with flammable materials under the vehicle, such as dry grass, brush, spilled fuel, etc.</b></li> <li>• <b>A broken down vehicle presents a high accident risk for itself and others. Switch on emergency flashers and set up a warning triangle to warn oncoming traffic.</b></li> </ul>

## WARNING

Roads and bridges may be dangerously icy even if the outside air temperature is above freezing.

- If you use the outside temperature display to tell you about frost conditions, remember that roads can even ice over at temperatures above +39 °F (+4 °C). Always remember: even if the “snowflake symbol” (ice warning) is not displayed, there could still be black ice on the road.
- Never rely exclusively on the outside temperature display.

## NOTICE

Failure to heed warning lights or text WARNINGS can result in vehicle damage.

 The instrument cluster displays and their arrangement may vary depending on the vehicle model and engine. For displays without warning and information messages, malfunctions are only signaled with indicator lights.

 If there are multiple warning messages, the symbols are displayed for several seconds in order of importance. The symbols are displayed until the cause has been corrected.

## Compass

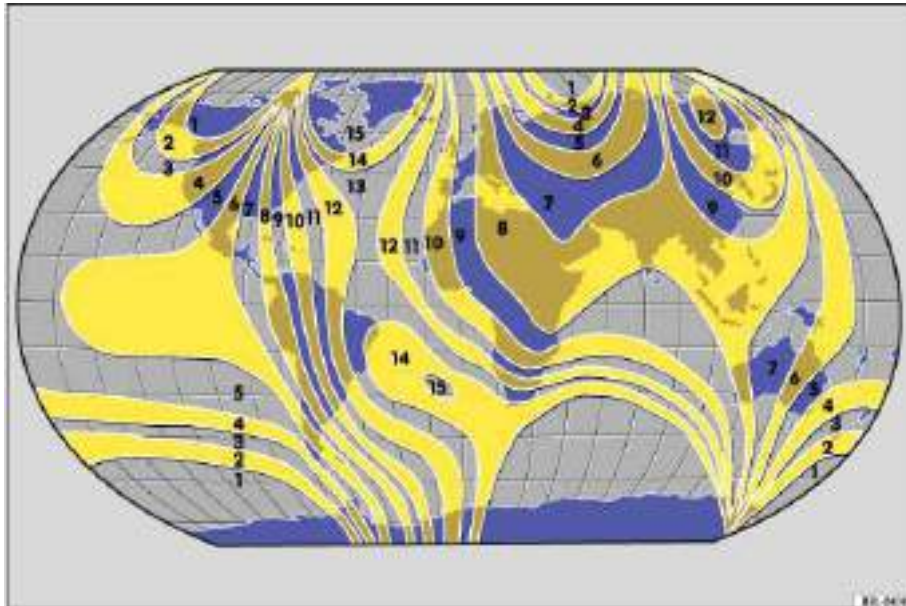

Fig. 15 Compass zones.



**ⓘ Please first read and note the introductory information and heed the WARNINGS ⚠**

The compass does not need to be calibrated in vehicles with a factory-installed navigation system. There is no **Compass** menu item in this case.

On vehicles without a factory-installed navigation system that have the Premium instrument cluster, the compass is calibrated automatically. If electrical or metallic accessories are added to the vehicle, the compass must be manually recalibrated.

#### **Adjusting the compass zone**

- Switch on the ignition.
- Select the **Settings** menu followed by the **Compass** and **Zone** menu items.
- Select the compass zone according to the current location ⇒ [fig. 15](#).
- Adjust and confirm compass zone (1–15).

#### **Calibrating the compass**

In order to calibrate the compass, you need a valid compass zone for the location and enough room to drive in a circle.

- Switch on the ignition.
- Select the **Settings** menu followed by the **Compass** and **Calibration** menu items.
- Confirm the **Please drive a full circle to calibrate** message by pressing the **OK** button on the multi-function steering wheel, and then drive in a complete circle at about 6 mph (10 km/h).

During calibration, **CAL** is shown in the instrument cluster display. The calibration is complete when the compass direction is displayed.

## **Service reminder display**

---

**ⓘ Please first read and note the introductory information and heed the WARNINGS ⚠**

The service appointment reminder is shown in the instrument cluster display ⇒ [fig. 11 \(4\)](#) ⇒ [fig. 12 \(4\)](#).

For information on maintenance intervals please see the ⇒ booklet *Warranty and Maintenance booklet*.

For vehicles with **time- or distance driven-dependent service**, only fixed service intervals are displayed.

#### **Service reminder**

If service is due in the near future, a **service reminder** is displayed when the ignition is switched on.

For *vehicles without text messages* (Basic instrument cluster), a wrench symbol  and a **miles (kilometers)** indicator are shown in the instrument cluster display. The distance shown in miles (kilometers) is the maximum distance the vehicle can be driven without having a service completed. A clock symbol is displayed and the number of days until the required service is shown.

For *vehicles with text messages* (Premium instrument cluster), **Oil change** and **Inspection** are shown in the instrument cluster display with the number of miles (kilometers) and days remaining until service is due.



#### **Service event**

For *vehicles without text messages*, a warning chime sounds when the ignition is switched on, and a flashing wrench symbol  is displayed for several seconds when **service is due**.

For *vehicles with text messages*, **Oil change now!** or **Inspection now!** is indicated in the instrument cluster display.

### Viewing service message

The current **service message** can be accessed when the ignition is switched on, the engine is switched off, and the vehicle is stopped:

- For *vehicles without text messages*: Push the  button in the instrument cluster several times until the wrench symbol  appears.
- For *vehicles with text messages*: Select the **Settings** menu.
- In the **Service** sub-menu, select the **Info** menu item.
- **OR:** If the **Vehicle status** main menu is active, use the arrow buttons to navigate to the service reminder display.

A **minus sign** in front of the number of miles (kilometers) or days means that **service is overdue**.

### Resetting the oil change service reminder

If the service was not performed by an authorized Volkswagen dealer or an authorized Volkswagen Service Facility, the oil change service reminder can be reset as follows:

---

#### Vehicles with Premium display:

---

---

Switch off the ignition.

Press and hold the  button in the instrument cluster.

Switch on the ignition.

Release the  button.

A confirmation message appears in the display. Confirm request with the  button on the multi-function steering wheel.

---

---

#### Vehicles with Basic display:



---

---

Switch off the ignition.

Press and hold the  button in the instrument cluster.

Switch on the ignition.

Release the  button and push the  button in the instrument cluster within about 20 seconds.

---

### Resetting the inspection service reminder

If the service was not performed by an authorized Volkswagen dealer or an authorized Volkswagen Service Facility, the inspection service reminder can be reset as follows:

---

**Vehicles with Premium display:**

---

Switch off the ignition.

Switch on the emergency flashers.

Press and hold the  button in the instrument cluster.

Switch on the ignition.

Release the  button.

A confirmation message appears in the display. Confirm request with the  button on the multi-function steering wheel.

Switch off the emergency flashers.

---

---

**Vehicles with Basic display:**

---



Switch off the ignition.

Switch on the emergency flashers.

Press and hold the  button in the instrument cluster.



Switch on the ignition.

Release the  button.

Release the  button and push the  button in the instrument cluster within about 20 seconds.

Switch off the emergency flashers.

---

 The service reminder disappears after a few seconds when the engine is running or the  button on the multi-function steering wheel has been pushed.

# Volkswagen Information System

## Introduction

---

In this section you'll find information about:

Menu structure – overview: Basic version

Menu structure – overview: Basic version

Menu structure – overview: Premium version

Menu structure – overview: Premium version

Using the instrument cluster menus: Basic version

Using the instrument cluster menus: Premium version

Main menus: Premium version

MFI menu (Multi-Function Indicator): Premium version

Settings menu

Convenience sub-menu

Lights and Vision sub-menu

When the ignition is switched on, you can display different types of information in the instrument cluster. The menu options vary depending on whether you have a Basic or Premium version of the Volkswagen Information System. With the Premium instrument cluster display, you can also control certain vehicle features.

Buttons on the windshield wiper lever operate the menus for Basic instrument cluster. The Premium version has control buttons on the right side of the multi-function steering wheel.

The number of menus in the instrument cluster display depends on the electronics and equipment on the vehicle.

An authorized Volkswagen dealer or an authorized Volkswagen Service Facility may be able to add or modify functions depending on your vehicle's equipment.

Some menu items can only be accessed when the vehicle is not moving.

As long as a priority 1 warning message is displayed, no menus can be accessed on vehicles with the Premium instrument cluster. In order to display menus, acknowledge the warning by pressing the  button on the multi-function steering wheel.

### More information:

- Outside mirrors
- Driver assistance systems
- Radio or navigation system ⇒ booklet *Radio* or ⇒ Chapter *Navigation System*
- Mobile phone package ⇒ booklet *Mobile phone package*

### WARNING

**Driving on today's roads demands the full attention of the driver at all times. Driver distraction causes accidents, collisions and serious personal injury!**

- **Never access menus when the vehicle is moving.**

 Emergency starting and starting the engine with a very weak vehicle battery or after the vehicle battery has been replaced may change or delete system settings (including time, date, personal convenience settings and programming). Check the settings and correct as necessary once the vehicle battery has built up a sufficient charge.

## Menu structure – overview: Basic version

---

 Please first read and note the introductory information and heed the WARNINGS

The instrument cluster display is divided into 3 parts. The time (digital clock) is displayed in the top part. The bottom part contains the odometer and the trip odometer “trip”. You can select the following displays for the middle part:

 and fuel range estimate

xx miles (trip memory 1 and 2)

0 --- mph (average speed)

 (speed warning)

--° F (outside temperature)

Travel time

--- mpg (current fuel consumption)

0 --- mpg (average fuel consumption)

## Menu structure – overview: Premium version

---

 Please first read and note the introductory information and heed the WARNINGS

The instrument cluster display is divided into 3 parts. The time (digital clock) is displayed in the top part. The bottom part contains the odometer and the trip odometer “trip”. You can select the following displays for the middle part:

**Multi-Function Indicator (MFI) ⇒ MFI menu (Multi-Function Indicator): Premium version**

- Travel time
- Consumption --.- mpg (current fuel consumption)
- Av. consumption --.- mpg (average fuel consumption)
- Route
- Average speed
- Digit. speed (digital speed display)
- Speed warning

**Audio ⇒ booklet *Radio* or ⇒ booklet *Navigation system***

**Navigation ⇒ booklet *Navigation system***

**Phone ⇒ booklet *Mobile phone package***

**Vehicle status ⇒ *Main menus: Premium version***

**Settings ⇒ *Settings menu***

- Language
- MFI Data
  - Travel time
  - Curr. consum. (current fuel consumption)
  - Av. consum. (average fuel consumption)

- Route
- Av. speed
- Digit. speed (digital speed display)
- Speed warn. (speed warning)
- Compass (vehicles without navigation system)
- Convenience ⇒ *Convenience sub-menu*
  - ATA confirm
  - Central locking
    - Auto unlock
    - Unlock doors
  - Window op. (Window operation)
    - Off
    - All
    - Driver
  - Mirror Adj. (Mirror adjust)
    - Individually
    - Both mirrors
    - Mirror down (vehicles with memory seats)
    - Back
  - Factory Set. (Factory setting).
- Lights / Vision
  - Coming home
  - Leaving home
  - Footwell light
  - Conv. turn sig. (convenience turn signal)
  - Factory setting
- Time
  - Hours
  - Minutes
  - 24 hr. mode
  - Daylight save
- Snow tires (winter tires)
  - On
  - + 5 mph
  - - 5 mph
- Units
  - Temperature
  - Consump./ dist.
- Service
  - Info
  - Back
- Tire Monitor ⇒ *Tire Pressure Monitoring System (TPMS)*
- Factory setting

## Using the instrument cluster menus: Basic version

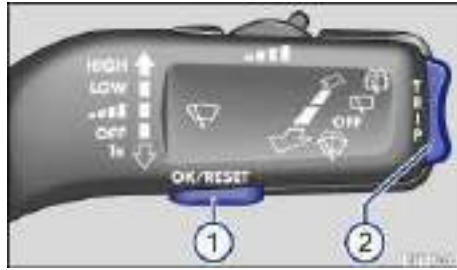

**Fig. 16** Basic version (vehicles without menu control multi-function steering wheel): Control buttons 1 and 2 on the windshield wiper lever.

### **⚠ Please first read and note the introductory information and heed the WARNINGS ⚠**

In the Basic version, the instrument cluster displays are controlled by the **OK/RESET** button and the TRIP rocker switch on the windshield wiper lever (⇒ [fig. 16 \(1\)](#) and [\(2\)](#)).

Switch on the ignition. The instrument cluster display is divided into 3 parts. The time (digital clock) is displayed in the top part. The bottom part contains the odometer and the trip odometer "trip". The display in the middle part is selected by pushing the TRIP rocker switch [\(2\)](#) on the end of the windshield wiper lever.

### **The available displays are as follows:**

**Fuel range estimate  $\text{B}$  (estimated distance you can drive with the fuel remaining in the tank).**

**Trip memory 1 (single trip memory) and trip memory 2 (total trip memory).**

- Push the **OK/RESET** button [\(1\)](#) on the windshield wiper lever to toggle between trip memories 1 and 2.
- Push and hold the **OK/RESET** button to reset a trip memory to 0.
- The function of the 2 trip memories is explained in ⇒ *MFI menu (Multi-Function Indicator): Premium version*. The 2 trip memories are in addition to the trip odometer, which is displayed in the bottom part of the instrument cluster and controlled using the **0.0/SET** button on the right of the instrument panel ⇒ [fig. 11](#), ⇒ [fig. 12](#).

**$\emptyset$  --- mph ( $\emptyset$  --- km/h) shows the average speed on trips per trip memories 1 and 2.**

- Push the **OK/RESET** button on the windshield wiper lever to toggle between the 2 average speed figures.

**$\ominus$ --- mph ( $\ominus$ --- km/h) or xx mph (xx km/h). Use this menu to set or disable the speed warning feature.**

- Push the **OK/RESET** button to toggle between --- mph (--- km/h) (speed warning disabled) and xx mph (xx km/h).
- A warning chime will sound you if you reach the set speed; there may also be a visual message.
- The set speed will blink for a few seconds after you toggle to xx mph (xx km/h).
- Press the TRIP rocker switch [\(2\)](#) while the set speed is flashing to increase or decrease the speed.

**Outside temperature.**

**Travel time since last reset of trip memories 1 and 2.**

- Push the **OK/RESET** button to toggle between the 2 time figures.

**--- mpg (l/100 km) current fuel consumption.**

**$\emptyset$  --- mpg ( $\emptyset$  l/100 km) average fuel consumption of trips per trip memories 1 and 2.**

- Push the **OK/RESET** button to toggle between the 2 figures.

## Using the instrument cluster menus: Premium version

---



**Fig. 17** Premium version (vehicles with menu control multi-function steering wheel): Buttons on the right side of the steering wheel.

**Please first read and note the introductory information and heed the WARNINGS** ⚠

On vehicles with menu control multi-function steering wheels (Premium version), the instrument cluster menus are controlled with buttons on the right side of the steering wheel ⇒ [fig. 17](#).

### Accessing the instrument cluster menus

- Switch on the ignition. You will see the vehicle icon or a message in the instrument cluster display.
- Push the **OK** button on the right side of the multi-function steering wheel until a main menu appears in the instrument cluster display. For a list of main menus, see ⇒ *Menu structure – overview: Premium version*, ⇒ *Menu structure – overview: Premium version*.
- Push buttons **←** or **→** to move to another main menu, and push the arrow up and down buttons **▲** and **▼** to navigate inside the current main menu. For example, in the **Settings** main menu, press the arrow down button **▼** to navigate to the **MFI data** sub-menu.

### Displaying sub-items

- Press the **OK** button to display sub-items located behind the items in a menu. For instance, after scrolling to **MFI data** in the **Settings** main menu, press the **OK** button to display the various MFI data sub-items (Travel time, curr. consum., etc.).

### Selecting a setting

- Some menus are used to select settings for certain features. Push the **OK** button ( ) to select a setting. For example, the 2 settings under **Mirror adjust** (Settings > Convenience > Mirror adjust) are **Individually** and **Both mirrors**. After navigating to these items, use the arrow up and down buttons to highlight one and then push the **OK** button to select this setting.

### Returning to the higher menu level

- Use the arrow down button **▼** to select **Back** and then press the **OK** button ( ).

## Main menus: Premium version

---

**Please first read and note the introductory information and heed the WARNINGS** ⚠



There are 6 main menus:

Main menus	Function	See
<b>MFI</b>	Multi-Function Indicator (MFI) information.	
<b>Audio</b>	Station indicator in radio mode. Track display in CD mode. Track display in media mode.	⇒ booklet <i>Radio</i> or ⇒ booklet <i>Navigation system</i>
<b>Navigation</b>	Information displays on the navigation system: When destination guidance is active, turn arrows and proximity bars are shown. The illustration is similar to the symbol display in the navigation system. If destination guidance is inactive, driving direction (compass function) and the current street name are displayed.	⇒ booklet <i>Navigation system</i>
<b>Phone</b>	Information and settings of the mobile phone package.	⇒ booklet <i>Mobile Phone Package</i>
<b>Vehicle status</b>	Current warning and information messages. This menu item is only displayed when warning or information messages are available. The number of available messages is shown in the display. Example: 1/1 or 2/2.	
<b>Settings</b>	Includes the Convenience and Lights & Vision sub-menus, as well as many settings such as time, speed warning for winter tires, language, units and "Display OFF".	

## MFI menu (Multi-Function Indicator): Premium version

ⓘ Please first read and note the introductory information and heed the WARNINGS ⚠

The MFI menu has 2 automatic trip memories: **1 – single trip memory** and **2 – total trip memory**. The number of the memory is shown at the upper right of the display. The trip memories are in addition to the trip odometer, which is displayed in the bottom part of the instrument cluster and controlled using the **0.0/SET** button on the right of the instrument panel ⇒ [fig. 11 \(7\)](#), ⇒ [fig. 12 \(7\)](#).

To display the distance driven on trips 1 and 2, select the **Route** item in the MFI menu (**MFI > Route**). Press the **OK** button (⇒ [fig. 17](#)) to toggle between Route 1 and Route 2 (trip 1 and trip 2). Push and hold the **OK** button to manually reset a trip memory to 0.

<b>1</b>	Single trip memory	The memory accumulates and stores information about distance driven and fuel used from the time the ignition was switched on until the time it was switched off. If the ignition stays off for 2 hours or more, stored information is automatically deleted. If the trip is continued within 2 hours after the ignition was switched off, the new values are added.
----------	--------------------	--



2	Total trip memory	The memory displays and stores the accumulated driving and fuel consumption data of any number of single trips up to a total driving time of 99 hours and 59 minutes, and up to a total distance of 9999 miles (9999 km), depending on the instrument cluster version. If one of the maximum values is exceeded, then the memory is automatically cleared and starts again from 0.
---	-------------------	--

### Possible MFI menu displays

The following displays can be accessed in the MFI menu if enabled under **Settings > MFI data**. Displays that are not enabled will not appear.





Display	Function
<b>Travel time</b>	Driving time in hours (h) and minutes (min) corresponding to trip memories 1 and 2 (toggle).
<b>Curr. consumption</b> -- - mpg	Current fuel consumption in miles per gallon (l/100 km) while driving. <i>When units are set to miles</i> , dashes appear instead of a number when the engine is running and the vehicle is standing still. <i>When units are set to kilometers</i> , the display shows liters consumed per hour when the engine is running and the vehicle is standing still.
<b>Av. consumption</b> ø -- - mpg	Average fuel consumption in miles per gallon (l/100 km) on trips per trip memories 1 and 2 (toggle) is displayed once the vehicle has been driven about 330 feet (100 m). Until then, dashes appear instead of a number. The value displayed is updated every 5 seconds.
<b>Range</b>	Estimated distance in miles (km) that the vehicle can go with the fuel left in the tank the way you are currently driving. Takes account of the current fuel consumption, among other things.
<b>Route</b>	Distance driven in miles (km) per trip memories 1 and 2 (toggle).
<b>Av. speed</b> ø	Average speed on trips per trip memories 1 and 2 (toggle). Displayed once the vehicle has been once the vehicle has been driven about 300 feet (100 m). Until then, dashes appear instead of a number. The value displayed is updated every 5 seconds.
<b>Digit. speed</b>	Digital display of current vehicle speed.
<b>Speed warn.</b> --- mph (km/h)	When the set speed (from 20 to 155 mph - 30 to 250 km/h) is exceeded, an acoustic warning sounds, and a visual message may also appear in the instrument cluster display.

### Switching between the displays

- Use the arrow up and down buttons ( and ) on the multi-function steering wheel.

### Storing speed for the speed warning

- Navigate to MFI > Speed warning (**Speed warning at --- mph**).
- Press the  button to save the current speed and to activate the warning.

- If the speed is not right, press buttons  or  on the multi-function steering wheel to set a different speed within about 5 seconds. Then press the  button a second time or just wait a few seconds. The speed is saved and the warning is activated.
- To deactivate, toggle to --- mph and press the  button. The set speed is deleted.

### Manually erasing trip memory 1 or 2

- Navigate to MFI > Route.
- Select the memory to be erased.
- Press the  button for about 2 seconds.

### Enabling and disabling displays

Use the **Settings** menu, submenu **MFI data** (Settings > MFI data) to enable displays you want to be available under the MFI menu in the instrument cluster display. The units in which data is displayed can also be changed ⇒ *Settings menu*.

## Settings menu

 Please first read and note the introductory information and heed the **WARNINGS**

Settings menu	Function
<b>Language</b>	Set language for messages in the display and navigation system.
<b>MFI Data</b>	Enable the features you want to be available under the MFI menu in the instrument cluster display ⇒ <i>MFI menu (Multi-Function Indicator): Premium version</i> .
<b>Compass</b>	Calibrating the compass on vehicles without a factory-installed navigation system. To calibrate, follow instructions in the instrument cluster display 16.
<b>Convenience</b>	Convenience function settings
<b>Lights &amp; Vision</b>	Vehicle lighting settings
<b>Time</b>	Set hours and minutes for the instrument cluster clock and in the Radio Navigation System clock. The digital clocks can be set to show the time in 12 or 24 hour format. Resetting clocks to daylight savings time or standard time.
<b>Snow tires</b>	Set up visual and acoustic speed warning. Use the feature only when winter tires are installed that have a speed rating less than top vehicle speed.
<b>Units</b>	Set units for temperature, fuel consumption and distances should be displayed (for example, whether to show distance driven in miles or kilometers).
<b>Tire pressure</b>	Reset the tire pressure, for example after replacing tires.
<b>Service</b>	Display service messages or reset service interval display.

Settings menu	Function
Factory settings	Resets the functions in the <b>Settings</b> menu to the default factory settings.
Back	The display returns to the main menu.

## Convenience sub-menu

ⓘ Please first read and note the introductory information and heed the **WARNINGS** ⚠

Convenience menu	Function
ATA confirm	The horn beeps once when the vehicle is locked with the remote control vehicle key if <b>ATA confirm</b> is checked
Central locking 43	<b>Auto unlock</b> Doors are unlocked as follows depending on the option selected: – <b>All doors:</b> Pushing the unlock button on the remote control vehicle key, unlocks all doors and the rear hatch. – <b>Single door:</b> Pushing the unlock button on the remote control vehicle key unlocks only the driver door. To unlock all doors and the rear hatch, push the unlock button <input checked="" type="checkbox"/> on the key a second time within about 5 seconds. On vehicles with Keyless Access, touching the sensor surface of the door handle on the side where the valid vehicle key is located unlocks the respective door. – <b>Vehicle side:</b> Pushing the unlock button on the remote control vehicle key unlocks the doors on the driver side of the vehicle. On vehicles with Keyless Access touching the sensor surface of a door handle on the side where the valid remote control vehicle key is located unlocks the doors on that side of the vehicle.
	<b>Unlock doors</b> <b>Auto unlock:</b> You can enable or disable Auto unlock. If Auto unlock is enabled (box checked), it is triggered on vehicles without Keyless Access by taking the key out of the ignition. On Keyless Access vehicles, Auto unlock is triggered by opening the driver door. Auto unlock works only if the vehicle has been automatically locked after reaching a speed of 10 mph (15 km/h) 42. It unlocks the doors that would be unlocked if you pushed the unlock button on the remote control vehicle key once.
Window adjust	Power window settings: When unlocking/locking the vehicle from the driver door with the fold out key bit (mechanical key), all windows can be opened or closed. by holding the key in the open/close position.
Mirror down	Tilts passenger mirror down when backing up so you can see the curb. Feature only available on vehicles equipped with memory seats.

Convenience menu	Function
Mirror adjust	The setting <b>Both mirrors</b> adjusts the passenger-side outside mirror as well when the driver-side outside mirror is repositioned. This feature is not factory enabled and must be activated in the <b>Convenience</b> sub-menu.
Factory setting	Resets certain features in the <b>Convenience</b> sub-menu to the factory settings.
Back	The display switches back to the <b>Settings</b> menu.

## Lights and Vision sub-menu

ⓘ Please first read and note the introductory information and heed the **WARNINGS** ⚠

Light & Vision menu	Function
Coming home	Set how long the headlights and inside lights stay on after locking or unlocking the vehicle. Feature can also be switched on or off
Leaving home	
Ambient light	Adjust the brightness of the ambient lighting or switch the feature on or off.
Footwell light	Set footwell lighting brightness when the doors are open.
Daytime running lights	Switch daytime running lights (DRL) on and off.
Conv. turn sig.	Enable/disable lane change flash (convenience turn signal). When the feature is enabled, the turn signal flashes at least 3 times when the turn signal is tapped
Factory set.	Resets the functions in the <b>Light &amp; Vision</b> sub-menu back to the factory settings.
Back	The display switches back to the <b>Settings</b> menu.

# Driving checklists and warnings

## Introduction

---

In this section you'll find information about:

Getting ready and driving safely  
Driving in other countries  
Driving through water on roads

### More information:

- Sitting properly and safely
- Transporting
- Starting, shifting, parking
- Saving fuel and helping the environment
- Consumer information

### WARNING

**Driving under the influence of alcohol, illegal drugs, narcotics and some medications may cause collisions and other accidents, severe personal injuries and even death.**

- Alcohol, illegal drugs, narcotics and some medications may severely affect perception, reaction times and safe driving, which may result in the loss of vehicle control.

## Getting ready and driving safely

---

 Please first read and note the introductory information and heed the WARNINGS 

### Checklist

---

Observe the following points before and during every drive for your own safety, the safety of all passengers and others ⇒ .

- ✓ Check proper function of lights and turn signals.
- ✓ Check tire pressure (⇒ *Tires and wheels*) and fuel level (⇒ *Refueling*).
- ✓ Make sure that all windows are clean.
- ✓ Store items and all luggage safely in the storage compartments and in the luggage compartment and, if necessary, on the roof ⇒ *Transporting*.
- ✓ Always make sure that nothing keeps the pedals from moving freely.
- ✓ Make sure that children are properly secured by a restraint system appropriate for their size and weight ⇒ *Child safety and child restraints*.
- ✓ Properly adjust front seats, all head restraints and mirrors to the correct height ⇒ *Adjusting the seating position*.
- ✓ Wear shoes that give your feet a good grip, and that give you a feel for the pedals.
- ✓ Make sure that the floormat on the driver side is properly fastened and cannot interfere with the pedals.

- ✓ Assume a proper seating position before the vehicle starts to move and keep this position while driving. Make sure that all passengers do the same ⇒ *Adjusting the seating position*.
- ✓ Properly fasten your safety belt before driving the vehicle and wear your safety belt properly at all times while driving. Make sure that all passengers do the same ⇒ *Safety belts*.
- ✓ Only transport as many passengers as there are seats and safety belts available.
- ✓ Never drive if your driving ability has been impaired, for example by medication, alcohol or illegal drugs.
- ✓ Never let passengers or phone calls distract you while driving and never take your attention off the road while using vehicle software or adjusting vehicle equipment or accessories.
- ✓ Always adapt your speed and driving style to visibility, weather, road, and traffic conditions.
- ✓ Always obey traffic laws and speed limits.
- ✓ On long trips make frequent rest stops – at least once every 2 hours.
- ✓ Secure animals in the vehicle with a system that corresponds to weight and size.



### WARNING

**Always observe posted speed limits and use common sense. Your good judgment can mean the difference between arriving safely at your destination and being seriously injured in a crash or other kind of accident.**



Regular service and maintenance of your vehicle is important both for operational and driving safety and to help prolong your vehicle's service life. Always follow the scheduled maintenance intervals in the ⇒ booklet *Warranty and Maintenance*, especially for changing the brake fluid. Hard use, frequent stop-and-go driving, driving in very dusty areas, trailer towing, and other factors may make it necessary to have the vehicle serviced more frequently. Ask an authorized Volkswagen dealer or an authorized Volkswagen Service Facility for more information.

## Driving in other countries

☐ Please first read and note the introductory information and heed the WARNINGS ⚠

### Checklist

Some countries have special safety standards and emissions requirements that your vehicle may not meet. Before taking your vehicle to another country, Volkswagen therefore recommends that you ask your authorized Volkswagen dealer or authorized Volkswagen Service Facility about the following issues with regard to the country to which you would like to travel:

- ✓ Should the vehicle be technically prepared for the trip abroad, such as masking or adjusting headlights?
- ✓ Are maintenance, repair facilities, necessary tools and testing equipment as well as spare parts readily available for your vehicle?
- ✓ Are there authorized Volkswagen dealers and authorized Volkswagen Service Facilities in the countries where you will be driving?
- ✓ For gasoline engines: Is unleaded fuel with the right octane rating readily available?
- ✓ Are engine oil (⇒ *Engine oil*) and other operating fluids that meet Volkswagen quality and performance requirements available where you will be driving? For more information, please see ⇒ Booklet *Warranty and Maintenance*.

- ✓ Does the factory-installed navigation system work in the countries where you will be driving, and is navigation data available?
  - ✓ Are special or heavy-duty tires necessary for the kind of driving expected?
- 

### NOTICE

Volkswagen is not responsible for mechanical damage that may result from substandard fuel or service or the unavailability of Genuine Volkswagen parts.

## Driving through water on roads

---

 Please first read and note the introductory information and heed the WARNINGS 

Note the following to help prevent vehicle damage when driving through water, for example on flooded roads:

- Check the depth of the water before driving through it. The water **must not be any higher than** the bottom of the vehicle body ⇒ , see *dimensions*
- Do not drive faster than walking speed.
- Never stop the vehicle, and do not drive in reverse or switch the engine off when driving through water.
- Oncoming vehicles may create waves that raise the water level and make it too deep for your vehicle to drive through safely.

### WARNING

After driving through water, mud, sludge, etc., the brakes react slower and need longer stopping distances.

- Always dry the brakes and clean off any ice coatings with a few careful applications of the brake. Make sure not to endanger other motorists or cyclists or disobey legal requirements.
- Avoid abrupt or sudden braking maneuvers immediately after driving through water.

### NOTICE

- Vehicle components such as the engine, transmission, suspension or electrical system may be severely damaged by driving through water.
- Never drive through salt water. Salt causes vehicle corrosion. Thoroughly rinse with fresh water all vehicle parts that were exposed to salt water.



## Technical data

### Introduction

---

In this section you'll find information about:

Important vehicle labels

Engine data

Dimensions

Your vehicle's engine type is shown on the vehicle identification label.

The specifications in this Manual refer to the base model. The stated values may vary, depending upon different equipment or models, as well as with respect to special vehicles and vehicles exported to different countries.

#### More information:

- Transporting
- Tires and wheels
- Saving fuel and helping the environment
- Fuel
- Engine oil
- Engine coolant
- Consumer information



#### WARNING

Disregarding or exceeding stated values for weights, loads, dimensions and maximum speed may result in accidents and serious personal injuries.

### Important vehicle labels

---



Fig. 18 Vehicle identification label: Shown in the example with engine identification code CBFA 3.

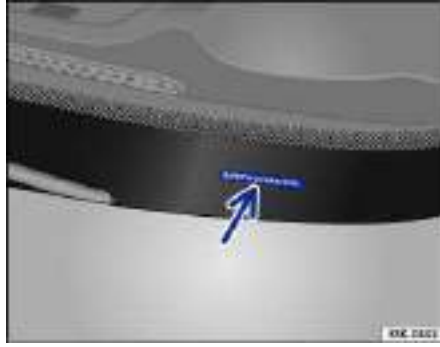

**Fig. 19** Vehicle identification number (VIN).

**⚠ Please first read and note the introductory information and heed the WARNINGS ⚠**

Factory-installed safety certificates, stickers, and signs containing important information regarding vehicle operation can be found in the engine compartment and on certain vehicle components, such as inside the fuel filler flap, on the passenger sun visor, in the driver door jamb, or on the luggage compartment floor.

- Do not remove, alter, or render unusable or illegible any safety certificates, stickers, and labels.
- If vehicle components bearing safety certificates, stickers, or labels are replaced, make certain that the firm doing the work attaches new conforming certificates, stickers, or labels to the same part of the new components.

**Vehicle identification number**

The vehicle identification number is on a plate on top of the instrument panel on the driver side, and is visible from the outside through the windshield ⇒ [fig. 19](#) (arrow). The view window is on the side at the bottom of the windshield. The vehicle identification number is also stamped into the top of the right drip channel in the engine compartment. The drip channel is between the spring strut tower and the right fender. Open the engine hood to read the vehicle identification number ⚠

**Vehicle identification label**

The vehicle identification label ⇒ [fig. 18](#) is affixed to the area of the spare wheel well underneath the rear hatch floor panel and contains the following information:

- (1) Vehicle identification number (VIN)
- (2) Vehicle type, engine output, transmission
- (3) Engine and transmission identification code, paint number, interior. In the example, the engine classification code is "CBFA".
- (4) Optional equipment, part numbers

**Safety Compliance Certification Label**

A safety certificate affixed to the door jamb in the driver door confirms that at time of production all necessary safety standards and requirements of the traffic safety agency of the respective country were met. The month and year of production as well as the vehicle identification number may be listed as well.

**Radiator fan and high voltage warning sticker**

A warning sticker about the radiator fan and the high voltage of the electrical system is located in the engine compartment next to the engine hood release. The vehicle ignition system complies with the Canadian standard ICES-002.

## Tire inflation pressure label

A tire inflation pressure label is on the driver door jamb ⇒ *Tires and wheels*.

## Engine data

☐ Please first read and note the introductory information and heed the WARNINGS ⚠

### Gasoline engine

Maximum power output (SAE net)	Injection technology	Engine ID code	Maximum torque (SAE net)	No. of cylinders Displacement
200 hp at 5100 – 6000 rpm 147 kW at 5100 – 6000 rpm	TSI®	CCTA 2.0L	207 ft-lbs at 1700 – 5000 rpm 280 Nm at 1700 – 5000 rpm	4 cylinders 121.1 CID (1984 ccm)

## Dimensions

☐ Please first read and note the introductory information and heed the WARNINGS ⚠

Length	174.5 inches (4427 mm)
Width	71.2 inches (1809 mm)
Height (unloaded)	66.3 inches (1683 mm)
Wheelbase	102.5 inches (2605 mm)
Minimum turning circle diameter (wall to wall) <sup>2</sup>	39 feet (12 m)
Track <sup>2</sup> front	61.8 inches (1570 mm)
Track <sup>2</sup> rear	61.9 inches (1571 mm)
Ground clearance	6.9 inches (175 mm) <sup>3</sup>
Approach angle – Off-road	28 degrees
Departure angle	25 degrees

<sup>2</sup> Slight differences to these figures are possible, depending on wheel and tire size fitted and the level selected.

<sup>3</sup> Approx. figure for fully loaded standard vehicle; varies depending on your vehicle's equipment (engine, tires, wheels, tire inflation pressure, driving situation and other factors).

Ramp angle	21.3 degrees
Max. gradient	31 degrees
Fording depth	6.9 inches (175 mm)

 **NOTICE**

- Please be careful when parking your vehicle in areas with parking barriers or curbs. These vary in height and could damage your bumper and related parts if the front of your vehicle hits a barrier or curb that is too high while you are getting into or out of a parking spot.
- Always be careful when you enter a driveway or drive up or down steep ramps or over curbs or other obstacles. Parts of the vehicle close to the ground may be damaged (such as bumper covers, spoilers, and parts of the engine, suspension, and exhaust systems).

## Vehicle key set

### Introduction

---

In this section you'll find information about:

Remote control vehicle keys  
Mechanical key  
Indicator light in the remote control vehicle key  
Replacing the remote control vehicle key battery  
Synchronizing the remote control vehicle key

#### More information:

- Volkswagen Information System
- Power locking and closing system
- Starting and stopping the engine
- Consumer information
- Emergency closing and opening

#### DANGER

20 mm button cells and other lithium batteries will cause serious personal injury and even death within a short time if swallowed.

- Always keep remote control vehicle key fobs with batteries, spare batteries, as well as dead button cell and larger 20 mm batteries out of the reach of children.
- Get medical attention immediately if you suspect that a battery has been swallowed.

#### WARNING

Improper use of vehicle keys can result in serious personal injury.

- Always take the key with you when you leave the vehicle. It can be used to start the engine and operate vehicle systems such as the power windows, leading to serious personal injury. Children or other unauthorized persons could also lock the doors and the luggage compartment.
- Never leave children, disabled persons, or anyone who cannot help themselves in the vehicle. The doors can be locked with the remote control vehicle key. This could result in people being trapped in the vehicle in an emergency. For example, depending on the time of year, people trapped in the vehicle can be exposed to very high or very low temperatures.
- Heat buildup in the passenger and luggage compartment of a parked vehicle can result in temperatures in the vehicle that are much higher than the outside temperatures, particularly in summer. Temperatures can quickly reach levels that can cause unconsciousness and death, particularly to small children.
- Never remove the key from the ignition switch while the vehicle is moving or rolling to a stop. The steering wheel will lock and you will not be able to steer or control the vehicle.

## Remote control vehicle keys

---



Fig. 20 Remote control vehicle key with panic button.

⚠ Please first read and note the introductory information and heed the WARNINGS ⚠

### Remote control vehicle key

The remote control vehicle key can unlock and lock the vehicle from a distance ⇒ *Power locking and closing system*.

The remote transmitter and battery are inside the remote control vehicle key. The receiver is inside the passenger compartment. The operating range of the remote control vehicle key for a fresh battery is several yards (meters) around the vehicle.

If the remote control vehicle key will not lock or unlock your vehicle, you probably need to replace the battery in the remote control vehicle key ⇒ *Replacing the remote control vehicle key battery*. If this is not the problem, the key should be resynchronized by an authorized Volkswagen dealer, an authorized Volkswagen Service Facility, or another qualified workshop. See also ⇒ *Synchronizing the remote control vehicle key*.

### Folding the key bit in or out

Pressing button ⇒ [fig. 20 \(1\)](#) releases the key bit and folds it out.

To *fold the key bit in* press button [\(1\)](#) while pressing the key bit back until it clicks.

### Panic button

Press the panic button [\(2\)](#) only in emergencies! After pushing the panic button, the horn will sound and the turn signals will flash. Press the panic button again to switch off the panic feature.

### Replacement vehicle keys

The vehicle identification number is required to get a replacement key or an additional remote control vehicle key.

Up to 8 vehicle keys, each of which must be properly cut, coded, programmed, and synchronized, can be used with your vehicle.

Each new vehicle key contains a microchip and must be coded with the data from the vehicle's electronic immobilizer. A vehicle key will not work if it does not contain a microchip or contains a chip that is not coded, even if the key bit was cut correctly.

You can obtain additional or duplicate remote control vehicle keys from authorized Volkswagen dealers, authorized Volkswagen Service Facilities and from certain independent repair facilities and locksmiths which are qualified to make remote control vehicle keys.

Each vehicle key must be programmed by an authorized Volkswagen dealer, an authorized Volkswagen Service Facility in order for it to work with your vehicle.

To find the nearest qualified independent repair facility, locksmith or Volkswagen dealer which can cut and code replacement vehicle keys call the VW Customer Care Hotline at 1-800-822-8987 or visit <http://www.vw.com> and search for "replacement keys".

Canadian customers can contact an authorized Volkswagen dealer or Volkswagen Service Facility or call the Volkswagen Canada Customer CARE Center at 1-800-822-8987.

## NOTICE

**The remote control vehicle keys contain electrical components. Protect them from damage, moisture and rough handling.**

 Do not press the buttons on the remote control vehicle key unless you actually want to use the function in question. Since terrain and conditions vary, pressing a button on the remote control vehicle key when it is not necessary may unlock the vehicle or set off the panic alarm, even if you think you are out of range.

 Remote control vehicle key functions can be temporarily disrupted by interference from transmitters near the vehicle that use the same frequency range (such as radio equipment or cellular phones).

 Things between the remote control vehicle key and vehicle, bad weather, as well as a weak battery can reduce the operating range.

 If the remote control vehicle key buttons or the power locking buttons ⇒ *Vehicle key set* are pushed repeatedly in quick succession, the power locking system is switched off for a brief period to help keep it from being overloaded. The vehicle is then unlocked for about 30 seconds. Unless a door or the rear hatch is opened in this span of time, the vehicle is automatically locked afterwards.

## Mechanical key

---

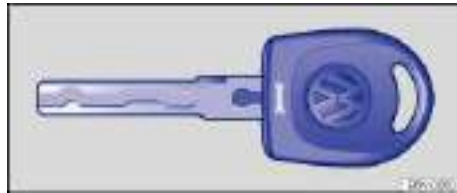

Fig. 21 Mechanical key.

 Please first read and note the introductory information and heed the WARNINGS 

The remote control vehicle key set includes a mechanical key ⇒ [fig. 21](#).

Use the mechanical key for:

- Manually locking and unlocking the vehicle
- Starting engine

## Indicator light in the remote control vehicle key

---



Fig. 22 Indicator light in the remote control vehicle key.

**⚠ Please first read and note the introductory information and heed the WARNINGS ⚠**

If a button in the remote control vehicle key is pressed briefly, the indicator light (arrow) ⇒ fig. 22 will flash once briefly. If you push and hold a button, it flashes repeatedly.

If the indicator light in the remote control vehicle key does not come on when the button is pressed, the battery inside the key must be replaced ⇒ *Replacing the remote control vehicle key battery*. A Declaration of Compliance with United States FCC and Industry Canada regulations is found in the Consumer Information section of this Manual ⇒ *Declaration of Compliance, Telecommunications and Electronic Systems*.

## Replacing the remote control vehicle key battery

---



Fig. 23 Remote control vehicle key: Open battery compartment cover.





Fig. 24 Remote control vehicle key: Remove old battery.

**⚠ Please first read and note the introductory information and heed the WARNINGS ⚠**

Volkswagen recommends having the battery in the remote control vehicle key changed by an authorized Volkswagen dealer or an authorized Volkswagen Service Facility.

The battery is on the back of the remote control vehicle key under a cover ⇒ fig. 23. When changing the battery, pay attention to the correct polarity and use the same type of battery ⇒ ⚠.

**Replacing the battery**

- Unfold the key bit on the remote control vehicle key ⇒ *Folding the key bit in or out.*
- Remove the cover on the back of the remote control vehicle key in the direction of the arrow ⇒ fig. 24.
- Use a thin object to pry the battery out of the battery compartment .
- Position the new battery in as shown and press it into the battery compartment (opposite to direction of the arrow) .
- Position the cover as shown ⇒ fig. 23 and press it down (opposite to direction of the arrow) until you hear it click into place.



**NOTICE**

- **Changing the battery improperly can damage the remote control vehicle key.**
- **Using the wrong battery can damage the remote control vehicle key. Replace a dead battery with a new one that has the same voltage, size, and specifications.**
- **Make sure the plus and minus poles of the battery are correctly positioned.**



Dispose of old batteries in an environmentally responsible manner and keep them out of the reach of children.



Batteries of the type used in your remote control vehicle key may contain **Perchlorate Material**. Special handling may apply – see <http://www.dtsc.ca.gov/hazardouswaste/perchlorate>. Obey all legal requirements regarding handling and disposal of these batteries. Authorized Volkswagen dealers and authorized Volkswagen service facilities are familiar with the requirements, and we recommend that you have them perform this service for you.

## **Synchronizing the remote control vehicle key**

**⚠ Please first read and note the introductory information and heed the WARNINGS ⚠**

If the  button is pressed often while outside the operating range, it is possible that the vehicle cannot be locked or unlocked anymore with the remote control vehicle key. Synchronize the vehicle key as follows:

- Unfold the key bit on the remote control vehicle key ⇒ *Remote control vehicle keys*.
- Remove the cap from the door handle on the driver door ⇒ *Emergency closing and opening*.
- Press the  button on the remote control vehicle key. Stand immediately next to vehicle while doing so.
- Manually unlock the vehicle using the key bit within one minute.
- Switch the ignition on with the vehicle key. The synchronization is complete.
- Reinstall the cap.

# Power locking and closing system

## Introduction

---

In this section you'll find information about:

- Indicator light in the driver door
- Description of the power locking system
- Unlocking or locking the vehicle from the outside
- Unlocking or locking the vehicle from the inside
- Unlocking or locking the vehicle with Keyless Access
- Anti-theft alarm system

The power locking system works properly only when all doors and the rear hatch are completely closed. When the driver door is open, the vehicle *cannot* be locked with the remote control vehicle key.

For vehicles equipped with the Keyless Access locking and starting system, the vehicle can be locked *only* if the ignition is switched off and the driver door is closed.

Leaving the vehicle unlocked for longer periods of non-use (for example, in your garage) can cause the vehicle battery to drain so that the engine can no longer be started.

### **More information:**

- Exterior views
- Volkswagen Information System
- Vehicle key set
- Doors
- Rear hatch
- Power windows
- Power sunroof
- Trailer towing
- Emergency closing and opening

## WARNING

Improper use of power locks can result in serious personal injury.

- The power locking button locks all doors. Locking the doors from the inside can help prevent unintended door opening during a collision and can also prevent unwanted entry from the outside. Locked doors can, however, delay assistance to vehicle occupants and rescue from the outside in an accident or other emergency.
- Never leave children or anyone who cannot help themselves behind in the vehicle. All doors can be locked from the inside with the power lock button. This could leave people trapped in the vehicle in an emergency. Depending on the time of year, people trapped in the vehicle can be exposed to very high or very low temperatures.
- A closed vehicle can become very hot or very cold, depending on the season. Particularly in the summer, heat buildup in the passenger and luggage compartment of a parked vehicle can result in temperatures in the vehicle that are much higher than the outside temperatures. Temperatures can quickly reach levels that can cause unconsciousness and death, particularly to small children.
- Never allow passengers to remain in a locked vehicle. In an emergency any person still inside the vehicle might not be able to get out.

## Indicator light in the driver door

 Please first read and note the introductory information and heed the WARNINGS 

The indicator light for the power locking system is in the driver door ⇒ *Passenger compartment*.

After the vehicle is locked	Meaning
The red LED light flashes for about 2 seconds in short intervals, then slower.	The vehicle is locked.
Red LED light flashes for about 2 seconds in short intervals, then lights up continuously for about 30 seconds.	Locking system malfunction. See an authorized Volkswagen dealer or an authorized Volkswagen Service Facility.

## NOTICE

Failure to heed warning lights or text WARNINGS can result in vehicle damage.

## Description of the power locking system

 Please first read and note the introductory information and heed the WARNINGS 

The power locking system lets you unlock and lock all doors, the rear hatch, and the fuel filler flap:

- From the outside with the remote control vehicle key.

- From the outside with Keyless Access ⇒ *Unlocking or locking the vehicle from the outside.*
- From the inside with the power locking button ⇒ *Unlocking or locking the vehicle from the inside.*

Special functions of the power locking system can be activated or deactivated via the **Convenience** sub-menu in the **Settings** menu on vehicles with the Premium instrument cluster ⇒ *Volkswagen Information System* or by an authorized Volkswagen dealer or authorized Volkswagen Service Facility.

The doors and the rear hatch can be locked manually if the remote control vehicle key or the power locking system is not working.

#### **Automatic locking (Auto lock)**

The vehicle will lock automatically when it reaches a speed of about 10 mph (15 km/h). When the vehicle is locked, the indicator light  comes on in the power locking button ⇒ [fig. 26](#).

#### **Automatic unlocking (Auto unlock)**

All doors automatically unlock when you switch off the ignition and open a door from inside the vehicle. On vehicles with automatic transmission, the doors will also unlock when the selector lever is in Park **(P)** and the ignition is switched off. Auto unlock works only if the vehicle has been automatically locked with the Auto lock feature. The indicator light  goes out in the power locking button when the doors unlock ⇒ [fig. 26](#).

#### **Locking the vehicle after airbag inflation**

If the airbags are activated during a collision, the entire vehicle is unlocked. Depending on the severity of the damage, the vehicle can be locked after a collision when the airbags have deployed as follows:

<b>Function</b>	<b>Action</b>
Locking the vehicle <b>with the power locking button</b> :	<ul style="list-style-type: none"> <li>– Switch the ignition off.</li> <li>– Open a door once.</li> <li>– Press the power locking button .</li> </ul>
Locking the vehicle <b>with the remote control vehicle key</b> :	<ul style="list-style-type: none"> <li>– Switch the ignition off and on again</li> <li><b>OR:</b> Remove the remote control vehicle from the ignition.</li> <li>– Open a door once.</li> <li>– Lock the vehicle with the remote control vehicle key.</li> </ul>



 If the remote control vehicle key buttons ⇒ *Vehicle key set* or one of the power locking buttons 47 are pushed repeatedly in quick succession, the power locking system is switched off for a brief period to help keep it from being overloaded. The vehicle is then unlocked for about 30 seconds. Unless a door or the rear hatch is opened during this time, the vehicle is automatically locked afterwards.

## Unlocking or locking the vehicle from the outside



Fig. 25 Remote control vehicle key with panic button.

ⓘ Please first read and note the introductory information and heed the WARNINGS ⚠

Function	Using the buttons on the remote control vehicle key buttons ⇒ fig. 25
Unlock the vehicle.	Press the  button. Keep pressed to unlock all doors and the rear hatch.
Lock the vehicle.	Press the  button.
Unlock the rear hatch.	Press the  button.

**Note:** Depending on the settings for the power locking system in the **Convenience** sub-menu on vehicles with the Premium instrument cluster, it may be necessary to press the  button on the remote control vehicle key twice to unlock all doors and the rear hatch ⇒ *Volkswagen Information System*.

The vehicle key unlocks or locks the vehicle only when the battery in the remote control key has enough power, and the remote control vehicle key is within a few yards/meters of the vehicle.

- All turn signals flash once and the horn beeps once to confirm that the vehicle has been locked. The horn beep can be disabled by deactivating the “ATA confirmation” feature in the **Convenience** submenu ⇒ *Convenience sub-menu*.
- All turn signals flash *twice* to confirm that the vehicle has been unlocked.

If the turn signals *do not* flash to confirm locking, one or more doors, the rear hatch or the engine hood is not locked.

If the driver door is open, the vehicle cannot be locked with the remote control vehicle key.

If the vehicle was unlocked with the remote control vehicle key and the door or the rear hatch has not been opened in about 30 seconds, the vehicle is automatically locked again. This feature helps prevent you from leaving the vehicle unlocked unintentionally.

## Unlocking or locking the vehicle from the inside



---



Fig. 26 On all 4 doors: Power locking button.

⚠ Please first read and note the introductory information and heed the WARNINGS ⚠



Press button ⇒ fig. 26:

- 
- |   |                     |
|---|---------------------|
|  | Unlock the vehicle. |
|  | Lock the vehicle.   |
- 

The power locking button works whether the ignition is switched on or off but only when *all* doors are closed.

If the vehicle is locked with the remote control vehicle key, the power locking switch is deactivated.

If the vehicle is locked with the power locking button:

- The yellow indicator light  in the power locking button comes on to indicate that all doors and the rear hatch are locked.
- Opening doors or the rear hatch from the *outside* is not possible, at a traffic light, for example.
- Doors can be unlocked and opened separately from inside the vehicle by pulling the door handle to open the door. The indicator light  goes out. The unopened doors and rear hatch remain locked and cannot be opened from the outside.
- An open driver door will not be locked. This helps keep the driver from being locked out of the vehicle.

The vehicle is unlocked if you push the  button while the vehicle is standing still. Depending on the settings in the **Convenience** submenu ⇒ *Convenience sub-menu*, it may also be unlocked when you switch off the ignition and open a door from inside the vehicle (**Auto unlock**). On vehicles with automatic transmission, it may also be unlocked when the selector lever is in Park (**P**) and the ignition is switched off.

## Unlocking or locking the vehicle with Keyless Access

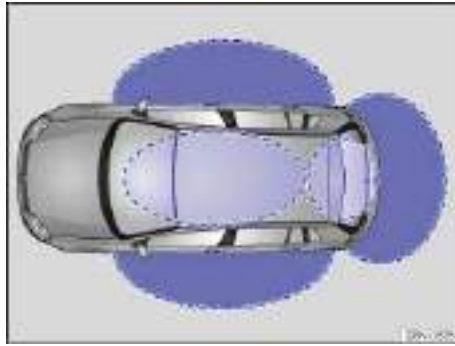

Fig. 27 Ranges of the Keyless Access locking and starting system.

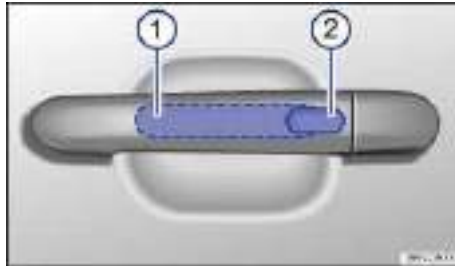

Fig. 28 Keyless Access locking and starting system: Sensor 1 for unlocking on the inside of the front door handles. Sensor for locking 2 on the outside of the door handles.

⚠ Please first read and note the introductory information and heed the WARNINGS ⚠

Keyless Access is a keyless starting and locking system that unlocks and locks the vehicle without active use of a remote control vehicle key. All you have to do is touch a sensor surface on one of the front door handles ⇒ [fig. 27](#) or push the button on the rear hatch ⇒ *Opening the rear hatch* when a valid vehicle key is within range ⇒ ⚠.

### General information

When a valid vehicle key comes within range, the Keyless Access locking and starting system recognizes a valid vehicle entry request as soon as a door handle sensor is touched on the driver or front passenger door or the button on the rear hatch is pressed. The following functions are then enabled without active use of the vehicle key:

- Keyless Entry: Unlocking the vehicle with the sensor surfaces on the door handles of the driver or front passenger door ⇒ [fig. 28 \(1\)](#) or by using the button on the rear hatch.
- Keyless Go: Start the engine and drive. just have to press the starter button and a valid remote control vehicle key must be inside the vehicle.
- Keyless Exit: Locking the vehicle via the door handle of the driver or front passenger door [\(2\)](#).

The power locks and the closing system work like the *standard* unlocking and locking system. Only the way that the systems are operated is different.

All turn signals flash twice to confirm that the vehicle has been unlocked and once to confirm that it has been locked.



If the vehicle was unlocked and within the next few seconds no door or the rear hatch has been opened, the vehicle is automatically locked again.

#### **Unlocking and opening doors (Keyless Entry)**

- Grasp the door handle of the driver or front passenger door so that you touch the unlocking sensor surface (1).
- Open the door.

#### **Closing and locking doors (Keyless Exit)**

- Close the driver door.
- Touch the sensor surface in the door handle on the driver or front passenger door (2) *once*. The vehicle is locked. The door being locked must be closed.

#### **Unlocking and locking the rear hatch**

If the vehicle is locked and if a valid vehicle key is within range ⇒ [fig. 27](#) of the rear hatch, it unlocks automatically when opened.

- Open and close the rear hatch as you would a *standard* rear hatch

The rear hatch locks automatically when it is closed *except* in the following situations:

- The vehicle is completely unlocked.
- When an authorized vehicle key is inside the vehicle.

#### **Locking with a second vehicle key**

If a remote control vehicle key is inside the passenger compartment, the vehicle can be locked from the outside only if a second valid vehicle key is within range.

When the vehicle is locked from the outside, the keyless go (starting) function of any keys left in the passenger compartment will be deactivated. All other functions (remote central locking and unlocking as well as emergency starting) remain active and unchanged.

A key that was inside the vehicle when it was locked from the outside is reactivated:

- by pressing a button on the deactivated key.
- by pressing a door handle sensor when the deactivated key is outside of the vehicle, but within range.
- by starting the engine with the starter button on the center console.

#### **Automatic deactivation of sensors**

If the vehicle has not been unlocked or locked for a longer period of time, the proximity sensors in the passenger door are automatically deactivated.

If a sensor on the door handle of a locked vehicle is activated too often, for instance by a bush or hedge that rubs against the vehicle, the sensors in the door handle on that side of the vehicle are switched off for about 30 minutes.

The door handle sensors become active again if one of the following events occurs:

- 30 minutes have passed.
- **OR:** The vehicle is unlocked using the  button in the remote control vehicle key.
- **OR:** The rear hatch is opened.
- **OR:** The vehicle is mechanically unlocked with the vehicle key.

#### **Convenience features**

To use the convenience closing feature to close all power windows, hold your finger on the lock sensor surface ⇒ [fig. 28 \(2\)](#) on the outside of the door handle for a few seconds until the windows close.

Remove your finger from the lock sensor surface (2) to stop the function. If you touch the unlock sensor surface 1 on the inside of the door handle immediately after releasing the lock sensor surface 1

(arrow), all of the windows will open (safety function). Pinch protection is active during convenience closing of the windows.

The settings in the **Settings – Convenience** menu 19 determine which doors open when the door handle sensor surface is touched.

## NOTICE

**The door handle sensor surfaces can be activated by a strong stream of water or steam if a valid vehicle key is within range of the vehicle.**

• **All windows may open if you turn the spray of water or steam away from and then back onto the door handle sensor surface in quick succession. If at least one power window is opened and the sensor is continuously activated, convenience closing is started.**

 The door may not open if the outside and inside door handles are used at the same time.

 If the automatic transmission is **not** in Park (**P**) position, the electronic steering column lock will not lock and the vehicle will not lock via sensors in the front door handles or the remote control vehicle key.

 If the vehicle battery or the battery in the remote control vehicle key is weak or dead, it might not be possible to unlock and lock the vehicle using Keyless Access. The vehicle can still be manually locked or unlocked with the key bit

 The driver message **Key not in range** appears in the instrument cluster display if there is no remote control vehicle key inside the vehicle or if the system does not recognize the vehicle key. The key may not be recognized, for example, if it is covered by something that interferes with the signal (such as a briefcase), or if the remote control vehicle key battery is weak. Electronic devices such as mobile phones can also interfere with the signal.

 Dirt on the door handles that contains a lot of salt (especially in winter) can affect the way the door handle sensors work. Cleaning the door handles can help with this problem

## Anti-theft alarm system

---

 **Please first read and note the introductory information and heed the WARNINGS** 

Your vehicle is either equipped with an anti-theft alarm system or pre-equipped for anti-theft alarm system installation. If the vehicle is pre-equipped for installation of the anti-theft alarm system, the alarm system can be retrofitted by an authorized Volkswagen dealer or an authorized Volkswagen Service Facility.

The anti-theft alarm system makes it more difficult for someone to break into or steal the vehicle.

The anti-theft alarm system is automatically activated when the vehicle is locked by pressing the lock button on the remote control vehicle key.

### When is the alarm triggered?

The anti-theft alarm system sounds for about 30 seconds and the turn signals flash for up to 5 minutes if the following occurs with respect to the locked vehicle:

- Opening a door that has been mechanically unlocked.
- Forcibly opening a door.



- Forcibly opening the engine hood.
- Forcibly opening the rear hatch.
- Switching on the ignition with an invalid key.
- Disconnecting the vehicle battery.
- Disconnecting an anti-theft system integrated trailer.

### Deactivating the alarm

Unlock the vehicle with the unlock button on the remote control vehicle key and switch on the ignition with a valid remote control vehicle key.

For vehicles with Keyless Access, the alarm can be deactivated by grasping one of the door handles when a valid vehicle key is in range or by holding the remote control vehicle key to the right of the steering column trim and pressing the starter button ⇒ *Unlocking or locking the vehicle with Keyless Access*.

 After the alarm has stopped and the vehicle is opened again in the same or a different area that is protected by the alarm, the alarm is triggered again. For example, the alarm will sound again if the rear hatch is opened after one of the doors has been opened.

 The anti-theft alarm system is **not** activated when the vehicle is locked with the power lock switch  on the inside of the driver or front passenger doors.

 If the driver door is mechanically unlocked using the vehicle key bit, only the driver door is unlocked, but not the entire vehicle. Switching on the ignition deactivates the anti-theft alarm system and activates the central locking button. To unlock the doors, use the central locking button or remote control vehicle key.

 If the vehicle battery is dead or weak, the anti-theft alarm system will not work properly.

# Doors

## Introduction

---

In this section you'll find information about:

- Warning light
- Child safety lock

### More information:

- Exterior views
- Vehicle key set
- Power locking and closing system
- Power windows
- Emergency closing and opening

 **WARNING**

A door that is not closed properly may open suddenly when the vehicle is moving and cause severe injuries.

- Stop immediately and close the door.
- Make sure that the door is safely and completely latched when closed. The closed door must be flush with the surrounding auto body parts.
- Open or close doors only if no one is in the way.

 **WARNING**



A door kept open with the door stop may close in strong winds or on inclines and cause injuries.

- Always hold doors by the door handle while opening and closing.

## Warning light

---

 Please first read and note the introductory information and heed the WARNINGS 

Lights up	Possible cause	Proper response
	At least one vehicle door is open or improperly closed.	 <b>Stop!</b> Open and close the door again.

When the ignition is switched on, several warning and indicator lights come on briefly for a function check. They go out after a few seconds.

If a door is not closed properly, the red warning light  comes on in the instrument cluster display showing an open door.

Depending on your vehicle's equipment and options, a symbol may be displayed in the instrument cluster instead of the warning light. The symbol will still be displayed even after the ignition is switched off. The Premium instrument cluster display goes out about 15 seconds after the vehicle has been locked.

## Child safety lock

---

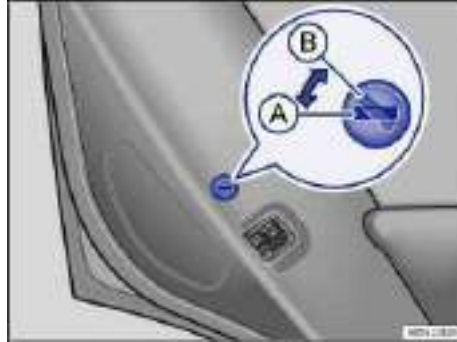

**Fig. 29** In the left rear door: Child safety lock A deactivated, B activated.

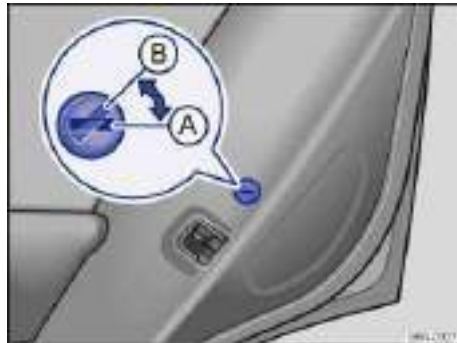

**Fig. 30** In the right rear door: Child safety lock A deactivated, B activated.

 **Please first read and note the introductory information and heed the WARNINGS **

The child safety lock keeps the rear doors from being opened from the inside, so that children cannot open them accidentally. When the child safety lock is engaged, the rear doors can only be opened from the outside.

### Engaging or disengaging child safety lock

- Unlock the vehicle and open the respective rear door.
- Unfold the key bit from the remote control vehicle key.
- Using the key bit, move the slot into the desired position.

Slot position ⇒ [fig. 29](#) or ⇒ [fig. 30](#):

(A) Child safety lock disengaged.

(B) Child safety lock engaged.

 **WARNING**

**When the child safety lock is engaged, that rear door cannot be opened from the inside.**

- **Never leave children, disabled persons, or anyone who cannot help themselves, in the vehicle when locking the doors. This could result in people being locked in the vehicle. This could result in people being trapped in the vehicle in an emergency. Depending on the time of year, people trapped in the vehicle can be exposed to very high or very low temperatures.**
- **A closed vehicle can become very hot or very cold, depending on the season. Particularly in the summer, heat buildup in the passenger and luggage compartment of a parked vehicle can result in temperatures in the vehicle that are much higher than the outside temperatures. Temperatures can quickly reach levels that can cause unconsciousness and death, particularly to small children.**

## Rear hatch

### Introduction

---

In this section you'll find information about:

Warning light

Opening the rear hatch

Closing the rear hatch

#### More information:

- Exterior views
- Power locking system
- Transporting
- Emergency closing and opening



#### WARNING

Accidents and severe personal injuries can result if you unlock, open, or close the rear hatch when someone is in the way.

- Only open or close the rear hatch if no one is in the way.
- After closing the rear hatch, always make sure that it is properly closed and locked so that it cannot open suddenly when the vehicle is moving. The closed rear hatch must be flush with the surrounding auto body parts.
- Always keep the rear hatch closed while driving to help keep poisonous exhaust gas from being drawn into the vehicle.
- Never open the rear hatch when a luggage rack is installed and loaded. If, for example, there are bicycles on a carrier on the rear hatch, it is possible that the hatch may be difficult to open. An open rear hatch may fall on its own because of the additional weight. The open rear hatch must be supported or the weight must be removed from the luggage rack first.
- Close and lock the rear hatch and all doors when the vehicle is not in use. First, make sure that no one is left inside the vehicle.
- Never leave your vehicle unattended or let children play around your vehicle, especially when the rear hatch is open. A child could crawl into the vehicle and pull the rear hatch shut, becoming trapped and unable to get out. A closed vehicle can become very hot or very cold, depending on the season. Particularly in the summer, heat buildup in the passenger and luggage compartment of a parked vehicle can result in temperatures in the vehicle that are much higher than the outside temperatures. Temperatures can quickly reach levels that can cause unconsciousness and death, particularly to small children.
- Never leave children or anyone who cannot help themselves behind in the vehicle. They may lock the vehicle with the vehicle key or the power locking button and lock themselves in.



#### NOTICE



Before opening or closing the rear hatch, make sure there is enough room to do so, as for example when the vehicle has a trailer or is in a garage.

 **NOTICE**

Never use the gas strut to hold or clamp a load in place. This can damage the rear hatch and make it impossible to close.

## Warning light

 Please first read and note the introductory information and heed the WARNINGS 

Lights up	Possible cause	Proper response
  <b>OR</b>  icon appears in the display	Rear hatch open or improperly closed.	 <b>Stop!</b> Open the rear hatch and then close it again.

When the ignition is switched on, several warning and indicator lights come on briefly for a function check. They go out after a few seconds.

If the rear hatch is not closed properly, the red  warning light comes on in the instrument cluster or the vehicle icon appears in the instrument cluster display showing an open rear hatch.

Depending on your vehicle's equipment and options, the red warning light or icon may still be displayed even after the ignition is switched off as long as the key has not been taken out of the ignition. The icon in the instrument cluster display goes out about 15 seconds after the vehicle has been locked.

 **WARNING**

If the rear hatch is not closed properly, it may open suddenly when the vehicle is moving and cause severe injuries.

- Stop immediately and close the rear hatch.
- Always make sure the rear hatch is securely latched after you close it.



## Opening the rear hatch



Fig. 31 In the remote control vehicle key: Button to unlock and open the rear hatch.



Fig. 32 Opening rear hatch from the outside.

**⚠ Please first read and note the introductory information and heed the WARNINGS ⚠**

Always remove any item(s) being transported on the rear hatch before opening it ⇒ ⚠.

### Unlocking with the remote control vehicle key

Briefly press the  or  button on the remote control vehicle key ⇒ [fig. 31](#) to **unlock** the rear hatch.

### Opening with the button on the rear hatch

- Unlock the vehicle or the rear hatch, or open a door.
- Lift the rear hatch slightly at the button ⇒ [fig. 32](#) (arrow).

### **⚠ WARNING**

**Improper or unsupervised unlocking or opening of the rear hatch can cause severe injuries. Never open the hatch when someone is in the way.**

- If a bicycle or luggage rack is installed on the rear hatch, it may be hard to see that the rear hatch is unlatched. An unlatched rear hatch may open suddenly when the vehicle is moving.

### **ⓘ NOTICE**

**Before opening or closing the rear hatch, make sure there is enough room to do so, as for example when the vehicle has a trailer or is in a garage.**

**ⓘ** At temperatures below +32 °F (0 °C), the rear hatch may not open automatically after you unlock it. It will be necessary to lift it by hand.

## Closing the rear hatch

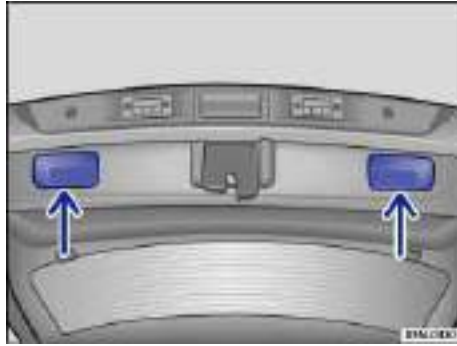

Fig. 33 Opened rear hatch: Recessed grips for closing.

ⓘ Please first read and note the introductory information and heed the WARNINGS ⚠

### Closing the rear hatch

- Grasp one of the recessed grips in the trim of the rear hatch ⇒ fig. 33 (arrows).
- Pull the rear hatch down and close it securely so that the latch engages.
- Check the rear hatch to make sure it is securely latched.

### Locking the rear hatch

If you unlock the vehicle with the vehicle key, but do not open either a door or the rear hatch in about the next 30 seconds, the vehicle is automatically locked again. This feature helps prevent you from leaving the vehicle unlocked unintentionally.

It is only possible to lock the rear hatch when it is securely closed and latched.

- The power locking system also locks the rear hatch.
- If the rear hatch of a locked vehicle is unlocked with the  button on the remote control vehicle key, it will lock again right after it is closed.
- A closed but unlocked rear hatch automatically locks at speeds about 5 mph (10 km/h).

### WARNING

**Improper or unsupervised closing of the rear hatch can cause severe injuries. Never close the hatch when someone is in the way.**

- **Never leave your vehicle unattended or let children play around your vehicle, especially with the rear hatch left open. A child could crawl into the vehicle and pull the rear hatch shut, becoming trapped and unable to get out. A closed vehicle can become very hot or very cold depending on the season. Temperatures can quickly levels that can cause unconsciousness or death, particularly to small children.**

 Make sure that the remote control vehicle key is not in the luggage compartment before closing the rear hatch.

## Power windows

### Introduction

---

In this section you'll find information about:

- Opening and closing power windows
- Power windows – features
- Power window pinch protection

#### More information:

- Volkswagen Information System
- Power locking and closing system

#### WARNING

Improper use of power windows can result in serious personal injury.

- Never let anyone get in the way of a power window when closing it.
- When locking the vehicle from the outside, make sure that no one, especially children, remains in the vehicle. The windows will not open in case of an emergency.
- Always take the key with you when you leave the vehicle. You can still use the power windows for several minutes after the ignition is switched off as long as the driver or front passenger door has not been opened.
- Always use the safety switch when children are in the back seat to disable the rear power windows and keep them from being opened and closed.

#### NOTICE

If you leave the windows open, rain or other precipitation may enter the vehicle from outside and can damage the vehicle interior.

### Opening and closing power windows

---

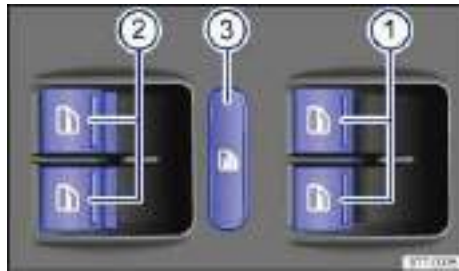

Fig. 34 In the driver door: Switches for front and rear power windows.



 Please first read and note the introductory information and heed the WARNINGS 

## Switches in the driver door

Key to fig. 34:

- (1) For the windows in the front doors.
- (2) For the windows in the rear doors.
- (3) Safety switch.

## Opening or closing windows

Function	Action
Opening:	Press the  switch.
Closing:	Pull the  switch.
Stopping automatic window movement:	Press or pull the switch again.
	The safety switch (3) deactivates the power windows in the rear doors. The yellow indicator light in the switch comes on.

The power windows operate only when the ignition is switched on.

You can still use the power windows for several minutes after the ignition is switched off as long as the driver or front passenger door has not been opened. When the vehicle key has been removed from the ignition and the driver door has been opened, the power windows cannot be opened or closed.



A separate button for controlling the window is located in the front passenger door.

## Power windows – features

 Please first read and note the introductory information and heed the WARNINGS

### One-touch opening and closing

The one-touch feature automatically opens/closes a power window all the way. The window switch does not have to be held down/up.

**For one-touch closing:** Pull the switch for the window up briefly as far as it goes.

**For one-touch opening:** Press the switch for the window down briefly as far as it goes.

**Stopping automatic movement:** Pull/press the switch again.

### Reactivating the one-touch feature

If the vehicle battery is disconnected or dead and the windows are not completely closed, the one-touch feature will not work and must be reactivated:

- Close all windows and doors.
- Pull up the switch for the respective window and hold it for at least 2 seconds in this position.
- Release the switch, pull up and hold again. The one-touch feature is now reactivated.

The one-touch feature can be reactivated for one or more windows at the same time.

## Convenience closing

The convenience closing feature lets you close the windows and the power sunroof as follows:

- From inside the vehicle, pull up and hold the switch for the driver window until all windows and the sunroof are closed ⇒ *Power locking and closing system*.

From outside the vehicle (vehicles with Keyless Access), hold your finger on the lock sensor surface on the outside of the door handle for a few seconds until the windows close 46.

Convenience closing first closes the windows and then the power sunroof.

 **WARNING**

**Improper use of power windows can result in serious personal injury.**

- **Never let anyone get in the way of a power window when closing it.**
- **When locking the vehicle from the outside, make sure that no one, especially children, remains in the vehicle. The windows will not open in case of an emergency.**
- **Always take the key with you when you leave the vehicle. You can still use the power windows for several minutes after the ignition is switched off as long as the driver or front passenger door has not been opened.**
- **Always use the safety switch when children are in the back seat to disable the rear power windows and keep them from being opened and closed.**

 If the power windows malfunction, the one-touch feature, as well as pinch protection, will not work properly. See an authorized Volkswagen dealer or authorized Volkswagen Service Facility right away.

## Power window pinch protection

 Please first read and note the introductory information and heed the **WARNINGS** 

Pinch protection can help reduce the risk of pinching injuries when closing a power window ⇒ . If one-touch window closing meets resistance or there is something in the way, the window will stop and go down again.

- Check why the window did not close.
- Try one-touch window closing again.
- If the window meets resistance a second time, so that it stops and goes back down, one-touch closing is deactivated for about 10 seconds.
- If you pull the power window button up all the way and hold it during this 10 second interval, the window will close **without pinch protection** ⇒ .

### Closing the window without pinch protection

- Try to close the window again within 10 seconds by holding the switch. **Pinch protection is turned off for a short distance in the window track!**
- If closing takes longer than about 10 seconds, pinch protection is turned on again. The window stops again if there is resistance.
- If the window still will not close, please see an authorized Volkswagen dealer or an authorized Volkswagen Service Facility.

 **WARNING**

Without pinch protection, power windows will close with enough force to cause serious personal injury.

- Always be careful when closing power windows.
- Always make sure that no one is in the way when overriding pinch protection to close power windows!
- Pinch protection cannot prevent fingers or other parts of the body from being pressed against the window frame; injuries may result.

 Pinch protection is also active during convenience closing of the windows and the power sunroof  
⇒ *Convenience closing.*

## Power sunroof

### Introduction

---

In this section you'll find information about:

Opening or closing the power sunroof

Opening or closing the power sunroof

Opening or closing the power sunshade

Opening or closing the power sunshade

Power sunroof – convenience closing feature

Pinch protection for the power sunroof and the power sunshade

Initializing the power sunroof

#### **More information:**

- Volkswagen Information System
- Power locking and closing system
- Roof rack
- Emergency closing and opening



#### **WARNING**

**Improper use of the power sunroof can result in serious personal injury.**

- Always make sure that no one is in the way of the power sunroof when it is closing.
- Always take the key with you when you leave the vehicle.
- Never leave children or disabled persons in the vehicle – particularly if they have access to the vehicle key. Unsupervised use of the remote control vehicle key makes it possible to lock the vehicle, start the engine, turn on the ignition and operate the sunroof.
- You can still open or close the power sunroof for several minutes after you switch off the ignition, as long as the driver or front passenger door has not been opened.



#### **NOTICE**

- To help prevent damage, remove ice and snow from the sunroof before opening it in winter weather.
- Always close the sunroof before leaving the vehicle or if it begins raining. If the sunroof is open, rain could enter the vehicle interior and cause extensive damage to the electrical system. This could result in further vehicle damage.



Remove leaves and other objects from the sunroof guide rails regularly either by hand or using a vacuum cleaner.



If the power sunroof malfunctions, pinch protection does not function properly. See an authorized Volkswagen dealer or an authorized Volkswagen Service Facility.

## Opening or closing the power sunroof

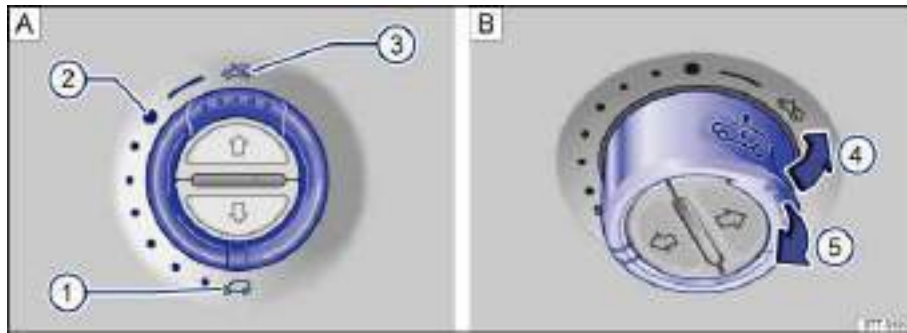

**Fig. 35** In the headliner: Rotary switch for the power sunroof. A: Turn the rotary switch to slide the sunroof open or closed. B: Press or pull the switch to tilt open or to close.

**⚠ Please first read and note the introductory information and heed the WARNINGS ⚠**

The rotary switch must be turned to its home position (3) in order to tilt the power sunroof.

Function	Switch position	Action
	⇒ fig. 35 A	
To open sliding sunroof fully:	(3)	Turn the switch past position (2) and hold it there until the glass roof moves to the desired position.
To move the sliding sunroof to comfort position:	(2)	Turn the switch to the desired position.
To set an intermediate position:	(2) to (1)	
To close the sliding sunroof fully:	(1)	
<b>B</b>		
To tilt open the tilting roof fully:	(4)	Push the rear part of the switch briefly.
To stop the one-touch feature:	(4) or (5)	Push or pull switch again briefly.
To set an intermediate position:	(4) to (5)	Pull or push the rear part of the switch briefly until the desired position is reached.
To close fully:	(5)	Pull the rear part of the switch briefly.



The power sunroof only works when the ignition is on. You can still open or close the power sunroof for several minutes after you switch off the ignition, as long as the driver or front passenger door has not been opened.

All procedures are interrupted as soon as the rotary switch is operated.

The sunshade opens automatically when the power sunroof opens if the shade was previously completely closed or in front of the glass roof. The sunshade remains in the previous position and does not close automatically with the sunroof. The sunshade cannot be closed completely until the power sunroof is closed.

If your power sunroof will not close properly, do not try to close it yourself, doing so can cause serious and expensive damage that will not be covered by any Volkswagen Limited Warranty. Special knowledge and tools are required to close the power sunroof if it will not close on its own. To help prevent damage to the sunroof, have an authorized Volkswagen dealer or an authorized Volkswagen Service Facility help you close and repair the power sunroof.

 The comfort position (2) provides sufficient ventilation without loud wind noise.

## Opening or closing the power sunshade

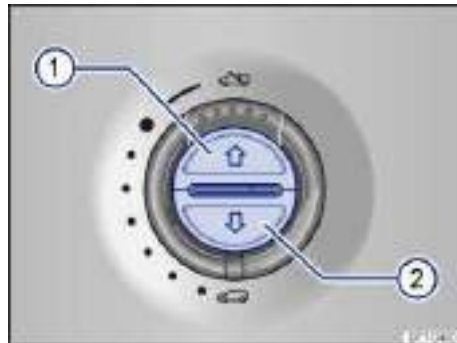

Fig. 37 In the headliner: Buttons for sunshade.

 Please first read and note the introductory information and heed the WARNINGS 

Function	Response
To open fully (one-touch feature):	Briefly press the ⇒ fig. 37 (1) button.
To stop the one-touch feature:	Briefly press the (1) button or the (2) button.
To set an intermediate position:	Keep the (1) button or (2) button pressed until the position has been reached.
To close fully (one-touch feature):	Briefly press the (2) button.

You can still use the sunshade for several minutes after the ignition is switched off as long as the driver or passenger door has not been opened.

When the power sunroof is completely open the sunshade is automatically moved to a ventilation position.

When the power sunroof is in the tilt position the sunshade will also open a small gap.

 When the power sunroof is open, the power sunshade can only be closed up to the front edge of the glass roof.

## Power sunroof – convenience closing feature

---

 Please first read and note the introductory information and heed the WARNINGS 

### Convenience closing

The convenience closing feature lets you close the power sunroof as follows:

- Turn the vehicle key bit in the lock of the driver door to the closing position and hold it there ⇒ *Power locking and closing system*. The power sunroof is closed. Release the vehicle key in order to stop the process.
- Vehicles with Keyless Access: hold your finger on the lock sensor surface on the outside of the door handle for a few seconds until the windows and power sunroof close ⇒ *Unlocking or locking the vehicle with Keyless Access*.

Convenience closing first closes the windows and then the power sunroof.

 Convenience closing of the power sunroof from the outside leaves the rotary switch in the last selected position. The switch must be newly positioned when starting to drive again.

 If convenience closing of the power sunroof requires removing the cover cap of the lock cylinder on the driver door, the cover cap must be reinstalled after the vehicle is locked ⇒ *Manually unlocking and locking the driver door*.

## Pinch protection for the power sunroof and the power sunshade

---

 Please first read and note the introductory information and heed the WARNINGS 

Pinch protection can help reduce the risk of pinching injuries when closing the power sunroof and the sunshade ⇒ . If the power sunroof or the sunshade closing meets resistance or there is something in the way, the sunroof and sunshade open again immediately.

- Check why the power sunroof or the sunshade did not close.
- Try to close the power sunroof or the sunshade again.
- If the power sunroof or the sunshade still cannot close, the sunroof or sunshade will stop where the resistance is located. The power sunroof or the sunshade will close the next time without pinch protection.

### Opening and closing the power sunroof without pinch protection

- The switch ⇒ [fig. 36](#), ⇒ [fig. 35](#) must be rotated to the “Closed” position (1) **A**.

- **Power sunroof:** Within 5 seconds after the pinch protection was triggered, pull the rear part of the switch ⇒ [fig. 36 \(5\)](#), ⇒ [fig. 35 \(5\) B](#) until the sunroof is fully closed.
- **Sunshade:** Within 5 seconds after the pinch protection was triggered, press the ⇒ [fig. 37 \(2\)](#), ⇒ [fig. 38 \(2\)](#) switch until the sunshade is fully closed.
- **The power sunroof or sunshade will now close without pinch protection!**
- If the power sunroof still will not close, please see an authorized Volkswagen dealer or an authorized Volkswagen Service Facility.

If you let go of the switch while the roof is closing, the power sunroof opens automatically.



### WARNING

**Without pinch protection, the power sunroof and sunshade will close with enough force to cause serious personal injury.**

- **Always be careful when closing the power sunroof.**
- **Always make sure that no one is in the way when overriding the pinch protection to close the power sunroof or the sunshade!**
- **Pinch protection cannot prevent fingers or other parts of the body from being pressed against the edge of the roof; injuries may result.**



Pinch protection is also active during convenience closing of the windows and the power sunroof ⇒ *Power windows – features*.



If the power sunroof malfunctions, pinch protection may not function properly. See an authorized Volkswagen dealer or an authorized Volkswagen Service Facility for assistance.

## Initializing the power sunroof

📖 Please first read and note the introductory information and heed the WARNINGS ⚠️

### Initializing the sunroof

If the vehicle battery has been disconnected or is dead, the sunroof must be initialized.

- The switch ⇒ [fig. 36](#), ⇒ [fig. 35](#) must be rotated to the “Closed” position (3) A.
- Pull the switch at the rear until the sunroof is fully closed.
- **The power sunroof or sunshade will now close without pinch protection!**
- Release the switch.
- Pull and hold the switch at the rear. The sunroof will open and close on its own.
- When the sunroof is closed once again, release the switch.
- If the sunroof still will not close, contact an authorized Volkswagen dealer or an authorized Volkswagen Service Facility.

 **WARNING**

Careless or unsupervised use of the sunroof can cause serious injuries.

- Always make sure that no one is in the way of the power sunroof when it is closing.
- Always take all vehicle keys with you when leaving the vehicle.
- Never leave children or persons requiring assistance unattended in the vehicle, especially if they have access to the remote control vehicle key. Unsupervised use of the remote control vehicle key can lock the vehicle, start the engine, switch on the ignition and operate the sunroof.
- The sunroof can still be opened or closed for a short period after the ignition has been switched off, as long as the driver or passenger door is not opened.

 **WARNING**

Closing the sunroof without pinch protection can cause severe injuries.

- Always be careful when closing the sunroof.
- Always make sure that no one is in the way when overriding pinch protection to close the sunroof.
- Pinch protection does not prevent fingers or other body parts from being pressed against the roof frame, thereby causing injury.

 If the sunroof malfunctions or pinch protection does not operate properly. See an authorized Volkswagen dealer or an authorized Volkswagen Service Facility for assistance.

 If the power sunroof malfunctions, pinch protection may not function properly. See an authorized Volkswagen dealer or an authorized Volkswagen Service Facility for assistance.

# Adjusting the seating position

## Introduction

---

In this section you'll find information about:

- Examples of improper seating positions
- Proper seating position
- Manual controls on the driver and front passenger seats
- Electrical controls on the driver and front passenger seats
- Adjusting the rear seat
- Adjusting front and rear head restraints
- Removing and reinstalling head restraints
- Adjusting the steering wheel position
- Center armrest

### Number of seats

The vehicle has a total of **5** seating positions: 2 in front and 3 in the rear. Each seating position has a safety belt.

### More information:

- Seat functions
- Safety belts
- Airbag system
- Child safety and child restraints



### WARNING

**Improper seating positions increase the risk of severe or fatal injuries in a crash or other accidents, especially when the airbag deploys.**

- **All occupants must sit properly and be properly restrained at all times.**
- **Never let more people ride in the vehicle than there are seating positions with safety belts available.**
- **Always secure children in the vehicle with an approved and suitable restraint system appropriate for their age, weight, and height ⇒ *Child safety and child restraints*, ⇒ *Airbag system*.**
- **Always keep your feet on the floor in front of the seat. Never rest them on the seat, instrument panel, out of the window, etc. The airbag system and safety belt will not be able to protect you properly and can even increase the risk of injury in a crash.**

 **WARNING**

Always adjust seat, safety belts and head restraints properly before driving and make sure that all passengers are properly restrained.

- Push the passenger seat as far back as possible. Always be sure that there are at least 10 inches (25 cm) between the front passenger's breastbone and the instrument panel.
- Always adjust the driver's seat and the steering wheel so that there are at least 10 inches (25 cm) between your breastbone and the steering wheel.
- Adjust the driver's seat so that you can easily push the pedals all the way to the floor while keeping your knee(s) slightly bent. The distance to the instrument panel in the knee area must be at least 4 inches (10 cm).
- If these requirements cannot be met for physical reasons, contact an authorized Volkswagen dealer or an authorized Volkswagen Service Facility to see whether adaptive equipment is available.
- Always hold the steering wheel on the outside of the steering wheel rim with your hands at the 9 o'clock and 3 o'clock positions to help reduce the risk of personal injury if the driver's airbag inflates.
- Never hold the steering wheel at the 12 o'clock position or with your hands at other places inside the steering wheel rim or on the steering wheel hub. Holding the steering wheel the wrong way can cause serious injuries to the hands, arms, and head if the driver airbag inflates.
- Pointing the steering wheel toward your face decreases the ability of the driver's airbag to help protect you in a collision.
- Never drive with backrests reclined or tilted back farther than necessary to drive comfortably. The farther back the backrests are tilted, the greater the risk of injury caused by incorrect positioning of the safety belts and improper seating position.
- Never drive with the front seat passenger backrest tilted forward. If the front airbag deploys, the front backrest can be forced backward and injure passengers on the rear seat.
- Sit as far back as possible from the steering wheel and the instrument panel.
- Always sit upright with your back against the backrest with the front seats properly adjusted. Never lean against or place any part of your body too close to the area where the airbags are located.
- Rear seat passengers who are not properly seated and restrained are more likely to be seriously injured in a crash.

 **WARNING**

Improper adjustment of the seats can cause accidents and severe injuries.

- Never adjust the seats while the vehicle is moving. Your seat may move unexpectedly and you could lose control of the vehicle. In addition, you will not be in the correct seating position while adjusting the seats.
- Adjust the front seat height, angle and longitudinal direction only if the seat adjustment area is clear.
- The adjustment of the front seats must not be restricted by things in the footwell in front or behind the seats.



## WARNING

Some kinds of cigarette lighters can be lit unintentionally, or crushed causing a fire that can result in serious burns and vehicle damage.

- Always make sure that there are no lighters in the seat tracks or near other moving parts before adjusting the seats.
- Before closing a storage compartment, always make sure that no cigarette lighter can be activated, crushed, or otherwise damaged.
- Never leave a cigarette lighter in a storage compartment, on the instrument panel or in other places in the vehicle. Heat buildup in the passenger and luggage compartment of a parked vehicle can result in temperatures in the vehicle that are much higher than the outside temperatures, particularly in summer. High temperatures could cause the cigarette lighter to catch fire.

## Examples of improper seating positions

---

 Please first read and note the introductory information and heed the WARNINGS 

Not wearing or improperly fastening safety belts increases the risk of severe or fatal injuries. Safety belts can work only when they are properly positioned on the body. An improper seating position significantly impairs the protection provided by safety belts. This can cause severe or even fatal injuries. Improper seating positions also increase the risk of serious injury or death when an airbag deploys and strikes an occupant who is not in the proper seating position. The driver is responsible for all passengers and especially children riding in the vehicle.

The following are only some examples of seating positions that will increase the risk of serious injury or death.

### Therefore, whenever the vehicle is moving

- Never stand up in the vehicle.
- Never stand on the seats.
- Never kneel on the seats.
- Never ride with the seat backrest reclined.
- Never lean up against the instrument panel.
- Never lie down on the rear seat.
- Never sit on the edge of the seat.
- Never sit sideways.
- Never lean out the window.
- Never put your feet out the window.
- Never put feet on the instrument panel.
- Never rest your feet on the seat cushion or back of the seat.
- Never ride in the footwell.
- Never sit on the front or rear center armrest.
- Never ride without your safety belt properly fastened.
- Never ride in the luggage compartment.

**⚠ WARNING**

Contact with parts of the vehicle interior can cause serious personal injury in a crash.

- Always make sure that all vehicle occupants stay in a proper seating position and are properly restrained whenever the vehicle is moving.
- Improper seating positions increase the risk of serious and fatal injury, especially when an airbag deploys and strikes a passenger in an improper seating position.

## Proper seating position

---

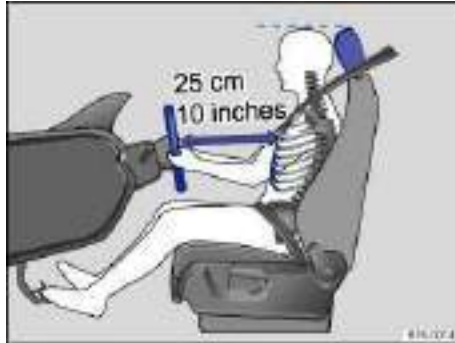

Fig. 39 The driver should never sit closer than 10 inches (25 cm) of the steering wheel.

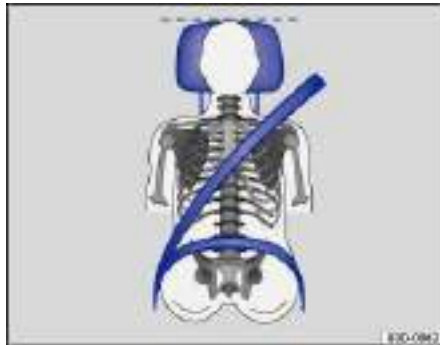

Fig. 40 Proper safety belt positioning and head restraint adjustment.

**⚠ Please first read and note the introductory information and heed the WARNINGS ⚠**

The following describes the proper seating positions for the driver and front seat passengers.

If you have a physical impairment or condition that prevents you from sitting properly on the driver seat with the safety belt properly fastened and reaching the pedals, special modifications to your vehicle may be necessary. Only the proper seating position ensures optimum protection by the safety belt and airbag.

Contact your authorized Volkswagen dealer or authorized Volkswagen Service Facility or call the Volkswagen Customer CARE Center at 1-800-822-8987 for information about possible modifications to your vehicle.



For your own safety and to reduce injuries in the event of sudden braking maneuvers or accidents, Volkswagen recommends the following seating positions:

**Applies to all vehicle occupants:**

- Adjust head restraints so that the upper edge of the head restraint is at least at eye level or higher. Position the back of your head as close as possible to the head restraint ⇒ [fig. 39](#) and ⇒ [fig. 40](#).
- Push the head restraint completely down for short people, even if the top of the head is then below the upper edge of the head restraint.
- Tall people should pull the head restraint all the way up.
- Adjust the seat backrest angle to an upright position so that your back is in full contact with it when the vehicle is moving.
- Always keep both feet on the floor and in the footwell whenever the vehicle is moving.
- Always adjust and fasten safety belts properly ⇒ *Safety belts*.

**Driver - Seat and steering wheel adjustment:**

- Adjust the steering wheel so that there are at least 10 inches (25 cm) between the steering wheel and your breast bone ⇒ [fig. 39](#). When adjusting the proper distance to the steering wheel, grasp the top of the steering wheel with your elbows slightly bent.
- Always hold the steering wheel on the outside of the steering wheel rim with your hands at the 9 o'clock and 3 o'clock positions to help reduce the risk of personal injury if the driver's airbag inflates.
- Never hold the steering wheel at the 12 o'clock position or with your hands at other places inside the steering wheel rim or on the steering wheel hub. Holding the steering wheel the wrong way can cause serious injuries to the hands, arms, and head if the driver's airbag inflates.
- Adjust the steering wheel so that the steering wheel cover points at your chest and not at your face. Pointing the steering wheel toward your face decreases the ability of the driver's airbag to help protect you in a collision.
- Adjust the driver's seat so that you can easily push the pedals all the way to the floor while keeping your knee(s) slightly bent.
- Adjust the seat height so that the top point of the steering wheel can be reached.
- Always keep both feet in the footwell so that you are in control of the vehicle at all times.

**Passenger - front seat adjustment:**

- Push the passenger seat as far back as possible in order to ensure optimum protection if the airbag is deployed.

## Manual controls on the driver and front passenger seats

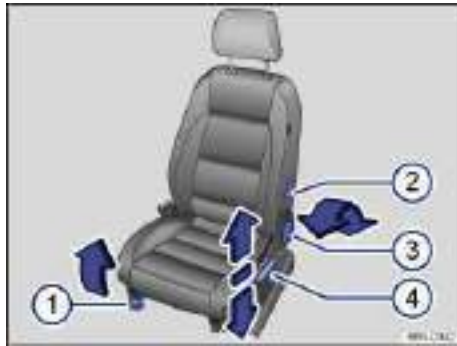

Fig. 41 Controls on the left front seat.

**⚠ Please first read and note the introductory information and heed the WARNINGS ⚠**

The controls on the front passenger seat mirror those on the driver seat.

There may be manual and electrical controls on the same seat.

⇒ fig. 41	Function	Action
(1)	Move the front seat backward or forward.	Pull the lever up and move the front seat. The front seat must lock in place after the lever is released!
(2)	Lumbar support control.	Push the lever forward or pull it backward.
(3)	Adjust backrest angle.	Lean forward and turn the adjuster wheel forward or backward.
(4)	Adjust seat height.	Move the lever several times up or down.

## Electrical controls on the driver and front passenger seats

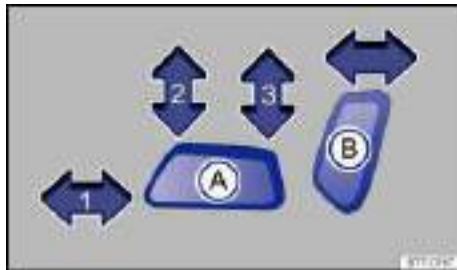

Fig. 42 Driver seat controls to adjust the seat backward and forward, change seat cushion height and angle, and adjust backrest angle.

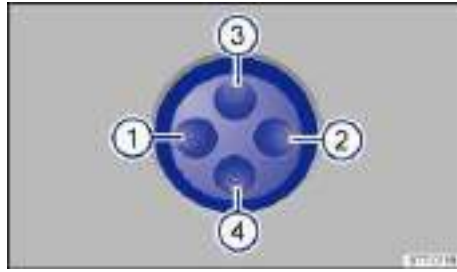

Fig. 43 Lumbar support control.

**⚠ Please first read and note the introductory information and heed the WARNINGS ⚠**

The controls on the front passenger seat mirror those on the driver seat.

There may be both manual and electrical controls on the same seat.

fig. 42 Press the switch in the direction of the arrow:

(A)	(1)	Slide the seat backward or forward.
	(2) and (3)	Raise or lower the seat cushion.
	(2) or (3)	Adjust seat cushion angle.
(B)	<i>Forward or backward.</i>	Adjust backrest angle.

Press fig. 43 switch for each area:

(1) or (2)	Adjust lumbar support.
(3) or (4)	Adjust lumbar support height.

### **⚠ WARNING**

Improper use of electrical seat controls can cause serious personal injuries.

- The front seats in your vehicle can be electrically adjusted even when the vehicle key has been removed from the ignition or, on a vehicle with Keyless Access, even if there is no key in the vehicle.
- Never leave children and persons who need help in the vehicle alone because the unsupervised use of the electric seat adjustments can result in serious personal injury.
- Always make sure that no one is in the way while the front seats are being adjusted, or while calling up the stored memory settings for the front seats. In an emergency, stop automatic seat adjustment by pressing a seat adjustment switch.

## NOTICE

To help prevent damage to electrical parts in the seat, do not kneel on the front seats or apply concentrated pressure to a small area of the seat or backrest.

 If the vehicle battery is too weak, the electrical seat adjustment controls may not work.

 Starting the engine stops seat adjustment.

 When entering and exiting the vehicle, be careful not to come into contact with any switches that could change the seat adjustment.

## Adjusting the rear seat

---

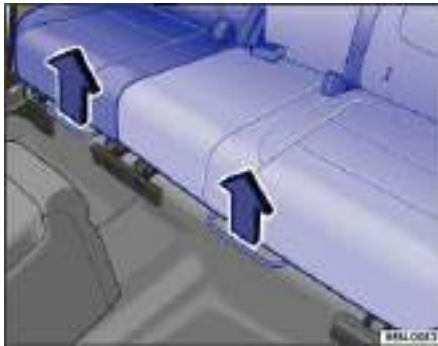

Fig. 44 Adjusting the rear seat.



Fig. 45 Adjusting the rear backrest.

 Please first read and note the introductory information and heed the WARNINGS 

The rear seat is divided asymmetrically into 2 sections. Each section can be adjusted separately.

Pull right or left lever upwards ⇒ [fig. 44](#) and push the respective rear seat section forward or backward. Release the lever and lock the rear seat section by gently sliding it forward or backward.

Place one hand on the right or left rear backrest and pull the respective pull strap with the other hand ⇒ [fig. 45](#). Move the rear backrest to the desired position by hand against the force of the spring. Release the pull strap and lock the rear backrest by gently tilting it forward or backward.

### **WARNING**

**Improper adjustment of the rear seat can cause accidents and severe injuries.**

- Adjust the rear seat only when the vehicle is stopped, since the seat could otherwise move unexpectedly when the vehicle is moving.
- Adjust the rear seat only if no one is in the way.
- Always guide the backrest down by hand and never let it fall into place on its own.

### **NOTICE**

Items in the luggage compartment could be damaged or cause damage when the rear seat is adjusted in the fore and aft direction.

- If the rear seat is in a forward position, items can get into the area between the seat and the luggage compartment floor. When you slide the rear seat back again, make sure that the area behind the seat is clear of objects.

## Adjusting front and rear head restraints

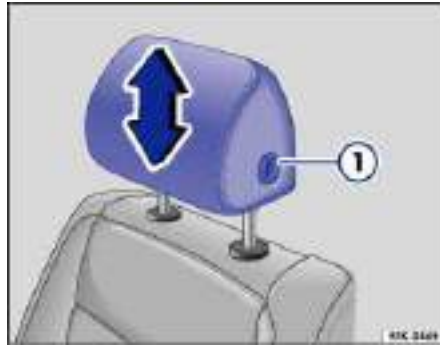

**Fig. 46** Adjusting the front head restraints.

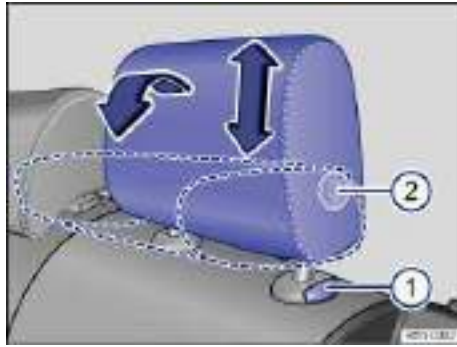

Fig. 47 Adjusting or folding the rear head restraints.

⚠ Please first read and note the introductory information and heed the WARNINGS ⚠ 69.

All seats are equipped with head restraints. The rear center head restraint is designed only for the center seat on the rear bench. Therefore, only install the center head restraint in the center position.

There are notches in the head restraint guide rods so that the head restraint can lock into place. Only properly installed head restraints can lock into place at the adjustment range notches. In order to prevent inadvertent removal of the head restraints after installation, there are stops at the top and bottom of the adjustment range.

#### Adjusting the height

- Push the head restraint up in the direction of the arrow or down when the button ⇒ fig. 46 (1) or ⇒ fig. 47 (1) is pressed ⇒ ⚠.
- The head restraint must lock securely in the position selected.

#### Folding the outer rear head restraints down

- With the (2) button pressed, fold the head restraint forward and down ⇒ ⚠.
- To use the seating area, fold the head restraint back up until it locks in place.

#### Proper head restraint adjustment

Adjust head restraints so that the upper edge of the head restraint is at least at eye level or higher. Position the back of the head as close as possible to the head restraint.

#### Adjusting the head restraint for short people

Push the head restraint down as far as it will go, even if this means the person's head is still below the top edge of the head restraint. A small gap may remain between the head restraint and the backrest when the head restraint is all the way down.

#### Adjusting the head restraint for tall people

Pull the head restraint up as far as it will go.

**⚠ WARNING**

Driving without head restraints or with improperly adjusted head restraints increases the risk of serious injuries in a collision.

- Always drive with the head restraints in place and properly adjusted to help minimize the risk of neck injury in a crash.
- Every person in the vehicle must have a properly adjusted head restraint to minimize the risk of neck injury in a crash. Each head restraint must be adjusted according to the occupants' size so that the upper edge is even with the top of the person's head, but no lower than eye level. Always sit so that the back of your head is as close as possible to the head restraint.
- Never adjust head restraint while driving.

## Removing and reinstalling head restraints

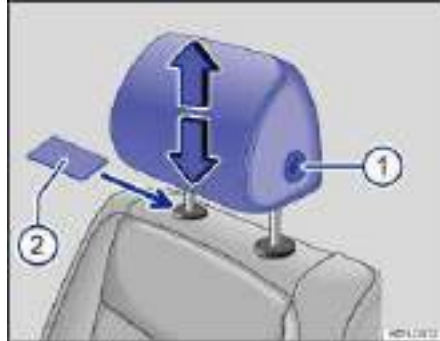

Fig. 48 Removing the front head restraints.



Fig. 49 Removing the rear head restraints.

**⚠ Please first read and note the introductory information and heed the WARNINGS**

All seats are equipped with head restraints. The rear center head restraint is designed only for the center seat on the rear bench. Therefore, only install the center head restraint in the center position.

### Removing the front head restraints

- Sit in the back seat behind the head restraint you want to remove. Pull the head restraint all the way up ⇒  in *Adjusting front and rear head restraints*. Recline the backrest with the head restraint so that there is enough overhead clearance to remove it.
- Slide a flat object, such as a plastic credit card, underneath the right side of the cap on the right-hand seat guide rod ⇒ *fig. 48 (2)* to unlock the head restraint.
- Use one hand to hold the release button in with the flat object. With your other hand, lift the same guide rod slightly to expose a notch in the rod at the bottom (can be seen and felt with fingers). The right-hand guide rod is now released.
- To release the left-hand guide rod, press button (1) in (towards guide rod) and hold.
- Pull the head restraint out completely while holding button (1).

### Installing the front head restraints

- Position head restraint properly over the head restraint guides of the respective seat backrest and insert the head restraint into the guides.
- Push the head restraint down while pressing button (1) or ⇒ *fig. 49 (1)*.
- Adjust the head restraint according to the occupant's size ⇒ *Adjusting front and rear head restraints*.

### Removing the rear head restraint

- Unlock the rear bench and fold it forward ⇒ *Luggage compartment*.
- Pull the head restraint all the way up ⇒ .
- Slide a flat object, such as a plastic credit card, underneath the right side of the cap on the right-hand seat guide rod (2) to unlock the head restraint.
- Use one hand to hold the release button in with the flat object. With your other hand, lift the same guide rod slightly to expose a notch in the rod at the bottom (can be seen and felt with fingers). The right-hand guide rod is now released.
- To release the left-hand guide rod, press button (1) in (towards guide rod) and hold.
- Pull the head restraint out completely while holding button (1).
- Fold the backrest of the rear bench back so that it locks securely.

### Reinstalling the rear head restraint

- Unlock the rear bench and fold it forward ⇒ *Luggage compartment*.
- Position head restraint properly over the head restraint guides of the respective seat backrest and insert the head restraint into the guides.
- Push the head restraint down while pressing button (1).
- Fold the backrest of the rear bench back so that it locks securely.
- Adjust the head restraint according to the occupant's size ⇒ *Adjusting front and rear head restraints*.

## WARNING

**Driving without head restraints or with improperly adjusted head restraints increases the risk of serious injuries in a collision.**

- **Always drive with the head restraints in place and properly adjusted to help minimize the risk of neck injury in crash.**
- **Always reinstall head restraints as soon as possible so that vehicle occupants are properly protected.**



**NOTICE**

When removing or reinstalling the head restraint, take care that the head restraint does not strike the headliner or the back of the front seat. The headliner or other parts of the vehicle could otherwise be damaged.

## Adjusting the steering wheel position

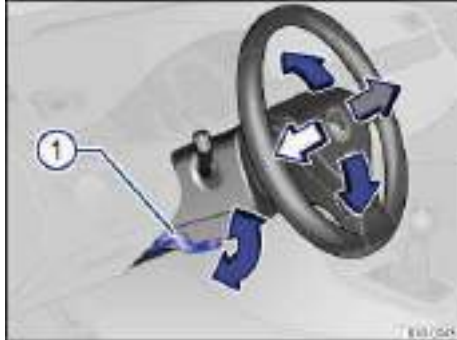

Fig. 50 Manual adjustment for steering wheel position.

**⚠ Please first read and note the introductory information and heed the WARNINGS ⚠**

Adjust the steering wheel only when the vehicle is not moving.

- Push down on the lever ⇒ [fig. 50 \(1\)](#).
- Adjust the steering wheel so that it can be held with hands at 9 o'clock and 3 o'clock positions on the outside of the steering wheel rim and with the arms slightly bent at the elbow.
- Pull the lever up firmly until it is flush with the steering column ⇒ ⚠.

**⚠ WARNING**

Improper use of the steering column adjustment feature can result in serious personal injury and even death.

- Always pull the lever (1) firmly upward after adjusting the steering column so that the steering wheel does not change position suddenly while the vehicle is moving.
- Never adjust the steering column while the vehicle is moving. If you find that you need to adjust the steering wheel while driving, stop the vehicle in a safe place and make the proper adjustment.
- Never adjust the steering wheel so that it points toward your face. Always make sure that the steering wheel points toward your chest. Otherwise, the airbag system cannot protect you properly in the event of a crash.
- Always hold the steering wheel on the outside of the steering wheel rim with your hands at the 9 o'clock and 3 o'clock positions to help reduce the risk of serious personal injury if the driver airbag inflates.
- Never hold the steering wheel at the 12 o'clock position or with your hands anywhere inside the steering wheel or on the steering wheel hub. Holding the steering wheel the wrong way increases the risk of severe injury to the arms, hands, and head if the driver airbag deploys.

## Center armrest

---

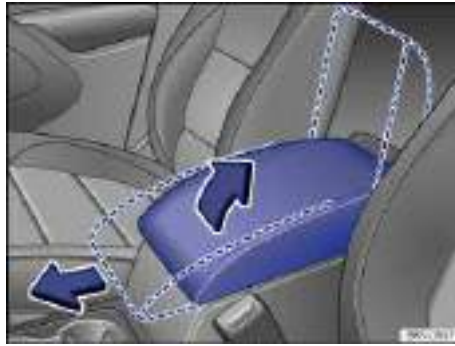

Fig. 51 Front center armrest.



Fig. 52 Folded down rear center armrest with storage compartment (arrow).

**⚠ Please first read and note the introductory information and heed the WARNINGS ⚠**

### Front center armrest

There is a storage compartment under the front center armrest ⇒ *Storage compartment in the front center armrest.*

To *open*, press button and lift the center armrest section up completely in the direction of the arrow ⇒ [fig. 51](#).

To *close*, push the center armrest down until it latches in place.

To *move* the center armrest forwards and backwards, pull it forward or slide it backward until it clicks into place.

### Rear center armrest

There may be a fold-down armrest with cup holders in the backrest of the center rear seat ⇒ *Cup holders in the rear center armrest.*

To *fold down* the center armrest, push the head restraint of the middle seat all the way down

⇒ *Adjusting the seating position* and fold the center armrest forward using the pull strap ⇒ [fig. 52 \(1\)](#).

The cushion can be pulled off the center armrest from above to access the cup holders beneath it  
⇒ *Cup holders in the rear center armrest.* When the cushion is replaced, the notch in the cushion must be on the left (small arrow) and securely latched.

To *fold up*, push the center armrest up as far as it will go.



#### **WARNING**

**The center armrest can restrict the driver's arm movement and cause crashes and serious personal injury.**

- **Always keep storage compartments in the center armrest closed while driving.**
- **Never let a passenger, especially a child, ride on the center armrest. Improper seating position can increase the risk of serious personal injury in a crash.**
- **Never put hot drinks or other liquids in the cup holder. Hot liquids can spill when the vehicle is moving as well as during braking or other sudden maneuvers.**



#### **NOTICE**

**When the center armrest is folded up, the armrest cushion could be soiled or damaged by items in the luggage compartment.**

## Seat functions

### Introduction

---

In this section you'll find information about:

Seat heating

Memory seat

Folding the front passenger backrest forward

#### More information:

- Adjusting the seating position
- Safety belts
- Airbag system
- Child safety and child restraints
- Outside mirrors

#### WARNING

Improper use of seat adjustment controls can cause severe personal injuries.

- Always sit properly at all times before starting to drive and while the vehicle is moving. Make sure all passengers, especially children, are properly seated whenever the vehicle is moving.
- Keep hands, fingers, feet and other body parts away from moving parts and adjustment areas of the seats.

### Seat heating

---

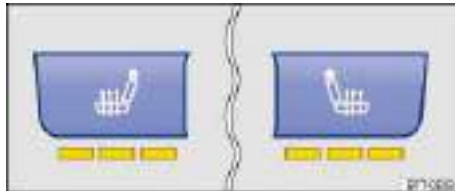

Fig. 53 In the center console: Seat heating control for front seats.







#### Please first read and note the introductory information and heed the WARNINGS

When the ignition is switched on, the front seats can be electrically heated by heating elements that warm the seat backrest and cushion.

Do not use the seat heating if any of the following conditions apply:

- If the seat is not being used.
- If there is a child restraint installed on the front passenger seat.
- If there is a blanket or seat cover on the front passenger seat.

- If the seat is damp or wet.
- If the outside temperature or the temperature inside the passenger compartment is 77 °F (25 °C) or more.

Function	Action for seat heating ⇒ fig. 53
Switch on:	Press the  or  button. Seat heating is switched on to maximum.
Adjusting heating level:	Press the button  or  repeatedly until the desired heating level is set.
Switch off:	Press the button  or  repeatedly until all indicator lights in the button are off.

### Special seat heating features

The seat heating on the passenger side is switched off every time the ignition is switched off. Seat heating must be switched on again each time the ignition is switched on.

On the driver side the seat heating will resume at the setting that was set when the ignition was switched off. However, this feature only works if the key is not taken out of the ignition switch, or, for vehicles with Keyless Access, the doors are not opened or the vehicle is not locked.

People suffering from a low level of perceived pain or a lowered awareness of pain as from medication, paralysis, or chronic illness (e.g. diabetes) should NEVER use the seat heating feature

⇒ .

The use of seat heating by persons with these conditions could result in burns to the back, buttocks, and legs that may take a long time to heal and may never heal completely. If you have any of these conditions, you should take regular breaks and get out of the vehicle, particularly on long trips. Consult your doctor for advice regarding your specific condition.

 **WARNING**

**Certain medical conditions, such as paralysis and diabetes, and certain medications, can increase the risk of serious burns when the seat heating feature is switched on.**

- Vehicle occupants who have a low level of perceived pain or a lowered awareness of pain can receive serious burns to the back, buttocks, and legs that take a long time to heal or may never heal completely.
- Never use the seat heating feature if you or your passengers are at risk of being burned because of a medical condition. Take regular breaks and get out of the vehicle, particularly on long trips. Consult your doctor for advice regarding your specific condition.
- Never let exposed skin remain in contact with the seat upholstery when the seat heating is being used.

 **WARNING**

**A wet seat can cause the seat heating to malfunction and increase the risk of serious burns.**

- Always make sure the seats are dry before using the seat heating.
- Never sit on the seat with wet clothes.
- Never put damp or wet things including clothes on the seat.
- Never spill liquids on the seats.

## ! NOTICE

- To help prevent damage to electrical and other parts in the seat, do not kneel on the front seats or apply concentrated pressure to a small area of the seat or backrest.
- Liquids, sharp objects and things that do not let the heat in the seat escape into the air, including, for example, a child restraint, a blanket or seat covers on the seat can damage seat heating.
- If you smell an odor, immediately shut off seat heating and have it checked by an authorized Volkswagen dealer or authorized Volkswagen Service Facility.
- Never install leather upholstery on a vehicle with seat heating that originally had cloth upholstery. The seat heating elements for seats with cloth seats will overheat if the cloth upholstery is replaced with leather upholstery.



Switch off seat heating when it is not needed to help reduce unnecessary fuel consumption.

## Memory seat

---



Fig. 54 Memory buttons on the outer side of the driver seat.

ⓘ Please first read and note the introductory information and heed the WARNINGS ⚠

### Memory buttons

Personal settings for the driver seat, and the outside mirrors can be assigned to the memory buttons and to every remote control vehicle key.

These settings can be assigned to individual remote control vehicle keys. The settings are applied after unlocking the vehicle and opening the driver door.

### Storing driver seat settings and forward driving settings for outside mirrors

- Apply the electronic parking brake.
- Shift the transmission into Neutral (**N**).
- Switch on the ignition.
- Adjust driver seat and outside mirrors.
- Press the **SET** button ⇒ fig. 54.
- Within about 10 seconds press the desired memory button **1**, **2** or **3**. A chime sounds to confirm that the setting has been stored.

### Storing passenger side outside mirror settings for backing up

- Apply the electronic parking brake.
- Shift the transmission into Neutral (N).
- Switch the ignition on.
- Briefly press the desired memory button **1**, **2** or **3** on the driver door.
- Shift the transmission into Reverse (R).
- Adjust the passenger outside mirror to provide good visibility of the curb, for example.
- The adjusted mirror position is automatically stored and assigned to the vehicle key used to unlock the vehicle. The preselected position will be recalled when the key assigned to that mirror adjustment position is used again.

The passenger-side outside mirror automatically adjusts back from the position stored for backing up when the vehicle moves forward at about 10 mph (15 km/h) or more or when the rotary knob ⇒ [fig. 96](#) is rotated from (R) into a different position.

### Recalling settings for driver seat and outside mirrors

- Briefly press the appropriate memory button when the vehicle is not moving, the ignition is switched off, and the driver door is open.
- **OR:** If the ignition is switched on and the driver door is closed, press and hold the appropriate memory button until the stored position is reached.
- The passenger-side outside mirror automatically adjusts back from the position stored for backing up when the vehicle moves forward at about 10 mph (15 km/h) or more or when the rotary knob is rotated from (R) into a different position.

### Assigning driver seat and outside mirror settings to a vehicle key

The memory function of all vehicle keys is disabled when the vehicle is first delivered from the factory.

To enable vehicle key memory feature:

- Unlock the driver door.
- Press and hold a memory button until memory position is reached.
- Press and hold the unlock button **U** on the vehicle key and then press the desired memory button at the same time within about 3 seconds. A chime sounds to confirm activation.

To disable remote control vehicle key memory function:

- Press and hold the **SET** button.
- Press and hold the unlock button **U** on the remote control vehicle key **within** about 10 seconds. A chime sounds to confirm deactivation.

### Assigning settings to an additional vehicle key

- Follow the instructions ⇒ *Assigning driver seat and outside mirror settings to a vehicle key* to assign the driver seat and outside mirror settings to the vehicle key.
- Unlock the vehicle with the same vehicle key.
- Adjust driver seat and outside mirrors.
- Lock the vehicle with locking button **L** in the vehicle key to store the settings.

Once the settings are stored, the driver seat and the outside mirrors move to the stored positions whenever the vehicle is unlocked with the vehicle key open button **O** and the driver door is opened. If 2 people use the vehicle, each of them should always use the key in which his or her personal settings have been stored.

### Initializing the memory seats

The memory system must be initialized by an authorized Volkswagen dealer, an authorized Volkswagen Service Facility, or another qualified workshop in certain situations, for instance, if a new driver seat is installed.

Initializing clears all memories and assignments of the memory seat. After that, memory buttons can be reprogrammed and assigned to a remote control vehicle key.

- Open the driver door but do not enter the vehicle.
- Adjust the seats from the outside.
- Move the angle of the backrest forward as far as it will go.
- Release the backrest adjustment switch and press it again until you hear a chime sound.

#### **Cancellation conditions when storing settings for the memory buttons**

When one of the following conditions is met, the storing process will be cancelled:

- Charging condition of the vehicle battery is weak.
- The **SET** button is pressed again within about 10 seconds.
- The seat position is readjusted within about 10 seconds after pressing the **SET** button.

### **Folding the front passenger backrest forward**

---



**Fig. 55** Folding the front passenger backrest forward.



**Fig. 56** Unlocking the foldable front passenger backrest.

**⚠ Please first read and note the introductory information and heed the WARNINGS ⚠**

The front passenger backrest can be folded forward and locked in a horizontal position.



If objects are transported on the front passenger seat while it is folded down, make sure that the PASSENGER AIR BAG OFF  light is on and stays on whenever the ignition is switched on

#### Folding the front passenger backrest forward

- Remove objects from the front passenger seat ⇒ .
- Move the front passenger seat to the lowest position
- Move the front passenger seat to the rearmost position in the seat's fore and aft adjustment range.
- Push the head restraint all the way down
- Unlock the front passenger backrest in the direction of the arrow ⇒ [fig. 55 \(1\)](#).
- Fold the front passenger backrest forward into the horizontal position in the direction of the arrow [\(2\)](#).
- The front passenger backrest must be securely latched in the folded down position.

#### Folding the front passenger backrest into place

- Make sure that nobody is near the hinges when folding the backrest back into place.
- Unlock the front passenger backrest to fold it back ⇒ [fig. 56](#).
- Fold the front passenger backrest into the upright position.
- The front passenger backrest must be securely latched in the upright position.

#### WARNING

Improper folding and improper latching of the front passenger backrest can cause serious personal injury.

- Never fold the front passenger backrest forward or back when the vehicle is moving.
- Always make sure that the PASSENGER AIR BAG OFF  light is on and stays on whenever the backrest of the front passenger seat is folded forward.
- Always keep hands, fingers, feet and other body parts out of the way of the seat hinges and the seat locking mechanism when folding the backrest forward and back.
- Floor mats and other objects can get caught in the front passenger backrest hinges. This can cause the front passenger backrest to incorrectly latch when folded back into the upright position.
- When folded back into place, the front passenger backrest must be securely latched in the upright position. An improperly latched front passenger backrest can suddenly move and cause serious personal injury.

#### WARNING

Open seat mountings and hinges of the folded front passenger backrest can cause severe injuries in the event of a braking maneuver or accident.

- Do not let passengers or children occupy the front passenger seat when the front passenger backrest is folded forward.
- When the front passenger backrest is folded down, only the outer seat of the rear bench behind the driver seat can be occupied. This also applies to children in child safety seats.

# Safety belts

## Introduction

---

In this section you'll find information about:

Warning light  
Frontal collisions and laws of physics  
What happens to passengers not wearing a safety belt?  
Safety belts protect  
Using safety belts  
Fastening and unfastening safety belts  
Safety belt position  
Safety belt height adjusters  
Safety belt extender  
Safety belt retractor, pretensioner, load limiter  
Service and disposal of belt pretensioners

Properly worn safety belts are the single most effective means of reducing the risk of serious injury and death in a collision or other accident.

Damage to safety belts reduces their overall effectiveness and increases the risk of serious personal injury and death whenever the vehicle is being used.

Check the condition of all safety belts regularly.

If a safety belt shows damage to webbing, bindings, retractors or buckles, have the safety belt replaced by an authorized Volkswagen dealer or an authorized Volkswagen Service Facility ⇒ .

### **More information:**

- Adjusting the seating position
- Airbag system
- Child safety and child restraints
- Parts, accessories, repairs and modifications



## WARNING

Not wearing a safety belt or wearing an improperly positioned safety belt increases the risk of severe personal injury or death. Safety belts offer optimum protection only when they are used properly.

- Properly worn safety belts are the single most effective means of reducing the risk of serious injury and death in a collision or other accident. For this reason, always wear your safety belt properly and make sure all passengers wear their safety belts properly as well whenever the vehicle is moving.
- The driver must always make sure that every person in the vehicle is properly seated on a seat of his or her own, properly fastens the safety belts belonging to that seat before the vehicle starts to move, and keeps the belts properly fastened while riding in the vehicle. This applies even when just driving around town. Therefore, always wear your safety belts and make sure that everybody in your vehicle is properly restrained.
- Always secure children in the vehicle with a restraint system appropriate for their age, weight and height
- Always fasten safety belts correctly before driving off and make sure that all passengers are properly restrained.
- Never attach the safety belt to the buckle of another seat. Attaching the safety belt to the wrong buckle will reduce safety belt effectiveness and can cause serious personal injury.
- Never let any objects or liquids get into the safety belt latch and prevent it from working properly.
- Never remove a safety belt while the vehicle is moving. Doing so will increase your risk of being injured or killed.
- Never strap more than one person, including small children, into any single safety belt.
- Never let children or babies ride sitting on your lap and never place a safety belt over a child sitting on your lap.
- Never wear belts over rigid or breakable objects in or on your clothing, such as eye glasses, pens, keys, etc., as these may cause injury.
- Several layers of heavy clothing (such as a coat worn over top of a sports jacket) may interfere with proper positioning of the belt and reduce the overall effectiveness of the system.
- Never use comfort clips or devices that create slack in the shoulder belt. However, special clips may be required for the correct use of some child restraint systems.
- Safety belts offer optimum protection only when the seat backrest is upright and belts are correctly positioned on the body.

**⚠ WARNING**

Damage to safety belts reduces their overall effectiveness and increases the risk of serious personal injury and death whenever the vehicle is being used.

- Never let safety belts become damaged by being caught in the door or seat hardware.
- Torn or frayed safety belts can tear, and damaged safety belt hardware can break in an accident.
- Inspect belts regularly for damage. If webbing, bindings, buckles, or retractors are damaged, have the belts replaced immediately with the correct replacement belts approved by Volkswagen for your vehicle, model, and model year.
- Safety belts that were subject to stress in an accident and stretched must be replaced with a correct, new safety belt, preferably by an authorized Volkswagen dealer or authorized Volkswagen Service Facility.
- Replacement after a crash may be necessary even if a safety belt shows no visible damage. Anchorages that have been loaded must also be inspected.
- Damaged safety belts must be replaced; they cannot be repaired.
- Never try to repair a damaged safety belt yourself. Never remove or modify the safety belts in any way.
- Have safety belts, bindings, retractors and buckles replaced by an authorized Volkswagen dealer or authorized Volkswagen Service Facility.
- Always keep the belts clean. Dirty belts may not work correctly and can impair the function of the inertia reel.

**Warning light**



Fig. 57 Warning light in the instrument cluster.

ⓘ Please first read and note the introductory information and heed the WARNINGS ⚠

Lights up or flashes	Possible cause	Proper response
⚠	Driver and front passenger have not fastened their safety belts, if front passenger seat is occupied.	Fasten safety belts.
	Heavy items on the front passenger seat.	Remove items from front passenger seat and stow them safely.

When the ignition is switched on, several warning and indicator lights come on briefly for a function check. They go out after a few seconds.

A warning chime also sounds.

The safety belt warning light  comes on for 6 seconds when the ignition is switched on. A warning chime also sounds for up to 6 seconds if the driver's safety belt is not buckled. The chime stops sooner if the driver buckles his or her safety belt. The warning light and the chime also go out when both driver and front passenger have buckled their safety belts.

If the driver and front seat passenger do not both fasten their safety belts within about 24 seconds after the chime stops and the vehicle is moving at a speed of more than about 15 mph (25 km/h), the chime will again sound for about 6 seconds, then go off for about 24 seconds, then sound again for about another 6 seconds. The same thing happens if one of the safety belts is fastened and then unfastened while the vehicle is moving. The safety belt warning light also flashes . The warning chime continues to sound at 24 seconds intervals for up to 2 minutes. No chime sounds at speeds of less than about 5 mph (8 km/h).

If the ignition is switched on, the safety belt warning light  stays until the driver and front passenger have both buckled their safety belts.

 <b>WARNING</b>
<b>Not wearing a safety belt or wearing an improperly positioned safety belt increases the risk of severe personal injury or death. Safety belts offer optimum protection only when used correctly.</b>

## Frontal collisions and laws of physics

---



Fig. 58 A vehicle with passengers not wearing safety belts approaches a wall.



Fig. 59 A vehicle with passengers not wearing safety belts hits a wall.

**⚠ Please first read and note the introductory information and heed the WARNINGS ⚠**

The physical principles of a frontal collision are simple. Both the moving vehicle and the passenger possess energy ⇒ [fig. 58](#), which varies with vehicle speed and body weight. Engineers call this energy “kinetic energy.”

The higher the speed of the vehicle and the greater the vehicle's weight, the more energy has to be “absorbed” in the crash.

Vehicle speed is the most significant factor. If your speed doubles (for example from 15 mph to 30 mph - 25 km/h to 50 km/h), the energy increases 4 times!

Because the occupants of the vehicle in the above example are not using safety belts, they are not “attached” to the vehicle. In a frontal collision, they will keep moving at the same speed the vehicle was moving just before the crash, until something stops them - here, the inside of the passenger compartment. Because the occupants of the vehicle in the example are not wearing safety belts, their entire kinetic energy will be absorbed by impact with the wall ⇒ [fig. 59](#).

The same principles apply to people in a vehicle that is in a frontal collision on the highway. Even at city speeds of 20 to 30 mph (30 to 50 km/h), the forces acting on the body can reach one ton (2000 lbs or 1000 kg) or more. At greater speeds, these forces are even higher.

Of course, the laws of physics don't apply just to frontal collisions; they determine what happens in all kinds of accidents and collisions.

### What happens to passengers not wearing a safety belt?



**Fig. 60** The unbelted driver is thrown forward.



Fig. 61 Unbelted passengers in the rear seats are thrown forward on top of the belted driver.

**⚠ Please first read and note the introductory information and heed the WARNINGS ⚠**

Many people believe that it is possible to resist the forces of an impact by holding tight or bracing themselves. That is simply not true!

Even at low collision speeds, the forces acting on the body are too much for the body to be held in the seat with the arms and hands. In a frontal collision, unrestrained occupants will slam violently into the steering wheel, instrument panel, windshield or anything else in the way ⇒ fig. 60.

Never rely on airbags alone for protection. Even when they deploy, airbags provide only additional protection. Airbags are not supposed to deploy in all kinds of accidents. Even if your vehicle is equipped with airbags, all vehicle occupants, including the driver, must wear safety belts correctly in order to minimize the risk of severe injury or death in a crash, regardless of whether a seating position has an airbag or not.

An airbag will deploy only once. Safety belts are always there to offer protection in those accidents in which airbags are not supposed to deploy or when they have already deployed. Unbelted occupants can also be thrown out of the vehicle, causing even more severe injuries or death.

It is also important for occupants in the rear seats to wear their safety belts properly since they can be thrown violently forward through the vehicle in the event of an accident. Unbelted passengers in the rear seats endanger not only themselves but also the driver and other passengers in the vehicle

⇒ fig. 61.

## Safety belts protect

---



Fig. 62 Belted driver secured by the correctly worn safety belt in the event of a sudden braking maneuver.

**ⓘ Please first read and note the introductory information and heed the WARNINGS ⚠**

Used properly, safety belts can make a big difference. Safety belts help to keep passengers in their seats, gradually reduce energy levels applied to the body in a collision, and help prevent the uncontrolled movement that can cause serious injuries. In addition, safety belts reduce the danger of being thrown out of the vehicle ⇒ [fig. 62](#).

Safety belts attach passengers to the car and give them the benefit of being slowed down more gently or “softly” through the “give” in the safety belts, crumple zones, and other safety features (such as airbags) engineered into today’s vehicles. The front crumple zones and other passive safety features (such as the airbag system) are also designed to absorb kinetic energy. By “absorbing” the kinetic energy over a longer period of time, the forces on the body become more “tolerable” and less likely to cause injury.

Although these examples are based on a frontal collision, safety belts can also substantially reduce the risk of injury in other kinds of crashes. So, whether you’re on a long trip or “just going to the corner store,” always buckle up and make sure that others do, too.

Accident statistics show that vehicle occupants properly wearing safety belts have a lower risk of being injured and a much better chance of surviving a collision. Properly using safety belts also greatly increases the ability of the supplemental airbags to do their job in a collision. For this reason, wearing a safety belt is required by law in most countries including the United States and Canada.

Although your Volkswagen is equipped with airbags, you still have to wear the safety belts provided. Front airbags, for example, are activated only in some frontal collisions. The front airbags are not activated in all frontal collisions, in side and rear collisions, in rollovers, or in cases when the conditions for deployment stored in the electronic control unit are not met. The same goes for the other airbag systems on your Volkswagen.

So always wear your safety belt and make sure that everybody in your vehicle is properly restrained!

## Using safety belts

---

**ⓘ Please first read and note the introductory information and heed the WARNINGS ⚠**

### Checklist

---

Using safety belts ⇒ ⚠:

- ✓ Damage to safety belts reduces their overall effectiveness and increases the risk of serious personal injury and death whenever the vehicle is being used.
  - ✓ Check the condition of all safety belts regularly.
  - ✓ Keep safety belts clean.
  - ✓ Keep objects and liquids away from safety belt webbing, the safety belt buckle tongue, and the safety belt buckle latch and opening.
  - ✓ Do not pinch or damage the safety belt or buckle tongue (for instance, when closing a door).
  - ✓ Never modify, disassemble or try to repair safety belts and safety belt anchorages.
  - ✓ Always fasten your safety belt properly before driving and keep it fastened whenever the vehicle is moving.
- 

### Twisted safety belt

If it is difficult to pull the safety belt out of the belt guide, the belt may be twisted inside the side trim because the belt retracted too quickly when it was taken off.

- Hold the safety belt tongue, slowly and carefully pull safety belt all the way out.
- Untwist the safety belt and slowly return the belt by hand.



If you cannot untwist the safety belt, wear it anyway. Make sure that the safety belt is twisted in a spot where it does not come in direct contact with your body. Have the safety belt untwisted immediately by an authorized Volkswagen dealer or authorized Volkswagen Service Facility.

### Lockable safety belt

The retractors for the rear seat safety belts and the front passenger safety belt have a switchable locking feature for child restraints in addition to the emergency locking feature. Whenever a child restraint is installed with a safety belt, the safety belt must be locked so that the safety belt webbing cannot unreel. The switchable locking feature lets you lock the belt so that a child restraint can be properly installed and, for example, so that it can't tip to the side when the vehicle goes around a corner ⇒ *Child safety and child restraints*.

To see whether a safety belt is lockable, pull the safety belt *all the way* out of the safety belt retractor. You should then hear a "clicking" sound as the belt winds back into the retractor reel. Test the switchable locking feature by pulling on the belt. When the switchable locking feature is active, you should no longer be able to pull the belt out of the retractor.

The locking feature must be deactivated when a vehicle occupant uses the safety belt.



### WARNING

**Improper use and care of safety belts increases the risk of severe personal injury or death.**

- Regularly check safety belts and related parts for damage.
- Damaged safety belts must be replaced; they cannot be repaired.
- Always keep safety belts clean.
- Never catch, damage or chafe safety belt webbing on sharp edges.
- Always keep objects and liquids away from the belt buckle and buckle opening.

### Fastening and unfastening safety belts

---



Fig. 63 Inserting the buckle tongue into the belt buckle.



Fig. 64 Releasing the buckle tongue from the belt buckle.

**ⓘ Please first read and note the introductory information and heed the WARNINGS ⚠**

Properly worn safety belts help to hold occupants in their seats and provide optimum protection during braking or in a collision or other accident ⇒ ⚠.

The switchable locking feature makes a “clicking” sound when the safety belt is winding back onto the safety belt retractor wheel after being pulled *all the way* out. Whenever a child restraint is installed with a safety belt, the safety belt must be locked so that the safety belt webbing cannot unreel ⇒ *Child safety and child restraints*. If active, deactivate the locking feature before using the safety belt to restrain a person without a child restraint system.

### Fastening safety belts

Always buckle your safety belt before driving.

- Adjust the front seat and head restraint correctly ⇒ *Adjusting the seating position*.
- Make sure the seat backrest of the rear seat bench is in an upright position and securely latched in place before using the safety belt ⇒ ⚠.
- Hold the safety belt by the tongue and pull it slowly and evenly across the chest and pelvis. Do **not** twist the safety belt webbing ⇒ ⚠.
- Insert the tongue into the correct buckle for your seat until you hear it latch securely ⇒ [fig. 63](#).
- Pull on the safety belt to make sure that it is securely latched in the buckle.

### Unfastening safety belts

Unfasten safety belts only when the vehicle is not moving ⇒ ⚠.

- Press the red button on the buckle ⇒ [fig. 64](#). The buckle tongue is ejected.
- Let the belt wind up on the retractor as you guide the belt tongue to its stowed position to help prevent the safety belt from twisting and to help avoid damage to the interior trim.

## **⚠ WARNING**

**Improperly positioned safety belts can cause serious personal injury or death in an accident.**

- **Safety belts offer optimum protection only when the seat backrest is upright and belts are correctly positioned on the body.**
- **A person who is not properly restrained can be seriously injured by the safety belt itself if it slips from the stronger parts of the body into sensitive areas like the abdomen.**
- **Unfastening safety belts while the vehicle is in motion can cause severe personal injury or death in the event of an accident or braking maneuver!**

## Safety belt position

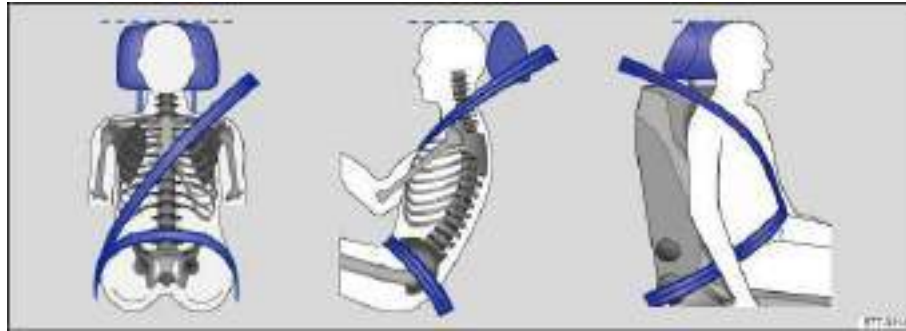

Fig. 65 Proper safety belt positioning and head restraint adjustment.



Fig. 66 Proper safety belt positioning for expectant mothers.

### **⚠ Please first read and note the introductory information and heed the WARNINGS ⚠**

Wearing safety belts improperly can cause serious injury or death. Safety belts can only work when they are correctly positioned on the body. A properly worn safety belt also helps to position the occupant so that an airbag can provide maximum protection when deployed. Therefore, always fasten your safety belt and make sure that it is properly positioned over your body.

Improper seating positions reduce the effectiveness of safety belts and even increase the risk of injury or death by moving the safety belt to critical areas of the body. Improper seating positions also increase the risk of severe injury or death when an airbag deploys and strikes an occupant who is not seated properly ⇒ *Adjusting the seating position.*

### **Proper safety belt position**

- The shoulder portion of the safety belt must always run over the center of the shoulder and never over the throat, over the arm, under the arm or behind the back.
- The lap portion of the safety belt must always run as low as possible over the pelvis and never over the abdomen.
- Always wear the safety belt flat and snug against the body. Pull on the safety belt to tighten if necessary.

**Expectant mothers** must always wear the lap portion of the safety belt as low as possible across the pelvis and below the rounding of the abdomen – throughout the pregnancy. The safety belt must lie flat against the body to avoid pressure against the abdomen ⇒ [fig. 66](#).

### **Adjusting safety belt height**

The safety belt position can be adjusted using the following features:

- Safety belt height adjusters for the front seats.
- Front seats with height adjustment.

** WARNING**

**Improperly positioned safety belts can cause serious personal injury in an accident or a sudden braking maneuver.**

- Always make sure that all vehicle occupants are correctly restrained and stay in a correct seating position whenever the vehicle is being used.
- Safety belts offer optimum protection only when the seat backrest is upright and belts are correctly positioned on the body.
- A loose-fitting safety belt can cause serious injuries by shifting its position on your body from the strong bones to more vulnerable soft tissue and cause serious injury.
- The shoulder belt portion of the safety belt must be positioned over the middle of the occupant's shoulder and never across the neck or throat.
- The safety belt must lie flat and snug on the occupant's upper body.
- Never wear the shoulder part of the safety belt under your arm or otherwise out of position.
- The lap portion of the safety belt must be positioned as low as possible across the pelvis and never over the abdomen. Make sure the belt lies flat and snug against the pelvis. Pull on the safety belt to tighten if necessary.
- Expectant mothers must always wear the lap portion of the safety belt as low as possible across the pelvis and below the rounding of the abdomen.
- Do not twist the belt when attaching it. If you cannot untwist a twisted safety belt, wear it anyway, but make sure the twisted part is not in contact with your body. Have the problem corrected right away by an authorized Volkswagen dealer or authorized Volkswagen Service Facility.
- Never hold the safety belt away from your body with your hand.
- Never wear belts over rigid or breakable objects, such as eye glasses, pens or keys.
- Never modify the position of the belt using comfort clips, loops or similar devices.



- If you have a physical impairment or condition that prevents you from sitting properly on the seat with the safety belt properly fastened, special modifications to your vehicle may be necessary.
- Contact your authorized Volkswagen dealer or authorized Volkswagen Service Facility or call the Volkswagen Customer CARE Center at 1-800-822-8987 for information about possible modifications to your vehicle.

## Safety belt height adjusters

---



Fig. 67 Next to the front seats: Safety belt height adjuster.

**ⓘ Please first read and note the introductory information and heed the WARNINGS ⚠**

Safety belt height adjusters for the front seats can be used to adjust the height of the shoulder portion of the safety belt so that it is positioned correctly:

- Press and hold the safety belt attachment ⇒ [fig. 67](#).
- Pinch the safety belt attachment together as indicated by the arrows and slide the seat belt attachment to the desired position .
- Slide the belt and upper attachment up or down until the safety belt is positioned over the center of the shoulder ⇒ *Safety belt position*.
- Release the safety belt attachment.
- Pull on the safety belt to make sure that the upper attachment is securely locked in place.



### WARNING

Never adjust the height of the safety belt while driving.

## Safety belt extender

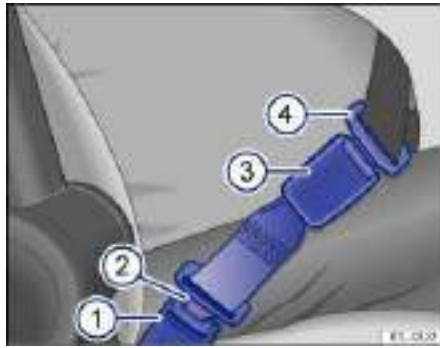

Fig. 68 A safety belt extender properly attached to the factory-installed safety belt.

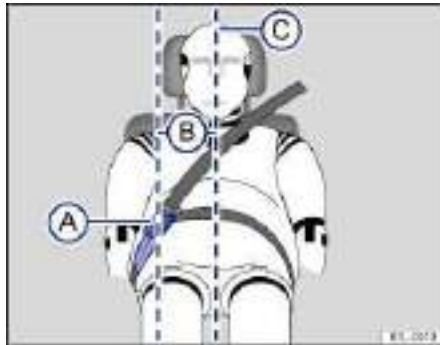

Fig. 69 Positioning of the safety belt extender.

⚠ Please first read and note the introductory information and heed the WARNINGS ⚠

If a safety belt is too short to correctly fit you or one of your passengers even when the safety belt is pulled out all the way, you can use a safety belt extender.

Never use the safety belt extender for any other purpose – including the attachment of a child restraint.

The extender adds about 8 inches (20 cm) to the safety belt. Always remove the safety belt extender when it is not needed and stow it safely. Contact an authorized Volkswagen dealer or authorized Volkswagen Service Facility if you believe you may need an extender.

**Key to fig. 68:**

- (1) Vehicle safety belt buckle.
- (2) Buckle tongue on the safety belt extender.
- (3) Safety belt buckle on the safety belt extender.
- (4) Safety belt buckle tongue on the factory-installed safety belt.

**Key to fig. 69:**

- (A) Safety belt buckle on the safety belt extender.
- (B) Distance between the safety belt buckle on the safety belt extender and the centerline of the person using the safety belt extender. **The distance must be more than 6 inches (15 cm)!**
- (C) Centerline of the person using the safety belt extender.

### **Using a safety belt extender**

- Adjust both the seat and the head restraint properly ⇒ *Adjusting the seating position*.
- Insert the buckle tongue on the safety belt extender ⇒ [fig. 68 \(2\)](#) into the vehicle belt buckle for the seat where the safety belt extender is being used [\(1\)](#).
- Fastening or unfastening the vehicle safety belt ⇒ *Fastening and unfastening safety belts*.
- Pull the belt to make sure that the tongues are securely locked in the buckles.
- Make sure that the safety belt is positioned properly ⇒ *Safety belt position*.

### **Properly using safety belt extenders**

- Use a safety belt extender only when the factory installed safety belt is too short when worn properly by a person in proper seating position.
- Only use one safety belt extender per seat and vehicle safety belt.
- Always remove the safety belt extender when it is not needed.
- Never leave a safety belt extender attached to the vehicle safety belt buckle when the extender is not needed and being used with the safety belt. Otherwise, the airbag control module will receive an incorrect signal from the safety belt buckle and this will prevent the airbag from working properly for a person who is not using the safety belt. Leaving the extender attached to the safety belt buckle when the front seat is occupied and the safety belt is not being used will signal the airbag control unit during a collision that the front passenger seat is occupied and that the safety belt is being used. The electronic control unit for the airbag system will then receive incorrect information that will cause the safety belt pretensioner to deploy unnecessarily and the front passenger airbag to deploy later in collisions that would normally trigger the front airbag earlier in the collision to help protect an unrestrained front seat occupant. The airbag will not be able to provide enough protection for an occupant not wearing a safety belt.
- Only use the safety belt extender approved by Volkswagen for your vehicle.

## WARNING

Improper use or positioning of a safety belt extender increases the risk of serious personal injury and death.

- A driver or passenger who is not properly restrained can be seriously injured by striking the interior of the passenger compartment or by the safety belt itself, which can be displaced from stronger parts of the body into sensitive areas like the abdomen.
- Safety belt extenders offer optimum protection only when they are properly used.
- Only use the extender when the belt is not long enough to be worn low and snug and the person is in the correct seating position. Remove and stow extender safely when not needed.
- Always make sure the safety belt tongue of the safety belt extender is securely inserted into the buckle for the seating position that belongs to the seat where the safety belt extender is being used. Attaching the safety belt to the wrong buckle will reduce safety belt effectiveness and can cause serious personal injury.
- Never use the safety belt extender if you can properly attach the safety belt without it. Using a safety belt extender when not needed can increase the risk of injury, especially in a collision.
- Never use a safety belt extender if the distance  $\Rightarrow$  fig. 69 (B) between the front edge of the safety belt extender buckle (A) and the centerline of the person using the safety belt extender (C) is less than 6 inches (15 cm).
- Never leave a safety belt extender attached to the vehicle safety belt buckle when the extender is not needed and being used with the safety belt. Otherwise, the airbag control module will receive an incorrect signal from the safety belt buckle and this will prevent the airbag from working properly for a person who is not using the safety belt.
- Never use more than one extender with a safety belt. Using more than 1 extender can change the way the safety belt passes over the body and can cause serious injury.
- Never use the safety belt extender to secure a child restraint.
- Never use a safety belt extender on your Volkswagen that you got from another automobile manufacturer or from an automotive parts store.
- Never use the safety belt extender you got for your vehicle for any other vehicle, regardless of make, model, or model year.

## NOTICE

- Leaving the extender attached to the safety belt buckle when the front seat is occupied and the safety belt is not being used will signal to the airbag control unit that the front passenger seat is occupied and that the safety belt is being used. The electronic control unit for the airbag system will then receive incorrect information that will
  - cause the safety belt pretensioner to deploy unnecessarily in collisions;
  - cause the front passenger airbag to deploy later in collisions in which the front airbag would otherwise be triggered earlier to help protect an unrestrained front seat passenger.
- A pretensioner that has deployed cannot be repaired. The entire safety belt must be replaced.

## NOTICE

If the safety belt extender is left attached to the safety belt buckle, the safety belt warning system will sense that the safety belt for that seat is being used. The warning light will not come on and the warning chime will not sound even though the seat is occupied and the safety belt is not being used.



## Safety belt retractor, pretensioner, load limiter

---

 Please first read and note the introductory information and heed the **WARNINGS** 

The safety belts in the vehicle are part of the vehicle's safety concept ⇒ *Safety equipment* and consist of the following important features:

### Automatic safety belt retractors

Every safety belt is equipped with an automatic belt retractor on the shoulder belt. As long as the safety belt is pulled out slowly, the shoulder belt will extend to let you move freely under normal driving conditions. The automatic safety belt retractor locks the belt when the belt is pulled out fast, during hard braking and in a collision. The belt may also lock when you drive up or down a steep hill or through a sharp curve.

### Safety belt pretensioner

The retractors for the driver and front passenger have a pretensioner that helps take the slack out of the safety belt and tighten it when the pretensioner is activated.

The pretensioners are activated by the electronic control unit for the airbag system in front, side, and rear collisions. By tightening the safety belt, the pretensioner helps to reduce the occupant's forward movement. The belt pretensioner works together with the airbag system; its function is monitored by the airbag system indicator light. The belt pretensioner will not deploy in a rollover if the side airbags are not activated.

A fine dust may be released upon activation. This is normal and is not caused by a fire in the vehicle.

### Safety belt load limiter

The front and rear safety belts also have load limiters to help reduce the forces applied to the body in a crash.

 Heed all safety regulations if the vehicle or individual components of the system have to be scrapped. Your authorized Volkswagen dealer and authorized Volkswagen Service Facility are familiar with these regulations ⇒ *Service and disposal of belt pretensioners*.

## Service and disposal of belt pretensioners

---

 Please first read and note the introductory information and heed the **WARNINGS** 

The pretensioners are part of the safety belts installed at the front seats in your vehicle. Installing, removing, servicing, or repairing of safety belt pretensioners can damage the safety belt system and prevent it from working correctly in a collision. The pretensioners themselves may then also not work in the event of an accident, or not work properly.

There are some important things you have to know to make sure that the effectiveness of the system will not be impaired and that discarded components do not cause injury or pollute the environment. Undeployed safety belt pretensioners and airbag modules contain explosive materials that can cause serious injuries to the general public and to people who work at dealerships and workshops, scrap yards, and recycling facilities. For this reason, the systems must be properly handled when they or the vehicles they are installed in are scrapped.

Undeployed safety belt pretensioners and airbag modules can also pollute the environment. Never abandon vehicles or vehicle parts. If your vehicle must be scrapped, please make sure that it is done safely, responsibly, and in compliance with all applicable environmental regulations. Take it to a licensed facility that has the knowledge and experience to properly dispose of the vehicle and its safety belt system. Your authorized Volkswagen dealer and authorized Volkswagen Service Facility are familiar with these regulations.

 **WARNING**

Improper handling, care, servicing, and repair procedures can increase the risk of personal injury and death by preventing a belt pretensioner from activating when needed or by causing it to activate unexpectedly.

- The pretensioner can be activated only once. If a pretensioner has been activated, the safety belt must be replaced.
- Safety belt systems including the pretensioners cannot be repaired. Special procedures are required to remove, install, and dispose of this system.
- Never repair, adjust, or change pretensioners or any other part of the safety belt system yourself. We strongly recommend that you have any work on the safety belt system performed by an authorized Volkswagen dealer or authorized Volkswagen Service Facility.

They have the necessary technical information, training, and special equipment ⇒ *Parts, accessories, repairs and modifications.*

 **WARNING**

Undeployed safety belt pretensioners and airbag modules contain explosive materials that can cause serious personal injuries if they are not properly handled when they or the vehicles they are installed in are scrapped.

- Never abandon vehicles or vehicle parts.
- Always scrap vehicles and vehicle parts, especially those containing undeployed airbag modules and undeployed safety belt pretensioners, at a licensed facility that has the knowledge and experience to properly dispose of the vehicle and its safety belt and airbag systems.



Undeployed airbag modules and safety belt pretensioners are classified as **Perchlorate Material**. Special handling may apply – see <http://www.dtsc.ca.gov/hazardouswaste/perchlorate>. Obey all applicable legal requirements regarding handling and disposal of the vehicle or parts of its restraint system, including airbag modules and safety belts with pretensioners. Authorized Volkswagen dealers and authorized Volkswagen Service Facilities are familiar with the requirements, and we recommend that you have them perform this service for you.

# Lights

## Introduction

---

In this section you'll find information about:

Indicator lights

Turn signal lever and high beam switch

Switching lights on and off

Lights and vision features

Lights and vision features

“Coming home” and “Leaving home” feature (orientation lighting)

Instrument panel lighting and headlight range adjustment

Interior and reading lights

Always obey local vehicle lighting laws.

The driver is always responsible for the correct headlight settings.

### More information:

- Exterior views
- Volkswagen Information System
- Changing a light bulb

 **WARNING**

Headlights that are aimed too high and improper use of the headlight flasher or high beams can blind and distract other drivers. This can lead to a crash and serious personal injuries.



- Always make sure that headlights are properly adjusted.
- Never use the headlight flasher or high-beams when they can blind or distract other drivers.

## Indicator lights

---

 Please first read and note the introductory information and heed the WARNINGS 

Lights up	Possible cause	Proper response
	One or more driving lights not working or cornering light malfunction.	Replace burned out bulb or if all light bulbs are OK, visit an authorized Volkswagen dealer or authorized Volkswagen Service facility.
	Cornering light system malfunction.	See an authorized Volkswagen dealer or authorized Volkswagen Service Facility
	Adaptive Front Lighting System malfunction.	

Lights up	Possible cause	Proper response
	Left or right turn signal.	Check the turn signals on the vehicle and the trailer.
	The indicator light blinks twice as fast if a turn signal is not working on the vehicle or the trailer.	
 <b>DRL</b>	Daytime running lights (DRL) on.	
	High beams switched on or headlight flashers in use.	

When the ignition is switched on, several warning and indicator lights come on briefly for a function check. They go out after a few seconds.

### **WARNING**

Failure to heed warning lights and instrument cluster text messages can cause the vehicle to break down in traffic and result in a collision and serious personal injury.

- Never ignore warning lights or text WARNINGS.
- Always stop the vehicle as soon as it is safe to do so.
- Whenever stalled or stopped for repair, move the vehicle a safe distance off the road, stop the engine, turn on the emergency flashers, and use other warning devices to warn approaching traffic.
- Never park the vehicle in areas where the hot catalytic converter and exhaust system can come into contact with dry grass, brush, spilled fuel, oil, or other material that can catch fire.
- A broken down vehicle presents a high accident risk for itself and others. Switch on emergency flashers and set up a warning triangle to warn oncoming traffic.

### **NOTICE**

Failure to heed warning lights or text WARNINGS can result in vehicle damage.

 High Intensity Discharge (HID) headlights provide bright, uniform lighting to help you see and be seen. The light comes from an electric arc between two electrodes in the gas-filled bulb. Over time, the electrodes can wear down and the gap between them will get wider. The HID lamp's control unit then increases the voltage to keep the arc's brightness constant. However, the commonly called "Xenon" bulbs will also ultimately burn out. Before they burn out, HID lamps can flicker. A message will then appear in the MFI. This is your reminder to see an authorized Volkswagen dealer or an authorized Volkswagen Service facility to check the headlights.



## Turn signal lever and high beam switch



Fig. 83 Turn signal lever and high beam switch.

**ⓘ Please first read and note the introductory information and heed the WARNINGS ⚠**

**Move the lever to the desired position.**

- (A) Right turn signal.
- (B) Left turn signal.
- (C) Switching high beams on ⇒ ⚠. An indicator light  comes on in the instrument cluster when the high beams are switched on.
- (D) Switching the high beams off and operating the headlight flasher: The *headlight flasher* turns on the high beams as long as the lever is pulled and manually held in the pulled position. The indicator light  lights up. When released, the lever moves back to the home position and turns off the high beams. The indicator light  goes out.

Move the lever back to the home position to turn the feature off.

### Convenience turn signal (lane change feature)

To use the convenience turn signal feature, move the lever up or down slightly, just to the point of resistance and then release it. If you have the convenience turn signal (**Conv. turn sig.**) switched on, the turn signals and the turn signal indicator flash 3 times. If it is switched off, they flash as long as you hold the lever up or down, and go out when you release the lever.

The convenience turn signal is switched on and off in the **Lights & Vision** menu in the instrument cluster display ⇒ *Volkswagen Information System*. If your vehicle is not equipped with the **Lights & Vision** menu, the convenience turn signal feature can be deactivated by an authorized Volkswagen dealer or authorized Volkswagen Service Facility.

### **WARNING**

**Improper use of high beams can cause distract and blind others, causing accidents and serious injuries.**

 The turn signal light works only when the ignition is switched on. The emergency flasher works even when the ignition is switched off ⇒ *In an emergency*.

 The indicator light flashes twice as fast if a turn signal bulb is burned out.

 High beams can only be switched on when low beams are on.

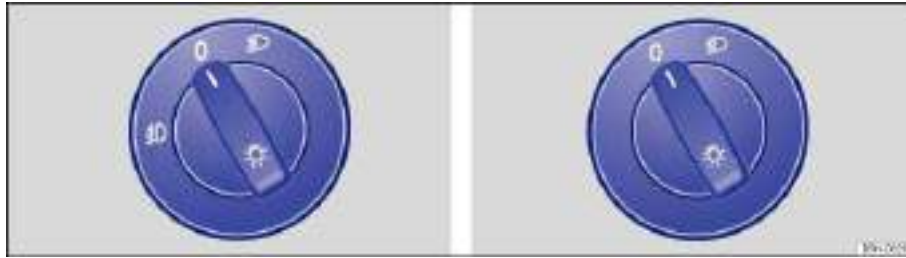

## Switching lights on and off



**Fig. 84** Headlight switch next to the steering wheel: A: Vehicles with front fog lights. B: Vehicles without front fog lights.



 Please first read and note the introductory information and heed the WARNINGS 

Adjust the light switch to the desired position ⇒ [fig. 84](#):

	When the ignition is switched off	When the ignition is switched on
0	Fog lights, low beams and parking lights switched off.	Headlights off daytime running lights (DRL) on.
	Low beams off. Parking lights and daytime running lights on. The length of time they stay on depends on the battery charge.	Low beams switched on.
	Fog lights switched off. The DRL may stay on for some time.	Headlights and fog lights switched on.

### Fog lights:

The indicator light  in the headlight switch or the instrument cluster shows that the fog lights are switched on.

- To switch on the fog lights : first turn the light switch to position , then pull the light switch out to the first detent.
- To switch off the fog lights, push the switch back in from the first detent. To then turn off the headlights, turn the switch to position 0.

### Acoustic warning when lights are not switched off

In the following situation, a warning chime will sound if you take the key out of the ignition and open the driver door. This is to remind you that lights are still on.

- Light switch in position  if the vehicle has no orientation lighting ⇒ *Coming home and Leaving home feature (orientation lighting)*.



## WARNING

Daytime running lights and parking lights are not bright enough to let you see ahead or be seen by others when it is dark.

- Always switch on the low-beam headlights at dusk or when it is dark and whenever the weather is bad or visibility is poor.
- Never use the daytime running lights to see where you are going. They are not bright enough and will not let you see far enough ahead for safety, especially at dusk or when it is dark. Always switch on the low-beam headlights at dusk or when it is dark.
- The taillights do not come on with the daytime running lights. Unless the taillights are on, a vehicle cannot be seen by others in bad weather, at dusk, or when it is dark.



In cool or humid weather, the insides of the headlights, the taillights, and turn signals can temporarily fog up. This is normal and does not affect the service life of the vehicle's lighting system.

## Lights and vision features

📖 Please first read and note the introductory information and heed the **WARNINGS** ⚠️

### Daytime running lights (DRL)

Separate lamps are installed in the headlights or in the front bumper for the daytime running lights.

When the daytime running lights are switched on, only these separate lamps come on ⇒ ⚠️.

The daytime running lights are switched on whenever the ignition is switched on and the light switch is in position **0**. The indicator light  or **DRL** in the instrument cluster indicates that the feature is active ⇒ *Indicator lights*.

### Daytime running lights (DRL) parking feature

Some models are equipped with a daytime running lights (DRL) parking feature that switches the daytime running lights off when the vehicle is parked and the ignition is switched on.

Function	Action
Switching the DRL off:	<ul style="list-style-type: none"> <li>– Switch the ignition on.</li> <li>– Turn the light switch to the <b>0</b> position.</li> <li>– Set the parking brake.</li> </ul>
Switching the DRL back on:	<ul style="list-style-type: none"> <li>– Release the parking brake.</li> </ul>

### Static cornering lights

Your vehicle may have fog lights under the front bumper that are also static cornering lights. At speeds below about 25 mph (40 km/h), the light on one side of the vehicle will come on when you turn a corner. If you turn to the right, the right fog light comes on; turn left and the left fog light comes on. The light dims and goes out when the steering wheel is straightened out again.

When you move the selector lever to Reverse (**R**), the static cornering lights on both sides of the vehicle may come on so that you can see the area around the vehicle better when backing up.

The static cornering lights work only when the headlights are on. The static cornering lights do not come on when the headlight switch is in the **0** position or when the fog lights themselves have been switched on 110.

## Adaptive Front Lighting System (AFS)

The Adaptive Front Lighting System works only with the low beams switched on and only at speeds above about 6 mph (10 km/h). The swivel-mounted lamps automatically improve road illumination during cornering.

On vehicles equipped with the Adaptive Front Lighting System, the feature is switched on and off via the **Assistant** menu

### **WARNING**

Crashes and other accidents can happen when you cannot see the road ahead and when you cannot be seen by other motorists.

- Never use daytime running lights (DRL) to see where you are going. DRL are not bright enough to light up the roadway and be seen by other motorists. You will not be able to see far enough ahead for safety, especially at dusk or when it is dark. Always switch on the low-beam headlights at dusk or when it is dark.
- The taillights do not come on when the daytime running lights are switched on. A vehicle without taillights on cannot be seen by others in bad weather, at dusk, or when it is dark.



In cool or humid weather, the insides of the headlights, rear lights, and turn signals can temporarily fog up. This is normal and does not affect the service life of the vehicle's lighting system.

## “Coming home” and “Leaving home” feature (orientation lighting)

 Please first read and note the introductory information and heed the WARNINGS 

The “Coming home” feature must be switched on manually. The “Leaving home” feature is automatically controlled by a low-light sensor.

“Coming home”	Operation
Switch on:	<ul style="list-style-type: none"><li>– Switch off the ignition.</li><li>– Operate the headlight flasher for about 1 second 109</li></ul> The “Coming home” lighting is switched on when the driver door is open and the low light sensor detects <i>darkness</i> . The <i>delay period</i> starts once the last vehicle door or the rear hatch is closed.
Switch off:	<ul style="list-style-type: none"><li>– Automatically after delay period is over.</li><li>– Automatically, if a vehicle door or the rear hatch is still open about 30 seconds after activation.</li><li>– Turn light switch to 0 position.</li><li>– Switch the ignition on.</li></ul>

“Leaving home”	Operation
Switch on:	<ul style="list-style-type: none"><li>– Unlock the vehicle and the low light sensor registers <i>darkness</i>.</li></ul>



"Leaving home"	Operation
Switch off:	<ul style="list-style-type: none"> <li>- Automatically after preset delay period is over.</li> <li>- Lock the vehicle.</li> <li>- Turn the light switch to the 0 position.</li> <li>- Switch the ignition on.</li> </ul>

### Background lighting in the outside mirrors

The background lighting in the outside mirrors lights up the area close to the doors while you are getting into or out of the vehicle. It is switched on when the vehicle is unlocked, a vehicle door is opened, or the "Coming home" or "Leaving home" feature is activated. If the vehicle is equipped with a light sensor, the background lighting in the outside mirrors is only switched on in darkness.

 The delay period can be adjusted and the feature can be switched on and off in the **Lights & Vision** menu ⇒ *Volkswagen Information System*.

 If the "Coming home" feature is switched on and the driver door is opened, no acoustic chime will sound to alert you that the lights are still on.

## Instrument panel lighting and headlight range adjustment



**Fig. 85** Next to the headlight switch: Control for instrument cluster lighting.

 **Please first read and note the introductory information and heed the WARNINGS** 

### Instrument panel lighting

When the lights are on, the brightness of the instrument panel lighting is adjusted by turning the thumbwheel ⇒ [fig. 85](#).

In some vehicles with daytime running lights (DRL), the instrument cluster lighting switches on automatically when it is dark outside or when driving through tunnels, for example. You will need to switch the headlights on manually when this happens, so that the vehicle's taillights will turn on.

### Dynamic headlight range adjustment - Adaptive Front Lighting System

The headlight range is automatically adjusted to the vehicle load when the Adaptive Front Lighting System is switched on.





**! WARNING**

Headlights that are aimed too high because of the way the vehicle is loaded can blind and distract other drivers. This can lead to a crash and serious personal injuries.

- Always adjust headlights to loading conditions so that they do not blind others.

## Interior and reading lights

 Please first read and note the introductory information and heed the WARNINGS 

Button	Function
0	Interior lights off.
	Door contact switch - center position. Interior lights go on automatically when the vehicle is unlocked, a door is opened or the vehicle key is removed from the ignition. The lights go out about 20 seconds after you close the doors. They also go out when you lock the vehicle or switch on the ignition.
	Interior lights on.
	Reading light on or off.
	

### Glove and luggage compartment lights

The glove and luggage compartments may have lights that come on automatically when they are opened and go off when they are closed.

### Background lighting

When the ignition and headlights are switched on, the roof console control buttons light up.

There may also be footwell lighting.



The interior and reading lights go out when you lock the vehicle or a few minutes after you remove the vehicle key from the ignition. This helps to prevent unnecessary drain on the vehicle battery.

## Sun protection

### Introduction

---

In this section you'll find information about:

Sun visors

Windshield made of heat-insulating glass

#### **⚠ WARNING**

**Sun visors and side windows shades can reduce visibility.**

- **Always stow sun visors and side window shades when not needed to block sun glare.**

### Sun visors

---

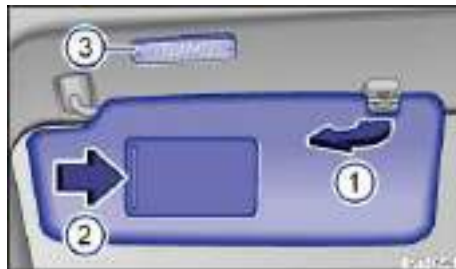

Fig. 86 Sun visor.

**ⓘ Please first read and note the introductory information and heed the WARNINGS ⚠**

#### **Sun visor adjustment:**

- Flip the sun visor down toward the windshield.
- Lift it out of the retaining clip and swivel it over toward the door ⇒ [fig. 86 \(1\)](#).

#### **Vanity mirror and lighting**

A vanity mirror is behind a cover in the sun visor. When the cover is slid open (2), the light (3) comes on.

The light goes out when you shut the cover or if you flip the sun visor up again.



The vanity mirror light and the interior light above the sun visor go out after several minutes. This helps to prevent unnecessary drain on the vehicle battery.

## Windshield made of heat-insulating glass

---



**Fig. 87** Heat-reflective windshield with communications window (blue shaded area).

**⚠ Please first read and note the introductory information and heed the WARNINGS ⚠ 115.**

Windshields made of insulating glass have a transparent metallic infrared-reflecting coating. There is an uncoated area (communications window) just above the inside rearview mirror ⇒ [fig. 87](#). This serves as a communications window for transmitting signals to and from electronic components and accessories.

The uncoated area must not be blocked on the inside or outside or covered with stickers because this can cause the electronic components to malfunction.

## Windshield wipers and washer

### Introduction

---

In this section you'll find information about:

Indicator light

Windshield wiper lever

Windshield wiper functions

Windshield wiper service position

Rain sensor

Checking and refilling windshield washer fluid

#### More information:

- Exterior views
- Climate control
- Working in the engine compartment
- Exterior care and cleaning

#### WARNING

Windshield washer fluid without enough frost protection can freeze on the windshield and reduce visibility.

- Use the windshield washer system with enough frost protection for winter temperatures.
- Never use the windshield wipers/washers when it is freezing without first defrosting the windshield. The washer solution may freeze on the windshield and reduce visibility.

#### WARNING

Worn or dirty wiper blades reduce visibility and increase the risk of accidents and severe injuries.

- Always replace wiper blades that are worn, damaged, or do not keep the windshield clear.

#### NOTICE

To help prevent damage to the wiper blades and the wiper motor when it is cold outside, always make sure that blades are not frozen to the windshield before operating the wipers. Using the windshield wiper service position can be helpful in cold weather so the wipers do not freeze to the windshield

### Indicator light

---

 Please first read and note the introductory information and heed the WARNINGS 

Lights up	Possible cause	Proper response
	Not enough windshield washer fluid.	Refill windshield washer reservoir at the next opportunity

When the ignition is switched on, several warning and indicator lights come on briefly for a function check. They go out after a few seconds.

**! NOTICE**

Failure to heed warning lights or text WARNINGS can result in vehicle damage.

**Windshield wiper lever**

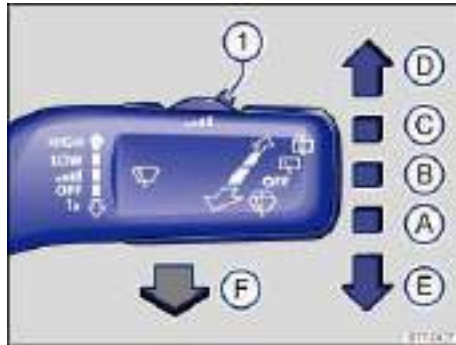

Fig. 88 Operating the front windshield wiper.







Fig. 89 Operating the rear wiper.

**⚠ Please first read and note the introductory information and heed the WARNINGS ⚠**

Move the lever to the desired position ⇒ **!**:

(A)	OFF	Wiper switched off.
-----	-----	---------------------

Move the lever to the desired position ⇒ :

(B)		Intermittent wiping for the windshield. Adjust the interval settings with switch ⇒ <a href="#">fig. 88 (1)</a> (vehicles without rain sensors) or the sensitivity of the rain sensor (vehicles with rain sensors).
(C)	LOW	Slow wiper speed.
(D)	HIGH	Fast wiper speed.
(E)	1x	One-tap wiping – brief wiping. Hold the lever pressed down longer to wipe more often.
(F)		Pull the lever toward the steering wheel to activate the windshield washers, then release.
(G)		Intermittent wiping for the rear window. The wiper wipes about every 6 seconds.
(H)		Press the lever forward as far as it will go to activate the rear window washers, then release.

### NOTICE

- To help prevent damage to the wiper blades and the wiper motor when it is cold outside, always make sure that blades are not frozen to the windshield before operating the wipers. Using the service position can be helpful in cold weather so the wipers do not freeze to the windshield ⇒ *Windshield wiper service position*.
- If the ignition is switched off while the wipers are running, the wipers will continue at the same wiping speed when the ignition is switched on again. Frost, ice, snow, leaves, and other objects on the windshield can damage the wipers and the wiper motor.
- Remove snow and ice from the wipers before you begin driving.
- If the wiper blades freeze to the windshield, loosen them carefully. Volkswagen recommends using a deicing spray.

### NOTICE

Never switch on the windshield wipers when the windshield is dry because the windshield can be scratched.

 The windshield wipers work only if the ignition is switched on and the engine hood is closed. The windshield wipers turn off automatically when the engine hood is opened. The rear windshield wipers turn off automatically when the rear hatch is opened.

 If the front wipers are on, the rear wiper is switched on automatically when backing up.

 If the windshield wiper lever is in the rear window intermittent wiping position ⇒ [fig. 89 \(G\)](#) when the ignition is switched off and back on or the engine is started, rear window wiper action does not resume until the windshield wipers are activated. This is to keep the wiper from working when the

window is dry. By switching rear window intermittent wiping off and then back on, you can override this feature and activate the rear window wiper immediately.

 The intermittent wiping for the front windshield depends on the driving speed. The higher the speed, the faster the wipers move.

 If the wiper blades freeze to the windshield, loosen them carefully. Volkswagen recommends using a deicing spray.

## Windshield wiper functions

---

 Please first read and note the introductory information and heed the WARNINGS

### Wiper performance in different situations:

---

When the vehicle is not moving:	The wiper speed changes temporarily to the next lower speed.
During automatic wipe/wash:	While the washer system is working, the Climatronic switches to recirculation for about 30 seconds to help prevent the washer fluid odor from entering the vehicle interior.
During intermittent wiping:	Speed-dependent interval control: The higher the vehicle speed, the faster the wipers move.

### Heated washer nozzles

The heating thaws frozen water nozzles, but not the fluid supply hoses. When the ignition is switched on, the heat applied to the washer nozzles is automatically regulated depending on the outside air temperature.

 If there is something on the windshield, the wiper will try to wipe it away. If it continues to block the wiper, the wiper will stop moving. Remove the obstacle and switch the wiper on again.



## Windshield wiper service position

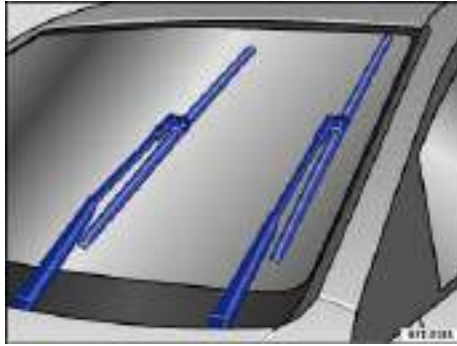

Fig. 90 Windshield wiper in service position.

**⚠ Please first read and note the introductory information and heed the WARNINGS ⚠**

In the service position, the wiper arms can be lifted away from the windshield ⇒ fig. 90. The wipers are moved to the service position as follows:

- The engine hood must be closed ⇒ *Working in the engine compartment*.
- Switch the ignition off, turn it on briefly, and then off again.
- Press the windshield wiper lever down briefly ⇒ fig. 88 (E) when the ignition is off.
- Wipers move into service position.

Carefully fold the wiper arms back onto the windshield before driving! Switch the ignition on and press the windshield wiper lever down briefly ⇒ fig. 88 (E). The wiper arms move back to their original position.

### Lifting the wiper blades and tilting them away from the windshield

- Put the wiper arms in service position ⇒ ⚠.
- Do not handle the wiper blades, handle the wiper arms only at the attachment above the wiper blades.

### ⚠ NOTICE

- To help prevent damage to the engine hood and the windshield wiper arms, lift the wiper arms away from the windshield only when they are in the service position.
- Always carefully fold the windshield wiper arms down against the windshield before driving the vehicle.

## Rain sensor

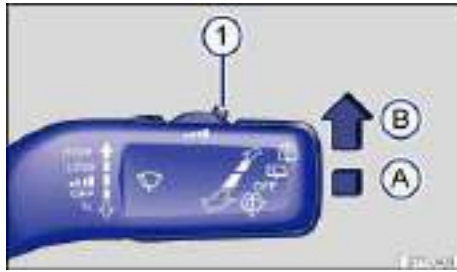

Fig. 91 Windshield wiper lever: Adjusting rain sensor 1.

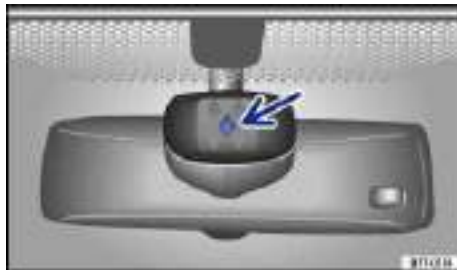

Fig. 92 Sensitive rain sensor surface.

### **⚠ Please first read and note the introductory information and heed the WARNINGS ⚠**

When switched on, the rain sensor automatically shortens or lengthens the delay between wiping intervals depending on how hard it is raining ⇒ ⚠. The rain sensor's sensitivity can be adjusted manually. Manual wiping (vehicles without rain sensors)

Push the lever into the desired position ⇒ fig. 91:

- (A) Rain sensor off windshield wiper lever home position).
- (B) Rain sensor active – automatic wiping as needed.
- (1) Adjusting the sensitivity of the rain sensor:
  - Move switch to the right – high sensitivity.
  - Move switch to the left – low sensitivity.

After switching the ignition off and back on again, the rain sensor stays on and works again with the wiper lever in position (A) when the vehicle speed is over 10 mph (16 km/h).

Even if the rain sensor is disabled, it is still necessary to reach this speed to reactivate the wipers when the windshield wiper lever is in the intermittent wiping position. The wipers then wipe at fixed intervals instead of wiping as needed, as they do in rain sensor mode.

### **Possible reasons for changes in the way the rain sensor works**

The rain sensor may misread what is happening in the *detection zone of its sensitive rain-sensor surface* ⇒ fig. 92 (arrow) and not work for a number of reasons, which include:

- Worn out wiper blades: Worn out wiper blades may leave a film of water or wiping streaks; this can cause the wipers to run longer, to wipe more often, or to wipe continuously at high speed.
- Insects: Insects hitting the sensor may trigger the wipers.

- Salt streaks: Salt streaks on the windshield from winter driving can cause wiping more often or continuously on glass that is almost dry.
- Dirt: Caked-on dust, wax, any other buildup on the windshield (lotus effect), or car-wash detergent residue can lower the rain sensor's sensitivity and cause it to react too slowly or not at all.
- Crack or chip in the windshield: If a stone hits and chips the windshield while the rain sensor is on, this will trigger a wiper cycle. After that, the rain sensor will recognize the change and recalibrate itself to respond to the smaller detection zone. Depending on the size of the chip, the sensor's reaction pattern may or may not change.



### WARNING

The rain sensor cannot always recognize rain and activate the wipers.

- Switch the wipers on manually when water on the windshield reduces visibility.



Clean the rain sensor's sensitive surface regularly and check the wiper blades for wear or damage.



To remove wax and coats of polish safely, we recommend using an alcohol-based windshield cleaner.

## Checking and refilling windshield washer fluid





Fig. 93 In the engine compartment: Cap of the windshield washer fluid reservoir.

**⚠ Please first read and note the introductory information and heed the WARNINGS ⚠**

Check the windshield washer fluid level regularly and refill as necessary.

There is a filter screen in the filler neck of the windshield washer fluid reservoir. The screen helps to keep large particles and debris from getting into and clogging the windshield washer nozzles when adding windshield washer fluid. Take the screen out only to clean it. If the screen is damaged or missing, have it replaced immediately, otherwise the system may become clogged and not work properly.

- Open the engine hood ⚠
- The windshield washer fluid reservoir can be identified by the symbol on its cap ⇒ fig. 93.
- Check if there is still enough windshield washer fluid in the reservoir.

- Refill with an appropriate windshield washer fluid that is recommended by Volkswagen ⇒ . Follow the directions on the container.
- In cold weather, always use a special windshield washer antifreeze solution that will help keep the water from freezing ⇒ .

#### Recommended cleaners

- For the warmer months, Windscreen Clear SummerG 052 184 A1 or equivalent. Mixing ratio 1:100 (1 part concentrate to 100 parts water) in the windshield washer reservoir.
- All-season Windscreen ClearG 052 164 A2 or equivalent. the mixing ratio in winter to 0 °F (-18 °C) about 1:2 (1 part concentrate to 2 parts water), otherwise, mixing ratio 1:4 in the windshield washer reservoir.

#### Filling capacity

The windshield washer fluid reservoir holds about 3.2 qts. (3.0 liters).

 <b>WARNING</b>	
<b>Never mix antifreeze or similar additives into the windshield washer reservoir. This could produce an oily film on the windshield, which would considerably reduce visibility.</b>	
<ul style="list-style-type: none"><li>• Use clear water with a cleaning solution recommended by Volkswagen.</li><li>• If necessary, blend with a suitable windshield washer fluid antifreeze agent.</li></ul>	

 <b>NOTICE</b>	
---	--

- |   |
|---|
| <ul style="list-style-type: none"><li>• Never mix cleaning solutions recommended by Volkswagen with other cleaning agents. If you do, this could cause sediments or other by-products that can clog the windshield wiper nozzles.</li><li>• When refilling, do not confuse one type of operating liquid with another! Otherwise serious malfunctions and engine damage can occur!</li></ul> |
|---|

# Mirrors

## Introduction

---

In this section you'll find information about:

Inside mirror

Outside mirrors

For your driving safety, it is important that you properly adjust the outside mirrors and the inside mirror before you start driving ⇒ .

The outside mirrors and the inside mirror help you see and adapt your driving to traffic behind you. Remember that the inside and outside rearview mirrors will not show everything behind you. There can be blind spots. Blind spots can be significantly larger if the mirrors are not properly adjusted.

### More information:

- Exterior views
- Adjusting the seating position
- Memory seat
- Shifting
- Braking and parking

### WARNING

Adjusting mirrors when the vehicle is moving can cause driver distraction, accidents, and serious personal injury.

- Always adjust the rearview mirrors when the vehicle is not moving.
- Always be aware of what is happening around the vehicle when changing lanes, passing, turning, or parking. Another vehicle, pedestrian, or object could be in your blind spot.
- Always make sure mirrors are properly adjusted and the view to the rear is not reduced by moisture, ice, snow, or other things.

### WARNING

Auto-dimming mirrors contain an electrolyte fluid which can leak if the mirror glass is broken. Electrolyte fluid can irritate the skin, eyes, and respiratory system.

- Repeated or prolonged exposure to electrolyte fluid can irritate the respiratory system, especially among people with asthma or other respiratory conditions. Get fresh air immediately by leaving the vehicle or, if that is not possible, open windows and doors all the way.
- If electrolyte fluid gets into the eyes, flush them thoroughly with large amounts of clean water for at least 15 minutes; medical attention is recommended.
- If electrolyte fluid contacts skin, flush affected area with clean water for at least 15 minutes and then wash affected area with soap and water; medical attention is recommended. Thoroughly wash affected clothing and shoes before reuse.
- If swallowed, and the person is conscious, rinse mouth with water for at least 15 minutes. Get medical attention immediately. Do not induce vomiting unless instructed to do so by a medical professional.

**!** NOTICE

Broken glass in the auto-dimming mirrors can cause electrolyte fluid leakage. Liquid electrolyte leaked from a broken mirror glass will damage any plastic surfaces it comes in contact with. Clean up spilled electrolyte fluid immediately with clear water and a sponge.

## Inside mirror

---



Fig. 94 Manually adjustable inside mirror.

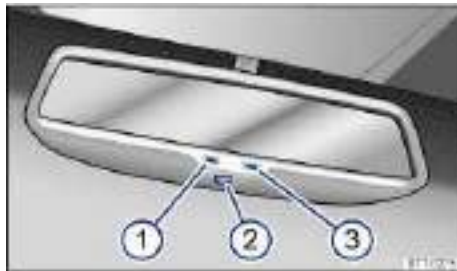

Fig. 95 Auto-dimming inside mirror.

**⚠ Please first read and note the introductory information and heed the WARNINGS ⚠**

Adjust the inside mirror to make sure that there is good visibility through the rear window.

For example, visibility through the rear window could be impaired if there is a sunshade on the rear window or clothing on the luggage compartment cover, or if the rear window is covered with ice, snow, or dirt.

### Manually adjustable inside mirror

- Home position: Lever on the bottom edge of the mirror points forward.
- To adjust to non-glare visibility, move the lever so that it points backwards ⇒ [fig. 94](#).

### Auto-dimming inside mirror (if applicable)

Key to [fig. 95](#):

- (1) Indicator light.
- (2) Switch.
- (3) Sensor for recognizing entry of light.

The auto-dimming feature can be switched on and off with the switch on the inside mirror (2). When auto-dimming is activated, the indicator light (1) is on.

If the ignition is switched on, the sensor (3) *automatically* darkens the inside mirror depending on the amount of light shining into the vehicle from the rear.

The auto-dimming feature is deactivated when you shift the transmission into reverse or switch on the interior lights or the reading light.

Do not attach external navigation devices to the windshield or in the vicinity of the auto-dimming inside mirror ⇒ ⚠.

### ⚠ WARNING

The illuminated display on an external navigation device can cause the auto-dimming inside mirror to malfunction, which can result in crashes and serious injuries.

- Malfunctions in the auto-dimming function can result in the rearview mirror being unable to evaluate the exact distance of vehicles in the rear or other objects.

**i** If the light striking the sensor is filtered or blocked (such as by a sunshade), the auto-dimming inside mirror will not work properly or may not work at all.

## Outside mirrors

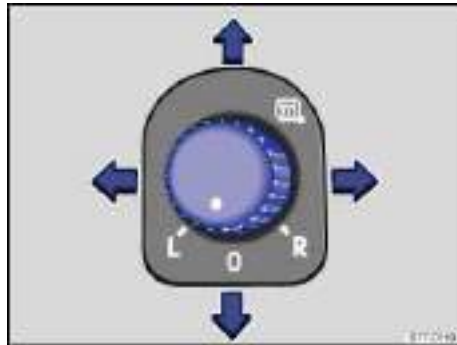



Fig. 96 In the driver door: Adjusting knob for outside mirrors.

**⚠ Please first read and note the introductory information and heed the WARNINGS**

Turn the knob ⇒ fig. 96 to adjust the outside mirrors.

**Turn the rotary knob to the desired position:**

	Switch on outside mirror heating. Heats only at outside air temperatures below +68 °F (+20 °C).
<b>L</b>	Adjust the left outside mirror by pressing the knob to left/right and up/down.

### Turn the rotary knob to the desired position:

R	Adjust the right outside mirror by pressing the knob to left/right and up/down.
O	Neutral position. Outside mirror folded out, no heating or adjustment possible.

### Synchronous mirror adjustment

- In the **Settings – Convenience** menu select “Mirror adjust: Both mirrors” for synchronous outside mirror adjustment
- Turn the adjusting knob to the **L** position.
- Adjust the left outside mirror. The right (passenger) outside mirror will automatically adjust at the same time.
- If needed, correct the position of the right mirror by turning the adjusting knob to the **R** position.

### Auto-dimming outside mirror on the driver side

The auto-dimming outside mirror is controlled together with the auto-dimming inside mirror ⇒ *Inside mirror*.

### Memory for front passenger side mirror (when backing up)

- Choose the remote control vehicle key that will be used with the settings about to be made.
- Unlock the vehicle with that remote control vehicle key.
- Set the parking brake.
- Shift the transmission into Neutral (**N**).
- Switch on the ignition.
- Activate the function **Mirror down** in the **Settings – Convenience** menu.
- Shift the transmission into reverse.
- Adjust the passenger outside mirror for a clear view of the curb, for example.
- The adjusted mirror position is automatically stored and assigned to the vehicle key used to unlock the vehicle. The preselected position will be recalled when the key assigned to that mirror adjustment position is used again.

### Recalling passenger side mirror settings

- Turn the adjusting knob for the side mirrors to the **R** position.
- Shift the transmission into reverse gear with the ignition switched on.
- The mirror moves back to the regular position when the vehicle moves forwards faster than about 10 mph (15 km/h) or the adjusting knob is turned to the **O** or **L** position.

### **WARNING**

Improper use of the folding outside mirrors can cause personal injury.

- Always make sure that nobody is in the way when folding the mirrors in or out.
- Make sure that you do not get your finger caught between the mirror and the mirror base when moving the mirrors.





## WARNING

Incorrectly estimating distances with the right outside mirror can cause collisions and serious injury.

- The right outside mirror has a convex (curved) surface. This widens your field of vision. But vehicles or other objects seen in a convex mirror will look smaller and farther away than they really are.
- If you use the right outside mirror to judge distances from vehicles behind you when changing lanes, you could estimate incorrectly and cause a crash and serious injuries.
- Whenever possible, use the inside mirror to more accurately judge distance and size of vehicles or other objects seen in the convex mirror.
- Always make sure you have a clear view to the rear of the vehicle.



## NOTICE

- Always fold in the outside mirrors when taking the vehicle through an automatic car wash.
- Never fold power mirrors in manually because doing so could damage the electrical drive.



To reduce fuel consumption, use outside mirror heating only when needed.



When first switched on, outside mirror heating works with maximum heat for about 2 minutes.



If power mirror adjustment does not work, the outside mirrors can be adjusted by hand by pressing on the edges of the mirror surface.

# Driving tips

## Introduction

---

In this section you'll find information about

Stowing luggage

Driving with an open rear hatch

Driving a loaded vehicle

Weights and axle weights

Always stow heavy objects in the luggage compartment and make sure that the rear seat backrests are securely latched. Always use the tie-downs in the luggage compartment and secure the objects with suitable straps. Never overload the vehicle. Remember that the vehicle load, as well as how it is distributed, can affect vehicle handling and braking ⇒ .

### More information:

- Rear hatch
- Folding down the passenger seat backrest forward
- Lights
- Luggage compartment
- Roof rack
- Trailer towing
- Tires and wheels

### WARNING

Unsecured or incorrectly stowed items can fly through the vehicle, causing serious personal injury during hard braking or sharp steering or in an accident. Loose items can also be struck and thrown through the passenger compartment by the front airbags if they inflate. To help reduce the risk of serious personal injury:

- Always stow all objects securely in the vehicle.
- Always keep storage compartments closed while driving.
- Do not stow hard, heavy, or sharp objects in open bins in the vehicle or on top of the instrument panel.
- Remove hard, heavy, and sharp objects from clothing and bags in the vehicle interior and stow securely. Always put heavy items in the luggage compartment.
- Always secure objects in the passenger compartment properly with suitable straps so that they cannot move into the deployment area of a side or front airbag during braking, in a sudden maneuver, or in a collision.
- Always make sure that there is nothing on the front passenger seat when the backrest is folded forward. When the backrest is folded forward, even light objects could be pushed into the seat cushion and cause the weight-sensing mat in the seat to register enough weight to turn the airbag on
- Always make sure that the **PASSENGER AIR BAG OFF**  light is on and stays on whenever the backrest of the front passenger seat is folded forward
- Passengers must never ride in an incorrect seating position because objects are being transported in the vehicle.
- Never let anybody sit in a seat that is blocked by objects being carried in the vehicle.



## WARNING

Heavy loads will influence the way your vehicle handles and increase stopping distances. Heavy loads that are not properly stowed or secured can cause loss of control and serious injury.

- Secure the load properly to keep it from shifting.
- Always remember when transporting heavy objects that a change in the center of gravity also changes the way your vehicle handles:
  - Always distribute the load as evenly as possible.
  - Secure heavy objects properly as far forward in the luggage compartment as possible.
  - Always tie down heavy items securely with suitable straps using the tie-downs in the luggage compartment.
  - Securely latch the rear seat backrest in the upright position.
- Never exceed the Gross Axle Weight Rating or the Gross Vehicle Weight Rating on the safety compliance sticker on the left door jamb. Exceeding permissible weight can cause the vehicle to skid and handle differently.
- Always adapt your speed and driving to the heavier load and the weight distribution in the vehicle. Take road, weather, traffic, and visibility conditions into account as well.
- Always accelerate gently and avoid sudden braking and driving maneuvers.
- Always brake earlier than you would if you were not driving a loaded vehicle.

## Stowing luggage

☐ Please first read and note the introductory information and heed the WARNINGS

### Always stow all luggage securely in the vehicle

- Distribute the load in the vehicle and in the trailer as evenly as possible.
- Put heavy objects as far forward as possible in the luggage compartment and securely latch the rear seat backrest in the upright position.
- Secure luggage in the luggage compartment to the tie-downs with suitable straps ⇒ *Luggage compartment*.
- Adjust the headlight range
- Check the pressure in all 4 tires when the tires are still cold. Never reduce air pressure in warm tires to match cold tire inflation pressure. Heed the information on the tire pressure label ⇒ *Tires and wheels*.
- Pay especially close attention to your vehicle's Tire Pressure Monitoring System when driving with a heavy load ⇒ *Tire Pressure Monitoring System (TPMS)*.



## NOTICE

The defroster heating wires or antenna in the rear window can be damaged by objects that rub against them.



Please review information about loading a trailer ⇒ *Trailer towing* and a roof rack ⇒ *Roof rack*.

## Driving with an open rear hatch

 Please first read and note the introductory information and heed the WARNINGS 

Driving with an open rear hatch can lead to serious personal injury. If you have to drive with an open rear hatch, make sure that all objects and the hatch itself are properly secured and take appropriate measures to keep toxic exhaust fumes from entering the vehicle.

### WARNING

Driving with an unlatched or open rear hatch can lead to serious personal injury.

- Never transport objects larger than those fitting completely into the luggage compartment, because the rear hatch cannot be closed properly.
- After closing the hatch, always pull up on it to make sure that it is properly closed and cannot open suddenly when the vehicle is moving.
- Always stow all objects securely in the luggage compartment. Loose objects can fall out of the luggage compartment and injure others on the road behind you.
- Drive carefully; anticipate what other drivers will do.
- Avoid abrupt or sudden acceleration, steering, or braking, because the unlatched rear hatch can move suddenly.
- Always mark objects sticking out from the luggage compartment clearly for others to see. Obey all applicable legal requirements.
- Never use the rear hatch to “clamp” or “hold” objects that stick out of the luggage compartment.
- Always remove any luggage rack or other rack mounted on the rear hatch (along with any luggage on the rack) before driving with an open rear hatch.

### WARNING

Driving with an open rear hatch can cause poisonous carbon monoxide in the engine exhaust to get into the passenger compartment.

- Carbon monoxide causes drowsiness, inattentiveness, poisoning, and loss of consciousness. It can lead to accidents and severe personal injuries.
- Always keep the rear hatch closed while driving to help keep poisonous exhaust fumes from being drawn into the vehicle.
- Never transport objects that are too large to fit completely into the luggage area, because then the rear hatch cannot be fully closed.
- If you absolutely must drive with an open rear hatch, do the following to reduce the risk of carbon monoxide poisoning:
  - Close all windows and the power sunroof.
  - Switch off the climate control system's air recirculation feature.
  - Open all air vents in the instrument panel.
  - Set the fresh air fan to the highest speed.

### NOTICE

The open rear hatch changes the vehicle's length and height.

## Driving a loaded vehicle

---

📖 Please first read and note the introductory information and heed the WARNINGS ⚠️

For good handling when driving a loaded vehicle, please observe the following:

- Securely stow all luggage ⇒ *Stowing luggage*.
- Drive especially carefully and accelerate gently.
- Avoid sudden braking and driving maneuvers.
- Brake earlier than you would if you were not driving a loaded vehicle.
- If applicable, observe information about driving with a trailer ⇒ *Trailer towing*.
- If applicable, observe information about driving with a roof rack ⇒ *Roof rack*

### ⚠️ WARNING

**Heavy loads can change the way your vehicle handles and increase stopping distances. Heavy loads that are not properly stowed or secured can shift suddenly, causing loss of control and serious injury.**

- **Secure the load properly to keep it from shifting.**
- **Always remember when transporting heavy objects that they change the vehicle's center of gravity and also the way it handles.**
  - Always distribute the load as evenly as possible.
  - Secure heavy objects as far forward in the luggage compartment as possible.
  - Use your vehicle's luggage compartment tie-downs with suitable straps.
- **Always tie down heavy items securely with suitable straps.**
- **Securely latch the rear seat backrest in the upright position.**
- **Never exceed the Gross Axle Weight Rating or the Gross Vehicle Weight Rating on the safety compliance sticker on the left door jamb. Exceeding permissible weight can cause the vehicle to skid and handle differently.**
- **Always adapt speed and driving to the heavier load and the weight distribution in the vehicle. Take road, weather, traffic, and visibility conditions into account as well.**
- **Always accelerate gently and avoid sudden braking and driving maneuvers.**
- **Always brake earlier than you would if you were not driving a loaded vehicle.**

## Weights and axle weights

---

📖 Please first read and note the introductory information and heed the WARNINGS ⚠️

The actual gross weight of any vehicle depends on the engine, basic equipment, any factory-installed optional equipment for the given model, and any accessories that have been installed. The Gross Vehicle Weight Rating (GVWR) and the Gross front and Rear Axle Weight Ratings (GAWR) for a given vehicle are printed on the vehicle's Safety Compliance Certification Label on the driver door jamb.

The **Gross Vehicle Weight Rating** includes the weight of the vehicle itself with all of its factory-installed equipment, plus a full tank of gasoline, the engine oil and coolant, all vehicle occupants (150 lbs/68 kg per seating position) and cargo.

The **Gross Axle Weight Ratings** specify the maximum allowable load for each axle.

The cargo payload may not be increased by using a roof rack without commensurately reducing the weight from vehicle occupants ⇒ ⚠️. Determining the Gross Vehicle Weight Rating ⇒ *Tires and wheels*.

Vehicle payload consists of the combined weight of the following:

- Passengers.
- Total luggage and other cargo.
- Factory-installed or retrofitted accessories.
- Roof load including roof rack system.
- Hitch weight and tongue weight for trailer operation.

Please refer to the Gross Vehicle Weight Rating (GVWR) and the Gross front and rear Axle Weight Ratings (GAWR) for your vehicle, which are printed on the vehicle's Safety Compliance Certification Label on the driver door jamb.

### **WARNING**

**Exceeding maximum permissible weight ratings can result in vehicle damage, accidents, and serious personal injury.**

- **Never let the actual weights at the front and rear axles exceed the permissible Gross Axle Weight Rating. Also, never let the total of these actual weights exceed the Gross Vehicle Weight Rating.**
- **Always remember that the vehicle's handling and braking will be affected by extra load and the distribution of this load. Adjust your speed accordingly.**

### **NOTICE**

- **Always distribute the load evenly and as low as possible in the vehicle. The vehicle capacity weight figures apply when the load is distributed evenly in the vehicle (passengers and luggage).**
- **When transporting a heavy load in the luggage compartment, carry the load as close to the rear axle (as far forward) as possible so that the vehicle's handling and braking are affected as little as possible.**

# Luggage compartment

## Introduction

---

In this section you'll find information about:

- Folding the rear seat backrest forward and back into place
- Removing and reinstalling the rear seat
- Luggage compartment cover
- Luggage compartment pass-through
- Tie-downs
- Shopping bag hooks
- Luggage net
- Variable luggage compartment floor

Always stow heavy objects in the luggage compartment and make sure that the rear seat backrests are securely latched in their upright position. Always secure objects to the tie-downs with suitable straps. Never overload the vehicle. Remember that the vehicle load, as well as how it is distributed, can affect vehicle handling and braking ⇒ .

### More information:

- Adjusting the seating position
- Safety belts
- Airbag system
- Lights
- Transporting
- Trailer towing
- Tires and wheels



### WARNING

**An open or unlocked luggage compartment poses special risks for children.**

- **Close and lock the rear hatch and all doors when the vehicle is not in use. First, make certain that no one is left inside.**
- **Never leave your vehicle unattended or let children play around the vehicle, especially with the rear hatch left open. A child could crawl into the vehicle and pull the hatch shut, becoming trapped and unable to get out. This could cause severe or fatal injuries.**
- **A closed vehicle can become very hot or very cold, depending on the season. Temperatures can quickly reach levels that can cause unconsciousness or death, particularly to small children.**
- **Never let children play in or around the vehicle.**
- **Never let anyone ride in the luggage compartment.**

 **WARNING**

Unsecured or incorrectly stowed items can fly through the vehicle, causing serious personal injury during hard braking or sharp steering or in an accident. Loose items can also be struck and thrown through the passenger compartment by the front airbags if they inflate. To help reduce the risk of serious personal injury:

- Always stow all objects securely in the vehicle. Always put luggage and heavy items in the luggage compartment.
- Always secure objects in the passenger compartment properly with suitable straps so that they cannot move into the deployment zone of a side or front airbag during a sudden braking, in a sudden maneuver, or in a collision.
- Always keep storage compartments closed while driving.
- Never stow hard, heavy, or sharp objects in the vehicle's open storage compartments, on the shelf behind the rear seat bench, or on the top of the instrument panel.
- Always remove hard, heavy, or sharp objects from clothing and bags in the vehicle interior and stow them securely in the luggage compartment.

 **WARNING**

Transporting heavy objects causes the handling characteristics of the vehicle to change and increases braking distances. Heavy loads which are not properly stowed or secured in the vehicle can lead to a loss of vehicle control and cause serious person injury.

- Transporting heavy items causes the handling characteristics of the vehicle to change by shifting the vehicle's center of gravity.
- Always distribute luggage evenly and as low as possible within the vehicle. The vehicle capacity weight figures apply when the load is distributed evenly in the vehicle (passengers and luggage).
- Always stow luggage and heavy items in the luggage compartment as far forward of the rear axle as possible and secure them with appropriate straps to the tie-downs provided.
- Never exceed the vehicle's Gross Vehicle Weight Rating or Gross Axle Weight Ratings, which are printed on the Safety Compliance Certification Label located on the door jamb of the driver door. Exceeding the permissible weight can cause the vehicle to skid and behave differently.
- Always adapt your speed and driving style to accommodate your payload and its weight distribution within your vehicle.
- Be especially cautious and gentle when stepping on the accelerator pedal and avoid sudden braking and other maneuvers.
- Brake earlier than you would if you were not driving a loaded vehicle.

 **NOTICE**

- The defroster heating wires or antenna in the rear window can be damaged by objects that rub against them.



The ventilation slots between the rear window and the luggage compartment cover must not be blocked so that stale air can escape from the vehicle.



## Folding the rear seat backrest forward and back into place

---



Fig. 97 Folding the backrest forward and back.

**⚠ Please first read and note the introductory information and heed the WARNINGS ⚠**

The rear backrest is divided into 2 sections. Each section of the rear seat backrest can be folded down individually to increase the luggage space.

### Folding the rear seat backrest forward

- Push the head restraint all the way down ⇒ *Adjusting the seating position.*
- Push the rear seat all the way back ⇒ *Adjusting the rear seat.*
- Pull the pull strap forward in the direction of the arrow ⇒ [fig. 97](#) while folding the rear backrest forward.
- If the rear backrest is folded down, no one, including children, may ride on the rear seat.

### Folding the rear backrest back into place

- Fold the rear backrest back until it engages securely ⇒ ⚠.
- The rear backrest must be securely latched into place for the safety belts on the rear seats to provide optimal protection.

## **⚠ WARNING**

Improper folding and improper latching of the rear seat backrest can cause serious personal injury.

- Always make sure there are no people or animals in the area around the rear seat backrest when folding it forward.
- Never fold the rear seat backrest up or down while the vehicle is moving.
- When folding the rear seat backrest back up, make sure that the safety belt does not get caught or damaged.
- Keep hands, fingers, feet and other body parts out of the way when folding the rear seat backrest up and down.
- Each rear seat backrest must be securely latched into place in the upright position so that the safety belts on the rear seats can provide protection. This is particularly the case for the middle seat on the rear bench.
- If a seat is used with an unsecured backrest, the passenger will move forward together with the rear seat backrest during sudden braking, driving maneuvers, or a collision.
- No one, including children, may ride on the rear seats if the rear seat backrest is folded down or not correctly latched.

## **⚠ NOTICE**

Before folding the rear seat backrest forward, adjust the front seats so that the rear seat's head restraint or backrest cushion will not touch the front seats.

## **⚠ NOTICE**

Items in the luggage compartment could be damaged or cause damage when the rear seat is adjusted in the fore and aft direction.

## **Removing and reinstalling the rear seat**

---

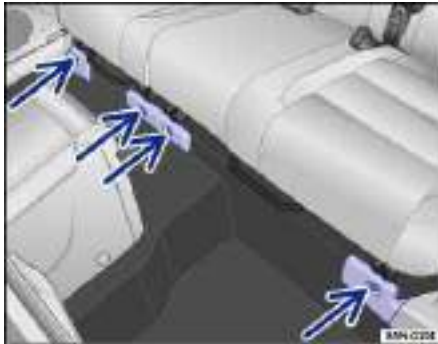

**Fig. 98** Front attachment of the rear seat.

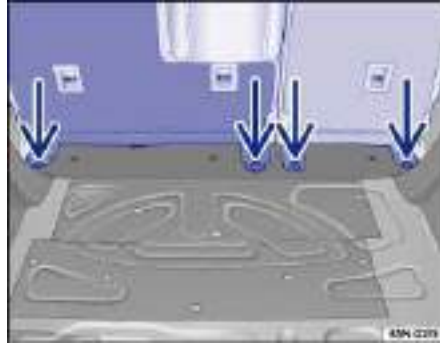

Fig. 99 Rear attachment of the rear seat.

**⚠ Please first read and note the introductory information and heed the WARNINGS ⚠**

Perform the following work yourself only if you have the necessary knowledge and experience to do so safely. Volkswagen recommends having the work performed by an authorized Volkswagen dealer or authorized Volkswagen Service Facility.

The lug wrench from the vehicle tool kit is required for removing and installing the rear seat ⇒ *Vehicle tool kit*.

---

**Removing the rear seat**

1. Push the driver seat and front passenger seat as far forward as possible ⇒ *Adjusting the seating position*.
2. Remove all rear head restraints ⇒ *Adjusting the seating position*.
3. Remove the luggage compartment cover ⇒ *Luggage compartment cover*.
4. Remove the luggage compartment floor ⇒ *Variable luggage compartment floor*.
5. Remove the spare wheel and foam insert from the vehicle ⇒ *Compact spare wheel*.
6. Move the backrests to the upright position and lock them ⇒ *Adjusting the rear seat*.
7. Push the rear seats as far back as possible ⇒ *Adjusting the rear seat*.
8. Unclip the small covers (not pictured) on the hexagonal nuts in the rear footwell ⇒ [fig. 98](#) (arrows).
9. Remove all hexagonal nuts (arrows) with the lug wrench.
10. Remove the 3 plastic covers.
11. Push the rear seats all the way forward ⇒ *Adjusting the rear seat*.
12. Remove all hexagonal nuts ⇒ [fig. 99](#) (arrows) in the luggage compartment using the lug wrench.
13. First, lift the smaller rear seat on the right from the vehicle through the right rear door.
14. Then lift the left rear seat from the vehicle through the rear hatch.

---

**Installing the rear seat**

1. Push the driver seat and front passenger seat as far forward as possible ⇒ *Adjusting the seating position*.
2. Then lift the left rear seat into the vehicle through the rear hatch.
3. Set the seat rails of the rear seat first on the front anchoring studs and then on the rear studs.

4. Secure both seat rails of the rear seat in front and back with 2 hexagonal nuts each, tightening the nuts by hand - do not tighten them with the lug wrench yet.
  5. Lift the right rear seat into the vehicle through the right rear door.
  6. Set the seat rails of the rear seat first on the front anchoring studs and then on the rear studs.
  7. Secure both seat rails of the rear seat in front and back with 2 hexagonal nuts each, tightening the nuts by hand - do not tighten them with the lug wrench yet.
  8. To align the seat rails, press the left rear seat all the way to the left in the vehicle.
  9. To align the seat rails, press the right rear seat all the way to the right in the vehicle.
  10. Tighten the hexagonal nuts in the luggage compartment (arrows) to 44 ft-lbs (60 Nm) using a torque wrench. If no torque wrench is available, tighten the hexagonal nuts using the lug wrench and have the torque checked at a qualified workshop as soon as possible.
  11. Push the rear seats as far back as possible ⇒ *Adjusting the rear seat.*
  12. Remove the hexagonal nuts in the rear of the footwell again, set the 3 plastic covers ⇒ [fig. 98](#) on the studs and screw on with the hexagonal nuts.
  13. Tighten the hexagonal nuts (arrows) to 44 ft-lbs (60 Nm) using a torque wrench. If no torque wrench is available, tighten the hexagonal nuts using the lug wrench and have the torque checked at a qualified workshop as soon as possible.
  14. Clip on the small covers (not pictured) on the hexagonal nuts (arrows).
  15. Install the foam insert and spare wheel in the vehicle ⇒ *Compact spare wheel.*
  16. Install the luggage compartment floor ⇒ *Variable luggage compartment floor.*
  17. Install the luggage compartment cover ⇒ *Luggage compartment cover.*
  18. Install all rear head restraints ⇒ *Adjusting the seating position.*
- 

 **WARNING**

No one may ride in the back of the vehicle when the rear seat has been removed.

 **WARNING**

An improperly installed rear seat can separate from its mountings during an accident.

- All securing bolts must be tightened to the specified torque after the rear seat has been installed.

 **CAUTION**

Sharp-edged parts are located on the underside of the rear seat.

- Protect your hands when you lift the rear seat in or out.

 **NOTICE**

- Have at least one person help to lift the rear seat in or out. One person should be in the vehicle and one outside.

- The lever ⇒ [fig. 44](#) for the fore and aft adjustment of the rear seat must not be operated while the seat is removed. If the position of the fore and aft adjustment is changed, the rear seat can only be installed by a qualified workshop.

## Luggage compartment cover

---



**Fig. 100** Installing and removing the luggage compartment cover.

**ⓘ Please first read and note the introductory information and heed the WARNINGS ⚠**

When you open or close the rear hatch, the supporting straps, when attached, will automatically raise or lower the luggage compartment cover.

You can put light articles of clothing on the luggage compartment cover. But remember that your view through the rear window must not be obstructed.

### Removing the luggage compartment cover

- Unhook the supporting straps from the rear hatch ⇒ [fig. 100](#) (top arrows).
- Pull the luggage compartment cover back and out of the side brackets (bottom arrows).

### Installing the luggage compartment cover

- Slide the luggage compartment cover forward into the side brackets (bottom arrows).
- Hook the supporting straps onto the rear hatch (top arrows).

### **⚠ WARNING**

In a sudden braking or other maneuver, or in a collision, unsecured or improperly secured objects or animals on the luggage compartment cover could cause serious injury.

- Never leave hard, heavy or sharp objects in bags or loose on the luggage compartment cover.
- Never let animals ride on the luggage compartment cover.

### **ⓘ NOTICE**

To help prevent damage to the luggage compartment cover, the luggage compartment may only be loaded to a height at which the luggage compartment cover will not press on the cargo when the rear hatch is closed.

- Things on the luggage compartment cover can damage it.
- The defroster heating wires or antenna in the rear window can be damaged by objects that rub against them.

 Do not cover the ventilation slots in the side consoles. Otherwise, stale air cannot escape from the vehicle.

## Luggage compartment pass-through

---

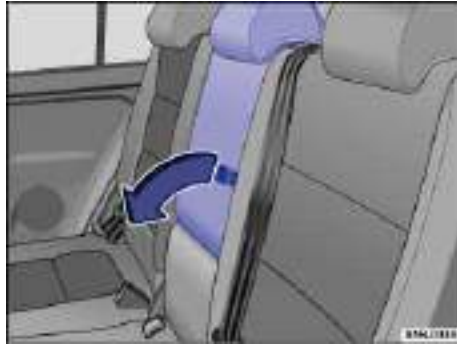

**Fig. 101** In the rear backrest: Opening the luggage compartment pass-through.

 **Please first read and note the introductory information and heed the WARNINGS** 

There is a pass-through for transporting things like skis in the rear seat backrest behind the center armrest.

To help prevent soiling the vehicle interior, cover dirty items before sliding them into the pass-through.

If the center armrest is folded down, no one can sit on the middle seat of the rear bench.

### Opening the pass-through

- Open the rear hatch.
- Push the head restraint for the center seat all the way down ⇒ *Adjusting the seating position*.
- Pull the loop in the direction of the arrow ⇒ [fig. 101](#) and fold down center armrest.
- Remove the cushion
- Slide long objects from the luggage compartment through the pass-through.
- Secure objects with the safety belt.
- Close the rear hatch.

### Closing the pass-through

- Open the rear hatch.
- Unfasten the items secured with the safety belt.
- Remove items from the luggage compartment through the pass-through.
- Fold the center armrest back until it engages securely.
- Reinstall the cushion
- Close the rear hatch.

 The pass-through can also be opened from the luggage compartment. Push down the release button (arrow) and push the center section of the rear seat backrest (pass-through) all the way forward.

## Tie-downs

---



Fig. 102 In the luggage compartment: Tie-downs.

 Please first read and note the introductory information and heed the **WARNINGS** 

There are 4 tie-downs in the front and rear of the luggage compartment, which you can use to secure luggage or other items ⇒ [fig. 102](#) (arrows).

Elastic straps can snap back towards you if they are not properly attached.

If you use elastic straps to secure items in the luggage compartment, be sure to first securely attach them to the tie-downs just behind the rear seat backrest first and then to the tie-downs at the loading edge of the luggage compartment.

Remove the hooks from the tie-downs in the reverse order described above, first from the tie-downs at the loading edge and then from the tie-downs behind the rear seat backrest so that if the hooks come loose suddenly, they will move away from you.

### **WARNING**

**Unsuitable, worn, or damaged tie-down straps (elastic or non-elastic) can snap or come loose during braking or other maneuvers or in a collision. Objects secured with these straps can then come loose and fly through the passenger compartment, causing severe personal injuries or death.**

- To help prevent baggage or other items from coming loose and flying around, always use suitable undamaged tie-down straps.
- Securely fasten the tie-down straps to the tie-downs.
- Loose or improperly secured objects in the luggage compartment can slide about suddenly and change the vehicle's handling.
- Secure even small and light objects. Loose objects in the luggage or passenger compartment can fly about during sudden braking maneuvers or in the event of an accident and injure occupants.
- Never exceed the maximum allowable load on the tie-downs when securing objects.
- Never secure a child seat to the tie-downs.

## **⚠ WARNING**

Elastic straps have to be stretched when being attached to the tie-downs in the luggage compartment. Hooks on elastic straps can cause serious personal injury if not handled properly and attached securely.

- Always protect eyes and face from injury from the hooks when attaching them to the vehicle and do not let them snap back and hit you.
- Always hold the hooks on elastic straps firmly when attaching to the vehicle and do not let them snap back and hit you.
- First attach hooks on the straps to the tie-downs at the rear seat backrest in the luggage compartment and then to the tie-downs near the loading edge of the luggage compartment. This way, if one of the hooks on the elastic straps snaps back, it will move away from you, decreasing the risk of personal injury.

**i** The maximum load for the tie-downs is about 785 lbs. (356 kg).

**i** For suitable ratchet straps and luggage stowage systems, please see an authorized Volkswagen dealer or authorized Volkswagen Service Facility.

## Shopping bag hooks



Fig. 103 In the luggage compartment: Shopping bag hooks.

**ⓘ** Please first read and note the introductory information and heed the WARNINGS **⚠**

A pull-down shopping bag hook in the upper left part of the luggage compartment can be used for conveniently holding light shopping bags.

- Press at the bottom to fold out the shopping bag hook ⇒ [fig. 103](#).
- Press at the top to fold out the shopping bag eye .

## **⚠ WARNING**

**Never use the shopping bag hooks as tie-downs. The hooks could break off during sudden breaking maneuvers or in a collision.**



**NOTICE**

The maximum load for the shopping bag hook is 6.6 lbs. (3 kg).

Applicable only in the United States

## Luggage net

---

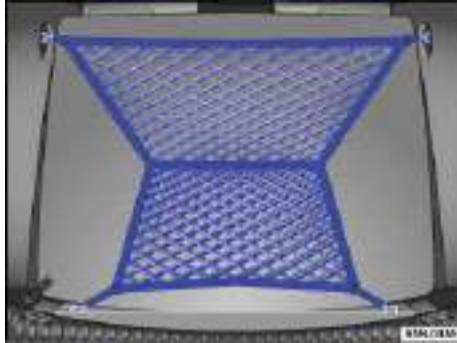

**Fig. 104** In the luggage compartment: Luggage net hooked in place.

**⚠ Please first read and note the introductory information and heed the WARNINGS ⚠**

The luggage net helps prevent lighter luggage from shifting. The luggage net also has a pocket that can hold smaller items.

There are several ways to install the luggage net in the luggage compartment.

### **Example 1: Securing the luggage net flat on the luggage compartment floor**

- First secure the luggage net hooks to the tie-downs at the rear seat backrest ⇒ [fig. 104](#) ⇒ ⚠. The luggage net pocket opening must face upwards.
- Secure the luggage net hooks to the tie-downs at the loading edge of the luggage compartment .

### **Example 2: Securing the luggage net to the loading edge**

First attach the loops to the shopping bag hooks.

Then secure the short luggage net hooks to the tie-downs at the loading edge of the luggage compartment ⇒ ⚠. The luggage net pocket opening must face upwards.

### **Removing the luggage net**

The installed luggage net is stretched tight ⇒ ⚠.

- Remove the hooks and loops of the luggage net from the tie-downs in the reverse order described above so that if the hooks come loose suddenly, they will move away from you.
- Stow the luggage net in the luggage compartment.

**⚠ WARNING**

The elastic luggage net has to be stretched when being attached to the tie-downs in the luggage compartment. The hooks can cause serious personal injury if not handled properly and attached securely.

- Always hold the hooks on the luggage net bag firmly when attaching to the vehicle and do not let them spring back and hit you.
- Always protect eyes and face from injury from the metal hooks when attaching them to the tie-downs in the luggage compartment.
- First attach the luggage net bag hooks to the tie-downs on the rear seat backrest or on the shopping bag hooks in the luggage compartment and then to the tie-downs near the loading edge of the luggage compartment. If one of the hooks on the luggage bag net snaps back, it will move away from you and not towards you, increasing the risk of injury.

## Variable luggage compartment floor

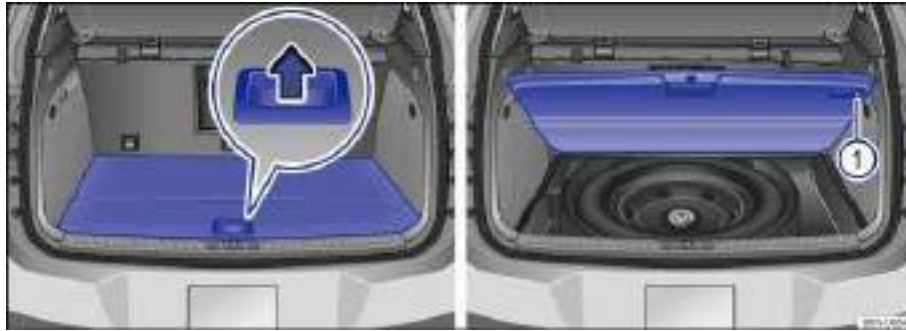

Fig. 105 In the luggage compartment: Opening and securing the variable luggage compartment floor.



Fig. 106 Extending the luggage compartment floor forward or downward.

ⓘ Please first read and note the introductory information and heed the WARNINGS ⚠

### Opening and closing the luggage compartment floor

- To *open*, fold out handle in the direction of the arrow and raise the luggage compartment floor completely ⇒ fig. 105.

- To *secure*, push the retaining pin to the right.
- To *close*, push the retaining pin (1) to the left and guide the luggage compartment floor downwards.

#### Extending the luggage compartment floor forward

- Remove the luggage compartment cover ⇒ *Luggage compartment cover*.
- Remove the rear head restraints ⇒ *Adjusting the seating position*.
- Push both sections of the rear seat forward ⇒ *Adjusting the seating position*.
- Fold the rear backrests forward ⇒ *Adjusting the seating position*.
- Fold the cover forward ⇒ [fig. 106 \(1\)](#).

#### Extending the luggage compartment floor downward

- Remove the luggage compartment cover ⇒ *Luggage compartment cover*.
- Raise the luggage compartment floor, pull from the side pins (2) and remove it from the vehicle to the rear.

There may be a foam element with the spare wheel ⇒ [fig. 105](#) located beneath the variable luggage compartment floor. If a spare wheel is present, remove it ⇒ *Compact spare wheel* and remove the foam element from the luggage compartment.

### WARNING

During hard braking or an accident, loose objects can fly through the passenger compartment and cause serious or even fatal injuries.

- Even if the luggage compartment floor panel is properly raised, it is still necessary to secure all objects.
- Objects stowed between the rear seat bench and the luggage compartment floor panel must never be more than 2/3 as high as the raised floor panel.
- Objects stowed between the rear seat bench and the raised luggage compartment floor panel must never weigh more than about 16.5 lbs. (7.5 kg).

### NOTICE

Do not let the luggage compartment floor fall freely when closing it. Always guide it down into place. The trim or the luggage compartment floor could be damaged.

 If you slide the rear seats forward, there is a gap between the luggage compartment floor and the rear seats. Make certain there are no objects in this space before sliding the rear seats back again.

# Roof rack

## Introduction

---

In this section you'll find information about:

Attaching the roof rack base carrier and roof rack  
Securing a load on the roof rack

The roof of your vehicle has been designed to optimize aerodynamics and does not have traditional rain gutters that are used to attach many kinds of roof racks.

Since the rain gutters are molded into the roof to provide efficient aerodynamics, only Volkswagen-approved base carrier mounts and roof racks can be used.

### When should the roof rack be removed?

- When it is no longer needed.
- Before driving through an automatic car wash.
- When the vehicle would otherwise be too high for minimum clearance to enter, for example, a garage.

### More information:

- Lights
- Transporting
- Saving fuel and helping the environment
- Tires and wheels
- Parts, accessories, repairs and modifications

### WARNING

Transporting heavy or bulky loads on the roof rack will change the way the vehicle handles by shifting the vehicle's center of gravity and increasing the wind drag.

- Always secure the load properly with suitable and undamaged straps so that the load will not shift.
- Cargo that is large, heavy, bulky, long or flat will have a negative effect on the vehicle's aerodynamics, center of gravity and overall handling.
- Always avoid sudden maneuvers and hard braking.
- Always adapt your speed and driving to the heavier load and the weight distribution in the vehicle. Take road, weather, traffic, and visibility conditions into account as well.

### NOTICE

- Always remove the roof rack before driving through an automatic car wash.
- Your vehicle is higher when the roof rack is installed, especially when it is loaded. Compare the vehicle height with existing clearance heights, such as underpasses and garage doors.
- Always make sure that the roof rack system and anything being carried on it does not interfere with the roof antenna or the movement of the power sunroof or the rear hatch.
- Make sure that the rear hatch does not touch items on the roof rack when opened.

 If a roof rack is installed, fuel consumption increases due to increased air resistance.

## Attaching the roof rack base carrier and roof rack

---

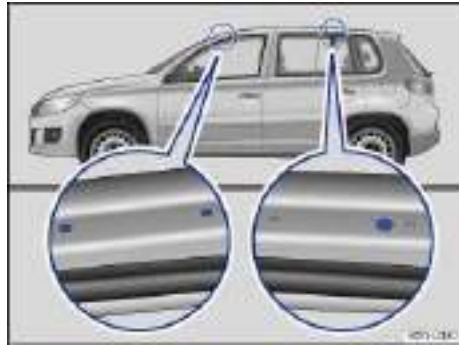

**Fig. 107** Vehicles without roof railing: Attachment points for the base carrier and roof rack.

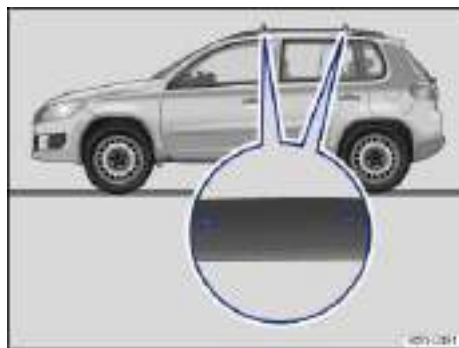

**Fig. 108** Vehicles with roof railing: Attachment points for the base carrier and roof rack.

 **Please first read and note the introductory information and heed the WARNINGS** 

The base carrier is the basis of a complete roof carrier system. For safety reasons, additional attachments are necessary for transporting luggage, bicycles, surfboards, skis and small boats. Suitable accessories can be purchased from your authorized Volkswagen dealer or authorized Volkswagen Service Facility.

### **Vehicles without roof railing: Mounting the base carrier and roof rack**

Always attach the base carrier and roof rack correctly.

Always carefully follow the installation instructions from the base carrier or roof rack manufacturer.

The mounting holes are on the underside of the roof frame and are only visible when the door is open

⇒ [fig. 107](#).

Only mount the roof rack base carrier at the holes shown in the illustration.

### Vehicles with roof railing: Mounting the roof rack

Typical roof racks cannot be attached to the roof railing. Only roof racks which have been approved by Volkswagen may be used.

Always carefully follow the installation instructions from the roof rack manufacturer.

The attachment holes are on the inside of the roof railing ⇒ [fig. 108](#) (magnified view).

Only mount the roof rack base carrier at the holes shown in the illustration.

**⚠ WARNING**

Installing or using a base carrier or roof rack improperly can cause the entire system to fly off the vehicle, causing accidents and injuries.

- Always follow the installation instructions provided by the manufacturer.
- Use the base carrier and roof rack only if they are undamaged and properly installed.
- Mount the roof rack base carrier only at the markings shown in the illustration ⇒ [fig. 107](#) or ⇒ [fig. 108](#).
- Always install the base carrier and roof rack properly.
- Make sure that all bolts and fasteners are properly installed and properly tightened before every trip and retighten them as needed after driving a short distance. During a long trip, check all bolts and fasteners at each stop.
- Always properly install special fixtures for items such as bicycles, skis, surfboards, etc.
- Do not modify or repair the base carrier or roof rack.

**i** Follow the installation instructions provided for installing the roof rack system. Always carry them in the vehicle.

### Securing a load on the roof rack

---

**⚠ Please first read and note the introductory information and heed the WARNINGS**

It is not possible to secure a load unless the roof rack system has been properly installed ⇒ **⚠**.

#### Maximum permissible roof load

The maximum permissible roof load for vehicles **without** a roof railing is **165 lbs. (75 kg)** and for vehicles **with** a roof railing, **220 lbs. (100 kg)**. The roof load is the combined weight of the roof rack and the items being carried on the roof ⇒ **⚠**.

Be sure you know the weight of the roof rack and the items you want to transport on the roof. Weigh them if necessary. Never carry a total of more than the maximum permissible roof load.

When using a roof rack with a lower load limit, do not load the rack to the maximum weight mentioned above. In this case, you may only load the roof rack to the weight limit specified in the system's installation instructions.

#### Distributing the load

Distribute the load evenly and secure it properly ⇒ **⚠**.

#### Checking the mountings

After the base carrier and roof rack have been installed, check all bolts and fasteners after driving a short time and at regular intervals thereafter.



### **WARNING**

If the maximum permissible roof load is exceeded, accidents and substantial vehicle damage may occur.

- Never exceed the specified roof load, the maximum gross axle weight rating, or the gross vehicle weight rating.
- Do not exceed the loading capacity of the roof rack, even if the permissible roof load is not fully utilized.
- Always make sure that loads are evenly distributed and that heavier items are, as far as possible, toward the front.



### **WARNING**

Loose or improperly secured loads can be thrown from the roof rack and cause accidents and injuries.

- Always use suitable, undamaged tie-down ropes and ratchet straps.
- Secure the load properly.

## Trailer towing

### Introduction

---

In this section you'll find information about:

- Technical requirements
- Hitching up and connecting a trailer
- Loading the trailer
- Driving with a trailer
- Ball mount
- Retrofitting a trailer hitch
- Maximum permissible trailer weight

Obey country-specific requirements about trailer towing and trailer hitches.

Your Volkswagen was mainly designed for carrying passengers. If you plan to tow a trailer, please remember your vehicle will be performing a job for which it was not primarily intended. The additional load will affect durability, handling, fuel economy, and performance, and may require the vehicle to be serviced more often.

Trailer towing not only places more stress on the vehicle, it calls for more concentration from the driver. Always follow the operating and driving instructions given, and use common sense.

Under winter conditions, install winter tires on the vehicle **and** the trailer.

#### **Tongue weight**

The *maximum* permissible trailer tongue weight exerted on the ball mount should not exceed **220 lbs (100 kg)**.

#### **More information:**

- Power locking and closing system
- Anti-theft alarm system
- Lights
- Braking and parking
- Saving fuel and helping the environment
- Tires and wheels
- Parts, accessories, repairs and modifications

#### **WARNING**

**Riding in a trailer is dangerous and may be illegal.**





## WARNING

Improper use of the trailer hitch can cause accidents and injuries. An improperly installed, incorrect, or damaged trailer hitch can cause the trailer to separate from the towing vehicle and cause serious personal injuries.

- Only use an undamaged, properly mounted trailer hitch.
- Never repair or modify the trailer hitch.
- To reduce the risk of injury in rear-end collisions, and the risk to pedestrians and cyclists when the vehicle is parked, always remove the ball mount when you are not towing a trailer.
- Never install a “weight distributing” or “load equalizing” trailer hitch on your vehicle. The vehicle was not designed for these kinds of trailer hitches. The trailer hitch attachment can fail, causing the trailer to tear loose from the vehicle.



## WARNING

Improper trailer towing can cause loss of vehicle control and serious personal injury.

- Driving with a trailer and carrying heavy or large things can change the way the vehicle handles, increase the distance it needs to stop safely, and cause accidents.
- Always secure the load properly with suitable and undamaged straps so that the load will not shift.
- Always adapt your speed and driving to the heavier load and the weight distribution in the vehicle. Take road, weather, traffic, and visibility conditions into account as well.
- Reduce your speed even more than you otherwise would when going downhill and under unfavorable load, weather, or wind conditions.
- Trailers with a high center of gravity tip more easily than trailers with a low center of gravity.
- Always avoid sudden maneuvers and hard braking.
- Be especially careful when passing other vehicles.
- Reduce speed immediately if the trailer shows the slightest sign of swaying.
- Never try to stop the swaying by accelerating.
- Always obey speed limits. In some areas, the speed limits for vehicles towing trailers are lower than for vehicles without trailers. Never drive faster than 50 mph (80 km/h; under exceptional circumstances 60 mph - 100 km/h) when towing a trailer. This applies even if the local speed limit is higher.



If you are driving a new vehicle or a vehicle with a new or rebuilt engine, do not tow a trailer during the break-in period, about 600 miles (1000 km)



If you tow a trailer, your vehicle may need maintenance more often because of the extra load it has to move.



When you are not towing, remove the trailer hitch ball. This helps keep the trailer hitch from causing damage to your vehicle and to others if your vehicle is hit from behind.



Some models need a trailer hitch to tow or tow-start other vehicles. You may want to always carry the ball mount in the vehicle after it has been removed. Be sure to stow it securely.

## Technical requirements

### **ⓘ Please first read and note the introductory information and heed the WARNINGS ⚠**

Use only a weight-carrying trailer hitch designed and approved for the gross weight of the trailer you want to tow. The trailer hitch must be suitable for your vehicle and trailer and must be securely bolted to the appropriate place on the vehicle chassis. Use only a trailer hitch with a removable ball mount. Always check with the trailer hitch manufacturer to make sure that you are using the correct trailer hitch and carefully follow the hitch manufacturer's instructions. Never install a "weight distributing" or "load equalizing" trailer hitch on your vehicle. The vehicle is not designed for this kind of trailer hitch

⇒ ⚠.

Your authorized Volkswagen dealer or authorized Volkswagen Service Facility has the genuine Volkswagen hitch receiver, ball mount and electrical kit that has been specifically approved for your vehicle.

### **Do not use a bumper-mounted trailer hitch**

Never install a trailer hitch on the bumper or on the bumper attachments. The trailer hitch must not interfere with the impact-absorbing bumper system. Do not make any changes to the vehicle exhaust and brake systems. From time to time, check that all trailer hitch mounting bolts are securely fastened. When you are not towing, remove the trailer hitch. This helps keep the trailer hitch from causing damage if your vehicle is hit from behind.

### **Engine cooling system**

Towing a trailer makes the engine and its cooling system work harder. It is important that the engine cooling system is up to the job. Make sure that the cooling system has enough coolant.

### **Trailer brakes**

If your trailer has its own brakes, make sure it meets all regulations. The trailer brake system must never be directly connected to the vehicle's brake system.

### **Safety chains**

Always use **safety chains** between your vehicle and the trailer ⇒ *Hitching up and connecting a trailer.*

### **Trailer taillights**

Trailer lights must meet all regulations ⇒ *Hitching up and connecting a trailer.*

Never connect the trailer lights directly to the electrical system of your vehicle. Be sure to check with your authorized Volkswagen dealer or authorized Volkswagen Service Facility about correct wiring, switches and relays.

### **Outside mirrors**

If you cannot see the traffic behind you using the regular outside mirrors, then you must install extended mirrors. Extended mirrors may also be required by law in some countries/states/provinces. Always adjust the outside mirrors before driving. It's vital that you always have a clear view to the rear of the vehicle.

### **Maximum power consumption for the trailer**

Do not exceed the power ratings listed in the chart below.

Electrical load	Maximum power
Taillights total	108 watts
Turn signals per side	54 watts

Electrical load	Maximum power
Side marker lights total <sup>4</sup>	100 watts
Taillights lights total	54 watts

### **WARNING**

- An improperly installed or incorrect trailer hitch can cause a trailer to separate from the tow vehicle and cause serious personal injuries.
- If you don't have to tow a trailer any more, remove the entire trailer hitch. Always seal all bolt holes to prevent water and deadly exhaust fumes from getting into the vehicle.

### **NOTICE**

- If the trailer lights are not connected properly, the vehicle's electronics may be damaged.
- If the trailer uses too much electricity, the vehicle's electronics may be damaged.
- Never connect the electrical system for the trailer directly to the electrical connections for the rear lights or to any other unsuitable power sources. Use only a suitable connector to provide power to the trailer.

 If you tow a trailer frequently, Volkswagen recommends having the vehicle serviced between the regular maintenance and inspection intervals because of the extra load it has to pull.

 In some countries an additional fire extinguisher must be carried if the total weight of the trailer exceeds 5,512 lbs. (2,500 kg).

## Hitching up and connecting a trailer

 Please first read and note the introductory information and heed the **WARNINGS** 

### Safety chains

Always make sure that the safety chains are properly attached to the towing vehicle. Leave enough slack in the chains so that you can go around corners without stretching the chains. The safety chains must not drag on the ground, however.

### Trailer electrical socket

The vehicle may be optionally equipped with a setup for connecting a trailer socket. The electrical connection between the towing vehicle and the trailer is a conventional 7-pin trailer socket.

### Trailer taillights

Make sure that the trailer lights work properly and meet legal requirements. Do not exceed the maximum power consumption for the trailer ⇒ *Maximum power consumption for the trailer.*

<sup>4</sup> Side marker lights may be located on the side of the vehicle body, in the headlight assembly, or in the taillight assembly.

## WARNING

Improper connections to the vehicle electrical system can cause malfunctions that affect the entire vehicle electrical system, which can lead to accidents and serious personal injury.

- Have any work on the electrical system done by an authorized Volkswagen dealer or authorized Volkswagen Service Facility.
- Never connect the electrical system for the trailer directly to the electrical connections for the rear lights or to any other unsuitable power sources. Use only a suitable connector to provide power to the trailer.

## NOTICE

Never attach a trailer to the vehicle or leave it attached to the vehicle when the trailer is supported by a trailer jack or blocks. Various things (such as a change in trailer or vehicle load or a flat tire) can lower or raise the vehicle. This subjects the trailer hitch and the trailer to strong forces that can damage the vehicle or the trailer.

 Any problems with the vehicle's electrical system when attached to a trailer should be checked by an authorized Volkswagen dealer or authorized Volkswagen Service Facility.

 If the engine is switched off and accessories in the trailer are on and use electricity from the vehicle, the vehicle battery will be drained as long as the electrical systems of the vehicle and the trailer are connected.

## Loading the trailer

---

 Please first read and note the introductory information and heed the WARNINGS 

### Maximum permissible trailer weight and tongue weight

Maximum permissible trailer weight is the load that the vehicle can tow ⇒ . The tongue load or tongue weight is the load pressing down on the trailer hitch ball mount ⇒ *Ball mount*.

The maximum permissible trailer weight and tongue weight for your vehicle are listed on in this Manual.

The trailer load and tongue weight on the type identification plate for the trailer hitch are only test values. The vehicle-specific figures are often *lower than* these values. In some countries, but generally not in the United States, the vehicle-specific figures are listed in the official vehicle documents. Specifications in official vehicle documents always take precedence.

To help ensure optimum handling and driving safety, Volkswagen recommends always using the maximum permissible **tongue weight**. If the tongue weight is too low, the vehicle and trailer will not handle as well.

Tongue weight increases the load on the rear axle and, in turn, reduces the remaining load your vehicle can carry ⇒ *Maximum permissible trailer weight*.

### Combined towing weight

Combined towing weight is the weight of the loaded towing vehicle plus the weight of the loaded trailer.

This vehicle has not been designed to tow a Class II trailer and must never be retrofitted to tow a Class II trailer. Always make sure that your vehicle has been designed to tow the trailer you want to use and that it is legal to tow the trailer where you will be driving.

### Loading the trailer

The weight distribution in the vehicle and trailer must be balanced. Use the maximum permissible tongue weight and make sure that the load in the trailer is evenly distributed and that it is not front-heavy or tail-heavy:

- Distribute the load in the trailer so that heavy objects are directly above the axle or as close as possible to the axle.
- Secure loads properly on the trailer.

### Tire pressure

Always follow the trailer manufacturer's tire pressure recommendations for the trailer tires.

When towing, inflate the towing vehicle's tires to the maximum permissible pressure listed on the tire pressure label ⇒ *Tires and wheels*.

 **WARNING**

**Exceeding the gross weight ratings for axle, tongue, vehicle, trailer or combined weight can cause accidents and serious personal injury.**

- Never exceed the specified values.
- Never let the actual weights at the front and rear axles exceed the Gross Axle Weight Rating. Never let the combined front and rear weights exceed the Gross Vehicle Weight Rating.

 **WARNING**

**Trailer loads that are not properly secured can shift when the vehicle is moving or braking and suddenly change the way the vehicle handles, causing accidents and severe injuries.**

- Always load the trailer properly.
- Always secure the load properly with suitable, undamaged straps that can be tightened so that the load cannot shift.

## Driving with a trailer

---

 Please first read and note the introductory information and heed the **WARNINGS** 

### Headlight settings

Towing a trailer can raise the front end of the vehicle enough for the low beams to blind other road users. If your vehicle does not have headlight range adjustment, have the headlights adjusted by an authorized Volkswagen dealer or authorized Volkswagen Service Facility. Vehicles with Xenon headlights self-adjust to vehicle load and do not need manual adjustment.

### Special towing considerations



- If the trailer has an **overrun brake**, apply the brakes *gently at first* and then firmly. This helps to prevent sudden brake shock and helps prevent trailer wheels from locking up.
- Due to the combined towing weight including the higher gross vehicle weight, the stopping distance is longer.

- Before driving downhill, especially on hills that are long or steep, shift into a lower gear (manual or automatic transmission) so that the engine helps to brake the vehicle. Otherwise, the brake system could overheat and might fail.
- The vehicle's center of gravity and, in turn, the vehicle's handling, will change because of the trailer load and the increased combined towing weight of the vehicle and trailer.
- Weight distribution is especially bad if the towing vehicle is empty and the trailer is loaded. If you absolutely must drive with this combination, drive with extra care and at a reduced speed.

#### **Starting off with a trailer on hills**

Depending on how steep the hill is and the combined towing weight, a parked vehicle with trailer can roll backwards when you first start moving.

When starting off with a trailer on a hill:

- Depress and hold the brake pedal (and depress and hold the clutch - manual transmission).
- Shift into first gear or drive position **(D)** ⇒ *Braking and parking*.
- Press the  button once to deactivate the electronic parking brake ⇒ *Braking and parking*.
- Pull and hold the  button to hold the vehicle and trailer with the electronic parking brake ⇒ *Braking and parking*.
- At the same time, release the brake pedal and gradually depress the accelerator and, for manual transmission, let out the clutch until you can feel the car moving forward. Do not release the  button until the engine starts to move the vehicle forward. If your vehicle has an automatic transmission, you can also depress and hold the brake pedal for added braking and then let up on the brake pedal when you feel that the vehicle "wants" to move forward.
- Drive ahead slowly.

 <b>WARNING</b>
<p><b>Improper trailer towing can cause loss of vehicle control and serious personal injury.</b></p> <ul style="list-style-type: none"> <li>• <b>Driving with a trailer and carrying heavy or bulky items changes the way the vehicle handles and increases the distance it needs to stop safely.</b></li> <li>• <b>Always watch what is happening up ahead and around you. Brake earlier than you would if you were not towing a trailer.</b></li> <li>• <b>Always adapt your speed and driving to the heavier load and the weight distribution in the vehicle. Take road, weather, traffic, and visibility conditions into account as well.</b></li> <li>• <b>Reduce your speed even more than you otherwise would when going downhill and under unfavorable load, weather, or wind conditions.</b></li> <li>• <b>Drive especially carefully and accelerate gently. Always avoid sudden maneuvers and hard braking.</b></li> <li>• <b>Be especially careful when passing other vehicles.</b></li> <li>• <b>Reduce speed immediately if the trailer shows even the slightest sign of swaying.</b></li> <li>• <b>Never try to stop the swaying by accelerating.</b></li> <li>• <b>Always obey speed limits. In some areas speed limits for vehicles towing trailers are lower than for vehicles without trailers.</b></li> </ul>

## Ball mount

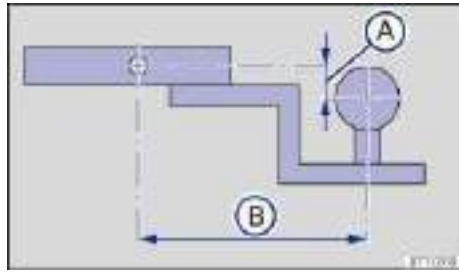

Fig. 109 Dimensions of the ball mount support.

### ⚠ Please first read and note the introductory information and heed the WARNINGS ⚠

If you must tow a trailer, you must have the necessary electrical wiring and socket together with a suitable trailer hitch installed. Because towing a trailer places a great deal of stress on the vehicle, the attachment of a trailer to the vehicle and the dimensions of the receiver and ball mount are very important so that the extra forces the vehicle has to withstand can be properly handled.

Depending on its equipment, certain parts required for the installation of a trailer hitch may already have been installed at the factory. If your vehicle does not already have the preparation package installed, your authorized Volkswagen dealer or authorized Volkswagen Service facility can install the necessary parts and equipment including the proper trailer hitch for you.

The receiver used requires both a ball mount and a ball that meet special requirements regarding geometry and size. This applies to both the height of the ball above the surface where it attaches

⇒ fig. 109 (A), and the pin-to-ball distance (B).

These dimensions are important because they help determine the way that the forces that arise during towing are applied to the receiver and its attachments to the vehicle. If you buy a ball mount and ball, make sure that they meet the following specifications.

#### Ball mount dimensions

- The drop height (A) from the center of the ball to the center of the hole for the securing pin on the ball mount must be at least 1 inch (25.4 mm) and at most  $2\frac{7}{8}$  inches (73 mm).
- The pin-to-ball distance (B) from the center of the ball to the center of the hole for the securing pin on the ball mount must be no more than 7 inches (178 mm).
- The ball diameter must be no more than 2 inches (51 mm).

Volkswagen recommends that you have an authorized Volkswagen dealer or authorized Volkswagen Service Facility install the hitch receiver, electrical system and socket.

A ball mount and ball combination that does not meet these specifications can damage your vehicle and may even fail in use ⇒ ⚠.

Never install a “weight distributing” or “load equalizing” trailer hitch on your vehicle. The vehicle is not designed for this kind of trailer hitch ⇒ ⚠.

### ⚠ WARNING

An improperly installed or unsuitable trailer hitch can cause the trailer to separate from the towing vehicle and result in a major accident with serious personal injuries.

- Have any trailer hitch retrofit or other work on a trailer hitch done by a qualified workshop.

 **CAUTION**

The ball mount sticks out behind the rear bumper and can cause injury to pedestrians and cyclists.

- To reduce the risk of injury in rear-end collisions, and the risk to pedestrians and cyclists when the vehicle is parked, always remove the ball carrier when you are not towing a trailer.

 **NOTICE**

- Never use a hitch ball larger than 2 inches (51 mm) on your vehicle. The vehicle was not designed to tow heavier trailers with a receivers larger than the specified ball. The increased loads can damage the attachment points for the trailer hitch.
- Never use an adapter to increase the size of the trailer hitch receiver from 2 inches to a larger size to tow a trailer that is heavier than the maximum permissible trailer weight that your vehicle can tow.
- You can use an adapter if required for the proper installation of a bicycle rack or other similar carrier as long as the maximum weight limits are observed. When using bicycle racks or similar carriers, make sure that the rear lights are not blocked.
- Only use trailer hitches that are approved by the hitch manufacturer for your vehicle and model.



## Retrofitting a trailer hitch

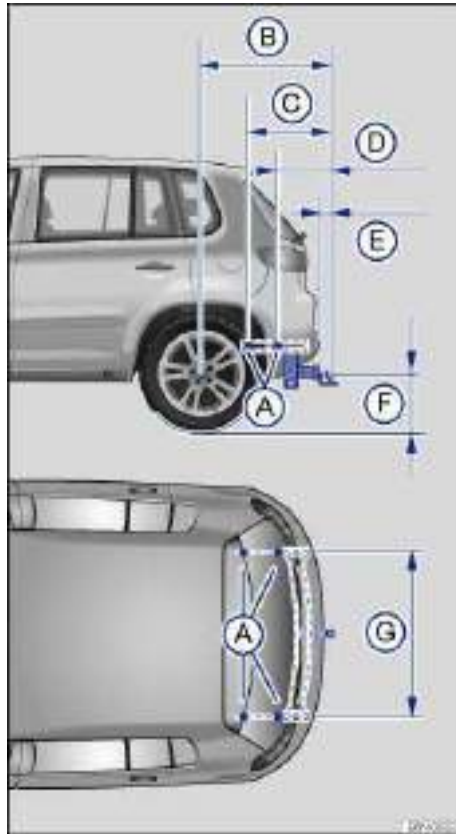

Fig. 110 Dimensions and attachment points for retrofitting a trailer hitch.

**⚠ Please first read and note the introductory information and heed the WARNINGS ⚠**

Volkswagen recommends having the trailer hitch retrofit performed by a qualified workshop because cooling system modifications or the installation of heat shields may be necessary. Volkswagen recommends that you see an authorized Volkswagen dealer or an authorized Volkswagen Service Facility before having a hitch installed on your vehicle.

When retrofitting a trailer hitch, the specified distance dimensions must be strictly adhered to. Under no circumstances may the distance from the center of the hitch ball to the surface of the road

⇒ fig. 110 (F) be less than the specified minimum. This minimum height must be present even when the vehicle is fully loaded and subject to the maximum tongue weight.

**Distance dimensions :**

- (A) Attachment points
- (B) 38 inch (966 mm)
- (C)  $23\frac{7}{10}$  inch (602 mm)
- (D) at least 14 inch (355 mm)
- (E)  $2\frac{14}{25}$  inch (min. 65 mm)
- (F) from  $13\frac{4}{5}$  inch to  $16\frac{1}{2}$  inch (350 - 420 mm)

(G) 41<sup>2</sup>/<sub>5</sub> inch (1051 mm)

**⚠ WARNING**

Improper or incorrect connections to the vehicle electrical system can cause malfunctions that affect the entire vehicle electrical system and cause accidents and serious personal injury.

- Never connect the electrical system of the trailer directly to the electrical connections of the rear lights or other unsuitable power sources. Use only a suitable connector to provide power to the trailer.
- Have any trailer hitch retrofit or other work on a trailer hitch done by a qualified workshop.

**⚠ WARNING**

An improperly installed or unsuitable trailer hitch can cause the trailer to separate from the towing vehicle and result in a major accident with serious personal injuries.

**i** Only use trailer hitches that are approved by Volkswagen for your vehicle and model.

## Maximum permissible trailer weight

**📖** Please first read and note the introductory information and heed the WARNINGS **⚠**

Maximum permissible trailer weights	lbs.	kg
Trailer with brake	2200	998
Trailer without brake	1650	748
Tongue weight	220	100

The Gross Vehicle Weight Rating and the Gross Axle Weight Rating must not be exceeded, even with a trailer. These ratings are listed on the safety compliance label on the left front door jamb 33. When a trailer is towed, the weight of the ball mount and the tongue weight of the trailer are added to the vehicle weight ⇒ *Determining the correct load limit.*

The trailer weight ratings given above are valid only up to altitudes of 3000 ft (1000 m) above sea level. The maximum permissible combined towing weight must be reduced by about 10% for every 3000 ft (1000 m), or portion thereof, of additional altitude.

**⚠ WARNING**

Exceeding the gross trailer weight rating and tongue weight can cause accidents and serious personal injury.

- Never let the actual weights at the front and rear axles exceed the Gross Axle Weight Rating (GAWR). Never let the combined front and rear weights exceed the Gross Vehicle Weight Rating (GVWR).



## **NOTICE**

**Exceeding the gross weight ratings can cause extensive vehicle damage that is not covered by any Volkswagen Limited Warranty.**

# Tires and wheels

## Introduction

---

In this section you'll find information about:

Tire and wheel handling  
Wheel rims  
New and replacement tires  
Tire inflation pressure  
Tire inflation pressure in cold tires  
Tread depth and tread wear indicators  
Tire wear and damage  
Compact spare wheel  
Tire labeling  
Winter tires  
Snow chains  
Glossary of tire and loading terminology  
Tires and vehicle load limits  
Determining the correct load limit  
UTQG classification

Volkswagen recommends that all work on tires and wheels be done by an authorized Volkswagen dealer or authorized Volkswagen Service Facility. They are familiar with the technical requirements and recommended procedures, have the necessary special tools and spare parts, and can properly dispose of old tires.

### **More information:**

- Transporting
- Trailer towing
- Tire Pressure Monitoring System
- Braking and parking
- Exterior care and cleaning
- Consumer information
- Vehicle tool kit
- Wheel covers
- Changing a wheel



## WARNING

New tires or tires that are old, worn or damaged cannot provide maximum control and braking performance.

- Improper care and handling of tires and wheels can reduce driving safety and cause accidents and severe injuries.
- Install only radial tires of the same make, the same dimensions (tread circumference), and similar tread profile on all 4 wheels.
- New tires tend to be slippery and must be broken in. Always drive with special care for the first 350 miles (560 km) to help reduce the risk of losing control, a collision, and serious personal injuries.
- Check tire inflation pressure regularly when the tires are cold and always maintain the prescribed tire pressure. Low tire pressure can cause tires to get too hot, resulting in tread separation, sudden loss of pressure, and blowouts. Tires with excessively low pressure flex (bend) more, which can cause the tire to overheat and fail suddenly without warning.
- Check tires regularly for wear and damage.
- Never drive with worn or damaged tires (for example, tires with punctures, cuts, cracks, blisters, or bumps). Driving with worn or damaged tires can lead to loss of vehicle control, sudden tire failure including blowouts and sudden deflation, crashes, and serious personal injuries.
- Have worn or damaged tires replaced immediately.
- Never exceed the maximum speed rating or the maximum load rating of the tires on your vehicle.
- The effectiveness of the driver assistance systems and the braking support systems depends on the tire traction.
- If you notice unusual vibration or if the vehicle pulls to one side when driving, always stop as soon as it is safe to do so and check the wheels and tires for damage.
- To reduce the risk of losing control, crashes, and serious personal injuries, never loosen the bolts on wheels with bolted rim rings.
- Never mount used tires on your vehicle if you are not sure of their past use. Old, used tires and wheels may have damage that cannot be seen that can lead to sudden tire failure and loss of vehicle control.
- Tires age even if they are not being used and can fail suddenly, especially at high speeds, causing loss of vehicle control, accidents, and severe personal injuries. Tires that are more than 6 years old can be used only in an emergency and even then only with special care and at low speed.



For technical reasons it is usually not possible to use wheel rims from other vehicles. Even wheel rims from the same model may not fit properly. Check with an authorized Volkswagen dealer or authorized Volkswagen Service Facility if necessary.

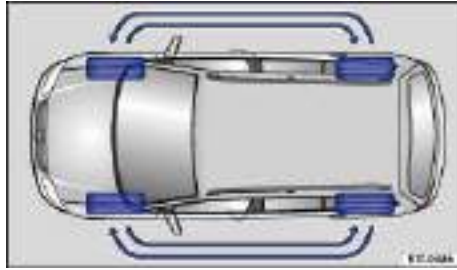

Fig. 111 Tire rotation diagram.

**⚠ Please first read and note the introductory information and heed the WARNINGS ⚠**

Tires may be the least appreciated and most abused parts of a motor vehicle. Tires are very important, since their small patches of rubber are the only contact between your vehicle and the road.

Maintaining correct tire pressure, making sure that your vehicle and its tires do not have to carry more weight than they can safely handle, and regularly inspecting tires for damage (such as cuts, slashes, irregular wear, and overall condition) are the most important things that you can do to help avoid sudden tire failure, including tread separation and blowout.

The tires and wheels are essential parts of the vehicle's design. The tires and wheels approved by Volkswagen are specially matched to the characteristics of the vehicle for good road holding and safe handling when in good condition and properly inflated.

### Avoiding tire damage

- If you must drive over a curb or other obstacle, drive very slowly and as much as possible at a right angle to the curb with the tire tread of both front wheels contacting the curb at the same time.
- Regularly check tires for damage, such as punctures, cuts, tears and blisters.
- Remove embedded material in the tread profile that **has not yet penetrated the inside of the tire** ⇒ *Tire wear and damage*.
- Heed all warning messages from the Tire Pressure Monitoring System (TPMS) ⇒ *Tire Pressure Monitoring System (TPMS)*.
- Replace worn or damaged tires immediately ⇒ *Tire wear and damage*.
- Damage to tires and wheels is often not readily visible. If you notice unusual vibration or the vehicle pulls to one side, this may indicate that one of the tires is damaged. The tires must be checked immediately for **hidden damage** by an authorized Volkswagen dealer or an authorized Volkswagen Service Facility. See also ⇒ *Tire wear and damage*.
- Never exceed the load and permissible maximum speed rating of the tires ⇒ *Tire labeling*.
- Always keep aggressive chemicals including grease, oil, gasoline and brake fluid off the tires, including the compact spare tire ⇒ ⚠.
- Replace missing valve caps immediately.

### Unidirectional tires

Unidirectional tires are designed to rotate only in one direction. Unidirectional tires have arrows on the sidewalls that show the direction of rotation ⇒ *Tire labeling*. Unidirectional tires must always be mounted according to the specified direction of rotation in order to deliver their best grip, braking performance, low road noise, and good wear as well as good hydroplaning resistance.

If you have to mount a tire opposite to its proper direction of rotation, you must drive more carefully, since the tire is no longer being used as designed. This is particularly important on wet roads. You

must replace or remount the tire as soon as possible in order to restore the correct direction of rotation.

### Rotating tires

To help ensure even wear on all tires, regular tire rotation according to the diagram ⇒ [fig. 111](#) is recommended. In this way all tires can have about the same service life.

Volkswagen recommends that you have your tires rotated by an authorized Volkswagen dealer or authorized Volkswagen Service Facility.

### Tires more than 6 years old

Tires age even if they are not being used. Physical and chemical processes reduce tire strength and performance and cause them to harden and become brittle. Old tires can fail suddenly and without warning.

Volkswagen recommends replacing tires that are 6 years and older. This also applies to tires that look new (including the tire on the compact spare wheel) or that seem to still be usable with tread depth that has not yet reached the legal minimum depth ⇒ .

The age of each tire can be determined with the manufacturing date that is part of the U.S. DOT tire identification number (TIN) ⇒ *Tire labeling*.

### Tire storage

Mark tires before removing them to help make sure that the previous location (left, right, front, rear) and rolling direction can be maintained when remounting them. Store tires in a cool, dry and preferably dark place. Do **not** store tires mounted on wheels standing up.

Tires not mounted on wheels should be covered to help protect them from dirt and stored vertically (sitting on the tread).



#### WARNING

**Aggressive fluids and materials can cause visible and invisible tire damage that can cause tire blowouts.**

- Always keep chemicals, oils, grease, fuels, braking fluids and other aggressive substances away from tires.



#### WARNING

**Tires age even if they are not being used and can fail suddenly, especially at high speeds, causing loss of vehicle control, accidents, and severe personal injuries.**

- Tires that are more than 6 years old can be used only in an emergency and even then only with special care and at low speed.



Always dispose of old tires in accordance with legal requirements.

## Wheel rims

---

 Please first read and note the introductory information and heed the **WARNINGS** 

The design of wheel bolts is matched to the factory-installed wheels. If different wheels are installed, wheel bolts with the right length and bolt head shape must be used. This helps to ensure that wheels can be mounted securely and that the brakes will work correctly ⇒ *Changing a wheel*.

In most cases, you cannot use wheel bolts from a different vehicle. Even wheel rims from the same model may not fit properly.

Tires and wheel rims approved by Volkswagen have been matched precisely to your vehicle model and contribute considerably to good handling and safe vehicle performance.

### Tightening Torque

Wheel bolts must always be installed with the correct tightening torque ⇒ *Changing a wheel*. The required tightening torque for your vehicle's wheel bolts is **103 ft lbs (140 Nm)** for front-wheel drive vehicles and **88 ft lbs (120 Nm)** for vehicles with four-wheel drive (4MOTION). After changing a wheel, the bolt torque must be checked as soon as possible with an accurate torque wrench. See an authorized Volkswagen dealer or authorized Volkswagen Service Facility.

### Wheel rims with bolted rim rings

Wheel rims with bolted rim rings have several parts. The parts are bolted together with special screws in a special process. This helps to ensure that they will work properly, prevent leaks, run true and safely. Damaged wheel rims must be replaced, and you must never take them apart or try to repair them yourself. Have an authorized Volkswagen dealer or an authorized Volkswagen Service Facility repair them for you ⇒ ⚠.

### Wheel rims with bolted decorative covers

Light-alloy wheels may have interchangeable decorative covers attached to the rim with self-locking screws. If you want to replace damaged wheel covers, contact your authorized Volkswagen dealer or authorized Volkswagen Service Facility ⇒ ⚠.

#### **WARNING**

Using improper or damaged wheel rims can affect driving safety, cause accidents and severe personal injuries.

- Use only wheel rims approved for the vehicle.
- Regularly check wheel rims for damage and replace them if necessary.

#### **WARNING**

Improper loosening and tightening of the bolts on wheel rims with bolted rim rings can cause accidents and severe personal injury.



- Never loosen bolted connections on wheel rims with bolted rim rings.
- Have all work on wheel rims with bolted rim rings performed by an authorized Volkswagen dealer or authorized Volkswagen Service Facility.

## New and replacement tires

---

 Please first read and note the introductory information and heed the WARNINGS 

### New tires

- Drive a vehicle with new tires especially carefully for the first 350 miles (560 km) because the tires must first be *broken in*. Tires that are not broken in have reduced traction ⇒  and braking performance ⇒ .
- Install only radial tires only of the same make, same dimensions (tread circumference), and similar tread profile on all 4 wheels.



- The tread depth of new tires can differ between tire models and manufacturers because of different design features and tread design.

### Replacing tires

- Tires should be replaced in pairs and not individually (both front tires or both rear tires at the same time) ⇒ .
- Replace tires only with tires that have the same specifications, including width and diameter, load and top speed rating as the tires approved by Volkswagen for your vehicle and model.
- Never use tires that are larger or wider than the dimensions of the tires approved by Volkswagen for your vehicle and model. Larger tires could scrape and rub on the vehicle body or other parts of the vehicle.

### Tire Pressure Monitoring System (TPMS) considerations

The Tire Pressure Monitoring System must be recalibrated in the appropriate menu in the MFI whenever you remove and remount or change any wheel or tire on the vehicle, even if the reinstalled or replacement wheels and tires are identical to those that were removed and even if the tire pressure does not change ⇒ *Tire Pressure Monitoring System (TPMS)*.

#### **WARNING**

**New tires tend to be slippery and must be broken in.**

- **Always drive with special care for the first 350 miles (560 km) to help reduce the risk of losing control, a collision, and serious personal injuries.**

#### **WARNING**

**Tires must have the required clearance. Tires that do not have enough clearance can rub against parts of the vehicle body, suspension, and brake system, causing brake system failure, tread delamination, and sudden blowouts.**

- **Always make sure that new tires are not larger than the tires approved for your vehicle and that the new tires do not rub against parts of the vehicle.**

#### **NOTICE**

- **When switching to different tires, make certain the valves are not damaged.**
- **Never drive without valve stem caps. The valves could be damaged.**



Always dispose of old tires in accordance with legal requirements.



If the replacement wheel is different from the tires that you have mounted on your vehicle (for example winter tires or wider, low-profile tires, or a compact spare), then use the replacement wheel for a short time only, and drive cautiously.

- Replace it with a tire matching the others on your vehicle as soon as possible.



Although tire size specifications can be the same, the actual dimensions may differ from those nominal values for different tire makes, or the tire contours may be significantly different.

## Tire inflation pressure



Fig. 112 Location of the tire inflation pressure label.

**⚠ Please first read and note the introductory information and heed the WARNINGS ⚠**

The correct tire inflation pressure for the factory-installed tires is listed on a label. The factory-installed tires may be summer, winter, or all-season tires. The label ⇒ [fig. 112](#) is on the driver door jamb.

Under- or over-inflation significantly shortens the service life of your tires and affects the handling of the vehicle ⇒ ⚠. The correct tire pressure is very important, particularly when the vehicle is driven at **higher speeds**. Incorrect tire pressure causes increased wear and even sudden tire failure and blowouts.

Therefore, tire pressure should be checked at least once a month and always before long trips.

The specified tire inflation pressure applies to a **cold tires**. When tires are warm, the pressure will be higher than when the tires are cold.

Do not reduce the tire pressure on warm tires to match the required cold tire inflation pressure. The tire inflation pressure would then be too low and could cause sudden tire failure and blowout.

### Checking tire inflation pressure

Always check the tire pressure only on “cold” tires when the vehicle has not been driven more than a couple of miles (kilometers) at low speed within the last 3 hours.

- Check tire inflation pressure regularly and on cold tires. Check all the tires, including the compact spare, if any. In colder climates tire pressure should be checked more often, but only when the tires are cold. Always use an accurate tire pressure gauge.
- After adjusting the tire inflation pressures, make sure to screw the valve caps back on; replace missing valve caps immediately. Please read and heed the information on resetting the Tire Pressure Monitoring System, if necessary ⇒ *Tire Pressure Monitoring System (TPMS)*.
- Remember that the vehicle manufacturer, not the tire manufacturer, determines the correct tire pressure for the tires on your vehicle. Never exceed the maximum inflation pressure listed on the tire sidewall for any reason.

Inflate the **spare wheel** to the pressure specified for the vehicle's road wheels on the tire pressure label; inflate a **compact spare wheel** to the pressure specified for the compact spare on the tire pressure label or on a separate label for the compact spare, if there is one.



## WARNING

Incorrect tire pressure can cause a sudden tire failure or blowout, loss of control, collision, serious personal injury, and even death.

- Always inflate tires to the recommended and correct cold tire pressure before driving off.
- Low tire pressure can cause tires to get too hot, resulting in tread separation, sudden loss of pressure, and blowouts. Tires with excessively low pressure flex (bend) more, which can cause the tire to overheat and fail suddenly without warning.
- Excessive speed and/or overloading can cause heat buildup, sudden tire failure including a blowout and sudden deflation and loss of control.
- If the tire pressure is too low or too high, the tires will wear prematurely and the vehicle will not handle well.
- Regularly check tire inflation pressure, at least once a month, and also especially before a long trip.
- Check the pressure in all four tires when the tires are still cold. Never reduce air pressure in warm tires to match cold tire inflation pressure.



## NOTICE

- Make sure not to jam the tire pressure gauge into the valve stem. Otherwise you can damage the tire valves.
- Driving without valve caps, with the wrong valve caps, or with valve caps that are not properly screwed on can damage the tire valves and the sensors on the Tire Pressure Monitoring System. To help prevent damage, always use valve stem caps like those originally installed at the factory. The caps must be screwed on tightly. Do not use metal valve caps or “comfort” valve stem caps.



Underinflation increases fuel consumption.



Pressures measured with a gauge when inflating the tires may be different from the pressures read by the tire pressure sensors. The electronic TPMS is more accurate.



When the TPMS warns that the pressure in at least one tire is too low, check the tire pressure in all 4 tires with an accurate tire pressure gauge. Low tire pressure usually cannot be spotted by looking at the tire. This is especially true for low-profile tires. When checking the tire pressures, refer to ⇒ *Tire Pressure Monitoring System (TPMS)*.

## Tire inflation pressure in cold tires

☞ Please first read and note the introductory information and heed the WARNINGS

Drive train	Tire dimensions	Tire pressures		
		psi	kPa	bar
Front-wheel drive	215/65 R16	35	240	2.4

Drive train	Tire dimensions	Tire pressures		
		psi	kPa	bar
	235/55 R17	35	240	2.4
	235/50 R18	35	240	2.4
	255/40 R19	38	260	2.6
	T145/80 R18 <sup>5</sup>	61	415	4.1
	215/65 R16	38	260	2.6
<b>Four-wheel drive (4MOTION)</b>	235/55 R17	38	260	2.6
	235/50 R18	38	260	2.6
	255/40 R19	41	280	2.8
	T145/80 R18 <sup>5</sup>	61	415	4.1
xl = reinforced sidewall.				
<p>The Tire Pressure Monitoring System is configured at the factory with the correct tire inflation pressure applicable for the vehicle model, engine and factory-installed tires. The tire inflation pressure is listed on the tire inflation pressure label on the driver door jamb 170. The tire inflation pressures for the road tires are listed on this label. The inflation pressure for the compact spare is as specified on the tire pressure label or on a separate label for the compact spare, if there is one. In the event of a discrepancy between the above figures and the tire pressures listed on the tire inflation pressure label, the pressures listed on the label are the ones you should use. The Tire Pressure Monitoring System must be recalibrated in the appropriate menu in the MFI whenever you remove and remount or change any wheel or tire on the vehicle, even if the reinstalled or replacement wheels and tires are identical to those that were removed and even if the tire pressure does not change.</p>				

---

<sup>5</sup> Compact spare wheel

## Tread depth and tread wear indicators

---



Fig. 113 Tread pattern: Wear indicator.

☐ Please first read and note the introductory information and heed the WARNINGS ⚠

### Tread depth

Most driving situations require as much tread depth as possible and similar tread depth for the tires on the front and rear wheels. This is especially true when driving in winter weather, at low temperatures and under wet conditions ⇒ ⚠.

In most countries the legally permissible minimum tread depth is 1/16 in. (1.6 mm), as measured in tread grooves next to the wear indicators. Please be sure to obey country-specific legal requirements.

**Winter tires** are no longer suitable for winter operation once the tread pattern is worn down to a depth of 3/16 in. (4.8 mm).

The tread depth of new tires can differ between tire models and manufacturers because of the different design features and tread patterns.

### Tread wear indicator (TWI) in the tire

The 1/16 in. (1.6 mm) high wear indicators are molded into the bottom of the tread grooves of the original tires running across the treads ⇒ fig. 113. Several wear indicators are evenly spaced around the tire. Markings on the sides of the tires (for example "TWI" or symbols) show the position of the wear indicators.

Wear indicators show when the tires are worn down. The tires must be replaced no later than when the tread pattern is worn down to the wear indicators.

### ⚠ WARNING

**Worn tires are dangerous and can cause loss of vehicle control including serious personal injuries.**

- **Never drive a vehicle when the tread on any tire is worn down to the wear indicators, replace them sooner.**
- **Worn tires do not grip the road properly, especially on wet roads, increasing your risk of "hydroplaning" and loss of control.**
- **Worn tires reduce the ability of your vehicle to handle well in normal and difficult driving situations and increase braking distances and the risk of skidding.**

## Tire wear and damage

---

☐ Please first read and note the introductory information and heed the WARNINGS ⚠

Wheel rim and tire damage is often difficult to see. Unusual **vibrations** or **pulling to one-side** can be an indication of tire damage ⇒ .

- If you suspect tire damage, immediately reduce speed!
- Check tires and wheel rims for damage.
- If a tire is damaged, do not drive any farther. Get expert assistance.
- If no external damage is visible, slowly and carefully drive to the nearest authorized Volkswagen dealer or authorized Volkswagen Service Facility or other qualified workshop and have the vehicle checked.

#### **Objects embedded in the tire**

- If embedded objects have penetrated to the inside of the tire, do not remove them! If objects are stuck in the tread grooves of the tire, they can be removed.
- • *With a spare wheel or compact spare wheel* If necessary, change the damaged wheel ⇒ *Changing a wheel*. If necessary, get professional assistance to change the wheel.
- Check tire pressure and adjust if necessary.

#### **Tire wear**

Tire wear depends on several factors, including:

- Driving style.
- Unbalanced wheels.
- Wheel alignment.

*Driving style* - Fast cornering, hard acceleration and braking increase tire wear. If you experience increased tire wear under normal driving conditions, have the vehicle suspension checked by an authorized Volkswagen dealer or authorized Volkswagen Service Facility.

*Unbalanced wheels* - The wheels on a new vehicle are balanced. When driving, however, various conditions can cause a wheel to become unbalanced. Unbalanced wheels can cause wear to the steering and suspension systems. Have all wheels rebalanced. A wheel must always be rebalanced if a new tire has been mounted.

*Wheel alignment* - Incorrect wheel alignment causes excessive and uneven tire wear, impairing vehicle safety. If you notice excessive or uneven tire wear, have the wheel alignment checked by an authorized Volkswagen dealer or authorized Volkswagen Service Facility.

### **WARNING**

**Unusual vibrations or pulling to one side can indicate tire damage.**

- **Reduce speed immediately and stop when it is safe to do so.**
- **Check tires and wheel rims for damage.**
- **Never drive with a damaged tire or rim. Get expert assistance instead.**
- **If no external damage is visible, slowly and carefully drive to the nearest authorized Volkswagen dealer or authorized Volkswagen Service Facility or other qualified workshop and have the vehicle checked.**

## Compact spare wheel



Fig. 114 In the luggage compartment: Compact spare wheel.



Fig. 115 In the luggage compartment: Held in place with a retainer.

⚠ Please first read and note the introductory information and heed the WARNINGS ⚠

### Removing the compact spare wheel

- Open the rear hatch, raise the entire luggage compartment floor, press the retaining pin ⇒ fig. 114 (1) to the right and slowly lower the luggage compartment floor.
- If applicable: Remove the Fender premium audio subwoofer ⇒ *Removing Fender Premium Audio subwoofer*.
- Completely unscrew the threaded retainer in the center of the compact spare wheel (2) counterclockwise and remove the compact spare wheel .

### Stowing the replaced wheel

One of the vehicles normal wheels will not fit in the well for the compact spare wheel in the floor of the luggage compartment. Therefore, in the event of a flat tire, the wheel which was changed must be secured, for example, with suitable straps in the luggage compartment.

Open the rear hatch, raise the entire luggage compartment floor, press the retaining pin (1) to the right and slowly lower the luggage compartment floor.

Put the wheel you took off the vehicle into the spare wheel well so that the center hole of the rim is aligned with the threaded pin.

Turn the threaded retainer in the center of the compact spare wheel (2) clockwise until the wheel replaced is securely in place.

If necessary, return the vehicle tool kit to its location in the luggage compartment.

Raise the floor covering and release the retaining pin, then fold the floor covering back down onto the floor of the luggage compartment.

Close the rear hatch.

### **Differences between the road tires and the compact spare**

The compact spare is different in design from the road tires and must be used only in the event of a flat tire, only for a brief time, and only when driving with extra caution ⇒ .

Replace it with a tire matching the others on your vehicle as soon as possible.

#### **Please heed the following:**

- Do not drive faster than 50 mph (80 km/h)!
- Avoid full-throttle acceleration, hard braking and fast cornering!
- Do not use snow chains on the compact spare wheel ⇒ *Snow chains*.
- After installing the compact spare tire, check the tire pressure as soon as possible ⇒ *Tire inflation pressure*.

Check the tire inflation pressure of the compact spare whenever you check the tire pressure of the road wheels, at least once a month. Inflate a **compact spare tire** to the cold tire pressure specified for the compact spare on the tire pressure label or on a separate label for the compact spare, if there is one.





## WARNING

Improper use of a compact spare tire can cause loss of vehicle control, a crash or other accident, and serious personal injury.

- Never use a compact spare tire if it is damaged or worn down to the wear indicators.
- In some vehicles, the compact spare tire is smaller than the original tire. A smaller compact spare tire is identified with a sticker and the words “50 mph” or “80 km/h”. This is the maximum permissible speed when driving with this tire.
- Never drive faster than 50 mph (80 km/h) with a compact spare tire. Avoid full-throttle acceleration, heavy braking, and fast cornering!
- Never drive more than 125 miles (200 km) if a compact spare wheel is installed on the front axle (drive axle).
- Replace the compact spare with a normal wheel and tire as soon as possible. Compact spare tires are designed for brief use only.
- Regularly check the U.S. DOT Tire Identification Number (TIN) to determine the age of the compact spare tire ⇒ *Tire labeling*. Tires age even if they are not being used and can fail suddenly, especially at higher speeds.
- Tires age even if they are not being used and can fail suddenly, especially at higher speeds.
- Tires that are more than 6 years old can only be used in an emergency and then with special care and at low speeds.
- The compact spare tire must always be secured with the wheel bolts provided by the factory.
- Never drive using more than one compact spare wheel.
- After installing the compact spare tire, the tire pressure must be checked as soon as possible ⇒ *Tire inflation pressure*.
- Snow chains cannot be used on the compact wheel tire. If you must use snow chains and have a compact spare wheel mounted, move the compact spare tire to the rear axle if a front tire has to be replaced. The tire taken off the rear axle can then be used to replace the flat front tire. Be sure you do not change the tire's direction of rotation. Install the snow chains on the full-sized road tire.



## NOTICE

When the spare wheel or compact spare is being used, the TPMS indicator light can start flashing after about 10 minutes.



If possible, attach the compact spare tire or the tire you took off the vehicle securely in the luggage compartment.

## Tire labeling



Fig. 116 International tire labeling.

⚠ Please first read and note the introductory information and heed the WARNINGS ⚠

Knowing about tire specifications makes it easier to choose the correct replacement tires. Radial tires have specifications marked on the sidewall.

Tire labeling (example)	Meaning	
Brand, Logo	Manufacturer	
Tire name	Individual tire designation of the manufacturer.	
P255/55 R 18	Dimensions:	
	P	Tire application: Passenger car
	255	Nominal sidewall-to-sidewall width of tire in millimeters.
	55	Ratio of height to width (aspect ratio)
	R	Tire belt design letter code for radial.
	18	Rim diameter (in inches)
95 H	Load rating code and speed rating code	

<b>Tire labeling (example)</b>	<b>Meaning</b>										
XL	Indicates “reinforced” tire (heavy-duty)										
M+S or M/S or 	Indicates Mud and Snow capability (also M/S)										
SSR or DSST, Eufonia, RFT, ROF, RSC, ZP	Manufacturer-dependent labeling for run-flat tires.										
RADIAL TUBELESS	Tubeless radial tire.										
E4 ...	Labeling according to international regulations (E) including number of the approving country. The multi-digit approval number is listed next.										
DOT BT RA TY5 1709	Tire identification number ( <b>TIN</b> <sup>6</sup> – in some cases only on one side of the tire – and the manufacturing date: <table border="1" data-bbox="695 554 1284 856"> <tr> <td>DOT</td> <td>The tire complies with the requirements of the United States Department of Transportation, responsible for issuing safety standards.</td> </tr> <tr> <td>BT</td> <td>Identification letter of the manufacturing site.</td> </tr> <tr> <td>RA</td> <td>Manufacturer information regarding tire dimensions.</td> </tr> <tr> <td>TY5</td> <td>Tire characteristics provided by the manufacturer.</td> </tr> <tr> <td>1709</td> <td>Manufacturing date: 17th week in 2009.</td> </tr> </table>	DOT	The tire complies with the requirements of the United States Department of Transportation, responsible for issuing safety standards.	BT	Identification letter of the manufacturing site.	RA	Manufacturer information regarding tire dimensions.	TY5	Tire characteristics provided by the manufacturer.	1709	Manufacturing date: 17th week in 2009.
DOT	The tire complies with the requirements of the United States Department of Transportation, responsible for issuing safety standards.										
BT	Identification letter of the manufacturing site.										
RA	Manufacturer information regarding tire dimensions.										
TY5	Tire characteristics provided by the manufacturer.										
1709	Manufacturing date: 17th week in 2009.										
TWI	Marks the position of the tread wear indicator										
Made in Germany	Country of manufacture.										
MAX LOAD 615 KG (1356 LBS)	United States maximum load rating per wheel.										
MAX INFLATION 350 KPA (51 PSI)	United States maximum permissible inflation pressure.										
SIDEWALL 1 PLY RAYON	Tire ply composition and materials used: 1 layer of rayon.										
TREAD 4 PLYS 1 RAYON + 2 STEEL + 1 NYLON	Tire tread composition and materials used: In this example there are 4 layers under the tread: 1 layer of rayon, 2 layers of steel belt and 1 layer of nylon.										
<b>Consumer information regarding comparison to specified base tires (standardized test procedure) 189:</b>											

<sup>6</sup> TIN represents the serial number of the tire.

<b>Tire labeling (example)</b>	<b>Meaning</b>
TREADWEAR 280	Relative service life expectancy of the tire referenced to a US-specific standard test.
TRACTION AA	Traction rating under wet conditions (AA, A, B or C).
TEMPERATURE A	Temperature stability of the tire at increased test bench speeds (A, B or C).

**Additional numbers found on the tire could either be tire manufacturer internal labels or country-specific labels (e.g. for Brazil and China).**

### **Unidirectional tires**

Unidirectional tires are designed to rotate only in one direction. Unidirectional tires have arrows on the sidewalls that show the direction of rotation. Make sure you mount the tire so that it rotates in the proper direction. The tire's performance with regard to hydroplaning, traction, noise, and wear is worse if it is not mounted in the proper direction of rotation.

If you have to mount a tire opposite to its proper direction of rotation, you must drive more carefully, since the tire is no longer being used as designed. This is particularly important on wet roads. You must replace or remount the tire as soon as possible in order to restore the correct direction of rotation.

### **Load rating code**

The load index indicates the maximum permissible load per individual tire in pounds (kilograms).

91	1356 lbs (615 kg)
93	1433 lbs (650 kg)
95	1521 lbs (690 kg)
97	1609 lbs (730 kg)
98	1653 lbs (750 kg)
99	1709 lbs (775 kg)
100	1763 lbs (800 kg)
101	1819 lbs (825 kg)
102	1874 lbs (850 kg)
103	1929 lbs (875 kg)
104	1984 lbs (900 kg)
110	2337 lbs (1060 kg)

### **Speed rating code letter**

The speed rating code letter indicates the maximum permissible road speed of the tires.

P	up to 93 mph (150 km/h)
Q	up to 99 mph (160 km/h)
R	up to 105 mph (170 km/h)
S	up to 111 mph (180 km/h)
T	up to 118 mph (190 km/h)
U	up to 124 mph (200 km/h)

- H up to 130 mph (210 km/h)
- V up to 149 mph (240 km/h)
- Z over 149 mph (240 km/h)
- W up to 167 mph (270 km/h)
- Y up to 186 mph (300 km/h)

Some tire manufacturers label tires with a maximum permissible road speed above 149 mph (240 km/h) with the letter combination "ZR".

** WARNING**

**Using incorrect or unmatched tires and/or wheels or improper tire and wheel combinations can lead to loss of control, collision and serious personal injury.**

- **Always use tires, wheels and wheel bolts that meet the specifications of the original factory-installed tires or other combinations that have been specifically approved by the vehicle manufacturer.**
- **All 4 wheels must be fitted with radial tires of the same type, the same size (tread circumference), and the same tread pattern. Driving with different tires reduces vehicle handling and can lead to a loss of control.**
- **Never drive faster than the maximum speed for which the tires installed on your vehicle are rated because tires that are driven faster than their rated speed can fail suddenly.**
- **Overloading tires can cause heat buildup, sudden tire failure, including a blowout and sudden deflation and loss of control.**
- **Temperature grades apply to tires that are properly inflated and not over- or underinflated.**

## Winter tires

** Please first read and note the introductory information and heed the WARNINGS **

Winter tires improve the handling characteristics of your vehicle significantly when driving under wintry road conditions. Summer tires have less traction on snow and ice because of their design (width, rubber composition, tread design). Volkswagen strongly recommends that you always have winter tires or all-season tires installed on all 4 wheels on your vehicle, especially when winter road conditions are expected. Winter tires also improve the vehicle's braking performance and help reduce stopping distances during winter weather. Volkswagen recommends installing winter tires once temperatures are below +45 °F (+7 °C).

Winter tires are no longer suitable for winter driving once the **tread pattern** is worn down to a depth of 3/16 in (4.8 mm). In addition, winter tire performance decreases with **age** - independent of the tread profile depth.

### When using winter tires:

- Obey state and country-specific legal requirements.
- Install winter tires on all 4 wheels.
- Use snow tires only under wintry road conditions.
- Only use winter snow tires with dimensions approved for the vehicle.
- Use only winter tires of the same tire belt design, the same dimensions (tread circumference), and the same tread design.
- Follow speed restrictions according to the winter tire's speed rating code letter ⇒ .

## Speed restrictions

Winter tires are certified up to a top speed identified by speed rating code letters on the side wall

⇒ *Tire labeling.*

In some vehicle models it is possible to set a speed warning in the MFI menu in the instrument cluster display (Multi-Function Indicator - MFI) ⇒ *Volkswagen Information System.*

Top speed rating and tire inflation pressure for **V winter tires** depend on the engine installed in your vehicle. Be sure to ask your authorized Volkswagen dealer or authorized Volkswagen Service Facility about the maximum permissible speed and the required tire inflation pressure for the winter tires that you plan to use.

## All-wheel drive (4MOTION)

Vehicles with all-wheel drive and standard road wheels have good forward motion and traction even under wintry road conditions. However, Volkswagen recommends installing winter tires or all season tires on *all 4* wheels to improve handling as well as *braking performance.*

If you use **snow chains**, please read and heed information and directions

**⚠ WARNING**

**Driving faster than the maximum speed for which the winter tires on your vehicle were designed can cause sudden tire failure including a blowout and sudden deflation, loss of control, crashes and serious personal injuries.**

- **Winter tires have a maximum speed rating that may be lower than your vehicle's maximum speed.**
- **Never drive faster than the maximum speed for which the winter tires installed on your vehicle are rated because tires that are driven faster than their rated speed can fail suddenly.**
- **Never exceed the maximum load rating for the winter tires installed on your vehicle.**

 Install summer tires promptly in the spring. Summer tires offer better handling characteristics for temperatures above +45 °F (+7 °C). They are quieter, do not wear as quickly, and reduce fuel consumption.

 The Tire Pressure Monitoring System must be recalibrated using the appropriate menu in the MFI whenever you remove and remount or change any wheel or tire on the vehicle, even if the reinstalled or replacement wheels and tires are identical to those that were removed and even if the tire pressure does not change

 If necessary, ask your authorized Volkswagen dealer or authorized Volkswagen Service Facility about permissible winter tire dimensions.

## Snow chains

**⚠ Please first read and note the introductory information and heed the WARNINGS**

Obey local regulations as well as the applicable speed limits when driving with snow chains.

Snow chains improve forward motion, traction and braking characteristics under wintry conditions.

Snow chains may be used **only on the front wheels** when driving on roads and highways. This applies even to **all-wheel drive vehicles (4MOTION)**. Snow chains may be used **only in the following tire and wheel rim combinations:**

Tire dimensions	Rim
215/65 R16	6 1/2 J x 16 ET 33
215/60 R17	6 1/2 J x 17 ET 33

Please contact your authorized Volkswagen dealer or authorized Volkswagen Service Facility about appropriate wheel, tire and snow chain dimensions.

If possible, use only chains with low profile links that are not thicker than 37/64 in (15 mm) including the tensioner.

Remove hubcaps and decorative rim rings before installing snow chains ⇒ . However, for safety reasons, caps must be installed on the wheel bolts. These are available from authorized Volkswagen dealers and authorized Volkswagen Service Facilities.

### Compact spare

For technical reasons, snow chains cannot be used on the compact spare

If you must use snow chains and have a compact spare tire mounted, move the compact spare wheel to the rear axle if a front tire has to be replaced. The tire taken off the rear axle can then be used to replace the flat front tire. Be sure to install the unidirectional tires so that they will run in the proper direction. Volkswagen recommends installing the snow chains before mounting the wheel to the vehicle.

 **WARNING**

**Using the wrong snow chains or installing snow chains improperly can cause accidents and severe personal injuries.**

- Always use the proper snow chains.
- Follow the installation instructions provided by the snow chain manufacturer.
- Never exceed the permissible speed limit when driving with snow chains.

 **NOTICE**

- Remove snow chains when roads are free of snow. Otherwise, the chains can damage the tires, impair vehicle handling and can be quickly worn down.
- Snow chains can scratch or damage wheel rims, if they have direct contact with the rims. Volkswagen recommends using coated snow chains.

 Snow chains are available in different sizes for each vehicle model.

## Glossary of tire and loading terminology

---

 Please first read and note the introductory information and heed the WARNINGS 

### Accessory weight

The combined weight (in excess of those standard items which may be replaced) of automatic transmission, electro-mechanical power steering, power brakes, power windows, power seats, radio, and heater, to the extent that these items are available as factory-installed equipment (whether installed or not).

**Aspect ratio**

The ratio of sidewall height to tire width, expressed as a percentage. A number of 70 (0.7:1 or 70%) or lower indicates a low-profile tire with a shorter sidewall for improved steering response and better overall handling on dry pavement.

**Bead**

The part of a tire made of steel wires, wrapped or reinforced by ply cords, with the shape and structure to ensure proper fit to the wheel rim.

**Bead separation**

A breakdown of the bond between components in the bead.

**Carcass**

The tire structure, except tread and sidewall rubber which, when inflated, bears the load.

**Chunking**

The breaking away of pieces of the tread or sidewall.

**Cord**

The strands of material forming the plies in the tire.

**Cord Separation**

The parting of cords from adjacent rubber compounds.

**Cracking**

Any parting within the tread, sidewall, or inner liner of the tire extending to cord material.

**Cold tire inflation pressure**

The tire pressure recommended by the vehicle manufacturer for a tire of a specified size that has not been driven for more than a couple of miles (kilometers) at low speeds in the 3 hour period before the tire pressure is measured or adjusted.

**Curb weight**

The weight of a motor vehicle with standard equipment including the maximum capacity of fuel, oil, and coolant, air conditioner, and additional weight of optional equipment.

**Extra load tire**

A tire designed to operate at higher loads and at higher inflation pressures than the corresponding standard tire.

**Gross Axle Weight Rating (GAWR)**

The load-carrying capacity of a single axle system, measured where the tire contacts the ground.

**Gross Vehicle Weight Rating (GVWR)**

The maximum loaded weight of the vehicle.

**Groove**

The space between 2 adjacent tread ribs.

**Load rating (code)**

The maximum load that a tire is rated to carry for a given inflation pressure. You may not find this information on all tires because it is not required by law.



**Maximum load rating**

The load rating for a tire at the maximum permissible inflation pressure for that tire.

**Maximum loaded vehicle weight**

The total of:

- Curb weight.
- Accessory weight.
- Vehicle capacity weight.
- Production options weight.

**Maximum (permissible) inflation pressure**

The maximum cold inflation pressure to which a tire may be inflated. Also called "maximum inflation pressure."

**Normal occupant weight**

Means 150 lbs (68 kilograms) times the number of occupants seated in the vehicle up to the total seating capacity of your vehicle.

**Occupant distribution**

The placement of passengers in a vehicle.

**Outer diameter**

The diameter of a new, properly inflated tire.

**Overall width**

Total width measured at the exterior sidewalls of an inflated tire, including the additional width of labeling, decorations, or protective bands or ribs.

**Passenger car tire**

A tire intended for use on passenger cars, multipurpose passenger vehicles, and trucks, that have a gross vehicle weight rating (GVWR) of 10,000 pounds or less.

**Ply**

A layer of rubber-coated parallel cords. A parting of rubber compound between adjacent plies.

**Ply separation**

A parting of rubber compound between adjacent plies.

**Pneumatic tire**

A mechanical device made of rubber, chemicals, fabric, and steel or other materials, that, when mounted on an automotive wheel, provides the traction and contains the gas or fluid that sustains the load.

**Production options weight**

The combined weight of installed regular production options weighing over 5 lbs (2.3 kg) more than the standard items they replace, and not previously considered as curb weight or accessory weight. These include, for example, heavy-duty brakes, ride levelers, heavy-duty battery, and special trim.

**Radial ply tires**

A pneumatic tire in which the ply cords that extend to the beads are laid at substantially 90 degrees to the centerline of the tread.

**Recommended inflation pressure**

The tire pressure recommended by the vehicle manufacturer for a tire of a specified size that has not been driven for more than a couple of miles (kilometers) at low speeds in the 3 hour period before the tire pressure is measured or adjusted.

**Reinforced tire**

A tire designed to operate at higher loads and at higher inflation pressures than the corresponding standard tire.

**Rim**

The outer edge of a wheel upon which the tire beads are seated.

**Rim diameter**

The nominal diameter of the wheel's tire bead seating surface. If you change your wheel size, to wheels of a different diameter, you will have to purchase new tires to match the new wheels.

**Rim size**

Designation means rim diameter and width.

**Rim type designation**

The industry or manufacturer's designation for a rim by style or code.

**Rim width**

The nominal distance between wheel rim flanges.

**Section width**

The linear distance between the exteriors of the sidewalls of an inflated tire, excluding elevations due to labeling decoration, or protective bands.

**Sidewall**

The portion of a tire between the bead and the tread.

**Sidewall separation**

The parting of the rubber compound from the cord material in the sidewall.

**Speed rating (letter code)**

A standardized letter code indicating the maximum speed at which a tire is designed to be driven for extended periods of time. The ratings range from 93 mph or 150 km/h ("P") to 186 mph or (300 km/h) "Y".

The speed rating letter code, where applicable, is molded on the tire sidewall ⇒ *Speed rating code letter*. You may not find this information on all tires because it is not required by law.

**Tire Pressure Monitoring System**

A system that detects when at least one of a vehicle's tires is underinflated and illuminates a low tire-pressure warning light.

**Tread**

The portion of a tire that normally touches the road.

**Tread rib**

A tread section running circumferentially around a tire.

**Tread separation**

Tire failure caused by the tread pulling away from the tire carcass.

### Tread wear indicators (TWI)

Raised areas within the main tread grooves that show, visually, when tires are worn and near the end of their useful life ⇒ *Tread depth and tread wear indicators.*

### Uniform Tire Quality Grading (UTQG)

A tire information system developed by the U.S. National Highway Traffic Safety Administration (NHTSA) that is designed to help buyers compare tires. UTQG is not a safety rating, nor is it a guarantee that a tire will last for a certain number of miles or perform a certain way. It gives tire buyers more information to compare with factors such as price, brand loyalty and dealer recommendations. Under UTQG, tires are graded by the tire manufacturers in 3 areas: tread wear, traction and temperature resistance. UTQG information is molded into the tire sidewalls.

### U.S. DOT Tire Identification Number (TIN)

A tire's serial number. It begins with the letters "DOT" ("Department of Transportation") and indicates that the tire meets all federal standards. The next 2 numbers or letters indicate the plant where the tire was manufactured. The last 4 numbers represent the week and year of manufacture.

For example, the numbers 1801 mean that the tire was produced in the 18th week of 2001. Any other numbers are marketing codes used by the tire manufacturer. This information is used to help identify affected consumers if a tire defect requires a recall.

### Vehicle capacity weight

The total rated cargo, luggage and passenger load. Passenger load is 150 lbs (68 kilograms) times the vehicle's total seating capacity (as listed on the label inside the driver door).

### Vehicle maximum load on the tire

The load on an individual tire that is determined by taking each axle's share of the maximum loaded vehicle weight (GAWR) and dividing by 2.

### Vehicle normal load on the tire

The load on an individual tire that is determined by taking each axle's share of the curb weight, accessory weight, and normal occupant weight (distributed according to the table below) and dividing by 2.

### Wheel size designation

Wheel rim diameter and width.

### Occupant loading and distribution for vehicle normal load for various designated seating capacities

Designated seating capacity, number of occupants	Vehicle normal load, number of occupants	Occupant distribution in a normally loaded vehicle
2,3 or 4	2	2 in front
5	3	2 in front, 1 in back

## Tires and vehicle load limits

**⚠ Please first read and note the introductory information and heed the WARNINGS ⚠**

There are limits to the load any vehicle or any tire can carry. A vehicle that is overloaded will not handle well and is more difficult to stop. Overloading can damage important parts of the vehicle.

Overloading can also lead to blowout, sudden loss of pressure or other tire failure that can cause loss of control.

Your safety and the safety of your passengers depends on making sure that load limits are not exceeded. Vehicle load includes everybody and everything in and on the vehicle. These load limits are technically referred to as the vehicle's **Gross Vehicle Weight Rating (GVWR)**.

The GVWR includes the weight of the basic vehicle, all factory-installed and other accessories, a full tank of fuel, oil, coolant and other fluids plus maximum load. The maximum load includes the number of passengers that the vehicle is intended to carry (seating capacity) with an assumed weight of 150 lbs (68 kg) for each passenger at a designated seating position and the total weight of any luggage in the vehicle. If you tow a trailer, the weight of the trailer hitch and the tongue weight of the loaded trailer must be included as part of the vehicle weight. At altitudes above 3000 ft (1000 m), combined towing weight (vehicle plus trailer) must be reduced by 10 % for every 3000 ft (1000 m).

**The Gross Axle Weight Rating (GAWR)** is the maximum load that can be carried at each of the vehicle's 2 axles (by the front or rear tires). GVWR and GAWR are listed on the safety compliance label on the driver door jamb. Your vehicle has 5 total seating positions: 2 in the front and 3 in back. Each seating position has a safety belt. Because there is an upper limit to your vehicle's total weight (GVWR), the weight of whatever is being carried (including the weight of a trailer hitch and the tongue weight of the loaded trailer) is also limited. More passengers, or passengers who are heavier than the assumed 150 lbs (68 kg), mean that less weight can be carried as luggage or other cargo. The tire pressure label on your Volkswagen also lists the maximum combined weight of all of the occupants and luggage or other cargo that the vehicle can carry.

### **WARNING**

**Overloading a vehicle can cause loss of vehicle control, a crash or other accident, serious personal injury, and even death.**

- **Carrying more weight than your vehicle was designed to carry will prevent the vehicle from handling properly and increase the risk of the loss of vehicle control.**
- **The brakes on a vehicle that has been overloaded may not be able to stop the vehicle in a safe distance.**
- **Tires on a vehicle that has been overloaded can fail suddenly, including a blowout and sudden deflation, causing loss of control and a crash.**
- **Always make sure that the total load being transported - including the weight of a trailer hitch and the tongue weight of a loaded trailer - does not make the vehicle heavier than the vehicle's Gross Vehicle Weight Rating.**

## Determining the correct load limit

 Please first read and note the introductory information and heed the **WARNINGS** 

Never overload tires. The following example illustrates how to determine the combined weight of all vehicle occupants and luggage or other vehicle payloads. Never overload the vehicle!

### Steps for Determining Correct Load Limit:

1. Locate the statement "THE COMBINED WEIGHT OF OCCUPANTS AND CARGO SHOULD NEVER EXCEED XXX KG OR XXX LBS" on your vehicle's placard (tire inflation pressure label)
2. Determine the combined weight of the driver and passengers that will be riding in your vehicle.

### Steps for Determining Correct Load Limit:

3. Subtract the combined weight of the driver and passengers from XXX kg or XXX lbs.
4. The resulting figure equals the available amount of cargo and luggage load capacity. For example, if the "XXX" amount equals 1400 lbs and there will be five 150 lbs passengers in your vehicle, the amount of available cargo and luggage load capacity is 650 lbs (1400-750 (5 x 150) = 650 lbs).
5. Determine the combined weight of luggage and cargo being loaded on the vehicle. That weight may not safely exceed the available cargo and luggage load capacity calculated in Step 4.
6. If your vehicle will be towing a trailer, load from your trailer will be transferred to your vehicle. Consult this Manual to determine how this reduces the available cargo and luggage capacity of your vehicle.

Check the tire sidewall to determine the load index specified for the tire.

### UTQG classification

**⚠ Please first read and note the introductory information and heed the WARNINGS ⚠**

Uniform Tire Quality Grading (UTQG): Quality grades can be found where applicable on the tire sidewall between the tread shoulder and maximum section width. Example:

- Treadwear (number)
- Traction: AA, A, B or C
- Temperature: A, B or C

For example: Treadwear 200, Traction AA Temperature A

All passenger car tires must conform to Federal Safety Requirements in addition to these grades.

#### Treadwear

The tread wear grade is a comparative rating based on the wear rate of the tire when tested under controlled conditions on a specified government test course.

For example, a tire graded 150 (Tread wear-value 150) would wear one-and-one-half (1 1/2) times as well on the government course as a tire graded 100.

The relative performance of tires depends upon the actual conditions of their use, however, and may depart significantly from the norm due to variations in driving habits, service practices and differences in road characteristics and climate.

#### Traction

The traction grades from highest to lowest, are AA, A, B and C. Those grades represent the tire's ability to stop on wet pavement as measured under controlled conditions on specified government test surfaces of asphalt and concrete. A tire marked C may have poor traction performance ⇒ ⚠.

#### Temperature

The temperature grades are A (the highest), B, and C representing the tire's resistance to the generation of heat, and its ability to dissipate heat when tested under controlled conditions on a specified indoor laboratory test wheel.

Sustained high temperature can cause the material of the tire to degenerate and reduce tire life, and excessive temperature can lead to sudden tire failure.

The grade C corresponds to a level of performance which all passenger car tires must meet under the Federal Motor Vehicle Safety Standard No. 109. Grades B and A represent higher levels of performance on the laboratory test wheel than the minimum required by law ⇒ ⚠.

**⚠ WARNING**

**The traction grade assigned to this tire is based on straight-ahead braking traction tests, and does not include acceleration, cornering, hydroplaning or peak traction characteristics.**

**⚠ WARNING**

**The temperature grade for this tire is established for a tire that is properly inflated and not overloaded. Excessive speed, underinflation or excessive loading, either separately or in combination, can cause heat buildup and possible tire failure.**

# Tire Pressure Monitoring System (TPMS)

## Introduction

---

In this section you'll find information about:

Indicator light (telltale) 

Tire Pressure Monitoring System and recalibration with the MFI

Your vehicle's Tire Pressure Monitoring System (TPMS) uses the Anti-lock Brake System (ABS) sensors to indirectly check the tire pressure of all four tires while you are driving. The sensors monitor the tread circumference (rolling circumference) and vibration characteristics of the individual tires. TPMS warns if there is a significant loss of pressure in one or more tires while the vehicle is moving. Pressure loss is signaled by the indicator light  (described below) as well as by acoustic warnings and text warnings in the instrument cluster display if your vehicle has this display (Multi-Function Indicator - MFI).

The original benchmark pressure is the recommended maximum load cold tire inflation pressure for the tires that come with your vehicle. This pressure is listed on the tire pressure label on the driver door jamb 170. After adjusting the tire pressures in all 4 tires, you can confirm the new cold inflation pressures by storing them in the appropriate menu in the MFI and change the benchmark pressure to match the current pressure of the tires on your vehicle.

Recalibrating the TPMS to reset the benchmark cold tire inflation pressure is explained below

### **More information:**

- Volkswagen Information System
- Transporting
- Tires and wheels
- Braking and parking
- 
- Exterior care and cleaning
- Parts, accessories, repairs and modifications
- Accessories, replacement parts, repairs and changes
- Consumer information

 **WARNING**

Incorrect tire pressures and/or underinflation can cause sudden tire failure, loss of control, collision, serious personal injury or even death.

- When the warning symbol appears in the instrument cluster, stop and inspect the tires.
- Incorrect tire pressure and/or underinflation can cause increased tire wear and can affect the handling of the vehicle and stopping ability.
- Incorrect tire pressures and/or underinflation can also lead to sudden tire failure, including a blowout and sudden deflation, causing loss of vehicle control.
- The driver is responsible for the correct tire pressures for all tires on the vehicle. The recommended tire pressure values are listed on a sticker inside the driver door 170.
- The TPMS can only work correctly when all tires on the vehicle are filled to the correct cold tire inflation pressure.
- Using incorrect tire pressure values can cause accidents or other damage. Always inflate the tires to the correct specified cold tire pressure values for the tires installed on the vehicle.
- Always maintain correct cold tire inflation pressure so that TPMS can do its job.
- Always inflate tires to the recommended and correct tire pressure before driving off.
- Driving with underinflated tires causes them to flex (bend) more, letting them get too hot, resulting in tread separation, sudden tire failure, and loss of control.
- Excessive speed and/or overloading can cause heat buildup, sudden tire failure and loss of control.
- If the tire pressure is too low or too high, the tires will wear prematurely and the vehicle will not handle well.
- If the tire is not “flat” and you do not have to change a wheel immediately, drive carefully and at reduced speed to the nearest service station to check the tire pressure and add air as required.
- When replacing tires or wheel rims on vehicles equipped with TPMS always read and heed the information and all WARNINGS regarding *Tires and wheels*
- The Tire Pressure Monitoring System must be recalibrated using the MFI whenever you remove and remount or change any wheel or tire on the vehicle, even if the reinstalled or replacement wheels and tires are identical to those that were removed and even if the tire pressure does not change

 **WARNING**

Improper use of the MFI reset function can cause the TPMS to give false warnings or to give no warning despite dangerously low tire pressure



Underinflation increases fuel consumption and tire wear.



Do not rely solely on the Tire Pressure Monitoring System. Check your tires regularly to make sure they are properly inflated and have no signs of damage, such as punctures, cuts, cracks, and blisters. Remove any objects that become embedded in the tire tread but have not penetrated into the body of tire itself.



When you take delivery of the vehicle, the Tire Pressure Monitoring System is calibrated for the factory-recommended cold tire inflation pressure for the tires on your vehicle, as shown on the label inside the driver door

- The system must be recalibrated in the appropriate menu in the MFI whenever you remove and remount or change any wheel or tire on the vehicle, even if the reinstalled or replacement wheels and



tires are identical to those that were removed and even if the tire pressure does not change ⇒ *Tire inflation pressure.*

- If you have to adjust the tire pressure on a warm tire, fill the tire with 2.0 - 4.35 psi (20 - 30 kPa) more than the pressure specified on the tire pressure label
- If the TPMS determines that the air pressure in at least one tire is too low, carefully check the pressure in all four tires with an accurate tire pressure gauge. Low tire pressure usually cannot be determined by looking at the tire. This is especially true of low-profile tires.





 If you have work done on your wheels or tires, inform the workshop that the vehicle is equipped with a Tire Pressure Monitoring System (TPMS).

 New tires may expand slightly the first time they are driven at high speeds, which can trigger a tire pressure warning. Remember that tire pressure can only be properly measured when the tire is "cold"

 Only replace old tires with tires that have been approved by Volkswagen for your vehicle type.

## Indicator light (telltale)

 Please first read and note the introductory information and heed the **WARNINGS** 

Tire Pressure Monitoring System display messages in the instrument cluster		
Display	Possible cause or meaning ⇒ 	Proper response
 Lights up	Lights up and a chime sounds once: The inflation pressure of one or more tires is significantly lower than the benchmark pressure set by the driver - or a tire has structural damage. Depending on vehicle equipment, the message <b>Please check tires!</b> will appear in the instrument cluster display.	 <b>Stop safely as soon as possible!</b> Reduce speed immediately! Avoid fast concerning and hard braking! Check the condition and inflation pressure of all tires. Have damaged tires replaced.
 Flashes	Flashes for about 70 seconds and then stays on: System malfunction.	Check and, if necessary, adjust the tire inflation pressure in all 4 tires. If the tire pressure is correct, switch the ignition off and back on. If the indicator light flashes again and then stays on or does not go out after checking and adjusting the air pressure in all four tires and storing the benchmark pressure in the MFI, take the vehicle to an authorized Volkswagen dealer or an authorized Volkswagen Service Facility. Have the system checked.

When the ignition is switched on, several warning and indicator lights come on briefly for a function check. They go out after a few seconds.

 **WARNING**

Incorrect tire pressures and/or underinflation can cause sudden tire failure, loss of control, collision, serious personal injury, or even death.

- When the warning symbol (D) appears in the instrument cluster, stop the vehicle as soon as it is safe to do so and inspect all tires.
- Incorrect tire pressure and/or underinflation can cause increased tire wear and can affect the handling of the vehicle and its stopping ability.
- Incorrect tire pressure and/or underinflation can also lead to sudden tire failure, including a blowout and sudden deflation, causing loss of vehicle control.
- The driver is responsible for the correct tire pressures for all tires on the vehicle. The recommended tire pressure values are listed on a sticker inside the driver door
- The TPMS can only work correctly when all tires on the vehicle are filled to the correct cold tire inflation pressure. Always maintain the correct cold tire inflation pressure so that TPMS can do its job.
- Using incorrect tire pressure values can cause accidents or other damage. Check the pressure in all four tires when the tires are still cold. Never reduce air pressure in warm tires to match cold tire inflation pressure.
- Always inflate the tires to the correct specified cold tire pressure values for the tires installed on the vehicle; see the tire inflation pressure label on the driver door jamb ⇒ *Tires and wheels*.
- Always inflate tires to the recommended and correct tire pressure before driving off.
- Driving with underinflated tires causes them to flex (bend) more, letting them get too hot, which can result in tread separation, sudden tire failure, and loss of control.
- Excessive speed and/or overloading can cause heat buildup, sudden tire failure, and loss of control.
- If the tire pressure is too low or too high, the tires will wear prematurely and the vehicle will not handle well.
- If the tire is not “flat” and you do not have to change the tire or wheel immediately, drive at reduced speed to the nearest service station to check the tire pressure and add air as required.
- When replacing tires or wheel rims on vehicles equipped with TPMS, always read and heed the information and all WARNINGS in the section *Tires and wheels*
- The Tire Pressure Monitoring System must be recalibrated using the MFI whenever you remove and remount or change any wheel or tire on the vehicle, even if the reinstalled or replacement wheels and tires are identical to those that were removed and even if the tire pressure does not change ⇒ *Resetting and recalibrating the benchmark tire pressure*.

 **WARNING**

Improper use of the MFI reset function can cause the TPMS to give false warnings or to give no warning despite dangerously low tire pressure

 **WARNING**

Failure to heed warning lights and instrument cluster text messages can cause the vehicle to break down in traffic and result in a collision and serious personal injury.

- Never ignore warning lights or text WARNINGS.
- Always stop the vehicle as soon as it is safe to do so.



## NOTICE

**Failure to heed warning lights or text WARNINGS can result in vehicle damage.**



If the ignition is switched on, an acoustic warning sounds when low tire pressure is detected. If a system malfunction is detected, no acoustic warning sounds.



Driving for a longer period of time on rough roads or with a dynamic and sporty style can make the TPMS system temporarily unavailable. The indicator light will come on, signaling a malfunction, but will go out again once road condition or driving style change.

## Tire Pressure Monitoring System and recalibration with the MFI

**📖 Please first read and note the introductory information and heed the WARNINGS ⚠️**

Your vehicle's Tire Pressure Monitoring System (TPMS) indirectly checks the tire pressure of all 4 tires while you are driving by using the Anti-lock Brake System (ABS) sensors to monitor the tread circumference (rolling circumference) and vibration characteristics of the individual tires.

The tread circumference of a tire can change:

- If a tire's inflation pressure is too low.
- If the tire's tread is damaged or the tire is structurally damaged.
- If one side of the vehicle is more heavily loaded than the other.
- If there is more weight on one axle than the other (such as when towing a trailer).
- If a compact spare tire has been mounted.
- If a wheel was replaced on each axle.
- If a tire was changed.
- If the tire pressure was changed, or wheels were rotated or replaced, but the TPMS was not reset.
- If there are snow chains on the tires. Using snow chains can cause the system to give false warnings because snow chains increase tire circumference.

The Tire Pressure Monitoring System (!) may not react at first or may not react at all when you are driving in a sporty manner, or on snow-covered or unpaved roads, when you are driving with snow chains, or in certain other situations. A change in the tread circumference of a tire is signaled by the Tire Pressure Monitoring System indicator in the instrument cluster (telltale).

The tire pressure recommended for the tires originally installed on the vehicle is on a sticker on the driver door jamb ⇒ *Tires and wheels*.

Each tire, including the spare (if provided), should be checked monthly when cold and inflated to the inflation pressure recommended by the vehicle manufacturer on the vehicle placard or tire inflation pressure label. (If your vehicle has tires of a different size than the size indicated on the vehicle placard or tire inflation pressure label, you should determine the proper tire inflation pressure for those tires.)

As an added safety feature, your vehicle has been equipped with a Tire Pressure Monitoring System (TPMS) that illuminates a low tire pressure telltale when one or more of your tires is significantly underinflated. Accordingly, when the low tire pressure telltale illuminates, you should stop and check your tires as soon as possible, and inflate them to the proper pressure. Driving on a significantly underinflated tire causes the tire to overheat and can lead to tire failure. Under inflation also reduces fuel efficiency and tire tread life, and may affect the vehicle's handling and stopping ability.

Please note that the TPMS is not a substitute for proper tire maintenance, and it is the driver's responsibility to maintain correct tire pressure, even if underinflation has not reached the level to trigger illumination of the TPMS low tire pressure telltale.

Your vehicle has also been equipped with a TPMS malfunction indicator to indicate when the system is not operating properly. The TPMS malfunction indicator is combined with the low tire pressure telltale. When the system detects a malfunction, the telltale will flash for approximately one minute and then remain continuously illuminated. This sequence will continue upon subsequent vehicle start-ups as long as the malfunction exists.

When the malfunction indicator is illuminated, the system may not be able to detect or signal low tire pressure as intended. TPMS malfunctions may occur for a variety of reasons, including the installation of replacement or alternate tires or wheels on the vehicle that prevent the TPMS from functioning properly. Always check the TPMS malfunction telltale after replacing one or more tires or wheels on your vehicle to ensure that the replacement or alternate tires and wheels allow the TPMS to continue to function properly.

### **Resetting and recalibrating the benchmark tire pressure**

Resetting the tire pressures in the Multi-function Indicator (MFI) resets the benchmark tire pressure used by the TPMS to the current tire pressure in the tires based on the circumference of the tires.

To reset the reference tire pressure, switch on the ignition. In the MFI, navigate to the **Settings** menu and select **Tire pressure**. Store and confirm the new tire pressures.

The re-calibration must be performed each time the tire pressure in one or more tires has been adjusted or after one or more tires has been changed, exchanged, or repaired. The new tire pressures are stored in the system only after at least 20 minutes of normal driving.

If you have reset the benchmark tire pressure when your tires do not have the correct tire pressure, this will prevent the TPMS from working properly. It may then give false warnings or may not give any warning even if the tire pressure is too low.

**For this reason, it is vital to make certain that all four tires are inflated to the correct pressure when they are cold, before calibrating the system.** Cold tire tires are tires that have not been driven more than a couple of miles (kilometers) at low speed within the last 3 hours.

### **Recalibrate the system to reset the benchmark TPMS pressure in the following situations:**

- After installing tires on your vehicle that have recommended cold tire inflation pressures that are different from the tires that were taken off.
- After any tire on your vehicle is removed and then remounted, even if the same tire and wheel rim that were taken off are reinstalled (for instance, after repair).
- After any tire on your vehicle is changed and replaced by another tire, even if the replacement tire is the same type and is inflated to the same pressure as the tire it replaced.
- After adjusting the tire pressure of any tire on the vehicle to its correct cold tire inflation pressure, either by putting air in one or more tires or by letting air out. Do this even though air was only added (or let out) to bring the tire to the inflation pressure it should have had all along.
- After rotating the front and rear wheels
- After mounting the compact spare tire.

### **WARNING**

**Incorrect calibration can cause the TPMS to give false warnings or to give no warning despite dangerously low tire pressures. Make certain the tire inflation pressure of all tires is correct before calibrating the system.**



## WARNING

Incorrect tire pressure can cause sudden tire failure, loss of vehicle control and serious personal injury.

- Always check and correct air pressure in all four tires, particularly after changing, exchanging, or repairing tires.
- After that, always make sure that all 4 tires are inflated to the correct tire pressure for the tires installed on the vehicle. Then recalibrate the system so that it can properly monitor the pressure in the tire.
- The Tire Pressure Monitoring System must be recalibrated using the MFI whenever you remove and remount or change any wheel or tire on the vehicle, even if the reinstalled or replacement wheels and tires are identical to those that were removed and even if the tire pressure does not change ⇒ *Resetting and recalibrating the benchmark tire pressure.*
- See the tire pressure label ⇒ *Tire inflation pressure* and the Owner's Literature for recommended cold tire inflation pressure and other important information.
- When replacing tires or wheel rims, always read and heed all of the information and WARNINGS ⇒ *Tires and wheels.*
- The Tire Pressure Monitoring System must be recalibrated using the MFI whenever you remove and remount or change any wheel or tire on the vehicle, even if the reinstalled or replacement wheels and tires are identical to those that were removed and even if the tire pressure does not change.



The Tire Pressure Monitoring System stops working if there is an ESC/ABS malfunction.

⇒ *Vehicle operation.*



After a low tire pressure warning, the vehicle must stand and must not be driven for at least one minute before the new benchmark tire pressures can be stored.

## Storage areas

### Introduction

---

In this section you'll find information about:

- Storage compartment in the front doors
- Storage compartment on the driver side
- Eyeglass storage compartment in the overhead console
- Storage compartments in the overhead console
- Storage compartment in the front center console
- Storage compartment in the front center armrest
- Card holder
- Glove compartment
- Storage compartment in the rear center console
- Other storage compartments

Store only lightweight or small objects in storage compartments.

Depending on options, there may be a factory-installed **AUX-IN jack**, or **Media Device Interface (MDI) / (MEDIA-IN)** in the storage compartment in the front center armrest.

#### **More information:**

- Passenger compartment
- Power locking and closing system
- Driver assistance systems
- Interior care and cleaning
- ⇒ booklet *Radio* or ⇒ booklet *Navigation system*

#### **WARNING**

**Loose objects can be thrown around the inside of the vehicle when the vehicle is moving, especially during sudden maneuvers and hard braking. This can cause serious personal injuries and even make the driver lose control of the vehicle.**

- **Never let animals ride in the vehicle's open storage compartments, on top of the instrument panel, or on the shelf behind the rear seats.**
- **Never put hard, heavy or sharp objects in these places or in articles of clothing or bags in the passenger compartment.**
- **Always keep storage compartments closed while driving.**



### WARNING

Objects in the driver footwell can prevent the pedals from moving freely. This can cause loss of vehicle control and increase the risk of serious personal injuries.

- Always make sure that nothing can interfere with the pedals.
- Always fasten floor mats securely to the floor.
- Never put floor mats or other floor coverings on top of already installed floor mats.
- Always make sure that nothing can fall into the driver footwell while the vehicle is moving.



### WARNING

Some kinds of cigarette lighters can be lit unintentionally, or crushed causing a fire that can result in serious burns and vehicle damage.

- Always make sure that there are no lighters in the seat tracks or near other moving parts before adjusting the seats.
- Before closing a storage compartment, always make sure that no cigarette lighter can be activated, crushed, or otherwise damaged.
- Never leave a cigarette lighter in a storage compartment, on the instrument panel or in other places in the vehicle. Heat buildup in the passenger and luggage compartment of a parked vehicle can result in temperatures in the vehicle that are much higher than the outside temperatures, particularly in summer. High temperatures could cause the cigarette lighter to catch fire.



### NOTICE

- The defroster heating wires or antenna in the rear window can be damaged by hard or sharp things on the shelf below the rear window
- Do not keep any food, medicine, or other items sensitive to heat or cold in the vehicle. They can be damaged or made unusable by heat or cold.
- Things that are made of transparent materials (such as eyeglasses, magnifying glasses, or transparent suction cups on the windows) can magnify sunlight and damage the vehicle.



The ventilation slots between the rear window and the luggage compartment cover must not be blocked so that stale air can escape from the vehicle.

## Storage compartment in the front doors

---

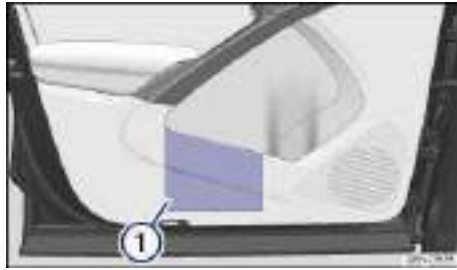

Fig. 117 In the driver door: Storage compartment.

**⚠ Please first read and note the introductory information and heed the WARNINGS ⚠**

There is a storage compartment in the driver and front passenger door. ⇒ [fig. 117 \(1\)](#).

## Storage compartment on the driver side

---



Fig. 118 On driver side: Storage compartment.

**⚠ Please first read and note the introductory information and heed the WARNINGS ⚠**

To *open* the compartment, pull in the direction of the arrow ⇒ [fig. 118](#).

To *close*, push up storage compartment until it latches.

Coin holders may be in this storage compartment.



## Eyeglass storage compartment in the overhead console

---

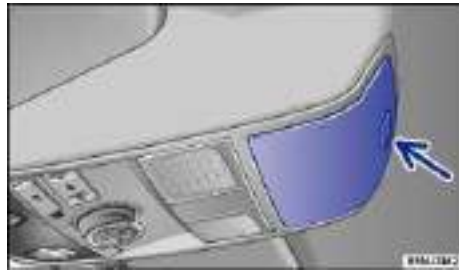

Fig. 119 In the overhead console: Storage compartment.

**⚠ Please first read and note the introductory information and heed the WARNINGS ⚠**

This storage compartment can be used for storing eyeglasses or other light objects.

To *open*, briefly press and release the storage compartment cover ⇒ [fig. 119](#) (arrow).

To *close*, push the hatch up until it latches.

## Storage compartments in the overhead console

---

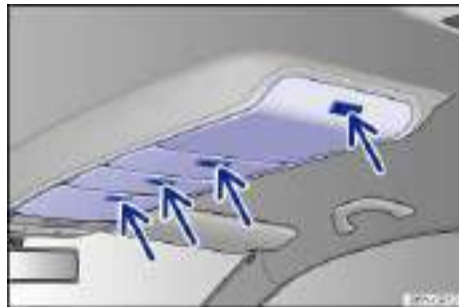

Fig. 120 In the overhead console: Storage compartments.

**⚠ Please first read and note the introductory information and heed the WARNINGS ⚠**

To *open*, briefly press and release the button ⇒ [fig. 120](#) (arrow).

To *close*, push up storage compartment until it latches.

## Storage compartment in the front center console

---



Fig. 121 In the lower center console: Storage compartment.

**ⓘ Please first read and note the introductory information and heed the WARNINGS ⚠**

This storage compartment can be used for storing small items or other light objects.

To *open*, fold the cover up from the bottom in the direction of the ⇒ fig. 121 (arrow).

To *close*, push the cover down until it latches.



The front center console storage compartment has a 12 Volt socket ⇒ *12 Volt sockets in the vehicle.*

## Storage compartment in the front center armrest

---

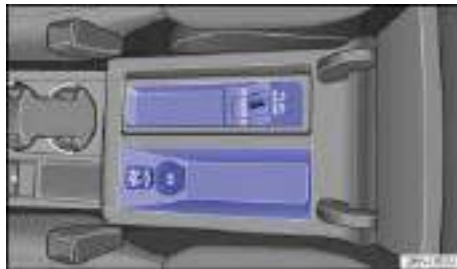

Fig. 122 In the front center armrest: Storage compartment.

**ⓘ Please first read and note the introductory information and heed the WARNINGS ⚠**

The sections of a center armrest can be opened separately to access the storage compartment.

A MEDIA-IN, AUX-IN and 12 Volt socket may also be located in the storage compartment.

To *open*, press the button and lift up the center armrest completely in the direction of the arrow ⇒ fig. 51.

To *close* the cover, you must first open the armrest completely. This will reset the height position, and allow the cover to be closed completely.

**⚠ WARNING**

The center armrest can restrict the driver's arm movement and cause crashes and serious personal injury.

- Always keep storage compartments in the center armrest closed while driving.

**⚠ WARNING**

Never let a passenger, especially a child, ride on the center armrest.

**i** There may be a factory-installed (MEDIA IN), Apple iPod® adapter, AUX-IN or 12 Volt socket located in the storage compartment in the front center armrest ⇒ Booklet *Radio* or ⇒ Booklet *Navigation system*.

## Card holder

---



Fig. 123 In the lower part of the center console: Card holder.



Fig. 124 In the upper part of the center console: Card holder.

**⚠ Please first read and note the introductory information and heed the WARNINGS**

Both the lower part of the center console ⇒ fig. 123 and the upper part of the center console ⇒ fig. 124 may have a card holder (arrow) to store coins, gas cards, parking receipts or similar items, for example.

 To help prevent theft and unauthorized use, do not use a card holder to store ATM cards or credit cards.

## Glove compartment

---



Fig. 125 Glove compartment.

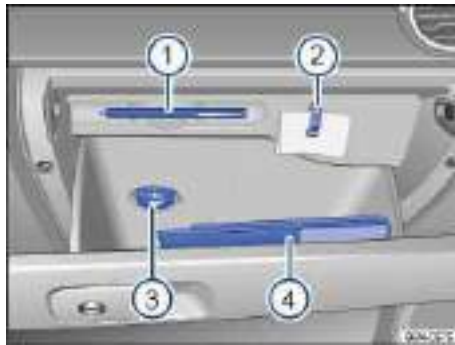

Fig. 126 Open glove compartment.

 Please first read and note the introductory information and heed the WARNINGS 

- (1) Holder for pen and notepad.
- (2) Notepad holder.
- (3) Air vent.
- (4) Owner's Manual in Owner's Manual slot.

### Opening and closing the glove compartment

If necessary, unlock the glove compartment. It is locked when the key slot is vertical.

- To *open*, pull the handle ⇒ [fig. 125](#).
- To *close*, push the hatch up.

### Owner's Manual slot

The Owner's Manual ⇒ [fig. 126 \(4\)](#) is located in this slot and should always be kept there.

## Holders

There is a pen holder (1) and a notepad holder (2) in the glove compartment.

## Cooling the glove compartment

There is an air vent (3) in the back of the glove compartment. Cool air can be directed into the glove compartment if the air conditioner is on. Open or close the air vent by turning it.



### WARNING

An open glove compartment door can increase the risk of serious injury during sudden braking or driving maneuvers or in a crash.

- Always keep the glove compartment closed while the vehicle is moving.



### NOTICE

In some vehicle models, design considerations have made it necessary to have openings in the glove compartment behind the owner's manual slot, for example. Small items may fall through these openings and get behind the instrument panel. This can cause unusual noises and damage the vehicle. Never put any small objects in the glove compartment for this reason.

## Storage compartment in the rear center console

---



Fig. 127 Storage compartment in the rear center console.

 Please first read and note the introductory information and heed the WARNINGS 

A storage compartment is located in the rear center console ⇒ [fig. 127](#).

## Other storage compartments

---



Fig. 128 On the left in the luggage compartment: Side storage compartment.



Fig. 129 On the right in the luggage compartment: Side storage compartment.

ⓘ Please first read and note the introductory information and heed the WARNINGS ⚠

### Storage compartments in the luggage compartment

Additional storage compartments are located in the sides of the luggage compartment ⇒ [fig. 128](#) and ⇒ [fig. 129](#).

- To *open*, turn the latch counterclockwise and fold down the lid.
- To *close*, fold the compartment lid all the way up and turn the latch clockwise.

### Additional storage

- In the front and rear center consoles.
- In the front and rear door trim panels.
- **Coat hooks** on the center door pillars and on the overhead grab handles in the rear.
- **Shopping bag hooks** in the luggage compartment ⇒ *Luggage compartment*.



## **WARNING**

Clothes or other items on the shelf behind the rear seat backrest may limit visibility, and cause accidents and severe personal injuries.

- Always hang clothes so that they do not limit visibility.
- Always use the built-in coat hooks only for lightweight clothing. Never leave any heavy or sharp-edged items in the pockets that may interfere with airbag deployment and can cause personal injury in a collision.

## Cup holders

### Introduction

---

In this section you'll find information about:

- Cup holders in the front center console
- Cup holders in the rear center armrest

#### **Beverage bottle holders**

There is a place for bottles in the open compartments in the driver and passenger doors.

The bottle volume must not exceed 24 oz. (0.5 liter) ⇒ .

#### **More information:**

- Interior care and cleaning

#### **WARNING**

Improper use of beverage holders can cause injuries.

- Never put hot drinks in the cup holders. During normal or sudden maneuvers, sudden braking or in a collision, hot liquid can be spilled and cause burns!
- Make certain that bottles or other items cannot fall into the driver's footwell while the vehicle is moving and interfere with the movement of the pedals.
- Never put heavy cups, food or other heavy items in the cup holders. Heavy items can fly through the passenger compartment in a crash and cause serious injury.

#### **WARNING**

Hot or freezing temperatures in the passenger compartment can cause closed bottles to explode or break.

- Never leave closed bottles a very hot or cold vehicle.

#### **WARNING**

Bottles and other things can fall into the driver's footwell and interfere with the pedals while driving.

- Make sure that bottles cannot fall into the driver's footwell during driving to avoid obstructing the pedals.
- Use the bottle holders only for standard beverage bottles holding no more than 1.5 quarts / 1.5 l (front doors) and 0.5 quarts / 0.5 l (rear doors).

#### **NOTICE**

Never put open drinks in the cup holder when the vehicle is moving. The drinks can spill and damage the vehicle, including the electrical system.



 The cup holder has inserts that can be removed for cleaning.

## Cup holders in the front center console

---



Fig. 130 In the front center console: Cup holders.

 Please first read and note the introductory information and heed the WARNINGS 

### Opening the cup holder compartment

- Slide the cover to the rear ⇒ fig. 130.

### Closing the cup holder

- Slide the cover forward.

## Cup holders in the rear center armrest

---



Fig. 131 In the rear center armrest: Cup holders.

 Please first read and note the introductory information and heed the WARNINGS 

In order to use the cup holder in the rear center armrest, the padded armrest must be pulled off

 **WARNING**

Always keep the armrest folded up when the vehicle is moving to reduce the risk of injury.

- Never let anybody, especially children, ride on the rear center armrest or in the center position on the rear seat when the armrest is folded down. An improper seating position can increase the risk of serious injury in a crash.

## Power outlets

### Introduction

---

In this section you'll find information about:

12 Volt sockets in the vehicle

Electrical devices can be connected to the vehicle sockets.

The connected devices must be in good working order.

#### **More information:**

- Storage areas
- Parts, accessories, repairs and modifications
- Consumer information

#### **WARNING**

**Improper use of electrical sockets and electrical devices may start a fire and cause severe personal injury.**

- **Never leave children unattended in the vehicle. Sockets and connected devices can be used when the ignition is switched on.**
- **If the connected device gets warm, immediately switch it off and disconnect the power supply.**

#### **NOTICE**

- **To help prevent damage to the electrical system, never connect any accessories such as a solar panel or vehicle battery charger to a 12 Volt socket.**
- **Only use accessories which have been tested for electromagnetic compatibility with a motor vehicle.**
- **To help prevent damage from voltage fluctuations, switch off all electrical consumers connected to the 12 Volt socket before switching the ignition on or off or starting the engine.**
- **Never connect devices to a 12 Volt socket that draw more than the maximum wattage the socket can supply. Drawing too much power can damage the vehicle electrical system.**



Please turn off the engine when you stop for any length of time.



The vehicle battery will drain if you use electrical equipment when the engine is not running.



Unshielded devices may interfere with radio reception or the vehicle's electrical system.



Operating electrical devices near the windshield-integrated antenna may interfere with AM radio reception.

## 12 Volt sockets in the vehicle



Fig. 132 In the luggage compartment: 12 Volt socket.



Fig. 133 Rear center console: 12 Volt.

ⓘ Please first read and note the introductory information and heed the WARNINGS ⚠

### Maximum power draw

Socket	Maximum power draw
12 Volt	120 watts

The maximum power draw at any one socket must never be exceeded. Electrical devices should have information on them that says how much power they draw.

If 2 or more electrical devices are connected at the same time, the total power draw of all connected devices must never be more than 190 watts ⇒ ⚠.

### 12 Volt socket

The 12 Volt socket works only when the ignition is switched on.

If the ignition is on but the engine is not running, the vehicle battery will be drained by any device that is plugged in and turned on. For this reason, never use the electrical socket unless the engine is running.

To help prevent damage from voltage fluctuations, switch off all electrical devices connected to a 12 Volt socket before switching the ignition on or off or starting the engine.

The vehicle may have 12 Volt sockets at the following places:

- In the storage compartment in the lower front center console.
- In the storage compartment in the front center armrest.
- In the luggage compartment ⇒ [fig. 132](#).
- In the rear center console ⇒ [fig. 133](#).



#### NOTICE

- **Follow the manufacturer's instructions for connected devices!**
- **Never exceed the maximum power consumption, or the entire vehicle electrical system may be damaged.**
- **Only use equipment that has been tested for electromagnetic compatibility and complies with applicable guidelines.**
- **Never feed current into the socket, with a solar panel, for example.**



Unshielded devices may interfere with radio reception or the vehicle's electrical system.

# Starting and stopping the engine

## Introduction

---

In this section you'll find information about:

Warning and indicator lights  
Vehicle key positions in the ignition switch  
Starter button  
Starting the engine  
Starting the engine  
Stopping the engine  
Stopping the engine  
Electronic immobilizer

### **Immobilizer display**

If an unauthorized vehicle key is used or the system malfunctions, or **Immobilizer active!** may appear on the instrument cluster. The engine cannot be started.

### **Push-starting and tow-starting**

For technical reasons, **never** try to push-start or tow-start the vehicle. Jump-start the vehicle instead while following proper and safe procedures.

### **More information:**

- Vehicle key set
- Shifting
- Steering
- Braking and parking
- Refueling
- Fuel
- Emergency closing and opening
- Jump-starting
- Towing

### **WARNING**

**Switching off the engine while the vehicle is moving can make the vehicle harder to stop and result in loss of vehicle control, leading to collisions and severe personal injuries.**

- **Brake and steering assistance systems, the airbag system, safety belt pretensioners, and other vehicle safety features only work when the engine is running.**
- **Switch off the engine only when the vehicle is not moving.**



### WARNING

To reduce the risk of serious personal injury when starting and running the vehicle's engine:

- Never start the engine or let it run in a confined or enclosed area. Engine exhaust contains carbon monoxide, a poisonous, colorless, and odorless gas. Carbon monoxide can cause unconsciousness and death.
- Never leave the vehicle unattended with the engine running. The vehicle could move suddenly or some other unexpected event could occur resulting in property damage or personal injury.
- Never use starting assist fluids. Starting fluids can explode and can cause a "run-away" vehicle condition.



### WARNING

The vehicle exhaust system and the catalytic converter can get very hot. They can cause fires and serious personal injury.

- Never park the vehicle where the hot exhaust system or catalytic converter could ignite flammable materials, such as brush, leaves, dry grass, spilled fuel, etc.
- Never apply additional undercoating or rustproofing on or near the exhaust manifold, exhaust pipes, catalytic converter, or heat shields.

## Warning and indicator lights

Please first read and note the introductory information and heed the WARNINGS

Lights up	Possible cause	Proper response
	Brake pedal not depressed.	Apply the brake pedal to select a drive gear. Also refer to electronic parking brake

Flashes	Possible cause	Proper response
	The release button in the selector lever did not engage. Vehicle movement is prevented.	Engage selector lever release button

When the ignition is switched on, several warning and indicator lights come on briefly for a function check. They go out after a few seconds.

## **⚠ WARNING**

Failure to heed warning lights and instrument cluster text messages can cause the vehicle to break down in traffic and result in a collision and serious personal injury.

- Never ignore warning lights or text WARNINGS.
- Always stop the vehicle as soon as it is safe to do so.
- Whenever stalled or stopped for repair, move the vehicle a safe distance off the road, turn on the emergency flashers, stop the engine, and use other warning devices to warn approaching traffic.

## **ⓘ NOTICE**

Failure to heed warning lights or text WARNINGS can result in vehicle damage.

### Vehicle key positions in the ignition switch



Fig. 134 In the ignition switch: Vehicle key positions.

**ⓘ Please first read and note the introductory information and heed the WARNINGS ⚠**

If there is no vehicle key in the ignition, the steering column is locked.

Vehicle key position ⇒ [fig. 134](#)

- (0) Ignition switched off, steering column lock engaged. The vehicle key can be removed.
- (1) Ignition is switched on. Steering column lock can be released.
- (2) Start the engine. When the engine starts, release the vehicle key. When released, the vehicle key returns to position (1).

#### **If you use the wrong key**

If an unauthorized vehicle key has been inserted into the ignition switch, it can be removed as follows:

- *Automatic transmission:* The vehicle key cannot be removed from the ignition unless both the key and the selector lever have been moved to the correct position. Press the release button on the transmission selector lever, move the selector lever to the Park (**P**) position and release the button. The vehicle key can now be removed.
- *Manual transmission:* Pull out the vehicle key.





**WARNING**

Improper use of remote control vehicle keys can result in serious personal injury.

- Always take the key with you when you leave the vehicle. The engine can be started and vehicle systems such as the power windows can be operated, leading to serious personal injury.
- Never leave children, disabled persons, or anyone who cannot help themselves in the vehicle. The doors can be locked with the remote control vehicle key. This could result in people being trapped in the vehicle in an emergency. For example, depending on the time of year, people trapped in the vehicle can be exposed to very high or very low temperatures.
- Heat buildup in the passenger and luggage compartment of a parked vehicle can result in temperatures in the vehicle that are much higher than the outside temperatures, particularly in summer. Temperatures can quickly reach levels that can cause unconsciousness and death, particularly to small children.
- Never remove the key from the ignition switch while the vehicle is moving or rolling to a stop. The steering wheel will lock and you will not be able to steer or control the vehicle.

 Leaving the key in the ignition for a long time when the engine is not running will drain the vehicle battery.

 Leaving the selector lever for a long period of time in any position other than Park (P) when the ignition is switched off can drain the vehicle battery.

 On **automatic transmission vehicles**, the vehicle key can be removed from the ignition switch only when the transmission is in Park (P). You may have to press the release button on the transmission selector lever to put the lever into Park (P).

Applicable only in the United States

## **Starter button**

---



**Fig. 135** In the center console: Starter button of the Keyless Access locking and starting system.



Fig. 136 Emergency starting feature on vehicles with Keyless Access.

**ⓘ Please first read and note the introductory information and heed the WARNINGS ⚠**

The starter button can only be used when an authorized vehicle key is in the vehicle.

**When leaving the vehicle**, the electronic steering column lock is activated when the ignition is switched off and the driver door is opened ⇒ *Steering*.

#### Switching the ignition on and off

- Briefly press the starter button once without depressing the brake or clutch pedals ⇒ ⚠.

#### Emergency start feature

If an authorized remote control vehicle key is in the passenger compartment but the instrument cluster displays **Key not in Range** when you push the starter button, the remote control vehicle key battery is weak or dead. You can still start the engine using the Emergency start feature:

- Make sure the selector lever is in the Park **(P)** position.
- Hold the remote control vehicle key against the right side of the steering column trim immediately after pressing the starter button ⇒ [fig. 136](#).
- The ignition automatically switches on and the engine starts.

#### Emergency shut-off

If the engine does not switch off by briefly pressing the starter button, emergency shutoff is necessary:

- Press the starter button twice within 1 second or once for more than 2 seconds ⇒ ⚠ in *Stopping the engine* ⇒ *Stopping the engine*.
- The engine switches off automatically.

#### Engine restart function

If no authorized remote control vehicle key is identified in the passenger compartment after the engine has been switched off, the engine can be restarted within about 5 seconds. A related message is shown in the instrument cluster display.

After the 5 seconds have passed, the engine can no longer be started without an authorized vehicle key in the passenger compartment.

### **⚠ WARNING**

**Unintended vehicle movement can cause serious personal injury.**

- Do *not* depress the brake or clutch pedals when switching on the ignition, as the engine could otherwise start immediately.



## WARNING

Improper use of vehicle keys can result in serious personal injury.

- Always take the key with you when you leave the vehicle. Children or unauthorized persons may use it to lock the vehicle, start the engine, and operate vehicle systems such as the power windows, leading to serious personal injury.
- Never leave children, disabled persons, or anyone who cannot help themselves in the vehicle. The doors can be locked using the remote control vehicle key. This could result in people being trapped in the vehicle in an emergency. For example, depending on the time of year, people trapped in the vehicle can be exposed to very high or very low temperatures.
- Heat buildup in the passenger and luggage compartment of a parked vehicle can result in temperatures in the vehicle that are much higher than the outside temperatures, particularly in summer. Temperatures can quickly reach levels that can cause unconsciousness and death, particularly to small children.



If the ignition is switched on or the engine is running and the driver door is opened, a chime sounds. The chime is also a reminder to switch off the engine and turn off the ignition before leaving and locking the vehicle from the outside.

## Starting the engine

Please first read and note the introductory information and heed the WARNINGS 214.

Please perform these steps only in the order listed.

Step	Vehicles without Keyless Access	Vehicles with Keyless Access
1.	<b>Automatic transmission:</b> Depress the brake pedal and hold it down until step 4 is completed.	
1a.	<b>Manual transmission:</b> Depress clutch pedal fully and hold until the engine has started.	
2.	Shift the transmission into Neutral ( <b>N</b> ) or Park ( <b>P</b> ) (automatic), or into Neutral (manual only).	
3.	Turn the vehicle key to position ⇒ <a href="#">fig. 134 (2)</a> – do not depress the accelerator pedal.	Briefly press the starter button ⇒ <a href="#">fig. 135</a> – do not depress the accelerator pedal. An authorized vehicle key must be inside the vehicle in order to start the engine.
4.	When the engine starts, release the remote control vehicle key.	When the engine starts, release the starter button.
5.	If the engine does not start, switch off the ignition and start again after about 1 minute.	If the engine does not start, switch off the ignition and start again after about one minute. Use the emergency start function if necessary
6.	Release the electronic parking brake when you are ready to start driving	

**⚠ WARNING**

Never leave the vehicle unattended while the engine is running. The vehicle could move suddenly, especially when the vehicle is in gear, resulting in accidents and personal injury.

**⚠ WARNING**

“Starting fluids” can explode and can cause a “run-away” vehicle condition.

- Never use starting assist fluids.

**! NOTICE**

- You can damage the starter or the engine if you try to start the engine when the vehicle is still moving, or if you try to restart the engine right after switching it off.
- Avoid high engine speeds, full throttle acceleration, and heavy engine loads when the engine is cold.
- Do not try to start the engine by pushing or towing the vehicle. Unburned fuel can get into the catalytic converter and damage it. The steering column may also be locked.



Do not let your vehicle warm up while standing; instead, start driving right away after making sure that you have good visibility through all windows. This will help the engine reach operating temperature faster and keep down emissions.



Major consumers of electricity are temporarily switched off when the engine is being started.



After starting a cold engine, there may be increased operating noises for a few seconds. This is normal and harmless.

## Stopping the engine

**📖 Please first read and note the introductory information and heed the WARNINGS ⚠**

Please perform these steps only in the order listed.

	Vehicles without Keyless Access	Vehicles with Keyless Access
1.	Bring the vehicle to a complete stop ⇒ ⚠.	
2.	Depress and hold down the brake pedal until step 4 is completed.	
3.	Automatic transmission: Shift the transmission into Park (P).	
4.	Apply the electronic parking brake to help prevent the vehicle from moving	

Please perform these steps only in the order listed.

	Vehicles without Keyless Access	Vehicles with Keyless Access
5.	Turn the vehicle key to position ⇒ fig. 134 (0) in the ignition switch.	Briefly press the starter button ⇒ fig. 135. If the engine will not switch off, carry out the emergency shutoff procedure
6.	With a manual transmission, shift into 1st gear (vehicle on flat surface or pointing uphill) or reverse (vehicle pointing downhill).	
7.	Removing the vehicle key from the ignition switches off electrical equipment and activates the steering column lock.	Opening the doors switches off electrical equipment and activates the steering column lock.



### WARNING

Never stop the engine before the vehicle has come to a complete stop. You can lose control of the vehicle, crash, and be seriously injured.

- The airbags and safety belt pretensioners will not work when the ignition is switched off.
- The brake booster does not work when the engine is not running. More brake pedal pressure will be needed to stop the vehicle.
- The power steering system does not work when the engine is not running, and you will need more force to steer the vehicle.
- When the key is removed from the ignition switch, the steering will lock and you will not be able to steer the vehicle.



### NOTICE

If the vehicle has been driven hard for a long time, the engine could overheat when it is stopped. To reduce the risk of engine damage, let the engine idle in Neutral for about 2 minutes before you switch off the ignition.



If the ignition is switched on or the engine is running and the driver door is opened, a chime sounds. The chime is also a reminder to switch off the engine and turn off the ignition before leaving and locking the vehicle from the outside.



On vehicles with automatic transmissions, the vehicle key can only be removed from the ignition when the transmission is in Park (P).



After the engine has been switched off, the radiator fan in the engine compartment may keep running for several minutes, or may start running after the vehicle has been parked for a while, even if the ignition is switched off and the vehicle key has been removed. The radiator fan shuts off automatically when the engine has cooled down enough.

## Stopping the engine

 Please first read and note the introductory information and heed the WARNINGS 

Please perform these steps only in the order listed.

Vehicles without Keyless Access	
1.	Bring the vehicle to a complete stop ⇒  .
2.	Depress and hold down the brake pedal until step 4 is completed.
3.	Automatic transmission: Shift the transmission into Park (P).
4.	Apply the electronic parking brake to help prevent the vehicle from moving
5.	Turn the remote control vehicle key to position ⇒ <a href="#">fig. 134 (0)</a> in the ignition switch.
6.	With a manual transmission, shift into 1st gear (vehicle on flat surface or pointing uphill) or reverse (vehicle pointing downhill).
7.	Removing the vehicle key from the ignition switches off electrical equipment and activates the steering column lock.

### WARNING

Never stop the engine before the vehicle has come to a complete stop. You can lose control of the vehicle, crash, and be seriously injured.

- The airbags and safety belt pretensioners will not work when the ignition is switched off.
- The brake booster does not work when the engine is not running. More brake pedal pressure will be needed to stop the vehicle.
- The power steering system does not work when the engine is not running, and you will need more force to steer the vehicle.
- When the key is removed from the ignition switch, the steering will lock and you will not be able to steer the vehicle.

### NOTICE

If the vehicle has been driven hard for a long time, the engine could overheat when it is stopped. To reduce the risk of engine damage, let the engine idle in Neutral for about 2 minutes before you switch off the ignition.

 If the ignition is switched on or the engine is running and the driver door is opened, a chime sounds. The chime is also a reminder to switch off the engine and turn off the ignition before leaving and locking the vehicle from the outside.

 On vehicles with automatic transmissions, the vehicle key can only be removed from the ignition when the transmission is in Park (**P**).

 After the engine has been switched off, the radiator fan in the engine compartment may keep running for several minutes, or may start running after the vehicle has been parked for a while, even if the ignition is switched off and the vehicle key has been removed. The radiator fan shuts off automatically when the engine has cooled down enough.

## Electronic immobilizer

---

 **Please first read and note the introductory information and heed the WARNINGS** 

The immobilizer helps to prevent the engine from being started and driven with an unauthorized vehicle key.

There is a microchip inside the vehicle key. The chip deactivates the immobilizer automatically when an authorized remote control vehicle key is inserted into the ignition switch.

The electronic immobilizer is automatically activated when the remote control vehicle key is pulled out of the ignition switch. On vehicles with Keyless Access, the vehicle key must be outside the vehicle.

⇒ *Unlocking or locking the vehicle from the outside.*

The engine can therefore only be started with an authorized and correctly coded genuine Volkswagen vehicle key. Coded vehicle keys are available from authorized Volkswagen dealers, authorized Volkswagen Service Facilities, and from certain independent repair facilities and locksmiths who are qualified to make these vehicle keys ⇒ *Vehicle key set.*

If an unauthorized vehicle key is used, **Immobilizer active!** appears in the instrument cluster display. The vehicle cannot be operated with this key.

A Declaration of Compliance with the United States FCC and Industry Canada regulations is on

⇒ *Declaration of Compliance, Telecommunications and Electronic Systems.*

 Using genuine Volkswagen keys helps minimize the risk of malfunctions.

# Shifting

## Introduction

---

In this section you'll find information about:

Warning and indicator lights

Pedals

Manual transmission: Gearshift lever

Automatic transmission: Selector lever

Shifting with Tiptronic®

Driving with automatic transmission

Automatic transmission malfunction

### **When the ignition is switched on and the transmission is in Reverse (R):**

- The backup lights come on.
- Climatronic switches automatically to air recirculating mode.
- The rear window wiper switches on when the windshield wipers are switched on.
- The camera for the Rear Assist switches on (if applicable).

### **More information:**

- Lower center console
- Instruments
- Braking and parking
- Reverse driving assistant (Rear Assist) ⇒ *Rear Assist*
- Climate control
- Engine control and emission control system
- Emergency closing and opening

### **WARNING**

**Rapid acceleration can cause skidding and loss of traction, especially on slippery roads, resulting in a loss of vehicle control, collisions, and serious personal injury.**

- Only use the kick-down feature or fast acceleration if visibility, weather, road, and traffic conditions permit and other drivers will not be endangered by your driving and the vehicle's acceleration.

### **WARNING**

**Constant braking causes the brakes to overheat and even to fail leading to collisions and serious personal injury.**



- Never "ride" the brakes or apply the brake pedal too often or too long.
- Riding the brakes will substantially reduce braking performance, increase stopping distance, and can cause complete brake system failure.





 **NOTICE**

- Never “ride” the brakes by keeping your foot on the brake pedal when you do not want to brake. This will make the brakes wear faster.
- Before driving downhill, especially on hills that are long or steep, always reduce speed and shift into lower gear (manual or automatic transmission). This will let the vehicle use engine braking and reduce the load on the brakes. Otherwise, the brake system could overheat and even fail. Only use the brakes when you need them to slow the vehicle down more or to stop.

### Warning and indicator lights

 Please first read and note the introductory information and heed the **WARNINGS** 

Lights up	Possible cause	Proper response
	Brake pedal not depressed.	Apply the brake pedal to select a drive gear. Also refer to electronic parking brake

Flashes	Possible cause	Proper response
	The release button in the selector lever did not engage. Vehicle movement is prevented.	Engage selector lever release button
	Automatic transmission malfunction. The symbol alternates with the selector lever indicator (D, for example).	Drive at low engine speed (rpm) to the nearest authorized Volkswagen dealer or authorized Volkswagen Service Facility to have the system checked.

When the ignition is switched on, several warning and indicator lights come on briefly for a function check. They go out after a few seconds.

 **WARNING**

Failure to heed warning lights and instrument cluster text messages can cause the vehicle to break down in traffic and result in a collision and serious personal injury.

- Never ignore warning lights or text **WARNINGS**.
- Always stop the vehicle as soon as it is safe to do so.
- Whenever stalled or stopped for repair, move the vehicle a safe distance off the road, turn on the emergency flashers, stop the engine, and use other warning devices to warn approaching traffic.

 **NOTICE**

Failure to heed warning lights or text **WARNINGS** can result in vehicle damage.

## Pedals

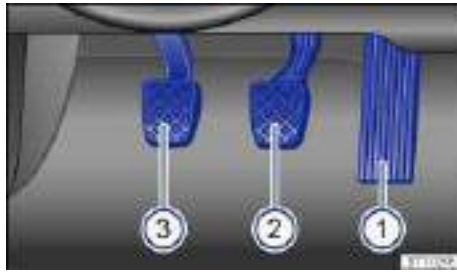

Fig. 137 Pedals in vehicles with manual transmission: 1 Accelerator pedal, 2 Brake pedal, 3 Clutch pedal.

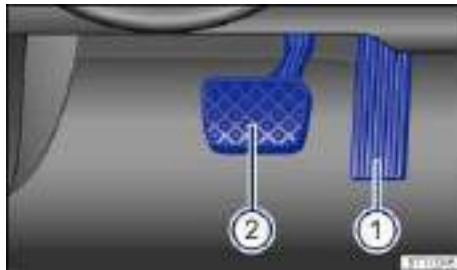

Fig. 138 Pedals in vehicles with automatic transmission: 1 Accelerator pedal, 2 Brake pedal.

**ⓘ Please first read and note the introductory information and heed the WARNINGS ⚠**

All pedals must always be able to move freely in and out without interference from floor mats or other things.

Only use floor mats that leave the pedal area free and are held securely in place with floor mat fasteners to help prevent sliding.

If a brake circuit malfunctions, more brake pedal travel is needed to bring the vehicle to a full stop, and it is important that nothing is in the way when you have to depress the brake pedal harder and farther than normal.

### **⚠ WARNING**

Objects in the driver footwell can prevent the pedals from moving freely. This can cause loss of vehicle control and increase the risk of serious personal injuries.

- Always make sure that nothing can interfere with the pedals.
- Always fasten floor mats securely to the floor.
- Never put floor mats or other floor coverings on top of already installed floor mats.
- Always make sure that nothing can fall into the driver footwell while the vehicle is moving.

### **ⓘ NOTICE**

Always make sure that the pedals are able to move freely and that nothing can interfere with them. If a brake circuit fails, more brake pedal travel will be needed to bring the vehicle to a stop. The brake pedal must be pressed farther and harder than normal.

## Manual transmission: Gearshift lever



Fig. 139 Gearshift pattern of a 6-speed manual transmission.

**⚠ Please first read and note the introductory information and heed the WARNINGS ⚠**

The positions of the individual gears are shown on the gearshift lever ⇒ [fig. 139](#).

- Depress the clutch pedal all the way and hold.
- Move the gearshift lever into the desired position.
- Release the clutch pedal to engage the gear.

The clutch pedal must be fully depressed to start the engine.

### Shifting into reverse

- Only shift to the reverse gear when the vehicle is not moving.
- Depress the clutch pedal fully and hold ⇒ ⚠.
- Move the gearshift lever to neutral and press down.
- Move the shift lever to the left and then push forward into the reverse gear position (R) ⇒ ⚠.
- Release the clutch pedal to engage the gear.

### Downshifting

You should always downshift gear by gear when driving, meaning always into the next lowest gear. Do not downshift when the engine rpm (revolutions per minute) is too high ⇒ ⚠. At fast speeds or high engine rpms, skipping over one or more gears when downshifting can cause damage to the clutch and transmission, even if a gear is not engaged ⇒ ⚠.

### **⚠ WARNING**

**Downshifting to a lower gear incorrectly can result in loss of vehicle control and can cause accidents and serious personal injuries.**

## **⚠ WARNING**

When the engine is running and a gear is engaged, the vehicle will start to move as soon as the clutch pedal is released, even when the parking brake is applied. This also applies when the parking brake is engaged.

- Never shift into reverse when the vehicle is moving.

## **ⓘ NOTICE**

Shifting down to a gear that is too low when driving at fast speeds or high engine rpms can cause extensive damage to the clutch and transmission. That is true even if the clutch pedal is pressed so that the clutch is not engaged.

## **ⓘ NOTICE**

To help prevent damage and premature wear:

- Do not rest your hand on the gearshift lever while driving. Over time, the pressure will cause premature wear in the transmission.
- Make sure that the vehicle has come to a complete stop before shifting into reverse.
- Always depress the clutch pedal all the way when changing gears.
- Do not hold the vehicle on a hill using engine power with the clutch pedal partially engaged and the engine running.

## **Automatic transmission: Selector lever**

---



**Fig. 140** Automatic transmission selector lever with shift lever release button (arrow).

**⚠ Please first read and note the introductory information and heed the WARNINGS**

Automatic transmission vehicles have an Automatic Shift Lock (ASL). With ASL, you must depress the brake pedal and hold it down while pressing the release button on the selector lever handle in the direction of the arrow ⇒ [fig. 140](#) in order to move the selector lever out of Park (**P**) and into a drive gear. When the selector lever is in Neutral (**N**), you also have to depress the brake pedal before you can move the selector lever to Drive (**D**), Sport Drive (**S**), or Reverse (**R**).

If the ignition is switched on, either the current selector lever setting or the current gear is shown in the instrument cluster display.

Selector lever position	Designation	Meaning ⇒ 
P	Park	The drive wheels are mechanically locked. Select only when the vehicle is <i>not moving</i> . To change the selector lever position, switch on the ignition (if it is off) and then press the selector lever release button while holding down the brake pedal.
R	Reverse	The reverse gear is engaged. Shift into Reverse only when the vehicle is <i>not moving</i> .
N	Neutral	Transmission is in Neutral position. No power is transmitted to the wheels and no engine braking effect is available.
D	Drive (standard driving position)	All forward gears shift up and down automatically. The transmission shifts as needed depending on engine load, individual driving style, and vehicle speed.
S	Sport Drive (Sport driving position)	All forward gears automatically upshift <i>later</i> and downshift <i>earlier</i> than in the (D) (Drive) position, to take full advantage of the engine's power reserves. The transmission shifts as needed depending on engine load, individual driving style, and vehicle speed.

#### Automatic Shift Lock (ASL)

The Automatic Shift Lock (ASL) in Park (P) and Neutral (N) prevents drive positions from being engaged inadvertently, which would cause the vehicle to move.

To release the ASL, depress and hold the brake pedal with the ignition switched on. Press the release button on the selector lever at the same time.

The ASL is not engaged if the selector lever is moved quickly through Neutral (N) (e.g., when shifting from Reverse (R) to Drive (D)). This makes it possible to "rock" the vehicle backwards and forwards if it is stuck in snow or mud. The ASL engages automatically if the brake pedal is not depressed and the lever is in Neutral (N) for more than about 1 second and the vehicle is traveling no faster than about 3 mph (5 km/h).

- Depress and then release the brake pedal.



#### WARNING

Moving the selector lever to the wrong position can cause loss of vehicle control, a collision, and serious personal injury.

- Never accelerate when moving the selector lever.
- When the engine is running and a drive position is engaged, the vehicle will start to move as soon as the brake pedal is released.
- Never shift into Reverse or Park when the vehicle is moving.

## **⚠ WARNING**

Unintended vehicle movement can cause serious personal injury.

- Never get out of the driver's seat while the engine is running, especially when the transmission is in a drive gear. If you must leave your vehicle while the engine is running, always set the parking brake and shift the transmission into Park (P).
- Never leave the vehicle in Neutral (N). It will roll down hills, whether the engine is running or not.
- When the engine is running and a drive gear - Drive (D), Sport Drive (S), or Reverse (R) - has been selected, press and hold the brake pedal to keep the vehicle from moving. The vehicle may "creep" and move forward or backward even if the engine is idling slowly.
- Never shift into Reverse (R) or Park (P) when the vehicle is moving.

## **! NOTICE**

Even though the transmission is in Park (P), the vehicle may move a couple of inches (a few centimeters) forwards or backwards if you take your foot off the brake pedal after stopping the vehicle without first setting the electronic parking brake.

**i** If the selector lever is moved into Neutral (N) by mistake when the vehicle is moving, take your foot off the accelerator pedal. Wait until the engine speed has dropped to idle speed before moving the selector lever into a drive gear.

**i** Leaving the selector lever for a long period of time in any position other than Park (P) when the ignition is switched off can drain the vehicle battery.

## Shifting with Tiptronic®

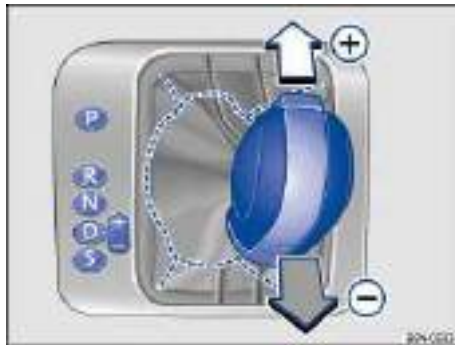



Fig. 141 Selector lever in Tiptronic position.

**⚠ Please first read and note the introductory information and heed the WARNINGS**

Tiptronic lets you upshift and downshift manually with the automatic transmission. When Tiptronic mode is used, the transmission stays in the current gear and does not upshift or downshift automatically unless the transmission senses a situation where upshifting or downshifting is necessary to keep the engine from over- or under-revving.

### Using Tiptronic with the selector lever

- Push the selector lever sideways to the right from Drive **(D)** position into the Tiptronic position ⇒  in *Automatic transmission: Selector lever*.
- Briefly push the selector lever forward **(+)** to upshift into a higher gear or backward **(-)** to downshift into a lower gear ⇒ [fig. 141](#).



#### NOTICE

- During acceleration, the transmission will shift automatically into the next higher gear before reaching maximum engine speed (rpm).
- If you use Tiptronic to shift into a lower gear, the transmission will downshift only when doing so will not over-rev the engine.

## Driving with automatic transmission

---

 Please first read and note the introductory information and heed the **WARNINGS** .

All forward gears shift up and down automatically.

### Driving on hills

The steeper the grade, the lower the gear that must be selected. Lower gears increase the braking effect of the engine. Never coast downhill in Neutral **(N)**.

- Reduce speed.
- Switch to Tiptronic mode by moving the selector lever from Drive **(D)** to the right into the Tiptronic position ⇒ *Shifting with Tiptronic®*.
- Downshift by pulling the selector lever back briefly (-).

**Stopping and starting on hills:** If you stop on a hill with the vehicle in gear, you must depress the brake pedal or engage the electronic parking brake to keep the vehicle from rolling. Do not release the brake pedal or the parking brake until the vehicle has started to move forwards ⇒ .

### Kick-down acceleration

The kick-down feature permits maximum acceleration when the selector lever is in the Drive **(D)**, Sport Drive **(S)** or Tiptronic mode.

If you push the accelerator all the way down, the vehicle will automatically downshift, depending on vehicle speed and engine speed (rpm). This feature lets you take advantage of the full acceleration capacity of the vehicle ⇒ .

With kick-down actuated, the transmission will stay in the current gear longer and not upshift until the engine reaches maximum rpm.



#### WARNING

**Rapid acceleration can cause skidding and loss of traction, especially on slippery roads, resulting in a loss of vehicle control, collisions, and serious personal injury.**

- Only use the kick-down feature or fast acceleration if visibility, weather, road, and traffic conditions allow it and other drivers will not be endangered by your driving and the vehicle's acceleration.
- Always adapt your driving to the traffic flow.

## NOTICE

- When stopping on hills with the transmission in a drive gear, do not use the accelerator to help prevent the vehicle from rolling backwards. This can cause the automatic transmission to overheat and be damaged.
- Never let the vehicle coast or roll down a hill in Neutral (N), especially when the engine is not running. The transmission will not be lubricated and will be damaged.

## Automatic transmission malfunction

---

 Please first read and note the introductory information and heed the WARNINGS 

### Emergency shift program

If all selector lever position indicators in the instrument cluster display are highlighted against a bright background, there is a system malfunction. The automatic transmission will then operate in the emergency shift program. The emergency shift program lets you drive the vehicle, but at a reduced speed and without being able to use all of the forward gears.

In any event, have the automatic transmission checked by an authorized Volkswagen dealer or authorized Volkswagen Service Facility.

## NOTICE

- As soon as you get any of these warnings about transmission overheating, you must either park the vehicle in a safe place or drive faster than 12 mph (20 km/h).
- If the text message and acoustic warning repeat themselves every 10 seconds or so, you must park the vehicle in a safe place as soon as you can safely do so and stop the engine. Let the transmission cool down.
- To help prevent damage to the transmission, do not drive the vehicle again until the acoustic warning has stopped. As long as the engine is overheated, avoid stop and start driving and avoid low speeds (“walking pace”).



# Steering

## Introduction

In this section you'll find information about:

- Warning and indicator lights
- Steering system information

The power steering system is not hydraulic, it is electro-mechanical. In both cases, the power steering works only when the engine is running.

The hydraulic power steering system uses hydraulic lines, hydraulic oil, a pump, a filter, and other parts to maintain a constant oil pressure in the hydraulic system.

The electromechanical power steering system automatically adjusts to driving speed, steering torque, and the steering angle of the wheels. It delivers extra steering force only when you are actually turning the wheels. The electromechanical power steering works only when the engine is running.



### More information:

- Starting and stopping the engine
- 12 Volt vehicle battery
- Towing 414



 <b>WARNING</b>	
<b>Turning the steering wheel is very hard when the power steering system is not working. This makes it harder to steer and control the vehicle.</b>	
<ul style="list-style-type: none"><li>• <b>Power steering works only when the engine is running.</b></li><li>• <b>Never let the vehicle coast with the engine switched off.</b></li><li>• <b>Never remove the key from the ignition switch while the vehicle is moving or rolling to a stop. The steering wheel will lock and you will be unable to control the vehicle.</b></li></ul>	

## Warning and indicator lights

 Please first read and note the introductory information and heed the **WARNINGS** 

Lights up	Possible cause	Proper response
	Power steering malfunction.	 <b>Stop!</b> Have the power steering system checked immediately by an authorized Volkswagen dealer or an authorized Volkswagen Service Facility.

Lights up	Possible cause	Proper response
	Power steering assist is reduced.	Stop, restart the engine, and drive a short distance. If the yellow warning light does not come on again, you do <b>not</b> need to have the steering system checked. Otherwise, have the steering checked immediately by an authorized Volkswagen dealer or an authorized Volkswagen Service Facility.
	Vehicle battery was disconnected and has been reconnected.	Drive a short distance at about 10 - 12 mph (15 - 20 km/h).

Flashes	Possible cause	Proper response
	Electronic steering column lock malfunction.	 <b>Stop!</b> The ignition cannot be switched on. The vehicle must not be towed! Get professional assistance.
	Steering system stiff.	Turn the steering wheel back and forth.
	Steering column not locked / unlocked.	Switch the ignition off and then switch it on again. Heed any messages shown in the instrument cluster display, if applicable. On vehicles with Keyless Access, press the starter button briefly twice in a row without depressing the brake or clutch pedal. <b>Do not drive any farther</b> if the steering column remains locked after you switch on the ignition. Contact your authorized Volkswagen dealer or an authorized Volkswagen Service Facility for assistance.

When the ignition is switched on, several warning and indicator lights come on briefly for a function check. They go out after a few seconds.

### **WARNING**

Failure to heed warning lights and instrument cluster text messages can cause the vehicle to break down in traffic and result in a collision and serious personal injury.

- Never ignore warning lights or text WARNINGS.
- Always stop the vehicle as soon as it is safe to do so.

### **NOTICE**

Failure to heed warning lights or text WARNINGS can result in vehicle damage.

## Steering system information

ⓘ Please first read and note the introductory information and heed the WARNINGS ⚠

To help make it more difficult to steal your vehicle, you should always make sure the steering column is locked before leaving the vehicle.

### Electronic steering column lock

The steering column is locked by removing the remote control vehicle key from the ignition switch when the vehicle is not moving standing still. The electronic steering column lock does not lock if the vehicle moves for more than 10 seconds after the remote control vehicle key is removed.

Vehicles with Keyless Access: The steering column is locked if the driver door is opened with the ignition switched off. The vehicle must be standing still and the transmission must be in Park (P) on an automatic transmission vehicle.

If the driver door is opened before the ignition is switched off, the electronic steering column lock is activated only after the vehicle has been locked with the vehicle key or via the sensor in the door handle.

### Mechanical steering column lock

Vehicles without Keyless Access: The steering column is locked if the vehicle is stationary and the vehicle key is removed from the ignition switch.

Engaging the steering column lock	Disengaging the steering column lock
Parking the vehicle	Turn the steering wheel slightly to take pressure off the steering column lock.
Remove the vehicle key.	Insert the vehicle key into the ignition switch.
Turn the steering wheel slightly until you hear the steering column lock engage.	Hold the steering wheel in this position and turn the ignition switch.

### Power steering

Power steering automatically adjusts to driving speed, steering torque, and the steering angle of the wheels. Power steering works only when the engine is running.

If power steering is reduced or lost completely, it will be much harder to steer and control the vehicle.

### Counter-steering assistance

Counter-steering assistance is part of Electronic Stability Control (ESC). This feature makes it easier for the driver to control the vehicle in difficult situations. For example, if you have to brake hard on a surface that provides uneven traction, the vehicle could pull to the right or left. ESC detects this

situation and helps the driver counter-steer with additional steering power ⇒ ⚠.

### WARNING

The counter-steering assistance in ESC can do no more than help the driver steer in difficult situations. The driver must still control the vehicle. The vehicle does not steer by itself with this feature!

 **NOTICE**

If the ignition is off, the steering column lock will engage and the vehicle cannot be steered. For this reason, you must leave the ignition on when going through an automatic car wash, for example, so that the wheels will still steer.

## Braking and parking

### Introduction

---

In this section you'll find information about:

Warning and indicator lights  
Electronic parking brake  
Parking  
About the brakes  
Braking assistance systems  
Switching Anti-Slip Regulation (ASR) on and off  
Brake fluid

The **braking assistance systems** are the Anti-Lock Brake System (ABS), Brake Assist System (BAS), Electronic Differential Lock (EDL), Anti-Slip Regulation (ASR) and Electronic Stability Control (ESC).

#### **More information:**

- Trailer towing 151
- Tires and wheels
- Parts, accessories, repairs and modifications



#### **WARNING**

**Driving with bad brakes or worn brake pads can cause a collision and serious personal injury.**

- **If the symbol **BRAKE WEAR** or  lights up in the instrument cluster display, whether alone or together with a text message, immediately contact an authorized Volkswagen dealer or authorized Volkswagen Service Facility to have the brake pads checked and, if necessary, replaced.**

## WARNING

Parking improperly can cause serious personal injury.



- Never remove the key from the ignition switch while the vehicle is moving or rolling to a stop. The steering wheel will lock and you will not be able to steer or control the vehicle.
- Never park the vehicle where the hot exhaust system or catalytic converter could ignite flammable materials, such as brush, leaves, dry grass, spilled fuel, etc.
- Always apply the parking brake when parking your vehicle.
- Improper use of the parking brake can seriously injure you and your passengers.
- Never use the parking brake to slow down the vehicle when it is moving, except in an emergency. The stopping distance is much longer because only the rear wheels are braked. Always use the foot brake to stop the vehicle.
- Never activate the throttle manually from the engine compartment when the engine is running and the automatic transmission is in gear. The vehicle will start to move as soon as the engine speed increases even if the parking brake is on.
- Never leave children or anyone who cannot help themselves behind in the vehicle. They could release the parking brake and move the gear selector lever or gear shift, which could cause the vehicle to start moving. This can lead to a crash and serious personal injuries.
- Always take the key with you when you leave the vehicle. The engine can be started and vehicle systems such as the power windows can be operated, leading to serious personal injury.
- Never leave children, disabled persons, or anyone who cannot help themselves in the vehicle. The doors can be locked with the remote control vehicle key, trapping passengers in the vehicle in an emergency. For example, depending on the time of year, people trapped in the vehicle can be exposed to very high or very low temperatures.
- Heat buildup in the passenger and luggage compartment of a parked vehicle can result in temperatures in the vehicle that are much higher than the outside temperatures, particularly in summer. Temperatures can quickly reach levels that can cause unconsciousness and death, particularly to small children.















## NOTICE





- Always be careful when you park in areas with parking barriers or high curbs. These vary in height and could damage your bumper and related parts if the front of your vehicle hits a barrier or curb that is too high while you are getting into or out of a parking spot. To help prevent damage, stop before the tires of your vehicle touch a parking barrier or curb.
- Always be careful when you enter a driveway or drive up or down steep ramps or over curbs or other obstacles. Parts of the vehicle close to the ground may be damaged (such as bumper covers, spoilers, and parts of the engine, suspension, and exhaust systems).

## Warning and indicator lights

 Please first read and note the introductory information and heed the WARNINGS 

Lights up	Possible cause or meaning ⇒ 	Proper response
 / BRAKE	Brake system malfunction.	 <b>Stop!</b> Get professional assistance immediately 244.

Lights up	Possible cause or meaning ⇒ 	Proper response
	Brake fluid level too low.	 <b>Stop!</b> Check the brake fluid level
	Together with ABS indicator light  or <b>ABS</b> : there is an ABS failure.	See an authorized Volkswagen dealer or an authorized Volkswagen Service Facility. The vehicle brakes will work without ABS.
 / <b>PARK</b>	The electronic parking brake is set.	To begin driving, press the brake pedal to release the electronic parking brake
<b>BRAKE WEAR</b>	Brake pads worn.	If you believe that it is safe to do so, immediately take the vehicle to an authorized Volkswagen dealer or authorized Volkswagen Service Facility. Check, and if necessary replace, <b>all</b> brake pads.
		
	Lights up: ESC malfunctioning or switched off by the system.	Switch ignition off and on again. You may have to drive a short distance. See an authorized Volkswagen dealer or an authorized Volkswagen Service Facility.
	Together with the ABS indicator light  or <b>ABS</b> : ABS malfunction.	See an authorized Volkswagen dealer or an authorized Volkswagen Service Facility. The vehicle brakes will work without ABS.
	Vehicle battery has been reconnected.	Drive a short distance at a speed of 10 – 12 mph (15 - 20 km/h). If the indicator light stays on, see an authorized Volkswagen dealer or an authorized Volkswagen Service Facility
 / <b>ESC OFF</b>	ASR switched off.	Automatically switch on ASR by turning the ignition on and off.
 / <b>ABS</b>	Together with ESC indicator light  : ABS malfunction.	See an authorized Volkswagen dealer or an authorized Volkswagen Service Facility. The vehicle brakes will work without ABS.
	Together with the  , <b>BRAKE</b> or  warning light: ABS failure.	
	Together with a flashing  or <b>BRAKE</b> warning light: there is an electronic parking brake malfunction.	See an authorized Volkswagen dealer or an authorized Volkswagen Service Facility.
	Brake pedal not depressed.	Depress the brake pedal to select a gear or drive position.
		Depress the brake pedal to release the electronic parking brake .

Flashes	Possible cause ⇒ 	Solution
 / PARK	Electronic parking brake malfunction.	 <b>Stop!</b> Contact an authorized Volkswagen dealer or authorized Volkswagen Service Facility for assistance.
	ESC or ASR regulating.	Take foot off accelerator pedal. Adapt driving to road conditions.
	The release button in the selector level is not engaged in position.	Engage the Automatic Shift Lock (ASL)

When the ignition is switched on, several warning and indicator lights come on briefly for a function check. They go out after a few seconds.





### WARNING

Failure to heed warning lights and instrument cluster text messages can cause the vehicle to break down in traffic and result in a collision and serious personal injury.

- Never ignore warning lights or text WARNINGS.
- Always stop the vehicle as soon as it is safe to do so.

### WARNING

Driving with bad brakes can cause a collision and serious personal injury.

- If the brake warning light **BRAKE** or  does not go out, or comes on when driving, either the brake fluid level in the reservoir is too low or there is a fault in the brake system. Stop the vehicle as soon as you can do so safely and get expert assistance ⇒ *Brake fluid*.
- If the brake warning light **BRAKE** or  comes on at the same time as the ABS warning light **ABS** or , the ABS may not be working properly. This could cause the rear wheels to lock up relatively quickly during braking. Rear wheel brake lock-up can cause loss of vehicle control.
- If you believe the vehicle is safe to drive, drive slowly and very carefully to the nearest authorized Volkswagen dealer or authorized Volkswagen Service Facility or other qualified workshop and have the brake system inspected. Avoid sudden hard braking and steering.
- If the ABS indicator light **ABS** or  does not go out, or if it comes on while driving, the ABS system is not working properly. The vehicle can then be stopped only with the standard brakes (without ABS). You will not have the protection ABS provides. Contact your authorized Volkswagen dealer or an authorized Volkswagen Service Facility as soon as possible.
- If the symbol **BRAKE WEAR** or  lights up in the instrument cluster display, whether alone or together with a text message, immediately contact an authorized Volkswagen dealer or authorized Volkswagen Service Facility to have the brake pads checked and, if necessary, replaced.

### NOTICE

Failure to heed warning lights or text WARNINGS can result in vehicle damage.



## Electronic parking brake

---



Fig. 142 In the lower center console: Button for the electronic parking brake.

⚠ Please first read and note the introductory information and heed the WARNINGS ⚠

### Setting the electronic parking brake

You can engage the electronic parking brake any time the vehicle is not moving - even if the ignition is switched off. Always engage the parking brake when you leave or park the vehicle.

- Pull and hold the button ⇒ fig. 142.
- The parking brake is engaged when the indicator light (P) in the button and in the instrument cluster ⇒ *Braking and parking* comes on.

### Releasing the electronic parking brake

- Switch the ignition on.
- Press the button . At the same time, press the brake pedal firmly or press the accelerator pedal lightly if the engine is running.
- The parking brake is released when the indicator light (P) in the instrument cluster ⇒ *Warning and indicator lights* goes out.

### Releasing the electronic parking brake automatically when you start driving

The electronic parking brake releases automatically when you start driving if the driver's door is closed **and** the driver's safety belt is buckled. With a **manual transmission**, you must also press the clutch pedal all the way down before you start driving so the system recognizes that the parking brake should be released.

### Emergency braking function

Only use the emergency braking function in an emergency, when you cannot stop the vehicle using the brake pedal ⇒ ⚠ !

- Pull and hold the button to brake the vehicle **hard**. An audio warning signal will sound at the same time.
- To stop the braking maneuver, release the button or press the accelerator pedal.

## WARNING

Improper use of the electronic parking brake can cause accidents and severe injuries.

- Never use the parking brake to slow down the vehicle when it is moving, except in an emergency. Braking distance is much longer, since only the rear wheels are braked. Always use the foot brake.
- Never press the accelerator pedal when a selector lever position or gear is engaged and the engine is running. The vehicle could begin moving, even if the electronic parking brake is set.
- Never activate the throttle manually from the engine compartment when the engine is running and the automatic transmission is in gear. The vehicle will start to move even if the parking brake is engaged.

## NOTICE

Even though the transmission is in Park (P), the vehicle may move a couple of inches (a few centimeters) forwards or backwards if you take your foot off the brake pedal after stopping the vehicle without first firmly setting the parking brake.

 Vehicles with manual transmission: the electronic parking brake releases automatically when you release the clutch pedal and press the accelerator pedal at the same time.

 If the vehicle battery is dead, the electronic parking brake cannot be released. Use a jump-start 409.

 You may hear noises when setting or releasing the electronic parking brake.

 If the electronic parking brake is not used for a while, an automatic system check will occasionally run when the vehicle is parked. This system check makes audible noises.

## Parking

---

 Please first read and note the introductory information and heed the WARNINGS 

Please note legal regulations when stopping and parking your vehicle.

### Parking the vehicle

Please perform these steps only in the order listed.

- Stop the vehicle on a suitable surface ⇒ .
- Hold the brake pedal down until the engine is switched off.
- Apply the electronic parking brake to help prevent the vehicle from moving ⇒ *Electronic parking brake*.
- For automatic transmissions: Shift the transmission into Park (P).
- Switch off the engine and then take your foot off the brake.
- Remove the vehicle key from the ignition.
- If necessary, turn the steering wheel slightly to engage the steering column lock.

- Shift manual transmission into 1st gear (on level ground or if pointed uphill) or reverse (if pointed downhill) and let the clutch out.
- Make sure all passengers and especially children leave the vehicle.
- Take all vehicle keys with you when leaving your vehicle.
- Lock the vehicle.

### On hills

Before stopping the engine, turn the steering wheel so that, if the vehicle starts to roll, its front wheels will roll into the curb:

- Facing downhill, turn the front wheels so that they point toward the curb.
- Facing uphill, turn the front wheels so that they point away from the curb.



### WARNING

The vehicle exhaust system and the catalytic converter get very hot. They can cause fires and serious personal injury.

- Never park where the hot exhaust system could ignite flammable materials, such as brush, leaves, dry grass, spilled fuel, etc.



### NOTICE

- Always be careful when you park in areas with parking barriers or high curbs. These vary in height and could damage your bumper and related parts if the front of your vehicle hits a barrier or curb that is too high while you are getting into or out of a parking spot. To help prevent damage, stop before the tires of your vehicle touch a parking barrier or curb.
- Always be careful when you enter a driveway or drive up or down steep ramps or over curbs or other obstacles. Parts of the vehicle close to the ground may be damaged (such as bumper covers, spoilers, and parts of the engine, suspension, and exhaust systems).

## About the brakes

---

☞ Please first read and note the introductory information and heed the WARNINGS ⚠

**New brake pads** do not provide full performance during the first 100 to 200 miles (200 to 300 km) and must first be “broken” in ⇒ ⚠. To some extent, you can make up for the somewhat reduced performance by applying more pressure to the brake pedal. But, **during the break-in period**, the stopping distance for hard braking and emergency braking will be longer until the brakes are fully broken in. Avoid hard braking and situations that might require hard braking (such as following other vehicles too closely) – especially during the break-in period.

**Brake pad wear** depends mostly on operating conditions and the way the vehicle is driven. If you do a lot of city and short-distance driving and/or have a sporty driving style, you should have the brake pads checked by an authorized Volkswagen dealer or authorized Volkswagen Service Facility more often than the regular service intervals.

**Wet brakes** (for example, after driving through water or washing the vehicle or after heavy rainfall) will not brake as well. Stopping distances will be longer when brake discs are wet or, in winter, even icy. Wet or icy brakes must be dried as soon as possible by carefully applying the brakes a couple of times while traveling at a relatively high speed. Make sure nobody is behind you and that you do not endanger yourself or others ⇒ ⚠.

**Brakes coated with road salt** also react slower and need longer stopping distances. If there is salt on the roads and you are not braking regularly, brake carefully and gently from time to time to remove any salt coating from the brake disks and pads ⇒ ⚠.

Brake disc **corrosion** (rust) and **dirt** buildup on the brake pads are more likely to occur if the vehicle is not driven much or is driven only for short distances with little braking. If the brakes have not been used and there is some rust on the discs, clean the brake discs and pads once in a while by carefully braking a couple of times while driving at relatively high speed to help clean the brake discs and pads.

Make sure nobody is behind you and that you do not endanger yourself or others ⇒ ⚠.

### Brake system malfunction

If you brake and find that vehicle doesn't brake nearly as well as it used to (sudden increase in stopping distance), a brake circuit may have failed. The brake warning light **BRAKE** or Ⓢ will come on and a message may appear in the instrument cluster display. If you believe the vehicle is safe to drive, immediately take it to the nearest authorized Volkswagen dealer or authorized Volkswagen Service Facility for repair. Drive slowly and very carefully, allow for the longer stopping distance, and be ready to push longer and harder on the brake pedal to slow the vehicle down.

### Brake booster

The brake booster works only when the engine is running. It increases the force on the brakes above and beyond the pressure put on the brake pedal by the driver.

If the brake booster is not working, or if the vehicle has to be towed, you will have to push the brake pedal harder to make up for the lack of booster assistance and the resulting longer stopping distance ⇒ ⚠.

### WARNING

**New brake pads do not provide maximum braking performance.**

- New brake pads do not have the best stopping power for the first 200 miles (320 km) and must be "broken in". You can compensate for the slightly reduced braking force by putting more pressure on the brake pedal.
- Drive with extra care while the new brake pads are being broken in. This reduces the risk of collisions and serious personal injuries due to a loss of control over the vehicle.
- Never follow other vehicles too closely or put yourself into other situations that might require sudden, hard braking, especially when the brake pads have not been broken in.

### WARNING

**Overheated brakes will reduce the vehicle's stopping power and increase stopping distances considerably.**

- When driving downhill, the brakes have to work especially hard and heat up quickly.
- Before driving downhill, especially on hills that are long or steep, always reduce speed and shift into lower gear (manual or automatic transmission). This will let the vehicle use engine braking and reduce the load on the brakes. Otherwise, the brake system could overheat and possibly fail. Only use the brakes when you need them to slow the vehicle down more or to stop.
- A damaged front spoiler or a nonstandard spoiler can reduce airflow to the brakes and make them overheat.



### WARNING

Wet brakes or brakes coated with ice or road salt react slower and need longer stopping distances.

- Carefully apply the brakes to test them.
- Always dry brakes and clean off ice and salt coatings with a few cautious brake applications when visibility, weather, road and traffic conditions permit.



### WARNING

Driving when the brake booster is not working increases stopping distances and can cause accidents and serious personal injuries.

- Never let the vehicle coast when the engine is switched off.
- If the brake booster is not working (such as when the vehicle is being towed), a lot more pedal force is needed to slow down and stop.



### NOTICE

- Never “ride” the brakes by keeping your foot on the brake pedal when you do not want to brake. Constant pressure on the brake pedal can make the brakes overheat. Riding the brakes will substantially reduce braking performance, increase stopping distance, and can cause complete brake system failure.
- Before driving downhill, especially on hills that are long or steep, always reduce speed and shift into lower gear (manual or automatic transmission). This will let the vehicle use engine braking and reduce the load on the brakes. Otherwise, the brake system could overheat and possibly fail. Only use the brakes when you need them to slow the vehicle down more or to stop.



When the front brakes are serviced, you should have the rear brake pads inspected at the same time. The wear of all brake pads should be visually checked regularly. The best way to check for brake pad wear is to have your authorized Volkswagen dealer or authorized Volkswagen Service Facility visually inspect the pads through the openings in the wheel rims or from underneath the vehicle. If necessary, the wheels can be taken off for a more thorough inspection.

## Braking assistance systems

---

**⚠ Please first read and note the introductory information and heed the WARNINGS**

The ESC, ABS, BAS, ASR, and EDL braking assistance systems work only when the engine is running. These systems can significantly improve active driving safety.

### Electronic Stability Control (ESC)

ESC helps to improve road holding and vehicle dynamics to help reduce the probability of skidding and loss of vehicle control. It works only when the engine is running. ESC detects certain difficult driving situations, including when the vehicle is beginning to spin (yaw) out of control. ESC then helps you to get the vehicle back under control by selectively braking the wheels and/or reducing engine power and by providing steering assistance to help hold the vehicle on the driver's intended course.

ESC has limitations. It is important to remember that ESC cannot overcome the laws of physics. It will not always be able to help out under all conditions you may come up against. For example, ESC may not always be able to help you master situations where there is a sudden change in the coefficient of friction of the road surface. When there is a section of dry road that is suddenly covered with water,

slush or snow, ESC cannot perform the same way it would on a dry surface. If the vehicle "hydroplanes" (rides on a cushion of water instead of the road surface), ESC will not be able to help you steer the vehicle because contact with the pavement has been interrupted and the vehicle cannot be braked or steered. During fast cornering, particularly on winding roads, ESC cannot always deal as effectively with difficult driving situations as it can at lower speeds. When towing a trailer, ESC is not able to help you regain control as it would if you were not towing a trailer.

Always adjust your speed and driving style to visibility, road, traffic, and weather conditions. ESC cannot override the vehicle's physical limits, increase the available traction, or keep a vehicle on the road if road departure is a result of driver inattention. Instead, ESC improves the possibility of keeping the vehicle under control and on the road during extreme maneuvers by using the driver's steering inputs to help keep the vehicle going in the intended direction. If you are traveling at a speed that causes you to run off the road before ESC can provide any assistance, you may not experience the benefits of ESC.

ESC includes and/or works together with the ABS, BAS, ASR, EDL, and XDL systems (see below). ESC is switched on all the time and cannot be switched off.

### **Anti-Lock Brake System (ABS)**

ABS helps to keep the wheels from locking up and helps to maintain the driver's ability to steer and control the vehicle. This means the vehicle is less likely to skid, even during hard braking:

- Push the brake pedal down hard and hold it there. Don't take your foot off the pedal or reduce the force on the pedal!
- Do not "pump" the brake pedal or let up on it!
- Steer the vehicle while pushing down hard on the brake pedal.
- ABS stops working if you release or let up on the brake.

When ABS is doing its job, you will notice a **slight vibration** through the brake pedal and hear a noise. *ABS cannot shorten the stopping distance under all conditions.* The stopping distance may even be longer, for instance, when driving on gravel or on newly fallen snow covering an icy or slippery surface.

When driving forwards on loose surfaces, a special off-road ABS is automatically activated. In this mode, the front wheels could lock briefly. This shortens the braking distance in off-road situations as the wheels dig into loose surfaces. This occurs only when driving straight ahead. When the front wheels are turned, the normal ABS is activated.

### **Brake Assist (BAS)**

The Brake Assist System can help to reduce stopping distances. If you press the brake pedal very quickly, BAS detects an emergency situation. It then very quickly builds up full brake system pressure, maximizing braking power and reducing the stopping distance. This way, ABS can be activated more quickly and efficiently.

Do **not** reduce pressure on the brake pedal! BAS switches off automatically as soon as you release or let up on the brake.

### **Anti-Slip Regulation (ASR)**

ASR reduces engine power directed to spinning wheels and adjusts power to the road conditions. Even under poor road conditions, ASR can make it easier to get moving, accelerate, and climb hills.

ESC and ASR can help when driving on loose surfaces (such as gravel) and in deep snow. If you get stuck in deep snow, you may be able to get going again by "rocking" the vehicle back and forth. ESC and ASR recognize this special driving situation and automatically increase the speed of the front wheels. Keep pressing the accelerator and let ESC increase the speed of the front wheels to help you keep moving or get moving again.

### **Electronic Differential Lock (EDL and XDL)**

EDL is applied during regular straight-line acceleration. EDL gently brakes a drive wheel that has lost traction (spinning) and redirects the drive force to other drive wheels. In extreme cases, EDL

automatically switches off to keep the brake from overheating. As soon as the brake has cooled down, EDL automatically switches on again.

XDL is an extension of the Electronic Differential Lock system. XDL does not react to drive wheel slippage when driving straight ahead. Instead, XDL detects slippage of the inside front wheel during fast cornering. XDL applies enough brake pressure to this wheel in order to stop the slippage. This improves traction, which helps the vehicle stay on track.

### **WARNING**

**Driving fast on icy, slippery, or wet roads can lead to a loss of control and result in serious personal injury for you and your passengers.**

- **Always adjust your speed and driving style to road, traffic, weather, and visibility conditions. Never let the additional safety that ESC, ABS, BAS, ASR, and EDL can provide tempt you into taking extra risks.**
- **Braking assistance systems cannot overcome the laws of physics and always prevent loss of vehicle control. Slippery and wet roads are still dangerous even with ESC and the other systems!**
- **Driving too fast on wet roads can cause the wheels to lose contact with the road and “hydroplane.” A vehicle that has lost road contact cannot be braked, steered, or controlled.**
- **These systems cannot reduce the risk of accident, for example if you drive too fast for conditions or if you do not keep your distance from the vehicle in front of you.**
- **Although these systems are very effective and can help you control the vehicle in many difficult situations, always remember that your vehicle handling control is limited by tire traction.**
- **When accelerating on a slippery surface, for example on ice and snow, depress the accelerator carefully. Even with these systems, the wheels may start to spin, leading to a loss of vehicle control.**

### **WARNING**

**The effectiveness of ESC can be significantly reduced if other components and systems that affect vehicle dynamics, including but not limited to brakes, tires, and other systems mentioned above, are not properly maintained or functioning.**

- **Always remember that vehicle alterations or modifications can affect the functioning of the ABS, BAS, ASR, EDL and ESC systems.**
- **Changing the vehicle suspension or using an unapproved tire/wheel combination can change the way the ABS, BAS, ASR, EDL and ESC systems work and reduce their effectiveness.**
- **The effectiveness of ESC is also determined by the tires fitted ⇒ *Tires and wheels.***

 All 4 wheels must be equipped with identical tires in order for ESC and ASR to work properly. Differences in the tread circumference of the tires can cause the system to reduce the engine power when it is not expected.

 If ABS is not working, ESC, ASR, and EDL will also not work.

 You may hear noises when these systems are active.

## Switching Anti-Slip Regulation (ASR) on and off

---



Fig. 143 In the center console: Button to manually switch ASR on and off.

**⚠ Please first read and note the introductory information and heed the WARNINGS ⚠**

The Electronic Stability Control (ESC) only works when the engine is running. This system includes ABS, EDL and ASR.

ASR can be switched off by pressing  button ⇒ fig. 143 while the engine is running. Switch off ASR only in situations where there is not enough traction, such as the following:

- When driving in deep snow or on loose surfaces.
- When “rocking” the vehicle back and forth when you are stuck.

Afterward, reactivate ASR by pressing the  button again.

## Brake fluid

---



Fig. 144 In engine compartment: Brake fluid reservoir cap

**⚠ Please first read and note the introductory information and heed the WARNINGS ⚠**

Brake fluid absorbs water from the air over time. Too much water in the brake fluid will damage the brake system. Water also lowers the boiling point of the brake fluid. Too much water in the brake fluid can cause vapor lock during heavy brake use or hard braking. Vapor lock reduces braking performance, increases stopping distances and can even cause total brake failure. Your safety and the safety of others depends on brakes that are working properly at all times ⇒ ⚠.



### Brake fluid specifications

Volkswagen has developed a special brake fluid that is optimized for the brake system in your Volkswagen. Volkswagen recommends that you expressly use brake fluid that conforms to quality standard **VW Standard 501 14** for optimum performance of the brake system. Check the information on the container for the brake fluid you want to use to make sure it meets the requirements for your vehicle.

Brake fluid that complies with **VW Standard 501 14** can be purchased from your authorized Volkswagen dealer or authorized Volkswagen Service Facility.

If this special brake fluid is not available you may – under these circumstances – use another high-quality brake fluid that complies with U.S. Federal Motor Vehicle Safety Standard (FMVSS) 116 DOT 4

⇒ .

Please note, however, that not all brake fluids that comply with U.S. Federal Motor Vehicle Safety Standard FMVSS 116 DOT 4 have the same chemical composition. Some of these brake fluids can contain chemicals that could, over time, degrade or damage internal parts of the vehicle's brake system.

Volkswagen therefore recommends that you use brake fluid that expressly complies with **VW Standard 501 14** for optimum brake system performance over the long term.

### Brake fluid level

The fluid level in the transparent brake fluid reservoir must always be between the MIN and MAX marking ⇒ .

On some vehicles, engine components block the view of the brake fluid reservoir and make it impossible to see the brake fluid level. If you cannot clearly see the brake fluid level in the brake fluid reservoir, please see an authorized Volkswagen dealer or authorized Volkswagen Service Facility.

The brake fluid level drops slightly when the vehicle is being used as the brake pads wear and the brakes are automatically adjusted.

### Changing brake fluid

Brake fluid must be changed according to the service schedule in your ⇒ booklet *Warranty and Maintenance*. Have the brake fluid checked by an authorized Volkswagen dealer or an authorized Volkswagen Service Facility. Refill only with new brake fluid that meets the standards listed above.

### WARNING

**Brake failure and reduced brake performance can be caused by not having enough brake fluid in the reservoir or by old or incorrect brake fluid.**

- Check the brake system and brake fluid level regularly.
- Always change the brake fluid according to the service schedule in your ⇒ booklet *Warranty and Maintenance*.
- Hard braking with old brake fluid may cause vapor lock. Vapor lock reduces braking performance, increases stopping distances and can even cause total brake failure.
- Always make sure that only the correct brake fluid is used. Only use brake fluid that expressly conforms to VW Standard 501 14 or if it is not available, only use a high-quality brake fluid that conforms to U.S. Standard FMVSS 116 DOT 4 requirements.
- Using another brake fluid, or one that is not of high quality, can impair the function of the brake system and reduce its effectiveness. If the container does not say that the brake fluid complies with VW Standard 501 14, or U.S. Standard FMVSS 116 DOT 4, do not use it.
- The brake fluid must be new.

 **WARNING**

Brake fluid is poisonous.

- To reduce the risk of poisoning, never use food, beverage or other non-original containers to store brake fluid. Someone might be misled by the original label on the container, or by the shape of the container, and drink the brake fluid. This could occur even if you relabel the container as “brake fluid.”
- Only store brake fluid in the closed, original container and keep it out of the reach of children.

 **NOTICE**

Brake fluid will damage vehicle paint, plastic parts and tires. Wipe any brake fluid off vehicle paint and other vehicle parts immediately.



Brake fluid can pollute the environment. Brake fluid that has leaked out must be collected and disposed of properly, following all applicable environmental regulations.

# Saving fuel and helping the environment

## Introduction

---

In this section you'll find information about:

Efficient driving style  
Fuel-efficient driving

Fuel consumption, environmental impact, and wear and tear on engine, brakes and tires depend mainly on the following 3 factors:

- Your personal driving style.
- External conditions (weather, road conditions).
- Technical requirements.

You can reduce fuel consumption by up to 25% by using a few simple techniques and adjusting your driving style.

### **WARNING**

**Always adjust your speed and the distance you keep between you and the vehicles ahead of you to the road, traffic, weather, and visibility conditions.**

## Efficient driving style

---

 **Please first read and note the introductory information and heed the WARNINGS **

### **Shifting faster**

As a rule, the following applies: The higher gear is always the most efficient gear. The rule of thumb for most vehicles is to drive in 3rd gear at 20 mph/30 km/h, 4th gear at 25 mph/40 km/h, 5th gear at 30 mph/50 km/h, and 6th gear at 36 mph/60 km/h.

If traffic and driving conditions permit, “skipping” gears when upshifting also saves fuel.

Do not run the gears up to their limit. Use 1st gear only to start moving and then smoothly shift into 2nd gear. Avoid kick-downs in vehicles with automatic transmissions.

### **Coasting**

If you take your foot off the accelerator, fuel delivery to the engine is interrupted, which lowers fuel consumption.

Therefore, when nearing a red stop light, for instance, allow the vehicle to coast without using the accelerator. Press the clutch pedal and release it only if the vehicle moving too slowly or the coasting distance is too long. The engine will then continue to run at idle.

In situations where the vehicle will be stopped for a longer period of time, such as at a railroad crossing, physically switch off the engine.

### **Defensive driving and “flowing” with traffic**

Frequent braking and acceleration increases fuel consumption significantly. Just by driving defensively and keeping a sufficiently large distance away from the vehicle in front of you can make up for the

speed fluctuations caused by taking your foot off the accelerator. Active braking and accelerating is then not necessarily required.

### **Calm and smooth driving**

Consistency is more important than speed. The more smoothly you drive, the less fuel the vehicle consumes.

When driving on the highway or freeway, a constant, moderate speed is more efficient and economical than constantly accelerating and braking. Usually you can reach your destination just as quickly by driving at a moderate, but steady speed.

The cruise control system can assist in maintaining a uniform driving style.

### **Moderate use of extra electrical loads**

Comfort inside the vehicle is nice and important, but it is important to use them in an environmentally conscious manner.

Some devices can increase fuel consumption when activated (examples):

- Climate control system (air conditioner): If the air conditioner has to produce starkly contrasting temperatures, it requires a large amount of energy, which is generated by the engine. The temperature in the vehicle should therefore not be extremely different from that of the outside temperature. It may be helpful to ventilate the vehicle before driving and then to drive a short distance with the windows open. After that, switch on the air conditioner with the windows closed. Keep the windows closed when driving at high speeds. Open windows increase fuel consumption.
- Switch off seat heating once it has served its purpose.
- Switch off the rear window defroster as soon as the windows are free of fog and ice.

### **Additional factors that increase fuel consumption (examples):**

- Malfunctioning engine control.
- Driving in the mountains.
- Towing a trailer.

## **NOTICE**

**Never let the vehicle coast or roll down a hill in Neutral (N), especially when the engine is not running. The transmission will not be lubricated and will be damaged.**

## Fuel-efficient driving

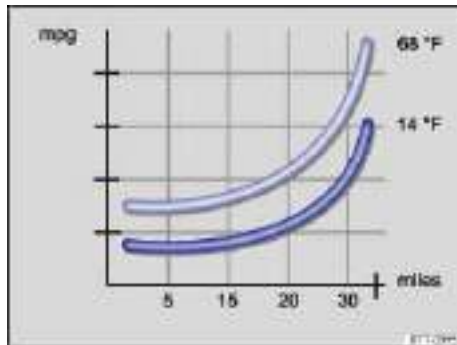

Fig. 145 Fuel consumption in mpg at 2 different outside air temperatures.

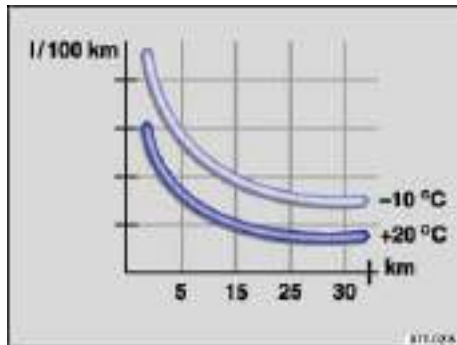

Fig. 146 Fuel consumption in l/100 km at 2 different outside air temperatures.

### ⚠ Please first read and note the introductory information and heed the WARNINGS ⚠

Driving defensively and economically can easily reduce fuel consumption by 10 to 15%.

The vehicle consumes the most fuel when accelerating. Defensive driving requires less braking and therefore less acceleration. If possible, coast the vehicle to a stop, for example, when you can see that the next traffic light is red or is about to turn red.

### Avoid traveling short distances

A cold engine consumes significantly more fuel immediately after starting. It takes a few miles (km) before the engine is warmed up and fuel consumption is stabilized.

To reduce fuel consumption and the emission of pollutants effectively, the engine and catalytic converter must reach their optimal **operating temperature**. Critical in this context is also the **outside air temperature**.

⇒ fig. 145 and ⇒ fig. 146 display the varying fuel consumption rates for the same distance driven, once at +68 °F (+20 °C) and once at +14 °F (-10 °C).

Therefore, avoid driving short distances unnecessarily and consolidate routes.

Under the same conditions, the vehicle consumes more fuel in winter than in summer.

“Letting the engine run to warm up” is not only illegal in some places, but also technically not necessary and wastes fuel.

**Adjust the tire pressure**

The proper tire pressure helps reduce rolling resistance as well as fuel consumption.

When purchasing new tires, always make sure that the tires are optimized for lower rolling resistance.

**Use low viscosity engine oil**

Fully "synthetic," low viscosity engine oils that expressly comply with Volkswagen oil quality standards reduce fuel consumption. Low viscosity engine oils reduce the frictional resistance on the engine and are distributed more evenly and quickly, particularly when cold-starting the engine. The effect is particularly apparent in vehicles that frequently travel short distances.

Always ensure the right engine oil level is maintained and keep to the scheduled service intervals (engine oil changes).

Make sure the engine oil that you purchase expressly complies with Volkswagen oil quality standards and is the oil approved by Volkswagen for your vehicle.

**Avoid unnecessary weight**

The lighter the vehicle, the more economical and eco-friendly it will be. For example, an extra 220 lbs (100 kg) of weight increases fuel consumption by up to 1 pint per 60 miles (0.3 l/100 km).

Remove all unnecessary items and unnecessary dead weight from the vehicle.

**Remove unnecessary aftermarket components**

The more aerodynamic the vehicle, the less fuel it will consume. Aftermarket components such as bicycle racks reduce its aerodynamic performance.

Therefore, remove unnecessary structures and unused rack systems, particularly if planning to drive at higher speeds.

## Cruise control system (CCS)

### Introduction

In this section you'll find information about:

- Warning and indicator lights
- Warning and indicator lights
- Cruise control operation

The cruise control system (CCS) helps maintain an individually stored constant speed when driving above 12 mph (20 km/h).

The CCS slows down the vehicle only by reducing the flow of fuel to the engine, not by braking ⇒ ⚠.

#### More information:

- Shifting
- Parts, accessories, repairs and modifications

**⚠ WARNING**

Using the cruise control when it is not possible to drive safely at a constant speed can be dangerous and can lead to an accident and serious personal injuries.

- Never use cruise control when driving in heavy or varying traffic or when you cannot keep a safe distance between you and the vehicles ahead of you.
- Never use cruise control on steep, winding, or slippery roads (such as gravel roads, wet roads, or snowy or icy roads) or on roads with standing water.
- Never use cruise control when driving off-road or on unpaved roads.
- Always adjust your speed and the distance you keep between you and the vehicles ahead of you to the road, traffic, weather, and visibility conditions.
- To help prevent unintended operation of cruise control, switch the system off when it is not being used.
- It is dangerous to use the Resume feature when the previously set speed is too high for the existing road, traffic, or weather conditions.
- When going downhill, the cruise control may not be able to maintain a constant speed. The vehicle will speed up because of its own weight. Downshift and/or use the foot brake to slow the vehicle.

### Warning and indicator lights

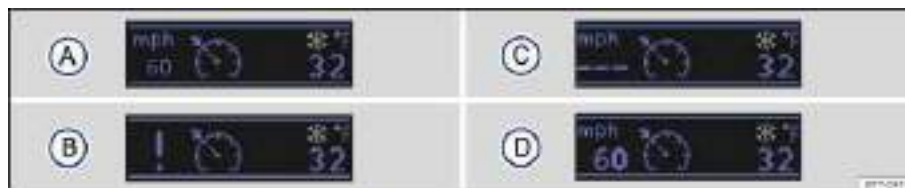

Fig. 147 In the instrument cluster display: Cruise control status indications.

ⓘ Please first read and note the introductory information and heed the WARNINGS ⚠

### Display

Different cruise control versions are available. The stored speed is shown in the instrument cluster display on some equipment versions.

**Status** [fig. 147](#)

- (A) Cruise control temporarily deactivated. Stored speed in small numbers.
- (B) System malfunction. See an authorized Volkswagen dealer or an authorized Volkswagen Service Facility.
- (C) Cruise control activated. No speed stored in memory.
- (D) Cruise control is active. Stored speed in large numbers.

### Indicator lights

Lights up	Possible cause
	Cruise control is regulating the speed.
CRUISE	

When the ignition is switched on, several warning and indicator lights come on briefly for a function check. They go out after a few seconds.

**⚠ WARNING**

Failure to heed warning lights and instrument cluster text messages can cause the vehicle to break down in traffic and result in a collision and serious personal injury.

- Never ignore warning lights or text WARNINGS.
- Always stop the vehicle as soon as it is safe to do so.

**! NOTICE**

Failure to heed warning lights or text WARNINGS can result in vehicle damage.

## Cruise control operation



**Fig. 149** On the left side of the steering column: Cruise control buttons and switches.



ⓘ Please first read and note the introductory information and heed the **WARNINGS** ⚠

In order to:	You must: ⇒ <a href="#">fig. 149</a>	Result:
Switch on cruise control.	Move switch (2) to <b>ON</b> position.	System is switched on, but does not regulate vehicle speed until a speed is set.
Set cruise control to current vehicle speed.	Press button (3) <b>SET/-</b> .	Current vehicle speed is set; cruise control helps to maintain this speed.
Temporarily deactivate cruise control.	Move switch (2) to the <b>CANCEL</b> position. <b>OR:</b> depress the brake or clutch pedal.	Cruise control is temporarily deactivated. The speed is still stored in the memory.
Resume speed stored in cruise control.	Press button (1) <b>RES/+</b> .	Cruise control resumes speed previously set.
Increase set speed (while cruise control is actively controlling vehicle speed).	Press the button (1) <b>RES/+</b> briefly to increase the set speed in small steps. <i>briefly</i> to increase the stored speed in small steps of 1 mph (1 km/h) each.	The vehicle will accelerate until the new higher speed is reached and saves the new higher speed in the memory.
	Press and hold button (1) to increase the set speed until the higher desired speed is reached and button is released.	
Reduce set speed (while cruise control is actively controlling vehicle speed).	Press the button (3) <b>SET/-</b> <i>briefly</i> to decrease the stored speed in small steps of 1 mph (1 km/h) each.	Cruise control will slow the vehicle down <i>without braking</i> by reducing the flow of fuel to the engine until the new lower speed is reached and saves the new lower speed in the memory.
	Press and hold button (3) to reduce the set speed until the lower desired speed is reached and the button is released.	
Switch off cruise control.	Move switch (2) in the <b>OFF</b> position.	System is switched off. The set speed is deleted.

### Driving downhill with cruise control

If cruise control cannot maintain constant speed while driving downhill, slow the vehicle with the foot brake and downshift if necessary.

### Automatic deactivation

Cruise control speed regulation is automatically deactivated or temporarily interrupted:

- If the system detects an error that could affect the function of the cruise control.
- If the vehicle has accelerated and goes faster than the stored speed for a longer time.
- If the brake or clutch pedal is depressed.
- If the vehicle shifts gear (manual transmission).
- If an airbag deploys.

## Rear Assist

### Introduction

---

In this section you'll find information about:

Operation  
Parking

There is a camera in the luggage compartment lid to assist the driver while backing up or maneuvering. The camera image is shown together with the orientation lines projected by the system on the screen of the factory-installed radio or navigation system.

Rear Assist may take a few seconds to bring up the camera image.

#### More information and warnings:

- Exterior views
- Parts, accessories, repairs and modifications
- ⇒ booklet *Radio* or ⇒ booklet *Navigation system*

#### WARNING

Rear Assist is not able to give you a clear and undistorted view of all areas behind the vehicle.

- The camera has blind spots in which it cannot detect people and objects.
- Always be careful and look around you when parking. The camera cannot show people, animals, and objects in certain situations. Watch out for small children and animals in particular.
- Due to the screen resolution or in low-light conditions, the camera may not pick up thin posts, chain-link fences and similar fences, and other objects, or it may not show them clearly.
- The camera lens enlarges and distorts the field of vision and causes objects on the screen to appear altered and imprecise.
- Always keep the camera lens clean and free of snow and ice; do not cover the lens.

#### WARNING

Rear Assist technology cannot overcome the laws of physics and the limits of the system. Careless or unintentional use of Rear Assist may result in accidents and severe injuries.

- Always adjust your speed and driving style to road, traffic, weather, and visibility conditions.
- Always keep an eye on the parking direction and the vehicle surroundings. The front of the vehicle swings out more than the rear of the vehicle.
- Never pay so much attention to the graphics shown on the screen that you fail to notice what is going on around you.
- Always watch for people, especially small children, animals, and objects, because the camera may not always be able to detect them.
- The system may not be able to clearly show everything behind the vehicle.
- Use Rear Assist only when the luggage compartment lid is completely closed.

**NOTICE**

- The camera shows only two-dimensional images on the screen. Due to the lack of depth of field, it may be difficult or impossible to identify protruding objects or recesses in the road, for example.
- Things like thin rods, fences, posts, and trees may not be detected by the camera and could damage the vehicle.

**Operation**



Fig. 150 In the luggage compartment lid: Location of the Rear Assist camera.

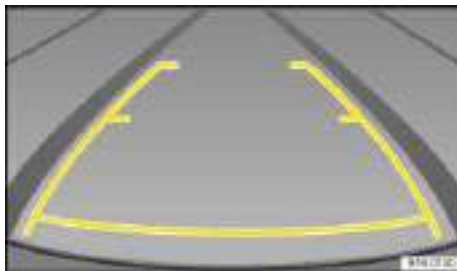

Fig. 151 Rear Assist display.

**ⓘ Please first read and note the introductory information and heed the WARNINGS ⚠**

In order to	Operation
Automatically activate display:	Shift into Reverse when the ignition is switched on or the engine is running.
Manually deactivate display:	Press a function selection button on the radio or the navigation system ⇒ booklet <i>Radio</i> or ⇒ booklet <i>Navigation system</i> . <b>OR:</b> Switch off the ignition. The Rear Assist display turns off after a few seconds.

In order to	Operation
Switch off display by shifting out of Reverse:	The display switches off after about 10 seconds.
Deactivate display by driving forward:	Drive forward faster than about 10 mph (15 km/h).

### Special considerations

#### 1) Do not use Rear Assist in the following situations:

- When an incorrect or unclear image is displayed, such as when there is poor visibility or the lens is dirty.
  - If the area behind the vehicle cannot be seen clearly or completely.
    - If the rear of the vehicle is heavily loaded.
  - When the luggage compartment lid is open.
  - If the driver is not familiar with the system.
- If the position or angle of the camera has changed, such as after a rear-end collision. Have the system checked by an authorized Volkswagen dealer or an authorized Volkswagen Service Facility.

#### 2) Examples of optical distortion by the camera

The Rear Assist camera displays only two-dimensional images. Recesses and protruding objects on the ground or protruding parts on other vehicles are difficult or impossible to identify due to the lack of depth of field.

Objects or another vehicle may seem closer or farther away on the screen than they really are:

- When driving from a level surface onto an upward or downward slope.
  - When driving up or down a slope onto a level surface.
    - If the rear of the vehicle is heavily loaded.
- When approaching protruding objects. These objects can disappear from the field of view when backing up.

### Cleaning the camera lens

Keep the camera lens clean and free of snow and ice:

- Engage the parking brake.
- Switch on the ignition.
- Select the reverse gear.

- Wet the camera lens with a commercially available alcohol-based glass cleaner and clean with a dry cloth ⇒ ⚠.
- Remove snow with a brush.
- Remove ice with deicer spray ⇒ ⚠.

### ⚠ NOTICE

- **Never use abrasive cleaning agents to clean the camera lens.**
- **Never remove snow or ice on the camera lens with warm or hot water. This can damage the camera lens.**

**i** Volkswagen recommends practicing parking with Rear Assist in a safe place with little or no traffic or in a parking lot under good visibility and weather conditions in order to familiarize yourself with the system, the orientation lines and the way they work.

**i** Rear Assist does not work when the luggage compartment lid is open.

## Parking

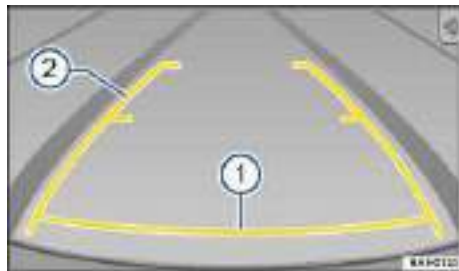

**Fig. 152** On the screen: Static orientation lines for the parking space behind the vehicle.

**⚠ Please first read and note the introductory information and heed the WARNINGS ⚠**

### Orientation lines overview

The yellow area displayed stops about 2 yards (meters) behind the vehicle on the road.

Meaning of the orientation lines on the screen<sup>7</sup> ⇒ [fig. 152](#).

- (1) Safety distance: area up to about 16 inches (40 cm) behind the vehicle on the road.
- (2) Projection of the vehicle (widened somewhat) toward the rear. The middle markers are about 40 inches (1 meter) behind the vehicle on the road.

### Parking

- Position the vehicle in front of a parking space and shift into Reverse.
- Slowly back up and steer so that the yellow orientation lines lead into the parking space (2).
- Align the vehicle in the parking place so that the yellow orientation lines are parallel with the parking space.

<sup>7</sup> All distances of the orientation lines refer to a vehicle that is on a level surface.

# Heating and air conditioning

## Introduction

---

In this section you'll find information about:

Manual controls  
Climatronic controls  
Operation  
Air vents  
Air recirculation

### **Manual air conditioning (AC) and Climatronic**

**Your vehicle is equipped either with a Manual A/C climate control system or with a Climatronic climate control system.** On vehicles with Climatronic climate control, system status messages will appear briefly in the Climatronic display and/or on the factory-installed Radio system or Radio & Navigation system.

The temperature units (Fahrenheit or Celsius) in the factory installed radio or navigation system screen can be changed in the **Settings** menu in the Premium instrument cluster display in appropriately equipped vehicles.

### **The dust and pollen filter**

The dust and pollen filter with an activated carbon insert reduces the entry of pollutants into the passenger compartment.

The dust and pollen filter must be replaced at the intervals recommended in ⇒ booklet *Warranty and Maintenance* so that the air conditioner can work properly.

If the effectiveness of the filter decreases prematurely due to operating the vehicle where the outside air is heavily polluted, the dust and pollen filter should be replaced more frequently than indicated.

### **More information:**

- Exterior views
- Volkswagen Information System
- Seat functions
- Windshield wiper and washer
- Starting and stopping the engine
- Exterior care and cleaning



### WARNING

Poor visibility increases the risk of collisions and other accidents that cause serious personal injuries.

- Always make sure all windows are clear of ice, snow and condensation for good visibility to the front, sides, and rear.
- Maximum heating output and defrosting performance are not possible until the engine has reached operating temperature. Wait until you have good visibility before driving off.
- Always make sure you know how to properly use the heating and ventilation systems as well as the rear window defroster that you will need for good visibility.
- Never use air recirculation for long periods of time. When the air conditioner is off and recirculation mode is on, condensation can quickly form on the windows and greatly reduce visibility.
- Always switch off recirculation mode when it is not needed.



### WARNING

Stale air causes driver fatigue and reduces driver alertness, which can cause accidents, collisions and serious personal injury.

- Never switch off the fan for a long period of time and never use air recirculation a long period of time because no fresh air will enter the passenger compartment.



### NOTICE

- If you think the air conditioner is not working properly or may be damaged, switch it off to help prevent more damage. Have the air conditioner checked by an authorized Volkswagen dealer or authorized Volkswagen Service Facility.
- Air conditioner repair requires specialized knowledge and special tools. Volkswagen recommends that you see an authorized Volkswagen dealer or an authorized Volkswagen Service Facility.
- Do not smoke when air recirculation is switched on. Smoke drawn into the ventilation system can leave residue on the evaporator and on the dust and pollen active carbon filter, resulting in permanent odors whenever the air conditioner is switched on.



If the air conditioner is switched off, the fresh outside air will not be dehumidified. To help keep the windows from fogging over, Volkswagen recommends leaving the air conditioner (compressor) switched on. Press the **AC** button. The indicator light in the button must come on.



When it is very hot and humid outside, **water condensation** can drip from the air conditioner evaporator and form a puddle under the vehicle. This is normal and does not indicate a leak.



Keep the air intake slots in front of the windshield free of ice, snow and leaves in order to maintain proper functioning of the heating and ventilation systems.



Maximum heating output and defrosting performance are not possible until the engine has reached operating temperature.

 Emergency starting and starting the engine with a very weak vehicle battery or after the vehicle battery has been replaced may change or delete system settings (including time, date, personal convenience settings and programming). Check the settings and correct as necessary once the vehicle battery has built up a sufficient charge.





## Manual controls









Fig. 153 In the center console: Manual AC controls.

 Please first read and note the introductory information and heed the WARNINGS

Press the corresponding button to switch a function on or off. If a function is switched on, an indicator light in or under the button comes on. To switch off a function, press the button again.

Button / Knob	More information: Manual AC ⇒ <a href="#">fig. 153</a> .
Temperature (1) 	Turn knob to set the desired temperature. The <b>MAX A/C</b> position provides maximum cooling output. Recirculation mode and the cooling system switch on automatically.
Fan (2) 	: Setting 0: the fan and manual A/C are switched off. Setting 6: highest fan speed.
Air distribution (3)	Direct airflow by turning knob to any setting (continuously adjustable).
	Defog / defrost button: Airflow is directed to the windshield. Recirculation mode switches off automatically in this position. Increases the fan speed to clear the windshield as quickly as possible. The cooling system switches on automatically to dehumidify the air.
	Air distribution to the air vents in the instrument panel.
	Air distribution to the instrument panel and in the footwells.



<b>Button / Knob</b>	<b>More information: Manual AC ⇒ fig. 153.</b>
	Air distribution in the footwells.
	Air distribution to the windshield and footwells.
	Rear window defroster: Functions only when the engine is running and switches off automatically after 10 minutes or less.
	Air recirculation
 or 	Buttons for seat heating
<b>A/C</b>	Press the button to switch the air conditioner on or off.
<b>MAX A/C</b>	Turn knob (1) to the <b>MAX A/C</b> position for maximum cooling output. The air recirculation and air conditioning switches on automatically.
<b>OFF</b>	Switching off. Turn fan switch to position 0.

**⚠ WARNING**

Stale air causes driver fatigue and reduces alertness, which can cause accidents, collisions, and serious personal injury.

- Never switch off the fan for a long time, because no fresh air will enter the passenger compartment.

## Climatronic controls

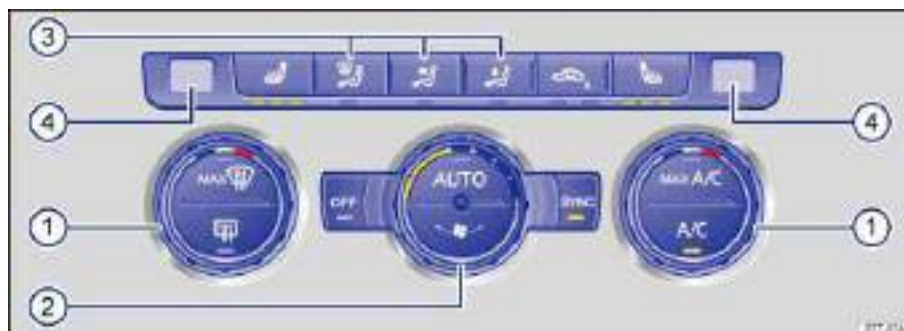













Fig. 154 In the center console: Climatronic controls.

**ⓘ Please first read and note the introductory information and heed the WARNINGS ⚠**

Press the corresponding button to switch a function on or off. If a function is switched on, an indicator light in or under the button comes on. To switch off a function, press the button again.

Button / Knob	More information: Climatronic ⇒ <a href="#">fig. 154.</a>
Temperature (1) 	Left and right sides of the vehicle can be set to different temperatures. Turn the knob to set the temperature. The temperature is displayed on the outer ring.
Fan (2) 	The fan speed is automatically controlled depending on the vehicle speed in order to help prevent unnecessary noise. The fan can also be adjusted manually.
Air distribution (3)	Air flow is automatically adjusted to a comfortable level. It can also be manually adjusted with button (3).
Displays (4)	Left-side and right-side digital temperature displays.
	Defog / defrost button: The incoming outside air is directed to the windshield, and air recirculation is automatically switches off. To defrost the windshield as quickly as possible, humidity is removed from the air at temperatures above about 35 °F (+1.5 °C), and the blower is set to a high speed.
	Air distribution to the air vents in the instrument panel.
	Air distribution in the footwells.
	Air is directed upward.
	Rear window defroster: Functions only when the engine is running and switches off automatically after 10 minutes or less.
	Manual and automatic air recirculation
	Buttons for seat heating
<b>A/C</b>	Press the button to switch the air conditioner on or off.
	Push button for maximum air conditioner cooling. The air recirculation and air conditioning switches on automatically and the vents direct air in the  position.
<b>SYNC</b>	Applies the temperature settings for the driver side to the passenger side: If the indicator light in the <b>SYNC</b> button comes on, the temperature settings for the driver side also apply to the passenger side. Press the button or turn the temperature knob for the passenger side to set a different temperature for the passenger side. The indicator light in the button goes out.
<b>AUTO</b>	Automatic temperature control, fan speed and air distribution.

<b>Button / Knob</b>	<b>More information: Climatronic ⇒ fig. 154.</b>
	Press the button: The AUTO High (high fan speed) function switches on. The right indicator light in the button comes on. Press the button again: The AUTO Low (low blower speed) function switches on. The left indicator light in the button comes on.
<b>OFF</b>	Switching off. Press <b>OFF</b> button or set the fan manually to 0. If the system is switched off, an indicator light in the <b>OFF</b> button lights up.

**⚠ WARNING**

**Stale air causes driver fatigue and reduces alertness, which can cause accidents, collisions, and serious personal injury.**

- **Never switch off the fan for a long time, because no fresh air will enter the passenger compartment.**

## Operation

📖 Please first read and note the introductory information and heed the **WARNINGS** ⚠

The air conditioner works only when the ignition is switched on. The cooling system for the passenger compartment works only when the engine is running and the fan is on.

The air conditioner is most efficient when the windows and the power sunroof are closed. If the vehicle is not moving and the passenger compartment becomes very hot due to sunlight, briefly opening the windows and the power sunroof may speed up the cooling process.

Keep the air intake slots in front of the windshield free of ice, snow and leaves so that the heating and ventilation systems can work properly.

### Settings for optimum visibility

When you switch on the cooling system, both the temperature and humidity in the vehicle are reduced. This will help make passengers feel more comfortable and help keep the windows from fogging up.

#### For manual AC

- Switch off air recirculation ⇒ *Air recirculation*.
- Set fan to 1 or 2.
- Turn the temperature knob to the center position.
- Open and adjust all air vents in the instrument panel ⇒ *Air vents*.
- Turn the air distribution knob to the desired setting.
- Push the **A/C** button to switch the air conditioning system on. The indicator light in the button comes on.

#### For Climatronic

- Press the **AUTO** button.
- Set temperature to +72 °F (+22 °C).
- Open and adjust all air vents in the instrument panel ⇒ *Air vents*.

### **Climatronic: Changing the temperature unit on the factory-installed Radio or Radio & Navigation system display**

For vehicles with a Premium instrument cluster: The inside and outside temperatures can be displayed in either Fahrenheit (F) or Celsius (C). Select Units

Press the **A/C** and **AUTO** buttons at the same time to toggle between Celsius and Fahrenheit and vice versa.

For vehicles with a Premium instrument cluster: The inside and outside temperatures can be displayed in either Fahrenheit (F) or Celsius (C). Select "Units" in the instrument cluster display using in the

**Settings** main menu ⇒ *Volkswagen Information System*.

### **Heating**

Maximum heating output and defrosting performance are not possible until the engine has reached operating temperature.

### **Air conditioner does not work**

The air conditioner may not switch on for one of the following reasons:

- The engine is not running.
- The fan is switched off.
- The air conditioner fuse has blown.
- The outside air temperature is colder than about +38 °F (+3 °C).
- The air conditioner compressor has been temporarily switched off due to excessive engine coolant temperature.
- There is another malfunction in the vehicle. Have the air conditioner checked by an authorized Volkswagen dealer or authorized Volkswagen Service Facility.

### **Special considerations**

When it is very hot and humid outside, **water condensation** can drip from the air conditioner evaporator and form a puddle under the vehicle. This is normal and does not indicate a leak.

 The climate control system adjusts the passenger compartment temperature as fast as possible considering the outside temperature.

 Due to residual moisture in the air conditioner, the windshield may fog up after the engine is started. Switch on the windshield defroster to help evaporate the condensation as quickly as possible.

 The air coming out of the vents flows through the passenger compartment and out through vents below the rear window. Do not cover these slots with clothing or other things.

## Air vents

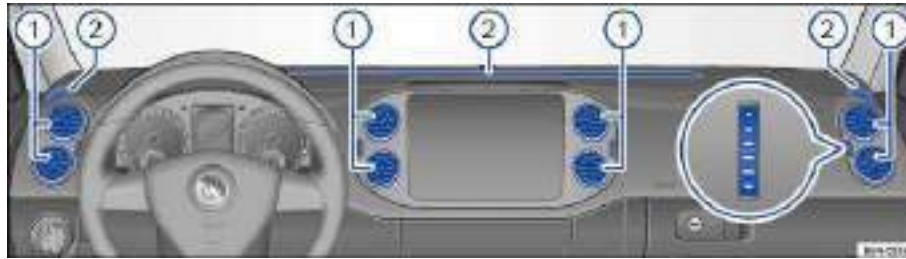

Fig. 155 In the instrument panel: Air vents.

⚠ Please first read and note the introductory information and heed the WARNINGS ⚠

### Air vents

To help ensure sufficient heating, cooling and ventilation in the passenger compartment, never close the air vents completely ⇒ fig. 155 (1).

- To open and close the air vents, turn the thumb wheel (close-up) in the desired direction. When the thumbwheel is turned all the way toward the 0, the air vent is closed.
- Use the lever on the vent grille to adjust the airflow direction.

Additional, non-adjustable air vents (2) are located in the door pillars and the instrument panel, in the footwells, as well as in the rear area of the passenger compartment.

### ⚠ NOTICE

**Do not place food, medications, or other heat-sensitive things in front of the air vents. Food, medications, and other things that are sensitive to heat or cold can be damaged or made unusable by the air flow from the vents.**

**i** The air coming out of the vents flows through the passenger compartment and out through vents below the rear window. Do not cover these slots with clothing or other things.

## Air recirculation

⚠ Please first read and note the introductory information and heed the WARNINGS ⚠

### General information

There are different types of air recirculation:

	Manual air recirculation (manual AC).
	The left indicator light under the button comes on: manual air recirculation is switched on (Climatronic).

---

**There are different types of air recirculation:**



---

The right indicator light under the button comes on: automatic air recirculation is switched on (Climatronic).
--

---

The air recirculation mode helps prevent outside air from entering the vehicle interior.

In very hot or cold outside temperatures, temporarily switch to manual air recirculation in order to cool or heat the vehicle interior faster.

For safety reasons, air recirculation is switched off when the  button is pressed, and the air distribution switch is turned to  ⇒ .

**Switching manual air recirculation on and off **

*Switching on:* Press the button  repeatedly until the indicator light in the button comes on.

*Switching off:* Press the button  repeatedly until the indicator light in the button goes out.

**Switching manual air recirculation on and off **

*Switching on:* Press the  button repeatedly until the left indicator light under the button comes on.

*Switching off:* Press the  button repeatedly until the indicator light under the button goes out.

**Automatic air recirculation **

In the  setting, fresh air enters the passenger compartment. If the system detects an increased concentration of pollutants in the outside air, it automatically switches to air recirculation. As soon as the pollutant level is back in the normal range, air recirculation is switched off.

Unpleasant odors cannot be detected by the system.

Air recirculation is **not** automatically activated under the following outside temperatures and conditions:

- The air conditioning is on (indicated by the light in the  button) and the outside air temperature is colder than about +38 °F (+3 °C).
- The cooling system and the windshield wiper are switched off and the outside air temperature is cooler than about +50 °F (+10 °C).
- The cooling system is switched off, the outside air temperature is cooler than about +59 °F (+15 °C), and the windshield wiper is switched on.



**Switching automatic air recirculation on and off**

*Switching on:* Press the  button repeatedly until the right indicator light under the button comes on.

*Switching off:* Press the  button repeatedly until no indicator light under the button is on.

It is not possible to activate automatic air recirculation when the outside air temperature is colder than about +38 °F (+3 °C).

**Temporarily deactivating the automatic air recirculation **

- Press the  button once to switch to air recirculation temporarily in the event of unpleasant odors. The left indicator light comes on.
- Press the  button again after more than 2 seconds to resume automatic air recirculation. The right indicator light comes on.



## WARNING

Stale air causes driver fatigue and reduces driver alertness, which can cause accidents, collisions and serious personal injury.

- Never use air recirculation mode over an extended period of time, since no fresh air will enter the passenger compartment.
- When the air conditioner is off and recirculation mode is on, condensation can quickly form on the windows and greatly reduce visibility.
- Always switch off recirculation mode when it is not needed.



## NOTICE

Do not smoke when air recirculation is switched on. Smoke drawn into the ventilation system can leave residue on the evaporator and on the dust and pollen active carbon filter, resulting in permanent odors whenever the air conditioner is switched on.



**Climatronic:** When backing up and while the automatic wiper/washer is operating, air recirculation is briefly activated to help keep exhaust fumes from getting into the passenger compartment.

# Refueling

## Introduction

---

In this section you'll find information about:

Indicator lights and fuel gauge  
Refueling  
Fuel capacities  
Refueling checklist

The fuel filler flap is located on the rear right side of the vehicle.

### More information:

- Exterior views
- Fuel
- Working in the engine compartment

### WARNING

Improper refueling or handling of fuel is dangerous and can cause fire, explosion, and severe burns.

- Always make sure that the fuel filler cap is screwed on all the way. This helps keep fuel from spilling out or evaporating.
- Fuel is highly flammable and explosive; it can cause severe burns and other severe injuries.
- Failure to shut the engine off while refueling and/or to insert the pump nozzle all the way into the fuel filler neck can cause fuel to overflow and to spray out. Fuel spray and overflowing fuel are dangerous because they can cause fire and serious personal injury.
- During fueling, the engine and the ignition must be switched off for safety reasons.
- Never use a cellular telephone, CB radio, or other radio equipment while refueling. The electromagnetic radiation can cause sparks that can ignite fuel vapors and cause a fire.
- Never get back into your vehicle while refueling. If in exceptional circumstances you must get back in your vehicle while refueling, make certain that you close the door and touch metal to discharge static electricity before touching the filler nozzle again. This helps avoid the build-up of static electricity, which can cause sparks that can ignite fuel vapors released during refueling.
- Never smoke or have an open flame (or sparks, cigarettes, or other smoldering objects) anywhere in or near your vehicle when refueling or filling a portable fuel container.
- Follow all safety instructions and procedures that apply at the service station where you refuel.
- Never spill fuel in the vehicle or the luggage compartment.





## WARNING

Even if empty, portable fuel containers can leak and cause a fire and serious personal injuries, especially in a crash.

- For your safety, we strongly recommend that you do not travel with a portable fuel container in your vehicle.
- If, under exceptional circumstances, you must transport a portable fuel container, please observe the following:
  - Never fill a portable fuel container while it is anywhere in or on the vehicle (for example, in the luggage compartment or on the rear hatch). Static electricity can build up while filling and can ignite fuel vapors, causing a fire.
  - Always place a portable fuel container on the ground before filling. Never spill fuel inside the vehicle or luggage compartment. Fuel vapors are highly flammable.
  - Always keep the filler nozzle completely inside the portable container before and during filling.
  - If filling a portable container made of metal, the filler nozzle must always be in contact with the container. This will help prevent static electricity from discharging and causing a fire.
  - Always observe local and state or provincial laws about the use, storage, and transportation of portable fuel containers.
  - Make certain that the portable fuel container meets industry standards, such as ANSI/ASTM F852-86.



## NOTICE

- Remove fuel spills from the vehicle immediately to help prevent damage to the paint, tires, and wheel housings.
- Refueling with diesel fuel when your vehicle has a gasoline engine can cause very serious and expensive engine and fuel system damage that is not covered by any Volkswagen Limited Warranty.
- If you put any amount of incorrect fuel in the fuel tank, do not start the engine under any circumstances. Immediately contact the nearest authorized Volkswagen dealer or authorized Volkswagen Service Facility for assistance. These fuels contain substances that can severely damage the fuel system and the engine if the engine is started.



Fuels can pollute the environment. Spilled fuel must be collected and disposed of properly, following all applicable environmental regulations.



There is no emergency release for the fuel filler flap. Contact an authorized Volkswagen dealer or an authorized Volkswagen Service Facility for assistance.

## Indicator lights and fuel gauge



Fig. 156 Fuel gauge in the instrument cluster: A Refuel warning zone.

ⓘ Please first read and note the introductory information and heed the WARNINGS ⚠

Lights up	Gauge position ⇒ fig. 156	Possible cause or meaning ⇒ ⚠	Proper response
	Refuel warning zone	Fuel tank almost empty. Running on reserve 276.	Time to refuel ⇒ ⚠.
		Fuel filler cap not properly closed.	Stop and close fuel filler cap properly.

When the ignition is switched on, several warning and indicator lights come on briefly for a function check. They go out after a few seconds.

### Fuel filler cap not properly closed ⚠

If the indicator light comes on or you see a text message in the instrument cluster display indicating that the fuel filler cap is not properly closed, stop the vehicle in a safe place and switch off the engine and the ignition.

Open the fuel filler flap and take the fuel filler cap off the filler neck. Then put the fuel filler cap back on the filler neck and screw it on clockwise until you clearly hear a clicking sound. Close the fuel filler flap.

After switching on the ignition, the indicator light may stay on or the text message may still appear in the instrument cluster display, even if the fuel filler cap is now properly closed. This is normal and no reason to take your vehicle in for service.

If, however, the malfunction indicator light also comes on, drive to your nearest authorized Volkswagen dealer or authorized Volkswagen Service Facility and have the fuel system and the engine checked.

## WARNING

Driving with a fuel tank that is almost empty can lead to stalling in traffic, a collision, and serious personal injuries.

- When the fuel tank is almost empty, fuel supply to the engine can be interrupted, especially when driving over bumps, across slopes, and up and down hills.
- Steering and braking assistance as well as ESC and related systems will not work if the engine “sputters” or stalls due to lack of fuel.
- Always refuel when the tank is 1/4 full to reduce the risk of running out of fuel and stalling in traffic.

## NOTICE

- Failure to heed warning lights or text WARNINGS can result in vehicle damage.
- Never drive until the fuel tank is completely empty. The irregular fuel supply can cause the engine to misfire. This allows unburned fuel to get into the exhaust system and damage the catalytic converter.

 The small arrow next to the gas pump symbol in the fuel gauge shows the side of the vehicle with the fuel filler flap.

## Refueling

---

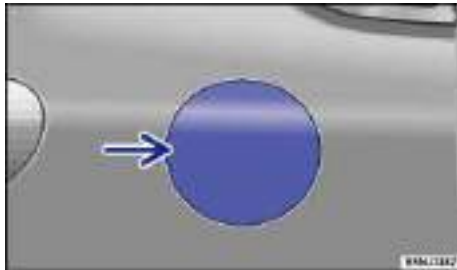

Fig. 157 Right rear side of vehicle: Opening the fuel filler flap.

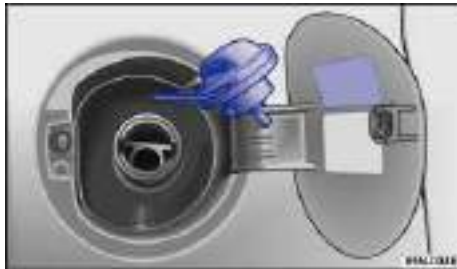

Fig. 158 Fuel cap placed on the open fuel filler flap.

 Please first read and note the introductory information and heed the WARNINGS 

**Before** refueling, always switch off the engine, the ignition, and all mobile phones, and leave them switched off until refueling is complete.

### Opening the fuel filler cap

- Unlock the vehicle from the outside with the vehicle key or press the central locking button in driver door to unlock the vehicle from the inside ⇒ *Power locking and closing system*.
- The fuel filler flap is located at the right rear of the vehicle.
- Press on the back part of the fuel filler flap ⇒ [fig. 157](#) (arrow) and fold open.
- Unscrew fuel cap counterclockwise and remove. Use the receptacle on the filler flap hinge to hold the cap while refueling ⇒ [fig. 158](#).

### Refueling

The correct fuel grade for your vehicle ⇒ *Fuel* is listed on a sticker on the inside of the fuel filler flap .

- The fuel tank is *full* when the automatic filler nozzle pump switches off the first time ⇒ .
- Do not try to add fuel after the pump stops! Topping off the tank in this way may fill the expansion space that the tank needs and cause fuel to overflow, for example, if it gets warmer outside.

### Closing the fuel filler cap

- Screw the fuel cap clockwise onto the fuel filler neck until you hear it click into place.
- Close the fuel filler flap until you hear it latch shut. The fuel filler flap must be flush with the vehicle body.

## WARNING

Spilled fuel can cause fires, explosions, burns, and other severe injuries.

- Always stop refueling once the pump nozzle switches off so that the tank does not overflow.

## NOTICE

Remove fuel spills from all vehicles surfaces immediately to help prevent damage to the paint, tires, and wheel housings.



Fuel spills may pollute the environment.

## Fuel capacities

 Please first read and note the introductory information and heed the WARNINGS 

Fuel tank capacity
--------------------

About 16,8 gallons (63.5 liters), including about 2 gallons (7.5 liters) reserve.
---

## Refueling checklist

---

**⚠ Please first read and note the introductory information and heed the WARNINGS ⚠**

The engine compartment of any motor vehicle is a hazardous area. Never do any work on the engine or in the engine compartment unless you

- know exactly how to carry out the job,
- have the correct technical information and the proper tools and supplies, and
- are familiar with the necessary safety precautions ⇒ *Working in the engine compartment.*

### Checklist

---

If you are uncertain in any way, have the work done by an authorized Volkswagen dealer or authorized Volkswagen Service Facility. Serious personal injury may result from improperly performed work. Make sure that you check the following items regularly. The best thing is to check them every time you refuel:

- ✓ Windshield washer fluid level ⇒ *Windshield wipers and washer*
- ✓ Engine oil level ⇒ *Engine oil*
- ✓ Engine coolant level ⇒ *Engine coolant*
- ✓ Brake fluid level ⇒ *Braking and parking*
- ✓ Tires and wheels ⇒ *Tires and wheels*
- ✓ Vehicle lighting necessary for driving safety:
  - Turn signals
  - Parking lights, low beams and high beams
  - Taillights
  - Brake lights
  - License plate light

---

Information regarding replacing light bulbs ⇒ *Replacing light bulbs.*



### WARNING

**Disregarding the safety-related checklist may lead to accidents and injuries.**

- **Please note and follow the points listed in the checklist.**

# Fuel

## Introduction

---

In this section you'll find information about:

Gasoline

Gasoline additives

The correct fuel grade for your engine is shown on a sticker located on the inside of the fuel filler flap  
⇒ [fig. 158](#).

Bad or poor quality fuel reduces operating performance, efficiency and service life of the engine. If you notice any symptoms like rough engine idle or performance or "bucking", immediately reduce the vehicle speed, accelerate slowly and keep the engine speed in the middle of the rpm range. Avoid high rpm and rapid acceleration. If these symptoms should appear right after refueling, switch off the engine. In both cases contact an authorized Volkswagen dealer or an authorized Volkswagen Service Facility to have the engine checked.

### More information:

- ⇒ booklet *Warranty and Maintenance*
- Refueling
- Engine control and exhaust system

 **WARNING**

**Improper refueling or handling of fuel can cause fire, explosion, and severe burns.**

- Fuel is highly explosive and flammable and can cause severe burns and other injuries.
- Heed applicable safety warnings and obey local fuel handling regulations.
- Always make sure the fuel cap is screwed on all the way. This keeps fuel from spilling out and from evaporating.
- Failure to shut the engine off while refueling and/or to insert the pump nozzle fully into the vehicle's filler neck could cause fuel overflow and fuel spray. Fuel spray and overflowing fuel are dangerous because they can cause fire or serious injury.
- For safety reasons, the engine must be turned off when refueling.
- Never get back into your vehicle while refueling. If in exceptional circumstances you must get back in your vehicle while refueling, make certain that you close the door and touch metal to discharge static electricity before touching the filler nozzle again. Static electricity can cause sparks that can ignite fuel vapors released during refueling.

## Gasoline

---

 Please first read and note the introductory information and heed the **WARNINGS** 

### Octane rating

Octane rating indicates a gasoline's ability to resist engine damaging "knock" caused by pre-ignition. Using the correct grade of gasoline is very important to help prevent engine damage and loss of engine performance.

The recommended gasoline octane rating for your engine is listed on a label inside of the fuel filler flap. This rating may be specified according to AKI (CLC) or RON (ROZ) standards.

If unleaded Premium grade gasoline is specified for your vehicle, then Volkswagen recommends using TOP TIER Detergent Gasoline with a minimum octane rating of 91 AKI (95 RON). For more information on TOP TIER Detergent Gasoline, please go to the official website <http://www.toptiergas.com>.

The gasoline grades most commonly sold in the United States and Canada have the following octane ratings, which can usually be found on the filler pump:

- Premium grade: 91 to 96 AKI
- Regular grade: 87 to 90 AKI

#### **Unleaded gasoline**

Unleaded gasoline is available throughout the USA and Canada. Volkswagen recommends that you do not take your vehicle to places where unleaded gasoline may not be available.

#### **Gasoline containing alcohol or MTBE**

You may use unleaded gasoline blended with alcohol or MTBE (methyl tertiary butyl ether), commonly referred to as oxygenated fuels, if the blended mixture meets the following criteria:

##### **Blends of gasoline and methanol (wood alcohol or methyl alcohol):**

- Anti-Knock Index (AKI) must be 87 or higher.
- Blend must contain no more than 3% methanol.
- Blend must contain more than 2% co-solvents.

##### **Blends of gasoline and ethanol (grain alcohol or ethyl alcohol):**

- Anti-Knock Index (AKI) must be 87 or higher.
- Blend must contain no more than 10% ethanol.

##### **Blends of gasoline and MTBE:**

- Anti-Knock Index (AKI) must be 87 or higher.
- Blend must contain no more than 15% MTBE.

#### **Seasonally adjusted gasoline**

Many fuels are blended especially for winter or summer conditions. When seasons change, Volkswagen suggests that you buy fuel at busy stations where the seasonal adjustment is more likely to be made earlier.



#### **WARNING**

**Starting fluids can explode and cause a “run-away” vehicle condition.**

- **Never use starting assist fluids.**



#### **NOTICE**

- **Never use fuel with an octane rating lower than 87 AKI/91 RON. Using lower octane fuel may cause expensive engine damage.**
- **Never use leaded gasoline! Leaded gasoline will severely damage your vehicle's catalytic converter.**
- **Methanol-blended fuels that do not meet the criteria listed above may cause corrosion and may damage plastic and rubber parts in the fuel system.**

- **Never use fuels that contain lead or other metals (check listing on the fuel pump). Even lead replacement gasoline (LRP fuels) contain metallic additives in high concentrations. They can damage the engine.**
- **Do not use fuels that fail to meet the criteria above, or with contents that cannot be identified.**
- **If you cannot tell whether a particular fuel blend meets the criteria above, ask your service station or its fuel supplier. If you notice a loss of fuel economy or drivability and performance problems using one of these fuel blends, we recommend that you switch to unblended fuel.**
- **Using fuels that are different from those specified above can damage your vehicle's engine and fuel system and cause performance problems.**
- **Damage to the engine and fuel system and performance problems caused by using fuels that are different from those specified above or by using "starting assist fluids" are not the responsibility of Volkswagen and are not covered under the Emission warranties or any other Volkswagen Limited Warranty.**



Even a single tank full of leaded fuel can do major damage to the catalytic converter and degrade its effectiveness in reducing polluting emissions.



If you notice a loss of fuel economy or drivability and performance problems using one of these fuel blends, we recommend that you switch to unblended fuel. Never use fuel line antifreeze offered for gasoline engines.

## Gasoline additives

**ⓘ Please first read and note the introductory information and heed the WARNINGS ⚠**

Additives are used to improve the quality of the gasoline.

Fuel quality impacts the operating performance, efficiency and service life of the engine. Therefore, use high quality gasoline that is already blended by the fuel supplier with suitable gasoline additives that do not contain metal. The additives provide corrosion protection, clean the fuel system, and help prevent deposits on the engine.

Volkswagen recommends TOP TIER Detergent Gasoline. For more information on TOP TIER Detergent Gasoline, please go to the official Web site <http://www.toptiergas.com>.

If quality gasoline with additives that do not contain metal is not available or engine malfunctions occur, you should add the required additives while refueling ⇒ ⓘ.

Not all gasoline additives are effective. Using the wrong additives can cause significant and expensive damage to the engine and the catalytic converter. Never use additives that contain metal. Please note that metal can be included in some aftermarket gasoline additives that are available to be added to gasoline during or after refueling to help improve knock resistance or increase the octane rating.

Volkswagen recommends using only additives approved by Volkswagen. Appropriate additives as well as instructions on how to use them are available from your authorized Volkswagen dealer or authorized Volkswagen Service Facility. Do not add any other gasoline additives.



### NOTICE

**You can damage the engine by using incorrect additives.**

- **Using incorrect gasoline additives can cause extensive engine damage as well as damage to the catalytic converter.**
- **If you must fuel your vehicle with gasoline whose octane rating is too low, only drive with the engine speed in the middle of the rpm range and with low engine load. Avoid high rpm and**



heavy engine load. Otherwise, the engine could be damaged. Refuel your vehicle with gasoline with the required octane rating as soon as possible.

- Do not use fuel that is labeled at the pump as containing metal. Lead replacement fuel contains high concentrations of metallic additives. Engine damage could result.
- Fueling your vehicle just one time with leaded fuel or fuel that contains other metallic additives can affect the performance of the catalytic converter and cause extensive damage to it.

## Some basics

### Introduction

---

In this section you'll find information about:

Rollover warning  
Before driving off-road  
General rules and good driving practices  
Technical terms explained  
Useful off-road driving equipment  
Safety and off-road driving

Your vehicle can be driven on and off-road. In this chapter you will find important information on driving your vehicle. It is very important to review this chapter before taking your vehicle off-road.

Driving off the beaten path is challenging - for the driver, the passengers, and the vehicle itself.

It requires special knowledge and skills different from those needed for highway driving. Successful off-roading comes from a combination of theory and practice. This includes knowing the right way to handle the expected and the unexpected ⇒ .

Safety must always have top priority. Never overestimate your own abilities or underestimate the difficulties that come with driving off-road. Never let determination get the better of your common sense. If the going gets too difficult, turn back and find a better route to your destination.

The wide range of terrain you can come up against, and the many risks and dangers the terrain may hide, make it impossible to foresee and deal in this Manual with every conceivable off-road situation you may face. For this reason, it is vital for you to know what lies ahead and evaluate possible dangers before trying to drive over difficult or unfamiliar terrain.

The vehicle is not designed for trips with "an expedition-like character".

#### **More information:**

- Driving instructions
- Adjusting the seating position
- Safety belts
- Off-road driving situations



## WARNING

Inadequate experience and knowledge of the demands of off-road driving can lead to critical situations and cause serious personal injury.

- Never take routes or risks that could put you or your passengers in danger. If you cannot go on, or have doubts about the safety of your route, turn back and take a new route.
- The intelligent technology of the vehicle cannot change the laws of physics. Despite the ABS, adverse terrain can cause instability through blocked wheels – for example, if you brake hard when driving on a loose gravel road. Difficult terrain may also prevent the ESC from doing its job.
- Never operate the vehicle at the limit of its performance ability. Always leave a good safety margin.
- To reduce the risk of loss of control and serious personal injury, never use the cruise control when driving off-road.
- Even terrain that looks easy can be difficult and dangerous, putting you and your passengers in a critical situation. It is often best to check an area out on foot first.
- Drive with special care and think ahead in off-road terrain. If you drive too fast, or fail to maneuver the vehicle properly, you could cause personal injury and damage the vehicle.
- Never drive faster than is appropriate for the prevailing terrain and the road, traffic, and weather conditions.
- Never drive too fast across embankments, ramps, or slopes. The vehicle could become airborne. If that happens, you will not be able to steer and can lose control.
- If your vehicle becomes airborne, always keep the front wheels pointing straight ahead. If the wheels are not pointing straight ahead when the vehicle lands, it could roll over.
- Never allow people to stand in front of or behind the vehicle if you have put items such as stones or pieces of wood under the wheels to improve traction on slippery ground. Spinning wheels can turn these items into dangerous flying objects causing serious personal injury.
- Even areas that look harmless can be dangerous. Potholes, ditches, trenches, drop-offs, different kinds of obstacles, and soft or swampy ground often cannot be seen and can be partially or fully covered by water, grass, branches, or other things. Driving over such terrain can cause accidents and severe injuries. Before crossing an unknown area, carefully explore the route you plan to take on foot.



## WARNING

Never drive off-road if you are low on fuel. Too little fuel in the tank can cause an accident and serious injuries. You can also run out of fuel in a remote area where getting help is difficult or impossible.

- When the fuel tank is almost empty, fuel supply to the engine can be interrupted, especially when driving over bumps, across slopes, and up and down hills. The interruption in fuel flow could stall the engine during a maneuver in difficult terrain and make you lose control of the vehicle.
- Steering and braking assistance as well as ESC and related systems will not work if the engine “sputters” or stalls due to lack of fuel. This can cause loss of vehicle control, especially in difficult terrain.
- Always refuel when the tank is 1/4 full to reduce the risk of running out of fuel.



## NOTICE

If the power sunroof or the windows are open when it rains or snows, the interior of the vehicle will get wet and the vehicle may be damaged. Always keep the windows and the power sunroof closed when driving off-road.

## Rollover warning

---

☑ Please first read and note the introductory information and heed the WARNINGS ⚠

A vehicle's **center of gravity** affects its rollover characteristics. Since vehicle has higher ground clearance for off-road driving, its center of gravity is also higher than that of "standard" passenger cars. The higher center of gravity increases the risk of vehicle rollover while driving. Always keep this in mind when driving. Heed the safety information and warnings in this Manual.

### WARNING

Utility vehicles have a significantly higher rollover rate than other types of vehicles.

- In a rollover crash, an unbelted person is significantly more likely to die than a person wearing a safety belt.
- Your vehicle has a higher center of gravity and an increased risk of rollover while driving than a standard passenger vehicle that is not suitable for occasional off-road use.
- Never drive too fast, particularly through curves, and never attempt extreme driving maneuvers.
- Always adjust your speed and driving style to road, terrain, traffic, and weather conditions.
- Transporting luggage or other objects on top of your vehicle raises the center of gravity and can further increase the risk of rollover.
- Always avoid driving crosswise on a slope ⇒ *Driving crosswise on a slope*.
- If stopped crosswise on a slope, never get out of the vehicle using the doors that face downhill. The combined center of gravity of the vehicle and its contents (passengers and load) can shift, causing the vehicle to tip over and roll down the slope. Always exit the vehicle calmly using the doors that face uphill ⇒ *Driving crosswise on a slope*.

## Before driving off-road

---

☑ Please first read and note the introductory information and heed the WARNINGS ⚠

### Checklist: Review before every off-road trip!

For your own safety and that of your passengers, carry out each of the following steps in the order listed before every off-road trip ⇒ ⚠:

- ✓ Inform yourself thoroughly before exploring nature and the terrain you plan to visit.
- ✓ Do not plan extensive day trips. Consider the increased fuel consumption during off-road driving.
- ✓ Fill the fuel tank completely. Off-road driving consumes significantly more fuel than driving on the road.
- ✓ Check whether the tires are suitable for the off-road trip you are planning. For difficult terrain, always use special off-road tires.
- ✓ Check, and if necessary correct, the cold tire inflation pressure in all tires, including the collapsible spare tire (if any).
- ✓ Fill engine oil up to the MAX mark so the engine can be properly lubricated. This is especially important when driving through potholes and up and down hills.
- ✓ Completely refill the windshield washer reservoir with water and window washer fluid.
- ✓ Install a towing eye in the front and back of the vehicle. Once the vehicle gets stuck, it may no longer be possible to install a towing eye.

- ✓ Check the vehicle tool kit. Add tools and other gear based on the special requirements of the trip you will be taking
  - ✓ Stow luggage as low and flat as possible in the vehicle. Safely secure all loose objects.
- 

### Before driving off-road the first time

Before you drive your vehicle off-road, we urge you to take an appropriate off-road driving course. Taking a course is especially important if you have little or no experience driving off-road. Even more experienced off-roaders can benefit from an off-road driving course.

A good course can show you how to handle the vehicle in a wide range of off-road situations and how to more safely deal with difficult terrain. Driving off-road demands a different attitude and very different skills compared with highway driving. Your safety and that of your passengers will depend on your

knowledge, skill, and caution as a driver ⇒ ⚠

 <b>WARNING</b>
<b>Disregarding the safety-related checklist may lead to accidents and serious personal injuries.</b>
<ul style="list-style-type: none"><li>• Always review and follow the checklist above. Follow commonly accepted safety practices and use common sense.</li><li>• All occupants must sit properly and wear safety belts whenever the vehicle is moving.</li></ul>

## General rules and good driving practices

---

📖 Please first read and note the introductory information and heed the WARNINGS ⚠

### Off-road rules of conduct

Always be responsible and respect the environment when driving off-road. Driving through undergrowth and over meadows can destroy areas where animals live.

- Only drive where it is permitted.
- Keep noise and dust to a minimum.
- Leave nature as you found it.
- Always stay on designated trails and paths.
- Avoid sensitive natural habitats.
- Yield to drivers who are driving uphill or passing.

### Good driving practices

Special rules apply to off-road driving ⇒ ⚠:

- Never drive off-road alone. At least 2 off-road vehicles should travel together. Unexpected situations can occur. For this reason, take along the equipment you need to call for help in case of an emergency.
- Stop and explore the route on foot wherever necessary and always before traveling over difficult trails or terrain.
- Drive over hill crests slowly. Otherwise, the vehicle can tip and be damaged and disabled.
- Drive slowly through difficult terrain segments. On slippery surfaces, upshift and keep the vehicle moving.
- Look for terrain that is firm and stable. Off-road ground is frequently soft, and the tires can sink into it. This reduces ground clearance and fording depth.
- Even at low speeds, always follow other vehicles at a safe distance. If the first vehicle suddenly gets stuck, the second vehicle can still stop in time without getting stuck as well.

## WARNING

Off-road driving can be dangerous, can lead to accidents, vehicle damage, stranding in remote areas, and serious personal injury.

- Never drive too fast or for terrain and weather conditions.
- Always adjust your speed and driving style to road, terrain, traffic, and weather conditions.
- Always avoid sudden, sharp maneuvers that increase the risk of loss of vehicle control or getting stuck.
- When driving off-road look and think ahead, expect the unexpected.
- To reduce the risk of loss of control and serious personal injury, never use the cruise control when driving off-road. Cruise control is designed for highway use. It is completely unsuitable for off-road situations and can even be dangerous when used off-road.

## NOTICE

Always make sure the vehicle has enough ground clearance. Severe damage to the underbody can occur if the vehicle bottoms out. The damage could disable the vehicle and leave you stranded.

- While driving off-road do not drag the clutch or rest one foot on the clutch pedal. Otherwise, in bumpy terrain you might press the clutch accidentally, resulting in loss of vehicle control. In addition, the frictional connection between the engine and transmission is lost. Further, driving while dragging the clutch causes fast wear of the clutch lining.



"Tread lightly" is an educational program designed to increase public awareness of land use regulations and responsibilities in our nation's wilderness areas. Volkswagen supports the U.S. Forest Service and the Bureau of Land Management in encouraging you to preserve our national forests and other public and private lands by "treading lightly".

## Technical terms explained

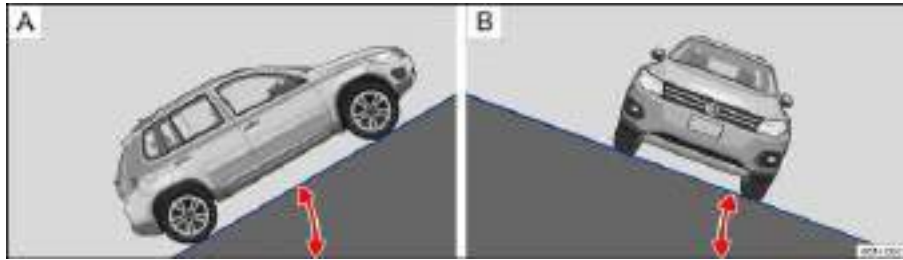

Fig. 159 Illustration of A: Ascent angle. B: Lateral gradient.

 Please first read and note the introductory information and heed the WARNINGS 

The technical data in the table below only apply to ideal conditions. The values were determined on flat, firm, and non-slippery road surfaces and under dry weather conditions.

Changes in vehicle load and the condition of the ground and the surroundings will affect the stated maximum values. The maximum values do not apply, for example, to off-road situations and will also

be lower on hard, firm surfaces if ideal conditions do not exist. As the driver, you are always responsible for deciding whether your vehicle is able to handle a particular situation ⇒ ⚠.

Term	Explanation	Technical data
Ground clearance	This is the vertical distance between the level ground and the lowest part on the vehicle.	Maximum 7.6 in (195 mm).
Gradient angle	The number of feet (meters) in altitude gained when traveling 100 ft (30.48 m) is given as a percentage or in degrees ⇒ fig. 159 A. Information on the maximum slope the vehicle can climb unassisted (depends on road surface and engine power).	Maximum permissible 31 degrees (corresponds to 60 %).
Lateral angle (vehicle slope)	The maximum angle the vehicle may be driven across terrain without the vehicle rolling over (depends on height of center of gravity) B.	Maximum permissible 27 degrees.
Breakover angle	Maximum permitted angle given in degrees that a vehicle driven at low speed can clear a ramp without the underbody of the vehicle scraping the ramp.	Maximum 21.3 degrees.
Approach/departure angle	Transition from horizontal plane to a slope, or from a slope to flat ground. Maximum angle in degrees the vehicle can be driven at low speed along an embankment without the bumper or underbody scraping.	Approach angle for off-road front end: Maximum 28 degrees.
		Departure angle: Maximum 25 degrees.
Fall line	This is the vertical drop route.	
Articulation	Articulation capability of the vehicle while driving on one side over an object.	



### WARNING

**Never exceed the recommended maximum values in the above table. Exceeding these values will result in serious personal injury and/or damage to your vehicle.**

- All values listed above are for ideal conditions and assume firm, even surfaces that are dry and not slippery.
- Off-road conditions will always be less than ideal. Always reduce the maximum values listed in the table above to allow an adequate margin of safety between the ideal maximum value and your vehicle's actual off-road situation.

## Useful off-road driving equipment

---

☐ Please first read and note the introductory information and heed the WARNINGS ⚠

The checklist lists only a few of the items that could be very helpful when driving off-road ⇒ ⚠. If you have user's manuals or assembly instructions for the listed extra equipment, take them with you off-road and heed them.

### Checklist

---

Checklist: Useful off-road driving equipment ⇒ ⚠:

- ✓ Water, compass, maps, flashlight and spare batteries.
  - ✓ Cable winch, tow rod or tow rope strong enough for your vehicle.
  - ✓ Mobile phone, shovel, blankets, and rubber boots, tape measure, and yardstick.
  - ✓ Electric air compressor to connect to the 12 volt outlet in the vehicle for inflating the tires.
  - ✓ A wooden plank about 2 inches thick and 3 feet long or similar aluminum frame as traction aid for a stuck vehicle or as a base for the vehicle jack.
  - ✓ Snow chains for all 4 tires, additional spare tires.
- 

### WARNING

Accidents and severe personal injury can result from the improper use of tools or equipment as well as from the use of tools or equipment that are damaged or not right for the job to be done.

## Safety and off-road driving

---

☐ Please first read and note the introductory information and heed the WARNINGS ⚠

Proper seating position and safety belt use is always important, regardless of whether you are on the highway or driving off-road.

- Every person in the vehicle must sit properly and wear his or her safety belt whenever the vehicle is moving
- Every occupant must properly fasten the safety belt belonging to the seat he or she occupies and keep the belt properly fastened while riding in the vehicle. This applies to the driver and all passengers, even when driving off-road

Safety belts save lives – on the road and off.

### Distance to the steering wheel

When driving off-road, you may want to sit a little differently than you would for normal highway driving.

Depending on the terrain, you may need more strength to control the steering wheel because of the higher forces that can come up from the front wheels.

Sit so that you can clearly see the terrain in front of you, especially when you are driving up or down slopes. Never sit so that the distance from the center of your breast bone to the center of the airbag cover on the steering wheel is less than 10 inches ⇒ *Adjusting the seating position.*

### Suitable shoes

Never wear shoes with a slippery sole or high-heels when driving off-road, and never drive off-road barefoot. Always wear shoes that support your feet properly and give you a good feel for the pedals.





## **WARNING**

**Not wearing safety belts, or wearing them improperly will increase the risk of serious injuries when driving off-road. Holding the steering wheel improperly will reduce your ability to control the vehicle and can also increase the risk of injury when driving off-road.**

- **Properly worn safety belts are the single most effective means of reducing the risk of serious injury and death during sudden braking or driving maneuvers and in automobile accidents. For this reason, always wear your safety belt properly and make sure all passengers wear their safety belts properly as well whenever the vehicle is moving.**
- **Never wrap your thumbs around the steering wheel rim. When driving off-road, obstacles in front of the wheels can make the steering wheel jerk suddenly in your hands and cause personal injury. Rest your thumbs pointing up on the on the surface of the steering wheel at the 3 and 9 o'clock positions.**

## Off-road driving situations

### Introduction

---

In this section you'll find information about:

- Selecting the right gear
- Driving in rough terrain
- Driving through water
- Driving over snow-covered terrain
- Driving in steep terrain
- Driving crosswise on a slope
- Avoiding deep ruts and depressions
- Crossing ditches
- Driving in sand and mud
- If the vehicle is stuck
- After driving off-road

Driving off-road: Drive at a crawl; don't speed! Even harmless-looking areas can be dangerous ⇒ .

Volkswagen recommends that you get out of the vehicle and explore the terrain personally before trying to cross it. Walk the area and make sure that the ground is firm enough. Check for obstacles or other hidden dangers. Always obey local requirements and regulations; follow commonly accepted safety practices and use common sense

The examples discussed in this chapter are intended to help you drive safely off-road. But the situation facing you may not fit any of these examples.

The wide range of terrain you can come up against, as well the risks and dangers it may hide, make it impossible to deal with every conceivable situation in this Manual. The examples in this chapter are only general guidelines to help you drive safely off-road. The guidelines may not apply in every situation you encounter. Therefore, it is vital that you know what lies ahead and evaluate possible dangers before you try to drive over difficult or unfamiliar terrain. This will help you to evaluate and prepare for possible dangers.

Driver assistance systems were designed only for driving on paved roads.

#### More information:

- Before leaving

#### WARNING

**Areas that look harmless can, in fact, be very dangerous. Potholes, ditches, trenches, drop-offs, different kinds of obstacles, and soft or swampy ground often cannot be seen and can be partially or fully covered by water, grass, branches, or other things. Driving over such terrain can cause accidents and severe injuries.**

- **Before crossing an unknown area, carefully explore the route you plan to take on foot.**
- **Never choose a risky route or run a risk that will endanger you and your passengers. If you have any doubts as to whether the route is safe, turn around use a different route.**
- **Always adapt driving speed and style to load, terrain, visibility, and weather conditions.**

## Selecting the right gear

---

☐ Please first read and note the introductory information and heed the WARNINGS ⚠

Different kinds of terrain require different gears. Selecting the right one helps you to get through safely.

Before driving over a difficult section, think carefully about which gear you should select. With time, you will learn which gear is best for various types of terrain.

### Basics

- If you select the right gear you will usually not have to slow the vehicle down with the foot brake when driving down slopes - the engine will brake the vehicle. You will then only have to use the brake when the braking power of the engine is not enough.
- Never accelerate more than necessary when driving off-road. If you accelerate too hard, the wheels could lose traction and you could lose control of the vehicle.

### Manual transmission

- **Never** disengage the clutch or change gears in difficult terrain. Due to the increased adhesion of all wheels, the vehicle can come to standstill if the clutch is disengaged in mud or deep sand or on an incline. Driving off again from a standstill under these conditions may be difficult or even impossible.
- Use first or second gear when driving up or down steep slopes.
- On soft surfaces drive with appropriate speed and the highest possible gear.

### Automatic transmission

- Use selector lever position **(D)** when driving on ordinary level areas.
- Use Tiptronic mode and put the vehicle in **2nd** or **3rd** gear when driving through moderately difficult off-road terrain, for example mud, sand, water, or hills 223.
- Use Tiptronic mode and shift into 1st gear when driving up or down steep hills **1st** 223.
- On soft or slippery surfaces, drive at an appropriate speed and in the highest possible driving range of the Tiptronic.

## Driving in rough terrain

---

☐ Please first read and note the introductory information and heed the WARNINGS ⚠

### Driving tips

- Drive no faster than a crawl over rocky sections.
- Drive around obstacles such as rocks wherever possible. If this is not possible:
- Carefully advance until one front wheel is *on* the rock and then slowly drive over it ⇒ ⚠.

### ⚠ NOTICE

- **If you are facing a large rock or tree stump or other large obstacle, do not attempt to drive straight over it or to climb over it with just 2 wheels. A rock or other obstacle that is too high for your vehicle to clear will damage and may disable the vehicle if you try to drive over it. You could be stranded far away from help. Never let large obstacles pass under the vehicle. If there is no way around them and they are too large to drive over, back up and find another route.**
- **Even obstacles that are lower than your vehicle's ground clearance can come into contact with the underbody and damage or disable your vehicle. Such obstacles are especially dangerous when the ground around them is soft or there is a dip right in front of or behind them. They are also dangerous if you drive over them too quickly and the shock absorbers are compressed.**



Leaking engine oil and brake fluid can pollute the environment. Collect leaking operating fluids and dispose of them properly in accordance with applicable environmental laws and regulations.

## Driving through water

---

**ⓘ Please first read and note the introductory information and heed the WARNINGS ⚠**

### Important factors when deciding whether to drive through water:

- Water depth.
- Strength of the current.
- Firmness of stream bed and bank.
- Shape of the bank.
- Objects in the water.

### Before driving through water

Stop, get out of the vehicle, and assess the situation ⇒ 

- Measure water depth from one side to the other. The water must not be any higher than the bottom of the vehicle body (see *Dimensions* 35). Check the firmness of the bed and banks; check for drop-offs and obstacles in the water ⇒ .
- Make sure it is possible to enter and exit the water safely.
- Check the angle of the embankment and the firmness of the ground on each bank.

### Driving through standing and slow-moving water

The vehicle can drive through standing water if the ground under the water is firm enough ⇒ .

- Drive slowly into a river in the direction of the flow. Never exceed the departure/approach angle and lateral angle (vehicle slope).
- Always drive at a constant speed to the other side.

This will help prevent engine damage from the water. It also allows an air pocket to form in front of the engine that can supply it with the necessary air.

Entering the water quickly or driving too fast through the water will create a bow wave. A bow wave can force its way into the engine air intake duct and seriously damage the engine.

### Driving through fast-moving water

Driving through fast-moving water is very dangerous ⇒ .

The vehicle can be swept away by the current. Even vehicles with high ground clearance can get stuck if the ground is washed out from under the tires. Fast-moving water will build up against the side of your vehicle. This will make the water deeper. Always think about this before entering the water. Water volume, speed, and depth can be very unpredictable and dangerous.

If you are uncertain how fast the water is flowing, look for a shallower place where you can cross in safety. If you cannot find a safe place to cross, turn back.

### After driving through water

- After crossing through deep water, stop the engine and check the oil dipstick. If there are beads of water on the oil dipstick or the oil level has increased, do not start the engine. Change the engine oil immediately. Depending on the amount of water in the oil, running or starting the engine can result in engine failure or serious engine damage.

- Always dry the brakes by braking a couple of times.
- After driving through water, have the vehicle drive train and electrical system thoroughly inspected for damage by an authorized Volkswagen dealer or an authorized Volkswagen Service Facility.

### **WARNING**

Flowing water is very powerful and can sweep your vehicle away. This can lead create an extremely dangerous situation and cause an accident with serious personal injuries.

- Never take routes or risks that could put you or your passengers in danger. If you cannot go on or have doubts about the safety of your route, turn back and take a new route.
- Never stop in the water.
- If water gets into the engine, your vehicle can break down. You will lose control of a broken down vehicle, and it can be swept away.
- Soft surfaces, mud, underwater obstacles, and holes can cause accidents and can cause the vehicle to break down in the water. This can lead pose extreme danger.
- Rapidly flowing water can develop strong forces that can pull the vehicle downstream. This can cause accidents and fatal injuries.
- Drive through water only where the banks and bottom are firm enough and the water is shallower at all points than the maximum permissible fording depth for your vehicle.

### **NOTICE**

- Vehicle components such as the engine, drive train, suspension or electrical system may be severely damaged by driving through water.
- Avoid stopping in deep water. This can let water get inside the vehicle.
- On soft ground, the tires dig into the surface. This reduces fording depth. Make sure that the ground is sufficiently firm.
- Avoid creating a bow wave in front of the vehicle while driving through water. A bow wave could force its way into the engine air intake duct and seriously damage the engine.
- If you even briefly exceed the maximum fording depth when driving through water, severe engine damage will result. This engine damage will lead to a vehicle breakdown. This can disable the vehicle in the water.
- Never drive over salt flats or through salt or salty water. Salt causes vehicle corrosion. Rinse all parts of the vehicle that were exposed to salt or salt water right away with fresh water.

## Driving over snow-covered terrain

 Please first read and note the introductory information and heed the WARNINGS 

Install snow chains on all 4 tires before driving over snow-covered terrain.

Snow-covered terrain may look harmless but the snow can hide many dangers. This is particularly true for stretches where you can't see the tracks left by other vehicles.

## **WARNING**

Driving through snow-covered terrain is very dangerous.

- Never take routes or risks that could put you or your passengers in danger. If you cannot go on or have doubts about the safety of your route, turn back and take a new route.
- Potholes, ruts, ditches, drop-offs, and other obstacles are often partially or completely hidden by the snow, especially when it is deep.
- Snow-covered dangers can lead to an accident, serious personal injury, or stranding under extreme weather conditions.
- Always adapt driving speed and style to load, terrain, visibility, and weather conditions.

## Driving in steep terrain

---

 Please first read and note the introductory information and heed the WARNINGS 

### Driving on slopes

**Before** driving up or down a slope, get out of the vehicle, explore the terrain, and assess the situation.

- Walk the grade you intend to drive, check the stretch for firmness and obstacles or other hidden dangers ⇒ .
- Find out how the route continues at the end of a steep angle.
- If the route is too steep or too uneven or the ground is too loose, do not drive this route. Find an alternative.
- Drive at a constant speed straight up or down a slope.
- Use just as much power as needed to get up the slope. Too much power makes the tires slip, spin, or lose traction. This can increase your risk of losing control. However, too little power will increase the likelihood of stalling.
- Never stop or try to turn around on a slope.
- Do not let the engine stall.
- Do not change gears while climbing the slope.

### If you get stuck while driving up a slope

- Never try to turn around.
- If your engine stalls, apply the foot brake and restart the engine.
- Shift into reverse and back your vehicle carefully straight down the slope.
- Use the brake to keep the speed steady when backing down to a safe place.

### Driving down a slope

Never exceed the vehicle's maximum lateral angle (vehicle slope). If an emergency forces you to cross the slope and the vehicle threatens to roll over, immediately steer the vehicle downhill along the fall line.

There is an increased risk of rollover when driving down a slope. For this reason, concentrate on steering safely down the slope.

- Drive down steep slopes in first gear.
- Gently apply the foot brake to help keep the vehicle under control.
- If it is possible and if it is not dangerous, drive straight down the fall line (maximum slope).
- Do not depress the clutch pedal or shift into Neutral (**N**).

**⚠ WARNING**

Never try to drive up or down slopes that are too steep for your vehicle. The vehicle could slide away, tip over, or roll over.

- Never take routes or risks that could put you or your passengers in danger. If you cannot go on or have doubts about the safety of your route, turn back and take a new route.
- The lateral angle must never be more than the maximum angle approved for the vehicle.
- Always drive along the fall line when driving up or down a slope.
- Never try to turn the vehicle around on a slope. The vehicle could tip over or roll down the slope.
- If the engine stalls or you can no longer drive up the slope for any reason, stop and apply the foot brake. If stalled, apply the foot brake and restart the engine. Then shift into Reverse (R) and carefully back your vehicle straight down the slope along the fall line. Keep the vehicle speed slow and even.
- If the engine will not restart, apply constant pressure to the foot brake and carefully back straight down the slope the same way you drove up. Keep the vehicle speed slow and even.
- If the engine is running, select Reverse and carefully back straight down the slope the same way you drove up. Use engine braking power and the foot brake to keep the vehicle speed slow and even.
- Never just roll down a slope with the clutch depressed or the transmission in Neutral (N). You could lose control of the vehicle.

### Driving crosswise on a slope

---



Fig. 160 Steer downhill along the fall line.



**Fig. 161** On a slope, always exit on the uphill side of the vehicle.

**⚠ Please first read and note the introductory information and heed the WARNINGS ⚠**

Driving crosswise on a slope is one of the most dangerous off-road driving situations ⇒ ⚠.

Even if it seems harmless, never underestimate the difficulties and hazards when driving crosswise on a slope. A vehicle perpendicular to the slope of the hill can become uncontrollable and slide away, tip, or roll over. This could cause severe or fatal injuries to all occupants.

#### **Driving at an angle to the slope**

**Before** driving crosswise on a slope, check whether there is a different, safer route.

If you have to drive across a slope, first make sure the ground is firm and even along your route. If the ground is soft or slippery, the vehicle is more likely to slip away to the side. Make sure that the angle does not become too great due to surface unevenness. This can make the vehicle tip and roll over.

The steeper the slope across which the vehicle is moving, the more important it becomes to make sure the wheels on the lower side do not run over holes or depressions. The wheels on the high side must never run over protruding rocks, tree stumps, or other obstacles.

If the vehicle threatens to tip, immediately steer downhill into the "fall line" and gently accelerate ⇒ [fig. 160](#). If it is not possible to steer down the fall line, steer uphill and gently accelerate.

The vehicle center of gravity should be as low as possible. The weight of all passengers should be evenly distributed. Taller or heavier passengers should sit on the higher side of the vehicle. Luggage on the roof should be removed and heavy objects should be secured, as the vehicle could tilt due to the sudden shifting of objects in the vehicle ⇒ ⚠.

While driving across the slope, passengers on the rear bench should always sit on the uphill side of the vehicle. In extreme cases, passengers on the downhill side must get out of the vehicle until the hill has been safely crossed.

#### **Exiting on a hillside**

If the vehicle comes to a standstill at a significantly tilted angle on the hillside, all passengers should exit the vehicle on the uphill side ⇒ [fig. 161](#). This applies even if the uphill door is hard to open. The uphill-side door may swing shut due to its weight or carelessness.





## WARNING

Never try to drive crosswise on a slope, especially one that is too steep for your vehicle. The vehicle could slide sideways and tumble down the slope. To reduce the risk of accidents and serious injuries:

- Never underestimate the difficulties and dangers of driving crosswise on a slope. Never take routes or risks that could put you or your passengers in danger. If you cannot go on or have doubts about the safety of your route, turn back and take a different route.
- When driving crosswise on a hill, the vehicle can lose its hold, slide sideways, tip or turn over and roll down the hill.
- Make certain that the wheels on the downhill side of the vehicle do not run over holes or depressions. Make certain that the wheels on the high side of the vehicle do not run over rocks, tree stumps, or protruding objects.
- Before driving crosswise on a hill, check whether it is possible to steer into the fall line along the selected route. If this is not possible, select a different route. If the vehicle threatens to tip, immediately steer downhill into the fall line and gently accelerate ⇒ [fig. 160](#).
- If the vehicle is stopped a hillside and is laterally tilted, avoid sudden and uncontrolled movement in the vehicle. The vehicle can lose its hold, slide sideways, tip, or turn over and roll down the hill.
- If the vehicle is stopped at while pointed crosswise on a steep slope, make certain that no one exits the vehicle through a door on the downhill side. This can shift the vehicle center of gravity to the downhill side. The can tilt or roll over and roll down the hill. To help minimize this risk, always exit the vehicle through the doors that are facing uphill ⇒ [fig. 161](#).
- When getting out, make certain that doors opened on the uphill side are not closed carelessly and do not swing shut due to their own weight and injure anybody.

## Avoiding deep ruts and depressions

📖 Please first read and note the introductory information and heed the WARNINGS ⚠️

Ruts are very common on forest trails, in grassland and fields, as well as on much-used cross-country lanes.

If the ruts and depressions are firm and shallow, simply follow the ruts.

Do not drive in ruts and depressions that are too deep ⇒ ⚠️. If deep ruts and depressions cannot be avoided, turn around.



## NOTICE

If ruts and depressions become too deep, the vehicle underbody can bottom out and get stuck. This can damage or even disable the vehicle.

## Crossing ditches

📖 Please first read and note the introductory information and heed the WARNINGS ⚠️

- Check whether the approach/departure angle and the lateral angle (tilt) are small enough to allow the vehicle to cross the ditch.
- If possible, cross the ditch at an acute angle ⇒ ⚠️.
- This is only possible if the lateral angle (side-to-side tilt) is not too large.

## WARNING

If the approach/departure angle or the lateral angle of the ditch are too steep for the vehicle, do not attempt to cross the ditch. The vehicle can fall over on its side, slide sideways, or turn over.

## NOTICE



If you enter at right angles to the ditch, the front wheels will fall into the ditch. The underbody of the vehicle can get stuck and the vehicle can be damaged or disabled. Getting out of a ditch without assistance is rarely possible, even with all-wheel drive.

## Driving in sand and mud

---

 Please first read and note the introductory information and heed the WARNINGS 

Always drive at a constant speed through sand and mud; do not shift gears manually and do not stop.

- Check whether ESC is active. The indicator light  or  in the instrument cluster must both be off 236.
- Select a suitable gear and remain in this gear until solid ground is reached
- Always keep the vehicle moving.

Never drive too fast through sand and mud. The wheels may spin and the vehicle can get stuck. If the tires no longer grip, turn the steering wheel back and forth slightly in short, quick movements. This can improve front wheel traction when driving in sand and mud.

### Driving through sand

Never reduce tire inflation pressure before driving through sand ⇒ . If you have reduced the tire pressure to drive through sand, make sure to correct the tire pressure afterwards before driving any further. Driving with reduced tire pressure can make you lose control of the vehicle and increase the risk of serious or fatal injuries.

### Driving through mud

Do not change your speed or your direction. The tires can lose their grip in mud. If the vehicle skids, steer in the direction the vehicle is sliding to try to get it back under control.

## WARNING

Driving through sand and mud can be dangerous. The vehicle can skid out of control and crash, causing serious injuries. Always drive carefully when driving in sand and mud.

- Never take routes or risks that could put you or your passengers in danger. If you cannot go on or have doubts about the safety of your route, turn back and take a different route.



## WARNING

Driving on tires that are not inflated to the correct cold tire inflation pressure can cause an accident with serious or fatal injuries.

- If the tires are not inflated to the correct pressure, they will wear out faster and the vehicle will not handle as well.
- Incorrect tire pressure can make tires overheat, resulting in tire damage including tire tread separation and sudden blowouts, that can make you lose control of the vehicle.

## If the vehicle is stuck

 Please first read and note the introductory information and heed the WARNINGS 

It takes experience and a fine touch to “rock” a vehicle back and forth to get it going when it is stuck. If you go about it the wrong way, you'll dig the vehicle in even deeper and need someone to tow you free.

### If the vehicle won't budge

- Carefully dig out all four wheels and make sure that no other parts of the vehicle are stuck in the sand.
- Select reverse gear.
- Carefully accelerate and try to back up in your own track.

If this doesn't help, try placing brushwood, floor mats, or burlap sackcloth directly in front of the tires to improve grip and traction ⇒ 

### Rocking the vehicle free

Don't spin the wheels. It's unlikely to help you get going and all but certain to dig you in even deeper if you do it too much ⇒ 

- Switch off Anti-Slip Regulation (ASR)
- Turn the steering wheel so that it points straight ahead.
- Shift into reverse and accelerate just to the point where the wheels first start to spin.
- Immediately engage first gear and accelerate again until the wheels just begin to spin.
- Repeat this process to get the vehicle to rock back and forth and then hopefully develop enough forward momentum to get going again.
- Once the vehicle is free, switch ASR back on



## WARNING

Make sure there are no people or animals in front of or behind the vehicle, especially when it is stuck and you are trying to rock it loose.

- Stones, brush, pieces of wood, and other objects under the wheels can be thrown at great velocity when they spin. This can cause serious or even fatal injuries.
- If the stuck vehicle suddenly regains traction, it will lurch forward and can run over anybody who is standing too close to it in the front or in the back.

## After driving off-road

**ⓘ Please first read and note the introductory information and heed the WARNINGS ⚠**

After an off-road drive, you always need to check the vehicle's underbody for damage and may need to clean the radiator grille ⇒ ⚠.

### Checklist

Checklist: Perform after every off-road drive ⇒ ⚠:

- ✓ Switch on ASR again
- ✓ Clean the turn signal lights, the headlights and taillights, the license plate, and all windows.
- ✓ If required, remove the towing eye(s) and snow chains.
- ✓ Check tires, suspension struts, and axles for damage and remove coarse dirt, stones, and foreign objects from the tire tread.
- ✓ Examine the vehicle underbody and remove objects such as twigs, leaves, or bits of wood that have gotten stuck in the brake system, the wheels, the suspension, the exhaust system, of the engine ⇒ ⚠. If damage or leaks are detected, see an authorized Volkswagen dealer or an authorized Volkswagen Service Facility.
- ✓ Remove coarse dirt from the radiator grille and the vehicle underbody ⇒ *Exterior care and cleaning.*
- ✓ Check the engine compartment to for dirt that interferes with engine operation ⚠ ⇒ *Working in the engine compartment.*
- ✓ After driving in sandy or dusty areas, have the air cleaner checked, and if necessary cleaned by an authorized Volkswagen dealer or authorized Volkswagen Service Facility so that dust, sand, and grit does not get drawn into the engine.

### **⚠ WARNING**

**Objects trapped under the vehicle floor can damage the brake system, fuel lines, gaskets, and other underbody parts. Such objects can also ignite on contact with hot vehicle components. You must check after each off-road outing to see whether any foreign objects have gotten stuck in the vehicle underbody.**

- **Never drive the vehicle if any foreign objects are stuck in the brake system, the wheels, the suspension, the exhaust system, or the engine or engine compartment.**
- **Flammable materials such as dry leaves or twigs can catch fire from contact with hot vehicle components. A fire can cause serious personal injuries.**
- **Trapped objects can damage or block the fuel lines, the brake system, gaskets, and other parts of the suspension system. This can cause you to lose control of the vehicle and have an accident.**

### **ⓘ NOTICE**

**Dust, sand, grit, and other material that has collected in the air filter after driving in certain kinds of off-road terrain can be drawn into the engine and cause expensive damage. After driving off-road where it is very dusty or sandy, be sure to have the air filter checked and, if necessary, cleaned by an authorized Volkswagen dealer or authorized Volkswagen Service Facility.**

# Working in the engine compartment

## Introduction

---

In this section you'll find information about:

Warning light

Working in the engine compartment

Opening and closing the engine compartment

Always position the vehicle on a firm and level surface before doing any work in the engine compartment.

The engine compartment of a vehicle is a hazardous area. Never do any work on the engine or in the engine compartment unless you

- know exactly how to carry out the job,
- have the correct technical information and the proper tools and supplies, and
- are familiar with the necessary safety precautions ⇒  !

If you are uncertain in any way, have the work done by an authorized Volkswagen dealer or an authorized Volkswagen Service Facility. Serious personal injury may result from improperly performed work.

### More information:

- Exterior views
- Windshield wiper and washer
- Starting and stopping the engine
- Brake fluid
- Checks while refueling
- Engine oil
- Engine coolant
- 12 Volt vehicle battery
- Exterior care and cleaning
- Parts, accessories, repairs and modifications



### WARNING

**Unintended vehicle movement during maintenance work can cause serious personal injuries.**

- **Never work under the vehicle unless you have safely secured the vehicle from moving. If you must work under the vehicle with the wheels on the ground, always make sure that the vehicle is on level ground, that all four wheels are chocked to keep them from moving, and that the key is not in the ignition.**
- **If you must work under a vehicle raised on a floor jack, always make sure that the vehicle is safely supported on safety stands intended for that purpose that are strong enough to support the weight of the vehicle. The jack supplied with the vehicle is not strong enough for this purpose and can collapse causing serious personal injury.**

 **WARNING**

The engine compartment of any motor vehicle is a potentially dangerous area and can cause serious personal injury.

- Always use extreme caution when doing any work in the engine compartment. Always follow commonly accepted safety practices and use common sense. Never risk personal injury.
- Never perform any work in the engine compartment unless you know exactly how to carry out the job and have the correct technical information and the correct tools.
- If you are uncertain about what to do, have the work performed by an authorized Volkswagen dealer, an authorized Volkswagen Service Facility, or another qualified workshop. Serious personal injury may result from improperly performed work.
- We strongly recommend that you always have HID - High Intensity Discharge (Xenon) lights and H7/H15 bulbs replaced by a qualified technician. Serious personal injury may result from improperly performed work.
- Never open or close the engine hood if steam or coolant is escaping. Hot steam or coolant can cause serious burns. Always wait until you no longer see or hear steam or coolant escaping from the engine.
- Always let the engine cool down completely before carefully opening the hood.
- Hot parts of the engine and the exhaust system will burn skin on contact.
- When the engine has cooled down and you are ready to open the hood:
  - Firmly apply the parking brake and shift the transmission into Park (P) (automatic) or Neutral (manual only).
  - Take the vehicle key out of the ignition.
  - On vehicles with Keyless Access, make sure that the remote control vehicle key is out of range of the vehicle and that the vehicle cannot be started by depressing the starter button.
  - Always keep children and others away from the engine compartment and never leave them unsupervised.
- The engine coolant system is under pressure when the engine is hot. Never unscrew the coolant expansion tank cap when the engine is hot. Hot coolant can spray out and cause severe burns and other serious injuries.
  - Turn the cap slowly and very carefully in a counterclockwise direction while applying light downward pressure on the top of the cap.
  - Always protect your face, hands, and arms from hot escaping coolant or steam by covering the cap with a large, thick rag.
- Never spill fluids on the engine or exhaust system when refilling. Spilling fluids onto hot parts of the engine or exhaust system can cause a fire.



### WARNING

High voltage systems in the engine compartment can cause electrical shocks or even electrocution, severe burns, other serious injuries, and even death!

- Never short-circuit the electrical system. Be especially careful when using jumper cables. The vehicle's battery could explode!
- To reduce the risk of electrical shock and personal injury while the engine is running or being started:
  - Never touch ignition cables. Never touch other components of the high voltage electronic ignition system.
  - Never touch the wiring of the HID - High Intensity Discharge (Xenon) headlights.
- Read and heed the important information and warnings on cleaning the engine compartment



### WARNING

Moving parts in the engine compartment can cause serious personal injury on contact.

- Never reach into the area around or touch the radiator fan. Contact with the blades can cause serious personal injury. Always remember that the radiator fan is temperature-controlled and can come on suddenly even when the engine has been switched off for a while and the key has been removed from the ignition.
- If you have to perform a check or repair when the engine is running, there are more risks from the rotating parts, such as the drive belts, alternator, radiator fan, etc., and from the high-voltage ignition system. Always use extreme care.
  - Always make sure that jewelry, loose clothing and long hair do not get caught in rotating engine parts. Before starting any work remove your jewelry, take off your necktie, tie back and cover your hair, and do not wear clothing that can hang down and get caught in moving engine parts.
  - Always use extreme caution if the accelerator pedal has to be depressed to perform a check. The vehicle will start to move even if the electronic parking brake is on.
- Never leave any objects in the engine compartment, for example cleaning rags and tools. Objects left behind can cause malfunctions, engine damage, and even fires.



### WARNING

Operating fluids and some materials in the engine compartment can catch fire easily, causing burns and other serious personal injuries!

- Do not smoke.
- Never work next to open flames or sparks.
- Never pour or spill operating fluids or other flammable liquids on the engine. These fluids can ignite on hot engine parts and cause injuries.
- If work on the fuel system or the electrical system is necessary:
  - Always disconnect the 12 Volt vehicle battery. Make sure the vehicle is unlocked when you disconnect the battery, or the alarm will go off. Never touch the electrical wiring of the ignition system.
  - Never work near heaters, water heaters, or other open flames.
- Always have a functional, approved fire extinguisher nearby.

## NOTICE



When changing or topping off fluids, make sure that you pour the fluids into the correct reservoirs. Adding the wrong type of operating fluids will cause serious malfunctions and engine damage.



Fluid leaks are harmful to the environment. Regularly check the ground underneath your vehicle for this reason. If you find spots of oil or other fluids, have your vehicle checked by your authorized Volkswagen dealer or authorized Volkswagen Service Facility. Dispose of leaked operating fluids properly.

## Warning light

 Please first read and note the introductory information and heed the WARNINGS 

Lights up	Possible cause	Proper response
	Engine hood not properly closed.	 <b>Stop!</b> Close the engine hood.

When the ignition is switched on, several warning and indicator lights come on briefly for a function check. They go out after a few seconds.

If the engine hood is open or not closed properly, the  warning light comes on in the instrument cluster.

Depending on your vehicle's equipment and options, a symbol showing that the hood is not properly closed may appear in the instrument cluster display instead of the warning light. The symbol will still be displayed even after the ignition is switched off. The display goes out about 15 seconds after the vehicle has been locked with the doors closed.

## WARNING

Failure to heed warning lights and instrument cluster text messages can cause the vehicle to break down in traffic and result in a collision and serious personal injury.

- Never ignore warning lights or text WARNINGS.
- Always stop the vehicle as soon as it is safe to do so.

## Working in the engine compartment

 Please first read and note the introductory information and heed the WARNINGS 

### Checklist

Before any work in the engine compartment, carry out the following steps in the order in which they are listed ⇒ 

- ✓ Park the vehicle in a safe place on a firm, level surface.
- ✓ Hold the brake pedal down until the engine is switched off.
- ✓ Apply the electronic parking brake to help prevent the vehicle from moving ⇒ *Braking and parking*.



- ✓ Shift the transmission into Park **(P)** (automatic) or Neutral (manual only) ⇒ *Shifting*.
- ✓ Stop the engine and remove the key from the ignition switch ⇒ *Starting and stopping the engine*.
- ✓ Let the engine cool down sufficiently.
- ✓ Keep children and others away from the vehicle.
- ✓ Make sure the vehicle cannot move unexpectedly.

**⚠ WARNING**

Disregarding the safety-related checklist may result in serious injuries.

- Always review and follow the checklist. Follow accepted safety practices and use common sense.

## Opening and closing the engine compartment

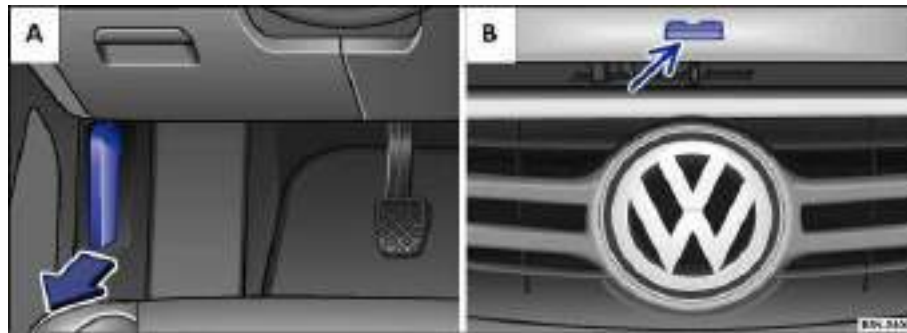

Fig. 162 A: Inside engine hood release in the footwell on the driver side. B: Outside engine hood release in the radiator grille.

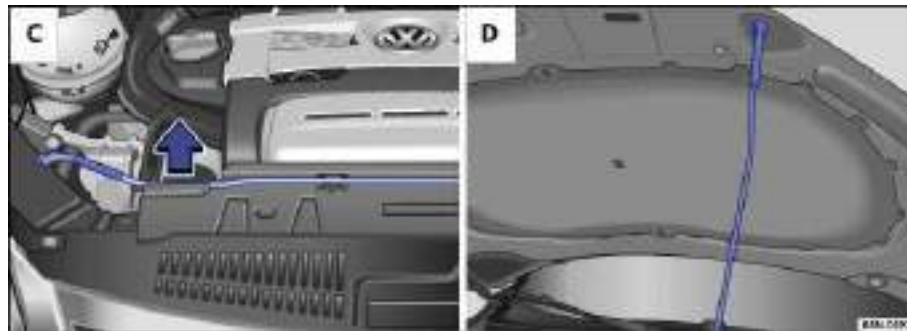





Fig. 163 A: Bracket for hood support in the engine compartment. B: Hood propped open.

⚠ Please first read and note the introductory information and heed the WARNINGS ⚠

### Opening the engine hood

- Before you open the hood, make sure that the windshield wiper arms are resting on the windshield ⇒ .
- Open the driver door and pull the inside hood release lever in the direction of the arrow ⇒ [fig. 162](#)
- A. The engine hood is released from its latch by a spring ⇒ .
- Push the outside hood release lever **B** (arrow) and lift the hood all the way up.
- Pull the hood support out of its bracket in the direction of the arrow ⇒ [fig. 163 C](#) and insert it into the opening in the hood **D**.

### Closing the engine hood

- Lift the hood slightly ⇒ .
- Take out the hood support and clamp it in place in its bracket **C**.
- Lower the hood by hand until it is about 1 ft. (30 cm) above its latch and then let it drop into place to latch it. *Do not* push down on it afterwards!

If the hood does not close completely, open it again and close it properly.

When the hood is properly closed, you can see that it fits flush with the other body parts. The indicator light in the instrument cluster will go out

### WARNING

**If the hood is not closed properly, it could fly up and block your view while you are driving. This can lead to a crash and serious personal injuries.**

- After closing the engine hood, check that the hood release lever is properly latched into the hood latch. The engine hood must be flush with the surrounding auto body parts.
- If you ever notice that the hood latch is not properly secured when the vehicle is moving, stop at once and close it.
- Never let anyone get in the way of the hood when closing it.

### NOTICE

- Make sure the windshield wipers are switched off and the windshield wiper arms are resting on the windshield before you open the hood. Otherwise, the windshield wipers and the hood may be damaged.
- Always put the windshield wiper arms down against the windshield before driving the vehicle.

### NOTICE

Before opening or closing the engine hood, make sure there is enough room to do so, for example when the vehicle is in a garage.

# Engine oil

## Introduction

---

In this section you'll find information about:

- Warning and indicator lights
- Engine oil specifications
- Engine oil capacities
- Checking the engine oil level and adding oil
- Engine oil consumption
- Changing engine oil

### More information:

- ⇒ booklet *Warranty and Maintenance booklet*
- Working in the engine compartment
- Parts, accessories, repairs and modifications

 **WARNING**

Improper handling of engine oil can cause severe burns and other serious injuries.

- Always wear eye protection.
- Engine oil is poisonous and must be stored out of the reach of children.
- Store engine oil only in the closed original container. This also applies to used oil until disposal.
- To reduce the risk of poisoning, never drain the oil into empty food or beverage containers that might mislead someone into drinking from them.
- Continuous contact with used engine oil is harmful to your skin. Always protect your skin by washing thoroughly with soap and water.
- Engine oil becomes extremely hot when the engine is running and can cause severe burns. Always let the engine cool down to the touch.



 Like all other operating fluids, engine oil can pollute the environment. Collect leaked or spilled operating fluids and dispose of them properly in accordance with applicable environmental laws and regulations.

## Warning and indicator lights

---

 Please first read and note the introductory information and heed the WARNINGS 

Lights up	Possible cause	Proper response
	Engine oil level too low.	Stop the engine. Check the engine oil level

Flashes	Possible cause	Proper response
	Engine oil pressure too low.	<p> <b>Stop!</b></p> <p>Switch off the engine. Check the engine oil level.</p> <p>– If the warning light flashes although the oil level is normal, <i>do not</i> continue driving or let the engine idle. Otherwise, the engine could be damaged. Contact an authorized Volkswagen dealer or an authorized Volkswagen Service Facility.</p>
	Engine oil system malfunction.	Have the engine oil sensor checked by an authorized Volkswagen dealer or an authorized Volkswagen Service Facility.

When the ignition is switched on, several warning and indicator lights come on briefly for a function check. They go out after a few seconds.

 **WARNING**

Failure to heed warning lights and instrument cluster text messages can cause the vehicle to break down in traffic and result in a collision and serious personal injury.

- Never ignore warning lights or text WARNINGS.
- Always stop the vehicle as soon as it is safe to do so.

 **NOTICE**

Failure to heed warning lights or text WARNINGS can result in vehicle damage.

## Engine oil specifications

 Please first read and note the introductory information and heed the WARNINGS 

The engine oil used must conform to exact specifications.

Using the proper engine oil is important for the functionality and service life of the engine. Your engine was factory-filled with a high-quality multi-grade oil which can usually be used throughout the entire year.

Engine oils are constantly being improved. Authorized Volkswagen dealers and authorized Volkswagen Service Facilities are always up-to-date regarding new developments and changes. Volkswagen therefore recommends that you have the engine oil changed by an authorized Volkswagen dealer or an authorized Volkswagen Service Facility.

Engine oil quality is based not only on requirements for engines and exhaust treatment systems, but also on fuel quality. Engine oil comes into contact with fuel and fuel residue in all internal combustion engines, causing engine oil to age and its lubricating qualities to deteriorate.

Your engine was factory-filled with a high-quality, "synthetic" all-season engine oil that meets strict Volkswagen oil quality standards and has a viscosity grade of SAE 5W-40 or SAE 5W-30. You can use this oil for normal driving in all temperatures.

If you need to add oil between oil changes, use only a high quality oil that expressly complies with the Volkswagen oil quality standard specified for your vehicle's engine:

Engines	Engine oil specification
All gasoline engines	VW 502 00, VW 503 00, VW 504 00

At the time this Manual was printed, the engine oils available in the U.S. that meet these Volkswagen standards are "synthetic" oils. This does not mean, however, that any "synthetic" engine oil will meet Volkswagen standards. Always use an approved oil that expressly complies with the Volkswagen oil quality standard that applies to your vehicle's engine.

**General recommendations:**

If "synthetic" oil that meets the applicable Volkswagen oil quality standard with viscosity grade SAE 5W-40 or SAE 5W-30 is not available in your area, be sure to use a viscosity grade suitable for the climate, season, and operating conditions that exist where the vehicle is used. Make sure the oil meets the quality standard listed in ⇒ table

Engine oils are constantly being improved. Authorized Volkswagen dealers and authorized Volkswagen Service Facilities are always up-to-date regarding new developments and changes. Volkswagen therefore recommends that you have the engine oil changed by an authorized Volkswagen dealer or an authorized Volkswagen Service Facility.

 **NOTICE**

- If you need to add oil and there is none available that meets the Volkswagen oil quality standard your engine requires, you may add a total of no more than 1/2 quart (0.5 liter) of a high-quality "synthetic" oil that meets ACEA A3 specifications and has a viscosity grade of SAE 5W-40 or SAE 5W-30.
- Use only a high quality engine oil that expressly complies with the Volkswagen oil quality standard specified for your vehicle's engine. Using any other oil can cause serious engine damage that will not be covered by any Volkswagen Limited Warranty.
- Do not mix any lubricants or other additives into the engine oil. Doing so can cause engine damage! Damage caused by these kinds of additives are not covered by any Volkswagen Limited Warranty.

**Engine oil capacities**

 Please first read and note the introductory information and heed the WARNINGS 

Engines	Engine oil capacity (with filter)
Gasoline engines	About 4.9 quarts (4.6 liters)

## Checking the engine oil level and adding oil

---

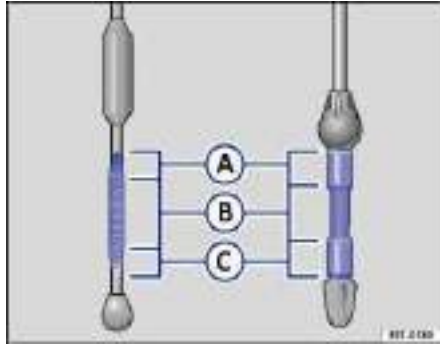

Fig. 164 Oil dipstick with engine oil level marks.



Fig. 165 In the engine compartment: Engine oil filler cap.





⚠ Please first read and note the introductory information and heed the WARNINGS ⚠

### Checklist

---

Perform the steps in the order listed ⇒ ⚠:

1. With the engine at **operating temperature**, park the vehicle on a level surface to help prevent an incorrect oil level reading.
2. Switch off the engine and wait a few minutes for the engine oil to flow back into the oil pan.
3. Open the engine hood ⇒ ⚠.
4. Find the oil filler opening and the dipstick. You can identify these by the  symbol on the engine oil filler cap ⇒ [fig. 165](#) and the colored handle on the dipstick. If you are not sure where the cap and the dipstick are located, see your authorized Volkswagen dealer or authorized Volkswagen Service Facility for assistance.
5. Remove the dipstick from the guide tube and wipe the dipstick off using a clean cloth.
6. Reinsert the dipstick into the guide tube and push it all the way in. If there is an alignment tab on the engine oil dipstick, make sure it lines up with the notch in the guide tube, and that the dipstick goes all the way in.

7. Remove the dipstick again and read the oil level on the dipstick ⇒ [fig. 164](#) as described below:
  - (A): **Do not** add any oil ⇒ . Continue with step 15.
  - (B): Oil may be added (about 1 pint / 0.5 liter). Continue with step 8 or step 15.
  - (C): **You must** add oil (about 1 quart / 1.0 liter). Continue with step 8.
8. After reading the oil level, reinsert the dipstick back into the guide tube and push it all the way in.
9. Remove the cap on the engine oil filler opening ⇒ [fig. 165](#).
10. Only add engine oil that Volkswagen has approved for that engine. Add the oil gradually in small quantities (no more than 1 pint / 0.5 liter).
11. To avoid overfilling, you must wait about one minute each time you add oil so that the oil can flow into the oil pan up to the marking on the dipstick.
12. Read the oil level on the dipstick again before adding another small amount, if necessary. Never add too much oil ⇒ .
13. After adding oil, the level must at least be in the center of the ⇒ [fig. 164 \(B\)](#) area, but never above (A) ⇒ .
14. After adding oil, securely install the cap on the engine oil filler opening. Otherwise, oil could leak out while the engine is running.
15. Insert the oil dipstick back in the guide tube and push it all the way in.
16. Close the hood ⇒ .

### Engine oil level ranges

	Required action according to the respective engine oil level:
Range (A)	Do <b>not</b> refill oil ⇒  .
Range (B)	<b>You may</b> add oil (about 1 pint / 0.5 liters). The oil level may go into the (A) range, but not above the (A) range.
Range (C)	<b>You must</b> add oil (about 1 quart / 1.0 liter). After adding oil, make sure that the oil level is about in the middle of the (B) range.



### WARNING

Engine oil can ignite when it touches hot engine parts. This can cause fires, burns, and other severe injuries.

- Never spill oil on the engine. Oil spilled on a cold engine can also cause a fire when the engine warms up
- Always make certain that you screw the cap of the engine oil filler opening back on tightly after adding oil and that the dipstick has been pushed all the way back into the in the guide tube. This helps prevent engine oil from leaking onto the hot engine when the engine is running.

## NOTICE

- **Do not start the engine if the engine oil level is above range (A). Contact an authorized Volkswagen dealer or an authorized Volkswagen Service Facility. Otherwise the catalytic converter and engine can be damaged!**
- **When changing or topping off fluids, make sure that you pour the fluids into the correct reservoirs. Adding the wrong type of operating fluids will cause serious malfunctions and engine damage.**



The engine oil level should never be above range (A). Otherwise oil can be drawn in by the crankcase ventilation system and enter the atmosphere via the exhaust system.

## Engine oil consumption

---

 **Please first read and note the introductory information and heed the WARNINGS **

To provide effective lubrication and cooling for internal engine parts, all internal combustion engines use some oil. Oil consumption varies from engine to engine and may change over the life of the engine. Engines tend to use more oil during the break-in period than they do afterward, when oil consumption has stabilized.

Under normal conditions, the rate of oil consumption depends on oil quality as well as viscosity, engine speed (rpm), outside temperature, road conditions, the amount of oil dilution caused by condensed water or fuel residue, and oxidation of the oil. Oil consumption may increase with engine wear over time, until replacement of worn engine parts may become necessary.

Volkswagen recommends that you to check the engine oil level at regular intervals, preferably every time you fill the fuel tank, and always before a long trip. Your vehicle may consume engine oil depending on several variables. A maximum of 1 quart per 1200 miles (1 liter per 2000 km) would be considered normal. New vehicles may consume more oil over the first 3000 miles (5000 km).

**The oil pressure warning light is not an indicator of low engine oil level. If the warning light stays on or flashes while driving (above 1500 rpm), a chime will sound. It indicates that the oil pressure is too low. Stop the engine immediately, check the engine oil level and add oil if necessary. If the engine oil level is normal, but the light continues to flash, do not keep driving or let the engine idle, as damage may occur.**

If you believe your engine uses too much oil, we recommend that you consult your authorized Volkswagen dealer or authorized Volkswagen Service Facility so that the cause of your concern can be properly diagnosed. Please keep in mind that accurate measurement of oil consumption requires great care and may take some time. Your authorized Volkswagen dealer and authorized Volkswagen Service Facility have instructions for how to measure oil consumption accurately.



Depending on the way the vehicle is driven and the operating conditions, oil consumption can be up to 1 quart per 1200 miles (0.5 liter per 1000 km). Consumption may be higher for new vehicles during the first 3000 miles (5000 km).

## Changing engine oil

---

 **Please first read and note the introductory information and heed the WARNINGS **

The engine oil must be changed according to the intervals specified in your ⇒ booklet *Warranty and Maintenance*.



Changing oil at regular intervals is very important because the lubricating properties of oil decrease gradually during normal vehicle use. If you are not sure when to have the oil changed, ask your authorized Volkswagen dealer or authorized Volkswagen Service Facility.

Sometimes, engine oil should be changed more often than specified for normal use. Change oil more frequently if you often drive short distances, in dusty areas or in stop-and-go traffic, or if you use your vehicle where temperatures stay below freezing for long periods.

Volkswagen recommends that you have your oil and oil filter changed by an authorized Volkswagen dealer or an authorized Volkswagen Service Facility ⇒ ⚠. They have the required expertise and special tools and will dispose of the old oil properly.

Detergent additives in the oil will make fresh oil look dark after the engine has been running a short time. This is normal and no reason to change engine oil more often.



### WARNING

**If you must change the engine oil yourself, be sure to take the following precautions:**

- **Always wear eye protection.**
- **To reduce the risk of burns from hot engine oil, let the engine cool down completely before beginning.**
- **When removing the oil drain plug with your fingers, stay as far away as possible. Always keep your forearm parallel to the ground to help prevent hot oil from running down your arm.**
- **Drain the oil into a container designed for this purpose, one large enough to hold at least the total amount of oil in your engine.**
- **To reduce the risk of poisoning, never drain the oil into empty food or beverage containers that might mislead someone into drinking from them.**
- **Engine oil is poisonous and must be stored out of the reach of children.**
- **Continuous contact with used engine oil is harmful to your skin. Always protect your skin by washing thoroughly with soap and water.**



Before changing the oil, first make sure you know where you can properly dispose of the old oil.



Dispose of the old oil an environmentally-responsible manner. Never dump the old oil on garden soil, in wooded areas, in the street, into streams, rivers, or bodies of water, or down sewage drains.



Recycle used oil by taking it to a collection facility for used engine oil in your area, or contact an authorized Volkswagen dealer or an authorized Volkswagen Service Facility.



Volkswagen recommends that you always have your oil and oil filter changed by an authorized Volkswagen dealer or an authorized Volkswagen Service Facility. They have the required expertise and special tools and will dispose of the old oil properly.

# Engine coolant

## Introduction

---

In this section you'll find information about:

Warning light and engine coolant temperature gauge  
Engine coolant specifications  
Checking engine coolant level and topping off

Never do any work on the coolant system unless you

- know exactly how to carry out the job,
- have the correct technical information and the proper tools, supplies, and operating fluids, and
- are familiar with the necessary safety precautions ⇒  !

If you are uncertain in any way, have the work done by an authorized Volkswagen dealer or an authorized Volkswagen Service Facility.

Serious personal injury may result from improperly performed work.

### More information:

- Trailer towing
- Working in the engine compartment
- Parts, accessories, repairs and modifications

### WARNING

#### Engine coolant is poisonous!

- Always keep the coolant in its original container stored in a safe place.
- To reduce the risk of poisoning, never store engine coolant in empty food or beverage containers or in any other containers that might mislead someone into drinking from them.
- Always keep engine coolant out of reach of children.
- Always make sure there is enough of the correct coolant additive to provide proper antifreeze protection at the coldest temperatures that can be expected where the vehicle will be used.
- At extremely cold temperatures, the coolant could freeze, causing the vehicle to break down. The heater would also not work, and vehicle occupants could be without protection at subfreezing temperatures.

 Coolant and coolant additives can pollute the environment. Collect leaking operating fluids and dispose of them properly in accordance with applicable environmental laws and regulations.

## Warning light and engine coolant temperature gauge



**Fig. 166** Engine coolant temperature gauge in the instrument cluster: A Engine cold; B Normal temperature range; C Warning zone.

**⚠ Please first read and note the introductory information and heed the WARNINGS ⚠**

If the indicator in the engine coolant temperature gauge is located in the cold range (A), the engine has not reached operating temperature. High engine speeds and heavy engine loads should be avoided.

Under normal driving conditions, the needle should be in the middle of the gauge. The temperature may go higher when the engine is working hard, especially in hot weather.

When the ignition is switched on, several warning and indicator lights come on briefly for a function check. They go out after a few seconds.

The following table explains what to do if the engine coolant warning light  does not go out a few seconds after the engine is started or lights up or starts flashing while driving.

Flashes	Temperature gauge needle ⇒ <a href="#">fig. 166</a>	Possible cause	Proper response
	(C) Warning zone	Engine coolant temperature too high.	<p><b>🛑 Stop!</b> Pull off the road and stop as soon as you can do so safely. Stop the engine and let it cool down until the temperature needle is in the normal range again. Check the engine coolant level and add coolant if needed 318.</p> <p>If the engine coolant level is correct or the problem continues after adding coolant and driving a short distance, <b>do not drive any farther</b>. Contact the nearest authorized Volkswagen dealer or authorized Volkswagen Service Facility.</p> <p>If the coolant level is correct, the overheating may be caused by a radiator fan fault. Check the fuses and replace as necessary</p>

Flashes	Temperature gauge needle ⇒ fig. 166	Possible cause	Proper response
	(B) Normal range	Engine coolant level too low.	Check the engine coolant level after the engine has cooled down and add engine coolant if low If the engine coolant level is correct or the problem continues after adding coolant, <b>do not drive any farther</b> . Contact an authorized Volkswagen dealer or authorized Volkswagen Service Facility. These instructions apply only when the coolant temperature stays in the normal range. Stop immediately if the needle goes into the red warning zone (C).
	–	Engine coolant system malfunction.	 <b>Stop!</b> Get assistance from an authorized Volkswagen dealer, an authorized Volkswagen Service Facility, or another qualified workshop.
–	(A) Cold range	The engine has not yet warmed up.	Do not drive at high engine speeds or with heavy engine loads until the engine warms up.

When the ignition is switched on, several warning and indicator lights come on briefly for a function check. They go out after a few seconds.

 **WARNING**

Failure to heed warning lights and instrument cluster text messages can cause the vehicle to break down in traffic and result in a collision and serious personal injury.

- Never ignore warning lights or text WARNINGS.
- Always stop the vehicle as soon as it is safe to do so.

 **NOTICE**

Failure to heed warning lights or text WARNINGS can result in vehicle damage.

## Engine coolant specifications

 Please first read and note the introductory information and heed the WARNINGS 

The engine cooling system is filled at the factory with a mixture of specially conditioned water and at least 40 percent of Volkswagen engine coolant additive **G 13** (TL-VW 774 J). This engine coolant additive is pink.

This mixture provides antifreeze protection down to -13 °F (-25 °C). It also helps to protect the light alloy parts in the engine cooling system against corrosion. In addition, the mixture helps prevent calcium deposits and increases the boiling point of the engine coolant.

To protect the engine, the mixture must *always* contain *at least 40% coolant additive* even in warm weather or climates where antifreeze protection is not needed.

If more antifreeze protection is needed for climate conditions, the percentage of coolant additive can be increased. However, the coolant additive percentage must never be more than 60%; otherwise, antifreeze protection is reduced and the ability of the mixture to cool the engine is also reduced.

When adding engine coolant, use a mixture of **distilled** water and at least 40% coolant additive G 13 or G 12 plus-plus (TL-VW 774 G) for optimum corrosion protection ⇒ .

Do not mix G 13 with G 12 plus or G 11. Mixing these coolant additives together significantly reduces corrosion protection ⇒  and can lead to engine damage that is not covered by any Volkswagen Limited Warranty.



### WARNING

**Too little antifreeze protection in the engine cooling system can cause engine failure and severe injuries.**

- Always make sure there is enough of the correct coolant additive to provide proper antifreeze protection at the coldest temperatures that can be expected where the vehicle will be used.
- At extremely cold temperatures, the coolant could freeze, causing the vehicle to break down. The heater would also not work, and vehicle occupants could be without protection at subfreezing temperatures.



### NOTICE

**Never mix original Volkswagen engine coolant additives with other additives not approved by Volkswagen. Mixing Volkswagen coolant additives with coolant additives made by other manufacturers can seriously damage the engine and the engine cooling system.**

- If the fluid in the engine coolant reservoir is any color but pink, then G 13 was mixed with a different engine coolant. If this is the case, the engine coolant must be replaced immediately. Otherwise serious malfunctions or engine damage can occur!



Engine coolant and engine coolant additives can pollute the environment. Collect leaking operating fluids and dispose of them properly in accordance with applicable environmental laws and regulations.

## Checking engine coolant level and topping off

---



Fig. 167 Coolant expansion tank in the engine compartment.



Fig. 168 Coolant expansion tank cap in the engine compartment.

**⚠ Please first read and note the introductory information and heed the WARNINGS ⚠**

If the coolant level drops too low, the engine coolant level/temperature warning light lights up.





### Preparations

- Park the vehicle on level ground.
- Always let the engine cool down ⇒ ⚠.
- Open the engine hood ⇒ ⚠.
- There is a ⚠ symbol on the cap of the engine coolant expansion tank ⇒ fig. 168.

### Checking engine coolant level

- When the engine is cold, check the engine coolant level relative to the marking on the side of the expansion tank ⇒ fig. 167.
- If the coolant level in the tank is below the minimum mark ("min"), add coolant. When the engine is warm, the engine coolant level may be slightly above the upper edge of the marked range.

### Adding engine coolant

- Always protect face, hands and arms from hot escaping coolant or steam by covering the cap with a large, thick rag.
- Carefully unscrew the cap ⇒ .
- Add only **new** engine coolant according to Volkswagen specifications (⇒ *Engine coolant specifications*) ⇒ .
- The engine coolant level must be inside the marks on the side of the reservoir . **Do not fill above the top edge of the filling range!** ⇒ .
- Screw the lid tightly.
- Even in an emergency, **do not** use any other kind of coolant additive if engine coolant meeting Volkswagen specifications (⇒ *Engine coolant specifications*) is unavailable! Instead, add **distilled water only** ⇒ . As soon as possible, have the correct coolant ratio restored using engine coolant that meets Volkswagen specifications ⇒ *Engine coolant specifications*.



### WARNING

Hot steam and hot engine coolant can cause serious burns.

- **Never open the hood if you see steam or coolant escaping from the engine compartment. Always wait until you no longer see or hear steam or coolant escaping from the engine.**
- **Always let the engine cool down completely before carefully opening the hood. Hot components will burn skin on contact.**
- **When the engine has cooled down and you are ready to open the hood:**
  - Apply the electronic parking brake and shift the transmission into Park (P) (automatic) or Neutral (manual only).
  - Take the vehicle key out of the ignition.
  - On vehicles with Keyless Access, make sure that the remote control vehicle key is out of range of the vehicle and that the vehicle cannot be started by depressing the starter button
  - Always keep children and others away from the engine compartment and never leave them unsupervised.
- **The engine coolant system is under pressure when the engine is hot. Never unscrew the coolant expansion tank cap when the engine is hot. Hot coolant can spray out and cause severe burns and other serious injuries.**
  - Turn the cap slowly and very carefully in a counterclockwise direction while applying light downward pressure on the top of the cap.
  - Always protect your face, hands, and arms from hot escaping coolant or steam by covering the cap with a large, thick rag.
- **Never spill fluids on the engine or exhaust system when refilling. Spilling fluids onto hot parts of the engine or exhaust system can cause a fire. Under some conditions, the ethylene glycol in engine coolant can catch fire.**



### NOTICE

- **Use distilled water only when adding coolant! All other types of water contain chemical compounds that can cause extensive corrosion damage to the engine. This can even lead to engine failure. If you have added non-distilled water, take the vehicle immediately to an authorized Volkswagen dealer or an authorized Volkswagen Service Facility to have the coolant system drained, flushed, and refilled completely with the proper coolant.**

- Refill engine coolant only up to the top edge of the marked fill range . Excess engine coolant may forced out of the engine cooling system when it gets hot and cause damage.
- In the case of significant engine coolant loss, refill engine coolant only when the engine is *completely cooled down*. Significant engine coolant loss is a sign of leaks in the cooling system. Have the engine cooling system checked immediately by an authorized Volkswagen dealer or an authorized Volkswagen Service Facility. Otherwise the engine may be damaged!
- When changing or topping off operating fluids, make sure that you pour the fluids into the correct reservoirs. Serious malfunctions and engine damage can result if you pour operating fluids into the wrong reservoir.



## 12 Volt vehicle battery

### Introduction

---

In this section you'll find information about:

Warning light

Checking the vehicle battery electrolyte level

Charging, replacing, disconnecting and connecting the 12 Volt vehicle battery

The standard 12 Volt vehicle battery is part of the vehicle electrical system.

Never do any work on the vehicle electrical system unless you





- know exactly how to carry out the job,
- have the correct technical information and the proper tools, and
- are familiar with the necessary safety precautions ⇒  !

If you are uncertain in any way, have the work done by an authorized Volkswagen dealer or authorized Volkswagen Service Facility. Serious personal injury may result from improperly performed work.

#### Location of the vehicle battery

The 12 Volt vehicle battery is located in the engine compartment.

#### Explanation of the warnings on the vehicle battery

Symbol	Meaning
	Always wear eye protection!
	Battery acid is highly corrosive. Always wear protective gloves and eye protection!
	Fire, sparks, open light and smoking are prohibited!
	When a battery is charged, it produces hydrogen gas which is highly explosive!
	Always keep children away from battery acid and vehicle batteries!

#### More information:

- ⇒ booklet *Warranty and Maintenance*
- Working in the engine compartment
- Parts, accessories, repairs and modifications

 **WARNING**

Working on the batteries or the electrical system in your vehicle can cause serious acid burns, fires, explosions, or electrical shocks. Always read and heed the following WARNINGS and safety precautions before working on the batteries or the electrical system.

- Before working on the electrical system, always switch off the ignition and all electrical consumers and disconnect the negative (-) cable from the standard 12 Volt battery.
- When you change a light bulb, always switch off the light first.
- Always keep children away from battery acid and vehicle batteries in general.
- Always wear eye protection. Never let battery acid or lead particles come into contact with your eyes, skin, or clothing.
- Sulfuric battery acid is very corrosive. It can burn unprotected skin and cause blindness. Always wear protective gloves and eye protection. To reduce your risk of injury, never tilt the batteries, as this could spill acid through the vents and burn you.
- If you get battery acid in your eyes or on your skin, immediately rinse with cold water for several minutes and then get immediate medical attention. If you swallow any battery acid, get medical attention immediately.
- When disconnecting the batteries from the vehicle electrical system, always disconnect the negative cable (-) first and then the positive cable (+).
- Always switch off all electrical consumers before reconnecting 12 Volt batteries. Reconnect the plus cable (+) first and then the negative cable (-). Never reverse the polarity of the connections. This could cause a fire.
- A highly explosive mixture of gases is given off when the battery is being charged.
- Do not smoke and avoid fires, sparks, and open flames when working. Never create sparks or electrostatic charges when handling cables and electrical equipment. Never short circuit the battery terminals. High-energy sparks can cause serious personal injury.
- Never use or attempt to charge a damaged or frozen battery, or a battery that was frozen but has thawed. Charging a frozen or thawed battery could cause explosions and chemical burns! Replace damaged or frozen vehicle batteries immediately. A dead battery can freeze at temperatures around +32 °F (0 °C).
- If the battery has a vent line or tube, make sure that it is properly connected to the battery.
- Always make sure that the vent line is securely attached to a vehicle battery that is located in the luggage compartment.

 **WARNING**

California Proposition 65 Warning

- Battery posts, terminals, and related accessories contain lead and lead components, chemicals known to the State of California to cause cancer and reproductive harm. Wash your hands after handling.

 **NOTICE**

- Do not expose the vehicle battery to direct sunlight for an extended period of time as ultraviolet rays may damage the battery housing.
- If the vehicle is left standing in the cold for a long time, protect the vehicle battery from freezing. A battery will be permanently damaged by freezing.



Emergency starting and starting the engine with a very weak vehicle battery or after the vehicle battery has been replaced may change or delete system settings (including time, date, personal

convenience settings and programming). Check the settings and correct as necessary once the vehicle battery has built up a sufficient charge.

## Warning light

☑ Please first read and note the introductory information and heed the WARNINGS ⚠

Lights up	Possible cause	Proper response
	Alternator malfunction.	See an authorized Volkswagen dealer or an authorized Volkswagen Service Facility. Have the electrical system checked. Switch off unnecessary electrical loads. The vehicle battery will not be charged by the alternator as you drive.

When the ignition is switched on, several warning and indicator lights come on briefly for a function check. They go out after a few seconds.

**⚠ WARNING**

Failure to heed warning lights and instrument cluster text messages can cause the vehicle to break down in traffic and result in a collision and serious personal injury.

- Never ignore warning lights or text WARNINGS.
- Always stop the vehicle as soon as it is safe to do so.

**ⓘ NOTICE**

Failure to heed warning lights or text WARNINGS can result in vehicle damage.

## Checking the vehicle battery electrolyte level

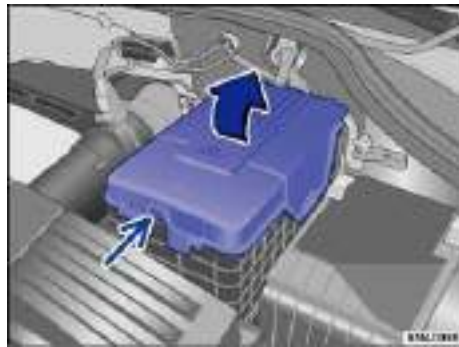

Fig. 169 In the engine compartment: Remove the cover from the vehicle battery.



**Fig. 170** In the engine compartment: Open the sleeve covering of the vehicle battery.

**⚠ Please first read and note the introductory information and heed the WARNINGS ⚠**

Check the electrolyte level of the battery regularly if the vehicle has high mileage, in places with warm climate and if the vehicle has an old battery. Otherwise the vehicle battery does not require maintenance.

### Preparations

- Prepare the vehicle for work in the engine compartment ⇒ *Working in the engine compartment.*
- Open the engine hood ⚠

### Opening the battery cover

Depending on the engine type, there are different kinds of battery covers:

- *With a hard cover* ⇒ [fig. 169](#): Press on the tab (small arrow) and remove the cover upward.
- *With a soft cover* ⇒ [fig. 170](#): Open the sleeve cover to the side.

### Checking the vehicle battery acid level

- If the lighting conditions are poor, use a flashlight so that you can clearly see the battery acid level indicator and tell what color it is. Never use an open flame or an unprotected light source.
- The round battery window ("acid level indicator") on the top of the battery changes color, depending on the battery's electrolyte level.

Color	Response
<i>Light yellow or colorless</i>	Battery electrolyte level is too low. The battery may need to be replaced. Have it checked by an authorized Volkswagen dealer or an authorized Volkswagen Service Facility.
<i>Black</i>	Battery electrolyte level is satisfactory.



## WARNING

Working on the batteries can cause serious acid burns, explosion, or electrical shock.

- Always wear eye protection and protective gloves.
- Sulfuric battery acid is very corrosive. It can burn unprotected skin and cause blindness. Always wear protective gloves and eye protection.
- Never tilt the vehicle battery. Acid could spill out of the battery vents and burn you.
- Never open a vehicle battery.
- If you get battery acid in your eyes or on your skin, immediately rinse with cold water for several minutes and then get immediate medical attention.
- If you swallow any battery acid, get medical attention immediately.

## Charging, replacing, disconnecting and connecting the 12 Volt vehicle battery

📖 Please first read and note the introductory information and heed the WARNINGS ⚠️

### Charging the vehicle battery

Vehicle batteries should be charged by an authorized Volkswagen dealer or an authorized Volkswagen Service Facility because the factory-installed battery requires a charger with overload protection ⇒ ⚠️.

### Replacing the vehicle battery

The battery in your vehicle is specially developed for its location, with special dimensions and safety features. Before buying a new battery, ask an authorized Volkswagen dealer or authorized Volkswagen Service Facility what batteries are suitable with regard to electro-magnetic compatibility, dimensions, required maintenance, performance, and safety specifications. Have the battery replaced by an authorized Volkswagen dealer or an authorized Volkswagen Service Facility.

Only use maintenance-free vehicle batteries meeting standards TL 825 06 and VW 7 50 73. These standards must date from August 2008 or later.

### Disconnecting the vehicle battery

If the battery must be disconnected from the vehicle's electrical system, note the following:

- Switch off all electrical systems and devices and the ignition.
- Unlock the vehicle before disconnecting the battery; otherwise the alarm system will go off.
- First disconnect the negative cable (-) and then the positive cable (+) ⇒ ⚠️.

### Connecting the vehicle battery

- Prior to reconnecting the battery, switch off all electrical systems and devices and the ignition.
- Connect the positive cable (+) first and then the negative cable (-) ⇒ ⚠️.

After the battery is connected and the ignition is switched on, different indicator lights may come on. They should go out after you drive a short distance at 10 – 12 mph (15 – 20 km/h). If the indicator lights do not go out, contact an authorized Volkswagen dealer or an authorized Volkswagen Service Facility and have the vehicle checked.

If the battery was disconnected for a long time, the next scheduled service may not be correctly calculated and displayed ⇒ *Instrument cluster*. The maximum permissible service and maintenance intervals are shown in the ⇒ Booklet *Warranty and Maintenance booklet*.

### Vehicles with Keyless Access

If the ignition will not start after reconnecting the vehicle battery, lock the vehicle from the outside and unlock it again ⇒ *Unlocking or locking the vehicle with Keyless Access*. Then try to start the ignition again. If the ignition cannot be switched on, contact an authorized Volkswagen dealer, an authorized Volkswagen Service Facility, or another qualified workshop for assistance.

### Automatic electrical load deactivation

If the vehicle battery drain is high, the intelligent onboard electrical system management automatically takes steps to help prevent battery drain.

- The idle speed is increased so that the alternator provides more power.
- The power to devices that consume a lot of electricity is cut back or switched off completely.
- When the engine is started, the power supply to the 12 Volt sockets is temporarily interrupted.

The onboard electrical system management cannot always keep the battery from being drained. For example, the battery will drain if the engine is not running, but the ignition is switched on or the parking lights are left on for a long time when parked.

### Battery disconnection in an accident with airbag deployment

In vehicles with a battery in the luggage compartment, the electrical connection to the battery is disconnected automatically in a collision with airbag deployment. This helps to prevent a short-circuit.

### What drains the battery?

- Long periods when the engine is not running, especially when the ignition is on.
- Using electrical systems or devices when the engine is switched off.
- Leaving the vehicle unlocked for several days when not in use.
- The selector lever is left for a long period of time in any position other than **(P)** when the ignition is switched off ⇒ *Automatic transmission: Selector lever*.

### WARNING

**Failure to use the proper battery with proper mounting and connections may cause short circuits, fires, and serious personal injuries.**

- Always use only maintenance-free or cycle-free, leakproof batteries with the same specifications and dimensions as the original equipment battery. Specifications are listed on the battery housing.

### WARNING

**When the vehicle battery is charged, it produces highly explosive hydrogen gas.**

- Charge vehicle batteries only in well-ventilated areas.
- Never charge a frozen or thawed battery. A dead battery can freeze at temperatures around +32 °F (0 °C).
- You must replace the vehicle battery if it was frozen.
- Incorrectly connected cables can cause a short-circuit. First connect the positive cable (+) and then the negative cable (-).



## NOTICE

**Never disconnect a vehicle battery or connect 2 vehicle batteries to each other when the ignition is switched on or the engine is running. Using the wrong battery can damage the electrical system or electronic components and cause electrical malfunctions.**

- **Never use a vehicle battery that does not meet specifications for the vehicle battery for your vehicle. Using the wrong battery can damage the electrical system or electronic components and cause electrical malfunctions.**
- **Never connect power generating equipment, such as a solar panel or battery charger, to the 12 Volt socket in order to charge the vehicle battery. This can damage the vehicle's electrical system.**



Dispose of the vehicle battery according to regulations. Vehicle batteries contain poisonous substances such as sulfuric acid and lead.



Battery acid can pollute the environment. Catch leaking operating fluids and dispose of them properly.

## Exterior care and cleaning

### Introduction

---

In this section you'll find information about:

- Washing the vehicle
- Washing with a power washer
- Cleaning windows and outside mirrors
- Cleaning and changing the windshield wiper blades
- Waxing and polishing vehicle paint
- Caring for and cleaning chrome and aluminum parts
- Cleaning wheel rims
- Caring for rubber door and window seals
- Deicing door lock cylinders
- Cleaning the power sunroof and the sunshade
- Cleaning the power sunroof and the sunshade
- Undercoating
- Cleaning the engine compartment

Regular and expert care helps to **preserve the value** of your vehicle. Such expert care may also be one of the requirements of your New Vehicle Limited Warranty if corrosion repair or repainting is necessary.

Vehicle care products are available from your authorized Volkswagen dealer or Authorized Volkswagen Service Facility.

#### **More information:**

- ⇒ booklet *Warranty and Maintenance*
- Interior care and cleaning
- Working in the engine compartment
- Parts, accessories, repairs and modifications

#### **WARNING**

**Vehicle care products can be dangerous. Improper use can cause accidents, burns, poisoning, or other serious personal injuries.**

- **Always store vehicle care products only in original containers that are securely closed.**
- **Always read and heed all the instructions and all WARNINGS on the package.**
- **To reduce the risk of poisoning, never use empty food or beverage containers that might mislead someone into drinking from them.**
- **Always keep vehicle care products out of the reach of children.**
- **Always use such products outdoors or in well-ventilated areas, because harmful vapors may be released when these products are used.**
- **Never use fuel, turpentine, engine oil, nail polish remover or other volatile fluids for vehicle care. They are poisonous and highly flammable.**





## WARNING

Improper care and cleaning of vehicle components can impact the safety features of the vehicle and cause severe injuries.

- Always clean and maintain vehicle components according to manufacturer's instructions.
- Only use approved or recommended cleaners.



## NOTICE

Vehicle care products containing solvents can damage plastics and other vehicle materials.



Wash the vehicle only at specifically designated wash locations to prevent water contaminated with oil, grease and fuel from entering the storm drain sewer system. In some areas it is against the law to wash motor vehicles anywhere other than at specified designated car washing locations.



When buying vehicle care products, try to choose those that are not harmful to the environment.



Never throw out vehicle care products with ordinary household waste. Always read and heed all the instructions and all WARNINGS on the package.

## Washing the vehicle

---

☐ Please first read and note the introductory information and heed the WARNINGS

The longer insect splatter, bird droppings, tree sap, road dirt, industrial deposits, tar, soot, road salt, and other aggressive materials stay on your vehicle, the more damage they do to the paint finish. High temperatures (including strong sunlight) increase the corrosive effects. The vehicle **underbody** should also be washed regularly and thoroughly.

### Car wash

**Pay close attention to the information provided by the car wash operator.** Before going through a car wash, be sure to take the usual precautions to help prevent, such as closing the windows, folding back the outside mirrors, etc. If you have installed additional accessories on the vehicle, such as a spoiler or an antenna, always ask the car wash operator if this poses a problem ⇒ .

The paint finish is tough enough that the vehicle can normally be washed without problems in an automatic car wash. However, the effect on the paint depends to a large extent on the type of car wash. Volkswagen recommends using brushless car wash facilities.

To remove wax residue from the windows and avoid jerky windshield wiper movement, heed the following tips ⇒ *Cleaning windows and outside mirrors.*

### Washing by hand

When washing by hand, first soften the dirt with plenty of water and then rinse off as much dirt as possible.

Then clean the vehicle with a soft **sponge**, a **washing mitt** or **brush** using only light pressure. Start on the roof and work down. Use special **shampoo** only on hard-to-remove dirt or grime.

Rinse the sponge or glove thoroughly and often.

Clean the wheels and under the door sills last. Use a different sponge or wash mitt.

## WARNING

After the vehicle has been washed, the wet brakes or, in winter, brake discs or pads coated with ice, react slower and need longer stopping distances.

- Always dry the brakes and clean off any ice coatings with a few careful applications of the brake. Make sure not to endanger other motorists or cyclists or disobey legal requirements.

## CAUTION

Sharp edges under the vehicle can cut exposed skin.

- Always protect your hands and arms from cuts on sharp metal edges when cleaning the underbody, the inside of the wheel housings, etc.

## NOTICE

- The water temperature must not be more than +140 °F (+60 °C).
- To help prevent damage to the paint, do not wash the vehicle in direct sunlight.
- Do not use insect sponges, abrasive kitchen sponges or similar things to clean the vehicle. These can damage the paint finish.
- Never clean headlights with a dry cloth or sponge. Always use a wet cloth or sponge. For best results use soapy water.
- When washing or rinsing the vehicle in cold weather, do not let water get into the lock cylinders or point the hose at gaps around the doors, hood, or rear hatch. The water could freeze on the locks and seals and make it difficult to open the vehicle!

## NOTICE

To help prevent vehicle damage in a car wash:

- Compare the vehicle track width with the dimensions of the guide rails in the car wash to help prevent damage to wheel rims and tires!
- Switch off the rain sensor before driving through a car wash 122.
- Make sure there is enough clearance for the height and width of the vehicle.
- To help prevent paint damage to the engine hood, place wiper blades against the windshield after they have dried. Do not let them snap back into place.
- Fold the outside mirrors toward the vehicle body. Do not fold power mirrors manually!
- Lock the rear hatch to prevent unintentional opening in the car wash.

## Washing with a power washer

 Please first read and note the introductory information and heed the WARNINGS 

Always follow the instructions for the power washer. This especially applies to the **pressure** and **spraying distance** ⇒ .

Make sure there is enough distance to soft material such as rubber hoses or insulating material as well as the sensors of the Park Distance Control system. The Park Distance Control system sensors can be in the rear and, if applicable, front bumper ⇒ .

Never use **concentrated jet nozzles** or so-called **dirt blasters** ⇒ .

Never use a power washer to clean the engine compartment ⇒ *Cleaning the engine compartment*.

### **WARNING**

Improper use of power washers can cause serious invisible permanent damage leading to tire failure and loss of vehicle control. This can cause accidents and severe personal injury.

- Keep sufficient distance between water jet and tires. Never wash tires with a nozzle that sprays the water out in a direct stream regardless of the distance to the tire and even for a very short time.
- Never use “dirt blasters” to clean tires. Even spraying from a relatively long distance for a very short time can do visible or invisible damage to tires.

### **WARNING**

After the vehicle has been washed, the wet brakes or, in winter, brake discs or pads coated with ice, react slower and need longer stopping distances.

- Always dry the brakes and clean off any ice coatings with a few careful applications of the brake. Make sure not to endanger other motorists or cyclists or disobey legal requirements.

### **NOTICE**

- Water temperature should not be more than +140 °F (+60 °C).
- To help prevent damage to the paint, do not wash the vehicle in direct sunlight.
- When using a power washer or steam cleaner, only spray the rear assist sensors directly for a short period of time and always keep the nozzle at least 4 inches (10 cm) from the sensor.
- Do not clean icy or snow-covered windows with a power washer.
- When washing or rinsing the vehicle in cold weather, do not let water get into the lock cylinders or point the hose at gaps around the doors, hood, or rear hatch. The water could freeze on the locks and seals and make it difficult to open the vehicle!

## Cleaning windows and outside mirrors

---

 Please first read and note the introductory information and heed the **WARNINGS** .

### Cleaning windows and outside mirrors

Spray windows and outside mirrors with a commercially available alcohol-based window cleaner.

Dry windows and mirrors with a clean chamois or a lint-free cloth. Do not use a chamois that has been used to wipe painted surfaces because it will have absorbed an oily residue that will smear the glass surfaces.

Use window cleaner or a silicone remover to remove rubber, oil, grease and silicone deposits ⇒ .

### Removing wax residue

Automatic car washes and vehicle care products can leave a **wax residue** on all glass surfaces. These wax residues can only be removed with special cleaners or cleaning cloths. Wax residue left on the windshield can cause the windshield wipers to grab and squeak instead of gliding smoothly. We recommend that after every car wash you remove any wax residue left on the windshield with a cleaning cloths/chamois G 052 522 A1 or equivalent.

Windshield wiper squeak and grab can be reduced by filling the windshield washer fluid tank with a wiper fluid containing wax-removing agents. Make sure to maintain the proper mixing ratio when refilling the washer fluid tank. Grease-removing cleaning agents cannot remove wax residue ⇒ .

Special cleaners or cleaning cloths are available from your authorized Volkswagen dealer and authorized Volkswagen Service Facility.

All-season Windscreen Clear G 052 164 A2 or equivalent. Mixing ratio in winter to -0.4 °F (-18 °C) about 1:2 (1 part concentrate to 2 parts water), otherwise mixing ratio 1:4 in windshield washer reservoir.

Window cleaning cloths / chamois G 052 522 A1 or equivalent for all windows and outside mirrors.

### Removing snow

Remove snow from all windows and outside mirrors with an appropriate brush.

### Removing ice

The best way to remove ice is with a deicer spray. When using an ice scraper always scrape in one direction, **never** back and forth. Dirt can scratch the glass when moving the scraper backward.

## WARNING

Dirty or fogged up windows reduce visibility and increase the risk of accidents and severe injuries.

- Don't drive until you have clear visibility through all windows.
- Remove ice, snow and condensation from all inside and outside window surfaces.

## NOTICE

- Never mix recommended cleaning agents with other cleaning agents in the windshield washer reservoir. If you do, this could cause sediments or other by-products that can clog the windshield wiper nozzles.
- Never use warm or hot water to remove snow and ice from windows and mirrors. This could cause the glass to crack!
- The heating elements for the rear defroster are on the inside of the rear window. Do not put stickers over the heating elements on the inside of the rear window and never clean the inside of the windows with corrosive or acidic cleaning agents or other chemicals that could damage the heating elements.
- Antennas installed on the insides of windows can be damaged by abrasive objects or by corrosive or acidic cleaning agents or other chemicals. Do not place any stickers on the windshield-integrated antenna and never clean the antenna with corrosive or acidic cleaning agents or other chemicals.

## Cleaning and changing the windshield wiper blades

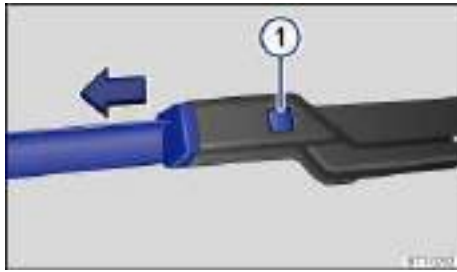

Fig. 171 Changing the windshield wiper blades.



Fig. 172 Changing the rear window wiper blades.

### ⚠ Please first read and note the introductory information and heed the WARNINGS ⚠

Factory-installed wiper blades have a graphite coating. The graphite coating lets the wiper blades glide smoothly over the windshield. If this coating is worn or damaged, the wipers may grab or squeak.

Check all wiper blades regularly. **Wiper blades that grab and squeak** must be replaced if worn or damaged and cleaned if dirty ⇒ ⚠.

Replace worn or damaged wiper blades immediately. Replacement blades may be purchased from any authorized Volkswagen dealer or authorized Volkswagen Service Facility.

### Lifting and tilting windshield wiper arms

Move the wiper arms into the service position before lifting them away from the windshield/rear window (Note: no service position for rear wiper) ⇒ *Windshield wipers and washer*.

It is not possible to lift the wiper arms away from the windshield when they are not in the service position.

When lifting or replacing a wiper blade on a window, grip it **only** by its mounting and not by the blade itself.

### Cleaning the wiper blades

- Lift the wiper arm(s) away from the windshield/rear window after moving them to the service position (Note: no service position for rear wiper).
- Using a soft cloth, carefully remove dust and dirt from the wiper blades.
- If the blades are very dirty, carefully clean them with a sponge or cloth ⇒ ⚠.
- Carefully fold the wiper arm back down onto the windshield.

### Changing wiper blades

- Lift the wiper arm(s) away from the windshield.
- Press and hold the release button ⇒ [fig. 171 \(1\)](#) and pull off the wiper blade in the direction of the arrow.
- Install a new wiper blade of **same length and type** onto the wiper arm by pushing in the opposite direction of the arrow until it latches.
- Carefully fold the wiper arm back down onto the windshield.

### Changing the rear window wiper blade

- Lift the wiper arm away from the rear window.
- Rotate the wiper blade 90 °.
- Support the wiper arm with one hand.
- Pull the release on bracket in the direction of the arrow ⇒ [fig. 172 \(1\)](#). This may require a moderate force.
- Fold back the wiper blade in the direction of the arrow (2) this will create a gap between the wiper arm and the latch (3) (magnifying glass).
- Pull the wiper blade to the direction of the vehicle outside (direction of arrow) (4).
- Install a new wiper blade of **same length and type** onto the wiper arm by pushing in the opposite direction of the arrow (4) until it latches.
- Support the wiper arm with one hand.
- Slide the release in the opposite direction of the arrow (3) in order to secure the wiper blade.
- Carefully fold the wiper arm back down onto the window.

### WARNING

**Worn or dirty wiper blades reduce visibility and increase the risk of accidents and severe injuries.**

- **Always change wiper blades if they are damaged or worn, and if they cannot clean the windows sufficiently.**

### NOTICE

- **Damaged or dirty wiper blades can scratch the windshield and the rear window.**
- **Solvents, abrasive sponges and sharp-edged objects will damage the graphite coating on the wiper blades.**
- **Do not clean the windows with gasoline, nail polish remover, paint thinner or similar fluids.**
- **To help prevent damage to the engine hood and the windshield wiper arms, lift the wiper arms away from the windshield only when they are in the service position.**

## Waxing and polishing vehicle paint

---

 Please first read and note the introductory information and heed the WARNINGS 

### Waxing

A good coat of wax helps to protect the vehicle paint. When water no longer forms small drops and **runs off** when the paint is *clean*, apply a new coat of good **hard wax** to protect the vehicle again.

Even if a **wax solution** is used regularly at the car wash, Volkswagen recommends applying a coat of hard wax at least twice a year to protect the paint.

## Polishing

Polish your vehicle if the paint has lost its shine and the gloss cannot be brought back with wax.

The vehicle must be waxed after polishing if the polish used does not contain wax compounds to seal the paint.

### NOTICE

- To help prevent damage, do not use hard wax or polish on matte-finished parts, plastic parts, headlights or rear lights.
- Do not wax or polish your vehicle if it is dirty, or in a sandy or dusty place.

## Caring for and cleaning chrome and aluminum parts

---

 Please first read and note the introductory information and heed the WARNINGS 

- Clean the surface using a clean, soft, lint-free cloth dampened with water.
- If the surface is especially dirty, use a special **solvent-free** cleaning material.
- Then polish chrome and aluminum parts with a soft, dry cloth.

### NOTICE

To help prevent damage to chrome and aluminum parts:

- Do not clean or polish in direct sunlight.
- Do not clean or polish in sandy or dusty places.
- Do not use abrasive cleaners or abrasive sponges.
- Do not polish dirty surfaces.
- Do not use cleaning materials that contain solvents.
- Do not use hard wax.

### NOTICE

Chrome wheel covers and hubcaps have an extra coating. Do not treat them with chrome care or polishing products. Use regular paint care and polishing products.

## Cleaning wheel rims

---

 Please first read and note the introductory information and heed the WARNINGS 

### Cleaning steel wheels

Stubborn brake dust can be removed with an industrial cleaner. Clean steel wheels regularly with a separate sponge.

Repair any paint damage on steel wheels before rust begins to form.

### Cleaning alloy wheels

**Every 2 weeks:** Wash road salt and brake dust off alloy wheels, and clean the wheels with an acid-free detergent. **Every 3 months:** Volkswagen recommends applying a hard wax compound to the wheels.

If road salt and brake dust are not removed regularly, they can corrode the metal.

Use an acid-free detergent specifically designed for light alloy wheels. Do not use car polish or other abrasive products.

If the protective coating is damaged, for example by stone impact, repair the damaged area right away.

## Caring for rubber door and window seals

---

ⓘ Please first read and note the introductory information and heed the WARNINGS ⚠

The rubber seals around the doors and windows will stay soft and flexible, seal better and last longer if the seals are treated regularly with a suitable rubber care product.

Before applying the treatment, use a soft cloth to remove dust and dirt from the rubber seals.

ⓘ Do not apply any rubber care products to the rubber seals on the body in the areas around the windows in the driver's and front passenger's doors. The product could run down onto the windows and smudge them.

## Deicing door lock cylinders

---

ⓘ Please first read and note the introductory information and heed the WARNINGS ⚠

Volkswagen recommends using only genuine Volkswagen deicer spray with lubricating and anticorrosive properties to deice door lock cylinders.

### ⓘ NOTICE

Lock deicers that contain grease solvents can cause the lock cylinder to rust.

Applicable only in the United States

## Cleaning the power sunroof and the sunshade

---

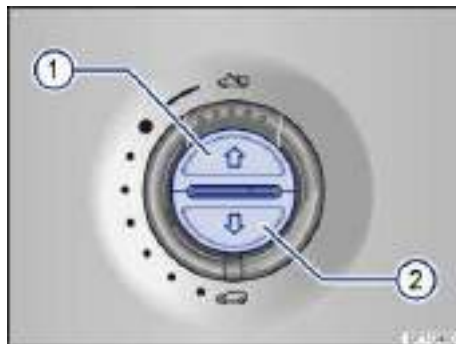

Fig. 173 In the headliner: Buttons for sunshade.



**ⓘ Please first read and note the introductory information and heed the WARNINGS ⚠**

Dirt and debris can impair the function of the power sunroof

The power sunroof only works when the ignition is on. You can still open or close the power sunroof for several minutes after you switch off the ignition, as long as the driver or front passenger door has not been opened.

#### **Moving the sunshade to the cleaning position**

- Park the vehicle safely.
- Open the power sunroof completely 62.
- Press and hold the button ⇒ [fig. 173 \(2\)](#) for about 5 seconds until the sunshade is completely closed.
- If the sunshade is heavily soiled, carefully clean it with a cloth and warm water.

#### **⚠ NOTICE**

**Close the power sunroof completely before driving off. Driving with the sunshade in the cleaning position can lead to damage to the vehicle.**

#### **⚠ NOTICE**

**Do not attempt to clean the drain tubes for the power sunroof. This could result in vehicle damage caused by punctured or damaged drain tubes.**

**ⓘ** Remove leaves and other objects from the sunroof guide rails regularly either by hand or using a vacuum cleaner.

Applicable only in Canada

### **Cleaning the power sunroof and the sunshade**

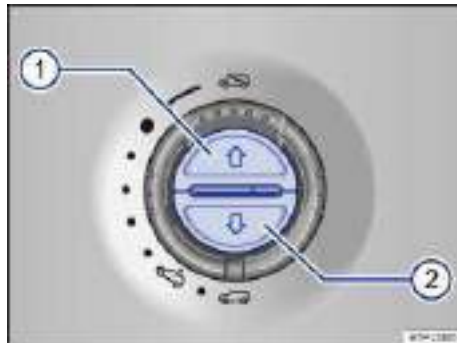

**Fig. 174** In the headliner: Buttons for sunshade.

**ⓘ Please first read and note the introductory information and heed the WARNINGS ⚠**

Dirt and debris can impair the function of the power sunroof

The power sunroof only works when the ignition is on. You can still open or close the power sunroof for several minutes after you switch off the ignition, as long as the driver or front passenger door has not been opened.

#### Moving the sunshade to the cleaning position

- Park the vehicle safely.
- Open the power sunroof completely
- Press and hold the button ⇒ [fig. 174 \(2\)](#) for about 5 seconds until the sunshade is completely closed.
- If the sunshade is heavily soiled, carefully clean it with a cloth and warm water.

#### NOTICE

**Close the power sunroof completely before driving off. Driving with the sunshade in the cleaning position can lead to damage to the vehicle.**

#### NOTICE

**Do not attempt to clean the drain tubes for the power sunroof. This could result in vehicle damage caused by punctured or damaged drain tubes.**



Remove leaves and other objects from the sunroof guide rails regularly either by hand or using a vacuum cleaner.

## Undercoating

 Please first read and note the introductory information and heed the WARNINGS 

The vehicle underbody is coated to help protect it from corrosion and damage. The undercoating could be damaged during normal use. We therefore recommend that you have the protective coatings on the underbody and suspension inspected regularly, and repaired if necessary.

#### WARNING

**Undercoating and rustproofing products can catch fire on the hot exhaust system or any other hot engine component.**

- **Never apply additional undercoating or rustproofing on or near the exhaust manifold, the exhaust pipes, the catalytic converter, the heat shields, or any other hot vehicle component.**

## Cleaning the engine compartment

 Please first read and note the introductory information and heed the WARNINGS 

The engine compartment of a vehicle is a dangerous area ⇒ *Working in the engine compartment.*

If necessary, the engine compartment should be cleaned by an authorized Volkswagen dealer or authorized Volkswagen Service Facility. Incorrect cleaning procedures could remove corrosion protection and damage electrical components, among other things. In addition, water could enter directly into the vehicle interior through the plenum chamber ⇒ .

Never use a power washer to clean the engine compartment ⇒ ⚠.

If the engine compartment is extremely dirty, have it cleaned professionally by your authorized Volkswagen dealer or authorized Volkswagen Service Facility.

### Plenum chamber

The plenum chamber is located in the engine compartment between windshield and engine, under a perforated cover. Outside air is taken into the vehicle interior from the plenum chamber via the climate control system.

Regularly remove leaves and other loose objects from the plenum chamber cover by hand or with a vacuum cleaner.



### WARNING

**Injuries, scalding, electric shock, accidents and fire hazards can occur while working on the engine or in the engine compartment!**

- Before working in the engine compartment, be sure to familiarize yourself with the necessary procedures and generally accepted safety precautions ⇒ *Working in the engine compartment*.
- Volkswagen recommends having the work performed by an authorized Volkswagen dealer or authorized Volkswagen Service Facility.



### NOTICE

**Spraying or pouring water (e.g. with power washer) into the plenum chamber can cause severe damage to the vehicle.**



Wash the engine compartment only in special wash bays so that the oily dirt and fuel residue that are washed off the vehicle will not enter the sewage system. In some areas it is illegal to wash the engine compartment anywhere other than at such specified locations.

## Interior care and cleaning

### Introduction

---

In this section you'll find information about:

- Caring for upholstery
- Cleaning upholstery, fabric trim and Alcantara®
- Care and cleaning of leather upholstery
- Cleaning leatherette
- Cleaning storage compartments and cup holders
- Care and cleaning of plastic components, wood trim and instrument panel
- Cleaning the safety belts

Modern clothing fabrics such as dark denim may not be completely colorfast. Even with normal use, dye from these and other fabrics can rub off on seat upholstery and leave visible discolorations (especially on light-colored seat upholstery). This is caused by a lack of colorfastness in the clothing fabric, not by any fault in the seat upholstery fabric. To help prevent damage to the seat upholstery, always make sure your clothing is colorfast. Volkswagen recommends having a qualified specialist remove any discolorations from the seat upholstery.

The longer stains, dirt and other deposits remain on the surfaces of vehicle components and upholstery, the more difficult it may be to clean them. If stains, dirt and deposits are left untreated for a long period of time, they may become impossible to remove.

#### **More information:**

- Exterior care and cleaning
- Parts, accessories, repairs and modifications

#### **WARNING**

**Vehicle care products can be dangerous. Improper use can cause accidents, burns, poisoning, or other serious personal injuries.**

- Always store vehicle care products only in original containers that are securely closed.
- Always read and heed all the instructions and all WARNINGS on the package.
- To reduce the risk of poisoning, never use empty food or beverage containers that might mislead someone into drinking from them.
- Always keep vehicle care products out of the reach of children.
- Always use such products outdoors or in well-ventilated areas, because harmful vapors may be released when these products are used.
- Never use fuel, turpentine, engine oil, nail polish remover or other volatile fluids for vehicle care. They are poisonous and highly flammable.



## WARNING

Improper care and cleaning of vehicle components can compromise the vehicle's safety features and cause severe injuries.

- Always clean and maintain vehicle components according to manufacturer's instructions.
- Only use approved or recommended cleaners.



## NOTICE

- Vehicle care products containing solvents can cause irreparable damage to damage plastics and other vehicle the materials.
- Stains, dirt and other deposits that contain aggressive substances or solvents can corrode vehicle materials and cause permanent damage, even after brief contact with the surface.
- Remove stains, dirt, and other deposits as quickly as possible and do not allow them to dry.
- To help prevent damage, have stubborn stains removed by a professional who has the necessary expertise and experience.



Suitable care products are available from authorized Volkswagen dealers and authorized Volkswagen Service Facilities.

## Caring for upholstery

 Please first read and note the introductory information and heed the **WARNINGS** 

### Checklist

Please note the following when it comes to the care and preservation of the upholstery ⇒ :

- ✓ Open Velcro® fasteners can damage upholstery, fabric, and trim. Before you get into the vehicle, close all Velcro® fasteners that could come into contact with upholstery fabrics and cloth trim.
- ✓ Sharp-edged objects and items on clothing and belts (such as belt clips, mobile phone cases, zippers, rivets, and rhinestones) can damage upholstery material and fabric trim. To help prevent damage, do not let such items come into direct contact with the upholstery and fabric trim.
- ✓ Dust and dirt particles in pores, folds, and seams can have a “scouring” effect on material and damage the surface. Remove dust and dirt regularly to help prevent permanent surface damage.
- ✓ Check clothing for colorfastness to help prevent upholstery discoloration, especially to light-colored upholstery.



## NOTICE

Disregarding the upholstery-related checklist may lead to damage or discoloration of upholstery and fabric trim.

- Please note and follow the points listed in the checklist.



Volkswagen recommends having any discoloration removed by an authorized Volkswagen dealer or authorized Volkswagen Service Facility.

## Cleaning upholstery, fabric trim and Alcantara®

📖 Please first read and note the introductory information and heed the WARNINGS ⚠️

### Cleaning upholstery on heated seats and power seats or seats with airbag components

Airbag components and electrical connectors may be installed in the driver seat, the front passenger seat. Damaging, cleaning and handling incorrectly, or wetting or soaking these seat surfaces and backrests can damage the vehicle electrical system and prevent the airbag system from working properly ⇒ ⚠️.

Electrical components and connectors that could be damaged by incorrect cleaning or handling are installed in power seats and heated seats ⇒ ⚠️. This can also result in damage to other parts of the vehicle electrical system.

For this reason, read and follow these cleaning instructions:

- Do not use pressure washers, steam cleaners, or cooling spray.
- Do not use detergent pastes or mild detergent solutions.
- Do not wet the surface completely.
- Only use cleaning products approved by Volkswagen.
- If you have questions or concerns, consult a professional cleaner.
- Before using any cleaning agent, familiarize yourself with instructions and warnings on the packaging.
- Vacuum upholstery, fabric trim, Alcantara® upholstery, and carpeting regularly with a suitable brush attachment.
- A soft sponge or a commercially available lint-free microfiber cloth may be used for general cleaning ⇒ ⚠️.
- Clean Alcantara® surfaces with a damp cotton or wool cloth or a commercially available lint-free microfiber cloth ⇒ ⚠️.

Upholstery and fabric trim with light generalized soiling can be cleaned with a commercially available dry-foam cleaner.

If the upholstery fabric and fabric trim pieces are heavily soiled, see your authorized Volkswagen dealer or authorized Volkswagen Service Facility before you begin cleaning to learn about suitable cleaning options. If necessary, have the cleaning done by a professional.

### Cleaning upholstery on non-heated seats, manual seats, or seats without airbag components

- Before using any cleaning agent, familiarize yourself with instructions and warnings on the packaging.
- Vacuum upholstery, fabric trim, Alcantara® upholstery, and carpeting regularly with a suitable brush attachment.
- Do not use pressure washers, steam cleaners, or cooling spray.
- A soft sponge or a commercially available lint-free microfiber cloth may be used for general cleaning ⇒ ⚠️.
- Clean Alcantara® surfaces with a damp cotton or wool cloth or a commercially available lint-free microfiber cloth ⇒ ⚠️.

Upholstery and fabric trim with light generalized soiling can be cleaned with a commercially available dry-foam cleaner.

If the upholstery fabric and fabric trim pieces are heavily soiled, see your authorized Volkswagen dealer or authorized Volkswagen Service Facility before you begin cleaning to learn about suitable cleaning options. If necessary, have the cleaning done by a professional.

## Removing stains

When treating stains, it may be necessary to clean the entire surface and not just the stain itself. This is especially true if the entire surface has become dirty from normal use. Otherwise, the area that is treated may become lighter than the untreated area. If you have questions or concerns, consult a professional cleaner.

Type of stain	Recommended cleaning for fabric and upholstery
<i>Water-based stains</i> , such as coffee or fruit juice.	<ul style="list-style-type: none"><li>– Moisten a sponge with water and rub the stain gently with a circular motion.</li><li>– Wipe dry with an absorbent cloth.</li></ul>
<i>Persistent stains</i> , such as chocolate or make-up.	<ul style="list-style-type: none"><li>– Use only Volkswagen-approved cleaning products.</li><li>– If necessary, have the fabric or upholstery professionally cleaned.</li></ul>
<i>Grease-based stains</i> , such as oil, lipstick, etc.	<ul style="list-style-type: none"><li>– Use only Volkswagen-approved cleaning products.</li><li>– If necessary, have the fabric or upholstery professionally cleaned.</li></ul>

### **WARNING**

If there is a malfunction in the airbag system, the airbag may not deploy correctly or at all, or it may deploy unexpectedly. This could cause fatal injuries.

- Have the airbag system inspected immediately by your authorized Volkswagen dealer or authorized Volkswagen Service Facility.

### **NOTICE**

If the upholstery on power seats, heated seats, or seats with airbag components is wet, electrical components and the vehicle electrical system could be damaged.

- If the seating surface becomes soaked, have it dried and the system components checked immediately by an authorized Volkswagen dealer or authorized Volkswagen Service Facility.
- Do not use steam cleaners because the steam could cause the dirt to penetrate deeper into the fabric and make it impossible to remove.
- Pressure washers and cooling sprays can damage the upholstery.

### **NOTICE**

- Clean only the carpet and floor mats with brushes. Other textile surfaces can be damaged by brushes.
- If detergent pastes or mild detergent solutions are applied with a damp cloth or sponge, the surfactants in the detergent may cause visible lines to form at the edges of the area where the detergent was applied. These lines are generally difficult or impossible to remove.

### **NOTICE**

- Do not soak Alcantara®.
- Do not treat Alcantara® with leather care products, solvents, floor wax, shoe polish, stain remover or similar products.

- Do not use brushes for damp cleaning, because they can damage upholstery surfaces.
- Do not use a steam cleaner, because dirt will penetrate deeper into the fabric.

## Care and cleaning of leather upholstery

📖 Please first read and note the introductory information and heed the WARNINGS ⚠️

If you have questions regarding the care and cleaning of the leather upholstery in the vehicle, please contact an authorized Volkswagen dealer or authorized Volkswagen Service Facility.

### Care and treatment

Natural leather requires special attention and care. Napa leather has a smooth surface. The intensity of the color application determines the leather's appearance and texture. If you can see the leather grain and other natural characteristics, this is an untreated napa leather that will provide very comfortable seating. Delicate veins, closed scars, insect bites, folds, and a slightly clouded color remain visible and represent authentic characteristics of the natural material. Untreated napa leather has no protective coating. It is therefore more susceptible to damage. You should keep this in mind if the leather is going to be exposed to severe wear from children, animals, or other factors. By contrast, leather that has a protective coating is more robust. This has a positive effect on the leather's durability in daily use. The typical natural characteristics are hardly visible or no longer visible at all, but that has no impact on the quality of the leather itself. The typical characteristics of untreated leather are much more distinctive than those of a surface-treated leather.

- After each cleaning, apply cream that waterproofs the leather and protects it against the sun. Such creams also nourish the leather, let it breathe, keep it flexible and moisturized. At the same time it protects the surface.
- Clean leather every 2 to 3 months and remove any new stains.
- Treat leather with a suitable leather-care product twice a year ⇒ ⚠️.
- Apply cleaning and conditioning materials sparingly and always with a dry, lint-free cotton or wool cloth. Do not apply cleaning and conditioning materials directly to the leather.
- Remove fresh stains such as ballpoint pen, lipstick, ink, shoe polish, etc. as soon as possible.
- Preserve the leather's color. If necessary, refresh fading spots with a specially-colored leather cream.
- Wipe the leather with a soft cloth.

### Cleaning

Volkswagen recommends using a slightly moistened cotton or wool cloth for general cleaning.



It is important not to let water soak through the leather or penetrate into seams.

**Before cleaning** leather surfaces, read and heed the information ⇒ *Cleaning upholstery on heated seats and power seats or seats with airbag components.*

Type of stain	Cleaning
<i>Heavy stains</i>	<ul style="list-style-type: none"> <li>– Apply a mild soapy solution with a cloth that has been wrung nearly dry<sup>8</sup>.</li> <li>– Dab dry with an absorbent cloth.</li> </ul>

<sup>8</sup> Mild soap solution: 2 tablespoons of liquid soap in one quart of water.



Type of stain	Cleaning
<i>Water-based stains</i> , such as coffee, tea, juice, or blood.	Remove fresh stains with an absorbent cloth. – If the stains are already dry, use an appropriate cleaning agent ⇒  .
<i>Grease-based stains</i> , such as oil, lipstick, etc.	Remove fresh stains with an absorbent cloth. – Use an appropriate cleaning agent on stains that have not yet penetrated the surface ⇒  .
<i>Special stains</i> , such as ballpoint pen, marker, nail polish, latex paint, or shoe polish.	– Dab dry with an absorbent cloth. – Clean with a special stain remover designed for leather.

### NOTICE

- Stains that have been left in place too long will penetrate the surface of the leather and cannot be removed.
- Never treat leather with solvents, floor wax, shoe polish, stain remover or similar products.
- Wipe up spilled liquids immediately with an absorbent cloth. Liquid can penetrate leather surfaces and seams within a few seconds.
- If the vehicle is left in the sun for a long time, cover the upholstery to protect the leather from direct sunlight and to help prevent fading and discoloration.

 Slight discoloration caused by wear and tear is normal.

## Cleaning leatherette

 Please first read and note the introductory information and heed the **WARNINGS** 

Clean leatherette upholstery only with water and a mild soap solution.

**Before cleaning** leatherette surfaces, read and heed the information ⇒ *Cleaning upholstery on heated seats and power seats or seats with airbag components.*

### NOTICE

- Do not clean leatherette with solvents, floor wax, shoe polish, stain remover, or similar products.
- These can cause the material to become brittle and break. Sharp-edged objects and items on clothing and belts (such as belt clips, mobile phone cases, zippers, rivets, and rhinestones) can damage upholstery material and fabric trim.
- If the vehicle is left in the sun for a long time, cover the upholstery to protect the leatherette from direct sunlight and to help prevent fading or discoloration.

## Cleaning storage compartments and cup holders

---

📖 Please first read and note the introductory information and heed the WARNINGS ⚠️

### Cleaning storage compartments and cup holders

Some storage compartments and cup holders have a removable rubber insert at the bottom.

- Moisten a clean, lint-free cloth with water and clean the parts.
- If this is not sufficient, then use a special **solvent-free** care and cleaning product designed for plastics.

## Care and cleaning of plastic components, wood trim and instrument panel

---

📖 Please first read and note the introductory information and heed the WARNINGS ⚠️

- Moisten a clean, lint-free cloth with water and clean the parts.
- Clean *plastic components (inside and outside of the vehicle) and the instrument panel* only with a **solvent-free** care and cleaning product that is specifically designed for plastics and approved by Volkswagen ⇒ ⚠️.
- Clean *wood trim* with a mild soap solution.

 <b>WARNING</b>	
<b>Using solvents or other improper cleaning products on surfaces where airbags are located can change the way airbags deploy in a crash.</b>	
<ul style="list-style-type: none"><li>• Products containing solvents will change the properties of the plastics and may cause plastic parts to break and fly around when the airbag deploys in a crash, causing injury.</li><li>• Never use solvents or cleaners on the steering wheel horn pad or on the instrument panel because they can damage the airbag cover or change the stiffness or strength of the material so that the airbag cannot deploy and protect properly.</li><li>• When cleaning the horn pad and instrument panel, use only a soft, dry cloth or a cloth moistened with plain water.</li></ul>	

## Cleaning the safety belts

---

📖 Please first read and note the introductory information and heed the WARNINGS ⚠️

If a safety belt is dirty, this can prevent the belt from working properly. Keep safety belts clean and regularly check all safety belts for damage.

Safety belts must never be taken apart for cleaning.

- Remove coarse dirt with a soft brush ⇒ ⚠️.
- Carefully pull the dirty safety belt out of the retractor and keep it out.
- Clean the safety belt with a *mild* soap solution.
- After cleaning, always give the safety belts time to dry thoroughly before letting them retract. This helps prevent damage to the retractor.
- Do not let the safety belts retract until they are completely dry.



## **WARNING**

Damage to safety belts reduces their overall effectiveness and increases the risk of serious personal injury and death whenever the vehicle is being used.

- Check the condition of all safety belts regularly. If you notice that the safety belt webbing, hardware, retractor, buckle, or any other part of the safety belts is damaged, immediately have an authorized Volkswagen dealer or authorized Volkswagen Service Facility replace the safety belt with the correct replacement belt for your vehicle model and model year.
- Never use chemical cleaning agents, solvents, or any substance that may damage or weaken the safety belt webbing or any other parts of the safety belt. Never let the belts come into contact with corrosive fluids or sharp objects. Otherwise, the safety belt webbing will be significantly weakened.
- After cleaning, always give the safety belts time to dry completely before letting them retract. The moisture can damage the retractor and keep it from working properly.
- Never let foreign objects or liquids get into the safety belt latch. This could prevent the belt buckles and safety belts from working properly.
- Damaged safety belts must be replaced; they cannot be repaired.
- Never try to repair a damaged safety belt yourself. Never remove or modify the safety belts in any way.
- Safety belts that were subject to stress in an accident and stretched must be replaced with a correct, new safety belt, preferably by an authorized Volkswagen dealer or authorized Volkswagen Service Facility.
- Replacement after a crash may be necessary even if a safety belt shows no visible damage. Anchorages that have been loaded must also be inspected.

# Parts, accessories, repairs and modifications

## Introduction

---

In this section you'll find information about:

Break-in period

Parts and accessories

Operating fluids and equipment

Repairs and technical modifications

Repairs and other things that can affect Advanced Airbag performance

Notice about data recorded by vehicle control modules

Using the mobile phone without a vehicle integrated antenna - some important things to know

### **More information:**

- Safety belts
- Airbag system
- Roof rack
- Trailer towing
- Sockets
- Braking and parking
- Cruise control system (CCS)
- Tire Pressure Monitoring System
- Working in the engine compartment
- Engine oil
- Engine coolant
- 12 Volt Vehicle battery
- Exterior care and cleaning
- Interior care and cleaning
- Consumer information
- ⇒ booklet *Radio*
- ⇒ booklet *Radio & Navigation system*
- ⇒ booklet *Mobile phone package*



## WARNING

Inappropriate spare parts and accessories as well as unprofessionally performed work, modifications and repairs can cause vehicle damage, accidents and serious personal injuries.

- Volkswagen strongly recommends to only use accessories approved by Volkswagen and Genuine Volkswagen Parts®. These parts and accessories have been evaluated by Volkswagen for their suitability, reliability and safety.
- Have repairs and vehicle modifications performed by an authorized Volkswagen dealer or authorized Volkswagen Service Facility. Authorized Volkswagen dealers and authorized Volkswagen Service Facilities have the required tools, diagnostic equipment, repair information, and trained personnel to properly replace any airbag in your vehicle and assure system effectiveness in a crash.
- Only install parts on the vehicle that are consistent with factory-installed parts with respect to design and characteristics.
- Never store, mount or attach objects, such as cup or phone cradles, on or next to the airbag module covers or within the airbags deployment zones.
- Only use wheel rim/tire combinations approved by Volkswagen for the respective vehicle type.

## Break-in period

---

 Please first read and note the introductory information and heed the WARNINGS

Note applicable requirements for breaking in new parts.

### Breaking in a new engine

A new engine must be carefully broken in during the first 1000 miles (1600 km). During the first few hours of driving, the engine's internal friction is higher than later when all moving parts have been broken in.

Engine life is influenced by how you drive the vehicle for the first 1000 miles (1600 km). Even afterwards, driving at moderate engine speeds, especially when the engine is cold, will tend to reduce engine wear and help the engine to last longer and go farther. But do not drive at an excessively low engine speed, either. Always downshift if the engine is not running smoothly. **For the first 600 miles (1000 km):**

- Do not use full throttle.
- Don't let the engine speed get above 2/3 of the maximum speed.
- Do not tow a trailer.

**From 600 to 1000 miles (1000 to 1600 km):** Speed may *gradually* be increased to maximum permissible road and engine speed.

### New tires and brake pads

- New tires and replacing tires ⇒ *Tires and wheels*
- Brakes ⇒ *About the brakes*



Breaking in a new engine gently, will increase service life and reduce oil consumption.

## Parts and accessories

📖 Please first read and note the introductory information and heed the WARNINGS ⚠️

Volkswagen recommends that you consult an authorized Volkswagen dealer or authorized Volkswagen Service Facility before purchasing accessories, spare parts or other equipment. Always do so if you want to install additional accessories or replace parts. Your authorized Volkswagen dealer or authorized Volkswagen Service Facility can provide information about legal requirements and factory-recommended accessories, spare parts, and other equipment.

### WARNING

**Improper vehicle modifications and repairs affect the performance of the airbag system and cause malfunctions and severe personal injuries.**

- Never store, mount or attach objects, such as cup holders or phone cradles, on or next to the airbag module covers or within the airbags deployment zones.
- Objects on or near the surface where airbags are located can come loose and cause serious personal injury if the airbag deploys.

## Operating fluids and equipment

📖 Please first read and note the introductory information and heed the WARNINGS ⚠️

**Operating fluids and parts that wear out with use** (such as timing belts, tires, engine coolants, engine oils, spark plugs, and vehicle batteries) are constantly being improved. For this reason, it is important to have operating fluids changed and wearing parts replaced by an authorized Volkswagen dealer or authorized Volkswagen Service Facility. Authorized Volkswagen dealers and authorized Volkswagen Service Facilities are always up-to-date regarding new developments and changes.

### WARNING

**Improper use of operating fluids and equipment can cause accidents, serious personal injuries, burns and/or poisoning.**

- Always store vehicle care products in a safe place in original-containers that are securely closed.
- To reduce the risk of poisoning, never use empty food or beverage containers that might mislead someone into drinking from them.
- Always keep vehicle care products out of the reach of children.
- Always read and heed all the instructions and all WARNINGS on the package before using vehicle care products.
- When using products that give off harmful fumes, always work outdoors or in a well ventilated area.
- Never use fuel, turpentine, engine oil, nail polish remover or other volatile fluids for vehicle care. They are poisonous and highly flammable. They could cause fires and explosions!

### NOTICE

- Only refill with suitable operating fluids. When changing or topping off fluids, make sure that you pour the fluids into the correct reservoirs. Adding incorrect fluids will cause serious malfunctions and engine damage! Under no circumstances should you mix up operating fluids. Otherwise serious malfunctions and engine damage can occur!

- **Accessories and other things installed in front of the cooling air intakes impair the efficiency of the engine coolant. The engine can overheat under high outside temperatures or under high engine loads!**



Leaking operating fluids can pollute the environment. Collect leaking operating fluids in suitable containers and dispose of them properly in accordance with applicable environmental laws and regulations.

## Repairs and technical modifications

---

Please first read and note the introductory information and heed the **WARNINGS**

**Volkswagen guidelines for repairs and technical modifications must be followed** ⇒ !

Changes to electronic components and related software can cause malfunctions. These malfunctions can also affect other systems that are related to the component or software that was modified. The vehicle's operational safety can be seriously jeopardized, increased vehicle component wear can occur, and the vehicle may no longer meet applicable emissions requirements.

Volkswagen recommends having all repairs and technical modifications performed by an authorized Volkswagen dealer or authorized Volkswagen Service Facility using **Genuine Volkswagen Parts**<sup>®</sup>.

Damage that is caused by improper repairs or unapproved technical modifications will not be covered by any Volkswagen Limited Warranty.



### **WARNING**

**Improperly performed repairs and modifications can cause vehicle damage and malfunctions, and can impair the efficiency of driver assistance systems. This can lead to accidents and severe personal injuries.**

- **Have repairs and vehicle modifications done by an authorized Volkswagen dealer or an authorized Volkswagen Service Facility.**



### **NOTICE**

**Improperly performed repairs and modifications can cause increased component wear and result in vehicle emissions that no longer meet applicable requirements.**

## Repairs and other things that can affect Advanced Airbag performance

---

Please first read and note the introductory information and heed the **WARNINGS**

Repairs and modifications of front bumpers, doors, front seats, headliners and the chassis can affect proper airbag performance and should be performed by an authorized Volkswagen dealer or authorized Volkswagen Service Facility. These vehicle areas can contain important parts of the airbag system.

Components of the airbag system can be damaged during removal, assembly and repair activities on the airbag system itself or related components. Damage to airbag parts can prevent the system from working properly in a collision.

Observe all regulations so that the effectiveness of the airbag is not affected and to prevent disassembled parts from causing injuries and pollution. Authorized Volkswagen dealers, authorized Volkswagen Service Facilities, and other qualified workshops are familiar with these regulations.

Changing the vehicle's suspension system can change the way that the airbag system works in a crash. For example, using tire-rim combinations not approved by Volkswagen, lowering the vehicle, changing the stiffness of the suspension, including the springs, suspension struts, shock absorbers etc. can change the forces that are measured by the airbag sensors and sent to the electronic control unit. Some suspension changes can, for example, increase the force levels measured by the airbag sensors and sent to the electronic control unit and make the airbag system deploy in crashes in which it would not deploy if the changes had not been made. Other kinds of changes may reduce the force levels measured by the sensors and prevent the airbag from deploying when it should.

Never install leather upholstery on a vehicle that originally had cloth upholstery. Never install cloth upholstery on a vehicle that originally had leather upholstery. The weight-sensing mat for the Advanced Airbag system will not work properly if different upholstery is installed on the passenger seat than the upholstery originally installed on the vehicle when it was originally manufactured.

 **WARNING**

**Changing the vehicle's suspension including use of unapproved tire-rim combinations can change airbag performance and increase the risk of serious personal injury in a crash.**

- Never install suspension components that do not have the same performance characteristics as the components originally installed on your vehicle.
- Never use tire-rim combinations that have not been approved by Volkswagen.

 **WARNING**

**Leaving the optional safety belt extender attached to the safety belt buckle on the front passenger seat when the safety belt is not being used will prevent the Advanced Airbag System from working properly and can increase the risk of serious personal injury in a collision.**

- Leaving the extender attached to the safety belt buckle when the front seat is occupied and the safety belt is not being used will signal to the airbag control unit that the front passenger seat is occupied and that the safety belt is being used. The electronic control unit for the airbag system will then receive incorrect information that will
  - cause the safety belt pretensioner to deploy unnecessarily in collisions and
  - cause the front passenger airbag to deploy later in collisions in which the front airbag would otherwise be triggered earlier to help protect an unrestrained front seat passenger.
- Always remove the safety belt extender when it is not needed and stow it safely.
- Never use the safety belt extender to secure a child restraint.

 **WARNING**

**Items stored between the safety belt buckle and the center console can cause safety belt buckle to send the wrong information to the airbag control unit and prevent the Advanced Airbag System from working properly.**

- Always make sure that nothing can interfere with the safety belt buckles and that they are not obstructed.





## WARNING

Improper care and servicing, and improper modification and repair work, can increase the risk of personal injury and death by preventing an airbag from deploying when needed or deploying an airbag unexpectedly:

- Never repair, adjust, or change any parts of the airbag system.
- All work on the airbag system, steering wheel, instrument panel, front seats or electrical system (including the installation of audio equipment, cellular telephones and CB radios, etc.) should be performed by authorized Volkswagen dealers or authorized Volkswagen Service Facilities. They have the necessary manuals, training, and special equipment.
- The airbag system can be activated only once. After an airbag has inflated, it must be replaced.
- Use only original equipment airbags approved by Volkswagen. Have them installed by a trained technician who has the necessary tools and diagnostic equipment to properly replace any airbag in your vehicle and assure system effectiveness in a crash.
- Never permit salvaged or recycled airbags to be installed in your vehicle.



Undeployed airbag modules and safety belt pretensioners are classified as **Perchlorate Material**. Special handling may apply – see <http://www.dtsc.ca.gov/hazardouswaste/perchlorate>. Obey all applicable legal requirements regarding handling and disposal of the vehicle or parts of its restraint system, including airbag modules and safety belts with pretensioners. Authorized Volkswagen dealers and authorized Volkswagen Service Facilities are familiar with the requirements, and we recommend that you have them perform this service for you.

## Notice about data recorded by vehicle control modules

---

Please first read and note the introductory information and heed the WARNINGS

Your vehicle is **not equipped** with an Event Data Recorder (EDR).

EDRs, sometimes called “crash recorders,” are installed by some manufacturers for the express purpose of capturing data for retrieval after an accident or crash event.

Some state laws restrict the retrieval or downloading of data stored by EDRs installed in a vehicle for the express purpose of retrieving data after an accident or crash event without the owner's consent.

Although your vehicle is not equipped with an EDR, it is equipped with a number of electronic control modules for various vehicle systems, such as engine management, emission control, airbags, and safety belts.

These electronic control modules also record data during normal vehicle operation for diagnostic and repair purposes. Their recording capability is limited to data (no sound is recorded). Only a small amount of data is actually recorded over a very limited period of time, or stored when a system fault is detected by a control module. Some of the data stored may relate to vehicle speed, direction, or braking, as well as restraint system use and performance in the event of a crash. Stored data can only be read and downloaded with special equipment.

## Using the mobile phone without a vehicle integrated antenna - some important things to know

---

Please first read and note the introductory information and heed the WARNINGS

Mobile or mobile telephones send and receive radio waves, sometimes called “radiofrequency energy” (RF energy), both when they are being used and when they are in stand-by mode. Current scientific literature indicates that radio waves that exceed a certain level can have effects on the human body.

Limits and guidelines have been established by governmental authorities and international committees in an effort to keep the electromagnetic radiation from mobile phones at levels that will not cause health problems. However, there is no scientifically based proof that wireless phones are absolutely safe.

Therefore some experts recommend a precautionary approach regarding the use of mobile phones by taking measures that lower the personal exposure to electromagnetic fields.

When using a mobile phone inside a motor vehicle without a proper connection to an integrated vehicle telephone antenna, the personal exposure to electromagnetic fields will be higher than when using the mobile telephone while properly connected to an integrated or other outside vehicle telephone antenna.

Your vehicle may be equipped with an optional hands-free system that will permit many of the features of compatible Bluetooth<sup>®</sup> enabled mobile telephones to be used for greater convenience and is consistent with the laws of an increasing number of states and localities that prohibit the use of mobile telephones without some kind of hands-free device.

The hands-free system in your vehicle can be used with certain mobile phones that are connected by wire and hardware connector or via compatible Bluetooth<sup>®</sup> enabled phones with a cradle that is designed to fit your mobile telephone. The special cradle offers several advantages: The phone cradle must be safely secured to the base plate. Your phone is firmly attached to the instrument panel and is within reach at all times. Placing the phone in its cradle permits it to be charged, but more importantly connects the mobile phone to the vehicle's outside antenna. A mobile telephone that is properly connected to the integrated or other outside vehicle telephone antenna will lower the personal exposure to electromagnetic fields. You should also experience a better quality of service. Although a mobile telephone can be used inside your vehicle without a cradle, the phone will not be securely attached to the vehicle, will not be charged through the cradle wiring, and more importantly will not be connected to the vehicle's integrated telephone antenna. The mobile phone will also not be recharged. You might also experience more dropped calls and an overall impaired quality of the connection.

Therefore we strongly recommend that you use your mobile telephone in your vehicle only when it is properly attached to an appropriate cradle mounted on a base plate on the instrument panel.

Because of the large number and variety of mobile telephones on the market and the frequency with which new models are introduced, Volkswagen does not offer cradles for mobile telephones. Please check with the manufacturer of the mobile telephone that you plan to use.

Bluetooth<sup>®</sup> is a registered trademark of Bluetooth<sup>®</sup> SIG, Inc.

### **WARNING**

**A mobile phone on the seat, instrument panel or in other places can be thrown around the inside of the vehicle during a sudden braking maneuver, a crash or other accident and injure vehicle occupants.**

- **Never place or attach accessories or other objects (such as cup holders, telephone brackets, notepads, navigation systems, large, heavy or bulky objects) on the doors, on the windshield, over or near the area marked "AIRBAG" on the steering wheel, instrument panel, backrests or between these areas and the occupant. Such objects could cause serious injury in a collision, especially if an airbag inflates.**



## **WARNING**

Using a mobile phone or CB radio inside the vehicle without a properly installed and separate outside antenna can be dangerous to your health and that of your passengers because the electromagnetic radiation energy that mobile phones and CB radios emit may be above established limits. This also applies if the outside antenna is not installed properly.

- Always keep the mobile phone antenna at least 8 in (20 cm) away from pacemakers. Heart specialists advise that mobile phones can adversely affect the way of pacemakers work.
- Never carry a mobile phone that is switched on in the breast pocket directly over a pacemaker.
- If you suspect there may be interference with a pacemaker or other medical device, switch the mobile phone off immediately.

## Consumer information

### Introduction

---

In this section you'll find information about:

Operating your vehicle outside of the United States and Canada  
Radio antenna and reception  
Volkswagen service information

**More information:**

- Exterior views
- Technical data
- Parts, accessories, repairs and modifications
- ⇒ booklet *Warranty and Maintenance*

#### **WARNING**

**Improper vehicle care and use, as well as improper changes to the vehicle, increase the risk of accidents and injuries.**

- Obey all applicable legal requirements.
- Read your Owner's Manual and heed all WARNINGS.

#### **NOTICE**

**Improper vehicle care and use, as well as improper changes to the vehicle, can result in damage to the vehicle.**

- Obey all applicable legal requirements.
- Perform service according to the specifications in ⇒ booklet *Warranty and Maintenance*.
- Read your Owner's Manual and heed all WARNINGS.

### Operating your vehicle outside of the United States and Canada

 Please first read and note the introductory information and heed the WARNINGS 

Government regulations in the United States and Canada require that automobiles meet specific emission regulations and safety standards. Therefore, vehicles built for the U.S. and Canada differ from vehicles sold in other countries.

If you plan to take your vehicle outside the continental limits of the United States or Canada, there is the possibility that:

- Unleaded fuels for vehicles with catalytic converters may not be available.
- Fuel may have a considerably lower octane rating and may cause engine damage.
- Service may be inadequate due to lack of proper service facilities, tools or testing equipment.
- Replacement parts may not be readily available.

- DVD navigation systems for vehicles built for the United States and Canada will not necessarily work in Europe, and may not work in other countries outside of North America.

## NOTICE

**Volkswagen is not responsible for mechanical damage that may result from substandard fuel or service or the unavailability of Genuine Volkswagen parts.**

- **Volkswagen is not responsible if the vehicle does not meet the respective legal requirements in other countries and continents.**

## Radio antenna and reception

---

 **Please first read and note the introductory information and heed the WARNINGS **

If the radio and navigation systems were installed at the factory, the radio antenna may be installed in different locations in the vehicle:

- On the inside of the rear window with the rear window defroster,
- On the inside of the rear side windows,
- On the inside of the windshield,
- On the vehicle roof.

Antennas on the insides of windows are thin wires.

## NOTICE

**Antennas installed on the insides of windows can be damaged by abrasive objects or by corrosive or acidic cleaning agents or other chemicals. Do not place any stickers on the windshield-integrated antenna and never clean the antenna with corrosive or acidic cleaning agents or other chemicals.**

 If electrical devices are operated close to the integrated windshield antenna, interference with AM radio reception may occur.

## Volkswagen service information

---

 **Please first read and note the introductory information and heed the WARNINGS **

Volkswagen service information is published as soon as possible after model introduction.

To order service information contact:

Volkswagen Technical Literature Ordering Center

<http://www.vw.techliterature.com>

## WARNING

**Improperly performed repairs and modifications can cause vehicle damage and malfunctions, and can impair the efficiency of driver assistance systems and the airbag system. This can lead to accidents and severe personal injuries.**

- **Have repairs and vehicle modifications performed by an authorized Volkswagen dealer or an authorized Volkswagen Service Facility.**

# Declaration of Compliance, Telecommunications and Electronic Systems

---

Radio Frequency Devices and Radio communication Equipment User Manual Notice.

## Radio-based equipment

- Mobile phone package
- Electronic immobilizer.
- Remote control vehicle key.
- Keyless Access locking and starting system.

## These devices comply with:

### FCC Part 15.19

These devices comply with **Part 15 of the FCC Rules**. Operation is subject to the following 2 conditions:

- (1) This device may not cause harmful interference, and
- (2) this device must accept any interference received, including interference that may cause undesired operation.

### FCC Part 15.21

#### CAUTION:

Changes or modifications not expressly approved by the party responsible for compliance could void the user's authority to operate the equipment.

These devices comply with **RSS-210 of Industry Canada**.

Operation is subject to the following 2 conditions:

- (1) This device may not cause interference, and
- (2) this device must accept any interference, including interference that may cause undesired operation of the device.

The manufacturer is not responsible for any radio or TV interference caused by unauthorized modifications to this equipment.

## Reporting Safety Defects

---

If you believe that your vehicle has a defect which could cause a crash or could cause injury or death, you should immediately inform the National Highway Traffic Safety Administration (NHTSA) in addition to notifying Volkswagen of America, Inc. 3800 Hamlin Road, Auburn Hills, MI 48326.

If NHTSA receives similar complaints, it may open an investigation, and if it finds that a safety defect exists in a group of vehicles, it may order a recall and remedy campaign. However, NHTSA cannot become involved in individual problems between you, your dealer, or Volkswagen of America, Inc.

To contact NHTSA, you may call the Vehicle Safety Hotline toll-free at 1-888-327-4236 (TTY: 1-800-424-9153);

go to <http://www.nhtsa.gov>;

or write to:

Administrator  
NHTSA  
1200 New Jersey Avenue, SE.  
Washington, D.C. 20590

You can also obtain other information about motor vehicle safety from  
<http://www.safercar.gov>.

<http://www.tc.gc.ca/eng/roadsafety/menu.htm>

# Engine control and emission control system

## Introduction

---

In this section you'll find information about:

Indicator lights

Catalytic converter

### More information:

- Shifting
- Refueling
- Fuel
- Engine oil
- 12 Volt vehicle battery
- Notice about data recorded by vehicle control modules
- Towing

 **WARNING**

The vehicle exhaust system and the catalytic converter or diesel particulate filter get very hot. This can cause a fire and serious personal injury.

- Never park where parts of the hot exhaust system and catalytic converter could ignite flammable materials, such as brush, leaves, dry grass, spilled fuel, etc.
- Never apply additional undercoating or rustproofing on or near the exhaust manifold, exhaust pipes, catalytic converter, diesel particulate filter, or heat shields.

 **WARNING**

California Proposition 65 Warning

- Engine exhaust, some of its constituents, and certain vehicle components contain or emit chemicals known to the State of California to cause cancer and birth defects and reproductive harm. In addition, certain fluids contained in vehicles and certain products of component wear contain or emit chemicals known to the State of California to cause cancer and birth defects and reproductive harm.



## Indicator lights

---

 Please first read and note the introductory information and heed the WARNINGS 

Lights up	Possible cause	Proper response
-----------	----------------	-----------------





Lights up	Possible cause	Proper response
	Engine control malfunction (Electronic Power Control).	Have engine checked immediately by an authorized Volkswagen dealer or authorized Volkswagen Service Facility.
	Engine control/monitoring system malfunction (engine Malfunction Indicator Light - MIL).	Ease off the accelerator. Carefully drive to the nearest authorized Volkswagen dealer or authorized Volkswagen Service Facility. Have engine checked.

Flashes	Possible cause	Proper response
	Misfire, which can damage the catalytic converter.	Ease off the accelerator. Carefully drive to the nearest authorized Volkswagen dealer or authorized Volkswagen Service Facility. Have engine checked.

When the ignition is switched on, several warning and indicator lights come on briefly for a function check. They go out after a few seconds.

### NOTICE

**Failure to heed warning lights or text WARNINGS can result in vehicle damage.**

 As long as the indicator lights  or **EPC** are on, expect engine malfunctions, increased fuel consumption and loss of engine efficiency.

## Catalytic converter

 **Please first read and note the introductory information and heed the WARNINGS** 

The catalytic converter provides exhaust gas after-treatment to help reduce pollutants in the exhaust gas. To help ensure long service life of the exhaust system and gasoline engine catalytic converter:

- Only use unleaded fuel.
- Never completely empty the fuel tank.
- Do not exceed the correct oil level ⇒ *Engine oil*.
- Do not tow the vehicle to start it, but use a jump-start instead ⇒ *Jump-starting*.

If you experience misfires, loss of power or the engine is not running smoothly while driving, reduce speed immediately and have the vehicle checked by an authorized Volkswagen dealer or authorized Volkswagen Service Facility. Otherwise, gasoline could reach the exhaust system and get into the atmosphere. The catalytic converter could also be damaged by overheating!

## Frequently asked questions (FAQ)

If you suspect a malfunction or vehicle damage, read and follow the following advice **before** contacting an authorized Volkswagen dealer or an authorized Volkswagen Service Facility. You may also find helpful information under "Characteristics" and "Checklist" in the index.

Description	Possible causes among others	Possible remedy
Engine does not start.	Vehicle battery dead.	<ul style="list-style-type: none"> <li>– Perform jump start</li> <li>– Charge vehicle battery</li> </ul>
	The wrong remote control vehicle key is used.	Use a valid remote control vehicle key
	Fuel level too low.	Refuel
Vehicle cannot be locked or unlocked using remote control vehicle key.	<ul style="list-style-type: none"> <li>– Battery in remote control vehicle key dead.</li> <li>– Too far away from vehicle. (out of range).</li> <li>– Buttons have been pressed too many times.</li> </ul>	<ul style="list-style-type: none"> <li>– Replace battery in the remote control key <ul style="list-style-type: none"> <li>– Move closer to vehicle.</li> </ul> </li> <li>– Synchronize remote control vehicle key</li> <li>– Lock or unlock vehicle manually</li> </ul>
Unusual noises.	Cold engine, braking support systems, electronic parking brake.	Check the "Noises" entry in the keyword index.
Odd driving behavior.	Assistance systems activated.	Check the "Assistance systems" entry in the index.
Driver seat and outside mirrors move when vehicle is unlocked.	Convenience settings are stored.	Correct convenience settings
	Memory-seat settings are stored.	<ul style="list-style-type: none"> <li>– Reassign seat setting</li> <li>– Clear memory-seat memory</li> </ul>
Front seats cannot be adjusted with power controls.	Vehicle battery dead.	Charge vehicle battery
	Fuse blown.	Check fuse and replace if necessary
Features do not work as described in this manual.	Settings were adjusted in the Volkswagen Information System.	Check and reset to factory settings if necessary
Headlights do not light up the road as they should.	<ul style="list-style-type: none"> <li>– Headlights incorrectly adjusted.</li> <li>– Light bulbs burned out.</li> <li>– Low beams not switched on.</li> </ul>	Have the headlight range adjusted by an authorized Volkswagen dealer or an authorized Volkswagen Service Facility. Adjust headlight range – <ul style="list-style-type: none"> <li>Change light bulbs</li> <li>– Switch on low beams</li> </ul>

Description	Possible causes among others	Possible remedy
Electrical consumers do not work.	Vehicle battery charge too low.	Charge vehicle battery
	Remaining fuel level too low.	Refuel
	Fuse blown.	Check fuse and replace if necessary
Fuel consumption higher than indicated.	<ul style="list-style-type: none"> <li>– Short hauls.</li> <li>– “Jumpy accelerator pedal”.</li> </ul>	<ul style="list-style-type: none"> <li>– Avoid short distance driving.</li> <li>– Drive defensively.</li> <li>– Accelerate smoothly.</li> </ul>
	Electrical loads switched on.	Switch off unnecessary loads.
	Engine control malfunctioning.	Have the malfunction corrected
	Tire pressure too low.	Adjust tire pressure
	Driving in the mountains.	No direct corrective action possible.
	Towing a trailer or driving with a roof rack.	<ul style="list-style-type: none"> <li>– Check use.</li> <li>– Remove if not in use.</li> </ul>
	Driving with heavy payload.	No direct corrective action possible.
	Driving at high engine speed.	Select a higher gear.

## Lift points for the vehicle

---

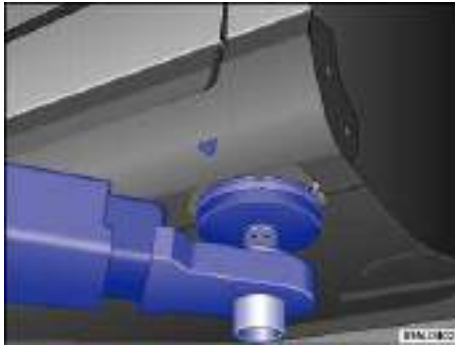

Fig. 175 Front lift point for workshop hoist or floor jack.

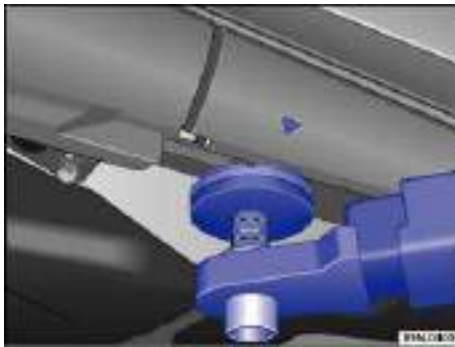

Fig. 176 Rear lift point for workshop hoist or floor jack.

The vehicle may only be raised at the lift points shown in illustrations ⇒ [fig. 175](#) and ⇒ [fig. 176](#). If the vehicle is lifted at different points, vehicle damage ⇒ ⚠ and serious injuries may occur ⇒ ⚠.

Workshop hoists that use fluid cushions (receiving platforms) must not be used for lifting the vehicle.

There are many precautions that have to be followed when lifting a vehicle on a workshop hoist or floor jack. Do not try to lift a vehicle on a workshop hoist or floor jack unless you have the training, knowledge and experience to be able to do so safely.

Information about lifting the vehicle jack ⇒ *Lifting the vehicle with the vehicle jack*.



## WARNING

Improperly lifting your vehicle with workshop hoist or a floor jack can cause the vehicle to fall off and cause serious personal injury.

- Always read and heed the operating instructions from the floor jack manufacturer and legal regulations if necessary before using the floor jack to lift the vehicle.
- Never let anyone stay in the vehicle when it is being lifted or when it is off the ground.
- Always lift your vehicle only at the designated lift points shown in the illustrations ⇒ [fig. 175](#) and ⇒ [fig. 176](#). Not using the designated lift points can cause the vehicle to fall off the floor jack when heavy parts such as the engine or transmission are removed.
- Always make sure that the vehicle's lift points lie as flat as possible and centered on the carrier plates of the floor jack.
- Never start the engine when you have raised the vehicle on the floor jack. The engine vibrations and vehicle movements could knock the vehicle off the floor jack.
- If you must work under a vehicle raised on a floor jack, always make sure that the vehicle is safely supported on safety stands intended for that purpose that are strong enough to support the weight of the vehicle.
- Never use the floor jack as a ladder or step ladder.
- Always make sure that the weight of the vehicle is not heavier than the lifting capacity of the floor jack and safety stands being used.



## NOTICE

- To help prevent serious vehicle damage, never lift the vehicle by the engine oil pan, transmission housing, or by the front or rear axles or suspension.
- To help prevent damage to the underbody or chassis, always insert a rubber pad between the hoist and the lifting points. In addition make sure the lifting arms have enough clearance.
- The lifting arms should not touch side sills or other parts of the vehicle.

## In an emergency

### Introduction

---

In this section you'll find information about:

Protecting yourself and the vehicle

**More information:**

- Braking and parking
- Emergency closing and opening
- Vehicle tool kit
- Changing a wheel

** WARNING**

A vehicle breakdown in traffic is dangerous and creates a great risk for you, your passengers, and others.

- Always stop the vehicle as soon as it is safe to do so. Move the vehicle a safe distance off the road where it is safe to park and, if necessary, lock all doors in an emergency. Turn on the emergency flashers and set up another warning device about 25 yards (25 meters) behind the vehicle to warn approaching traffic.
- Never leave children, disabled persons, or anyone who cannot help themselves alone in the vehicle when locking the doors. This could result in people being trapped in the vehicle in an emergency. Depending on the time of year, people trapped in the vehicle can be exposed to very high or very low temperatures.

### Protecting yourself and the vehicle

---



Fig. 177 In the center of the instrument panel: Switch for emergency flashers.

 Please first read and note the introductory information and heed the WARNINGS 



Obey all legal requirements regarding protecting a broken-down vehicle. For example, turning on the emergency flashers and wearing a safety vest are mandatory in many countries.

## Checklist

---

For your own safety and that of your passengers, carry out the following steps in the order listed

⇒ :

1. Park the vehicle at safe distance from traffic and on a suitable surface ⇒ .
  2. Switch on emergency flashers by pressing the  switch ⇒ [fig. 177](#).
  3. Apply the electronic parking brake to help prevent the vehicle from moving ⇒ *Braking and parking*.
  4. Shift the transmission into Park (**P**) (automatic) or Neutral (manual only)
  5. Stop the engine and remove the key from the ignition switch ⇒ *Starting and stopping the engine*.
  6. Have all passengers exit and go to a safe location away from moving traffic, such as behind a guard rail.
  7. Take all vehicle keys with you when leaving your vehicle.
  8. Set up a warning triangle or other warning device in order to alert other motorists and cyclists.
  9. Let the engine cool down and get expert assistance if necessary.
- 

If the emergency flashers are on, use the turn signal lever to indicate a direction or lane change, for example when the vehicle is being towed. This temporarily interrupts the emergency flashers.

### Switch on the emergency flashers when:

- Traffic suddenly slows down or stops in front of you to warn those approaching from behind.
- In any emergency situation.
- If the vehicle breaks down.
- When being towed.

Always obey traffic laws that govern the use of emergency flashers where you are driving.

If the emergency flashers are not working, a different method – as permitted by law – must be used to alert other motorists and cyclists to the breakdown.

### **WARNING**

**Disregarding the safety-related checklist may lead to accidents and serious personal injuries.**

- **Always review and follow the checklist. Follow accepted safety practices and use common sense.**

### **WARNING**

**The vehicle exhaust system and the catalytic converter or diesel particulate filter get very hot. They can cause fires and serious personal injury.**

- **Never park where parts of the hot exhaust system or catalytic converter could ignite flammable materials, such as dry grass, brush, leaves, spilled fuel, etc.**



The vehicle battery will be drained if the emergency flashers are on for a long time – even if the ignition is switched off.

# Emergency closing and opening

## Introduction

---

In this section you'll find information about:

- Manually unlocking and locking the driver door
- Manually locking the passenger doors
- Opening the rear hatch from inside the luggage compartment
- Emergency fuel filler flap release
- Emergency release for the selector lever lock

The doors and the rear hatch can be manually locked and, in some cases, unlocked if necessary, for instance because the power locking system or the remote control vehicle key malfunctions.

Emergency closing of the power sunroof is not possible with means in the vehicle. Contact an authorized Volkswagen dealer or authorized Volkswagen Service Facility for assistance.

### **More information:**

- Vehicle key set
- Power locking and closing system
- Doors
- Rear hatch
- Power sunroof
- In an emergency

### **WARNING**

**Serious injuries can result if the emergency closing and opening procedures are used carelessly.**

- **Never leave children, disabled persons, or anyone who cannot help themselves in the vehicle. The doors can be locked with the remote control vehicle key. This could result in people being trapped in the vehicle in an emergency.**
- **A closed vehicle can become very hot or very cold, depending on the season. Particularly in the summer, heat buildup in the passenger and luggage compartment of a parked vehicle can result in temperatures in the vehicle that are much higher than the outside temperatures. Temperatures can quickly reach levels that can cause unconsciousness and death, particularly to small children.**

### **WARNING**

**Careless opening and closing of doors, the rear hatch, and the power sunroof is dangerous and can cause serious personal injury.**

- **Open or close doors, the rear hatch, and the power sunroof only when no one is in the way.**

### **NOTICE**

**To help prevent vehicle damage, carefully remove and properly reinstall parts after emergency locking or unlocking.**



## Manually unlocking and locking the driver door

---

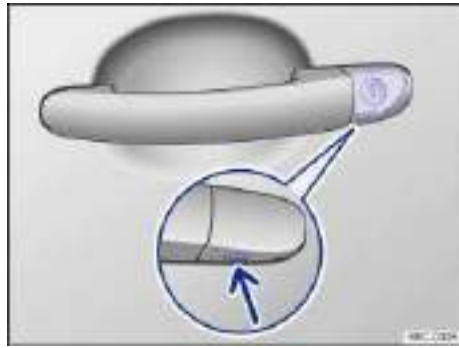

Fig. 178 Door handle on driver door: Concealed lock cylinder.

### **⚠ Please first read and note the introductory information and heed the WARNINGS**

When locking the vehicle manually, all doors are locked. Keep the key turned in the locking position to close all windows and the power sunroof (convenience closing). When the vehicle is unlocked manually, only the driver door is unlocked. Keep the key turned in the unlocking position to open all windows. Note the instructions for the anti-theft alarm system ⇒ *Anti-theft alarm system*.

- Unfold the key bit from the remote control vehicle key ⇒ *Vehicle key set*.
- Insert the key bit from below into the opening of the cover cap on the driver door ⇒ [fig. 178](#) (arrow) and lift the cover cap off. Grasping the door handle and pulling slightly makes it easier to remove the cap.
- Insert the key bit into the lock cylinder of the driver door and unlock or lock the door.
- Reinsert the cover cap from top to bottom and press until it clicks into place. Grasping the door handle and pulling slightly makes it easier to install the cap.

### **Special considerations when unlocking**

- If the vehicle is equipped with an The anti-theft alarm system, the system remains activated for the unlocked vehicle. But no alarm is triggered at first ⇒ *Power locking and closing system*.
- Open the driver door; the alarm will sound if the ignition is not switched on within about 15 seconds.
- Switch on the ignition. The electronic immobilizer recognizes a valid remote control vehicle key when the ignition is switched on and deactivates the anti-theft alarm system.



The driver door can be unlocked separately from the inside the vehicle by pulling the door handle to open the door ⇒ *Power locking and closing system*.



The anti-theft alarm system is not activated when the vehicle is locked manually with the key bit ⇒ *Power locking and closing system*.

## Manually locking the passenger doors



Fig. 179 On the front side of the right rear door: Emergency lock, covered by a rubber seal.



Fig. 180 On the front side of the right rear door: Manual vehicle locking with the key bit in the vehicle key.

### **⚠ Please first read and note the introductory information and heed the WARNINGS ⚠**

The passenger door and rear doors can each be locked manually. This will **not** activate the anti-theft alarm system.

- Open the door.
- Remove the rubber seal on the front side of the door. The seal is marked with a lock  ⇒ fig. 179.
- Unfold the key bit from the remote control vehicle key ⇒ *Vehicle key set*.
- Insert the key bit horizontally into the opening and press the small colored lever forward ⇒ fig. 180.
- Reinsert the rubber seal and completely close the door.
- Make sure that the door is locked.
- Repeat the procedure for other doors if necessary.
- Have the vehicle checked immediately by an authorized Volkswagen dealer or an authorized Volkswagen Service Facility.

 Doors can be unlocked and opened separately from inside the vehicle by pulling the door handle once. If necessary, pull the door handle again ⇒ *Power locking and closing system*.

## Opening the rear hatch from inside the luggage compartment

---

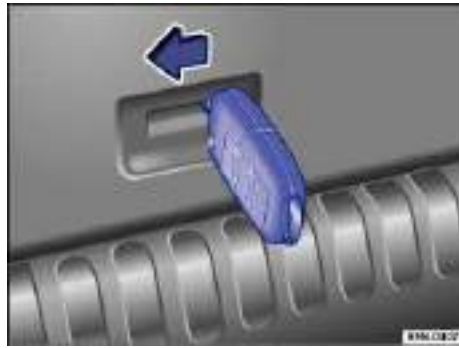

**Fig. 181** View from luggage compartment: Emergency unlocking rear hatch with the remote control vehicle key.

**ⓘ Please first read and note the introductory information and heed the WARNINGS ⚠**

- If necessary, fold the rear seat backrest forward ⇒ *Seat functions*.
- Remove luggage in order to reach the rear hatch from the inside.
- Unfold the key bit from the vehicle key fob ⇒ *Remote control vehicle keys*
- Insert the key bit into the opening in the rear hatch trim and press in the direction of the arrow ⇒ [fig. 181](#) to unlock the rear hatch.

## Emergency fuel filler flap release

---

**ⓘ Please first read and note the introductory information and heed the WARNINGS ⚠**

There is no emergency release for the fuel filler flap. Contact an authorized Volkswagen dealer or an authorized Volkswagen Service Facility for assistance.

## Emergency release for the selector lever lock

---



Fig. 182 Removing the selector gate cover.

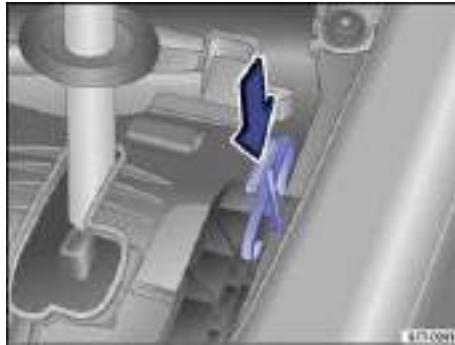

Fig. 183 Releasing the selector lever lock.

**⚠ Please first read and note the introductory information and heed the WARNINGS ⚠**

If the power supply fails (due to a dead vehicle battery, for example) and the vehicle has to be pushed or towed, the emergency release must be used to move the selector lever to Neutral (**N**).

The emergency release is located under the selector gate cover on the right side when viewed in driving direction.

### Preparations

- Set the electronic parking brake. If the electronic parking brake cannot be set, you must find another way to help prevent the vehicle from moving.
- Switch off the ignition.

### Removing the selector gate cover

- Pull upward on the cover around the selector lever sleeve ⇒ [fig. 182](#).
- Slip the cover up and over the selector lever ⇒ ⚠.

### Emergency release for the selector lever

- Push the release lever ⇒ [fig. 183](#) in the direction of the arrow and hold it in this position.

- Press the release button ⇒ [fig. 182](#) (arrow) in the selector lever handle and shift the selector lever to Neutral (**N**).

 **WARNING**

Never shift the transmission out of Park (P) without first firmly applying the parking brake. Otherwise, the vehicle can start to roll unexpectedly, especially on hills or inclines, and cause an accident and serious injuries.

 **NOTICE**

Even with the selector lever is in Neutral (N), the automatic transmission will be damaged if the vehicle is towed (or you let it coast) for an extended period or at high speed with the engine shut off.

## Vehicle tool kit

### Introduction

---

In this section you'll find information about:

Storage

Contents

Folding chocks

When securing the vehicle after a breakdown, always obey all applicable legal requirements.

**More information:**

- Power locking and closing system
- Anti-theft alarm system
- Lights
- Brakes
- Trailer towing
- Working in the engine compartment
- In an emergency
- Changing a wheel

 **WARNING**

Loose tools and other items in the vehicle tool kit and a loose compact spare wheel may be thrown through the passenger compartment if you brake suddenly or steer sharply or are involved in an accident. This can cause severe injuries.

- Always make sure the vehicle tool kit and compact spare wheel are securely stowed in the luggage compartment.

 **WARNING**

Improper or damaged vehicle tools can lead to accidents and injury.

- Never work with tool that are damaged or not right for the job.

## Storage

---



Fig. 184 On the left in the luggage compartment: Storage compartment.



Fig. 185 On the right in the luggage compartment: Storage compartment.

**ⓘ Please first read and note the introductory information and heed the WARNINGS ⚠**

The vehicle tool kit is in the storage compartment on the left in the luggage compartment ⇒ [fig. 184](#). Rotate the quick-release fasteners 90 ° to open the storage compartment.

**ⓘ** Completely retract the jack after use. Otherwise it will not fit in its compartment and cannot be stowed safely.

## Contents

---

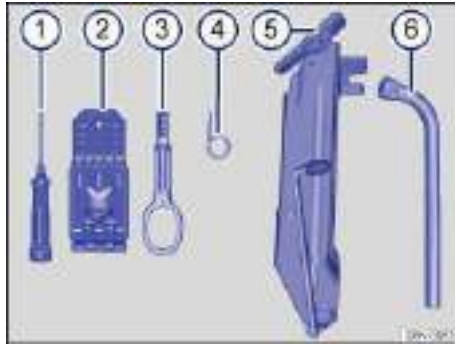

Fig. 186 Contents of the vehicle tool kit.

**⚠ Please first read and note the introductory information and heed the WARNINGS ⚠**

The contents of the vehicle tool kit depend on the vehicle configuration. The following describes the maximum contents.

**Contents of the vehicle tool kit** ⇒ [fig. 186](#)

- (1) Screwdriver with a hexagonal socket in the handle for removing or inserting previously loosened wheel bolts. The screwdriver blade is reversible. The screwdriver may be stored under the lug wrench.
- (2) Folding chocks ⇒ *Folding chocks*.
- (3) Screw-in towing eye.
- (4) Hubcap puller clips for removing hubcaps, full wheel covers or wheel bolt caps.
- (5) Jack. Before putting the jack back, be sure to completely crank the jack down to its original position. Then the crank must be clamped against the side of the jack.
- (6) Lug wrench.

## Folding chocks

---

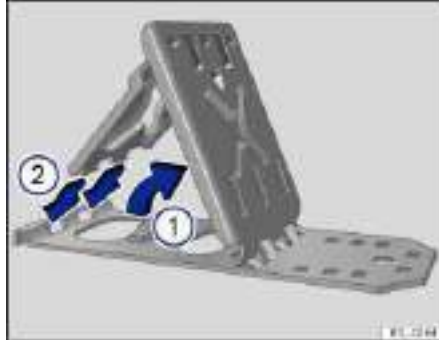

Fig. 187 Unfolding the folding chock.

**⚠ Please first read and note the introductory information and heed the WARNINGS ⚠**



The folding chock is in the vehicle tool kit ⇒ [fig. 186](#).

#### **Setting up the folding chock**

- Raise the support plate ⇒ [fig. 187 \(1\)](#).
- Insert both “lugs” of the securing plate completely in the elongated holes of the base plate [\(2\)](#).

#### **Proper use**

The folding chock can be used to block the wheel diagonal to the wheel which is to be changed.

The folding chock must be placed directly in front of and behind the wheel and may be used only on firm surfaces.



#### **WARNING**

**Improper setup or improper use of the folding chocks can cause accidents and injuries.**

- **Never use damaged folding chocks.**
- **Never use folding chocks to secure the vehicle on slopes.**

## Wheel trim

### Introduction

---

In this section you'll find information about:

Hubcaps

Wheel bolt caps

Wheel covers

**More information:**

- Exterior care and cleaning
- Vehicle tool kit
- Changing a wheel

#### **WARNING**

Unsuitable wheel covers and improper installation of wheel covers can cause accidents and severe injuries.

- Improperly installed wheel covers can come loose while driving and endanger other motorists and cyclists.
- Do not use damaged wheel covers.
- Always make sure that the flow of air for brake system cooling is not blocked or reduced before installing wheel covers. This applies to both factory installed wheel covers and aftermarket wheel covers. Insufficient air supply may significantly increase stopping distance.

#### **NOTICE**

To help prevent damage to the vehicle, be careful when removing wheel covers and be sure to install them properly.

## Hubcaps

---

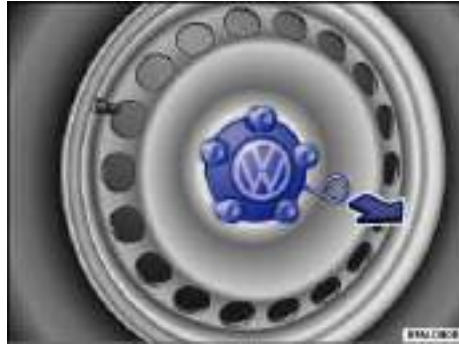

Fig. 188 Pulling off hubcap.

⚠ Please first read and note the introductory information and heed the WARNINGS ⚠

- To remove take the wire clip out of vehicle tool kit ⇒ fig. 186 (4) and hook it into the edge of the hubcap ⇒ fig. 188.
- Pull the hubcap off in the direction of the arrow.
- To install press hubcap against the rim until it latches.

The hubcaps are designed to protect the wheel bolts and should be firmly reinstalled after the wheel change.

## Wheel bolt caps

---



Fig. 189 Pulling cover caps off wheel bolts.

⚠ Please first read and note the introductory information and heed the WARNINGS ⚠

- Take the wire clip out of the vehicle tool kit ⇒ *Vehicle tool kit*.
- Insert the wire clip through the opening of the cover cap ⇒ fig. 189 and pull off in the direction of the arrow.

The caps are designed to protect the wheel bolts and should be installed again after the wheel change.

## Wheel covers

---



Fig. 190 Pulling the wheel cover off.

**⚠ Please first read and note the introductory information and heed the WARNINGS ⚠**

### **Pulling off the wheel cover**

- Take the lug wrench and wire clip out of the vehicle tool kit ⇒ *Vehicle tool kit*.
- Place the wire clip hook in one of the openings of the wheel cover.
- Slide the lug wrench through the clip ⇒ [fig. 190](#) and pull the wheel cover off in the direction of the arrow.

### **Installing the wheel cover**

Make sure that the valve cutout is aligned with the valve, and press the wheel cover onto the wheel rim. Make sure that the wheel cover is latched onto the rim along the entire circumference.

# Changing a wheel

## Introduction

---

In this section you'll find information about:

Preparations for changing a wheel

Wheel bolts

Lifting the vehicle with the vehicle jack

Changing a wheel

After changing a wheel

Removing Fender Premium Audio subwoofer

Some vehicle designs and models are not delivered with a jack and lug wrench. In such cases, Volkswagen recommends having tires and wheels changed by an authorized Volkswagen dealer or an authorized Volkswagen Service Facility.

Change a wheel by yourself only if the vehicle is parked in a safe location, you are familiar with safety procedures and the technical steps, and you have proper tools available. Otherwise, get expert assistance.

The vehicle jack can only be safely used to change the wheel on a vehicle that has only one flat or damaged tire. The vehicle will not have the support it needs from 3 fully inflated tires. The vehicle can fall off the jack. If more than one tire on the vehicle is flat or damaged, do not lift the vehicle with the vehicle jack. Instead, get expert assistance.

### **More information:**

- Exterior views
- Vehicle key set
- Tires and wheels
- In an emergency
- Vehicle tool kit
- Wheel covers

## WARNING

Changing a wheel, especially on the side of the road, can be dangerous. To help reduce the risk of serious personal injury:

- Always stop the vehicle as soon as it is safe to do so. Move the vehicle a safe distance off the road where it is safe to change the wheel.
- Always make sure that all passengers, especially children, are in a safe place outside the vehicle and away from the vehicle and traffic (such as behind a guard rail).
- Turn on the emergency flashers and set up another warning device about 25 yards (25 meters) behind the vehicle to warn approaching traffic.
- Change a wheel by yourself only if you are familiar with the necessary steps. Otherwise, get expert assistance.
- Always switch the engine off, apply the electronic parking brake, and shift the transmission into Park (P) (automatic transmission) or any gear (manual only) to help prevent the vehicle from moving suddenly and slipping off the jack.
- Always make sure that the ground is level and firm. If necessary, place the jack on a large and sturdy board or on a similar ground support.
- Always block the wheel diagonally opposite the wheel being changed with chocks or similar things.
- If you are towing a trailer, always unhitch it from your vehicle before starting to change the wheel. Always apply the trailer brakes firmly and make sure the trailer cannot move unintentionally.
- Always use proper and undamaged tools when changing a wheel.
- Once a wheel is lifted off the ground, having the transmission in Park (P) or in gear will not prevent sudden vehicle movement.
- Always use a jack that has been approved by the manufacturer for your vehicle. Never use other jacks, even if they have been approved for use on other Volkswagen models.
- To reduce the risk of losing control, crashes, and serious personal injuries, never loosen the screws on rims with threaded rim rings.
- After changing a wheel, have the wheel bolt tightening torque checked with an accurate torque wrench.
- After changing a wheel or tire, reset the Tire Pressure Monitoring System ⇒ *Tire Pressure Monitoring System (TPMS)*.

## Preparations for changing a wheel

 Please first read and note the introductory information and heed the WARNINGS 

### Checklist

Getting ready to change a wheel. Follow these steps in the order listed here ⇒ .

1. If you have a flat tire, move as far away from traffic as possible. Park the vehicle on a flat and level surface where no part of the hot catalytic converter and exhaust system can come into contact with flammable materials under the vehicle, such as dry grass, brush, spilled fuel, etc.
2. Apply the electronic parking brake to help prevent the vehicle from moving ⇒ *Braking and parking*.
3. Automatic transmission: Shift the transmission into Park (P) ⇒ *Shifting*.
4. Stop the engine and remove the key from the ignition switch ⇒ *Starting and stopping the engine*.
5. Manual transmission: Engage a gear ⇒ *Shifting*.

6. Have all passengers exit and go to a safe place, such as behind a guard rail.
7. Block the diagonally opposite wheel with chocks from vehicle tool kit or other suitable things.
8. If towing a trailer: Unhitch the trailer from the vehicle and park the trailer properly.
9. If the luggage compartment is loaded: Remove the luggage.
10. Raise and secure the luggage compartment floor.
11. If applicable: Remove the Fender Premium Audio subwoofer ⇒ *Removing Fender Premium Audio subwoofer*.
12. Unscrew the fastening screw with washer counterclockwise and remove.
13. Take the compact spare wheel out of the luggage compartment.
14. If applicable: Take off the wheel covers ⇒ *Wheel trim*.

### **⚠ WARNING**

**Disregarding the safety-related checklist may lead to accidents and serious personal injuries.**

- **Always review and follow the checklist. Follow accepted safety practices and use common sense.**

## Wheel bolts



**Fig. 191** Changing a wheel: Loosening wheel bolts.

**⚠ Please first read and note the introductory information and heed the WARNINGS ⚠**

Loosen the wheel bolts only with the lug wrench that was supplied with the vehicle.

Loosen the wheel bolts only about 1 turn before lifting the vehicle with the jack.

If a wheel bolt does not come loose, carefully push the end of the lug wrench with your foot. Make sure you are standing firmly on the ground and hold on to the vehicle for support.

### **Loosening the wheel bolts**

- Push the lug wrench over the wheel bolt all the way ⇒ [fig. 191](#).
- Holding the lug wrench at the end, loosen the wheel bolt by turning it counterclockwise about 1 complete turn (360 °) ⇒ ⚠.

### Important information regarding wheel bolts

The design of rims and wheel bolts is matched to the factory-installed wheels. If different wheels are installed, wheel bolts with the right length and bolt head shape must be used. The attachment of the wheels and function of the brake system depend on this.

It may not be possible to use wheel bolts from different vehicles of the same model.

### Wheel bolt tightening torque

Correctly tightened bolts for steel and alloy wheel rims should have a torque of **103 ft lbs (140 Nm)** for front-wheel drive vehicles and **88 ft lbs (120 Nm)** for vehicles with four-wheel drive (4MOTION). After changing a wheel, have the wheel bolt tightening torque checked right away with an accurate torque wrench.

**Before you check** the tightening torque, replace corroded and difficult-to-turn wheel bolts and clean the threads in the wheel hub.

Never grease or oil the wheel bolts and the threads in the wheel hubs. The bolts can come loose while driving if greased or oiled, even if tightened to the required torque.

### WARNING

**Improperly tightened wheel bolts can come loose while driving and cause you to lose control over the vehicle, resulting in accidents and serious injuries.**

- Only use wheel bolts that belong your vehicle and to the wheel being installed.
- Never use different wheel bolts.
- Wheel bolts and wheel hub threads must always be clean, easy-to-turn and free of oil and grease.
- Only use the lug wrench that is supplied with the vehicle to loosen the wheel bolts.
- Loosen the wheel bolts only about one turn before lifting the vehicle with the jack.
- Never grease or oil the wheel bolts and the threads in the wheel hubs. The bolts can come loose while driving if greased or oiled, even if tightened to the required torque.
- Never loosen bolted connections on wheel rims with bolted rim rings.
- If the wheel bolts are not tightened to the proper torque, the wheel can come off the vehicle when it is moving. Extremely high torque can damage the wheel bolts and/or their threads.

### Lifting the vehicle with the vehicle jack



Fig. 192 Lift points for the jack.



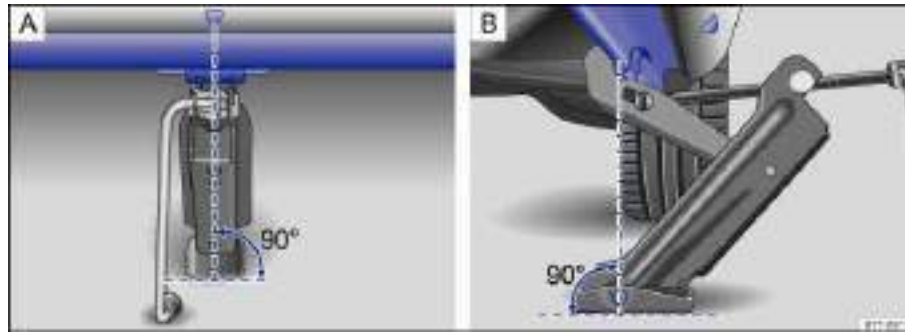

**Fig. 193** Jack in position at the left rear lift point.

**⚠ Please first read and note the introductory information and heed the WARNINGS ⚠**

The jack must be positioned at one of the four lift points marked on the vehicle body (2 on each side as shown in ⇒ [fig. 192](#)). You must use the lift point closest to the wheel being changed ⇒ ⚠.

The vehicle may only be lifted by a jack positioned at 1 of the 4 jack lift points.

Do not jack up the vehicle until all the wheel bolts on the wheel being changed have been loosened ⇒ *Wheel bolts*.

### **Checklist**

For your own safety and that of your passengers, carry out the following steps in the order listed ⇒ ⚠:

1. Find a level spot on firm ground for lifting the vehicle.
2. Switch off the engine. Automatic transmission: shift the transmission into Park (**P**), Manual transmission only: shift into a gear ⇒ *Shifting*. Then apply the parking brake to help prevent the vehicle from moving ⇒ *Braking and parking*.
3. If towing a trailer: Unhitch the trailer from the vehicle and park the trailer properly.
4. Straighten the steering wheel so that the front wheels point straight forward.
5. Block the diagonally opposite wheel with chocks or other suitable things.
6. Loosen the wheel bolts of the wheel to be changed
7. Remove the jack and tools from the vehicle.
8. Find the jack lift point on the vehicle frame that is closest to the wheel to be changed.
9. Crank up the jack so that it still just fits underneath the lift point.
10. Position the jack so that its base is directly underneath the lift point ⇒ [fig. 193](#), making sure that the entire base of the jack rests securely on the ground.
11. Align the jack and wind up the jack claw at the same time, until the claw cradles the vertical rib underneath the vehicle **A / B**.
12. Continue cranking up the jack until the wheel is just a little off the ground.

## **⚠ WARNING**

Improper use of your vehicle jack can cause the vehicle to fall off the jack leading to serious personal injury. To help reduce the risk of serious personal injury:

- Use only jacks approved by Volkswagen for the vehicle. Other jacks might slip, even those approved for other Volkswagen models, but not for your vehicle.
- Always set up the jack on firm and level ground. The vehicle may slip off the jack if the jack is resting on soft or sloping ground. If necessary place a sturdy board under the jack.
- On a hard, slippery surface (such as a tiled floor), use an anti-skid rubber mat or something similar to prevent the jack from slipping.
- Position the jack only at the described vehicle lift points. Before you raise your vehicle, always make sure the jack claw properly grips the vertical rib under the sill so that the jack does not slip off when you are raising the vehicle .
- Never have any part of your body (such as your arm or leg) under the vehicle when it is supported by the jack. Never let other persons have any part of their body under the vehicle, either!
- If you must work under a vehicle raised on a floor jack, always make sure that the vehicle is safely supported on safety stands intended for that purpose that are strong enough to support the weight of the vehicle.
- Never lift the vehicle when it is tilted or inclined to one side or the engine is running.
- Never lift the vehicle when more than one tire is flat or damaged.
- Do not start the engine while the vehicle is supported by a jack. Engine vibrations may cause the vehicle to slip off the jack.

## **⚠ WARNING**

Disregarding the safety-related checklist may lead to accidents and serious personal injuries.

- Always review and follow the checklist. Follow accepted safety practices and use common sense.

## Changing a wheel

---



**Fig. 194** Changing a wheel: Remove previously loosened wheel bolts using the screwdriver handle.

**⚠ Please first read and note the introductory information and heed the WARNINGS**

## Removing the wheel

- Review the checklist ⇒ *Preparations for changing a wheel.*
- Loosen the wheel bolts ⇒ *Wheel bolts.*
- Lift the vehicle ⇒ *Lifting the vehicle with the vehicle jack.*
- Completely unscrew and remove the previously loosened wheel bolts using the hexagonal socket in the screwdriver handle ⇒ [fig. 194](#). Place the wheel bolts on a clean surface.
- Remove the wheel.

## Installing a spare tire or a compact spare wheel

If the tire is a unidirectional tire, be sure to install it in the proper rolling direction ⇒ *Unidirectional tires.*

- Place the spare tire or compact spare into place on the vehicle.
- Screw in all wheel bolts clockwise and tighten them *slightly* using the hexagonal socket in the screwdriver handle.
- Lower the vehicle with the jack.
- Use the lug wrench to firmly tighten all wheel bolts (turn clockwise) ⇒ . Do not tighten them in sequence! Tighten any wheel bolt to begin, then tighten the wheel bolt diagonally opposite the first bolt, and so forth.
- Install the wheel bolt caps, center wheel hubcap, or wheel cover, if any ⇒ *Wheel trim.*

### **WARNING**

Wheel bolts that are tightened or installed improperly can come loose, causing loss of vehicle control, a crash, and serious personal injury.

- Always keep wheel bolts and threads in the wheel hub clean and free of oil and grease. The wheel bolts must turn easily and must be tightened with the right torque.
- Use the hexagonal socket in the screwdriver handle only to turn the wheel bolts when they are loose, never to loosen them or tighten them firmly.

### **WARNING**

Improper use of a compact spare tire can cause loss of vehicle control, a crash or other accident, and serious personal injury.

- Never use a compact spare tire if it is damaged or worn down to the wear indicators.
- Never drive faster than 50 mph (80 km/h) with a compact spare tire. Avoid full-throttle acceleration, heavy braking, and fast cornering!
- Never drive more than 125 miles (200 km) with a compact spare wheel that is installed on the front axle (drive axle).
- Replace the compact spare with a normal wheel and tire as soon as possible. Compact spare tires are designed for brief use only.

## After changing a wheel

 Please first read and note the introductory information and heed the **WARNINGS** 

- Clean the tools in the vehicle tool kit if necessary and stow them in the left storage compartment in the luggage compartment ⇒ *Vehicle tool kit.*

- Securely store the compact spare wheel or the wheel you took off the vehicle in the luggage compartment.
- Have the wheel bolt tightening torque immediately checked with a torque wrench ⇒ *Wheel bolts*.
- Have the damaged wheel replaced as soon as possible.

 The Tire Pressure Monitoring System must be "recalibrated" after each tire change ⇒ *Tire Pressure Monitoring System (TPMS)*.

## Removing Fender Premium Audio subwoofer

---

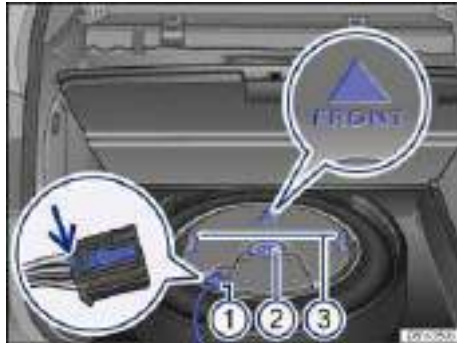

Fig. 195 Under the luggage compartment floor: Fender Premium Audio subwoofer.

 Please first read and note the introductory information and heed the WARNINGS 

The subwoofer is located under the luggage compartment floor.

### Removing the subwoofer

---

Follow these steps in the order listed here:

1. Completely unscrew the fastening screw ⇒ fig. 195 (2) counterclockwise and remove with metal cap.
2. Grasp the subwoofer by the handles (3) and partially remove it from the recess.
3. Disconnect the electrical connector (1) from the subwoofer by pressing the release tab in the direction of the arrow (close-up), then pulling the connector out of the socket.
4. Place the subwoofer in a clean storage location.

### Reinstalling the subwoofer

---

1. Grasp the subwoofer by the handles (3) and put it down close enough to allow the electrical connector (1) to be reconnected.
  2. Reinstall the subwoofer and put it back into the recess.
  3. The arrow must be pointing toward the front of the vehicle (close-up).
  4. Reinstall the fastening screw with metal cap and tighten it (2) clockwise.
  5. Lower the luggage compartment floor and guide it downwards back into place.
-

# Fuses

## Introduction

---

In this section you'll find information about:

Fuses in the vehicle

Replacing blown fuses

Due to ongoing development of the vehicle, configuration-dependent allocation of fuses and the combined fuse protection of multiple loads with one fuse, an up-to-date overview of the fuse location per load is not possible at the time of printing. Detailed information regarding fuse box layout is available from authorized Volkswagen dealers and authorized Volkswagen Service Facilities.

In general, one fuse can protect several loads. One load can also be protected by several fuses.

Find out why the fuse blew and correct the problem before replacing a blown fuse. If a newly replaced fuse blows again after a short time, the electrical system should be checked by an authorized Volkswagen dealer or an authorized Volkswagen Service Facility.

### More information:

- Working in the engine compartment

### WARNING

High voltage systems in the engine compartment can cause electrical shocks, severe burns, and even death!

- Never touch ignition cables. Never touch other components of the high voltage electronic ignition system.
- Avoid short circuits in the electrical system.

### WARNING

Using the wrong fuse, using a blown fuse that has been repaired, and using metal objects in place of fuses to complete the electrical connection in the circuit can cause fires and serious personal injury.

- Never replace a fuse with one that has a higher amp rating. Replace a blown fuse only with a fuse of the same amperage (same color and same imprint) and same overall size.
- Never repair fuses.
- Never replace fuses with a metal strip, a paper clip, or a similar object.

### NOTICE

- To help prevent damage to the electrical system, switch off all lights and accessories, switch off the ignition, and remove the key from the ignition switch before replacing a fuse.
- If a fuse is replaced with a fuse with higher amperage, this can also cause damage at different locations in the electrical system.
- Open fuse boxes must be protected from dirt and moisture. Dirt and moisture in fuse boxes can cause damage to the electrical system.

## Fuses in the vehicle

---

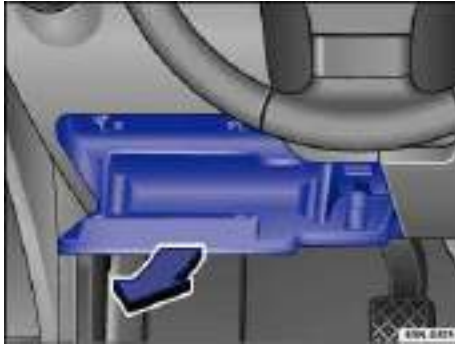

Fig. 196 On the driver side in the instrument panel: Fuse box cover.



Fig. 197 In the engine compartment: Fuse box cover.

⚠ Please first read and note the introductory information and heed the WARNINGS ⚠

Replace a blown fuse only with a fuse of the same amperage (same color and same imprint) and same overall size.

### Fuse color coding

Color	Current strength in amps
Purple	3
Light brown	5
Brown	7.5
Red	10
Blue	15

Color	Current strength in amps
Yellow	20
White or clear	25
Green	30
Orange	40

#### Opening the fuse box in the instrument panel

- Open storage compartment and pull back firmly in the direction of the arrow ⇒ [fig. 196](#).

#### Opening the fuse box in the engine compartment

- Open the engine hood 
- Move the release tabs in the direction of the arrows to unlock the fuse box cover ⇒ [fig. 197](#).
- Remove the cover upward.
- To **install** push the cover onto the fuse box. Move release buttons back opposite the direction of the arrows, until they audibly latch.

#### NOTICE

- To help prevent vehicle damage, be careful when removing fuse box covers and be sure to reinstall them properly.
- Open fuse boxes must be protected from dirt and moisture. Dirt and moisture in fuse boxes can cause damage to the electrical system.

 The vehicle contains other fuses in addition to those mentioned in this section. Have these fuses replaced by an authorized Volkswagen dealer or an authorized Volkswagen Service Facility.

## Replacing blown fuses

---

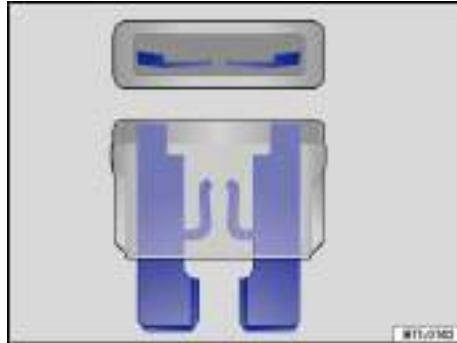

**Fig. 198** Illustration of a blown fuse.

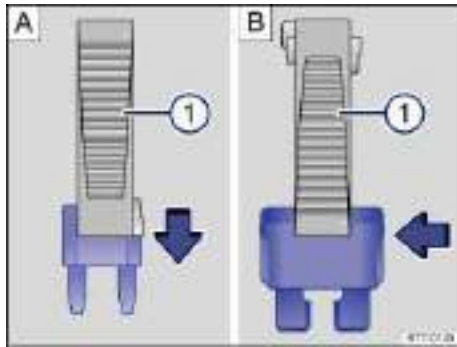

Fig. 199 Removing or inserting a fuse using the plastic tweezers.

⚠ Please first read and note the introductory information and heed the WARNINGS ⚠

#### Preparations

- Switch off the headlights, the ignition, and all electrical consumers.
- Open the appropriate fuse box ⇒ *Fuses in the vehicle*.

#### Identifying blown fuses

A blown fuse can be recognized by the burned metal strip ⇒ fig. 198.

Shine a flashlight on the fuse. This makes it easier to tell if the fuse has blown.

#### Replacing the fuse

- If needed, remove the plastic tweezers from the fuse box cover.
- For *small fuses*, slide the tweezers ⇒ fig. 199 (1) onto the fuse from the top **A**.
- For *larger fuses*, slide the tweezers (1) onto the fuse from the side **B**.
- Pull out the blown fuse.
- If the fuse is blown, replace the fuse with a new fuse of the *same* amperage (same color and same imprint) and same overall size ⇒ ⚠.
- If necessary, replace the plastic tweezers in the fuse box cover.
- Replace the cover.

#### ⚠ NOTICE

If a fuse is replaced with a fuse with higher amperage, then damage can occur at various places in the electrical system.



# Replacing light bulbs

## Introduction

---

In this section you'll find information about:

Indicator light

Information on light bulb replacement

Replacing light bulbs in the Halogen headlight

Replacing light bulbs in the HID-High Intensity Discharge (Xenon) headlight

Replacing light bulbs in the front bumper

Replacing light bulbs in the rear hatch

Replacing light bulbs in the vehicle body

Replacing license plate light bulbs

Replacing the light bulb in the backup lamp

Replacing a light bulb requires a certain amount of skill. If you are uncertain about how to proceed, Volkswagen recommends having the light bulb changed by an authorized Volkswagen dealer or an authorized Volkswagen Service Facility. Special training and knowledge are generally required when other vehicle parts must be disassembled to replace a bulb, or when HID – High Intensity Discharge (Xenon) lamps must be replaced.

You should always keep a box in the vehicle with all the replacement bulbs required for traffic safety. Replacement bulbs are available from your authorized Volkswagen dealer or Authorized Volkswagen Service Facility. The laws of some countries explicitly require you to have replacement bulbs in the vehicle.

Driving with outside lights that do not work may be against the law.

### **Additional light bulb specifications**

Some factory-installed light bulbs in the headlights or the rear lights may have different specifications than conventional light bulbs. Specifications are on the glass bulb or on the metal base.

### **More information:**

- Exterior views
- Lights and vision
- Working in the engine compartment
- Vehicle tool kit
- Fuses



### **WARNING**

**Crashes and other accidents can happen when you cannot see the road ahead and when you cannot be seen by other motorists.**

## WARNING

Improper replacement of burned out headlights and other light bulbs can cause serious personal injury.

- Stop! Always read and heed the WARNINGS before doing any work in the engine compartment ⇒ *Working in the engine compartment*. The engine compartment of any motor vehicle is a potentially dangerous area, and work in this area can lead to serious personal injury.
- HID – High Intensity Discharge (Xenon) get power from a high voltage source that can cause severe personal injury and even death if handled improperly.
- H7/H15 bulbs and HID – High Intensity Discharge (Xenon) are under high pressure and can explode if handled improperly.
- Always let a burned out light bulb cool down before replacing it.
- Never replace a light bulb unless you are familiar with all of the necessary procedures. In particular, never remove a headlight unless you know exactly how to carry out the job and have the correct tools and light bulbs.
- If you are uncertain about what to do, have the work performed by an authorized Volkswagen dealer, an authorized Volkswagen Service Facility, or another qualified workshop. Serious personal injury may result from improperly performed work.
- We strongly recommend that you always have HID – High Intensity Discharge (Xenon) lamps and H7/H15 bulbs replaced by a qualified technician.
- Do not touch the glass of light bulbs with your bare hands. Fingerprints left on the bulb evaporate due to the heat when the bulb is switched on and cause the reflector to “cloud”.
- There are sharp edges on and around the headlight housing in the engine compartment and the rear light housing. Wear hand protection if you replace bulbs.

## NOTICE

After replacing a headlight bulb or other light bulb, always make sure that the rubber covers or plastic caps have been properly and securely reinstalled to help prevent water from getting into the electrical connections and headlight housing and damaging the electrical system.

## Indicator light

 Please first read and note the introductory information and heed the WARNINGS 

Lights up	Possible cause	Proper response
	Light bulb of the exterior vehicle lighting not working.	Replace the light bulb that isn't working.

When the ignition is switched on, several warning and indicator lights come on briefly for a function check. They go out after a few seconds.



## WARNING

Failure to heed warning lights and instrument cluster text messages can cause the vehicle to break down in traffic and result in a collision and serious personal injury.

- Never ignore warning lights or text WARNINGS.
- Always stop the vehicle as soon as it is safe to do so.



## NOTICE

Failure to heed warning lights or text WARNINGS can result in vehicle damage.



Failure of a single LED within a taillight is not indicated. However, the  indicator light will come on if all LEDs fail.

## Information on light bulb replacement

---

 Please first read and note the introductory information and heed the WARNINGS 

### Checklist

---

Steps for replacing a light bulb. Please carry out these steps only in the order listed ⇒ .

1. Stop the vehicle in a safe place on level and firm ground at a safe distance from traffic.
  2. Luggage compartment cover
  3. Set the electronic parking brake to help prevent the vehicle from moving ⇒ *Braking and parking*.
  4. Turn the light switch to **0** position ⇒ *Lights*.
  5. Move the turn signal lever to neutral position ⇒ *Lights*.
  6. Automatic transmission: Shift the transmission into Park (**P**) ⇒ *Shifting*.
  7. Stop the engine and remove the key from the ignition switch ⇒ *Starting and stopping the engine*.
  8. Manual transmission: Engage a gear ⇒ *Shifting*.
  9. Let orientation lighting go out ⇒ *Lights*.
  10. Let the burned out light bulb cool down.
  11. Check if the fuse is blown ⇒ *Fuses*.
  12. Replace the burned out light bulb according to instructions ⇒ . Always replace a burned-out light bulb with a good bulb with the same specifications. Specifications are on the glass bulb or on the metal base.
  13. Never touch the glass of the light bulb with your bare hands. Fingerprints can cloud the outer surface of the light bulb when heated, affecting the lighting power, clouding the reflector, and reducing the brightness.
  14. Always make sure that the new bulb works. If the bulb does not work, it may not be installed correctly; the connection plug may not be completely seated; the corresponding fuse may be burned out; or the bulb may be bad.
  15. Always have the headlights adjusted by an authorized Volkswagen dealer or an authorized Volkswagen Service Facility after a headlight bulb has been replaced.
-

**⚠ WARNING**

Disregarding the safety-related checklist may lead to accidents and serious personal injuries.

- Always review and follow the checklist. Follow accepted safety practices and use common sense.

**! NOTICE**

Always insert and remove lamps carefully to avoid damage to the vehicle paint or to other parts of the vehicle.

### Replacing light bulbs in the Halogen headlight

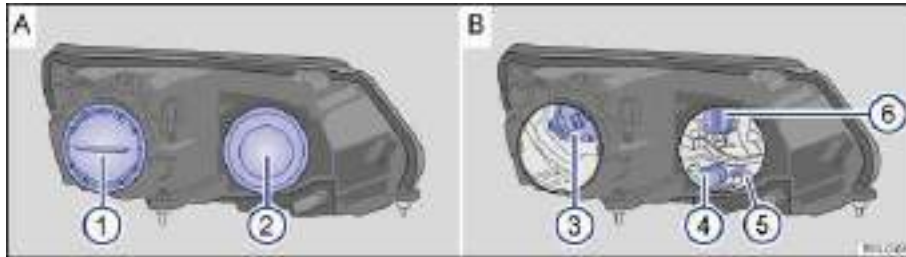

**Fig. 200** In the engine compartment: Cover 1 on the left headlight for the low beam bulb holder 3 and cover 2 for the parking light bulb holder 4, turn signal bulb holder 5 and high beam or daytime running light bulb 6.

**ⓘ Please first read and note the introductory information and heed the WARNINGS ⚠**

The following instructions only apply to vehicles with halogen headlight bulbs. Contact your authorized Volkswagen dealer or an authorized Volkswagen Service Facility for assistance with HID headlight replacement.

**Only perform these steps in the specified order:**

fig. 200	Low beam headlight	Parking light	Turn signal	High beam headlight or daytime running light
1.	Please review and follow the checklist			
2.	Open the engine hood ⚠			
3.	Turn the cover (1) A on the back of the headlight counterclockwise until it stops and remove the cover.	Remove the rubber cover (2) A on the back of the headlight.		

Only perform these steps in the specified order:

fig. 200	Low beam headlight	Parking light	Turn signal	High beam headlight or daytime running light
4.	Turn the bulb holder (3) <b>B</b> counterclockwise until it stops and remove it toward the rear with the bulb.	Unclip the bulb holder (4) <b>B</b> upward out of the guide and remove it toward the rear with the bulb.	Unclip the parking light bulb holder (4) <b>B</b> upward out of the guide and remove it toward the rear with the bulb. Turn the turn signal bulb holder (5) <b>B</b> counterclockwise until it stops and remove it toward the rear with the bulb.	Turn the bulb (6) <b>B</b> counterclockwise until it stops and remove it toward the rear.
5.	If necessary, press the locking mechanism on the bulb holder and pull the bulb straight out of the bulb holder.			
6.	Replace the burned out light bulb with a new bulb of the same type.			
7.	Reinsert the bulb holder (3) <b>B</b> into the headlight and turn it clockwise until it stops.	Reinsert the bulb holder (4) <b>B</b> into the headlight and clip it into the guide.	Reinsert the turn signal bulb holder (5) <b>B</b> into the headlight and turn it clockwise until it stop. Insert the parking light bulb holder (4) <b>B</b> into the headlight and clip it into the guide.	Reinsert the bulb (6) <b>B</b> into the headlight and turn it clockwise until it stops.
8.	Install the cover (1) <b>A</b> on the back of the headlight (retainer vertical) and turn it clockwise until it stops.	Install the rubber cover (2) <b>A</b> .		

 The illustrations show the left headlight assembly from the rear. The right headlight assembly is the mirror image of the left headlight assembly.

 Different models may have different lights, and the location and design of covers, bulb holders, and bulbs may be in a different location than shown in the illustrations.

 You cannot replace the LEDs in LED daytime running lights. Contact your authorized Volkswagen dealer or an authorized Volkswagen Service Facility for assistance.

## Replacing light bulbs in the HID-High Intensity Discharge (Xenon) headlight

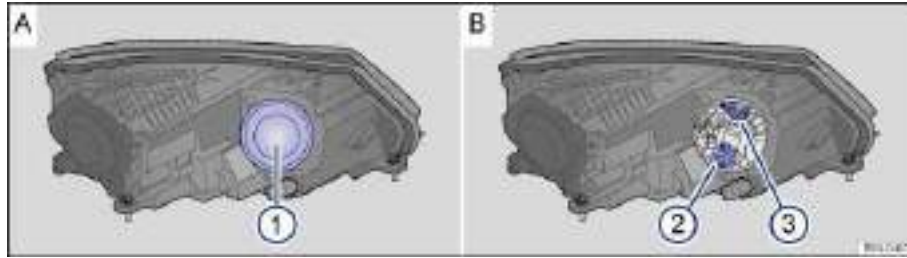

**Fig. 201** In the engine compartment: cCover 1 on the left headlight for the turn signal bulb holder 2 and the cornering light bulb holder 3.

**ⓘ Please first read and note the introductory information and heed the WARNINGS ⚠**

The headlight does not need to be removed in order to replace the bulb.

Contact your authorized Volkswagen dealer or an authorized Volkswagen Service Facility for assistance with HID headlight replacement.

**Only perform these steps in the specified order:**

⇒ fig. 201	Turn signal	Cornering light
1.	Follow the checklist and perform the steps	
2.	Open the hood ⚠	
3.	Remove the rubber cover (1) A on the side of the headlight.	
4.	Turn the bulb holder (2) B counterclockwise until it stops and remove it toward the rear with the bulb.	Turn the bulb holder (3) B counterclockwise until it stops and remove it toward the rear with the bulb.
5.	If necessary, press the locking mechanism on the bulb holder and pull the bulb straight out of the bulb holder.	
6.	Replace burned out bulbs with new bulbs that are identical to the ones being replaced.	
7.	Reinsert the bulb holder in the headlight and turn it clockwise until it stops.	
8.	Install the rubber cover (1) A.	

**ⓘ** The illustrations show the left headlight assembly from the rear. The right headlight assembly is the mirror image of the left headlight assembly.

 Different models may have different lights, and the location and design of covers, bulb holders, and bulbs may be in a different location than shown in the illustrations.

 You cannot replace the LEDs in LED daytime running lights. Contact your authorized Volkswagen dealer or an authorized Volkswagen Service Facility for assistance.

## Replacing light bulbs in the front bumper

---



Fig. 202 In right front bumper: Removing light assembly.

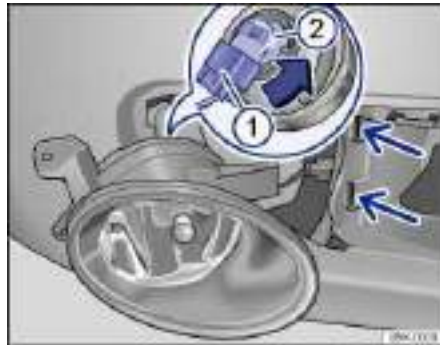

Fig. 203 Replacing light bulb in headlight.

 Please first read and note the introductory information and heed the WARNINGS 

**Please carry out each step only in the order specified:**

- 
- |    |  |
|----|--|
| 1. | Please review and follow the checklist |
|----|--|
- 
- |    |  |
|----|--|
| 2. | Remove the wire bracket from the vehicle tool kit and secure it in the opening in the cover<br>⇒ <a href="#">fig. 202</a> . Pull the cover upward in the direction of the arrow. |
|----|--|
-

**Please carry out each step only in the order specified:**

3. Remove the screw (1) using the screwdriver in the vehicle tool kit
4. Remove the headlight.
5. Release the connector ⇒ fig. 203 (1) and disconnect it.
6. Turn the bulb holder (2) counterclockwise in the direction of the arrow until it stops and remove it toward the rear with the bulb.
7. Replace the burned out light bulb with a new bulb of the same type.
8. Insert the bulb holder into the headlight assembly and turn it clockwise until it stops.
9. Connect the connector (1) on the bulb holder (2). You must hear the connector click into place.
10. Insert the headlight.
11. Tighten the screw ⇒ fig. 202 (1) with the screwdriver.
12. Install cover in the bumper .

### **Replacing light bulbs in the rear hatch**

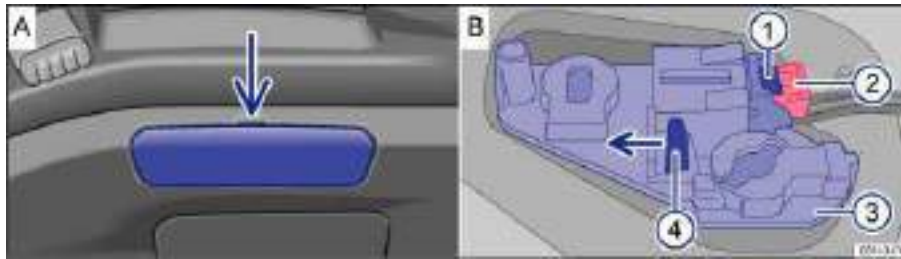

**Fig. 204** In the rear hatch: Removing the cover and the bulb holder.



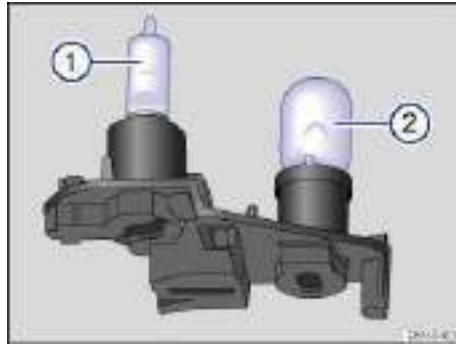

Fig. 205 Bulb holder with backup light bulb 2.

⚠ Please first read and note the introductory information and heed the WARNINGS ⚠

Please carry out each step only in the order specified:

1.	Please review and follow the checklist
2.	Open the rear hatch
3.	Using the screwdriver from the vehicle tool kit carefully pry the cover off with the flat blade of the screw driver inserted in the opening ⇒ fig. 204 A (arrow).
4.	Remove the red locking mechanism (2) B as illustrated and disconnect the electrical connector with the lever pressed down (1) B.
5.	Press the locking tab (4) B in the direction of the arrow and remove the bulb holder (3) B.
6.	Replace burned out rear light bulbs ⇒ fig. 205 (1) or (2) with bulbs that are identical to the ones being replaced.
7.	Insert the bulb holder. You must hear the locking tab click into place.
8.	Insert the electrical connector into the bulb holder until it clicks into place. Press the red locking mechanism ⇒ fig. 204 (2) B back in.
9.	Insert the cover. The cover must lock into place and be secure.

#### LEDs in the rear lights

Changing LEDs is not possible without dismantling vehicle components. Contact an authorized Volkswagen dealer or an authorized Volkswagen Service Facility.

Taillights with LEDs may also have some "standard" light bulbs. These bulbs can be replaced.

**i** Different models may have different lights, and the location and design of covers, bulb holders, and bulbs may be in a different location than shown in the illustrations.

## Replacing light bulbs in the vehicle body

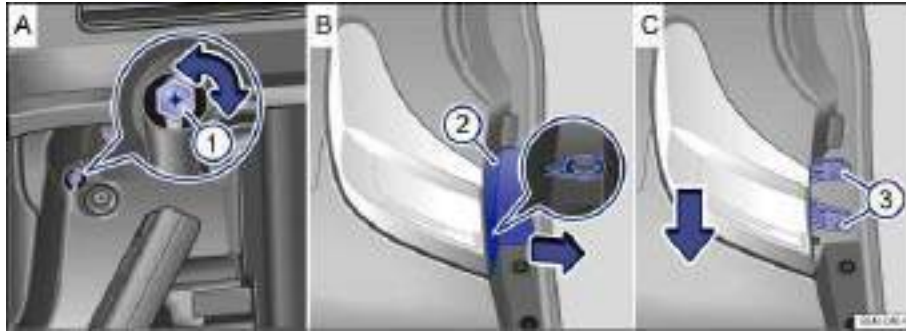

**Fig. 206** In the side of the luggage compartment: Releasing the tail light, removing the trim panel and removing the screws.

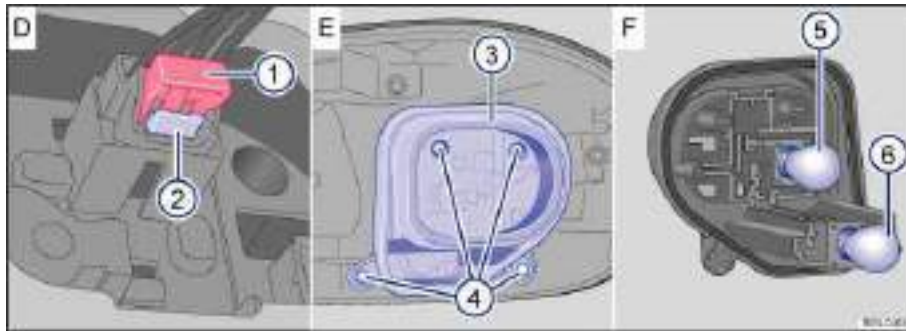

**Fig. 207** Removed tail light: Removing the bulb holder and replacing the tail light and brake light bulb 3 or turn signal bulb 4.

**⚠ Please first read and note the introductory information and heed the WARNINGS ⚠**

Please perform these steps only in the order listed.

### Removing the tail lights

1.	Please review and follow the checklist
2.	Open the rear hatch
3.	Insert the wire bracket from the vehicle tool kit into the small hole in the trim panel ⇒ fig. 206 (2) B. Remove the trim panel in the direction of the arrow using the wire bracket.
4.	Open the side storage compartment in the luggage compartment
5.	Using the Phillips screwdriver from the vehicle tool kit, turn the locking mechanism (1) A 90 ° counterclockwise until it stops.

6.	Remove the screws (3) <b>C</b> .
7.	Pull the tail light out of the body carefully until the electrical connector is visible.
8.	Remove the red locking mechanism ⇒ fig. 207 (1) <b>D</b> as illustrated and disconnect the electrical connector with the lever (2) <b>D</b> pressed down.
9.	Lay the tail light on a clean and level surface.

### Replacing light bulbs

10.	Remove the screws (4) <b>E</b> .
11.	Remove the bulb holder (3) <b>E</b> from the tail light.
12.	Replace burned out tail light, brake light (5) <b>F</b> or turn signal bulbs (6) <b>F</b> with bulbs that are identical to the ones being replaced.
13.	Insert the bulb holder in the tail light and screw it in <b>E</b> .

### Installing the tail lights

14.	Turn the locking mechanism ⇒ fig. 206 (1) <b>A</b> 90 ° clockwise until it stops.
15.	Insert the electrical connector into the bulb holder until it clicks into place. Press the red locking mechanism ⇒ fig. 207 (1) <b>D</b> back in.
16.	Insert the tail light into the opening on the body carefully.
17.	Hold the tail light in the correct position with one hand and tighten the screws with the other hand (3) <b>C</b> .
18.	Insert the trim panel ⇒ fig. 206 (2) <b>B</b> into its original position, first at the bottom and then at the top.
19.	Close the side storage compartment in the luggage compartment.
20.	Close the rear hatch

### LEDs in the rear taillights

Changing LEDs is not possible without dismantling vehicle components. Contact an authorized Volkswagen dealer or an authorized Volkswagen Service Facility.

Taillights with LEDs may also have some "standard" light bulbs. These bulbs can be replaced.



Different models may have different lights, and the location and design of covers, bulb holders, and bulbs may be in a different location than shown in the illustrations.

## Replacing license plate light bulbs

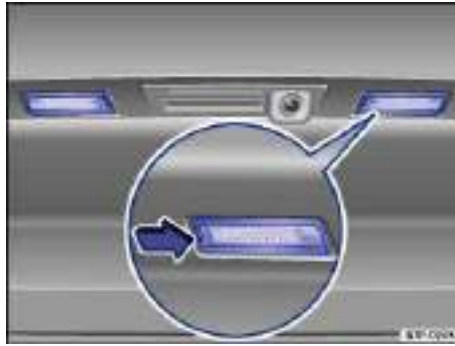

Fig. 208 In the rear hatch: Clamped license plate lamp.



Fig. 209 In the rear hatch: Screwed license plate lamp.

⚠ Please first read and note the introductory information and heed the WARNINGS ⚠

Please carry out each step only in the order specified:

	Clamped license plate lamp	Screwed license plate lamp
1.	Please review and follow the checklist	
2.	Press the flat blade of the screwdriver from the vehicle tool kit in the direction of the arrow in the notch in the license plate lamp ⇒ fig. 208.	Remove the screws of the license plate lamp ⇒ fig. 209 with the screwdriver from the vehicle tool kit.
3.	Pull out the license plate lamp slightly. The connector must not be separated for this.	
4.	Replace the burned out light bulb with a new bulb of the same type.	

Please carry out each step only in the order specified:

	Clamped license plate lamp	Screwed license plate lamp
5.	Carefully insert the license plate lamp into the opening in the bumper. Ensure that the license plate lamp is installed in the correct direction.	Carefully insert the license plate lamp into the opening in the bumper. Make sure that the adhesive anti-glare strip faces forward.
6.	Press the license plate lamp into the bumper until it audibly latches.	Tighten the securing screws of the license plate lamp with the screwdriver.



Different models may have different lights, and the location and design of covers, bulb holders, and bulbs may be in a different location than shown in the illustrations.



You cannot replace the LEDs. Contact your authorized Volkswagen dealer or an authorized Volkswagen Service Facility for assistance.

## Replacing the light bulb in the backup lamp

Please first read and note the introductory information and heed the **WARNINGS**

The light bulbs for the backup lights are "Lifetime" bulbs with a very long service life. If the bulb is defective, you cannot change it yourself because other vehicle components must be removed. Defective backup light bulbs should be changed by an authorized Volkswagen dealer or authorized Volkswagen Service facility.

## Jump-starting

### Introduction

---

In this section you'll find information about:

Using jumper cables

If your engine does not start because the vehicle battery is dead, your vehicle's battery can be connected to the battery of another vehicle to start your engine (jump-starting). Check the battery acid level indicator window before jump-starting ⇒ *12 Volt vehicle battery*.

You must use jumper cables that meet recognized industrial standards (check information provided by the jumper cable manufacturer). For vehicles with **gasoline engines**, the cross-section of the jumper cable wire must be at least 0.038 in<sup>2</sup> (25 mm<sup>2</sup>), or about 3 ga. (AWG).

#### **More information:**

- Working in the engine compartment
- 12 Volt vehicle battery

#### **WARNING**

**Working on the batteries or the electrical system in your vehicle can cause serious acid burns, fires, or electrical shock.**

- **Always keep children away from battery acid and vehicle batteries in general.**
- **Sulfuric battery acid is very corrosive and can cause blindness and damage to unprotected skin. Never let battery acid or lead particles contact your eyes, skin, and clothing.**
- **Never lean over a vehicle battery. Always wear protective gloves and eye protection. To reduce your risk of injury, never tilt the batteries; acid could spill out through the vents and burn you.**
- **A highly explosive mixture of gases is given off when the battery is being charged.**
- **Always avoid fires, sparks, open flame, and smoking. Never create sparks or electrostatic charges when handling cables and electrical equipment. Never short-circuit the battery terminals. High-energy sparks can cause serious personal injury.**
- **If you get battery acid in your eyes or on your skin, immediately rinse with cold water for several minutes and get medical attention immediately. If you swallow any battery acid, get medical attention immediately.**



## WARNING

Improper use of jumper cables when jump-starting a vehicle with a dead battery can cause the battery to explode, leading to serious personal injury. To help reduce the risk of battery explosion:

- All work on the batteries or the electrical system in your vehicle can cause serious acid burns, fires, or electrical shocks. Always read and heed the following WARNINGS and safety precautions before working on the batteries or the electrical system ⇒ *12 Volt vehicle battery*.
- Always make sure that the battery providing starting assistance (the booster battery) has the same voltage as the dead battery (12 V) and about the same amperage capacity (see battery label).
- Never jump-start a vehicle with a thawed or frozen vehicle battery. The battery can explode. A dead battery can freeze at temperatures around +32 °F (0 °C).
- A battery that is frozen or was frozen, but has since thawed, must be replaced.
- When the vehicle battery is jump started, it gives off hydrogen gas, which is highly explosive! Always keep fire, sparks, open flame, and smoking materials far away from vehicle batteries. Never use a mobile telephone while connecting or disconnecting jumper cables.
- Jump-start batteries only in well-ventilated areas. Batteries give off highly explosive hydrogen gas during jump-starting.
- Always route the jumper cables so that they cannot get caught in any moving parts in the engine compartment.
- Never short out the battery terminals by connecting the positive terminal (+) and negative (-) terminals with each other.
- Never connect the negative cable from the other vehicle directly to the negative terminal of the dead battery, as this may cause the hydrogen gas given off by the dead battery to explode.
- Never attach the negative cable from the vehicle providing starting assistance to any part of the fuel system or to the brake hoses or brake lines.
- Never allow the non-insulated parts of the battery clamps to touch.
- Never allow the jumper cable attached to the positive battery terminal to contact metal parts of the vehicle.
- Always follow the instructions of the jumper cable manufacturer.



## NOTICE

To help prevent extensive damage to the vehicle electrical system, read and heed the following:

- Connecting jumper cables improperly can cause a short circuit and do expensive damage to the vehicle's electrical system.
- Do not let the vehicles touch each other while the jumper cables are connected. If they do, electrical current may flow between the vehicles when the positive (+) terminals are connected, causing electrical system damage.

## Using jumper cables

---

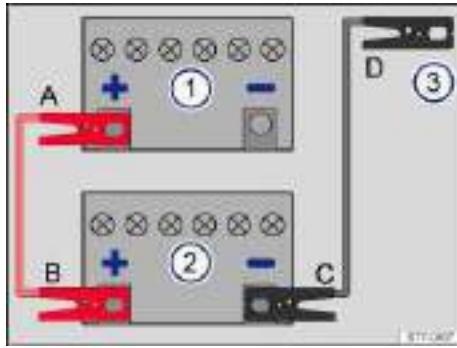

Fig. 210 Diagram for attaching the jumper cables: Dead battery 1 and booster battery 2.

⚠ Please first read and note the introductory information and heed the WARNINGS ⚠

The dead battery must be properly connected to the vehicle's electrical system.

Make certain that the vehicles are not touching each other. Otherwise, electric current could flow as soon as the positive terminals (+) are connected. Use longer jumper cables if necessary.

The clamps on the jumper cables must have good contact to bare metal on the battery terminals.

If the engine does not start, stop the process after 10 seconds and repeat after about one minute.

The procedure for attaching and for removing the jumper cables is described below. Perform each of the following steps only in the order described, which follow the letters shown in the illustration

⇒ fig. 210 A – B – C – D.

### Attaching the jumper cables

---

1. Switch off the ignition in both vehicles.
  2. If necessary, open the battery cover in the engine compartment ⇒ *12 Volt vehicle battery*.
  3. Attach one end of the *red* jumper cable to the **positive terminal (+)** of the dead battery (1) ⇒ ⚠.
  4. Attach the other end of the *red* jumper cable to the **positive terminal (+)** of the good battery (booster battery) (2).
  5. Attach one end of the *black* jumper cable to the **negative terminal (-)** of the booster battery: Battery (2) .
  6. Attach the other end of the *black* jumper cable (3) to a **bare metal part of the vehicle with the dead battery**. This part should be connected directly to the engine block. You may also attach the cable to the engine block itself. Attach the clamp to a point that is as far away as possible from the dead battery (1) ⇒ ⚠.
  7. Route the jumper cables so that they cannot get caught in any moving parts in the engine compartment of either vehicle.
- 

### Starting the engine

- Start the engine of the vehicle with the good battery that is providing help and let it run at idle speed.



- Turn the ignition of the vehicle with the dead battery. If the engine starts, wait 2 to 3 minutes until it “runs smoothly” before removing the jumper cables as described below ⇒ ⚠. If the engine does not start within about 10 seconds, turn off the ignition and wait at least one minute; then try again.

---

#### **Before removing the jumper cables**

---

1. Switch off the headlights (if they are on).
  2. In the vehicle with the dead battery, switch on the heater fan and the rear window defroster. This helps to minimize voltage spikes when the cables are disconnected.
- 

#### **Removing jumper cables**

---

With the engine running, remove the jumper cables **in reverse order** to the way they were connected.

1. Disconnect the black (-) cable from the vehicle with the **dead** battery.
  2. Disconnect the black (-) cable from the other vehicle (vehicle with the **good** battery).
  3. Disconnect the red (+) cable from the other vehicle (vehicle with the **good** battery).
  4. Disconnect the red (+) cable from the vehicle with the **dead** battery.
  5. Close the battery cover as the case may be.
-

 **WARNING**

Improper use of jumper cables when jump-starting a vehicle with a dead battery can cause the battery to explode, leading to serious personal injury. To help reduce the risk of battery explosion:

- All work on the batteries or the electrical system in your vehicle can cause serious acid burns, fires, or electrical shocks. Always read and heed the following WARNINGS and safety precautions before working on the batteries or the electrical system ⇒ *12 Volt vehicle battery*.
- Always wear proper eye protection. Never lean over the vehicle batteries.
- Attach the jumper cables in the correct order: first the positive cable, then the negative cable.
- Never connect the negative cable from the vehicle providing starting assistance to parts of the fuel system or to the brake hoses or brake lines.
- Never allow the non-insulated parts of the battery clamps to touch.
- Never allow the jumper cable attached to the positive battery terminal to contact metal parts of the vehicle.
- Check the battery acid level indicator window on the vehicle battery. Use a flashlight, never a match, cigarette lighter, or other open flame. If you cannot see the color of the window clearly, or if it is light yellow or colorless, do not jump-start the vehicle. Get expert assistance.
- Avoid electrostatic discharge in the vicinity of the vehicle battery. Sparks may cause the hydrogen gas escaping from the vehicle battery to ignite.
- Never jump-start a vehicle with a battery that is damaged or frozen or that was frozen and has thawed. The battery can explode. Replace the battery instead.
- Always follow the instructions of the jumper cable manufacturer.
- Always make sure that the battery providing starting assistance has the same voltage as the dead battery (12 V) and about the same capacity (see battery label).
- Batteries give off explosive hydrogen gas. Always keep fire, sparks, open flame and smoking materials away from batteries.
- Never connect the negative cable from the other vehicle directly to the negative terminal of the dead battery. The hydrogen gas from the battery is explosive.
- Never short out the battery terminals by connecting the positive (+) and negative (-) terminals with each other.

# Towing

## Introduction

---

In this section you'll find information about:

Towing on a commercial tow truck

Tips on towing

Installing the front towing eye

Installing the rear towing eye

Driving tips while towing

Observe legal requirements when towing.

Your vehicle is equipped with a trailer package.

### For technical reasons:

- **A vehicle with a dead battery must never be towed; Jump-start the vehicle instead.**
- **It is not possible to tow-start or push-start your vehicle; Jump-start the vehicle instead.**

Vehicles with Keyless Access may only be towed with the ignition on.

Towing the vehicle when the engine is turned off and the ignition is turned on drains the vehicle battery. Depending on the charge level of the vehicle battery, it is possible that even after just a few minutes, electrical devices such as the emergency flashers may not have the power necessary to function. The steering wheel might lock in vehicles with Keyless Access ⇒ .

### More information:

- Exterior views
- Shifting
- Engine control and emission control system
- Jump-starting



### WARNING

**Never tow a vehicle without any electrical power.**

- **Never remove the remote control vehicle key from the ignition switch while the vehicle is moving. The electronic steering column lock could suddenly engage, and you would not be able to steer or control the vehicle. You can lose control of the vehicle, crash, and seriously injure yourself and others.**
- **If the vehicle loses power while it is being towed, stop towing the vehicle immediately and contact your authorized Volkswagen dealer or authorized Volkswagen Service Facility for assistance.**

## WARNING

Towing a vehicle changes the way it handles and brakes. To help reduce the risk of an accident and serious personal injury, note the following:

- The driver of the vehicle that is being towed:
  - Since the brake booster also does not work when the engine is stopped, you will need to press harder on the brake pedal to slow down or stop. Always be alert so as not to rear-end towing vehicle.
  - Will have to use considerable more force to turn the steering wheel because the power steering is not working.
- The driver of the vehicle that is doing the towing:
  - Must accelerate gradually and gently and avoid jerking movements.
  - Must not brake hard or steer sharply.
  - Must brake earlier and more gently than in normal driving.

## NOTICE

- Be careful not to damage the paint when installing and removing the towing eye and the cover for the threaded hole behind the bumper.
- Unburned fuel can get into the catalytic converter during towing and damage it.

## NOTICE

The vehicle may be damaged if it is towed with a tow rope or a tow bar.

- Never let the vehicle be towed with a tow rope or a tow bar unless it is absolutely necessary.
- If the vehicle breaks down, it can only be towed by a special tow truck.

## Towing on a commercial tow truck

---

 Please first read and note the introductory information and heed the WARNINGS 

To help avoid damaging the vehicle, have it towed only by a professional towing company. Read and heed the following information:

### General information

Never let the vehicle be towed at speeds above 30 mph (50 km/h).

Never let the vehicle be towed for more than 30 miles (50 km).

### Towing manual transmission vehicles

- Release the parking brake.
- Shift the transmission into Neutral (**N**).
- If possible, have the vehicle towed with the front wheels off the ground.
- If necessary, the vehicle can also be towed with the rear wheels off the ground ⇒ .

### Towing automatic transmission vehicles

- Release the parking brake.
- Shift the transmission into Neutral (**N**).

- Tow the vehicle only with its front wheels off the ground ⇒ .

#### **Special towing instructions for vehicles with all-wheel drive (4MOTION)**

- To help prevent unnecessary damage, vehicles with all-wheel drive (4MOTION) must be transported on a flat-bed truck.
- To load the vehicle on the flat bed, use the towing eye found in the vehicle tool kit and attach it to the front anchorage

#### **When not to tow your vehicle**

If there is little or no oil in the transmission because of damage to your vehicle, it must be moved with the drive wheels off the ground. The vehicle can only be towed if its ignition is switched on and its electrical system is operating. In the following situations, the vehicle cannot be towed at all and must be transported on a flatbed truck or trailer:

- If the front and rear wheels cannot turn.
- If the vehicle battery is dead (because the steering is locked and the electronic parking brake and the electronic steering column lock cannot be released if engaged).
- If you have to tow an automatic transmission vehicle more than 30 miles (50 km).

#### **WARNING**

**It is not safe for children or other persons to ride in a vehicle that is being towed.**

- **Never let children or anyone else remain in the vehicle while it is being towed.**

#### **NOTICE**

**The drive axle rotates while the vehicle is being towed with its rear wheels off the ground. This can damage the automatic transmission.**

- **Never tow automatic transmission vehicle with the rear wheels off the ground.**
- **Tow manual transmission vehicles with the rear wheels off the ground only if it is certain that no transmission fluid can leak out.**

### Tips on towing

 Please first read and note the introductory information and heed the **WARNINGS** 

#### **Towing eye; tow rope or tow bar**

A towing eye is included in your vehicle's tool kit. This can be inserted in a threaded hole in the front bumper and used when your vehicle is being towed by another vehicle. On most vehicles, there is another threaded hole in the rear bumper, so you can use the towing eye to tow other vehicles as well. Towing a vehicle with a tow bar is safer and easier on both vehicles than using a tow rope. A tow rope should be used only if a tow bar is not available.

The tow rope should be flexible enough to help protect both vehicles from damage. Use a synthetic fiber rope or similar rope.

Attach the tow rope or tow bar only to the towing eye included in the vehicle tool kit for this purpose, or to a trailer hitch.

#### **Towing manual transmission vehicles**

Check whether your vehicle can be towed at all; see below *When not to tow your vehicle*.

If yes, note the following for the towed vehicle:

- Shift the gearshift lever to Neutral 223.
- Do not tow faster than 30 mph (50 km/h).
- Do not tow more than 30 miles (50 km).

#### **Towing automatic transmission vehicles**

Check whether your vehicle can be towed at all; see below *When not to tow your vehicle*.

If yes, note the following for the towed vehicle:

- Put the transmission in Neutral (**N**).
- Do not tow faster than 30 mph (50 km/h).
- Do not tow more than 30 miles (50 km).
- When a commercial tow truck is being used, the vehicle must only be towed with the front wheels lifted off the ground.
- Follow the special instructions for towing vehicles with all-wheel drive (4MOTION).

#### **Towing vehicles with all-wheel drive (4MOTION)**

Vehicles with all-wheel drive (4MOTION) should be towed with a tow bar or a tow rope. If the vehicle is towed with the front or rear axles lifted off the ground, the engine must be switched off. Otherwise the powertrain may be damaged.

#### **When not to tow your vehicle**

In the following situations, the vehicle cannot be towed and must be transported on a flatbed truck or trailer:

- If transmission fluid has leaked out of the transmission.
- If there is little or no oil in the transmission because of damage to your vehicle, it must be moved with the drive wheels off the ground.
- If the front and rear wheels cannot turn.
- When the vehicle battery is dead, since the steering may remain disabled, and it may not be possible to release the electronic steering column lock and the electronic parking brake.
- If you have to tow an automatic transmission vehicle more than 30 miles (50 km).

#### **Towing other vehicles**

- Obey all legal requirements.
- Read and heed all towing information in the owner's manual for the other vehicle.



A vehicle can be towed only if the electronic parking brake and the electronic steering column lock can be released. In case of a power loss or malfunctions of the electrical system, the engine may have to be jump-started in order to release the electronic parking brake and the electronic steering column lock.

## Installing the front towing eye



Fig. 211 In right front bumper: Screwing in towing eye.

### ⚠ Please first read and note the introductory information and heed the WARNINGS ⚠

The attachment point for the towing eye is located on the right in the front bumper.

Always keep the towing eye in the vehicle and stow it securely.

Read and follow the notes about towing ⇒ *Tips on towing*.

### Installing the towing eye

- Take the towing eye, the lug wrench, and the screwdriver out of the vehicle tool kit in the luggage compartment ⇒ *Vehicle tool kit*.
- Insert the flat blade of the screwdriver into the slot between the cover and the bumper.
- Carefully pry out the cover. A slightly stronger force might be required. Leave the cover hanging.
- Screw the towing eye **counterclockwise** into the threaded hole as far as it will go (arrow)  
⇒ fig. 211 ⇒ ⚠. Use the lug wrench to turn and tighten the towing eye.
- When towing is complete, unscrew the towing eye **clockwise** to remove it and replace the cover.
- Clean the towing eye and lug wrench if necessary and put them back in the vehicle tool kit in the luggage compartment.

### ⚠ NOTICE

Always make sure the towing eye is screwed all the way into threaded hole so that it is secure. Otherwise, it could be ripped out while your vehicle is being towed.

## Installing the rear towing eye

---

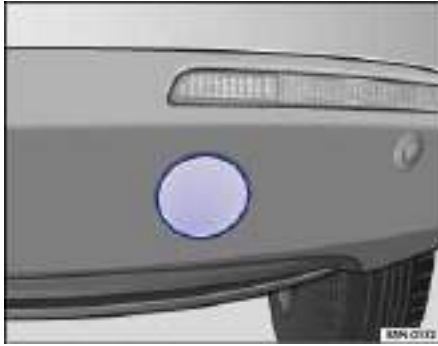

Fig. 212 On the right in the rear bumper: Cover.

### **⚠ Please first read and note the introductory information and heed the WARNINGS**

Your vehicle is factory-equipped with a preparation for a trailer hitch. Therefore, there is **no** attachment point for a towing eye behind the cover on the right of the rear bumper ⇒ [fig. 212](#). To tow a vehicle, a trailer hitch must be installed.

## Driving tips while towing

---

### **⚠ Please first read and note the introductory information and heed the WARNINGS**

Towing requires some experience, especially when using a towing rope. Both drivers must be familiar with the techniques required for towing. Inexperienced drivers should not try to tow a vehicle or to drive a vehicle that is being towed.

Do not pull too hard with the towing vehicle, and avoid jerking the tow rope. When towing on an unpaved road, there is always a risk of overloading and damaging the attachment points.

If your vehicle is being towed, it can still signal turns even if the emergency flashers are activated, as long as the ignition is switched on. Use the turn signal in the normal way. The emergency flashers go off as long as the turn signal is flashing. As soon as the turn signal lever returns to its neutral position, the emergency flashers are automatically activated again.

#### **As driver of the towed vehicle:**

- If your vehicle is the one being towed, the ignition switch must be switched on to keep the steering wheel from locking. Also make sure that the turn signals, horn, windshield wipers, and windshield washers work properly.
- Since power steering does not work when the engine is switched off, more effort is needed to steer the vehicle.
- Since the brake booster also does not work when the engine is stopped, you will need to press harder on the brake pedal to slow down or stop. Do not hit the towing vehicle.
- Read and heed the information and WARNINGS in the towing vehicle's owner's manual.

#### **As driver of the towing vehicle**

- Drive especially carefully and accelerate gently. Avoid sudden driving maneuvers.
- Brake earlier than usual and with light pedal pressure.
- Read and heed the information and WARNINGS in the owner's manual of the vehicle being towed.



## Abbreviations

<b>Abbreviation</b>	<b>Meaning</b>
5S manual	5-speed manual transmission
6S automatic	6-speed automatic transmission
6S manual	6-speed manual transmission
ABS	Anti-lock Brake System
AFS	Adaptive Front Lighting System
AKI	Anti-Knock Index
ANSI	American National Standards Institute
ASL	Automatic Shift Lock
ASR	Anti-Slip Regulation
ATA	Anti-Theft Alarm system
BAS	Brake Assist System
ccm	Cubic centimeter unit of volume for specifying engine displacement
CCS	Cruise Control System
CID	Cubic inch displacement, unit of volume for specifying engine displacement
cm	Centimeter – metric unit of measure for length
CO <sub>2</sub>	Carbon dioxide
DIN	Deutsches Institut für Normung (German Institute for Standardization)
DRL	Daytime running lights
EDL	Electronic Differential Lock
EDR	Event Data Recorder
EN	European Norm
EPC	Engine control (Electronic Power Control)
ESC	Electronic Stability Control
g/mi (g/km)	Generated carbon monoxide amount in grams per mile (kilometer) driven
GAWR	Gross Axle Weight Rating
GVWR	Gross Vehicle Weight Rating
HID	High Intensity Discharge headlights (HID)
hp	Horsepower, unit used to rate engine power
kg	Kilogram – metric unit for weight
kN	Kilonewton, a measure of force
kp	Kilopond, a measure of force
kW	Kilowatt, engine rating
LED	Light Emitting Diode
m	Meter – metric unit of measure for length

MFI	Multi-Function Indicator
MIL	Malfunction Indicator Light (engine)
MTBE	Methyl Tertiary Butyl Ether
Nm	Newton meter, engine torque unit
RON	Research Octane Number, measurement of antiknock resistance of gasoline
rpm	Engine revolutions per minute (engine speed)
SAE	Society of Automotive Engineers
TSI <sup>®</sup>	Twin-charged Stratified Injection