

## Side view

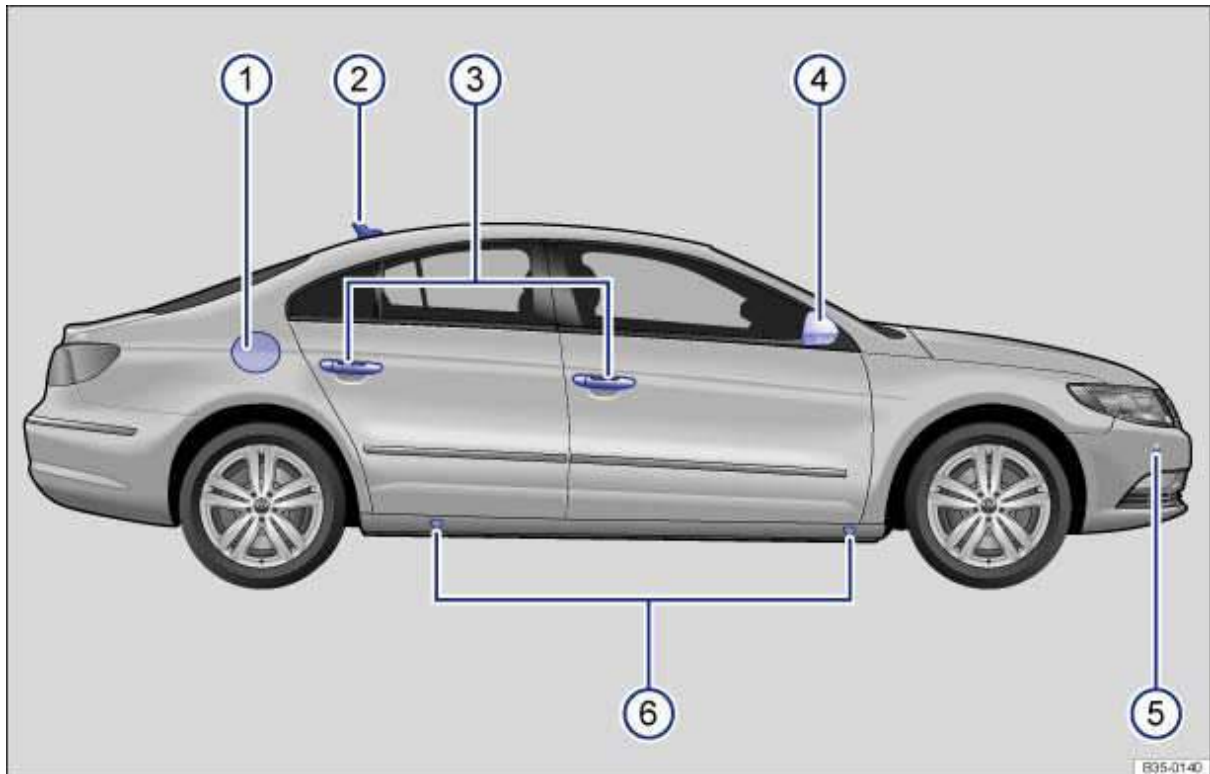

**Fig. 1** Vehicle side overview.

Key to ⇒ **fig. 1**:

- (1) Fuel filler flap
- (2) Roof antenna
- (3) Outside door handles
- (4) Outside mirror
  - Additional turn signal light
  - Background lighting
- (5) Park Distance Control (PDC) sensors (if applicable)
- (6) Lift points for the jack

## Front view

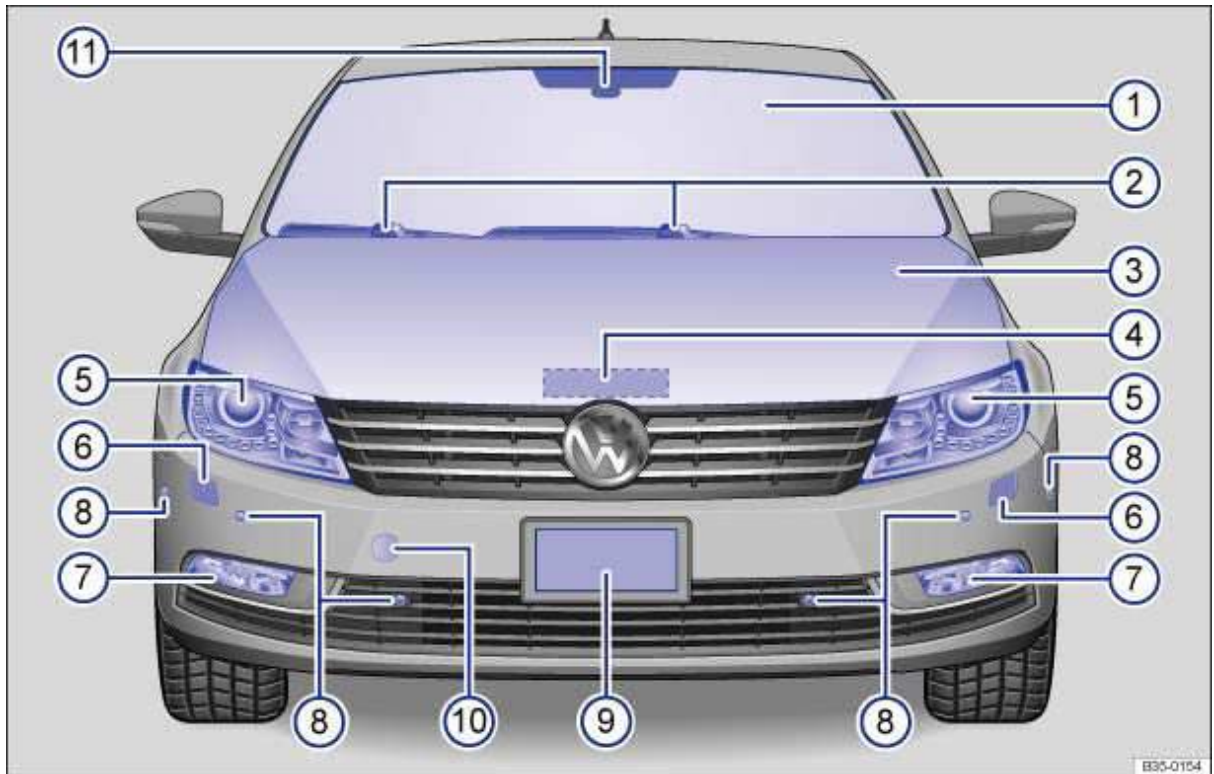
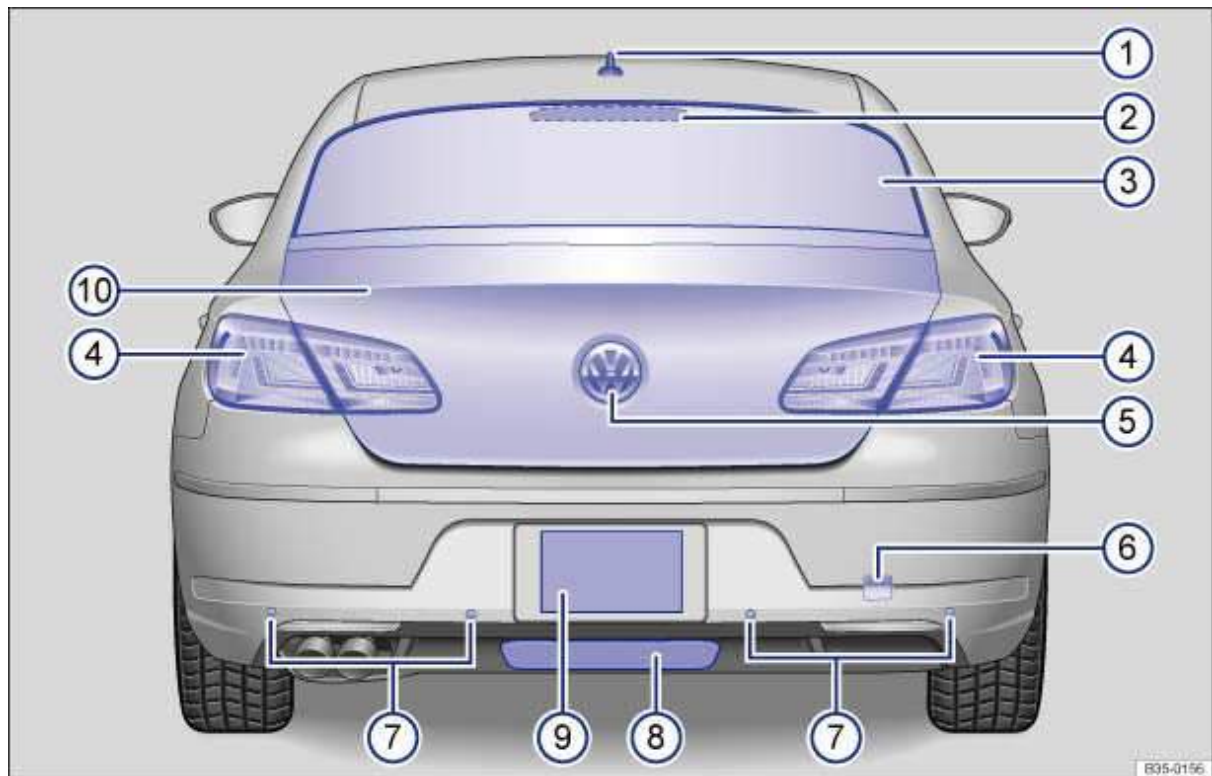

Fig. 2 Vehicle front overview.

Key to ⇒ fig. 2:

- (1) Windshield
- (2) Windshield wipers
- (3) Engine hood
- (4) Engine hood release
- (5) Headlights
- (6) Headlight washers
- (7) Fog lights/static cornering lights
- (8) Park Distance Control (PDC) sensors (if applicable)
- (9) Front license plate bracket
- (10) Threaded hole for the front towing eye (behind cover)
- (11) Sensor on mirror base for:
  - Rain sensor
  - Low-light sensor

## Rear view

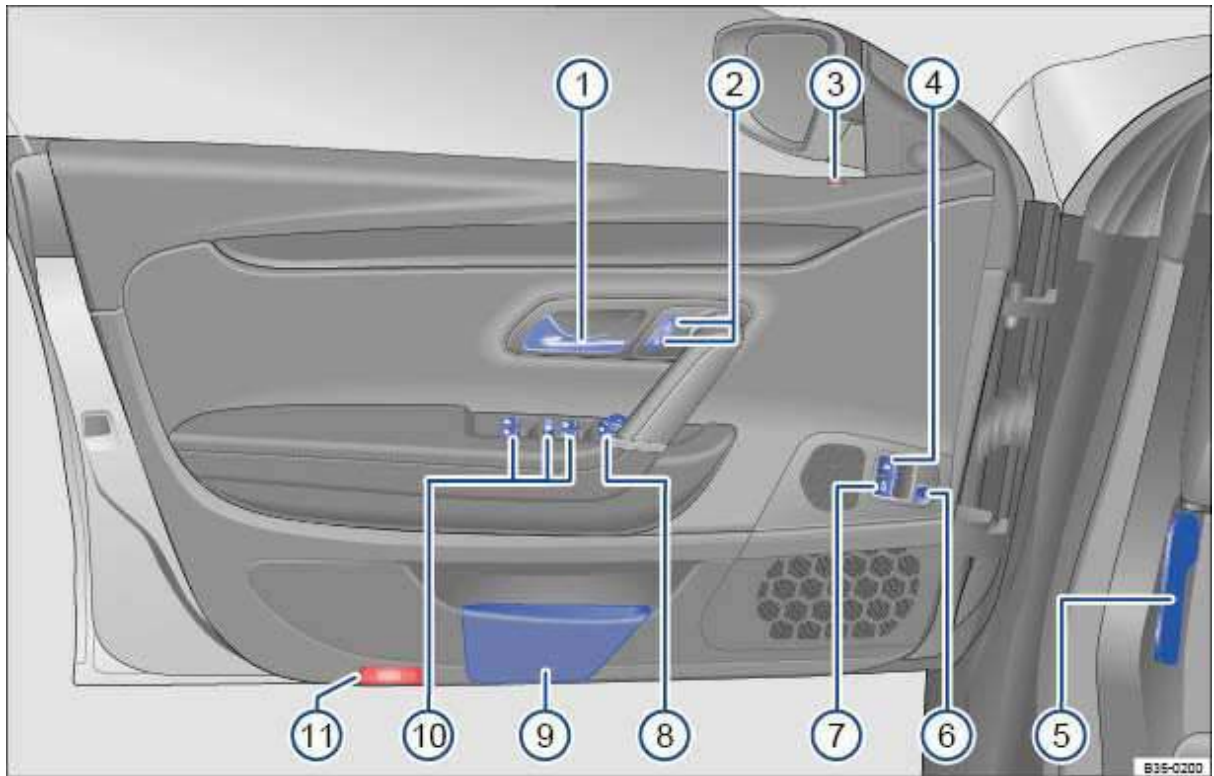

**Fig. 3** Vehicle rear overview.

Key to ⇒ **fig. 3**:







- (1) Roof antenna
- (2) High-mounted brake light
- (3) Rear window
  - Rear window defroster
  - Rear window antenna
- (4) Taillights ,
- (5) Volkswagen emblem. Area for:
  - Luggage compartment release
  - Rear Assist camera
- (6) Threaded hole for the rear towing eye (behind cover)
- (7) Park Distance Control (PDC) sensors (if applicable)
- (8) Area for attaching a trailer hitch
- (9) Rear license plate bracket
- (10) Luggage compartment lid

## Driver door overview



**Fig. 4** Overview of controls in the driver door.

Key to **fig. 4**:

- (1) Door handle
- (2) Power locking button for locking and unlocking the vehicle  - 
- (3) Indicator light for anti-theft alarm system
- (4) Fuel filler flap release 
- (5) Lever for releasing the engine hood
- (6) Key switch for locking the luggage compartment lid .
- (7) Luggage compartment release switch 
- (8) Switch for adjusting the outside mirror
  - Adjusting outside mirrors **L** - **0** - **R**
  - Outside mirror heating 
  - Electrically folding outside mirrors
- (9) Storage compartment
- (10) Buttons for operating the power windows
  - Power windows 
  - Safety switch for rear power windows 
- (11) Light or reflector

## Driver side overview

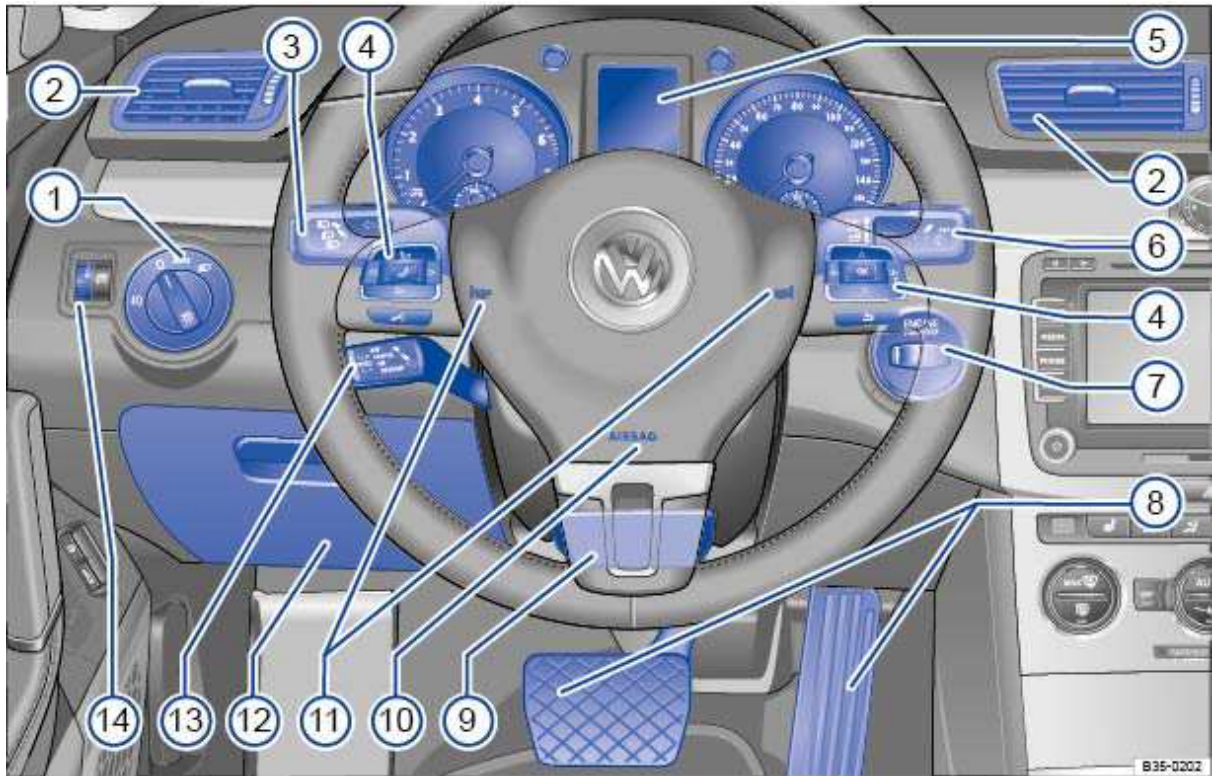





Fig. 5 Driver side overview.

Key to ⇒ fig. 5:

- (1) Headlight switch ☼
  - Off position 0
  - Automatic headlight control **AUTO**
  - Low beams ☾
  - Fog lights ☽)
- (2) Air vents ◀ - ... - ▶
- (3) Lever for
  - High beams ☾
  - Headlight flasher ☾1x
  - Turn signals ↔
  - Driver assistance systems button (if applicable)
- (4) Multi-function steering wheel controls
  - Volume setting for radio, navigation system notifications, or telephone calls + -
  - Mute switching for radio or activation of voice control 📞
  - Audio, Navigation ◀ - ▶
  - Display Phone main menu or accept telephone calls 📞
  - Control buttons for the Volkswagen Information System 📁 - OK - 📁, ▲ - ▼, ↻
- (5) Instrument cluster:
  - Instruments
  - Display
  - Warning and indicator lights
- (6) Windshield wiper and washer lever
  - Windshield wiper **HIGH** - **LOW**

- Intermittent operation for windshield wipers . . . ■
  - Windshield wiper **OFF**
  - "One-tap wiping" 1x
  - Windshield wiper 
  - Automatic wipe/wash for windshield 
- (7) Ignition switch
- (8) Pedals
- (9) Lever for adjustable steering wheel
- (10) Driver front airbag
- (11) Horn (only works when the ignition is switched on)
- (12) Storage compartment
- (13) Lever for:
- Cruise Control System (CCS) **ON** - **CANCEL** - **OFF** - **RES/+** - **SET/-**
- (14) Dimmer control for the instrument and switch illumination 

# Center console overview

## Upper center console

---

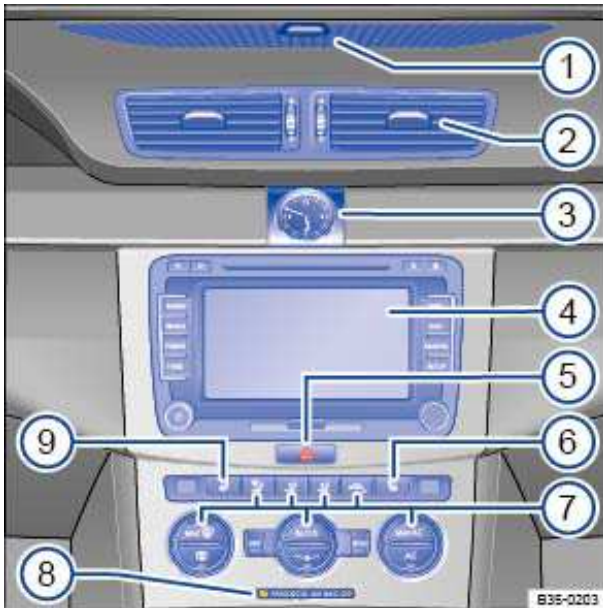

Fig. 6 Overview of the upper center console.

Key to ⇒ fig. 6:

- (1) Air vent for indirect ventilation .
- (2) Air vents ◀ - . . . - ▶
- (3) Analog clock .
- (4) Radio or Radio & Navigation system (factory-installed) ⇒ Booklet *Radio* or  
⇒ Booklet *Navigation system*.
- (5) Switch for emergency flashers ⚠
- (6) Passenger seat heating button 🖱
- (7) Climatronic controls .
- (8) PASSENGER AIR BAG **OFF** light (front airbag for front seat passenger)
- (9) Driver seat heating button 🖱

## Lower center console

---

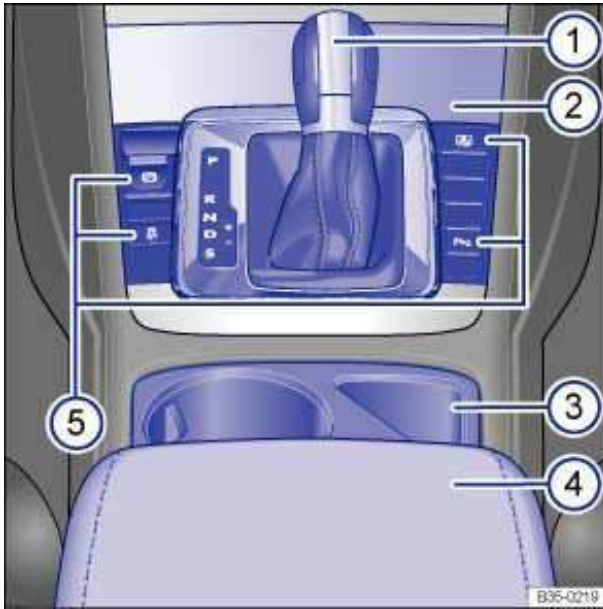

**Fig. 7** Overview of the lower center console.

Key to ⇒ **fig. 7**:

- (1) Lever for:
  - Manual transmission
  - Automatic transmission
- (2) Storage compartment
  - with 12 Volt socket
- (3) Storage compartment with cup holder in the center console
- (4) Storage compartment in the center armrest
- (5) Buttons for:
  - Electronic parking brake (P)
  - Anti-slip regulation (ASR) (ASR OFF)
  - Rear window sunshade (Sunshade)
  - Park Distance Control (ParkPilot) (P)



## Front passenger side overview

---

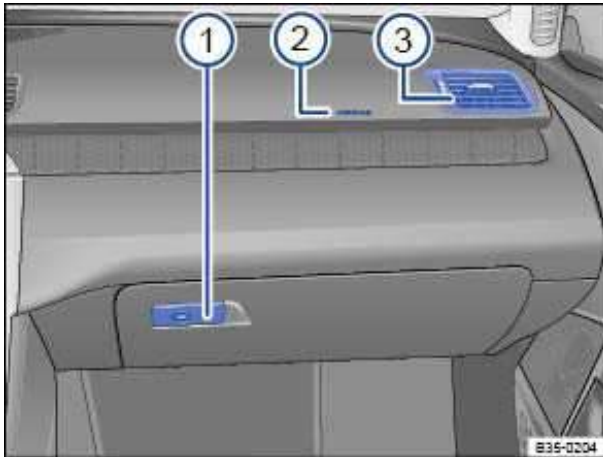





**Fig. 8** Overview of the front passenger side.

Key to ⇒ **fig. 8**:

- (1) Opening handle for the lockable glove compartment
- (2) Passenger front airbag location in the instrument panel (approximate)
- (3) Air vents ◀ - ■■■ - ▶

## Symbols on the roof console and sun visor

---

Symbol	Meaning
	Interior and reading lights
	Power sunroof.
	Three-button module ⇒ Booklet <i>Mobile Phone Package</i> .
	HomeLink® Universal Transmitter

# Instrument cluster

## Introduction

In this section you'll find information about:

Instrument overview

Displays

Compass

Service reminder display

### More information:

- Warning and indicator lights
- Volkswagen Information System
- Display of the selected gears (automatic transmission)
- Service reminder information ⇒ Booklet *Warranty and Maintenance*.



### WARNING

Driving on today's roads demands the full attention of the driver at all times. Driver distraction causes accidents, collisions and serious personal injury!

- Never use the buttons in the instrument cluster while driving.

## Instrument overview

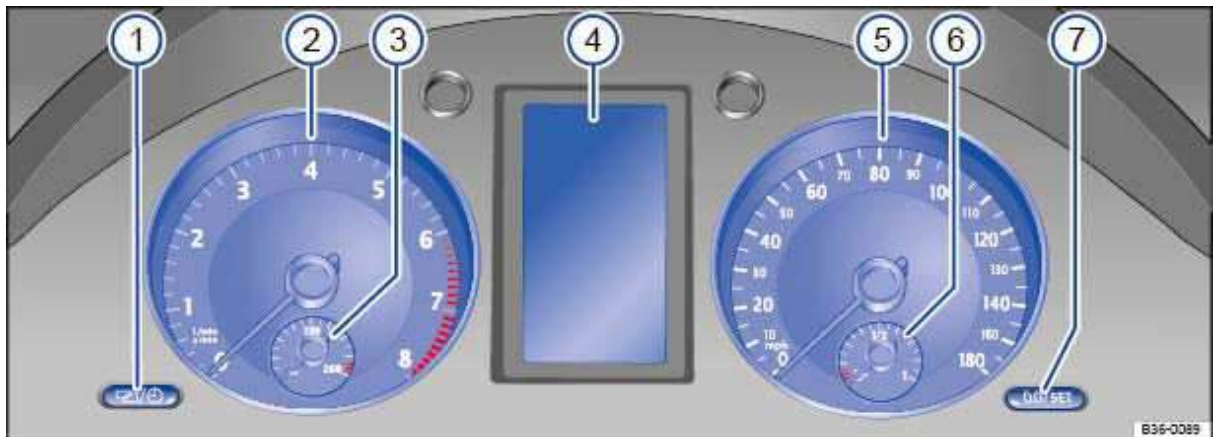









Fig. 9 Instrument cluster in the instrument panel.

Please first read and note the introductory information and heed the WARNINGS ⚠

Instrument explanations ⇒ [fig. 9](#):

- (1) **Button for setting the instrument cluster clock, the Radio or Radio & Navigation system clock, and the analog clock<sup>1</sup>.**
  - With the ignition on, push the  /  button to highlight the hour or the minutes in the clock display.
  - To advance the clock, push the  (7). Press and hold the button to fast forward.
  - Push the  /  button again to finish setting the clock. The analog clock may take a few seconds to show the updated time.
- (2) **Tachometer** (thousands of revolutions per minute when the engine is running).  
The red zone at the end of the scale indicates maximum permissible engine rpm (revolutions per minute) for all gears after the break-in period. Before reaching the red zone, select the next higher gear or selector level position **D**, or ease your foot off the accelerator ⇒ .
- (3) **Engine coolant temperature display** 
- (4) **Displays**
- (5) **Speedometer.**
- (6) **Fuel gauge**
- (7) **Reset button** for the trip odometer display (*trip*).
  - Push the  for about 1 second to reset to zero.

## NOTICE

- To help prevent engine damage, always avoid high engine speeds, full throttle acceleration and heavy engine loads when the engine is cold.
- To help prevent engine damage, the tachometer needle should only enter the red zone (warning zone) briefly.



Upshifting early into the next higher gear saves fuel and reduces engine noise.

## Displays

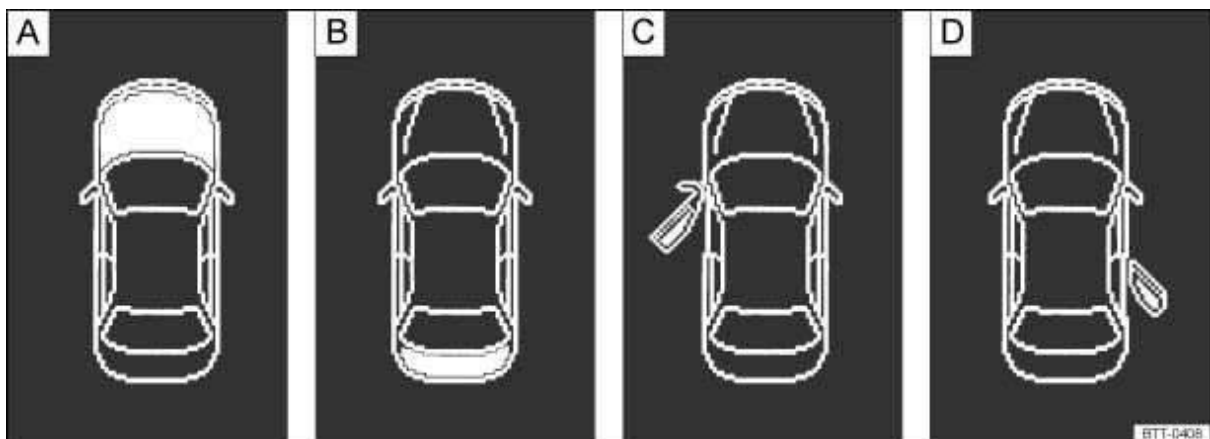

**Fig. 10** In the instrument cluster display: A: Open engine hood, B: Open luggage compartment lid, C: Open front driver side door, D: Open rear passenger side door.

<sup>1</sup> On appropriately equipped vehicles, the clocks can also be set via the **Settings** menu in the instrument cluster display

## Please first read and note the introductory information and heed the WARNINGS

Depending on the vehicle model, different information may be shown in the instrument cluster display ⇒ [fig. 9 \(4\)](#).

- Warning and information texts
- Odometer displays
- Time
- Outside temperature
- Compass display
- Open door, engine hood, or luggage compartment lid ⇒ [fig. 10](#)
- Selector lever position
- Gear recommendation (manual transmission)
- Multi-Function Indicator (MFI) and menus for different settings
- Service reminder display
- Alternative speed display (**Settings** menu)

### Odometer displays

The *odometer* indicates the total distance driven by the vehicle.

The *trip odometer (Trip)* shows the distance driven since the last time the trip odometer was reset. The last digit indicates 1/10 mile (100 meters).

### Outside temperature display

At outside temperatures below about +39 °F (+4 °C), a “snowflake symbol” (icy road warning) appears in the display. The symbol flashes at first, then stays on until the outside temperature rises above +43 °F (+6 °C) ⇒ .

When the vehicle is not moving or when you are driving at very low speeds, the temperature displayed may be slightly higher than the actual outside temperature.

The measurement range is from -40 °F (-40 °C) to +122 °F (+50 °C).

### Compass display (if applicable)

On vehicles equipped with compass display, the current compass direction is indicated in the instrument cluster display when the ignition and navigation system are switched on, *Compass*.

### Selector lever positions

The selector lever position is shown both on the side of the selector lever and in the instrument cluster display. The respective gear may also be shown in the instrument cluster display in Drive **D** and Sport Drive **S**, as well as in Tiptronic® mode.

### Gear recommendation (manual transmission)

When the vehicle is moving, a fuel economy gear recommendation may appear in the instrument cluster display .

### Alternative speed display (mph or km/h)

The alternative speed display shows the current vehicle speed in units *other than* the units shown on the vehicle’s speedometer. For example, if the speedometer shows mph, the alternative speed display shows a digital readout of the current vehicle speed in km/h. This feature can be especially helpful when driving in countries where speed limit signs are posted in units other than those shown on the vehicle’s speedometer.

In the instrument cluster display, select the **Alt. speed dis.** menu item in the **Settings** menu .



## WARNING

Failure to heed warning lights and instrument cluster text messages can cause the vehicle to break down in traffic and result in a collision and serious personal injury.

- Never ignore warning lights or text WARNINGS.
- Always stop the vehicle as soon as it is safe to do so.
- Park the vehicle at a safe distance from moving traffic and where no part of the hot catalytic converter and exhaust system can come into contact with flammable materials under the vehicle, such as dry grass, brush, spilled fuel, etc.
- A broken down vehicle presents a high accident risk for itself and others. Switch on emergency flashers and set up a warning triangle to warn oncoming traffic.



## WARNING

Roads and bridges may be dangerously icy even if the outside air temperature is above freezing.

- If you use the outside temperature display to tell you about frost conditions, remember that roads can even ice over at temperatures above +39 °F (+4 °C). Always remember: even if the “snowflake symbol” (icy road warning) is not displayed, there could still be black ice on the road.
- Never rely exclusively on the outside temperature display.



## NOTICE

Failure to heed warning lights or text WARNINGS can result in vehicle damage.



The instrument cluster displays and their arrangement may vary depending on the vehicle model and engine. For displays without warning and information messages, malfunctions are only signaled with indicator lights.



If there are multiple warning messages, the symbols are displayed for several seconds in order of importance. The symbols are displayed until the cause has been corrected.

## Compass

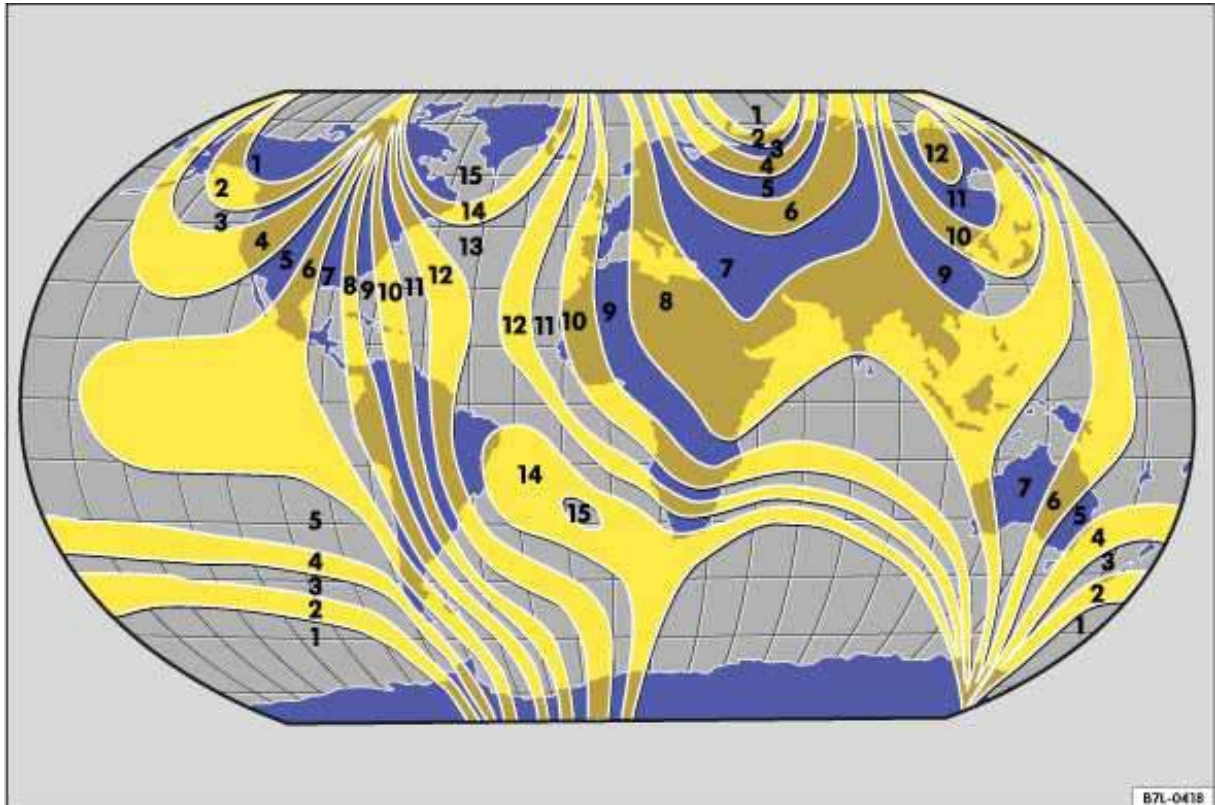

Fig. 11 Compass zones.

⚠ Please first read and note the introductory information and heed the WARNINGS ⚠

The compass does not need to be calibrated in vehicles with a factory-installed navigation system. There is no **Compass** menu item in this case.

On vehicles without a factory-installed navigation system, the compass is calibrated automatically. If electrical or metallic accessories are added to the vehicle, the compass must be recalibrated.

### Adjusting the compass zone

- Switch on the ignition.
- Select the **Settings** menu followed by the **Compass** and **Zone** menu items.
- Select the compass zone according to the current location ⇒ [fig. 11](#).
- Adjust and confirm compass zone (**1-15**) by using the arrow buttons.

### Calibrating the compass

In order to calibrate the compass, you need a valid compass zone for the location and enough room to drive in a circle.

- Switch on the ignition.
- Select the **Settings** menu followed by the **Compass** and **Calibrate** menu items.
- Confirm the **Please drive a full circle to calibrate** message by pressing the  $\alpha$  button on the multi-function steering wheel, and then drive in a complete circle at about 6 mph (10 km/h).

During calibration, **CAL** is shown in the instrument cluster display. The calibration is complete when the compass direction is displayed.

## Service reminder display

---

ⓘ Please first read and note the introductory information and heed the WARNINGS ⚠

The service appointment reminder is shown in the instrument cluster display ⇒ fig. 9 (4).

For information on maintenance intervals, please see the ⇒ Booklet *Warranty and Maintenance*.

For vehicles with **time- or distance driven-dependent service**, only fixed service intervals are displayed.

### Service reminder

If service is due in the near future, a **service reminder** is displayed when the ignition is switched on. The message **Service in --- mi or --- days (Service in --- km or --- days)** is shown in the instrument cluster display.

### Service event

When **service is due**, a warning chime sounds when the ignition is switched on, and a flashing wrench symbol  is displayed for several seconds. The message **Service now** is indicated in the instrument cluster display.

### Viewing service message

The current **service message** can be accessed when the ignition is switched on, the engine is switched off, and the vehicle is stopped:

- Select the **Settings** menu.
- In the **Service** submenu, select the **Info** menu item.

**Service since --- mi or --- days** or (**Service since --- km or --- days**) is shown in the instrument cluster display when service is overdue.

### Resetting the service reminder display

If the service was not performed by an authorized Volkswagen dealer or an authorized Volkswagen Service Facility, the service reminder can be reset as follows:

---

Select the **Settings** menu.

---



In the **Service** submenu, select the **Reset** menu item.

---

Confirm request with the  button on the multi-function steering wheel.

---

 Do **not** reset the service reminder between service intervals; otherwise, incorrect information will be displayed.

 The service reminder disappears after a few seconds when the engine is running or the  button on the multi-function steering wheel has been pushed.



# Volkswagen Information System

## Introduction

---

In this section you'll find information about:

Menu structure – overview

Menu structure – overview

Using the instrument cluster menus

Driver assistance systems button

Main menu

*MFI* menu (Multi-Function Indicator)

*Settings* menu

*Settings* menu

*Convenience* submenu

*Lights & Vision* submenu

Personal convenience settings

When the ignition is switched on, you can display different types of information in the instrument cluster and control certain vehicle features.

The control buttons are on the right side of the multi-function steering wheel.

The number of menus in the instrument cluster display depends on the electronics and equipment on the vehicle.

An authorized Volkswagen dealer or an authorized Volkswagen Service Facility may be able to add or modify functions depending on your vehicle's equipment.

Some menu items can only be accessed when the vehicle is not moving.

As long as a priority 1 warning message is displayed, no menus can be accessed. In order to display menus, acknowledge the warning by pressing the  button on the multi-function steering wheel

⇒ [fig. 12](#).

### More information:

- Outside mirrors
- Driver assistance systems
- Radio or Navigation system ⇒ Booklet *Radio* or ⇒ Booklet *Navigation system*
- Mobile phone package ⇒ Booklet *Mobile Phone Package*



### WARNING

**Driving on today's roads demands the full attention of the driver at all times. Driver distraction causes accidents, collisions and serious personal injury!**

- **Never access menus when the vehicle is moving.**



Emergency starting and starting the engine with a very weak vehicle battery or after the vehicle battery has been replaced may change or delete system settings (including time, date, personal convenience settings, and programming). Check the settings and correct as necessary once the vehicle battery has built up a sufficient charge.

Applicable only in the United States

## Menu structure – overview

---

**ⓘ Please first read and note the introductory information and heed the WARNINGS **

The instrument cluster display is divided into 3 parts. The time (digital clock) is displayed in the top part. The bottom part contains the odometer and the trip odometer (“trip”). You can select the following displays for the middle part:

### Multi-Function Indicator (MFI)

- Travel time
- Consumption --.- mpg (current fuel consumption)
- Av. consumption --.- mpg (average fuel consumption)
- Range
- Route
- Average speed
- xx mph (digital speed display)
- Oil temp. (3.6 liter engine only)
- Speed warning --- mph

**Audio** ⇒ Booklet *Radio* or ⇒ Booklet *Navigation system*

**Navigation** ⇒ Booklet *Navigation system*

**Phone** ⇒ Booklet *Mobile Phone Package*

### Assistants

- AFS

### Vehicle status

#### Settings

- Language
- MFI data
  - Travel time
  - Curr. consum. (current fuel consumption)
  - Av. consum. (average fuel consumption)
  - Route
  - Av. speed
  - Digit. speed (digital speed display)
  - Oil temp. (3.6 liter engine only)
  - Speed warn. (speed warning)
  - Back
- Convenience
  - ATA confirm
  - Central locking
    - Auto lock
    - Auto unlock
    - Unlock doors
    - Back
  - Window op. (window operation)
    - Off
    - All
    - Driver

- Back
- Mirror down (on/off)
- Mirror adjust
  - Individually
  - Both mirrors
- Back
- Factory setting
- Back
- Lights & Vision
  - Coming Home
  - Leaving Home
  - Footwell light
  - Conv. turn sig. (convenience turn signal)
  - Factory setting
  - Back
- Time
  - Hours
  - Minutes
  - 24 hr. mode
  - Daylight save
  - Back
- Snow tires (winter tires)
  - On
  - + 5 mph
  - - 5 mph
  - Back
- Compass (vehicles without navigation system)
- Units
  - Temperature
  - Consump./dist.
  - Air pressure
  - Back
- Alt. speed dis.
- Service
  - Info
  - Reset
  - Back
- Factory setting

Applicable only in Canada

## Menu structure – overview

---

**ⓘ Please first read and note the introductory information and heed the WARNINGS **

The instrument cluster display is divided into 3 parts. The time (digital clock) is displayed in the top part. The bottom part contains the odometer and the trip odometer (“trip”). You can select the following displays for the middle part:

## **Multi-Function Indicator (MFI)**

- Travel time
- Consumption --.- l/100 km (current fuel consumption)
- Av. consumption --.- l/100 km (average fuel consumption)
- Range
- Route
- Average speed
- xx km/h (digital speed display)
- Oil temp. (3.6 liter engine only)
- Speed warning --- km/h

**Audio** ⇒ Booklet *Radio* or ⇒ Booklet *Navigation system*

**Navigation** ⇒ Booklet *Navigation system*

**Phone** ⇒ Booklet *Mobile Phone Package*

## **Assistants**

- AFS

## **Vehicle status**

### **Settings**

- Language
- MFI data
  - Travel time
  - Curr. consum. (current fuel consumption)
  - Av. consum. (average fuel consumption)
  - Route
  - Av. speed
  - Digit. speed (digital speed display)
  - Oil temp. (3.6 liter engine only)
  - Speed warn. (speed warning)
  - Back
- Convenience
  - ATA confirm
  - Central locking
    - Auto lock
    - Auto unlock
    - Unlock doors
    - Back
  - Window op. (window operation)
    - Off
    - All
    - Driver
    - Back
  - Mirror down (on/off)
  - Mirror adjust
    - Individually
    - Both mirrors
    - Back
  - Factory setting

- Back
- Lights & Vision
  - Coming Home
  - Leaving Home
  - Footwell light
  - Conv. turn sig. (convenience turn signal)
  - Factory setting
  - Back
- Time
  - Hours
  - Minutes
  - 24 hr. mode
  - Daylight save
  - Back
- Snow tires (winter tires)
  - On
  - + 10 km/h
  - - 10 km/h
  - Back
- Compass (vehicles without navigation system)
- Units
  - Temperature
  - Consump./dist.
  - Air pressure
  - Back
- Tire pressure
- Alt. speed dis.
- Service
  - Info
  - Reset
  - Back
- Factory setting

## Using the instrument cluster menus

---



**Fig. 12** Right side of the multi-function steering wheel: Controls for menus in the instrument cluster.

## ⚠ Please first read and note the introductory information and heed the WARNINGS ⚠

The instrument cluster menus are controlled with buttons on the right side of the steering wheel ⇒ [fig. 12](#).

### Accessing the instrument cluster menus

- Switch on the ignition. You will see the vehicle icon or a message in the instrument cluster display.
- Push the **OK** button ( ) on the right side of the multi-function steering wheel until a main menu appears in the instrument cluster display.
- Push buttons **←** or **→** to move to another main menu, and push the arrow up and down buttons **▲** and **▼** to navigate inside the current main menu. For example, in the **Settings** main menu, press the arrow down button **▼** to navigate to the **MFI data** submenu.

### Displaying a submenu

- Press the **OK** button to display submenu items. For instance, after scrolling to **MFI data** in the **Settings** main menu, press the **OK** button to display items available under the **MFI data** submenu.

### Selecting a setting

- Some menus are used to select settings for certain features. Push the **OK** button ( ) to select a setting.
- Use the arrow up and down buttons **▲** and **▼** on the multi-function steering wheel to navigate through the available options.
- The selected menu item is located between the 2 horizontal lines. There is also a triangle (◀) on the right.
- Push the **OK** button to select the setting.

### Returning to the main menu

- *Via menu:* Use the arrow down button **▼** to select **Back** and then press the **OK** button .
- *For operation with multi-function steering wheel:* Press **↵**

Applicable only in the United States

## Driver assistance systems button

---



**Fig. 13** In the turn signal and high beam lever: Driver assistance systems button.

## ⚠ Please first read and note the introductory information and heed the WARNINGS ⚠

You can switch the driver assistance systems on or off in the **Assistants** menu using the button in the turn signal and high beam lever.

### Switching individual driver assistance systems on or off

- Press the button ⇒ [fig. 13](#) (arrow) **briefly** to open the **Assistants** menu.
- Select the driver assistance system (for example, AFS). A “check mark” indicates if the selected driver assistance system is switched on.

- Confirm the selection with  $\alpha$

### Switching all driver assistance systems on or off

- Press and hold the button (arrow) **longer than one second** to switch the driver assistance systems selected in the **Assistants** menu on or off at the same time.
- If no driver assistance system was activated in the **Assistants** menu, all systems are switched on.

## Main menu

ⓘ Please first read and note the introductory information and heed the WARNINGS ⚠

Menu	Function	See
<b>MFI</b>	Multi-Function Indicator (MFI) information.	
<b>Audio</b>	Station indicator in radio mode. Track display in CD mode. Track display in media mode.	⇒ Booklet <i>Radio</i> or ⇒ Booklet <i>Navigation system</i>
<b>Navigation</b>	Information displays on the navigation system (if applicable): When destination guidance is active, turn arrows and proximity bars are shown. The illustration is similar to the symbol display in the navigation system. If destination guidance is inactive, driving direction (compass function) and the current street name are displayed.	⇒ Booklet <i>Navigation system</i>
<b>Phone</b>	Information and settings of the mobile phone package.	⇒ Booklet <i>Mobile Phone Package</i>
<b>Assistants</b>	Turn the Adaptive Front Lighting System (AFS) on and off.	
<b>Vehicle status</b>	Current warning and information messages. This menu item is only displayed when warning or information messages are available. The number of available messages is shown in the display. Example: 1/1 or 2/2.	
<b>Settings</b>	Includes the Convenience and Lights & Vision submenus, as well as many settings such as time, speed warning for winter tires, language, and units.	

## MFI menu (Multi-Function Indicator)

ⓘ Please first read and note the introductory information and heed the WARNINGS ⚠

The MFI display has 2 automatic memories: **1 – single trip memory** and **2 – total trip memory**. The number of the trip memory is shown at the upper right of the display.



The trip memories are in addition to the trip odometer, which is displayed in the bottom part of the instrument cluster and controlled using the  $\alpha$  / SET button on the right of the instrument panel ⇒ [fig. 9 \(7\)](#).

To display the distance driven on trips 1 and 2, select the **Route** item in the **MFI** menu. Press the **OK** button ⇒ [fig. 12](#) to toggle between Route 1 and Route 2 (trip 1 and trip 2). Push and hold the **OK** button to manually reset a trip memory to zero.

<b>1</b>	Single trip memory	The memory accumulates and stores information about distance driven and fuel used from the time the ignition was switched on until the time it was switched off. If the ignition stays off for 2 hours or more, stored information is automatically deleted. If the trip is continued within 2 hours after the ignition was switched off, the new values are added.
<b>2</b>	Total trip memory	The memory displays and stores the accumulated driving and fuel consumption data of any number of single trips up to a total driving time of 99 hours and 59 minutes, and up to a total distance of 9,999 miles (9,999 km). If one of the maximum values is exceeded, then the memory is automatically cleared and starts again from 0.

### Possible MFI menu displays

The following displays can be accessed in the MFI menu if enabled under **Settings > MFI data**. Displays that are not enabled will not appear.

Display	Function
<b>Travel time -- h/min</b>	Driving time in hours (h) and minutes (min) corresponding to trip memories 1 and 2 (toggle).
<b>Consumption --.- mpg</b>	Current fuel consumption in miles per gallon (l/100 km) while driving. <i>When units are set to miles</i> , dashes appear instead of a number when the engine is running and the vehicle is standing still. <i>When units are set to kilometers</i> , the display shows liters consumed per hour when the engine is running and the vehicle is standing still.
<b>Consumption --.- l/100 km</b>	
<b>Av. consumption --.- mpg</b>	Average fuel consumption in miles per gallon (l/100 km) on trips per trip memories 1 and 2 (toggle) is displayed once the vehicle has been driven about 330 feet (100 m). Until then, dashes appear instead of a number. The value displayed is updated every 5 seconds.
<b>Av. consumption --.- l/100 km</b>	
<b>Range  -- mi</b>	Estimated distance in miles (km) that the vehicle can go with the fuel left in the tank the way you are currently driving. Takes account of the current fuel consumption, among other things.
<b>Range  -- km</b>	
<b>Route -- mi</b>	Distance driven in miles (km) per trip memories 1 and 2 (toggle).
<b>Route -- km</b>	
<b>Average speed -- mph</b>	Average speed on trips per trip memories 1 and 2 (toggle). Displayed once the vehicle has been driven about 300 feet (100 m). Until then, dashes may appear instead of a number. The value displayed is updated every 5 seconds.
<b>Average speed -- km/h</b>	
<b>-- mph</b>	Digital display of current vehicle speed.
<b>-- km/h</b>	
<b>Oil temp.</b>	Current engine oil temperature (digital display; 3.6 liter engine only).
<b>Speed warning --- mph</b>	When the set speed (from 20–155 mph or 30–250 km/h) is exceeded, an acoustic warning sounds and a visual message may also appear in



Display	Function
<b>Speed warning</b> --- km/h	the instrument cluster display.

### Switching between the displays

- Use the arrow up and down buttons  $\Delta$  and  $\nabla$  on the multi-function steering wheel.

### Storing speed for the speed warning

- Navigate to MFI > Speed warning (**Speed warning -- mph** or **Speed warning -- km/h**) display.
- Press the  $\alpha$  button to save the current speed and to activate the warning.
- If the speed is not right, press buttons  $\Delta$  or  $\nabla$  on the multi-function steering wheel to set a different speed within about 5 seconds. Then press the  $\alpha$  button a second time or just wait a few seconds. The speed is saved and the warning is activated.
- *To deactivate*, toggle to --- mph or --- km/h and press the  $\alpha$  button. The set speed is deleted.

### Manually erasing trip memory 1 or 2

- Navigate to **MFI > Route**.
- Select the memory to be erased.
- Press the  $\alpha$  button for about 2 seconds.

### Enabling and disabling displays

Use the **Settings** menu, submenu **MFI data** to enable displays you want to be available under the MFI menu in the instrument cluster display. The units in which data is displayed can also be changed

Applicable only in the United States

## Settings menu

Please first read and note the introductory information and heed the **WARNINGS** 

Settings menu	Function
<b>Language</b>	Set the language for messages in the display and navigation system.
<b>MFI data</b>	Select the features you want to have displayed in the MFI menu in the instrument cluster display
<b>Convenience</b>	Convenience function settings
<b>Lights &amp; Vision</b>	Vehicle lighting settings
<b>Time</b>	Set hours and minutes for the instrument cluster clock, the Radio & Navigation System clock, and the analog clock. The digital clocks can be set to show the time in 12 or 24 hour format, and can also be set to daylight savings time.
<b>Snow tires</b>	Set up a visual and acoustic speed warning. Use this feature only when winter tires are installed that have a speed rating less than top vehicle speed.
<b>Compass</b>	Calibrating the compass on vehicles without a factory-installed navigation system. To calibrate, follow the instructions in the instrument cluster display

<b>Settings menu</b>	<b>Function</b>
<b>Units</b>	Set the units in which temperature, fuel consumption, and distances should be displayed (for example, whether to show distance driven in miles or kilometers).
<b>Alt. speed dis.</b>	Activate/deactivate alternative speed display (mph or km/h).
<b>Service</b>	Display service messages or reset service reminder display.
<b>Factory setting</b>	Reset the functions in the <b>Settings</b> menu back to the factory settings.

Applicable only in Canada





## **Settings menu**

Please first read and note the introductory information and heed the **WARNINGS** 

<b>Settings menu</b>	<b>Function</b>
<b>Language</b>	Set the language for messages in the display and navigation system.
<b>MFI data</b>	Select the features you want to have displayed in the MFI menu in the instrument cluster display
<b>Convenience</b>	Convenience function settings
<b>Lights &amp; Vision</b>	Vehicle lighting settings
<b>Time</b>	Set hours and minutes for the instrument cluster clock, the Radio & Navigation System clock, and the analog clock. The digital clocks can be set to show the time in 12 or 24 hour format, and can also be set to daylight savings time.
<b>Snow tires</b>	Set up a visual and acoustic speed warning. Use the feature only when winter tires are installed that have a speed rating less than top vehicle speed.
<b>Compass</b>	Calibrating the compass on vehicles without a factory-installed navigation system. To calibrate, follow the instructions in the instrument cluster display 19.
<b>Units</b>	Set the units in which temperature, fuel consumption, and distances should be displayed (for example, whether to show distance driven in miles or kilometers).
<b>Tire pressure</b>	Reset the tire pressure, for example after replacing tires
<b>Alt. speed dis.</b>	Activate/deactivate alternative speed display (mph or km/h).
<b>Service</b>	Display service messages or reset service reminder display.
<b>Factory setting</b>	Reset the functions in the <b>Settings</b> menu back to the factory settings.

## Convenience submenu

ⓘ Please first read and note the introductory information and heed the WARNINGS ⚠

Convenience menu	Function	
<b>ATA confirm</b>	The horn beeps once when the vehicle is locked with the remote control vehicle key if <b>ATA confirm</b> is checked.	
<b>Central Locking</b>	<b>Auto lock</b>	If Auto lock is enabled (box checked), all doors and the luggage compartment lid lock automatically after the vehicle reaches a speed of about 10 mph (15 km/h).
	<b>Auto unlock</b>	If Auto unlock is enabled (box checked), all doors and the luggage compartment lid unlock when the vehicle key is removed from the ignition.
	<b>Unlock doors</b>	Doors are unlocked as follows depending on the option selected: – <b>All doors</b> : Pushing the unlock button  on the remote control vehicle key unlocks all doors and the luggage compartment lid. – <b>Single door</b> : Pushing the unlock button  on the remote control vehicle key unlocks only the driver door. To unlock all doors and the luggage compartment, push the unlock button  on the key a second time within about 5 seconds. – <b>Vehicle side</b> : Pushing the unlock button  on the remote control vehicle key unlocks the doors on the driver side of the vehicle.
<b>Window op.</b>	Power window and power sunroof settings when manually unlocking/locking the driver door with the emergency key.	
<b>Mirror down</b>	Tilts passenger mirror down when backing up so you can see the curb Feature only available on vehicles equipped with memory seats.	
<b>Mirror adjust</b>	<b>Individually</b>	Both outside mirrors are adjusted separately.
	<b>Both mirrors</b>	The front passenger outside mirror is adjusted at the same time as the driver outside mirror.
	<b>Back</b>	The display returns to the <b>Convenience</b> menu.
<b>Factory setting</b>	Resets the features in the <b>Convenience</b> submenu back to the factory settings.	
<b>Back</b>	The display returns to the <b>Settings</b> menu.	

## Lights & Vision submenu

ⓘ Please first read and note the introductory information and heed the WARNINGS ⚠

Lights & Vision menu	Function
<b>Coming Home</b>	Set how long the headlights and inside lights stay on after locking or unlocking the vehicle. Feature can also be switched on or off
<b>Leaving Home</b>	

<b>Lights &amp; Vision menu</b>	<b>Function</b>
<b>Footwell light</b>	Set footwell lighting brightness or switch this feature on or off
<b>Conv. turn sig.</b>	Enable/disable lane change flash (convenience turn signal). When the feature is enabled, the turn signal flashes at least 3 times when the turn signal is tapped 98.
<b>Factory setting</b>	Resets the functions in the <b>Lights &amp; Vision</b> submenu back to the factory settings.
<b>Back</b>	The display returns to the <b>Settings</b> menu.

## Personal convenience settings

ⓘ Please first read and note the introductory information and heed the WARNINGS ⚠

When 2 people use the vehicle, Volkswagen recommends that each person always use “a separate” remote control vehicle key. When the ignition is switched off or the vehicle is locked, personal convenience settings are stored automatically and assigned to the remote control vehicle key

The personal convenience settings for the following menu items can be assigned to a remote control vehicle key:

### **Settings menu**

- Time
- Language
- Units

### **Settings / Convenience menu**

- Door unlock
- Mirror down

### **Settings / Lights & Vision menu**

- Coming Home / Leaving Home
- Convenience turn signal (lane change flash)

The stored settings are recalled when the ignition is switched on. Please also see information about the memory seat

# Driving checklists and warnings

## Introduction

---

In this section you'll find information about:

- Getting ready and driving safely
- Driving in other countries
- Driving through water on roads

### More information:

- Sitting properly and safely
- Transporting
- Starting, shifting, parking
- Saving fuel and helping the environment
- Consumer information



### WARNING

**Driving under the influence of alcohol, illegal drugs, narcotics and some medications may cause collisions and other accidents, severe personal injuries and even death.**

- **Alcohol, illegal drugs, narcotics and some medications may severely affect perception, reaction times and safe driving, which may result in the loss of vehicle control.**

## Getting ready and driving safely

---

 Please first read and note the introductory information and heed the **WARNINGS** 

### Checklist

---

Observe the following points before and during every drive for your own safety, the safety of all passengers and others ⇒ :

- ✓ Check proper function of lights and turn signals.
- ✓ Check tire pressure and fuel level
- ✓ Make sure that all windows are clean.
- ✓ Store items and all luggage safely in the storage compartments, the luggage compartment and, if necessary, on the roof
- ✓ Always make sure that nothing keeps the pedals from moving freely.
- ✓ Make sure that children are properly secured by a restraint system appropriate for their size and weight
- ✓ Properly adjust front seats, all head restraints and mirrors to the correct height
- ✓ Wear shoes that give your feet a good grip, and that give you a feel for the pedals.
- ✓ Make sure that the floormat on the driver side is properly fastened and cannot interfere with the pedals.
- ✓ Assume a proper seating position before the vehicle starts to move and keep this position while driving. Make sure that all passengers do the same

- ✓ Properly fasten your safety belt before driving the vehicle and wear your safety belt properly at all times while driving. Make sure that all passengers do the same
- ✓ Only transport as many passengers as there are seats and safety belts available.
- ✓ Never drive if your driving ability has been impaired, for example by medication, alcohol or illegal drugs.
- ✓ Never let passengers or phone calls distract you while driving, and never take your attention off the road while using vehicle software or adjusting vehicle equipment or accessories.
- ✓ Always adapt your speed and driving style to visibility, weather, road, and traffic conditions.
- ✓ Always obey traffic laws and speed limits.
- ✓ On long trips make frequent rest stops – at least once every 2 hours.
- ✓ Secure animals in the vehicle with a system that corresponds to weight and size.



## WARNING

**Always observe traffic rules and posted speed limits and use common sense. Your good judgment can mean the difference between arriving safely at your destination and being seriously injured in a crash or other kind of accident.**



Regular service and maintenance of your vehicle is important both for operational and driving safety and to help prolong your vehicle's service life. Always follow the scheduled maintenance intervals in the ⇒ Booklet *Warranty and Maintenance*, especially for changing the brake fluid. Hard use, frequent stop-and-go driving, driving in very dusty areas, trailer towing, and other factors may make it necessary to have the vehicle serviced more frequently. Ask an authorized Volkswagen dealer or an authorized Volkswagen Service Facility for more information.

## Driving in other countries

❏ Please first read and note the introductory information and heed the **WARNINGS** ⚠

### Checklist

Some countries have special safety standards and emissions requirements that your vehicle may not meet. Before taking your vehicle to another country, Volkswagen therefore recommends that you ask your authorized Volkswagen dealer or authorized Volkswagen Service Facility about the following issues with regard to the country to which you would like to travel:

- ✓ Should the vehicle be technically prepared for the trip abroad, such as masking or adjusting headlights?
- ✓ Are maintenance, repair facilities, necessary tools and testing equipment as well as spare parts readily available for your vehicle?
- ✓ Are there authorized Volkswagen dealers and authorized Volkswagen Service Facilities in the countries where you will be driving?
- ✓ For gasoline engines: Is unleaded fuel with the right octane rating readily available?
- ✓ Are engine oil and other operating fluids that meet Volkswagen quality and performance requirements available where you will be driving? For more information, please see ⇒ Booklet *Warranty and Maintenance*.
- ✓ Does the factory-installed navigation system work in the countries where you will be driving, and is navigation data available?
- ✓ Are special or heavy-duty tires necessary for the kind of driving expected?

---

## NOTICE

Volkswagen is not responsible for mechanical damage that may result from substandard fuel or service or the unavailability of Genuine Volkswagen parts.

## Driving through water on roads

---

 Please first read and note the introductory information and heed the WARNINGS 

Note the following to help prevent vehicle damage when driving through water, for example on flooded roads:

- Check the depth of the water before driving through it. The water **must not be any higher than** the bottom of the vehicle body ⇒ .
- Do not drive faster than walking speed.
- Never stop the vehicle, and do not drive in reverse or switch the engine off when driving through water.
- Oncoming vehicles may create waves that raise the water level and make it too deep for your vehicle to drive through safely.

## WARNING

After driving through water, mud, sludge, etc., the brakes react slower and need longer stopping distances.

- Always dry the brakes and clean off any ice coatings with a few careful applications of the brake. Make sure not to endanger other motorists or cyclists or disobey legal requirements.
- Avoid abrupt or sudden braking maneuvers immediately after driving through water.

## NOTICE

- Vehicle components such as the engine, transmission, suspension or electrical system may be severely damaged by driving through water.
- Never drive through salt water. Salt causes vehicle corrosion. Thoroughly rinse with fresh water all vehicle parts that were exposed to salt water.

# Technical data

## Introduction

In this section you'll find information about:

Important vehicle labels

Engine data

Dimensions

Your vehicle's engine type is shown on the vehicle identification label.

The specifications in this Manual refer to the base model. The stated values may vary, depending upon different equipment or models, as well as with respect to special vehicles and vehicles exported to different countries.

### More information:

- Transporting
- Saving fuel and helping the environment
- Fuel
- Engine oil
- Engine coolant
- Tires and wheels
- Consumer information

**⚠ WARNING**  
Disregarding or exceeding stated values for weights, loads, dimensions and maximum speed may result in accidents and serious personal injuries.

## Important vehicle labels



Fig. 14 Vehicle identification label: shown in the example with engine identification code CBFA 3.



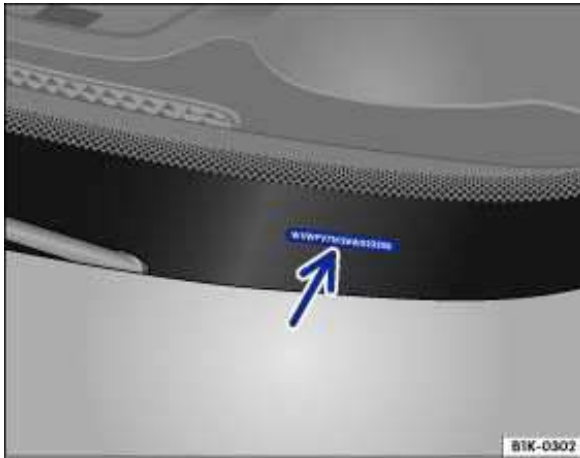

**Fig. 15** Vehicle identification number (VIN).

☐ Please first read and note the introductory information and heed the WARNINGS ⚠

### Vehicle identification number

The vehicle identification number is on a plate on top of the instrument panel on the driver side, and is visible from the outside through the windshield ⇒ [fig. 15](#). The view window is on the side at the bottom of the windshield. The vehicle identification number is also stamped into the top of the right drip channel in the engine compartment. The drip channel is between the spring strut tower and the right fender. Open the engine hood to read the vehicle identification number ⚠

### Vehicle identification label

The vehicle identification label ⇒ [fig. 14](#) is affixed to the area of the spare wheel well in the luggage compartment and contains the following information:

- (1) Vehicle identification number (VIN)
- (2) Vehicle type, engine output, transmission
- (3) Engine and transmission classification code, paint number, interior. In the example, the engine classification code is "CBFA" .
- (4) Optional equipment, part numbers

### Other important vehicle labels

Other important vehicle labels are discussed elsewhere in this Manual:

- **Safety Compliance Certification Label**, affixed to the driver door jamb (see, *Consumer information*).
- **Radiator fan and high voltage warning sticker** in the engine compartment next to the engine hood release (see, *Consumer information*).
- **Tire inflation pressure label** on the driver door jamb (see, *Tires and wheels*).

## Engine data

---

☐ Please first read and note the introductory information and heed the WARNINGS ⚠

### Gasoline engines

Maximum power output (SAE net)	Injection technology	Engine code	Maximum torque	No. of cylinders Displacement
200 hp at 5100 – 6000 rpm 147 kW at 5100 – 6000 rpm	TSI <sup>®</sup>	CCTA CBFA 2.0T	207 lb-ft at 1700 – 5000 rpm 280 Nm at 1700 – 5000 rpm	4 cylinders 121 CID 1984 ccm
280 hp at 6200 rpm 206 kW at 6200 rpm	FSI <sup>®</sup> 3.6L	CNNA 3.6L	265 lb-ft at 2750 rpm 360 Nm at 2750 rpm	6 cylinders 219 CID 3597 ccm

## Dimensions

❏ Please first read and note the introductory information and heed the WARNINGS 

Length	189 in – 193 in (4802 – 4902 mm)
Width	73 in (1855 mm)
Height (unloaded)	55.7 – 56.1 in (1417 – 1425 mm)
Wheelbase	106.6 in (2708 mm)
Minimum turning circle diameter (wall to wall) <sup>2</sup>	37.4 ft (11.4 m)
Track <sup>2</sup> , front	61.1 – 61.3 in (1552 – 1556 mm)
Track <sup>2</sup> , rear	61.3 – 61.5 in (1557 – 1562 mm)
Ground clearance (unloaded)	4.9 in (124 mm)



### NOTICE

- Please be careful when parking your vehicle in areas with parking barriers or curbs. These vary in height and could damage your bumper and related parts if the front of your vehicle hits a barrier or curb that is too high while you are getting into or out of a parking spot.
- Always be careful when you enter a driveway or drive up or down steep ramps or over curbs or other obstacles. Parts of the vehicle close to the ground may be damaged (such as bumper covers, spoilers, and parts of the engine, suspension, and exhaust systems).

<sup>2</sup> Slight differences to these figures are possible, depending on wheel and tire size fitted and the level selected.

# Vehicle key set

## Introduction

---

In this section you'll find information about:

Remote control vehicle keys

Emergency key

Indicator light in the remote control vehicle key

Replacing the remote control vehicle key battery

Synchronizing the remote control vehicle key

### **More information:**

- Volkswagen Information System
- Power locking and closing system
- Starting and stopping the engine
- Consumer information
- Emergency closing and opening



### **WARNING**

**Improper use of vehicle keys can result in serious personal injury.**

- **Always take the key with you when you leave the vehicle. It can be used to start the engine and operate vehicle systems such as the power windows, leading to serious personal injury. Children or other unauthorized persons could also lock the doors and the luggage compartment.**
- **Never leave children, disabled persons, or anyone who cannot help themselves in the vehicle. The doors can be locked with the remote control vehicle key. This could leave people trapped in the vehicle in an emergency. Depending on the time of year, people trapped in the vehicle can be exposed to very high or very low temperatures.**
- **A closed vehicle can become very hot or very cold, depending on the season. Particularly in the summer, heat build-up in the passenger and luggage compartment of a parked vehicle can result in temperatures in the vehicle that are much higher than the outside temperatures. Temperatures can quickly reach levels that can cause unconsciousness and death, particularly to small children.**
- **Never remove the key from the ignition switch while the vehicle is moving or rolling to a stop. The steering wheel will lock and you will not be able to steer or control the vehicle.**

## Remote control vehicle keys



**Fig. 16** Remote control vehicle key with panic button.

**⚠ Please first read and note the introductory information and heed the WARNINGS ⚠**

### Remote control vehicle key

The remote control vehicle key can unlock and lock the vehicle from a distance

The remote transmitter and battery are inside the remote control vehicle key. The receiver is inside the passenger compartment. The operating range of the remote control vehicle key for a fresh battery is several yards (meters) around the vehicle.

If the remote control vehicle key will not lock or unlock your vehicle, you probably need to replace the battery in the remote control vehicle key 42, *Replacing the remote control vehicle key battery*. If this is not the problem, the key should be resynchronized by an authorized Volkswagen dealer, an authorized Volkswagen Service Facility, or another qualified workshop. See also , *Synchronizing the remote control vehicle key*.

### Panic button

Press the panic button ⇒ [fig. 16](#) only in emergencies! After pushing the panic button, the horn will sound and the turn signals will flash. Press the panic button again to switch off the panic feature.

### Replacement vehicle keys

The vehicle identification number is required to get a replacement key or an additional remote control vehicle key.

Up to 8 vehicle keys, each of which must be properly cut, coded, programmed, and synchronized, can be used with your vehicle.

Each new vehicle key contains a microchip and must be coded with the data from the vehicle's electronic immobilizer. A vehicle key will not work if it does not contain a microchip or contains a chip that is not coded, even if the key bit was cut correctly.

You can obtain additional or duplicate remote control vehicle keys from authorized Volkswagen dealers, authorized Volkswagen Service Facilities, and from certain independent repair facilities and locksmiths which are qualified to make remote control vehicle keys.

Each vehicle key must be programmed by an authorized Volkswagen dealer or an authorized Volkswagen Service Facility in order for it to work with your vehicle.

To find the nearest qualified independent repair facility, locksmith, or Volkswagen dealer which can cut and code replacement vehicle keys, call the VW Customer Care Hotline at 1-800-822-8987 or visit <http://www.vw.com> and search for “replacement keys.”

Canadian customers can contact an authorized Volkswagen dealer or Volkswagen Service Facility or call the Volkswagen Canada Customer CARE Center at 1-800-822-8987.

### NOTICE

**The remote control vehicle keys contain electrical components. Protect them from damage, moisture and rough handling.**

**i** Do not press the buttons on the remote control vehicle key unless you actually want to use the function in question. Since terrain and conditions vary, pressing a button on the remote control vehicle key when it is not necessary may unlock the vehicle or set off the panic alarm, even if you think you are out of range.

**i** Remote control vehicle key functions can be temporarily disrupted by interference from transmitters near the vehicle that use the same frequency range (such as radio equipment or cellular phones).

**i** Things between the remote control vehicle key and vehicle, bad weather, as well as a weak battery can reduce the operating range.

**i** If the remote control vehicle key buttons 47 or the power locking buttons 48 are pushed repeatedly in quick succession, the power locking system is switched off for a brief period to help keep it from being overloaded. The vehicle is then unlocked for about 30 seconds. Unless a door or the luggage compartment lid is opened in this span of time, the vehicle is automatically locked afterwards.

## Emergency key

---

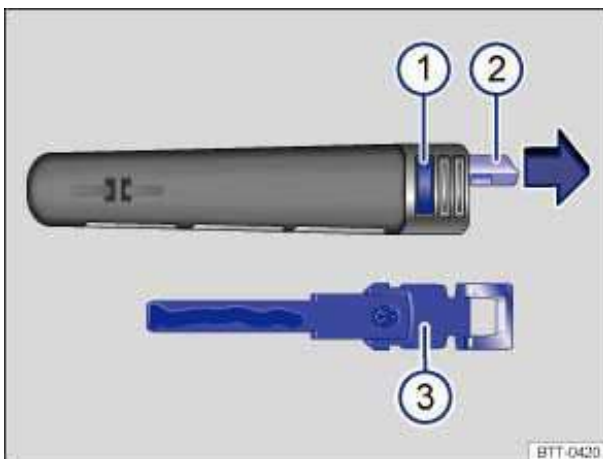

**Fig. 17** Remote control vehicle key (side view): Press the button 1 and remove emergency key 3 by the eyelet 2.

**⚠ Please first read and note the introductory information and heed the WARNINGS ⚠**

Inside the remote control vehicle key, there is an emergency key ⇒ [fig. 17 \(3\)](#) for manually unlocking and locking the vehicle.

In the vehicle key :

- (1) Emergency key release button.
- (2) Emergency key in the remote control vehicle key, with eyelet for fastening to a key chain.
- (3) Emergency key removed.

### Releasing and removing the emergency key

Press and hold button (1).

Pull out the emergency key by the eyelet (2) in the direction of the arrow.

### Using the emergency key

The emergency key can be used for the following:

- Locking and unlocking the glove compartment on the passenger side
- Locking and unlocking the luggage compartment pass-through
- Locking and unlocking the luggage compartment lid using the key switch in the driver door
- Manually locking and unlocking the vehicle

### Reinserting the emergency key

Insert the emergency key (3) into the opening in the remote control vehicle key.

Slide the emergency key in the direction opposite to the arrow until it locks into place.

## Indicator light in the remote control vehicle key

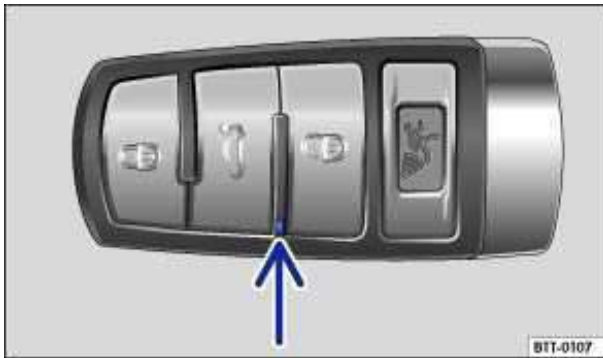

Fig. 18 Indicator light in the remote control vehicle key.

**⚠ Please first read and note the introductory information and heed the WARNINGS ⚠**

If a button in the remote control vehicle key is pressed briefly, the indicator light ⇒ fig. 18 (arrow) will flash once briefly. If you push and hold a button, it flashes repeatedly.

If the indicator light in the remote control vehicle key does not come on when the button is pressed, the battery inside the key must be replaced

A Declaration of Compliance with United States FCC and Industry Canada regulations is found in the Consumer information section of this Manual

## Replacing the remote control vehicle key battery





Fig. 19 Remote control vehicle key: Opening the battery compartment cover.

**ⓘ Please first read and note the introductory information and heed the WARNINGS ⚠**

Volkswagen recommends having the battery in the remote control vehicle key changed by an authorized Volkswagen dealer or authorized Volkswagen Service Facility.

The battery is on the back of the remote control vehicle key under a cover ⇒ [fig. 19](#). When changing the battery, pay attention to the correct polarity and use the same type of battery ⇒ .

### Replacing the battery

- Take the emergency key out of the vehicle key fob
- Push the cap (A) in the direction of the arrow and remove it ⇒ .
- Use an appropriate tool or object to remove the cover on the back of the vehicle key by pushing it in the direction of the arrow (B).
- Use a thin object to pry the battery out of the battery compartment (C).
- Position the new battery as shown (C) and press it into the battery compartment (opposite the direction of the arrow) ⇒ .
- Position the cover as shown (B) and press it down (opposite the direction of the arrow) until you hear it click into place ⇒ .
- Position the cap as shown (A) and press it down (opposite the direction of the arrow) until you hear it click into place.

### NOTICE

- **Changing the battery improperly can damage the remote control vehicle key.**
- **Using the wrong battery can damage the remote control vehicle key. Replace a dead battery with a new one that has the same voltage, size, and specifications.**
- **Make sure the plus and minus poles of the battery are correctly positioned.**



Dispose of old batteries in an environmentally responsible manner and keep them out of the reach of children.





Batteries of the type used in your remote control vehicle key may contain **Perchlorate Material**. Special handling may apply – see <http://www.dtsc.ca.gov/hazardouswaste/perchlorate>. Obey all legal requirements regarding handling and disposal of these batteries. Authorized Volkswagen dealers and authorized Volkswagen Service Facilities are familiar with the requirements, and we recommend that you have them perform this service for you.

## Synchronizing the remote control vehicle key

---

**ⓘ Please first read and note the introductory information and heed the WARNINGS ⚠**

If the  button is pressed often while outside the operating range, it is possible that the vehicle cannot be locked or unlocked anymore with the remote control vehicle key. Synchronize the vehicle key as follows:

- Take the emergency key out of the remote control vehicle key
- Remove the cap from the door handle on the driver door
- Press the  button on the remote control vehicle key. Stand immediately next to vehicle while doing so.
- Manually unlock the vehicle using the emergency key within 1 minute.

- Switch the ignition on with the remote control vehicle key. The synchronization is complete.
- Insert the emergency key into the vehicle key.
- Reinstall the cap.



# Power locking and closing system

## Introduction

---

In this section you'll find information about:

- Description of the power locking system
- Unlocking or locking the vehicle from the outside
- Unlocking or locking the vehicle from the inside
- Anti-theft alarm system

The power locking system works properly only when all doors and the luggage compartment lid are completely closed. When the driver door is open, the vehicle *cannot* be locked with the remote control vehicle key.

Leaving the vehicle unlocked for longer periods of non-use (for example, in your garage) can cause the vehicle battery to drain so that the engine can no longer be started.

### More information:

- Exterior views
- Volkswagen Information System
- Vehicle key set
- Doors
- Luggage compartment lid
- Power windows
- Power sunroof
- Trailer towing
- Emergency closing and opening



### WARNING

**Improper use of power locks can result in serious personal injury.**

- **The power locking button locks all doors. Locking the doors from the inside can help prevent unintended door opening during a collision and can also prevent unwanted entry from the outside. Locked doors can, however, delay assistance to vehicle occupants and rescue from the outside in an accident or other emergency.**
- **Never leave children or anyone who cannot help themselves behind in the vehicle. All doors can be locked from the inside with the power lock button. This could leave people trapped in the vehicle in an emergency. Depending on the time of year, people trapped in the vehicle can be exposed to very high or very low temperatures.**
- **A closed vehicle can become very hot or very cold, depending on the season. Particularly in the summer, heat build-up in the passenger and luggage compartment of a parked vehicle can result in temperatures in the vehicle that are much higher than the outside temperatures. Temperatures can quickly reach levels that can cause unconsciousness and death, particularly to small children.**
- **Never allow passengers to remain in a locked vehicle. In an emergency any person still inside the vehicle might not be able to get out.**

## Description of the power locking system

 Please first read and note the introductory information and heed the **WARNINGS**

The power locking system lets you unlock and lock all doors and the luggage compartment lid:

- From the outside with the vehicle key
- From the inside with the power locking button

Special functions of the power locking system can be turned on or off via the **Convenience** submenu in the **Settings** menu or by an authorized Volkswagen dealer or authorized Volkswagen Service Facility.

The doors and the luggage compartment lid can be locked manually if the vehicle key or power locking system is not working

### Automatic locking (Auto Close)

The vehicle locks automatically when it reaches a speed of about 10 mph (15 km/h). When the vehicle is locked, the indicator light  comes on in the power locking button ⇒ [fig. 21](#).

### Automatic unlocking (Auto Open)

The vehicle unlocks automatically when the vehicle key is taken out of the ignition. Auto open works only if the vehicle has been automatically locked with the Auto Close feature. The indicator light  goes out in the power locking button when the doors unlock ⇒ [fig. 21](#).

### Locking the vehicle after airbag inflation

If the airbags are activated during a collision, the entire vehicle is unlocked. Depending on the severity of the damage, the vehicle can be locked after a collision when the airbags have deployed as follows:

Function	Action
Locking the vehicle <b>with the power locking button</b> :	<ul style="list-style-type: none"><li>– Switch the ignition off.</li><li>– Open and close a door once.</li><li>– Press the power locking button .</li></ul>
Locking the vehicle <b>with the remote control vehicle key</b> :	<ul style="list-style-type: none"><li>– Switch the ignition off.</li><li><b>OR:</b> Remove the vehicle key from the ignition.</li><li>– Open a door once.</li><li>– Lock the vehicle with the remote control vehicle key.</li></ul>



 If the vehicle key buttons [47](#) or the power locking buttons [48](#) are pushed repeatedly in quick succession, the power locking system is switched off for a brief period to help keep it from being overloaded. The vehicle is then unlocked for about 30 seconds. Unless a door or the luggage compartment lid is opened during this time, the vehicle is automatically locked afterwards.

## Unlocking or locking the vehicle from the outside



Fig. 20 Remote control vehicle key with panic button.

ⓘ Please first read and note the introductory information and heed the WARNINGS ⚠

Function	Using the buttons on the remote control vehicle key ⇒ fig. 20
Unlock the vehicle.	Press the  button.
Lock the vehicle.	Press the  button.
Unlock the luggage compartment lid.	Press the  button. The luggage compartment lid opens automatically

**Note:** Depending on the settings for the power locking system in the **Convenience** submenu, it may be necessary to press the  button on the remote control vehicle key twice to unlock all doors and the luggage compartment lid

The vehicle key unlocks or locks the vehicle only when the battery in the remote control vehicle key has enough power, and the remote control vehicle key is within a few yards/meters of the vehicle.

- All turn signals flash *once* and the horn beeps once to confirm that the vehicle has been locked. The horn beep can be disabled by deactivating the **ATA confirm** feature in the **Convenience** submenu
- All turn signals flash *twice* to confirm that the vehicle has been unlocked.

If the turn signals *do not* flash to confirm locking, one or more doors or the luggage compartment lid is not locked.

If the driver door is open, the vehicle cannot be locked with the remote control vehicle key.

If the vehicle was unlocked with the remote control vehicle key and the door or the luggage compartment lid has not been opened within a few seconds, the vehicle is automatically locked again. This feature helps prevent you from leaving the vehicle unlocked unintentionally.

### ⓘ NOTICE

**Check to make sure that the windows go down slightly when you unlock the vehicle. Otherwise the windows and seals could be damaged when opening the door.**

## Unlocking or locking the vehicle from the inside



---



**Fig. 21** In the vehicle doors: Power locking button.

**⚠ Please first read and note the introductory information and heed the WARNINGS ⚠**

**Press button ⇒ fig. 21:**

- 
- |   |                     |
|---|---------------------|
|  | Unlock the vehicle. |
|  | Lock the vehicle.   |
- 

The power locking button works whether the ignition is switched on or off but only when *all* doors are closed.

If the vehicle is locked with the vehicle key, the power locking button is deactivated.

If the vehicle is locked with the power locking button:

- The yellow indicator light in the power locking button comes on to indicate that all doors are locked.
- The anti-theft alarm system is **not** turned on.
- Opening doors or the luggage compartment lid from the *outside* is not possible, at a traffic light, for example.
- Doors can be unlocked and opened separately from inside the vehicle by pulling the door handle to open the door. The indicator light goes out. The unopened doors and luggage compartment lid remain locked and cannot be opened from the outside.
- An open driver door will not be locked. This helps keep the driver from being locked out of the vehicle.

The vehicle is unlocked if you push the  button while the vehicle is standing still. Depending on the settings in the **Convenience** submenu, it may also be unlocked when you take the vehicle key out of the ignition.

## Anti-theft alarm system

---

**⚠ Please first read and note the introductory information and heed the WARNINGS ⚠**

The anti-theft alarm system makes it more difficult for someone to break into or steal the vehicle.

The anti-theft alarm system is automatically activated when the vehicle is locked by pressing the lock button on the remote control vehicle key.

## When is the alarm triggered?

The anti-theft alarm system sounds for about 30 seconds and the turn signals flash for up to 5 minutes if the following occurs with respect to the locked vehicle:

- Opening a door that has been mechanically unlocked with the emergency key
- Forcibly opening a door.
- Forcibly opening the engine hood.
- Forcibly opening the luggage compartment lid.
- Switching on the ignition with an invalid key.
- Disconnecting the vehicle battery.

## Deactivating the alarm

Unlock the vehicle with the unlock button on the remote control vehicle key or switch on the ignition with a valid remote control vehicle key.



After the alarm has stopped and the vehicle is opened again in the same or a different area that is protected by the alarm, the alarm is triggered again. For example, the alarm will sound again if the luggage compartment lid is opened after one of the doors has been opened.



The anti-theft alarm system is **not** activated when the vehicle is locked with the power lock switch  on the inside of the driver or front passenger doors.



If the driver door is mechanically unlocked using the emergency key, only the driver door is unlocked, not the entire vehicle. Switching on the ignition deactivates the anti-theft alarm system and activates the central locking button. To unlock the doors, use the central locking button or remote control vehicle key.



If the vehicle battery is dead or weak, the anti-theft alarm system will not work properly.

# Doors

## Introduction

---

In this section you'll find information about:

Warning light

Child safety lock

### **More information:**

- Exterior views
- Vehicle key set
- Power locking and closing system
- Power windows
- Emergency closing and opening



### **WARNING**

A door that is not closed properly may open suddenly when the vehicle is moving and cause severe injuries.

- Stop immediately and close the door.
- Make sure that the door is safely and completely latched when closed. The closed door must be flush with the surrounding auto body parts.
- Open or close doors only if no one is in the way.



### **WARNING**

A door kept open with the door stop may close in strong winds or on inclines and cause injuries.

- Always hold doors by the door handle while opening and closing.



### **NOTICE**

Check to make sure that the windows go down slightly when you unlock the vehicle. Otherwise the windows and seals could be damaged when opening the door.

## Child safety lock

---

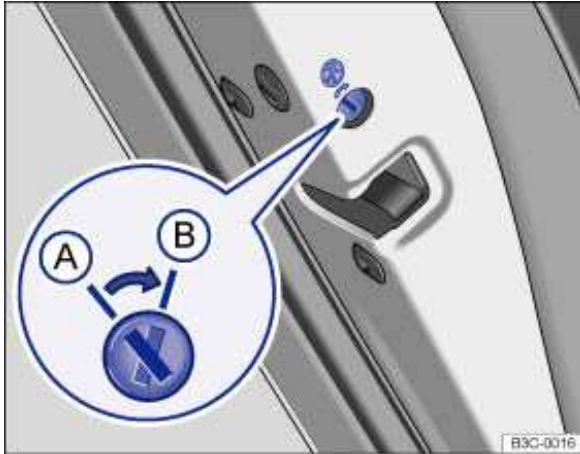

Fig. 22 In the left rear door: Child safety lock A deactivated, B activated.

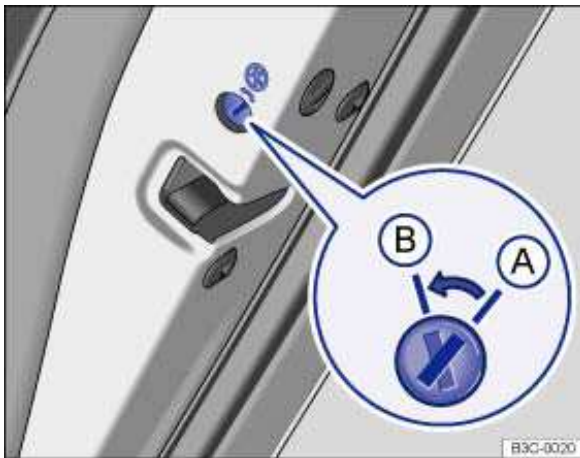

Fig. 23 In the right rear door: Child safety lock A deactivated, B activated.

**⚠ Please first read and note the introductory information and heed the WARNINGS ⚠**

The child safety lock keeps the rear doors from being opened from the inside, so that children cannot open them accidentally. When the child safety lock is engaged, the rear doors can only be opened from the outside.

### Engaging or disengaging child safety lock

- Unlock the vehicle and open the respective rear door.
- Using the emergency key, move the slot into the desired position.

Slot position ⇒ [fig. 22](#) or ⇒ [fig. 23](#):

- (A) Child safety lock disengaged.
- (B) Child safety lock engaged.



## **WARNING**

**When the child safety lock is engaged, that rear door cannot be opened from the inside.**

- **Never leave children, disabled persons, or anyone who cannot help themselves, in the vehicle when locking the doors. This could result in people being locked in the vehicle. This could result in people being trapped in the vehicle in an emergency. Depending on the time of year, people trapped in the vehicle can be exposed to very high or very low temperatures.**
- **A closed vehicle can become very hot or very cold, depending on the season. Particularly in the summer, heat build-up in the passenger and luggage compartment of a parked vehicle can result in temperatures in the vehicle that are much higher than the outside temperatures. Temperatures can quickly reach levels that can cause unconsciousness and death, particularly to small children.**



# Luggage compartment lid

## Introduction

---

In this section you'll find information about:

Warning light

Opening the luggage compartment lid

Closing the luggage compartment lid

### More information:

- Exterior views
- Power locking system
- Transporting
- Emergency closing and opening



### WARNING

Accidents and severe personal injuries can result if you unlock, open, or close the luggage compartment lid when someone is in the way.

- Only open or close the luggage compartment lid if no one is in the way.
- After closing the luggage compartment lid, always make sure that it is properly closed and locked so that it cannot open suddenly when the vehicle is moving. The closed luggage compartment lid must be flush with the surrounding auto body parts.
- Always keep the luggage compartment lid closed while driving to help keep poisonous exhaust gas from being drawn into the vehicle.
- Never open the luggage compartment lid when a luggage rack is installed and loaded. If, for example, there are bicycles on a carrier on the luggage compartment lid, it is possible that the lid will not be able to open automatically. An open luggage compartment lid may fall on its own because of the additional weight. If necessary, prop open the luggage compartment lid. Remove the weight from the luggage rack first.
- Close and lock the luggage compartment lid and all doors when the vehicle is not in use. First, make sure that no one is left inside the vehicle.
- Never leave your vehicle unattended or let children play around your vehicle, especially when the luggage compartment lid is open. A child could crawl into the vehicle and pull the luggage compartment lid shut, becoming trapped and unable to get out. A closed vehicle can become very hot or very cold, depending on the season. Particularly in the summer, heat build-up in the passenger and luggage compartment of a parked vehicle can result in temperatures in the vehicle that are much higher than the outside temperatures. Temperatures can quickly reach levels that can cause unconsciousness and death, particularly to small children.
- Never leave children or anyone who cannot help themselves behind in the vehicle. They may lock the vehicle with the vehicle key or the power locking button and lock themselves in.





### NOTICE

Before opening or closing the luggage compartment lid, make sure there is enough room to do so, as for example when the vehicle has a trailer or is in a garage.

## Warning light

❏ Please first read and note the introductory information and heed the WARNINGS ⚠

Lights up	Possible cause	Proper response
 <b>OR</b> icon appears in the display	Luggage compartment lid open or improperly closed.	 <b>Stop!</b> Open the luggage compartment lid and then close it again.

When the ignition is switched on, several warning and indicator lights come on briefly for a function check. They go out after a few seconds.

If the luggage compartment lid is not closed properly, the red <sup>2</sup> warning light comes on in the instrument cluster or the vehicle icon appears in the instrument cluster display showing an open luggage compartment lid.

Depending on your vehicle's equipment and options, the red warning light or icon may still be displayed even after the ignition is switched off as long as the key has not been taken out of the ignition. The icon in the instrument cluster display goes out about 15 seconds after the vehicle has been locked.

### **WARNING**

If the luggage compartment lid is not closed properly, it may open suddenly when the vehicle is moving and cause severe injuries.

- Stop immediately and close the luggage compartment lid.
- Always make sure the luggage compartment lid is securely latched after you close it.

## Opening the luggage compartment lid

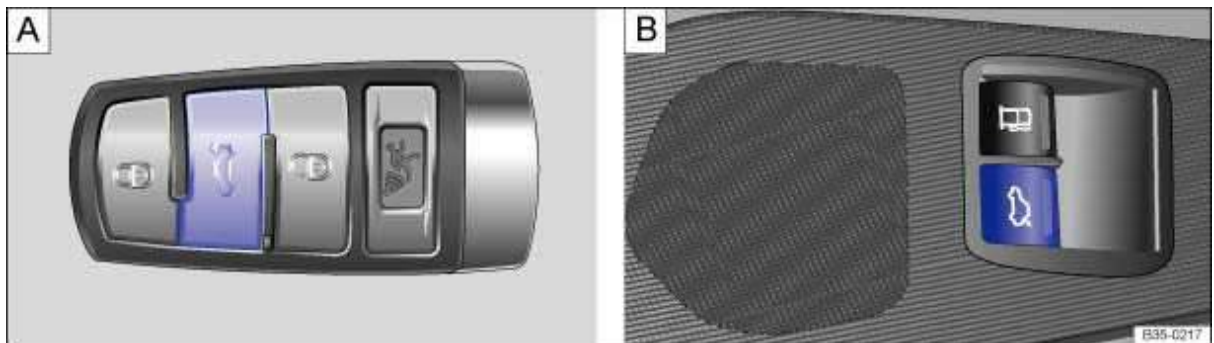

**Fig. 24** A: In the remote control vehicle key: button to unlock and open the luggage compartment lid. B: In the driver door: Button to unlock and open the luggage compartment lid.

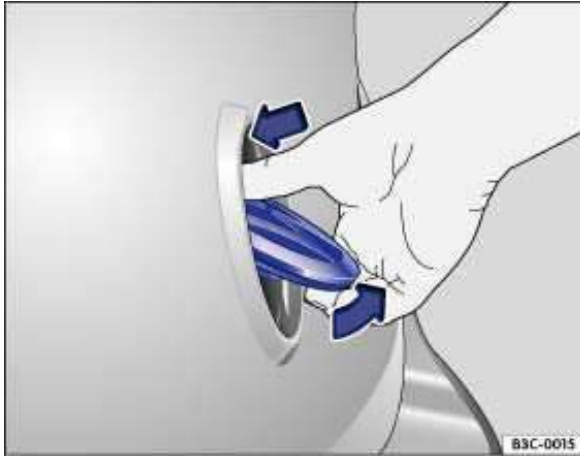

**Fig. 25** Opening luggage compartment lid from the outside.

**⚠ Please first read and note the introductory information and heed the WARNINGS ⚠**

Always remove any item(s) being transported on the luggage compartment lid before opening it ⇒ ⚠.

### **Unlocking and opening with the vehicle key**

- Press and hold the  button on the remote control vehicle key ⇒ [fig. 24 A](#) to *unlatch and automatically open* the luggage compartment lid.

### **Unlocking and opening with the unlock switch on the driver door**

Pull up the  switch on the driver door **B** until the luggage compartment lid opens automatically.

The switch in the driver door also works when the ignition is switched off.

### **Opening with the Volkswagen emblem**

- Unlock the vehicle or the luggage compartment lid, or open a door.
- Using your thumb, press the top of the Volkswagen emblem ⇒ [fig. 25](#) (arrow) and move the top of the emblem down. The luggage compartment lid opens automatically.

## **⚠ WARNING**

**Improper or unsupervised unlocking or opening of the luggage compartment lid can cause severe injuries. Never open the luggage compartment lid when someone is in the way.**

- **If a bicycle or luggage rack is installed on the luggage compartment lid, it may be hard to see that the luggage compartment lid is unlatched. An unlatched luggage compartment lid may open suddenly when the vehicle is moving.**



At temperatures below +32 °F (0 °C), the luggage compartment lid may not open automatically after you unlock it. It will be necessary to lift it by hand.

## Closing the luggage compartment lid



Fig. 26 Opened luggage compartment lid: Recessed grips for closing.

❏ Please first read and note the introductory information and heed the WARNINGS ⚠



### Closing the luggage compartment lid

- Grasp one of the recessed grips in the trim of the luggage compartment lid ⇒ fig. 26 (arrows).
- Pull the luggage compartment lid down and close it securely so that the latch engages.
- Check the luggage compartment lid to make sure it is securely latched.

### Locking the luggage compartment lid

If you unlock the vehicle with the vehicle key, but do not open either a door or the luggage compartment lid in about the next 30 seconds, the vehicle is automatically locked again. This feature helps prevent you from leaving the vehicle unlocked unintentionally.

It is only possible to lock the luggage compartment lid when it is securely closed and latched.

- The power locking system also locks the luggage compartment lid.
- If the luggage compartment lid of a locked vehicle is unlocked with the  button on the remote control vehicle key, it will lock about 20 seconds after it is closed. The anti-theft alarm system is activated after the vehicle is locked
- A closed but unlocked luggage compartment lid automatically locks at speeds above about 5 mph (10 km/h).
- The luggage compartment lid can also be locked manually with the emergency key via the key switch in the driver door 8. When the luggage compartment lid has been locked manually with the emergency key, it cannot be opened using the  button on the remote control vehicle key or the  switch inside the driver door.

### WARNING

Improper or unsupervised closing of the luggage compartment lid can cause severe injuries. Never close the luggage compartment lid when someone is in the way.

- Never leave your vehicle unattended or let children play around your vehicle, especially with the luggage compartment lid left open. A child could crawl into the vehicle and pull the luggage compartment lid shut, becoming trapped and unable to get out. A closed vehicle can become very hot or very cold depending on the season. Temperatures can quickly reach levels that can cause unconsciousness or death, particularly to small children.



Make sure that the remote control vehicle key is not in the luggage compartment before closing the luggage compartment lid.

# Power windows

## Introduction

In this section you'll find information about:

Opening and closing power windows

Power windows – features

Power window pinch protection

### More information:

- Volkswagen Information System
- Power locking and closing system

### WARNING

Improper use of power windows can result in serious personal injury.

- Never let anyone get in the way of a power window when closing it.
- When locking the vehicle from the outside, make sure that no one, especially children, remains in the vehicle. The windows will not open in case of an emergency.
- Always take the key with you when you leave the vehicle. You can still use the power windows for several minutes after the ignition is switched off as long as the driver or front passenger door has not been opened.
- Always use the safety switch when children are in the back seat to disable the rear power windows and keep them from being opened and closed.

### NOTICE

If you leave the windows open, rain or other precipitation may enter the vehicle from outside and can damage the vehicle interior.

## Opening and closing power windows

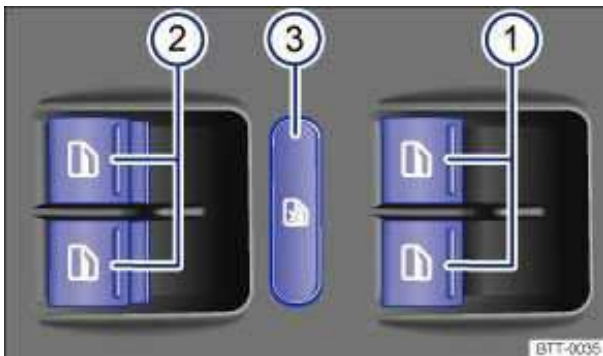

Fig. 27 In the driver door: Switches for front and rear power windows.



 Please first read and note the introductory information and heed the WARNINGS

## Switches in the driver door

Key to fig. 27:

- (1) For the windows in the front doors.
- (2) For the windows in the rear doors.
- (3) Safety switch.

## Opening or closing windows

Function	Action
Opening:	Press the  switch.
Closing:	Pull the  switch.
Stopping automatic movement:	Press/pull the switch again.
	The safety switch (3) deactivates the power windows in the rear doors. The yellow indicator light in the switch comes on.

You can still use the power windows for several minutes after the ignition is switched off as long as the driver or front passenger door has not been opened. When the vehicle key has been removed from the ignition and the driver door has been opened, the power windows cannot be opened or closed.

 A separate button for controlling the window is located in the front passenger door.

## Power windows – features

---

 Please first read and note the introductory information and heed the WARNINGS

### Automatic lowering of the windows

Closed windows in the doors will go down slightly when the vehicle is unlocked, the door handle is pulled, and after the vehicle key has been removed from the ignition ⇒ .

For **vehicles with the single door unlocking function activated**, only the window in the driver door will go down slightly when the vehicle is unlocked from the outside. The windows in the other doors will also go down slightly if the vehicle is unlocked a second time.

If no doors are opened, the windows will close again after several seconds. The windows will also close if the door is closed or the vehicle is locked.

The windows can freeze to the seals at low outside temperatures and prevent the windows from going down when the vehicle is unlocked or the door is opened. **Do not open the door if the window does not go down slightly** ⇒ .

- Lock the vehicle again.
- Remove the ice with deicing spray.
- Unlock the vehicle and retry the function.
- If necessary, repeat until the windows are fully operational.

### One-touch opening and closing

The one-touch feature automatically opens/closes a power window all the way. The window switch does not have to be held down/up.

**For one-touch opening:** Press the switch for the window down briefly as far as it goes.

**For one-touch closing:** Pull the switch for the window up briefly as far as it goes.

**Stopping automatic movement:** Pull/press the switch again.

### **Reactivating the one-touch feature**

If the vehicle battery is disconnected or dead and the windows are not completely closed, the one-touch feature will not work and must be reactivated:

- Switch on the ignition.
- Close all windows and doors.
- Pull up the switch for the respective window and hold it for at least 2 seconds in this position.
- Release the switch, pull up and hold again. The one-touch feature is now reactivated.

The one-touch feature can be reactivated for one or more windows at the same time.



### **WARNING**

**Improper use of power windows can result in serious personal injury.**

- **Never let anyone get in the way of a power window when closing it.**
- **When locking the vehicle from the outside, make sure that no one, especially children, remains in the vehicle. The windows will not open in case of an emergency.**
- **Always take the key with you when you leave the vehicle. You can still use the power windows for several minutes after the ignition is switched off as long as the driver or front passenger door has not been opened.**
- **Always use the safety switch when children are in the back seat to disable the rear power windows and keep them from being opened and closed.**



### **NOTICE**

**The windows must go down slightly when you unlock the vehicle. Otherwise the windows and seals could be damaged when opening the doors.**



If the power windows malfunction, the one-touch feature, as well as pinch protection may not work properly. See an authorized Volkswagen dealer or authorized Volkswagen Service Facility right away.



# Power sunroof

## Introduction

---

In this section you'll find information about:

Opening and closing the power sunroof

Pinch protection for the power sunroof

Depending on equipment, the vehicle may be equipped with a Panoramic tilting sunroof.

### **More information:**

- Volkswagen Information System
- Power locking and closing system
- Emergency closing and opening



### **WARNING**

**Improper use of the power sunroof can result in serious personal injury.**

- **Always make sure that no one is in the way of the power sunroof when it is closing.**
- **Always take the key with you when you leave the vehicle.**
- **Never leave children or disabled persons in the vehicle – particularly if they have access to the vehicle key. Unsupervised use of the remote control vehicle key makes it possible to lock the vehicle, start the engine, turn on the ignition and operate the sunroof.**
- **You can still open or close the power sunroof for several minutes after you switch off the ignition, as long as the driver or front passenger door has not been opened.**



### **NOTICE**

- **To help prevent damage, remove ice and snow from the sunroof before opening or tilting it in winter weather.**
- **Always close the sunroof before leaving the vehicle or if it begins raining. If the sunroof is open or tilted, rain could enter the vehicle interior and cause extensive damage to the electrical system. This could result in further vehicle damage.**



Remove leaves and other objects from the sunroof guiderails regularly either by hand or using a vacuum cleaner.



If the power sunroof malfunctions, pinch protection may not function properly. See an authorized Volkswagen dealer or an authorized Volkswagen Service Facility.

## Opening and closing the power sunroof



**Fig. 28** In the headliner: switch for the Panoramic tilting sunroof.

ⓘ Please first read and note the introductory information and heed the WARNINGS ⚠ 61.

Function	Operation
To tilt fully:	Briefly press the ↶ switch.
To stop the one-touch feature:	Briefly press the ↶ switch again.
To close fully:	Briefly pull the ↶ switch.
To set an intermediate position:	Hold the ↶ switch until the desired position is reached.

You must switch on the ignition to operate the power sunroof. After switching off the ignition, you can still open or close the power sunroof for a short time as long as the driver or front passenger door has not been opened.

### Sliding headliner

Use the handle in the front area of the roof opening to move the sliding headliner to the desired position.

# HomeLink® Universal Transmitter

## Introduction

---

In this section you'll find information about:

Programming the HomeLink® Universal Transmitter

Operating the HomeLink® Universal Transmitter

Depending on vehicle equipment, the vehicle may be equipped with a Homelink® Universal Transmitter.

The HomeLink® Universal Transmitter in your vehicle can be used to open/close an automatic garage door or gate, activate a house alarm, or control a lighting system or other devices. Such devices usually come with a hand-held remote control that sends a signal to a controller to operate the device.

These instructions will help you program the HomeLink® Universal Transmitter in your vehicle so that you will not have to use the hand-held remote control that was supplied with the garage door opener or other device, inside your vehicle.

### Fixed code or rolling code

The garage door opener or other device may work with either a fixed or rolling code. For garage door openers or other devices with rolling codes, the HomeLink® Universal Transmitter must be synchronized *after* programming the device

### Compatibility

Volkswagen recommends that you consult an authorized Volkswagen dealer or authorized Volkswagen Service Facility about compatible devices **before you buy** a garage door opener or other device that you want to control with the HomeLink® Universal Transmitter.

The HomeLink® Universal Transmitter can be programmed to the radio frequency codes of most current hand-held remote controls.

Safety switches are mandatory for garage door openers.

A Declaration of Compliance with the United States FCC and Industry Canada regulations is found on



### DANGER

**20 mm button cells and other lithium batteries will cause serious personal injury and even death within a short time if swallowed.**

- Always keep hand-held remote control devices with batteries, spare batteries, as well as dead button cell and larger 20 mm batteries out of the reach of children.
- Get medical attention immediately if you suspect that a battery has been swallowed.

## **⚠ WARNING**

Improper use of the HomeLink® Universal Transmitter can cause serious or even fatal personal injury.

- Garage doors operate with enough force to cause serious personal injury.
- Never let anyone get in the way of a garage door when it is opening or closing.
- When programming the HomeLink® Universal Transmitter, you may be operating a garage door or estate gate. Always make sure that people and objects are out of the way to help prevent serious personal injury or property damage.
- When operating the “training” button on a garage door opener with a rolling code, you will need to stand on a ladder or step-stool. Always take extra precautions to prevent falls and serious injury.
- Never use the HomeLink® Universal Transmitter with any garage door opener that does not have the safety stop-and-reverse feature, as required by federal safety standards. This includes any garage door opener model manufactured before April 1, 1982.
- A garage door opener that cannot detect an object, signaling the door to stop and reverse, does not meet current federal safety standards. Using a garage door opener without these features increases the risk of serious injury or death.
- Follow the installation manual and the included safety information from the manufacturer when using the remote-controlled garage door opener or electrical drive.

## **Programming the HomeLink® Universal Transmitter**

---



**Fig. 29** In the driver side sun visor: The remote control and buttons for the HomeLink Universal Transmitter.



**Fig. 30** To program: Simultaneously press the buttons for the HomeLink Universal Transmitter and the remote control.

ⓘ Please first read and note the introductory information and heed the **WARNINGS** ⚠

### Getting ready to program

- ✓ Please read the product manufacturer's instructions **before** programming the garage door opener or other device.
- ✓ Safely park the vehicle within range of the device to be programmed.
- ✓ Switch the ignition on, but do not start the engine.

The buttons **1**, **2**, and **3** on the keypad in the sun visor can operate up to 3 separate devices (for example, a gate and garage door, house alarm or lighting system).

### Please carry out each step only in the order specified:

1. **For first time programming only:** Press and hold the 2 outer HomeLink buttons **1** and **3** at the same time for about 20 seconds, releasing only when the HomeLink indicator light above button **2** begins to flash.  
This step deletes any old settings. **Do not perform this step when programming the additional HomeLink buttons.**
2. Position the hand-held transmitter for your remote control device 1–3 inches (25–75 mm) away from the HomeLink keypad on the driver side sun visor, keeping the HomeLink indicator light in view, as shown ⇒ [fig. 29](#).
3. Using both hands, simultaneously press and hold both the HomeLink button you want to program (**1**, **2**, or **3**) and the hand-held transmitter button, as shown ⇒ [fig. 30](#). **Do not release the buttons until the HomeLink indicator light flashes slowly and then rapidly.** When the indicator light flashes rapidly, release both buttons. The rapid flashing indicates successful programming.
4. Press and hold the programmed HomeLink button and watch the indicator light.  
*If the indicator light comes on and does not flash*, programming is complete and your garage door opener or other device should activate when the HomeLink button is pressed and released.  
*If the indicator light blinks rapidly for 2 seconds and then stays on*, proceed with the following programming instructions for a rolling code device. A second person may make the following steps quicker and easier. Please use a ladder or other device. Do not stand on your vehicle to perform the next steps ⇒ ⚠

**Please carry out each step only in the order specified:**

5. At the garage door opener receiver (overhead unit) in the garage, locate the “learn” or “training” button. The name and color of the button may vary by manufacturer. This button is usually located near the hanging antenna wire attachment point on the unit. If you cannot locate the “training” button, refer to the garage door opener’s user manual.
6. Press and release the “training” button.  
**Once the button is pressed, you have 30 seconds to initiate the next step.**
7. Return to the vehicle. Firmly press and hold the programmed HomeLink button for 2 seconds and release.
8. Repeat the “press/hold/release” sequence up to 3 times to complete the programming process for that button.

Repeat the steps to program the other buttons for the HomeLink® Universal Transmitter on the sun visor keypad to control other devices.

**Deleting programming for all buttons**

Be sure to delete programming on all buttons on the sun visor keypad before selling the vehicle or turning it over to people you do not know.

- Complete the programming preparation steps described above.
- Press and hold buttons **1** and **3** at the same time, for about 20 seconds.
- When the indicator light above button **2** begins to flash, immediately release buttons **1** and **3**. This step deletes all old settings.

**After programming**

Test the garage door opener 66, *Operating the HomeLink® Universal Transmitter*.

**Operating the HomeLink® Universal Transmitter**

**⚠ Please first read and note the introductory information and heed the WARNINGS ⚠**

- The vehicle must be in operating range of the garage or outer gate drives.
- With ignition turned on or engine running, press the appropriate button on the sun visor ⇒ ⚠.

The range of the HomeLink® Universal Transmitter roughly corresponds to the range of the original remote control of the device or the electrical drive. If the garage door or the electrical drive does not work, this could be for one of the following reasons:

Malfunction	Possible cause	Possible remedy
Garage door or electrical drive does not work.	Distance or transmission angle too great.	Try different distances and angles to the receiver.
	Garage door or electrical drive not compatible.	May not comply with legal requirements and may have to be replaced.
	Incorrect programming.	Reprogram the garage door opener.

## DANGER

20 mm button cells and other lithium batteries will cause serious personal injury and even death within a short time if swallowed.

- Always keep hand-held remote control devices with batteries, spare batteries, as well as dead button cell and larger 20 mm batteries out of the reach of children.
- Get medical attention immediately if you suspect that a battery has been swallowed.

## WARNING

Improper use of the HomeLink® Universal Transmitter can cause serious or even fatal personal injury.

- Garage doors operate with enough force to cause serious personal injury.
- Never let anyone get in the way of a garage door when it is opening or closing.
- When programming the HomeLink® Universal Transmitter, you may be operating a garage door or estate gate. Always make sure that people and objects are out of the way to help prevent serious personal injury or property damage.
- When operating the “training” button on a garage door opener with a rolling code, you will need to stand on a ladder or step-stool. Always take extra precautions to prevent falls and serious injury.
- Never use the HomeLink® Universal Transmitter with any garage door opener that does not have the safety stop-and-reverse feature, as required by federal safety standards. This includes any garage door opener model manufactured before April 1, 1982.
- A garage door opener that cannot detect an object, signaling the door to stop and reverse, does not meet current federal safety standards. Using a garage door opener without these features increases the risk of serious injury or death.
- Follow the installation manual and the included safety information from the manufacturer when using the remote-controlled garage door opener or electrical drive.

## NOTICE

The wrong batteries can damage the hand-held remote control. Replace a dead battery with one that has the same voltage, size, and specifications.



Please dispose of old batteries properly and in an environmentally responsible manner. Always keep them out of the reach of children.



Certain batteries used in hand-held remote controls are classified as **Perchlorate Material**. Special handling may apply – see <http://www.dtsc.ca.gov/hazardouswaste/perchlorate>. Obey all legal requirements regarding proper disposal. Authorized Volkswagen dealers and authorized Volkswagen Service Facilities are familiar with the requirements, and we recommend that you have them perform this service for you.

# Adjusting the seating position

## Introduction

---

In this section you'll find information about:

Examples of improper seating positions

Proper seating position

Manual controls on the driver and passenger seat

Electrical controls on the driver and front passenger seats

Adjusting the front and rear head restraints

Removing and reinstalling the head restraints

Adjusting the steering wheel position

Center armrest

### **Number of seats**

The vehicle has a total of **5** seating positions: 2 in front and 3 in the rear. Each seating position has a safety belt.

### **More information:**

- Seat functions
- Safety belts
- Airbag system
- Child safety and child restraints



### **WARNING**

**Improper seating positions increase the risk of severe or fatal injuries in a crash or other accidents, especially when the airbag deploys.**

- **All occupants must sit properly and be properly restrained at all times.**
- **Never let more people ride in the vehicle than there are seating positions with safety belts available.**
- **Always secure children in the vehicle with an approved and suitable restraint system appropriate for their age, weight, and height .**
- **Always keep your feet on the floor in front of the seat. Never rest them on the seat, instrument panel, out of the window, etc. The airbag system and safety belt will not be able to protect you properly and can even increase the risk of injury in a crash.**





## WARNING

Always adjust seat, safety belts, and head restraints properly before driving and make sure that all passengers are properly restrained.

- Push the passenger seat as far back as possible. Always be sure that there are at least 10 inches (25 cm) between the front passenger's breastbone and the instrument panel.
- Always adjust the driver's seat and the steering wheel so that there are at least 10 inches (25 cm) between your breastbone and the steering wheel.
- Adjust the driver's seat so that you can easily push the pedals all the way to the floor while keeping your knee(s) slightly bent. The distance to the instrument panel in the knee area must be at least 4 inches (10 cm).
- If these requirements cannot be met for physical reasons, contact an authorized Volkswagen dealer or an authorized Volkswagen Service Facility to see whether adaptive equipment is available.
- Always hold the steering wheel on the outside of the steering wheel rim with your hands at the 9 o'clock and 3 o'clock positions to help reduce the risk of personal injury if the driver's airbag inflates.
- Never hold the steering wheel at the 12 o'clock position or with your hands at other places inside the steering wheel rim or on the steering wheel hub. Holding the steering wheel the wrong way can cause serious injuries to the hands, arms, and head if the driver's airbag inflates.
- Pointing the steering wheel toward your face decreases the ability of the driver's airbag to help protect you in a collision.
- Never drive with backrests reclined or tilted back farther than necessary to drive comfortably. The farther back the backrests are tilted, the greater the risk of injury caused by incorrect positioning of the safety belts and improper seating position.
- Never drive with the front seat passenger backrest tilted forward. If the front airbag deploys, the front backrest can be forced backward and injure passengers on the rear seat.
- Sit as far back as possible from the steering wheel and the instrument panel.
- Always sit upright with your back against the backrest with the front seats properly adjusted. Never lean against or place any part of your body too close to the area where the airbags are located.
- Rear seat passengers who are not properly seated and restrained are more likely to be seriously injured in a crash.



## WARNING

Improper adjustment of the seats can cause accidents and severe injuries.

- Never adjust the seats while the vehicle is moving. Your seat may move unexpectedly and you could lose control of the vehicle. In addition, you will not be in the correct seating position while adjusting the seats.
- Adjust the front seat height, angle and longitudinal direction only if the seat adjustment area is clear.
- The adjustment of the front seats must not be restricted by things in the footwell in front or behind the seats.

## Examples of improper seating positions

☐ Please first read and note the introductory information and heed the WARNINGS

Not wearing or improperly fastening safety belts increases the risk of severe or fatal injuries. Safety belts can work only when they are properly positioned on the body. An improper seating position significantly impairs the protection provided by safety belts. This can cause severe or even fatal injuries. Improper seating positions also increase the risk of serious injury or death when an airbag deploys and strikes an occupant who is not in the proper seating position. The driver is responsible for all passengers and especially children riding in the vehicle.

The following are only some examples of seating positions that will increase the risk of serious injury or death.

**Therefore, whenever the vehicle is moving:**

- Never stand up in the vehicle.
- Never stand on the seats.
- Never kneel on the seats.
- Never ride with the seat backrest reclined.
- Never lean up against the instrument panel.
- Never lie down on the rear seat.
- Never sit on the edge of the seat.
- Never sit sideways.
- Never lean out the window.
- Never put your feet out the window.
- Never put feet on the instrument panel.
- Never rest your feet on the seat cushion or back of the seat.
- Never ride in the footwell.
- Never sit on the front or rear center armrest.
- Never ride without your safety belt properly fastened.
- Never ride in the luggage compartment.



**WARNING**

**Contact with parts of the vehicle interior can cause serious personal injury in a crash.**

- **Always make sure that all vehicle occupants stay in a proper seating position and are properly restrained whenever the vehicle is moving.**
- **Improper seating positions increase the risk of serious and fatal injury, especially when an airbag deploys and strikes a passenger in an improper seating position.**

## Proper seating position

---

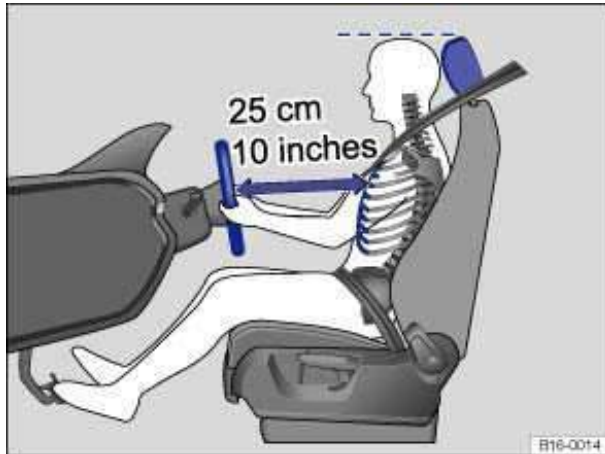

**Fig. 31** The driver should never sit closer than 10 inches (25 cm) of the steering wheel.

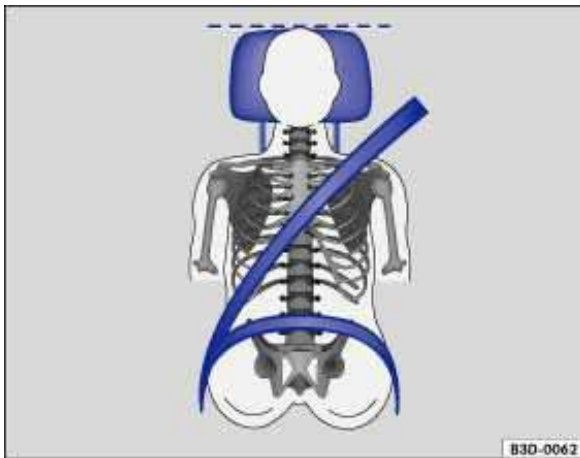

**Fig. 32** Proper safety belt positioning and head restraint adjustment.

**⚠ Please first read and note the introductory information and heed the WARNINGS ⚠**

The following describes the proper seating positions for the driver and front seat passenger.

If you have a physical impairment or condition that prevents you from sitting properly on the driver seat with the safety belt properly fastened and reaching the pedals, special modifications to your vehicle may be necessary. Only the proper seating position ensures optimum protection by the safety belt and airbag.

Contact your authorized Volkswagen dealer or authorized Volkswagen Service Facility or call the Volkswagen Customer CARE Center at 1-800-822-8987 for information about possible modifications to your vehicle.

For your own safety and to reduce injuries in the event of sudden braking maneuvers or accidents, Volkswagen recommends the following seating positions:

### **Applies to all vehicle occupants:**

- Adjust head restraints so that the upper edge of the head restraint is at least at eye level or higher. Position the back of your head as close as possible to the head restraint ⇒ [fig. 31](#) and ⇒ [fig. 32](#).
- Adjust the head restraints so they are as close as possible to the back of the head.
- Push the head restraint completely down for short people, even if the top of the head is then below the upper edge of the head restraint.

- Tall people should pull the head restraint all the way up.
- Adjust the seat backrest angle to an upright position so that your back is in full contact with it when the vehicle is moving.
- Always keep both feet on the floor and in the footwell whenever the vehicle is moving.
- Always adjust and fasten safety belts properly

#### **Driver–seat and steering wheel adjustment:**

- Adjust the steering wheel so that there are at least 10 inches (25 cm) between the steering wheel and your breast bone ⇒ [fig. 31](#). When adjusting the proper distance to the steering wheel, grasp the top of the steering wheel with your elbows slightly bent.
- Always hold the steering wheel on the outside of the steering wheel rim with your hands at the 9 o'clock and 3 o'clock positions to help reduce the risk of personal injury if the driver's airbag inflates.
- Never hold the steering wheel at the 12 o'clock position or with your hands at other places inside the steering wheel rim or on the steering wheel hub. Holding the steering wheel the wrong way can cause serious injuries to the hands, arms, and head if the driver's airbag inflates.
- Adjust the steering wheel so that the steering wheel cover points at your chest and not at your face. Pointing the steering wheel toward your face decreases the ability of the driver's airbag to help protect you in a collision.
- Adjust the driver's seat so that you can easily push the pedals all the way to the floor while keeping your knee(s) slightly bent.
- Adjust the seat height so that the top point of the steering wheel can be reached.
- Always keep both feet in the footwell so that you are in control of the vehicle at all times.

#### **Passenger–front seat adjustment:**

- Push the passenger seat as far back as possible in order to ensure optimum protection if the airbag is deployed.

## **Manual controls on the driver and passenger seat**

---



**Fig. 33** Controls on the left front seat.

**⚠ Please first read and note the introductory information and heed the WARNINGS ⚠**

The controls on the front passenger seat mirror those on the driver seat.

There may be manual and electrical controls on the same seat.

fig. 33	Function	Action
(1)	Move the front seat backward or forward.	Pull the lever up and move the front seat. The front seat must lock in place after the lever is released!
(2)	Lumbar support control.	Pull the lever up or push it down.
(3)	Adjust the backrest angle.	Lean forward and turn the adjuster wheel forward or backward.
(4)	Adjust the seat height.	Move the lever several times up or down.

## Electrical controls on the driver and front passenger seats

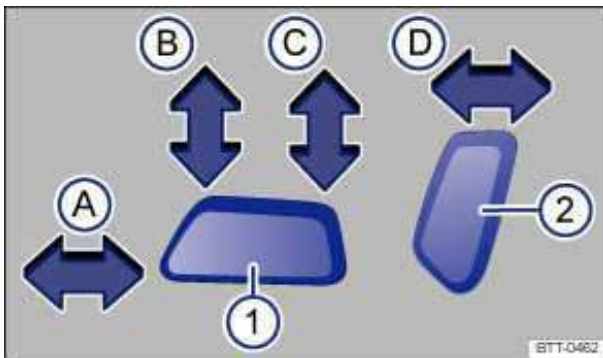

**Fig. 34** Driver seat: Controls to adjust the seat backward and forward, adjust seat cushion height and angle, and backrest angle.

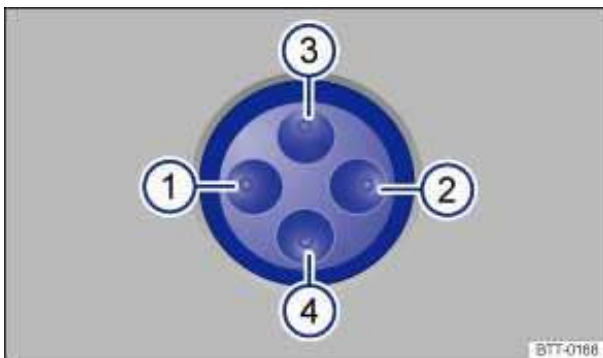

**Fig. 35** Lumbar support control.

**⚠ Please first read and note the introductory information and heed the WARNINGS ⚠ 68.**

The controls on the front passenger seat mirror those on the driver seat.

There may be manual and electrical controls on the same seat.

**fig. 34** Press the control in the direction of the arrow or in the area shown.

(1)	(A)	Slide the seat backward or forward.
	(B) and (C)	Raise or lower the seat cushion.
	(B) or (C)	Adjust seat cushion angle.
(2)	(D)	Adjust backrest angle.

⇒ **fig. 35** Press the switch for each area:

(1) or (2)	Adjust lumbar support.
(3) or (4)	Adjust lumbar support height.

## **⚠ WARNING**

Improper use of electrical seat controls can cause serious personal injuries.

- The front seats in your vehicle can be electrically adjusted even when the vehicle key has been removed from the ignition.
- Never leave children and persons who need help in the vehicle alone because the unsupervised use of the electric seat adjustments can result in serious personal injury.
- Always make sure that no one is in the way while the front seats are being adjusted, or while calling up the stored memory settings for the front seats. In an emergency, stop automatic seat adjustment by pressing a seat adjustment switch.

## **ⓘ NOTICE**

To help prevent damage to electrical parts in the seat, do not kneel on the front seats or apply concentrated pressure to a small area of the seat or backrest.

**i** If the vehicle battery is too weak, the electrical seat adjustment controls may not work.

**i** Starting the engine stops seat adjustment.

**i** When entering and exiting the vehicle, be careful not to come into contact with any switches that could change the seat adjustment.

## **Adjusting the front and rear head restraints**

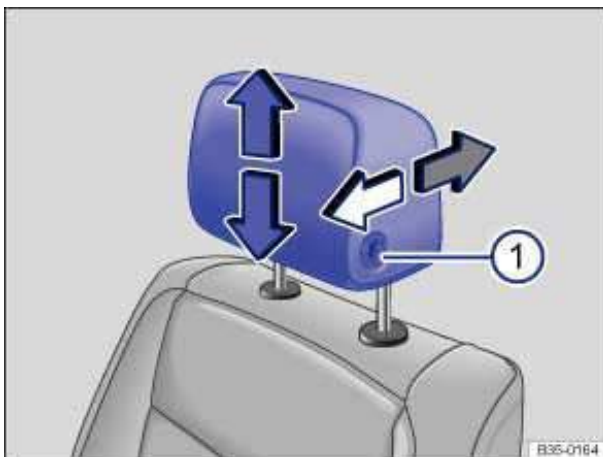

**Fig. 36** Adjusting the front head restraints.

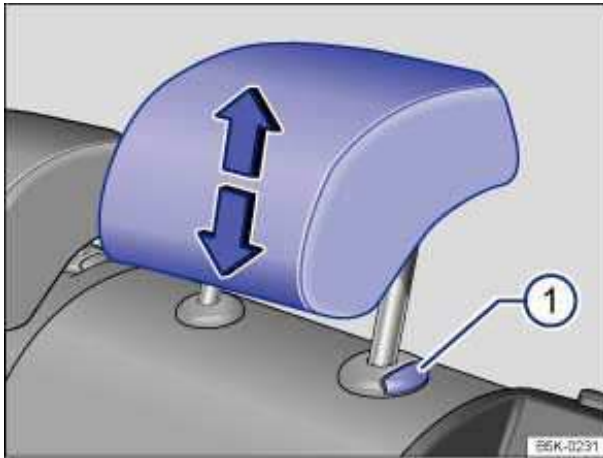

**Fig. 37** Adjusting the rear head restraints.

**⚠ Please first read and note the introductory information and heed the WARNINGS ⚠**

All seats are equipped with head restraints. The rear center head restraint is designed only for the center seat on the rear bench. Therefore, only install the center head restraint in the center position.

There are notches in the head restraint guide rods so that the head restraint can lock into place. Only properly installed head restraints can lock into place at the adjustment range notches. In order to prevent inadvertent removal of the head restraints after installation, there are stops at the top and bottom of the adjustment range.

### **Adjusting the height**

- Push the head restraint up in the direction of the arrow or down when the button ⇒ [fig. 36 \(1\)](#) or ⇒ [fig. 37 \(1\)](#) is pressed ⇒ ⚠.
- The head restraint must lock securely in the position selected.

### **Moving the front head restraints forward and back**

- Push the head restraint forward in the direction of the arrow or slide it back with the button pressed ⇒ [fig. 36 \(1\)](#).
- The head restraint must lock securely in the position selected.

### **Proper head restraint adjustment**

Adjust head restraints so that the upper edge of the head restraint is at least at eye level or higher. Position the back of the head as close as possible to the head restraint. Adjust the head restraints on the front seats so they are as close as possible to the back of the head.

### **Adjusting the head restraint for short people**

Push the head restraint down as far as it will go, even if this means the person's head is still below the top edge of the head restraint. A small gap may remain between the head restraint and the backrest when the head restraint is all the way down.

### **Adjusting the head restraint for tall people**

Pull the head restraint up as far as it will go.

## WARNING

Driving without head restraints or with improperly adjusted head restraints increases the risk of serious injuries in a collision.

- Always drive with the head restraints in place and properly adjusted to help minimize the risk of neck injury in crash.
- Every person in the vehicle must have a properly adjusted head restraint to minimize the risk of neck injury in a crash. Each head restraint must be adjusted according to the occupants' size so that the upper edge is even with the top of the person's head, but no lower than eye level. Always sit so that the back of your head is as close as possible to the head restraint.
- Never adjust head restraint while driving.

## Removing and reinstalling the head restraints

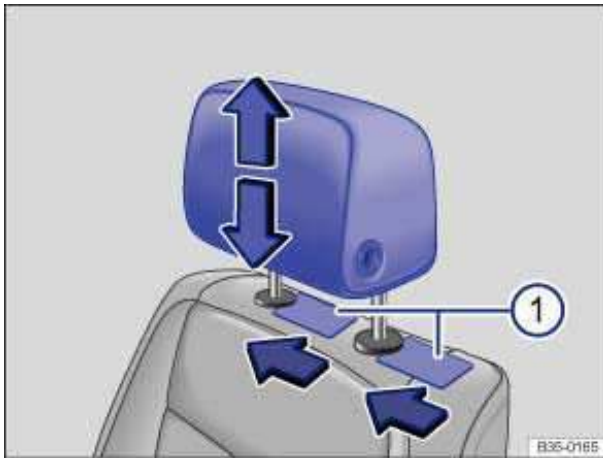

Fig. 38 Removing the front head restraints.

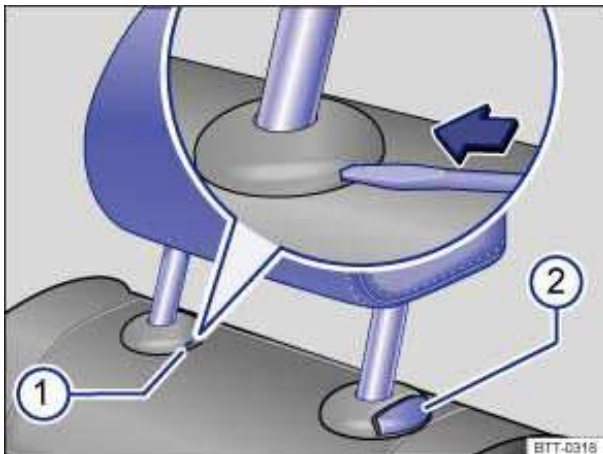



Fig. 39 Removing the rear head restraints.

 Please first read and note the introductory information and heed the WARNINGS 

All seats are equipped with head restraints. The rear center head restraint is designed only for the center seat on the rear bench. Therefore, only install the center head restraint in the center position.



## Removing the front head restraints

- Sit in the back seat behind the head restraint you want to remove. Pull the head restraint all the way up ⇒  in *Adjusting the front and rear head restraints*. Recline the backrest so that there is enough overhead clearance to remove it.
- Slide the head restraint all the way up and back.
- On each side of the seat, slide a flat object, such as a plastic credit card, between the seat backrest and the cap of each head restraint rod guide ⇒ [fig. 38 \(1\)](#) to unlock the head restraint. Press lightly at the same time to release the rods.
- Pull the head restraint all the way out.

## Installing the front head restraints

- Pull both rods as far as possible out of the head restraint.
- Position head restraint properly over the head restraint guides of the respective seat backrest and insert the head restraint into the guides.
- Push the head restraint down until both rods lock in place.
- Adjust the head restraint according to the occupant's size

## Removing the rear head restraint

- Unlock the backrest of the rear seat bench and fold it forward .
- Pull the head restraint all the way up ⇒ .
- If necessary, press the flat blade of the screwdriver from the vehicle tool kit into the slit of the trim cap ⇒ [fig. 39 \(1\)](#) in the direction of the arrow and hold it in this position.
- At the same time press button [\(2\)](#) while a second person pulls out the head restraint completely.
- Fold the backrest of the rear seat bench back so that it locks securely.

## Reinstalling the rear head restraint

- Unlock the backrest of the rear seat bench and fold it forward.
- Position head restraint properly over the head restraint guides of the respective seat backrest and insert the head restraint into the guides.
- Push the head restraint down while pressing button [\(2\)](#).
- Fold the backrest of the rear seat bench back so that it locks securely.
- Adjust the head restraint according to the occupant's size .



### WARNING

**Driving without head restraints or with improperly adjusted head restraints increases the risk of serious injuries in a collision.**

- **Always drive with the head restraints in place and properly adjusted to help minimize the risk of neck injury in crash.**
- **Always reinstall head restraints as soon as possible so that vehicle occupants are properly protected.**



### NOTICE

**When removing or reinstalling the head restraint, take care that the head restraint does not strike the headliner or other parts of the vehicle. The headliner or other parts of the vehicle could otherwise be damaged.**

## Adjusting the steering wheel position

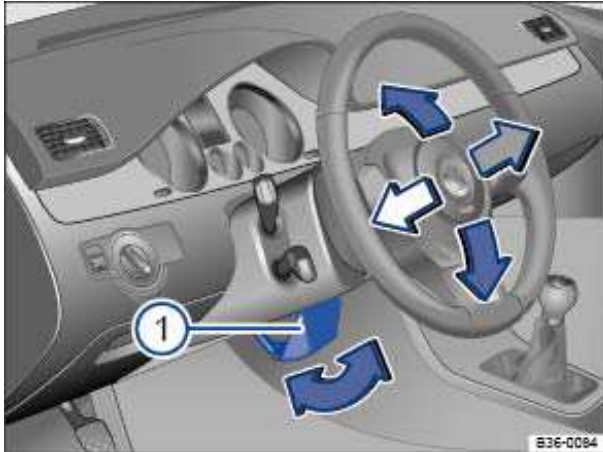

Fig. 40 Manual adjustment for the steering wheel position.

❏ Please first read and note the introductory information and heed the WARNINGS ⚠ .

Adjust the steering wheel only when the vehicle is not moving.

- Push down on the lever ⇒ fig. 40 (1).
- Adjust the steering wheel so that it can be held with hands at the 9 o'clock and 3 o'clock positions on the outside of the steering wheel rim and with the arms slightly bent at the elbow.
- Pull the lever up firmly until it is flush with the steering column ⇒ ⚠.

### ⚠ WARNING

Improper use of the steering column adjustment feature can result in serious personal injury and even death.

- Always pull the lever (1) firmly upward after adjusting the steering column so that the steering wheel does not change position suddenly while the vehicle is moving.
- Never adjust the steering column while the vehicle is moving. If you find that you need to adjust the steering wheel while driving, stop the vehicle in a safe place and make the proper adjustment.
- Never adjust the steering wheel so that it points toward your face. Always make sure that the steering wheel points toward your chest. Otherwise, the airbag system cannot protect you properly in the event of a crash.
- Always hold the steering wheel on the outside of the steering wheel rim with your hands at the 9 o'clock and 3 o'clock positions to help reduce the risk of serious personal injury if the driver's airbag inflates.
- Never hold the steering wheel at the 12 o'clock position or with your hands anywhere inside the steering wheel or on the steering wheel hub. Holding the steering wheel the wrong way increases the risk of severe injury to the arms, hands, and head if the driver airbag deploys.

## Center armrest

---



Fig. 41 Front center armrest.

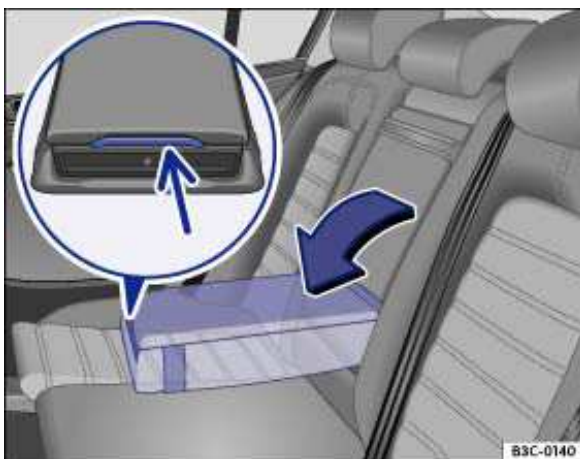

Fig. 42 Folding down the rear center armrest with storage compartment (arrow).

⚠ Please first read and note the introductory information and heed the WARNINGS ⚠

### Front center armrest

There is a storage compartment under the front center armrest

To *raise* the center armrest, pull the armrest and latch upward in the direction of the arrow ⇒ fig. 41.

To *lower* the center armrest, first lift it all the way up. Then you can lower the center armrest.

### Rear center armrest

There may be a fold-down armrest with a small storage compartment in the backrest of the center rear seat ⇒ fig. 42.

To *fold down*, pull the loop in the direction of the large arrow .

To *open* the center armrest storage compartment, see .

To *fold up*, push the center armrest up as far as it will go.



## **WARNING**

The center armrest can restrict the driver's arm movement and cause crashes and serious personal injury.

- Always keep storage compartments in the center armrest closed while driving.
- Never let a passenger, especially a child, ride on the center armrest. Improper seating position can increase the risk of serious personal injury in a crash.
- Never put hot drinks or other liquids in the cup holder. Hot liquids can spill when the vehicle is moving as well as during braking or other sudden maneuvers.



## **NOTICE**

Do not press on the cup holder cover when raising the rear center armrest. The cup holder could open and be damaged.

# Seat functions

## Introduction

In this section you'll find information about:

Seat heating

Ventilated seats

Memory seat

Back massage feature

### More information:

- Adjusting the seating position
- Safety belts
- Airbag system
- Child safety and child restraints
- Outside mirrors



### WARNING

**Improper use of seat adjustment controls can cause severe personal injuries.**

- **Always sit properly at all times before starting to drive and while the vehicle is moving. Make sure all passengers, especially children, are properly seated whenever the vehicle is moving.**
- **Only turn the back massage feature on and off when the vehicle is not moving 86.**
- **Keep hands, fingers, feet and other body parts away from moving parts and adjustment areas of the seats.**

## Seat heating

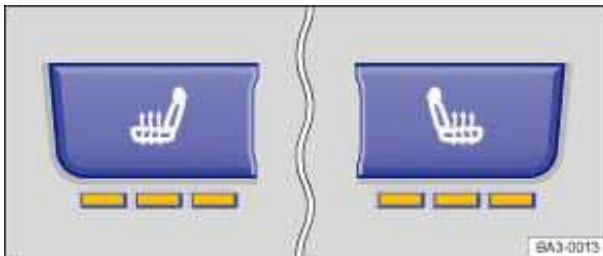

**Fig. 43** In the center console: Seat heating buttons for the front seats.







**Please first read and note the introductory information and heed the WARNINGS**

When the ignition is switched on, the front seats can be electrically heated by heating elements that warm the seat backrest and cushion.

Do not use the seat heating if any of the following conditions apply:

- If the seat is not being used.

- If there is a child restraint installed on the front passenger seat.
- If there is a blanket or seat cover on the front passenger seat.
- If the seat is damp or wet.
- If the outside temperature or the temperature inside the passenger compartment is 77 °F (25 °C) or more.

Function	Action for seat heating ⇒ <a href="#">fig. 43</a>
Switch on:	Press the  or  button. Seat heating is switched on to maximum.
Adjust the heating level:	Press the  or  button repeatedly until the desired heating level is set.
Switch off:	Press the  or  button repeatedly until all indicator lights in the button are off.

### Special seat heating features

On the driver and the passenger side, the seat heating will resume at the setting that was set when the ignition was switched off. However, this feature only works if the key is not taken out of the ignition switch.

People suffering from a low level of perceived pain or a lowered awareness of pain as from medication, paralysis, or chronic illness (e.g. diabetes) should NEVER use the seat heating feature

⇒ !

The use of seat heating by persons with these conditions could result in burns to the back, buttocks, and legs that may take a long time to heal and may never heal completely. If you have any of these conditions, you should take regular breaks and get out of the vehicle, particularly on long trips. Consult your doctor for advice regarding your specific condition.



#### WARNING

**Certain medical conditions, such as paralysis and diabetes, and certain medications can increase the risk of serious burns when the seat heating feature is switched on.**

- **Vehicle occupants who have a low level of perceived pain or a lowered awareness of pain can receive serious burns to the back, buttocks, and legs that take a long time to heal or may never heal completely.**
- **Never use the seat heating feature if you or your passengers are at risk of being burned because of a medical condition. Take regular breaks and get out of the vehicle, particularly on long trips. Consult your doctor for advice regarding your specific condition.**
- **Never let exposed skin remain in contact with the seat upholstery when the seat heating is being used.**



#### WARNING

**A wet seat can cause the seat heating to malfunction and increase the risk of serious burns.**

- **Always make sure the seats are dry before using the seat heating.**
- **Never sit on the seat with wet clothes.**
- **Never put damp or wet things including clothes on the seat.**
- **Never spill liquids on the seats.**

## ! NOTICE

- To help prevent damage to electrical and other parts in the seat, do not kneel on the front seats or apply concentrated pressure to a small area of the seat or backrest.
- Liquids, sharp objects and things that do not let the heat in the seat escape into the air, including, for example, a child restraint, a blanket, or seat covers on the seat can damage seat heating.
- If you smell an odor, immediately shut off seat heating and have it checked by an authorized Volkswagen dealer or authorized Volkswagen Service Facility.
- Never install leather upholstery on a vehicle with seat heating that originally had cloth upholstery. The seat heating elements for seats with cloth seats will overheat if the cloth upholstery is replaced with leather upholstery.



Switch off seat heating when it is not needed to help reduce unnecessary fuel consumption.

Applicable only in the United States

## Ventilated seats



Fig. 44 On front seat: Switch for seat ventilation.

**⚠ Please first read and note the introductory information and heed the WARNINGS ⚠**

The seat base and backrest as well as the seat and backrest sides of the front seats can be ventilated from the inside at 3 ventilation levels (**low**, **medium** and **high**).

The seat is ventilated with air from the vehicle interior. This helps body moisture to be wicked away, although the seat is not directly cooled. This feature does not thermally cool the seat like an air conditioner.



For long trips, Volkswagen recommends setting the seat ventilation level to **low**.

### Turning seat ventilation on or off

- Switch on the ignition.
- Push the button ⇒ fig. 44 (1) to turn on seat ventilation for the front seats. The indicator light in the front seat (3) comes on.
- Push the button (1) again to turn seat ventilation off. The indicator light in the front seat (3) goes out.

Seat heating must be switched on again if needed each time the ignition is switched on.

## Setting the ventilation level

- Move the fan switch (2) all the way down toward the  symbol to set the ventilation level to **low**.
- Move the fan switch (2) to the middle position to set the ventilation level to **medium**.
- Move the fan switch (2) all the way up toward the  symbol to set the ventilation level to **high**.

If the indicator light in the front seat (3) flashes, there is a malfunction in the system. Have the system inspected by your authorized Volkswagen dealer or authorized Volkswagen Service Facility.

 You may hear the sound of the seat ventilation when the feature is switched on. The sound is part of normal operation and not a cause for concern.

## Memory seat

---

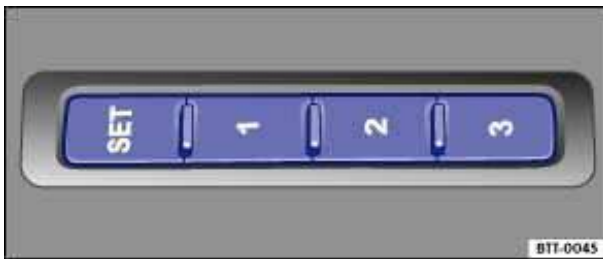

Fig. 45 On the outer side of the driver seat: Memory buttons.

 Please first read and note the introductory information and heed the **WARNINGS** 

### Memory buttons

Personal settings for the driver seat and outside mirrors can be assigned to each memory button.

These settings can be assigned to individual remote control vehicle keys. The settings are applied after unlocking the vehicle and opening the driver door.

### Storing driver seat settings and forward driving settings for outside mirrors

- Set the electronic parking brake.
- Shift the transmission to Neutral (**N**).
- Switch on the ignition.
- Adjust the driver seat and outside mirrors.
- Press the **SET** button for at least 1 second ⇒ [fig. 45](#).
- Press the desired memory button **1**, **2**, or **3** within 10 seconds. A chime sounds to confirm that the setting has been stored.

### Storing passenger-side outside mirror settings for backing up

- Set the electronic parking brake.
- Shift the transmission to Neutral (**N**).
- Switch on the ignition.
- Briefly press the desired memory button **1**, **2**, or **3** on the outside of the driver seat.
- Shift the transmission into Reverse (**R**).
- Adjust the passenger outside mirror to provide good visibility of the curb, for example.
- The adjusted mirror position is automatically stored and assigned to the vehicle key used to unlock the vehicle. The preselected position will be recalled when the key assigned to that mirror adjustment position is used again.



## Recalling settings for driver seat and outside mirrors

- Briefly press the appropriate memory button when the vehicle is not moving, the ignition is switched off, and the driver door is open.
- **OR:** If the ignition is switched on and the driver door is closed, press and hold the appropriate memory button until the stored position is reached.
- The passenger-side outside mirror automatically adjusts back from the position stored for backing up when the vehicle moves forward at about 10 mph (15 km/h) or more or when the rotary knob is rotated from **R** into a different position.

## Assigning driver seat and outside mirror settings to a vehicle key

The memory function of all vehicle keys is disabled when the vehicle is first delivered from the factory.

To enable vehicle key memory function:

- Unlock the driver door.
- Press and hold a memory button until memory position is reached.
- Press and hold the unlock button  on the vehicle key and then press the desired memory button at the same time within about 3 seconds. A chime sounds to confirm activation.

To disable vehicle key memory function:

- Press and hold the **SET** button.
- Press and hold the unlock button  on the vehicle key and the desired memory button at the same time within about 10 seconds. A chime sounds to confirm deactivation.

## Assigning settings to an additional vehicle key

- Follow the instructions 85 to assign the driver seat and outside mirror settings to the vehicle key.
- Unlock the vehicle with the same vehicle key.
- Adjust driver seat and outside mirrors.
- Lock the vehicle with locking button  in the vehicle key to store the settings.

Once the settings are stored, the driver seat and the outside mirrors move to the stored positions whenever the vehicle is unlocked with the vehicle key open button  and the driver door is opened. If 2 people use the vehicle, each of them should always use the key in which his or her personal settings have been stored.

## Initializing the memory seats

The memory system must be initialized by an authorized Volkswagen dealer, an authorized Volkswagen Service Facility, or another qualified workshop in certain situations, for instance, if a new driver seat is installed.

Initializing clears all memories and assignments of the memory seat. After that, memory buttons can be reprogrammed and assigned to a vehicle key.

- Open the driver door but do not enter the vehicle.
- Adjust the seats from the outside.
- Move the angle of the backrest forward as far as it will go.
- Release the backrest adjustment switch and press it again until you hear a chime sound.

## Cancellation conditions when storing settings for the memory buttons

When one of the following conditions is met, the storing process will be cancelled:

- The vehicle battery is weak or dead.
- The **SET** button is pressed again within about 10 seconds.
- The seat position is readjusted within about 10 seconds after pressing the **SET** button.



Applicable only in the United States

## Back massage feature

---

**ⓘ Please first read and note the introductory information and heed the WARNINGS **

With the back massage feature, the lumbar support moves to massage the lumbar area of the back. You can adjust the curvature of the lumbar support using the lumbar support control

Function	Action
Switch on:	Press the  button in the seat control panel.
Switch off:	Press the  button in the seat control panel again.
Automatic shut-off:	The back massage feature switches off automatically after about 10 minutes.

# Safety belts

## Introduction

---

In this section you'll find information about:

Warning light  
Frontal collisions and laws of physics  
What happens to passengers not wearing a safety belt  
Safety belts protect  
Using safety belts  
Fastening and unfastening safety belts  
Safety belt position  
Safety belt height adjusters  
Safety belt extender  
Safety belt retractor, pretensioner, load limiter  
Service and disposal of belt pretensioners

Properly worn safety belts are the single most effective means of reducing the risk of serious injury and death in a collision or other accident.

Damage to safety belts reduces their overall effectiveness and increases the risk of serious personal injury and death whenever the vehicle is being used.

Check the condition of all safety belts regularly.

If a safety belt shows damage to webbing, bindings, retractors or buckles, have the safety belt replaced by an authorized Volkswagen dealer or an authorized Volkswagen Service Facility ⇒ .

### **More information:**

- Adjusting the seating position
- Airbag system
- Child safety and child restraints
- Parts, accessories, repairs and modifications



## **WARNING**

Not wearing a safety belt or wearing an improperly positioned safety belt increases the risk of severe personal injury or death. Safety belts offer optimum protection only when they are used properly.

- Properly worn safety belts are the single most effective means of reducing the risk of serious injury and death in a collision or other accident. For this reason, always wear your safety belt properly and make sure all passengers wear their safety belts properly as well whenever the vehicle is moving.
- The driver must always make sure that every person in the vehicle is properly seated on a seat of his or her own, properly fastens the safety belts belonging to that seat before the vehicle starts to move, and keeps the belts properly fastened while riding in the vehicle. This applies even when just driving around town. Therefore, always wear your safety belts and make sure that everybody in your vehicle is properly restrained.
- Always secure children in the vehicle with a restraint system appropriate for their age, weight and height 102.
- Always fasten safety belts correctly before driving off and make sure that all passengers are properly restrained.
- Never attach the safety belt to the buckle of another seat. Attaching the safety belt to the wrong buckle will reduce safety belt effectiveness and can cause serious personal injury.
- Never let any objects or liquids get into the safety belt latch and prevent it from working properly.
- Never remove a safety belt while the vehicle is moving. Doing so will increase your risk of being injured or killed.
- Never strap more than one person, including small children, into any single safety belt.
- Never let children or babies ride sitting on your lap, and never place a safety belt over a child sitting on your lap.
- Never wear belts over rigid or breakable objects in or on your clothing, such as eyeglasses, pens, keys, etc., as these may cause injury.
- Several layers of heavy clothing (such as a coat worn over top of a sports jacket) may interfere with proper positioning of the safety belt and reduce the overall effectiveness of the system.
- Never use comfort clips or devices that create slack in the shoulder belt. However, special clips may be required for the correct use of some child restraint systems.
- Safety belts offer optimum protection only when the seat backrest is upright and belts are correctly positioned on the body.



## WARNING

Damage to safety belts reduces their overall effectiveness and increases the risk of serious personal injury and death whenever the vehicle is being used.

- Never let safety belts become damaged by being caught in the door or seat hardware.
- Torn or frayed safety belts can tear, and damaged safety belt hardware can break in an accident.
- Inspect belts regularly for damage. If webbing, bindings, buckles, or retractors are damaged, have the belts replaced immediately with the correct replacement belts approved by Volkswagen for your vehicle, model, and model year.
- Safety belts that were subject to stress in an accident and stretched must be replaced with a correct, new safety belt, preferably by an authorized Volkswagen dealer or authorized Volkswagen Service Facility.
- Replacement after a crash may be necessary even if a safety belt shows no visible damage. Anchorages that have been loaded must also be inspected.
- Damaged safety belts must be replaced; they cannot be repaired.
- Never try to repair a damaged safety belt yourself. Never remove or modify the safety belts in any way.
- Have safety belts, bindings, retractors and buckles replaced by an authorized Volkswagen dealer or authorized Volkswagen Service Facility.
- Always keep the belts clean. Dirty belts may not work correctly and can impair the function of the inertia reel.

## Warning light



Fig. 46 Warning light in the instrument cluster.

ⓘ Please first read and note the introductory information and heed the WARNINGS ⚠

Lights up or flashes	Possible cause	Proper response
	Driver and front passenger have not fastened their safety belts, if front passenger seat is occupied.	Fasten safety belts.
	Heavy items on the front passenger seat.	Remove items from front passenger seat and stow them safely.

When the ignition is switched on, several warning and indicator lights come on briefly for a function check. They go out after a few seconds.

A warning chime also sounds.

The safety belt warning light  comes on for 6 seconds when the ignition is switched on. A warning chime also sounds for up to 6 seconds if the driver's safety belt is not buckled. The chime stops sooner if the driver buckles his or her safety belt. The warning light and the chime go out when both driver and front passenger have buckled their safety belts.

If the driver and front seat passenger do not both fasten their safety belts within about 24 seconds after the chime stops and the vehicle is moving at a speed of more than about 15 mph (25 km/h), the chime will again sound for about 6 seconds, then go off for about 24 seconds, then sound again for about another 6 seconds. The same thing happens if one of the safety belts is fastened and then unfastened while the vehicle is moving. The safety belt warning light  also flashes. The warning chime continues to sound at 24 second intervals for up to 2 minutes. No chime sounds at speeds of less than about 5 mph (8 km/h).

If the ignition is switched on, the safety belt warning light  stays on until the driver and front passenger have both buckled their safety belts.

 **WARNING**

**Not wearing a safety belt or wearing an improperly positioned safety belt increases the risk of severe personal injury or death. Safety belts offer optimum protection only when used correctly.**

## Frontal collisions and laws of physics

---



Fig. 47 A vehicle with passengers not wearing safety belts approaches a wall.

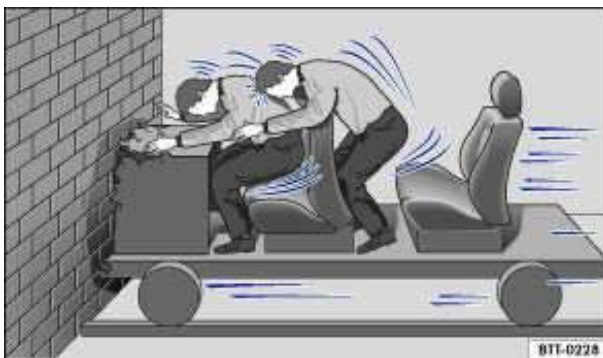

Fig. 48 A vehicle with passengers not wearing safety belts hits a wall.

**⚠ Please first read and note the introductory information and heed the WARNINGS ⚠**

The physical principles of a frontal collision are simple. Both the moving vehicle and the passenger possess energy ⇒ [fig. 47](#), which varies with vehicle speed and body weight. Engineers call this energy “kinetic energy.”

The higher the speed of the vehicle and the greater the vehicle's weight, the more energy has to be “absorbed” in a crash.

Vehicle speed is the most significant factor. If your speed doubles (for example, from 15 mph to 30 mph – 25 km/h to 50 km/h), the energy increases 4 times!

Because the occupants of the vehicle in the above example are not using safety belts, they are not “attached” to the vehicle. In a frontal collision, they will keep moving at the same speed the vehicle was moving just before the crash, until something stops them - here, the inside of the passenger compartment. Because the occupants of the vehicle in the example are not wearing safety belts, their entire kinetic energy will be absorbed by impact with the wall ⇒ [fig. 48](#).

The same principles apply to people in a vehicle that is in a frontal collision on the highway. Even at city speeds of 20–30 mph (30–50 km/h), the forces acting on the body can reach one ton (2,000 lbs or 1,000 kg) or more. At greater speeds, these forces are even higher.

Of course, the laws of physics don't apply just to frontal collisions; they determine what happens in all kinds of accidents and collisions.

## What happens to passengers not wearing a safety belt



**Fig. 49** The unbelted driver is thrown forward.



**Fig. 50** Unbelted passengers in the rear seats are thrown forward on top of the belted driver.

**⚠ Please first read and note the introductory information and heed the WARNINGS ⚠**

Many people believe that it is possible to resist the forces of an impact by holding tight or bracing themselves. That is simply not true!

Even at low collision speeds, the forces acting on the body are too much for the body to be held in the seat with the arms and hands. In a frontal collision, unrestrained occupants will slam violently into the steering wheel, instrument panel, windshield or anything else in the way ⇒ [fig. 49](#).

Never rely on airbags alone for protection. Even when they deploy, airbags provide only additional protection. Airbags are not supposed to deploy in all kinds of accidents. Even if your vehicle is equipped with airbags, all vehicle occupants, including the driver, must wear safety belts correctly in order to minimize the risk of severe injury or death in a crash, regardless of whether a seating position has an airbag or not.

An airbag will deploy only once. Safety belts are always there to offer protection in those accidents in which airbags are not supposed to deploy or when they have already deployed. Unbelted occupants can also be thrown out of the vehicle, causing even more severe injuries or death.

It is also important for occupants in the rear seats to wear their safety belts properly since they can be thrown violently forward through the vehicle in the event of an accident. Unbelted passengers in the rear seats endanger not only themselves but also the driver and other passengers in the vehicle

⇒ [fig. 50](#).

## Safety belts protect

---



**Fig. 51** Belted driver secured by the correctly worn safety belt in the event of a sudden braking maneuver.



## **⚠️ Please first read and note the introductory information and heed the WARNINGS ⚠️**

Used properly, safety belts can make a big difference. Safety belts help to keep passengers in their seats, gradually reduce energy levels applied to the body in a collision, and help prevent the uncontrolled movement that can cause serious injuries. In addition, safety belts reduce the danger of being thrown out of the vehicle ⇒ [fig. 51](#).

Safety belts attach passengers to the car and give them the benefit of being slowed down more gently or “softly” through the “give” in the safety belts, crumple zones, and other safety features (such as airbags) engineered into today's vehicles. The front crumple zones and other passive safety features (such as the airbag system) are also designed to absorb kinetic energy. By “absorbing” the kinetic energy over a longer period of time, the forces on the body become more “tolerable” and less likely to cause injury.

Although these examples are based on a frontal collision, safety belts can also substantially reduce the risk of injury in other kinds of crashes. So, whether you're on a long trip or “just going to the corner store,” always buckle up and make sure that others do, too.

Accident statistics show that vehicle occupants properly wearing safety belts have a lower risk of being injured and a much better chance of surviving a collision. Properly using safety belts also greatly increases the ability of the supplemental airbags to do their job in a collision. For this reason, wearing a safety belt is required by law in most countries including the United States and Canada.

Although your Volkswagen is equipped with airbags, you still have to wear the safety belts provided. Front airbags, for example, are activated only in some frontal collisions. The front airbags are not activated in all frontal collisions, in side and rear collisions, in rollovers, or in cases when the conditions for deployment stored in the electronic control unit are not met. The same goes for the other airbag systems on your Volkswagen.

So always wear your safety belt and make sure that everybody in your vehicle is properly restrained!

## **Using safety belts**

---

### **⚠️ Please first read and note the introductory information and heed the WARNINGS ⚠️**

#### **Checklist**

---

Using safety belts ⇒ ⚠️

- ✓ Damage to safety belts reduces their overall effectiveness and increases the risk of serious personal injury and death whenever the vehicle is being used.
  - ✓ Check the condition of all safety belts regularly.
  - ✓ Keep safety belts clean.
  - ✓ Keep objects and liquids away from safety belt webbing, the safety belt buckle tongue, and the safety belt buckle latch and opening.
  - ✓ Do not pinch or damage the safety belt or buckle tongue (for instance, when closing a door).
  - ✓ Never modify, disassemble or try to repair safety belts and safety belt anchorages.
  - ✓ Always fasten your safety belt properly before driving and keep it fastened whenever the vehicle is moving.
- 

#### **Twisted safety belt**

If it is difficult to pull the safety belt out of the belt guide, the belt may be twisted inside the side trim because the belt retracted too quickly when it was taken off.

- Hold the safety belt tongue, slowly and carefully pull safety belt all the way out.
- Untwist the safety belt and slowly return the belt by hand.

If you cannot untwist the safety belt, wear it anyway. Make sure that the safety belt is twisted in a spot where it does not come in direct contact with your body. Have the safety belt untwisted immediately by an authorized Volkswagen dealer or authorized Volkswagen Service Facility.

### Lockable safety belt

The retractors for the rear seat safety belts and the front passenger safety belt have a switchable locking feature for child restraints in addition to the emergency locking feature. Whenever a child restraint is installed with a safety belt, the safety belt must be locked so that the safety belt webbing cannot unreel. The switchable locking feature lets you lock the belt so that a child restraint can be properly installed and, for example, so that it can't tip to the side when the vehicle goes around a corner

To see whether a safety belt is lockable, pull the safety belt *all the way* out of the safety belt retractor. You should then hear a "clicking" sound as the belt winds back into the retractor reel. Test the switchable locking feature by pulling on the belt. When the switchable locking feature is active, you should no longer be able to pull the belt out of the retractor.

The locking feature must be deactivated when a vehicle occupant uses the safety belt.

**⚠ WARNING**

**Improper use and care of safety belts increases the risk of severe personal injury or death.**

- Regularly check safety belts and related parts for damage.
- Damaged safety belts must be replaced; they cannot be repaired.
- Always keep safety belts clean.
- Never catch, damage or chafe safety belt webbing on sharp edges.
- Always keep objects and liquids away from the belt buckle and buckle opening.

## Fastening and unfastening safety belts

---



**Fig. 52** Inserting the safety belt buckle tongue into the belt buckle.



**Fig. 53** Releasing the buckle tongue from the belt buckle.

**⚠ Please first read and note the introductory information and heed the WARNINGS ⚠**

Properly worn safety belts help to hold occupants in their seats and provide optimum protection during braking or in a collision or other accident ⇒ ⚠.

The switchable locking feature makes a “clicking” sound when the safety belt is winding back onto the safety belt retractor wheel after being pulled *all the way* out. Whenever a child restraint is installed with a safety belt, the safety belt must be locked so that the safety belt webbing cannot unreel *Child safety and child restraints*. If active, deactivate the locking feature before using the safety belt to restrain a person without a child restraint system.

### Fastening safety belts

Always buckle your safety belt before driving.

- Adjust the front seat and head restraint correctly
- Make sure the seat backrest of the rear seat bench is in an upright position and securely latched in place before using the safety belt ⇒ ⚠.
- Hold the safety belt by the tongue and pull it slowly and evenly across the chest and pelvis. Do **not** twist the safety belt webbing ⇒ ⚠.
- Insert the tongue into the correct buckle for your seat until you hear it latch securely ⇒ [fig. 52](#).
- Pull on the safety belt to make sure that it is securely latched in the buckle.

### Unfastening safety belts

Unfasten safety belts only when the vehicle is not moving ⇒ ⚠.

- Press the red button on the buckle ⇒ [fig. 53](#). The buckle tongue is ejected.
- Let the belt wind up on the retractor as you guide the belt tongue to its stowed position to help prevent the safety belt from twisting and to help avoid damage to the interior trim.

## **⚠ WARNING**

**Improperly positioned safety belts can cause serious personal injury or death in an accident.**

- **Safety belts offer optimum protection only when the seat backrest is upright and belts are correctly positioned on the body.**
- **A person who is not properly restrained can be seriously injured by the safety belt itself if it slips from the stronger parts of the body into sensitive areas like the abdomen.**
- **Unfastening safety belts while the vehicle is in motion can cause severe personal injury or death in the event of an accident or braking maneuver!**

## Safety belt position

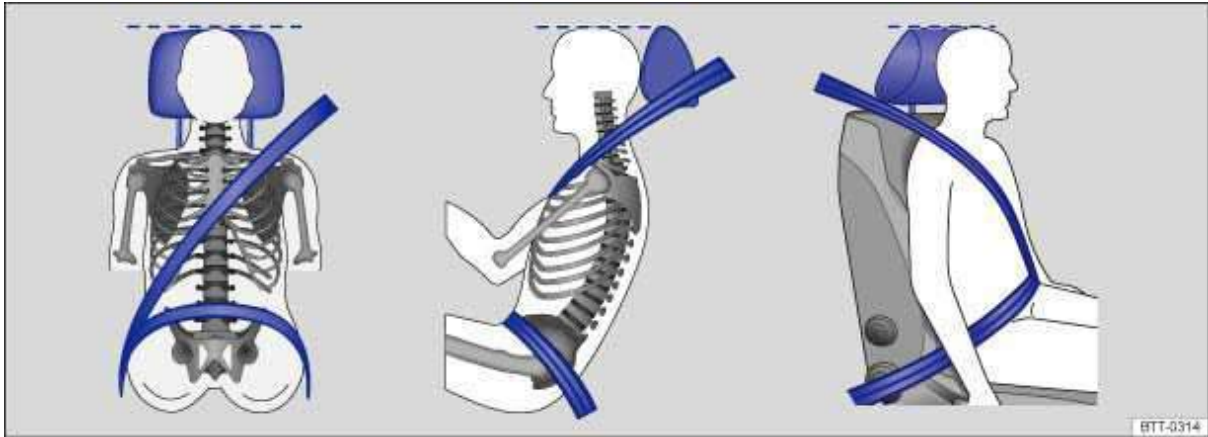

Fig. 54 Proper safety belt positioning and head restraint adjustment.



Fig. 55 Proper safety belt positioning for expectant mothers.

### **⚠ Please first read and note the introductory information and heed the WARNINGS**

Wearing safety belts improperly can cause serious injury or death. Safety belts can only work when they are correctly positioned on the body. A properly worn safety belt also helps to position the occupant so that an airbag can provide maximum protection when deployed. Therefore, always fasten your safety belt and make sure that it is properly positioned over your body.

Improper seating positions reduce the effectiveness of safety belts and even increase the risk of injury or death by moving the safety belt to critical areas of the body. Improper seating positions also increase the risk of severe injury or death when an airbag deploys and strikes an occupant who is not seated properly 67, *Adjusting the seating position*.

### **Proper safety belt position**

- The shoulder portion of the safety belt must always run over the center of the shoulder and never over the throat, over the arm, under the arm or behind the back.
- The lap portion of the safety belt must always run as low as possible over the pelvis and never over the abdomen.
- Always wear the safety belt flat and snug against the body. Pull on the safety belt to tighten if necessary.

**Expectant mothers** must always wear the lap portion of the safety belt as low as possible across the pelvis and below the rounding of the abdomen – throughout the pregnancy. The safety belt must lie flat against the body to avoid pressure against the abdomen ⇒ [fig. 55](#).

## Adjusting safety belt height

The safety belt position can be adjusted using the following features:

- Safety belt height adjusters for the front seats.
- Front seats with height adjustment.



### **WARNING**

**Improperly positioned safety belts can cause serious personal injury in an accident or a sudden braking maneuver.**

- **Always make sure that all vehicle occupants are correctly restrained and stay in a correct seating position whenever the vehicle is being used.**
- **Safety belts offer optimum protection only when the seat backrest is upright and belts are correctly positioned on the body.**
- **A loose-fitting safety belt can cause serious injuries by shifting its position on your body from the strong bones to more vulnerable soft tissue and cause serious injury.**
- **The shoulder belt portion of the safety belt must be positioned over the middle of the occupant's shoulder and never across the neck or throat.**
- **The safety belt must lie flat and snug on the occupant's upper body.**
- **Never wear the shoulder part of the safety belt under your arm or otherwise out of position.**
- **The lap portion of the safety belt must be positioned as low as possible across the pelvis and never over the abdomen. Make sure the belt lies flat and snug against the pelvis. Pull on the safety belt to tighten if necessary.**
- **Expectant mothers must always wear the lap portion of the safety belt as low as possible across the pelvis and below the rounding of the abdomen.**
- **Do not twist the belt when attaching it. If you cannot untwist a twisted safety belt, wear it anyway, but make sure the twisted part is not in contact with your body. Have the problem corrected right away by an authorized Volkswagen dealer or authorized Volkswagen Service Facility.**
- **Never hold the safety belt away from your body with your hand.**
- **Never wear belts over rigid or breakable objects, such as eyeglasses, pens or keys.**
- **Never modify the position of the belt using comfort clips, loops or similar devices.**



If you have a physical impairment or condition that prevents you from sitting properly on the seat with the safety belt properly fastened, special modifications to your vehicle may be necessary. Contact your authorized Volkswagen dealer or authorized Volkswagen Service Facility or call the Volkswagen Customer CARE Center at 1-800-822-8987 for information about possible modifications to your vehicle.

## Safety belt height adjusters

---

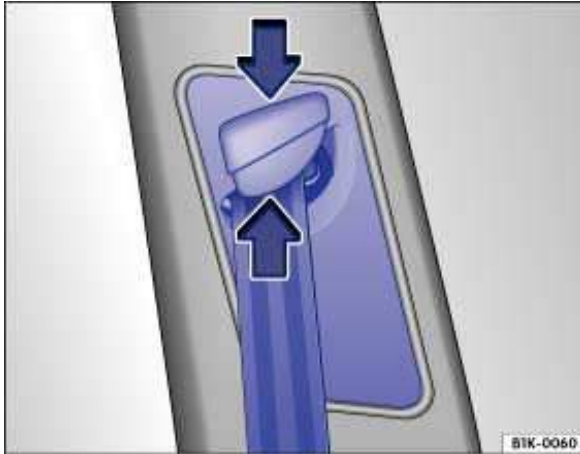

Fig. 56 Next to the front seats: Safety belt height adjuster.

❏ Please first read and note the introductory information and heed the WARNINGS ⚠

Safety belt height adjusters for the front seats can be used to adjust the height of the shoulder portion of the safety belt so that it is positioned correctly:

- Pinch the safety belt attachment together as indicated by the arrows and hold ⇒ fig. 56.
- Slide the belt and upper attachment up or down until the safety belt is positioned over the center of the shoulder, *Safety belt position*.
- Release the safety belt attachment.
- Pull on the safety belt to make sure that the upper attachment is securely locked in place.

### ⚠ WARNING

Never adjust the height of the safety belt while driving.

## Safety belt extender

---

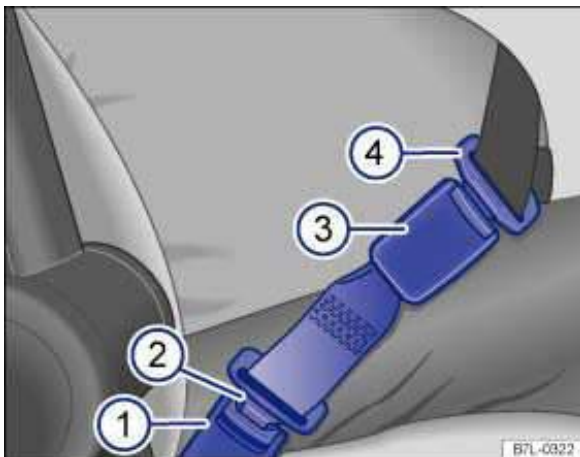
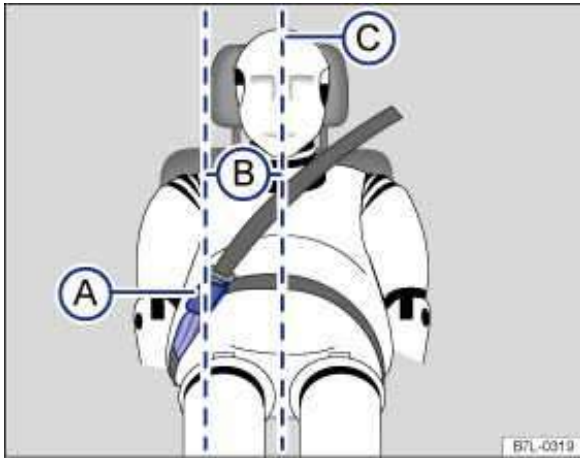

Fig. 57 A safety belt extender properly attached to the factory-installed safety belt.



**Fig. 58** Positioning of the safety belt extender.

**⚠ Please first read and note the introductory information and heed the WARNINGS ⚠**

If a safety belt is too short to correctly fit you or one of your passengers, even when the safety belt is pulled out all the way, you can use a safety belt extender.

Never use the safety belt extender for any other purpose – including the attachment of a child restraint.

The extender adds about 8 inches (20 cm) to the safety belt. Always remove the safety belt extender when it is not needed and stow it safely. Contact an authorized Volkswagen dealer or authorized Volkswagen Service Facility if you believe you may need an extender.

**Key to fig. 57:**

- (1) Vehicle safety belt buckle.
- (2) Buckle tongue on the safety belt extender.
- (3) Safety belt buckle on the safety belt extender.
- (4) Safety belt buckle tongue on the factory-installed safety belt.

**Key to fig. 58:**

- (A) Safety belt buckle on the safety belt extender.
- (B) Distance between the safety belt buckle on the safety belt extender and the centerline of the person using the safety belt extender. **The distance must be more than 6 inches (15 cm)!**
- (C) Centerline of the person using the safety belt extender.

**Using a safety belt extender**

- Adjust both the seat and the head restraint properly .
- Insert the buckle tongue on the safety belt extender ⇒ [fig. 57 \(2\)](#) into the vehicle belt buckle for the seat where the safety belt extender is being used [\(1\)](#).
- Fastening or unfastening the vehicle safety belt
- Pull the belt to make sure that the tongues are securely locked in the buckles.
- Make sure that the safety belt is positioned properly , *Safety belt position*.

**Properly using safety belt extenders:**

- Use a safety belt extender only when the factory installed safety belt is too short when worn properly by a person in proper seating position.
- Only use 1 safety belt extender per seat and vehicle safety belt.
- Always remove the safety belt extender when it is not needed.
- Never leave a safety belt extender attached to the vehicle safety belt buckle when the extender is not needed and being used with the safety belt. Otherwise, the airbag control module will receive an incorrect signal from the safety belt buckle and this will prevent the airbag from working properly for a person who is not using the safety belt. Leaving the extender attached to the safety belt buckle when

the front seat is occupied and the safety belt is not being used will signal the airbag control unit during a collision that the front passenger seat is occupied and that the safety belt is being used. The electronic control unit for the airbag system will then receive incorrect information that will cause the safety belt pretensioner to deploy unnecessarily and the front passenger airbag to deploy later in collisions that would normally trigger the front airbag earlier in the collision to help protect an unrestrained front seat occupant. The airbag will not be able to provide enough protection for an occupant not wearing a safety belt.

- Only use the safety belt extender approved by Volkswagen for your vehicle.

## **WARNING**

**Improper use or positioning of a safety belt extender increases the risk of serious personal injury and death.**

- **A driver or passenger who is not properly restrained can be seriously injured by striking the interior of the passenger compartment or by the safety belt itself, which can be displaced from stronger parts of the body into sensitive areas like the abdomen.**
- **Safety belt extenders offer optimum protection only when they are properly used.**
- **Only use the extender when the belt is not long enough to be worn low and snug and the person is in the correct seating position. Remove and stow extender safely when not needed.**
- **Always make sure the safety belt tongue of the safety belt extender is securely inserted into the buckle for the seating position that belongs to the seat where the safety belt extender is being used. Attaching the safety belt to the wrong buckle will reduce safety belt effectiveness and can cause serious personal injury.**
- **Never use the safety belt extender if you can properly attach the safety belt without it. Using a safety belt extender when not needed can increase the risk of injury, especially in a collision.**
- **Never use a safety belt extender if the distance (B) between the front edge of the safety belt extender buckle (A) and the centerline of the person using the safety belt extender ⇒ [fig. 58 \(C\)](#) is less than 6 inches (15 cm).**
- **Never leave a safety belt extender attached to the vehicle safety belt buckle when the extender is not needed and being used with the safety belt. Otherwise, the airbag control module will receive an incorrect signal from the safety belt buckle and this will prevent the airbag from working properly for a person who is not using the safety belt.**
- **Never use more than 1 extender with a safety belt. Using more than 1 extender can change the way the safety belt passes over the body and can cause serious injury.**
- **Never use the safety belt extender to secure a child restraint.**
- **Never use a safety belt extender on your Volkswagen that you got from another automobile manufacturer or from an automotive parts store.**
- **Never use the safety belt extender you got for your vehicle for any other vehicle, regardless of make, model, or model year.**

## **NOTICE**

- Leaving the extender attached to the safety belt buckle when the front seat is occupied and the safety belt is not being used will signal to the airbag control unit that the front passenger seat is occupied and that the safety belt is being used. The electronic control unit for the airbag system will then receive incorrect information that will
  - **cause the safety belt pretensioner to deploy unnecessarily in collisions.**
  - **cause the front passenger airbag to deploy later in collisions in which the front airbag would otherwise be triggered earlier to help protect an unrestrained front seat passenger.**
- **A pretensioner that has deployed cannot be repaired. The entire safety belt must be replaced.**



## NOTICE

If the safety belt extender is left attached to the safety belt buckle, the safety belt warning system will sense that the safety belt for that seat is being used. The warning light will not come on and the warning chime will not sound even though the seat is occupied and the safety belt is not being used.

## Safety belt retractor, pretensioner, load limiter

---

 Please first read and note the introductory information and heed the WARNINGS

The safety belts in the vehicle are part of the vehicle's safety concept and consist of the following important features:

### Automatic safety belt retractors

Every safety belt is equipped with an automatic belt retractor on the shoulder belt. As long as the safety belt is pulled out slowly, the shoulder belt will extend to let you move freely under normal driving conditions. The automatic safety belt retractor locks the belt when the belt is pulled out fast, during hard braking and in a collision. The belt may also lock when you drive up or down a steep hill or through a sharp curve.

### Safety belt pretensioner

The safety belt retractors for the front and rear outboard seats have a pretensioner that helps take the slack out of the safety belt and tighten it when the pretensioner is activated.

The pretensioners are activated by the electronic control unit for the airbag system in front, side, and rear collisions. By tightening the safety belt, the pretensioner helps to reduce the occupant's forward movement. The belt pretensioner works together with the airbag system; its function is monitored by the airbag system indicator light. The belt pretensioner will not deploy in a rollover if the side airbags are not activated.

A fine dust may be released upon activation. This is normal and is not caused by a fire in the vehicle.

### Safety belt load limiter

The front and rear outboard safety belts also have load limiters to help reduce the forces applied to the body in a crash.

 Heed all safety regulations if the vehicle or individual components of the system have to be scrapped. Your authorized Volkswagen dealer and authorized Volkswagen Service Facility are familiar with these regulations

## Service and disposal of belt pretensioners

---

 Please first read and note the introductory information and heed the WARNINGS

The pretensioners are part of the safety belts installed at the front seats in your vehicle. Installing, removing, servicing, or repairing of safety belt pretensioners can damage the safety belt system and prevent it from working correctly in a collision. The pretensioners themselves may then also not work in the event of an accident, or not work properly.

There are some important things you have to know to make sure that the effectiveness of the system will not be impaired and that discarded components do not cause injury or pollute the environment. Undeployed safety belt pretensioners and airbag modules contain explosive materials that can cause serious injuries to the general public and to people who work at dealerships and workshops, scrap

yards, and recycling facilities. For this reason, the systems must be properly handled when they or the vehicles they are installed in are scrapped.

Undeployed safety belt pretensioners and airbag modules can also pollute the environment. Never abandon vehicles or vehicle parts. If your vehicle must be scrapped, please make sure that it is done safely, responsibly, and in compliance with all applicable environmental regulations. Take it to a licensed facility that has the knowledge and experience to properly dispose of the vehicle and its safety belt system. Your authorized Volkswagen dealer and authorized Volkswagen Service Facility are familiar with these regulations.

 **WARNING**

**Improper handling, care, servicing, and repair procedures can increase the risk of personal injury and death by preventing a belt pretensioner from activating when needed or by causing it to activate unexpectedly.**

- **The pretensioner can be activated only once. If a pretensioner has been activated, the safety belt must be replaced.**
- **Safety belt systems including the pretensioners cannot be repaired. Special procedures are required to remove, install, and dispose of this system.**
- **Never repair, adjust, or change pretensioners or any other part of the safety belt system yourself. We strongly recommend that you have any work on the safety belt system performed by an authorized Volkswagen dealer or authorized Volkswagen Service Facility. They have the necessary technical information, training, and special equipment**

 **WARNING**

**Undeployed safety belt pretensioners and airbag modules contain explosive materials that can cause serious personal injuries if they are not properly handled when they or the vehicles they are installed in are scrapped.**

- **Never abandon vehicles or vehicle parts.**
- **Always scrap vehicles and vehicle parts, especially those containing undeployed airbag modules and undeployed safety belt pretensioners, at a licensed facility that has the knowledge and experience to properly dispose of the vehicle and its safety belt and airbag systems.**



Undeployed airbag modules and safety belt pretensioners are classified as **Perchlorate Material**. Special handling may apply – see <http://www.dtsc.ca.gov/hazardouswaste/perchlorate>. Obey all applicable legal requirements regarding handling and disposal of the vehicle or parts of its restraint system, including airbag modules and safety belts with pretensioners. Authorized Volkswagen dealers and authorized Volkswagen Service Facilities are familiar with the requirements, and we recommend that you have them perform this service for you.

# Lights

## Introduction

---

In this section you'll find information about:

Indicator lights

Turn signal lever and high beam switch

Switching lights on and off

Lights and vision features

Lights and vision features

“Coming home” and “Leaving home” feature (orientation lighting)

Instrument panel lighting and headlight range adjustment

Interior and reading lights

Always obey local vehicle lighting laws.

The driver is always responsible for the correct headlight settings.

### **More information:**

- Exterior views
- Volkswagen Information System
- Changing a light bulb



### **WARNING**

Crashes and other accidents can happen when you cannot see the road ahead and when you cannot be seen by other motorists.

- Always switch on the low beam headlights at dusk or when it is dark and whenever the weather is bad or visibility is poor.



### **WARNING**





Headlights that are aimed too high and improper use of the headlight flasher or high beams can blind and distract other drivers. This can lead to a crash and serious personal injuries.

- Always make sure that headlights are properly adjusted.
- Never use the headlight flasher or high beams when they can blind or distract other drivers.

## Indicator lights

---

 Please first read and note the introductory information and heed the WARNINGS 

Lights up	Possible cause	Proper response
	One or more driving lights not working or Adaptive Front Lighting System (AFS) malfunction.	Replace burned out bulb, or If all light bulbs are OK, see an authorized Volkswagen dealer or authorized Volkswagen Service Facility.
	Fog lights switched on (indicator light on the headlight switch or the instrument cluster).	
	Left or right turn signal. The indicator light blinks twice as fast if a turn signal is not working on the vehicle or the trailer.	Check the turn signals on the vehicle and the trailer.
 <b>DRL</b>	Daytime running lights (DRL) on.	
	High beams switched on or headlight flashers in use.	

When the ignition is switched on, several warning and indicator lights come on briefly for a function check. They go out after a few seconds.

**⚠ WARNING**

**Failure to heed warning lights and instrument cluster text messages can cause the vehicle to break down in traffic and result in a collision and serious personal injury.**

- Never ignore warning lights or text WARNINGS.
- Always stop the vehicle as soon as it is safe to do so.
- Whenever stalled or stopped for repair, move the vehicle a safe distance off the road, stop the engine, turn on the emergency flashers, and use other warning devices to warn approaching traffic.
- Never park the vehicle in areas where the hot catalytic converter and exhaust system can come into contact with dry grass, brush, spilled fuel, oil, or other material that can catch fire.
- A broken down vehicle presents a high accident risk for itself and others. Switch on emergency flashers and set up a warning triangle to warn oncoming traffic.

**ⓘ NOTICE**

**Failure to heed warning lights or text WARNINGS can result in vehicle damage.**

**i** High Intensity Discharge (HID) headlights provide bright, uniform lighting to help you see and be seen. The light comes from an electric arc between two electrodes in the gas-filled bulb. Over time, the electrodes can wear down and the gap between them will get wider. The HID lamp's control unit then increases the voltage to keep the arc's brightness constant. However, the commonly called "Xenon" bulbs will also ultimately burn out. Before they burn out, HID lamps can flicker. A message will then appear in the MFI. This is your reminder to see an authorized Volkswagen dealer or an authorized Volkswagen Service facility to check the headlights.

## Turn signal lever and high beam switch

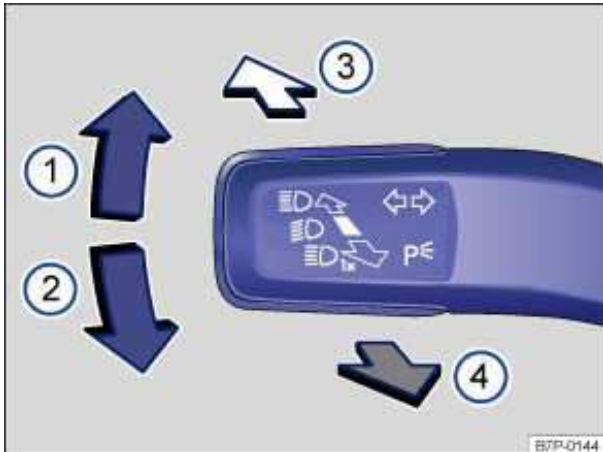

Fig. 72 Turn signal lever and high beam switch.

ⓘ Please first read and note the introductory information and heed the WARNINGS ⚠

**Move the lever to the desired position.**

- (1) Right turn signal.
- (2) Left turn signal.
- (3) Switching high beams on ⇒ ⚠. An indicator light § comes on in the instrument cluster when the high beams are switched on.
- (4) Switching the high beams off and operating the headlight flasher. The *headlight flasher* turns on the high beams as long as the lever is pulled and manually held in the pulled position. The indicator light § lights up. When released, the lever moves back to the home position and turns off the high beams. The indicator light § goes out.

Move the lever back to the home position to turn the selected feature off.

### Lane change signaling feature (convenience turn signal)

To use the lane change signaling feature, move the lever up or down slightly, just to the point of resistance and then release it. If you have lane change flash (*Conv. turn sig.*) switched on, the turn signals and the turn signal indicator flash 3 times. If it is switched off, they flash as long as you hold the lever up or down, and go out when you release the lever.

Lane change flash is switched on and off in the **Lights & Vision** menu in the instrument cluster display 21. If your vehicle is not equipped with the **Lights & Vision** menu, the lane change flash feature can be deactivated by an authorized Volkswagen dealer or authorized Volkswagen Service Facility.

### ⚠ WARNING

**Improper use of high beams can distract and blind others, causing accidents and serious injuries.**

ⓘ The turn signal light works only when the ignition is switched on. The emergency flasher works even when the ignition is switched off

ⓘ The indicator light flashes twice as fast if a turn signal bulb is burned out.

 High beams can only be switched on when the low beams are on.

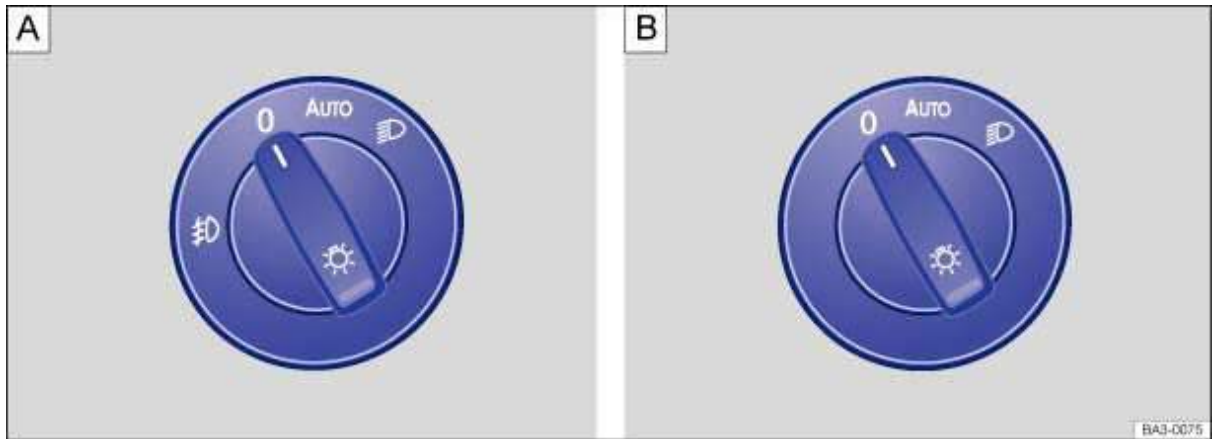

## Switching lights on and off



**Fig. 73** Headlight switch next to the steering wheel. A: Vehicles with fog lights. B: Vehicles without fog lights.



 Please first read and note the introductory information and heed the **WARNINGS** 

Adjust the light switch to the desired position ⇒ **fig. 73**:

Symbol	When the ignition is switched off	When the ignition is switched on
<b>0</b>	Fog lights and low beams switched off.	Headlights off, daytime running lights (DRL) on.
<b>AUTO</b>	Orientation lighting may be switched on.	Automatic headlight control active; DRL on.
	Low beams switched off. The DRL may stay on. The length of time they stay on depends on the vehicle battery charge.	Low beams switched on.
	Fog lights switched off. The DRL may stay on for some time.	Headlights and fog lights switched on.

### Fog lights

The indicator light  in the headlight switch or the instrument cluster shows that the fog lights are switched on.

- To switch on the fog lights : first turn the light switch to position , then pull the light switch out to the first detent.
- To switch off the fog lights, push the switch back in from the first detent. To then turn off the headlights, turn the switch to position **0**.

### Acoustic warning when lights are not switched off

In the following situation, a warning chime will sound if you take the key out of the ignition and open the driver door. This is to remind you that lights are still on.

- Light switch in position  if the vehicle has no orientation lighting



## WARNING

Daytime running lights are not bright enough to let you see ahead or be seen by others when it is dark.

- Always switch on the low-beam headlights at dusk or when it is dark and whenever the weather is bad or visibility is poor.
- Never use the daytime running lights to see where you are going. They are not bright enough and will not let you see far enough ahead for safety, especially at dusk or when it is dark. Always switch on the low-beam headlights at dusk or when it is dark.
- The taillights do not come on with the daytime running lights. Unless the taillights are on, a vehicle cannot be seen by others in bad weather, at dusk, or when it is dark.
- Even if automatic headlight control (AUTO) is switched on, the low-beam headlights may still not come on by themselves in fog or heavy rain. You have to switch on the low-beam headlights manually.



In cool or humid weather, the insides of the headlights, the taillights, and turn signals can temporarily fog up. This is normal and does not affect the service life of the vehicle's lighting system.

Applicable only in the United States

## Lights and vision features

Please first read and note the introductory information and heed the WARNINGS

### Daytime running lights (DRL)

Separate lamps are installed in the headlights or in the front bumper for the daytime running lights (DRL).

When the daytime running lights are switched on, only these separate lamps come on ⇒

The daytime running lights are switched on whenever the ignition is switched on and the light switch is in position **0** or **AUTO**. The indicator light or **DRL** may come on in the instrument cluster to indicate that the feature is active

If the light switch is in position **AUTO**, a low-light sensor switches the low beams as well as the instrument and switch lighting on and off automatically.

### Daytime running lights (DRL) parking feature

Some models are equipped with a daytime running lights (DRL) parking feature that switches the daytime running lights off when the vehicle is parked and the ignition is switched on.

Function	Action
Switching the DRL off:	<ul style="list-style-type: none"> <li>– Switch the ignition on.</li> <li>– Turn the light switch to the <b>0</b> position.</li> <li>– Set the parking brake.</li> </ul>
Switching the DRL back on:	<ul style="list-style-type: none"> <li>– Release the parking brake.</li> </ul>

### Static cornering lights

Your vehicle may have fog lights under the front bumper, which on some models are also static cornering lights. On some models the static cornering lights may be integrated in the headlights. At speeds below about 25 mph (40 km/h), the light on one side of the vehicle will come on automatically

when you turn a corner. If you turn to the right, the right fog light comes on; turn left and the left fog light comes on. The light dims and goes out when the steering wheel is straightened out again.

When you move the selector lever to Reverse (R), the static cornering lights on both sides of the vehicle may come on so that you can see the area around the vehicle better when backing up.

The static cornering lights work only when the headlights are on. If you are using automatic headlight control (headlight switch in the AUTO position ⇒ fig. 73), they work only when the headlights have been automatically switched on. The static cornering lights do not come on when the headlight switch is in the 0 position or when the fog lights themselves have been switched on

### Automatic headlight control (AUTO)

Automatic headlight control is a convenience feature only and cannot always recognize all lighting and driving situations.

If the light switch is in the AUTO, position, both vehicle lighting and instrument and switch lighting are automatically switched on and off in the following situations ⇒ ⚠:

Automatic activation:	Automatic deactivation:
If the low-light sensor registers <i>darkness</i> , for example when driving through a tunnel.	If sufficient brightness is registered.
If the rain sensor recognizes rain and switches the windshield wipers on.	If the windshield wipers have not moved for several minutes.

### Adaptive Front Lighting System (AFS)

The Adaptive Front Lighting System works only with the low beams switched on and only at speeds above about 6 mph (10 km/h). The swivel-mounted lamps automatically improve road illumination during cornering.

On vehicles equipped with the Adaptive Front Lighting System, the feature is switched on and off via the **Assistants** menu in the instrument cluster display

**⚠ WARNING**

Crashes and other accidents can happen when you cannot see the road ahead and when you cannot be seen by other motorists.

- Never use daytime running lights (DRL) to see where you are going. DRL are not bright enough to light up the roadway and be seen by other motorists. You will not be able to see far enough ahead for safety, especially at dusk or when it is dark. Always switch on the low-beam headlights at dusk or when it is dark.
- The taillights do not come on when the daytime running lights are switched on. A vehicle without taillights on cannot be seen by others in bad weather, at dusk, or when it is dark.
- If automatic headlight control (AUTO) is switched on, the low-beam headlights still may not be switched on in fog or heavy rain. You have to switch on the low-beam headlights yourself.

**i** In cool or humid weather, the insides of the headlights, the rear lights, and turn signals can temporarily fog up. This is normal and does not affect the service life of the vehicle's lighting system.

Applicable only in Canada

## Lights and vision features

☐ Please first read and note the introductory information and heed the WARNINGS ⚠



## Daytime running lights (DRL)

Separate lamps are installed in the headlights or in the front bumper for the daytime running lights (DRL).

When the daytime running lights are switched on, only these separate lamps come on ⇒ .

The daytime running lights are switched on whenever the ignition is switched on and the light switch is in position **0** OR **AUTO**. The indicator light  OR **DRL** may come on in the instrument cluster to indicate that the feature is active

If the light switch is in position **AUTO**, a low-light sensor switches the low beams as well as the instrument and switch lighting on and off automatically.

## Static cornering lights

Your vehicle may have fog lights under the front bumper, which on some models are also static cornering lights. On some models the static cornering lights may be integrated in the headlights. At speeds below about 25 mph (40 km/h), the light on one side of the vehicle will come on automatically when you turn a corner. If you turn to the right, the right fog light comes on; turn left and the left fog light comes on. The light dims and goes out when the steering wheel is straightened out again.

When you move the selector lever to Reverse (**R**), the static cornering lights on both sides of the vehicle may come on so that you can see the area around the vehicle better when backing up.

The static cornering lights work only when the headlights are on. If you are using automatic headlight control (headlight switch in the **AUTO** position) ⇒ [fig. 73](#), they work only when the headlights have been automatically switched on. The static cornering lights do not come on when the headlight switch is in the **0** position or when the fog lights themselves have been switched on.

### Automatic headlight control **AUTO**

Automatic headlight control is a convenience feature only and cannot always recognize all lighting and driving situations.

If the light switch is in the **AUTO**, position, both vehicle lighting and instrument and switch lighting are automatically switched on and off in the following situations ⇒ .

<b>Automatic activation:</b>	<b>Automatic deactivation:</b>
If the low-light sensor registers <i>darkness</i> , for example when driving through a tunnel.	If sufficient brightness is registered.
If the rain sensor recognizes rain and switches the windshield wipers on.	If the windshield wipers have not moved for several minutes.

## Adaptive Front Lighting System (AFS)

The Adaptive Front Lighting System works only with the low beams switched on and only at speeds above about 6 mph (10 km/h). The swivel-mounted lamps automatically improve road illumination during cornering.

On vehicles equipped with the Adaptive Front Lighting System, the feature is switched on and off via the **Assistants** menu in the instrument cluster display



## WARNING

Crashes and other accidents can happen when you cannot see the road ahead and when you cannot be seen by other motorists.

- Never use daytime running lights (DRL) to see where you are going. DRL are not bright enough to light up the roadway and be seen by other motorists. You will not be able to see far enough ahead for safety, especially at dusk or when it is dark. Always switch on the low-beam headlights at dusk or when it is dark.
- The taillights do not come on when the daytime running lights are switched on. A vehicle without taillights on cannot be seen by others in bad weather, at dusk, or when it is dark.
- If automatic headlight control (AUTO) is switched on, the low-beam headlights still may not be switched on in fog or heavy rain. You have to switch on the low-beam headlights yourself.



In cool or humid weather, the insides of the headlights, the rear lights, and turn signals can temporarily fog up. This is normal and does not affect the service life of the vehicle's lighting system.

## “Coming home” and “Leaving home” feature (orientation lighting)

**Please first read and note the introductory information and heed the WARNINGS** 

The “Coming home” feature must be switched on manually. The “Leaving home” feature is controlled automatically by a low-light sensor.

“Coming home”	Action
Switch on:	<ul style="list-style-type: none"> <li>– Switch off the ignition.</li> <li>– Operate the headlight flasher for about 1 second .</li> </ul> <p>The “Coming home” lighting is switched on when the driver door is open. The <i>delay period</i> starts once the last vehicle door or the luggage compartment lid is closed.</p>
Switch off:	<ul style="list-style-type: none"> <li>– Automatically after delay period is over.</li> <li>– Automatically, if a vehicle door or the luggage compartment lid is still open about 30 seconds after activation.</li> <li>– Turn light switch to the <math>\circ</math> position.</li> <li>– Switch the ignition on.</li> </ul>

“Leaving home”	Action
Switch on:	<ul style="list-style-type: none"> <li>– Unlock the vehicle if the light switch is in the <b>AUTO</b> position and the low-light sensor registers <i>darkness</i>.</li> </ul>
Switch off:	<ul style="list-style-type: none"> <li>– Automatically after preset delay period is over.</li> <li>– Lock the vehicle.</li> <li>– Turn the light switch to the <b>O</b> position.</li> <li>– Switch the ignition on.</li> </ul>

### Background lighting in the outside mirrors

The background lighting in the outside mirrors illuminates the area near the doors when entering and exiting the vehicle. It is switched on when the vehicle is unlocked, a vehicle door is opened, or the “Coming home” or “Leaving home” feature is activated. If the vehicle is equipped with a light sensor, the background lighting in the outside mirrors is only switched on in darkness.

 The delay period can be adjusted and the function can be switched on and off in the **Lights & Vision** menu

 If the “Coming home” feature is switched on and the driver door is opened, no warning chime will sound to alert you that the lights are still on.

## Instrument panel lighting and headlight range adjustment

---



**Fig. 74** To the left of the steering wheel: Thumbwheel to adjust instrument panel lighting 1.

 Please first read and note the introductory information and heed the **WARNINGS**

### Instrument panel lighting

When the lights are on, the brightness of the instrument panel lighting is adjusted by turning the thumbwheel ⇒ [fig. 74 \(1\)](#).

### Instrument cluster brightness

When the lights are on, the brightness of the instrument cluster lighting is adjusted by turning the thumbwheel (1).

In some vehicles with daytime running lights (DRL), the instrument cluster lighting switches on automatically when it is dark outside or when driving through tunnels, for example. You will need to switch the headlights on manually when this happens, so that the vehicle's taillights will turn on.

### Dynamic headlight range adjustment

In vehicles with HID (Xenon) headlights, the headlight range is automatically adjusted to the vehicle loading condition once the low beams are switched on ⇒ .

## WARNING

Headlights that are aimed too high because of the way the vehicle is loaded can blind and distract other drivers. This can lead to a crash and serious personal injuries.

- Always make sure the headlights are adjusted to loading conditions so that they do not blind others.



## WARNING

If dynamic headlight range adjustment does not work properly or at all, the headlights could blind and distract other drivers. This can lead to a crash and serious personal injuries.

- Have headlight range adjustment checked immediately by an authorized Volkswagen dealer or an authorized Volkswagen Service Facility.

## Interior and reading lights

ⓘ Please first read and note the introductory information and heed the WARNINGS

Button	Function
	Interior lights off.
	Interior lights on.
	Door contact switch - center position. Interior lights go on automatically when the vehicle is unlocked, a door is opened, or the vehicle key is removed from the ignition. The lights go out about 20 seconds after you close the doors. They also go out when you lock the vehicle or switch on the ignition.
	Reading light on or off.

### Glove and luggage compartment lights

The glove and luggage compartments may have lights that come on automatically when they are opened and go off when they are closed.

### Background lighting

When the ignition and headlights are switched on, the background lighting in the roof console lights up.

There may also be lighting in the footwells and on the inside door trim and door handle recesses.



The interior and reading lights go out when you lock the vehicle or a few minutes after you remove the vehicle key from the ignition. This helps to prevent unnecessary drain on the vehicle battery.

# Sun protection

## Introduction

In this section you'll find information about:

Sun visors

Rear window sunshade

Windshield made of heat-insulating glass

### **⚠ WARNING**

**Sun visors and side window shades can reduce visibility.**

- **Always stow sun visors and side window shades when not needed to block sun glare.**

## Sun visors

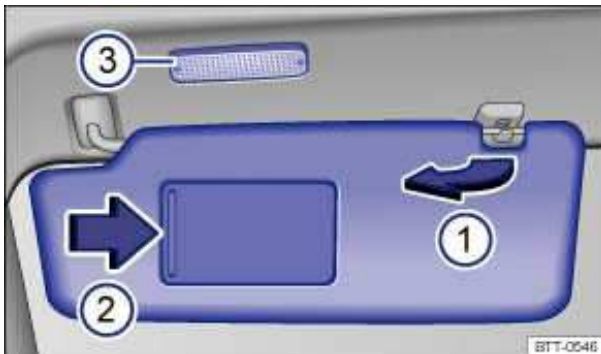

Fig. 75 Sun visor.

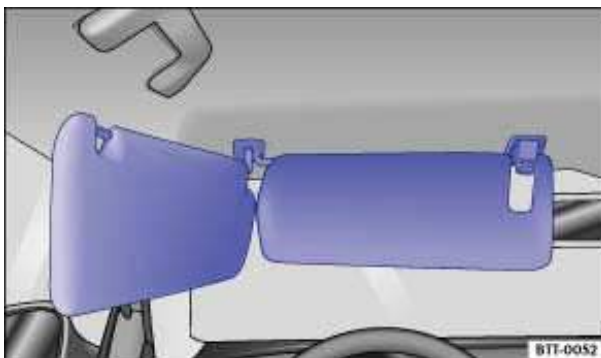

Fig. 76 Double sun visors (if equipped).

**⚠ Please first read and note the introductory information and heed the WARNINGS ⚠**

### **Sun visor adjustment:**

- Flip the sun visor down toward the windshield.

- Lift it out of the retaining clip ⇒ [fig. 75 \(1\)](#) and swivel it over toward the door.

#### Additional sun visor positions:

- On some vehicles, you can slide the sun visor towards the rear of the vehicle after swiveling it over to the door.

#### Vanity mirror and lighting

A vanity mirror is behind a cover in the sun visor. A light (3) may come on when you slide the cover (2) open.

The light goes out when you shut the cover or if you flip the sun visor up again.

 The vanity mirror light and the interior light above the sun visor go out after several minutes. This helps to prevent unnecessary drain on the vehicle battery.

## Rear window sunshade

---



**Fig. 77** In the center console: Button for the electrical sunshade on the rear window.

 Please first read and note the introductory information and heed the WARNINGS

The sunshade in front of the rear window protects against intense sunlight.

#### Manual sunshade

- Pull the sunshade all the way up by the handle.
- Insert each end of the handle into the corresponding bracket. Turn the handle slightly downward to do this. Make sure that the pulled out sunshade is safely latched in both brackets.
- Pull the sunshade slightly upward by its handle and then manually guide it down to return it into its holder ⇒ .

#### Power sunshade

- Switch on the ignition.
- Press the  button to deploy or retract the rear window sunshade. The sunshade moves to its end position.

### NOTICE

To help prevent damage to the sunshade or the interior rim, do not let the manual sunshade “snap” back down as it retracts.

## Windshield made of heat-insulating glass

---

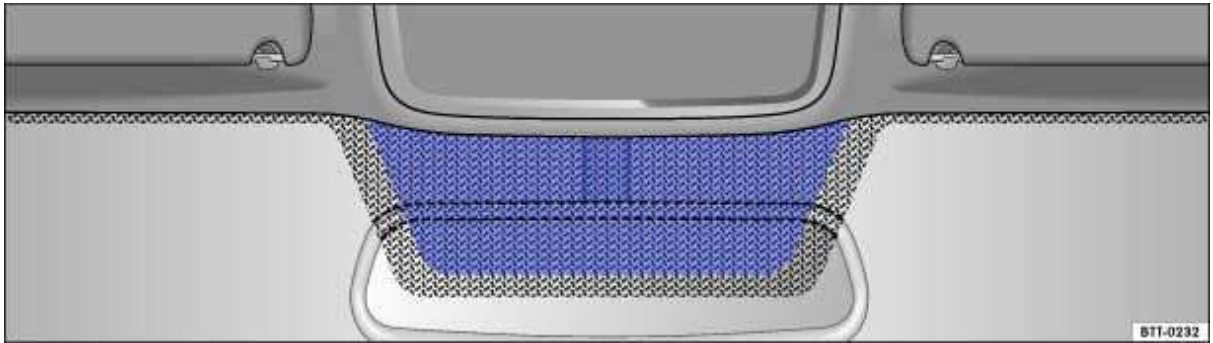

**Fig. 78** Heat-reflective windshield with communications window (blue shaded area).

**⚠ Please first read and note the introductory information and heed the WARNINGS ⚠**

Windshields made of insulating glass have a transparent metallic infrared-reflecting coating. There is an uncoated area (communications window) just above the inside rearview mirror ⇒ [fig. 78](#). This serves as a communications window for transmitting signals to and from electronic components and accessories.

The uncoated area must not be blocked on the inside or outside or covered with stickers because this can cause the electronic components to malfunction.

# Windshield wiper and washer

## Introduction

---

In this section you'll find information about:

Indicator light

Windshield wiper lever

Windshield wiper functions

Windshield wiper service position

Rain sensor

Checking and refilling windshield washer fluid

### More information:

- Exterior views
- Climate control
- Preparations for working in the engine compartment
- Exterior care and cleaning

### WARNING

Windshield washer fluid without enough frost protection can freeze on the windshield and reduce visibility.

- Use the windshield washer system with enough frost protection for winter temperatures.
- Never use the windshield wipers/washers when it is freezing without first defrosting the windshield. The washer solution may freeze on the windshield and reduce visibility.

### WARNING

Worn or dirty wiper blades reduce visibility and increase the risk of accidents and severe injuries.

- Always replace wiper blades that are worn, damaged, or do not keep the windshield clear.

### NOTICE

To help prevent damage to the wiper blades and the wiper motor when it is cold outside, always make sure that blades are not frozen to the windshield before operating the wipers. Using the windshield wiper service position can be helpful in cold weather so the wipers do not freeze to the windshield

## Indicator light

---

 Please first read and note the introductory information and heed the WARNINGS 



Lights up	Possible cause	Proper response
	Not enough windshield washer fluid.	Refill windshield washer reservoir at the next opportunity

When the ignition is switched on, several warning and indicator lights come on briefly for a function check. They go out after a few seconds.

## NOTICE

Failure to heed warning lights or text **WARNINGS** can result in vehicle damage.

## Windshield wiper lever

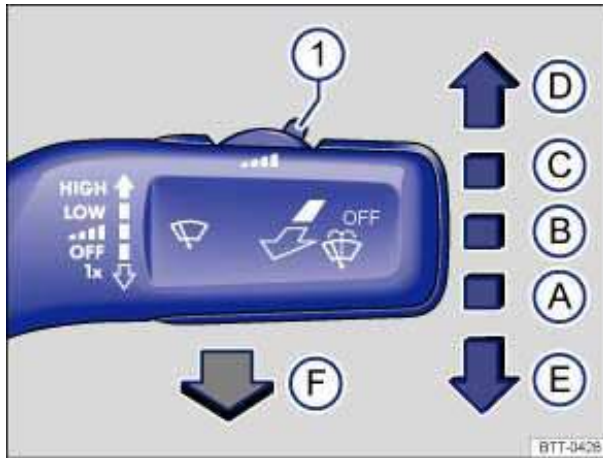



Fig. 79 Operating the front windshield wiper.

 Please first read and note the introductory information and heed the **WARNINGS** 

Move the lever to the desired position ⇒ :

(A)	<b>OFF</b>	Wiper switched off.
(B)		Intermittent wiping for the windshield. Adjust the interval settings with switch ⇒ <a href="#">fig. 79 (1)</a> (vehicles without rain sensors) or the sensitivity of the rain sensor (vehicles with rain sensors).
(C)	<b>LOW</b>	Slow wiper speed.
(D)	<b>HIGH</b>	Fast wiper speed.
(E)	1x	One-tap wiping – brief wiping. Hold the lever pressed down longer to wipe more often.
(F)		Pull the lever toward the steering wheel to activate the windshield washers, then release.

## NOTICE

To help prevent damage to the wiper blades and the wiper motor when it is cold outside, always make sure that blades are not frozen to the windshield before operating the wipers. Using the service position can be helpful in cold weather so the wipers do not freeze to the windshield

- If the ignition is switched off while the wipers are running, the wipers will continue at the same wiping speed when the ignition is switched on again. Frost, ice, snow, leaves, and other objects on the windshield can damage the wipers and the wiper motor.
- Remove snow and ice from the wipers before you begin driving.
- If the wiper blades freeze to the windshield, loosen them carefully. Volkswagen recommends using a deicing spray.

## NOTICE

Never switch on the windshield wipers when the windshield is dry because the windshield can be scratched.

 The windshield wipers work only if the ignition is switched on and the engine hood is closed. The windshield wipers turn off automatically when the engine hood is opened.

 The intermittent wiping for the front windshield depends on the driving speed. The higher the speed, the faster the wipers move.

 If the wiper blades freeze to the windshield, loosen them carefully. Volkswagen recommends using a deicing spray.

## Windshield wiper functions

 Please first read and note the introductory information and heed the WARNINGS

### Wiper performance in different situations:

When the vehicle is not moving:	The wiper speed changes temporarily to the next lower speed.
During automatic wipe/wash:	While the washer system is working, the Climatronic switches to recirculation for about 30 seconds to help prevent the washer fluid odor from entering the vehicle interior.
During intermittent wiping:	Speed-dependent interval control: The higher the vehicle speed, the faster the wipers move.

### Heated washer nozzles

The heating thaws frozen washer nozzles, but not the fluid supply hoses. When the ignition is switched on, the heat applied to the washer nozzles is automatically regulated depending on the outside air temperature.

## Headlight washer system

The headlight washer system cleans the headlight glass.

If the ignition and the headlights (high or low beams) are switched on, the headlights are cleaned the first time and every fifth time the front windshield washers are activated. This happens only when the low or high beams are on when the windshield wiper lever is pulled towards the steering wheel. However, the headlights must still be washed by hand periodically (for instance, during refueling) in order to get rid of hard-to-remove dirt (like insect splatter).

To help make sure that the headlight cleaning system works during winter weather, always keep the headlight washer nozzles free of snow and remove any ice with a deicer spray before driving. Use a deicer spray to remove any ice.



If there is something on the windshield, the wiper will try to wipe it away. If it continues to block the wiper, the wiper will stop moving. Remove the obstacle and switch the wiper on again.

## Windshield wiper service position

---

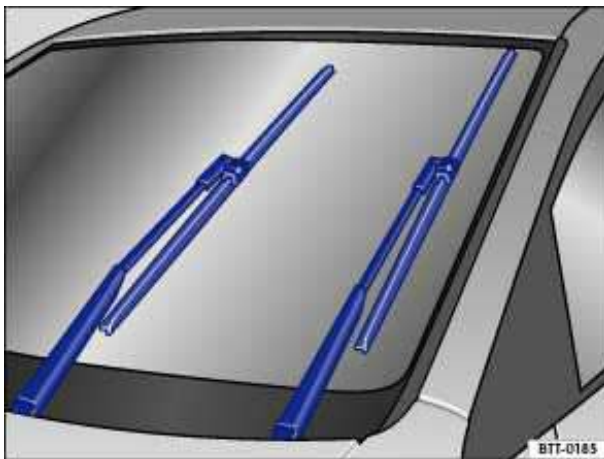

Fig. 80 Windshield wiper in service position.

**⚠ Please first read and note the introductory information and heed the WARNINGS ⚠**

In the service position, the wiper arms can be lifted away from the windshield ⇒ fig. 80. The wipers are moved to the service position as follows:

- The engine hood must be closed
- Switch the ignition off, turn it on briefly, and then off again.
- Press the windshield wiper lever down briefly ⇒ fig. 79 (E) when the ignition is off.
- Wipers move into service position.

Carefully fold the wiper arms back onto the windshield before driving! Switch the ignition on and press the windshield wiper lever down briefly ⇒ fig. 79 (E). The wiper arms move back to their original position.

### Lifting the wiper blades and tilting them away from the windshield

- Put the wiper arms in service position ⇒ ⚠.
- Do not handle the wiper blades, handle the wiper arms only at the attachment above the wiper blades.

## NOTICE

- To help prevent damage to the engine hood and the windshield wiper arms, lift the wiper arms away from the windshield only when they are in the service position.
- Always carefully fold the windshield wiper arms down against the windshield before driving the vehicle.

## Rain sensor

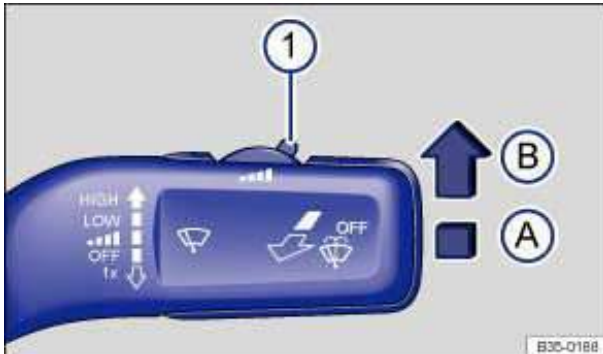

Fig. 81 Windshield wiper lever: Adjusting rain sensor 1.

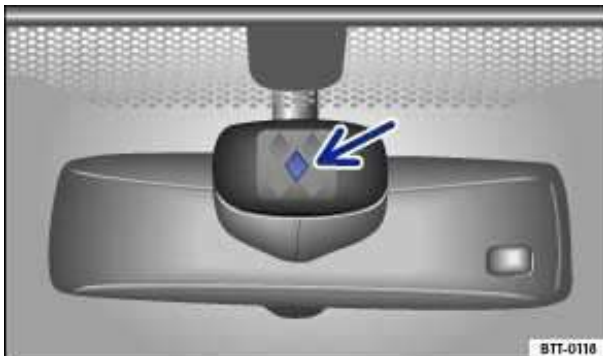

Fig. 82 Inside the front windshield above the inside mirror: Sensitive rain sensor surface.

**Please first read and note the introductory information and heed the WARNINGS** ⚠

When switched on, the rain sensor automatically shortens or lengthens the time between wiping intervals depending on how hard it is raining ⇒ ⚠. The rain sensor's sensitivity can be adjusted manually. Manual wiping (vehicles without rain sensors)

Push the lever into the desired position ⇒ fig. 81:

- (A) Rain sensor off (windshield wiper lever home position).
- (B) Rain sensor active – automatic wiping as needed.
- (1) Adjusting the sensitivity of the rain sensor:
  - Move switch to the right – high sensitivity.
  - Move switch to the left – low sensitivity.

After switching the ignition off and back on again, the rain sensor stays on and works again with the wiper lever in position (B) when the vehicle speed is over 10 mph (15 km/h).

## Possible reasons for changes in the way the rain sensor works

The rain sensor may misread what is happening in the *detection zone of its sensitive rain-sensor surface* ⇒ [fig. 82](#) (arrow) and not work for a number of reasons, which include:

- Worn out wiper blades: Worn out wiper blades may leave a film of water or wiping streaks; this can cause the wipers to run longer, to wipe more often, or to wipe continuously at high speed.
- Insects: Insects hitting the sensor may trigger the wipers.
- Salt streaks: Salt streaks on the windshield from winter driving can cause wiping more often or continuously on glass that is almost dry.
- Dirt: Caked-on dust, wax, any other buildup on the windshield (lotus effect), or car-wash detergent residue can lower the rain sensor's sensitivity and cause it to react too slowly or not at all.
- Crack or chip in the windshield: If a stone hits and chips the windshield while the rain sensor is on, this will trigger a wiper cycle. After that, the rain sensor will recognize the change and recalibrate itself to respond to the sensitive surface's reduced detection zone. Depending on the size of the chip, the sensor's reaction pattern may or may not change.



### WARNING

The rain sensor cannot always recognize rain and activate the wipers.

- Switch the wipers on manually when water on the windshield reduces visibility.



Clean the rain sensor's sensitive surface (arrow) regularly and check the wiper blades for wear or damage.



To remove wax and coats of polish safely, we recommend using an alcohol-based windshield cleaner.

## Checking and refilling windshield washer fluid

---





**Fig. 83** In the engine compartment: Cap of the windshield washer fluid reservoir.

**⚠ Please first read and note the introductory information and heed the WARNINGS**

Check the windshield washer fluid level regularly and refill as necessary.

- Open the engine hood
- The windshield washer fluid reservoir can be identified by the symbol on its cap ⇒ [fig. 83](#).

- Check if there is still enough windshield washer fluid in the reservoir.
- Refill with an appropriate windshield washer fluid that is recommended by Volkswagen ⇒ . Follow the directions on the container.
- In cold weather, always use a special windshield washer antifreeze solution that will help keep the water from freezing ⇒ .

### Recommended cleaners

- For the warmer months, Windscreen Clear SummerG 052 184 A1 or equivalent. Mixing ratio 1:100 (1 part concentrate to 100 parts water) in the windshield washer reservoir.
- All-season Windscreen ClearG 052 164 A2 or equivalent. Mixing ratio in winter to 0 °F (-18 °C) about 1:2 (1 part concentrate to 2 parts water), otherwise, mixing ratio 1:4 in the windshield washer reservoir.

### Filling capacity

The windshield washer fluid reservoir holds about 3.1 qts. (3 liters); in vehicles with a headlight cleaning system about 6.3 qts (6 liters).



### WARNING

**Never mix antifreeze or similar additives into the windshield washer reservoir. This could produce an oily film on the windshield, which would considerably reduce visibility.**

- Use clear water with a cleaning solution recommended by Volkswagen.
- If necessary, blend with a suitable windshield washer fluid antifreeze agent.



### NOTICE

- Never mix cleaning solutions recommended by Volkswagen with other cleaning agents. If you do, this could cause sediments or other by-products that can clog the windshield wiper nozzles.
- When refilling, do not confuse one type of operating liquid with another! Otherwise serious malfunctions and engine damage can occur!

# Mirrors

## Introduction

---

In this section you'll find information about:

Inside mirror

Outside mirrors

For your driving safety, it is important that you properly adjust the outside mirrors and the inside mirror before you start driving ⇒ .

The outside mirrors and the inside mirror help you see and adapt your driving to traffic behind you. Remember that the inside and outside rearview mirrors will not show everything behind you. There can be blind spots. Blind spots can be significantly larger if the mirrors are not properly adjusted.

### More information:

- Exterior views
- Volkswagen Information System
- Adjusting the seating position
- Shifting gears
- Braking, stopping and parking



### WARNING

Adjusting mirrors when the vehicle is moving can cause driver distraction, accidents, and serious personal injury.

- Always adjust the rearview mirrors when the vehicle is not moving.
- Always be aware of what is happening around the vehicle when changing lanes, passing, turning, or parking. Another vehicle, pedestrian, or object could be in your blind spot.
- Always make sure mirrors are properly adjusted and the view to the rear is not reduced by moisture, ice, snow, or other things.



### WARNING

Auto-dimming mirrors contain an electrolyte fluid which can leak if the mirror glass is broken. Electrolyte fluid can irritate the skin, eyes, and respiratory system.

- Repeated or prolonged exposure to electrolyte fluid can irritate the respiratory system, especially among people with asthma or other respiratory conditions. Get fresh air immediately by leaving the vehicle or, if that is not possible, open windows and doors all the way.
- If electrolyte fluid gets into the eyes, flush them thoroughly with large amounts of clean water for at least 15 minutes; medical attention is recommended.
- If electrolyte fluid contacts skin, flush affected area with clean water for at least 15 minutes and then wash affected area with soap and water; medical attention is recommended. Thoroughly wash affected clothing and shoes before reuse.
- If swallowed, and the person is conscious, rinse mouth with water for at least 15 minutes. Get medical attention immediately. Do not induce vomiting unless instructed to do so by a medical professional.

## NOTICE

Broken glass in the auto-dimming mirrors can cause electrolyte fluid leakage. Liquid electrolyte leaked from a broken mirror glass will damage any plastic surfaces it comes in contact with. Clean up spilled electrolyte fluid immediately with clear water and a sponge.

### Inside mirror

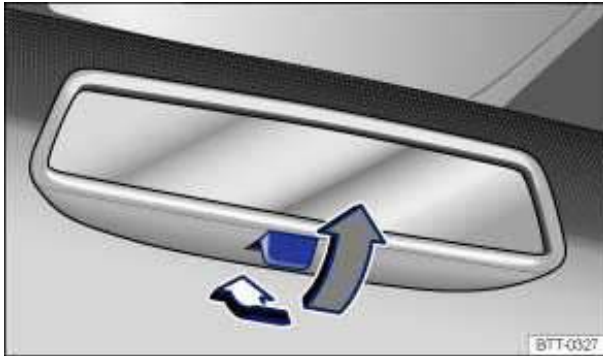

Fig. 84 Manually adjustable inside mirror.

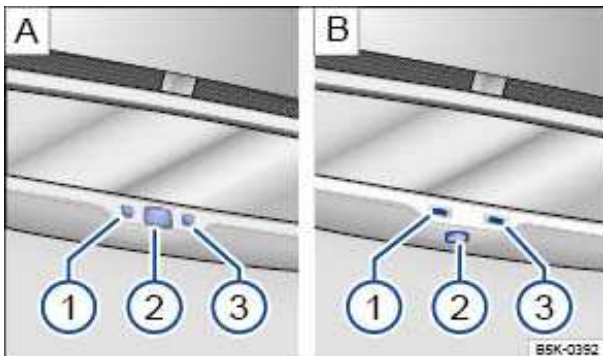

Fig. 85 Auto-dimming inside mirror (if applicable): Version A and Version B.

**⚠ Please first read and note the introductory information and heed the WARNINGS ⚠**

Adjust the inside mirror to make sure that there is good visibility through the rear window.

For example, visibility through the rear window could be impaired if there is a sunshade on the rear window or clothing on the luggage compartment cover, or if the rear window is covered with ice, snow, or dirt.

#### Manually adjustable inside mirror

- Home position: Lever on the bottom edge of the mirror points forward.
- To adjust to non-glare visibility, move the lever so that it points backward ⇒ [fig. 84](#).

#### Auto-dimming inside mirror (if applicable)

Key to [fig. 85](#):

- (1) Indicator light
- (2) Switch
- (3) Sensor for recognizing entry of light



The auto-dimming feature can be switched on and off with the switch on the inside mirror (2) **A** or (2) **B**. When auto-dimming is activated, the indicator light (1) is on.

If the ignition is switched on, the sensor (3) *automatically* darkens the inside mirror depending on the amount of light shining into the vehicle from the rear.

The auto-dimming feature is deactivated when you shift the transmission into reverse or switch on the interior lights or the reading light.

Do not attach external navigation devices to the windshield or in the vicinity of the auto-dimming inside mirror ⇒ ⚠.

## ⚠ WARNING

The illuminated display on an external navigation device can cause the auto-dimming inside mirror to malfunction, which can result in crashes and serious injuries.

- Malfunctions in the auto-dimming function can result in the inside mirror being unable to evaluate the exact distance of vehicles in the rear or other objects.



If the light striking the sensor is filtered or blocked (such as by a sunshade), the auto-dimming inside mirror will not work properly or may not work at all.

## Outside mirrors

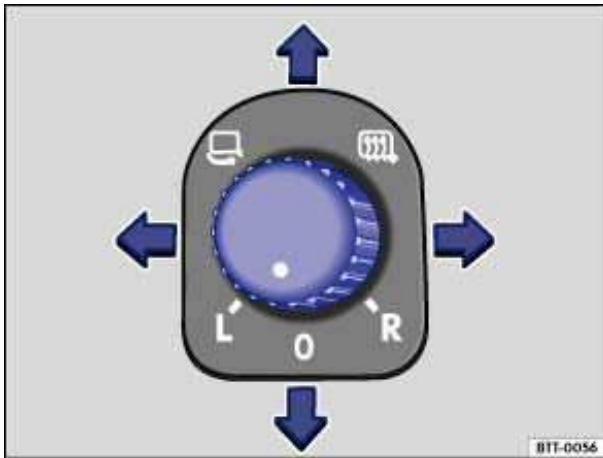

Fig. 86 In the driver door: Adjusting knob for the outside mirrors.

ⓘ Please first read and note the introductory information and heed the WARNINGS ⚠

Turn the knob ⇒ fig. 86 to adjust the outside mirrors.

### Turn the rotary knob to the desired position:



Fold the outside mirror in toward the vehicle body ⇒ ⚠.



Switch on outside mirror heating. Heats only at outside air temperatures below +68 °F (+20 °C).



Adjust the left outside mirror by pressing the knob to left/right and up/down.

### Turn the rotary knob to the desired position:

- |          |   |
|----------|---|
| <b>R</b> | Adjust the right outside mirror by pressing the knob to left/right and up/down. |
| <b>O</b> | Neutral position. Outside mirror folded out, no heating or adjustment possible. |

### Synchronous mirror adjustment

- In the **Settings - Convenience** menu, select **Mirror adjust - Both mirrors** for synchronous outside mirror adjustment
- Turn the adjusting knob to the **L** position.
- Adjust the left outside mirror. The right (passenger) outside mirror will automatically adjust at the same time.
- If needed, correct the position of the right mirror by turning the adjusting knob to the **R** position.

### Auto-dimming outside mirror on the driver side

Some models are equipped with an auto-dimming outside mirror, which is controlled together with the auto-dimming inside mirror

### Memory for front passenger side mirror (when backing up)

On vehicles equipped with memory seats, the passenger side mirror settings for backing up can be stored as follows:

- Choose the remote control vehicle key that will be used with the settings about to be made.
- Unlock the vehicle with that remote control vehicle key.
- Set the electronic parking brake.
- Switch on the ignition.
- Activate the function **Mirror down** in the **Settings - Convenience** menu.
- Shift the transmission into Reverse (**R**).
- Adjust the passenger outside mirror for a clear view of the curb, for example.
- The adjusted mirror position is automatically stored and assigned to the vehicle key used to unlock the vehicle. The preselected position will be recalled when the key assigned to that mirror adjustment position is used again.

### Recalling passenger side mirror settings

- Turn the adjusting knob for the side mirrors to the **R** position.
- Shift the transmission into reverse gear with the ignition switched on.
- The mirror moves back to the regular position when the vehicle moves forward faster than about 10 mph (15 km/h) or the adjusting knob is turned to the **O** or **L** position.



### WARNING

Improper use of the folding outside mirrors can cause personal injury.

- Always make sure that nobody is in the way when folding the mirrors in or out.
- Make sure that you do not get your finger caught between the mirror and the mirror base when moving the mirrors.



## WARNING

Incorrectly estimating distances with the right outside mirror can cause collisions and serious injury.

- The right outside mirror has a convex (curved) surface. This widens your field of vision. But vehicles or other objects seen in a convex mirror will look smaller and farther away than they really are.
- If you use the right outside mirror to judge distances from vehicles behind you when changing lanes, you could estimate incorrectly and cause a crash and serious injuries.
- Whenever possible, use the inside mirror to more accurately judge distance and size of vehicles or other objects seen in the convex mirror.
- Always make sure you have a clear view to the rear of the vehicle.



## NOTICE

Always fold in the outside mirrors when taking the vehicle through an automatic car wash.

- Never fold power mirrors in manually because doing so could damage the electrical drive.



To reduce fuel consumption, use outside mirror heating only when needed.



When first switched on, outside mirror heating works with maximum heat for about 2 minutes.



If power mirror adjustment does not work, the outside mirrors can be adjusted by hand by pressing on the edges of the mirror surface.

# Driving tips

## Introduction

---

In this section you'll find information about:

Stowing luggage

Driving with an open luggage compartment lid

Driving a loaded vehicle

Weights and axle weights

Always stow heavy objects in the luggage compartment and make sure that the rear seat backrests are securely latched. Always use the tie-downs in the luggage compartment and secure the objects with suitable straps. Never overload the vehicle. Remember that the vehicle load, as well as how it is distributed, can affect vehicle handling and braking ⇒ .

### More information:

- Luggage compartment lid
- Folding the passenger seat backrest forward
- Lights
- Luggage compartment
- Roof rack
- Trailer towing
- Tires and wheels



### WARNING

Unsecured or incorrectly stowed items can fly through the vehicle, causing serious personal injury during hard braking or sharp steering or in an accident. Loose items can also be struck and thrown through the passenger compartment by the front airbags if they inflate. To help reduce the risk of serious personal injury:

- Always stow all objects securely in the vehicle.
- Always keep storage compartments closed while driving.
- Do not stow hard, heavy, or sharp objects in open bins in the vehicle or on top of the instrument panel.
- Remove hard, heavy, and sharp objects from clothing and bags in the vehicle interior and stow securely. Always put heavy items in the luggage compartment.
- Always secure objects in the passenger compartment properly with suitable straps so that they cannot move into the deployment area of a side or front airbag during braking, in a sudden maneuver, or in a collision.
- Always make sure that there is nothing on the front passenger seat when the backrest is folded forward. When the backrest is folded forward, even light objects could be pushed into the seat cushion and cause the weight-sensing mat in the seat to register enough weight to turn the airbag on.
- Always make sure that the PASSENGER AIR BAG OFF light is on and stays on whenever the backrest of the front passenger seat is folded forward 80.
- Passengers must never ride in an incorrect seating position because objects are being transported in the vehicle.
- Never let anybody sit in a seat that is blocked by objects being carried in the vehicle.



## WARNING

Heavy loads will influence the way your vehicle handles and increase stopping distances. Heavy loads that are not properly stowed or secured can cause loss of control and serious injury.

- Secure the load properly to keep it from shifting.
- Always remember when transporting heavy objects that a change in the center of gravity also changes the way your vehicle handles:
  - Always distribute the load as evenly as possible.
  - Secure heavy objects properly as far forward in the luggage compartment as possible.
  - Always tie down heavy items securely with suitable straps using the tie-downs in the luggage compartment.
- Securely latch the rear seat backrest in the upright position.
- Never exceed the Gross Axle Weight Rating or the Gross Vehicle Weight Rating on the safety compliance sticker on the left door jamb. Exceeding permissible weight can cause the vehicle to skid and handle differently.
- Always adapt your speed and driving to the heavier load and the weight distribution in the vehicle. Take road, weather, traffic, and visibility conditions into account as well.
- Always accelerate gently and avoid sudden braking and driving maneuvers.
- Always brake earlier than you would if you were not driving a loaded vehicle.

## Stowing luggage

☐ Please first read and note the introductory information and heed the WARNINGS

### Always stow all luggage securely in the vehicle

- Distribute the load in the vehicle, on the roof, and in the trailer as evenly as possible.
- Put heavy objects as far forward as possible in the luggage compartment and securely latch the rear seat backrest in the upright position.
- Secure luggage in the luggage compartment to the tie-downs with suitable straps
- Have the headlight range adjusted, if necessary
- Check the pressure in all 4 tires when the tires are still cold. Never reduce air pressure in warm tires to match cold tire inflation pressure. Heed the information on the tire pressure label
- Pay especially close attention to your vehicle's Tire Pressure Monitoring System when driving with a heavy load



## NOTICE

The defroster heating wires or antenna in the rear window can be damaged by objects that rub against them.



Please review the information on loading a trailer and a roof rack

## Driving with an open luggage compartment lid

☐ Please first read and note the introductory information and heed the WARNINGS

Driving with an open luggage compartment lid can lead to serious personal injury. If you have to drive with an open luggage compartment lid, make sure that all objects and the lid itself are properly secured and take appropriate measures to keep toxic exhaust fumes from entering the vehicle.

### **WARNING**

Driving with an unlatched or open luggage compartment lid can lead to serious personal injury.

- Never transport objects larger than those that fit completely in the luggage compartment, because the luggage compartment lid cannot be fully closed properly.
- After closing the lid, always pull up on it to make sure that it is properly closed and cannot open suddenly when the vehicle is moving.
- Always stow all objects securely in the luggage compartment. Loose objects can fall out of the luggage compartment and injure others on the road behind you.
- Drive carefully; anticipate what other drivers will do.
- Avoid abrupt or sudden acceleration, steering, or braking, because the unlatched luggage compartment lid can move suddenly.
- Always mark objects sticking out from the luggage compartment clearly for others to see. Obey all applicable legal requirements.
- Never use the luggage compartment lid to “clamp” or “hold” objects that stick out of the luggage compartment.
- Always remove any luggage rack or other rack mounted on the luggage compartment lid (along with any luggage on the rack) before driving with an open luggage compartment lid.

### **WARNING**

Driving with an open luggage compartment lid can cause poisonous carbon monoxide in the engine exhaust to get into the passenger compartment.

- Carbon monoxide causes drowsiness, inattentiveness, poisoning, and loss of consciousness. It can lead to accidents and severe personal injuries.
- Always keep the luggage compartment lid closed while driving to help keep poisonous exhaust fumes from being drawn into the vehicle.
- Never transport objects that are too large to fit completely into the luggage area, because then the luggage compartment lid cannot be fully closed.
- If you absolutely must drive with an open luggage compartment lid, do the following to reduce the risk of carbon monoxide poisoning:
  - Close all windows and the power sunroof.
  - Switch off the climate control system's air recirculation feature.
  - Open all air vents in the instrument panel.
  - Set the fresh air fan to the highest speed.

### **NOTICE**

The open luggage compartment lid changes the vehicle height.

## Driving a loaded vehicle

 Please first read and note the introductory information and heed the WARNINGS 

For good handling when driving a loaded vehicle, please observe the following:

- Securely stow all luggage
- Drive especially carefully and accelerate gently.
- Avoid sudden braking and driving maneuvers.
- Brake earlier than you would if you were not driving a loaded vehicle.
- If applicable, observe information about driving with a trailer
- If applicable, observe information about driving with a roof rack



## WARNING

**Heavy loads can change the way your vehicle handles and increase stopping distances. Heavy loads that are not properly stowed or secured can shift suddenly, causing loss of control and serious injury.**

- **Secure the load properly to keep it from shifting.**
- **Always remember when transporting heavy objects that they change the vehicle's center of gravity and also the way it handles.**
  - Always distribute the load as evenly as possible.
  - Secure heavy objects as far forward in the luggage compartment as possible.
  - Use your vehicle's luggage compartment tie-downs with suitable straps.
- **Always tie down heavy items securely with suitable straps.**
- **Securely latch the rear seat backrest in the upright position.**
- **Never exceed the Gross Axle Weight Rating or the Gross Vehicle Weight Rating on the safety compliance sticker on the left door jamb. Exceeding permissible weight can cause the vehicle to skid and handle differently.**
- **Always adapt speed and driving to the heavier load and the weight distribution in the vehicle. Take road, weather, traffic, and visibility conditions into account as well.**
- **Always accelerate gently and avoid sudden braking and driving maneuvers.**
- **Always brake earlier than you would if you were not driving a loaded vehicle.**

## Weights and axle weights

❏ Please first read and note the introductory information and heed the **WARNINGS**

The actual gross weight of any vehicle depends on the engine, basic equipment, any factory-installed optional equipment for the given model, and any accessories that have been installed. The Gross Vehicle Weight Rating (GVWR) and the Gross front and Rear Axle Weight Ratings (GAWR) for a given vehicle are printed on the vehicle's Safety Compliance Certification Label on the driver door jamb.

The **Gross Vehicle Weight Rating** includes the weight of the vehicle itself with all of its factory-installed equipment, plus a full tank of gasoline, the engine oil and coolant, all vehicle occupants (150 lbs/68 kg per seating position) and cargo.

The **Gross Axle Weight Ratings** specify the maximum allowable load for each axle.

The cargo payload may not be increased by using a roof rack without commensurately reducing the weight from vehicle occupants ⇒ . Determining the Gross Vehicle Weight Rating 270, *Tires and wheels*.

Vehicle payload consists of the combined weight of the following:

- Passengers.
- Total luggage and other cargo.

- Roof load including the roof rack system.
- Factory-installed or retrofitted accessories.
- Hitch weight and tongue weight for trailer towing.

Please refer to the Gross Vehicle Weight Rating (GVWR) and the Gross front and rear Axle Weight Ratings (GAWR) for your vehicle, which are printed on the vehicle's Safety Compliance Certification Label on the driver door jamb.



## **WARNING**

**Exceeding maximum permissible weight ratings can result in vehicle damage, accidents, and serious personal injury.**

- **Never let the actual weights at the front and rear axles exceed the permissible Gross Axle Weight Rating. Also, never let the total of these actual weights exceed the Gross Vehicle Weight Rating.**
- **Always remember that the vehicle's handling and braking will be affected by extra load and the distribution of this load. Adjust your speed accordingly.**



## **NOTICE**

- **Always distribute the load evenly and as low as possible in the vehicle. The vehicle capacity weight figures apply when the load is distributed evenly in the vehicle (passengers and luggage).**
- **When transporting a heavy load in the luggage compartment, carry the load as close to the rear axle (as far forward) as possible so that the vehicle's handling and braking are affected as little as possible.**



# Luggage compartment

## Introduction

---

In this section you'll find information about:

Folding the rear seat backrest forward and back into place

Luggage compartment pass-through

Tie-downs

Shopping bag hooks

Luggage net

Always stow heavy objects in the luggage compartment and make sure that the rear seat backrests are securely latched in their upright position. Always secure objects to the tie-downs with suitable straps. Never overload the vehicle. Remember that the vehicle load, as well as how it is distributed, can affect vehicle handling and braking ⇒ .

### More information:

- Airbag system
- Lights
- Transporting
- Trailer towing
- Tires and wheels



### WARNING

**An open or unlocked luggage compartment poses special risks for children.**

- **Close and lock the luggage compartment lid and all doors when the vehicle is not in use. First, make certain that no one is left inside.**
- **Never leave your vehicle unattended or let children play around the vehicle, especially with the luggage compartment lid left open. A child could crawl into the vehicle and pull the lid shut, becoming trapped and unable to get out. This could cause severe or fatal injuries.**
- **A closed vehicle can become very hot or very cold, depending on the season. Temperatures can quickly reach levels that can cause unconsciousness or death, particularly to small children.**
- **Never let children play in or around the vehicle.**
- **Never let anyone ride in the luggage compartment.**



## WARNING

Unsecured or incorrectly stowed items can fly through the vehicle, causing serious personal injury during hard braking or sharp steering or in an accident. Loose items can also be struck and thrown through the passenger compartment by the front airbags if they inflate. To help reduce the risk of serious personal injury:

- Always stow all objects securely in the vehicle. Always put luggage and heavy items in the luggage compartment.
- Always secure objects in the passenger compartment properly with suitable straps so that they cannot move into the deployment zone of a side or front airbag during sudden braking, in a sudden maneuver, or in a collision.
- Always keep storage compartments closed while driving.
- Never stow hard, heavy, or sharp objects in the vehicle's open storage compartments, on the shelf behind the rear seat bench, or on the top of the instrument panel.
- Always remove hard, heavy, or sharp objects from clothing and bags in the vehicle interior and stow them securely in the luggage compartment.



## WARNING

Transporting heavy objects causes the handling characteristics of the vehicle to change and increases braking distances. Heavy loads which are not properly stowed or secured in the vehicle can lead to a loss of vehicle control and cause serious personal injury.

- Transporting heavy items causes the handling characteristics of the vehicle to change by shifting the vehicle's center of gravity.
- Always distribute luggage evenly and as low as possible within the vehicle. The vehicle capacity weight figures apply when the load is distributed evenly in the vehicle (passengers and luggage).
- Always stow luggage and heavy items in the luggage compartment as far forward of the rear axle as possible and secure them with appropriate straps to the tie-downs provided.
- Never exceed the vehicle's Gross Vehicle Weight Rating or Gross Axle Weight Ratings, which are printed on the Safety Compliance Certification Label located on the door jamb of the driver door. Exceeding the permissible weight can cause the vehicle to skid and behave differently.
- Always adapt your speed and driving style to accommodate your payload and its weight distribution within your vehicle.
- Be especially cautious and gentle when stepping on the accelerator pedal and avoid sudden braking and other maneuvers.
- Brake earlier than you would if you were not driving a loaded vehicle.



## NOTICE

The defroster heating wires or antenna in the rear window can be damaged by objects that rub against them.



The ventilation slots between the rear window and the shelf behind the rear seat backrest must not be blocked so that stale air can escape from the vehicle.

## Folding the rear seat backrest forward and back into place

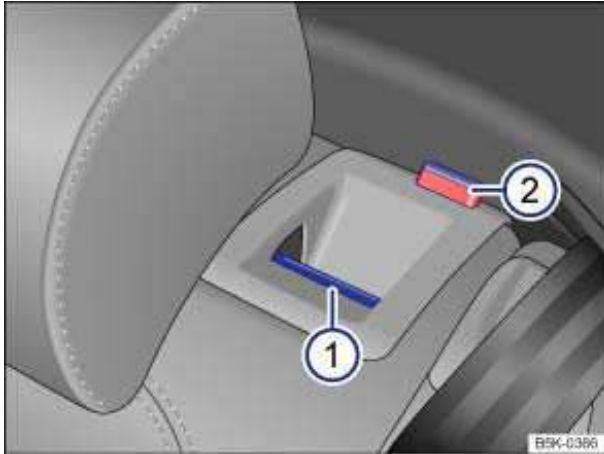

Fig. 87 Rear seat backrest: Release button 1; red mark 2.

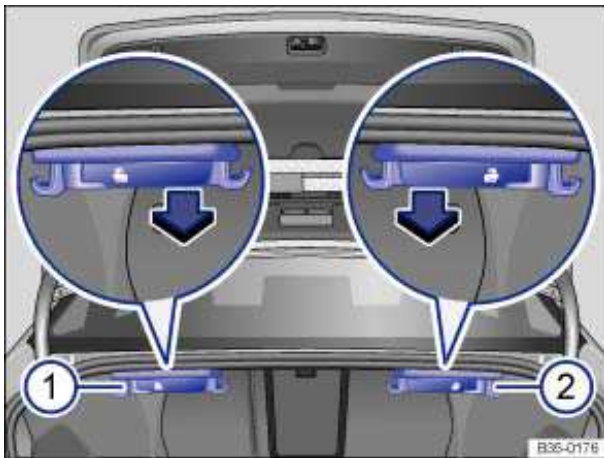

Fig. 88 In the luggage compartment: Release lever for the left 1 and right 2 sections of the rear seat backrest.

**⚠ Please first read and note the introductory information and heed the WARNINGS ⚠**

The rear seat backrest is divided into 2 sections. Each section of the rear seat backrest can be folded down individually to increase luggage space.

### Folding the rear seat backrest forward with the release button

- Push the head restraint all the way down
- Pull the release button ⇒ [fig. 87 \(1\)](#) forward while folding the rear seat backrest forward.
- The rear seat backrest is unlocked when the red mark on the button ([2](#)) is visible.
- The rear seat backrest is released and can be folded forward.
- If the rear backrest is folded down, no one, including children, may ride on the rear seat.

### Folding the rear seat backrest forward with the release lever in the luggage compartment

- Push the head restraint all the way down
- Open the luggage compartment lid
- Pull the remote release lever for the left ⇒ [fig. 88 \(1\)](#) or right ([2](#)) rear seat backrest in the direction of the arrow. The unlocked section of the rear seat folds forward automatically.
- Close the luggage compartment lid, if necessary

- The rear seat backrest is unlocked when the red mark on the button ⇒ [fig. 87 \(2\)](#) is visible.
- If the rear backrest is folded down, no one, including children, may ride on the rear seat.

### Folding the rear seat backrest back into place

- Fold the rear seat backrest back until it engages securely ⇒ .
- The red mark on the release button [\(2\)](#) should no longer be visible.
- The rear seat backrest must be securely latched into place in order for the safety belts on the rear seats to provide optimal protection.



### WARNING

Improper folding and improper latching of the rear seat backrest can cause serious personal injury.

- Always make sure there are no people or animals in the area around the rear seat backrest when folding it forward.
- Never fold the rear seat backrest forward or back while the vehicle is moving.
- When folding the rear seat backrest back up, make sure that the safety belt does not get caught or damaged.
- Keep hands, fingers, feet and other body parts out of the way when folding the rear seat backrest forward or back.
- Each rear seat backrest must be securely latched in the upright position so that the safety belts on the rear seats can provide protection. This is particularly the case for the middle seat on the rear seat bench.
- If a seat is used with an unsecured backrest, the passenger will move forward together with the rear seat backrest during sudden braking, driving maneuvers, or in a collision.
- If the red marking on the button [\(2\)](#) is visible, this indicates that the backrest is not latched into place. Always check to make sure that the red marking is not visible whenever the rear seat backrest is in the upright position.
- No one, including children, may ride on the rear seats if the rear seat backrest is folded down or not correctly latched.



### NOTICE

Before folding the rear seat backrest forward, adjust the front seats so that the rear seat's head restraint or backrest cushion will not touch the front seats.

## Luggage compartment pass-through

---

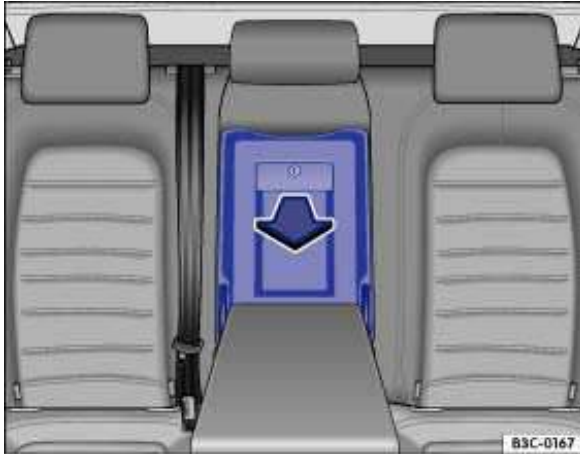

Fig. 89 In the rear seat backrest: Opening the luggage compartment pass-through.

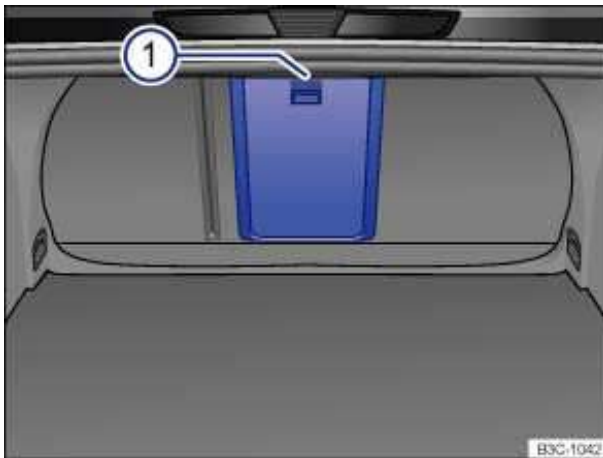

Fig. 90 In luggage compartment: Release lever with marking 1.

**⚠ Please first read and note the introductory information and heed the WARNINGS ⚠**

There is a pass-through for transporting things like skis in the rear seat backrest behind the center armrest.

To help prevent soiling the vehicle interior, cover dirty items before sliding them into the pass-through.

If the center armrest is folded down, no one can sit on the middle seat of the rear bench.

### Opening the pass-through

- Fold down the rear center armrest
- If the pass-through is equipped with a lock, use the emergency key to unlock the luggage compartment pass-through.
- Pull the release lever ⇒ [fig. 89](#) and fold the pass-through cover all the way forward.
- Open the luggage compartment lid.
- Slide long objects from the luggage compartment through the pass-through.
- Secure objects with the safety belt.
- Close the luggage compartment lid.

## Closing the pass-through

- Fold the pass-through cover back until it engages securely. The red marking on the luggage compartment side ⇒ [fig. 90 \(1\)](#) should not be visible.
- Close the luggage compartment lid.
- If the pass-through is equipped with a lock, use the emergency key to lock the luggage compartment pass-through.
- If necessary, fold the center armrest up.



The pass-through can also be opened from the luggage compartment. Press the release lever (1) down and push the cover forward.

## Tie-downs

---



**Fig. 91** In the luggage compartment: Tie-downs.

**ⓘ Please first read and note the introductory information and heed the WARNINGS ⚠**

There are tie-downs in the front and rear of the luggage compartment, which you can use to secure luggage or other items ⇒ [fig. 91](#) (arrows).

Some tie-downs may have to be folded open for use.

Elastic straps can snap back toward you if they are not properly attached ⇒ ⚠.

If you use elastic straps to secure items in the luggage compartment, be sure to first securely attach them to the tie-downs just behind the rear seat backrest first and then to the tie-downs at the loading edge of the luggage compartment.

Remove the hooks from the tie-downs in the reverse order described above, first from the tie-downs at the loading edge and then from the tie-downs behind the rear seat backrest so that if the hooks come loose suddenly, they will move away from you.



## WARNING

Unsuitable, worn, or damaged tie-down straps (elastic or non-elastic) can snap or come loose during braking or other maneuvers or in a collision. Objects secured with these straps can then come loose and fly through the passenger compartment, causing severe personal injuries or death.

- To help prevent baggage or other items from coming loose and flying around, always use suitable undamaged tie-down straps.
- Securely fasten the tie-down straps to the tie-downs.
- Loose or improperly secured objects in the luggage compartment can slide about suddenly and change the vehicle's handling.
- Secure even small and light objects. Loose objects in the luggage or passenger compartment can fly about during sudden braking maneuvers or in the event of an accident and injure occupants.
- Never exceed the maximum allowable load on the tie-downs when securing objects.
- Never secure a child seat to the tie-downs.



## WARNING

Elastic straps have to be stretched when being attached to the tie-downs in the luggage compartment. Hooks on these straps can cause serious personal injury if not handled properly and attached securely.

- Always protect eyes and face from injury from the hooks when attaching them to the tie-downs in the luggage compartment.
- Always hold the hooks on elastic straps firmly when attaching to the vehicle and do not let them snap back and hit you.
- First attach the hooks on the straps to the tie-downs at the rear seat backrest in the luggage compartment and then to the tie-downs near the loading edge of the luggage compartment. This way, if one of the hooks on the elastic straps snaps back, it will move away from you, decreasing the risk of personal injury.



The maximum load for the tie-downs is about 785 lbs. (356 kg).



For suitable straps and luggage stowage systems, please see an authorized Volkswagen dealer or authorized Volkswagen Service Facility.

## Shopping bag hooks

---

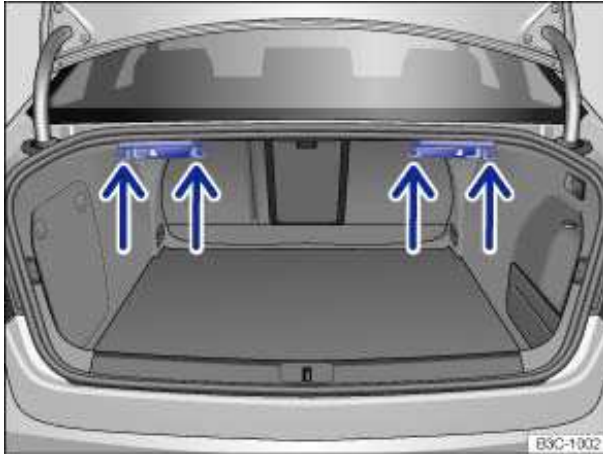

**Fig. 92** In the luggage compartment: Shopping bag hooks.

⚠ Please first read and note the introductory information and heed the **WARNINGS** ⚠

### Shopping bag hooks

The shopping bag hooks in the upper right and left areas of the luggage compartment can be used for conveniently holding light shopping bags.

- Hang the bags on the shopping bag hooks as shown in ⇒ [fig. 92](#) (arrow).

### **⚠ WARNING**

**Never use the shopping bag hooks as tie-downs. The hooks could break off during sudden braking maneuvers or in a collision.**

### **ⓘ NOTICE**

**The maximum load for each shopping bag hook is 5 lbs. (2.5 kg).**



## Luggage net

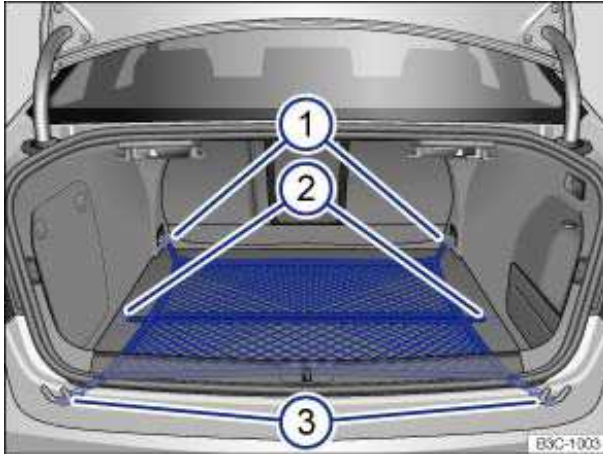

Fig. 93 In the luggage compartment: Luggage net hung horizontally.

❏ Please first read and note the introductory information and heed the WARNINGS ⚠

The luggage net helps prevent lighter luggage from shifting. The luggage net also has a built-in zippered pocket that can hold smaller items.

There are several ways to install the luggage net in the luggage compartment.

### Securing the luggage net flat on the luggage compartment floor

- First, secure the luggage net hooks ⇒ fig. 93 (1) to the tie-downs on the rear seat backrest (1) ⇒ ⚠. The luggage net zipper must face upwards.
- Then secure the luggage net hooks (3) to the tie-downs on the loading edge (3) of the luggage compartment.

### Removing the luggage net

The installed luggage net is stretched tight ⇒ ⚠.

- Remove the hooks and loops of the luggage net from the tie-downs in the reverse order described above so that if the hooks come loose suddenly, they will move away from you.
- Stow the luggage net in the luggage compartment.

## ⚠ WARNING

The elastic luggage net has to be stretched when being attached to the tie-downs in the luggage compartment. The metal hooks can cause serious personal injury if not handled properly and attached securely.

- Always hold the hooks on the luggage net bag firmly when attaching to the vehicle and do not let them spring back and hit you.
- Always protect eyes and face from injury from the metal hooks when attaching them to the tie-downs in the luggage compartment.
- First attach the luggage net hooks to the tie-downs on the rear seat backrest in the luggage compartment and then to the tie-downs near the loading edge of the luggage compartment. If one of the hooks on the luggage bag net snaps back, it will move away from you and towards you, increasing the risk of injury.

# Roof rack

## Introduction

---

In this section you'll find information about:

Securing a load on the roof rack

The roof of your vehicle has been designed to optimize aerodynamics and does not have traditional rain gutters that are used to attach many kinds of roof racks.

Since the rain gutters are molded into the roof to provide efficient aerodynamics, only Volkswagen-approved base carrier mounts and roof racks can be used.

### When should the roof rack be removed?

- When it is no longer needed.
- Before driving through an automatic car wash.
- When the vehicle would otherwise be too high for minimum clearance to enter, for example, a garage.

### More information:

- Lights
- Transporting
- Saving fuel and helping the environment
- Tires and wheels
- Parts, accessories, repairs and modifications



### WARNING

Transporting heavy or bulky loads on the roof rack will change the way the vehicle handles by shifting the vehicle's center of gravity and increasing the wind drag.

- Always secure the load properly with suitable and undamaged straps so that the load will not shift.
- Cargo that is large, heavy, bulky, long or flat will have a negative effect on the vehicle's aerodynamics, center of gravity and overall handling.
- Always avoid sudden maneuvers and hard braking.
- Always adapt your speed and driving to the heavier load and the weight distribution in the vehicle. Take road, weather, traffic, and visibility conditions into account as well.



### NOTICE

- Always remove the roof rack before driving through an automatic car wash.
- Your vehicle is higher when the roof rack is installed, especially when it is loaded. Compare the vehicle height with existing clearance heights, such as underpasses and garage doors.
- Always make sure that the roof rack system and anything being carried on it does not interfere with the roof antenna, the power sunroof or the luggage compartment lid.
- Make sure that the luggage compartment lid does not touch items on the roof rack when opened.



If a roof rack is installed, fuel consumption increases due to increased air resistance.

## Securing a load on the roof rack

---

❏ Please first read and note the introductory information and heed the WARNINGS ⚠

It is not possible to secure a load unless the roof rack system has been properly installed ⇒ ⚠.

### Maximum permissible roof load

The maximum permissible roof load is **220 lbs. (100 kg)**. The roof load is the combined weight of the roof rack and the items being carried on the roof ⇒ ⚠.

Be sure you know the weight of the roof rack and the items you want to transport on the roof. Weigh them if necessary. Never carry a total of more than the maximum permissible roof load.

When using a roof rack with a lower load limit, do not load the rack to the maximum weight mentioned above. In this case, you may only load the roof rack to the weight limit specified in the system's installation instructions.

### Distributing the load

Distribute the load evenly and secure it properly ⇒ ⚠.

### Checking the mountings

After the base carrier and roof rack have been installed, check all bolts and fasteners after driving a short time and at regular intervals thereafter.

#### **WARNING**

If the maximum permissible roof load is exceeded, accidents and substantial vehicle damage may occur.

- Never exceed the specified roof load, the maximum Gross Axle Weight Rating, or the Gross Vehicle Weight Rating.
- Do not exceed the loading capacity of the roof rack, even if the permissible roof load is not fully utilized.
- Always make sure that loads are evenly distributed and that heavier items are, as far as possible, toward the front.

#### **WARNING**

Loose or improperly secured items can fall off the roof rack and cause accidents and injuries.

- Always use suitable, undamaged tie-down ropes and ratchet straps.
- Secure the load properly.

# Trailer towing

## Introduction

---

In this section you'll find information about:

- Technical requirements
- Hitching up and connecting a trailer
- Loading the trailer
- Driving with a trailer
- Ball mount
- Retrofitting a trailer hitch
- Maximum permissible trailer weight

Obey country-specific requirements about trailer towing and trailer hitches.

Volkswagen does not recommend installing a trailer hitch on your vehicle. Your Volkswagen was mainly designed for carrying passengers. If you plan to tow a trailer, please remember your vehicle will be performing a job for which it was not primarily intended. The additional load will affect durability, handling, fuel economy, and performance, and may require the vehicle to be serviced more often.

Trailer towing not only places more stress on the vehicle, it calls for more concentration from the driver. Always follow the operating and driving instructions given, and use common sense.

Under winter conditions, install winter tires on the vehicle **and** the trailer.

### Tongue weight

The *maximum* permissible trailer tongue weight exerted on the ball mount should not exceed **200 lbs (91 kg)**.

### More information:

- Power locking and closing system
- Anti-theft alarm system
- Lights and vision
- Braking, stopping, and parking
- Saving fuel and helping the environment
- Starting assistance systems
- Tires and wheels
- Parts, accessories, repairs and modifications



### WARNING

Riding in a trailer is dangerous and may be illegal.



## WARNING

Improper use of the trailer hitch can cause accidents and injuries. An improperly installed, incorrect, or damaged trailer hitch can cause the trailer to separate from the towing vehicle and cause serious personal injuries.

- Only use an undamaged, properly mounted trailer hitch.
- Never repair or modify the trailer hitch.
- To reduce the risk of injury in rear-end collisions, and the risk to pedestrians and cyclists when the vehicle is parked, always remove the ball mount when you are not towing a trailer.
- Never install a “weight distributing” or “load equalizing” trailer hitch on your vehicle. The vehicle was not designed for these kinds of trailer hitches. The trailer hitch attachment can fail, causing the trailer to tear loose from the vehicle.



## WARNING

Improper trailer towing can cause loss of vehicle control and serious personal injury.

- Driving with a trailer and carrying heavy or large things can change the way the vehicle handles, increase the distance it needs to stop safely, and cause accidents.
- Always secure the load properly with suitable and undamaged straps so that the load will not shift.
- Always adapt your speed and driving to the heavier load and the weight distribution in the vehicle. Take road, weather, traffic, and visibility conditions into account as well.
- Reduce your speed even more than you otherwise would when going downhill and under unfavorable load, weather, or wind conditions.
- Trailers with a high center of gravity tip more easily than trailers with a low center of gravity.
- Always avoid sudden maneuvers and hard braking.
- Be especially careful when passing other vehicles.
- Reduce speed immediately if the trailer shows the slightest sign of swaying.
- Never try to stop the swaying by accelerating.
- Always obey speed limits. In some areas, the speed limits for vehicles towing trailers are lower than for vehicles without trailers. Never drive faster than 50 mph (80 km/h; under exceptional circumstances 60 mph - 100 km/h) when towing a trailer. This applies even if the local speed limit is higher.



If you are driving a new vehicle or a vehicle with a new or rebuilt engine, do not tow a trailer during the break-in period, about 600 miles (1000 km)



If you tow a trailer, your vehicle may need maintenance more often because of the extra load it has to move.



When you are not towing, remove the trailer hitch ball. This helps keep the trailer hitch from causing damage to your vehicle and to others if your vehicle is hit from behind.



Some models need a trailer hitch to tow or tow-start other vehicles. You may want to always carry the ball mount in the vehicle after it has been removed. Be sure to stow it securely.

## Technical requirements

---

ⓘ Please first read and note the introductory information and heed the WARNINGS ⚠ 144.

Use only a weight-carrying trailer hitch designed and approved for the gross weight of the trailer you want to tow. The trailer hitch must be suitable for your vehicle and trailer and must be securely bolted to the appropriate place on the vehicle chassis. Use only a trailer hitch with a removable ball mount. Always check with the trailer hitch manufacturer to make sure that you are using the correct trailer hitch and carefully follow the hitch manufacturer's instructions. Never install a "weight-distributing" or "load-equalizing" trailer hitch on your vehicle. The vehicle is not designed for this kind of trailer hitch ⇒ ⚠.

### Do not use a bumper-mounted trailer hitch

Never install a trailer hitch on the bumper or on the bumper attachments. The trailer hitch must not interfere with the impact-absorbing bumper system. Do not make any changes to the vehicle exhaust and brake systems. From time to time, check that all trailer hitch mounting bolts are securely fastened. When you are not towing, remove the trailer hitch. This helps keep the trailer hitch from causing damage if your vehicle is hit from behind.

### Engine cooling system

Towing a trailer makes the engine and its cooling system work harder. It is important that the engine cooling system is up to the job. Make sure that the cooling system has enough coolant.

### Trailer brakes

If your trailer has its own brakes, make sure it meets all regulations. The trailer brake system must never be directly connected to the vehicle's brake system.

### Safety chains

Always use safety chains between your vehicle and the trailer .

### Trailer taillights

Trailer lights must meet all regulations

Never connect the trailer lights directly to the electrical system of your vehicle.

### Outside mirrors

If you cannot see the traffic behind you using the regular outside mirrors, then you must install extended mirrors. Extended mirrors may also be required by law in some countries/states/provinces. Always adjust the outside mirrors before driving. It's vital that you always have a clear view to the rear of the vehicle.

### Maximum power consumption for the trailer

Do not exceed the power ratings listed in the chart below.

Electrical load	Maximum power
Brake lights total	108 watts
Turn signals per side	54 watts
Side marker lights total	100 watts
Taillights total	54 watts



## WARNING

- An improperly installed or incorrect trailer hitch can cause a trailer to separate from the tow vehicle and cause serious personal injuries.
- If you don't have to tow a trailer any more, remove the entire trailer hitch. Always seal all bolt holes to prevent water and deadly exhaust fumes from getting into the vehicle.



## NOTICE

- If the trailer lights are not connected properly, the vehicle's electronics may be damaged.
- If the trailer uses too much electricity, the vehicle's electronics may be damaged.
- Never connect the electrical system for the trailer directly to the electrical connections for the rear lights or to any other unsuitable power sources. Use only a suitable connector to provide power to the trailer.



If you tow a trailer frequently, Volkswagen recommends having the vehicle serviced between the regular maintenance and inspection intervals because of the extra load it has to pull.

## Hitching up and connecting a trailer

---

❏ Please first read and note the introductory information and heed the WARNINGS

### Safety chains

Always make sure that the safety chains are properly attached to the towing vehicle. Leave enough slack in the chains so that you can go around corners without stretching the chains. The safety chains must not drag on the ground, however.

### Trailer taillights

Make sure that the trailer lights work properly and meet legal requirements. Do not exceed the maximum power consumption for the trailer



## WARNING

Improper connections to the vehicle electrical system can cause malfunctions that affect the entire vehicle electrical system, which can lead to accidents and serious personal injury.

- Have any work on the electrical system done by an authorized Volkswagen dealer or authorized Volkswagen Service Facility.
- Never connect the electrical system for the trailer directly to the electrical connections for the rear lights or to any other unsuitable power sources. Use only a suitable connector to provide power to the trailer.



## NOTICE

Never attach a trailer to the vehicle or leave it attached to the vehicle when the trailer is supported by a trailer jack or blocks. Various things (such as a change in trailer or vehicle load or a flat tire) can lower or raise the vehicle. This subjects the trailer hitch and the trailer to strong forces that can damage the vehicle or the trailer.



If the engine is switched off and accessories in the trailer are on and use electricity from the vehicle, the vehicle battery will be drained as long as the electrical systems of the vehicle and the trailer are connected.

## Loading the trailer

---

**Please first read and note the introductory information and heed the WARNINGS**

### Maximum permissible trailer weight and tongue weight

Maximum permissible trailer weight is the load that the vehicle can tow ⇒ . The tongue load or tongue weight is the load pressing down on the trailer hitch ball mount.

The maximum permissible trailer weight and tongue weight for your vehicle is listed in this Manual.

The trailer load and tongue weight on the type identification plate for the trailer hitch are only test values. The vehicle-specific figures are often *lower than* these values. In some countries, but generally not in the United States, the vehicle-specific figures are listed in the official vehicle documents. Specifications in official vehicle documents always take precedence.

To help ensure optimum handling and driving safety, Volkswagen recommends always using the maximum permissible **tongue weight**. If the tongue weight is too low, the vehicle and trailer will not handle as well.

Tongue weight increases the load on the rear axle and, in turn, reduces the remaining load your vehicle can carry, *Determining the correct load limit*.

### Combined towing weight

Combined towing weight is the weight of the loaded towing vehicle plus the weight of the loaded trailer.

This vehicle has not been designed to tow a Class III trailer and must never be retrofitted to tow a Class III trailer. Always make sure that your vehicle has been designed to tow the trailer you want to use and that it is legal to tow the trailer where you will be driving.

### Loading the trailer

The weight distribution in the vehicle and trailer must be balanced. Use the maximum permissible tongue weight and make sure that the load in the trailer is evenly distributed and that it is not front-heavy or tail-heavy:

- Distribute the load in the trailer so that heavy objects are directly above the axle or as close as possible to the axle.
- Secure loads properly on the trailer.

### Tire pressure

Always follow the trailer manufacturer's tire pressure recommendations for the trailer tires.

When towing, inflate the towing vehicle's tires to the maximum permissible pressure listed on the tire pressure label



### WARNING

**Exceeding the gross weight ratings for axle, tongue, vehicle, trailer or combined weight can cause accidents and serious personal injury.**

- **Never exceed the specified values.**
- **Never let the actual weights at the front and rear axles exceed the Gross Axle Weight Rating. Never let the combined front and rear weights exceed the Gross Vehicle Weight Rating.**





## WARNING

Trailer loads that are not properly secured can shift when the vehicle is moving or braking and suddenly change the way the vehicle handles, causing accidents and severe injuries.

- Always load the trailer properly.
- Always secure the load properly with suitable, undamaged straps that can be tightened so that the load cannot shift.

## Driving with a trailer

---

☞ Please first read and note the introductory information and heed the WARNINGS

### Headlight settings

Towing a trailer can raise the front end of the vehicle enough for the low beams to blind other road users. If your vehicle does not have headlight range adjustment, have the headlights adjusted by an authorized Volkswagen dealer or authorized Volkswagen Service Facility. Vehicles with Xenon headlights self-adjust to vehicle load and do not need manual adjustment.

### Special towing considerations

- If the trailer has an **overrun brake**, apply the brakes *gently at first* and then firmly. This helps to prevent sudden brake shock and helps prevent trailer wheels from locking up.
- Due to the combined towing weight including the higher gross vehicle weight, the stopping distance is longer.
- Before driving downhill, especially on hills that are long or steep, shift into a lower gear (manual or automatic transmission) so that the engine helps to brake the vehicle. Otherwise, the brake system could overheat and might fail.
- The vehicle's center of gravity and, in turn, the vehicle's handling, will change because of the trailer load and the increased combined towing weight of the vehicle and trailer.
- Weight distribution is especially bad if the towing vehicle is empty and the trailer is loaded. If you absolutely must drive with this combination, drive with extra care and at a reduced speed.

### Starting off with a trailer on hills

Depending on how steep the hill is and the combined towing weight, a parked vehicle with trailer can roll backwards when you first start moving.

When starting off with a trailer on a hill:

- Depress and hold the brake pedal (and depress and hold the clutch - manual transmission).
- Press the button once to deactivate the electronic parking brake
- Press the button again and hold it to use the electronic parking brake to help prevent the vehicle and trailer from rolling backwards. If applicable, follow the instructions for the Hill Hold feature *Starting assistance systems*.
- Shift into first gear or Drive **D**, *Shifting*.
- Release the brake pedal.
- Drive ahead slowly at first. If your vehicle has manual transmission, slowly let out the clutch.
- Do not release the button until the engine starts to move the vehicle forward. If your vehicle has an automatic transmission, you can also depress and hold the brake pedal for added braking and then let up on the brake pedal when you feel that the vehicle “wants” to move forward.
- Drive ahead slowly.



## WARNING

Improper trailer towing can cause loss of vehicle control and serious personal injury.

- Driving with a trailer and carrying heavy or bulky items changes the way the vehicle handles and increases the distance it needs to stop safely.
- Always watch what is happening up ahead and around you. Brake earlier than you would if you were not towing a trailer.
- Always adapt your speed and driving to the heavier load and the weight distribution in the vehicle. Take road, weather, traffic, and visibility conditions into account as well.
- Reduce your speed even more than you otherwise would when going downhill and under unfavorable load, weather, or wind conditions.
- Drive especially carefully and accelerate gently. Always avoid sudden maneuvers and hard braking.
- Be especially careful when passing other vehicles.
- Reduce speed immediately if the trailer shows even the slightest sign of swaying.
- Never try to stop the swaying by accelerating.
- Always obey speed limits. In some areas speed limits for vehicles towing trailers are lower than for vehicles without trailers.

## Ball mount

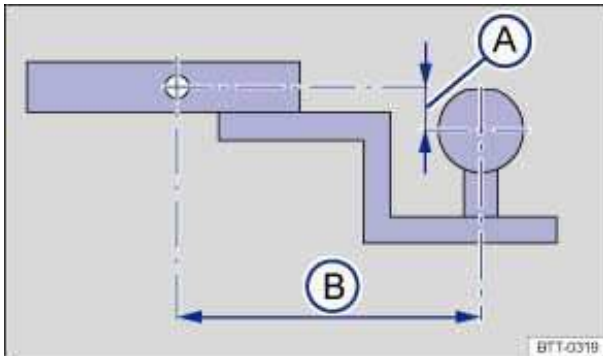

Fig. 95 Dimensions of the ball mount support.

**⚠ Please first read and note the introductory information and heed the WARNINGS**

Your vehicle is not equipped with a trailer hitch or preparations for the installation of a trailer hitch. If you must tow a trailer, you must have the necessary electrical wiring and socket together with a suitable trailer hitch installed. Because towing a trailer places a great deal of stress on the vehicle, the attachment of a trailer to the vehicle and the dimensions of the receiver and ball mount are very important so that the extra forces the vehicle has to withstand can be properly handled.

The receiver used requires both a ball mount and a ball that meet special requirements regarding geometry and size. This applies to both the height of the ball above the surface where it attaches ⇒ fig. 95 (A), and the pin-to-ball distance (B).

These dimensions are important because they help determine the way that the forces that arise during towing are applied to the receiver and its attachments to the vehicle. If you buy a ball mount and ball, make sure that they meet the following specifications.

### Ball mount dimensions

- The drop height (A) from the center of the ball to the center of the hole for the securing pin on the ball mount must be at least 1 inch (25.4 mm) and at most  $2\frac{7}{8}$  inches (73 mm).

- The pin-to-ball distance (B) from the center of the ball to the center of the hole for the securing pin on the ball mount must be no more than 7 inches (178 mm).
- The ball diameter must be no more than 1<sup>1</sup>/<sub>4</sub> inches (32 mm).

A ball mount and ball combination that does not meet these specifications can damage your vehicle and may even fail in use ⇒ .

Never install a “weight distributing” or “load equalizing” trailer hitch on your vehicle. The vehicle is not designed for this kind of trailer hitch ⇒ .

### WARNING

An improperly installed or unsuitable trailer hitch can cause the trailer to separate from the towing vehicle and result in a major accident with serious personal injuries.

- Have any trailer hitch retrofit or other work on a trailer hitch done by a qualified workshop.

### CAUTION

The ball mount sticks out behind the rear bumper and can cause injury to pedestrians and cyclists.

- To reduce the risk of injury in rear-end collisions, and the risk to pedestrians and cyclists when the vehicle is parked, always remove the ball carrier when you are not towing a trailer.

### NOTICE

- Never use a ball larger than 1<sup>1</sup>/<sub>4</sub> inches (32 mm) on your vehicle. The vehicle was not designed to tow heavier trailers with a receiver larger than the specified ball. The increased loads can damage the attachment points for the trailer hitch.
- Never use an adapter to increase the size of the trailer hitch receiver from 1<sup>1</sup>/<sub>4</sub> inches (32 mm) to 2 inches (50.8 mm) or more to tow a trailer that is heavier than the maximum permissible trailer weight that your vehicle can tow.
- You can use an adapter if required for the proper installation of a bicycle rack or other similar carrier as long as the maximum weight limits are observed. When using bicycle racks or similar carriers, make sure that the rear lights are not blocked.
- Only use trailer hitches that are approved by the hitch manufacturer for your vehicle and model.

## Retrofitting a trailer hitch

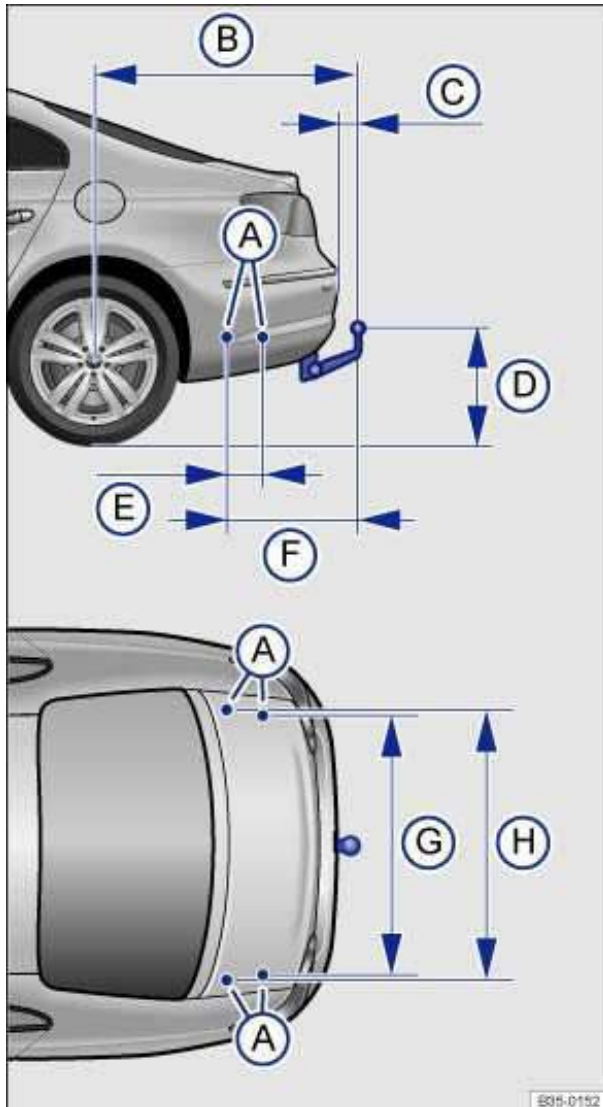

Fig. 96 Dimensions and attachment points for retrofitting a trailer hitch.

⚠ Please first read and note the introductory information and heed the WARNINGS ⚠

Volkswagen recommends having the trailer hitch retrofit performed by a qualified workshop because cooling system modifications or the installation of heat shields may be necessary. Volkswagen recommends that you see an authorized Volkswagen dealer or an authorized Volkswagen Service Facility before having a trailer hitch installed on your vehicle.

When retrofitting a trailer hitch, the specified distance dimensions must be strictly adhered to. Under no circumstances may the distance from the center of the hitch ball to the surface of the road ⇒ fig. 96 (D) be less than the specified minimum. This minimum height must be present even when the vehicle is fully loaded and subject to the maximum tongue weight.

### Distance dimensions :

- (A) Attachment points.
- (B) 46 inches (1170 mm)
- (C) at least 3 inches (79 mm)
- (D) 14–16 inches (350 – 420 mm)
- (E) 10 inches (251 mm)

- (F) 21 inches (546 mm)
- (G) 41 inches (1031 mm)
- (H) 41 inches (1036 mm)

**⚠ WARNING**

Improper or incorrect connections to the vehicle electrical system can cause malfunctions that affect the entire vehicle electrical system and cause accidents and serious personal injury.

- Never connect the electrical system of the trailer directly to the electrical connections of the rear lights or other unsuitable power sources. Use only a suitable connector to provide power to the trailer.
- Have any trailer hitch retrofit or other work on a trailer hitch done by a qualified workshop.

**⚠ WARNING**

An improperly installed or unsuitable trailer hitch can cause the trailer to separate from the towing vehicle and result in a major accident with serious personal injuries.

## Maximum permissible trailer weight

ⓘ Please first read and note the introductory information and heed the WARNINGS ⚠

Maximum permissible trailer weight	lbs.	kg
Trailer with brake	2000	907
Trailer without brake	1650	748
Tongue weight	200	91

The Gross Vehicle Weight Rating and the Gross Axle Weight Rating must not be exceeded, even with a trailer. These ratings are listed on the safety compliance label on the driver door jamb 36. When a trailer is towed, the weight of the ball mount and the tongue weight of the trailer are added to the vehicle weight 293, *Determining the correct load limit*.

The trailer weight ratings given above are valid only up to altitudes of 3000 ft (1000 m) above sea level. The maximum permissible combined towing weight must be reduced by about 10% for every 3000 ft (1000 m), or portion thereof, of additional altitude.

**⚠ WARNING**

Exceeding the gross trailer weight rating and tongue weight can cause accidents and serious personal injury.

- Never let the actual weights at the front and rear axles exceed the Gross Axle Weight Rating (GAWR). Never let the combined front and rear weights exceed the Gross Vehicle Weight Rating (GVWR).



## **NOTICE**

**Exceeding the gross weight ratings can cause extensive vehicle damage that is not covered by any Volkswagen Limited Warranty.**

# Storage areas

## Introduction

---

In this section you'll find information about:

- Storage compartment in the driver door
- Storage compartment on the driver side
- Eyeglass storage compartment in the overhead console
- Storage compartment in the front center console
- Storage compartment in the front center armrest
- Glove compartment
- Rear center armrest storage compartment
- Other storage compartments

Store only lightweight or small objects in storage compartments.

A factory-installed **AUX-IN jack** may be located in the storage compartment in the front center armrest.

Depending on options, there may be a factory-installed **CD changer** or **Media Device Interface (MDI) / (MEDIA-IN)** in the glove compartment.

### More information:

- Passenger compartment
- Power locking and closing system
- Driver assistance systems
- Interior care and cleaning
- ⇒ Booklet *Radio* or ⇒ Booklet *Navigation system*

### WARNING

Loose objects can be thrown around the inside of the vehicle when the vehicle is moving, especially during sudden maneuvers and hard braking. This can cause serious personal injuries and even make the driver lose control of the vehicle.

- Never let animals ride in the vehicle's open storage compartments, on top of the instrument panel, or on the shelf behind the rear seat backrests.
- Never put hard, heavy or sharp objects in these places or in articles of clothing or bags in the passenger compartment.
- Always keep storage compartments closed while driving.

### WARNING

Objects in the driver footwell can prevent the pedals from moving freely. This can cause loss of vehicle control and increase the risk of serious personal injuries.

- Always make sure that nothing can interfere with the pedals.
- Always fasten floor mats securely to the floor.
- Never put floor mats or other floor coverings on top of already installed floor mats.
- Always make sure that nothing can fall into the driver footwell while the vehicle is moving.

## NOTICE

- The defroster heating wires or antenna in the rear window can be damaged by hard or sharp things on the shelf below the rear window.
- Do not keep any food, medicine, or other items sensitive to heat or cold in the vehicle. They can be damaged or made unusable by heat or cold.
- Things that are made of transparent materials (such as eyeglasses, magnifying glasses, or transparent suction cups on the windows) can magnify sunlight and damage the vehicle.

 The ventilation slots between the rear window and the shelf behind the rear seat backrest must not be blocked so that stale air can escape from the vehicle.

## Storage compartment in the driver door

---

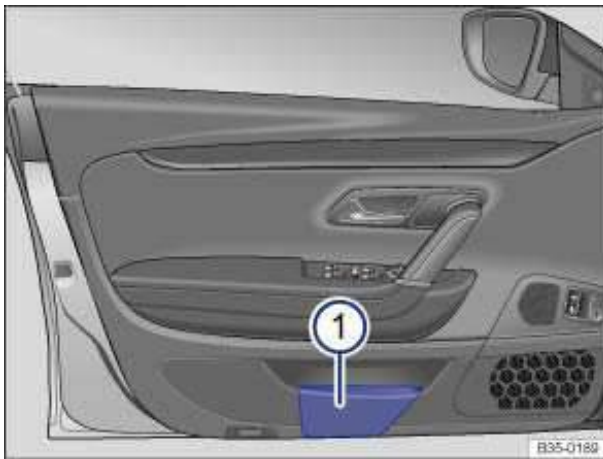

**Fig. 97** In the driver door: Storage compartment.

 Please first read and note the introductory information and heed the WARNINGS 

There is a storage compartment in the driver door. ⇒ [fig. 97 \(1\)](#).



## Storage compartment on the driver side

---



Fig. 98 On driver side: Storage compartment.

⚠ Please first read and note the introductory information and heed the WARNINGS ⚠

To *open* the compartment, pull the handle in the direction of the arrow ⇒ fig. 98.

To *close*, push the lid up until it latches.

Coin holders may be in this storage compartment (1).

## Eyeglass storage compartment in the overhead console

---

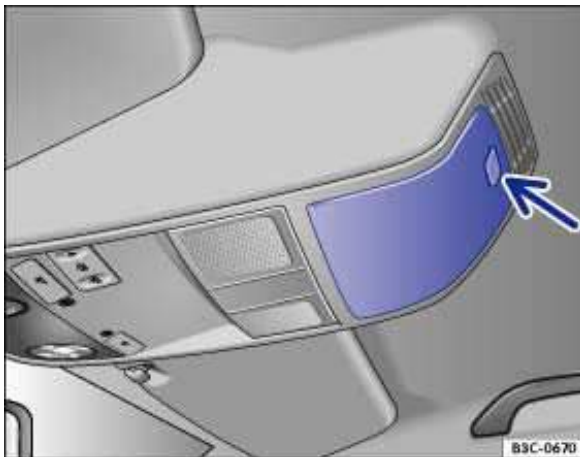

Fig. 99 In the overhead console: Storage compartment.

⚠ Please first read and note the introductory information and heed the WARNINGS ⚠

Your vehicle may have a storage compartment that can be used for storing eyeglasses or other light objects.

To *open*, briefly press and release the button ⇒ fig. 99 (arrow) on the storage compartment cover.

To *close*, push the lid up until it latches.

## Storage compartment in the front center console

---



Fig. 100 In the front center console: Storage compartment.

**ⓘ Please first read and note the introductory information and heed the WARNINGS ⚠**

If the compartment has a cover, *open* by pressing the cover in the direction of the arrow ⇒ [fig. 100](#).  
To *close*, press the lid down completely.

**ⓘ** The front center console storage compartment may have a 12 Volt socket 165.

## Storage compartment in the front center armrest

---



Fig. 101 In the front center armrest: Storage compartment.

**ⓘ Please first read and note the introductory information and heed the WARNINGS ⚠**

To *open*, lift up the center armrest as far as it will go in the direction of the arrow ⇒ [fig. 101](#).  
To *close*, put the center armrest down.

### **⚠ WARNING**

The center armrest can restrict the driver's arm movement and cause crashes and serious personal injury.

- Always keep storage compartments in the center armrest closed while driving.



## WARNING

Never let a passenger, especially a child, ride on the center armrest.



A telephone cradle for the cell phone package may be installed in the upper section of the storage compartment ⇒ Booklet *Mobile Phone Package*.



There may be an AUX-IN jack in the center armrest storage compartment ⇒ Booklet *Radio*, or ⇒ Booklet *Navigation system*.

## Glove compartment

---

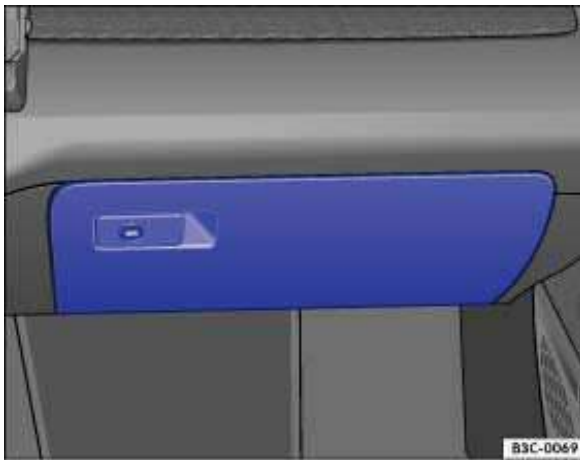

Fig. 102 On the passenger side: Glove compartment.

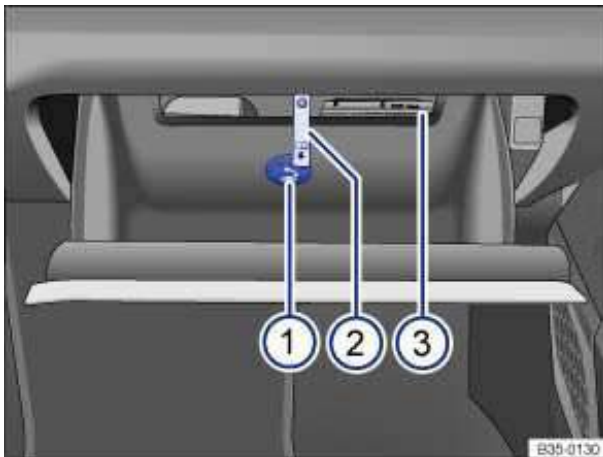

Fig. 103 Inside the glove compartment.

❏ Please first read and note the introductory information and heed the WARNINGS ⚠

Key to ⇒ fig. 103:

- (1) Air vent
- (2) Strap indicating the location of the storage compartment handle
- (3) Owner's Manual or MDI (MEDIA-IN) jack in the pull-down storage compartment

## Opening and closing the glove compartment

If necessary, unlock the glove compartment with the emergency key. It is locked when the key slot is vertical.

To *open*, pull the handle ⇒ [fig. 102](#).

To *close*, push the lid up.

## Opening and closing the Owner's Manual storage compartment

The storage compartment at the top of the glove compartment is designed to hold the Owner's Manual or the MDI (MEDIA-IN) jack.

The Owner's Manual or MDI (MEDIA-IN) jack is located in a storage compartment at the top, which can be pulled down to open ⇒ [fig. 103 \(3\)](#).

The strap (2) indicates the handle for opening the storage compartment.

If the vehicle is not equipped with the MDI (MEDIA-IN) jack, always keep the Owner's Manual in this storage compartment. To stow the Owner's Manual, place it in the slot with the binding facing the inside of the glove compartment door.

## Holders

Depending on the model, there may be holders for a pen and a notepad in the glove compartment.

## Cooling the glove compartment

There is an air vent (1) in the back of the glove compartment. Cool air can be directed into the glove compartment if the air conditioner is on. Open or close the air vent by turning it.



### WARNING

**An open glove compartment door can increase the risk of serious injury during sudden braking or driving maneuvers or in a crash.**

- Always keep the glove compartment closed while the vehicle is moving.



### NOTICE

Keep the storage compartment with the CD changer (3) closed while the vehicle is moving, otherwise the CD changer may be damaged by vibrations.



### NOTICE

In some vehicle models, design considerations have made it necessary to have openings in the glove compartment behind the Owner's Manual slot, for example. Small items may fall through these openings and get behind the instrument panel. This can cause unusual noises and damage the vehicle. Never put any small objects in the glove compartment for this reason.



Depending on options, a factory-installed **CD changer** or **Media Device Interface (MDI) / (MEDIA-IN)** may be located in the glove compartment ⇒ Booklet *Radio*, or ⇒ Booklet *Navigation system*.

## Rear center armrest storage compartment

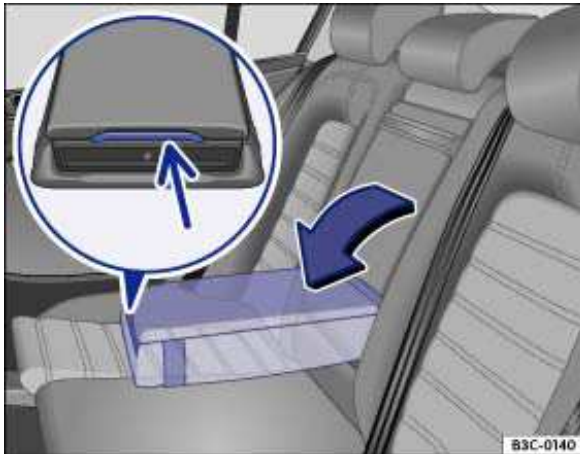

Fig. 104 Storage compartment in the rear center armrest.

ⓘ Please first read and note the introductory information and heed the WARNINGS ⚠

There may be a storage compartment in the rear center armrest or in the rear bench behind the center armrest.

If the center armrest is folded down, no one can sit on the middle seat of the rear bench.

### Opening or closing the center armrest storage compartment

To *open*, press the button ⇒ fig. 104 (small arrow) when the center armrest is folded down and then open the cover upward.

To *close*, fold the lid down ⇒ ⓘ.

### ⚠ WARNING

The center armrest must always be folded up and the storage compartment and cup holders closed to reduce the risk of injuries when the vehicle is moving.

- Never let anybody, especially children, ride on the rear center armrest or in the center position on the rear seat when the armrest is folded down. An improper seating position can increase the risk of serious injury in a crash.
- Close the storage compartment only if no one is in the way.

### ⓘ NOTICE

Do not press on the cup holder cover when raising the center armrest. The cup holder could open and be damaged.

## Other storage compartments

---

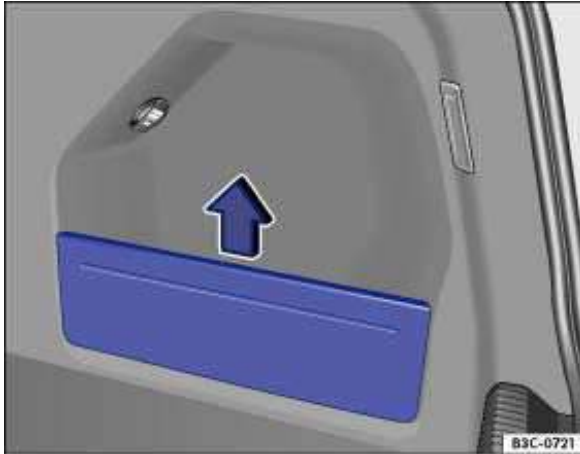

**Fig. 105** In the luggage compartment: Side storage compartment.

❏ Please first read and note the introductory information and heed the **WARNINGS** ⚠

### Storage compartments in the luggage compartment

Additional storage compartments are located in the sides of the luggage compartment. The side panels can be removed by pushing upward in the direction of the arrow ⇒ [fig. 105](#) to make room for larger objects in the luggage compartment.

#### Additional storage:

- In the front and rear center consoles.
- In the door trim panels (front and rear).
- Shelf behind the rear seat backrest – only for light clothing or similar objects that do not interfere with visibility to the rear!
- **Coat hooks** on the center door pillars and on the overhead grab handles in the rear.

### **⚠ WARNING**

**Clothes or other items on the shelf behind the rear seat backrest may limit visibility and cause accidents and severe personal injuries.**

- **Always hang clothes so that they do not limit visibility.**
- **Always use the built-in coat hooks only for lightweight clothing. Never leave any heavy or sharp-edged items in the pockets that may interfere with airbag deployment and can cause personal injury in a collision.**

# Cup holders

## Introduction

---

In this section you'll find information about:

Cup holders in the front center console

Cup holders in the rear center armrest

### More information:

- Interior care and cleaning

### WARNING

Improper use of beverage holders can cause injuries.

- Never put hot drinks in the cup holders. During normal or sudden maneuvers, sudden braking or in a collision, hot liquid can be spilled and cause burns!
- Make certain that bottles or other items cannot fall into the driver's footwell while the vehicle is moving and interfere with the movement of the pedals.
- Never put heavy cups, food or other heavy items in the cup holders. Heavy items can fly through the passenger compartment in a crash and cause serious injury.

### WARNING

Hot or freezing temperatures in the passenger compartment can cause closed bottles to explode or break.

- Never leave closed bottles in a very hot or cold vehicle.

### WARNING

Bottles and other things can fall into the driver's footwell and interfere with the pedals while driving.

- Make sure that bottles cannot fall into the driver's footwell during driving to avoid obstructing the pedals.

### NOTICE

Never put open drinks in the cup holder when the vehicle is moving. The drinks can spill and damage the vehicle, including the electrical system.



The cup holder inserts can be removed for cleaning.

## Cup holders in the front center console

---

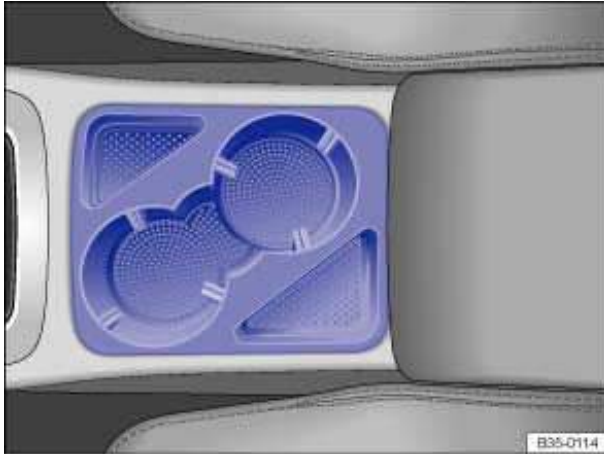

**Fig. 106** In the front center console: Cup holders.

⚠ Please first read and note the introductory information and heed the WARNINGS ⚠

Place the drink in the cup holder ⇒ [fig. 106](#).

## Cup holders in the rear center armrest

---

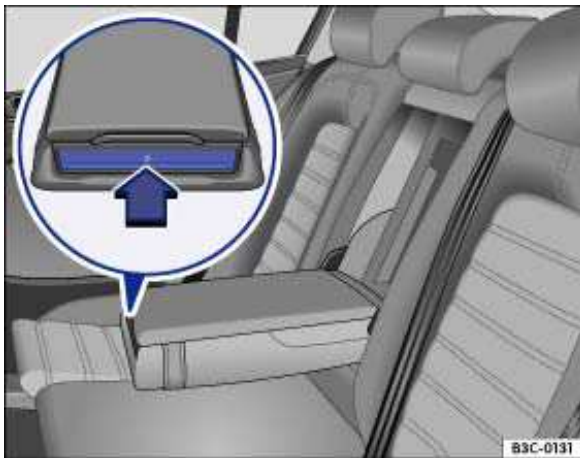

**Fig. 107** In the rear center armrest: opening the cup holders.

⚠ Please first read and note the introductory information and heed the WARNINGS ⚠

### Opening the cup holder

- Fold the center armrest down.
- Press on the front of the center armrest in the direction of the arrow ⇒ [fig. 107](#). The cup holder opens.

### Closing the cup holder

Press the cup holder all the way back into the center armrest until it locks in place.





## **WARNING**

Always keep the armrest folded up when the vehicle is moving to reduce the risk of injury.

- Never let anybody, especially children, ride on the rear center armrest or in the center position on the rear seat when the armrest is folded down. An improper seating position can increase the risk of serious injury in a crash.



## **NOTICE**

Do not press on the cup holder cover when raising the center armrest. The cup holder could open and be damaged.

# 12 Volt sockets

## Introduction

---

In this section you'll find information about:

Opening the socket cover  
12 Volt sockets in the vehicle

Electrical devices can be connected to the vehicle 12 Volt sockets.  
The connected devices must be in good working order.

### **More information:**

- Parts, accessories, repairs and modifications
- Consumer information



### **WARNING**

**Improper use of electrical sockets and electrical devices may start a fire and cause severe personal injury.**

- **Never leave children unattended in the vehicle. Sockets and connected devices can be used when the ignition is switched on.**
- **If the connected device gets warm, immediately switch it off and disconnect the power supply.**



### **NOTICE**

- **To help prevent damage to the electrical system, never connect any accessories such as a solar panel or vehicle battery charger to a 12 Volt socket.**
- **Only use accessories which have been tested for electromagnetic compatibility with a motor vehicle.**
- **To help prevent damage from voltage fluctuations, switch off all electrical consumers connected to the 12 Volt socket before switching the ignition on or off or starting the engine.**
- **Never connect devices to a 12 Volt socket that draw more than the maximum wattage the socket can supply. Drawing too much power can damage the vehicle electrical system.**



Please turn off the engine when you stop for any length of time.



The vehicle battery will drain if you use electrical equipment when the engine is not running.



Unshielded devices may interfere with radio reception or the vehicle's electrical system.



Operating electrical devices near the rear-window antenna may interfere with AM radio reception.

## Opening the socket cover

---

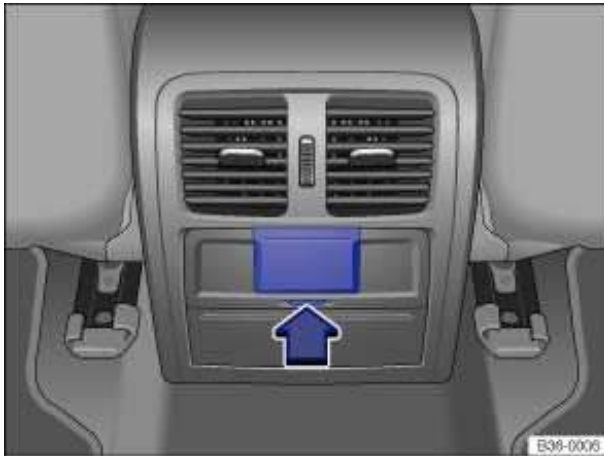

**Fig. 108** Rear center console: Open by pushing a button.

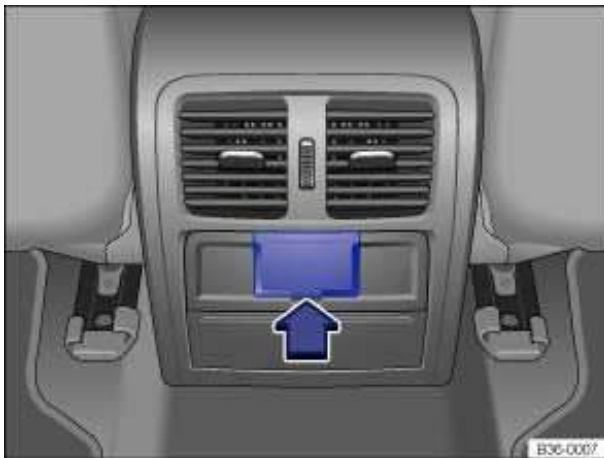

**Fig. 109** Rear center console: Open by pushing the cover up.

⚠ Please first read and note the introductory information and heed the WARNINGS ⚠

### **Vehicles with a button below the cover:**

Push the button for the socket cover ⇒ [fig. 108](#) (arrow).

### **Vehicles with a folding cover:**

Reach into the opening from below ⇒ [fig. 109](#) (arrow) and flip the cover up.

## 12 Volt sockets in the vehicle



Fig. 110 In the luggage compartment: 12 Volt socket.

ⓘ Please first read and note the introductory information and heed the WARNINGS ⚠

### Maximum power draw

Socket	Maximum power draw
12 volts	120 watts

The maximum power draw at any one socket must never be exceeded. Electrical devices should have information on them that says how much power they draw.

If 2 or more electrical devices are connected at the same time, the total power draw of all connected devices must never be more than 190 watts ⇒ ⚠.

### 12 Volt socket

The 12 Volt socket works only when the ignition is switched on.

If the ignition is on but the engine is not running, the vehicle battery will be drained by any device that is plugged in and turned on. For this reason, never use the electrical sockets unless the engine is running.

To help prevent damage from voltage fluctuations, switch off all electrical devices connected to a 12 Volt socket before switching the ignition on or off or starting the engine.

The vehicle may have 12 Volt sockets at the following places:

- In the storage compartment in the front center console
- In the rear center console
- In the luggage compartment ⇒ [fig. 110](#).

### ⚠ NOTICE

- **Follow the manufacturer's instructions for connected devices!**
- **Never exceed the maximum power consumption, or the entire vehicle electrical system may be damaged.**
- **12 Volt socket:**
  - **Only use equipment that has been tested for electromagnetic compatibility and complies with applicable guidelines.**
  - **Never feed current into the socket, with a solar panel, for example.**



Unshielded devices may interfere with radio reception or the vehicle's electrical system.

# Starting and stopping the engine

## Introduction

---

In this section you'll find information about:

Indicator lights  
Vehicle key positions in the ignition switch  
Starting the engine  
Stopping the engine  
Electronic immobilizer  
Engine preheating system

**Explanatory notes in this section regarding automatic transmissions also apply to the DSG® Direct Shift Gearbox automatic transmission.**

### **Immobilizer display**

If an unauthorized vehicle key is used or the system malfunctions, *Immobilizer active!* may appear on the instrument cluster display. The engine cannot be started.

### **Push-starting and tow-starting**

For technical reasons, **never** try to push-start or tow-start the vehicle. Jump-start the vehicle instead while following proper and safe procedures.

### **More information:**

- Vehicle key set
- Shifting gears
- Braking, stopping and parking
- Steering
- Starting assistance systems
- Refueling
- Fuel
- Emergency closing and opening
- Jump-starting
- Towing



### **WARNING**

Switching off the engine while the vehicle is moving can make the vehicle harder to stop and result in loss of vehicle control, leading to collisions and severe personal injuries.

- Brake and steering assistance systems, the airbag system, safety belt pretensioners, and other vehicle safety features only work when the engine is running.
- Switch off the engine only when the vehicle is not moving.



## WARNING

To reduce the risk of serious personal injury when starting and running the vehicle's engine:

- Never start the engine or let it run in a confined or enclosed area. Engine exhaust contains carbon monoxide, a poisonous, colorless, and odorless gas. Carbon monoxide can cause unconsciousness and death.
- Never leave the vehicle unattended with the engine running. The vehicle could move suddenly or some other unexpected event could occur, resulting in property damage or personal injury.
- Never use starting assist fluids. Starting fluids can explode and can cause a “run-away” vehicle condition.



## WARNING

The vehicle exhaust system and the catalytic converter get very hot. They can cause fires and serious personal injury.

- Never park the vehicle where the hot exhaust system or catalytic converter could ignite flammable materials, such as brush, leaves, dry grass, spilled fuel, etc.
- Never apply additional undercoating or rust proofing on or near the exhaust manifold, exhaust pipes, catalytic converter, or heat shields.

## Indicator lights

☐ Please first read and note the introductory information and heed the WARNINGS

Lights up	Possible cause	Proper response
	Brake pedal not depressed.	Apply the brake pedal to start the engine

Flashes	Possible cause	Proper response
	The release button in the selector lever did not engage. Vehicle movement is prevented.	Engage the selector lever release button

When the ignition is switched on, several warning and indicator lights come on briefly for a function check. They go out after a few seconds.



## WARNING

Failure to heed warning lights and instrument cluster text messages can cause the vehicle to break down in traffic and result in a collision and serious personal injury.

- Never ignore warning lights or text WARNINGS.
- Always stop the vehicle as soon as it is safe to do so.
- Whenever stalled or stopped for repair, move the vehicle a safe distance off the road, turn on the emergency flashers, stop the engine, and use other warning devices to warn approaching traffic.

## ⚠ NOTICE

Failure to heed warning lights or text **WARNINGS** can result in vehicle damage.

### Vehicle key positions in the ignition switch

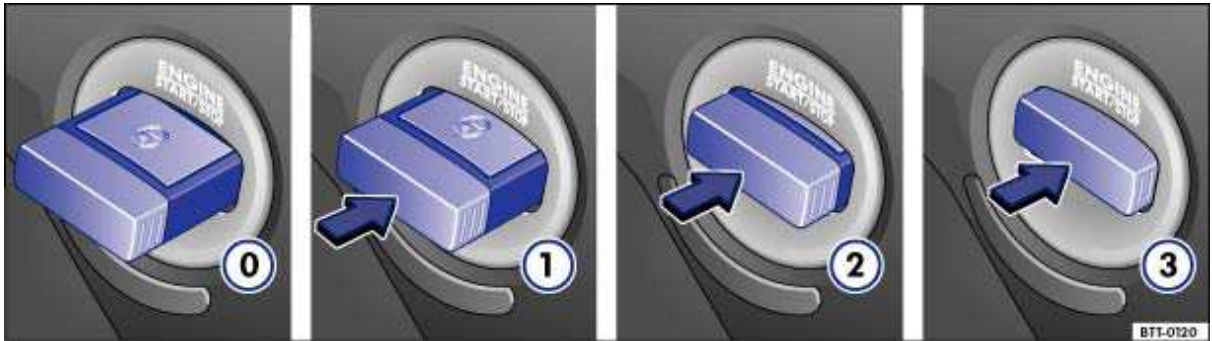

Fig. 111 In the ignition switch: Vehicle key positions.

⚠ Please first read and note the introductory information and heed the **WARNINGS** ⚠

If there is no vehicle key in the ignition, the steering column is locked.

Vehicle key position ⇒ [fig. 111](#)

- (0) Ignition switched off. Steering column lock engaged. The vehicle key can be removed.
- (1) Ignition switched off. Steering column lock disengaged. Vehicle key can be removed.
- (2) Ignition is switched on. Vehicle key can be removed from ignition switch.
- (3) Start the engine. Once the engine has started, the vehicle key stays in this position. To remove the vehicle key, push it fully into the ignition switch. When released, the vehicle key returns to position (1) the engine is switched off.

#### If you use the wrong key

If an unauthorized vehicle key has been inserted into the ignition switch, it can be removed as follows:

- *Automatic transmission:* The vehicle key cannot be removed from the ignition unless both the key and the selector lever have been moved to the correct position. Press the release button on the transmission selector lever, move the selector lever to the Park (**P**) position, and release the button. The vehicle key can now be removed.
- *Manual transmission:* Pull out the vehicle key.





## WARNING

Improper use of vehicle keys can result in serious personal injury.

- Always take the key with you when you leave the vehicle. The engine can be started and vehicle systems such as the power windows can be operated, leading to serious personal injury.
- Never leave children, disabled persons, or anyone who cannot help themselves in the vehicle. The doors can be locked with the remote control vehicle key. This could result in people being trapped in the vehicle in an emergency. For example, depending on the time of year, people trapped in the vehicle can be exposed to very high or very low temperatures.
- Heat build-up in the passenger and luggage compartment of a parked vehicle can result in temperatures in the vehicle that are much higher than the outside temperatures, particularly in summer. Temperatures can quickly reach levels that can cause unconsciousness and death, particularly to small children.
- Never remove the key from the ignition switch while the vehicle is moving or rolling to a stop. The steering wheel will lock and you will not be able to steer or control the vehicle.



Leaving the key in the ignition for a long time when the engine is not running will drain the vehicle battery.



Leaving the selector lever for a long period of time in any position other than Park (P) when the ignition is switched off can drain the vehicle battery.



On **automatic transmission vehicles**, the vehicle key can be removed from the ignition switch only when the transmission is in Park (P). You may have to press the release button on the transmission selector lever to put the lever into Park (P).

## Starting the engine

 Please first read and note the introductory information and heed the WARNINGS 

Please perform these steps only in the order listed.

Step	Operation
1.	<b>Automatic transmission:</b> Depress the brake pedal and hold it down until step 5 is completed.
1 a.	<b>Manual transmission:</b> Depress clutch pedal fully and hold until the engine has started.
2.	Shift the transmission into Neutral (N) or Park (P) (automatic), or into Neutral (manual only).
3.	Push the vehicle key to position ⇒ <a href="#">fig. 111 (3)</a> – do not depress the accelerator pedal.
4.	When the engine starts, release the vehicle key.
5.	If the engine does not start, switch off the ignition and start again after about 1 minute.
6.	Release the electronic parking brake when you are ready to start driving



## WARNING

Never leave the vehicle unattended while the engine is running. The vehicle could move suddenly, especially when the vehicle is in gear, resulting in accidents and personal injury.



## WARNING

“Starting fluids” can explode and can cause a “run-away” vehicle condition.

- Never use starting assist fluids.



## NOTICE

- You can damage the starter or the engine if you try to start the engine when the vehicle is still moving, or if you try to restart the engine right after switching it off.
- Avoid high engine speeds, full throttle acceleration, and heavy engine loads when the engine is cold.
- Do not try to start the engine by pushing or towing the vehicle. Unburned fuel can get into the catalytic converter and damage it. The steering column may also be locked.



Do not let your vehicle warm up while standing; instead, start driving right away after making sure that you have good visibility through all windows. This will help the engine reach operating temperature faster and keep down emissions.



Major consumers of electricity are temporarily switched off when the engine is being started.



After starting a cold engine, there may be increased operating noises for a few seconds. This is normal and harmless.

## Stopping the engine

❏ Please first read and note the introductory information and heed the WARNINGS

Please perform these steps only in the order listed.

Step	Operation
1.	Bring the vehicle to a complete stop ⇒ .
2.	Depress and hold down the brake pedal until step 4 is completed.
3.	<b>Automatic transmission:</b> Shift the transmission into Park (P).
4.	Apply the electronic parking brake to help prevent the vehicle from moving
5.	Push the vehicle key fully into the ignition switch and release. The vehicle key springs back to position ⇒ <a href="#">fig. 111 (1)</a> .
6.	<b>Manual transmission:</b> Shift into 1st gear (vehicle on flat surface or pointing uphill) or reverse (vehicle pointing downhill).

Please perform these steps only in the order listed.

Step	Operation
7.	Removing the vehicle key from the ignition switches off electrical equipment and activates the steering column lock.

### **WARNING**

Never stop the engine before the vehicle has come to a complete stop. You can lose control of the vehicle, crash, and be seriously injured.

- The airbags and safety belt pretensioners will not work when the ignition is switched off.
- The brake booster does not work when the engine is not running. More brake pedal pressure will be needed to stop the vehicle.
- The power steering system does not work when the engine is not running, and you will need more force to steer the vehicle.
- When the key is removed from the ignition switch, the steering will lock and you will not be able to steer the vehicle.

### **NOTICE**

If the vehicle has been driven hard for a long time, the engine could overheat when it is stopped. To reduce the risk of engine damage, let the engine idle in Neutral for about 2 minutes before you switch off the ignition.



If the ignition is switched on or the engine is running and the driver door is opened, a chime sounds. The chime is also a reminder to switch off the engine and turn off the ignition before leaving and locking the vehicle from the outside.



On vehicles with automatic transmissions, the vehicle key can only be removed from the ignition when the transmission is in Park (P).



After the engine has been switched off, the radiator fan in the engine compartment may keep running for several minutes, or may start running after the vehicle has been parked for a while, even if the ignition is switched off and the vehicle key has been removed. The radiator fan shuts off automatically when the engine has cooled down enough.

## Electronic immobilizer

 Please first read and note the introductory information and heed the **WARNINGS** 

The immobilizer helps to prevent the engine from being started and driven with an unauthorized vehicle key.

There is a microchip inside the vehicle key. The chip deactivates the immobilizer automatically when an authorized vehicle key is inserted into the ignition switch.

The electronic immobilizer is automatically activated when the remote control vehicle key is pulled out of the ignition switch.

The engine can therefore only be started with an authorized and correctly coded genuine Volkswagen vehicle key. Coded vehicle keys are available from authorized Volkswagen dealers, authorized

Volkswagen Service Facilities, and from certain independent repair facilities and locksmiths who are qualified to make these vehicle keys

If an unauthorized vehicle key is used, **Immobilizer active!** appears in the instrument cluster display. The vehicle cannot be operated with this key.

A Declaration of Compliance with the United States FCC and Industry Canada regulations is on



Using genuine Volkswagen keys helps minimize the risk of malfunctions.

Applicable only in Canada

## Engine preheating system

---

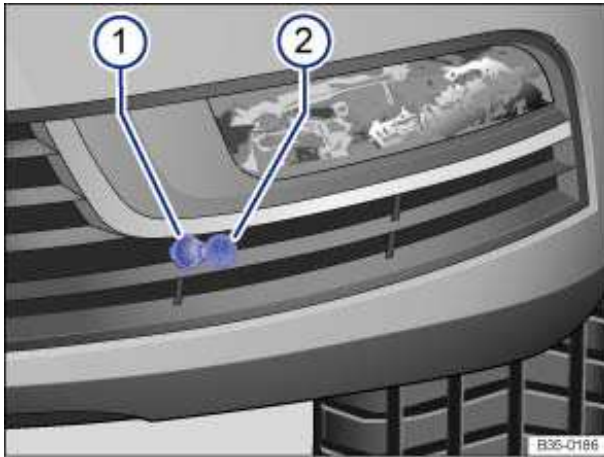

**Fig. 112** In the front bumper: Connection socket 2 for the engine preheating system.

**⚠ Please first read and note the introductory information and heed the WARNINGS ⚠ .**

Your vehicle may be equipped with an engine preheating system (engine preheater), which slowly warms the engine coolant using a heating element when the vehicle is parked. The included cable must be connected to a 120 Volt Ground Fault Circuit (GFI) protected outlet that is protected from water (in your garage, for instance). When the coolant is preheated, the engine reaches its operating temperature more quickly, uses less fuel, and produces less polluting emissions during the warm-up phase.

Preheating the engine can take up to 3 hours depending on the temperature outside.

### Connecting the engine preheating system

- Use only the provided connecting cable, together with an appropriate extension cable if necessary.
- All cables and adapters that are used must not be damaged ⇒ ⚠.
- Open the cover ⇒ [fig. 112 \(1\)](#).
- Plug the connecting cable into the socket [\(2\)](#).
- Attach the connecting cable to an extension cable if necessary. Always use a 12 gauge or heavier heavy-duty extension cable that can be properly grounded to a three-prong Ground Fault Circuit (GFI) wall outlet and is not longer than 100 ft (30 meters).
- Plug the connecting cable or the extension cable into a 120 Volt Ground Fault Circuit (GFI) wall outlet that is properly protected against rain and other moisture. Never plug the preheater into a normal outlet regardless of whether the outlet is grounded or not.
- Always disconnect the connecting cable and close the cover [\(1\)](#) before starting the engine.



## WARNING

Improper use of the engine preheating system may cause short circuits, fires, and serious or fatal personal injuries.

- Always connect the connecting cable to a 120 Volt Ground Fault Circuit (GFI) wall outlet. The outlet must be protected from water, moisture and other fluids.
- Never connect the engine preheating system to a conventional socket, regardless of whether the socket is protected or not.



## WARNING

Using an outlet or power cables that are incorrect or damaged, using electrical appliances incorrectly, or ignoring safety precautions can result in short circuits, accidents, injuries, and life-threatening electrical shocks.

- Never use a damaged outlet or a damaged power cable.
- Always plug the preheating system into a 120 Volt Ground Fault Circuit (GFI) wall outlet that is properly protected against rain and other moisture.
- Always check the fuse protection of the 120 Volt power source before using the connecting cable.
- Always use a 12 gauge or heavier heavy-duty extension cable that can be properly grounded to a three-prong GFI outlet. The extension cable must not be longer than 100 ft (30 meters).
- Check the cables for damage before every use. Never use a damaged cable. Damaged cables must be replaced. See an authorized Volkswagen dealer or an authorized Volkswagen Service Facility.
- Only use the cables provided.
- Always remove the connecting cable before starting the engine.
- Never attempt to alter or repair cables or other electrical components.
- Never let plugs or connectors come into contact with water, moisture, or any other fluids.



If the engine preheating system is used occasionally, test the GFI circuit breaker (Ground Fault Circuit Interrupter) once a month. Test it once a week if the system is used regularly.

# Shifting

## Introduction

---

In this section you'll find information about:

Warning and indicator lights

Pedals

Manual transmission: Gearshift lever

Automatic transmission: Selector lever

Shifting with Tiptronic®

Driving with automatic transmission

Automatic transmission malfunction

Gear recommendation

**Explanatory notes in this section regarding automatic transmissions also apply to the DSG® Direct Shift Gearbox automatic transmission.**

### **When the ignition is switched on and the transmission is in Reverse (R):**

- The backup lights come on.
- Climatronic switches automatically to air recirculation mode.
- The Park Distance Control system and the camera for Rear Assist switch on (if applicable).

### **More information:**

- Lower center console
- Instruments
- Braking, stopping and parking
- Park Distance Control (PDC)
- Reverse driving assistant (Rear Assist)
- Climate control
- Engine control and emission control system
- Emergency closing and opening



### **WARNING**

**Rapid acceleration can cause skidding and loss of traction, especially on slippery roads, resulting in a loss of vehicle control, collisions, and serious personal injury.**

- **Only use the kick-down feature or fast acceleration if visibility, weather, road, and traffic conditions permit and other drivers will not be endangered by your driving and the vehicle's acceleration.**



## WARNING

Constant braking causes the brakes to overheat and even to fail leading to collisions and serious personal injury.

- Never “ride” the brakes or apply the brake pedal too often or too long.
- Riding the brakes will substantially reduce braking performance, increase stopping distance, and can cause complete brake system failure.



## NOTICE

- Never “ride” the brakes by keeping your foot on the brake pedal when you do not want to brake. This will make the brakes wear faster.
- Before driving downhill, especially on hills that are long or steep, always reduce speed and shift into lower gear (manual or automatic transmission). This will let the vehicle use engine braking and reduce the load on the brakes. Otherwise, the brake system could overheat and even fail. Only use the brakes when you need them to slow the vehicle down more or to stop.

## Warning and indicator lights

☐ Please first read and note the introductory information and heed the WARNINGS

Lights up	Possible cause	Proper response
	DSG <sup>®</sup> transmission too hot.	<b>Do not continue driving!</b> Allow the transmission to cool with the selector lever in the <b>P</b> position. If the warning does not turn off, do not continue driving. See your authorized Volkswagen dealer for assistance. Otherwise, serious transmission damage could result
	Brake pedal not depressed.	Apply the brake pedal to select a drive gear. Also refer to electronic parking brake

Flashes	Possible cause	Proper response
	The release button in the selector lever did not engage. Vehicle movement is prevented.	Engage selector lever release button
	Automatic transmission malfunction.  blinks, alternating with the selector lever indicator, for example <b>D</b> .	Drive at low engine speed (rpm) to the nearest authorized Volkswagen dealer or authorized Volkswagen Service Facility to have the system checked.

When the ignition is switched on, several warning and indicator lights come on briefly for a function check. They go out after a few seconds.

## WARNING

Failure to heed warning lights and instrument cluster text messages can cause the vehicle to break down in traffic and result in a collision and serious personal injury.

- Never ignore warning lights or text WARNINGS.
- Always stop the vehicle as soon as it is safe to do so.
- Whenever stalled or stopped for repair, move the vehicle a safe distance off the road, turn on the emergency flashers, stop the engine, and use other warning devices to warn approaching traffic.

## NOTICE

Failure to heed warning lights or text WARNINGS can result in vehicle damage.

## Pedals

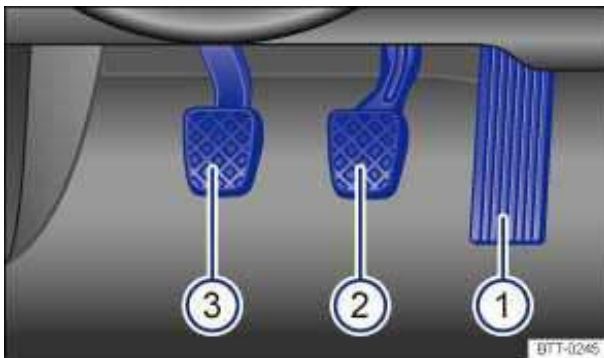

Fig. 113 Pedals in vehicles with manual transmission: 1 Accelerator pedal, 2 Brake pedal, 3 Clutch pedal.

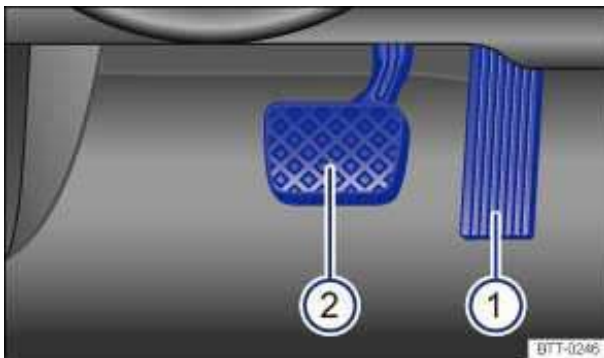

Fig. 114 Pedals in vehicles with automatic transmission: 1 Accelerator pedal, 2 Brake pedal.

 Please first read and note the introductory information and heed the WARNINGS 

All pedals must always be able to move freely in and out without interference from floor mats or other things.

Only use floor mats that leave the pedal area free and are held securely in place with floor mat fasteners to help prevent sliding.

If a brake circuit malfunctions, more brake pedal travel is needed to bring the vehicle to a full stop, and it is important that nothing is in the way when you have to depress the brake pedal harder and farther than normal.



## WARNING

Objects in the driver footwell can prevent the pedals from moving freely. This can cause loss of vehicle control and increase the risk of serious personal injuries.

- Always make sure that nothing can interfere with the pedals.
- Always fasten floor mats securely to the floor.
- Never put floor mats or other floor coverings on top of already installed floor mats.
- Always make sure that nothing can fall into the driver footwell while the vehicle is moving.

## NOTICE

Always make sure that the pedals are able to move freely and that nothing can interfere with them. If a brake circuit fails, more brake pedal travel will be needed to bring the vehicle to a stop. The brake pedal must be pressed farther and harder than normal.

### Manual transmission: Gearshift lever

---

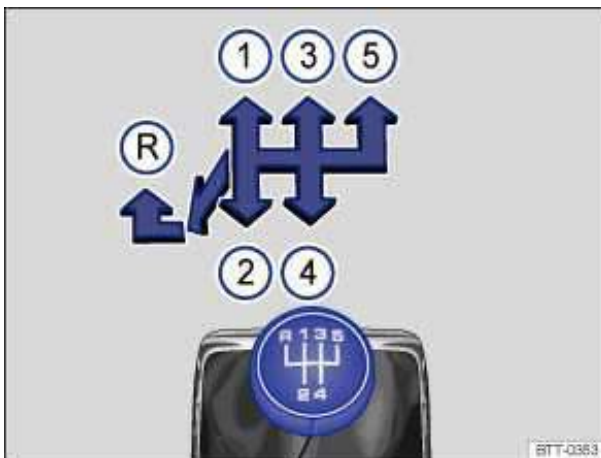



Fig. 115 Gearshift pattern of a 5-speed manual transmission.



Fig. 116 Gearshift pattern of a 6-speed manual transmission.

 Please first read and note the introductory information and heed the WARNINGS 

The positions of the individual gears are shown on the gearshift lever ⇒ [fig. 115](#) or ⇒ [fig. 116](#).



- Depress the clutch pedal all the way and hold.
- Move the gearshift lever into the desired position ⇒ .
- Release the clutch pedal to engage the gear.

The clutch pedal must be fully depressed to start the engine.

### Shifting into reverse

- Only shift to the reverse gear when the vehicle is not moving.
- Depress the clutch pedal fully and hold ⇒ .
- Move the gearshift lever to neutral and press down.
- Move the shift lever to the left and then push forward into the reverse gear position ⇒ [fig. 115 \(R\)](#) or ⇒ [fig. 116 \(R\)](#).
- Release the clutch pedal to engage the gear.

### Downshifting

You should always downshift gear by gear when driving, meaning always into the next lowest gear. Do not downshift when the engine rpm (revolutions per minute) is too high ⇒ . At fast speeds or high engine rpm, skipping over one or more gears when downshifting can cause damage to the clutch and transmission, even if a gear is not engaged ⇒ .



#### WARNING

**Downshifting to a lower gear incorrectly can result in loss of vehicle control and can cause accidents and serious personal injuries.**



#### WARNING

**When the engine is running and a gear is engaged, the vehicle will start to move as soon as the clutch pedal is released, even when the parking brake is applied. This also applies when the parking brake is engaged.**

- **Never shift into reverse when the vehicle is moving.**



#### NOTICE

**Shifting down to a gear that is too low when driving at fast speeds or high engine rpm can cause extensive damage to the clutch and transmission. That is true even if the clutch pedal is pressed so that the clutch is not engaged.**



#### NOTICE

**To help prevent damage and premature wear:**

- **Do not rest your hand on the gearshift lever while driving. Over time, the pressure will cause premature wear in the transmission.**
- **Make sure that the vehicle has come to a complete stop before shifting into reverse.**
- **Always depress the clutch pedal all the way when changing gears.**

- Do not hold the vehicle on a hill using engine power with the clutch pedal partially engaged and the engine running.

## Automatic transmission: Selector lever

---



Fig. 117 Side view: Automatic transmission selector lever with shift lever release button (arrow).



Fig. 118 Automatic transmission selector lever with shift lever release button (arrow).

**⚠ Please first read and note the introductory information and heed the WARNINGS ⚠**

Automatic transmission vehicles have an Automatic Shift Lock (ASL). With ASL, you must depress the brake pedal and hold it down while pressing the release button on the selector lever handle in the direction of the arrow ⇒ [fig. 117](#) or ⇒ [fig. 118](#) in order to move the selector lever out of Park (**P**) and into a drive gear. When the selector lever is in Neutral (**N**), you also have to depress the brake pedal before you can move the selector lever to Drive (**D**), Sport Drive (**S**), or Reverse (**R**).

If the ignition is switched on, either the current selector lever setting or the current gear is shown in the instrument cluster display.

Selector lever position	Designation	Meaning ⇒ 
<b>P</b>	<b>Park</b>	The drive wheels are mechanically locked. Select only when the vehicle is <i>not moving</i> . To change the selector lever position, switch on the ignition (if it is off) and then press the selector lever release button while holding down the brake pedal.
<b>R</b>	<b>Reverse</b>	The reverse gear is engaged. Shift into Reverse only when the vehicle is <i>not moving</i> .
<b>N</b>	<b>Neutral</b>	Transmission is in Neutral position. No power is transmitted to the wheels and no engine braking is available.
<b>D</b>	<b>Drive</b> (standard driving position)	All forward gears shift up and down automatically. The transmission shifts as needed depending on engine load, individual driving style, and vehicle speed.
<b>S</b>	<b>Sport Drive</b> (Sport driving position)	All forward gears automatically upshift <i>later</i> and downshift <i>earlier</i> than in the <b>D</b> (Drive) position, to take full advantage of the engine's power reserves. The transmission shifts as needed depending on engine load, individual driving style, and vehicle speed.

### Automatic Shift Lock (ASL)

The Automatic Shift Lock (ASL) in Park (**P**) and Neutral (**N**) prevents drive positions from being engaged inadvertently, which would cause the vehicle to move.

To release the ASL, depress and hold the brake pedal with the ignition switched on. Press the release button on the selector lever at the same time.

The ASL is not engaged if the selector lever is moved quickly through Neutral (**N**) (e.g., when shifting from Reverse (**R**) to Drive (**D**)). This makes it possible to “rock” the vehicle backwards and forwards if it is stuck in snow or mud. The ASL engages automatically if the brake pedal is not depressed and the lever is in Neutral (**N**) for more than about 1 second and the vehicle is traveling no faster than about 3 mph (5 km/h).

In rare cases, the ASL may not engage on vehicles with DSG® Direct Shift Gearbox. If this happens, power to the drive wheels will be interrupted to prevent the vehicle from moving unexpectedly. The green indicator light  will blink and a text message will be displayed. To engage the Automatic Shift Lock (ASL):

- On 6-speed transmissions: Depress and then release the brake pedal. Try to engage the ASL again.
- On 7-speed transmissions: First shift into Park (**P**) or Neutral (**N**), and then shift to a drive position.



### WARNING

Moving the selector lever to the wrong position can cause loss of vehicle control, a collision, and serious personal injury.

- Never accelerate when moving the selector lever.
- When the engine is running and a drive position is engaged, the vehicle will start to move as soon as the brake pedal is released.
- Never shift into Reverse or Park when the vehicle is moving.

## WARNING

Unintended vehicle movement can cause serious personal injury.

- Never get out of the driver's seat while the engine is running, especially when the transmission is in a drive gear. If you must leave your vehicle while the engine is running, always set the electronic parking brake and shift the transmission into Park (P).
- Never leave the vehicle in Neutral (N). It will roll down hills, whether the engine is running or not.
- When the engine is running and a drive gear - Drive (D), Sport Drive (S), or Reverse (R) - has been selected, press and hold the brake pedal to keep the vehicle from moving. The vehicle may “creep” and move forward or backward even if the engine is idling slowly.
- Never shift into Reverse (R) or Park (P) when the vehicle is moving.

## NOTICE

Even though the transmission is in Park (P), the vehicle may move a couple of inches (a few centimeters) forwards or backwards if you take your foot off the brake pedal after stopping the vehicle without first setting the parking brake.

 If the selector lever is moved into Neutral (N) by mistake when the vehicle is moving, take your foot off the accelerator pedal. Wait until the engine speed has dropped to idle speed before moving the selector lever into a drive gear.

 Leaving the selector lever for a long period of time in any position other than Park (P) when the ignition is switched off can drain the vehicle battery.

## Shifting with Tiptronic®

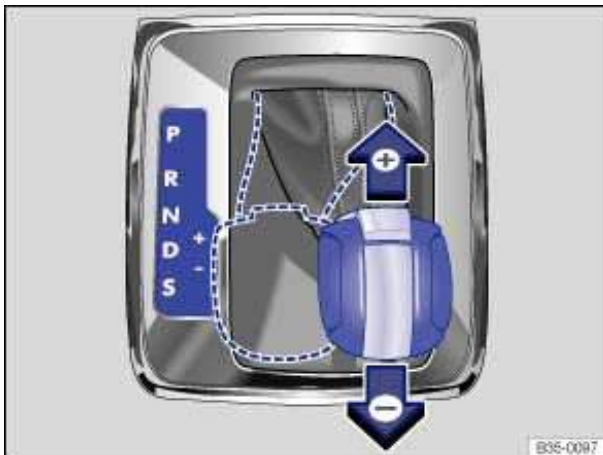

Fig. 119 Selector lever in Tiptronic position.



**Fig. 120** Steering wheel with optional Tiptronic shift paddles.

⚠ Please first read and note the introductory information and heed the WARNINGS ⚠

Tiptronic lets you upshift and downshift manually with the automatic transmission. When Tiptronic mode is used, the transmission stays in the current gear and does not upshift or downshift automatically unless the transmission senses a situation where upshifting or downshifting is necessary to keep the engine from over- or under-revving.

#### Using Tiptronic with the selector lever

- Push the selector lever sideways to the right from Drive (**D**) position into the Tiptronic position ⇒ ⚠ in *Automatic transmission: Selector lever*
- Briefly push the selector lever forward (+) to upshift into a higher gear or backward (-) to downshift into a lower gear ⇒ fig. 119.

#### Using Tiptronic with the shift paddles behind the steering wheel

- The paddles ⇒ fig. 120 (arrows) work when the selector lever is in the Tiptronic position or when the selector lever is in Drive (**D**) or Sport Drive (**S**). You do not have to move the selector lever over to the right into the Tiptronic position.
- To upshift, pull the paddle + **OFF** on the right toward you.
- To downshift, pull the paddle **OFF** on the left toward you.
- To switch off Tiptronic mode, pull the paddle + **OFF** on the right toward you and hold it there for about 1 second.

Tiptronic will switch off automatically if the shift paddles have not been used for a while and the selector lever is not in the Tiptronic position.

#### ⚠ NOTICE

- During acceleration, the transmission will shift automatically into the next higher gear before reaching maximum engine speed (rpm).
- If you use Tiptronic to shift into a lower gear, the transmission will downshift only when doing so will not over-rev the engine.

### Driving with automatic transmission

⚠ Please first read and note the introductory information and heed the WARNINGS ⚠ 170.

All forward gears shift up and down automatically.

## Driving on hills

The steeper the grade, the lower the gear that must be selected. Lower gears increase the braking effect of the engine. Never coast downhill in Neutral **(N)**.

- Reduce speed.
- Switch to Tiptronic mode by moving the selector lever from Drive **(D)** to the right into the Tiptronic position
- Downshift by pulling the selector lever back briefly (-).
- **OR:** Downshift using the paddles on the steering wheel

If you stop and start up again when going uphill, you should use Hill Hold as long as the engine is running.

**Vehicles without Hill Hold:** If you stop on a hill with the vehicle in gear, you must depress the brake pedal or engage the parking brake to keep the vehicle from rolling. Do not release the brake pedal or the parking brake until the vehicle has started to move forward ⇒ .

## Kick-down acceleration

The kick-down feature permits maximum acceleration when the selector lever is in the Drive **(D)**, Sport Drive **(S)** or Tiptronic mode.

If you push the accelerator all the way down, the vehicle will automatically downshift, depending on vehicle speed and engine speed (rpm). This feature lets you take advantage of the full acceleration capacity of the vehicle ⇒ .

With kick-down actuated, the transmission will stay in the current gear longer and not upshift until the engine reaches maximum rpm.



### WARNING

**Rapid acceleration can cause skidding and loss of traction, especially on slippery roads, resulting in a loss of vehicle control, collisions, and serious personal injury.**

- Only use the kick-down feature or fast acceleration if visibility, weather, road, and traffic conditions permit and other drivers will not be endangered by your driving and the vehicle's acceleration.
- Always adapt your driving to the traffic flow.
- Note that the drive wheels can spin and the vehicle can swerve when ASR is switched off, especially when the road is slippery.
- Once you have accelerated, switch ASR back on again.



### NOTICE

- When stopping on hills with the transmission in a drive gear, do not use the accelerator to help prevent the vehicle from rolling backwards. This can cause the automatic transmission to overheat and be damaged.
- Never let the vehicle coast or roll down a hill in Neutral **(N)**, especially when the engine is not running. The transmission will not be lubricated and will be damaged.

## Automatic transmission malfunction

 Please first read and note the introductory information and heed the WARNINGS 



## Emergency shift program

If all selector lever position indicators in the instrument cluster display are highlighted against a bright background, there is a system malfunction. The automatic transmission and the DSG automatic transmission will then operate in the emergency shift program. The emergency shift program lets you drive the vehicle, but at a reduced speed and without being able to use all of the forward gears.

In some cases, vehicles with a DSG<sup>®</sup> Direct Shift Gearbox automatic transmission may **not be able to shift into reverse**. It is then impossible to drive the vehicle backwards.

In any event, have the automatic transmission checked by an authorized Volkswagen dealer or authorized Volkswagen Service Facility.

## Overheating of Direct Shift Gearbox (DSG<sup>®</sup>) automatic transmission

The DSG<sup>®</sup> automatic transmission may overheat, for example, due to frequent starts, extended “creeping,” or stop-and-go traffic. Overheating is indicated by the warning light  and, if applicable, by a text message in the instrument cluster. An additional warning chime may sound. Stop and let the transmission cool down ⇒ .

## The vehicle does not move forward or in reverse even though a drive position is selected with the selector lever

If the vehicle does not move in the desired direction, the system may not have engaged the drive position correctly. Press the brake pedal and select the drive position again.

If the vehicle still does not move in the desired direction, there is a system malfunction. See your authorized Volkswagen dealer or authorized Volkswagen Service Facility for assistance to have the system checked.





### NOTICE

- **As soon as you get any of these warnings about transmission overheating, you must either park the vehicle in a safe place or drive faster than 12 mph (20 km/h).**
- **If the text message and acoustic warning repeat themselves every 10 seconds or so, you must park the vehicle in a safe place as soon as you can safely do so and stop the engine. Let the transmission cool down.**
- **To help prevent damage to the transmission, do not drive the vehicle again until the acoustic warning has stopped. As long as the engine is overheated, avoid stop and start driving and avoid low speeds (“walking pace”).**

## Gear recommendation

 Please first read and note the introductory information and heed the **WARNINGS**  170.

If your vehicle has a manual transmission, it may also be equipped with a gear recommendation feature. The gear recommendation displays a gear in the instrument cluster display that can help reduce fuel consumption.

Display	Meaning
	The selected gear is optimal.
	Recommendation to shift into a higher gear.
	Recommendation to shift into a lower gear.





## WARNING

The gear recommendation is only intended to assist the driver to select a gear for optimum fuel economy. The gear recommendation cannot take road and traffic conditions into account.

- The driver is responsible for selecting the correct gear for the current driving conditions, such as when passing, when driving on hills or when towing a trailer.



Selecting the optimal gear helps to reduce fuel consumption.



The gear recommendation display turns off when you press the clutch pedal.

# Braking, stopping, and parking

## Introduction

---

In this section you'll find information about:

Warning and indicator lights

Electronic parking brake

Parking

About the brakes

Braking assistance systems

Switching Anti-Slip Regulation (ASR) on and off

Brake fluid

The **braking assistance systems** are the Anti-Lock Brake System (ABS), Brake Assist System (BAS), Electronic Differential Lock (EDL), Anti-Slip Regulation (ASR) and Electronic Stability Control (ESC).

### **More information:**

- Trailer towing
- Starting assistance systems
- Tires and wheels
- Parts, accessories, repairs and modifications



### **WARNING**

**Driving with bad brakes or worn brake pads can cause a collision and serious personal injury.**

- **If the symbol  lights up in the instrument cluster display, whether alone or together with a text message, immediately contact an authorized Volkswagen dealer or authorized Volkswagen Service Facility to have the brake pads checked and, if necessary, replaced.**



## WARNING

Parking improperly can cause serious personal injury.

- Never remove the key from the ignition switch while the vehicle is moving or rolling to a stop. The steering wheel will lock and you will not be able to steer or control the vehicle.
- Never park the vehicle where the hot exhaust system or catalytic converter could ignite flammable materials, such as brush, leaves, dry grass, spilled fuel, etc.
- Always apply the electronic parking brake when parking your vehicle.
- Improper use of the electronic parking brake can seriously injure you and your passengers.
- Never use the parking brake to slow down the vehicle when it is moving, except in an emergency. The stopping distance is much longer because only the rear wheels are braked. Always use the foot brake to stop the vehicle.
- Never activate the throttle manually from the engine compartment when the engine is running and the automatic transmission is in gear. The vehicle will start to move as soon as the engine speed increases even if the parking brake is on.
- Never leave children or anyone who cannot help themselves behind in the vehicle. They could switch off the parking brake and move the gear selector lever or gear shift, which could cause the vehicle to start moving. This can lead to a crash and serious personal injuries.
- Always take the key with you when you leave the vehicle. The engine can be started and vehicle systems such as the power windows can be operated, leading to serious personal injury.
- Never leave children, disabled persons, or anyone who cannot help themselves in the vehicle. The doors can be locked with the remote control vehicle key, trapping passengers in the vehicle in an emergency. For example, depending on the time of year, people trapped in the vehicle can be exposed to very high or very low temperatures.
- Heat build-up in the passenger and luggage compartment of a parked vehicle can result in temperatures in the vehicle that are much higher than the outside temperatures, particularly in summer. Temperatures can quickly reach levels that can cause unconsciousness and death, particularly to small children.



















## NOTICE

- Always be careful when you park in areas with parking barriers or high curbs. These vary in height and could damage your bumper and related parts if the front of your vehicle hits a barrier or curb that is too high while you are getting into or out of a parking spot. To help prevent damage, stop before the tires of your vehicle touch a parking barrier or curb.
- Always be careful when you enter a driveway or drive up or down steep ramps or over curbs or other obstacles. Parts of the vehicle close to the ground may be damaged (such as bumper covers, spoilers, and parts of the engine, suspension, and exhaust systems).



## Warning and indicator lights

☞ Please first read and note the introductory information and heed the WARNINGS

Lights up	Possible cause or meaning ⇒	Proper response
	Electronic parking brake engaged.	

Lights up	Possible cause or meaning ⇒ 	Proper response
<b>PARK</b>		
 / <b>BRAKE</b>	Brake system malfunction.	 <b>Stop!</b> Get professional assistance immediately
	Brake fluid level too low.	 <b>Stop!</b> Check brake fluid level
	Together with ABS indicator light  or <b>ABS</b> : ABS failure.	See an authorized Volkswagen dealer or an authorized Volkswagen Service Facility. The vehicle brakes will work without ABS.
<b>BRAKE WEAR</b>	Brake pads worn.	If you believe that it is safe to do so, immediately take the vehicle to an authorized Volkswagen dealer or authorized Volkswagen Service Facility. Check, and if necessary replace, <b>all</b> brake pads.
		
 / <b>ESC</b>	ESC switched off by the system.	Switch ignition off and on again. You may have to drive a short distance.
	ESC malfunction.	See an authorized Volkswagen dealer or an authorized Volkswagen Service Facility.
	Together with ABS indicator light  or <b>ABS</b> : ABS malfunction.	See an authorized Volkswagen dealer or an authorized Volkswagen Service Facility. The vehicle brakes will work without ABS.
	Vehicle battery has been reconnected.	Drive a short distance at a speed of 10–12 mph (15–20 km/h). If the indicator light stays on, see an authorized Volkswagen dealer or an authorized Volkswagen Service Facility
		
<b>ESC OFF</b>	ASR manually deactivated.	Switch on ASR 193. ASR automatically turns on when you turn the ignition off and back on again.
 / <b>ABS</b>	Together with ESC indicator light  or <b>ESC</b> : ABS malfunction.	See an authorized Volkswagen dealer or an authorized Volkswagen Service Facility.
	Together with warning light  , <b>BRAKE</b> or  : ABS failure.	The vehicle brakes will work without ABS.
	Together with flashing warning light  or <b>BRAKE</b> : Electronic parking brake malfunction.	See an authorized Volkswagen dealer or an authorized Volkswagen Service Facility.
	Brake pedal not depressed.	Depress the brake pedal to select a gear or drive position.

Lights up	Possible cause or meaning ⇒ 	Proper response
		Depress the brake pedal to release electronic parking brake

Flashes	Possible cause	Proper response
	Electronic parking brake malfunction. The indicator light  may light up at the same time.	Contact an authorized Volkswagen dealer or authorized Volkswagen Service Facility because you may not be able to park the vehicle safely.
	ESC or ASR is operating.	Take foot off accelerator pedal. Adapt driving to road conditions.

When the ignition is switched on, several warning and indicator lights come on briefly for a function check. They go out after a few seconds.





 **WARNING**

Failure to heed warning lights and instrument cluster text messages can cause the vehicle to break down in traffic and result in a collision and serious personal injury.

- Never ignore warning lights or text WARNINGS.
- Always stop the vehicle as soon as it is safe to do so.

 **WARNING**

Driving with bad brakes can cause a collision and serious personal injury.

- If the brake warning light **BRAKE** or  does not go out, or comes on when driving, either the brake fluid level in the reservoir is too low or there is a fault in the brake system. Stop the vehicle as soon as you can do so safely and get expert assistance, *Brake fluid*.
- If the brake warning light **BRAKE** or  comes on at the same time as the ABS warning light **ABS** or , the ABS may not be working properly. This could cause the rear wheels to lock up relatively quickly during braking. Rear wheel brake lock-up can cause loss of vehicle control.
- If you believe the vehicle is safe to drive, drive slowly and very carefully to the nearest authorized Volkswagen dealer, authorized Volkswagen Service Facility, or other qualified workshop and have the brake system inspected. Avoid sudden hard braking and steering.
- If the ABS indicator light **ABS** or  does not go out, or if it comes on while driving, the ABS system is not working properly. The vehicle can then be stopped only with the standard brakes (without ABS). You will not have the protection ABS provides. Contact your authorized Volkswagen dealer or an authorized Volkswagen Service Facility as soon as possible.
- If the symbol **BRAKE WEAR** or  lights up in the instrument cluster display, whether alone or together with a text message, immediately contact an authorized Volkswagen dealer or authorized Volkswagen Service Facility to have the brake pads checked and, if necessary, replaced.

## ⚠ NOTICE

Failure to heed warning lights or text **WARNINGS** can result in vehicle damage.

### Electronic parking brake

---



**Fig. 121** In the lower section of the center console: Electronic parking brake button.

ⓘ Please first read and note the introductory information and heed the **WARNINGS** ⚠

#### Setting the electronic parking brake

You can engage the electronic parking brake any time the vehicle is not moving - even if the ignition is switched off. Always engage the parking brake when you leave or park the vehicle.

- Pull and hold the button ⇒ [fig. 121](#).
- The parking brake is engaged when the indicator light  $\text{g}$  in the button and in the instrument cluster 183 comes on.

#### Releasing the electronic parking brake

- Switch the ignition on.
- Press the button . At the same time, press the brake pedal firmly or press the accelerator pedal lightly if the engine is running.
- The parking brake is released when the indicator light  $\text{g}$  in the instrument cluster 183 goes out.

#### Releasing the electronic parking brake automatically when you start driving

The electronic parking brake releases automatically when you start driving if the driver's door is closed **and** the driver's safety belt is buckled. With a **manual transmission**, you must also press the clutch pedal all the way down before you start driving so the system recognizes that the parking brake should be released.

#### Emergency braking function

Only use the emergency braking function in an emergency, when you cannot stop the vehicle using the brake pedal ⇒ ⚠!

- Pull and hold the button to brake the vehicle **hard**. An audio warning signal will sound at the same time.
- To stop the braking maneuver, release the button or press the accelerator pedal.



## WARNING

Improper use of the electronic parking brake can cause accidents and severe injuries.

- Never use the parking brake to slow down the vehicle when it is moving, except in an emergency. Braking distance is much longer, since only the rear wheels are braked. Always use the foot brake.
- Never press the accelerator pedal when a selector lever position or gear is engaged and the engine is running. The vehicle could begin moving, even if the electronic parking brake is set.
- Never activate the throttle manually from the engine compartment when the engine is running and the automatic transmission is in gear. The vehicle will start to move even if the parking brake is engaged.



## NOTICE

Even though the transmission is in Park (P), the vehicle may move a couple of inches (a few centimeters) forwards or backwards if you take your foot off the brake pedal after stopping the vehicle without first firmly setting the parking brake.



Vehicles with manual transmission: the electronic parking brake releases automatically when you release the clutch pedal and press the accelerator pedal at the same time.



If the vehicle battery is dead, the electronic parking brake cannot be released. Use a jump-start



You may hear noises when setting or releasing the electronic parking brake.



If the electronic parking brake is not used for a while, an automatic system check will occasionally run when the vehicle is parked. This system check makes audible noises.

## Parking

---

**Please first read and note the introductory information and heed the WARNINGS **

Please note legal regulations when stopping and parking your vehicle.

### Parking the vehicle

Please perform these steps only in the order listed.

- Stop the vehicle on a suitable surface ⇒ .
- Hold the brake pedal down until the engine is switched off.
- Apply the electronic parking brake to help prevent the vehicle from moving 186.
- For automatic transmissions: Shift the transmission into Park (P).
- Switch off the engine and then take your foot off the brake.
- Remove the vehicle key from the ignition.
- If necessary, turn the steering wheel slightly to engage the steering column lock.
- Shift manual transmission into 1st gear (on level ground or if pointed uphill) or reverse (if pointed downhill) and let the clutch out.
- Make sure all passengers and especially children leave the vehicle.

- Take all vehicle keys with you when leaving your vehicle.
- Lock the vehicle.

### On hills

Before stopping the engine, turn the steering wheel so that, if the vehicle starts to roll, its front wheels will roll into the curb:

- Facing downhill, turn the front wheels so that they point toward the curb.
- Facing uphill, turn the front wheels so that they point away from the curb.

### WARNING

The vehicle exhaust system and the catalytic converter get very hot. They can cause fires and serious personal injury.

- Never park where the hot exhaust system could ignite flammable materials, such as brush, leaves, dry grass, spilled fuel, etc.

### NOTICE

- Always be careful when you park in areas with parking barriers or high curbs. These vary in height and could damage your bumper and related parts if the front of your vehicle hits a barrier or curb that is too high while you are getting into or out of a parking spot. To help prevent damage, stop before the tires of your vehicle touch a parking barrier or curb.
- Always be careful when you enter a driveway or drive up or down steep ramps or over curbs or other obstacles. Parts of the vehicle close to the ground may be damaged (such as bumper covers, spoilers, and parts of the engine, suspension, and exhaust systems).

## About the brakes

 Please first read and note the introductory information and heed the WARNINGS  182.

**New brake pads** do not provide full performance during the first 100 to 200 miles (200 to 300 km) and must first be “broken” in ⇒ . To some extent, you can make up for the somewhat reduced performance by applying more pressure to the brake pedal. But, **during the break-in period**, the stopping distance for hard braking and emergency braking will be longer until the brakes are fully broken in. Avoid hard braking and situations that might require hard braking (such as following other vehicles too closely) – especially during the break-in period.

**Brake pad wear** depends mostly on operating conditions and the way the vehicle is driven. If you do a lot of city and short-distance driving and/or have a sporty driving style, you should have the brake pads checked by an authorized Volkswagen dealer or authorized Volkswagen Service Facility more often than the regular service intervals.

**Wet brakes** (for example, after driving through water or washing the vehicle or after heavy rainfall) will not brake as well. Stopping distances will be longer when brake discs are wet or, in winter, even icy. Wet or icy brakes must be dried as soon as possible by carefully applying the brakes a couple of times while traveling at a relatively high speed. Make sure nobody is behind you and that you do not endanger yourself or others ⇒ .

**Brakes coated with road salt** also react slower and need longer stopping distances. If there is salt on the roads and you are not braking regularly, brake carefully and gently from time to time to remove any salt coating from the brake discs and pads ⇒ .

Brake disc **corrosion** (rust) and **dirt** buildup on the brake pads are more likely to occur if the vehicle is not driven much or is driven only for short distances with little braking. If the brakes have not been



used and there is some rust on the discs, clean the brake discs and pads once in a while by carefully braking a couple of times while driving at relatively high speed to help clean the brake discs and pads. Make sure nobody is behind you and that you do not endanger yourself or others ⇒ .

### Brake system malfunction

If you brake and find that the vehicle doesn't brake nearly as well as it used to (sudden increase in stopping distance), a brake circuit may have failed. The brake warning light  or **BRAKE** will come on and a message may appear in the instrument cluster display. If you believe the vehicle is safe to drive, immediately take it to the nearest authorized Volkswagen dealer or authorized Volkswagen Service Facility for repair. Drive slowly and very carefully, allow for the longer stopping distance, and be ready to push longer and harder on the brake pedal to slow the vehicle down.

### Brake booster

The brake booster works only when the engine is running. It increases the force on the brakes above and beyond the pressure put on the brake pedal by the driver.

If the brake booster is not working, or if the vehicle has to be towed, you will have to push the brake pedal harder to make up for the lack of booster assistance and the resulting longer stopping distance ⇒ .

### WARNING

**New brake pads do not provide maximum braking performance.**

- New brake pads do not have the best stopping power for the first 200 miles (320 km) and must be “broken in.” You can compensate for the slightly reduced braking force by putting more pressure on the brake pedal.
- Drive with extra care while the new brake pads are being broken in. This reduces the risk of collisions and serious personal injuries due to a loss of control over the vehicle.
- Never follow other vehicles too closely or put yourself into other situations that might require sudden, hard braking, especially when the brake pads have not been broken in.

### WARNING

**Overheated brakes will reduce the vehicle's stopping power and increase stopping distances considerably.**

- When driving downhill, the brakes have to work especially hard and heat up quickly.
- Before driving downhill, especially on hills that are long or steep, always reduce speed and shift into lower gear (manual or automatic transmission). This will let the vehicle use engine braking and reduce the load on the brakes. Otherwise, the brake system could overheat and possibly fail. Only use the brakes when you need them to slow the vehicle down more or to stop.
- A damaged front spoiler or a non-standard spoiler can reduce airflow to the brakes and make them overheat.

### WARNING

**Wet brakes or brakes coated with ice or road salt react slower and need longer stopping distances.**

- Carefully apply the brakes to test them.
- Always dry brakes and clean off ice and salt coatings with a few cautious brake applications when visibility, weather, road and traffic conditions permit.



## WARNING

Driving when the brake booster is not working increases stopping distances and can cause accidents and serious personal injuries.

- Never let the vehicle coast when the engine is switched off.
- If the brake booster is not working (such as when the vehicle is being towed), a lot more pedal force is needed to slow down and stop.



## NOTICE

- Never “ride” the brakes by keeping your foot on the brake pedal when you do not want to brake. Constant pressure on the brake pedal can make the brakes overheat. Riding the brakes will substantially reduce braking performance, increase stopping distance, and can cause complete brake system failure.
- Before driving downhill, especially on hills that are long or steep, always reduce speed and shift into lower gear (manual or automatic transmission). This will let the vehicle use engine braking and reduce the load on the brakes. Otherwise, the brake system could overheat and possibly fail. Only use the brakes when you need them to slow the vehicle down more or to stop.



When the front brakes are serviced, you should have the rear brake pads inspected at the same time. The wear of all brake pads should be visually checked regularly. The best way to check for brake pad wear is to have your authorized Volkswagen dealer or authorized Volkswagen Service Facility visually inspect the pads through the openings in the wheel rims or from underneath the vehicle. If necessary, the wheels can be taken off for a more thorough inspection.

## Braking assistance systems

**⚠ Please first read and note the introductory information and heed the WARNINGS ⚠**

The ESC, ABS, BAS, ASR, and EDL braking assistance systems work only when the engine is running. These systems can significantly improve active driving safety.

### Electronic Stability Control (ESC)

ESC helps to improve road holding and vehicle dynamics to help reduce the probability of skidding and loss of vehicle control. It works only when the engine is running. ESC detects certain difficult driving situations, including when the vehicle is beginning to spin (yaw) out of control. ESC then helps you to get the vehicle back under control by selectively braking the wheels and/or reducing engine power and by providing steering assistance to help hold the vehicle on the driver's intended course.

ESC has limitations. It is important to remember that ESC cannot overcome the laws of physics. It will not always be able to help out under all conditions you may come up against. For example, ESC may not always be able to help you master situations where there is a sudden change in the coefficient of friction of the road surface. When there is a section of dry road that is suddenly covered with water, slush or snow, ESC cannot perform the same way it would on a dry surface. If the vehicle “hydroplanes” (rides on a cushion of water instead of the road surface), ESC will not be able to help you steer the vehicle because contact with the pavement has been interrupted and the vehicle cannot be braked or steered. During fast cornering, particularly on winding roads, ESC cannot always deal as effectively with difficult driving situations as it can at lower speeds.

Always adjust your speed and driving style to visibility, road, traffic, and weather conditions. ESC cannot override the vehicle's physical limits, increase the available traction, or keep a vehicle on the road if road departure is a result of driver inattention. Instead, ESC improves the possibility of keeping the vehicle under control and on the road during extreme maneuvers by using the driver's steering inputs to help keep the vehicle going in the intended direction. If you are traveling at a speed that

causes you to run off the road before ESC can provide any assistance, you may not experience the benefits of ESC.

ESC includes and/or works together with the ABS, BAS, ASR, EDL, and XDL systems (see below). ESC is switched on all the time. In certain situations when you need less traction or additional traction cannot be achieved, you can switch off ASR by pressing the  button ⇒ [fig. 122](#). Be sure to switch ASR on again when you no longer need less traction.

### **Anti-Lock Brake System (ABS)**

ABS helps to keep the wheels from locking up and helps to maintain the driver's ability to steer and control the vehicle. This means the vehicle is less likely to skid, even during hard braking:

- Push the brake pedal down hard and hold it there. Don't take your foot off the pedal or reduce the force on the pedal!
- Do not “pump” the brake pedal or let up on it!
- Steer the vehicle while pushing down hard on the brake pedal.
- ABS stops working if you release or let up on the brake.

When ABS is doing its job, you will notice a **slight vibration** through the brake pedal and hear a noise. *ABS cannot shorten the stopping distance under all conditions.* The stopping distance may even be longer, for instance, when driving on gravel or on newly fallen snow covering an icy or slippery surface.

### **Brake Assist (BAS)**

The Brake Assist System can help to reduce stopping distances. If you press the brake pedal very quickly, BAS detects an emergency situation. It then very quickly builds up full brake system pressure, maximizing braking power and reducing the stopping distance. This way, ABS can be activated more quickly and efficiently.

Do **not** reduce pressure on the brake pedal! BAS switches off automatically as soon as you release or let up on the brake.

### **Anti-Slip Regulation (ASR)**

ASR reduces engine power directed to spinning wheels and adjusts power to the road conditions. Even under poor road conditions, ASR can make it easier to get moving, accelerate, and climb hills.

ASR can be switched on or off manually

### **Electronic Differential Lock (EDL and XDL)**

EDL is applied during regular straight-line acceleration. EDL gently brakes a drive wheel that has lost traction (spinning) and redirects the drive force to other drive wheels. In extreme cases, EDL automatically switches off to keep the brake from overheating. As soon as the brake has cooled down, EDL automatically switches on again.

XDL is an extension of the Electronic Differential Lock system. XDL does not react to drive wheel slippage when driving straight ahead. Instead, XDL detects slippage of the inside front wheel during fast cornering. XDL applies enough brake pressure to this wheel in order to stop the slippage. This improves traction, which helps the vehicle stay on track.



## WARNING

Driving fast on icy, slippery, or wet roads can lead to a loss of control and result in serious personal injury for you and your passengers.

- Always adjust your speed and driving style to road, traffic, weather, and visibility conditions. Never let the additional safety that ESC, ABS, BAS, ASR, and EDL can provide tempt you into taking extra risks.
- Braking assistance systems cannot overcome the laws of physics and always prevent loss of vehicle control. Slippery and wet roads are still dangerous even with ESC and the other systems!
- Driving too fast on wet roads can cause the wheels to lose contact with the road and “hydroplane.” A vehicle that has lost road contact cannot be braked, steered, or controlled.
- These systems cannot reduce the risk of accident, for example if you drive too fast for conditions or if you do not keep your distance from the vehicle in front of you.
- Although these systems are very effective and can help you control the vehicle in many difficult situations, always remember that your vehicle handling control is limited by tire traction.
- When accelerating on a slippery surface, for example on ice and snow, depress the accelerator carefully. Even with these systems, the wheels may start to spin, leading to a loss of vehicle control.



## WARNING

The effectiveness of ESC can be significantly reduced if other components and systems that affect vehicle dynamics, including but not limited to brakes, tires, and other systems mentioned above, are not properly maintained or functioning.

- Always remember that vehicle alterations or modifications can affect the functioning of the ABS, BAS, ASR, EDL, and ESC systems.
- Changing the vehicle suspension or using an unapproved tire/wheel combination can change the way the ABS, BAS, ASR, EDL, and ESC systems work and reduce their effectiveness.
- The effectiveness of ESC is also determined by the tires fitted



All 4 wheels must be equipped with identical tires in order for ESC and ASR to work properly. Differences in the tread circumference of the tires can cause the system to reduce the engine power when it is not expected.



If ABS is not working, ESC, ASR, and EDL will also not work.



You may hear noises when these systems are active.

## Switching Anti-Slip Regulation (ASR) on and off

---



**Fig. 122** In the center console: Button for switching ASR on and off manually.

**⚠ Please first read and note the introductory information and heed the WARNINGS ⚠**

The Electronic Stability Control (ESC) only works when the engine is running. This system includes ABS, EDL and ASR.

ASR can be switched off by pressing  ⇒ [fig. 122](#) while the engine is running. Switch off ASR only in situations where there is not enough traction, such as the following:

- When driving in deep snow or on loose surfaces.
- When “rocking” the vehicle back and forth when you are stuck.

Afterward, activate ASR again by pressing the button .

## Brake fluid

---



**Fig. 123** In the engine compartment: Brake fluid reservoir cap.

**⚠ Please first read and note the introductory information and heed the WARNINGS ⚠**

Brake fluid absorbs water from the air over time. Too much water in the brake fluid will damage the brake system. Water also lowers the boiling point of the brake fluid. Too much water in the brake fluid can cause vapor lock during heavy brake use or hard braking. Vapor lock reduces braking performance, increases stopping distances and can even cause total brake failure. Your safety and the safety of others depends on brakes that are working properly at all times ⇒ .

## Brake fluid specifications

Volkswagen has developed a special brake fluid that is optimized for the brake system in your Volkswagen. Volkswagen recommends that you use brake fluid that expressly conforms to quality standard **VW Standard 501 14** for optimum performance of the brake system. Check the information on the container for the brake fluid you want to use to make sure it meets the requirements for your vehicle.

Brake fluid that complies with **VW Standard 501 14** can be purchased from your authorized Volkswagen dealer or authorized Volkswagen Service Facility.

If this special brake fluid is not available you may – under these circumstances – use another high quality brake fluid that complies with U.S. Federal Motor Vehicle Safety Standard (FMVSS) 116 DOT 4

⇒ .

Please note, however, that not all brake fluids that comply with U.S. Federal Motor Vehicle Safety Standard FMVSS 116 DOT 4 have the same chemical composition. Some of these brake fluids can contain chemicals that could, over time, degrade or damage internal parts of the vehicle's brake system.

Volkswagen therefore recommends that you use brake fluid that expressly complies with **VW Standard 501 14** for optimum brake system performance over the long term.

## Brake fluid level

The fluid level in the transparent brake fluid reservoir must always be between the MIN and MAX marking ⇒ .

On some vehicles, engine components block the view of the brake fluid reservoir and make it impossible to see the brake fluid level. If you cannot clearly see the brake fluid level in the brake fluid reservoir, please see an authorized Volkswagen dealer or authorized Volkswagen Service Facility.

The brake fluid level drops slightly when the vehicle is being used as the brake pads wear and the brakes are automatically adjusted.

## Changing brake fluid

Brake fluid must be changed according to the service schedule in your ⇒ Booklet *Warranty and Maintenance*. Have the brake fluid checked by an authorized Volkswagen dealer or an authorized Volkswagen Service Facility. Refill only with new brake fluid that meets the standards listed above.



### WARNING

**Brake failure and reduced brake performance can be caused by not having enough brake fluid in the reservoir or by old or incorrect brake fluid.**

- Check the brake system and brake fluid level regularly.
- Always change the brake fluid according to the service schedule in your ⇒ Booklet *Warranty and Maintenance*.
- Hard braking with old brake fluid may cause vapor lock. Vapor lock reduces braking performance, increases stopping distances and can even cause total brake failure.
- Always make sure that only the correct brake fluid is used. Only use brake fluid that expressly conforms to VW Standard 501 14 or, if it is not available, only use a high-quality brake fluid that conforms to U.S. Standard FMVSS 116 DOT 4 requirements.
- Using another brake fluid, or one that is not of high quality, can impair the function of the brake system and reduce its effectiveness. If the container does not say that the brake fluid complies with VW Standard 501 14, or U.S. Standard FMVSS 116 DOT 4, do not use it.
- The brake fluid must be new.



## WARNING

**Brake fluid is poisonous.**

- To reduce the risk of poisoning, never use food, beverage or other non-original containers to store brake fluid. Someone might be misled by the original label on the container, or by the shape of the container, and drink the brake fluid. This could occur even if you relabel the container as “brake fluid.”
- Only store brake fluid in the closed, original container and keep it out of the reach of children.



## NOTICE

**Brake fluid will damage vehicle paint, plastic parts, and tires. Wipe any brake fluid off vehicle paint and other vehicle parts immediately.**



Brake fluid can pollute the environment. Brake fluid that has leaked out must be collected and disposed of properly, following all applicable environmental regulations.

# Saving fuel and helping the environment

## Introduction

---

In this section you'll find information about:

Efficient driving style

Fuel-efficient driving

Fuel consumption, environmental impact, and wear and tear on engine, brakes and tires depend mainly on the following 3 factors:

- Your personal driving style.
- External conditions (weather, road conditions).
- Technical requirements.

You can reduce fuel consumption by up to 25% by using a few simple techniques and adjusting your driving style.



### **WARNING**

**Always adjust your speed and the distance you keep between you and the vehicles ahead of you to the road, traffic, weather, and visibility conditions.**

## Efficient driving style

---

 Please first read and note the introductory information and heed the **WARNINGS** 

### **Shifting faster**

As a rule, the following applies: The higher gear is always the most efficient gear. The rule of thumb for most vehicles is to drive in 3rd gear at 20 mph (30 km/h), 4th gear at 25 mph (40 km/h), 5th gear at 30 mph (50 km/h), and 6th gear at 36 mph (60 km/h).

If traffic and driving conditions permit, “skipping” gears when upshifting also saves fuel.

Do not run the gears up to their limit. Use 1st gear only to start moving and then smoothly shift into 2nd gear. Avoid kick-downs in vehicles with automatic transmissions.

Vehicles with a gear indicator aid in fuel efficient driving by indicating the optimum time to shift gears.

### **Coasting**

If you take your foot off the accelerator, fuel delivery to the engine is interrupted, which lowers fuel consumption.

Therefore, when nearing a red stop light, for instance, allow the vehicle to coast without using the accelerator. Press the clutch pedal and release it only if the vehicle moving too slowly or the coasting distance is too long. The engine will then continue to run at idle.

In situations where the vehicle will be stopped for a longer period of time, such as at a railroad crossing, physically switch off the engine.

### **Defensive driving and “flowing” with traffic**

Frequent braking and acceleration increases fuel consumption significantly. Just by driving defensively and keeping a sufficiently large distance away from the vehicle in front of you can make up for the speed fluctuations caused by taking your foot off the accelerator. Active braking and accelerating is then not necessarily required.



## Calm and smooth driving

Consistency is more important than speed. The more smoothly you drive, the less fuel the vehicle consumes.

When driving on the highway or freeway, a constant, moderate speed is more efficient and economical than constantly accelerating and braking. Usually you can reach your destination just as quickly by driving at a moderate, but steady speed.

The cruise control system can assist in maintaining a uniform driving style.

## Moderate use of extra electrical loads

Comfort inside the vehicle is nice and important, but it is important to use them in an environmentally conscious manner.

Some devices can increase fuel consumption when activated (examples):

- Climate control system (air conditioner): If the air conditioner has to produce starkly contrasting temperatures, it requires a large amount of energy, which is generated by the engine. The temperature in the vehicle should therefore not be extremely different from that of the outside temperature. It may be helpful to ventilate the vehicle before driving and then to drive a short distance with the windows open. After that, switch on the air conditioner with the windows closed. Keep the windows closed when driving at high speeds. Open windows increase fuel consumption.
- Switch off seat heating once it has served its purpose.
- Switch off the rear window defroster as soon as the windows are free of fog and ice.

## Additional factors that increase fuel consumption (examples):

- Malfunctioning engine control.
- Driving in the mountains.
- Towing a trailer.



## NOTICE

Never let the vehicle coast or roll down a hill in Neutral (N), especially when the engine is not running. The transmission will not be lubricated and will be damaged.

## Fuel-efficient driving

---

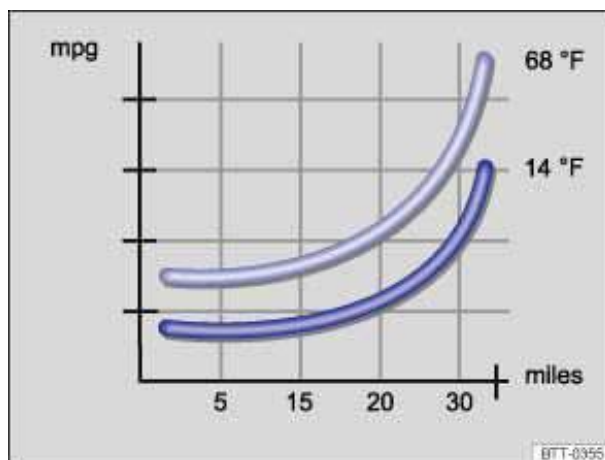
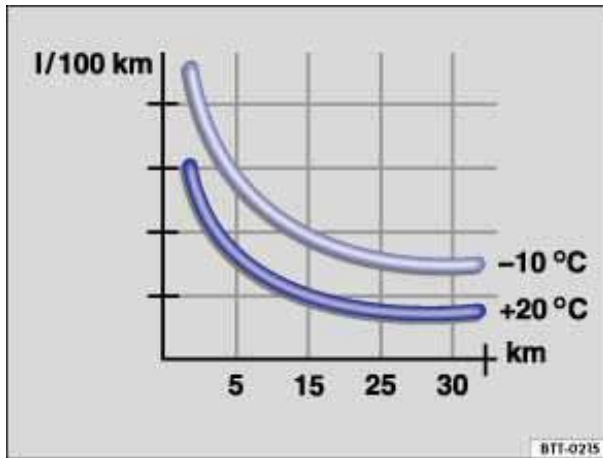

Fig. 124 Fuel consumption in mpg at 2 different outside air temperatures.



**Fig. 125** Fuel consumption in l/100 km at 2 different outside air temperatures.

**⚠ Please first read and note the introductory information and heed the WARNINGS ⚠**

Driving defensively and economically can easily reduce fuel consumption by 10 to 15%.

The vehicle consumes the most fuel when accelerating. Defensive driving requires less braking and therefore less acceleration. If possible, coast the vehicle to a stop, for example, when you can see that the next traffic light is red or about to turn red.

**Avoid traveling short distances**

A cold engine consumes significantly more fuel immediately after starting. It takes a few miles (km) before the engine is warmed up and fuel consumption is stabilized.

To reduce fuel consumption and the emission of pollutants effectively, the engine and catalytic converter must reach their optimal **operating temperature**. Critical in this context is also the **outside air temperature**.

fig. 125 and display the varying fuel consumption rates for the same distance driven, once at +68 °F (+20 °C) and once at +14 °F (-10 °C).

Therefore, avoid driving short distances unnecessarily and consolidate routes.

Under the same conditions, the vehicle consumes more fuel in winter than in summer.

“Letting the engine run to warm up” is not only illegal in some places, but also technically not necessary and wastes fuel.

**Adjust the tire pressure**

The proper tire pressure helps reduce rolling resistance as well as fuel consumption.

When purchasing new tires, always make sure that the tires are optimized for lower rolling resistance.

**Use low viscosity engine oil**

Fully “synthetic,” low viscosity engine oils that expressly comply with Volkswagen oil quality standards reduce fuel consumption. Low viscosity engine oils reduce the frictional resistance on the engine and are distributed more evenly and quickly, particularly when cold-starting the engine. The effect is particularly apparent in vehicles that frequently travel short distances.

Always ensure the right engine oil level is maintained and keep to the scheduled service intervals (engine oil changes).

Make sure the engine oil that you purchase expressly complies with Volkswagen oil quality standards and is the oil approved by Volkswagen for your vehicle.

**Avoid unnecessary weight**

The lighter the vehicle, the more economical and eco-friendly it will be. For example, an extra 220 lbs (100 kg) of weight increases fuel consumption by up to 1 pint per 60 miles (0.3 l/100 km).

Remove all unnecessary items and unnecessary dead weight from the vehicle.

**Remove unnecessary aftermarket components**

The more aerodynamic the vehicle, the less fuel it will consume. Aftermarket components such as bicycle racks reduce its aerodynamic performance.

Therefore, remove unnecessary structures and unused rack systems, particularly if planning to drive at higher speeds.

# Steering

## Introduction

---

In this section you'll find information about:

- Warning and indicator lights
- Steering system information

The power steering system is not hydraulic, it is electro-mechanical. In both cases, the power steering works only when the engine is running.

The hydraulic power steering system uses hydraulic lines, hydraulic oil, a pump, a filter, and other parts to maintain a constant oil pressure in the hydraulic system.

The electro-mechanical power steering system automatically adjusts to driving speed, steering torque, and the steering angle of the wheels. It delivers extra steering force only when you are actually turning the wheels. The electro-mechanical power steering works only when the engine is running.

### More information:

- Starting and stopping the engine
- Vehicle battery
- Towing



### WARNING



Turning the steering wheel is very hard when the power steering system is not working. This makes it harder to steer and control the vehicle.

- Power steering works only when the engine is running.
- Never let the vehicle coast with the engine switched off.
- Never remove the key from the ignition switch while the vehicle is moving or rolling to a stop. The steering wheel will lock and you will be unable to control the vehicle.



## Warning and indicator lights

---

 Please first read and note the introductory information and heed the WARNINGS 

Lights up	Possible cause	Proper response
	Power steering malfunction.	 <b>Stop!</b> Have the power steering system checked immediately by an authorized Volkswagen dealer or an authorized Volkswagen Service Facility.

Lights up	Possible cause	Proper response
	Power steering assist is reduced.	Stop, restart the engine, and drive a short distance. If the yellow warning light does not come on again, you do <b>not</b> need to have the steering system checked. Otherwise, have the steering checked immediately by an authorized Volkswagen dealer or an authorized Volkswagen Service Facility.
	Vehicle battery was disconnected and has been reconnected.	Drive a short distance at about 10–12 mph (15–20 km/h).

Flashes	Possible cause	Proper response
	Electronic steering column lock malfunction.	 <b>Stop!</b> The ignition cannot be switched on. The vehicle must not be towed! Get professional assistance.
	Steering system stiff.	Turn the steering wheel back and forth.
	Steering column not locked/unlocked.	Switch the ignition off and then switch it on again. Heed any messages shown in the instrument cluster display, if applicable. <b>Do not drive any farther</b> if the steering column remains locked after you switch on the ignition. Contact your authorized Volkswagen dealer or an authorized Volkswagen Service Facility for assistance.

When the ignition is switched on, several warning and indicator lights come on briefly for a function check. They go out after a few seconds.

 **WARNING**

Failure to heed warning lights and instrument cluster text messages can cause the vehicle to break down in traffic and result in a collision and serious personal injury.

- Never ignore warning lights or text WARNINGS.
- Always stop the vehicle as soon as it is safe to do so.

 **NOTICE**

Failure to heed warning lights or text WARNINGS can result in vehicle damage.

## Steering system information

 Please first read and note the introductory information and heed the WARNINGS 

To help make it more difficult to steal your vehicle, you should always make sure the steering column is locked before leaving the vehicle.

### **Electronic steering column lock**

The steering column is locked if the vehicle is not moving and the vehicle key is removed from the ignition switch. The electronic steering column will not lock if the vehicle is still moving for longer than 10 seconds after the vehicle key was removed.

### **Power steering**

Power steering automatically adjusts to driving speed, steering torque, and the steering angle of the wheels. Power steering works only when the engine is running.

If power steering is reduced or lost completely, it will be much harder to steer and control the vehicle.

### **Counter-steering assistance**

Counter-steering assistance is part of Electronic Stability Control (ESC). This feature makes it easier for the driver to control the vehicle in difficult situations. For example, if you have to brake hard on a surface that provides uneven traction, the vehicle could pull to the right or left. ESC detects this situation and helps the driver counter-steer with additional steering power ⇒ .



#### **WARNING**

**The counter-steering assistance in ESC can do no more than help the driver steer in difficult situations. The driver must still control the vehicle. The vehicle does not steer by itself with this feature!**



#### **NOTICE**

**If the ignition is off, the steering column lock will engage and the vehicle cannot be steered. For this reason, you must leave the ignition on when going through an automatic car wash, for example, so that the wheels will still steer.**

Reverse (manual transmission) or in Drive **(D)**, Sport Drive **(S)**, or Reverse **(R)** (automatic transmission) and you must use the foot brake to hold the vehicle before starting to move.

Hill Hold keeps the brake applied for not quite 2 seconds with the same force you used to prevent the vehicle from moving. This gives you time to take your foot off the brake, let the clutch out on a manual transmission vehicle, and gently depress the accelerator to get the vehicle moving again. If you do not depress the accelerator pedal and get the vehicle moving again within this time, the brakes will release and the vehicle will roll downhill. Furthermore, if any requirement for engaging Hill Hold is no longer met while the vehicle is stopped, Hill Hold disengages and the brakes are automatically released and will no longer hold the vehicle.

**Hill Hold is activated automatically when the following conditions are all met at the same time.**

**Points 1 to 3 must all be met at the same time:**

Step	Manual transmission	Automatic transmission
1.	Hold the <b>stopped</b> vehicle on an incline with the foot or parking brake.	
2.	The engine must be running “smoothly.”	
3.	A manual transmission vehicle must be in 1st gear <b>(1)</b> if headed up a hill or in Reverse <b>(R)</b> if backing up a hill; you must hold the clutch down and the foot brake must be depressed to keep the vehicle from moving.	An automatic transmission vehicle must be in Reverse <b>(R)</b> , Drive <b>(D)</b> , or Sport Drive <b>(S)</b> and the foot brake must be depressed to keep the vehicle from moving.
4.	To drive off, take your foot off the brake pedal as you let the clutch out and gently depress the accelerator within 2 seconds.	To drive off, take your foot off the brake pedal and gently depress the accelerator within 2 seconds.

**Hill Hold is immediately deactivated:**

- If any requirement listed in the table above is no longer met (see, *Hill Hold is activated automatically when the following conditions are all met at the same time.*).
- If the engine is not running smoothly or the engine malfunctions.
- If the engine stalls or is switched off.
- *Automatic transmission vehicles:* If the transmission is in Neutral **(N)**.
- *Automatic transmission vehicles:* If a tire does not have enough road contact (such as when the vehicle is tipped or at an angle).



## **WARNING**

**The intelligent technology of Hill Hold cannot overcome the laws of physics. Never let the increased convenience provided by Hill Hold tempt you into taking risks.**

- **The Hill Hold feature cannot hold the vehicle in all hill start situations (for example, if the surface is icy or slippery).**
- **Hill Hold can only help keep the vehicle from moving for less than 2 seconds. After that, the brakes will be released and the vehicle can roll down the hill.**

# Park Distance Control

Applicable only in the United States

## Introduction

---

In this section you'll find information about:

Park Distance Control (PDC)

The Park Distance Control system can help the driver when backing up and parking. PDC uses ultrasonic sensors in the bumper to measure the distance between the vehicle and objects. The system uses the time it takes for the ultrasonic waves to bounce back from the object to calculate the distance between the vehicle and an object. Park Distance Control works only at speeds up to about 10 mph (15 km/h).

If the vehicle gets too close to an obstacle behind it, a beeping signal sounds. The closer the vehicle gets to the obstacle, the faster the beep. When the obstacle is very close, the sound is continuous.

If you move even closer to the obstacle despite the continuous warning sound, the system cannot measure the distance remaining until collision.

A Declaration of Compliance with the United States FCC and Industry Canada regulations is found on 298.

### More information:

- Exterior views
- Braking, stopping, and parking
- Consumer information
- Exterior care and cleaning
- Parts, accessories, repairs and modifications
- Radio or Navigation system ⇒ Booklet *Radio* or ⇒ Booklet *Navigation System*



### WARNING

**Park Distance Control is no substitute for careful and attentive driving. Never rely completely on these systems for information about people and objects that might be in the way of the vehicle and could be struck resulting in serious personal injuries.**

- **The sensors have blind spots in which they cannot detect people, animals, and objects.**
- **Always be careful and look around you when parking. The sensors cannot always detect people, animals, and objects. Watch out for small children and animals in particular.**
- **Certain types of clothing and the surfaces of certain objects do not reflect the ultrasonic waves that the sensors send and receive. Such objects and persons wearing such clothing will not be detected by PDC or will not be detected accurately.**
- **Noise in the area can interfere with the signals of the Park Distance Control sensors. Under certain circumstances, the system will not detect people and objects for this reason.**



### NOTICE

- **Things like trailer draw bars, thin rods, fences, trees, narrow painted vertical poles, posts, or a luggage compartment lid that is opening may not be detected by the Park Distance Control sensors and could damage the vehicle.**



# Park Distance Control

Applicable only in the United States

## Introduction

---

In this section you'll find information about:

Park Distance Control (PDC)

The Park Distance Control system can help the driver when backing up and parking. PDC uses ultrasonic sensors in the bumper to measure the distance between the vehicle and objects. The system uses the time it takes for the ultrasonic waves to bounce back from the object to calculate the distance between the vehicle and an object. Park Distance Control works only at speeds up to about 10 mph (15 km/h).

If the vehicle gets too close to an obstacle behind it, a beeping signal sounds. The closer the vehicle gets to the obstacle, the faster the beep. When the obstacle is very close, the sound is continuous.

If you move even closer to the obstacle despite the continuous warning sound, the system cannot measure the distance remaining until collision.

A Declaration of Compliance with the United States FCC and Industry Canada regulations is found on 299.

### More information:

- Exterior views
- Braking, stopping, and parking
- Consumer information
- Exterior care and cleaning
- Parts, accessories, repairs and modifications
- Radio or Navigation system ⇒ Booklet *Radio* or ⇒ Booklet *Navigation System*

### WARNING

**Park Distance Control is no substitute for careful and attentive driving. Never rely completely on these systems for information about people and objects that might be in the way of the vehicle and could be struck resulting in serious personal injuries.**

- **The sensors have blind spots in which they cannot detect people, animals, and objects.**
- **Always be careful and look around you when parking. The sensors cannot always detect people, animals, and objects. Watch out for small children and animals in particular.**
- **Certain types of clothing and the surfaces of certain objects do not reflect the ultrasonic waves that the sensors send and receive. Such objects and persons wearing such clothing will not be detected by PDC or will not be detected accurately.**
- **Noise in the area can interfere with the signals of the Park Distance Control sensors. Under certain circumstances, the system will not detect people and objects for this reason.**

### NOTICE

- **Things like trailer draw bars, thin rods, fences, trees, narrow painted vertical poles, posts, or a luggage compartment lid that is opening may not be detected by the Park Distance Control sensors and could damage the vehicle.**

- If you continue driving closer to an object that the Park Distance Control has already detected and reported, the object may disappear from the sensor range and may no longer be detected. This is especially true for low or high objects. The system will no longer sound warnings about these objects. Ignoring signals from the Park Distance Control system could result in serious damage to the vehicle.
- The sensors in the bumper can be damaged or become misaligned in low speed impacts and parking maneuvers. Damaged or misaligned sensors cannot accurately detect or report objects that might be within range of the PDC system.
- To help make sure that the system works properly, always keep the sensors in the bumpers clean and free of snow and ice; do not cover the sensors with stickers or other objects.
- When cleaning the sensors with power washers or steam cleaners, only spray the sensors directly for a very short time, and always keep the washer nozzle at least 4 inches (10 cm) from the sensors.
- Noise from rough roads, cobblestones, other vehicles and the surrounding area, for example, can prevent the Park Distance Control system from accurately detecting and reporting people and objects that may be within range of the system sensors.



Volkswagen recommends practicing with the Park Distance Control system in a location or parking space with no traffic in order to become familiar with the system and how it works.

applicable only in the United States

## Park Distance Control (PDC)

---



Fig. 126 In the center console: Button to switch the Park Distance Control system on or off.



Fig. 127 Park Distance Control system sensors.

**⚠ Please first read and note the introductory information and heed the WARNINGS ⚠**

The Park Distance Control System sensors are in the front and rear bumpers

**Switching the Park Distance Control system on and off manually**

- Push the **PDC** button *once* ⇒ [fig. 126](#) when the ignition is switched on to switch the Park Distance Control on.
- Push the **PDC** button *again* when the ignition is switched on to switch the Park Distance Control off.

The indicator light in the button remains on as long as the feature is active.

**Switching the Park Distance Control system on and off automatically**

- *Turn on* Shift into Reverse (**R** on an automatic transmission vehicle) when the ignition is on.
- *Turn off*: Drive forward faster than about 10 mph (15 km/h ).

A chime sounds to tell you that the system is on. If the chime does **not** sound, PDC is not working. Have the system inspected by an authorized Volkswagen dealer or an authorized Volkswagen Service Facility.

**Special considerations when using Park Distance Control**

- In some cases, the Park Distance Control interprets water and ice on the sensors as an obstacle.
- If the distance remains the same, the warning tone volume decreases after a few seconds. If a continuous tone sounds, its volume remains the same.
- If the vehicle moves away from the obstacle, the beeping sound stops automatically. The beep turns on again automatically if the vehicle approaches the obstacle again.
- For vehicles with automatic transmissions, there is no beeping when the transmission is in Park (**P**).
- The volume of the audible signals can be adjusted by an authorized Volkswagen dealer or an authorized Volkswagen Service Facility.



**WARNING**

**Never rely completely on the PDC for information about people and objects that might be in the way of the vehicle and could be struck by the vehicle causing serious personal injury.**

- **The PDC sensors have blind spots where they cannot detect people or objects.**
- **Always watch for people, especially small children and animals, because the sensors may not always be able to detect them.**



If you hear a long beep lasting about 3 seconds when you first turn PDC on or the indicator light in the button starts blinking, this means there is a malfunction in the Park Distance Control system. Switch off the Park Distance Control system with the button and have it immediately checked by an authorized Volkswagen dealer or an authorized Volkswagen Service Facility.

# Rear Assist

## Introduction

---

In this section you'll find information about:

- Operation instructions
- Perpendicular parking (Mode 1)
- Parallel parking (Mode 2)

There is a camera in the luggage compartment lid to assist the driver while backing up or maneuvering. The camera image is shown together with orientation lines projected by the system on the screen of the factory-installed radio or navigation system.

Rear Assist may take a few seconds to bring up the camera image.

2 different orientation lines (modes) can be selected:

- **Mode 1:** Backing into a parking space at right angles to the direction of traffic, such as in a parking lot.
- **Mode 2:** Parallel parking (parking parallel to the direction of traffic).

You can select the mode by tapping the function key on the radio or navigation system screen. Only the mode selected is displayed.

### More information:

- Exterior views
- Parts, accessories, repairs and modifications
- ⇒ Booklet *Radio* or ⇒ Booklet *Navigation System*



### WARNING

Rear Assist is not able to give you a clear and undistorted view of all areas behind the vehicle.

- The camera has blind spots in which it cannot detect people and objects.
- Always be careful and look around you when parking. The camera cannot show people, animals, and objects in certain situations. Watch out for small children and animals in particular.
- Due to the screen resolution or in low-light conditions, the camera may not pick up thin posts, chain-link fences and similar fences, and other objects, or it may not show them clearly.
- The camera lens enlarges and distorts the field of vision and causes objects on the screen to appear altered and imprecise.
- Always keep the camera lens clean and free of snow and ice; do not cover the lens.

## **⚠ WARNING**

Rear Assist technology cannot overcome the laws of physics and the limits of the system. Careless or unintentional use of Rear Assist may result in accidents and severe injuries.

- Always adjust your speed and driving style to road, traffic, weather, and visibility conditions.
- Always keep an eye on the parking direction and the vehicle surroundings. The front of the vehicle swings out more than the rear of the vehicle.
- Never pay so much attention to the graphics shown on the screen that you fail to notice what is going on around you.
- Always watch for people, especially small children, animals, and objects, because the camera may not always be able to detect them.
- The system may not be able to clearly show everything behind the vehicle.
- Use Rear Assist only when the luggage compartment lid is completely closed.

## **ⓘ NOTICE**

- The camera shows only two-dimensional images on the screen. Due to the lack of depth of field, it may be difficult or impossible to identify protruding objects or recesses in the road, for example.
- Things like thin rods, fences, posts, and trees may not be detected by the camera and could damage the vehicle.

## Operation instructions

---

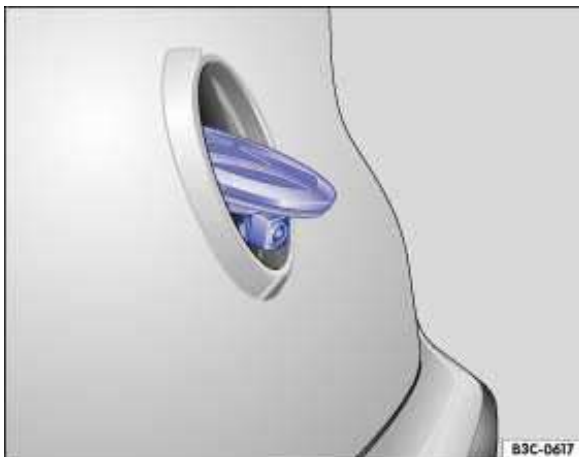

**Fig. 128** In the luggage compartment lid: Location of the Rear Assist camera.

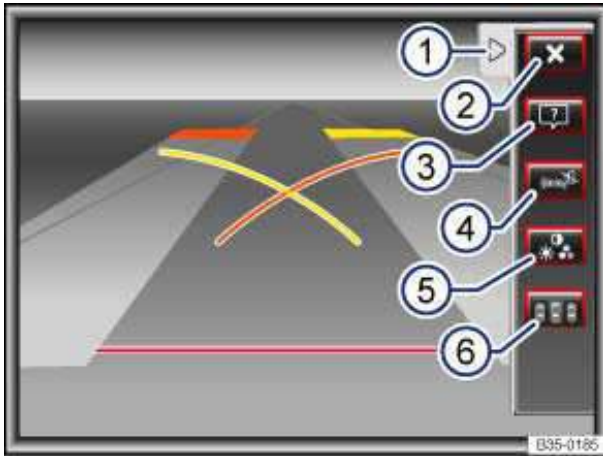

**Fig. 129** Display of the Rear Assist: Mode 2 activated.

**⚠ Please first read and note the introductory information and heed the WARNINGS ⚠**

Function buttons on the screen ⇒ [fig. 129](#):

- (1) Display the menu (◀) or hide the menu (▶).
- (2) ✕ Turn off the rearview camera screen.
- (3) Show help function. The surfaces and lines in the camera image are explained in the help overview. Press ↵ to leave the help overview.
- (4) Turn off sound.
- (5) Adjust display: brightness, contrast, color.
- (6) Activate orientation guides to park in reverse perpendicular to the road (Mode 1).

In order to:	Operation
Automatically activate display:	Shift into Reverse when the ignition is switched on or the engine is running. Mode 1 is displayed.
Manually deactivate display:	Press a function selection button on the radio or navigation system ⇒ Booklet <i>Radio</i> or ⇒ Booklet <i>Navigation system</i> . <b>OR:</b> Touch the ✕ function button on the screen. <b>OR:</b> Switch off the ignition. The Rear Assist display screen turns off after a few seconds.
Switch off display by shifting out of Reverse:	The display switches off after about 10 seconds.
Deactivate display by driving forward:	Drive forward faster than about 10 mph (15 km/h).

### Special considerations

#### 1) Do not use Rear Assist in the following situations:

- When an incorrect or unclear image is displayed, such as when there is poor visibility or the lens is dirty.
- If the area behind the vehicle cannot be seen clearly or completely.
- If the rear of the vehicle is heavily loaded.
- When the luggage compartment lid is open.

## 1) Do not use Rear Assist in the following situations:

- If the driver is not familiar with the system.
- If the position or angle of the camera has changed, such as after a rear-end collision. Have the system checked by an authorized Volkswagen dealer or an authorized Volkswagen Service Facility.

## 2) Examples of optical distortion by the camera:

The Rear Assist camera displays only two-dimensional images. Recesses and protruding objects on the ground or protruding parts on other vehicles are difficult or impossible to identify due to the lack of depth of field.

Objects or another vehicle may seem closer or farther away on the screen than they really are:

- When driving from a level surface onto an upward or downward slope.
- When driving up or down a slope onto a level surface.
- If the rear of the vehicle is heavily loaded.
- When approaching protruding objects. These objects can disappear from the field of view when backing up.

### Cleaning the camera lens

Keep the camera lens clean and free of snow and ice:

- Engage the parking brake.
- Switch on the ignition.
- Select the Reverse (**R**) gear.
- Wet the camera lens with a commercially available alcohol-based glass cleaner and clean with a dry cloth ⇒ ⚠.
- Remove snow with a brush.
- Remove ice with deicer spray ⇒ ⚠.

### ⚠ NOTICE

- **Never use abrasive cleaning agents to clean the camera lens.**
- **Never remove snow or ice on the camera lens with warm or hot water. This can damage the camera lens.**

**i** Volkswagen recommends practicing parking with Rear Assist in a safe place with little or no traffic or in a parking lot under good visibility and weather conditions in order to familiarize yourself with the system, the orientation lines and the way they work.

**i** Rear Assist does not work when the luggage compartment lid is open.

## Perpendicular parking (Mode 1)

---

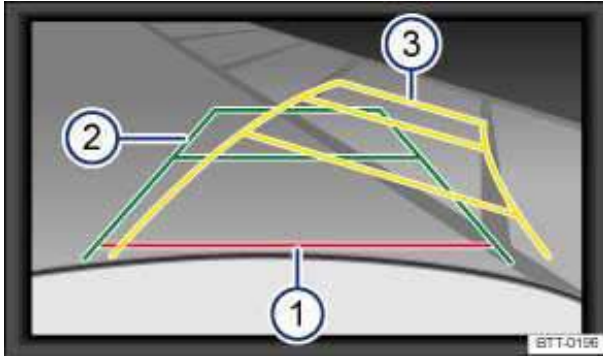

Fig. 130 On the screen: Orientation lines for the parking area behind the vehicle.

ⓘ Please first read and note the introductory information and heed the WARNINGS ⚠

### Orientation lines overview

Meaning of the orientation lines projected on the screen ⇒ fig. 130. All distances of the orientation lines refer to a vehicle on a level surface.

- (1) Red: Safety distance. Area up to about 16 inches (40 cm) behind the vehicle on the road.
- (2) Green: Vehicle extension (somewhat wider) toward the rear. The green area ends about 6 feet (2 meters) behind the vehicle on the road.
- (3) Yellow: The extension of the vehicle to the rear showing the vehicle path as determined by the position of the steering wheel. The yellow area ends about 10 feet (3 meters) behind the vehicle on the road.

### Parking

- Position the vehicle in front of a parking space and shift into Reverse.
- Slowly back up and steer so that the yellow orientation lines lead into the parking space (3).
- Align the vehicle so that the green and yellow orientation lines are parallel with the parking space.

## Parallel parking (Mode 2)

---

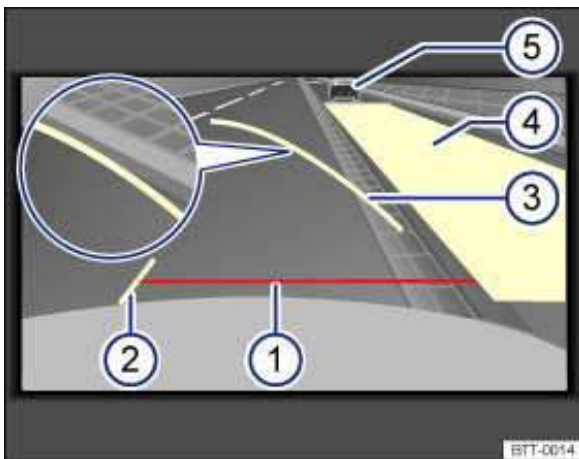

Fig. 131 On screen: Orientation lines and area of the parking space behind the vehicle.

ⓘ Please first read and note the introductory information and heed the WARNINGS ⚠



When a turn signal is set, unnecessary lines and areas are hidden.

### Orientation lines overview

Meaning of the orientation lines and areas projected on screen ⇒ [fig. 131](#). All distances of the orientation lines refer to a vehicle on a level surface.

- (1) Red: Safety distance. Area up to about 16 inches (40 cm) behind the vehicle on the road.
- (2) Vehicle's width limits.
- (3) Point to change steering angle.  
When the yellow line touches the curb or any other parking space boundary, the steering wheel must be turned in the opposite direction (close-up view).
- (4) The area parallel to the vehicle that is needed for parking. The area shown must fit completely into the parking space.
- (5) Parked vehicle at the curb.

### Parking

- Position the vehicle about 3 feet (1 meter) away from and parallel to the parking space and shift into Reverse.
- On the screen of the navigation system, activate Mode 2 for parallel parking.
- Back up slowly and steer the vehicle so that the yellow surface on the screen is flush with the side boundary of the parking space (such as the curb) and stops short of any obstacle (5), such as another vehicle.
- Turn the steering wheel as far as it will go into the direction of the parking space and slowly back up.
- Once the yellow line (3) touches the side of the parking space, for example, a marking or the curb (close-up view), turn the steering wheel as far as it will go in the opposite direction.
- Continue backing up until the vehicle is positioned in the parking space parallel to the road. If necessary, correct the parking position.



It may take up to 5 seconds for the area detected by the sensors to be displayed on the factory-installed radio or navigation system screen.

# Cruise Control System (CCS)

## Introduction

---

In this section you'll find information about:

Indicator lights

Indicator lights

Cruise control operation

The Cruise Control System (CCS) helps maintain an individually stored constant speed when driving above about 12 mph 20 (km/h).

The CCS slows down the vehicle only by reducing the flow of fuel to the engine, not by braking ⇒ .

### More information:

- Shifting gears
- Parts, accessories, repairs and modifications



### WARNING

Using the cruise control when it is not possible to drive safely at a constant speed can be dangerous and can lead to an accident and serious personal injuries.

- Never use cruise control when driving in heavy or varying traffic or when you cannot keep a safe distance between you and the vehicles ahead of you.
- Never use cruise control on steep, winding, or slippery roads (such as gravel roads, wet roads, or snowy or icy roads) or on roads with standing water.
- Never use cruise control when driving off-road or on unpaved roads.
- Always adjust your speed and the distance you keep between you and the vehicles ahead of you to the road, traffic, weather, and visibility conditions.
- To help prevent unintended operation of cruise control, switch the system off when it is not being used.
- It is dangerous to use the Resume feature when the previously set speed is too high for the existing road, traffic, or weather conditions.
- When going downhill, the cruise control may not be able to maintain a constant speed. The vehicle will speed up because of its own weight. Downshift and/or use the foot brake to slow the vehicle.

Applicable only in the United States

## Indicator lights



Fig. 132 In the instrument cluster display: Cruise control status indications.

⚠ Please first read and note the introductory information and heed the WARNINGS ⚠

### Display

Different cruise control versions are available. The stored speed is shown in the instrument cluster display on some equipment versions.

Status fig. 132

- (A) Cruise control temporarily deactivated. Stored speed in small numbers.
- (B) System malfunction. See an authorized Volkswagen dealer or an authorized Volkswagen Service Facility.
- (C) Cruise control activated. No speed stored in memory.
- (D) Cruise control is active. Stored speed in large numbers.

### Indicator lights

Lights up	Possible cause
	Cruise control is regulating the speed.
<b>CRUISE</b>	

When the ignition is switched on, several warning and indicator lights come on briefly for a function check. They go out after a few seconds.

### ⚠ WARNING

Failure to heed warning lights and instrument cluster text messages can cause the vehicle to break down in traffic and result in a collision and serious personal injury.

- Never ignore warning lights or text WARNINGS.
- Always stop the vehicle as soon as it is safe to do so.

### ⓘ NOTICE

Failure to heed warning lights or text WARNINGS can result in vehicle damage.

Applicable only in Canada

## Indicator lights



Fig. 133 In the instrument cluster display: Cruise control status indications.

⚠ Please first read and note the introductory information and heed the WARNINGS ⚠

### Display

Different cruise control versions are available. The stored speed is shown in the instrument cluster display on some equipment versions.

Status ⇒ fig. 133

- (A) Cruise control temporarily deactivated. Stored speed in small numbers.
- (B) System malfunction. See an authorized Volkswagen dealer or an authorized Volkswagen Service Facility.
- (C) Cruise control activated. No speed stored in memory.
- (D) Cruise control is active. Stored speed in large numbers.

### Indicator lights

Lights up	Possible cause
	Cruise control is regulating the speed.
<b>CRUISE</b>	

When the ignition is switched on, several warning and indicator lights come on briefly for a function check. They go out after a few seconds.

### ⚠ WARNING

Failure to heed warning lights and instrument cluster text messages can cause the vehicle to break down in traffic and result in a collision and serious personal injury.

- Never ignore warning lights or text WARNINGS.
- Always stop the vehicle as soon as it is safe to do so.

### ⓘ NOTICE

Failure to heed warning lights or text WARNINGS can result in vehicle damage.

## Cruise control operation

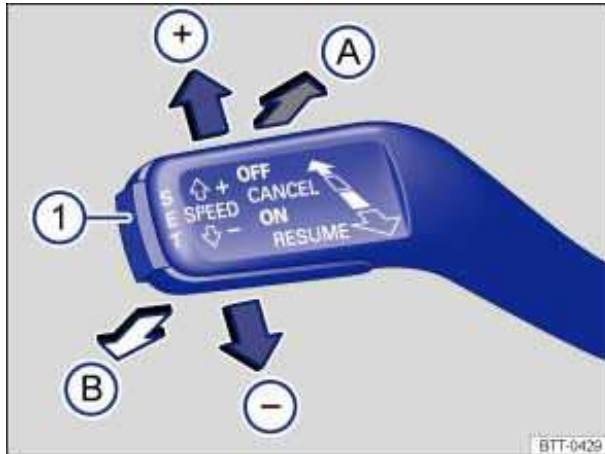

Fig. 134 On the left side of the steering column: Cruise control operating lever.

⚠ Please first read and note the introductory information and heed the WARNINGS ⚠

In order to:	You must ⇒ fig. 134	Result:
Switch on cruise control.	Move lever to the <b>ON</b> position (A)	System is switched on, but does not regulate vehicle speed until a speed is set.
Set cruise control to current vehicle speed.	Press the <b>SET</b> button (1).	Current vehicle speed is set; cruise control helps to maintain this speed. If the cruise control is already regulating vehicle speed, the stored speed is reduced by 1 mph (1 km/h) each time the button is pressed.
Temporarily deactivate cruise control.	Push the lever <i>briefly</i> to the <b>CANCEL</b> position (B). <b>OR:</b> Depress the brake or clutch pedal.	Cruise control is temporarily deactivated. The speed is still stored in the memory.
Resume speed stored in cruise control.	Pull the lever <i>briefly</i> to the <b>RESUME</b> position (A).	Cruise control resumes speed previously set. If there is not a previously stored speed, the cruise control system stores and maintains the current speed. If the cruise control is already regulating vehicle speed, the stored speed is increased by 1 mph (1 km/h) each time the button is pressed.
Increase set speed (while cruise control is actively controlling vehicle speed).	Push the lever <i>briefly</i> to the <b>SPEED +</b> position (+) to increase speed in increments of 5 mph (10 km/h) and store.	The vehicle will accelerate until the new higher speed is reached and saves the new higher speed in the memory.
	Push <i>and hold</i> the lever in the <b>SPEED +</b> position (+) to increase the set speed until the higher desired speed is reached and button is released.	

In order to:	You must ⇒ <a href="#">fig. 134</a>	Result:
Reduce set speed (while cruise control is actively controlling vehicle speed).	Push the lever <i>briefly</i> to the <b>SPEED</b> – position (–) to reduce speed in increments of 5 mph (10 km/h) and store.	Cruise control will slow the vehicle down <i>without braking</i> by reducing the flow of fuel to the engine until the new lower speed is reached and saves the new lower speed in the memory.
	Push <i>and hold</i> the lever in the <b>SPEED</b> – position (–) to reduce the set speed until the lower desired speed is reached and the button is released.	
Switch off cruise control.	Move the lever to the <b>OFF</b> position (B).	System is switched off. The set speed is deleted.

### Driving downhill with cruise control

If cruise control cannot maintain constant speed while driving downhill, slow the vehicle with the foot brake and downshift if necessary.

### Automatic deactivation

Cruise control speed regulation is automatically deactivated or temporarily interrupted:

- If the system detects an error that could affect the function of the cruise control.
- If the vehicle has accelerated and goes faster than the stored speed for a longer time.
- If the brake or clutch pedal is depressed.
- If the vehicle shifts gear (manual transmission).
- If an airbag deploys.

# Tire Pressure Monitoring System (TPMS)

Applicable only in the United States

## Introduction

---

In this section you'll find information about:

Indicator light (telltale) 

Indicator light (telltale) 

Tire Pressure Monitoring System (TPMS)

Tire Pressure Monitoring System (TPMS)

The Tire Pressure Monitoring System (TPMS) uses a pressure sensor in each wheel. Signals from the sensors are transmitted to the TPMS.

The TPMS checks the tire pressure of all 4 tires while you are driving and warns if there is a loss of pressure while the vehicle is moving. Pressure loss that is 25% or more of the benchmark value programmed into the system is signaled by the indicator light (telltale), by acoustic warnings, and by text messages in the instrument cluster display.

### **More information:**

- Volkswagen Information System
- Transporting
- Braking, stopping and parking
- Exterior care and cleaning
- Tires and wheels
- Parts, accessories, repairs and modifications
- Consumer information



## WARNING

Incorrect tire pressures and/or underinflation can cause sudden tire failure, loss of control, collision, serious personal injury or even death.

- When the warning symbol appears in the instrument cluster, stop and inspect the tires.
- Incorrect tire pressure and/or underinflation can cause increased tire wear and can affect the handling of the vehicle and stopping ability.
- Incorrect tire pressures and/or underinflation can also lead to sudden tire failure, including a blowout and sudden deflation, causing loss of vehicle control.
- The driver is responsible for the correct tire pressures for all tires on the vehicle. The recommended tire pressure values are listed on a sticker inside the driver door .
- The TPMS can only work correctly when all tires on the vehicle are filled to the correct cold tire inflation pressure specified for the tires installed on the vehicle.
- Using incorrect tire pressure values can cause accidents or other damage. Always inflate the tires to the correct specified cold tire pressure values for the tires installed on the vehicle.
- Always maintain correct cold tire inflation pressure so that TPMS can do its job.
- Always inflate tires to the recommended and correct tire pressure before driving off.
- Driving with underinflated tires causes them to flex (bend) more, letting them get too hot, resulting in tread separation, sudden tire failure, and loss of control.
- Excessive speed and/overloading can cause heat build-up, sudden tire failure, and loss of control.
- If the tire pressure is too low or too high, the tires will wear prematurely and the vehicle will not handle well.
- If the tire is not “flat” and you do not have to change a wheel immediately, drive carefully and at reduced speed to the nearest service station to check the tire pressure and add air as required.
- When replacing tires or wheel rims on vehicles equipped with TPMS always read and heed the information and all WARNINGS regarding , *Tires and wheels*.



## NOTICE

- The wheel electronics are attached to special aluminum valves on the wheels. These valves are screwed on rigidly. Never bend the valves “into position” when checking and adjusting tire pressure.
- Missing valve stem caps can cause damage to the valves as well as to the TPMS sensors. To help prevent damage, always use valve stem caps like those originally installed at the factory. The caps must be screwed on tightly. Do not use metal valve stem caps.
- Do not use “comfort valve caps.” They do not seal properly and can damage the sensors.
- When replacing or rotating tires, make certain the valves and sensors are not damaged.
- The aluminum valves that are installed should be replaced after about 6 years of use because of aging in the rubber seals. The valves can be replaced when a tire is changed. Do not reuse aluminum valves after they are removed. They must be replaced. The tire pressure sensor can be reused.
- When replacing the valve cores, use only nickel-plated replacement cores.
- The batteries in the wheel electronics last up to 10 years. It is not possible to replace the batteries. The entire device must be replaced.



Underinflation increases fuel consumption and tire wear.





Dispose of the wheel electronics and the old batteries in an environmentally responsible manner. Batteries of the type used in the wheel electronics may contain Perchlorate Material. Special handling may apply. See [www.dtsc.ca.gov/hazardouswaste/perchlorate](http://www.dtsc.ca.gov/hazardouswaste/perchlorate). Obey all applicable legal requirements regarding proper disposal.



Do not rely only on the Tire Pressure Monitoring System. Check your tires regularly to make sure they are properly inflated and have no signs of damage, such as punctures, cuts, cracks, and blisters. Remove any objects that become embedded in the tire tread but have not penetrated into the body of tire itself.



The Tire Pressure Monitoring System checks for the factory-recommended inflation pressure, as shown on the label inside the driver door

- For replacement tires that require a different inflation pressure, the TPMS must be adjusted to the new pressure specification by an authorized Volkswagen dealer or an authorized Volkswagen Service Facility. Only one value can be entered for each tire; see the tire inflation pressure label on the driver door pillar
- To help prevent damage to the sensor and valve, do not put excessive force on the valve when checking the tire pressure. Do not try to bend the valve.
- If sensors have to be replaced, have the valves changed at the same time.
- The tire valve gaskets must be replaced whenever a tire is mounted on the rim. Your authorized Volkswagen dealer or authorized Volkswagen Service Facility has a valve seal and gasket kit for this purpose. Always make sure that a valve seal and gasket kit is also used whenever a sensor is replaced.
- If you have to adjust the tire pressure on a “warm” tire, fill the tire with 2.0 - 4.35 psi (20 - 30 kPa) more than the pressure specified on the tire pressure label.
- When the TPMS determines that the air pressure in at least one tire is too low, carefully check the pressure in all 4 tires with an accurate tire pressure gauge. Low tire pressure usually cannot be determined by looking at the tire. This is especially true of low-profile tires.



A Declaration of Compliance with the United States FCC and Industry Canada regulations is found in the Consumer Information section of this Manual



There may be differences between the pressure readings from a tire pressure gauge and the pressures registered by the Tire Pressure Monitoring System. The electronic TPMS is more accurate.



If you have work done on your wheels or tires, inform the workshop that the vehicle is equipped with a Tire Pressure Monitoring System that has sensors in the wheels.

Applicable only in Canada

## Introduction

---

In this section you'll find information about:

Indicator light (telltale)

Indicator light (telltale)

Tire Pressure Monitoring System (TPMS)

Tire Pressure Monitoring System (TPMS)

Your vehicle's Tire Pressure Monitoring System (TPMS) uses the Anti-lock Brake System (ABS) sensors to indirectly check the tire pressure of all 4 tires while you are driving. The sensors monitor the tread circumference (rolling circumference) and vibration characteristics of the individual tires. TPMS warns if there is a significant loss of pressure in one or more tires while the vehicle is moving. Pressure loss is signaled by the indicator light  $\zeta$  (described below) as well as by text warnings in the instrument cluster display if your vehicle has this display (Multi-Function Indicator- MFI).

The original benchmark pressure is the recommended maximum load cold tire inflation pressure for the tires that come with your vehicle. This pressure is listed on the tire pressure label on the driver door jamb. After adjusting the tire pressures in all 4 tires, you must confirm and store the new cold inflation pressures using the **Settings** menu in the instrument cluster, which changes the benchmark pressure to match the current pressure of the tires on your vehicle.

Recalibrating the TPMS to reset the benchmark cold tire inflation pressure is explained below

**More information:**

- Volkswagen Information System
- Transporting
- Braking, stopping and parking
- Exterior care and cleaning
- Tires and wheels
- Parts, accessories, repairs and modifications
- Consumer information



## WARNING

Incorrect tire pressures and/or underinflation can cause sudden tire failure, loss of control, collision, serious personal injury or even death.

- When the warning symbol appears in the instrument cluster, stop and inspect the tires.
- Incorrect tire pressure and/or underinflation can cause increased tire wear and can affect the handling of the vehicle and stopping ability.
- Incorrect tire pressures and/or underinflation can also lead to sudden tire failure, including a blowout and sudden deflation, causing loss of vehicle control.
- The driver is responsible for the correct tire pressures for all tires on the vehicle. The recommended tire pressure values are listed on a sticker inside the driver door 272.
- The TPMS can only work correctly when all tires on the vehicle are filled to the correct cold tire inflation pressure.
- Using incorrect tire pressure values can cause accidents or other damage. Always inflate the tires to the correct specified cold tire pressure values for the tires installed on the vehicle.
- Always maintain correct cold tire inflation pressure so that TPMS can do its job.
- Always inflate tires to the recommended and correct tire pressure before driving off.
- Driving with underinflated tires causes them to flex (bend) more, letting them get too hot, resulting in tread separation, sudden tire failure, and loss of control.
- Excessive speed and/or overloading can cause heat build-up, sudden tire failure and loss of control.
- If the tire pressure is too low or too high, the tires will wear prematurely and the vehicle will not handle well.
- If the tire is not “flat” and you do not have to change a wheel immediately, drive carefully and at reduced speed to the nearest service station to check the tire pressure and add air as required.
- When replacing tires or wheel rims on vehicles equipped with TPMS always read and heed the information and all WARNINGS regarding , *Tires and wheels*.
- The Tire Pressure Monitoring System must be recalibrated whenever you remove and remount or change any wheel or tire on the vehicle, even if the reinstalled or replacement wheels and tires are identical to those that were removed and even if the tire pressure does not change .



## WARNING

Improper recalibration can cause the TPMS to give false warnings or to give no warning despite dangerously low tire pressure.



Underinflation increases fuel consumption and tire wear.





Do not rely solely on the Tire Pressure Monitoring System. Check your tires regularly to make sure they are properly inflated and have no signs of damage, such as punctures, cuts, cracks, and blisters. Remove any objects that become embedded in the tire tread but have not penetrated into the body of tire itself.



When you take delivery of the vehicle, the Tire Pressure Monitoring System is calibrated for the factory-recommended cold tire inflation pressure for the tires on your vehicle, as shown on the label inside the driver door .

- The system must be recalibrated whenever you remove and remount or change any wheel or tire on the vehicle, even if the reinstalled or replacement wheels and tires are identical to those that were removed and even if the tire pressure does not change .
- If you have to adjust the tire pressure on a warm tire, fill the tire with 2.0 - 4.35 psi (20 - 30 kPa) more than the pressure specified on the tire pressure label inside the driver door 272.
- If the TPMS determines that the air pressure in at least one tire is too low, carefully check the pressure in all 4 tires with an accurate tire pressure gauge. Low tire pressure usually cannot be determined by looking at the tire. This is especially true of low-profile tires.

 If you have work done on your wheels or tires, inform the workshop that the vehicle is equipped with a Tire Pressure Monitoring System (TPMS).





 New tires may expand slightly the first time they are driven at high speeds, which can trigger a tire pressure warning. Remember that tire pressure can only be properly measured when the tire is “cold” .



 Only replace old tires with tires that have been approved by Volkswagen for your vehicle type.

Applicable only in the United States

## Indicator light (telltale)

 Please first read and note the introductory information and heed the **WARNINGS**  222.

Lights up	Display text	Possible cause or meaning ⇒ 	Proper response
	<b>FLAT TIRE</b>	Rapid loss of pressure in one or more tires. At least one tire has a pressure below 20.3 psi (1.4 bar) or a loss of tire pressure greater than 2.9 psi/min (0.2 bar/min).	 <b>Stop!</b> Reduce speed immediately! Stop the vehicle as soon as it is safe to do so. Avoid fast cornering and hard braking! Check all tires for external damage and embedded objects. Check the inflation pressure of all 4 tires. If you are sure it is not necessary to change a tire right away, drive at reduced speed to the nearest authorized Volkswagen dealer or authorized Volkswagen Service Facility.
	<b>TIRE PRESSURE TOO LOW</b>	Critical loss of pressure in at least one tire with the pressure more than 7.25 psi (0.5 bar) below the specified value.	Immediately check the tire inflation pressure of all tires. If you are sure it is not necessary to change a tire right away, drive at reduced speed to the nearest authorized Volkswagen dealer or authorized Volkswagen Service Facility.

Flashes	Display text	Possible cause or meaning ⇒ 	Proper response
 (Intermittently while driving.)	–	There is a malfunction between a sensor and the system. The function can be temporarily disrupted by interference from transmitters in the vicinity of the vehicle working in the same frequency range such as radio equipment, remote controls or children's toys.	Switch the source of interference off.
	–	There is a system malfunction if the indicator light flashes for about 65 seconds and then stays on <i>continuously</i> .	If the tire pressure is correct but the indicator light stays on or keeps flashing after you switch the ignition off and on again, have an authorized Volkswagen dealer or an authorized Volkswagen Service Facility check the system.

When the ignition is switched on, several warning and indicator lights come on briefly for a function check. They go out after a few seconds.



## WARNING

Incorrect tire pressures and/or underinflation can cause sudden tire failure, loss of control, collision, serious personal injury, or even death.

- When the warning symbol  appears in the instrument cluster, stop the vehicle as soon as it is safe to do so and inspect all tires.
- Incorrect tire pressure and/or underinflation can cause increased tire wear and can affect the handling of the vehicle and its stopping ability.
- Incorrect tire pressure and/or underinflation can also lead to sudden tire failure, including a blowout and sudden deflation, causing loss of vehicle control.
- The driver is responsible for the correct tire pressures for all tires on the vehicle. The recommended tire pressure values are listed on a sticker inside the driver's door
- The TPMS can only work correctly when all tires on the vehicle are filled to the correct cold tire inflation pressure. Always maintain the correct cold tire inflation pressure so that TPMS can do its job.
- Using incorrect tire pressure values can cause accidents or other damage. Check the pressure in all 4 tires when the tires are still cold. Never reduce air pressure in warm tires to match cold tire inflation pressure.
- Always inflate the tires to the correct specified cold tire pressure values for the tires installed on the vehicle; see the tire inflation pressure label on the driver door jamb .
- Always inflate tires to the recommended and correct tire pressure before driving off.
- Driving with underinflated tires causes them to flex (bend) more, letting them get too hot, which can result in tread separation, sudden tire failure, and loss of control.
- Excessive speed and/or overloading can cause heat build-up, sudden tire failure, and loss of control.
- If the tire pressure is too low or too high, the tires will wear prematurely and the vehicle will not handle well.
- If the tire is not “flat” and you do not have to change the tire or wheel immediately, drive at reduced speed to the nearest service station to check the tire pressure and add air as required.
- When replacing tires or wheel rims on vehicles equipped with TPMS, always read and heed the information and all WARNINGS in the section, *Tires and wheels*.



## WARNING

Failure to heed warning lights and instrument cluster text messages can cause the vehicle to break down in traffic and result in a collision and serious personal injury.

- Never ignore warning lights or text WARNINGS.
- Always stop the vehicle as soon as it is safe to do so.





## NOTICE



Failure to heed warning lights or text WARNINGS can result in vehicle damage.

Applicable only in Canada

**Indicator light (telltale)** 

 Please first read and note the introductory information and heed the WARNINGS 

Lights up	Possible cause or meaning ⇒ 	Proper response
	<p>Lights up and a chime may also sound. The inflation pressure of one or more tires is significantly lower than the benchmark pressure set by the driver or a tire has structural damage. Depending on vehicle equipment, a text message may also appear in the instrument cluster display.</p>	<p> <b>Stop safely as soon as possible!</b>  Reduce speed immediately! Avoid fast cornering and hard braking!  Check the condition and inflation pressure of all tires. Have damaged tires replaced.</p>

Flashes	Possible cause or meaning ⇒ 	Proper response
	<p>Flashes for about 1 minute and then stays on:  System malfunction.</p>	<p>Check and, if necessary, adjust the tire inflation pressure in all 4 tires. If the tire pressure is correct, switch the ignition off and back on.  If the indicator light flashes again and then stays on or does not go out after checking and adjusting the air pressure in all 4 tires and you cannot calibrate the TPMS, take the vehicle to an authorized Volkswagen dealer or an authorized Volkswagen Service Facility. Have the system checked.</p>

When the ignition is switched on, several warning and indicator lights come on briefly for a function check. They go out after a few seconds.



## WARNING

Incorrect tire pressures and/or underinflation can cause sudden tire failure, loss of control, collision, serious personal injury, or even death.

- When the warning symbol  $\varphi$  appears in the instrument cluster, stop the vehicle as soon as it is safe to do so and inspect all tires.
- Incorrect tire pressure and/or underinflation can cause increased tire wear and can affect the handling of the vehicle and its stopping ability.
- Incorrect tire pressure and/or underinflation can also lead to sudden tire failure, including a blowout and sudden deflation, causing loss of vehicle control.
- The driver is responsible for the correct tire pressures for all tires on the vehicle. The recommended tire pressure values are listed on a sticker inside the driver door.
- The TPMS can only work correctly when all tires on the vehicle are filled to the correct cold tire inflation pressure. Always maintain the correct cold tire inflation pressure so that TPMS can do its job.
- Using incorrect tire pressure values can cause accidents or other damage. Check the pressure in all 4 tires when the tires are still cold. Never reduce air pressure in warm tires to match cold tire inflation pressure.
- Always inflate the tires to the correct specified cold tire pressure values for the tires installed on the vehicle; see the tire inflation pressure label on the driver door jamb *Tires and wheels*.
- Always inflate tires to the recommended and correct tire pressure before driving off.
- Driving with underinflated tires causes them to flex (bend) more, letting them get too hot, which can result in tread separation, sudden tire failure, and loss of control.
- Excessive speed and/or overloading can cause heat build-up, sudden tire failure, and loss of control.
- If the tire pressure is too low or too high, the tires will wear prematurely and the vehicle will not handle well.
- If the tire is not “flat” and you do not have to change the tire or wheel immediately, drive at reduced speed to the nearest service station to check the tire pressure and add air as required.
- When replacing tires or wheel rims on vehicles equipped with TPMS, always read and heed the information and all WARNINGS in the section 267, *Tires and wheels*.
- The Tire Pressure Monitoring System must be recalibrated whenever you remove and remount or change any wheel or tire on the vehicle, even if the reinstalled or replacement wheels and tires are identical to those that were removed and even if the tire pressure does not change



## WARNING

Improper recalibration can cause the TPMS to give false warnings or to give no warning despite dangerously low tire pressure



## WARNING

Failure to heed warning lights and instrument cluster text messages can cause the vehicle to break down in traffic and result in a collision and serious personal injury.

- Never ignore warning lights or text WARNINGS.
- Always stop the vehicle as soon as it is safe to do so.



## NOTICE

Failure to heed warning lights or text **WARNINGS** can result in vehicle damage.

**i** Driving for a longer period of time on rough roads or with a dynamic and sporty style can make the TPMS system temporarily unavailable. The indicator light will come on, signaling a malfunction, but will go out again once the road condition or driving style changes.

Applicable only in the United States

## Tire Pressure Monitoring System (TPMS)

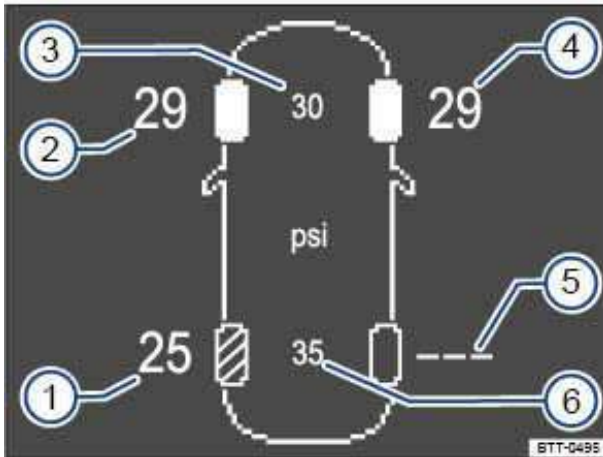

Fig. 135 Display screen in the instrument cluster: Current tire pressures in psi.

**⚠ Please first read and note the introductory information and heed the WARNINGS**

The Tire Pressure Monitoring System uses a pressure sensor in each wheel. Signals from the sensors are transmitted to the TPMS.

The TPMS checks the tire pressure of all 4 tires while you are driving and warns if there is a loss of pressure while the vehicle is moving. Pressure loss that is 25% or more of the benchmark value programmed into the system is signaled by the indicator light (telltale) described above, by acoustic warnings, and by text messages in the instrument cluster display.

If you mount tires of a different size than the factory installed tires, an authorized Volkswagen dealer or an authorized Volkswagen Service Facility can adjust the benchmark TPMS tire pressure to match the new tires. Without this adjustment, TPMS may not work correctly or at all.

The tire pressure recommended for the tires originally installed on the vehicle is on a sticker on the driver door jamb

### Display in the instrument cluster

The display in the instrument cluster shows the vehicle with the actual and benchmark tire pressures of all 4 road wheels ⇒ fig. 135

### Tire pressure display screen

	Meaning
(1)	Tire pressure warning, left rear tire.
(2)	Current tire pressure, front left tire.

## Tire pressure display screen

	Meaning
(3)	Benchmark pressure, front tires
(4)	Current tire pressure, front right tire.
(5)	No data received, right rear tire.
(6)	Benchmark pressure, rear tires

If the tire pressure is too low, the relevant tires and the respective readings are highlighted in yellow.

Each tire, including the spare (if provided), should be checked monthly when cold and inflated to the inflation pressure recommended by the vehicle manufacturer on the vehicle placard or tire inflation pressure label. (If your vehicle has tires of a different size than the size indicated on the vehicle placard or tire inflation pressure label, you should determine the proper tire inflation pressure for those tires.)

As an added safety feature, your vehicle has been equipped with a Tire Pressure Monitoring System (TPMS) that illuminates a low tire pressure telltale when one or more of your tires is significantly underinflated. Accordingly, when the low tire pressure telltale illuminates, you should stop and check your tires as soon as possible, and inflate them to the proper pressure. Driving on a significantly underinflated tire causes the tire to overheat and can lead to tire failure. Under-inflation also reduces fuel efficiency and tire tread life, and may affect the vehicle's handling and stopping ability.

Please note that the TPMS is not a substitute for proper tire maintenance, and it is the driver's responsibility to maintain correct tire pressure, even if under-inflation has not reached the level to trigger illumination of the TPMS low tire pressure telltale.

Your vehicle has also been equipped with a TPMS malfunction indicator to indicate when the system is not operating properly. The TPMS malfunction indicator is combined with the low tire pressure telltale. When the system detects a malfunction, the telltale will flash for approximately one minute and then remain continuously illuminated. This sequence will continue upon subsequent vehicle start-ups as long as the malfunction exists.

When the malfunction indicator is illuminated, the system may not be able to detect or signal low tire pressure as intended. TPMS malfunctions may occur for a variety of reasons, including the installation of replacement or alternate tires or wheels on the vehicle that prevent the TPMS from functioning properly. Always check the TPMS malfunction telltale after replacing one or more tires or wheels on your vehicle to ensure that the replacement or alternate tires and wheels allow the TPMS to continue to function properly.

### Spare wheel or compact spare wheel

The spare wheel or compact spare wheel has no tire pressure sensor. When the spare or compact spare wheel is mounted on the vehicle, the Tire Pressure Monitoring System (TPMS) indicator light will flash in the instrument cluster display. The TPMS continues to monitor the other 3 wheels.

### Tire storage

If the tires do not move for an extended period of time, the sensors will not transmit tire pressures to the system. This saves sensor battery life. When the ignition is switched on, the sensors transmit signals to the Tire Pressure Monitoring System.



## WARNING

Incorrect tire pressure can cause sudden tire failure, loss of vehicle control and serious personal injury.

- Always check and correct air pressure in all 4 tires, particularly after changing, exchanging, or repairing tires.
- After that, always make sure that all 4 tires are inflated to the correct tire pressure for the tires installed on the vehicle.
- See the tire pressure label and the Owner's Literature for recommended cold tire inflation pressure and other important information.
- When replacing tires or wheel rims on vehicles equipped with TPMS, always read and heed all of the information and WARNINGS .



## NOTICE

- The wheel electronics are attached to special aluminum valves on the wheels. These valves are screwed on rigidly. Never bend the valves “into position” when checking and adjusting tire pressure.
- Missing tire air valve caps could result in damage to the valves, as well as to the sensors on the Tire Pressure Monitoring System. Therefore, make sure your valve caps conform to the specifications of those originally installed on the vehicle and that they are always tightly and properly screwed on to the valves. Do not use metallic valve caps
- Do not use “comfort valve caps”, as these do not seal properly and could therefore cause damage to the sensors.
- When changing or rotating the tires, be careful not to damage the valves or sensors.
- The aluminum valves that are installed should be replaced after about 6 years of use because of aging in the rubber seals. The valves can be replaced when a tire is changed. Do not reuse aluminum valves after they are removed. They must be replaced. The tire pressure sensor can be reused.

Applicable only in Canada

## Tire Pressure Monitoring System (TPMS)

**❏ Please first read and note the introductory information and heed the WARNINGS  .**

Your vehicle's Tire Pressure Monitoring System (TPMS) indirectly checks the tire pressure of all 4 tires while you are driving by using the Anti-lock Brake System (ABS) sensors to monitor the tread circumference (rolling circumference) and vibration characteristics of the individual tires.

The tread circumference of a tire can change:

- If a tire's inflation pressure is too low.
- If the tire's tread is damaged or the tire is structurally damaged.
- If one side of the vehicle is more heavily loaded than the other.
- If there is more weight on one axle than the other (such as when towing a trailer).
- If a compact spare wheel has been mounted.
- If a wheel was replaced on each axle.
- If a tire was changed.
- If the tire pressure was changed, or wheels were rotated or replaced, but the TPMS was not reset.
- If there are snow chains on the tires. Using snow chains can cause the system to give false warnings because snow chains increase tire circumference.

The Tire Pressure Monitoring System may not react at first or may not react at all when you are driving in a sporty manner, or on snow-covered or unpaved roads, when you are driving with snow chains, or in certain other situations. A change in the tread circumference of a tire is signaled by the Tire Pressure Monitoring System indicator in the instrument cluster (telltale).

The tire pressure recommended for the tires originally installed on the vehicle is on a sticker on the driver door jamb

Each tire, including the spare (if provided), should be checked monthly when cold and inflated to the inflation pressure recommended by the vehicle manufacturer on the vehicle placard or tire inflation pressure label. (If your vehicle has tires of a different size than the size indicated on the vehicle placard or tire inflation pressure label, you should determine the proper tire inflation pressure for those tires.)

As an added safety feature, your vehicle has been equipped with a Tire Pressure Monitoring System (TPMS) that illuminates a low tire pressure telltale when one or more of your tires is significantly underinflated. Accordingly, when the low tire pressure telltale illuminates, you should stop and check your tires as soon as possible, and inflate them to the proper pressure. Driving on a significantly underinflated tire causes the tire to overheat and can lead to tire failure. Underinflation also reduces fuel efficiency and tire tread life, and may affect the vehicle's handling and stopping ability.

Please note that the TPMS is not a substitute for proper tire maintenance, and it is the driver's responsibility to maintain correct tire pressure, even if underinflation has not reached the level to trigger illumination of the TPMS low tire pressure telltale.

Your vehicle has also been equipped with a TPMS malfunction indicator to indicate when the system is not operating properly. The TPMS malfunction indicator is combined with the low tire pressure telltale. When the system detects a malfunction, the telltale will flash for approximately one minute and then remain continuously illuminated. This sequence will continue upon subsequent vehicle start-ups as long as the malfunction exists.

When the malfunction indicator is illuminated, the system may not be able to detect or signal low tire pressure as intended. TPMS malfunctions may occur for a variety of reasons, including the installation of replacement or alternate tires or wheels on the vehicle that prevent the TPMS from functioning properly. Always check the TPMS malfunction telltale after replacing one or more tires or wheels on your vehicle to ensure that the replacement or alternate tires and wheels allow the TPMS to continue to function properly.

### **Resetting and recalibrating the benchmark tire pressure**

Resetting the tire pressures in the Multi-function Display (MFI) resets the benchmark tire pressure used by the TPMS to the current tire pressure in the tires based on the circumference of the tires.

To reset the reference tire pressure, switch on the ignition. In the MFI, navigate to the **Settings** menu and select **Tire pressure**. Store and confirm the new tire pressures.

The recalibration must be performed each time the tire pressure in one or more tires has been adjusted or after one or more tires has been changed, exchanged, or repaired. The new tire pressures are stored in the system only after at least 20 minutes of normal driving.

If you have reset the benchmark tire pressure when your tires do not have the correct tire pressure, this will prevent the TPMS from working properly. It may then give false warnings or may not give any warning even if the tire pressure is too low.

**For this reason, it is vital to make certain that all 4 tires are inflated to the correct pressure when they are cold, before calibrating the system.** Cold tire tires are tires that have not been driven more than a couple of miles (kilometers) at low speed within the last 3 hours.

### **Recalibrate the system to reset the benchmark TPMS pressure in the following situations:**

- After installing tires on your vehicle that have recommended cold tire inflation pressures that are different from the tires that were taken off.
- After any tire on your vehicle is removed and then remounted, even if the same tire and wheel rim that were taken off are reinstalled (for instance, after repair).

- After any tire on your vehicle is changed and replaced by another tire, even if the replacement tire is the same type and is inflated to the same pressure as the tire it replaced.
- After adjusting the tire pressure of any tire on the vehicle to its correct cold tire inflation pressure, either by putting air in one or more tires or by letting air out. Do this even though air was only added (or let out) to bring the tire to the inflation pressure it should have had all along.
- After rotating the front and rear wheels
- After mounting the compact spare tire.



### **WARNING**

**Incorrect recalibration can cause the TPMS to give false warnings or to give no warning despite dangerously low tire pressure. Make certain the tire inflation pressure of all tires is correct before resetting the system.**



### **WARNING**

**Incorrect tire pressure can cause sudden tire failure, loss of vehicle control and serious personal injury.**

- **Always check and correct pressure in all 4 tires, particularly after changing, exchanging, or repairing tires.**
- **After that, always make sure that all 4 tires are inflated to the correct tire pressure for the tires installed on the vehicle. Then reset the system so that it can monitor the correct tire pressure.**
- **See the tire pressure label and the Owner's Literature for recommended cold tire inflation pressure and other important information.**
- **When replacing tires or wheel rims, always read and heed all of the information and WARNINGS**
- **The Tire Pressure Monitoring System must be recalibrated whenever you remove and remount or change any wheel or tire on the vehicle, even if the reinstalled or replacement wheels and tires are identical to those that were removed and even if the tire pressure does not change.**



The Tire Pressure Monitoring System stops working if there is an ESC/ABS malfunction.



After a low tire pressure warning, the vehicle must stand and must not be driven for at least one minute before the new benchmark tire pressures can be stored.

# Heating and air conditioning

## Introduction

---

In this section you'll find information about:

- Climatronic controls
- Air conditioner operation
- Air vents
- Air recirculation

### **Climatronic**

Climatronic information appears in the Climatronic display and/or on the screen of the factory-installed Radio system or Radio & Navigation system.

The temperature units (Fahrenheit or Celsius) in the factory-installed Radio system or Radio & Navigation system screen can be changed in the **Settings** menu in the instrument cluster display in appropriately equipped vehicles.

### **The dust and pollen filter**

The dust and pollen filter with an activated carbon insert reduces the entry of pollutants into the passenger compartment.

The dust and pollen filter must be replaced at the intervals recommended in ⇒ Booklet *Warranty and Maintenance* so that the air conditioner can work properly.

If the effectiveness of the filter decreases prematurely due to operating the vehicle where the outside air is heavily polluted, the dust and pollen filter should be replaced more frequently than indicated.

### **More information:**

- Exterior views
- Passenger compartment
- Volkswagen Information System
- Seat functions
- Windshield wiper and washer
- Starting and stopping the engine
- Exterior care and cleaning



## WARNING

Poor visibility increases the risk of collisions and other accidents that cause serious personal injuries.

- Always make sure all windows are clear of ice, snow and condensation for good visibility to the front, sides, and rear.
- Maximum heating output and defrosting performance are not possible until the engine has reached operating temperature. Wait until you have good visibility before driving off.
- Always make sure you know how to properly use the heating and ventilation systems as well as the rear window defroster that you will need for good visibility.
- Never use air recirculation for long periods of time. When the air conditioner is off and recirculation mode is on, condensation can quickly form on the windows and greatly reduce visibility.
- Always switch off recirculation mode when it is not needed.



## WARNING

Stale air causes driver fatigue and reduces driver alertness, which can cause accidents, collisions and serious personal injury.

- Never switch off the fan for a long period of time and never use air recirculation a long period of time because no fresh air will enter the passenger compartment.



## NOTICE

- If you think the air conditioner is not working properly or may be damaged, switch it off to help prevent more damage. Have the air conditioner checked by an authorized Volkswagen dealer or authorized Volkswagen Service Facility.
- Air conditioner repair requires specialized knowledge and special tools. Volkswagen recommends that you see an authorized Volkswagen dealer or an authorized Volkswagen Service Facility.
- Do not smoke when air recirculation is switched on. Smoke drawn into the ventilation system can leave residue on the evaporator and on the dust and pollen active carbon filter, resulting in permanent odors whenever the air conditioner is switched on.



If the air conditioner is switched off, the fresh outside air will not be dehumidified. To help keep the windows from fogging over, Volkswagen recommends leaving the air conditioner (compressor) switched on. Press the  button. The indicator light in the button must come on.



When it is very hot and humid outside, **water condensation** can drip from the air conditioner evaporator and form a puddle under the vehicle. This is normal and does not indicate a leak.



Keep the air intake slots in front of the windshield free of ice, snow and leaves in order to maintain proper functioning of the heating and ventilation systems.



Maximum heating output and defrosting performance are not possible until the engine has reached operating temperature.

**i** Emergency starting and starting the engine with a very weak vehicle battery or after the vehicle battery has been replaced may change or delete system settings (including time, date, personal convenience settings, and programming). Check the settings and correct as necessary once the vehicle battery has built up a sufficient charge.

## Climatronic controls

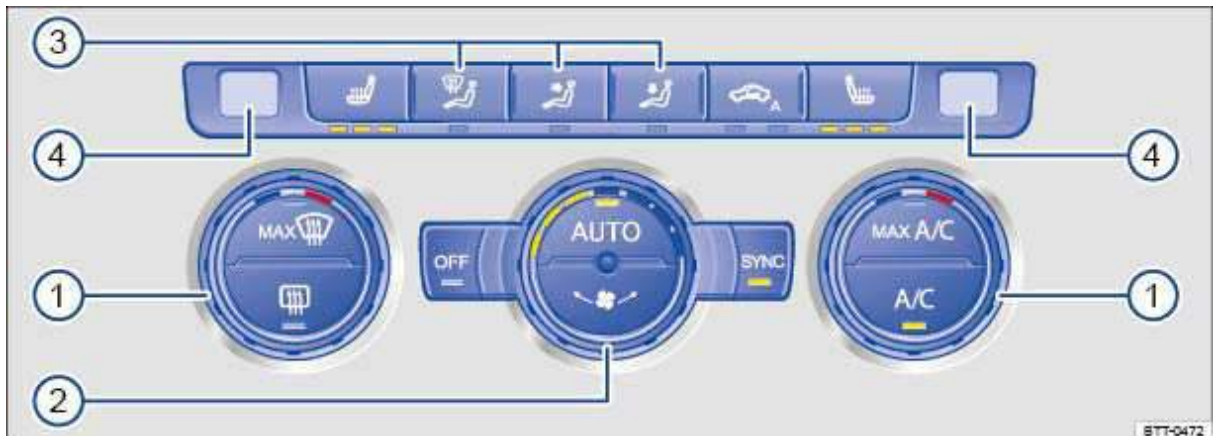



Fig. 136 In the center console: Climatronic controls.

**⚠ Please first read and note the introductory information and heed the WARNINGS**

Press the corresponding button to switch a function on or off. If a function is switched on, an indicator light in or under the button comes on. To switch off a function, press the button again.

Button/Knob	More information: Climatronic ⇒ fig. 136.
Temperature (1) 	Left and right sides of the vehicle can be set to different temperatures. Turn the knob to set the temperature.
Fan (2) 	The fan speed is automatically controlled depending on the vehicle speed in order to help prevent unnecessary noise. The fan can also be adjusted manually.
Air distribution (3)	Air flow is automatically adjusted to a comfortable level. It can also be manually adjusted with buttons (3).
Displays (4)	Left-side and right-side digital temperature displays.
	Defrost button. The incoming outside air is directed to the windshield, and air recirculation automatically switches off. To defrost the windshield as quickly as possible, humidity is removed from the air at temperatures above about +35 °F (+1.5 °C), and the blower is set to a high speed.
	Air distribution to the air vents in the instrument panel.
	Air distribution to the footwells.
	Air is directed upward.

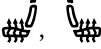

Button/Knob	More information: Climatronic ⇒ <a href="#">fig. 136</a> .
	Rear window defroster: Works only when the engine is running and switches off automatically after 10 minutes or less.
	Manual and automatic air recirculation .
	Buttons for seat heating
<b>A/C</b>	Press the button to switch the air conditioner on or off.
<b>MAX A/C</b>	Push button for maximum air conditioner cooling. The air recirculation and air conditioning switches on automatically and the vents direct air in the $q$ position.
<b>SYNC</b>	Applies the temperature settings for the driver side to the passenger side: If the indicator light in the <b>SYNC</b> button comes on, the temperature settings for the driver side also apply to the passenger side. Press the button or turn the temperature knob for the passenger side to set a different temperature for the passenger side. The indicator light in the button goes out.
<b>AUTO</b>	Automatic temperature control, fan speed, and air distribution. Press the <b>AUTO</b> button to switch on the feature. The indicator light in the button comes on.
<b>OFF</b>	Press the <b>OFF</b> button. If the system is switched off, the indicator light in the <b>OFF</b> button lights up.



## WARNING

Stale air causes driver fatigue and reduces alertness, which can cause accidents, collisions, and serious personal injury.

- Never switch off the fan for a long time, because no fresh air will enter the passenger compartment.

## Air conditioner operation

❏ Please first read and note the introductory information and heed the **WARNINGS** 

The air conditioner works only when the ignition is switched on. The cooling system for the passenger compartment works only when the engine is running and the fan is on.

The air conditioner is most efficient when the windows and the power sunroof are closed. If the vehicle is stationary and the passenger compartment becomes very hot due to sunlight, briefly opening the windows and the power sunroof may speed up the cooling process.

Keep the air intake slots in front of the windshield free of ice, snow, and leaves so that the heating and ventilation systems can work properly.

### Settings for optimum visibility

When you switch on the cooling system, both the temperature and humidity in the vehicle are reduced. This will help make passengers feel more comfortable and help keep the windows from fogging up.

- Press the **AUTO** button.
- Set temperature to +72 °F (+22 °C).
- Open and adjust all air vents in the instrument panel

## Changing the temperature unit on the factory-installed Radio or Radio & Navigation system display

The inside and outside temperatures can be displayed in either Fahrenheit (F) or Celsius (C).

Select **Units** in the instrument cluster display in the **Settings** main menu

You can also press and hold the **M/C** and **AUTO** buttons to switch the Climatronic temperature display from Celsius to Fahrenheit and vice versa.

## Heating

Maximum heating output and defrosting performance are not possible until the engine has reached operating temperature.

## Air conditioner does not work

The air conditioner may not switch on for one of the following reasons:

- The engine is not running.
- The fan is switched off.
- The air conditioner fuse has blown.
- The outside air temperature is colder than about +38 °F (+3 °C).
- The air conditioner compressor has been temporarily switched off due to excessive engine coolant temperature.
- There is another malfunction in the vehicle. Have the air conditioner checked by an authorized Volkswagen dealer or authorized Volkswagen Service Facility.

## Special considerations

When it is very hot and humid outside, **water condensation** can drip from the air conditioner evaporator and form a puddle under the vehicle. This is normal and does not indicate a leak.

**i** The climate control system adjusts the passenger compartment temperature as fast as possible considering the outside temperature.

**i** Due to residual moisture in the air conditioner, the windshield may fog up after the engine is started. Switch on the windshield defroster to help evaporate the condensation as quickly as possible.

**i** The air coming out of the vents flows through the passenger compartment and through the vents under the rear window. Do not cover these slots with clothing or other things.

## Air vents

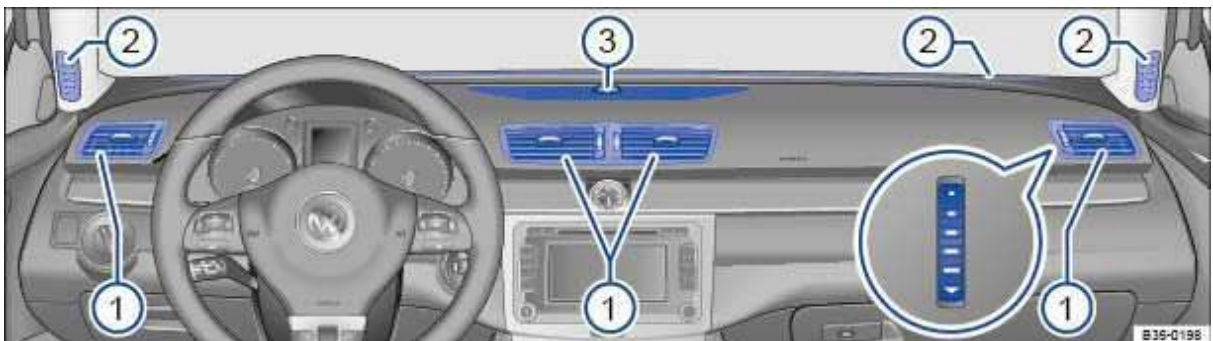

**Fig. 137** In the instrument panel: Air vents.

**ⓘ Please first read and note the introductory information and heed the WARNINGS ⚠**

### Air vents

To help ensure sufficient heating, cooling and ventilation in the passenger compartment, never close the air vents completely ⇒ [fig. 137 \(1\)](#).

- To open and close the air vents, turn the respective thumbwheel (magnified view) in the desired direction. When the thumbwheel is in the  $\downarrow$  position, the air vent is closed.
- Use the lever on the vent grille to adjust the airflow direction.

Additional, non-adjustable air vents are located in the front door pillars and the instrument panel (2), in the footwells, as well as in the rear area of the passenger compartment.

### Climatronic: Indirect ventilation

When Climatronic is set to the automatic mode, indirect ventilation is controlled automatically to provide ventilation without drafts. In this setting, the air flows through a ventilation surface that cannot be closed (3).

## ⚠ NOTICE

**Do not place food, medications, or other heat-sensitive things in front of the air vents. Food, medications, and other things that are sensitive to heat or cold can be damaged or made unusable by the air flow from the vents.**

**i** The air coming out of the vents flows through the passenger compartment and out through vents below the rear window. Do not cover these slots with clothing or other things.

## Air recirculation

**ⓘ Please first read and note the introductory information and heed the WARNINGS ⚠**

### General information

There are different types of air recirculation:

	The left indicator light under the button comes on: manual air recirculation is switched on.
	The right indicator light under the button comes on: automatic air recirculation is switched on.

The air recirculation mode  $\updownarrow$  helps prevent outside air from entering the vehicle interior.

In very hot outside temperatures, temporarily switch to air recirculation in order to cool the vehicle interior faster.

For safety reasons, air recirculation is switched off if you push the **MAX**  button ⇒ .

### Switching manual air recirculation on and off

*Switching on:* Press the  button repeatedly until the left indicator light under the button comes on.

*Switching off:* Press the  button repeatedly until the indicator light under the button goes out.

## Automatic air recirculation

In the  setting, fresh air enters the passenger compartment. If the system detects an increased concentration of pollutants in the outside air, it automatically switches to air recirculation. As soon as the pollutant level is back in the normal range, air recirculation is switched off.

Unpleasant odors cannot be detected by the system.

Air recirculation is **not** automatically activated under the following outside temperatures and conditions:

- The air conditioning is on (indicated by the light in the ) and the outside air temperature is colder than about +38 °F (+3 °C).
- The cooling system and the windshield wiper are switched off and the outside air temperature is cooler than about +50 °F (+10 °C).
- The cooling system is switched off, the outside air temperature is cooler than about +59 °F (+15 °C), and the windshield wiper is switched on.



## Switching automatic air recirculation on and off

*Switching on:* Press the  button repeatedly until the right indicator light under the button comes on.

*Switching off:* Press the  button repeatedly until no indicator light under the button is on.

It is not possible to activate automatic air recirculation when the outside air temperature is colder than about +38 °F (+3 °C).

## Temporarily deactivating the automatic air recirculation

- Press the  button once to switch to air recirculation temporarily in the event of unpleasant odors. The left indicator light comes on.
- Press the  button again after more than 2 seconds to resume automatic air recirculation. The right indicator light comes on.



### WARNING

**Stale air causes driver fatigue and reduces driver alertness, which can cause accidents, collisions and serious personal injury.**

- **Never use air recirculation mode over an extended period of time, since no fresh air will enter the passenger compartment.**
- **When the air conditioner is off and recirculation mode is on, condensation can quickly form on the windows and greatly reduce visibility.**
- **Always switch off recirculation mode when it is not needed.**



### NOTICE

**Do not smoke when air recirculation is switched on. Smoke drawn into the ventilation system can leave residue on the evaporator and on the dust and pollen active carbon filter, resulting in permanent odors whenever the air conditioner is switched on.**



**Climatronic:** When backing up and while the automatic wiper/washer is operating, air recirculation is briefly activated to help keep exhaust fumes from getting into the passenger compartment.

# Refueling

## Introduction

---

In this section you'll find information about:

Indicator lights and fuel gauge

Fuel capacities

Refueling checklist

The fuel filler flap is located on the rear right side of the vehicle.

### **More information:**

- Exterior views
- Fuel
- Preparations for working in the engine compartment



### **WARNING**

**Improper refueling or handling of fuel is dangerous and can cause fire, explosion, and severe burns.**

- **Always make sure that the fuel filler cap is screwed on all the way. This helps keep fuel from spilling out or evaporating.**
- **Fuel is highly flammable and explosive; it can cause severe burns and other severe injuries.**
- **Failure to shut the engine off while refueling and/or to insert the pump nozzle all the way into the fuel filler neck can cause fuel to overflow and to spray out. Fuel spray and overflowing fuel are dangerous because they can cause fire and serious personal injury.**
- **During refueling, the engine and the ignition must be switched off for safety reasons.**
- **Never use a cellular telephone, CB radio, or other radio equipment while refueling. The electromagnetic radiation can cause sparks that can ignite fuel vapors and cause a fire.**
- **Never get back into your vehicle while refueling. If in exceptional circumstances you must get back in your vehicle while refueling, make certain that you close the door and touch metal to discharge static electricity before touching the filler nozzle again. This helps avoid the build-up of static electricity, which can cause sparks that can ignite fuel vapors released during refueling.**
- **Never smoke or have an open flame (or sparks, cigarettes, or other smoldering objects) anywhere in or near your vehicle when refueling or filling a portable fuel container.**
- **Follow all safety instructions and procedures that apply at the service station where you refuel.**
- **Never spill fuel in the vehicle or the luggage compartment.**



## WARNING

Even if empty, portable fuel containers can leak and cause a fire and serious personal injuries, especially in a crash.

- For your safety, we strongly recommend that you do not travel with a portable fuel container in your vehicle.
- If, under exceptional circumstances, you must transport a portable fuel container, please observe the following:
  - Never fill a portable fuel container while it is anywhere in or on the vehicle (for example, in the luggage compartment or on top of the luggage compartment lid). Static electricity can build up while filling and can ignite fuel vapors, causing a fire.
  - Always place a portable fuel container on the ground before filling. Never spill fuel inside the vehicle or luggage compartment. Fuel vapors are highly flammable.
  - Always keep the filler nozzle completely inside the portable container before and during filling.
  - If filling a portable container made of metal, the filler nozzle must always be in contact with the container. This will help prevent static electricity from discharging and causing a fire.
  - Always observe local and state or provincial laws about the use, storage, and transportation of portable fuel containers.
  - Make certain that the portable fuel container meets industry standards, such as ANSI/ASTM F852-86.



## NOTICE

- Remove fuel spills from the vehicle immediately to help prevent damage to the paint, tires, and wheel housings.
- Refueling with gasoline when your vehicle has a diesel engine or refueling with diesel fuel when your vehicle has a gasoline engine can cause very serious and expensive engine and fuel system damage that is not covered by any Volkswagen Limited Warranty.
- If you put any amount of incorrect fuel in the fuel tank, do not start the engine under any circumstances. Immediately contact the nearest authorized Volkswagen dealer or authorized Volkswagen Service Facility for assistance. These fuels contain substances that can severely damage the fuel system and the engine if the engine is started.



Fuels can pollute the environment. Spilled fuel must be collected and disposed of properly, following all applicable environmental regulations.



There is no emergency release for the fuel filler flap. Contact an authorized Volkswagen dealer or an authorized Volkswagen Service Facility for assistance.

## Indicator lights and fuel gauge



**Fig. 138** In the instrument cluster: Fuel gauge.

ⓘ Please first read and note the introductory information and heed the **WARNINGS** ⚠

Lights up	Gauge position ⇒ <b>fig. 138</b>	Possible cause or meaning ⇒ ⚠	Proper response
	Red range (arrow)	Fuel tank almost empty. Running on reserve .	Time to refuel ⇒ ⚠.
	–	Fuel filler cap not properly closed.	Stop and close the fuel filler cap properly.

When the ignition is switched on, several warning and indicator lights come on briefly for a function check. They go out after a few seconds.

### Fuel filler cap not properly closed ⚠

If the indicator light ⚠ comes on or you see a text message in the instrument cluster display indicating that the fuel filler cap is not properly closed, stop the vehicle in a safe place and switch off the engine and the ignition.

Open the fuel filler flap and take the fuel filler cap off the filler neck. Then put the fuel filler cap back on the filler neck and screw it on clockwise until you clearly hear a clicking sound. Close the fuel filler flap.

After switching on the ignition, the indicator light ⚠ may stay on or the text message may still appear in the instrument cluster display, even if the fuel filler cap is now properly closed. This is normal and no reason to take your vehicle in for service.

If, however, the malfunction indicator light ⚠ also comes on, drive to your nearest authorized Volkswagen dealer or authorized Volkswagen Service Facility and have the fuel system and the engine checked.



## WARNING

Driving with a fuel tank that is almost empty can lead to stalling in traffic, a collision, and serious personal injuries.

- When the fuel tank is almost empty, fuel supply to the engine can be interrupted, especially when driving over bumps, across slopes, and up and down hills.
- Steering and braking assistance as well as ESC and related systems will not work if the engine “sputters” or stalls due to lack of fuel.
- Always refuel when the tank is 1/4 full to reduce the risk of running out of fuel and stalling in traffic.



## NOTICE

- Failure to heed warning lights or text WARNINGS can result in vehicle damage.
- Never drive until the fuel tank is completely empty. The irregular fuel supply can cause the engine to misfire. This allows unburned fuel to get into the exhaust system and damage the catalytic converter.



The small arrow next to the gas pump symbol in the fuel gauge shows the side of the vehicle with the fuel filler flap.

## Fuel capacities

☐ Please first read and note the introductory information and heed the WARNINGS

Engine	Fuel tank capacity
200 hp (147 kW), 2.0L	About 18.5 gallons (70.0 liters), of which about 2.1 gallons (8.0 liters) reserve.
280 hp (206 kW), 3.6L	About 18 gallons (68.0 liters), of which about 2.1 gallons (8.0 liters) reserve.

## Refueling checklist

☐ Please first read and note the introductory information and heed the WARNINGS

The engine compartment of any motor vehicle is a hazardous area. Never do any work on the engine or in the engine compartment unless you

- know exactly how to carry out the job,
- have the correct technical information and the proper tools and supplies, and
- are familiar with the necessary safety precautions 248, *Preparations for working in the engine compartment*.



## Checklist

---

If you are uncertain in any way, have the work done by an authorized Volkswagen dealer or authorized Volkswagen Service Facility. Serious personal injury may result from improperly performed work. Make sure that you check the following items regularly. The best thing is to check them every time you refuel:

- ✓ Windshield washer fluid level
- ✓ Engine oil level
- ✓ Engine coolant level
- ✓ Brake fluid level
- ✓ Tire pressure
- ✓ Vehicle lighting necessary for driving safety:
  - Turn signals
  - Low beams and high beams
  - Taillights
  - Brake lights
  - License plate lights

---

Information regarding changing light bulbs



### **WARNING**

**Disregarding the safety-related checklist may lead to accidents and injuries.**

- **Please note and follow the points listed in the checklist.**

# Fuel

## Introduction

---

In this section you'll find information about:

### Gasoline additives

The correct fuel grade for your engine is shown on a sticker located on the inside of the fuel filler flap ⇒ [fig. 140](#).

Bad or poor quality fuel reduces operating performance, efficiency and service life of the engine. If you notice any symptoms like rough engine idle or performance or "bucking," immediately reduce the vehicle speed, accelerate slowly, and keep the engine speed in the middle of the rpm range. Avoid high rpm and rapid acceleration. If these symptoms should appear right after refueling, switch off the engine. In both cases contact an authorized Volkswagen dealer or an authorized Volkswagen Service Facility to have the engine checked.

### More information:

- ⇒ Booklet *Warranty and Maintenance*
- Refueling
- Engine control and exhaust system



### WARNING

**Improper refueling or handling of fuel can cause fire, explosion, and severe burns.**

- **Fuel is highly explosive and flammable and can cause severe burns and other injuries.**
- **Heed applicable safety warnings and obey local fuel handling regulations.**
- **Always make sure the fuel cap is screwed on all the way. This keeps fuel from spilling out and from evaporating.**
- **Failure to shut the engine off while refueling and/or to insert the pump nozzle fully into the vehicle's filler neck could cause fuel overflow and fuel spray. Fuel spray and overflowing fuel are dangerous because they can cause fire or serious injury.**
- **For safety reasons, the engine must be turned off when refueling.**
- **Never get back into your vehicle while refueling. If in exceptional circumstances you must get back in your vehicle while refueling, make certain that you close the door and touch metal to discharge static electricity before touching the filler nozzle again. Static electricity can cause sparks that can ignite fuel vapors released during refueling.**

## Gasoline additives

---

 Please first read and note the introductory information and heed the **WARNINGS** 

Additives are used to improve the quality of the gasoline.

Fuel quality impacts the operating performance, efficiency and service life of the engine. Therefore, use high quality gasoline that is already blended by the fuel supplier with suitable gasoline additives

that do not contain metal. The additives provide corrosion protection, clean the fuel system, and prevent deposits on the engine.

Volkswagen recommends TOP TIER Detergent Gasoline. For more information on TOP TIER Detergent Gasoline, please go to the official Web site <http://www.toptiergas.com>.

If quality gasoline with additives that do not contain metal is not available or engine malfunctions occur, you should add the required additives while refueling ⇒ .

Not all gasoline additives are effective. Using the wrong additives can cause significant and expensive damage to the engine and the catalytic converter. Never use additives that contain metal. Please note that metal can be included in some aftermarket gasoline additives that are available to be added to gasoline during or after refueling to help improve knock resistance or increase the octane rating.

Volkswagen recommends using only additives approved by Volkswagen. Appropriate additives as well as instructions on how to use them are available from your authorized Volkswagen dealer or authorized Volkswagen Service Facility. Do not add any other gasoline additives.

## NOTICE

**You can damage the engine by using incorrect additives.**

- **Using incorrect gasoline additives can cause extensive engine damage as well as damage to the catalytic converter.**
- **If you must fuel your vehicle with gasoline whose octane rating is too low, only drive with the engine speed in the middle of the rpm range and with low engine load. Avoid high rpm and heavy engine load. Otherwise, the engine could be damaged. Refuel your vehicle with gasoline with the required octane rating as soon as possible.**
- **Do not use fuel that is labeled at the pump as containing metal. Lead replacement fuel contains high concentrations of metallic additives. Engine damage could result.**
- **Fueling your vehicle just one time with leaded fuel or fuel that contains other metallic additives can affect the performance of the catalytic converter and cause extensive damage to it.**

# Preparations for working in the engine compartment

## Introduction

---

In this section you'll find information about:

Warning light

Getting ready to work in the engine compartment

Opening and closing the engine compartment

Always position the vehicle on a firm and level surface before doing any work in the engine compartment.

The engine compartment of a vehicle is a hazardous area. Never do any work on the engine or in the engine compartment unless you

- know exactly how to carry out the job,
- have the correct technical information and the proper tools and supplies, and
- are familiar with the necessary safety precautions ⇒ .

If you are uncertain in any way, have the work done by an authorized Volkswagen dealer or an authorized Volkswagen Service Facility. Serious personal injury may result from improperly performed work.

### **More information:**

- Exterior views
- Windshield wiper and washer
- Starting and stopping the engine
- Brake fluid
- Checks while refueling
- Engine oil
- Engine coolant
- Vehicle battery
- Exterior care and cleaning
- Parts, accessories, repairs and modifications



### **WARNING**

**Unintended vehicle movement during maintenance work can cause serious personal injuries.**

- **Never work under the vehicle unless you have safely secured the vehicle from moving. If you must work under the vehicle with the wheels on the ground, always make sure that the vehicle is on level ground, that all 4 wheels are chocked to keep them from moving, and that the key is not in the ignition.**
- **If you must work under a vehicle raised on a floor jack, always make sure that the vehicle is safely supported on safety stands intended for that purpose that are strong enough to support the weight of the vehicle. The jack supplied with the vehicle is not strong enough for this purpose and can collapse causing serious personal injury.**



## WARNING

The engine compartment of any motor vehicle is a potentially dangerous area and can cause serious personal injury.

- Always use extreme caution when doing any work in the engine compartment. Always follow commonly accepted safety practices and use common sense. Never risk personal injury.
- Never perform any work in the engine compartment unless you know exactly how to carry out the job and have the correct technical information and the correct tools.
- If you are uncertain about what to do, have the work performed by an authorized Volkswagen dealer, an authorized Volkswagen Service Facility, or another qualified workshop. Serious personal injury may result from improperly performed work.
- We strongly recommend that you always have HID – High Intensity Discharge (Xenon) headlights and H7 bulbs replaced by a qualified technician. Serious personal injury may result from improperly performed work.
- Never open or close the engine hood if steam or coolant is escaping. Hot steam or coolant can cause serious burns. Always wait until you no longer see or hear steam or coolant escaping from the engine.
- Always let the engine cool down completely before carefully opening the hood.
- Hot parts of the engine and the exhaust system will burn skin on contact.
- When the engine has cooled down and you are ready to open the hood:
  - Firmly apply the parking brake and shift the transmission into Park (P) (automatic) or Neutral (manual only).
  - Take the vehicle key out of the ignition.
  - Always keep children and others away from the engine compartment and never leave them unsupervised.
- The engine coolant system is under pressure when the engine is hot. Never unscrew the coolant expansion tank cap when the engine is hot. Hot coolant can spray out and cause severe burns and other serious injuries.
  - Turn the cap slowly and very carefully in a counterclockwise direction while applying light downward pressure on the top of the cap.
  - Always protect your face, hands, and arms from hot escaping coolant or steam by covering the cap with a large, thick rag.
- Never spill fluids on the engine or exhaust system when refilling. Spilling fluids onto hot parts of the engine or exhaust system can cause a fire.



## WARNING

High voltage systems in the engine compartment can cause electrical shocks or even electrocution, severe burns, other serious injuries, and even death!

- Never short-circuit the electrical system. Be especially careful when using jumper cables. The vehicle's battery could explode!
- To reduce the risk of electrical shock and personal injury while the engine is running or being started:
  - Never touch ignition cables. Never touch other components of the high voltage electronic ignition system.
  - Never touch the wiring of the HID – High Intensity Discharge (Xenon) headlights.
- Read and heed the important information and warnings on cleaning the engine compartment, *Cleaning the engine compartment*



## WARNING

Moving parts in the engine compartment can cause serious personal injury on contact.

- Never reach into the area around or touch the radiator fan. Contact with the blades can cause serious personal injury. Always remember that the radiator fan is temperature-controlled and can come on suddenly even when the engine has been switched off for a while and the key has been removed from the ignition.
- If you have to perform a check or repair when the engine is running, there are more risks from the rotating parts, such as the drive belts, alternator, radiator fan, etc., and from the high-voltage ignition system. Always use extreme care.
  - Always make sure that jewelry, loose clothing and long hair do not get caught in rotating engine parts. Before starting any work remove your jewelry, take off your necktie, tie back and cover your hair, and do not wear clothing that can hang down and get caught in moving engine parts.
  - Always use extreme caution if the accelerator pedal has to be depressed to perform a check. The vehicle will start to move even if the electronic parking brake is on.
- Never leave any objects in the engine compartment, for example cleaning rags and tools. Objects left behind can cause malfunctions, engine damage, and even fires.



## WARNING

Operating fluids and some materials in the engine compartment can catch fire easily, causing burns and other serious personal injuries!

- Never smoke near the engine compartment.
- Never work next to open flames or sparks.
- Never pour or spill operating fluids or other flammable liquids on the engine. These fluids can ignite on hot engine parts and cause injuries.
- If work on the fuel system or the electrical system is necessary:
  - Always disconnect the 12 Volt vehicle battery. Make sure the vehicle is unlocked when you disconnect the battery, or the alarm will go off. Never touch the electrical wiring of the ignition system.
  - Never work near heaters, water heaters, or other open flames.
- Always have a functional, approved fire extinguisher nearby.



## NOTICE



When changing or topping off fluids, make sure that you pour the fluids into the correct reservoirs. Adding the wrong type of operating fluids will cause serious malfunctions and engine damage.



Fluid leaks and spills are harmful to the environment. Regularly check the ground underneath your vehicle for this reason. If you find spots of oil or other fluids, have your vehicle checked by your authorized Volkswagen dealer or authorized Volkswagen Service Facility. Dispose of leaked operating fluids properly.

## Warning light

☐ Please first read and note the introductory information and heed the WARNINGS

Lights up	Possible cause	Proper response
 <b>OR</b> icon appears in the display	Engine hood not properly closed.	 <b>Stop!</b> Close the engine hood.

When the ignition is switched on, several warning and indicator lights come on briefly for a function check. They go out after a few seconds.

If the engine hood is open or not closed properly, the  $\pm$  warning light comes on in the instrument cluster or the vehicle icon appears in the instrument cluster display showing the open engine hood.

Depending on your vehicle's equipment and options, the red warning light or icon may still be displayed even after the ignition is switched off as long as the key has not been taken out of the ignition. The icon in the instrument cluster display goes out about 15 seconds after the vehicle has been locked.

 **WARNING**

**Failure to heed warning lights and instrument cluster text messages can cause the vehicle to break down in traffic and result in a collision and serious personal injury.**

- Never ignore warning lights or text WARNINGS.
- Always stop the vehicle as soon as it is safe to do so.

## Getting ready to work in the engine compartment

Please first read and note the introductory information and heed the WARNINGS 

### Checklist

Before any work in the engine compartment, carry out the following steps in the order in which they are listed  $\Rightarrow$  :

- ✓ Park the vehicle in a safe place on a firm, level surface.
- ✓ Hold the brake pedal down until the engine is switched off.
- ✓ Apply the electronic parking brake to help prevent the vehicle from moving
- ✓ Shift the transmission into Park **(P)** (automatic) or Neutral (manual only) .
- ✓ Stop the engine and remove the key from the ignition switch
- ✓ Let the engine cool down sufficiently.
- ✓ Keep children and others away from the vehicle.
- ✓ Make sure the vehicle cannot move unexpectedly.

 **WARNING**

**Disregarding the safety-related checklist may result in serious injuries.**

- Always review and follow the checklist. Follow accepted safety practices and use common sense.

## Opening and closing the engine compartment

---

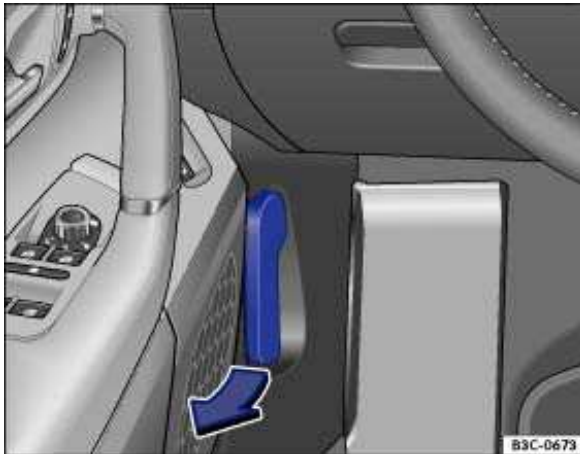

Fig. 141 In the footwell on the driver side: Inside engine hood release lever.



Fig. 142 Above the radiator grille: Outside engine hood release.

⚠ Please first read and note the introductory information and heed the WARNINGS ⚠

### Opening the engine hood

- Before you open the hood, make sure that the windshield wiper arms are resting on the windshield ⇒ ⚠.
- Open the driver door and pull the inside hood release lever in the direction of the arrow ⇒ fig. 141. The engine hood is released from its latch by a spring ⇒ ⚠.
- Push the outside hood release lever ⇒ fig. 142 (arrow) and lift the hood all the way up. A gas-filled strut will hold the hood up.

### Closing the engine hood

- Pull the hood down to overcome the resistance of the gas-pressure strut ⇒ ⚠.
- Lower the engine hood by hand until it is about 1 ft. (30 cm) above its latch and then let it drop into place to latch it. *Do not* push down on it afterwards!

If the hood does not close completely, open it again and close it properly.

When the hood is properly closed, you can see that it fits flush with the other body parts. The indicator light in the instrument cluster will go out





## WARNING

If the hood is not closed properly, it could fly up and block your view while you are driving. This can lead to a crash and serious personal injuries.

- After closing the engine hood, check that the hood release lever is properly latched into the hood latch. The engine hood must be flush with the surrounding auto body parts.
- If you ever notice that the hood latch is not properly secured when the vehicle is moving, stop at once and close it.
- Never let anyone get in the way of the hood when closing it.



## NOTICE

- Make sure the windshield wiper arms are resting on the windshield before you open the hood. Otherwise, the windshield wipers and the hood may be damaged.
- Always put the windshield wiper arms down against the windshield before driving the vehicle.



## NOTICE

Before opening or closing the engine hood, make sure there is enough room to do so, for example when the vehicle is in a garage.

# Engine oil

## Introduction

---

In this section you'll find information about:

- Warning and indicator lights
- Engine oil specifications
- Engine oil capacities
- Checking the engine oil level and adding oil
- Engine oil consumption
- Changing engine oil

### More information:

- ⇒ Booklet *Warranty and Maintenance*
- Preparations for working in the engine compartment
- Parts, accessories, repairs and modifications



### WARNING

**Improper handling of engine oil can cause severe burns and other serious injuries.**

- Always wear eye protection.
- Engine oil is poisonous and must be stored out of the reach of children.
- Store engine oil only in the closed original container. This also applies to used oil until disposal.
- To reduce the risk of poisoning, never drain the oil into empty food or beverage containers that might mislead someone into drinking from them.
- Continuous contact with used engine oil is harmful to your skin. Always protect your skin by washing thoroughly with soap and water.
- Engine oil becomes extremely hot when the engine is running and can cause severe burns. Always let the engine cool down to the touch.



Like all other operating fluids, engine oil can pollute the environment. Collect leaked or spilled operating fluids and dispose of them properly in accordance with applicable environmental laws and regulations.

## Engine oil specifications

---

 Please first read and note the introductory information and heed the WARNINGS 

The engine oil used must conform to exact specifications.

Using the proper engine oil is important for the functionality and service life of the engine. Your engine was factory-filled with a high-quality multi-grade oil which can usually be used throughout the entire year.

Engine oils are constantly being improved. Authorized Volkswagen dealers and authorized Volkswagen Service Facilities are always up-to-date regarding new developments and changes. Volkswagen therefore recommends that you have the engine oil changed by an authorized Volkswagen dealer or an authorized Volkswagen Service Facility.

Engine oil quality is based not only on requirements for engines and exhaust treatment systems, but also on fuel quality. Engine oil comes into contact with fuel and fuel residue in all internal combustion engines, causing engine oil to age and its lubricating qualities to deteriorate.

Your engine was factory-filled with a high-quality, “synthetic” all-season engine oil that meets strict Volkswagen oil quality standards and has a viscosity grade of SAE 5W-40 or SAE 5W-30. You can use this oil for normal driving in all temperatures.

If you need to add oil between oil changes, use only a high quality oil that expressly complies with the Volkswagen oil quality standard specified for your vehicle's engine:

Engines	Engine oil specification
200 hp (147 kW), 2.0L	VW 502 00, VW 503 00, VW 504 00
280 hp (206 kW), 3.6L	VW 501 01, VW 502 00, VW 503 00

At the time this Manual was printed, the engine oils available in the U.S. that meet these Volkswagen standards are “synthetic” oils. This does not mean, however, that any “synthetic” engine oil will meet Volkswagen standards. Always use an approved oil that expressly complies with the Volkswagen oil quality standard that applies to your vehicle's engine.

#### General recommendations:

If “synthetic” oil that meets the applicable Volkswagen oil quality standard with viscosity grade SAE 5W-40 or SAE 5W-30 is not available in your area, be sure to use a viscosity grade suitable for the climate, season, and operating conditions that exist where the vehicle is used. Make sure the oil meets the quality standard listed in ⇒ table

Engine oils are constantly being improved. Authorized Volkswagen dealers and authorized Volkswagen Service Facilities are always up-to-date regarding new developments and changes. Volkswagen therefore recommends that you have the engine oil changed by an authorized Volkswagen dealer or an authorized Volkswagen Service Facility.

#### NOTICE

- If you need to add oil and there is none available that meets the Volkswagen oil quality standard your engine requires, you may add a total of no more than 1/2 quart (0.5 liter) of a high-quality “synthetic” oil that meets ACEA A3 specifications and has a viscosity grade of SAE 5W-40 or SAE 5W-30.
- Use only a high quality engine oil that expressly complies with the Volkswagen oil quality standard specified for your vehicle's engine. Using any other oil can cause serious engine damage that will not be covered by any Volkswagen Limited Warranty.
- Do not mix any lubricants or other additives into the engine oil. Doing so can cause engine damage! Damage caused by these kinds of additives are not covered by any Volkswagen Limited Warranty.

## Engine oil capacities

---

ⓘ Please first read and note the introductory information and heed the WARNINGS ⚠

Engines	Engine oil capacity (with filter)
200 hp (147 kW), 2.0L	About 4.9 quarts (4.6 liters)
280 hp (206 kW), 3.6L	About 5.8 quarts (5.5 liters)

## Engine oil consumption

---

ⓘ Please first read and note the introductory information and heed the WARNINGS ⚠

To provide effective lubrication and cooling for internal engine parts, all internal combustion engines use some oil. Oil consumption varies from engine to engine and may change over the life of the engine. Engines tend to use more oil during the break-in period than they do afterward, when oil consumption has stabilized.

Under normal conditions, the rate of oil consumption depends on oil quality as well as viscosity, engine speed (rpm), outside temperature, road conditions, the amount of oil dilution caused by condensed water or fuel residue, and oxidation of the oil. Oil consumption may increase with engine wear over time, until replacement of worn engine parts may become necessary.

Volkswagen recommends that you to check the engine oil level at regular intervals, preferably every time you fill the fuel tank, and always before a long trip. Your vehicle may consume engine oil depending on several variables. A maximum of 1 quart per 1200 miles (1 liter per 2000 km) would be considered normal. New vehicles may consume more oil over the first 3000 miles (5000 km).

**The oil pressure warning light is not an indicator of low engine oil level. If the warning light stays on or flashes while driving (above 1500 rpm), a chime will sound. It indicates that the oil pressure is too low. Stop the engine immediately, check the engine oil level and add oil if necessary. If the engine oil level is normal, but the light continues to flash, do not keep driving or let the engine idle, as damage may occur.**

If you believe your engine uses too much oil, we recommend that you consult your authorized Volkswagen dealer or authorized Volkswagen Service Facility so that the cause of your concern can be properly diagnosed. Please keep in mind that accurate measurement of oil consumption requires great care and may take some time. Your authorized Volkswagen dealer and authorized Volkswagen Service Facility have instructions for how to measure oil consumption accurately.

ⓘ Depending on the way the vehicle is driven and the operating conditions, oil consumption can be up to 1 quart per 1200 miles (0.5 liter per 1000 km). Consumption may be higher for new vehicles during the first 3000 miles (5000 km).

# Engine coolant

## Introduction

---

In this section you'll find information about

Warning light and engine coolant temperature gauge

Engine coolant specifications

Checking engine coolant level and topping off

Never do any work on the coolant system unless you

- know exactly how to carry out the job,
- have the correct technical information and the proper tools, supplies, and operating fluids, and
- are familiar with the necessary safety precautions ⇒ !

If you are uncertain in any way, have the work done by an authorized Volkswagen dealer or an authorized Volkswagen Service Facility.

Serious personal injury may result from improperly performed work.

### **More information:**

- Trailer towing
- Preparations for working in the engine compartment
- Parts, accessories, repairs and modifications



### **WARNING**

**Engine coolant is poisonous!**

- **Always keep the coolant in its original container stored in a safe place.**
- **To reduce the risk of poisoning, never store engine coolant in empty food or beverage containers or in any other containers that might mislead someone into drinking from them.**
- **Always keep engine coolant out of reach of children.**
- **Always make sure there is enough of the correct coolant additive to provide proper antifreeze protection at the coldest temperatures that can be expected where the vehicle will be used.**
- **At extremely cold temperatures, the coolant could freeze, causing the vehicle to break down. The heater would also not work, and vehicle occupants could be without protection at subfreezing temperatures.**



Coolant and coolant additives can pollute the environment. Collect leaking operating fluids and dispose of them properly in accordance with applicable environmental laws and regulations.

## Warning light and engine coolant temperature gauge

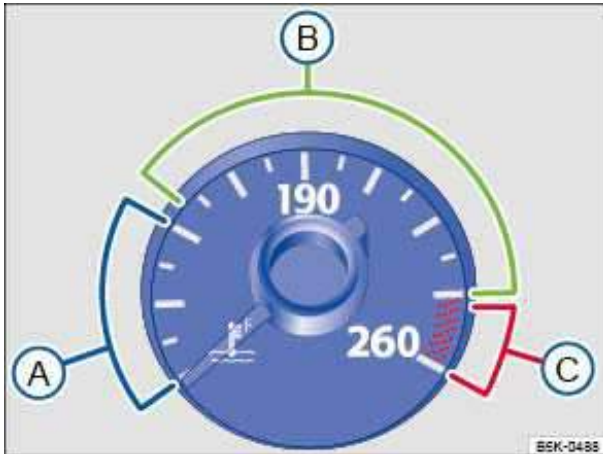

**Fig. 145** Engine coolant temperature gauge in the instrument cluster: A Engine cold; B Normal temperature range; C Warning zone.

### ⚠ Please first read and note the introductory information and heed the WARNINGS ⚠

If the indicator in the engine coolant temperature gauge is located in the cold range (A), the engine has not reached operating temperature. High engine speeds and heavy engine loads should be avoided.

Under normal driving conditions, the needle should be in the middle of the gauge. The temperature may go higher when the engine is working hard, especially in hot weather.

When the ignition is switched on, several warning and indicator lights come on briefly for a function check. They go out after a few seconds.

The following table explains what to do if the engine coolant warning light  does not go out a few seconds after the engine is started or lights up or starts flashing while driving.

Flashes	Temperature gauge needle ⇒ fig. 145	Possible cause	Proper response
	(C) Warning zone	Engine coolant temperature too high.	<p><b>2 Stop!</b> Pull off the road and stop as soon as you can do so safely. Stop the engine and let it cool down until the temperature needle is in the normal range again. Check the engine coolant level and add coolant if needed <b>Error! Bookmark not defined..</b> If the engine coolant level is correct or the problem continues after adding coolant and driving a short distance, <b>do not drive any farther</b>. Contact the nearest authorized Volkswagen dealer or authorized Volkswagen Service Facility. If the coolant level is correct, the overheating may be caused by a radiator fan fault. Check the fuses and replace as necessary</p>

Flashes	Temperature gauge needle ⇒ fig. 145	Possible cause	Proper response
	(B) Normal range	Engine coolant level too low.	Check the engine coolant level after the engine has cooled down and add engine coolant if low If the engine coolant level is correct or the problem continues after adding coolant, <b>do not drive any farther</b> . Contact an authorized Volkswagen dealer or authorized Volkswagen Service Facility. These instructions apply only when the coolant temperature stays in the normal range. Stop immediately if the needle goes into the red warning zone (C).
	–	Engine coolant system malfunction.	 <b>Stop!</b> Get assistance from an authorized Volkswagen dealer, an authorized Volkswagen Service Facility, or another qualified workshop.
–	(A) Cold range	The engine has not yet warmed up.	Do not drive at high engine speeds or with heavy engine loads until the engine warms up.

When the ignition is switched on, several warning and indicator lights come on briefly for a function check. They go out after a few seconds.

 **WARNING**

**Failure to heed warning lights and instrument cluster text messages can cause the vehicle to break down in traffic and result in a collision and serious personal injury.**

- **Never ignore warning lights or text WARNINGS.**
- **Always stop the vehicle as soon as it is safe to do so.**

 **NOTICE**

Failure to heed warning lights or text WARNINGS can result in vehicle damage.

## Engine coolant specifications

 Please first read and note the introductory information and heed the WARNINGS 

The engine cooling system is filled at the factory with a mixture of specially conditioned water and at least 40 percent of Volkswagen engine coolant additive **G 13** (TL-VW 774 J). This engine coolant additive is pink.

This mixture provides antifreeze protection down to -13 °F (-25 °C). It also helps to protect the light alloy parts in the engine cooling system against corrosion. In addition, the mixture helps prevent calcium deposits and increases the boiling point of the engine coolant.

To protect the engine, the mixture must *always* contain *at least 40% coolant additive* even in warm weather or climates where antifreeze protection is not needed.

If more antifreeze protection is needed for climate conditions, the percentage of coolant additive can be increased. However, the coolant additive percentage must never be more than 60%; otherwise, antifreeze protection is reduced and the ability of the mixture to cool the engine is also reduced.

When adding engine coolant, use a mixture of **distilled** water and at least 40% coolant additive G 13 or G 12 plus-plus (TL-VW 774 G) for optimum corrosion protection ⇒ .

Do not mix G 13 with G 12 plus or G 11. Mixing these coolant additives together significantly reduces corrosion protection ⇒  and can lead to engine damage that is not covered by any Volkswagen Limited Warranty.

## **WARNING**

**Too little antifreeze protection in the engine cooling system can cause engine failure and severe injuries.**

- **Always make sure there is enough of the correct coolant additive to provide proper antifreeze protection at the coldest temperatures that can be expected where the vehicle will be used.**
- **At extremely cold temperatures, the coolant could freeze, causing the vehicle to break down. The heater would also not work, and vehicle occupants could be without protection at subfreezing temperatures.**

## **NOTICE**

**Never mix original Volkswagen engine coolant additives with other additives not approved by Volkswagen. Mixing Volkswagen coolant additives with coolant additives made by other manufacturers can seriously damage the engine and the engine cooling system.**

- **If the fluid in the engine coolant reservoir is any color but pink, then G 13 was mixed with a different engine coolant. If this is the case, the engine coolant must be replaced immediately. Otherwise serious malfunctions or engine damage can occur!**



Engine coolant and engine coolant additives can pollute the environment. Collect leaking operating fluids and dispose of them properly in accordance with applicable environmental laws and regulations.



# Vehicle battery

## Introduction

---

In this section you'll find information about:

Warning light

Checking the vehicle battery electrolyte level

Charging, replacing, disconnecting and connecting the vehicle battery

The standard 12 Volt vehicle battery is part of the vehicle electrical system.

Never do any work on the vehicle electrical system unless you

- know exactly how to carry out the job,
- have the correct technical information and the proper tools, and
- are familiar with the necessary safety precautions ⇒ .





If you are uncertain in any way, have the work done by an authorized Volkswagen dealer or authorized Volkswagen Service Facility. Serious personal injury may result from improperly performed work.

### Location of the vehicle battery

Depending upon the engine type, the 12 Volt vehicle battery is located in the engine compartment or behind a cover in the luggage compartment. On vehicles with a 3.6 liter engine, the battery is behind a trim panel in the left rear corner of the luggage compartment.

Vehicles with the battery located in the luggage compartment are equipped with a battery isolator feature. In a collision, the airbag control module triggers a small pyrotechnic charge that physically disconnects the battery from the engine starter motor and the positive jump-start terminal in the engine compartment.

### Explanation of the warnings on the vehicle battery

Symbol	Meaning
	Always wear eye protection!
	Battery acid is highly corrosive. Always wear protective gloves and eye protection!
	Fire, sparks, open flame, and smoking are prohibited!
	When a battery is charged, it produces hydrogen gas which is highly explosive!
	Always keep children away from battery acid and vehicle batteries!

### More information:

- ⇒ Booklet *Warranty and Maintenance*
- Preparations for working in the engine compartment
- Parts, accessories, repairs and modifications



## WARNING

Working on the batteries or the electrical system in your vehicle can cause serious acid burns, fires, explosions, or electrical shocks. Always read and heed the following WARNINGS and safety precautions before working on the batteries or the electrical system.

- Before working on the electrical system, always switch off the ignition and all electrical consumers and disconnect the negative (-) cable from the standard 12 Volt battery.
- When you change a light bulb, always switch off the light first.
- Always keep children away from battery acid and vehicle batteries in general.
- Always wear eye protection. Never let battery acid or lead particles come into contact with your eyes, skin, or clothing.
- Sulfuric battery acid is very corrosive. It can burn unprotected skin and cause blindness. Always wear protective gloves and eye protection. To reduce your risk of injury, never tilt the batteries, as this could spill acid through the vents and burn you.
- If you get battery acid in your eyes or on your skin, immediately rinse with cold water for several minutes and then get immediate medical attention. If you swallow any battery acid, get medical attention immediately.
- When disconnecting the batteries from the vehicle electrical system, always disconnect the negative cable (-) first and then the positive cable (+).
- Always switch off all electrical consumers before reconnecting 12 Volt batteries. Reconnect the plus cable (+) first and then the negative cable (-). Never reverse the polarity of the connections. This could cause a fire.
- A highly explosive mixture of gases is given off when the battery is being charged.
- Do not smoke and avoid fires, sparks, and open flames when working. Never create sparks or electrostatic charges when handling cables and electrical equipment. Never short circuit the battery terminals. High-energy sparks can cause serious personal injury.
- Never use or attempt to charge a damaged or frozen battery, or a battery that was frozen but has thawed. Charging a frozen or thawed battery could cause explosions and chemical burns! Replace damaged or frozen vehicle batteries immediately. A dead battery can freeze at temperatures around +32 °F (0 °C).
- If the battery has a vent line or tube, make sure that it is properly connected to the battery.
- Always make sure that the vent line is securely attached to a vehicle battery that is located in the luggage compartment.



## WARNING

California Proposition 65 Warning

- Battery posts, terminals, and related accessories contain lead and lead components, chemicals known to the State of California to cause cancer and reproductive harm. Wash your hands after handling.



## NOTICE

- Do not expose the vehicle battery to direct sunlight for an extended period of time as ultraviolet rays may damage the battery housing.
- If the vehicle is left standing in the cold for a long time, protect the vehicle battery from freezing. A battery will be permanently damaged by freezing.



Undeployed battery isolator modules are classified as **Perchlorate Material**. Special handling may apply – see <http://www.dtsc.ca.gov/hazardouswaste/perchlorate>. Obey all applicable legal

requirements regarding handling and disposal of the vehicle or parts of its restraint system, including airbag modules and safety belts with pretensioners. Authorized Volkswagen dealers and authorized Volkswagen Service Facilities are familiar with the requirements, and we recommend that you have them perform this service for you.



Emergency starting and starting the engine with a very weak vehicle battery or after the vehicle battery has been replaced may change or delete system settings (including time, date, personal convenience settings, and programming). Check the settings and correct as necessary once the vehicle battery has built up a sufficient charge.

## Warning light

**Please first read and note the introductory information and heed the WARNINGS **

Lights up	Possible cause	Proper response
	Alternator malfunction.	See an authorized Volkswagen dealer or an authorized Volkswagen Service Facility. Have the electrical system checked. Switch off unnecessary electrical loads. The vehicle battery will not be charged by the alternator as you drive.

When the ignition is switched on, several warning and indicator lights come on briefly for a function check. They go out after a few seconds.



### WARNING

Failure to heed warning lights and instrument cluster text messages can cause the vehicle to break down in traffic and result in a collision and serious personal injury.

- Never ignore warning lights or text WARNINGS.
- Always stop the vehicle as soon as it is safe to do so.



### NOTICE

Failure to heed warning lights or text WARNINGS can result in vehicle damage.

# Exterior care and cleaning

## Introduction

---

In this section you'll find information about:

- Washing with a power washer
- Cleaning windows and outside mirrors
- Cleaning and changing the windshield wiper blades
- Waxing and polishing vehicle paint
- Caring for and cleaning chrome and aluminum parts
- Cleaning wheel rims
- Care of rubber door and window seals
- Deicing door lock cylinders
- Undercoating
- Cleaning the engine compartment

Regular and expert care helps to **preserve the value** of your vehicle. Such expert care may also be one of the requirements of your New Vehicle Limited Warranty if corrosion repair or repainting is necessary.

Vehicle care products are available from your authorized Volkswagen dealer or authorized Volkswagen Service Facility.

### **More information:**

- Preparations for working in the engine compartment
- Interior care and cleaning
- Parts, accessories, repairs and modifications



### **WARNING**

**Vehicle care products can be dangerous. Improper use can cause accidents, burns, poisoning, or other serious personal injuries.**

- **Always store vehicle care products only in original containers that are securely closed.**
- **Always read and heed all the instructions and all WARNINGS on the package.**
- **To reduce the risk of poisoning, never use empty food or beverage containers that might mislead someone into drinking from them.**
- **Always keep vehicle care products out of the reach of children.**
- **Always use such products outdoors or in well-ventilated areas, because harmful vapors may be released when these products are used.**
- **Never use fuel, turpentine, engine oil, nail polish remover or other volatile fluids for vehicle care. They are poisonous and highly flammable.**



## WARNING

Improper care and cleaning of vehicle components can impact the safety features of the vehicle and cause severe injuries.

- Always clean and maintain vehicle components according to manufacturer's instructions.
- Only use approved or recommended cleaners.



## NOTICE

Vehicle care products containing solvents can damage plastics and other vehicle the materials.



Wash the vehicle only at specifically designated wash locations to help prevent water contaminated with oil, grease and fuel from entering the storm drain sewer system. In some areas it is against the law to wash motor vehicles anywhere than other than at specified designated car washing locations.



When buying vehicle care products, try to choose those that are not harmful to the environment.



Never throw out vehicle care products with ordinary household waste. Always read and heed all the instructions and all WARNINGS on the package.

## Washing with a power washer

❑ Please first read and note the introductory information and heed the WARNINGS ⚠

Always follow the instructions for the power washer. This especially applies to the **pressure** and **spraying distance** ⇒ ⚠.

Make sure there is enough distance to soft materials such as rubber hoses or insulating material as well as the sensors of the Park Distance Control system. The Park Distance Control system sensors can be found in the front and rear bumpers ⇒ ⚠.

Never use **concentrated jet nozzles** or so-called **dirt blasters** ⇒ ⚠.

Never use a power washer to clean the engine compartment, *Cleaning the engine compartment.*



## WARNING

Improper use of power washers can cause serious invisible permanent damage leading to tire failure and loss of vehicle control. This can cause accidents and severe personal injury.

- Keep sufficient distance between water jet and tires. Never wash tires with a nozzle that sprays the water out in a direct stream regardless of the distance to the tire and even for a very short time.
- Never use “dirt blasters” to clean tires. Even spraying from a relatively long distance for a very short time can do visible or invisible damage to tires.



## WARNING

After the vehicle has been washed, the wet brakes or, in winter, brake discs or pads coated with ice, react slower and need longer stopping distances.

- Always dry the brakes and clean off any ice coatings with a few careful applications of the brake. Make sure not to endanger other motorists or cyclists or disobey legal requirements.



## NOTICE

- Water temperature should not be more than +140 °F (+60 °C).
- To help prevent damage to the paint, do not wash the vehicle in direct sunlight.
- In order for Park Distance Control to work correctly, the sensors in the rear bumper must be kept clean and clear of snow and ice.
- When using a power washer or steam cleaner, only spray the sensors directly for a short period of time and always keep the nozzle at least 4 inches (10 cm) from the sensor.
- Do not clean icy or snow-covered windows with a power washer.
- When washing or rinsing the vehicle in cold weather, do not let water get into the lock cylinders or point the hose at gaps around the doors, hood, or luggage compartment lid. The water could freeze on the locks and seals and make it difficult to open the vehicle!

## Undercoating

---

 Please first read and note the introductory information and heed the WARNINGS 

The vehicle underbody is coated to help protect it from corrosion and damage. The undercoating could be damaged during normal use. We therefore recommend that you have the protective coatings on the underbody and suspension inspected regularly, and repaired if necessary.



## WARNING

Undercoating and rustproofing products can catch fire on the hot exhaust system or any other hot engine component.

- Never apply additional undercoating or rust proofing on or near the exhaust manifold, the exhaust pipes, the catalytic converter, the heat shields, or any other hot vehicle component.

# Interior care and cleaning

## Introduction

---

In this section you'll find information about:

- Caring for upholstery
- Cleaning upholstery, fabric trim and Alcantara®
- Care and cleaning of leather upholstery
- Cleaning leatherette
- Cleaning storage compartments and cup holders
- Care and cleaning of plastic components, wood trim and instrument panel
- Cleaning the safety belts

Modern clothing fabrics such as dark denim may not be completely colorfast. Even with normal use, dye from these and other fabrics can rub off on seat upholstery and leave visible discolorations (especially on light-colored seat upholstery). This is caused by a lack of colorfastness in the clothing fabric, not by any fault in the seat upholstery fabric. To help prevent damage to the seat upholstery, always make sure your clothing is colorfast. Volkswagen recommends having a qualified specialist remove any discolorations from the seat upholstery.

The longer stains, dirt and other deposits remain on the surfaces of vehicle components and upholstery, the more difficult it may be to clean them. If stains, dirt and deposits are left untreated for a long time, they may become impossible to remove.

### More information:

- Exterior care and cleaning
- Parts, accessories, repairs and modifications



### WARNING

Vehicle care products can be dangerous. Improper use can cause accidents, burns, poisoning, or other serious personal injuries.

- Always store vehicle care products only in original containers that are securely closed.
- Always read and heed all the instructions and all WARNINGS on the package.
- To reduce the risk of poisoning, never use empty food or beverage containers that might mislead someone into drinking from them.
- Always keep vehicle care products out of the reach of children.
- Always use such products outdoors or in well-ventilated areas, because harmful vapors may be released when these products are used.
- Never use fuel, turpentine, engine oil, nail polish remover or other volatile fluids for vehicle care. They are poisonous and highly flammable.



## WARNING

Improper care and cleaning of vehicle components can compromise the vehicle's safety features and cause serious personal injury.

- Always clean and maintain vehicle components according to manufacturer's instructions.
- Only use approved or recommended cleaners.



## NOTICE

- Vehicle care products containing solvents can cause irreparable damage to plastics and other vehicle materials.
- Stains, dirt and other deposits that contain aggressive substances or solvents can corrode vehicle materials and cause permanent damage, even after brief contact with the surface.
- Remove stains, dirt, and other deposits as quickly as possible and do not allow them to dry.
- To help prevent damage, have stubborn stains removed by a professional who has the necessary expertise and experience.



Suitable care products are available from authorized Volkswagen dealers and authorized Volkswagen Service Facilities.

## Caring for upholstery

---

❏ Please first read and note the introductory information and heed the WARNINGS

### Checklist

---

Please note the following when it comes to the care and preservation of the upholstery ⇒

- ✓ Open Velcro® fasteners can damage upholstery, fabric, and trim. Before you get into the vehicle, close all Velcro® fasteners that could come into contact with upholstery fabrics and cloth trim.
  - ✓ Sharp-edged objects and items on clothing and belts (such as belt clips, mobile phone cases, zippers, rivets, and rhinestones) can damage upholstery material and fabric trim. To help prevent damage, do not let such items come into direct contact with the upholstery and fabric trim.
  - ✓ Dust and dirt particles in pores, folds, and seams can have a “scouring” effect on material and damage the surface. Remove dust and dirt regularly to help prevent permanent surface damage.
  - ✓ Check clothing for color-fastness to help prevent upholstery discoloration, especially to light-colored upholstery.
- 



## NOTICE

Disregarding the upholstery-related checklist may lead to damage or discoloration of upholstery and fabric trim.

- Please note and follow the points listed in the checklist.



Volkswagen recommends having any discoloration removed by an authorized Volkswagen dealer or authorized Volkswagen Service Facility.



# Tires and wheels

## Introduction

---

In this section you'll find information about:

Tire and wheel handling  
Wheel rims  
New and replacement tires  
New and replacement tires  
Tire inflation pressure  
Tire inflation pressure  
Tire inflation pressure in cold tires  
Tire inflation pressure in cold tires  
Tread depth and tread wear indicators  
Tire wear and damage  
Spare wheel or compact spare wheel  
Tire labeling  
Winter tires  
Snow chains  
Glossary of tire and loading terminology  
Tires and vehicle load limits  
Determining the correct load limit

Volkswagen recommends that all work on tires and wheels be done by an authorized Volkswagen dealer or authorized Volkswagen Service Facility. They are familiar with the technical requirements and recommended procedures, have the necessary special tools and spare parts, and can properly dispose of old tires.

### **More information:**

- Transporting
- Trailer towing
- Braking, stopping and parking
- Tire Pressure Monitoring System
- Exterior care and cleaning
- Vehicle tool kit
- Consumer information
- Wheel covers
- Changing a wheel



## WARNING

New tires or tires that are old, worn or damaged cannot provide maximum control and braking performance.

- Improper care and handling of tires and wheels can reduce driving safety and cause accidents and severe injuries.
- Install only radial tires of the same make, the same dimensions (tread circumference), and similar tread profile on all 4 wheels.
- New tires tend to be slippery and must be broken in. Always drive with special care for the first 350 miles (560 km) to help reduce the risk of losing control, a collision, and serious personal injuries.
- Check tire inflation pressure regularly when the tires are cold and always maintain the prescribed tire pressure. Low tire pressure can cause tires to get too hot, resulting in tread separation, sudden loss of pressure, and blowouts. Tires with excessively low pressure flex (bend) more, which can cause the tire to overheat and fail suddenly without warning.
- Check tires regularly for wear and damage.
- Never drive with worn or damaged tires (for example, tires with punctures, cuts, cracks, blisters, or bumps). Driving with worn or damaged tires can lead to loss of vehicle control, sudden tire failure including blowouts and sudden deflation, crashes, and serious personal injuries.
- Have worn or damaged tires replaced immediately.
- Never exceed the maximum speed rating or the maximum load rating of the tires on your vehicle.
- The effectiveness of the driver assistance systems and the braking support systems depends on the tire traction.
- If you notice unusual vibration or if the vehicle pulls to one side when driving, always stop as soon as it is safe to do so and check the wheels and tires for damage.
- To reduce the risk of losing control, crashes, and serious personal injuries, never loosen the bolts on wheels with bolted rim rings.
- Never mount used tires on your vehicle if you are not sure of their past use. Old, used tires and wheels may have damage that cannot be seen that can lead to sudden tire failure and loss of vehicle control.
- Tires age even if they are not being used and can fail suddenly, especially at high speeds, causing loss of vehicle control, accidents, and severe personal injuries. Tires that are more than 6 years old can be used only in an emergency and even then only with special care and at low speed.



For technical reasons it is usually not possible to use wheel rims from other vehicles. Even wheel rims from the same model may not fit properly. Check with an authorized Volkswagen dealer or authorized Volkswagen Service Facility if necessary.

## Tire and wheel handling

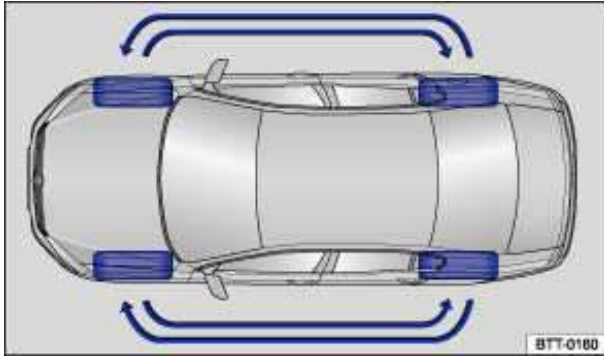

Fig. 151 Tire rotation diagram.

### **ⓘ Please first read and note the introductory information and heed the WARNINGS ⚠**

Tires may be the least appreciated and most abused parts of a motor vehicle. Tires are very important, since their small patches of rubber are the only contact between your vehicle and the road.

Maintaining correct tire pressure, making sure that your vehicle and its tires do not have to carry more weight than they can safely handle, and regularly inspecting tires for damage (such as cuts, slashes, irregular wear, and overall condition) are the most important things that you can do to help avoid sudden tire failure, including tread separation and blowout.

The tires and wheels are essential parts of the vehicle's design. The tires and wheels approved by Volkswagen are specially matched to the characteristics of the vehicle for good road holding and safe handling when in good condition and properly inflated.

### **Avoiding tire damage**

- If you must drive over a curb or other obstacle, drive very slowly and as much as possible at a right angle to the curb with the tire tread of both front wheels contacting the curb at the same time.
- Regularly check tires for damage, such as punctures, cuts, tears and blisters.
- Remove embedded material in the tread profile that **has not yet penetrated the inside of the tire** 279.
- Heed all warning messages from the Tire Pressure Monitoring System
- Replace worn or damaged tires immediately
- Damage to tires and wheels is often not readily visible. If you notice unusual vibration or the vehicle pulls to one side, this may indicate that one of the tires is damaged. The tires must be checked immediately for **hidden damage** by an authorized Volkswagen dealer or an authorized Volkswagen Service Facility.
- Never exceed the load and permissible maximum speed rating of the tires
- Always keep aggressive chemicals including grease, oil, gasoline and brake fluid off the tires, including the spare wheel ⇒ ⚠.
- Replace missing valve caps immediately.

### **Unidirectional tires**

Unidirectional tires are designed to rotate only in one direction. Unidirectional tires have arrows on the sidewalls that show the direction of rotation. Unidirectional tires must always be mounted according to the specified direction of rotation in order to deliver their best grip, braking performance, low road noise, and good wear as well as good hydroplaning resistance.

If you have to mount a tire opposite to its proper direction of rotation, you must drive more carefully, since the tire is no longer being used as designed. This is particularly important on wet roads. You must replace or remount the tire as soon as possible in order to restore the correct direction of rotation.

## Rotating tires

To help ensure even wear on all tires, regular tire rotation according to the diagram ⇒ [fig. 151](#) is recommended. In this way all tires can have about the same service life.

Volkswagen recommends that you have your tires rotated by an authorized Volkswagen dealer or authorized Volkswagen Service Facility.

## Tires more than 6 years old

Tires age even if they are not being used. Physical and chemical processes reduce tire strength and performance and cause them to harden and become brittle. Old tires can fail suddenly and without warning.

Volkswagen recommends replacing tires that are 6 years and older. This also applies to tires that look new (an unused spare and the tire on the compact spare wheel) or that seem to still be usable with tread depth that has not yet reached the legal minimum depth ⇒ .

The age of each tire can be determined with the manufacturing date that is part of the U.S. DOT tire identification number (T I N)

## Tire storage

Mark tires before removing them to help make sure that the previous location (left, right, front, rear) and rolling direction can be maintained when remounting them. Store tires in a cool, dry and preferably dark place. Do **not** store tires mounted on wheels standing up.

Tires not mounted on wheels should be covered to help protect them from dirt and stored vertically (sitting on the tread).



### WARNING

**Aggressive fluids and materials can cause visible and invisible tire damage that can cause tire blowouts.**

- Always keep chemicals, oils, grease, fuels, braking fluids and other aggressive substances away from tires.



### WARNING

**Tires age even if they are not being used and can fail suddenly, especially at high speeds, causing loss of vehicle control, accidents, and severe personal injuries.**

- Tires that are more than 6 years old can be used only in an emergency and even then only with special care and at low speed.



Always dispose of old tires in accordance with legal requirements.

## Wheel rims

---

**Please first read and note the introductory information and heed the WARNINGS **

The design of the wheel bolts is matched to the factory-installed wheels. If different wheels are installed, wheel bolts with the right length and bolt head shape must be used. This helps to ensure that wheels can be mounted securely and that the brakes will work correctly

In most cases, you cannot use wheel bolts from a different vehicle. Even wheel rims from the same model may not fit properly.

Tires and wheel rims approved by Volkswagen have been matched precisely to your vehicle model and contribute considerably to good handling and safe vehicle performance.

### **Tightening torque**

Wheel bolts must always be installed with the correct tightening torque. The required tightening torque for your vehicle's wheel bolts is **88 ft-lbs (120 Nm)**. After changing a wheel, the bolt torque must be checked as soon as possible with an accurate torque wrench. See an authorized Volkswagen dealer or an authorized Volkswagen Service Facility.

### **Wheel rims with bolted rim rings**

Wheel rims with bolted rim rings have several parts. The parts are bolted together with special screws in a special process. This helps to ensure that they will work properly, prevent leaks, run true and safely. Damaged wheel rims must be replaced, and you must never take them apart or try to repair them yourself. Have an authorized Volkswagen dealer or an authorized Volkswagen Service Facility repair them for you ⇒ .

### **Wheel rims with bolted decorative covers**

Light-alloy wheels may have interchangeable decorative covers attached to the rim with self-locking screws. If you want to replace damaged wheel covers, contact your authorized Volkswagen dealer or authorized Volkswagen Service Facility.



#### **WARNING**

**Using improper or damaged wheel rims can affect driving safety, cause accidents and severe personal injury.**

- Use only wheel rims approved for the vehicle.
- Regularly check wheel rims for damage and replace them if necessary.



#### **WARNING**

**Improper loosening and tightening of the bolts on wheel rims with bolted rim rings can cause accidents and severe personal injury.**

- Never loosen bolted connections on wheel rims with bolted rim rings.
- Have all work on wheel rims with bolted rim rings performed by an authorized Volkswagen dealer or authorized Volkswagen Service Facility.

Applicable only in the United States

Applicable only in the USA

## Tire inflation pressure

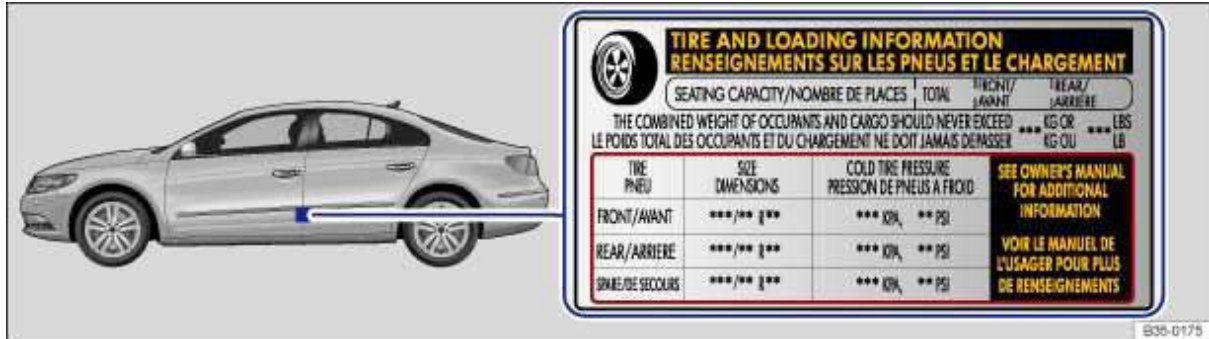

Fig. 152 Location of the tire inflation pressure label.

⚠ Please first read and note the introductory information and heed the WARNINGS ⚠

The correct tire inflation pressure for the factory-installed tires is listed on a label. The factory-installed tires may be summer, winter, or all-season tires. The label ⇒ fig. 152 is on the driver door jamb.

Under- or over-inflation significantly shortens the service life of your tires and affects the handling of the vehicle ⇒ ⚠. The correct tire pressure is very important, particularly when the vehicle is driven at **higher speeds**. Incorrect tire pressure causes increased wear and even sudden tire failure and blowouts.

Therefore, tire pressure should be checked at least once a month and always before long trips.

The specified tire inflation pressure applies to a **cold tire**. When tires are warm, the pressure will be higher than when the tires are cold.

Do not reduce the tire pressure on warm tires to match the required cold tire inflation pressure. The tire inflation pressure would then be too low and could cause sudden tire failure and blowout.

## Tire inflation pressure

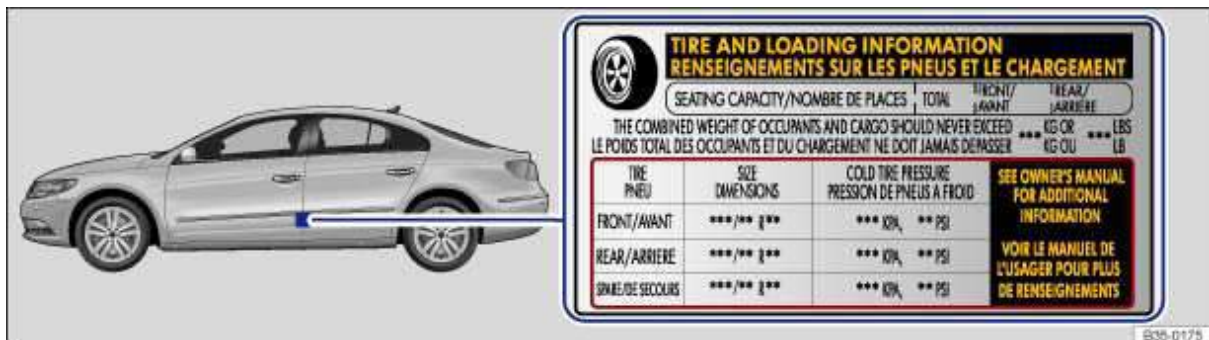



Fig. 153 Location of the tire inflation pressure label.

⚠ Please first read and note the introductory information and heed the WARNINGS ⚠

The correct tire inflation pressure for the factory-installed tires is listed on a label. The factory-installed tires may be summer, winter, or all-season tires. The label ⇒ fig. 153 is on the driver door jamb.

Under- or over-inflation significantly shortens the service life of your tires and affects the handling of the vehicle ⇒ . The correct tire pressure is very important, particularly when the vehicle is driven at **higher speeds**. Incorrect tire pressure causes increased wear and even sudden tire failure and blowouts.

Therefore, tire pressure should be checked at least once a month and always before long trips.

The specified tire inflation pressure applies to a **cold tire**. When tires are warm, the pressure will be higher than when the tires are cold.

Do not reduce the tire pressure on warm tires to match the required cold tire inflation pressure. The tire inflation pressure would then be too low and could cause sudden tire failure and blowout.

### Checking tire inflation pressure

Always check the tire pressure only on “cold” tires when the vehicle has not been driven more than a couple of miles (kilometers) at low speed within the last 3 hours.

- Check tire inflation pressure regularly and on cold tires. Check all the tires, including the compact spare, if any. In colder climates tire pressure should be checked more often, but only when the tires are cold. Always use an accurate tire pressure gauge.
- Adjust the tire pressure for heavy loads accordingly.
- After adjusting the tire inflation pressures, make sure to screw the valve caps back on; replace missing valve caps immediately. Please read and heed the information on resetting the Tire Pressure Monitoring System, if necessary
- Remember that the vehicle manufacturer, not the tire manufacturer, determines the correct tire pressure for the tires on your vehicle. Never exceed the maximum inflation pressure listed on the tire sidewall for any reason.

Inflate a **spare wheel** to the pressure specified for the vehicle's road wheels on the tire pressure label; inflate a **compact spare wheel** to the pressure specified for the compact spare on the tire pressure label or on a separate label for the compact spare, if there is one.

### WARNING

**Incorrect tire pressure can cause a sudden tire failure or blowout, loss of control, collision, serious personal injury, and even death.**

- **Always inflate tires to the recommended and correct cold tire pressure before driving off.**
- **Low tire pressure can cause tires to get too hot, resulting in tread separation, sudden loss of pressure, and blowouts. Tires with excessively low pressure flex (bend) more, which can cause the tire to overheat and fail suddenly without warning.**
- **Excessive speed and/or overloading can cause heat build-up, sudden tire failure including a blowout and sudden deflation and loss of control.**
- **If the tire pressure is too low or too high, the tires will wear prematurely and the vehicle will not handle well.**
- **Regularly check tire inflation pressure, at least once a month, and also especially before a long trip.**
- **Check the pressure in all 4 tires when the tires are still cold. Never reduce air pressure in warm tires to match cold tire inflation pressure.**

### NOTICE

- **Make sure not to jam the tire pressure gauge into the valve stem. Otherwise, you can damage the tire valves.**
- **Driving without valve caps, with the wrong valve caps, or with valve caps that are not properly screwed on can damage the tire valves. To help prevent damage, always use valve**

stem caps like those originally installed at the factory. The caps must be screwed on tightly. Do not use metal valve caps or “comfort” valve stem caps.



Underinflation increases fuel consumption.



There may be differences between the pressure readings from a tire pressure gauge and the pressures registered by the Tire Pressure Monitoring System. The electronic Tire Pressure Monitoring System is more accurate



When the TPMS warns that the pressure in at least one tire is too low, check the tire pressure in all 4 tires with an accurate tire pressure gauge. Low tire pressure usually cannot be spotted by looking at the tire. This is especially true for low-profile tires. When checking the tire pressures, refer to 218, *Tire Pressure Monitoring System (TPMS)*.

Applicable only in the United States

## Tire inflation pressure in cold tires

☐ Please first read and note the introductory information and heed the **WARNINGS**  269.

Engine	Tire dimensions	Tire pressure		
		bar	psi	kPa
2.0 l / 200 hp (147 kW)	235/45 R 17	2.1	30	210
	235/40 R 18 xl	2.3	33	230
	215/55 R 16 xl <sup>3</sup>	2.1 <sup>4</sup>	30 <sup>4</sup>	210 <sup>4</sup>
	215/55 R 16 xl <sup>3</sup>	2.3 <sup>5</sup>	33 <sup>5</sup>	230 <sup>5</sup>
3.6 l / 280 hp (206 kW)	235/45 R 17	2.3	33	230
	235/40 R 18 xl	2.5	36	250
	215/55 R 16 xl <sup>3</sup>	2.3 <sup>4</sup>	33 <sup>4</sup>	230 <sup>4</sup>
	215/55 R 16 xl <sup>3</sup>	2.5 <sup>5</sup>	36 <sup>5</sup>	250 <sup>5</sup>
3.6 l / 280 hp (206 kW) 4MOTION	235/45 R 17	2.3	34	230
	235/40 R 18 xl	2.6	38	260

xl = reinforced sidewall.

<sup>3</sup> Spare tire

<sup>4</sup> applies to R 17 tires

<sup>5</sup> applies to R 18 tires



Engine	Tire dimensions	Tire pressure		
		bar	psi	kPa
<p>The Tire Pressure Monitoring System is configured at the factory with the correct tire inflation pressure applicable for the vehicle model, engine and factory-installed tires. The tire inflation pressure is listed on the tire inflation pressure label on the driver door jamb 274. The tire inflation pressures for the road tires are listed on this label. The inflation pressure for the compact spare is as specified on the tire pressure label or on a separate label for the compact spare, if there is one. In the event of a discrepancy between the above figures and the tire pressures listed on the tire inflation pressure label, the pressures listed on the label are the ones you should use. The listed pressure applies to all road tires. If different tires are installed that do not have the same cold tire inflation pressure as the tires originally installed on your vehicle, the Tire Pressure Monitoring System cannot properly monitor tire inflation pressures unless the TPMS is reset to the new tire pressures 229. Authorized Volkswagen dealers and authorized Volkswagen Service Facilities have the necessary special tools and can reset the TPMS for the new tires on your vehicle.</p>				

Applicable only in Canada

## Tire inflation pressure in cold tires

❏ Please first read and note the introductory information and heed the **WARNINGS** ⚠

Engine	Tire dimensions	Tire pressure		
		bar	psi	kPa
<b>2.0 l / 200 hp (147 kW)</b>	235/45 R 17	2.1	30	210
	235/40 R 18 xl	2.3	33	230
	215/55 R 16 xl <sup>6</sup>	2.1 <sup>7</sup>	30 <sup>7</sup>	210 <sup>7</sup>
	215/55 R 16 xl <sup>6</sup>	2.3 <sup>8</sup>	33 <sup>8</sup>	230 <sup>8</sup>
<b>3.6 l / 280 hp (206 kW)</b>	235/45 R 17	2.3	33	230
	235/40 R 18 xl	2.5	36	250
	215/55 R 16 xl <sup>6</sup>	2.3 <sup>7</sup>	33 <sup>7</sup>	230 <sup>7</sup>
	215/55 R 16 xl <sup>6</sup>	2.5 <sup>8</sup>	36 <sup>8</sup>	250 <sup>8</sup>
<b>3.6 l / 280 hp (206 kW) 4MOTION</b>	235/45 R 17	2.3	34	230
	235/40 R 18 xl	2.6	38	260
xl = reinforced sidewall.				

<sup>6</sup> Spare tire

<sup>7</sup> applies to R 17 tires

<sup>8</sup> applies to R 18 tires

Engine	Tire dimensions	Tire pressure		
		bar	psi	kPa
<p>The Tire Pressure Monitoring System is configured at the factory with the correct tire inflation pressure applicable for the vehicle model, engine and factory-installed tires. The tire inflation pressure is listed on the tire inflation pressure label on the driver door jamb 274. The tire inflation pressures for the road tires are listed on this label. The inflation pressure for the compact spare is as specified on the tire pressure label or on a separate label for the compact spare, if there is one. In the event of a discrepancy between the above figures and the tire pressures listed on the tire inflation pressure label, the pressures listed on the label are the ones you should use. The listed pressure applies to all road tires. The Tire Pressure Monitoring System must be recalibrated whenever you change or adjust the cold tire inflation pressure or remove and remount or change any wheel or tire on the vehicle, even if the reinstalled or replacement wheels and tires are identical to those that were removed and even if the tire pressure does not change</p>				

## Tread depth and tread wear indicators

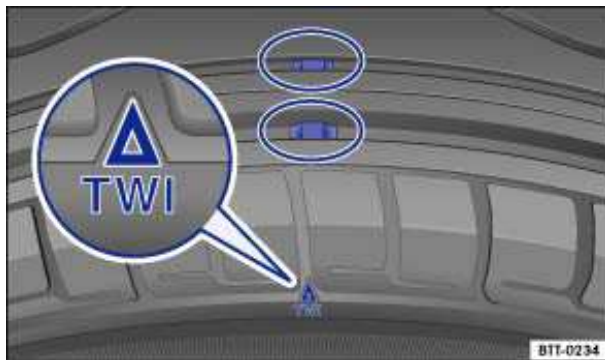

Fig. 154 Tread pattern: Wear indicator.

⚠ Please first read and note the introductory information and heed the WARNINGS ⚠

### Tread depth

Most driving situations require as much tread depth as possible and similar tread depth for the tires on the front and rear wheels. This is especially true when driving in winter weather, at low temperatures and under wet conditions ⇒ ⚠.

In most countries the legally permissible minimum tread depth is 1/16 in (1.6 mm), as measured in tread grooves next to the wear indicators. Please be sure to obey country-specific legal requirements.

**Winter tires** are no longer suitable for winter operation once the tread pattern is worn down to a depth of 3/16 in (4.8 mm)

The tread depth of new tires can differ between tire models and manufacturers because of the different design features and tread patterns.

### Tread wear indicator (TWI) in the tire

The 1/16 in (1.6 mm) high wear indicators are molded into the bottom of the tread grooves of the original tires running across the treads ⇒ fig. 154. Several wear indicators are evenly spaced around the tire. Markings on the sides of the tires (for example "TWI" or symbols) show the position of the wear indicators.

Wear indicators show when the tires are worn down. The tires must be replaced no later than when the tread pattern is worn down to the wear indicators.



## WARNING

Worn tires are dangerous and can cause loss of vehicle control including serious personal injuries.

- Never drive a vehicle when the tread on any tire is worn down to the wear indicators, replace them sooner.
- Worn tires do not grip the road properly, especially on wet roads, increasing your risk of “hydroplaning” and loss of control.
- Worn tires reduce the ability of your vehicle to handle well in normal and difficult driving situations and increase braking distances and the risk of skidding.

## Tire wear and damage

---

ⓘ Please first read and note the introductory information and heed the WARNINGS

Wheel rim and tire damage is often difficult to see. Unusual **vibrations** or **pulling to one-side** can be an indication of tire damage ⇒ .

- If you suspect tire damage, immediately reduce speed!
- Check tires and wheel rims for damage.
- If a tire is damaged, do not drive any farther. Get expert assistance.
- If no external damage is visible, slowly and carefully drive to the nearest authorized Volkswagen dealer, authorized Volkswagen Service Facility, or other qualified workshop and have the vehicle checked.

### Objects embedded in the tire

- If embedded objects have penetrated to the inside tire, do not remove them!
- For vehicles with run-flat tires (mobility tires): Leave the object in the tire and contact your Authorized Volkswagen dealer and authorized Volkswagen Service Facility for assistance. Sealant that has been applied to the inside of the tire running surface will surround the object and seal the tire temporarily.
- Get professional help immediately.

### Tire wear

Tire wear depends on several factors, including:

- Driving style.
- Unbalanced wheels.
- Wheel alignment.

*Driving style* – Fast cornering, hard acceleration and braking increase tire wear. If you experience increased tire wear under normal driving conditions, have the vehicle suspension checked by an authorized Volkswagen dealer or an authorized Volkswagen Service Facility.

*Unbalanced wheels* – The wheels on a new vehicle are balanced. When driving, however, various conditions can cause a wheel to become unbalanced. Unbalanced wheels can cause wear to the steering and suspension systems. Have all wheels rebalanced. A wheel must always be rebalanced if a new tire has been mounted.

*Wheel alignment* – Incorrect wheel alignment causes excessive and uneven tire wear, impairing vehicle safety. If you notice excessive or uneven tire wear, have the wheel alignment checked by an authorized Volkswagen dealer or an authorized Volkswagen Service Facility.

## WARNING

Unusual vibrations or pulling to one side can indicate tire damage.

- Reduce speed immediately and stop when it is safe to do so.
- Check tires and wheel rims for damage.
- Never drive with a damaged tire or rim. Get expert assistance instead.
- If no external damage is visible, slowly and carefully drive to the nearest authorized Volkswagen dealer, authorized Volkswagen Service Facility, or other qualified workshop and have the vehicle checked.

## Spare wheel or compact spare wheel

---



Fig. 155 In the luggage compartment: Handwheel holding spare wheel in place.



Fig. 156 In the luggage compartment: Compact spare wheel.

 Please first read and note the introductory information and heed the WARNINGS 

### Stowing the replaced wheel

- Hook the floor covering on the upper edge of the luggage compartment.
- Put the wheel you took off the vehicle into the spare wheel well so that the center hole of the rim is aligned with the threaded pin.
- Turn the handwheel clockwise until the wheel replaced is securely in place.

- If necessary, return the vehicle tool kit to its location in the luggage compartment.
- Unhook the floor covering and fold it back down onto the floor of the luggage compartment.
- Close the luggage compartment lid.

### **If the spare wheel is different from the road wheels**

If the spare is different from the road wheels, a compact spare wheel, for example, or if the road wheels are winter tires, the spare wheel must be used only in the event of a flat tire, only for a brief time, and only when driving with extra caution ⇒ .

Replace it with a tire matching the others on your vehicle as soon as possible.

#### **Please heed the following:**

- Do not drive faster than 50 mph (80 km/h)!
- Avoid full-throttle acceleration, hard braking and fast cornering!
- Do not use snow chains on the compact spare wheel
- After installing the spare wheel or compact spare wheel, check the tire pressure as soon as possible

Check the tire inflation pressure of the spare or compact spare whenever you check the tire pressure of the road wheels, at least once a month. Inflate a **spare wheel** to the cold tire pressure specified for the vehicle's road wheels on the tire pressure label; inflate a **compact spare wheel** to the cold tire pressure specified for the compact spare on the tire pressure label or on a separate label for the compact spare, if there is one.



### **WARNING**

**Improper use of a spare wheel or a compact spare wheel can cause loss of vehicle control, a crash or other accident, and serious personal injury.**

- **Never use a spare wheel or compact spare wheel if it is damaged or worn down to the wear indicators.**
- **In some vehicles, the spare wheel or compact spare wheel is smaller than the original tire. A smaller compact spare wheel is identified with a sticker and the words “50 mph” or “80 km/h”. This is the maximum permissible speed when driving with this tire.**
- **Never drive faster than 50 mph (80 km/h) with a compact spare wheel. Avoid full-throttle acceleration, heavy braking, and fast cornering!**
- **Never drive more than 125 miles (200 km) if a compact spare wheel is installed on the front axle (drive axle).**
- **Replace the compact spare with a normal wheel and tire as soon as possible. Compact spare tires are designed for brief use only.**
- **Regularly check the U.S. DOT Tire Identification Number (TIN) to determine the age of the compact spare wheel. Tires age even if they are not being used and can fail suddenly, especially at higher speeds.**
- **Tires that are more than 6 years old can only be used in an emergency and then with special care and at lower speeds.**
- **The compact spare wheel must always be secured with the wheel bolts provided by the factory.**
- **Never drive using more than one compact spare wheel.**
- **After installing the compact spare wheel, the tire pressure must be checked as soon as possible**
- **Snow chains cannot be used on the compact spare wheel. If you must use snow chains and have a compact spare wheel mounted, move the compact spare wheel to the rear axle if a front tire has to be replaced. The tire taken off the rear axle can then be used to replace the flat front tire. Be sure you do not change the tire's direction of rotation. Install the snow chains on the full-sized road tire.**

## NOTICE

When the spare wheel or compact spare is being used, the TPMS indicator light may start flashing after about 10 minutes.

**i** If possible, attach the spare wheel, compact spare wheel, or the wheel you took off the vehicle securely in the luggage compartment.

## Tire labeling

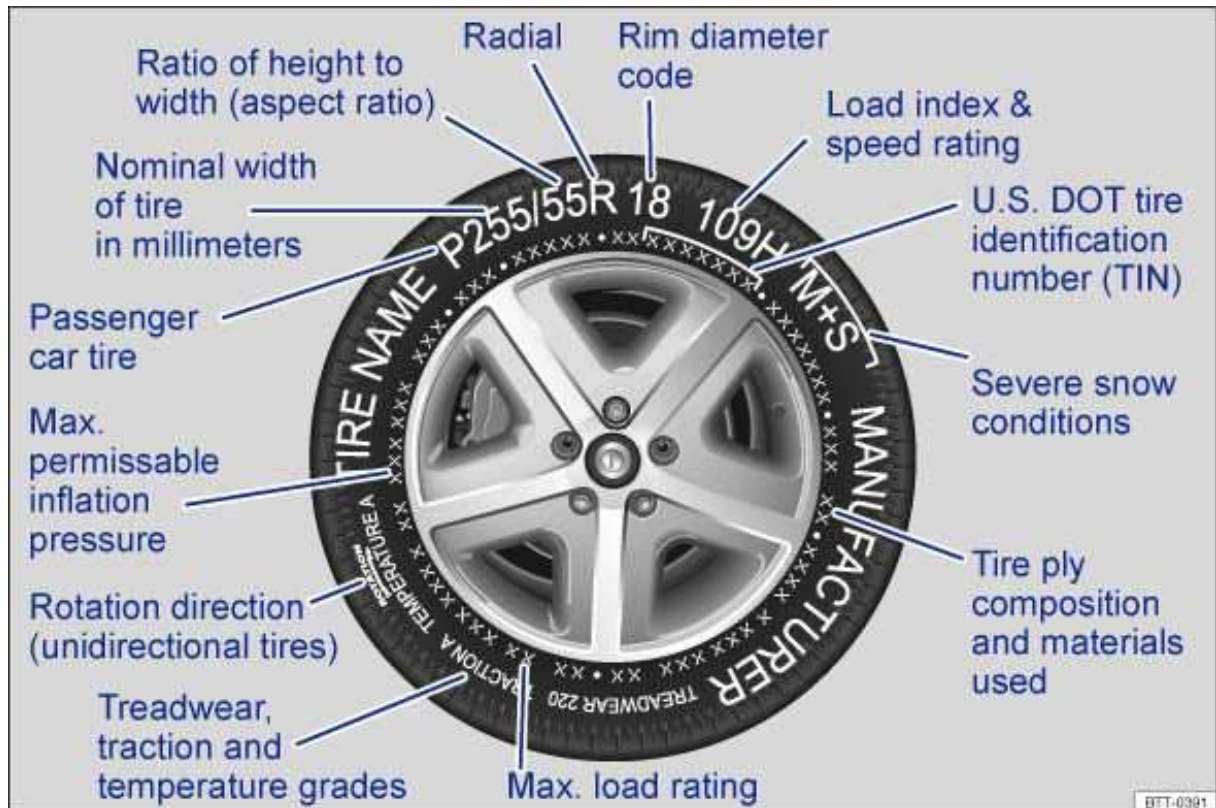

Fig. 157 International tire labeling.

**ⓘ** Please first read and note the introductory information and heed the **WARNINGS** **⚠**

Knowing about tire specifications makes it easier to choose the correct replacement tires. Radial tires have specifications marked on the sidewall.

Tire labeling (example)	Meaning	
<i>Brand, Logo</i>	<i>Manufacturer</i>	
<i>Tire name</i>	Individual tire designation of the manufacturer.	
P215 / 55 R 18	Dimensions:	
	P	Tire application: Passenger car
	255	Nominal sidewall-to-sidewall width of tire in millimeters.
	55	Ratio of height to width (aspect ratio)

<b>Tire labeling (example)</b>	<b>Meaning</b>	
	R	Tire belt design letter code for radial.
	18	Rim diameter (in inches)
95 H	Load rating code 284 and speed rating code	
XL	Indicates “reinforced” tire (heavy-duty)	
M+S or M/S	Indicates Mud and Snow capability (also M/S)	
RADIAL TUBELESS	Tubeless radial tire.	
E4 ...	Labeling according to international regulations (E) including number of the approving country. The multi-digit approval number is listed next.	
DOT BT RA TY5 1709	Tire identification number ( <b>TIN</b> ) <sup>9</sup> – In some cases the manufacturing date is only on one side of the tire:	
	DOT	The tire complies with the requirements of the United States Department of Transportation, responsible for issuing safety standards.
	BT	Identification letter of the manufacturing site.
	RA	Manufacturer information regarding tire dimensions.
	TY5	Tire characteristics provided by the manufacturer.
	1709	Manufacturing date: 17th week in 2009.
TWI	Marks the position of the treadwear indicator	
Made in Germany	Country of manufacture.	
MAX LOAD 615 KG (1356 LBS)	United States maximum load rating per wheel.	
MAX INFLATION 350 KPA (51 PSI)	United States maximum permissible inflation pressure.	
ROTATION	Rotation direction (unidirectional tires)	
SIDEWALL 1 PLY RAYON	Tire ply composition and materials used: 1 layer of rayon.	
TREAD 4 PLYS 1 RAYON + 2 STEEL + 1 NYLON	Tire tread composition and materials used: In this example there are 4 layers under the tread: 1 layer of rayon, 2 layers of steel belt and 1 layer of nylon.	
<b>Consumer information regarding comparison to specified base tires (standardized test procedure) 298:</b>		
TREADWEAR 220	Relative service life expectancy of the tire referenced to a U.S.-specific standard test.	
TRACTION A	Traction rating under wet conditions (AA, A, B or C).	
TEMPERATURE A	Temperature stability of the tire at increased test bench speeds (A, B or C).	
<b>Additional numbers found on the tire could either be tire manufacturer internal labels or country-specific labels (such as for Brazil and China).</b>		

<sup>9</sup> TIN represents the serial number of the tire.

## **Unidirectional tires**

Unidirectional tires are designed to rotate only in one direction. Unidirectional tires have arrows on the sidewalls that show the direction of rotation. Make sure you mount the tire so that it rotates in the proper direction. The tire's performance with regard to hydroplaning, traction, noise, and wear is worse if it is not mounted in the proper direction of rotation.

If you have to mount a tire opposite to its proper direction of rotation, you must drive more carefully, since the tire is no longer being used as designed. This is particularly important on wet roads. You must replace or remount the tire as soon as possible in order to restore the correct direction of rotation.

## **Load rating code**

The load index indicates the maximum permissible load per individual tire in pounds (kilograms).

91	1356 lbs (615 kg)
92	1388 lbs (630 kg)
93	1433 lbs (650 kg)
95	1521 lbs (690 kg)
97	1609 lbs (730 kg)
98	1653 lbs (750 kg)
99	1709 lbs (775 kg)
100	1763 lbs (800 kg)
101	1819 lbs (825 kg)
102	1874 lbs (850 kg)
103	1929 lbs (875 kg)
104	1984 lbs (900 kg)
110	2337 lbs (1060 kg)

## **Speed rating code letter**

The speed rating code letter indicates the maximum permissible road speed of the tires.

P	up to 93 mph (150 km/h)
Q	up to 99 mph (160 km/h)
R	up to 106 mph (170 km/h)
S	up to 112 mph (180 km/h)
T	up to 118 mph (190 km/h)
U	up to 124 mph (200 km/h)
H	up to 130 mph (210 km/h)
V	up to 149 mph (240 km/h)
Z	over 149 mph (240 km/h)
W	up to 168 mph (270 km/h)
Y	up to 186 mph (300 km/h)

Some tire manufacturers label tires with a maximum permissible road speed above 149 mph (240 km/h) with the letter combination "ZR."





## WARNING

Using incorrect or unmatched tires and/or wheels or improper tire and wheel combinations can lead to loss of control, collision and serious personal injury.

- Always use tires, wheels and wheel bolts that meet the specifications of the original factory-installed tires or other combinations that have been specifically approved by the vehicle manufacturer.
- All 4 wheels must be fitted with radial tires of the same type, the same size (tread circumference), and the same tread pattern. Driving with different tires reduces vehicle handling and can lead to a loss of control.
- Never drive faster than the maximum speed for which the tires installed on your vehicle are rated because tires that are driven faster than their rated speed can fail suddenly.
- Overloading tires can cause heat build-up, sudden tire failure, including a blowout and sudden deflation and loss of control.
- Temperature grades apply to tires that are properly inflated and not over- or underinflated.

## Winter tires

❏ Please first read and note the introductory information and heed the **WARNINGS**

Winter tires improve the handling characteristics of your vehicle significantly when driving under wintry road conditions. Summer tires have less traction on snow and ice because of their design (width, rubber composition, tread design). Volkswagen strongly recommends that you always have winter tires or all-season tires installed on all 4 wheels on your vehicle, especially when winter road conditions are expected. Winter tires also improve the vehicle's braking performance and help reduce stopping distances during winter weather. Volkswagen recommends installing winter tires once temperatures are below +45 °F (+7 °C).

Winter tires are no longer suitable for winter driving once the **tread pattern** is worn down to a depth of 3/16 in (4.8 mm). In addition, winter tire performance decreases with **age** – independent of the tread profile depth.

### When using winter tires:

- Obey state and country-specific legal requirements.
- Install winter tires on all 4 wheels.
- Use winter tires only under wintry road conditions.
- Only use winter tires with dimensions approved for the vehicle.
- Use only winter tires of the same tire belt design, the same dimensions (tread circumference), and the same tread design.
- Follow speed restrictions according to the winter tire's speed rating code letter ⇒ .

### Speed restrictions

Winter tires are certified up to a top speed identified by speed rating code letters on the side wall 284.

In some vehicle models it is possible to set a speed warning in the **MFI** menu in the instrument cluster display 19.

Top speed rating and tire inflation pressure for **V winter tires** depend on the engine installed in your vehicle. Be sure to ask your authorized Volkswagen dealer or authorized Volkswagen Service Facility about the maximum permissible speed and the required tire inflation pressure for the winter tires that you plan to use.

## All-wheel drive (4MOTION)

Vehicles with all-wheel drive and standard road wheels have good forward motion and traction even under wintery road conditions. However, Volkswagen recommends installing winter tires or all season tires on *all* four wheels to improve handling as well as *braking performance*.

If you use **snow chains**, please read and heed information and directions



### WARNING

**Driving faster than the maximum speed for which the winter tires on your vehicle were designed can cause sudden tire failure including a blowout and sudden deflation, loss of control, crashes and serious personal injuries.**

- Winter tires have a maximum speed rating that may be lower than your vehicle's maximum speed.
- Never drive faster than the maximum speed for which the winter tires installed on your vehicle are rated because tires that are driven faster than their rated speed can fail suddenly.
- Never exceed the maximum load rating for the winter tires installed on your vehicle.



Install summer tires promptly in the spring. Summer tires offer better handling characteristics for temperatures above +45 °F (+7 °C). They are quieter, do not wear as quickly, and reduce fuel consumption.



If new tires are not identical to those that were removed and require different cold tire inflation pressure, the tire inflation pressure values must be reprogrammed for the TPMS. Please see your authorized Volkswagen dealer or authorized Volkswagen Service Facility 229. Whenever you remove and remount or change any wheel or tire on the vehicle, the Tire Pressure Monitoring System must be recalibrated, even if the reinstalled or replacement wheels and tires are identical to those that were removed and even if the tire pressure does not change 231.



If necessary, ask your authorized Volkswagen dealer or authorized Volkswagen Service Facility about permissible winter tire dimensions.

## Snow chains

**Please first read and note the introductory information and heed the WARNINGS**

Obey local regulations as well as the applicable speed limits when driving with snow chains.

Snow chains improve forward motion, traction and braking characteristics under wintry conditions.

Snow chains may be used **only on the front wheels**. This applies also to **vehicles with all-wheel drive (4MOTION)**.

Please contact your authorized Volkswagen dealer or authorized Volkswagen Service Facility about appropriate wheel, tire and snow chain dimensions.

If possible, use only chains with low profile links that are not thicker than 37/64 in. (15 mm) including the tensioner.

Remove center hubcaps and decorative rim rings before installing snow chains ⇒ However, for safety reasons, caps must be installed on the wheel bolts. These are available from authorized Volkswagen dealers and authorized Volkswagen Service Facilities.

### Compact spare wheel

For technical reasons, snow chains cannot be used on the compact spare 280.

If you must use snow chains and have a compact spare wheel mounted, move the compact spare wheel to the rear axle if a front tire has to be replaced. The tire taken off the rear axle can then be used to replace the flat front tire. Be sure to install the unidirectional tires so that they will run in the proper direction. Volkswagen recommends installing the snow chains before mounting the wheel to the vehicle.



## WARNING

Using the wrong snow chains or installing snow chains improperly can cause accidents and severe personal injuries.

- Always use the proper snow chains.
- Follow the installation instructions provided by the snow chain manufacturer.
- Never exceed the permissible speed limit when driving with snow chains.



## NOTICE

- Remove snow chains when roads are free of snow. Otherwise, the chains can damage the tires, impair vehicle handling and can be quickly worn down.
- Snow chains can scratch or damage wheel rims if they have direct contact with the rims. Volkswagen recommends using coated snow chains.

## Glossary of tire and loading terminology

---

☐ Please first read and note the introductory information and heed the WARNINGS

### Accessory weight

The combined weight (in excess of those standard items which may be replaced) of automatic transmission, electro-mechanical power steering, power brakes, power windows, power seats, radio, and heater, to the extent that these items are available as factory-installed equipment (whether installed or not).

### Aspect ratio

The ratio of sidewall height to tire width, expressed as a percentage. A number of 70 (0.7:1 or 70%) or lower indicates a low-profile tire with a shorter sidewall for improved steering response and better overall handling on dry pavement.

### Bead

The part of a tire made of steel wires, wrapped or reinforced by ply cords, with the shape and structure to ensure proper fit to the wheel rim.

### Bead separation

A breakdown of the bond between components in the bead.

### Carcass

The tire structure, except tread and sidewall rubber which, when inflated, bears the load.

### Chunking

The breaking away of pieces of the tread or sidewall.

### Cord

The strands of material forming the plies in the tire.

**Cord separation**

The parting of cords from adjacent rubber compounds.

**Cracking**

Any parting within the tread, sidewall, or inner liner of the tire extending to cord material.

**Cold tire inflation pressure**

The tire pressure recommended by the vehicle manufacturer for a tire of a specified size that has not been driven for more than a couple of miles (kilometers) at low speeds in the 3 hour period before the tire pressure is measured or adjusted.

**Curb weight**

The weight of a motor vehicle with standard equipment including the maximum capacity of fuel, oil, and coolant, air conditioner, and additional weight of optional equipment.

**Extra load tire**

A tire designed to operate at higher loads and at higher inflation pressures than the corresponding standard tire.

**Gross Axle Weight Rating (GAWR)**

The load-carrying capacity of a single axle system, measured where the tire contacts the ground.

**Gross Vehicle Weight Rating (GVWR)**

The maximum loaded weight of the vehicle.

**Groove**

The space between 2 adjacent tread ribs.

**Load rating (code)**

The maximum load that a tire is rated to carry for a given inflation pressure. You may not find this information on all tires because it is not required by law.

**Maximum load rating**

The load rating for a tire at the maximum permissible inflation pressure for that tire.

**Maximum loaded vehicle weight**

The total of:

- Curb weight.
- Accessory weight.
- Vehicle capacity weight.
- Production options weight.

**Maximum (permissible) inflation pressure**

The maximum cold inflation pressure to which a tire may be inflated. Also called "maximum inflation pressure."

**Normal occupant weight**

Means 150 lbs (68 kilograms) times the number of occupants seated in the vehicle up to the total seating capacity of your vehicle.

**Occupant distribution**

The placement of passengers in a vehicle.

**Outer diameter**

The diameter of a new, properly inflated tire.

**Overall width**

Total width measured at the exterior sidewalls of an inflated tire, including the additional width of labeling, decorations, or protective bands or ribs.

**Passenger car tire**

A tire intended for use on passenger cars, multipurpose passenger vehicles, and trucks, that have a gross vehicle weight rating (GVWR) of 10,000 pounds or less.

**Ply**

A layer of rubber-coated parallel cords.

**Ply separation**

A parting of rubber compound between adjacent plies.

**Pneumatic tire**

A mechanical device made of rubber, chemicals, fabric, and steel or other materials, that, when mounted on an automotive wheel, provides the traction and contains the gas or fluid that sustains the load.

**Production options weight**

The combined weight of installed regular production options weighing over 5 lbs (2.3 kg) more than the standard items they replace, and not previously considered as curb weight or accessory weight. These include, for example, heavy-duty brakes, ride levelers, roof rack, heavy-duty battery, and special trim.

**Radial ply tires**

A pneumatic tire in which the ply cords that extend to the beads are laid at substantially 90 degrees to the centerline of the tread.

**Recommended inflation pressure**

The tire pressure recommended by the vehicle manufacturer for a tire of a specified size that has not been driven for more than a couple of miles (kilometers) at low speeds in the 3 hour period before the tire pressure is measured or adjusted.

**Reinforced tire**

A tire designed to operate at higher loads and at higher inflation pressures than the corresponding standard tire.

**Rim**

The outer edge of a wheel upon which the tire beads are seated.

**Rim diameter**

The nominal diameter of the wheel's tire bead seating surface. If you change your wheel size, to wheels of a different diameter, you will have to purchase new tires to match the new wheels.

**Rim size**

Designation means rim diameter and width.

**Rim type designation**

The industry or manufacturer's designation for a rim by style or code.

**Rim width**

The nominal distance between wheel rim flanges.

**Section width**

The linear distance between the exteriors of the sidewalls of an inflated tire, excluding elevations due to labeling decoration, or protective bands.

**Sidewall**

The portion of a tire between the bead and the tread.

**Sidewall separation**

The parting of the rubber compound from the cord material in the sidewall.

**Speed rating (letter code)**

A standardized letter code indicating the maximum speed at which a tire is designed to be driven for extended periods of time. The ratings range from 93 mph or 150 km/h ("P") to 186 mph or (300 km/h) "Y".

The speed rating letter code, where applicable, is molded on the tire sidewall , *Tire labeling*. You may not find this information on all tires because it is not required by law.

**Tire Pressure Monitoring System**

A system that detects when at least one of a vehicle's tires is underinflated and illuminates a low tire-pressure warning light.

**Tread**

The portion of a tire that normally touches the road.

**Tread rib**

A tread section running circumferentially around a tire.

**Tread separation**

Tire failure caused by the tread pulling away from the tire carcass.

**Tread wear indicators (TWI)**

Raised areas within the main tread grooves that show, visually, when tires are worn and near the end of their useful life 278, *Tread depth and tread wear indicators*.

**Uniform Tire Quality Grading (UTQG)**

A tire information system developed by the U.S. National Highway Traffic Safety Administration (NHTSA) that is designed to help buyers compare tires. UTQG is not a safety rating, nor is it a guarantee that a tire will last for a certain number of miles or perform a certain way. It gives tire buyers more information to compare with factors such as price, brand loyalty and dealer recommendations. Under UTQG, tires are graded by the tire manufacturers in 3 areas: tread wear, traction and temperature resistance. UTQG information is molded into the tire sidewalls.

**U.S. DOT Tire Identification Number (TIN)**

A tire's serial number. It begins with the letters "DOT" ("Department of Transportation") and indicates that the tire meets all federal standards. The next 2 numbers or letters indicate the plant where the tire was manufactured. The last 4 numbers represent the week and year of manufacture.

For example, the numbers 1709 mean that the tire was produced in the 17th week of 2009. Any other numbers are marketing codes used by the tire manufacturer. This information is used to help identify affected consumers if a tire defect requires a recall.

**Vehicle capacity weight**

The total rated cargo, luggage and passenger load. Passenger load is 150 lbs (68 kilograms) times the vehicle's total seating capacity (as listed on the label inside the driver door).

### Vehicle maximum load on the tire

The load on an individual tire that is determined by taking each axle's share of the maximum loaded vehicle weight (GAWR) and dividing by 2.

### Vehicle normal load on the tire

The load on an individual tire that is determined by taking each axle's share of the curb weight, accessory weight, and normal occupant weight (distributed according to the table below) and dividing by 2.

### Wheel size designation

Wheel rim diameter and width.

### Occupant loading and distribution for vehicle normal load for various designated seating capacities

Designated seating capacity, number of occupants	Vehicle normal load, number of occupants	Occupant distribution in a normally loaded vehicle
2, 3, or 4	2	2 in front
5	3	2 in front, 1 in back

## Tires and vehicle load limits

**⚠ Please first read and note the introductory information and heed the WARNINGS ⚠ .**

There are limits to the load any vehicle or any tire can carry. A vehicle that is overloaded will not handle well and is more difficult to stop. Overloading can damage important parts of the vehicle. Overloading can also lead to blowout, sudden loss of pressure or other tire failure that can cause loss of control.

Your safety and the safety of your passengers depends on making sure that load limits are not exceeded. Vehicle load includes everybody and everything in and on the vehicle. These load limits are technically referred to as the vehicle's **Gross Vehicle Weight Rating (GVWR)**.

The GVWR includes the weight of the basic vehicle, all factory-installed and other accessories, a full tank of fuel, oil, coolant and other fluids plus maximum load. The maximum load includes the number of passengers that the vehicle is intended to carry (seating capacity) with an assumed weight of 150 lbs (68 kg) for each passenger at a designated seating position and the total weight of any luggage in the vehicle. If you tow a trailer, the weight of the trailer hitch and the tongue weight of the loaded trailer must be included as part of the vehicle weight. At altitudes above 3000 ft (1000 m), combined towing weight (vehicle plus trailer) must be reduced by 10% for every 3000 ft (1000 m).

**The Gross Axle Weight Rating (GAWR)** is the maximum load that can be carried at each of the vehicle's 2 axles (by the front or rear tires). GVWR and GAWR are listed on the safety compliance label on the driver door jamb. Your vehicle has 5 total seating positions: 2 in the front and 3 in back. Each seating position has a safety belt. Because there is an upper limit to your vehicle's total weight (GVWR), the weight of whatever is being carried (including the weight of a trailer hitch and the tongue weight of the loaded trailer) is also limited. More passengers, or passengers who are heavier than the assumed 150 lbs (68 kg), mean that less weight can be carried as luggage or other cargo. The tire pressure label on your Volkswagen also lists the maximum combined weight of all of the occupants and luggage or other cargo that the vehicle can carry.



## WARNING

Overloading a vehicle can cause loss of vehicle control, a crash or other accident, serious personal injury, and even death.

- Carrying more weight than your vehicle was designed to carry will prevent the vehicle from handling properly and increase the risk of the loss of vehicle control.
- The brakes on a vehicle that has been overloaded may not be able to stop the vehicle in a safe distance.
- Tires on a vehicle that has been overloaded can fail suddenly, including a blowout and sudden deflation, causing loss of control and a crash.
- Always make sure that the total load being transported – including the weight of a trailer hitch and the tongue weight of a loaded trailer – does not make the vehicle heavier than the vehicle's Gross Vehicle Weight Rating.

## Determining the correct load limit

❏ Please first read and note the introductory information and heed the WARNINGS

Never overload tires. The following example illustrates how to determine the combined weight of all vehicle occupants and luggage or other vehicle payloads. Never overload the vehicle!

### Steps for Determining Correct Load Limit:

1. Locate the statement "THE COMBINED WEIGHT OF OCCUPANTS AND CARGO SHOULD NEVER EXCEED XXX KG OR XXX LBS" on your vehicle's placard (tire inflation pressure label) 274, 274.
2. Determine the combined weight of the driver and passengers that will be riding in your vehicle.
3. Subtract the combined weight of the driver and passengers from XXX kg or XXX lbs.
4. The resulting figure equals the available amount of cargo and luggage load capacity. For example, if the "XXX" amount equals 1400 lbs. and there will be five 150 lb. passengers in your vehicle, the amount of available cargo and luggage load capacity is 650 lbs. ( $1400 - 750 (5 \times 150) = 650$  lbs.)
5. Determine the combined weight of luggage and cargo being loaded on the vehicle. That weight may not safely exceed the available cargo and luggage load capacity calculated in Step 4.
6. If your vehicle will be towing a trailer, load from your trailer will be transferred to your vehicle. Consult this Manual to determine how this reduces the available cargo and luggage capacity of your vehicle.

Check the tire sidewall to determine the load index specified for the tire.



# Parts, accessories, repairs and modifications

## Introduction

---

In this section you'll find information about:

Break-in period

Parts and accessories

Operating fluids and equipment

Repairs and technical modifications

Repairs and other things that can affect Advanced Airbag performance

CB radio equipment

Notice about data recorded by vehicle control modules

Using a mobile phone in a motor vehicle when it is not connected to the vehicle telephone antenna - some important things to know

Lift points for the vehicle

### **More information:**

- Safety belts
- Airbag system
- Roof rack
- Trailer towing
- 12 Volt sockets
- Braking, stopping and parking
- Starting assistance systems
- Park Distance Control system
- Rear Assist
- Cruise control system (CCS)
- Tire Pressure Monitoring System
- Preparations for working in the engine compartment
- Engine oil
- Engine coolant
- Vehicle battery
- Exterior care and cleaning
- Interior care and cleaning
- Consumer information
- ⇒ Booklet *Radio*
- ⇒ Booklet *Navigation system*
- ⇒ Booklet *Mobile Phone Package*



## WARNING

Inappropriate spare parts and accessories as well as improperly performed work, modifications and repairs can cause vehicle damage, accidents and serious personal injuries.

- Volkswagen strongly recommends to only use accessories approved by Volkswagen and Genuine Volkswagen Parts®. These parts and accessories have been evaluated by Volkswagen for their suitability, reliability and safety.
- Have repairs and vehicle modifications performed by an authorized Volkswagen dealer or authorized Volkswagen Service Facility. Authorized Volkswagen dealers and authorized Volkswagen Service Facilities have the required tools, diagnostic equipment, repair information, and trained personnel to properly replace any airbag in your vehicle and assure system effectiveness in a crash.
- Only install parts on the vehicle that are consistent with factory-installed parts with respect to design and characteristics.
- Never store, mount, or attach objects, such as cup holders or phone cradles, on or next to the airbag module covers or within the airbags deployment zones.
- Only use wheel rim/tire combinations approved by Volkswagen for the respective vehicle type.

## Break-in period

---

ⓘ Please first read and note the introductory information and heed the WARNINGS 

Note applicable requirements for breaking in new parts.

### Breaking in a new engine

A new engine must be carefully broken in during the first 1000 miles (1600 kilometers). During the first few hours of driving, the engine's internal friction is higher than later when all moving parts have been broken in.

Engine life is influenced by how you drive the vehicle for the first 1000 miles (1600 km). Even afterwards, driving at moderate engine speeds, especially when the engine is cold, will tend to reduce engine wear and help the engine to last longer and go farther. But do not drive at an excessively low engine speed, either. Always downshift if the engine is not running smoothly. **For the first 600 miles (1000 km):**

- Do not use full throttle.
- Don't let the engine speed get above 2/3 the maximum speed.
- Do not tow a trailer.

**From 600 to 1000 miles (1000 to 1600 km):** Speed may *gradually* be increased to maximum permissible road and engine speed.

### New tires and brake pads

- New tires and replacement tires
- Brakes



Breaking in a new engine gently will increase service life and reduce oil consumption.

## Parts and accessories

---

❏ Please first read and note the introductory information and heed the WARNINGS ⚠

Volkswagen recommends that you consult an authorized Volkswagen dealer or authorized Volkswagen Service Facility before purchasing accessories, spare parts or other equipment. Always do so if you want to install additional accessories or replace parts. Your authorized Volkswagen dealer or authorized Volkswagen Service Facility can provide information about legal requirements and factory-recommended accessories, spare parts, and other equipment.

### WARNING

**Improper vehicle modifications and repairs affect the performance of the airbag system and cause malfunctions and severe personal injuries.**

- Never store, mount, or attach objects, such as cup holders or phone cradles, on or next to the airbag module covers or within the airbag deployment zones.
- Objects on or near the surface where airbags are located can come loose and cause serious personal injury if the airbag deploys.

## Operating fluids and equipment

---

❏ Please first read and note the introductory information and heed the WARNINGS ⚠

**Operating fluids and parts that wear out with use** (such as timing belts, tires, engine coolants, engine oils, spark plugs, and vehicle batteries) are constantly being improved. For this reason, it is important to have operating fluids changed and wearing parts replaced by an authorized Volkswagen dealer or authorized Volkswagen Service Facility. Authorized Volkswagen dealers and authorized Volkswagen Service Facilities are always up-to-date regarding new developments and changes.

### WARNING

**Improper use of operating fluids and equipment can cause accidents, serious personal injuries, burns and/or poisoning.**

- Always store vehicle care products in a safe place in original containers that are securely closed.
- To reduce the risk of poisoning, never use empty food or beverage containers that might mislead someone into drinking from them.
- Always keep vehicle care products out of the reach of children.
- Always read and heed all the instructions and all WARNINGS on the package before using vehicle care products.
- When using products that give off harmful fumes, always work outdoors or in a well ventilated area.
- Never use fuel, turpentine, engine oil, nail polish remover or other volatile fluids for vehicle care. They are poisonous and highly flammable. They could cause fires and explosions!

### NOTICE

- Only refill with suitable operating fluids. When changing or topping off fluids, make sure that you pour the fluids into the correct reservoirs. Adding incorrect fluids will cause serious malfunctions and engine damage! Under no circumstances should you mix up operating fluids. Otherwise serious malfunctions and engine damage can occur!

- **Accessories and other things installed in front of the cooling air intakes impair the efficiency of the engine coolant. The engine can overheat under high outside temperatures or under high engine loads!**



Leaking operating fluids can pollute the environment. Collect leaking operating fluids in suitable containers and dispose of them properly in accordance with applicable environmental laws and regulations.

## CB radio equipment

---

**ⓘ Please first read and note the introductory information and heed the WARNINGS **

An outside antenna is required for the operation of radio equipment in the vehicle.

Volkswagen approves the operation of radio equipment in the vehicle under the following conditions:

- Professionally installed outside antenna.
- Maximum transmission power 10 watts.

Optimal device coverage can only be assured when an outside antenna is properly installed.

Consult with an authorized Volkswagen dealer or authorized Volkswagen Service Facility if you would like to use a radio with transmission power higher than 10 watts. Authorized Volkswagen dealers and authorized Volkswagen Service Facilities are familiar with technical possibilities for the installation of aftermarket equipment or can advise you where equipment can be professionally installed. Obey legal requirements as well as instructions and operational guidelines provided by the equipment manufacturer in the operating manuals for the radio equipment.



### WARNING

**Loose or improperly installed radio equipment can be thrown around the passenger compartment during sudden driving or braking maneuvers or a crash and cause serious personal injuries.**

- **Always install radio equipment properly and securely outside of the airbag deployment zones.**



### WARNING

**Using a radio device in the vehicle without connection to an outside antenna can exceed electromagnetic radiation thresholds. This also applies if the outside antenna is not installed properly.**

- **Use a CB radio in the vehicle only with a professionally installed and connected outside antenna.**

## Notice about data recorded by vehicle control modules

---

**ⓘ Please first read and note the introductory information and heed the WARNINGS **

Your vehicle is **not equipped** with an Event Data Recorder (EDR).

EDRs, sometimes called “crash recorders,” are installed by some manufacturers for the express purpose of capturing data for retrieval after an accident or crash event.

Some state laws restrict the retrieval or downloading of data stored by EDRs installed in a vehicle for the express purpose of retrieving data after an accident or crash event without the owner's consent.

Although your vehicle is not equipped with an EDR, it is equipped with a number of electronic control modules for various vehicle systems, such as engine management, emission control, airbags, and safety belts.

These electronic control modules also record data during normal vehicle operation for diagnostic and repair purposes. Their recording capability is limited to data (no sound is recorded). Only a small amount of data is actually recorded over a very limited period of time, or stored when a system fault is detected by a control module. Some of the data stored may relate to vehicle speed, direction, or braking, as well as restraint system use and performance in the event of a crash. Stored data can only be read and downloaded with special equipment.

## Using a mobile phone in a motor vehicle when it is not connected to the vehicle telephone antenna - some important things to know

---

**⚠ Please first read and note the introductory information and heed the WARNINGS ⚠ .**

Mobile or cellular telephones send and receive radio waves, sometimes called “radiofrequency energy” (RF energy), both when they are being used and when they are in standby mode. Current scientific literature indicates that radio waves that exceed a certain level can have effects on the human body. Limits and guidelines have been established by governmental authorities and international committees in an effort to keep the electromagnetic radiation from cellular phones at levels that will not cause health problems. However, there is no scientifically based proof that wireless phones are absolutely safe.

Therefore some experts recommend a precautionary approach regarding the use of cellular phones by taking measures that lower the personal exposure to electromagnetic fields. When using a cellular telephone inside a motor vehicle without a proper connection to an integrated vehicle telephone antenna, the personal exposure to electromagnetic fields will be higher than when using the cellular telephone while properly connected to an integrated or other outside vehicle telephone antenna.

Your vehicle may be equipped with an optional hands-free system that will permit many of the features of compatible Bluetooth® enabled cellular telephones to be used for greater convenience and is consistent with the laws of an increasing number of states and localities that prohibit the use of cellular telephones without some kind of hands-free device.

The hands-free system in your vehicle can be used with certain cell phones that are connected by wire and hardware connector or via compatible Bluetooth® enabled phones with a cradle that is designed to fit your cellular telephone. The special cradle offers several advantages: The phone cradle must be safely secured to the base plate. Your phone is firmly attached to the instrument panel and is within reach at all times. Placing the phone in its cradle permits it to be charged, but more importantly connects the mobile phone to the vehicle's outside antenna. A cellular telephone that is properly connected to the integrated or other outside vehicle telephone antenna will lower the personal exposure to electromagnetic fields. You should also experience a better quality of service. Although a cellular telephone can be used inside your vehicle without a cradle, the phone will not be securely attached to the vehicle, will not be charged through the cradle wiring, and more importantly will not be connected to the vehicle's integrated telephone antenna. The mobile phone will also not be recharged. You might also experience more dropped calls and an overall impaired quality of the connection.

Therefore we strongly recommend that you use your cellular telephone in your vehicle only when it is properly attached to an appropriate cradle mounted on a base plate on the instrument panel.

Because of the large number and variety of cellular telephones on the market and the frequency with which new models are introduced, Volkswagen does not offer cradles for cellular telephones. Please check with the manufacturer of the cellular telephone that you plan to use.

Bluetooth® is a registered trademark of Bluetooth® SIG, Inc.



## **WARNING**

A mobile phone on the seat, instrument panel or in other places can be thrown around the inside of the vehicle during a sudden braking maneuver, a crash or other accident and injure vehicle occupants.

- Never place or attach accessories or other objects (such as cup holders, telephone brackets, note pads, navigation systems, large, heavy or bulky objects) on the doors, on the windshield, over or near the area marked "AIRBAG" on the steering wheel, instrument panel, backrests or between these areas and the occupant. Such objects could cause serious injury in a collision, especially if an airbag inflates.



## **WARNING**

Using a mobile phone or CB radio inside the vehicle without a properly installed and separate outside antenna can be dangerous to your health and that of your passengers because the electromagnetic radiation energy that cell phones and CB radios emit may be above established limits. This also applies if the outside antenna is not installed properly.

- Always keep the mobile phone antenna at least 8 in. (20 cm) away from pacemakers. Heart specialists advise that cell phones can adversely affect the way pacemakers work.
- Never carry a mobile phone that is switched on in the breast pocket directly over a pacemaker.
- If you suspect there may be interference with a pacemaker or other medical device, switch the mobile phone off immediately.

# Consumer information

## Introduction

---

In this section you'll find information about:

Stickers and labels

Operating your vehicle outside of the United States and Canada

Radio antenna and reception

UTQG classification

Volkswagen service information

### More information:

- Exterior views
- Starting assistance systems
- Parts, accessories, repairs and modifications
- ⇒ Booklet *Warranty and Maintenance*



### WARNING

Improper vehicle care and use, as well as improper changes to the vehicle, increase the risk of accidents and injuries.

- Obey all applicable legal requirements.
- Read your Owner's Manual and heed all WARNINGS.



### NOTICE

Improper vehicle care and use, as well as improper changes to the vehicle, can result in damage to the vehicle.

- Obey all applicable legal requirements.
- Perform service according to the specifications in the ⇒ Booklet *Warranty and Maintenance*.
- Read your Owner's Manual and heed all WARNINGS.

## Stickers and labels

---

 Please first read and note the introductory information and heed the WARNINGS 

Factory-installed safety certificates, stickers and signs containing important information regarding vehicle operation can be found in the engine compartment and on certain vehicle components, such as inside the fuel filler flap, on the passenger sun visor, in the driver door jamb or on the luggage compartment floor.

- Do not remove, alter or render unusable or illegible any safety certificates, stickers and labels.

- If vehicle components bearing safety certificates, stickers, or labels are replaced, make certain that the firm doing the work attaches new conforming certificates, stickers, or labels to the same part of the new components.

### **Safety Compliance Certification Label**

A safety certificate affixed to the door jamb in the driver door confirms that at time of production all necessary safety standards and requirements of the traffic safety agency of the respective country were met. The month and year of production as well as the vehicle identification number may be listed as well.

### **Radiator fan and high voltage warning sticker**

A warning sticker about the radiator fan and the high voltage of the electrical system is located in the engine compartment next to the engine hood release. The vehicle ignition system complies with the Canadian standard ICES-002.

## **Operating your vehicle outside of the United States and Canada**

---

**ⓘ Please first read and note the introductory information and heed the WARNINGS ⚠**

Government regulations in the United States and Canada require that automobiles meet specific emission regulations and safety standards. Therefore, vehicles built for the U.S. and Canada differ from vehicles sold in other countries.

If you plan to take your vehicle outside the continental limits of the United States or Canada, there is the possibility that:

- Unleaded fuels for vehicles with catalytic converters may not be available.
- Fuel may have a considerably lower octane rating and may cause engine damage.
- Service may be inadequate due to lack of proper service facilities, tools or testing equipment.
- Replacement parts may not be readily available.
- DVD navigation systems for vehicles built for the United States and Canada will not necessarily work in Europe, and may not work in other countries outside of North America.

### **ⓘ NOTICE**

**Volkswagen is not responsible for mechanical damage that may result from substandard fuel or service or the unavailability of Genuine Volkswagen parts.**

- **Volkswagen is not responsible if the vehicle does not meet the respective legal requirements in other countries and continents.**

## **Radio antenna and reception**

---

**ⓘ Please first read and note the introductory information and heed the WARNINGS ⚠**

If the radio and navigation systems were installed at the factory, the radio antenna may be installed in different locations in the vehicle:

- On the inside of the rear window with the rear window defroster,
- On the inside of the rear side windows,
- On the inside of the windshield,
- On the vehicle roof.

Antennas on the insides of windows are thin wires.





## NOTICE

**Antennas installed on the insides of windows can be damaged by abrasive objects or by corrosive or acidic cleaning agents or other chemicals. Do not place any stickers on the windshield-integrated antenna and never clean the antenna with corrosive or acidic cleaning agents or other chemicals.**



If electrical devices are operated close to the integrated windshield antenna, interference with AM radio reception may occur.

## UTQG classification

---

**⚠ Please first read and note the introductory information and heed the WARNINGS ⚠**

Uniform Tire Quality Grading (UTQG): Quality grades can be found where applicable on the tire sidewall between the tread shoulder and maximum section width. Example:

- Treadwear (number)
- Traction: AA, A, B or C
- Temperature: A, B or C

For example: Treadwear 200, Traction AA, Temperature A.

All passenger car tires must conform to Federal Safety Requirements in addition to these grades.

### Treadwear

The treadwear grade is a comparative rating based on the wear rate of the tire when tested under controlled conditions on a specified government test course.

For example, a tire graded 150 (Treadwear-value 150) would wear one-and-one-half (1 1/2) times as well on the government course as a tire graded 100.

The relative performance of tires depends upon the actual conditions of their use, however, and may depart significantly from the norm due to variations in driving habits, service practices and differences in road characteristics and climate.

### Traction

The traction grades, from highest to lowest, are AA, A, B and C. Those grades represent the tire's ability to stop on wet pavement as measured under controlled conditions on specified government test surfaces of asphalt and concrete. A tire marked C may have poor traction performance ⇒ ⚠.

### Temperature

The temperature grades are A (the highest), B, and C representing the tire's resistance to the generation of heat, and its ability to dissipate heat when tested under controlled conditions on a specified indoor laboratory test wheel.

Sustained high temperature can cause the material of the tire to degenerate and reduce tire life, and excessive temperature can lead to sudden tire failure.

The grade C corresponds to a level of performance which all passenger car tires must meet under the Federal Motor Vehicle Safety Standard No. 109. Grades B and A represent higher levels of performance on the laboratory test wheel than the minimum required by law ⇒ ⚠.



## WARNING

The traction grade assigned to this tire is based on straight-ahead braking traction tests, and does not include acceleration, cornering, hydroplaning or peak traction characteristics.



## WARNING

The temperature grade for this tire is established for a tire that is properly inflated and not overloaded. Excessive speed, underinflation or excessive loading, either separately or in combination, can cause heat build-up and possible tire failure.

## Volkswagen service information

---

❏ Please first read and note the introductory information and heed the WARNINGS 

Volkswagen service information is published as soon as possible after model introduction.

To order service information contact:

Volkswagen Technical Literature Ordering Center

[www.vw.techliterature.com](http://www.vw.techliterature.com)



## WARNING

Improperly performed repairs and modifications can cause vehicle damage and malfunctions, and can impair the efficiency of driver assistance systems and the airbag system. This can lead to accidents and severe personal injuries.

- Have repairs and vehicle modifications performed by an authorized Volkswagen dealer or an authorized Volkswagen Service Facility.

# Declaration of Compliance, Telecommunications and Electronic Systems

---

Radio Frequency Devices and Radiocommunication Equipment User Manual Notice.

## Radio-based equipment

- Mobile Phone Package
- Electronic immobilizer
- HomeLink® Universal Transmitter
- Remote control vehicle key
- Tire Pressure Monitoring System
- Park Distance Control (PDC) system

## These devices comply with:

### FCC Part 15.19

These devices comply with **Part 15 of the FCC Rules**. Operation is subject to the following 2 conditions:

- (1) This device may not cause harmful interference, and
- (2) this device must accept any interference received, including interference that may cause undesired operation.

### FCC Part 15.21

CAUTION:

Changes or modifications not expressly approved by the party responsible for compliance could void the user's authority to operate the equipment.

These devices comply with **RSS-210 of Industry Canada**.

Operation is subject to the following 2 conditions:

- (1) this device may not cause interference, and
- (2) this device must accept any interference, including interference that may cause undesired operation of the device.

The manufacturer is not responsible for any radio or TV interference caused by unauthorized modifications to this equipment.

Applicable only in the United States

## Reporting Safety Defects

---

If you believe that your vehicle has a defect which could cause a crash or could cause injury or death, you should immediately inform the National Highway Traffic Safety Administration (NHTSA) in addition to notifying Volkswagen of America, Inc. 3800 Hamlin Road, Auburn Hills, MI 48326.

If NHTSA receives similar complaints, it may open an investigation, and if it finds that a safety defect exists in a group of vehicles, it may order a recall and remedy campaign. However, NHTSA cannot become involved in individual problems between you, your dealer, or Volkswagen of America, Inc.

To contact NHTSA, you may call the Vehicle Safety Hotline toll-free at 1-888-327-4236 (TTY: 1-800-424-9153);

go to <http://www.nhtsa.gov>;

or write to:

Administrator  
NHTSA  
1200 New Jersey Avenue, SE.  
Washington, D.C. 20590

You can also obtain other information about motor vehicle safety from  
<http://www.safercar.gov>.

Applicable only in Canada

## Reporting Safety Defects

---

If you live in Canada and you believe that your vehicle has a defect that could cause a crash, injury or death, you should immediately inform Transport Canada, Defect Investigations and Recalls. You should also notify Volkswagen Canada, Inc.

### Transport Canada

Canadian customers who wish to report a safety-related defect to Transport Canada, Defect Investigations and Recalls, may either call Transport Canada toll-free at

Phone: 1-800-333-0510 or  
1-819-994-3328 (Ottawa region and from other countries)

**or contact Transport Canada by mail at:**

Transport Canada  
Motor Vehicle Safety Investigations Laboratory  
80 Noel Street  
Gatineau, QC  
J8Z 0A1

For additional road safety information, please visit the Road Safety web site at:

<http://www.tc.gc.ca/eng/roadsafety/menu.htm>

# Engine control and emission control system

## Introduction

---

In this section you'll find information about:

Indicator lights

Catalytic converter

### More information:

- Shifting gears
- Refueling
- Fuel
- Engine oil
- Vehicle battery
- Notice about data recorded by vehicle control modules
- Towing



### WARNING

The vehicle exhaust system and the catalytic converter get very hot. This can cause a fire and serious personal injury.

- Never park where parts of the hot exhaust system and catalytic converter could ignite flammable materials, such as brush, leaves, dry grass, spilled fuel, etc.
- Never apply additional undercoating or rust proofing on or near the exhaust manifold, exhaust pipes, catalytic converter, or heat shields.



### WARNING

#### California Proposition 65 Warning

- Engine exhaust, some of its constituents, and certain vehicle components contain or emit chemicals known to the State of California to cause cancer and birth defects and reproductive harm. In addition, certain fluids contained in vehicles and certain products of component wear contain or emit chemicals known to the State of California to cause cancer and birth defects and reproductive harm.

## Indicator lights

---

 Please first read and note the introductory information and heed the WARNINGS 

Lights up	Possible cause	Proper response
<b>EPC</b>	Engine control malfunction (Electronic Power Control).	Have engine checked immediately by an authorized Volkswagen dealer or authorized Volkswagen Service Facility.

Lights up	Possible cause	Proper response
	Engine control/monitoring system malfunction (engine Malfunction Indicator Light - MIL)	Ease off the accelerator. Carefully drive to the nearest authorized Volkswagen dealer or authorized Volkswagen Service Facility. Have engine checked.

Flashes	Possible cause	Proper response
	Misfire, which can damage the catalytic converter.	Ease off the accelerator. Carefully drive to the nearest authorized Volkswagen dealer or authorized Volkswagen Service Facility. Have engine checked.

When the ignition is switched on, several warning and indicator lights come on briefly for a function check. They go out after a few seconds.



## NOTICE

Failure to heed warning lights or text **WARNINGS** can result in vehicle damage.



As long as the  or **EPC** indicator light is on, anticipate engine malfunction, increased fuel consumption, and loss of engine efficiency.

## Catalytic converter

**Please first read and note the introductory information and heed the WARNINGS** 

The catalytic converter provides exhaust gas after-treatment to help reduce pollutants in the exhaust gas. To help ensure long service life of the exhaust system and gasoline engine catalytic converter:

- Only use unleaded fuel.
- Never completely empty the fuel tank.
- Do not exceed the correct oil level
- Do not tow the vehicle to start it, but use a jump-start instead

If you experience misfires, loss of power or the engine is not running smoothly while driving, reduce speed immediately and have the vehicle checked by an authorized Volkswagen dealer or authorized Volkswagen Service Facility. Otherwise, gasoline could reach the exhaust system and get into the atmosphere. The catalytic converter could also be damaged by overheating!

## Frequently asked questions

If you suspect a malfunction or vehicle damage, read and follow the following advice **before** contacting an authorized Volkswagen dealer or an authorized Volkswagen Service Facility. You may also find helpful information under “Special considerations” or “Checklist” in the index.

Description	Possible causes, among others	Possible remedy
Engine does not start.	Vehicle battery dead.	<ul style="list-style-type: none"> <li>– Perform jump-start</li> <li>– Charge vehicle battery</li> </ul>
	The wrong vehicle key is used.	Use a valid vehicle key
	Fuel level too low.	Refuel
Vehicle cannot be locked or unlocked using vehicle key.	<ul style="list-style-type: none"> <li>– Battery in the remote control vehicle key is dead.</li> <li>– Too far away from the vehicle (out of range).</li> <li>– Buttons have been pressed too many times.</li> </ul>	<ul style="list-style-type: none"> <li>– Replace the battery in the remote control vehicle key</li> <li>– Move closer to vehicle.</li> <li>– Synchronize vehicle key</li> <li>– Lock or unlock vehicle manually</li> </ul>
Unusual noises.	Cold engine, braking assist systems, electronic steering column lock.	Check the “Noises” entry in the index.
Odd driving behavior.	Assistance systems activated.	Check the “Assistance systems” entry in the index.
	DSG <sup>®</sup> Direct Shift Gearbox too hot.	Stop vehicle as soon as you can safely do so.
Driver seat and outside mirrors move when vehicle is unlocked.	Convenience settings are stored.	Correct convenience settings
	Memory-seat settings are stored.	<ul style="list-style-type: none"> <li>– Reassign seat setting.</li> <li>– Clear memory-seat memory</li> </ul>
Front seats cannot be adjusted with power controls.	Vehicle battery dead.	Charge vehicle battery
	Fuse blown.	Check fuse and replace if necessary
No jack, spare wheel, or compact spare wheel in the vehicle.	Equipment differs depending on the vehicle.	No direct corrective action possible; depends on the vehicle equipment. Contact an authorized Volkswagen dealer or an authorized Volkswagen Service Facility for assistance.
	Vehicle has run-flat tires (mobility tires).	
Features do not work as described in this manual.	Settings were adjusted in the Volkswagen Information System.	Check and reset to factory settings if necessary
Headlights do not light up the road as they should.	<ul style="list-style-type: none"> <li>– Headlights incorrectly adjusted.</li> <li>– Light bulbs burned out.</li> <li>– Low beams not switched on.</li> </ul>	<ul style="list-style-type: none"> <li>– Have the headlight range adjusted by an authorized Volkswagen dealer or an authorized Volkswagen Service Facility.</li> <li>– Change light bulbs</li> <li>– Switch on low beams</li> </ul>
Electrical consumers do not work.	Vehicle battery charge too low.	Charge vehicle battery
	Remaining fuel level too low.	Refuel

Description	Possible causes, among others	Possible remedy
	Fuse blown.	Check fuse and replace if necessary .
Fuel consumption higher than indicated.	<ul style="list-style-type: none"> <li>– Short hauls.</li> <li>– “Jumpy” accelerator pedal.</li> </ul>	<ul style="list-style-type: none"> <li>– Avoid short distance driving.</li> <li>– Drive defensively.</li> <li>– Accelerate smoothly.</li> </ul>
	Electrical loads switched on.	Switch off unnecessary loads.
	Engine control malfunction.	Have the malfunction corrected
	Tire pressure too low.	Adjust tire pressure
	Driving in the mountains.	No direct corrective action possible.
	Towing a trailer or driving with a roof rack.	<ul style="list-style-type: none"> <li>– Check use.</li> <li>– Remove if not in use.</li> </ul>
	Driving with heavy payload.	No direct corrective action possible.
	Driving at high engine speed.	Select a higher gear.



# In an emergency

## Introduction

---

In this section you'll find information about:

Protecting yourself and the vehicle

### More information:

- Braking, stopping and parking
- Emergency closing and opening
- Vehicle tool kit
- Changing a wheel

### WARNING

A vehicle breakdown in traffic is dangerous and creates a great risk for you, your passengers, and others.

- Always stop the vehicle as soon as it is safe to do so. Move the vehicle a safe distance off the road where it is safe to park and, if necessary, lock all doors in an emergency. Turn on the emergency flashers and set up another warning device about 25 yards (25 meters) behind the vehicle to warn approaching traffic.
- Never leave children, disabled persons, or anyone who cannot help themselves alone in the vehicle when locking the doors. This could result in people being trapped in the vehicle in an emergency. Depending on the time of year, people trapped in the vehicle can be exposed to very high or very low temperatures.

## Protecting yourself and the vehicle

---



**Fig. 160** In the center of the instrument panel: Switch for emergency flashers.



 Please first read and note the introductory information and heed the WARNINGS 

Obey all legal requirements regarding protecting a broken-down vehicle. For example, turning on the emergency flashers and wearing a safety vest are mandatory in many countries.

## Checklist

---

For your own safety and that of your passengers, carry out the following steps in the order listed ⇒ :

1. Park the vehicle at a safe distance from traffic and on a suitable surface ⇒ .
  2. Switch on emergency flashers by pressing the  switch ⇒ [fig. 160](#).
  3. Apply the electronic parking brake to help prevent the vehicle from moving
  4. Shift the transmission into Park **(P)** (automatic) or Neutral (manual only)
  5. Stop the engine and remove the key from the ignition switch
  6. Have all passengers exit and go to a safe location away from moving traffic, such as behind a guard rail.
  7. Take all vehicle keys with you when leaving your vehicle.
  8. Set up a warning triangle or other warning device in order to alert other motorists and cyclists.
  9. Let the engine cool down and get expert assistance if necessary.
- 

If the emergency flashers are on, use the turn signal lever to indicate a direction or lane change, for example when the vehicle is being towed. This temporarily interrupts the emergency flashers.

### Switch on the emergency flashers when:

- Traffic suddenly slows down or stops in front of you to warn those approaching from behind.
- In any emergency situation.
- If the vehicle breaks down.
- When being towed.

Always obey traffic laws that govern the use of emergency flashers where you are driving.

If the emergency flashers are not working, a different method – as permitted by law – must be used to alert other motorists and cyclists to the breakdown.



### WARNING

Disregarding the safety-related checklist may lead to accidents and serious personal injuries.

- Always review and follow the checklist. Follow accepted safety practices and use common sense.



### WARNING

The vehicle exhaust system and the catalytic converter get very hot. They can cause fires and serious personal injury.

- Never park where parts of the hot exhaust system or catalytic converter could ignite flammable materials, such as dry grass, brush, leaves, spilled fuel, etc.



The vehicle battery will be drained if the emergency flashers are on for a long time – even if the ignition is switched off.

# Emergency closing and opening

## Introduction

---

In this section you'll find information about:

Manually unlocking and locking the driver door

Manually locking the passenger door and rear doors

Opening the luggage compartment lid from inside the luggage compartment

Emergency closing of the power sunroof

Emergency release for the selector lever

The doors, the luggage compartment lid, and the power sunroof can be manually locked and, in some cases, unlocked if necessary, for instance because the power locking system or the remote control vehicle key malfunctions.

### **More information:**

- Vehicle key set
- Power locking and closing system
- Doors
- Luggage compartment lid
- Power sunroof
- In an emergency



### **WARNING**

**Serious injuries can result if the emergency closing and opening procedures are used carelessly.**

- **Never leave children, disabled persons, or anyone who cannot help themselves in the vehicle. The doors can be locked with the remote control vehicle key. This could result in people being trapped in the vehicle in an emergency.**
- **A closed vehicle can become very hot or very cold, depending on the season. Particularly in the summer, heat build-up in the passenger and luggage compartment of a parked vehicle can result in temperatures in the vehicle that are much higher than the outside temperatures. Temperatures can quickly reach levels that can cause unconsciousness and death, particularly to small children.**



### **WARNING**

**Careless opening and closing of doors, the luggage compartment lid, and the power sunroof is dangerous and can cause serious personal injury.**

- **Open or close doors, the luggage compartment lid, and the power sunroof only when no one is in the way.**



### **NOTICE**

**If the vehicle's battery fails or the power windows won't work, the door windows are not lowered when the door is opened or closed. Always close and open the door carefully to help prevent damage to the window, the paint, or the rubber seal.**

## ⚠ NOTICE

To help prevent vehicle damage, carefully remove and properly reinstall parts after emergency locking or unlocking.

### Manually unlocking and locking the driver door

---

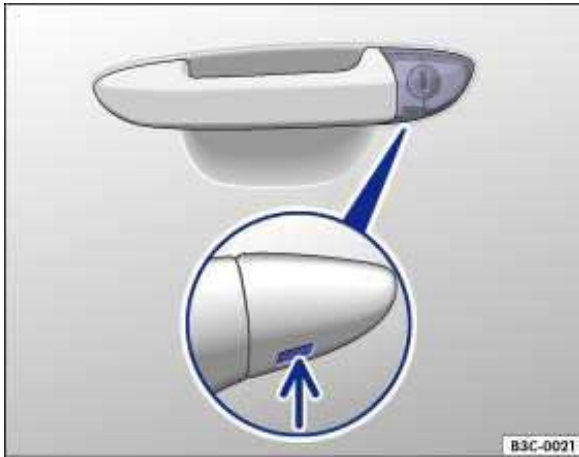

Fig. 161 Door handle on driver door: Concealed lock cylinder.

⚠ Please first read and note the introductory information and heed the WARNINGS ⚠

When locking the vehicle manually, all doors are locked. When the vehicle is unlocked manually, only the driver door is unlocked. Note the instructions for the anti-theft alarm system

- Take the emergency key out of the vehicle key
- Insert the emergency key from below into the opening of the cover cap on the driver door  
⇒ fig. 161 (arrow) and lift the cover cap off. Grasping the door handle and pulling slightly makes it easier to remove the cap.
- Insert the emergency key into the lock cylinder and unlock or lock the vehicle.
- Reinsert the cover cap from top to bottom and press until it clicks into place. Grasping the door handle and pulling slightly makes it easier to reinstall the cap.

#### Special considerations when unlocking:

- If the vehicle is equipped with an anti-theft alarm system, the system remains activated for the unlocked vehicle. But no alarm is triggered at first
- Open the driver door. The alarm will sound.
- Switch on the ignition. The electronic immobilizer recognizes a valid remote control vehicle key when the ignition is switched on and deactivates the anti-theft alarm system.

**i** The driver door can be unlocked separately from the inside the vehicle by pulling the door handle to open the door

**i** The anti-theft alarm system, when installed, is not activated when the vehicle is locked manually with the emergency key

## Manually locking the passenger door and rear doors

---



**Fig. 162** On the edge of the right rear door: Emergency lock, covered by a rubber seal.



**Fig. 163** Locking the vehicle using the emergency key.

**⚠ Please first read and note the introductory information and heed the WARNINGS ⚠**

The passenger door and rear doors can each be locked manually. This will **not** activate the anti-theft alarm system.

- Open the door.
- Remove rubber seal from the edge of the door. The seal is marked with a lock  $w$  ⇒ [fig. 162](#).
- Take the emergency key out of the vehicle key
- Insert the emergency key into the vertical slit and turn the emergency key away from the vehicle ⇒ [fig. 163](#).
- Reinsert the rubber seal and completely close the door.
- Make sure that the door is locked.
- Repeat the procedure for other doors if necessary.
- Have the vehicle checked immediately by an authorized Volkswagen dealer or an authorized Volkswagen Service Facility.

**i** The vehicle doors can be unlocked and opened separately from inside the vehicle by pulling the door handle to open the door

## Opening the luggage compartment lid from inside the luggage compartment

---

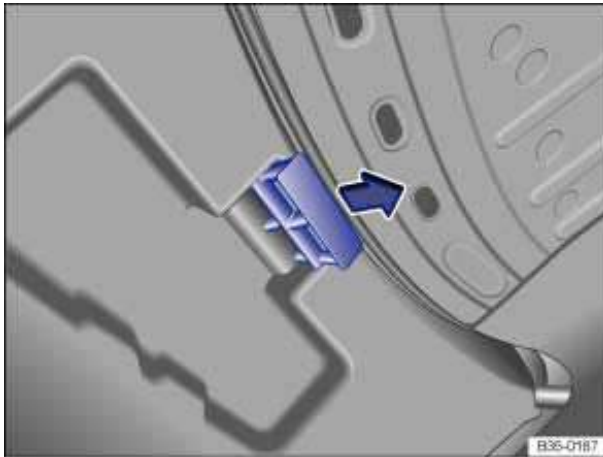

**Fig. 164** Inside the luggage compartment: Unlocking luggage compartment lid.

**⚠ Please first read and note the introductory information and heed the WARNINGS** 

If necessary, fold the rear seat backrest forward

Remove luggage in order to reach the luggage compartment lid from the inside.

### **Emergency releasing of the luggage compartment lid:**

- Locate the release handle in the luggage compartment lid ⇒ [fig. 164](#).
- Pull the handle down in the direction of the arrow to unlock and open the luggage compartment.



The release handle glows in the dark to help it be seen in low-light conditions.

## Emergency closing of the power sunroof

---

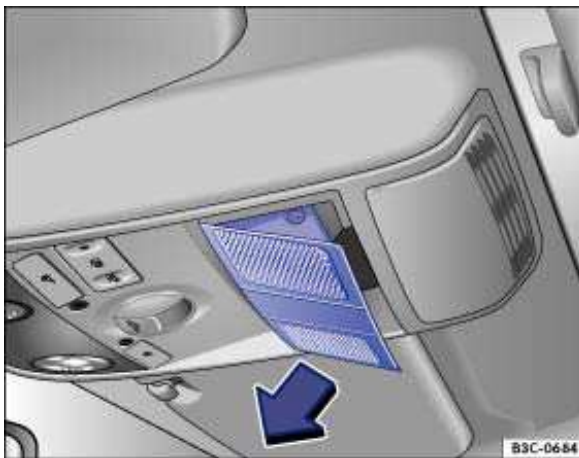

**Fig. 165** In headliner: Removing cover.

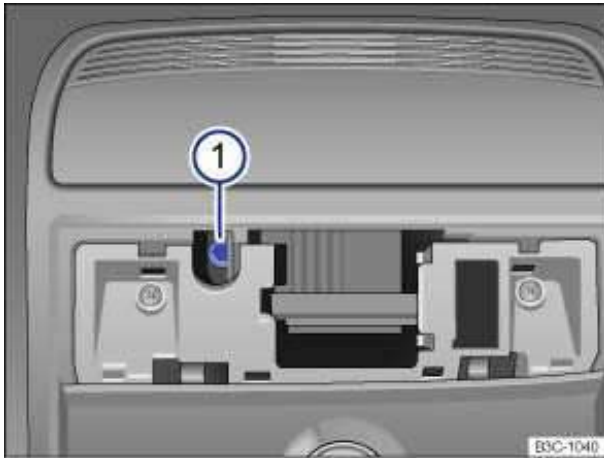

**Fig. 166** Hexagonal head screw for closing the power sunroof.

**⚠ Please first read and note the introductory information and heed the WARNINGS ⚠**

The power sunroof has an overheating protection feature that can temporarily turn the electric motor off under certain circumstances. This can happen after, for example, overriding the motor too often when closing the power sunroof without the pinch protection.

After the motor has cooled down enough, the overheating protection feature will let the motor work again and the power sunroof can be opened or closed with the rotary switch.

Before you try to use emergency closing procedures to close the power sunroof, please wait several minutes to make sure that the motor has not been temporarily turned off by the overheating protection feature.

**If you must perform an emergency closing, please do so in the following order:**

1. Remove the cover in direction of the arrow ⇒ [fig. 165](#).
2. Insert a commercially available 1/6 in (4 mm) Allen wrench<sup>10</sup> into the hexagonal head screw ⇒ [fig. 166 \(1\)](#).
3. Turn the wrench in order to close the power sunroof.
4. Install the cover again.
5. Have the power sunroof checked by an authorized Volkswagen dealer or an authorized Volkswagen Service Facility. Emergency closing may cause the power sunroof and its pinch protection to malfunction.

---

<sup>10</sup> Not included with the vehicle tool kit.

## Emergency release for the selector lever

---



Fig. 167 Removing the selector gate cover.

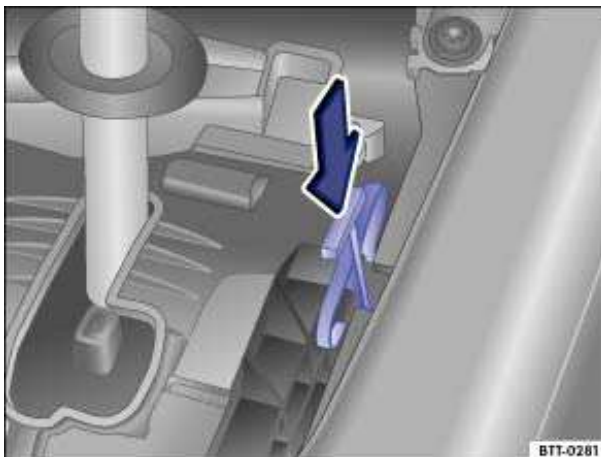

Fig. 168 Releasing the selector lever lock.

**⚠ Please first read and note the introductory information and heed the WARNINGS ⚠**

If the power supply fails (due to a dead vehicle battery, for example) and the vehicle has to be pushed or towed, the emergency release must be used to move the selector lever to Neutral (**N**).

The emergency release is located under the selector gate cover on the right side when viewed in the driving direction.

### Preparations

- Set the electronic parking brake. If the electronic parking brake cannot be set, you must find another way to help prevent the vehicle from moving.
- Switch off the ignition.

### Removing the selector gate cover

- Pull upward on the cover around the selector lever sleeve ⇒ [fig. 167](#).
- Slip the cover up and over the selector lever ⇒ ⚠.

### Emergency release for the selector lever

- Push the release lever ⇒ [fig. 168](#) in the direction of the arrow and hold it in this position.



- Press the release button ⇒ [fig. 167 \(1\)](#) in the selector lever handle and shift the selector lever to Neutral **(N)**.



### **WARNING**

**Never shift the transmission out of Park (P) without first setting the electronic parking brake. Otherwise, the vehicle can start to roll unexpectedly, especially on hills or inclines, and cause an accident and serious injuries.**



### **NOTICE**

**Even with the selector lever is in Neutral (N), the automatic transmission will be damaged if the vehicle is towed (or you let it coast) for an extended period or at high speed with the engine shut off.**

# Vehicle tool kit

## Introduction

---

In this section you'll find information about:

Storage

Contents

When securing the vehicle after a breakdown, always obey all applicable legal requirements.

### **More information:**

- Trailer towing
- Preparations for working in the engine compartment
- In an emergency
- Changing a wheel



### **WARNING**

Loose tools and other items in the vehicle tool kit and a loose spare (or compact spare) wheel may be thrown through the passenger compartment if you brake suddenly or steer sharply or are involved in an accident. This can cause severe injuries.

- Always make sure the vehicle tool kit and spare (or compact spare) wheel are securely stowed in the luggage compartment.



### **WARNING**

Improper or damaged vehicle tools can lead to accidents and injury.

- Never work with tools that are damaged or not right for the job.

## Storage

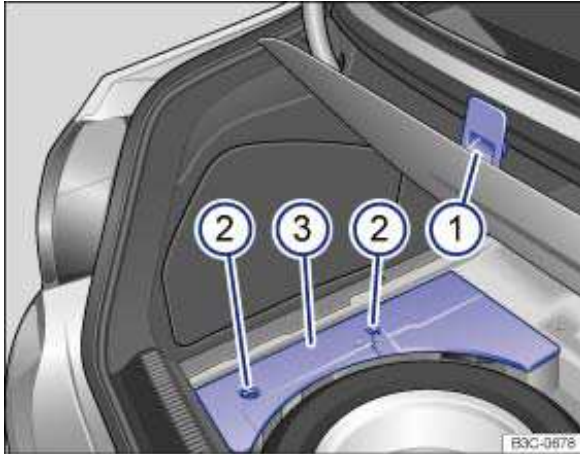

**Fig. 169** In the luggage compartment underneath the floor panel 1: Spare tire and cover 3 for vehicle tool kit.

**⚠ Please first read and note the introductory information and heed the WARNINGS**

The vehicle tool kit, spare wheel, or compact spare wheel may be located in one of several places, such as under the luggage compartment floor panel.

Storage in the luggage compartment	Response
In a foam insert under the floor cover:	<ul style="list-style-type: none"> <li>– Secure the floor cover on the top edge of the luggage compartment ⇒ <a href="#">fig. 169 (1)</a>.</li> <li>– Rotate the quick-release fasteners (2) 90° to remove the cover (3) of the vehicle tool kit.</li> </ul>
If applicable, behind a cover on the left or right side:	Rotate the quick-release fasteners 90° to remove the cover.

**i** Completely retract the jack after use. Otherwise it will not fit in its compartment and cannot be stowed safely.

## Contents

---

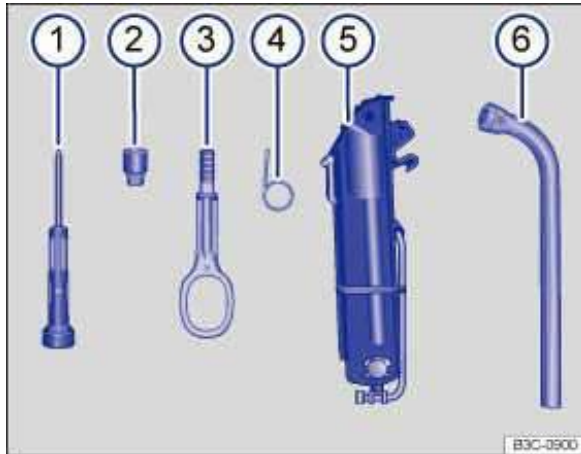

Fig. 170 Contents of the vehicle tool kit.

⚠ Please first read and note the introductory information and heed the WARNINGS ⚠

The contents of the vehicle tool kit depend on the vehicle's equipment. The following describes the maximum contents.

**Contents of the vehicle tool kit** ⇒ fig. 170

- (1) Screwdriver with a hexagonal socket in the handle for removing or inserting previously loosened wheel bolts. The screwdriver blade is reversible. The screwdriver may be stored under the lug wrench.
- (2) Adapter for anti-theft wheel bolts. Volkswagen recommends that you always carry the adapter for the wheel bolts in the vehicle along with the vehicle tool kit. The **code number** of the wheel bolt lock is imprinted on the front of the adapter. If lost, a replacement adapter can be ordered using this number. Record the code number of the wheel bolt lock and store it separate from the vehicle.
- (3) Screw-in towing eye.
- (4) Hubcap puller clips for removing hubcaps, full wheel covers, or wheel bolt caps.
- (5) Jack. Before putting the jack back in the tool kit, be sure to completely crank the jack down to its original position. The crank must then be locked against the side of the jack; otherwise, the jack will not fit and cannot be securely stowed.
- (6) Lug wrench.

# Wheel covers

## Introduction

---

In this section you'll find information about:

Hubcaps  
Wheel covers  
Wheel bolt caps

### **More information:**

- Exterior care and cleaning
- Vehicle tool kit
- Changing a wheel



### **WARNING**

**Unsuitable wheel covers and improper installation of wheel covers can cause accidents and severe injuries.**

- **Improperly installed wheel covers can come loose while driving and endanger other motorists and cyclists.**
- **Do not use damaged wheel covers.**
- **Always make sure that the flow of air for brake system cooling is not blocked or reduced before installing wheel covers. This applies to both factory-installed wheel covers and aftermarket wheel covers. Insufficient air supply may significantly increase stopping distance.**



### **NOTICE**

**To help prevent damage to the vehicle, be careful when removing wheel covers and be sure to install them properly.**

## Hubcaps

---



Fig. 171 Pulling the hubcap off.



Fig. 172 Twisting the hubcap off.

⚠ Please first read and note the introductory information and heed the WARNINGS ⚠

Depending on the vehicle model, the hubcaps can either be pulled off ⇒ [fig. 171](#) or removed by twisting ⇒ [fig. 172](#).

### Vehicles with pull-off hubcaps

- *To remove* Take the wire clip out of vehicle tool kit and hook it into one of the holes in the hubcap ⇒ [fig. 171](#).
- Pull the hubcap off in the direction of the arrow.
- *To install* Press the hubcap against the rim until it latches.

### Vehicles with twist-off hubcaps

- *To remove* Twist the hubcap to the left or right until it loosens from the wheel rim ⇒ [fig. 172](#).
- Grasp behind one of the lugs and pull the hubcap off.
- *To install* Push the hubcap onto the center of the rim.
- Press the hubcap against the rim until it latches.

## Wheel covers

---



Fig. 173 Pulling the wheel cover off.

⚠ Please first read and note the introductory information and heed the WARNINGS ⚠

### Pulling off the wheel cover

- Take the lug wrench and wire clip out of the vehicle tool kit
- Place the wire clip hook in one of the openings of the wheel cover.
- Slide the lug wrench through the clip ⇒ fig. 173 and pull the wheel cover off in the direction of the arrow.

### Installing the wheel cover

Before installing the wheel cover, the anti-theft wheel bolt must be screwed into position ⇒ fig. 176 (2) or (3) in relation to the position of the tire valve (1). Otherwise, the wheel cover cannot be installed.

Make sure that the valve cutout is aligned with the valve ⇒ fig. 176 (1), and press the wheel cover onto the wheel rim. Make sure that the wheel cover is latched onto the rim along the entire circumference.

## Wheel bolt caps

---



Fig. 174 Pulling cover caps off wheel bolts.

⚠ Please first read and note the introductory information and heed the WARNINGS ⚠

- Take the wire clip out of the vehicle tool kit
- Insert the wire clip through the opening of the cover cap ⇒ [fig. 174](#) and pull off in the direction of the arrow.

The caps are designed to protect the wheel bolts and should be installed again after the wheel change.

The **anti-theft wheel bolt** has a separate cap. This only fits the anti-theft wheel bolt, but not the standard wheel bolts.



# Fuses

## Introduction

---

In this section you'll find information about:

Fuses in the vehicle

Due to ongoing development of the vehicle, configuration-dependent allocation of fuses and the combined fuse protection of multiple loads with one fuse, an up-to-date overview of the fuse location per load is not possible at the time of printing. Detailed information regarding fuse box layout is available from authorized Volkswagen dealers and authorized Volkswagen Service Facilities.

In general, one fuse can protect several loads. One load can also be protected by several fuses.

Find out why the fuse blew and correct the problem before replacing a blown fuse. If a newly replaced fuse blows again after a short time, the electrical system should be checked by an authorized Volkswagen dealer or an authorized Volkswagen Service Facility.

### More information:

- Preparations for working in the engine compartment



### WARNING

High voltage systems in the engine compartment can cause electrical shocks, severe burns, and even death!

- Never touch ignition cables. Never touch other components of the high voltage electronic ignition system.
- Avoid short circuits in the electrical system.



### WARNING

Using the wrong fuse, using a blown fuse that has been repaired, and using metal objects in place of fuses to complete the electrical connection in the circuit can cause fires and serious personal injury.

- Never replace a fuse with one that has a higher amp rating. Replace a blown fuse only with a fuse of the same amperage (same color and same imprint) and same overall size.
- Never repair fuses.
- Never replace fuses with a metal strip, a paper clip, or a similar object.



### NOTICE

- To help prevent damage to the electrical system, switch off all lights and accessories, switch off the ignition, and remove the key from the ignition switch before replacing a fuse.
- If a fuse is replaced with a fuse with higher amperage, this can also cause damage at different locations in the electrical system.
- Open fuse boxes must be protected from dirt and moisture. Dirt and moisture in fuse boxes can cause damage to the electrical system.

## Fuses in the vehicle

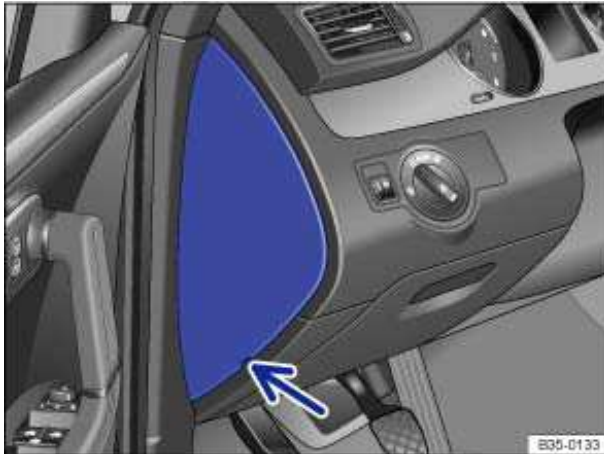

Fig. 182 On the driver side in the instrument panel: Fuse box cover.



Fig. 183 In the engine compartment: Fuse box cover.

**⚠ Please first read and note the introductory information and heed the WARNINGS ⚠**

Replace a blown fuse only with a fuse of the same amperage (same color and same imprint) and same overall size.

### Fuse color coding

Color	Current strength in amps
Purple	3
Light brown	5
Brown	7.5
Red	10
Blue	15
Yellow	20
White or clear	25
Green	30

Color	Current strength in amps
Orange	40

### Opening the fuse box in the instrument panel

- Insert a flat object, such as a screwdriver from the vehicle tool kit, into the opening ⇒ [fig. 182](#) (arrow) and carefully lift off the cover.
- On the inside of the cover there are plastic tweezers for removing and inserting fuses.
- To **install**, guide the cover from the bottom into the instrument panel and push until you can hear it latch into place.

### Opening the fuse box in the engine compartment

- Open the engine hood 
- Move the release buttons in the direction of the arrows ⇒ [fig. 183](#) to unlock the fuse box cover.
- Remove the cover upward.
- To **install**, place the cover on the fuse box. Slide release buttons against the direction of the arrows until they latch with an audible “click”.

### Vehicles with battery located in the luggage compartment

There may be additional fuses above the vehicle battery behind the panel on the left side of the luggage compartment. Have these fuses replaced by an authorized Volkswagen dealer or authorized Volkswagen Service Facility.



#### NOTICE

- **To help prevent vehicle damage, be careful when removing fuse box covers and be sure to reinstall them properly.**
- **Open fuse boxes must be protected from dirt and moisture. Dirt and moisture in fuse boxes can cause damage to the electrical system.**



The vehicle contains other fuses in addition to those mentioned in this section. Have these fuses replaced by an authorized Volkswagen dealer or an authorized Volkswagen Service Facility.

# Changing light bulbs

## Introduction

---

In this section you'll find information about:

Indicator light

Information on light bulb replacement

Changing headlight bulbs

Changing the fog light bulbs in the front bumper (CC R Line)

Replacing the taillight bulbs in the luggage compartment lid

Changing a light bulb requires a certain amount of skill. If you are uncertain about how to proceed, Volkswagen recommends having the light bulb changed by an authorized Volkswagen dealer or an authorized Volkswagen Service Facility. Special training and knowledge are generally required when other vehicle parts must be disassembled to replace a bulb, or when HID – High Intensity Discharge (Xenon) headlights must be replaced.

You should always keep a box in the vehicle with all the replacement bulbs required for traffic safety. Replacement bulbs are available from your authorized Volkswagen dealer or authorized Volkswagen Service Facility. The laws of some countries explicitly require you to have replacement bulbs in the vehicle.

Driving with outside lights that do not work may be against the law.

### **Additional light bulb specifications**

Some factory-installed light bulbs in the headlights or the rear lights may have different specifications than conventional light bulbs. Specifications are on the glass bulb or on the metal base.

### **More information:**

- Exterior views
- Lights and Vision
- Preparations for working in the engine compartment
- Vehicle tool kit
- Fuses



### **WARNING**

**Crashes and other accidents can happen when you cannot see the road ahead and when you cannot be seen by other motorists.**



## WARNING

Improper replacement of burned out headlights and other light bulbs can cause serious personal injury.

- Stop! Always read and heed the **WARNINGS** before doing any work in the engine compartment, *Preparations for working in the engine compartment*. The engine compartment of any motor vehicle is a potentially dangerous area, and work in this area can lead to serious personal injury.
- HID – High Intensity Discharge (Xenon) headlights get power from a high voltage source that can cause severe personal injury and even death if handled improperly.
- H7 bulbs and HID – High Intensity Discharge (Xenon) headlights are under high pressure and can explode if handled improperly.
- Always let a burned out light bulb cool down before replacing it.
- Never replace a light bulb unless you are familiar with all of the necessary procedures. In particular, never remove a headlight unless you know exactly how to carry out the job and have the correct tools and light bulbs.
- If you are uncertain about what to do, have the work performed by an authorized Volkswagen dealer, an authorized Volkswagen Service Facility, or another qualified workshop. Serious personal injury may result from improperly performed work.
- We strongly recommend that you always have HID – High Intensity Discharge (Xenon) headlights and H7 bulbs replaced by a qualified technician.
- Do not touch the glass of light bulbs with your bare hands. Fingerprints left on the bulb evaporate due to the heat when the bulb is switched on and cause the reflector to “cloud.”
- There are sharp edges on and around the headlight housing in the engine compartment and the rear light housing. Wear hand protection if you replace bulbs.



## NOTICE

After replacing a headlight bulb or other light bulb, always make sure that the rubber covers or plastic caps have been properly and securely reinstalled to help prevent water from getting into the electrical connections and headlight housing and damaging the electrical system.

## Indicator light

☐ Please first read and note the introductory information and heed the **WARNINGS**

Lights up	Possible cause	Proper response
	Light bulb of the exterior vehicle lighting not working.	Replace the light bulb that isn't working.

When the ignition is switched on, several warning and indicator lights come on briefly for a function check. They go out after a few seconds.



## WARNING

Failure to heed warning lights and instrument cluster text messages can cause the vehicle to break down in traffic and result in a collision and serious personal injury.

- Never ignore warning lights or text WARNINGS.
- Always stop the vehicle as soon as it is safe to do so.



## NOTICE

Failure to heed warning lights or text WARNINGS can result in vehicle damage.



Failure of a single LED within a taillight is not indicated. However, the  indicator light will come on if all LEDs fail.

## Information on light bulb replacement

---

 Please first read and note the introductory information and heed the WARNINGS 

### Checklist

---

Steps for replacing a light bulb. Please carry out these steps only in the order listed ⇒ .

1. Stop the vehicle in a safe place on level and firm ground at a safe distance from traffic.
  2. Set the electronic parking brake to help prevent the vehicle from moving
  3. Turn the light switch to **0** position
  4. Move the turn signal lever to neutral position
  5. Automatic transmission: Shift the transmission into Park (**P**)
  6. Stop the engine and remove the key from the ignition switch
  7. Manual transmission: Engage a gear
  8. Let orientation lighting go out
  9. Let the burned out light bulb cool down.
  10. Check if the fuse is blown
  11. Replace the burned out light bulb according to instructions ⇒ . Always replace a burned-out light bulb with a good bulb with the same specifications. Specifications are on the glass bulb or on the metal base.
  12. Never touch the glass of the light bulb with your bare hands. Fingerprints can cloud the outer surface of the light bulb when heated, affecting the lighting power, clouding the reflector, and reducing the brightness.
  13. Always make sure that the new bulb works. If the bulb does not work, it may not be installed correctly; the connection plug may not be completely seated; the corresponding fuse may be burned out; or the bulb may be bad.
  14. Always have the headlights adjusted by an authorized Volkswagen dealer or an authorized Volkswagen Service Facility after a headlight bulb has been replaced.
-

## WARNING

Disregarding the safety-related checklist may lead to accidents and serious personal injuries.

- Always review and follow the checklist. Follow accepted safety practices and use common sense.

## NOTICE

Always insert and remove lamps carefully to help prevent damage to the vehicle paint or to other parts of the vehicle.

## Changing headlight bulbs

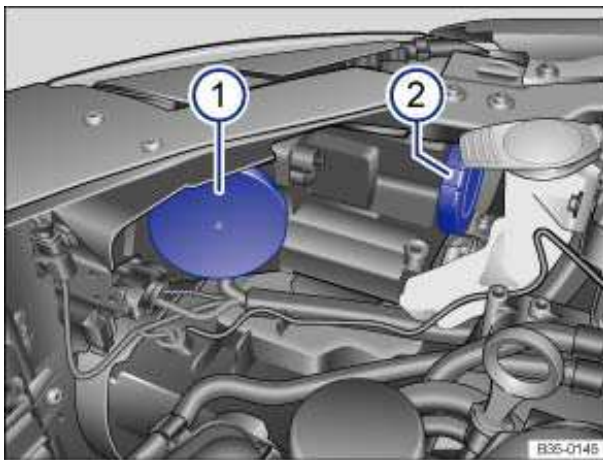

**Fig. 186** In the engine compartment: Cover for HID headlights 1, cornering light, daytime running light, parking light and turn signal 2.

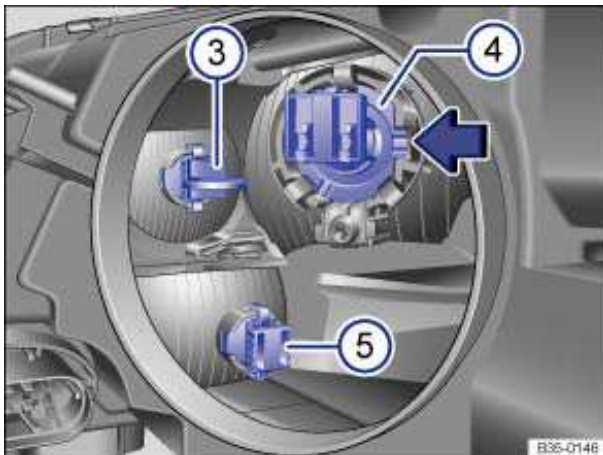

**Fig. 187** Removing and installing the bulbs for the daytime running light and parking light 3, cornering light 4 or turn signal 5.

 Please first read and note the introductory information and heed the WARNINGS 

The headlight does not need to be removed in order to replace the bulb.

Only perform these steps in the specified order:

## Replacing the daytime running light bulb and parking light bulb

In some models, the daytime running lights and parking lights use LEDs. The LEDs are a component of the headlight and cannot be replaced. See your authorized Volkswagen dealer or authorized service facility for assistance.

1.	Follow the checklist and perform the steps
2.	Open the hood 
3.	Pull the rubber cover on the rear side of the headlight to the side ⇒ <a href="#">fig. 186 (2)</a> .
4.	Remove the bulb holder ⇒ <a href="#">fig. 187 (3)</a> with the bulb and pull it toward the rear out of the headlight housing.
5.	Pull the bulb straight out of the bulb holder.
6.	Replace burned out bulbs with new bulbs that are identical to the ones being replaced.
7.	Insert the bulb holder with the new bulb in the original position in the headlight housing <a href="#">(3)</a> .
8.	Install the rubber cover ⇒ <a href="#">fig. 186 (2)</a> .

## Replacing the cornering light bulb

1.	Follow the checklist and perform the steps
2.	Open the hood 
3.	Pull the rubber cover on the rear side of the headlight to the side <a href="#">(2)</a> .
4.	Press in the direction of the arrow to remove the bulb holder ⇒ <a href="#">fig. 187 (4)</a> with the bulb and pull it toward the rear out of the headlight housing.
5.	Pull the bulb straight out of the bulb holder.
6.	Replace burned out bulbs with new bulbs that are identical to the ones being replaced.
7.	Insert the bulb holder with the new bulb in the original position in the headlight housing <a href="#">(4)</a> and press opposite to the direction of the arrow. The front of the bulb holder must fit correctly in the cutout on the headlight housing (arrow).
9.	Install the rubber cover ⇒ <a href="#">fig. 186 (2)</a> .

## Replacing the turn signal bulb

1.	Follow the checklist and perform the steps
2.	Open the hood 
3.	Pull the rubber cover on the rear side of the headlight to the side <a href="#">(2)</a> .
4.	Press downward to remove the bulb holder ⇒ <a href="#">fig. 187 (5)</a> with the bulb and pull it toward the rear out of the headlight housing.
5.	Pull the bulb straight out of the bulb holder.
6.	Replace burned out bulbs with new bulbs that are identical to the ones being replaced.
7.	Insert the bulb holder with the new bulb in the original position in the headlight housing <a href="#">(5)</a> and press upward.



### Replacing the HID bulb

See your authorized Volkswagen dealer or authorized Volkswagen Service Facility for assistance in replacing the HID bulb (1).

**i** The illustrations show the right headlight from behind. The left headlight is arranged as a mirror image of the right.

**i** Failure of a single LED within a headlight is not indicated. However, the = indicator light will appear if all LEDs fail.

**i** Different models may have different lights, and the location and design of covers, bulb holders, and bulbs may be in a different location than shown in the illustrations.

**i** You cannot replace the LEDs in LED daytime running lights. Contact your authorized Volkswagen dealer or an authorized Volkswagen Service Facility for assistance.

### Changing the fog light bulbs in the front bumper

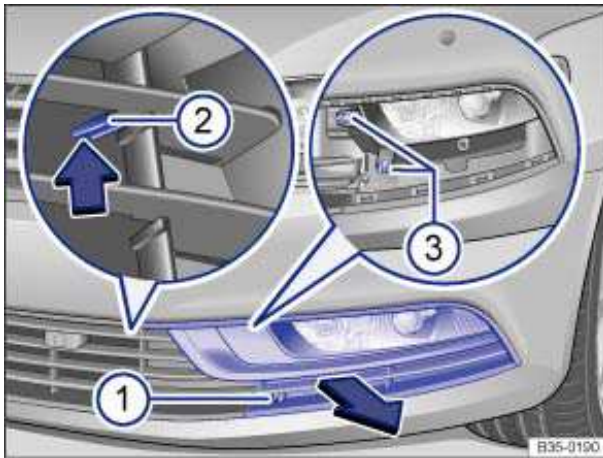

**Fig. 188** In the left front bumper: Fog light.

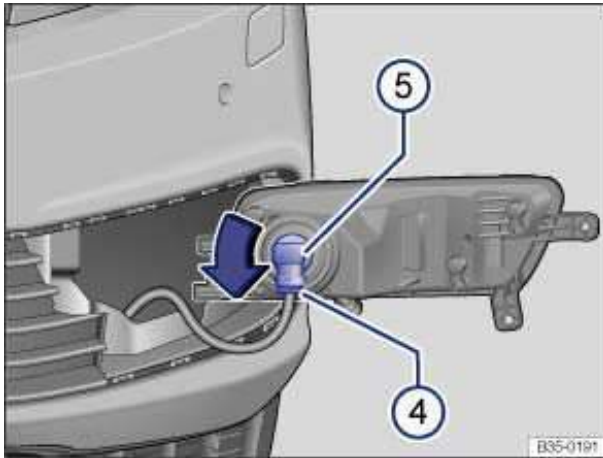

**Fig. 189** In the removed light: Replacing the bulb.

⚠ Please first read and note the introductory information and heed the WARNINGS ⚠

**Only perform these steps in the specified order:**

- |     |  |
|-----|--|
| 1.  | Follow the checklist and perform the steps   |
| 2.  | Remove the screw ⇒ <a href="#">fig. 188 (1)</a> using the screwdriver from the vehicle tool kit                |
| 3.  | Press the tab (2) upward in the direction indicated by the arrow to release the retainer.                      |
| 4.  | Pull the cover forward out of the bumper in the direction indicated by the arrow.                              |
| 5.  | Remove the screws (3) using the screwdriver from the vehicle tool kit.   |
| 6.  | Pull the light downward and then forward out of the bumper.  |
| 7.  | Release the connector ⇒ <a href="#">fig. 189 (4)</a> and disconnect it.  |
| 8.  | Turn the bulb (5) counterclockwise until it stops and then remove.   |
| 9.  | Replace burned out bulbs with new bulbs that are identical to the ones being replaced.                         |
| 10. | Insert the bulb (5) in the housing and turn clockwise until it reaches the original position.                  |
| 11. | Check if the bulb is installed securely.   |
| 12. | Connect the connector (4) on the bulb so that it clicks into place.  |
| 13. | Insert the light into the bumper.  |
| 14. | Install the screws ⇒ <a href="#">fig. 188 (3)</a> .  |
| 15. | Insert the cover in the bumper opposite the direction indicated by the arrow . The tab (2) must lock in place. |
| 16. | Install the screw (1).   |

**i** The illustrations show the left fog light. The right fog light is arranged as a mirror image of the left.

**i** Different models may have different lights, and the location and design of covers, bulb holders, and bulbs may be in a different location than shown in the illustrations.

## Changing the fog light bulbs in the front bumper (CC R Line)

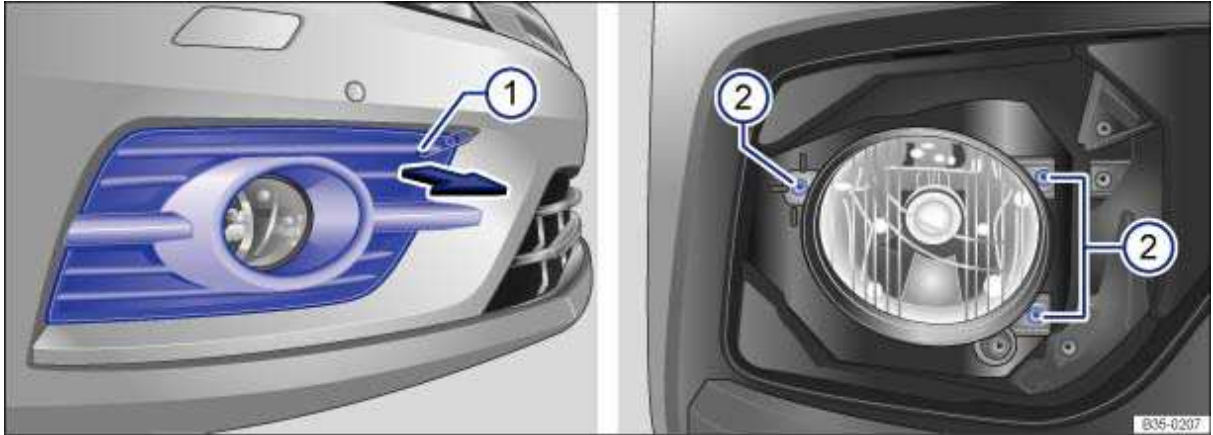

Fig. 190 In the right front bumper: Fog light.

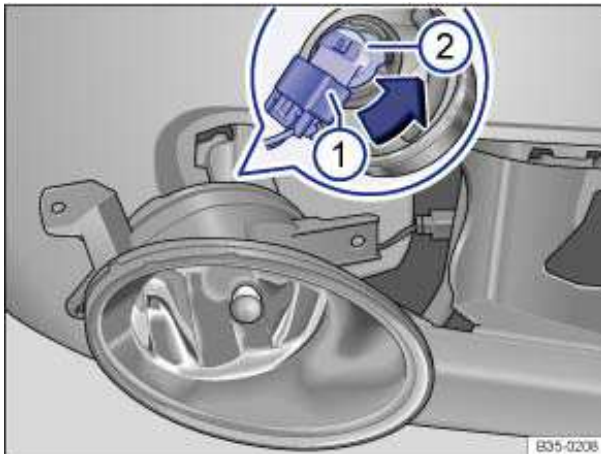

Fig. 191 In the removed light: Replacing the bulb.

⚠ Please first read and note the introductory information and heed the WARNINGS ⚠

**Only perform these steps in the specified order:**

1. Follow the checklist and perform the steps
2. Remove the screwdriver and the wire bracket from the vehicle tool kit in the luggage compartment
3. Insert the wire bracket into the opening ⇒ fig. 190 (1) on the cover and pull it forward in the direction of the arrow with the cover and remove.
4. Remove the screws (2) with the screwdriver.
6. Pull the light out slightly.
7. Release the connector ⇒ fig. 191 (1) and disconnect it.
8. Turn the bulb holder (2) counterclockwise until it stops and then it remove it toward the rear with the bulb.
9. Replace burned out bulbs with new bulbs that are identical to the ones being replaced.
10. Insert the bulb holder in the headlight and turn it clockwise until it stops.

---

**Only perform these steps in the specified order:**

---

- |     |  |
|-----|--|
| 11. | Check if the bulb is installed securely.   |
| 12. | Connect the connector (1) on the bulb so that it clicks into place.  |
| 13. | Insert the light into the bumper.  |
| 14. | Install the screws ⇒ fig. 190 (2).   |
| 15. | Insert the cover in the bumper opposite the direction indicated by the arrow . The cover must click into place securely. |
| 16. | Make sure the cover is installed securely.   |
- 

 The illustrations show the right fog light. The left fog light is arranged as a mirror image of the right.

## Replacing the taillight bulbs in the luggage compartment lid

---



**Fig. 192** In the luggage compartment lid: Removing the cover.

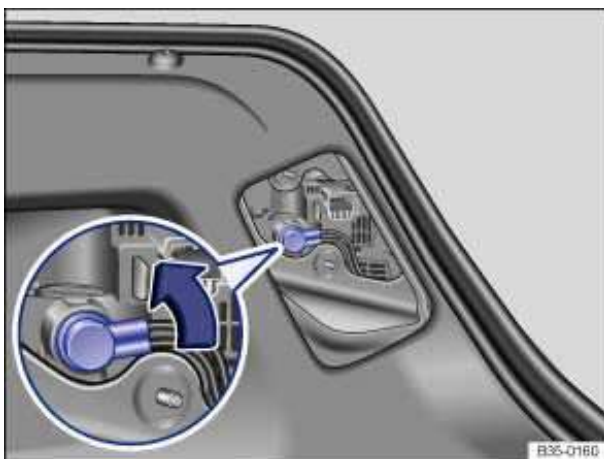

**Fig. 193** In the luggage compartment lid: Removing the bulb holder.

 Please first read and note the introductory information and heed the WARNINGS 

---

**Only perform these steps in the specified order:**

---

1. Follow the checklist and perform the steps.
  2. Open the luggage compartment lid
  3. Carefully pry the cover off ⇒ [fig. 192](#) using the flat screwdriver blade from the vehicle tool kit ⇒ [fig. 170](#).
  4. Turn the bulb holder approximately 30° counterclockwise and remove it with the bulb.
  5. Replace burned out bulbs with new bulbs that are identical to the ones being replaced.
  6. Insert the bulb holder in the taillight and turn it approximately 30° clockwise. The bulb holder must click into place.
  7. Insert the cover. The cover must lock into place and be secure.
- 

**LEDs in the taillights in the luggage compartment lid**

LEDs cannot be replaced. Contact your authorized Volkswagen dealer or authorized Volkswagen Service Facility for assistance.

 Different models may have different lights, and the location and design of covers, bulb holders, and bulbs may be in a different location than shown in the illustrations.

# Jump-starting

## Introduction

---

In this section you'll find information about:

Positive jump start terminal

Using jumper cables

If your engine does not start because the vehicle battery is dead, your vehicle's battery can be connected to the battery of another vehicle to start your engine (jump-starting). Check the battery acid level indicator on the vehicle battery before jump-starting.

You must use jumper cables that meet recognized industrial standards (check information provided by the jumper cable manufacturer). For vehicles with **gasoline engines**, the cross-section of the jumper cable wire must be at least 0.038 in.<sup>2</sup> (25 mm<sup>2</sup>), or about 3 ga. (AWG).

### More information:

- Starting assistance systems
- Preparations for working in the engine compartment
- Vehicle battery



### WARNING

**Working on the batteries or the electrical system in your vehicle can cause serious acid burns, fires, or electrical shock.**

- **Always keep children away from battery acid and vehicle batteries in general.**
- **Sulfuric battery acid is very corrosive and can cause blindness and damage to unprotected skin. Never let battery acid or lead particles contact your eyes, skin, and clothing.**
- **Never lean over a vehicle battery. Always wear protective gloves and eye protection. To reduce your risk of injury, never tilt the batteries; acid could spill out through the vents and burn you.**
- **A highly explosive mixture of gases is given off when the battery is being charged.**
- **Always avoid fires, sparks, open flame, and smoking. Never create sparks or electrostatic charges when handling cables and electrical equipment. Never short-circuit the battery terminals. High-energy sparks can cause serious personal injury.**
- **If you get battery acid in your eyes or on your skin, immediately rinse with cold water for several minutes and get medical attention immediately. If you swallow any battery acid, get medical attention immediately.**

# Jump-starting

## Introduction

---

In this section you'll find information about:

Positive jump start terminal

Using jumper cables

If your engine does not start because the vehicle battery is dead, your vehicle's battery can be connected to the battery of another vehicle to start your engine (jump-starting). Check the battery acid level indicator on the vehicle battery before jump-starting.

You must use jumper cables that meet recognized industrial standards (check information provided by the jumper cable manufacturer). For vehicles with **gasoline engines**, the cross-section of the jumper cable wire must be at least 0.038 in.<sup>2</sup> (25 mm<sup>2</sup>), or about 3 ga. (AWG).

### More information:

- Starting assistance systems
- Preparations for working in the engine compartment
- Vehicle battery



### WARNING

**Working on the batteries or the electrical system in your vehicle can cause serious acid burns, fires, or electrical shock.**

- **Always keep children away from battery acid and vehicle batteries in general.**
- **Sulfuric battery acid is very corrosive and can cause blindness and damage to unprotected skin. Never let battery acid or lead particles contact your eyes, skin, and clothing.**
- **Never lean over a vehicle battery. Always wear protective gloves and eye protection. To reduce your risk of injury, never tilt the batteries; acid could spill out through the vents and burn you.**
- **A highly explosive mixture of gases is given off when the battery is being charged.**
- **Always avoid fires, sparks, open flame, and smoking. Never create sparks or electrostatic charges when handling cables and electrical equipment. Never short-circuit the battery terminals. High-energy sparks can cause serious personal injury.**
- **If you get battery acid in your eyes or on your skin, immediately rinse with cold water for several minutes and get medical attention immediately. If you swallow any battery acid, get medical attention immediately.**



## WARNING

Improper use of jumper cables when jump-starting a vehicle with a dead battery can cause the battery to explode, leading to serious personal injury. To help reduce the risk of battery explosion:

- All work on the batteries or the electrical system in your vehicle can cause serious acid burns, fires, or electrical shocks. Always read and heed the following WARNINGS and safety precautions before working on the batteries or the electrical system, *Vehicle battery*.
- Always make sure that the battery providing starting assistance (the booster battery) has the same voltage as the dead battery (12 V) and about the same amperage capacity (see battery label).
- Never jump-start a vehicle with a thawed or frozen vehicle battery. The battery can explode. A dead battery can freeze at temperatures around +32 °F (0 °C).
- A battery that is frozen or was frozen, but has since thawed, must be replaced.
- When the vehicle battery is jump-started, it gives off hydrogen gas, which is highly explosive! Always keep fire, sparks, open flame, and smoking materials far away from vehicle batteries. Never use a cellular telephone while connecting or disconnecting jumper cables.
- Jump-start batteries only in well-ventilated areas. Batteries give off highly explosive hydrogen gas during jump-starting.
- Always route the jumper cables so that they cannot get caught in any moving parts in the engine compartment.
- Never short out the battery terminals by connecting the positive (+) and negative (-) terminals with each other.
- Never connect the negative cable from the other vehicle directly to the negative terminal of the dead battery, as this may cause the hydrogen gas given off by the dead battery to explode.
- Never attach the negative cable from the vehicle providing starting assistance to any part of the fuel system or to the brake hoses or brake lines.
- Never allow the non-insulated parts of the battery clamps to touch.
- Never allow the jumper cable attached to the positive battery terminal to contact metal parts of the vehicle.
- Always follow the instructions of the jumper cable manufacturer.



## NOTICE

To help prevent extensive damage to the vehicle electrical system, read and heed the following:

- Connecting jumper cables improperly can cause a short circuit and do expensive damage to the vehicle's electrical system.
- Do not let the vehicles touch each other while the jumper cables are connected. If they do, electrical current may flow between the vehicles when the positive (+) terminals are connected, causing electrical system damage.



## Positive jump start terminal

---

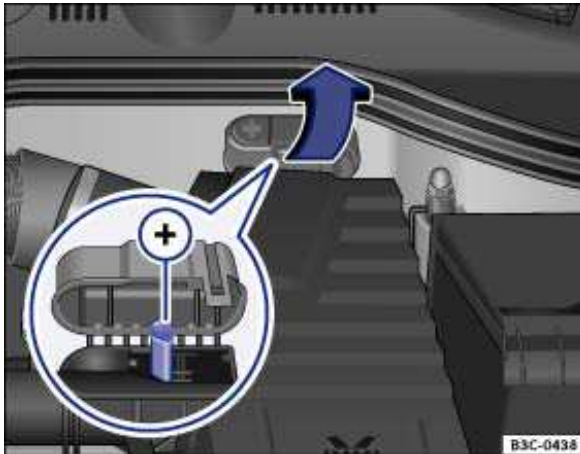

Fig. 196 In the engine compartment: Positive jump start terminal +.

⚠ Please first read and note the introductory information and heed the WARNINGS ⚠

Some vehicles have a jump start terminal (a positive (+) terminal) in the engine compartment under a colored cover.

## Using jumper cables

---

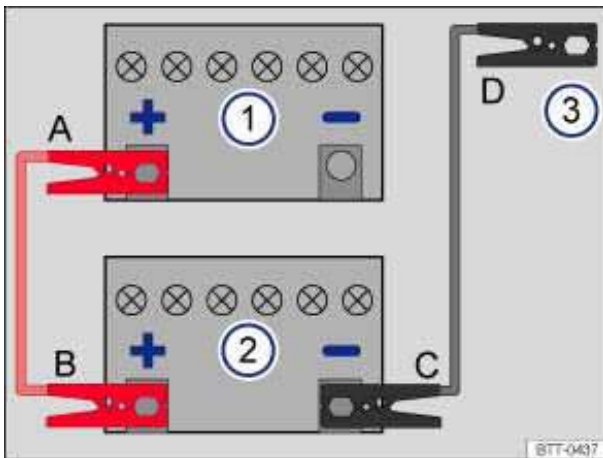

Fig. 197 Diagram for attaching the jumper cables: Dead battery 1 and booster battery 2.

⚠ Please first read and note the introductory information and heed the WARNINGS ⚠

The dead battery must be properly connected to the vehicle's electrical system.

Make certain that the vehicles are not touching each other. Otherwise, electric current could flow as soon as the positive terminals (+) are connected. Use longer jumper cables if necessary.

The clamps on the jumper cables must have good contact to bare metal on the battery terminals.

If the engine does not start, stop the process after 10 seconds and repeat after about 1 minute.

The procedure for attaching and for removing the jumper cables is described below. Perform each of the following steps only in the order described, which follow the letters shown in the illustration

⇒ fig. 197 A – B – C – D.

## Attaching jumper cables

---

1. Switch off the ignition in both vehicles
  2. Open the battery cover in the engine compartment if the battery has a cover or flip open the cap on the positive jump-start terminal<sup>11</sup>, ⇒ fig. 196 (+).
  3. Attach one end of the *red* jumper cable to the **positive terminal (+)** of the dead battery: (1) ⇒ ⚠.
  4. Attach the other end of the *red* jumper cable to the **positive terminal (+)** of the good battery (booster battery): (2).
  5. Attach one end of the *black* jumper cable to the **negative terminal (-)** of the booster battery: (2).
  6. Attach the other end of the *black* jumper cable (3) to a **bare metal part of the vehicle with the dead battery**. This part should be connected directly to the engine block. You may also attach the cable to the engine block itself. Attach the clamp to a point that is as far away as possible from the dead battery (1) ⇒ ⚠.
  7. Route the jumper cables so that they cannot get caught in any moving parts in the engine compartment of either vehicle.
- 

## Starting the engine

- Start the engine of the vehicle with the good battery that is providing help and let it run at idle speed.
- Turn on the ignition of the vehicle with the dead battery. If the engine starts, wait 2 to 3 minutes until it “runs smoothly” before removing the jumper cables as described below ⇒ ⚠. If the engine does not start within about 10 seconds, turn off the ignition and wait at least 1 minute; then try again.

## Before removing the jumper cables

- Switch off the headlights (if they are on).
- In the vehicle with the dead battery, switch on the heater fan and the rear window defroster. This helps to minimize voltage spikes when the cables are disconnected.

## Removing jumper cables

---

With the engine running, remove the jumper cables **in reverse order** to the way they were connected.

1. Disconnect the black (-) cable from the vehicle with the **dead** battery.
  2. Disconnect the black (-) cable from the other vehicle (vehicle with the **good** battery).
  3. Disconnect the red (+) cable from the other vehicle (vehicle with the **good** battery).
  4. Disconnect the red (+) cable from the vehicle with the **dead** battery.
  5. Close the battery cover or snap shut the cap on the positive jump-start terminal<sup>11</sup>, as the case may be.
  6. If necessary, unscrew the towing eye on the front of the vehicle
- 

---

<sup>11</sup> For vehicles without a battery in the engine compartment, see ⇒ page 330



## WARNING

Improper use of jumper cables when jump-starting a vehicle with a dead battery can cause the battery to explode, leading to serious personal injury. To help reduce the risk of battery explosion:

- All work on the batteries or the electrical system in your vehicle can cause serious acid burns, fires, or electrical shocks. Always read and heed the following WARNINGS and safety precautions before working on the batteries or the electrical system 260, *Vehicle battery*.
- Always wear proper eye protection. Never lean over the vehicle battery.
- Attach the jumper cables in the correct order: first the positive cable, then the negative cable.
- Never connect the negative cable from the vehicle providing starting assistance to parts of the fuel system or to the brake hoses or brake lines.
- Never allow the non-insulated parts of the battery clamps to touch.
- Never allow the jumper cable attached to the positive battery terminal to contact metal parts of the vehicle.
- Check the battery acid level indicator window on the vehicle battery. Use a flashlight, never a match, cigarette lighter, or other open flame. If you cannot see the color of the window clearly, or if it is light yellow or colorless, do not jump-start the vehicle. Get expert assistance.
- Avoid electrostatic discharge in the vicinity of the vehicle battery. Sparks may cause the hydrogen gas escaping from the vehicle battery to ignite.
- Never jump-start a vehicle with a battery that is damaged or frozen or that was frozen and has thawed. The battery can explode. Replace the battery instead.
- Always follow the instructions of the jumper cable manufacturer.
- Always make sure that the battery providing starting assistance has the same voltage as the dead battery (12 V) and about the same capacity (see battery label).
- Batteries give off explosive hydrogen gas. Always keep fire, sparks, open flame and smoking materials away from batteries.
- Never connect the negative cable from the other vehicle directly to the negative terminal of the dead battery. The hydrogen gas from the battery is explosive.
- Never short out the battery terminals by connecting the positive (+) and negative (-) terminals with each other.

# Towing

## Introduction

---

In this section you'll find information about:

Towing on a commercial tow truck

Tips on towing

Driving tips while towing

Observe legal requirements when towing.

### For technical reasons:

- **A vehicle with a dead battery must never be towed. Jump-start the vehicle instead.**
- **It is not possible to tow-start or push-start your vehicle. Jump-start the vehicle instead.**

### More information:

- Exterior views
- Shifting
- Engine control and emission control system
- Jump-starting

### WARNING

**Never tow a vehicle without any electrical power.**

- **Never remove the remote control vehicle key from the ignition switch while the vehicle is moving. The electronic steering column lock could suddenly engage, and you would not be able to steer or control the vehicle. You can lose control of the vehicle, crash, and seriously injure yourself and others.**

### WARNING

**Towing a vehicle changes the way it handles and brakes. To help reduce the risk of an accident and serious personal injury, note the following:**

- **The driver of the vehicle that is being towed:**
  - **Since the brake booster also does not work when the engine is stopped, you will need to press harder on the brake pedal to slow down or stop. Always be alert so as not to rear-end the towing vehicle.**
  - **Will have to use considerably more force to turn the steering wheel because the power steering is not working.**
- **The driver of the vehicle that is doing the towing:**
  - **Must accelerate gradually and gently and avoid jerking movements.**
  - **Must not brake hard or steer sharply.**
  - **Must brake earlier and more gently than in normal driving.**

## NOTICE

- Be careful not to damage the paint when installing and removing the towing eye and the cover for the threaded hole behind the bumper.
- Unburned fuel can get into the catalytic converter during towing and damage it.

## Towing on a commercial tow truck

---

 Please first read and note the introductory information and heed the WARNINGS 

To help avoid damaging the vehicle, have it towed only by a professional towing company. Read and heed the following information:

### General information

Never let the vehicle be towed at speeds above 30 mph (50 km/h).

Never let the vehicle be towed for more than 30 miles (50 km).

### Towing manual transmission vehicles

- Release the parking brake.
- Shift the transmission into Neutral (**N**).
- If possible, have the vehicle towed with the front wheels off the ground.
- If necessary, the vehicle can also be towed with the rear wheels off the ground ⇒ .

### Towing automatic transmission vehicles

- Release the parking brake.
- Shift the transmission into Neutral (**N**).
- Tow the vehicle only with its front wheels off the ground ⇒ .

### Special towing instructions for vehicles with all-wheel drive (4MOTION)

- To help prevent unnecessary damage, vehicles with all-wheel drive (4MOTION) must be transported on a flat-bed truck.
- To load the vehicle on the flat bed, use the towing eye found in the vehicle tool kit and attach it to the front anchorage

### When not to tow your vehicle

If there is little or no oil in the transmission because of damage to your vehicle, it must be moved with the drive wheels off the ground. The vehicle can only be towed if its ignition is switched on and its electrical system is operating. In the following situations, the vehicle cannot be towed at all and must be transported on a flatbed truck or trailer:

- If the front and rear wheels cannot turn.
- If the vehicle battery is dead (because the electronic steering column lock engages and cannot be released).
- If you have to tow an automatic transmission vehicle more than 30 miles (50 km).

## WARNING

It is not safe for children or other persons to ride in a vehicle that is being towed.

- Never let children or anyone else remain in the vehicle while it is being towed.

## NOTICE

The drive axle rotates while the vehicle is being towed with its rear wheels off the ground. This can damage the automatic transmission.

- Never tow automatic transmission vehicle with the rear wheels off the ground.
- Tow manual transmission vehicles with the rear wheels off the ground only if it is certain that no transmission fluid can leak out.

## Tips on towing

---

 Please first read and note the introductory information and heed the WARNINGS 

### Towing eye; tow rope or tow bar

A towing eye is included in your vehicle's tool kit. This can be inserted in a threaded hole in the front bumper and used when your vehicle is being towed by another vehicle. On most vehicles, there is another threaded hole in the rear bumper, so you can use the towing eye to tow other vehicles as well. Towing a vehicle with a tow bar is safer and easier on both vehicles than using a tow rope. A tow rope should be used only if a tow bar is not available.

The tow rope should be flexible enough to help protect both vehicles from damage. Use a synthetic fiber rope or similar rope.

Attach the tow rope or tow bar only to the towing eye included in the vehicle tool kit for this purpose, or to a trailer hitch.

### Towing manual transmission vehicles

Check whether your vehicle can be towed at all; see below , *When not to tow your vehicle*

If yes, note the following for the towed vehicle:

- Shift the gearshift lever to Neutral
- Do not tow faster than 30 mph (50 km/h).
- Do not tow more than 30 miles (50 km).

### Towing automatic transmission vehicles

Check whether your vehicle can be towed at all; see below 346, *When not to tow your vehicle*

If yes, note the following for the towed vehicle:

- Put the transmission in Neutral **(N)**.
- Do not tow faster than 30 mph (50 km/h).
- Do not tow more than 30 miles (50 km).
- When a commercial tow truck is being used, the vehicle must only be towed with the front wheels lifted off the ground.
- Follow the special instructions for towing vehicles with all-wheel drive (4MOTION).

### Towing vehicles with all-wheel drive (4MOTION)

Vehicles with all-wheel drive (4MOTION) should be towed with a tow bar or a tow rope. If the vehicle is towed with the front or rear axles lifted off the ground, the engine must be switched off. Otherwise the powertrain may be damaged.

For vehicles with the DSG<sup>®</sup> Direct Shift Gearbox, also follow the directions on how to tow a vehicle with automatic transmission

## When not to tow your vehicle

In the following situations, the vehicle cannot be towed and must be transported on a flatbed truck or trailer:

- If transmission fluid has leaked out of the transmission.
- If there is little or no oil in the transmission because of damage to your vehicle, it must be moved with the drive wheels off the ground.
- If the front and rear wheels cannot turn.
- When the vehicle battery is dead, because the steering may remain disabled and it may not be possible to release the electronic steering column lock. If the electronic parking brake was engaged when the battery died, it cannot be released.
- If you have to tow an automatic transmission vehicle more than 30 miles (50 km).

## Towing other vehicles

- Obey all legal requirements
- Read and heed all towing information in the owner's manual for the other vehicle.



A vehicle can be towed only if the electronic parking brake and the electronic steering column lock are released. In case of a power loss or malfunctions of the electrical system, the engine may have to be jump-started in order to release the electronic parking brake and the electronic steering column lock.

## Driving tips while towing

---

**ⓘ Please first read and note the introductory information and heed the WARNINGS ⚠**

Towing requires some experience, especially when using a tow rope. Both drivers must be familiar with the techniques required for towing. Inexperienced drivers should not try to tow a vehicle or to drive a vehicle that is being towed.

Do not pull too hard with the towing vehicle, and avoid jerking the tow rope. When towing on an unpaved road, there is always a risk of overloading and damaging the attachment points.

If your vehicle is being towed, it can still signal turns even if the emergency flashers are activated, as long as the ignition is switched on. Use the turn signal in the normal way. The emergency flashers go off as long as the turn signal is blinking. As soon as the turn signal lever returns to its neutral position, the emergency flashers are automatically activated again.

### As the driver of the vehicle being towed:

- If your vehicle is the one being towed, the ignition switch must be switched on to keep the steering wheel from locking and to be able to release the electronic parking brake. Also make sure that the turn signals, horn, windshield wipers, and windshield washers work properly.
- Since power steering does not work when the engine is switched off, more effort is needed to steer the vehicle.
- Since the brake booster also does not work when the engine is stopped, you will need to press harder on the brake pedal to slow down or stop. Do not hit the towing vehicle.
- Read and heed the information and WARNINGS in the towing vehicle's owner's manual.

### As the driver of the towing vehicle:

- Drive especially carefully and accelerate gently. Avoid sudden driving maneuvers.
- Brake earlier and more gently than usual and with light pedal pressure.
- Read and heed the information and WARNINGS in the owner's manual of the vehicle being towed.

# Abbreviations

<b>Abbreviation</b>	<b>Meaning</b>
---------------------	----------------

---

5S man	5-speed manual transmission
6S auto	6-speed automatic transmission
6S man	6-speed manual transmission
ABS	Anti-lock Brake System
AFS	Adaptive Front Lighting System
AKI	Anti-Knock Index
ANSI	American National Standards Institute
ASR	Anti-Slip Regulation
ATA	Anti-Theft Alarm system
BAS	Brake Assist System
ccm	Cubic centimeter – metric unit of measure for engine displacement
CCS	Cruise Control System
CID	Cubic inch displacement – unit of measure for engine displacement
cm	Centimeter – metric unit of measure for length
CO <sub>2</sub>	Carbon dioxide
DIN	Deutsches Institut für Normung (German Institute for Standardization)
DRL	Daytime Running Lights
DSG <sup>®</sup>	Direct Shift Gearbox automatic transmission
EDL	Electronic Differential Lock
EN	European Norm
EPC	Engine control (Electronic Power Control)
ESC	Electronic Stability Control
g/km	Generated carbon monoxide amount in grams per kilometer driven
GAWR	Gross Axle Weight Rating
GVWR	Gross Vehicle Weight Rating
HID	High Intensity Discharge headlights (Xenon)
hp	Horsepower – unit of measure for engine power
kg	Kilogram – metric unit of measure for weight
kN	Kilonewton – a unit of measure for force
kp	Kilopond – unit of measure for force
kPa	Kilopascal – unit of measure for tire pressure
kW	Kilowatt – engine rating
LED	Light Emitting Diode
m	Meter – metric unit of measure for length



MDI	Media Device Interface (MEDIA-IN)
MFI	Multi-Function Indicator
Nm	Newton meter – a unit of measure for engine torque
PDC	Park Distance Control
RON	Research Octane Number – measurement of anti-knock resistance of gasoline
rpm	Engine revolutions per minute (engine speed)
SAE	Society of Automotive Engineers
TSI <sup>®</sup>	Turbocharged gasoline engine with direct fuel injection
XDL	Extension of the Electronic Differential Lock system