

Volkswagen/Audi Vehicle Communication Software Manual

August 2013

EAZ0031B01E Rev. A

Trademarks

Snap-on is a trademark of Snap-on Incorporated.

All other marks are trademarks or registered trademarks of their respective holders.

Copyright Information

©2013 Snap-on Incorporated. All rights reserved.

Disclaimer

The information, specifications and illustrations in this manual are based on the latest information available at the time of printing.

Snap-on reserves the right to make changes at any time without notice.

Visit our website at:

<http://diagnostics.snapon.com> (North America)

For Technical Assistance Call:

1-800-424-7226 (North America)

Safety Information

For your own safety and the safety of others, and to prevent damage to the equipment and vehicles upon which it is used, it is important that the accompanying *Safety Information* be read and understood by all persons operating, or coming into contact with, the equipment. We suggest you store a copy near the unit in sight of the operator

This product is intended for use by properly trained and skilled professional automotive technicians. The safety messages presented throughout this manual are reminders to the operator to exercise extreme care when using this test instrument.

There are many variations in procedures, techniques, tools, and parts for servicing vehicles, as well as in the skill of the individual doing the work. Because of the vast number of test applications and variations in the products that can be tested with this instrument, we cannot possibly anticipate or provide advice or safety messages to cover every situation. It is the automotive technician's responsibility to be knowledgeable of the system being tested. It is essential to use proper service methods and test procedures. It is important to perform tests in an appropriate and acceptable manner that does not endanger your safety, the safety of others in the work area, the equipment being used, or the vehicle being tested.

It is assumed that the operator has a thorough understanding of vehicle systems before using this product. Understanding of these system principles and operating theories is necessary for competent, safe and accurate use of this instrument.

Before using the equipment, always refer to and follow the safety messages and applicable test procedures provided by the manufacturer of the vehicle or equipment being tested. Use the equipment only as described in this manual.

Read, understand and follow all safety messages and instructions in this manual, the accompanying safety manual, and on the test equipment.

Safety Message Conventions

Safety messages are provided to help prevent personal injury and equipment damage. All safety messages are introduced by a signal word indicating the hazard level.

DANGER

Indicates an imminently hazardous situation which, if not avoided, will result in death or serious injury to the operator or to bystanders.

WARNING

Indicates a potentially hazardous situation which, if not avoided, could result in death or serious injury to the operator or to bystanders.

CAUTION

Indicates a potentially hazardous situation which, if not avoided, may result in moderate or minor injury to the operator or to bystanders.

Safety messages contain three different type styles.

- Normal type states the hazard.
- Bold type states how to avoid the hazard.
- Italic type states the possible consequences of not avoiding the hazard.

An icon, when present, gives a graphical description of the potential hazard.

Example:

 **WARNING**



Risk of unexpected vehicle movement.

- **Block drive wheels before performing a test with engine running.**

A moving vehicle can cause injury.

Important Safety Instructions

For a complete list of safety messages, refer to the accompanying safety manual.

SAVE THESE INSTRUCTIONS

Table of Contents

Safety Information	iii
Chapter 1: Using This Manual	1
Conventions	1
Bold Text	1
Terminology	1
Notes and Important Messages	2
Notes	2
Important	2
Chapter 2: Introduction	3
Chapter 3: Operations	4
Identifying the Vehicle	4
Engine ID Codes	5
Vehicle Identification	11
Connecting to a Vehicle	11
Selecting a System	15
Demonstration Programs	17
Chapter 4: Expert Mode	18
Using Expert Mode	18
Initiating Expert Mode	19
Selecting a System	19
Expert Mode Function Selection Menu	20
Testing in Expert Mode	29
Chapter 5: Testing	30
VW/Audi Software Application List	30
Testing Engine Systems	32
VW/Audi Application Coverage	32
Clearing Codes	40
Data	42
Functional Tests	43
Testing Transmission Systems	53
Digimat Control Module Identification—Golf & Jetta, 1993–97	58
4-Speed Automatic Transmission—01N	60
VW Series—095, 096, 01M	60
Audi Transmission—01F, 01K	61
Important Tips for Transmission Codes	62
Transmission Basic Settings	63
Functional Tests—VW Passat 01V	64
VW/Audi Transmission Emergency Operation—01V	66
Testing Electronic Throttle Systems	67
Throttle Valve Control Module Adaptation	67

Electronic Throttle Types	69
Testing ABS Systems	72
ABS Basic Settings	75
Testing Immobilizer Systems	75
Important Tips for Testing Immobilizer III Systems.....	76
Audi Immobilizers.....	77
Immobilizer Adaptation Procedures	77
Radio Frequency Remote Control Functions.....	81
Immobilizer Frequently Asked Questions.....	82
Testing Electronic Instrument Panel Systems	83
Electronic Instrument Panel Types.....	83
Testing Airbag (SRS) Systems	88
Testing CAN Data Bus Systems	89
Sources of Interference.....	90
Powertrain CAN Bus	90
CAN Data Bus in the Convenience System	91
Chapter 6: Data Parameters	92
Alphabetical Parameter List.....	93
Gas Engine Parameters	105
Diesel Engine Parameters.....	136
Transmission Parameters.....	140
Transmission Expert Mode Parameters	148
ABS Parameters.....	150
Appendix A: Terms and Acronyms.....	151
Terms.....	151
Acronyms.....	151
Appendix B: Troubleshooting	154
Communication Problems	154
The Aftermarket Radio Problem	154
The Problem	154
Testing for this Problem	155
Appendix C: Fuel Control Learning Adaptation Values.....	157
Long-Term Fuel Control.....	157
Additive Adaptation	157
Multiplicative Adaptation	158
Examples of Display Groups for Long Term FT Adaptive Value	158
Important Tips for Long Term Fuel Control.....	160
Short-Term Fuel Control	160
Examples Short Term FT O2 Regulation	160
Important Tips for Short-Term Fuel Control.....	161
Oxygen Sensor Voltage.....	162
Early Vehicle Oxygen Sensor Reading.....	162
Example: Motronic 2.9 (1993–1995).....	163
Late Model Oxygen Sensor Reading.....	163
Oxygen Sensor Aging Test	164
Oxygen Sensor Control-Dwell Time Test	165
CAT Test Parameters	165

Index 170

This manual contains instructions for testing Audi and Volkswagen vehicles. Some of the illustrations shown in this manual may contain modules and optional equipment that are not included on your system. Contact your sales representative for availability of accessories, other modules, and optional equipment.

1.1 Conventions

This manual uses the conventions described below.

1.1.1 Bold Text

Bold text is used for emphasis and to highlight selectable items such as buttons and menu options.

Example:

- Select **OK** to continue.

1.1.2 Terminology

Certain terms are used to command specific actions throughout this manual. Those terms are described below.

Select

The term “select” means to highlight a menu item or other option, then pressing the **Y/a**, **OK**, **Accept**, or similar button to activate it.

Example:

- Select **Functional Tests**.

Scroll

The term “scroll” means moving the cursor or changing data by using the directional arrow buttons, scroll bars, or other means.

Example:

- Scroll to see any other codes and the data list.

Scan Tool

The term “scan tool” is used to refer to any tool that communicates directly with the vehicle data stream. When necessary, the term “Scanner” is used to distinguish Snap-on equipment from another diagnostic device, such as the Audi or Volkswagen factory scan tool.

1.2 Notes and Important Messages

The following messages appear throughout this manual.

1.2.1 Notes

A NOTE provides helpful information such as explanations, tips, and comments.

Example:

**NOTE:**

For additional information refer to...

1.2.2 Important

IMPORTANT indicates a situation which, if not avoided, may result in damage to the test equipment or vehicle.

Example:

IMPORTANT:

To avoid incorrect TPS adjustment or component damage, be sure to follow the on-screen instructions. Refer to a vehicle service manual for complete test or adjustment procedures.

This manual contains instructions for testing Volkswagen and Audi vehicles.

Some of the illustrations shown in this manual may contain modules and optional equipment that are not included on your system. Contact a Snap-on Sales Representative for availability of other modules and optional equipment.

This chapter provides an overview of the conventions used in this manual. The remainder of this guide is divided into the following chapters:

- **Operations**, on page 4—explains how to begin using the basic scan tool test functions, such as identifying a vehicle, selecting a system for testing, and connecting to a vehicle.
- **Expert Mode**, on page 18—details enhanced factory tool capabilities and special functions, such as setting adaptations and control module coding.
- **Testing**, on page 30—provides information and procedures for using the scan tool with specific control systems.
- **Data Parameters**, on page 92—provides definitions and operating ranges for the Volkswagen and Audi vehicle data stream parameters.
- **Terms and Acronyms**, on page 151—defines common terms and acronyms used in this manual.
- **Troubleshooting**, on page 154—contains information for troubleshooting specific problems that may arise when using the scan tool.
- **Fuel Control Learning Adaptation Values**, on page 157—explains OBD-II short and long term FT terminology applied to VW/Audi fuel control terminology.

This chapter explains how to begin using the basic scan tool test functions, such as identifying a vehicle, selecting a system for testing, and connecting to a vehicle. This information is specific to VW/Audi vehicles. For general scan tool functionality, see the manual for your diagnostic tool.

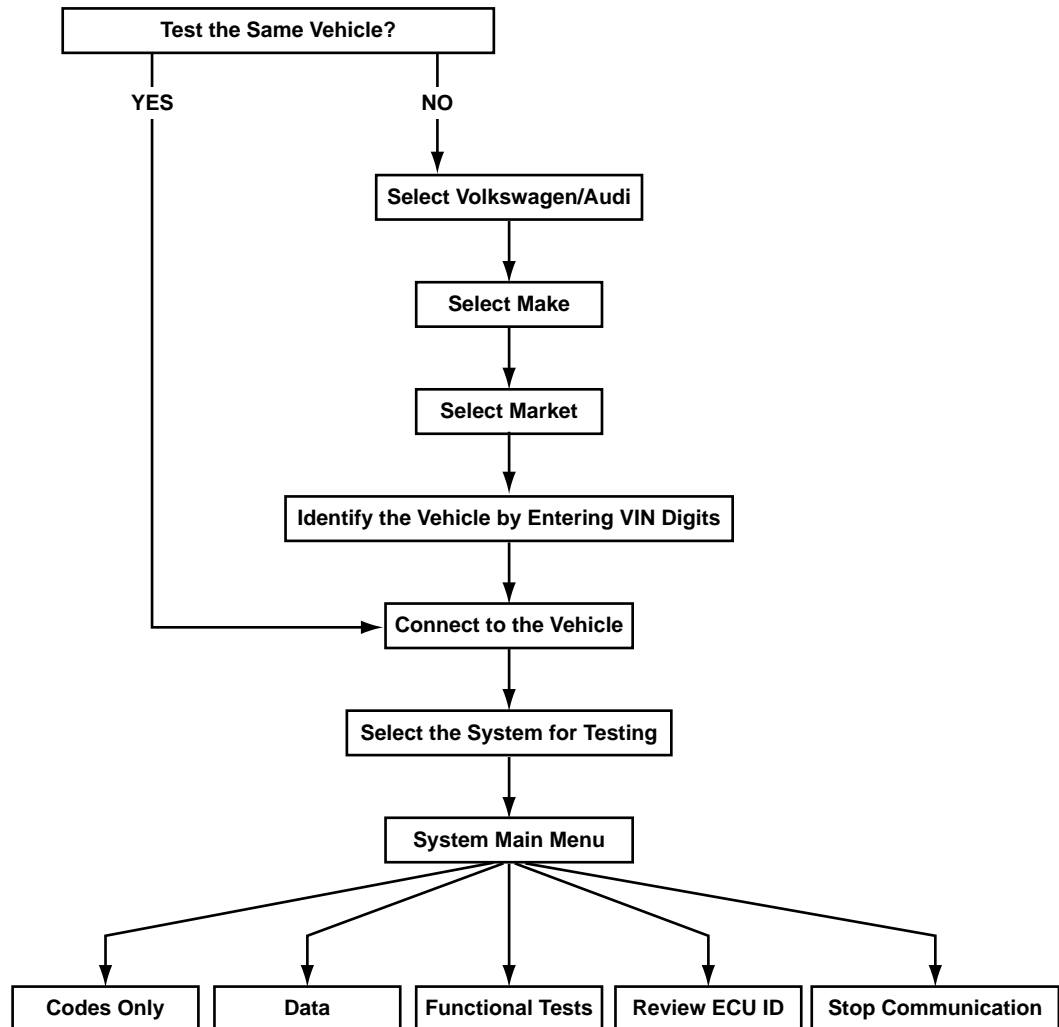

Figure 3-1 Basic Volkswagen Audi test routine

3.1 Identifying the Vehicle

The scan tool typically identifies a vehicle using certain characters of the vehicle identification number (VIN). The scan tool vehicle identification (ID) process prompts to you enter VIN characters and answer questions about the vehicle to be tested.

3.1.1 Engine ID Codes

The vehicle identification process includes entering the test vehicle's engine ID code. The exact engine ID code selection is usually not required for vehicle communications, however, in order for the scan tool to communicate with all installed systems, we recommend that you identify the correct engine code. The scan tool has to match all possible control module identities with the exact control module installed in the vehicle. In addition, the engine ID code is required to select the correct OBD-II Readiness Monitor setting procedures. See the *Volkswagen/Audi OBD-II Readiness Charts* for more information.

VW/Audi specific engine differences are determined by a three-digit engine ID code. In any particular year, there could be multiple engine ID codes for any one engine. The engine codes may represent different horsepower, torque rating or emission package.

Engine ID codes are stamped on the engine block in three-digit alpha characters followed by a series of numbers (usually six), for example, "AEG 029452". If more than 999,999 engines with the same engine code are produced, the first number is replaced by a letter. Newer models may also have an adhesive label located on the timing belt cover. The engine ID code can be difficult to locate on older engines with excessive oil and grease. Here are typical older model 4- and 6-cylinder locations:

- **4-cylinder engine codes** and numbers are usually stamped into the rear of the cylinder block casting near the oil filter flange near the engine/transmission joint.
- **6-cylinder engine codes** are usually located on the left side of the engine block below the camshaft timing chain tensioner. The code numbers should be visible when looking down between the throttle valve control module and the valve cover.

Note the following when looking for an engine ID code:

- Alternatively, look in the owners "maintenance" manual for an adhesive sticker.
- For most engines, the engine ID code is also included on the vehicle data plate, typically located in the trunk near the spare tire. This may be the easiest way to find the engine code.

Table 3-1 contains engine ID code locations for Audi models.

Table 3-1 Volkswagen engine ID code locations (part 1 of 4)

Model	Year	Engine	Code Location
Beetle	1999 and later	1.8L	APH, AWP, AWW: Near the engine/transmission joint. Also on a sticker on the toothed belt guard.
	1998–2002	1.9L 4-cyl 2V TDI	ALH: Between the diesel injection pump and the exhaust manifold on the engine block. Also on a sticker on the timing belt guard.
	2003	2.0L 4-cyl 2V	BBW, BDC: On the front of the engine near the engine/transmission joint. Also on a sticker on the cylinder head cover and vehicle data plate.
	2004 and later	1.8L Turbo	AWU: Unknown at this time. BKF: The engine number can be found on the joint between engine/gearbox. BNU: The engine number can be found on the joint between engine/gearbox.
1.9L TDI		BEW: The engine number can be found on the joint between engine/gearbox.	

Table 3-1 Volkswagen engine ID code locations (part 2 of 4)

Model	Year	Engine	Code Location
Beetle (continued)	2004 and later (continued)	2.0L	<p>AZG: Near the engine/transmission joint. Also on a sticker on the cylinder head cover and vehicle data plate.</p> <p>BDC: Front of the engine near the engine/transmission joint. Also on a sticker on the cylinder head cover and vehicle data plate.</p> <p>BER: Unknown at this time.</p> <p>BEV: The engine number can be found on the flange between engine/transmission.</p> <p>AEG: Near the engine/transmission joint. Also on a sticker on the cylinder head cover and vehicle data plate.</p> <p>AVH: Near the engine/transmission joint. Also on a sticker on the cylinder head cover and vehicle data plate.</p> <p>BHP: Unknown at this time.</p> <p>BGD: The engine number can be found at the front next to the joint between engine/transmission</p>
Eurovan	1999 and earlier	2.5L	AAF, ACU: Between cylinders 1 and 3 on the cylinder block. Also on a sticker on the toothed belt guard.
		2.8L	AES: Behind the cylinder head cover on the cylinder block. Also on a sticker attached to the cylinder head cover.
	2000 and later	2.8L	AES: On the cylinder block next to the vibration damper.
	2001 to 2004	2.8L	AXK: The engine code is located next to the vibration damper on the cylinder head.
Golf, Jetta, GTI	1999 and earlier	2.8L VR6 2V	<p>AFP: On the engine block next to the vibration damper. The engine ID number is found here from 06.27.99 production and from engine AFP-019059.</p> <p>Also on a sticker on the back of the intake manifold upper section near the vacuum connection. Remove the engine cover to view.</p>
	1999 and later	1.8L 4-cyl 5V Turbo	AWD, AWP, AWW: Near the engine/transmission joint. Also on a sticker on the toothed belt guard.
		1.9L 4-cyl 2V TDI	ALH: Between the diesel injection pump and the exhaust manifold on the engine block. Also on a sticker on the toothed belt guard.
		2.0L 4-cyl 2V	AEG, AVH, AZG: Near the engine/transmission joint. Also on a sticker on the cylinder head cover and vehicle data plate.
		2.8L	BDF: Next to the vibration damper on the cylinder block. Also on a sticker on the intake manifold.
	2000 and later	2.8L VR6 2V	AFP: On the engine block next to the cylinder head, beneath the chain tensioner for the camshaft roller chain. It can be seen by looking down between heating resistor N79 and the throttle valve control unit. Also on a sticker on the valve cover.
	2003	2.0L	BBW: Near the engine/transmission joint. Also on a sticker on the cylinder head cover and vehicle data plate.
	2004 and later	1.8L Turbo	BEK: Unknown at this time.
1.9L TDI		<p>BEW: The engine number can be found on the joint between engine/gearbox.</p> <p>BKC: Unknown at this time.</p> <p>BRM: Unknown at this time.</p>	

Table 3-1 Volkswagen engine ID code locations (part 3 of 4)

Model	Year	Engine	Code Location
Golf, Jetta, GTI (continued)	2004 and later (continued)	2.0L	BEV: The engine number can be found on the flange between engine/transmission. BER: Unknown at this time. BHP: Unknown at this time.
		3.2L	BFM: Unknown at this time. BML: Unknown at this time. BJS: The engine number is located next to the vibration damper on cylinder block under coolant pump.
	2005 and later	2.5L	BGQ: Unknown at this time. BGP: Unknown at this time.
Passat	1995–97	1.9L 4-cyl 2V TDI	AAZ, 1Z: On the cylinder block between the diesel injection pump and the exhaust. Also on a sticker on the toothed belt guard.
		2.8L VR6 2V	AAA: On the vibration damper end of the cylinder block. Also on a sticker on the cylinder head cover.
	1998 and later	1.8L 4-cyl 5V Turbo	AEB, ATW, AUG, AWM: On the left side of the cylinder block. Also on a sticker on the cylinder head cover. The engine code is also stamped on the front of the engine lifting eye (visible after removing the cover above the fuel injectors).
		2.8L V6 5V	AHA, ATQ: On the flat surface of the cylinder block, on the front of the right cylinder head.
		W8, 4.0L	BDP: On the left of the cylinder block. Also on a sticker on the cylinder head cover.
	2004 and later	2.0L	BHW: The engine number can be found on the joint between engine/transmission. BGW: Unknown at this time.
		2.8L	AMX: Unknown at this time. BBG: Unknown at this time.
		4.0L	BDN: Unknown at this time.
3.2L		AZZ: Unknown at this time BKJ: Unknown at this time BAA: The engine number is located on cylinder block next to the vibration damper and under coolant pump. BMX: The engine number is located next to the harmonic balancer on the cylinder block under the coolant pump	
Touareg	2004 and later	4.2L	AXQ: The engine number is stamped on the right side of the cylinder block. BHX: The engine number is stamped on the right hand side of the engine block.
		5.0L TDI	AYH: Unknown at this time. BKW: The engine number is located on the cylinder below the cylinder head of cylinder bank 2.
Phaeton	2004 and later	4.2L	BGJ: The engine number is stamped on the right side of the cylinder block BGH: The engine number is stamped on the right side of the cylinder block
		6.0L	BAP: The engine number is located at left on cylinder block BAN: Unknown at this time. BRP: The engine number is located at left on cylinder block

Table 3-1 Volkswagen engine ID code locations (part 4 of 4)

Model	Year	Engine	Code Location
New Jetta	2005 and later	1.9L TDI	BRM: The engine number can be found on the joint between engine/transmission.
		2.5L	BGP: The engine code and serial number are located on the backside of the engine, above the separation point of the engine block/upper point of oil pan. BGQ: The engine code and serial number are located on the backside of the engine, above the separation point of the engine block/upper point of oil pan.

Table 3-2 Audi engine ID code locations (part 1 of 3)

Model	Year	Engine	Code Location
A4	1998 and later	1.8L 4-cyl 5V Turbo	AUG, AWM: The engine ID code is stamped on the front of the engine lifting eye, which is visible after removing the cover above the fuel injectors. The Code is also printed on a sticker attached to the driver-side cylinder head.
	2001	1.8L	AEB, ATW: On the left side of the cylinder block between the transmission and above the oil filter. Also on a sticker on the timing belt guard. The engine ID is also stamped on the front of the engine mounting bracket (visible after removing cover above fuel injectors).
		2.8L	AFC: On the right-hand side of the engine block between the cylinder head and the power steering pump. Also on a sticker on the drive belt cover. AHA, ATQ: On the block in front of the right cylinder head. AHA Only: In vehicles with VINs up to 8D-V-205 000, the oil pump is mounted on the front of the engine and driven directly by the crankshaft. In vehicles with VINs from 8D-V-205 001 on, the oil pump is driven via a chain by the crankshaft and mounted inside the oil pan. Also, oil supply lines are mounted on the camshaft bearing caps.
	2003	4.2L	BHF: On the right of the intake manifold.
	2003 and later	1.8L	AMB: On the rear left of the cylinder block. Also on a sticker on the toothed belt guard and stamped on the front lifting eye (visible when engine cover panel is removed).
		3.0L	AVK: Remove the front engine cover; there is a sticker with the engine code and production number on the housing for vacuum diaphragm for intake manifold adjustment. If the sticker is not present and the engine identification is required, remove the rear engine cover; engine codes are stamped on the rear of the cylinder block, left side. If there is no sticker and the engine identification <i>and</i> production numbers are required, remove the bolts and vacuum diaphragm for intake manifold adjustment. Next, remove the compression spring and move the vacuum diaphragm aside with the lines connected. The engine code and production number are located at the front of the cylinder head, on top.

Table 3-2 Audi engine ID code locations (part 2 of 3)

Model	Year	Engine	Code Location
A4 (continued)	2004 and later	1.8 L Turbo	BKB: Unknown at this time. BFB: Unknown at this time. BEX: Unknown at this time.
		1.8 L Turbo	AMB: The engine number can be found on the rear left of the cylinder block.
		2.0L	BPG: The engine number can be found on the joint between engine/transmission.
		3.0L	ASN: Unknown at this time. BBJ: Unknown at this time.
		3.2L	BKH: The engine number is located on the front of the cylinder block below the right cylinder head.
		4.2L	BBK: Unknown at this time.
		4.2L	BHF: A sticker arrow with engine code and serial number is located on the intake manifold on the right side.
A6	1998 and later	2.7L, 2.8L	APB, AHA, ATQ: On the machined surface on the cylinder block, at the front of the right cylinder bank.
		4.2L	ART, AWN, BBD: On the left side of the cylinder block. Also on a sticker on the belt cover.
	2000 and later	3.0L	AVK: Remove the front engine cover; there is a sticker on the housing for the vacuum diagram for intake manifold adjustment. Also if the rear engine cover is removed engine codes are stamped on the rear of the cylinder block, left side.
		4.2L	AWN: Unknown at this time. BBD: The engine number is located at left on the cylinder block.
	2002 and later	3.0L	ASN: Unknown at this time. BBJ: Unknown at this time.
		3.2L	BKH: The engine number is located on the front of the cylinder block below the right cylinder head.
	2004 and later	2.7L	BES: Unknown at this time.
		4.2L	ANK: Unknown at this time. ASG: Unknown at this time.
			BNK: A sticker with the engine and serial number is affixed to the cylinder head cover on the right hand side.
	A6/S6	Sedan (1995–97)	2.2L
2.7L			BEL: On the cylinder block at the front of the right cylinder bank.
Wagon (1995–98)		2.2L	AAN: On the right-hand side at the rear of the cylinder head.
		2.7L	BEL: On the cylinder block at the front of the right cylinder bank.
2003		4.2L	BAS: On the right-hand side at the rear of the cylinder head.
		BCY: On top of the cylinder block. Also on a sticker on the drive belt cover.	
A8	2004 and later	4.2L	BFM: The engine number is located at left on cylinder block.
		6.0L	BHT: Unknown at this time.
			BSS: The engine number is located on the front of the cylinder block below the left cylinder head.

Table 3-2 Audi engine ID code locations (part 3 of 3)

Model	Year	Engine	Code Location
A8/S8		4.2L	AKB, AUX, AYS: On the left side of the cylinder block. Also on a sticker on the belt cover.
		3.7L, 4.2L	ABZ, AEW: On the left side of the cylinder block directly above the power steering pump. Also on a sticker on the toothed belt guard.
Cabriolet		2.8L	AAH, AFC: On the right-hand side of the engine block between the cylinder head and the power steering pump. Also on a sticker on the drive belt cover.
S4	2000	1.8L	AEB, ATW: On the left side of the cylinder block between the transmission and above the oil filter. Also on a sticker on the timing belt guard and stamped on the front of the engine mounting bracket (visible after removing cover above fuel injectors).
		2.8L	AFC: On the right-hand side of the engine block between the cylinder head and the power steering pump. Also on a sticker on the drive belt cover. AHA, ATQ: On the flat surface of the cylinder block in front of the right cylinder head. AHA Only: In vehicles with VINs up to 8D-V-205 000 the oil pump is mounted on the front of the engine and driven directly by the crankshaft. In vehicles with VINs from 8D-V-205 001 on, the oil pump is driven via a chain by the crankshaft and mounted inside the oil pan. Also, oil supply lines are mounted on the camshaft bearing caps.
	2004 and later	1.8L Turbo	AMB: Unknown at this time. BKB: Unknown at this time. BFB: Unknown at this time.
		3.0L	ASN: Unknown at this time. BGN: Remove the front engine cover; there is a sticker on the housing for the vacuum diagram for intake manifold adjustment. Also if the rear engine cover is removed engine codes are stamped on the rear of the cylinder block, left side. BBJ: Unknown at this time. AVK: Remove the front engine cover; there is a sticker on the housing for the vacuum diagram for intake manifold adjustment. Also if the rear engine cover is removed engine codes are stamped on the rear of the cylinder block, left side.
		4.2L	BBK: Unknown at this time. BHF: On the right of the intake manifold.
TT	2003 and earlier	1.8L, 3.2L	AMW, ATC, AWP, BEA, BHE: At the front next to the joint between engine and transmission. Also on a sticker on the cylinder head cover.
	2004 and later	1.8L	BAM: Unknown at this time.
		3.2L	BHE: The engine number can be found on the joint between engine/transmission.

3.1.2 Vehicle Identification

If you are powering up the scan tool after just installing the Volkswagen/Audi software, or if you exited from the Current Vehicle Identification screen, the Software Selection screen displays.



To enter vehicle identification:

1. Select to continue.
The Manufacturer Selection menu displays.
2. Either select **Audi** or scroll and select **Volkswagen** from the menu.
The mode menu displays.



NOTE:

An Expert Mode button may also display during vehicle identification. Expert Mode is an alternative diagnostic strategy that more closely resembles the factory tool, refer to “Chapter 4 Expert Mode” on page 18 for instructions on using Expert Mode.

3. Select **Vehicle Selection** from the mode.
A market selection screen displays that allows you to choose between models built for operation in the United States (US) or Europe (Euro).
4. Select a market option and the model year menu displays.
5. Select the correct year for the vehicle.
The model menu displays.
6. Select the model of the test vehicle.
Identification screens varies from this point depending on the equipment options available for the selected model. The screen instructions guide you through the selection process.
7. Enter any further VIN character requests and answer any yes or no questions.
At the end of vehicle identification, the scan tool displays the complete model and engine identification.
8. If the ID is correct, continue to store the identification in memory. If the ID is not completely correct, exit to return to the start of the identification steps.

3.2 Connecting to a Vehicle

Once a vehicle has been identified, a scan tool connection message appears, instructing you to use the supplied vehicle test adapters to connect the scan tool for testing.

IMPORTANT:

Before connecting the scan tool to 1997 and later vehicles, read “The Aftermarket Radio Problem” on page 154 in order to avoid seriously damaging your scan tool.

The following adapters are available to connect the scan tool to VW/Audi vehicles:

- **VW-1**—test adapter for 1991–94 VW and Audi vehicles. Hooks up to the white/black connector only (Connector for 1991–94 vehicles requires VW1 adapter).
- **DL-16**—test adapter with Personality Key S-7 for 1994 and later vehicles (DL). This OBD-II style connector is used for all vehicles. The S-44 key is used for CAN communications.

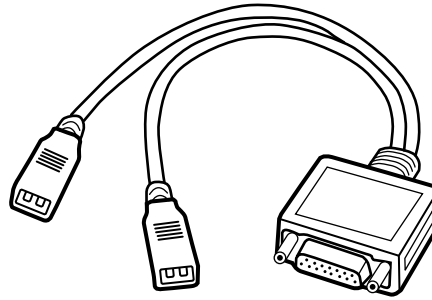

Figure 3-2 VW-1 adapter

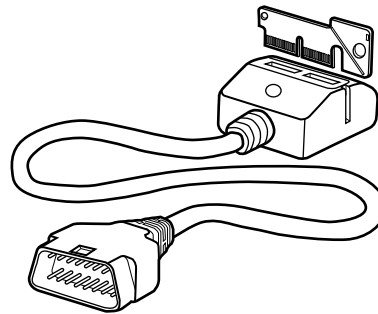
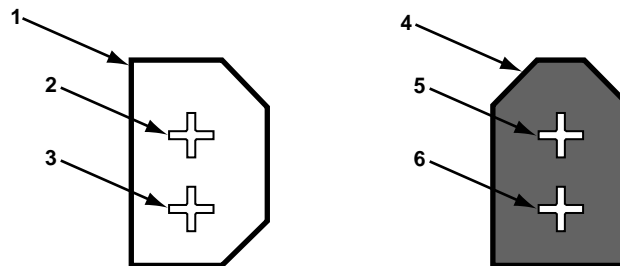

Figure 3-3 DL-16 adapter with S-7 Personality Key

The following vehicle connectors are found on VW/Audi vehicles.



- 1— White connector
- 2— Blue (“K”)
- 3— Yellow (“L”)
- 4— Black connector
- 5— Red (+12)
- 6— Black or Brown (ground)

Figure 3-4 Connector for 1991–94 vehicles, requires VW-1 adapter



NOTE:

There may be other connectors with the white/black connector. Audi may have a yellow (A/T blink codes) or blue (not used) connector, and VW may have a red connector for Airbag I systems. It may be possible to hook the white connector of the VW-1 adapter to these other connectors and read codes (without definitions).

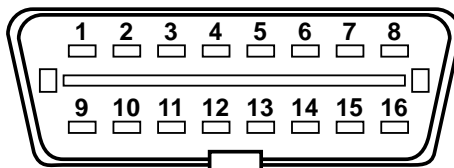

Figure 3-5 16-pin OBD-II connector, requires DL-16 adapter

Refer to Table 3-3 for Volkswagen diagnostic connector locations and to Table 3-4 for Audi diagnostic connector locations.

Follow the on-screen connection instructions to connect to the vehicle.

Table 3-3 Volkswagen diagnostic connector locations (part 1 of 2)

Model	Year	Connector Location
Cabrio	1994–97	On the instrument panel center section, on the right side of the ashtray, behind the cover. To access, remove the ashtray and slide the cover off.
Cabriolet	1991–93 (California only)	Manual transmission: On the center console under the shifter boot. To access, pull firmly to dislodge the boot. Automatic transmission: On the center console under the selector indicator cover. To access, remove the handle from the shifter, and then unsnap the indicator cover. The shifter can also be lifted up and turned without removing the handle.
Corrado	All	Manual transmission: On the center console under the shifter boot. To access, pull firmly to dislodge the boot. Automatic transmission: On the center console under the selector indicator cover. To access, remove the handle from the shifter, and then unsnap the indicator cover. The shifter can also be lifted up and turned without removing the handle.
Eurovan	1992–93	Behind the parcel shelf. To access, release the catch button, pull the shelf out from top, and lift out.
	1994	One of three locations: (1) behind the fold-down storage panel in front of the relay/fuse panel, (2) behind the panel in the dashboard, or (3) under the steering column.
	1995–2003	Under the steering column.
Eurovan Winnebago Camper & Rialta	1995	Behind the parcel shelf. To access, release the catch button, pull the shelf out from top, and lift out.
Fox	1991–93 (California only)	On the center console under the shifter boot. To access, pull firmly to dislodge the boot.

Table 3-3 Volkswagen diagnostic connector locations (part 2 of 2)

Model	Year	Connector Location
Golf/Jetta/GTI	1990–92	Manual transmission: On the center console under the shifter boot. To access, pull firmly to dislodge the boot. Automatic transmission: On the center console under the selector indicator cover. To access, remove the handle from the shifter, and then unsnap the indicator cover. The shifter can also be lifted up and turned without removing the handle.
	1993	On the instrument panel center section, below the heater controls behind the blank switch covers.
	1994	One of two locations: (1) on the instrument panel center section, below the heater controls behind the blank switch covers, or (2) on the instrument panel center section, on the right side of the ashtray, behind the cover.
	1995–97	On the instrument panel center section, on the right side of the ashtray, behind the cover. To access, remove the ashtray and slide the cover off.
	1998–2004	One of two locations: (1) below the dashboard near the hood release, or (2) on the instrument panel center section, below heater controls behind blank switch covers.
Passat	1993–94	Manual transmission: On the center console under the shifter boot. To access, pull firmly to dislodge the boot. Automatic transmission: On the center console under the selector indicator cover. To access, remove the handle from the shifter, and then unsnap the indicator cover. The shifter can also be lifted up and turned without removing the handle.
	1995–97	On the instrument panel, on the right side of the steering wheel, behind the cover.
	1998–2005	One of two locations: (1) below the dashboard near the hood release, or (2) between the front seats near the parking brake under a rubber cover.
New Jetta	2004-2005	Connector located near bonnet release handle.
Touareg	2004-2005	Connector located near bonnet release handle, behind cover.
Phaeton	2004-2005	Connector located near bonnet release handle.
New Beetle	1998-2005	Connector located near bonnet release handle.

Table 3-4 Audi diagnostic connector locations (part 1 of 2)

Model	Year	Connector Location
100/A6	1992–97	One of two locations: (1) in the fuse box under the hood near the firewall, or (2) between the front seats near the parking brake under a rubber cover.
200/V8	1990–94	One of three locations: (1) under the carpet in the passenger side footwell (2) in the fuse box under the hood near the firewall (3) between the front seats near the parking brake under a rubber cover.

Table 3-4 Audi diagnostic connector locations (part 2 of 2)

Model	Year	Connector Location
90	1993–95	In the fuse box under the hood near the firewall.
A3	1997–2003	Under the dashboard.
A4	1996–2001	One of two locations: (1) under the dashboard, or (2) under the sliding cover in the rear ashtray.
	2002–05	Under the dashboard.
A6/Allroad/S6/RS6	1998–2005	One of two locations: (1) under the dashboard, or (2) between the front seats near the parking brake under rubber cover.
A8	1997–2005	Under the dashboard.
Cabriolet	1994–1999	One of three locations: (1) in the fuse box under the hood near the firewall, or (2) under the sliding cover in the rear ashtray, or (3) under the dashboard.
	2004–2005	Connector located near bonnet release handle.
S3	1999–2003	Under the dashboard.
S4/S6	1992–95	One of two locations: (1) in the fuse box under the hood near the firewall, or (2) between the front seats near the parking brake under a rubber cover.
S4/RS4	2000–02	One of two locations: (1) under the dashboard, or (2) under the sliding cover in the rear ashtray.
	2003	Under the dashboard.
S8	2001–02	Under the dashboard.
TT	2000–03	Under the dashboard.

Note the following when connecting to VW/Audi vehicles:

- “Bonnet” is European for hood.
- *Do not* assume that the scan tool ID screen is correct if the scan tool communicates. If there are multiple selections, the scan tool will automatically identify the electronic control module, which means that scan tool communication does not depend on a correct engine ID code selection.

3.3 Selecting a System

Once you have confirmed a vehicle identification and connected to a vehicle (see previous sections), the Select System menu displays.

The items that appear on this menu vary depending on the vehicle you are testing, however, not all of the systems will be present—some of them are optional and others are mutually exclusive. For example, when an integrated immobilizer is present, there will be no separate immobilizer available.

**NOTE:**

Some early control modules may require an engine speed below 2000 RPM and a closed throttle (closed CTP switch) to initialize communication. However, once communication has initialized, higher engine speeds have no effect.

The following systems can be selected for VW/Audi vehicles:

- Engine Management
- Electronic Instrument Panel
- Abs/eds/esp/tcs
- Airbag/pretensioners
- Airbag USA Golf-cabrio
- Air-conditioning
- Alarm System Interior
- Audio System
- Automatic Transmission
- Central Door Lock System
- Immobilizer (Separated)
- Immobilizer (If Not Separated)
- Steering Wheel Electronics
- Steering Help (Separated)
- Steering Help (If Not Separated)
- 4wd Electronics
- Comfort Systems
- Seat Adjustment Driver's Side
- Seat & Mirror Adjusting
- Central Electronic Unit
- Can Bus Interface
- Add. Heater/parking Heater
- Electronic Level Control
- Level Control Xenon Lights
- Tire Pressure Monitoring
- Parking Help
- Radio
- Navigation Systems
- Electronic Roof Control
- Distance Control
- Suspension Electronics
- Back Spoiler
- Emergency Control
- Speech Control
- Light Control Left
- Light Control Right
- Auto Light Switch

Note the following when selecting a VW/Audi system for testing:

- If a system is listed on the Select System menu, that does not mean it is installed on the vehicle. To determine the installed systems, perform an Automatic System Test in Expert Mode (see "00-Automatic System Test" on page 20).

- “Separated” means a standalone control module. “Not Separated” means that the system is integrated with another control module.
- The 25-Immobilizer (Separated) and 44-Steering Help (Separated) systems can give the following ECU identification: “Bitte Adresse 17 eingeben”. This means that the selected system is integrated in the instrument panel and that you need to select 17-Electronic Instrument Panel for diagnostics. Although it is possible to continue and select the functions, the information retrieved is not valid.
- The numbers that precede each system selection (for example, “01” in front of “Engine Management”) are for use with the manufacturer scan tool only. These numbers are not used for Snap-on® scan tool operations.



To select a system for testing:

1. Select the system you would like to test.
An instructions screen displays.
2. Follow the on-screen instructions to continue.
The Connection In Progress screen displays while the scan tool attempts to communicate with the vehicle.
3. When the scan tool communicates with the vehicle, accept the defaults until the Main Menu displays.

3.4 Demonstration Programs

The Volkswagen/Audi software contains programs that demonstrate test capabilities without connecting to a vehicle. The demonstration program can help you become familiar with scan tool menus and operations by providing mock data and test results for a sample vehicle ID.

The demonstration program is accessed at the vehicle identification phase of scan tool operations.



To access a demonstration:

1. Select **Demonstration US**.
A screen displays, prompting you to identify a vehicle with “Demo” on line 1.
2. Select the defaults until the System Selection menu displays.
You are now in demonstration mode.

In addition to providing the same capability as standard or vehicle ID mode, Expert Mode has enhanced factory tool capabilities, giving the user special functions, such as setting adaptations and control module coding. Scan tool display screens in Expert Mode give no information about the specific procedures nor how to perform these special functions. Aftermarket information is limited in performing these functions. Expert Mode should only be used if the user is experienced in Volkswagen or Audi diagnostics and has the required information.

IMPORTANT:

It is possible to change and clear system settings with this function. Some functions can be disabled and/or the control module could be corrupted by incorrect use!

IMPORTANT:

Expert Mode functionality in this manual describes only the basic operation of some of the capabilities. Factory procedures for specific vehicles and systems must be followed to prevent any damage or inadvertent change in critical driveability, security and safety settings. For example, adaptation functions can disable or enable airbags, a major liability to a shop should there be a future accident with this vehicle.

4.1 Using Expert Mode

This section explains how to start using Expert Mode. The following is an outline of scan tool Expert Mode operation, starting with identifying the vehicle. Step 2 is described in “Chapter 3 Operations” on page 4.

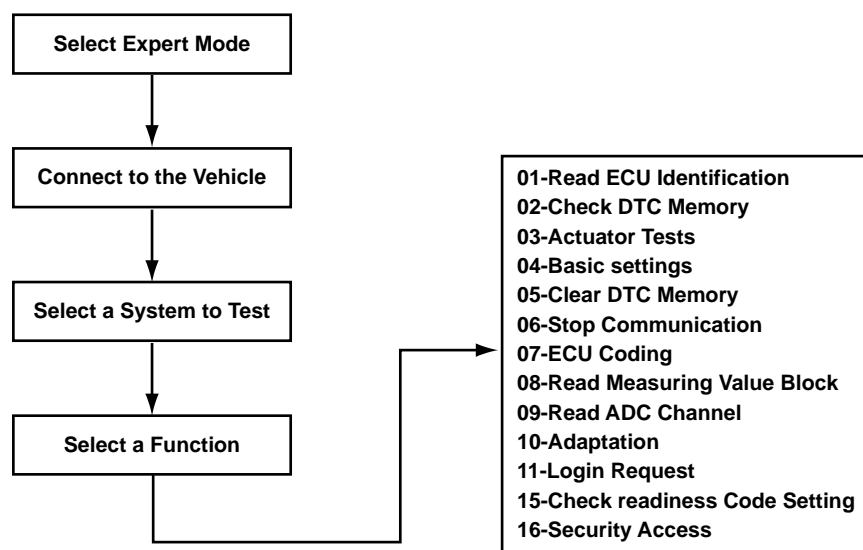

Figure 4-1 Expert Mode basic operations

The remaining steps are described in greater detail in this chapter.

1. **Select Expert Mode**—Instead of selecting Vehicle Systems US as you would for standard scan tool operations, select Expert Mode. See “Initiating Expert Mode” on page 19.
2. **Connect the scan tool**—Follow the connection instructions displayed after selecting Expert Mode to connect the scan tool with the vehicle. See “Connecting to a Vehicle” on page 11.
3. **Select the system**—Enter the system to be tested (engine, transmission, ABS, etc.). See “Selecting a System” on page 19.
4. **Select the Expert Mode function**—The scan tool displays the functions available on the identified vehicle electronic control module. Select the appropriate functions for the vehicle you have identified. See “Expert Mode Function Selection Menu” on page 20.

4.1.1 Initiating Expert Mode

After you have selected a manufacturer, you can initiate Expert Mode.



To initiate Expert Mode:

1. Select **Expert Mode**.
A warning screen displays.
2. **Select** to continue.
Instructions to connect the scan tool to the vehicle display.
See “Connecting to a Vehicle” on page 11 for information about connecting the scan tool to VW/Audi diagnostic connectors, or ID the vehicle in standard mode (see “Identifying the Vehicle” on page 4) until model-specific connection instructions display.
3. Connect to the correct diagnostic connector on the vehicle, then continue.
The System Selection menu displays.

4.1.2 Selecting a System

There are two special items on the Expert Mode System Selection menu that do not display on the standard System Selection menu:

- 00-Automatic System Test
- 01-Engine Management Master (11-Engine Management Slave is not used for US vehicles)

The rest of the items on the menu are the same as in standard mode (“Selecting a System” on page 15).



To select a system for testing:

1. Select the system you would like to test.
The communication instruction screen displays.



NOTE:

Selecting 00-Automatic System Test displays a different screen (see 00-Automatic System Test).

2. Select to continue.
A warning message displays.

3. Select to continue.
The scan tool displays the vehicle's electronic control module identification.
4. Select to go to the Expert Mode Function Selection menu (see "Expert Mode Function Selection Menu" on page 20).

00-Automatic System Test

The Automatic System Test is always the first menu choice in Expert Mode. This selection interrogates all installed controllers and automatically prints out all control module IDs and any DTCs stored there.



NOTE:

A printer must be connected for an Automatic System Test to run.

This test may take ten minutes or longer depending on the number of control modules. DTCs may be set in multiple controllers, therefore, all control modules need to be checked for DTCs and have DTCs cleared after repairs. Automatic System Test is a good way to know which controllers are installed on the vehicle and to obtain DTC information.

**To perform an Automatic System Test:**

1. Select 00-Automatic System Test from the System Selection menu. A screen displays, prompting you to select **Y** to begin the test or **N** to return to the previous menu.
2. Select to begin the Automatic System Test. The Printing in progress screen displays.

The scan tool prints the result when the test is finished.

4.1.3 Expert Mode Function Selection Menu

When the scan tool has established a connection with the vehicle, the scan tool displays a Function Selection menu, such as the Expert Mode Function Selection menu.

The Expert Mode Function Selection menu allows you to select from the following general functions:

- **01-Read ECU Identification**—displays the control module identification string, the control module coding, and Work Shop Code (see page 21).
- **02-Check DTC Memory**—displays all current diagnostic trouble codes present (see page 22).
- **03-Actuator Tests**—activates different actuator tests for about 30 seconds in sequence (see page 22).
- **04-Basic Setting**—performs a Basic Setting, depending on the entered block number (000-255) (see page 22).
- **05-Clear DTC Memory**—clears any existing trouble codes and checks if the trouble codes are really cleared (see page 22).
- **06-Stop Communication**—stops the communication and exits Expert Mode (see page 22).
- **07-ECU Coding**—changes the existing control module coding by entering a new coding (see page 23).

- **08-Read Measuring Value Block**—displays measuring value blocks after entering a valid block number (see page 23).
- **09-Read ADC Channel**—displays data from a single ADC channel (see page 27).
- **10-Adaptation**—changes adaptation values from the control module (see page 27).
- **11-Login Request**—performs a login request to the control module after entering a valid login code (see page 28).
- **15-Check Readiness Code Setting**—displays a readiness code and whether it is set or not (see page 28).
- **16-Security Access**— performs a security access request to the control module (see page 29).

Note the following when using Expert Mode:

- There is no Custom Setup available in Expert Mode (for example, you cannot change the temperature readings from Celsius to Fahrenheit).
- There are no Movie or Print Frame options, only Print Screen and Print Codes. Printer communication settings must be configured in standard mode using vehicle ID or in Demonstration mode to have the possibility to print. Expert Mode also will not work with Snap-link™ or ScanGrafix PC graphing programs.
- When using Expert Mode, supplemental information found in VAG service manuals is necessary to interpret displayed data values and to know the proper procedure to perform a specific test, coding, or adaptation.

01-Read ECU Information

This function displays the control module identification string, the control module coding, and Work Shop Code. Also, some systems will display some extra control module identification if selected.

VW/Audi part numbers for this controller contain a version number for the controller's internal firmware. Shop number identifies the Work Shop Code stored in the scan tool that last recorded this control module.



NOTE:

Some older control modules are not “codeable” and you may see a Bosch part number or other information in these fields.

The Extra ECU identification fields can store VIN and immobilizer information on some vehicles.

Work Shop Code

World Wide, every VW/Audi dealer is assigned a unique Work Shop Code (WSC). Factory scan tools require a valid WSC to function, and once it has been entered, it cannot be changed. Whenever a control module is coded, or adaptations are performed, the scan tool sends its WSC to the control module and the control module records it. If a factory scan tool was used to perform specific functions, such as disabling an airbag through the WSC, it may be possible to identify which dealer performed this procedure.

**NOTE:**

The Snap-on® VAG software does not change or alter the WSC. It reads the existing WSC and sends it back unchanged after a procedure has been performed.

02-Check DTC Memory

This function displays all diagnostic trouble codes (DTCs) currently present or stored in memory.

03-Actuator Tests

This function activates different actuator tests for about 30 seconds in sequence, or depending on the ECU you may select which available test to run. The user can abort or continue to the next test.

Some tests display a command to the user. For example, if “Press Brake Pedal” displays, the user has to press and hold the brake pedal and then continue. The sequence, number, and type of tests are dictated by the control module.

To perform the actuator tests, the entry conditions must be correct. For the correct entry conditions refer to the VAG system specific workshop manual. On some systems, the actuator tests cannot be restarted until the ignition key is switched off for some time. Alternatively, briefly start and run the engine, shut down, turn the ignition to the run position, then re-initiate the actuator tests.

04-Basic Settings

This function can put a system in basic mode or performs a Basic Setting. This depends on the entered block number (000–255). After entering a valid block number, data values or text can be displayed. There is no description of the data value, only the value and unit is displayed. For interpretation of the values, refer to the VAG system-specific workshop manual. See “Basic Settings” on page 45 for more information.

05-Clear DTC Memory

This function attempts to clear all current and stored DTCs. After clearing, the scan tool rechecks for DTCs, and any that reset from current problems will re-display.

06-Stop Communication

This function stops the communication and leaves the Expert Mode. If the scan tool gets accidentally disconnected, go back to the same controller and then exit properly using 06. This is the equivalent of selecting Other Systems in standard mode.

IMPORTANT:

Always exit out of any one module using 06-Stop Communication before selecting another module. Failure to do so may cause communication problems, corrupt data, or cause a parasitic draw on the battery.

07-ECU Coding

This function can change the existing control module coding by entering a new coding. The range of coding can be 0–127, 0–32767 or 0–1048575. The coding number can tell a control module about the configuration, for example, if cruise control is available or not.

After entering a new coding, it is sent to the control module and the scan tool reports if the new coding is accepted or not. A coding will not be accepted if it is an unknown number or if a control module cannot be coded. However, be aware that a control module usually does accept an incorrect coding number.

Some special codings require an unlocked control module. The control module can be unlocked with a Log-in or Security Access request.

Note the following regarding control module coding:

- The following login information is subject to change and is not guaranteed to work on every application. A common VW login is 01283; a common Audi login is 13861. Specific vehicle logins are found in that vehicle's service manual.
- 2002 vehicles using the new CAN Bus communication network may not require control modules to be version coded, as the version coding information is obtained from the other controllers sharing the CAN Bus. However, if the engine control module is replaced it will need to be adapted to the immobilizer (see "Testing Immobilizer Systems" on page 75).

08-Read Measuring Value Block

This function displays measuring value blocks. After entering a valid block number, data values or text are displayed. There is no description of the data value, only the value and unit is displayed. For interpretation of the values, refer to the VAG system specific workshop manual. Press **N** to enter the print exit menu. Scroll to change the block number. The displayed data is the actual data received from the control module.

VW/Audi Display Group Data

Instead of one long data list, VW and Audi data is organized into display groups (Table 4-1). However, these groups are not determined by a scan tool. Instead, these are manufacturer predetermined groups which change depending on the vehicle and engine. Table 4-1 provides some examples of group categories available on a late model VW and Audi.

Table 4-1 VW/Audi display group categories (part 1 of 2)

Display Group Number	Display Group Category
1–9	General engine activity data
10–19	Ignition
20–29	Knock control
30–39	O2 sensor control system
40–49	Three-way CAT
50–59	Engine speed control
60–69	Throttle drive
70–79	Emissions reduction
80–89	Special function
90–97	Power increase

Table 4-1 VW/Audi display group categories (part 2 of 2)

Display Group Number	Display Group Category
98–100	Compatibility
101–109	Fuel Ignition
110–119	Boost pressure control
120–129	Control unit communication
130–150	Special info

The following sections provide information that give examples of engine data interpretation. Note that data available varies by year, engine, engine code, and management system.

**NOTE:**

The display groups available using vehicle ID may vary from the total number of display groups available in Expert Mode. Display groups in standard vehicle ID mode are preselected based on priority of use. All possible display groups can be viewed using Expert Mode. To view a particular display group in Expert Mode, the specific group number must be manually entered.

The following examples may have additional display groups available in Expert Mode.

Example 1: 2002 VW Jetta Drive-by-Wire, Bosch ME 7.5 Control System

- Group=1, Basic Functions (1)
- Group=2, Basic Functions (2)
- Group=3, Basic Functions (3)
- Group=4, Basic Functions (4)
- Group=5, Operating Mode Engine
- Group=6, Altitude Correction
- Group=10 Ignition
- Group=20, Ignition, Knock Control Cyl 1-4
- Group=22, Ignition, Knock Control Cyl 1+2
- Group=23, Ignition, Knock Control Cyl 3+4
- Group=28, Knock Control
- Group=30, O2 Status
- Group=32, Learn Values O2
- Group=33, O2 Regulation Before Cat
- Group=37, Diagnose O2 Control System
- Group=41, O2 Sensor Heater
- Group=50, Idle Speed Control
- Group=54, Idle Speed Control
- Group=55, Idling Stabilization (1)
- Group=56, Idling Stabilization (2)
- Group=60, Adaptation Epc-system
- Group=61, Epc-system (1)
- Group=62, Epc-system (2)
- Group=99, O2 Loop

Example 2: 2002 Audi TT Drive-by-Wire, Bosch ME 7.1 Control System

- Group=1, Basic Functions (1)
- Group=2, Basic Functions (2)
- Group=4, Basic Functions (3)
- Group=5, Basic Functions (4)
- Group=6, Basic Functions (4)
- Group=10, Ignition
- Group=22, Ignition, Knock Control Cyl 1+2
- Group=23, Ignition, Knock Control Cyl 3+4
- Group=28, Diagnose Knock Sensors
- Group=30, O2 Status
- Group=32, Learn Values O2
- Group=33, O2 Regulation
- Group=41, O2 Sensor Heater
- Group=50, Idle Speed Control
- Group=54, Idle Speed Control
- Group=55, Idling Stabilization
- Group=56, Idling Stabilization
- Group=60, Adaptation Epc-system
- Group=60, Throttle Valve Adjuster
- Group=61, Throttle Valve Adjuster
- Group=62, Epc-system
- Group=63, Kickdown Function
- Group=66, Cruise Control Status
- Group=99, O2 Loop
- Group=113, Control Turbo Pressure
- Group=114, Control Turbo Pressure
- Group=115, Control Turbo Pressure
- Group=117, Control Turbo Pressure
- Group=118, Control Turbo Pressure
- Group=120, Tcs System
- Group=125, Can Bus Communication

Example 3: Motronic 2.9 (1993–1995)

Display group 000 has 10 channels or display fields, listed below.

1. Coolant temperature
2. Engine load
3. RPM
4. O2 factor
5. Idle Adapt
6. Part throttle adapt
7. Low load adapt

8. IAC adapt
9. Not used
10. IGN timing

The display fields are output in binary numbers. To understand the binary number, visualize a clock with 0 at the top center. The number 128 is at the center bottom. The binary clock counts from 0 to 255, a rich/lean correction from base midpoint (0).

In binary output 0–255, based on O2S output, numbers fluctuate between rich (high numbers) and lean (low numbers).

The number can theoretically range from 0 to 255 with 0 as the midpoint. A number of 13 to 128 indicates that the control module has commanded an overall lean mixture correction. A number of 128 to 243 indicates that the control module has commanded an overall rich mixture correction.

Example 4: Late Model Motronic 7.5

The following example concerns display group 000 for 1-bank systems:

1. Engine coolant temperature
2. Load
3. RPM
4. Voltage
5. Throttle valve potentiometer
6. Idle air control valve
7. Idle air control valve learning value
8. Lambda control
9. Lambda control learning value idle
10. Lambda control learning value partial load

Display group 000 for 2-bank systems:

1. Engine coolant temperature
2. Load
3. RPM
4. Throttle valve angle
5. Idle air control
6. Idle air control valve learning value
7. Lambda control Bank 1
8. Lambda control Bank 2
9. Lambda adaptation (add) Bank 1
10. Lambda adaptation (add) Bank 2

Example 5: Central Electronic Unit (09)

The four display fields for display group 012 indicate the following:

- **Display field 1: Check bus**—This field indicates whether the data bus is OK or faulty (e.g. fault in single wire).

- **Display field 2: Equipment front**—This field indicates which front control units are fitted and participate in data transfer.
- **Display field 3: Equipment rear**—This field indicates which rear control units are fitted and participate in data transfer.
- **Display field 4: Accessories**—This field indicates whether the seat and mirror adjustment memory system is fitted. Both systems (convenience system and memory system) interchange data.

**NOTE:**

Inter-module CAN data transfer currently cannot be checked.

09-Read ADC Channel (Except KW2000¹)

This function displays data from a single ADC channel. This function allows you to look at real-time data from control modules that support it. Currently, this data has no interpretation or scaling information.

**To set the Read ADC Channel function:**

1. Enter a valid channel number
A number from 0 to 65535 displays.
2. Scroll to change the channel number.

10-Adaptation

This function can change adaptation values from the control module and allows you to alter certain values and/or settings in control modules which support it.

IMPORTANT:

Function 10 changes baseline settings. Do not proceed with this function unless you know the exact procedure. Be aware that some Channels may not be documented.

Examples of things you can do with the adaptation selection:

- Alter the Idle Speed (e.g., 01-Engine Management > 10-Adaptation > 000/0001).
- Change the Service Intervals and resetting the Service Reminder Indicators (newer instrument clusters).
- Disable/enable various components of the airbag (SRS) system.
- Change the sensitivity of the Interior Monitor (Sonar Scan) component of the alarm system in many newer Audi models.
- Swap control modules and rematch keys (newer immobilizer-equipped cars).
- Select certain Central Locking options in newer vehicles.

¹ "KW2000" stands for Key Word 2000, and refers to a communication protocol which was used beginning in 2002 on limited vehicles, such as the VW Passat 1.8L turbo, the Audi A4 1.8L and 3.0L, and the Audi A6 3.0L.

To change adaptation values:

1. Read the adaptation.
2. Test the adaptation.
3. Save the adaptation.

To set an adaptation:

1. Select a valid channel.
The actual adaptation value is displayed. On some adaptation channels, there will be data displayed on the last line.
2. Scroll for manual input.
The new adaptation value can be tested or changed. For example, the engine speed is raised to numbers greater than 128 or lowered to numbers less than 128.
3. To exit and store a new value, select to confirm or abort.
Selecting channel 000 clears all adaptation values after confirming the request.

11-Login Request (Except KW2000)

This function performs a login request to the control module. After entering a valid login code, the control module is ready to perform a special coding or adaptation function.

Used on some (mostly 1996 and later) control modules, Login Request is necessary before you can recode or change adaptation values. On others, it “enables” certain features like cruise control. Valid login codes can be found in the workshop manual for the car.

The following login information is subject to change and is not guaranteed to work on every application:

- A common VW login is 01283
- A common Audi login is 13861

**NOTE:**

You get only one chance to enter the correct login number. If you enter the wrong number, turn off the ignition and wait 10 seconds before another attempt.

11-ECU Coding 2 (KW2000 Only)

This function can change the special control module coding by entering a new valid coding.

15-Check Readiness Code Setting (Except KW2000)

If the system has a readiness code, this function displays that readiness code and whether it is set or not. If the system has no special readiness block, sometimes the same information can be found in function 08 by selecting group 86 and checking Channel 1.

16-Security Access (KW2000 Only)

This function performs a security access request to the control module. After entering a valid code, the control module is ready to perform a special coding or adaptation function.

Note the following when using 16-Security Access:

- The Snap-on scan tool currently performs only 5-digit security codes.
- Some early systems cannot communicate if the engine is running.
- Some early systems cannot communicate or communication is lost if engine or vehicle speed exceeds a certain specification. Refer to the VAG system-specific manual for details.

4.2 Testing in Expert Mode

The functions available depend on the communication protocol. Functions that can be executed depend on the system and entry conditions. Some functions need a login or security access before executing the particular function. Not all systems support all functions.



NOTE:

The 25-Immobilizer (Separated) and 44-Steering Help (Separated) systems give the following control module identification: Bitte Adresse 17 eingeben. Although it is possible to continue and select the functions, the information retrieved is not valid and should be discarded. The selected system is integrated in the instrument panel. Please select 17-Electronic Instrument Panel for diagnostics.

For more testing information, see "Chapter 5 Testing" on page 30.

This chapter provides information and procedures for using the scan tool with specific control systems. Control systems discussed in this chapter are:

- **Testing Engine Systems**, on page 32
- **Testing Transmission Systems**, on page 53
- **Testing Electronic Throttle Systems**, on page 67
- **Testing ABS Systems**, on page 72
- **Testing Immobilizer Systems**, on page 75
- **Testing Electronic Instrument Panel Systems**, on page 83
- **Testing Airbag (SRS) Systems**, on page 88
- **Testing CAN Data Bus Systems**, on page 89

5.1 VW/Audi Software Application List

Table 5-1 provides VW/Audi systems covered by the scan tool.

Table 5-1 VW/Audi software application list (part 1 of 2)

Control Systems	Codes	Data	Advanced Functions
ABS/EDL/ESP/TCS	Standard & Expert Mode		Expert Mode Only
Add. Heater/Parking heater	Standard & Expert Mode	Expert Mode Only	Expert Mode Only
Airbag/Pretensioners	Standard & Expert Mode	Expert Mode Only	Expert Mode Only
Air-conditioning	Standard & Expert Mode	Expert Mode Only	Expert Mode Only
Alarm System Interior	Standard & Expert Mode	Expert Mode Only	Expert Mode Only
Anti-slip Control	Standard & Expert Mode	Expert Mode Only	Expert Mode Only
Audio System	Standard & Expert Mode	Expert Mode Only	Expert Mode Only
Auto Light Switch	Standard & Expert Mode	Expert Mode Only	Expert Mode Only
Automatic Transmission	Standard & Expert Mode		
Back Spoiler	Standard & Expert Mode	Expert Mode Only	Expert Mode Only
CAN Bus Interface	Standard & Expert Mode	Expert Mode Only	Expert Mode Only
Central Door Lock	Standard & Expert Mode	Expert Mode Only	Expert Mode Only
Central Electronic Unit	Standard & Expert Mode	Expert Mode Only	Expert Mode Only

Table 5-1 VW/Audi software application list (part 2 of 2)

Control Systems	Codes	Data	Advanced Functions
Clutch Electronics	Standard & Expert Mode	Expert Mode Only	Expert Mode Only
Comfort Systems	Standard & Expert Mode	Expert Mode Only	Expert Mode Only
Distance Control	Standard & Expert Mode	Expert Mode Only	Expert Mode Only
Electronic Instrument Panel	Standard & Expert Mode	Expert Mode Only	Standard & Expert Mode
Electronic Level Control	Standard & Expert Mode	Expert Mode Only	Expert Mode Only
Electronic Roof Control	Standard & Expert Mode	Expert Mode Only	Expert Mode Only
Emergency Unit	Standard & Expert Mode	Expert Mode Only	Expert Mode Only
Engine Management	Standard & Expert Mode		
Immobilizer	Standard & Expert Mode	Expert Mode Only	Expert Mode Only
Level Control Xenon Lights	Standard & Expert Mode	Expert Mode Only	Expert Mode Only
Light Control Left	Standard & Expert Mode	Expert Mode Only	Expert Mode Only
Light Control Right	Standard & Expert Mode	Expert Mode Only	Expert Mode Only
Navigation	Standard & Expert Mode	Expert Mode Only	Expert Mode Only
Parking Help	Standard & Expert Mode	Expert Mode Only	Expert Mode Only
Radio	Standard & Expert Mode	Expert Mode Only	Expert Mode Only
Seat Adjustment Driver Side	Standard & Expert Mode	Expert Mode Only	Expert Mode Only
Seat and Mirror Adjustment	Standard & Expert Mode	Expert Mode Only	Expert Mode Only
Speech Control	Standard & Expert Mode	Expert Mode Only	Expert Mode Only
Steering Help	Standard & Expert Mode	Expert Mode Only	Expert Mode Only
Steering Wheel Electronics	Standard & Expert Mode	Expert Mode Only	Expert Mode Only
Suspension Electronics	Standard & Expert Mode	Expert Mode Only	Expert Mode Only
Tire Pressure Monitoring	Standard & Expert Mode	Expert Mode Only	Expert Mode Only
4WD Electronics	Standard & Expert Mode	Expert Mode Only	Expert Mode Only

5.2 Testing Engine Systems

The following sections contain scan tool testing information for engine systems. Testing Engine Systems first lists the VW/Audi engines that communicate with the scan tool, and continues to provide procedures and tips for certain testing functions.

5.2.1 VW/Audi Application Coverage

The following sections contain US vehicle coverage for 1991–2005 VW and Audi.

Table 5-2 VW/Audi application coverage

Volkswagen	Audi
CIS-E or K-Jetronic/CIS (1990–92)	CIS-E or K-Jetronic/CIS (1990–92)
Digifant 1 (CA only) (1991–93)	MPI (1990–95)
Motronic M2.9 (1993–95)	Motronic M2.3 (1991–94)
Motronic M5.9 (1995–2000)	Motronic M2.3.2 (1993–95)
Motronic M5.9.2 (1997–2005)	Motronic M2.4 (1990–94)
Motronic M7.0 (1999–2001)	Motronic M2.9 (1993–95)
Motronic M7.1 (2000–01)	Motronic M5.4.2 (1995–96)
Motronic M7.1.1 (2002–05)	Motronic M5.9 (1996–98)
Motronic M7.5 (2001–05)	Motronic M5.9.2 (1998–2000)
Motronic M7.5.1 (2002)	Motronic ME7.1 (2000–01)
Diesel TDI (1996–2003)	Motronic ME7.5.1 (2002–03)

US Volkswagen Application Coverage

Table 5-3 provides application coverage for US Volkswagen engines.

Table 5-3 US VW application coverage (part 1 of 4)

Model	Year	Volume	Engine Code	Engine Info	Supported	Notes
Cabriolet (15)	1990–92	1.8	2H		YES	CA Only
Cabriolet (1E)	1995–2001	2.0	ABA		YES	
Cabriolet (1V)	2000–02	2.0	ABA		YES	
Corrado (50)	1992–1995	2.8	AAA		YES	
	1991–92	1.8	PG	G60	YES	CA Only
Eurovan (70)	1992–95	2.5	AAF	5L	YES	1992 Canada Only
	1995	2.5	ACU	5L	YES	1995 Only Winnebago/ Rialta
	1997–2000	2.8	AES	VR6	YES	
	2001–04	2.8	AXK	VR6	YES	
Fox (30)	1991–93	1.8	ABG		YES	CA Only

Table 5-3 US VW application coverage (part 2 of 4)

Model	Year	Volume	Engine Code	Engine Info	Supported	Notes	
Golf/Jetta/GTI (1G) MK II	1991–92	2.0	9A	16V	YES		
		1.8	PF		NO		
		1.8	RV		YES	CA Only	
Golf/Jetta/GTI (1H) MK III	1993–99	2.8	AAA	VR6	YES		
		2.0	ABA		YES		
	1993–97	1.8	ACC		YES	Canada Only	
	1998–99	1.9	IZ	TDI	YES		
			AHU	TDI	YES		
Golf/Jetta/GTI (1J) MKIV	1999–2002	2.8	AFP	VR6	YES		
	1999–2001	2.0	AEG		YES		
	1999–2003	1.9	ALH	TDI	YES		
	2000–01	1.8	AWD	Turbo	YES		
	2001–03	2.0	AVH		YES		
			1.8	AWW	Turbo	YES	
	2002	2.8	AFP	VR6	YES		
	2003–05	1.8	AWP	Turbo	YES		
			AZG		YES		
			2.0	BBW	SULEV	YES	
			2.8	BDF	VR6	YES	
	2004–05	1.8	BEK	Turbo	YES		
			BEW	TDI	YES		
		2.0	AZG		YES		
			BEV		YES		
			BER		YES		
		3.2	BJS		YES		
			BML		YES		
	BFM			YES			
	New Beetle (1C)	1999–2000	1.8	APH	Turbo	YES	
2001–05		1.8	AWV	Turbo	YES		
1998–2005		1.9	ALH	TDI	YES		
1998–2002		2.0	AEG		YES		
2000–03		2.0	AVH		YES		
2001–05		2.0	AZG		YES		
2003		2.0	BDC	Convertible	YES		
2004–05		1.8	AWU	Turbo	YES		
			AWP	Turbo	YES		
		1.9	BEW	TDI	YES		
		2.0	AZJ		YES		
	BDC			YES			
BEV			YES				

Table 5-3 US VW application coverage (part 3 of 4)

Model	Year	Volume	Engine Code	Engine Info	Supported	Notes	
New Beetle (1C) (continued)	2004–05	2.0	BER		YES		
			BGD		YES		
			BHP		YES		
	1999–2001	1.8	AWD	Turbo	YES		
	1999–2005	1.9	ALH	TDI	YES		
	1999–2001	2.0	AEG		YES		
	2000–03	2.0	AVH		YES		
			AZG		YES		
	1999–2002	2.8	AFP	VR6	YES		
	2003	2.8	BDF		YES		
2004–05	1.9	BEW	TDI	YES			
New Jetta (9M) MK IV	2005	1.9	BKC	TDI	YES		
			BRM	TDI	YES		
	2000–05	2.0	AVH		YES		
			AZG		YES		
	2004–05	2.0	BBW		YES		
			BER		YES		
			BEV		YES		
	2003-2005	2.8	BHP		YES		
			BDF		YES		
	2005	2.5	BGP		YES		
BGQ				YES			
Passat (31)	1991–93	2.0	9A	16V	YES		
	1993–94	2.8	AAA	VR6	YES		
Passat (3A)	1996–97	1.9	1Z	TDI	YES		
	1995–97	2.8	AAA		YES		
		2.0	ABA		YES		
New Passat (3B)	1998–99	1.8	AEB	Turbo	YES		
	1998–2000	2.8	AHA	V6	YES		
	2000–03	2.8	ATQ	V6	YES		
	1999–2001	1.8	ATW	Turbo with variable valve timing	YES		
	2003	4.0	BDP	W8	YES		
	2004–05		BGW		YES		
			2.0	BHW		YES	
			2.8	AMX		YES	
				BBG		YES	
4.0	BDN		YES				

Table 5-3 US VW application coverage (part 4 of 4)

Model	Year	Volume	Engine Code	Engine Info	Supported	Notes
Phaeton	2004–05	4.2	BGH		YES	
			BGJ		YES	
		6.0	BAN		YES	
			BAP		YES	
Tourag	2004–05	3.2	AZZ		YES	
			BAA		YES	
			BKJ		YES	
		4.2	AXQ		YES	
		5.0	AYH	TDI	YES	
			BKW	TDI	YES	

VW/Audi On-board Diagnostic Availability: 1990–1995 Gas, 1992–2002 Diesel

The VW/Audi software starts VW/Audi US VIN ID in 1991 (US vehicle systems) and only identifies those vehicles with Codes and Data (does not retrieve blink codes). Table 5-4 on page 36 depicts many early year models with some vehicles having scan tool diagnostics depending on Emission certification or country, engine system description, including emission certification and early systems without diagnostic capability.

Starting in 1990, VW and Audi started using digital engine management systems on some models that were sold only in California.

Note the following when determining diagnostic availability:

- Only some of these early systems may have codes and rapid or serial data.
- There are some early blink code only systems not listed in Table 5-4 on page 36.
- For 1991–93, certain engine codes have data on California (CA) models only. Federal vehicles with the same engine code will display a “no communication” message and an additional message stating “Federal Vehicles are not capable of communicating.” Federal Vehicles may have blink codes.
- If the underhood emission label is missing, distinguishing between CA or Federal vehicles may be difficult. Also, Federal vehicles may still have the white/black diagnostic connector (under shifter boot). This connector may not be functional or may be for transmission (4-speed only) or ABS data. Only the 9A Federal emission equipped engine has engine data. To help identify a CA emission engine, check for a functional Malfunction Indicator Lamp (ignition on, engine off) or check for an exhaust gas recirculation (EGR) valve installed on the engine.
- European IDs can be used where the VIN cannot. The following systems can not be identified using US VIN ID. Use the alternate IDs below.
 - For the 1990 Golf/Jetta/GTI/Corrado/Passat using the 2.0L (9A) with CIS-E Motronic, ID as a 1991 Passat or use European ID for 1990 Golf or Jetta.
 - For the 1993–1994 Golf 1.8L (ACC), ID as a 1995 model year or use European ID and select 1993 or 1994 Golf 1.8L ACC.

**NOTE:**

The scan tool vehicle ID provides connector messages and system information but because the control modules are identified automatically, an incorrect VIN or vehicle ID does not stop scan tool communication.

In addition, be aware that Expert Mode can also be used on any vehicle with diagnostic capability and does not require any vehicle ID.

Table 5-4 Early VW engine system coverage (part 1 of 2)

Model	Year	Engine Code	Displacement	Engine Management	Emission Cert. Only	Scan Tool Diagnostics
Cabriolet	1995	ABA	2.0L 4-cyl	Motronic M2.9		YES
	1990–92	2H	1.8L 4-cyl	Digifant	California	YES
Corrado	1992–95	AAA	2.8L (VR6)	Motronic M2.9		YES
	1990–92	PG	1.8L 4-cyl (G60)	Digifant	California	YES
Eurovan	1992–93	AAF	2.5L 5-cyl	Digifant	Canada Only for 1992	YES
		AAB	2.4L 5-cyl	Diesel	Canada	NO
	1995	ACU	2.5L 5-cyl (Winnebago, Rialta)	Digifant	Tier 1	YES
	1995–97	AAB	2.4L 5-cyl	Diesel	Canada	NO
Fox	1990	JN	1.8L 4-cyl	CIS-E (KA Jetronic)		NO
	1991–93	ABG	1.8L 4-cyl	Digifant	California	YES
Federal					NO	
Golf/GTI	1993–97	ACC	1.8L 4-cyl	Mono-Motronic	Canada	YES
	1994–95	AAA	2.8L (VR6)	Motronic M2.9		YES
	1993–95	AAZ	1.9L 4-cyl	Turbo Diesel	Canada	NO
	1990–92	9A	2.0L 4-cyl (16V)	CIS-E Motronic		YES
		PF/RV	1.8L 4-cyl	Digifant		NO
	1991	PF/RV	1.8L 4-cyl	Digifant		NO
	1993–99	RV	1.8L 4-cyl	Digifant	California	YES
ABA		2.0L 4-cyl	Motronic M2.9		YES	
Jetta	1994–95	AAA	2.8L 4-cyl	Motronic M2.9		YES
	1993–95	ABA	2.0L 4-cyl	Motronic M2.9		YES
		AAZ	1.9L 4-cyl	Turbo Diesel	Canada	NO
	1990–92	PF/RV	1.8L 4-cyl	Digifant		NO
		9A	2.0L 4-cyl (16V)	CIS-E Motronic		YES
	1991–92	RV	1.8L 4-cyl	Digifant	California	YES
	1990–91	ME	1.6L 4-cyl	Diesel		NO
MF		1.6L 4-cyl	Turbo Diesel	Canada	NO	
1F		1.6L 4-cyl	ECO Diesel Turbo		NO	

Table 5-4 Early VW engine system coverage (part 2 of 2)

Model	Year	Engine Code	Displacement	Engine Management	Emission Cert. Only	Scan Tool Diagnostics
Passat	1995	ABA	2.0L 4-cyl	Motronic M2.9		YES
	1993–95	AAA	2.8L (VR6)	Motronic M2.9		YES
		AAZ	1.9L 4-cyl	Turbo Diesel	Canada	NO
	1991–94	PG	1.8L 4-cyl (G-60)	Digifant	Canada	NO
	1990–93	9A	2.0L 4-cyl (16V)	CIS-E Motronic		YES
Vanagon	1990–91	MV	2.1L 4-cyl	Digifant		NO

US Audi Application Coverage

Table 5-5 provides early US Audi engines applications.

Table 5-5 US Audi engine system application coverage (part 1 of 3)

Model	Year	Volume	Engine Info	Engine Code	Supported	Notes
100 S4	1986–91	2.2	K-Jetronic	MC Turbo	NO	Manual blink codes
	1986	2.2	KE-Jetronic	KZ	NO	
	1991–95	2.2	Turbo 20V	AAN	YES	
	1986–1990	2.3	KE3-Jetronic	NF/NG	NO	Manual blink codes
	1990–94	2.8	V6 12V	AAH	YES	
	1994	2.8	V6 12V	AFC	YES	
200	1986–91	2.2	K-Jetronic	MC Turbo	NO	Manual blink codes
	1989–90	2.2	20V	3B Turbo	YES	
80	1988–90 (Type 89)	2.0	Motronic	3A	NO	Manual blink codes
	1992–94 (Type B4)	2.3	KE3-Jetronic	NG		
	1988–89 (Type 89)	2.3	20V	7A		
	1992–94 (Type B4)	2.8	V6 12V	AAH	YES	
	1993–94 (Type B4)	2.8	V6 12V	AFC	YES	
90	1987–91	2.3	KE3-Jetronic	NG	NO	Manual blink codes
	1988	2.3	20V	7A		
	1989–93	2.3	20V	7A	YES	
	1992–94 (Type B4)	2.8	V6 12V	AAH	YES	
	1993–95	2.8	V6 12V	AFC	YES	

Table 5-5 US Audi engine system application coverage (part 2 of 3)

Model	Year	Volume	Engine Info	Engine Code	Supported	Notes	
A4/S4	1995–99	1.8	Turbo	AEB	YES		
	2000	1.8	Turbo	ATW	YES		
	1994–97	2.8	V6 12V	AAH	YES		
	1995–97	2.8	V6 12V	AFC	YES		
	1996–97	2.8	V6 30V	AHA	YES		
	2000–01	2.8	V6 30V	ATQ	YES		
	2002–05	3.0	V6 30V	AVK	YES	2003 A4 Cabriolet	
	2002–05	1.8	Turbo	AMB	YES	2003 A4 Cabriolet	
	2001–03	2.7	Turbo V6 30V	APB	YES		
	2004–05	1.8		Turbo	BEX	YES	
				Turbo	BFB	YES	
				Turbo	BKB	YES	
		3.0			ASN	YES	
					BBJ	YES	
					BBK	YES	
4.2			BHF	YES			
A6/S6	1993–95	2.8	V6 12V	AAH	YES		
	1994–96	2.8	V6 12V	AFC	YES		
	1997–99	2.8	V6 30V	AHA	YES		
	2000–01	2.8	V6 30V	ATQ	YES		
	2000	4.2	V8	ART	YES		
	2000–03	2.7	Turbo V6 30V	APB	YES		
	2000–05	3.0	V6 30V	AVK	YES		
		4.2	V8	AWN	YES		
		4.2	V8	BBD	YES		
	2003–05	4.2	V8	BAS	YES		
				BCY	YES		
	2002–05	3.0		ASN	YES		
				BBJ	YES		
	2004–05	2.7		BEL	YES		
				BES	YES		
	2002–03	4.2		ART	YES		
	2004–05	4.2		ANK	YES		
				ASG	YES		

Table 5-5 US Audi engine system application coverage (part 3 of 3)

Model	Year	Volume	Engine Info	Engine Code	Supported	Notes
A8/S8	1997–99	4.2	V8	ABZ	YES	
	1999–2003	4.2	V8	AKB	YES	
	1997–99	3.7	V8	AEW	YES	
	2001–03	4.2	V8	AUX	YES	
	2002–03	4.2	V8	ABZ	YES	
				AYS	YES	
	2004–05	4.2		BFM	YES	
6.0					BHT	YES
All-road Quattro	2000–03	2.7	Turbo V6 30V	APB	YES	
Cabrio	1994–95	2.8	V6 12V	AAH	YES	
	1994–97	2.8	V6 12V	AFC	YES	
Cabriolet	2004–05	1.8	Turbo	AMB	YES	
				BFB	YES	
				BKB	YES	
	3.0	ASN	YES			
		AVK	YES			
		BBJ	YES			
		BEN	YES			
	4.2	BBK	YES			
	BHF	YES				
TT	2000–03	1.8	Turbo	AMU	YES	
	2000–01	1.8	Turbo	ATC	YES	
	2000–03	1.8	Turbo	AWP	YES	
	2003	1.8	Turbo	BEA	YES	
	2004–05	1.8	Turbo	BAM	YES	

Audi Early Model Application 1990–1995

The VW/Audi primary cartridge starts VW/Audi US VIN ID in 1991 (US vehicle systems) and only identifies those vehicles with Codes and Data (does not retrieve blink codes). The models in Table 5-6 on page 40 have diagnostic capability with the scan tool.

Table 5-6 Audi early model application 1990–95

Model	Year	Displacement	Engine Code	Engine Management
200/2000 Quattro Turbo 20V	1991	Turbo 2.2L 20V	3B	M2.3
V8 Quattro	1992–94	V8 4.2L 32V	ABH	M2.4
	1990–91	V8 3.6L 32V	PT	
100/1000 Quattro	1992–94	V6 2.8L 12V	AAH	MPI
S4	1993–94	2.2L	AAN	M2.3
A6				
90/90 Quattro	1993–95	V6 2.8L 12V	AAH	MPI
Cabrio	1994–95			

5.2.2 Clearing Codes

This function attempts to clear all current and stored DTCs. After clearing, the scan tool re-checks for DTCs, and any that reset from current problems will re-display.



To clear DTCs:

1. From any codes display, press N to display the Exit menu.
2. Select **Clear Codes**.
The Initiate Code Clearing screen displays.
3. Select to initiate code clearing.
A code-clearing message displays. This message varies depending on the control module.
4. Select to clear the codes automatically, if applicable for the vehicle under test.
The display indicates that codes are cleared by displaying the No Codes screen.
If the code-clearing operation fails for any reason, the previous codes reappear at the top of the data list when returning to Codes.
5. Exit to return to the Exit menu and repeat the Clear Codes operation if necessary.



To clear multiple DTCs:

1. Record all codes.
2. Clear all codes using the previous procedure.
Codes that re-display are current problems. Fix these first.
3. After repairs, clear codes again.
4. Perform a road test.
5. Re-check for codes.
6. Repair any codes that set.



To test drive a VW or Audi to verify repairs after DTCs are erased:

1. Warm the engine up to normal operating temperature.
2. Allow the engine to idle (1 or 2 minutes).
3. Road test at part throttle.

4. Road test at Wide Open Throttle (attain at least 3500 RPM).
5. Decelerate.
6. Perform all steps several times.

Remember that all modules should be re-checked for codes after the test drive. Use automatic test mode to automatically print out all interrogated modules and codes ("00-Automatic System Test" on page 20).

Important Tips for Codes

- The message on the scan tool states that to clear codes, the engine must be off. Input from field technicians indicates that this is not always necessary.
- Intermittent codes have the message "Error Occurs Intermittent" after the code description (VW calls these codes "sporadic"). Codes are considered intermittent if they occur for a maximum of five seconds. Intermittent codes do not turn the Check Engine Light on. They are automatically erased from memory after 40 drive cycles if they do not occur again. When a malfunction is first detected, it is stored as a static or pending malfunction. If the malfunction no longer exists after a pre-determined time or distance travelled, then it is labelled intermittent.
- Most 1995 and earlier Bosch control modules may show you a false DTC "00513 - Engine Speed Sensor (G28)" if the engine is not running. This fault code should disappear once the engine is started. With a defective sensor, the engine would not start. In addition, many automatic transmission control modules may show a DTC that indicates a faulty brake light switch. This usually can be ignored and usually will not appear if you press the brakes once before checking for fault codes.
- Disconnecting the battery may erase fault codes and basic settings on pre-OBD-II vehicles, which may result in driveability problems. Disconnecting the battery on OBD-II vehicles does not erase stored codes or turn the MIL off. However, intermittent codes and control unit adaptation learned values may be erased in both the engine and transmission.
- Disconnecting the battery may require resetting of convenience electronics such as alarm, interior lights, radio, etc. It is recommended to use a jumper battery or battery charger to maintain power when replacing a battery.
- Readiness Codes need to be reset after codes are cleared or the battery has been disconnected. Throttle body adaptation relearn is essential and may prevent the engine from starting. See "Testing Electronic Throttle Systems" on page 67 for more information.
- Be aware that clearing codes may not change throttle body adaptation status to "not ready" (060 or 098), but throttle body reset is highly recommended to ensure no problems. See the *Volkswagen/Audi OBD-II Readiness Code Charts* for additional information.
- Sometimes a fault code is displayed for a component which is not installed in the vehicle under test (i.e., a cruise control). This code cannot be cleared. Always make sure the component the code refers to is present when a code cannot be cleared.
- Performing activation tests may set false codes. Always check and clear codes after performing activation tests.
- Vehicles with Drive-by-Wire (no throttle cable) cannot be power-braked. The Brake On signal notifies the control module to command the throttle closed and may also set false codes.
- Vehicles with full Drive-by-Wire (no throttle cable), usually have a EPC (Electronic Power Control) indicator light. The EPC light should come on if there is any problem in the Drive-by-Wire system. Faults detected by the EPC set duplicate fault codes in the ECM.
- Electronic Instrument Clusters may store only up to four fault codes. Intermittent fault codes are automatically erased if they do not reoccur in the next 50 engine starts.

- **Diesel Only:** Late model Diesel TDI engines (1996 and newer) may have three different code-setting MILs. All three of the following lamps set codes in the ECM memory.
 - Engine Management Check Engine Lamp
 - Glow Plug Warning Lamp
This lamp has dual functions: the lamp is on when starting a cold engine, which normally indicates that glow plugs are on; blinking lamps indicate malfunctions that affect driveability.
 - Exhaust Warning Lamp
This lamp is switched on with faults that adversely affect emissions (not all exhaust gas faults turn the lamp on; always check for codes regardless of lamp).

5.2.3 Data

A Data selection is available from the Main Menu of most vehicles, but only when “Engine Management” is selected from the System Selection menu (see “Selecting a System” on page 15). Viewing data in standard mode with the scan tool does not affect vehicle operation.

The Data selection displays the following choices:

- **Data Groups** displays data in diagnostic groups to make problem solving easier.
- **Codes & Data** displays all data parameters and codes together but the screen data has a slower refresh rate.
- **Return To Main Menu** takes you back to the Main Menu.

NOTE:

Some late model vehicles may communicate with the scan tool with the ignition switched off, though communication is limited to the ECM, and data values received may be erroneous. Always communicate with the ignition on.

Data Groups

The Data Groups mode first displays a Group Selection screen.

The data group items available will vary from one vehicle to another. For some vehicles, the data groups list may be as short as two groups, or it may be as long as 25 groups.

NOTE:

It is possible to read any display group like the factory tool by selecting Readiness Code from the Functional Tests menu or by selecting Expert Mode > 08-Read Measuring Value Block and entering the display group. Data is displayed in a four-channel format, like the factory tool.

**To display data groups:**

1. Select any specific group.

A Data Group screen displays.

When the scan tool first enters the group, it displays the group title and three lines of data.

Scroll down and the scan tool displays the rest of the group data, until End Of Group displays.

2. Scroll past the last line and the scan tool attempts to communicate with the next group in the list and displays the Requesting Data Group screen.
3. After communication has been reestablished, the next group for that vehicle displays. In this way it is possible to scroll through all the data groups, scrolling in the opposite direction moves through the groups in reverse order.

Codes & Data

Selecting Codes & Data displays codes and data together.



NOTE:

The data in the Codes & Data display are preselected from the individual display groups. It is important to note that except for a few early models (with only one display group 000) the preselected "codes and data" represents a limited list that may not include all possible display groups. There may be more display groups available in Expert Mode than in standard mode. Check Expert Mode for any missing display groups.

Reading Codes & Data or individual display group data (Measuring Value Blocks 08) can be used for testing as the engine operates normally. The scan tool does not affect the control module when reading data (08). This is not true for 04-Basic Settings (see page 22).

5.2.4 Functional Tests

The Functional Tests menu gives you the ability to activate components of the engine management system.

Initiate Actuator Tests

Which actuators can be activated depends on the control module under test and the vehicle itself. Actuators can include the following:

- Fuel pump relay
- EVAP canister purge valve
- Injector valves (odd and even cylinders)
- Oxygen sensor (O2S) heater relay

IMPORTANT:

The Fuel Pump will run continuously while the Actuator tests are in progress.

The scan tool commands the control module to activate a component, but it does not check whether the component is actually operating correctly.

In most cases, the effect can be clearly heard: a relay clicks or a pump runs. Be aware, actuators can be mounted anywhere within the vehicle, (i.e., under the dashboard, under the hood, and even in the trunk). If no reaction can be heard at all, measure the actuator with an oscilloscope or a multimeter. This indicates whether the control module is controlling the component properly.

When Initiate Actuator Tests is selected, the scan tool sequentially activates each of the actuators for 30 seconds. For example, running actuator tests on a 2002 W8 Passat would activate the following actuators in the following sequence:

1. TANK Vent Valve
2. Secondary Air Control
3. Secondary Air Pump
4. Bank 1 Camshaft Adjustment
5. Evaporative Emission Control System L.D.P.
6. Valve Engine Mounting
7. Bank 2 Camshaft Adjustment
8. Exhaust Cam Timing Valve B1
9. Exhaust Cam Timing Valve B2
10. Control Vacuum Pump Brake
11. Cooling Fan High Speed
12. Cooling Fan Low Speed
13. Cooling Fan Low Speed Deactivated
14. Relay Additional Coolant Pump
15. Injector 1 Activated
16. Injector 1 Deactivated
17. Injector 2 Activated
18. Injector 2 Deactivated
19. Injector 3 Activated
20. Injector 3 Deactivated
21. Injector 4 Activated
22. Injector 4 Deactivated
23. Injector 5 Activated
24. Injector 5 Deactivated
25. Injector 6 Activated
26. Injector 6 Deactivated
27. Injector 7 Activated
28. Injector 7 Deactivated
29. Injector 8 Activated
30. Injector 8 Deactivated

Before the actuator tests can be re-initiated, the vehicle ignition must be turned off. Then, start the engine, turn the engine off, then turn the ignition switch on again. If the actuator tests are re-initialized without the ignition being cycled, the Actuator Test Not Possible screen displays.



To run actuator tests:

1. Select **Initiate Actuator Tests** from the Functional Tests menu.
A warning message displays.
2. Select to continue.

The scan tool proceeds directly to the first actuator test available for the current vehicle ID. This test automatically activates all the actuators applicable to the vehicle for approximately 30 seconds each. The current test displays on-screen.

Important Tips for VW/Audi Engine Actuator Tests

- The Output Test Function is only available when the engine is not running.
- Exiting and reselecting actuator tests will not re-initiate actuator tests on some engines. It is not recommended to interrupt the test sequence once it has been started. Exiting while an output is activated causes a "Close Controller" command to be issued. If exiting and reselecting the actuator test does not work, turn the key off for 10 seconds, then start the engine, then shut the engine off. Turn the ignition on, then reselect Initiate Actuator Tests from the Functional Test menu. Most control modules will permit the Output Test Sequence to be run only one time per session. Therefore, each new session will usually require an ignition reset and engine start. Verify that the component is present on the vehicle you are testing.
- Have the engine running only when instructed to do so by the scan tool and always follow the instructions displayed on the scan tool.
- With some engines, it is very difficult to hear the injectors click. Use a multimeter, scope, or stethoscope to make sure the injectors are activated properly (if injectors can be reached, it is sometimes possible to feel the injectors working).
- The sequence in which the tests are performed and the availability of the tests are controlled by the control module under test. Output tests available are not determined by the scan tool.
- On some engines, before the actuator test can be re-initiated, the engine has to run at least 30 seconds prior to the test.
- Some automatic transmission systems do not have actuator tests. If Initiate Actuator Tests is selected one of these systems, an Actuator Test Not Possible message displays.
- Some outputs require additional action before they become active. Fuel injectors are a common example. To activate a fuel injector, you must press (and in some cases release) the accelerator pedal.

⚠ WARNING

Risk of erratic vehicle response.

- **Do not use the Output Tests function on any system while the car is in motion.**
Erratic vehicle response can cause serious injury.

Review ECU ID

This menu item displays the identification data of the control module under test. The data displayed may be required when ordering replacement components for the vehicle.

Supplemental control module information may be available, if so, it can consist of the VIN number, module numbers for additional control units, or other information sent by the control module.

The Review ECU ID screen should display when selected, follow screen instructions.

Basic Settings

Basic Settings has different functions depending on the year, make, and model. Generally, it involves invoking a specific control module to run in a special mode of operation that either sets

the conditions to perform an adjustment or internally run a test. When in Basic Settings, the user may be required to:

- Command the scan tool by entering the correct numbers and making the correct on-screen selections.
- Create the correct vehicle conditions for a diagnostic test to run.
- Operate the vehicle for Accelerated Adaptive Learning.
- Perform an adjustment procedure.



NOTE:

Basic Setting mode is also used to run system or subsystem Readiness Codes, which verify repair work (see Readiness Code supplement for more information).

You can select BASIC SETTING from three different menu choices on the scan tool:

- **Functional Test menu > Basic Settings**—This Basic Setting selection will only have one or two preselected tests with help screens.
This selection for Basic Settings is different from the “Expert Mode” Basic Settings. This selection will list only one or two important procedures with help screens to guide you through the process. Note that in “Expert mode” neither Basic Settings nor any other selection have any help screens available.
- **Functional Test menu > Readiness Code > 04-Basic Setting**—This Readiness Code mini Expert Mode has some but not all of the functions available under the main Expert Mode.
- **Expert Mode > 01-Engine Management Master > 04-Basic Setting**—Viewing data in Basic Settings (04) is very similar to viewing data in display group mode (08, Measuring Value Blocks). The display group numbers and the specific data displayed are the same, however, the difference is that in Basic Settings the Control Module performs various calibrations or activates certain tests which should be reflected in the readings.

Engine Management Functional Test Menu

The following Basic Settings can be selected if available:

- **Throttle Valve Adjuster/Idling Control/Adaptation EPC-System (Electronic Throttle Body Adaptation).** In this Basic Setting, the control module relearns the throttle position using an automatic procedure. See “Testing Electronic Throttle Systems” on page 67.



NOTE:

If possible, the factory procedure recommends performing this test with the engine cold.

- **Kickdown Function.** In this Basic Setting, the control module relearns the kickdown position for the automatic transmission. The procedure must be followed exactly. Hold the throttle for 3 seconds, by pressing down the throttle fully to the floor, then release (make sure you feel the kickdown switch engage).
 - Always check for kickdown selection in the Engine Functional Test menu, as kickdown adaptation is not always included in the Readiness Code Charts.
 - Kickdown may also be selected in Expert Mode. In engine or transmission, select basic settings 04/000. Remember that in Expert mode there are no help screens. Once in Basic Settings, depress the throttle to the floor for three seconds, then release. Press **N** to exit. New kickdown learn settings should be set (no feedback on-screen).

On some models, kickdown relearn may not set properly using Basic Settings in the transmission controller. There is no way to verify that the kickdown reset test has been completed by looking at the transmission data. A test drive before and after may verify that the test was completed. Alternately, select engine management data and select display group 063. If kickdown adaptation status reports an error, go back and select Basic Settings in the Engine Management Functional Tests menu, then select kickdown as stated above.

- **Ignition Timing.** While in Basic Settings mode the ignition timing is fixed; the control module will not attempt to compensate for any variation in ignition timing or idle speed. After any adjustments, cancel to return engine control to the control module.
- **Start of Delivery (Diesel Engines).** In this Basic Setting, the engine is set in a mode so the start of delivery can be checked or manually adjusted. The actual value as well as the minimum and maximum values are displayed (values displayed depend on temperature).

Basic Setting Screen

With most Basic Settings, data displays with the required instructions.

Always end the Basic Setting session by selecting Other Systems to be sure that the settings are stored. Turn the ignition key off and wait 60 seconds, to ensure that adaptation has occurred.

IMPORTANT:

You should refer to the Service Manual for a specific vehicle and engine before attempting to use the Basic Settings function. Using an incorrect procedure can have negative consequences.

In Basic Settings, certain functions are disabled or stabilized to avoid learning interference and to allow specific tests to run or adaptive learning to happen. Learning usually starts 20 seconds after the initiation of Basic Settings if the engine is at normal operating temperature. Exactly what Basic Setting controls varies by year, vehicle and engine.

Example 1: 1993–1995 engine code AAA or ABA

1. Stabilizes ignition
2. Stabilizes Idle Speed
3. Disables the A/C
4. Disables the Evaporative Control System

Example 2: All Late Model OBD-II

1. A/C is shut off
2. No idle stabilization
3. Disables the Evaporative Control System
4. Runs Readiness Code Monitors
5. Enables accelerated learning

NOTE:



In Basic Settings, Evaporative and Leak Detection functions are usually only temporarily disabled depending on the function.

Basic Settings and Adaptive Learned Values

Operating parameter values are preprogrammed into the control module as default values. Control module adaptive learning adjusts to these default values as changes in engine conditions occur. If the battery or control module is disconnected or fault codes are erased, learned values are erased and the control module reverts back to the default values. The engine runs, but the default values may not match the current needs of the engine, which can result in poor performance. Also, when repairs are made, the default values may not match the current needs of the engine. The control module has to relearn new adaptive values over time as the vehicle is driven. To expedite the learning process, the scan tool in Basic Settings can force the control module to learn current conditions in several minutes compared to normally taking several days of extended driving to meet all the different conditions.

Basic Settings and Fuel Trim Accelerated Learning

After repairs, Long Term Fuel Trim adaptation settings need to be relearned or the vehicle may not operate properly. Basic Settings can be used to accelerate learning, greatly reducing the normal time under standard operating conditions that it would take for adaptation to readjust itself. Note that Audi repair strategy usually includes basic settings accelerated learning, but VW is limited to specific models and systems. However, because VW and Audi share the same technology, Basic Settings may work similarly on VW. For Fuel Trim accelerated Learning on both VW and Audi, initiate basic settings for accelerated learning in the appropriate fuel trim display group (see “Appendix C Fuel Control Learning Adaptation Values” on page 157). After selecting a display group in Basic Settings, check that the scan tool does not report an error, which usually indicates that Basic Settings is not available for that display group. If no error is reported and the engine is fully warmed up, perform a short road test and monitor if the readings change. If an error is reported, then Basic Settings cannot be used for accelerated learning and a longer road test will be necessary for proper fuel control learning to occur.

Example: Using basic settings for accelerated learning to assist in diagnosis.

After replacement of a faulty Mass Air Flow (MAF) sensor on a late model Audi, a technician wants to validate the repair and reset the Long-term fuel trim values. Being careful not to clear codes before road testing because this resets the learned values to 0, the technician records the fuel trim adaptation values (idle and part throttle adaptation) for after repair comparison. With the engine is at operating temperature, Basic Setting in display group 032 is selected, and idle for 3–5 minutes. Then a short road test (1–2 miles) is performed, which includes a few stop-and-go part throttle accelerations. The new MAF should substantially change the fuel trim adaptation values. If values are normal, clear codes and then set all the readiness codes to the OK status. If they all set OK, the technician is very confident that there are no other problems. A final road test is always a good idea, checking for any possible intermittent problems.



NOTE:

Out-of-range adaptation readings resulting from a faulty component like a MAF sensor usually will not set a code or turn the MIL on until values are excessive (± 14). Normal adaptation readings with a good MAF sensor should not exceed $\pm 5\%$. Clearing codes or initializing Basic Settings resets the adaptation values back to base or zero. Recording the previous reset readings for comparison is helpful to verify that the repair has corrected the problem.

Basic Settings and Readiness Codes on OBD-II Vehicles

Basic Settings is also used on OBD-II vehicles to set Readiness Codes. These are OBD-II Readiness monitor tests that are commanded by the scan tool using Basic Settings.

All Readiness Code tests are run using Basic Settings. OBD-II Readiness Code tests automate many of the previous OBD-I and some early Audi OBD-II adaptation learn procedures that previously required driving the vehicle. Now many of these relearn procedures can be accomplished in the shop without a complex test drive.

On OBD-II vehicles with electronic throttle bodies, the most common use for the Basic Settings function is to recalibrate the throttle position sensors. This is accomplished using Group 098 (electronic throttle with a cable) or 060 (electronic throttle without a cable—full, Drive-by-Wire).

Basic Settings learning is prohibited when:

- Malfunction codes are stored.
- Engine idle is uneven (surging).
- Engine coolant temperature is below 176°F (80°C) or above 230°F (110°C).
- Fuel Mixture is too rich or lean (an excessive difference between the richest and leanest oxygen sensor learning values).
- During acceleration and at Wide Open Throttle. Learning takes place only at idle (650–900 RPM) and at 1500–3000 RPM. Road test the vehicle at steady cruise to set the part throttle fuel trim adaptation.

NOTE:



During the diagnosis, if a vehicle has a possible fuel control related problem, it is recommended to record both the idle and part throttle adaptation values (usually display group 032) before clearing codes or performing basic settings. Out of specification adaptation readings may not always set a code. Clearing codes resets the adaptation values and basic settings initiates accelerated learning. Using the previous readings for comparison is helpful to verify that the repair has corrected the problem.

NOTE:



Always end the Basic Settings session by selecting Other Systems in standard mode or 06-Stop Communication in Expert Mode to be sure that the settings are stored. Turn the ignition key off and wait 60 seconds.

Other Basic Setting System Functions

Crankshaft Sensor Wheel Learning. Correction for flywheel gear teeth inconsistency for misfire detection. When the scan tool is connected to the vehicle during a road test in Basic Settings with the appropriate display group for a specific vehicle, the CKP Sensor wheel is tested during a deceleration fuel shutoff at 2200–4000 RPM. After the learning has occurred, Channel 4 changes to “OK” or learned status “YES”.

Basic Ignition Timing Check. Available on most late 1980s to mid-1990s vehicles with adjustable ignition timing. In 04-Basic Setting, the DIS (digital Idle stabilization) is shut down. Base ignition timing can now be checked. On some early vehicles, Basic Setting may also force an open loop operation to allow for mixture adjustment.

Xenon Lights base setting level control adjustment. Basic setting is required for Automatic vertical headlight aim control which keeps the tilt angle of the low beam constant regardless of acceleration or load shift.

Problems with Basic Settings

If the adaptation status displays Error, or other problems occur, read the trouble codes for more information. Check the required conditions and try the basic setting again.

Service Interval Reset

This section includes different service reset procedures for various types of electronic instrument clusters. However, most of these will apply to Audi only and also depend on whether a high or low end cluster is installed (optional equipment on some models).



NOTE:

Use Expert Mode for communication problems with the Electronic Instrument service interval reset or if Service Interval Reset is not on the menu. Select 17-Electronic Instrument Panel > 10-Adaptation, then select channel 5 (005), scroll in the 8 for 8,000 kilometers (5,000 miles). Channel 6 is the distance value (24 = 24,000 kilometers or 15,000 miles). Channel 7 is the time value until the next Inspection 1 (36 = 360 days). Channel 8 is the time to Inspection 2 (72 = 720 days). See "Chapter 4 Expert Mode" on page 18 for more information.

Vehicles with Manual Mechanical SRI Reset (1995–2000)

Most VWs have mechanical SRI reset; Audi may have electronic SRI reset depending on model and instrument cluster.



To mechanically reset the oil light:

1. Switch the ignition on.
2. Press and hold the odometer reset button located below the speedometer.
3. Switch the ignition off and release the odometer reset button.
OEL (Oil Engine Lamp) appears in the SRI display.
4. Press and hold the lower digital clock reset button or the analog clock reset button until 5 dashes (-----) appear in the display.
OEL SRI is now reset to 7500 miles or 6 months.



NOTE:

Once the OEL is reset, the other displays can be reset without switching the ignition on.



To reset the service light:

1. Press the odometer reset button to perform the inspection 01.
IN 01 should be displayed in the SRI display.
2. Reset by pressing the clock button.
3. If necessary, repeat the procedure for Inspection 02.
4. Turn ignition on.

When IN 01 appears in the SRI display, switch the ignition off, procedure is completed.

Vehicles with Electronic Service Interval Reset

On VW/Audi vehicles with electronic dashboards, the following functions may be available from the Functional Tests menu:

- Reset Service Interval
- Reset Service Interval Oil(Km)
- Reset Service Interval Insp1(Km)
- Reset Service Interval Insp1(Days)
- Reset Service Interval Insp2(Days)
- Reset Days And Km After Service
- Pre-set Value Oil(Km)
- Pre-set Value Oil(Days)
- Pre-set Value Insp1(Km)
- Pre-set Value Insp1(Days)
- Pre-set Value Insp2(Km)
- Pre-set Value Min Oil(Km)
- Pre-set Value Max Oil(Km)
- Pre-set Value Oil Quality(Km)
- Read, Set Km Remaining To Oil Service
- Read, Set Days Remaining To Oil Service
- Read, Set Km Remaining To Insp1
- Read, Set Days Remaining To Insp1
- Read, Reset Km After Oil Service
- Read, Reset Days After Oil Serv.
- Read, Reset Days After Insp1
- Read, Reset Km After Insp2

Note the following when performing an electronic service interval reset.

- Depending on the type of Electronic Instrument Panel, there are 4 to 9 functions available for Service Resetting.
- The service intervals are measured/set/reset in kilometers even when the speedometer shows miles. The scan tool will calculate the equivalence in miles when showing kilometers.
- Remember that the service intervals can be changed in steps of 100 or 1000 kilometers only. It is not always possible to set them to a round number of miles. The only exceptions are some new instrument panels, Type H and J, which use miles as base value.
- Depending on the type of Instrument Panel, up to three different types of service intervals are available:
 - Oil Service— Oil Change
 - Inspection 1— Yearly Inspection
 - Inspection 2— Bi-yearly Inspection
- Depending on the type of Instrument Panel, the limit values for the above type of inspections are in kilometers and/or days.

**To perform an electronic service interval reset:**

1. Select **17-Electronic Instrument Panel** from the System Selection menu.
2. From the Main Menu, select **Functional Tests**.
The Functional Tests menu displays.
3. Select **Reset Service Interval**.
The scan tool displays a warning message.
4. Select to **continue**.
The Reset Service Interval screen displays.
The number displayed is the recommended value by the factory. This value can be changed by scrolling.
5. Select the correct amount.
The new value is entered into the control module and the scan tool returns to the Functional Tests menu.

Pre-set Functions

The Pre-Set functions are used to specify the total length in kilometers and or days between the service intervals. These functions only specify the time or distance between intervals, they do not reset the interval.

**To use pre-set functions:**

1. Select the desired function from the Functional Tests menu.
The scan tool displays a warning message.
2. Select to continue.
The number displayed is the current value.
3. If the value is not to be changed, return to the Functional Tests menu. If the value requires changing, select continue to open the Change Confirmation screen.
4. Select continue.
The Change Preset Value screen displays.
The number displayed is the current value. When it has never been changed, it is the factory setting. This value can be changed by scrolling.
5. Select the correct amount.
The new value is entered into the control module and the scan tool returns to the Functional Tests menu.

Read, Set/Reset Functions

The Read, Set and Read, Reset functions can be used to read the kilometers or days since the last service set them to the required value. These functions are only needed when an inspection has been carried out prematurely (before the service interval is required). These functions work the same as the Pre-Set functions. See "Pre-set Functions" on page 52.

5.3 Testing Transmission Systems

The VAG software cartridge covers the following transmissions:

- AG4 Getriebe 001
- AG4 Getriebe 018
- AG4 Getriebe 01F
- AG4 Getriebe 01K
- AG4 Getriebe 01M
- AG4 Getriebe 01N
- AG4 Getriebe 01P
- AG4 Getriebe 096
- AG4 Getriebe 097
- AG4 Getriebe 098
- AG5 Getriebe 01L
- AG5 Getriebe 01V
- AG5 Getriebe 09A
- AG5 Getriebe 09B
- Digimat 0842
- Direkt-Schaltgetriebe DS085
- Multitronic V30 01J

VW automatic transmission controllers started using digital diagnostics in 1989 on the Passat with the 095 transmission (4-speed) and continued with 096/01M and 098/01P. 5-speeds include the 01V and 09A. All VW transmissions use digital controllers with codes.

Audi started with the 097 transmission (4-speed) in 1990 on 80/90/100 models and continued with 01F, 01K, 01N 5-speeds, which includes the 01L and 01V transmissions. The newest transmission called the Constant Velocity Transmission (CVT) is designated the 01J.

The VW/Audi vehicle communication software starts VIN ID in 1991 (US vehicle systems). On early 1990–1992 vehicles, using VIN ID regular mode the scan tool may display codes only.

Using regular mode, transmission data may not be available until 1993, but you can use Expert Mode to read transmission data on pre-1993 vehicles. See Table 5-8 for coverage.

Table 5-7 lists Volkswagen/Audi transmissions from 1988 to 2003 and their features, and Table 5-8 on page 57 lists Volkswagen/Audi transmissions with the models where they are found.

Table 5-7 *Transmission types and system descriptions (part 1 of 4)*

Transmission	Transmission Features	Notes
018 (ZF4HP24)	<ul style="list-style-type: none"> • 4-speed longitudinal AWD • TCC On/Off Solenoid 	
01F (ZF4HP18)	<ul style="list-style-type: none"> • 4-speed longitudinal AWD • TCC variable lockup • TCM: 54-pin, 55-pin, or 88-pin connector • 5 shift programs • 2 emergency running modes 	
01J	<ul style="list-style-type: none"> • CVT longitudinal FWD • TCM inside transmission rear cover 	

Table 5-7 *Transmission types and system descriptions (part 2 of 4)*

Transmission	Transmission Features	Notes
01K (ZF4HP18)	<ul style="list-style-type: none"> • 4-speed longitudinal FWD • TCC variable lockup • TCM: 54-pin, 55-pin, or 88-pin connector 	
01L (ZF5HP24)	<ul style="list-style-type: none"> • 5-speed longitudinal AWD • TCC variable lockup • Lifetime oil • TCM: 88-pin connector 	Tiptronic appeared on some models in 1998. E17 was the earliest control system. E18/2 started late 1998 on some models. CAN bus appear in some models in 1998.
01M	<ul style="list-style-type: none"> • 4-speed transverse FWD • Fuzzy logic, 253 constantly adapting shift strategies • Cold start & limp home programs • TCM: 68-pin connector • Converter clutch in torque converter and uses PWM solenoid for variable lockup • Sun shell speed sensor (trans VSS) added for shift timing • Trans ID stamped in case at top of starter boss • Dipstick replaced with fluid level plug 	096 was renamed 01M and used from mid-1995 to present; year model 1995 may have 096 Phase 1 or 01M Phase 2 trans.
01N	<ul style="list-style-type: none"> • 4-speed longitudinal FWD • Used mid-1995 to present • Lifetime oil • TCM: 68-pin connector • Dynamic shift program • Converter clutch in torque converter and Uses PWM solenoid for variable lockup • Sun shell speed sensor added for shift timing • Dipstick replaced with fluid level plug 	097 was renamed 01N in mid-1995; year model 1995 may have 097 Phase 1 or 01N Phase 2 trans.
01P	<ul style="list-style-type: none"> • 4-speed transverse FWD • Fuzzy logic, 253 constantly adapting shift strategies • Cold start & limp home programs • TCM: 68-pin connector • TCC-PWM • Sun shell speed sensor • Used mid-year 1995 to present • 098 renamed 01P. • Converter clutch in torque converter and uses PWM solenoid • Sun shell speed sensor added for shift timing • Dipstick replaced with fluid level plug 	Model year 1995 may have either 098 Phase 1 or 01P Phase 2 trans.

Table 5-7 *Transmission types and system descriptions (part 3 of 4)*

Transmission	Transmission Features	Notes
01V (ZF5HP19)	<ul style="list-style-type: none"> • 5-speed longitudinal • FWD or AWD • TCC variable lockup • Lifetime oil • TCM: 88-pin connector 	<p>(Used for VW and Audi) FL = FWD, FLA = AWD VW/Audi: Tiptronic appeared on some models in 1998. E17 was the earliest control system. E18/2 control system started late 1998 on some models. CAN bus appear in some models in 1998.</p> <p>VW Only: Replaces 01M transmission starting 1998 Passat model year.</p>
095	<ul style="list-style-type: none"> • 4-speed transverse FWD • Economy/Sport switch on console near shift lever. • K3 clutch locks gear train one to one with torque converter for lockup with On/Off solenoid. • Trans ID stamped at top of bell housing on some. • External transmission oil filter (If not updated "removed" with bulletin #37-91-03). 	<p>VW introduced the transverse 4-speed, electronically-controlled 095 automatic transmission in model year 1989. It was soon replaced by the 096 transmission in mid-1990.</p>
096	<ul style="list-style-type: none"> • 4-speed transverse FWD <p>Phase 0</p> <ul style="list-style-type: none"> • Used to mid-1993 • TCM: 38-pin connector • Economy/Sport switch on console near shift lever • K3 clutch locks gear train one to one with torque converter for lockup with On/Off solenoid • Trans ID stamped at top of bell housing <p>Phase 1</p> <ul style="list-style-type: none"> • Used mid-year 1993 to mid year 1995 • Fuzzy logic, 253 constantly adapting shift strategies • Cold start & limp home programs • TCM: 38-pin or 68-pin connector • K3 clutch locks gear train one to one with torque converter for lockup with On/Off solenoid • Economy/Sport switch deleted • Sport shift map in TCM 	<p>096 replaced the 095 transmission in mid-1990; year model 1993 may have 096 Phase 0 or Phase 1 trans; 1995 may have 096 phase 1 or 01M phase 2.</p>

Table 5-7 *Transmission types and system descriptions (part 4 of 4)*

Transmission	Transmission Features	Notes
097	<ul style="list-style-type: none"> • 4-speed longitudinal FWD Phase 0: <ul style="list-style-type: none"> • TCM: 38-pin connector • Used to mid-1993 • Economy/Sport switch on console near shift lever • K3 clutch locks gear train one to one with torque converter hub for lockup with On/Off solenoid Phase 1: <ul style="list-style-type: none"> • TCM: 38-pin connector • Used mid-1993 to mid-1995 • K3 clutch locks gear train one to one with torque converter for lockup. Uses On/Off solenoid • Economy/Sport switch deleted • Sport shift map in TCM 	Model year 1993 may have either 097 Phase 0 or Phase 1 trans.; 1995 may have either 097 or 01N.
098	<ul style="list-style-type: none"> • 4-speed transverse FWD • Fuzzy logic, 253 constantly adapting shift strategies • Cold start & limp home programs • TCC On/Off Phase 0: <ul style="list-style-type: none"> • TCM has 38-pin connector • Used to mid-1993 • Economy/Sport switch on console near shift lever • K3 clutch locks gear train one to one with torque converter hub for lockup with On/Off solenoid Phase 1: <ul style="list-style-type: none"> • TCM: 38-pin or 68-pin connector • Used mid-1993 to mid-1995 • K3 clutch locks gear train one to one with torque converter for lockup and Uses On/Off solenoid • Economy/Sport switch deleted • Sport shift map in TCM 	Introduced when Eurovan replaced Vanagon in 1992; year model 1993 may have 098 Phase 0 or Phase 1 trans.; 1995 also has 01P.
09A	<ul style="list-style-type: none"> • 5-speed transverse FWD • Lifetime oil • TCM: 68-pin connector 	2002 Golf/Jetta has either 01M or 09A
09G	<ul style="list-style-type: none"> • 6-speed automatic transmission • 6 hydraulically activated forward gears • 2nd, 3rd, 4th, and 6th gears mechanically driven with TCC locked. • ATF oil is filled for life and is not changed. • Uses fuzzy logic adaptation to driving with infinitely variable gear switch points. 	

Table 5-8 Transmission applications (part 1 of 2)

Transmission	Model	Engine	Year	Control System Version
018 (ZF4HP24)	V8	3.6L	1990–92	
		4.2L	1993–94	
01F (ZF4HP18)	A6	2.8L	1995–98	
	100	2.8L	1992–94	
01J	A4	1.8L, 1.9L, 2.0L, 2.4L, 2.5L, 3.0L	2003–05	Multitronic
	A6	3.0L		
01K (ZF4HP18)	A6	2.8L	1994–98	
	100	2.8L	1992–94	
01L (ZF5HP24)	A6	4.2L	1999–2005	E17–E18/2
	A8	4.2L	1997–2005	
	Phaeton	4.2L	2004–05	
		6.0L	2004–05	
01M	VW Cabrio	2.0L	1995–2002	All 01M trans. are Phase 2
	Golf/Jetta/GTI	L4 1.8L	1995–2005	
		1.9L TD	1995–2005	
		2.0L, V6 2.8L	1995–2005	
	New Beetle	1.8L, 1.9L, 2.0L	1998–2005	
Passat	1.8L, 1.9L, 2.0L, V6 2.8L	1995–97		
01N	Audi Cabriolet	2.8L	1995–98	All 01N trans. are Phase 2
	90	2.8L	1995	
01P	Eurovan	2.4L, L5 2.5L, 2.8L	1995–2005	All 01P trans. are Phase 2
01V (ZF5HP19)	A4	1.8L	1997–2003	E17–E18/2
		2.7L	1998–2003	
		2.8L	1996–2001	
		3.0L	2002	E18/2
	A6	2.7L	2000–03	
		2.8L	1998–2003	E17–E18/2
	A8	3.7L	1997–99	
	Golf/GTI/Jetta	1.8L, 2.8L	2001–03	
	Passat FWD	1.8L, 2.8L, 4.0L	1998–2005	
				Passat AWD
095	Corrado/ Passat		1989–90	Phase 0

Table 5-8 Transmission applications (part 2 of 2)

Transmission	Model	Engine	Year	Control System Version
096	Corrado	1.8L	1989–92	Phase 0
		2.8L	1992–93	
			1993–95	Phase 1
	Golf/Jetta	1.8L	1993	Phase 0
			1993–95	Phase 1
		2.0L	1993	Phase 0
			1993–95	Phase 1
		2.8L	1993	Phase 0
			1993–95	Phase 1
	Passat	2.0L	1990–93	Phase 0
			1993–95	Phase 1
		V6 2.8L	1993	Phase 0
1993–95			Phase 1	
VW Cabrio	2.0L	early 1995		
097	Audi Cabriolet	2.8L	1994–95	Phase 1
	80	2.3L	1990–92	Phase 0
	90	2.3L		
		2.8L	1992–mid-93	
	mid-1993–95		Phase 1	
	100		1990–92	Phase 0
098	Eurovan	L5 2.5L	1992–93	Phase 0
			1993–95	Phase 1
		2.4L	1993–95	
09A	Golf/Jetta	1.8L 132 KW, 2.8L 147 KW, 2.8L 150 KW	2002	
	Golf GTI Jetta Jetta Wagon R32	1.8L, 2.0L, 1.9TDI, 2.8L, 3.2 VR6	1999–05	
09G	VW New Beetle/Audi TT Passat, Jetta	1.8/2.0L, 1.9 TDI, 2.5L, 3.6L	1998 (Beetle) 2005 (TT)	6-speed

5.3.1 Digimat Control Module Identification—Golf & Jetta, 1993–97

Use Table 5-9 and Table 5-10 to identify which TCMs are available for various 50 state ECM/TCM combinations. Do not update a vehicle unless a specific condition has been identified.

When replacing a TCM for any reason, the TCM must be paired with the ECM according to the chart. VIN numbers are for general reference only. Most VINs shown are approximate.

When multiple TCM part numbers are listed for a particular ECM/TCM combination, they are shown in order of development, the earliest TCM at the top. Part numbers are for reference only. Always check a Volkswagen parts department for the latest information.

Table 5-9 Engine code AAA

Model Year	ECU Part Number	Vin	TCM Part Number	Digimat	Trans Code & Phase	Valve Body Code
1995	021906258BM 021906258EA 021906258CR California	From: 1H_S_012883 To: 1H_S_012952*	096927731CE	1.0	CFF Phase 1	QBA
		From: 1H_S_012883 To: 1H_S_072798	096927733AC 096927733BA	2.0		
		From: 1H_S_072799 To: 1H_S_999000	01M927733F 01M927733FJ	2.0 2.1	CLB Phase 2	7DK QCA
1996	021906259A	From: 1H_T_000001	01M927733AC	2.0		
			01M927733CB	2.1		
1997	021906259K	From: 1H_V_000001 To: 1H_V_073027	01M927733CB	2.1	DMA Phase 2	QEA
	021906259AA	From: 1H_V_073028 To: 1H_V_999000	01M927733DM			
* German-built vehicles						

Table 5-10 Engine code ABA (part 1 of 2)

Model Year	ECU Part Number	Vin	TCM Part Number	Digimat	Trans Code & Phase	Valve Body Code
1993	037906258T 037906258AA 037906258AH 037906258AE	From: 1H_P_012601 To: 1H_P_999000	096927731BH	1.0	CFH Phase 1	QBA
		From: 1H_R_000001 To: 1H_R_999000				
1995	037906258T 037906258AA 037906258AH 037906258AE	From: 1H_S_000001 To: 1H_S_012952	096927731BH	1.0	CFH Phase 1 CNK Phase 1	
		From: 1H_S_012953 To: 1H_S_066798	096927733AB 096927733AT	2.0		
		From: 1H_S_066799 To: 1H_S_999000	01M927733BA 01M927733CD 01M927733EB	2.0 2.1	CLK Phase 2 CLA Phase 2	7DK QCA

Table 5-10 Engine code ABA (part 2 of 2)

Model Year	ECU Part Number	Vin	TCM Part Number	Digimat	Trans Code & Phase	Valve Body Code
1996	037906259 037906259X 037906259JX	From: 1H_T_000001 To: See footnote	01M927733M 01M927733DN 01M927733EA	2.0	CLK Phase 2	7DK
	037906259D Tier 1 (w/LDP)*	From: 1H_T_118928 To: 1H_T_999000	01M927733CA	2.1		
	037906259E TLEV (w/air pumps & LDP)*	From: 1H_T_117284 To: 1H_T_999000				
1997	037906259D Tier 1 (w/LDP)*	From: 1H_V_000001 To: See footnote	01M927733CA	2.1	CLK Phase 2	7DK
	037906259E TLEV (w/air pumps & LDP)*					
	037906259M Tier 1 (w/LDP)*	From: 1H_V_070133 To: 1H_V_999000	01M927733DL		DLZ Phase 2 "ETA"	QEA
	037906259N TLEV (w/air pumps & LDP)*	From: 1H_V_074116 To: 1H_V_999000				

5.3.2 4-Speed Automatic Transmission—01N

The 01N transmission is an electronically-controlled transmission with adaptive control. Shift points are automatically regulated to provide three distinct operating characteristics:

- Comfort driving, maximum fuel economy (shift points are kept low)
- Average driving (shift points are slightly raised)
- High-performance driving (shift points increase to allow higher engine speed between gears)

The transmission control module can tune the shift program incrementally between these modes with up to 244 variations. This is referred to as the DSP (Dynamic Shift Program). Each of these 244 variations can be seen using the scan tool. Tapping the accelerator twice will raise the program one level, which means that the transmission shift points will occur at a higher engine RPM. These increments are indicated on the scan tool by numbers 0–244, with 0 representing the lowest RPM shift points and 244 indicating the highest.

5.3.3 VW Series—095, 096, 01M

These TCMs have gear changes based on driving situation (Fuzzy Logic). Depending on the driving situation and driving force resistance, gear change points are determined automatically.

These transmissions have the following advantages:

- Gear changes are fuel consumption orientated.
- Maximum engine output is always available.

- Individual adaptation of gear change points in all driving situations.
- Gear change points are infinitely variable.

A gear change map automatically selects gear changes for gradients depending on accelerator pedal position and driving speed, which has the following advantages:

- Gear change map for extreme uphill stretches is matched to engine output.
- Gear change map for extreme downhill stretches is matched to the engine braking effect.

5.3.4 Audi Transmission—01F, 01K



NOTE:

Audi transmission Fuzzy Logic Shift Adaptation features are usually more complicated than Volkswagen transmissions.

The Dynamic Selection Program (DSP) represents a new form of intelligent switching logic. DSP eliminates the program switch. It can choose automatically between five different selection programs and makes for optimum adaptation of the gear selection characteristic to vehicle handling and usage conditions. The signals for Throttle-valve Opening, Engine Speed, Road Speed and Vehicle Longitudinal Acceleration/deceleration are used by the TCM to determine a characteristic response number which forms the basis for selection of one of the five programs. Control of the shift points can be a long-term or a short-term function.

DSP offers the following advantages:

- Better adaptation of shift points to driving habits and traffic situations (five instead of two selection programs).
- No driver-selected program switch.
- Better handling in extreme situations, for example when towing a trailer or on a steep hill.
- Greater fuel economy than previous “Economy” driving program in urban traffic.
- Further improved power potential in selection program 5 as opposed to the previous “sport” driving program.

Long-term functions include the following:

- A normal driving style results in a low characteristic response number which results in a more fuel-economic selection program where the gears are shifted in average time.
- A sporty driving style results in a high characteristic response number and a selection program where switching up a gear is delayed and switching down a gear is done sooner.

Short-term functions include the following:

- Instant selection program at a road speed in excess of 34 MPH (55 KPH).
- With rapid acceleration, a shift-down to the lowest possible gear without fully depressing the kickdown switch.
- Returns to the original selection program following initiation of an upward gearshift or after dropping below a fixed throttle-valve value.

5.3.5 Important Tips for Transmission Codes

- For both VW and Audi, on 1996 and newer models, when emission or limp-home related transmission faults are stored, all the dash transmission gear selector indicator lights may turn on and stay on until fault is cleared. For some pre-OBD-II models, the PRND321 light may turn on or flash. Some may reverse video foreground/background (black background/white letters) when transmission codes are stored.
- For both VW and Audi, transmission limp-home mode defaults to a fixed gear (2nd or 3rd gear). Certain stored codes initiate limp-home mode. The transmission stays in limp-home until the fault or faults are repaired.
- Multifunction switch-related faults usually turn the transmission MIL on. Other faults are less predictable.
- Transmission codes affecting emissions may not turn on the transmission MIL.
- For some sensor-related faults, the transmission control unit may substitute a fixed value.
- Not all faults initiate limp-home mode. There are different degrees of limp-home mode depending on the problem.
- After repairs, solenoid-related faults usually clear failsafe mode. Other faults usually require a clear codes function before the failsafe clears. In addition, the transmission may not shift correctly until codes are cleared. Always clear codes after repairs which reset any modified shift operation or failsafe mode.
- On 1996 or newer models, disconnecting the vehicle battery will not turn out the engine or the transmission MIL.
- Intermittent faults have “Error Occurs Intermittent” after the code description. Intermittent codes are faults usually not reoccurring within a minimum of 3 miles or 6 minutes and a maximum of 12 miles or 24 minutes. When a malfunction is first detected, it is stored as a static or pending malfunction. If the malfunction no longer exists after the above listed pre-determined time or distance traveled, then it is labeled intermittent. Intermittent faults usually auto erase after 625 miles or 20 hours of operation.
- Codes may set if the vehicle battery is disconnected or if the transmission is removed from vehicle for service.
- Most 1995 and earlier Bosch control modules may display a false DTC, such as “00513-Engine Speed Sensor (G28)” or “00526-Brake Light Implausible Signal” if the engine is not running. These fault codes should disappear once the engine is started. With a defective sensor, the engine would not start.
- If DTC memory cannot be cleared, check that the ignition switch position was not altered during DTC retrieval. The ignition switch must remain on during DTC retrieval and the clearing procedure.
- DTCs need to have the test followed exactly. First, check DTC memory and repair malfunctions. Next, erase DTC memory.
- On early transmissions (1989–1992), use Expert Mode for data parameters. With some 1989 models with the scan tool hooked up, the vehicle may only accelerate to 1900 RPM. This is normal vehicle software operation. Use Expert mode to obtain the data group binary readings and get help with interpretation in “Transmission Expert Mode Parameters” on page 148.

5.3.6 Transmission Basic Settings

This selection for Basic Settings is different from the “Expert Mode” Basic Settings. This selection will only list up to two adaptation tests with help. See “Basic Settings” on page 45 for a complete description of Basic Settings.

The following selections are available from the Basic Setting menu. The first selection, Throttle Body Adaptation, must be done in Engine testing (see “Engine Management Functional Test Menu” on page 46). Kickdown Function may be done in Transmission testing.

Restore a system to Basic Setting (adaptation) after performing the following repairs:

- Engine exchange
- Throttle position adjustment
- Throttle valve conversion
- Replacement of throttle position sensor
- Replacement of transmission control module
- Transaxle shifting concern

**NOTE:**

Check for any codes present and clear before starting this procedure.

- **Throttle Body Adaptation.** In this Basic Setting, the control module learns the throttle position with an automatic procedure. The electronic throttle body needs to be readapted every time codes are cleared or control module power is disconnected.
- Throttle Body and Transmission kickdown adaptations (also included as part of Readiness Codes) must be set to avoid driveability problems. The other OBD-II Readiness Codes will set on their own eventually and not produce driveability problems. Clearing codes may not necessarily change throttle body adaptation status to NOT OK, however, driveability problems may occur after an extended road test.
- **Kickdown Function.** In this Basic Setting, the control module relearns the kickdown position for the automatic transmission. In addition, shift learned values are reset to base settings. Resetting can be very useful for various driving styles causing learned erratic shifting. The procedure must be followed exactly. Hold the throttle for 3 seconds, by pressing down the throttle fully to the floor, then release (make sure you feel the kickdown switch engage).
 - Always check for kickdown selection in the Engine Functional Test menu, as kickdown adaptation is not always included in the Readiness Code Charts.
 - Kickdown may also be selected in Expert Mode. In engine or transmission, select Basic Setting 04/000. Remember that in Expert mode there are no screen prompts. Once in Basic Settings, depress the throttle to floor for three seconds, then release. Press **N** to exit. New kickdown learn settings should be set (no feedback on-screen).
 - On some models, kickdown relearn may not set properly using Basic Settings in the transmission controller. There is no way to verify that the kickdown reset test has been completed by looking at the transmission data. A test drive before and after may verify that the test was completed or select engine management data and select display group 063. If kickdown adaptation status reports an error, go back and select Basic Settings in the Engine Management Functional Tests menu, then select kickdown as stated above.

**NOTE:**

VW added a resistor to the brake pedal circuit that activates the kickdown relearn procedure when the brake pedal has been depressed. This resets transmission adaptation on some models during brake apply.

Important Tips for Transmission Basic Settings

- Basic Settings 04/000 also resets transmission learned shifting adaptation to 0 or base point. Some early transmissions have no Basic Setting selection. To reset adaptation on these, switch the ignition on without starting the engine and press the accelerator all the way to the floor, turn ignition off, let up on accelerator, restart engine. Drive the car and monitor shifting. It should shift at default with no learning. Early transmissions may require an extended road test to learn new shift adaptation.

5.3.7 Functional Tests—VW Passat 01V

A differentiation is made between two types 01V transmissions:

- **Type I** has the transmission input speed sensor (inductive sensor) secured to the underside of the valve body (E17).
- **Type II** has the input speed sensor secured behind the valve body at the transmission housing (E 18-2).

Both types have the following output diagnostic tests available in Functional Tests:

- The output diagnostic test mode is a part of a system electric test. The output diagnostic test mode checks the solenoid valves, the shift lock solenoid, the kickdown switch, and the relay for the solenoid valves.
- The output diagnostic test mode can only be performed when the selector lever is position “P”, the engine is not running and the vehicle is stationary.
- The output diagnostic will be terminated if the engine is started.
- The function of the solenoid valves 1-N88-, 2-N89-, 3-N90- and the solenoids for the selector lever lock are checked acoustically during the output diagnostic test mode. Avoid noise in the surrounding area during the acoustic check because the switching noise (clicking) of the final controls is very quiet.
- The solenoid valves 4 –N91-, 5-N92-, 6-N93- and 7 –N94- are activated during the output diagnostic test mode. A direct functional check of these valves is not possible. But a possible electrical fault, which occurs during the activation, will be recognized by the on-board diagnostic (OBD) and stored in the DTC memory.
- Only one complete output diagnostic test mode is possible after switching the ignition on. To repeat the output diagnostic test mode, the ignition must be switched off and on again (sometimes this may require engine to be started).

Type I Transmission (E17) Solenoid Activation

Activation sequence:

1. Solenoid valve 1 –N88-
2. Solenoid valve 2 –N89-
3. Solenoid valve 3 –N90
4. Shift lock solenoid –N110-
5. Solenoid valve 4 –N91-
6. Solenoid valve 5 –N92-
7. Solenoid valve 6 –N93-
8. Solenoid valve 7 –N94-
9. Kickdown switch –F8- (Kickdown for air conditioner)
10. Solenoid valves relay



NOTE:

If the kickdown switch is operated, the transmission control module briefly switches off the air conditioner compressor.

Type II Transmission (E18/2) Solenoid Activation

Activation sequence:

1. Solenoid valve 1 –N88-
2. Solenoid valve 2 –N89-
3. Solenoid valve 3 –N90
4. Shift lock solenoid –N110-
5. Pressure control valve 1 –N215-
6. Pressure control valve 2 –N216-
7. Pressure control valve 3 –N217-
8. Pressure control valve 4 –N218-
9. Voltage supply for Solenoid valves



NOTE:

Pressure-regulating valve –5- for automatic transmission –N233- could be displayed erroneously—valve –5- does not exist on the –N233-.

Fail-safe Functions of the TCM

If individual or several components or sensors fail, the transmission control module (TCM) activates corresponding substitute functions or backup programs to ensure the automatic transmission operates, allowing a vehicle to be driven to a safe location. The respective effect is noticeable on the operation and quality of the gearshifts.

If critical malfunctions occur and the TCM is active, the gear engaged at that moment is maintained initially. The TCM activates the “Fail-safe mode with active control module” as soon as the driving situation permits it while ensuring transmission security and road safety.

Fail-safe Mode with Active Control Module

- Transmission shifts out of all forward gears into hydraulic 4th gear. Torque converter clutch is open. All solenoid valves are de-energized.
- Maximum shift pressure applied to the power-transmitting elements.
- Reverse gear can be engaged. Selector lever lock is inactive (In “P” and “N”)
- All the segments of the gear display light up completely.

If the TCM fails, the transmission immediately continues to operate in “Fail-safe mode with non-active control module”.

Fail-safe Mode with Non-active Control Module

- Transmission shifts out of all forward gears into hydraulic 4th gear. Torque converter clutch is open. All solenoid valves are de-energized.
- Maximum shift pressure applied to the power-transmitting elements.
- Reverse gear can be engaged. Selector lever lock is inactive (“P” and “N”).
- All the segments of the gear display are dark.
- The TCM is completely inoperative and it is not possible to initiate the on-board diagnostic.

5.3.8 VW/Audi Transmission Emergency Operation—01V

If an electrical fault occurs, and depending on the TCM, emergency operation may use two different limp-home programs to prevent transmission damage while retaining the ability of the vehicle to move. In either mode, all segments of gear indicator usually light up.

Emergency Operation 1

In the absence of certain signals, the TCM switches to maximum modulation pressure (pressure for actuating shift elements). Clutches and brakes in the transmission are rapidly operated and protected against damage. The transmission will shift harshly in this mode.

Emergency Operation 2

In the absence of certain signals or actuator circuits, the TCM de-energizes the relay for the solenoid valves. The solenoid valves in the valve assembly are deactivated, thus preventing gear selection. If this occurs while the engine is running, 4th gear is engaged. If the vehicle is braked to a standstill, the engine cuts out since 4th gear is a direct mechanical drive with no converter action. On restarting the engine, it is possible to drive in 2nd gear and reverse.

**NOTE:**

Two important relays are housed in the control module. The solenoid-valve relay serves as a safety relay and is de-energized in limp-home mode as is the relay for the cruise control system.

5.4 Testing Electronic Throttle Systems

The following sections contain scan tool testing information for VW/Audi electronic throttle systems.

5.4.1 Throttle Valve Control Module Adaptation

All 1996 VW/Audi electronic throttle systems require adaptation. There are different electronic throttle types as described further in this section, but all types require the adaptation procedure whenever one of the following has occurred:

- Throttle Valve Control Module, ECM, or TCM is removed or replaced.
- Power supply to control module is interrupted.
- Low or disconnected battery.
- Codes are cleared.

What the Adaptation Process Does

The adaptation process involves the control module learning the different throttle valve positions so that it knows the exact throttle position. It compares previous voltage readings with new voltage reading inputs from two angle position sensors located inside the throttle actuator housing. If the adaptation procedure is successful, these new positions are stored in the control module. Simply put, throttle adaptation is the control module learning exact throttle positions against previous preprogrammed values. If the two sets of readings exceed the range of tolerance, an error is reported.

Typical conditions before throttle adaptation include the following:

- Key on engine off.
- No stored DTCs.
- Battery Voltage of at least 11.5 volts.
- All electrical consumers switched off (lights, heater fan, etc.).
- Throttle must be in closed position (foot off accelerator pedal).
- Engine coolant temperature between 41–212°F (5–100°C). Certain vehicles may require above 176°F (80°C).
- Intake temperature less than 212°F (100°C).

Performing throttle body adaptation

Throttle body adaptation is performed using Basic Settings listed under the Functional Test menu (“Basic Settings” on page 45) or in Expert Mode (“04-Basic Settings” on page 22). If selected in

Functional Tests, the automated menu will prompt you through the process. If using Expert Mode, see the Readiness Code Chart Manual for the exact application procedure. If applicable, throttle adaptation is always one of the first steps in the chart.

Readiness Codes always need to be reset after codes are cleared or the battery has been disconnected. Throttle body adaptation relearn (part of Readiness Code procedure) is essential and may prevent the engine from starting (it can also cause MIL to go on or cause driveability problems). Clearing codes using a Generic OBD-II scan tool has the same effect.

**NOTE:**

Clearing codes may not change throttle body adaptation status to NOT READY (060 or 098), but performing a throttle body adaptation after clearing codes is recommended to ensure no problems. See the *Volkswagen/Audi OBD-II Readiness Code Charts* for more information.

An unsuccessful adaptation may be caused by any of the following:

- Throttle valve is unable to close because of dirt or carbon buildup.
- Battery voltage is too low.
- Throttle body actuator connector is loose or contacts are corroded or damaged.
- Throttle valve housing is distorted (check bolts for proper torque).
- Engine was started or throttle was depressed during the adaptation.

The scan tool performs the adaptation process by sending the correct command to the control module using a special operation mode called Basic Settings (see “Basic Settings” on page 45). After the scan tool sends the command to start the test, the control module sends the test measurements and the final adaptation result back to the scan tool.

**NOTE:**

Throttle body faults may also cause misfire faults.

If a throttle body faults occur, try to set adaptation again. If errors still occur, check and clean the throttle body. Attempt to set the adaptation again. If errors are still present, check for wiring and connection problems between the throttle body and the control module.

What should I do if I get pedal position faults?

If pedal position faults occur, first check the wiring by using scan tool in measuring block 62, which will allow you to see both pedal sensors. Look for one pedal position sensor not responding.

Next, check the connectors at throttle body and the control module. Check the wiring for continuity.

Throttle body or pedal position faults may be caused by any of the following:

- If the MIL stays on after the engine starts, the throttle body may be failing self-test at startup.
- Cell phone antennas and cables can cause electromagnetic interference problems.

Electronic throttle systems are sensitive to a low or disconnected battery, especially if the ignition was left on. With a low battery, adaptation settings may erase, which may cause poor idle or poor throttle response (emergency run mode). On the 2000/2001 Type III throttle actuator, this may cause a start and die condition. With this condition, the MIL may be on with a fault code set. The fault code will not clear until throttle body adaptation is performed. Throttle body adaptation reset procedure is done in Basic Settings Mode (04). See “Basic Settings” on page 45.

In an emergency, there is an alternative, less reliable method. Turn the ignition on for at least six seconds without operating the starter or depressing the accelerator pedal. The control module must register a Learning Requirement in order for this procedure to work because previously stored voltage readings from the angle sensors do not correspond to the new voltage readings.

Electronic throttle valves are sealed units and are not serviceable. Internal component failure means replacing a complete unit.

5.4.2 Electronic Throttle Types

Due to availability at the time of this writing, the information below references VW, but the information regarding the three electronic throttle control systems is applicable to Audi (throttle system type by years is the same for Audi). The types listed below were developed for VW only.

Type I

VW Electronic Throttle Valve Control started in 1996 with the M5.9 management system. This first design replaced the separate Throttle Position Sensor and Idle Air Control Valve. This first electronic throttle body module still has a throttle cable (not full Drive-by-Wire system). This early style controls idle speed only by means of a movable throttle stop controlled by an electric servo motor which is connected to the throttle plate. Within the sealed housing (no adjustment capability) are the following 4 components:

- Throttle Position Sensor (G69)
- Closed Throttle Position (CTP) switch (F60)
- Throttle Position (TP) sensor (G88)
- Throttle Position (TP) actuator (V60)

The G69 sensor has a full range (reads actual throttle plate position) 0.5–5.0V reference signal (called Throttle Position Sensor (V) on the scan tool). Voltage is high at idle, about 4.0–4.5V and low, about 0.3–0.8V, at wide open throttle (WOT).

The G88 sensor reads the position of the idle or bottom throttle stop position of the actuator. On this sensor (called Throttle Valve Adjuster (V) on the scan tool), voltage normally reads in the 3–4 V range. This type of sensor provides feedback on the throttle position actuator and the throttle stop position. Input voltage is crosschecked against the input voltage from the G69 sensor for plausibility. This G88 sensor, which has a reduced voltage range, changes minimally when the throttle is moved and the engine is running. The actuator only controls idle speed and opens during deceleration. Scan tool display group 060 or 098 (Throttle Valve Adjuster) at idle, part-throttle, and WOT:

Idle:

THROTTLE POSITION SENSOR (V) _____	4.380
THROTTLE VALVE ADJUSTER (IDLE) _____	3.680
THROTTLE ADJUSTER MODE _____	IDLE
ADAPTATION STATUS _____	OK

Part-throttle:

THROTTLE POSITION SENSOR (V)	3.90
THROTTLE VALVE ADJUSTER (IDLE) (V)	2.28
THROTTLE ADJUSTER MODE	PART
ADAPTATION STATUS	OK

WOT:

THROTTLE POSITION SENSOR (V)	0.8
THROTTLE VALVE ADJUSTER (IDLE) (V)	1.66
THROTTLE ADJUSTER MODE	ENRICH
ADAPTATION STATUS	OK

With the key on and the engine off, Throttle Valve Adjuster (Idle) (V) voltage does not change with throttle movement. With the engine running and throttle movement, voltage change is minimal and lags behind the actual Throttle Position Sensor. Also note that actual Throttle Position Sensor has opposite voltage graph pattern to engine speed (high at idle and low at WOT).

Type II

The next type of electronic throttle system came out in 1998 with the VW M5.9.2 engine management system. It is similar to Type 1 (still has a throttle cable) except that cruise control is now integrated into the throttle valve control module. The important difference from Type I is that the scan tool does not display throttle position voltages. Instead, the scan tool display reads throttle angle (degrees) and percent. Also different from Type I, Throttle Valve Angle now increases with engine speed (moves up and down in the same direction), while Thr Valve Adjuster moves in the opposite direction to throttle or engine speed.

Some vehicles may also read Display group 054 (Idle control) which includes Thr Valve Adjuster in degrees (THR ADJ (°) in a Codes & Data screen). Scan tool display group 060 (Throttle Valve Adjuster):

THROTTLE VALVE ANGLE (degrees)	2
THR VALVE ADJUSTER (%)	75.2
OPERATING MODE ENGINE	IDLE
ADAPTATION STATUS	OK
THROTTLE VALVE ANGLE (degrees)	36
THR VALVE ADJUSTER (%)	57.6
OPERATING MODE ENGINE	PART
ADAPTATION STATUS	OK
THROTTLE VALVE ANGLE (degrees)	85
THR VALVE ADJUSTER (%)	39.2
OPERATING MODE ENGINE	FULL
ADAPTATION STATUS	OK

Type III

The third type is the full Drive-by-Wire electronic throttle module that came out in 2000 (VW) on the M7.0, M7.1, M7.5.1 engine management systems. This system is easily recognized by the absence of a throttle cable. The accelerator pedal has two position sensors (variable resistors) both installed in a single housing and connected to the accelerator pedal. The throttle valve is actuated by a servo motor (throttle valve positioner) which is control module-controlled. There are two throttle valve angle sensors which measure throttle valve position. Each one sends its own

signal to the control module. Dual sensors are used for backup plausibility on both the accelerator position and throttle actuator position sensors in case one fails.

Emergency Running or Limp-Home Mode

There are two emergency running modes for accelerator pedal sensor failure; one for when one accelerator pedal sensor fails, and one for when both accelerator pedal sensors fail.

When one accelerator pedal sensor fails:

- Accelerator position is limited to a predefined value.
- Brake pedal switch on indicates idling speed.
- If there are implausible signals between sensors, then the lower value is used.
- Comfort functions are disabled.
- Electronic Engine Power (EPC) light is illuminated.

When both accelerator pedal sensors fail:

- EPC light is illuminated.
- Engine runs only at idle speed.

There are three emergency running modes for throttle actuator module failure. One for when one throttle valve angle sensor fails, one for when the throttle valve actuator fails or malfunctions, and one for when throttle valve position is not recognized.

When one throttle valve angle sensor fails, engine power output is greatly reduced.

When the throttle valve actuator fails or malfunctions (both angle sensors are good) and when throttle valve position is not recognized (implausible signals):

- Voltage to the actuator is shutoff.
- Throttle valve defaults to mechanical stop position.
- Engine speed is limited to 1200 RPM.

It is important to note that the control module can open and close the throttle valve independently of the driver. For example, under certain conditions, such as during traction control or electronic transmission shift optimization controlling engine torque, the driver's foot may have little or no affect on acceleration. This system is an integrated subsystem, complete with its own on-board monitoring system and EPC indicator light.

EPC Indicator Light Operation

The EPC dash warning lamp is used for the Electronic Throttle Control System (Drive-by-Wire). The control module checks the throttle control system and turns the EPC light off if all checks out OK. It also turns the EPC light on if it detects a malfunction. Codes are stored and read at the control module.



NOTE:

Field technicians note that in addition to Drive-by-Wire faults, the EPC light may also be turned on for other engine non-emission related faults. If a fault is emission-related and EPC-related, then both MIL and EPC lights may be on.

**NOTE:**

At idle, neither the Throttle Valve Angle Sensor nor the Accelerator Pedal Position Sensor are monitored for faults. If the accelerator pedal module becomes disconnected, it may not set a code nor turn the EPC light on (field reports indicate that in some cases a throttle body code may set). In this condition, the engine only idles and does not respond to accelerator input.

Here is an example of a late model Drive-by-Wire data as read on the scan tool in display group 062 (EPCSYSTEM):

IDLE:

THROTTLE VALVE ANGLE SNS 1 (%)	11
THROTTLE VALVE ANGLE SNS 2 (%)	87
ACCEL.PEDAL POSITION SNS 1 (%)	14
ACCEL.PEDAL POSITION SNS 2 (%)	7

WOT:

THROTTLE VALVE ANGLE SNS 1 (%)	87
THROTTLE VALVE ANGLE SNS 2 (%)	11
ACCEL.PEDAL POSITION SNS 1 (%)	76
ACCEL.PEDAL POSITION SNS 2 (%)	38

Readings for Throttle Valve Angle Sns 1 & 2 are inverse to each other at idle and WOT. Also note that Accel Pedal Position Sns 1 is double Accel Pedal Position Sns 2 (this is true for any pedal position).

5.5 Testing ABS Systems

The following sections contain scan tool testing information for VW/Audi antilock brake systems (ABS).

**NOTE:**

The VW/Audi vehicle communication software starts VW/Audi US VIN ID in 1991 and only identifies those ABS systems with Codes and Data (does not retrieve blink codes).

The scan tool communicates with the VW ABS systems in Table 5-11.

Table 5-11 VW ABS system applications (part 1 of 2)

ABS Systems	Codes	Data
ABS 20 IE CAN	YES	YES
ABS 30 IE CAN	YES	YES
ABS 5.3 Front	YES	YES
ABS 5.7 Front	YES	YES
ABS Bosch 5	YES	YES
ABS Front MK60	YES	YES
ABS ITTAE 20 DI	YES	YES
ABS Teves 04	YES	NO
ABS/ASR 5.3 Front	YES	YES

Table 5-11 VW ABS system applications (part 2 of 2)

ABS Systems	Codes	Data
ABS/EDS 20 IE CAN	YES	YES
ABS/EDS 5.3	YES	YES
ABS/EDS 5.3 Front	YES	YES
ABS/EDS 5.3 Quattro	YES	YES
ABS/EDS Bosch 5	YES	YES
ABS/EDS ITTAE 20 GI	YES	YES
ABS/EDS Teves 02	YES	NO
ABS/EDS Teves 04	YES	NO
ABS/ESP Allrad	YES	YES
ABS/ESP Front	YES	YES
ASR 20 IE CAN	YES	YES
ASR Front MK60	YES	YES
Bremson-Elektronik	YES	YES
ESP 20 CAN	YES	YES
ESP 5.3 T4 Front	YES	YES
ESP 5.7 Allrad	YES	YES
ESP 5.7 Front	YES	YES
ESP 5.7 RS	YES	YES
ESP Allrad MK60	YES	YES
ESP Front MK60	YES	YES

Table 5-12 lists VW ABS systems and Table 5-13 lists Audi ABS systems.

Table 5-12 VW ABS types and system descriptions (part 1 of 2)

ABS Type	Year/Model	Codes/Data	Connector
TEVES MK II ABS/EDL	• 1990 Jetta GLI (9A)	Blink codes	Gear lever box under shift lever cover. White/ Black connector
	• 1991–92 Jetta GLI (9A)	Codes and Data	
	• 1989–91 Corrado (PG)	Blink codes	
	• 1992 Corrado (AAA)	Codes and Data	
TEVES MK IV ABS/EDL	<ul style="list-style-type: none"> • 1994–95 Jetta VR6 (AAA) • 1995 Cabriolet (ABA) • 1993–95 Golf (ABA) • 1995 Golf/GTI VR6 (AAA) • 1993–94 Corrado (AAA) • 1992–95 Passat (AAA) 	Codes and Data	The connector may be in one of three locations. See Table 3-3 on page 13 for connector location information.
EDL = Electronic Differential Lock; ASR = Anti-Slip Regulation; ESP = Electronic Stability Program			

Table 5-12 VW ABS types and system descriptions (part 2 of 2)

ABS Type	Year/Model	Codes/Data	Connector
TEVES ITT MARK 20 IE ABS/EDL Smaller pump than TEVES MK IV	<ul style="list-style-type: none"> • 1996 Passat (AAA) • 1997/8–2000 all models • 1998–2005 New Beetle 	Codes and Data	OBD-II DLC under left side of dash
TEVES 60 IE/EDL/ ASR/ESP/Front wheel drive or 4 Motion	<ul style="list-style-type: none"> • All 2003 models • 2005 New Golf GTI 	Codes and Data	OBD-II DLC under left side of dash
ABS/EDL/ASR/ESP No mechanical brake pressure regulator	<ul style="list-style-type: none"> • 1997–2003 Eurovan (Bosch 5.0/5.3) • Up to 2001 Passat (Bosch 5.3) • 2002–03 Passat (Bosch 5.7) • 2004–05 Phaeton (Bosch 5.7) 	Codes and Data	OBD-II DLC under left side of dash
EDL = Electronic Differential Lock; ASR = Anti-Slip Regulation; ESP = Electronic Stability Program			

Table 5-13 Audi ABS types and system descriptions

ABS Type	Year/Model	Codes/Data	Connector
BOSCH II ABS	<ul style="list-style-type: none"> • 1996–88 5000 Quattro • 1988–92 90/90 Quattro • 1992–94 80 	None	None
	<ul style="list-style-type: none"> • 1992–94 S4 • 1994 100 • 1995 A6/A6 Quattro 	Codes	Auxiliary relay station 1 at rear of engine compartment
BOSCH 5.0 ABS/EDL	<ul style="list-style-type: none"> • 1996–97 A6 	Codes and Data	
BOSCH 5.3 ABS/EDL/ASR/ESP	<ul style="list-style-type: none"> • 1998–2002 A4/A6/A8 	Codes and Data	OBD-II DLC under left side of dash
BOSCH 5.7 ABS/EDL/ASR/ESP	<ul style="list-style-type: none"> • 2002-2004 A4 • 2003-2004 A4 Cabrio • 2004 S4 • 2004 A8L 		
ABS/EDL/ASR ITT Mark 20 IE	<ul style="list-style-type: none"> • 2001–02 A4 • 2001–04 A6 • 2005 TT 		
MARK 60 IE ABS/EDP/ESP ITT	<ul style="list-style-type: none"> • 2003–05 TT • 2005 A3 		
EDP = Electronic Brake Distribution			

Important Tips for Audi ABS Testing

- In many of the newer models, there will be a series of beeps from the dash when you access the ABS controller (and the ABS light will be on during diagnostics). This is normal and is done to notify the driver that the ABS is nonfunctional while in diagnostic mode.

WARNING

Risk of erratic vehicle response.

- **Do not use the Output Tests function on any system while the car is in motion. Running Output Tests on the ABS can temporarily disable brakes entirely and cause individual wheels to lock and unlock.**

Erratic vehicle response can cause serious injury.

5.5.1 ABS Basic Settings

Basic Setting must be selected from Expert Mode to perform the following for late model traction and stability control:

- Zero position adjustment of steering angle sensor.
- Test the plausibility of sensor signals (yaw and press) for transverse acceleration.
- Any brake bleeding on systems equipped with Electronic Stability Control (ESP) (ESP hydraulic pump requires basic settings to bleed).



NOTE:

ABS/ESP Basic Setting brake bleeding usually requires login.

**To login for ABS/ESP Basic Setting brake bleeding:**

1. Select 03-ABS/EDL/ESP/TCS.
2. Select 11 Login.
3. Enter Login Code from Service Manual (varies with model and year).
4. Select channel 002.
5. Follow procedure from the Service Manual.

5.6 Testing Immobilizer Systems



NOTE:

All Immobilizer functions must be done in Expert Mode.

In the US, Volkswagen has three generations of antitheft systems.

The **first system** was used in the early 1990s. The 1996–99 Golf/Jetta may have a key fob with a transmitter used for remote activation of the Pneumatic Central Locking System. This system has no self-diagnostic capability and is nothing more than series of micro switches in the doors, hood and trunk and a starter lockout. When armed, the alarm would sound if a door, hood or trunk was opened and the starter circuit would be deactivated. The important aspect to remember here is that this system does not have an ignition key immobilizer, it is an alarm system only.

The **second system**, Immobilizer II. It came out on some 1999 models, but was used only on the 2000/2001 Golf, Jetta and New Beetle. Immobilizer II uses an electronic key that prevents the engine from starting without a matching key microchip. There is a symbol in the instrument cluster showing a key inside a car. If a new (or different control module) is installed in the vehicle, the Immobilizer prevents the engine from running and causes the symbol to flash. The scan tool performs all of the adaptation functions on the Immobilizer II system including new key adaptation, but only if the 4-digit security code is available for that specific vehicle. This security code may be found under a scratch-off tag on the key fob or a scratch-off tab on the instrument cluster (which has to be removed to inspect).

The **third system**, called Immobilizer III, came out on some VW models in approximately 1999. Electric door locks replaced the pneumatic locks and Radio Remote Key fobs are replaced with either a straight or switchblade-type key that has an embedded transmitter. Immobilizer III also uses an electronic key. The Immobilizer prevents the engine from running without a matching key microchip. There is a symbol in the instrument cluster showing a key inside a car. If a new (or different control module) is installed in the vehicle, the Immobilizer prevents the car from running and causes the symbol to flash. The Immobilizer III system has self-diagnostic capability for both the remote and Locking Security System. The Immobilizer III system incorporates 4 systems:

- Central Door Lock System (35)
- Comfort System (46)
- Electronic Instrument Panel (17)
- Engine Control Module (01)

5.6.1 Important Tips for Testing Immobilizer III Systems

- Key matching is performed using an adaptation function in the Comfort System (46). With this system, a 7-digit secret key code (SKC) is required in order to perform any adaptation routine on most models. However, some early (1999) models use the 4-digit security code from the Immobilizer II system.
- The 7 digit security code routine changes depending on whether you are using a brand new control module that has never been in any other car, or if you are using a used control module that has been previously matched to another car. See “Immobilizer II Engine Control Module Replacement Adaptation” on page 77.
- The scan tool does not perform the Immobilizer III key adaptation function. The system requires a special 7-digit secret key code (SKC) currently only obtained from the VW or Audi dealer. In the future, the factory tool may be hooked directly to a VW site and eliminate the need for the dealer to obtain the code. However, the scan tool does read the 14-digit Immobilizer control module identification number which must be provided along with the VIN to obtain the 7-digit security code. The scan tool also can perform ignition key matching to the key remote control system (see “Radio Frequency Remote Control Functions” on page 81). The information on Immobilizer III key adaptation is only to help you understand the process given the extreme importance and need. Please understand that this information is subject to change and is only current for the date at the time this manual was written.

5.6.2 Audi Immobilizers

In the US, some early Audi models (1995–1996 A6) use the Infrared Remote key system and Pneumatic Central Locking that has no diagnostic capability. The 1997 A6, may have remote keys or a key fob with a transmitter to activate the central locking system. The remote key fob does not have diagnostic capability but the Central Locking does. Audi started using the Immobilizer III system in 1998.

5.6.3 Immobilizer Adaptation Procedures

The following sections provide Immobilizer adaptation procedures.

Immobilizer II Engine Control Module Replacement Adaptation

The following procedure introduces a new control module to the instrument cluster. This must be performed each time the engine control module is replaced on a system with Immobilizer II.



To perform control module replacement adaptation with Immobilizer II:

1. Install the new control module in the car.
2. Connect the scan tool to the vehicle and select **Expert Mode** (see “Initiating Expert Mode” on page 19 for more information).
The Expert Mode System Selection menu displays.
3. Select **17-Electronic Instrument Panel**.
The Expert Mode Function Selection menu displays.
4. Select **10-Adaptation**.
The Select Adaptation Channel screen displays.
5. Scroll in Channel **000** and press **Y**.
The Clear Adaptation Values confirmation screen displays.
6. Select to clear adaptation values.
The Adaptation Value Stored screen displays.
7. Select exit.
8. Select **06-Stop Communication**.
9. Turn the ignition off for 10 seconds, then back on again. Leave the ignition on for two minutes without starting the engine. After two minutes, start the vehicle.

Key Coding (Adaptation)

The following procedure outlines the key coding (adaptation) procedure for the Immobilizer II (early Immobilizer III) systems that use a 4-digit security code. Currently, the scan tool cannot perform key matching or adapting using the 7-digit security code obtained from the dealer. The 4-digit security code was available through 1999 (Immobilizer II) and may be found under a scratch-off tag on the key fob, or on a scratch-off tab on the instrument cluster (which has to be removed to inspect). All keys must be available at the start of the adaptation procedure.

**To perform a key adaptation:**

1. Connect the scan tool to the vehicle and select **Expert Mode** (see “Initiating Expert Mode” on page 19 for more information).
2. Select **17-Electronic Instrument Panel** (integrated immobilizer) or **25-Immobilizer** if separated.
The Function Selection menu displays.
3. Select **11-Login Request**.
4. Scroll in the 4-digit security code preceded with a zero (for example, 0XXXX).
5. Select to return to the Function Selection menu.
6. Select **10-Adaptation**.
7. Scroll in 021 (or 001 for separate Immobilizer 25).
8. Scroll in the number of keys to be programmed and select to store.
After 2 seconds, the Immobilizer warning light in the dashboard should go off. The key in the ignition is now matched (adapted).
9. Select to return to the Function Selection menu.
10. Turn the ignition off and remove the key from the ignition switch
11. Insert the next key into the ignition switch and turn the ignition switch on.
The dashboard Immobilizer warning light should go on for about 2 seconds, then go out.
12. As soon as the warning light goes out, turn the ignition off and remove the key.
This key is now matched (adapted).
13. Insert the next key into the ignition switch and turn the ignition switch on (within 30 seconds) and repeat procedure.

NOTE:

All keys must be inserted and the ignition switch turned on within 30 seconds after removing the last key.

14. After all keys are adapted, **exit** to return to the Function Selection menu.
15. Select **06-Stop Communication** before disconnecting the scan tool.

NOTE:

Any keys that are not present for the adaptation will not be recognized by the vehicle after the matching has completed. Any keys that are not adapted cause the Immobilizer light to flash. If a mismatched or unadapted key is used to start the car, the engine starts, runs for 2 seconds, and then dies.

Immobilizer III Engine Control Module Replacement Adaptation

The following procedure introduces a new control module to the instrument cluster. This must be performed when the engine control module is replaced on an Immobilizer III system.

**To perform control module replacement adaptation with Immobilizer III:**

1. Measure battery voltage.
Voltage should be maintained at 12.5V or higher.
2. Install the new control module in the vehicle.

3. Connect the scan tool to the vehicle and select **Expert Mode** (see “Initiating Expert Mode” on page 19 for more information).
The System Selection menu displays.
4. Select **01-Engine Management Master**.
The ECU ID screen displays.
5. Verify that the VIN and the 14-digit Immobilizer serial number have been written to the new control module by checking the ECU ID.
If they have not been written automatically to the new control module from the instrument cluster, a row of Xs displays, indicating that this action cannot be performed with the scan tool (requires 7-digit security code). If the VIN and the 14-digit serial number display, continue with the following steps to validate that the control module was coded correctly.
6. Select to proceed to the Function Selection menu.
7. Select **07-ECU Coding** to make sure the control module coding is correct.
8. Select to return to the Function Selection menu.
9. Perform a Readiness Code Setting. See the “Volkswagen/Audi OBD-II Readiness Code Charts” supplement manual for details.

Immobilizer II and III Adaptation: Remote Key Programming (Integrated Remote)

New or additional ignition keys must be matched to the Immobilizer and comfort system control electronics. The matching procedure must always be carried out for all the ignition keys, including the existing ones. The number of keys already matched will be displayed when the adaptation (matching) function is selected. You must have all ignition keys available to perform this procedure. If there is no existing ignition key, contact your VW/Audi dealer.



To match ignition keys to radio frequency remote control:

1. Insert correct profile (mechanically-programmed key marked “W”) key into the ignition lock (usually there is one mechanical key and 2 switchblade-type remote keys marked “W3”).
2. Connect the scan tool to the vehicle and select **Expert Mode** (see “Initiating Expert Mode” on page 19 for more information).
3. Select **46-Comfort System**.
4. Select **10-Adaptation**.
5. Enter Channel 000 (erase all keys with channel number 000).
It is not possible to match new or additional keys without erasing existing keys.
6. Select to confirm the deletion of learned values.
7. Scroll in Channel 001.
All keys are “learned” with channel number 001.
8. Scroll to select the number of keys, including the existing mechanical key in the ignition switch, (e.g. 00003) and select to confirm.
There is a maximum of four possible keys that can be matched.
9. Select to exit back to the Function Selection menu.
10. Press the lock or unlock button for one second, once on each of the radio frequency keys to be “learned” (in the example above, two keys). This must be completed within 15 seconds after exiting.
11. After all the remote keys are adapted, select **06-Stop Communication**.

12. Switch off the ignition and remove the ignition key.
13. Test the remote keys for proper operation.

VW 1996–99 Remote Key Programming (Separate Remote)

Two keys and all remote controls that will be programmed are needed. A maximum of four keys can be programmed (old and new keys included).



To program 1996–99 mechanical keys:

1. Insert the first key into the ignition switch and turn it to “ignition on.”
2. Insert the second key into the outer door handle and turn it to the unlocked position for 10 seconds.
The system alarm will beep three times.
3. Press button 1 on the first remote control to be programmed.
The system alarm will beep two times.
4. Press button 1 on the second remote control to be programmed.
The system alarm will beep two times.
5. Do the same for any further keys you wish to program.



NOTE:

All remote controls must be programmed within one minute, otherwise the new programming will be cancelled.

6. Turn the key in the outer door handle to the unlocked position for 10 seconds.
The system alarm will beep once.
7. Switch the ignition off.

Important Tips for Setting Immobilizer Adaptations

- All keys are “learned” in one matching sequence.
- 15 seconds must not be exceeded when matching all ignition keys (pressing either the lock or unlock button).
- A successful adaptation can be determined via Read Measured Value Block, function 08, display group number 013. The operation of the radio frequency unit measurement values must have the status OK. Simultaneously, the last measurement value will show the positional number of the key (i.e. first, second, third, fourth).
- If the remote control key is operated several times, the third display “no measured value” changes to “OK.”
- The matching of ignition keys is automatically terminated when:
 - Number of keys to be matched is reached.
 - A button of one of the keys to be “learned” is pressed frequently.
 - Permissible matching period of 15 seconds is exceeded (DTC is stored).
- Select function 02-Check DTC Memory. If there is no DTC stored, the matching of the keys has been successfully completed.

5.6.4 Radio Frequency Remote Control Functions

The functions in Table 5-14 on page 81 are examples of remote control variations that can be adapted by selecting 46-Comfort Systems > 10-Adaptation > channels 003–010.



To change the battery in the remote key:

1. Insert a screwdriver in the slot between the transmitter unit -1- and the main key.
2. Move the screwdriver to unclip the transmitter unit from the main key.
3. Pry the transmitter unit apart on the two locating lugs.
4. Unclip the upper battery from the retainers with a screwdriver.

The contact plate has two straight edges. When these edges are turned toward the retainers, the contact plate can be removed. The contact plate can also be unclipped with a screwdriver.

5. Unclip the lower battery from the retainers with a screwdriver.

Table 5-14 Sample remote key option settings

Passat, New Beetle, New Jetta, New Golf			
Channel	1998	1999–2000	Condition
03	Auto-lock: Vehicle is locked at 10 MPH (15 KPH)	Auto-lock: Vehicle is locked at 10 MPH (15 KPH)	1 = On 0 = Off
04	Interior monitoring switch off (if equipped)	Auto-unlock: Vehicle is unlocked when key is removed	
05	Unlock: Horn sounds	Interior monitoring switch off (if equipped)	
06	Lock: Horn sounds	Unlock: Horn sounds	
07	Unlock: Turn signals flash twice	Lock: Horn sounds	
08	Lock: Turn signals flash once	Unlock: Turn signals flash twice	
09	—	Lock: Turn signals flash once	
10	—	Not for North American vehicles	—

6. Place the battery with the positive terminal downward into the transmitter (positive terminal is marked on the housing).

Note the polarity and correct position when installing the batteries.

7. Place the contact plate on the battery.
8. Place the battery, with the positive terminal downward, onto the contact plate and secure.
9. Place the transmitter halves together and clip to fasten.
10. Engage the transmitter unit with the main key.



NOTE:

When operating a radio wave remote control, the LED must flash briefly. If the LED does not flash, the battery is discharged and must be replaced.

5.6.5 Immobilizer Frequently Asked Questions

Refer to the following frequently asked questions for additional information.

How do you tell if you have an Immobilizer?

With the key on and engine off, look for a yellow key dash light which should come on momentarily and then off.

What does a flashing key dash light mean?

If it does not go out and starts flashing, then the Immobilizer has detected a problem and most likely the engine will not start.

What are the possible causes for the Immobilizer light to flash?

- Wrong ignition key was inserted into the ignition switch
- Faulty key transponder
- Faulty control module
- Faulty Instrument Cluster

What should always be done after working on the Immobilizer system?

- Check and clear any engine faults.
- Check and clear any Immobilizer (25) faults.
- Check and clear any CAN bus (19) faults.
- Check and clear any Instrument Cluster (17) faults.

How do you tell if you have Immobilizer II or III?

Immobilizer III knows the VIN, which is imbedded in the CAN bus control unit.



To distinguish between Immobilizer II or III:

1. Connect the scan tool to the vehicle and select **Expert Mode** (see “Initiating Expert Mode” on page 19 for more information).
2. Select **17-Electronic Instrument Panel** or **25-Immobilizer (Separated)**.
3. Select until the ECU ID screen displays.

If you see something like “Immo-ID VWZ7Z0W0648696”, you have Immobilizer II.

If you see something like “WVZKB58001H231169 VWZ7Z0W0648696”, you have Immobilizer III. The first 17-digit string is the VIN. The second 14-digit string is the Immobilizer identification number.

What does the scan tool do on Immobilizer II?

It can perform all Immobilizer functions if the 4-digit, vehicle-specific security code is known.

Does the scan tool work on Immobilizer III?

Yes. The scan tool can do key matching to the remote system and remote key adaptation. However, the scan tool cannot adapt new keys or adapt either a control module or Instrument Cluster to the Immobilizer III system.

Is the key matching to the remote system the same procedure for Immobilizer II or III?

Yes, although there may be different remote key option configurations depending on the vehicle.

5.7 Testing Electronic Instrument Panel Systems

The following sections provide information for testing electronic instrument panel systems.

5.7.1 Electronic Instrument Panel Types

There are several types of Electronic Instrument Panels and the possibilities of each type are described in the following sections.

Electronic Instrument Panel, Type A

The available functions are:

- Reset Service Interval Oil(Km)
- Reset Service Interval Insp1(Km)
- Reset Service Interval Insp1(Days)
- Reset Service Interval Insp2(Days)

After an Oil Service, the following must be used:

- Reset Service Interval Oil(Km)

After an Inspection 1, the following must be used:

- Reset Service Interval Oil(Km)
- Reset Service Interval Insp1(Km)
- Reset Service Interval Insp1(Days)

After an Inspection 2, the following must be used:

- Reset Service Interval Oil(Km)
- Reset Service Interval Insp1(Km)
- Reset Service Interval Insp1(Days)
- Reset Service Interval Insp2(Days)

Electronic Instrument Panel, Type B

The available functions are:

- Reset Service Interval
- Pre-set Value Oil(Km)
- Pre-set Value Insp1(Km)
- Pre-set Value Insp1(Days)
- Read, Set Km Remaining To Oil Service
- Read, Set Km Remaining To Insp1
- Read, Set Days Remaining To Insp1

After any service, with the dashboard service indication on, the following must be used:

- Reset Service Interval

After an Oil Service, with the dashboard service indication off, such as a premature service, use the following function:

- Read, Set Km Remaining To Oil Service

After an Inspection 1, with the dashboard service indication off, such as a premature service, use the following functions:

- Read, Set Km Remaining To Insp1
- Read, Set Days Remaining To Insp1

Electronic Instrument Panel, Type C

The available functions are:

- Pre-set Value Oil(KM)
- Pre-set Value Oil(Days)
- Pre-set Value Insp1(Days)
- Pre-set Value Insp2(KM)
- Read, Reset Km After Oil Service
- Read, Reset Days After Oil Serv.
- Read, Reset Days After Insp1
- Read, Reset Km After Insp2

After performing the Oil Service, the following functions must be used:

- Read, Reset Km After Oil Service
- Read, Reset Days After Oil Serv.

After performing the Inspection 1, the following function must be used:

- Read, Reset Days After Insp1

After performing the Inspection 2, the following function must be used:

- Read, Reset Km After Insp2

Electronic Instrument Panel, Type D

The available functions are:

- Pre-set Value Oil(Km)
- Pre-set Value Insp1(Days)
- Read, Reset Km After Oil Service
- Read, Reset Days After Insp1

After an Oil Service, the following function must be used:

- Read, Reset Km After Oil Service

After an Inspection 1, the following function must be used:

- Read, Reset Days After Insp1

Electronic Instrument Panel, Type E

The available functions are:

- Reset Service Interval
- Pre-set Value Oil(Km)
- Pre-set Value Insp1(Days)
- Read, Reset Km After Oil Service
- Read, Reset Days After Insp1

After any service, with the dashboard service indication on, the following must be used:

- Reset Service Interval

After an Oil Service, with the dashboard service indication off, i.e. a premature service, the following function must be used:

- Read, Reset Km After To Oil Service

After an Inspection 1, with the dashboard service indication off, i.e. a premature service, the following function must be used:

- Read, Reset Days After Insp1

Electronic Instrument Panel, Type F

The Type F Instrument Panel can be programmed to use fixed or flexible Service Intervals (Table 5-15). For a fixed interval, the variables are set 15,000 KM. For flexible Service Intervals, minimum distance is set to 15,000 KM and Maximum is set to 30,000, 35,000 or 50,000 KM.

Table 5-15 *Service intervals*

Vehicle Type	Interval Type Required
Vehicles with fixed intervals (Oil Quality 1)	Fixed intervals (15000 kilometers, 9300 miles)
Gasoline engines (Oil Quality 2)	Flexible intervals (30000 kilometers, 18600 miles)
6-cylinder diesel engines (Oil Quality 3)	Flexible intervals (35000 kilometers, 21700 miles)
Diesel engines (Oil Quality 4)	Flexible intervals (50000 kilometers, 31000 miles)
Insp1 has a factory setting of 365 days (1 year) for fixed intervals and 730 days (2 years) for flexible intervals.	

The available functions are:

- Reset Service Interval
- Pre-set Value Oil Quality(Km)
- Pre-set Value Min Oil(Km)
- Pre-set Value Max Oil(Km)
- Pre-set Value Insp1(Days)

After the Inspection the following functions must be used:

- Pre-set Value Oil Quality(Km)

Even when this number stays the same, this value must be changed. It is necessary for the internal housekeeping of the Instrument Panel. When the Oil Quality has been changed, check Minimum, Maximum and Insp1 for correct values, then reset the rest of the Instrument Panel.

- Reset Service Interval

Electronic Instrument Panel, Type G

The Type G Instrument Panel can be programmed to use fixed or flexible Service Intervals. Interval variables are the same as for a Type F Instrument Panel. See Table 5-15 on page 85 for service intervals.

The available functions are:

- Reset Service Interval
- Pre-set Value Oil Quality(Km)
- Pre-set Value Min Oil(Km)
- Pre-set Value Max Oil(Km)
- Pre-set Value Min Insp(Days)
- Pre-set Value Max Insp(Days)

After the Inspection the following functions must be used:

- Pre-set Value Oil Quality(Km)

Even when this number stays the same, this value must be changed. It is necessary for the internal housekeeping of the Instrument Panel. When the Oil Quality has been changed, check Minimum, Maximum Oil and Minimum, Maximum Insp for correct values, then reset the rest of the Instrument Panel.

- Reset Service Interval

Electronic Instrument Panel, Type H

The available functions are:

- Reset Service Interval
- Pre-set Value Oil(Miles)
- Pre-set Value Insp1(Days)
- Read, Reset Miles After Oil Service
- Read, Reset Days After Insp1

After any service, with the dashboard service indication ON, the following must be used:

- Reset Service Interval

After an Oil Service, with the dashboard service indication OFF (a premature service), the following function must be used:

- Read, Reset Miles After Oil Service

After an Inspection 1, with the dashboard service indication OFF, (a premature service), the following function must be used:

- Read, Reset Days After Insp1

Electronic Instrument Panel, Type I

The available functions are:

- Reset Service Interval
- Pre-set Value Min Oil(Km)
- Pre-set Value Max Oil(Km)
- Pre-set Value Min Insp(Days)

After the service the following must be used:

- Reset Service Interval

Electronic Instrument Panel, Type J

The Type J Instrument Panel can be programmed to use fixed or flexible Service Intervals. Interval variables are the same as for a Type F Instrument Panel (see Table 5-15 on page 85).

The available functions are:

- Reset Service Interval
- Pre-set Value Oil Quality(Miles)
- Pre-set Value Min Oil(Miles)
- Pre-set Value Max Oil(Miles)
- Pre-set Value Insp1(Days)

After the Inspection the following functions must be used:

- Pre-set Value Oil Quality(Miles)

Even when this number stays the same, this value must be changed. It is necessary for the internal housekeeping of the Instrument Panel. When the Oil Quality has been changed, check Minimum, Maximum Oil and Minimum, Maximum Insp for correct values, then reset the rest of the Instrument Panel.

- Reset Service Interval

Electronic Instrument Panel, Type K

The available functions are:

- Reset Service Interval

After the service the following function must be used:

- Reset Service Interval

Refer to the vehicle owner's manual for the actual values of the Service Interval settings.

5.8 Testing Airbag (SRS) Systems

There are currently three types of airbag (SRS) systems on VW/Audi vehicles.

Airbag I came out in 1989 and was used until about 1993 for both VW and Audi. This system had only one driver's side airbag and limited diagnostics—codes only (no data). California emission equipped vehicles may have red, white and black connectors. The red connector is for the Airbag I system. If the vehicle is Federal emission equipped, then it may only have a red and black connector. The airbag module on this system is pre-coded at the factory (no version coding).



NOTE:

To read Airbag I codes without code definitions by hooking the white connector of the VW-1 adapter to the red vehicle connector and the black VW-1 connector to the black vehicle connector.

Airbag II was used from 1994 to 1995 for Audi models and from 1996 to 1998 for VW models. This SRS system displays codes and data and the module is version coded. This system uses pyrotechnics for seatbelt retraction and has dual airbags, one for the driver (steering wheel) and one for the passenger (front dash).

Airbag III is used from 1996 to 2003 for Audi models and from 1998 to 2003 for VW models. This system displays codes and data and the module is version coded. This system also uses pyrotechnics for seatbelt retraction and has dual airbags for the driver (steering wheel) and passenger (front dash).

Note the following when working on SRS systems:

- 1993–94 VW vehicles may have no airbag systems.
- For Airbag I, Audi has recalled KF for a static electricity deployment problem. The recall converts the system to an Airbag II module with codes and data but still has only the one driver's side airbag. To see if recall has been done, lift up the rear seat and look for two separate modules bolted to the body sheet metal. If both modules have been removed and the harnesses are taped, then the recall has been performed. If these two modules are present, then recall has not been performed and should be done.
- Airbag II and III systems are version coded. Be sure to use the latest version coding tables and that the battery is fully charged before coding the airbag modules. Coding is performed with the key on, engine off. Battery voltage should not drop below 11.6V. High quality battery chargers with noise and voltage spiking suppression are recommended.

IMPORTANT:

Coding and module corruption may occur if the battery goes dead during the coding process.

- SRS components made for European vehicles are not the same as for the US. Certain aftermarket sport steering wheels with SRS may be available for sale that do not meet U.S. SRS deployment specifications. Always identify the correct airbag system and verify the correct component configuration prior to version coding.

5.9 Testing CAN Data Bus Systems

Late 2001 and early 2002 models started using a CAN (Controller Area Network) data bus, which affects diagnostics and how and when the scan tool is used. The CAN data bus ensures that the electronics in the vehicle still remain manageable and do not take up too much space. CAN means that control units are networked and interchange data.

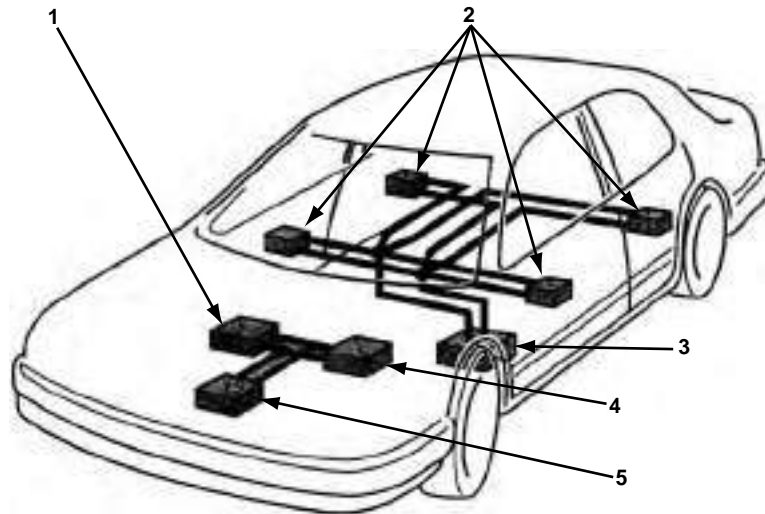

- 1— ABS control module
- 2— Door control modules
- 3— Central control module
- 4— Transmission control module
- 5— electronic control module

Figure 5-1 CAN control unit network

The CAN data bus is made up of a controller, a transceiver, two data bus terminals, and two data bus lines. Apart from the data bus lines, the components are located in the control units.

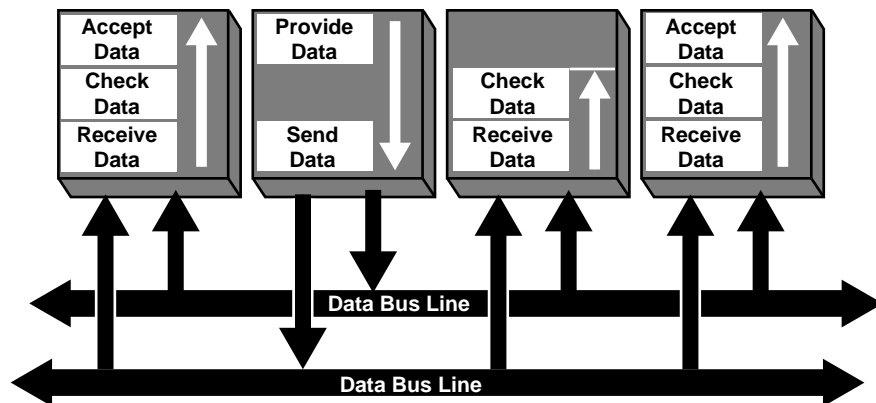

Figure 5-2 CAN bus data transfer process

The CAN controller receives the transfer data from the microcomputer integrated in the control unit. The CAN controller processes this data and relays it to the CAN transceiver. Likewise, the CAN controller receives data from the CAN transceiver, processes it and relays it to the microcomputer integrated in the control unit.

The data bus does not have a designated receiver. Data is sent over the data bus and is generally received and evaluated by all subscribers (modules on the data bus).

5.9.1 Sources of Interference

Components which produce sparks or in which electric circuits are open or closed during operation can be sources of interference. Other sources of interference include mobile telephones and transmitter stations, or any other object which produces electromagnetic waves. Electromagnetic waves can affect or corrupt data transfer.

To prevent interference with the data transfer, the two data bus lines are twisted together so that the voltage on both lines is opposed. That means that if a voltage of approximately 0 Volts is applied to the one data bus line, then a voltage of approximately 5 Volts is applied to the other line and vice versa. As a result, the total voltage remains constant at all times and the electromagnetic field effects of the two data bus lines cancel each other out. The data bus line is protected against received interference and is virtually neutral in sending interference.

5.9.2 Powertrain CAN Bus

The CAN data bus links the following:

- The Motronic Engine management control unit
- The ABS/EDL control unit
- The automatic gearbox control unit

The data bus operates at a speed of 500 kbit/s (500,000 bits per second). This means that it lies in a speed range (high speed) from 125 to 1000 kbit/s. A data protocol transfer takes about 0.25 milliseconds. Each control unit tries to send its data at intervals of 7–20 milliseconds.

If more than one control unit wants to send its data protocol simultaneously, the system must decide which control unit comes first. For safety reasons, the data protocol supplied by the ABS/EDL control unit is more important than the data protocol supplied by the engine control unit or automatic gearbox unit, so ABS/EDL data takes priority and is sent first. Table 5-16 demonstrates the order of priority of data on the CAN bus line.

Table 5-16 Order of CAN bus information priorities in the drive train

Priority	Control Unit	Example
1	ABS/EDL	Request for Traction Control System (TCS)
2	ECU, data protocol 1	Engine speed; throttle valve position; kickdown
3	ECU, data protocol 2	Coolant temperature; road speed
4	TCM	Gearshift; gearbox in emergency mode; selector lever position

**NOTE:**

All control units which interchange information must be regarded as an integrated system during self-diagnosis and troubleshooting. This means data displayed at one control unit may actually be shared from another control unit on the CAN Bus. Codes set in one control unit will often set codes in other control units which share the data bus. Always clear codes in each control unit and monitor in which control unit the codes return.

5.9.3 CAN Data Bus in the Convenience System

The following functions of the convenience system transfer data:

- Central locking
- Electric windows
- Switch illumination
- Electrically adjustable and heated door mirrors
- Self-diagnosis

In the convenience system, the CAN data bus currently connects the control units of the convenience system. These are a central electronic unit (09) and two or four door Central door Lock (35) control units.

The lines of the control units converge at one point in a star pattern. The advantage: if one of the control units fails, the other control units are still able to send their data protocols. Each control unit tries to send its data at intervals of 20 milliseconds.

The following list describes how the information in the convenience system is prioritized:

1. Central control unit
2. Control unit on driver's side
3. Control unit on front passenger's side
4. Control unit on rear left
5. Control unit on rear right

Since the data in the comfort system can be transferred at a relatively low speed, it is possible to use a transceiver with a lower power output. The advantage is that it is possible to change over to single-wire mode if a data bus line fails. The data can still be transferred.

The following chapters provide definitions and operating ranges for the Volkswagen and Audi vehicle data stream parameters.

The ECM provides two basic kinds of parameters: digital (or discrete) and analog:

- **Digital (discrete) parameters** are those that can be in only one of two states, such as on or off, open or closed, high or low, rich or lean, and yes or no. Switches, relays, and solenoids are examples of devices that provide discrete parameters on the control module data list.
- **Analog parameters** are displayed as a measured value in the appropriate units. Voltage, pressure, temperature, time, and speed parameters are examples of analog values. The scan tool displays them as numbers that vary through a range of values in units, such as pounds per square inch (psi), kilopascal (kPa), degrees Celsius (°C), degrees Fahrenheit (°F), kilometers per hour (KPH), or miles per hour (MPH).

The scan tool displays some data parameters in numbers that range from 0 to 100, 0 to 255, or 0 to 1800. These ranges are used because it is the range that the control module transmits for a given parameter. However, many parameter readings never reach the highest possible number.

The maximum range of a parameter often varies by year, model, and engine. On these applications, the word “variable” appears in the range heading. However, typical sampled values observed under actual test conditions are in the parameter description when available.

Parameters may also be identified as input signals or output commands.

- **Input or feedback parameters** are signals from various sensors and switches to the control module. They may display as analog or discrete values, depending upon the input device.
- **Output parameters** are commands that the control module transmits to various actuators, such as solenoids and fuel injectors. They are displayed as discrete (ON/OFF) parameters, analog values or as a pulse-width modulated (PWM) signal.

In the following section, parameters are presented as they appear on the scan tool screen. Most parameter descriptions are in alphabetical order, but there are exceptions. Often, the same parameter goes by a similar, but different, name when used on more than one model, engine, or control system. In these instances, all of the applicable parameter names, as displayed on the scan tool, are listed in alphabetical order before the description.

To find the description of a parameter, locate it in the alphabetical index, then go to the indicated page. Parameters are listed in the index as they appear on the scan tool screen.

The data parameter descriptions in this manual were created from a combination of sources. For most parameters, some basic information was provided by the vehicle manufacturers, then expanded through research and field testing. Parameter definitions and ranges may expand as more test results become available. For some parameters, no information is currently available.

The scan tool may display names for some data parameters that differ from names displayed by a factory tool and other scan tools.

Always use a meter or lab scope, to further validate the displayed values. If data is corrupted on multiple parameters, do not assume that the control module may be faulty. This corrupt data may be caused by improper communication between the scan tool and the control module controller.

6.1 Alphabetical Parameter List

A

A/C COMP SW OFF BY ENG-ECU	105
A/C COMPRESSOR	105
A/C COMPRESSOR OFF	105
A/C COMPRESSOR ON	105
A/C KICKDOWN	140
A/C MODE	105
A/C READINESS	105
A/C SWITCH	105
A/T	140
A/T INPUT(RPM)	140
A/T INPUT(RPM)	141
A/T INPUT(RPM)	141
A/T OUTPUT(RPM)	141
A/T SWITCH	141
A/T(RPM)	140
ACCEL.PEDAL POSITION SNS 1(%)	105
ACCEL.PEDAL POSITION SNS 2(%)	105
ACCELERATION ENRICHMENT	105
ACCELERATOR PEDAL POSITION(%)	136
Accelerator Pedal Value	148
ACTUAL ADAPTATION POSITION(V)	105
Actual Engine Torque	148
ACTUAL SELECTED GEAR	140
ACTUAL SOLENOID(A)	140
ADAPTATION ABORTED(BATTERY <8V)	105
ADAPTATION ERROR	105
Adaptation of start-from-stop behavior forward	148
Adaptation of start-from-stop characteristics Reverse	148
ADAPTATION REQUIRED	105
ADAPTATION RUNNING	105
ADAPTATION STATUS	106
ADP ENG SPEED SENSOR(CROWN GEAR)	106
ADP IDLING STABILIZATION(kg/h)	106
ADP STOPPED(TIME EXCEEDED)	106
ADP THROTTLE VALVE ADJUSTER	106
ADP VALUE AIR MASS IDLE(%)	106
ADP VALUE CANP SYSTEM	106
ADP VALUE CANP VALVE	106
ADP VALUE CANP VALVE 1(%)	106
ADP VALUE ISC	106
ADP VALUE MIXTURE(BANK1)	107
ADP VALUE MIXTURE(BANK1)(%)	106
ADP VALUE MIXTURE(BANK2)	107
ADP VALUE MIXTURE(BANK2)(%)	106
AIR DIVERT VALVE	107
AIR MASS IDLE(g/s)	107
ALTERNATOR DEFECT	107
ALTERNATOR LOAD(%)	107
ALTITUDE CORRECTION FACTOR	107

ALTITUDE CORRECTION FACTOR(%)	107
AMBIENT TEMPERATURE(°C/°F)	107
ATF TEMPERATURE(°C)	141
AUX HEATING REQUESTED	107

B

BAROMETRIC PRESSURE(mbar)	107
BASE THR POS(IDLE SW CLSD)(°)	108
BASE VALUE THROTTLE ADJUSTER	108
BASE VALUE TPS	108
BASE VALUE TPS(V)	108
BATTERY VOLTAGE	141
BATTERY VOLTAGE BELOW 9V	136
BATTERY VOLTAGE TOO LOW	108
BATTERY(V)	108
BOOST PRESSURE(ACTUAL)(mbar)	108
BOOST PRESSURE(ACTUAL)(mbar)	136
BOOST PRESSURE(DESIRED)(mbar)	108
BOOST PRESSURE(DESIRED)(mbar)	136
BOOST PRESSURE(mbar)	108
BRAKE LIGHT SWITCH	141
BRAKE PEDAL PRESSED	108
BRAKE PEDAL SWITCH	108

C

CAM ADJUSTER MODE	108
CAMSHAFT ADJUSTER	109
CAMSHAFT ADJUSTER(ACTIVE)(°)	109
CAMSHAFT ADVANCE(°)	109
CAMSHAFT PHASING	109
CAMSHAFT POSITION(BANK 1)(°)	109
CAMSHAFT POSITION(BANK 2)(°)	109
CANISTER PURGE MODE	109
CANP CHARGE(%)	109
CANP FLUSH	109
CANP SYSTEM ACTIVE	109
CANP VALVE CLOSED	109
CANP VALVE ON CHARGE	109
CANP VALVE ON MIN MODE	109
CANP VALVE ON NORMAL MODE	109
CAT TEMPERATURE>300°C	109
CATALYST EFFICIENCY(%)	110
CATALYST TEMPERATURE(°C/F)	109
CHANGE OVER TO CHARGE MODE CANP	110
CHANGE OVER TO CLOSE MODE CANP	110
CHANGE OVER TO MIN MODE CANP	110
CLUTCH PEDAL PRESSED	110
CLUTCH PEDAL SWITCH	110
CODING FOR SYNCRO(4WD)	110
COMBINED HALL & ENG SPEED SIGN	110
CONTROL VALUE MIXTURE(%)	110
COOLANT TEMPERATURE >80°C	110

COOLANT TEMPERATURE(°)	136
COOLANT TMP >70°C/OR AIR TEMP >5°C	136
COOLANT/AIRTMP SNS DEFECT	136
CRUISE CTRL ENABLED	110
CRUISE CTRL STATUS	110
CTRL VALUE IDLE AIR MASS(g/s)	110
CTRL VALUE MIXTURE(BANK 1)(%)	110
CTRL VALUE MIXTURE(BANK 2)(%)	110
CTRL VALUE MIXTURE/O2	111
CTRL VALUE MIXTURE/O2(%)	111
CURRENT CONSUMPTION IAC(A)	111
CURRENT CTRL FACTOR IAC	111
CURRENT CTRL IAC(%)	111
CYLINDER 1 RECOGNIZED	111

D

DC(DUTY CYCLE)START OF DELIVERY	139
DECEL ENLEAN	111
DECELERATE POSITION	111
DECELERATION ENLEANMENT	111
DIAGNOSE LEARN VALUE O2(BK1)IDLE	111
DIAGNOSE LEARN VALUE O2(BK1)P/T2	111
DIAGNOSE LEARN VALUE O2(BK1)P/T3	111
DIAGNOSE LEARN VALUE O2(BK1)P/T4	111
DIAGNOSE LEARN VALUE O2(BK2)IDLE	111
DIAGNOSE LEARN VALUE O2(BK2)P/T2	111
DIAGNOSE LEARN VALUE O2(BK2)P/T3	111
DIAGNOSE LEARN VALUE O2(BK2)P/T4	111
DRIVING SLIP CTRL	148
DUTY CYCLE CANP VALVE	112
DUTY CYCLE CANP VALVE(%)	112
DUTY CYCLE EGR-VALVE(%)	112
DUTY CYCLE FAN CTRL VALVE(%)	112
DUTY CYCLE IAC(%)	112
DUTY CYCLE ISC(%)	112
DUTY CYCLE THR ADJUSTER(%)	112
DUTY CYCLE WASTE GATE VALVE(%)	112

E

EDS CUT OFF	150
EGR-SYSTEM	112
EGR-TEMPERATURE(°C/°F)	112
ENGINE CRANKED IN LAST 10S	136
ENGINE LOAD AFTER REDUC(ms)	113
ENGINE LOAD(%)	112
ENGINE LOAD(ACTUAL)(%)	112
ENGINE LOAD(ACTUAL)(ms)	113
ENGINE LOAD(ACTUAL)(Nm)	113
ENGINE LOAD(AFTER CORR)(ms)	113
ENGINE LOAD(BEFORE CORR)(ms)	113
ENGINE LOAD(ms)	112
ENGINE LOAD(V)	112

ENGINE SPEED <2000 RPM	113
ENGINE SPEED <2300 RPM	113
ENGINE SPEED <2500 RPM	113
ENGINE SPEED <760 RPM	113
ENGINE SPEED >1800 RPM	113
ENGINE SPEED >2500 RPM	113
ENGINE SPEED SIGNAL RECOGNIZED	113
ENGINE SPEED(ACTUAL)(RPM)	113
ENGINE SPEED(DESIRED)(RPM)	113
ENGINE SPEED(IDLE)(RPM)	113
ENGINE SPEED(RPM)	113
ENGINE SPEED(RPM)	136
ENGINE TORQUE MAX	142
ENGINE TORQUE(Nm)	141
EXHAUST GAS TEMPERATURE(°C/°F)	114

F

FUEL CONS. AUX HEATER(l/h)	136
FUEL CONSUMPTION ISC(g/s)	136
FUEL CONSUMPTION SIGNAL	149
FUEL CONSUMPTION(l/h)	136
FUEL COOLING(%)	114
FUEL CUT OFF	114
FUEL CUT-OFF VALVE ACTIVE	114
FUEL HEAT(l/h)	114
FUEL LOW	114
FUEL TEMPERATURE(°)	137
FULL LOAD	114
FULL LOAD DETECTED	114
FULL LOAD SWITCH	114

G

GEAR POSITION	142
GEAR SELECTED	149
GLOW TIME(s)	137
GLOW(s)	137

H

HALL-SENSOR(°)	114
HANDBRAKE	150
HILL FACTOR(%)	142

I

IAC INTEGRATOR	114
IDLE AIR CORRECTION(g/s)	114
IDLE AIR CTRL(%)	114
IDLE AIR MASS(g/s)	114
IDLE SPEED CTRL VALVE	115
IDLE SPEED CTRL VALVE(%)	115
IDLE SPEED SWITCH	115
IDLE SPEED SWITCH CLOSED	115

IDLE SPEED SWITCH OPEN	115
IDLE SPEED(ACTUAL)(RPM)	114
IDLE SPEED(DESIRED)(RPM)	114
IGN ADV W KNOCK & ISC(AV)(°)	115
IGN RTD BY A/T-ECU(°)	115
IGN RTD BY DIGITAL ISC(°)	115
IGN RTD BY KNOCK CTRL(°)	115
IGN RTD BY KNOCK CTRL(CYL 1)(°)	115
IGN RTD BY KNOCK CTRL(CYL 2)(°)	115
IGN RTD BY KNOCK CTRL(CYL 3)(°)	115
IGN RTD BY KNOCK CTRL(CYL 4)(°)	115
IGN RTD BY KNOCK CTRL(CYL 5)(°)	115
IGN RTD BY KNOCK CTRL(CYL 6)(°)	115
IGN RTD BY KNOCK CTRL(CYL 7)(°)	115
IGN RTD BY KNOCK CTRL(CYL 8)(°)	115
IGN RTD BY KNOCK(°)	115
IGN RTD BY KNOCK(ALL CYL)(°)	115
IGN RTD BY TCS-ECU(COLD)(°)	115
IGN RTD W/O KNOCK & W/O ISC(°)	115
IGN RTD WITH KNOCK & ISC(°)	115
IGNITION ADV REDUCTION	116
IGNITION ADV(CALCULATED)(°)	116
IGNITION ADVANCE(°)	116
IGNITION MAP	116
INCREASED IDLE SPEED WITH A/C ON	116
INCREASING RPM	116
INJ DIFF CYL 1 TO 3(mg/S)	137
INJ DIFF CYL 1 TO 4(mg/S)	137
INJ DIFF CYL 1 TO 5(mg/S)	137
INJ DIFF CYL 1 TO AVERAGE(mg/S)	137
INJ DIFF CYL 2 TO 3(mg/S)	137
INJ DIFF CYL 2 TO 4(mg/S)	137
INJ DIFF CYL 2 TO 5(mg/S)	137
INJ DIFF CYL 2 TO AVERAGE(mg/S)	137
INJ DIFF CYL 3 TO 4(mg/S)	137
INJ DIFF CYL 3 TO 5(mg/S)	137
INJ DIFF CYL 3 TO AVERAGE(mg/S)	137
INJ DIFF CYL 4 TO 3(mg/S)	137
INJ DIFF CYL 4 TO 5(mg/S)	137
INJ DIFF CYL 4 TO AVERAGE(mg/S)	137
INJ DIFF CYL 5 TO 3(mg/S)	137
INJ DIFF CYL 5 TO 4(mg/S)	137
INJ DIFF CYL 6 TO 3(mg/S)	137
INJ QUANTITY(CRUISE)(mg/S)	137
INJ QUANTITY(DESIRED)(mg/S)	137
INJ QUANTITY(DRIVER)(mg/S)	137
INJ QUANTITY(mg/S)	137
INJ QUANTITY(mm3)	116
INJ QUANTITY(SMOKE)(mg/S)	137
INJ QUANTITY(TCS)(mg/S)	138
INJ QUANTITY(TORQUE A/T)(mg/S)	138
INJ QUANTITY(TORQUE)(mg/S)	137
INJECTION TIME(AVERAGE)(ms)	116

INJECTION TIME(ms)	116
INTAKE AIR TEMPERATURE(°)	136
INTAKE MANIFOLD PRESSURE(%)	116
INTAKE MANIFOLD PRESSURE(mbar)	116
ISC INTGRATOR	116
ISC UNDER LOAD	117
ISC(CTRL FACTOR)	116
ISC(POSITION)	116
ISC(REACTION TO MALFUNCTION)	116

K

KICKDOWN SWITCH	142
KICKDOWN SWITCH	142
KNOCK CTRL(°)	117
KNOCK SENSOR(CYL 1)(V)	117
KNOCK SENSOR(CYL 2)(V)	117
KNOCK SENSOR(CYL 3)(V)	117
KNOCK SENSOR(CYL 4)(V)	117
KNOCK SENSOR(CYL 5)(V)	117
KNOCK SENSOR(CYL 6)(V)	117
KNOCK SENSOR(CYL 7)(V)	117
KNOCK SENSOR(CYL 8)(V)	117

L

LACK OF FUEL	117
LEARN AIR MASS IDLE(D)(g/s)	117
LEARN AIR MASS IDLE(g/s)	117
LEARN AIR MASS IDLE(P/N)(g/s)	117
LEARN INJECTION TIME(ms)	117
LEARN MIXT(BANK 1)(IDLE)(%)	118
LEARN MIXT(BANK 1)(IDLE)(%)	118
LEARN MIXT(BANK 1)(P/T)(%)	118
LEARN MIXT(BANK 1)(P/T)(%)	118
LEARN MIXT(BANK 1)(P/T1)(%)	118
LEARN MIXT(BANK 1)(P/T2)(%)	118
LEARN MIXT(BANK 1)(P/T3)(%)	118
LEARN MIXT(BANK 2)(IDLE)(%)	118
LEARN MIXT(BANK 2)(IDLE)(%)	118
LEARN MIXT(BANK 2)(P/T)(%)	118
LEARN MIXT(BANK 2)(P/T)(%)	118
LEARN MIXT(BANK 2)(P/T1)(%)	118
LEARN MIXT(BANK 2)(P/T2)(%)	118
LEARN MIXT(BANK 2)(P/T3)(%)	118
LEARN RANGE O2 IDLE	118
LEARN RANGE O2 P/T 2	118
LEARN RANGE O2 P/T 3	118
LEARN RANGE O2(BK1)IDLE	118
LEARN RANGE O2(BK1)P/T2	118
LEARN RANGE O2(BK1)P/T3	118
LEARN RANGE O2(BK1)P/T4	118
LEARN RANGE O2(BK2)IDLE	118
LEARN RANGE O2(BK2)P/T2	118

LEARN RANGE O2(BK2)P/T3	118
LEARN RANGE O2(BK2)P/T4	118
LEARN VALUE AIR MASS IDLE(%)	118
LEARN VALUE AIR MASS IDLE(g/s)	118
LEARN VALUE CANP SYSTEM	119
LEARN VALUE DC ISC	119
LEARN VALUE DC ISC(%)	119
LEARN VALUE DC ISC(A/T)	119
LEARN VALUE DC ISC(MUL)(%)	119
LEARN VALUE IAC	119
LEARN VALUE IDLE SPEED(NOT P/N)	119
LEARN VALUE IDLE SPEED(P/N)	119
LEARN VALUE ISC	119
LEARN VALUE ISC(AT IN D)	119
LEARN VALUE ISC(MT/AT IN P/N)	119
LEARN VALUE KICKDOWN(%)	119
LEARN VALUE MAF-SENSOR	119
LEARN VALUE MIXTURE	119
LEARN VALUE MIXTURE CORR	121
LEARN VALUE MIXTURE CORR(%)	121
LEARN VALUE MIXTURE CORR(ms)	121
LEARN VALUE MIXTURE(%)	120
LEARN VALUE MIXTURE(ADAPTIVE)	120
LEARN VALUE MIXTURE(ADP)(ms)	120
LEARN VALUE MIXTURE(BANK 1)	120
LEARN VALUE MIXTURE(BANK 1)(%)	120
LEARN VALUE MIXTURE(BANK 2)	120
LEARN VALUE MIXTURE(BANK 2)(%)	120
LEARN VALUE MIXTURE(CANP ACT)(%)	120
LEARN VALUE MIXTURE(IDLE)(%)	121
LEARN VALUE MIXTURE(P/T1)(%)	121
LEARN VALUE MIXTURE(P/T2)(%)	121
LEARN VALUE MIXTURE(P/T3)(%)	121
LEARN VALUE O2	121
LEARN VALUE O2 IDLE OK	124
LEARN VALUE O2 P/T 1 OK	124
LEARN VALUE O2 P/T 2 OK	124
LEARN VALUE O2 P/T 3 OK	124
LEARN VALUE O2 SNS 1(IDLE)(%)	124
LEARN VALUE O2 SNS 1(P/T)(%)	124
LEARN VALUE O2(%)	122
LEARN VALUE O2(ACTUAL)(BK1)(%)	122
LEARN VALUE O2(ACTUAL)(BK2)(%)	122
LEARN VALUE O2(BK1)	122
LEARN VALUE O2(BK1)(%)	122
LEARN VALUE O2(BK1)(ADD)(%)	122
LEARN VALUE O2(BK1)(IDLE)(%)	122
LEARN VALUE O2(BK1)(MUL)(%)	122
LEARN VALUE O2(BK1)(P/T)(%)	122
LEARN VALUE O2(BK1)IDLE OK	123
LEARN VALUE O2(BK1)P/T1 OK	123
LEARN VALUE O2(BK1)P/T2 OK	123
LEARN VALUE O2(BK1)P/T3 OK	123

LEARN VALUE O2(BK2)	122
LEARN VALUE O2(BK2)(%)	122
LEARN VALUE O2(BK2)(ADD)(%)	122
LEARN VALUE O2(BK2)(IDLE)(%)	122
LEARN VALUE O2(BK2)(MUL)(%)	122
LEARN VALUE O2(BK2)(P/T)(%)	122
LEARN VALUE O2(BK2)IDLE OK	123
LEARN VALUE O2(BK2)P/T1 OK	123
LEARN VALUE O2(BK2)P/T2 OK	123
LEARN VALUE O2(BK2)P/T3 OK	123
LEARN VALUE O2(FULL)	123
LEARN VALUE O2(IDLE)	123
LEARN VALUE O2(IDLE)(%)	123
LEARN VALUE O2(IDLE)(ms)	123
LEARN VALUE O2(P/T)	123
LEARN VALUE O2(P/T)(%)	123
LEARN VALUE O2(P/T)(MUL)(%)	123
LEARN VALUE O2(P/T-WOT)	123
LEARN VALUE THR VALVE ADJUSTER	124
LEARN VALUE TPS	124
LEARN VALUE TPS(V)	124
LIMITED DYNAMIC ACTIVE	124
LIMITED OPERATION(LIMP)	124
LOCK-UP SLIP	142
LOCK-UP SLIP	142
LOCK-UP SLIP	142
LOS MODE	124
LRN IDLING STABILIZATION(kg/h)	124
LRN VALUE ISC(g/s)	119

M

MAF 1(mg/S)	138
MAF 2(mg/S)	138
MAF DES(mg/S)	138
MAF IDLE(g/s)	124
MAF ISC TRIM(%)	124
MAF TRIM(g/s)	125
MAF-SENSOR(V)	125
MAP(%)	125
MAP(mbar)	125
MAP(V)	125
MAP-CONTROLLED IDLE SPEED	125
MASS AIR FLOW(ACTUAL)(g/s)	125
MASS AIR FLOW(ACTUAL)(mg/S)	138
MASS AIR FLOW(DESIRED)(g/s)	125
MASS AIR FLOW(DESIRED)(ms/S)	138
MASS AIR FLOW(g/s)	125
MASS AIR FLOW(mg/S)	138
MASS AIR FLOW(V)	125
MAX VALUE THR ADJUSTER(%)	125
MAX VALUE THR ADJUSTER(V)	125
MIN VALUE THR ADJUSTER(%)	125
MIN VALUE THR ADJUSTER(V)	126

MISFIRES PER 200 REVS(ALL CYL)	126
MISFIRES PER 200 REVS(CYL.1)	126
MISFIRES PER 200 REVS(CYL.2)	126
MISFIRES PER 200 REVS(CYL.3)	126
MISFIRES PER 200 REVS(CYL.4)	126
MISFIRES PER 200 REVS(CYL.5)	126
MISFIRES PER 200 REVS(CYL.6)	126
MISFIRES PER 200 REVS(CYL.7)	126
MISFIRES PER 200 REVS(CYL.8)	126
MIXTURE	126
MIXTURE CORR(CANP ACTIVE)	126
MIXTURE CORRECTION	126
MIXTURE CORRECTION(%)	126
MODE HALL-REFERENCE SIGNAL	126

O

O2 ACTIVE	126
O2 ADP & ACTUAL VALUE(%)	127
O2 CONTROL MODE	127
O2 CORR(CANP ACTIVATED)	127
O2 CORR(CANP ACTIVATED)(%)	127
O2 CTRL & ACT(BANK 1)(%)	127
O2 CTRL & ACT(BANK 2)(%)	127
O2 CTRL FACTOR(BANK 1)	127
O2 CTRL FACTOR(BANK 2)	127
O2 CTRL FACTOR(CYL 1-3)(%)	128
O2 CTRL FACTOR(CYL 4-6)(%)	128
O2 CTRL READY	128
O2 CTRL(BANK 1)(%)	127
O2 CTRL(BANK 2)(%)	127
O2 INTEGRATOR	128
O2 LOOP CLOSED	128
O2 REGULATION	128
O2 REGULATION ACTIVE	129
O2 REGULATION ON STOP	129
O2 REGULATION(%)	129
O2 REGULATION(BANK 1)(%)	129
O2 REGULATION(BANK 2)(%)	129
O2 SENSOR 1(V)	129
O2 SENSOR 2(V)	129
O2 SENSOR HEATER	130
O2 SENSOR HEATER AFTER CAT	130
O2 SENSOR HEATER BEFORE CAT	130
O2 SENSOR HEATER(BK1-SNS1)	130
O2 SENSOR HEATER(BK1-SNS2)	130
O2 SENSOR HEATER(BK2-SNS1)	130
O2 SENSOR HEATER(BK2-SNS2)	130
O2 SENSOR READY	130
O2 SENSOR(BANK 1)(V)	129
O2 SENSOR(BANK 1)(V)	129
O2 SENSOR(BANK 2)(V)	129
O2 SENSOR(BANK 2)(V)	129
O2 SENSOR(V)	129

O2 VALUE	130
O2 VALUE(ACTUAL)(%)	130
O2 VALUE(BANK 1)(%)	130
O2 VALUE(BANK 2)(%)	130
OIL TEMPERATURE(°C/°F)	131
On-Board Diagnostic	149
OPERATING MODE	131
OVERRUN	131
Overrun/engine pulling signal	149

P

PARK/NEUTRAL POSITION	131
PARK/NEUTRAL POSITION	131
PART LOAD DETECTED	131
PHASE POSITION BK1(°CA)	131
PHASE POSITION BK2(°CA)	131
PHASE POSITION HALL SNS(°)	131
POWER SUPPLY ECU(V)	150
PRESS CNTRL(%)	131
PRESSURE CTRL(A)	143

R

REAR HEATER MODE	131
REAR HEATER SWITCH	131
REDUCTION TORQUE(ACTUAL)(Nm)	131
REL.HEAT HIGH	138
REL.HEAT LOW	138
RELATIVE AIR MASS(%)	131
RELAY HEATER HIGH	138
RELAY HEATER LOW	138
REQUIRED SOLENOID #4	143
REQUIRED SOLENOID #5	143
REQUIRED SOLENOID #6	143
REQUIRED SOLENOID #7	143
REQUIRED SOLENOID(A)	143
RETARDED IGNITION POINT	131
RETARDED IGNITION POINT(°)	131
RETARDING STEPS	131
ROTATIONAL SPEED(°/s)	150
RTD SIGNAL A/T ACTIVE	132

S

SECONDARY AIR MASS(g/s)	132
SELECTOR OUTPUTS	149
SHIFT LEVER LOCK	143
SIGNAL FROM A/T	132
SLIDE VALVE SENSOR(MAX)(V)	132
SLIDE VALVE SENSOR(MIN)(V)	132
SLIDE VALVE SENSOR(V)	138
SOLENOID #1	143
SOLENOID #2	143
SOLENOID #3	143

SOLENOID #4	143
SOLENOID #5	143
SOLENOID #7	143
SPORT FACTOR(%)	145
START OF DELIVERY(°)	132
START OF DELIVERY(ACTUAL)	139
START OF DELIVERY(ACTUAL)(°)	132
START OF DELIVERY(DESIRED)	139
START OF DELIVERY(DESIRED)(°)	132
START QUANTITY(mg/S)	139
START SYNCHRONIZATION(°)	132
STATUS FUEL COOLING(%)	132
STEERING ANGLE(°)	150
SUM MISFIRES	132

T

TCS STATUS	145
TCS SWITCH	150
TEETH COUNT TILL HALL-SIG SHIFT +TO -	132
THR ADJ SENSOR, MAX LRN OK/EXEC	132
THR ADJ SENSOR, MIN LRN OK/EXEC	132
THR ADJ/TPS BALANCE OK/EXEC	133
THR ADJUSTER(LIMP)(%)	133
THR POS SENSOR(AV)(LIMP)(V)	133
THR POS SENSOR(THR STOP)(V)	133
THR VALVE ADJUSTER ANGLE(V)	133
THR VALVE ANGLE(ABSOLUTE)(°)	133
THR VALVE ANGLE(LEARN)(°)	133
THROTTLE ADJUSTER MODE	133
THROTTLE POSITION SENSOR(V)	133
THROTTLE POSITION(IDLE)(V)	133
THROTTLE VALVE ADJUSTER ANGLE(°)	133
THROTTLE VALVE ADJUSTER MAX(%)	133
THROTTLE VALVE ADJUSTER MAX(V)	133
THROTTLE VALVE ADJUSTER MIN(%)	133
THROTTLE VALVE ADJUSTER MIN(V)	133
THROTTLE VALVE ADJUSTER(V)	133
THROTTLE VALVE ANGLE(°)	133
THROTTLE VALVE CLOSED	133
THROTTLE VALVE POSITION 1(%)	134
THROTTLE VALVE POSITION 1(°)	134
THROTTLE VALVE POSITION 2(%)	134
THROTTLE VALVE POSITION 2(°)	134
THROTTLE VALVE POSITION(%)	133
THROTTLE VALVE POSITION(V)	145
TIME COUNTER 1	134
TIME COUNTER 2	134
TIME COUNTER(O2)	134
TIPTRONIC	146
TORQUE (ACTUAL)(Nm)	134
Torque converter slip speed	149
TORQUE FROM A/T(Nm)	134
TORQUE FROM ENGINE(Nm)	134

TORQUE LOSS(Nm)	150
TORQUE MAX(Nm)	146
TORQUE RAISE	146
TORQUE REDUC	146
TORQUE REDUCTION	134
TORQUE REDUCTION(Nm)	134
TORQUE(%)	150
TORQUE(DESIRED)(Nm)	134
TORQUE(DESIRED, BY A/T-ECU)(Nm)	134
TORQUE(Nm)	146
TPS FULL RANGE(V)	134
TPS LOW RANGE(V)	134
TPS, MAX LRN OK/EXEC	134
TPS, MIN LRN OK/EXEC	134
TRANSVERSE ACCELERATION(m/s2)	150
TROUBLE CODE STORED IN MEMORY	135

U

UNPLAUSIBLE SIGNAL THR ADJ	135
----------------------------------	-----

V

VEHICLE SPEED	135
VEHICLE SPEED	146
VEHICLE SPEED CTRL	135
VEHICLE SPEED SENSOR(V)	146
VOLTAGE THR ADJ OUT OF RANGE	135

W

WARM UP CAT	135
WARM UP CAT(%)	135
WARN. SIGNAL INSTR. PANEL: REFUEL	135
WHEEL LEFT FRONT	150
WHEEL LEFT FRONT(RPM)	147
WHEEL LEFT REAR	150
WHEEL LEFT REAR(RPM)	147
WHEEL RIGHT FRONT	150
WHEEL RIGHT FRONT(RPM)	147
WHEEL RIGHT REAR	150
WHEEL RIGHT REAR(RPM)	147

6.2 Gas Engine Parameters

A/C COMP SW OFF BY ENG-ECU _____ (range: YES/NO)

Indicates an ECM-controlled switch which disables the operation of the A/C if a fault is detected by the ECM. If the ECM has switched the A/C off, the reading will be YES.

A/C COMPRESSOR _____ (range: ON/OFF)

Indicates a feedback signal from the A/C compressor clutch or relay. When the display reads ON, the clutch is engaged, when it reads OFF, the clutch is disengaged.

A/C COMPRESSOR OFF)
A/C COMPRESSOR ON _____ (range: YES/NO)

Indicates whether the A/C compressor is running.

A/C MODE _____ (range: HIGH/LOW)

Indicates whether the A/C system is set in the HIGH or LOW mode.

A/C READINESS _____ (range: YES/NO)

Indicates if the A/C is ready to be used. If A/C is fitted and no defects are found in the system, the reading will be YES. If the vehicle does not have A/C fitted or a fault in the system or wiring is found, the reading will be NO.

A/C SWITCH _____ (range: ON/OFF)

Informes the ECM whether the A/C switch is set at ON/OFF or HIGH/LOW.

ACCELERATION ENRICHMENT _____ (range: YES/NO)

Indicates whether the ECM provides a richer mixture during acceleration by momentarily increasing injector pulse width. It should read YES when the ECM is enriching the mixture during acceleration. Injector pulse width should also increase at the same time. It should read NO under all other conditions.

ACCEL.PEDAL POSITION SNS 1(%)
ACCEL.PEDAL POSITION SNS 2(%) _____ (range: not available)

Indicates the position of the acceleration pedal in percentage. A V-type Engine uses 2 sensors, which are designated by the 1 and 2 in the parameter name.

ACTUAL ADAPTATION POSITION(V) _____ (range: not available)

Indicates the adaptive position of the EGR valve calculated by the ECM in voltage.

ADAPTATION ABORTED(BATTERY <8V) _____ (range: YES/NO)

Indicates whether the ECM has recognized a battery voltage less than 8V. If the reading is NO, then Adaptation (adaptive learn) can take place. If the reading is YES, then the ECM will not relearn any values.

ADAPTATION ERROR _____ (range: YES/NO)

Indicates whether an error in the throttle adjustment is detected. It reads YES if a fault is detected, check for trouble codes. It reads NO at all other times.

ADAPTATION REQUIRED _____ (range: YES/NO)

Indicates whether the Idle Stabilizing Control (ISC) system is being operated outside of the learned values. It reads YES only when an Adaptation is required to inform the ECM of the new ISC position.

ADAPTATION RUNNING _____ (range: YES/NO)

Indicates whether the ECM is updating the throttle position sensors idle and full open positions. It reads YES during adaptation, NO at all other times.

ADAPTATION STATUS _____ (range: RUNNING/OK/ERROR)

Indicates whether the ECM is learning a position for the throttle valve, for example: under normal conditions the reading should be OK.

RUNNING will be displayed for a short time as the ECM learns the new values while in Basic Setting mode. If ERROR is displayed, then a fault in the learning processes has occurred.

ADP ENG SPEED SENSOR(CROWN GEAR) _____ (range: I/O or RUNNING)

Indicates the operation of the crankshaft sensor and the segmented gear fitted to the crankshaft and adapts the ECM for ignition misfires. The crown gear is the segmented disk fitted on the crankshaft and the engine speed sensor (Hall-effect sensor) takes its signal from the teeth on this gear. If the display reads RUNNING, then the sender/gear check has not yet been completed and the misfire detection is restricted until the adaptation is completed. The sender/gear check can only be performed during overrun conditions.

ADP IDLING STABILIZATION(kg/h) _____ (range: not available)

Indicates the learning value of the idle control system. The reading is the volume of air the ECM is commanding in kilograms per hour.

ADP STOPPED(TIME EXCEEDED) _____ (range: YES/NO)

Indicates whether the adaptation process was stopped because the maximum time allowed was exceeded. The normal reading is NO, Yes indicates an adaptation problem.

ADP THROTTLE VALVE ADJUSTER _____ (range: not available)

Indicates the current throttle adjuster adaptation mode and can display ADP, (running) ADP OK, or ADP ERROR.

ADP VALUE AIR MASS IDLE(%) _____ (range: not available)

Indicates the amount of extra air mass required to keep the engine idle speed correct when a change in load occurs, such as when the A/C or the rear heater is switched on.

ADP VALUE CANP SYSTEM _____ (range: not available)

Indicates the learning value of the canister purge system. It displays the duty cycle the ECM is commanding.

ADP VALUE CANP VALVE**ADP VALUE CANP VALVE 1(%)** _____ (range: not available)

Indicates the learning value of the canister purge system. It displays the duty cycle the ECM has learned.

ADP VALUE ISC _____ (range: not available)

Indicates the learning value of the idle control system. It displays the duty cycle the ECM is commanding.

ADP VALUE MIXTURE(BANK1)(%)**ADP VALUE MIXTURE(BANK2)(%)** _____ (range: not available)

Indicates the operation and Short-term correction of the fuel delivery for cylinders 1 to 3 (Bank 1) and cylinders 4 to 6 (Bank 2). It shows whether the ECM is commanding a rich or lean mixture.

A number above 0% indicates that the ECM has commanded a temporary rich mixture correction.

A number below 0% indicates that the ECM has commanded a temporary lean mixture correction.

These Short-term correction numbers are also used by the ECM to learn a fuel correction pattern or trend and are stored in the learned mixture or lambda values. Fuel correction parameters operate only in closed loop. In open loop, the number changes to a fixed value.

**ADP VALUE MIXTURE(BANK1)
ADP VALUE MIXTURE(BANK2)** _____ (range: 0.0 to 1.9)

Indicates the operation and Short-term correction of the fuel delivery for cylinders 1 to 4 (Bank 1) and for cylinders 5 to 8 (Bank 2). It shows whether the ECM is commanding a rich or lean mixture.

The number theoretically can range from 0.0 to 1.9 with 1.0 as the midpoint. A number above 1.0 indicates that the ECM has commanded a temporary rich mixture correction. A number below 1.0 indicates that the ECM has commanded a temporary lean mixture correction. Fuel correction parameters operate only in closed loop. In open loop, the number changes to a fixed value.

AIR DIVERT VALVE _____ (range: ON/OFF)

Indicates the state of the dual path intake manifold used on the 2.8 5V V6. There are two sets of intake runners of different lengths. At lower engine speeds the length of the intake manifold is lengthened with smaller diameter runners to produce a ram effect (increased air velocity). At higher RPM, the intake manifold is shortened with larger diameter runners to reduce restriction to faster moving air. Should read ON (ECM command) at 4500 RPM.

An actuator or rotary servo changes intake manifold position from low to high or high to low. At 4500 RPM after the Intake Manifold change over valve receives a signal from the ECM, it supplies vacuum to the servo which in turn moves the rotary valve to engage the high speed intake runners. When engine RPM drops, the change over valve shuts off vacuum to the servo (low speed intake runners) and vents trapped vacuum.

AIR MASS IDLE(g/s) _____ (range: not available)

Indicates the amount of alteration required to maintain idle speed when there is a change in load conditions at idle, such as when the heated rear window is switched on. Once the ECM has learned the new value, the figure should return to the mean setting (0).

ALTERNATOR DEFECT _____ (range: YES/NO)

Indicates whether the ECM has recognized a charging voltage. The reading is YES when the ECM is allowing adaptation (adaptive learn). If the reading is NO, the ECM will not relearn any adaptation values.

ALTERNATOR LOAD(%) _____ (range: not available)

Indicates the current alternator load.

**ALTITUDE CORRECTION FACTOR
ALTITUDE CORRECTION FACTOR(%)** _____ (range: not available)

Indicates the correction factor for altitude, which is applied to air intake and lambda values when driving in mountainous terrain. This is an ECM-calculated value that compares air mass and throttle angle, and is greatly influenced by intake air temperature.

AMBIENT TEMPERATURE(°C/°F) _____ (range: not available)

Indicates the temperature of the ambient air outside the vehicle.

AUX HEATING REQUESTED _____ (range: not available)

Indicates if Auxiliary Heat is requested or not.

BAROMETRIC PRESSURE(mbar) _____ (range: not available)

Indicates barometric pressure, which is provided by the barometric pressure (BARO) sensor, in millibars. The reading should be high when barometric pressure is near atmospheric pressure at sea level, and drop as barometric pressure drops.

The ECM uses the BARO sensor to calculate manifold vacuum and true absolute pressure. Some systems do not have a BARO sensor, but the ECM provides a BARO reading by sampling the MAP sensor reading with the key on and engine off just before cranking.

BASE THR POS(IDLE SW CLSD)(°) _____ (range: not available)

Indicates throttle opening in degrees based on the Throttle Position Sensor low range potentiometer. This is one of two potentiometers incorporated into one (throttle position) TP sensor. The signal is for the whole range (from idle to full throttle).

BASE VALUE THROTTLE ADJUSTER _____ (range: not available)

Indicates the stored base value for the throttle value potentiometer position when throttle valve is fully closed. The value is determined when base settings are activated with the throttle closed.

BASE VALUE TPS

BASE VALUE TPS(V) _____ (range: not available)

Indicates the voltage from throttle position (TP) sensor low range potentiometer. This is one from a set of two potentiometers incorporated into one TP sensor. The signal is for the whole range (from idle to full throttle).

BATTERY(V) _____ (range: not available)

Indicates vehicle battery voltage. The engine control system has no specific sensor to measure battery voltage, but some ECMs calculate this parameter from a sensing circuit across the supply voltage circuit. The reading should be close to normal charging system regulated voltage with the engine running. This is typically 13.5 to 14.5V at idle. Check the reading against actual voltage measured at the battery or alternator. Check vehicle specifications for exact values.

The battery voltage value is used principally for ECM self-diagnostics. Some ECM functions will be modified if voltage falls too low or rises too high. For example, if voltage drops below minimum value, the ECM will try to recharge the battery by running the engine at a higher idle speed. This may affect the idle speed control, fuel metering and ignition timing parameters.

BATTERY VOLTAGE TOO LOW _____ (range: YES/NO)

Indicates whether the ECM has recognized a battery voltage that is too low for reliable operation. If the reading is NO, then Adaptation (adaptive learn) can take place. If the reading is YES, then the ECM will not relearn any values.

BOOST PRESSURE(ACTUAL)(mbar) _____ (range: not available)

Indicates the current pressure in the intake manifold. The value is in millibar and will be an absolute pressure.

BOOST PRESSURE(DESIRED)(mbar) _____ (range: not available)

Indicates the desired intake manifold pressure under present operating conditions. The value is in millibar and will be an absolute pressure.

BOOST PRESSURE(mbar) _____ (range: not available)

Indicates the pressure in the intake manifold under current operating conditions. The value is in millibar and will be an absolute pressure.

BRAKE PEDAL PRESSED _____ (range: YES/NO)

Indicates whether the ECM has detected that the brake pedal has been pressed.

BRAKE PEDAL SWITCH _____ (range: OPEN/CLOSED)

Indicates whether the ECM has detected that the brake pedal switch is closed or open.

CAM ADJUSTER MODE _____ (range: ACTIVE/NOT ACTIVE)

Indicates whether the ECM has activated camshaft timing adjustments.

CAMSHAFT ADJUSTER _____ (range: ACTIVE/NOT ACTIVE)

Indicates whether the ECM has activated camshaft timing adjustments.

CAMSHAFT ADJUSTER(ACTIVE)(°)
CAMSHAFT ADVANCE(°) _____ (range: not available)

Indicates the amount of camshaft adjustment commanded by the ECM in degrees.

CAMSHAFT PHASING _____ (range: YES/NO)

Indicates whether the ECM has activated the camshaft timing adjustments.

CAMSHAFT POSITION(BANK 1)(°)
CAMSHAFT POSITION(BANK 2)(°) _____ (range: not available)

Indicates the amount of camshaft adjustment commanded by the ECM for the intake camshaft on cylinders 1 to 3 (Bank 1) or cylinders 4 to 6 (Bank 2) from its base position.

CANISTER PURGE MODE _____ (range: ACTIVE/NOT ACTIVE)

Indicates the operating mode of the canister purge valve.

CANP CHARGE(%) _____ (range: 0 to 100%)

Indicates the percentage of canister purge flow. The duty cycle solenoids in these systems are turned on to activate purging and turned off to block purging. A reading of 0 indicates that the solenoid is fully de-energized to cut off purging. A reading of 100 indicates that the solenoid is fully energized to allow maximum purging.

CANP FLUSH _____ (range: 0 to 100%)

Indicates the percentage of canister purge flushed from the charcoal canister back into the engine for re-burn. A reading of 0 indicates the solenoid is fully de-energized to cut off purging. A reading of 100 indicates the solenoid is fully energized to allow maximum purging.

CANP SYSTEM ACTIVE _____ (range: YES/NO)

Indicates the status of the canister purge valve, it reads YES when the canister purge valve (CANP) is active (purging).

CANP VALVE CLOSED _____ (range: YES/NO)

Indicates the status of the canister purge valve, it reads YES when the canister purge valve (CANP) is closed (not purging).

CANP VALVE ON CHARGE _____ (range: YES/NO)

Indicates the status of the canister purge valve, it reads YES when the canister purge valve (CANP) is in check mode. In check mode, the ECM calculates the fuel content of the fumes coming from the canister by measuring the effect the fumes have on the lambda signal.

CANP VALVE ON MIN MODE _____ (range: YES/NO)

Indicates the status of the canister purge valve, it reads YES when the canister purge valve (CANP) is at a minimum pulse width in order to stop sudden mixture changes and improve driveability.

CANP VALVE ON NORMAL MODE _____ (range: YES/NO)

Indicates the status of the canister purge valve, it reads YES when the canister purge valve (CANP) is operating normally.

CAT TEMPERATURE>300°C _____ (range: not available)

Indicates whether catalytic converter (CAT) temperature is above 300°C (572°F).

CATALYST TEMPERATURE(°C/F) _____ (range: not available)

Indicates catalytic converter (CAT) temperature.

CATALYST EFFICIENCY(%) _____ (range: not available)

Indicates the efficiency of the catalytic converter (CAT) based on O2S signals.

CHANGE OVER TO CHARGE MODE CANP _____ (range: YES/NO)

Indicates the status of the canister purge valve, it reads YES when the canister purge valve (CANP) is in charge mode.

CHANGE OVER TO CLOSE MODE CANP _____ (range: YES/NO)

Indicates the status of the canister purge valve, it reads YES when the canister purge valve (CANP) is closed.

CHANGE OVER TO MIN MODE CANP _____ (range: YES/NO)

Indicates the status of the canister purge valve, it reads YES when the canister purge valve (CANP) is at a minimum pulse width in order to stop sudden mixture changes and improve driveability.

CLUTCH PEDAL PRESSED _____ (range: YES/NO)

Indicates clutch pedal status, it reads YES when the ECM detects the clutch pedal is pressed.

CLUTCH PEDAL SWITCH _____ (range: OPEN/CLOSED)

Indicates the current state of the clutch pedal switch.

CODING FOR SYNCRO(4WD) _____ (range: YES/NO)

Indicates whether the ECM is coded for 4WD.

COMBINED HALL & ENG SPEED SIGN _____ (range: not available)

Indicates the number of teeth on the crankshaft sender wheel until the hall sensor on the camshaft switches. The ECM uses this to determine the relative positions of crank and cam.

CONTROL VALUE MIXTURE(%)

CTRL VALUE MIXTURE(BANK 1)(%)

CTRL VALUE MIXTURE(BANK 2)(%) _____ (range: not available)

Indicates the operation and Short-term correction of the fuel delivery for the stated cylinders. The reading shows whether the ECM is commanding a rich or lean mixture.

A number above 0% indicates that the ECM has commanded a temporary rich mixture correction. A number below 0% indicates that the ECM has commanded a temporary lean mixture correction.

These Short-term correction numbers are also used by the ECM to learn a fuel correction pattern or trend and are stored in the learned mixture or lambda values. Fuel correction parameters operate only in closed loop. In open loop, the number changes to a fixed value.

COOLANT TEMPERATURE >80°C _____ (range: YES/NO)

Indicates whether the engine coolant temperature is above 80°C (176°F). It is used during some adaptive learning processes.

CRUISE CTRL ENABLED _____ (range: ON/OFF)

Indicates the current state of the main cruise control switch.

CRUISE CTRL STATUS _____ (range: ACTIVE/NOT ACTIVE)

Indicates the current state of the main cruise control switch.

CTRL VALUE IDLE AIR MASS(g/s) _____ (range: not available)

Indicates the amount of air that bypasses the throttle at idle and thus controls the idle speed. The motor that drives the IAC valve returns a value of 0 to 255 to the ECM. The ECM then converts this value into an airflow value in grams per second.

CTRL VALUE MIXTURE/O2 _____ (range: not available)

Indicates the operation and Short-term correction of the fuel delivery. The reading shows whether the ECM is commanding a rich or lean mixture.

The number theoretically can range from 0.00 to 1.99 with 1.00 as the midpoint, but in practice the number only ranges from 0.9 to 1.1. A number above 1.0 indicates that the ECM has commanded a temporary rich mixture correction. A number below 1.0 indicates that the ECM has commanded a temporary lean mixture correction.

These Short-term correction numbers are also used by the ECM to learn a fuel correction pattern or trend and are stored in the learned mixture or lambda values. Fuel correction parameters operate only in closed loop. In open loop, the number changes to a fixed value.

CTRL VALUE MIXTURE/O2(%) _____ (range: not available)

Indicates the operation and Short-term correction of the fuel delivery. The reading shows whether the ECM is commanding a rich or lean mixture.

A number above 0% indicates that the ECM has commanded a temporary rich mixture correction. A number below 0% indicates that the ECM has commanded a temporary lean mixture correction.

These Short-term correction numbers are also used by the ECM to learn a fuel correction pattern or trend and are stored in the learned mixture or lambda values. Fuel correction parameters operate only in closed loop. In open loop, the number changes to a fixed value.

CURRENT CONSUMPTION IAC(A) _____ (range: not available)

Indicates the amount of current used by the IAC (Idle Air Control) valve as amperes.

CURRENT CTRL FACTOR IAC _____ (range: not available)

Indicates the amount of current used by the IAC (Idle Air Control) valve as a percentage.

CURRENT CTRL IAC(%) _____ (range: not available)

Indicates the control factor regulating the current to the IAC valve as a percentage.

CYLINDER 1 RECOGNIZED _____ (range: YES/NO)

Indicates whether the ECM has detected cylinder number 1 TDC.

DECEL ENLEAN _____ (range: not available)

Indicates whether the ECM is providing a lean air/fuel mixture during deceleration.

DECELERATE POSITION _____ (range: YES/NO)

Indicates whether the ECM determines the current engine operating condition as deceleration.

DECELERATION ENLEANMENT _____ (range: not available)

Indicates whether the ECM is providing a lean air/fuel mixture due to deceleration.

DIAGNOSE LEARN VALUE O2(BK1)IDLE**DIAGNOSE LEARN VALUE O2(BK1)P/T2****DIAGNOSE LEARN VALUE O2(BK1)P/T3****DIAGNOSE LEARN VALUE O2(BK1)P/T4****DIAGNOSE LEARN VALUE O2(BK2)IDLE****DIAGNOSE LEARN VALUE O2(BK2)P/T2****DIAGNOSE LEARN VALUE O2(BK2)P/T3****DIAGNOSE LEARN VALUE O2(BK2)P/T4 _____ (range: YES/NO)**

Indicates whether the relearn operation for the stated cylinders and engine/throttle load conditions was successful.

DUTY CYCLE CANP VALVE
DUTY CYCLE CANP VALVE(%) _____ (range: not available)

Indicates the percentage of canister purge flow. The duty cycle solenoids in these systems are turned on to activate purging and turned off to block purging. A reading of 0% indicates that the solenoid is fully de-energized to cut off purging. A reading of 100% indicates that the solenoid is fully energized to allow maximum purging.

DUTY CYCLE EGR-VALVE(%) _____ (range: not available)

Indicates the duty cycle of the Exhaust Gas Recirculating (EGR) valve. Exhaust gasses can be added to the intake air (to cool combustion temperatures thus reducing the formation of NO_x). EGR valve open/close rate depends on operating conditions of the engine.

DUTY CYCLE FAN CTRL VALVE(%) _____ (range: not available)

Indicates the duty-cycle of the electric ventilator. A lower percentage means the ventilator is blowing lightly.

DUTY CYCLE IAC(%) _____ (range: not available)

Indicates the duty cycle of the IAC valve.

DUTY CYCLE ISC(%) _____ (range: not available)

Indicates the duty cycle of the throttle valve positioner, which regulates the throttle stop position, thus controlling idle speed.

DUTY CYCLE THR ADJUSTER(%) _____ (range: not available)

Indicates the duty cycle of the throttle adjuster valve.

DUTY CYCLE WASTE GATE VALVE(%) _____ (range: not available)

Indicates the duty cycle of the turbo waste gate actuator valve. This action governs the turbo output (manifold) pressure.

EGR-SYSTEM _____ (range: ACTIVE/NOT ACTIVE)

Indicates whether the EGR system is active or not.

EGR-TEMPERATURE(°C/°F) _____ (range: not available)

Indicates EGR system temperature based on a feedback signal from a thermistor installed in the EGR passage.

ENGINE LOAD(%) _____ (range: not available)

Indicates the ECM calculated relative engine load based on engine speed (RPM), number of cylinders, and manifold airflow. High readings indicate a heavy load; low readings, a light load.

ENGINE LOAD(ms) _____ (range: not available)

Indicates the relative engine load based on a processed signal that comes from the Throttle Position Sensor and/or the Manifold Air Flow sensor and/or the Manifold Air Pressure sensor and/or the Intake Air Temperature sensor. The Engine Load has still to be corrected with all lambda factors. View this in conjunction with the injection period where Engine Load is the theoretical Injection time and the injection period is the corrected actual value.

ENGINE LOAD(V) _____ (range: not available)

Indicates the ECM calculated relative engine load as voltage based on engine speed (RPM), number of cylinders, and manifold airflow.

ENGINE LOAD(ACTUAL)(%) _____ (range: not available)

Indicates the ECM calculated actual engine load based on engine speed (RPM), number of cylinders, and manifold airflow. High readings indicate a heavy load; low readings, a light load.

ENGINE LOAD(ACTUAL)(ms) _____ **(range: not available)**

Indicates the actual engine load based on a processed signal that comes from the Throttle Position Sensor and/or the Manifold Air Flow sensor and/or the Manifold Air Pressure sensor and/or the Intake Air Temperature sensor. The load has been corrected with all factors.

ENGINE LOAD(ACTUAL)(Nm) _____ **(range: not available)**

Indicates the ECM calculated actual engine load based on engine speed (RPM), number of cylinders, and manifold airflow as newton meters (Nm).

ENGINE LOAD(AFTER CORR)(ms) _____ **(range: not available)**

Indicates the corrected engine load based on a processed signal that comes from the Throttle Position Sensor and/or the Manifold Air Flow sensor and/or the Manifold Air Pressure sensor and/or the Intake Air Temperature sensor. The load has been corrected with all factors.

ENGINE LOAD(BEFORE CORR)(ms) _____ **(range: not available)**

Indicates the uncorrected engine load based on a processed signal that comes from the Throttle Position Sensor and/or the Manifold Air Flow sensor and/or the Manifold Air Pressure sensor and/or the Intake Air Temperature sensor. The load has still to be corrected with all lambda factors.

ENGINE LOAD AFTER REDUC(ms) _____ **(range: not available)**

Indicates the engine load based on a processed signal that comes from the Throttle Position Sensor and/or the Manifold Air Flow sensor and/or the Manifold Air Pressure sensor and/or the Intake Air Temperature sensor. The load has been corrected with knock control factors.

ENGINE SPEED(RPM) _____ **(range: not available)**

Indicates whether the ECM is receiving engine speed information from the engine speed sensor, then passing this information on to the TCM.

Signal utilization: The engine speed signal is one of the most important input signals and is required for calculation of the shift points.

ENGINE SPEED <760 RPM**ENGINE SPEED <2000 RPM****ENGINE SPEED <2300 RPM****ENGINE SPEED <2500 RPM****ENGINE SPEED >2500 RPM****ENGINE SPEED >1800 RPM** _____ **(range: YES/NO)**

Indicates whether the engine is running at more than (<) or less than (>) the indicated RPM. They are used during some adaptive learning processes.

ENGINE SPEED(ACTUAL)(RPM)

Indicates the ECM calculated engine speed based on reference pulses from the ignition system or a crankshaft sensor. This is the recorded actual RPM as opposed to desired RPM.

ENGINE SPEED(DESIRED)(RPM) _____ **(range: not available)**

Indicates the idle speed that the ECM is trying to maintain. If there is a large difference between actual idle and desired RPM readings, the ECM may have reached its control limit without being able to control the idle speed. This may be due to a basic mechanical or electrical problem with the engine.

ENGINE SPEED(IDLE)(RPM) _____ **(range: not available)**

Indicates the actual recorded idle RPM as opposed to desired RPM.

ENGINE SPEED SIGNAL RECOGNIZED _____ **(range: YES/NO)**

Indicates whether the ECM has determined that the engine is running. The reading should be YES with the engine running, this value is used during some adaptive learning processes.

EXHAUST GAS TEMPERATURE(°C/°F) _____ (range: not available)

Indicates the exhaust-gas temperature.

FUEL COOLING(%) _____ (range: not available)

Indicates the percentage that the fuel is cooled.

FUEL CUT OFF

FUEL CUT-OFF VALVE ACTIVE _____ (range: YES/NO)

Indicates the status of the ECM command to cut off to the injectors during engine overrun.

FUEL HEAT(l/h) _____ (range: not available)

Indicates the amount of fuel that is used by the external heater.

FUEL LOW _____ (range: not available)

Indicates whether the fuel level is low.

FULL LOAD DETECTED

FULL LOAD _____ (range: YES/NO)

Indicates whether the engine is currently operating at full load. The reading is YES at full load, this value is used during some adaptive learning processes.

FULL LOAD SWITCH _____ (range: OPEN/CLOSED)

Indicates the ECM output to the TP sensor full load switch.

HALL-SENSOR(°)

Indicates the position of the Hall Sensor offset against the zero adjustment in crankshaft angle degrees.

IAC INTEGRATOR _____ (range: not available)

Indicates the working zero range of the idle air control (IAC). It represents the point that the ECM regards as IAC set to 0 (no adjustment required). The number can range from 0 to 255 with 128 as the midpoint. A number above 128 indicates that the ECM has learned to reduce the idle. A number below 128 indicates that the ECM has learned to increase the idle.

IDLE AIR CORRECTION(g/s) _____ (range: not available)

Indicates the correction factor of the idle control system. The value is the amount of airflow correction the ECM is commanding.

IDLE AIR CTRL(%) _____ (range: not available)

Indicates the duty cycle of the idle air control valve, which regulates the throttle stop position, thus controlling idle speed.

IDLE AIR MASS(g/s) _____ (range: not available)

Indicates the amount of air being drawn into the engine at idle. Most port fuel injection engines have an airflow sensor to measure the mass or weight of air entering the engine. The airflow sensor delivers a signal that indicates the mass airflow in grams per second at any given instant. The ECM uses the signal from the airflow sensor and other sensors to determine the air/fuel ratio needed by the engine and the amount of fuel to be injected.

IDLE SPEED(ACTUAL)(RPM) _____ (range: not available)

Indicates the actual engine idle speed recorded by the ECM, as opposed to desired RPM.

IDLE SPEED(DESIRED)(RPM) _____ (range: not available)

Indicates the engine idle speed the ECM is trying to maintain, as opposed to the actual RPM.

IDLE SPEED CTRL VALVE**IDLE SPEED CTRL VALVE(%)** _____ (range: not available)

Indicates the amount of air that bypasses the throttle at idle. The motor that drives the IAC valve returns a value of 0 to 255 to the ECM. The ECM then converts this value into an airflow value as a percentage of the total airflow.

IDLE SPEED SWITCH _____ (range: OPEN/CLOSED)

Indicates the ECM has detected idle switch state. It is used in conjunction with other parameters when the ECM is applying learned idle values.

IDLE SPEED SWITCH CLOSED _____ (range: YES/NO)

Indicates whether the ECM has detected that the idle switch is closed. It is used in conjunction with other parameters when the ECM is applying learned idle values.

IDLE SPEED SWITCH OPEN _____ (range: YES/NO)

Indicates whether the ECM has detected that the idle switch is open. It is used in conjunction with other parameters when the ECM is applying learned idle values.

IGN ADV W KNOCK & ISC(AV)(°) _____ (range: not available)

Indicates the average amount of ignition advance actually applied to the engine after any retardation by the knock sensor or idle speed control has been removed.

IGN RTD BY A/T-ECU(°) _____ (range: not available)

Indicates the amount of ignition advance removed by the ECM when the automatic transmission commands it. Timing is retarded from the optimum advance for the existing speed and load.

IGN RTD BY DIGITAL ISC(°) _____ (range: not available)

Indicates the amount of ignition advance removed by the ECM when the digital idle speed control (ISC) commands it. Timing is retarded from the optimum advance for the existing speed and load.

IGN RTD BY KNOCK(°)**IGN RTD BY KNOCK CTRL(°)****IGN RTD BY KNOCK(ALL CYL)(°)****IGN RTD BY KNOCK CTRL(CYL 1)(°)****IGN RTD BY KNOCK CTRL(CYL 2)(°)****IGN RTD BY KNOCK CTRL(CYL 3)(°)****IGN RTD BY KNOCK CTRL(CYL 4)(°)****IGN RTD BY KNOCK CTRL(CYL 5)(°)****IGN RTD BY KNOCK CTRL(CYL 6)(°)****IGN RTD BY KNOCK CTRL(CYL 7)(°)****IGN RTD BY KNOCK CTRL(CYL 8)(°)** _____ (range: not available)

Indicates the amount of ignition advance removed by the ECM when detonation is sensed by the knock sensor. Timing is retarded from the optimum advance for existing speed and load.

IGN RTD BY TCS-ECU(COLD)(°) _____ (range: not available)

Indicates the amount of ignition advance to be removed by the ECM using the traction control system (only with engine cold conditions) restrictions. Timing is retarded from the optimum advance for the existing speed and load.

IGN RTD WITH KNOCK & ISC(°) _____ (range: not available)

Indicates the amount of ignition advance actually applied to the engine after any retardation by the knock sensor or idle speed control has been removed.

IGN RTD W/O KNOCK & W/O ISC(°) _____ (range: not available)

Indicates the amount of ignition advance commanded by the ECM before any retardation by the knock sensor or idle speed control has been removed.

IGNITION ADV(CALCULATED)(°) _____ (range: not available)

Indicates the amount of ignition advance before other factors are removed by the ECM.

IGNITION ADV REDUCTION _____ (range: ACTIVE/NOT ACTIVE)

Indicates whether the ignition timing reduction system is active or not.

IGNITION ADVANCE(°) _____ (range: not available)

Indicates the total spark advance or retard commanded by the ECM, including base timing.

IGNITION MAP _____ (range: not available)

Indicates which ignition timing map is currently being used by the ECM. The map changeover is initiated by the knock sensor. The 1ST TIMING MAP is the default choice (98 octane) and the 2ND TIMING MAP retards the overall ignition timing (95 octane).

INCREASED IDLE SPEED WITH A/C ON _____ (range: YES/NO)

Indicates whether the ECM has detected the A/C is active. If so, the ECM increases the idle speed to compensate.

INCREASING RPM _____ (range: YES/NO)

Indicates whether the ECM is increasing the idle speed because the A/C is active.

INJ QUANTITY(mm3) _____ (range: not available)

Indicates the maximum quantity of fuel that has been injected under the present operating conditions. The value is in cubic milliliters per cylinder stroke.

INJECTION TIME(ms) _____ (range: not available)

Indicates the length of time that the ECM commands the fuel injectors to turn on in milliseconds (ms). A high reading indicates more "on time" and a richer mixture. A low reading indicates less "on time" and a leaner mixture. There are no definite specifications for injector pulse, but the reading should change as engine speed and load change.

INJECTION TIME(AVERAGE)(ms) _____ (range: not available)

Indicates the average length of time that the ECM commands the fuel injectors to turn on in milliseconds (ms). A high reading indicates more "on time" and a richer mixture. A low reading indicates less "on time" and a leaner mixture. There are no definite specifications for injector pulse, but the reading should change as engine speed and load change.

INTAKE MANIFOLD PRESSURE(%) _____ (range: not available)

Indicates intake manifold vacuum as a percentage. The ECM uses the figure in calculations to determine engine load.

INTAKE MANIFOLD PRESSURE(mbar) _____ (range: not available)

Indicates intake manifold vacuum as millibar. The ECM uses the figure in calculations to determine engine load.

ISC(CTRL FACTOR) _____ (range: not available)

Indicates the idle stabilizing control factor.

ISC(POSITION) _____ (range: not available)

Indicates the idle speed control valve position.

ISC(REACTION TO MALFUNCTION) _____ (range: not available)

Indicates the influence value of a system fault on the idle speed control system.

ISC INTGRATOR _____ (range: not available)

Indicates the integrator value for the idle speed control.

ISC UNDER LOAD _____ (range: not available)

Indicates the working range of the idle speed control (ISC) when a load is applied (example, with A/C operating). It indicates whether the ECM is commanding a faster or slower idle. The number can range from 0 to 255 with 128 as the midpoint. A number above 128 indicates that the ECM has commanded less air to slow the idle. A number below 128 indicates that the ECM has commanded more air to speed up the idle.

KNOCK CTRL(°) _____ (range: not available)

Indicates the amount of spark advance removed by the ECM when detonation is sensed by the knock sensor. Timing is retarded from the optimum advance for existing speed and load. The value is the amount of advance that has been taken away.

KNOCK SENSOR(CYL 1)(V)**KNOCK SENSOR(CYL 2)(V)****KNOCK SENSOR(CYL 3)(V)****KNOCK SENSOR(CYL 4)(V)****KNOCK SENSOR(CYL 5)(V)****KNOCK SENSOR(CYL 6)(V)****KNOCK SENSOR(CYL 7)(V)****KNOCK SENSOR(CYL 8)(V)** _____ (range: not available)

Indicates the voltage read by the ECM when detonation is sensed by the knock sensor on the indicated cylinder.

LACK OF FUEL _____ (range: not available)

Indicates whether or not there is a lack of fuel.

LEARN AIR MASS IDLE(g/s) _____ (range: not available)

Indicates the learned value of air that bypasses the throttle at idle and thus controls the idle speed. The motor that drives the IAC valve returns a value of 0 to 255 to the ECM. The ECM then converts this value into an airflow value in grams per second.

LEARN AIR MASS IDLE(D)(g/s) _____ (range: not available)

Indicates the learned value of air that bypasses the throttle at idle only if the transmission is in drive. The motor that drives the IAC valve returns a value of 0 to 255 to the ECM. The ECM then converts this value into an airflow value in grams per second.

LEARN AIR MASS IDLE(P/N)(g/s) _____ (range: not available)

Indicates the learned value of air that bypasses the throttle at idle only if the transmission is in park or neutral. The motor that drives the IAC valve returns a value of 0 to 255 to the ECM. The ECM then converts this value into an airflow value in grams per second.

LEARN INJECTION TIME(ms) _____ (range: not available)

Indicates the value in milliseconds that the ECM is using as an adaptive value for injection time correction.

LEARN MIXT(BANK 1)(IDLE)(%)
LEARN MIXT(BANK 1)(P/T)(%)
LEARN MIXT(BANK 1)(P/T1)(%)
LEARN MIXT(BANK 1)(P/T2)(%)
LEARN MIXT(BANK 1)(P/T3)(%)
LEARN MIXT(BANK 1)(IDLE)(%)
LEARN MIXT(BANK 1)(P/T)(%)
LEARN MIXT(BANK 2)(IDLE)(%)
LEARN MIXT(BANK 2)(P/T)(%)
LEARN MIXT(BANK 2)(P/T1)(%)
LEARN MIXT(BANK 2)(P/T2)(%)
LEARN MIXT(BANK 2)(P/T3)(%)
LEARN MIXT(BANK 2)(IDLE)(%)
LEARN MIXT(BANK 2)(P/T)(%) _____ **(range: not available)**

Indicates the operation and Long-term correction of the fuel delivery for the stated loads and cylinders. The readings show whether the ECM is commanding a rich or lean mixture.

A number above 0% indicates that the ECM has commanded an overall rich mixture correction. A number below 0% indicates that the ECM has commanded an overall lean mixture correction. Fuel correction parameters operate only in closed loop. In open loop, the number changes to a fixed value.

LEARN RANGE O2 IDLE
LEARN RANGE O2 P/T 2
LEARN RANGE O2 P/T 3
LEARN RANGE O2(BK1)IDLE
LEARN RANGE O2(BK1)P/T2
LEARN RANGE O2(BK1)P/T3
LEARN RANGE O2(BK1)P/T4
LEARN RANGE O2(BK2)IDLE
LEARN RANGE O2(BK2)P/T2
LEARN RANGE O2(BK2)P/T3
LEARN RANGE O2(BK2)P/T4 _____ **(range: REACHED/NOT REACHED)**

Indicates the state of the lambda learned range when at idle or part load section 2, 3, for cylinders 1 to 3 (Bank 1) when at idle or part load section 2, 3 or 4, and for cylinders 4 to 6 (Bank 2) when at idle or part load section 2, 3 or 4.



NOTE:

On some OBD-I (1991–1995) vehicles, the displayed values for Short-term fuel trim, LEARN O2 (IDLE), LEARN O2 (P/T), or LEARN O2 (FULL), may be mislabeled as reading in percentage. In actuality, they are reading a numeric factor of 1.0 midpoint ± 0.5 (0.5 to 1.5). For 2.8L AAA engine, the range is 0.80–1.20.

LEARN VALUE AIR MASS IDLE(%) _____ **(range: see description)**

Indicates the learned value correction for idle speed based on mass airflow. The number can range from -100% to 100% with 0% as the midpoint. A number above 0% indicates that the ECM has commanded a overall high idle correction. A number below 0% indicates that the ECM has commanded a overall low idle correction.

LEARN VALUE AIR MASS IDLE(g/s) _____ **(range: see description)**

Indicates learned value of air that bypasses the throttle at idle and thus controls the idle speed. The motor that drives the IAC valve returns a value of 0 to 255 to the ECM. The ECM then converts this value into an airflow value in grams per second.

LEARN VALUE CANP SYSTEM _____ (range: see description)

Indicates the learned canister purge value, an internal calculating factor and can be ignored.

LEARN VALUE DC ISC**LEARN VALUE DC ISC(%) _____ (range: see description)**

Indicates the learned duty cycle of the idle air control motor and thus controls the idle speed.

LEARN VALUE DC ISC(AT) _____ (range: see description)

Indicates the learned value of the idle air control motor on models with an automatic transmission. The value is the duty cycle of the ISC valve.

LEARN VALUE DC ISC(MUL)(%) _____ (range: not available)

Indicates the learned duty cycle of the idle air control motor and thus controls the idle speed.

LEARN VALUE IAC _____ (range: not available)

Indicates the current learned idle air control value.

LEARN VALUE IDLE SPEED(NOT P/N) _____ (range: not available)

Indicates the learning value for the idle stabilizing control system when an automatic transmission is in drive or reverse range.

LEARN VALUE IDLE SPEED(P/N) _____ (range: not available)

Indicates the learning value for the idle stabilizing control system when an automatic transmission is in neutral or park range, or when a manual transmission is in neutral.

LEARN VALUE ISC _____ (range: not available)

Indicates the current learned idle speed control value.

LRN VALUE ISC(g/s) _____ (range: not available)

Indicates the learned value of the idle speed control airflow when the transmission is in park or neutral range. The motor that drives the ISC valve returns the duty cycle to the ECM which calculates the airflow value in grams per second.

LEARN VALUE ISC(AT IN D) _____ (range: not available)

Indicates the learned value of the idle air control motor when an automatic transmission is in a forward or reverse range. The value is the ISC valve duty cycle.

LEARN VALUE ISC(MT/AT IN P/N) _____ (range: not available)

Indicates the learned value of the idle air control motor when the transmission is in park or neutral range. The value is the ISC valve duty cycle.

LEARN VALUE KICKDOWN(%) _____ (range: not available)

Indicates the learning value for the kickdown of the automatic transmission.

LEARN VALUE MAF-SENSOR _____ (range: not available)

Indicates the learning voltage being read by the Mass Air Flow (MAF) sensor. This voltage is used by the ECM to calculate the maximum amount of air being drawn into the engine.

LEARN VALUE MIXTURE _____ (range: not available)

Indicates the operation and Long-term correction of the fuel delivery. It shows whether the ECM is commanding a rich or lean mixture.

The number theoretically can range from 0.00 to 1.99 with 1.00 as the midpoint. A number above 1.0 indicates that the ECM has commanded an overall rich mixture correction. A number below 1.0 indicates that the ECM has commanded an overall lean mixture correction.

Fuel correction operates only in closed loop. In open loop, a fixed value displays.

LEARN VALUE MIXTURE(%)**LEARN VALUE MIXTURE(BANK 1)(%)****LEARN VALUE MIXTURE(BANK 2)(%)** _____ (range: not available)

Indicates the operation and Long-term correction of the fuel delivery. It shows whether the ECM is commanding a rich or lean mixture. The number theoretically can range from -100% to 100% with 0% as the midpoint. A number above 0% indicates that the ECM has commanded an overall rich mixture correction. A number below 0% indicates that the ECM has commanded an overall lean mixture correction.

These Long-term correction numbers are calculated by the ECM from the Short-term fuel correction patterns or trends. Fuel correction operates only in closed loop. In open loop, a fixed value displays.

LEARN VALUE MIXTURE(ADAPTIVE) _____ (range: not available)

Indicates the operation and Long-term correction of the fuel delivery. It shows whether the ECM is commanding a rich or lean mixture.

The number theoretically can range from 0 to 255 with 0 as the midpoint. A number of 13 to 128 indicates that the ECM has commanded an overall lean mixture correction. A number of 128 to 243 indicates that the ECM has commanded an overall rich mixture correction.

These Long-term correction numbers are calculated by the ECM from the Short-term fuel correction patterns or trends. Fuel correction operates only in closed loop. In open loop, a fixed value displays.

On some OBD-I (1991–1995) vehicles, values for short-term fuel trim may be mislabeled. See the note on page page 118 for details.

LEARN VALUE MIXTURE(ADP)(ms) _____ (range: not available)

Indicates what the ECM uses as a learned value for injection time correction in milliseconds.

On some OBD-I (1991–1995) vehicles, values for short-term fuel trim may be mislabeled. See the note on page page 118 for details.

LEARN VALUE MIXTURE(BANK 1)**LEARN VALUE MIXTURE(BANK 2)** _____ (range: not available)

Indicates the operation and Long-term correction of the fuel delivery for cylinders 1 to 4 (Bank 1) or 5 to 8 (Bank 2). The readings show if the ECM is commanding a rich or lean mixture.

The number theoretically can range from 0.00 to 1.99 with 1.00 as the midpoint. A number above 1.0 indicates that the ECM has commanded an overall rich mixture correction. A number below 1.0 indicates that the ECM has commanded an overall lean mixture correction. Fuel correction operates only in closed loop. In open loop, a fixed value displays.

On some OBD-I (1991–1995) vehicles, values for short-term fuel trim may be mislabeled. See the note on page page 118 for details.

LEARN VALUE MIXTURE(CANP ACT)(%) _____ (range: not available)

Indicates the operation and Short-term correction of the fuel delivery when the canister purge system is active. It shows whether the ECM is commanding a rich or lean mixture.

The number theoretically can range from -100% to 100% with 0% as the midpoint. Fuel correction operates only in closed loop. In open loop, a fixed value displays.

LEARN VALUE MIXTURE(IDLE)(%)
LEARN VALUE MIXTURE(P/T1)(%)
LEARN VALUE MIXTURE(P/T2)(%)
LEARN VALUE MIXTURE(P/T3)(%) _____ **(range: not available)**

Indicates the operation and Long-term correction of the fuel delivery when at idle or part throttle 1, 2 or 3 only. (Sections of a petitioned part load range). It shows whether the ECM is commanding a rich or lean mixture.

The number theoretically can range from -100% to 100% with 0% as the midpoint. A number above 0% indicates that the ECM has commanded an overall rich mixture correction. A number below 0% indicates that the ECM has commanded an overall lean mixture correction.

These Long-term correction numbers are calculated by the ECM from the Short-term fuel correction patterns or trends. Fuel correction operates only in closed loop. In open loop, a fixed value displays.

LEARN VALUE MIXTURE CORR _____ **(range: not available)**

Indicates the operation and Long-term correction of the fuel delivery. It shows whether the ECM is commanding a rich or lean mixture.

The number theoretically can range from 0 to 255 with 128 as the midpoint. A number above 128 indicates that the ECM has commanded an overall rich mixture correction. A number below 128 indicates that the ECM has commanded an overall lean mixture correction.

These Long-term correction numbers are calculated by the ECM from the Short-term fuel correction patterns or trends. Fuel correction operates only in closed loop. In open loop, a fixed value displays.

On some OBD-I (1991–1995) vehicles, values for short-term fuel trim may be mislabeled. See the note on page page 118 for details.

LEARN VALUE MIXTURE CORR(%) _____ **(range: not available)**

Indicates the operation and Short-term correction of the fuel delivery. It shows whether the ECM is commanding a rich or lean mixture.

The number theoretically can range from -100% to 100% with 0% as the midpoint. A number above 0% indicates that the ECM has commanded a temporary rich mixture correction. A number below 0% indicates that the ECM has commanded a temporary lean mixture correction. Fuel correction operates only in closed loop. In open loop, a fixed value displays.

LEARN VALUE MIXTURE CORR(ms) _____ **(range: not available)**

Indicates the learning value the ECM is using for injection time correction at idle in milliseconds.

On some OBD-I (1991–1995) vehicles, values for short-term fuel trim may be mislabeled. See the note on page page 118 for details.

LEARN VALUE O2 _____ **(range: not available)**

Indicates the Long-term correction of the fuel delivery. It shows whether the ECM is commanding a rich or lean mixture.

The number can range from 0 to 255 with 128 as the midpoint. A number above 128 indicates that the ECM has commanded a overall rich mixture correction. A number below 128 indicates that the ECM has commanded a overall lean mixture correction.

On some OBD-I (1991–1995) vehicles, values for short-term fuel trim may be mislabeled. See the note on page page 118 for details.

LEARN VALUE O2(%) _____ (range: not available)

Indicates the operation and Long-term correction of the fuel delivery. It shows whether the ECM is commanding a rich or lean mixture.

The number theoretically can range from -100% to 100% with 0% as the midpoint. A number above 0% indicates that the ECM has commanded an overall rich mixture correction. A number below 0% indicates that the ECM has commanded an overall lean mixture correction. Fuel correction operates only in closed loop. In open loop, a fixed value displays.

LEARN VALUE O2(ACTUAL)(BK1)(%)
LEARN VALUE O2(ACTUAL)(BK2)(%) _____ (range: not available)

Indicates the actual value (before correction) of the fuel delivery for cylinders 1 to 3 (Bank 1) or 4 to 6 (Bank 2). A number above 0% indicates a rich mixture. A number below 0% indicates a lean mixture. Fuel correction operates only in closed loop. In open loop, a fixed value displays.

LEARN VALUE O2(BK1)
LEARN VALUE O2(BK2) _____ (range: not available)

Indicates the operation and Short-term correction of the fuel delivery for cylinders 1 to 3 (Bank 1) or 4 to 6 (Bank 2). They show whether the ECM is commanding a rich or lean mixture.

The number theoretically ranges from 0.00 to 2.00 with 1.00 as the midpoint. A number above 1.0 indicates that the ECM has commanded a temporary rich mixture correction. A number below 1.0 indicates that the ECM has commanded a temporary lean mixture correction.

These Short-term correction numbers are also used by the ECM to learn a fuel correction pattern or trend and are stored in the learned mixture or lambda values. Fuel correction operates only in closed loop. In open loop, a fixed value displays.

On some OBD-I (1991–1995) vehicles, values for short-term fuel trim may be mislabeled. See the note on page 118 for details.

LEARN VALUE O2(BK1)(%)
LEARN VALUE O2(BK2)(%)
LEARN VALUE O2(BK1)(ADD)(%)
LEARN VALUE O2(BK2)(ADD)(%)
LEARN VALUE O2(BK1)(MUL)(%)
LEARN VALUE O2(BK2)(MUL)(%)
LEARN VALUE O2(BK1)(IDLE)(%)
LEARN VALUE O2(BK2)(IDLE)(%)
LEARN VALUE O2(BK1)(P/T)(%)
LEARN VALUE O2(BK2)(P/T)(%) _____ (range: not available)

Indicates the operation and Short-term correction of the fuel delivery for Bank 1 or Bank 2 under the stated engine load conditions. They show if the ECM is commanding a rich or lean mixture.

A number above 0% indicates that the ECM has commanded a temporary rich mixture correction. A number below 0% indicates that the ECM has commanded a temporary lean mixture correction.

These Short-term correction numbers are also used by the ECM to learn a fuel correction pattern or trend and are stored in the learned mixture or lambda values. Fuel correction operates only in closed loop. In open loop, a fixed value displays.

LEARN VALUE O2(BK1)IDLE OK
LEARN VALUE O2(BK1)P/T1 OK
LEARN VALUE O2(BK1)P/T2 OK
LEARN VALUE O2(BK1)P/T3 OK _____ (range: YES/NO)

Indicates whether the ECM has determined that the learned lambda value for cylinders 1 to 3 (Bank 1) at idle or part load sections is within tolerances. They read YES if adaptation is learned, and NO if the ECM has to relearn the lambda settings in this engine load range.

LEARN VALUE O2(BK2)IDLE OK
LEARN VALUE O2(BK2)P/T1 OK
LEARN VALUE O2(BK2)P/T2 OK
LEARN VALUE O2(BK2)P/T3 OK _____ (range: YES/NO)

Indicates whether the ECM has determined that the learned lambda value for cylinders 4 to 6 (Bank 2) at idle or part load sections is within tolerances. They read YES if adaptation is learned, and NO if the ECM has to relearn the lambda settings in this engine load range.

LEARN VALUE O2(FULL)
LEARN VALUE O2(IDLE) _____ (range: not available)

Indicates the operation and Long-term correction of the fuel delivery, when at full throttle or at idle only. They show whether the ECM is commanding a rich or lean mixture.

The number theoretically can range from 0.00 to 1.99 with 1.00 as the midpoint. A number above 1.0 indicates that the ECM has commanded an overall rich mixture correction. A number below 1.0 indicates that the ECM has commanded an overall lean mixture correction. Fuel correction operates only in closed loop. In open loop, a fixed value displays.

On some OBD-I (1991–1995) vehicles, values for short-term fuel trim may be mislabeled. See the note on page page 118 for details.

LEARN VALUE O2(IDLE)(%)
LEARN VALUE O2(P/T)(%)
LEARN VALUE O2(P/T)(MUL)(%) _____ (range: not available)

Indicates the operation and Short-term correction of the fuel delivery under the stated engine load conditions. They show whether the ECM is commanding a rich or lean mixture.

A number above 0% indicates that the ECM has commanded a temporary rich mixture correction. A number below 0% indicates that the ECM has commanded a temporary lean mixture correction. Fuel correction operates only in closed loop. In open loop, a fixed value displays.

LEARN VALUE O2(IDLE)(ms) _____ (range: not available)

Indicates the learning value that the ECM is using for injection time correction at idle in milliseconds.

On some OBD-I (1991–1995) vehicles, values for short-term fuel trim may be mislabeled. See the note on page page 118 for details.

LEARN VALUE O2(P/T)
LEARN VALUE O2(P/T-WOT) _____ (range: not available)

Indicates the operation and Long-term correction of the fuel delivery when at part load or full throttle (WOT). They show whether the ECM is commanding a rich or lean mixture.

The number theoretically can range from 0.00 to 1.99 with 1.00 as the midpoint. A number above 1.0 indicates that the ECM has commanded an overall rich mixture correction.

A number below 1.0 indicates that the ECM has commanded an overall lean mixture correction. Fuel correction operates only in closed loop. In open loop, a fixed value displays.

On some OBD-I (1991–1995) vehicles, values for short-term fuel trim may be mislabeled. See the note on page page 118 for details.

LEARN VALUE O2 IDLE OK
LEARN VALUE O2 P/T 1 OK
LEARN VALUE O2 P/T 2 OK
LEARN VALUE O2 P/T 3 OK _____ (range: YES/NO)

Indicates whether the ECM has determined that the learned lambda value for idle or part load sections is within tolerances. They read YES when within tolerance, and NO if the ECM has to relearn the lambda adaptation settings in the idle engine load range.

LEARN VALUE O2 SNS 1(IDLE)(%) _____ (range: not available)

Indicates the learning value for the O2S when the engine is idling.

LEARN VALUE O2 SNS 1(P/T)(%) _____ (range: not available)

Indicates the learning value for the O2S when the engine is in part load according to the throttle position.

LEARN VALUE THR VALVE ADJUSTER _____ (range: not available)

Indicates the internal ECM figure for the learning value for the idling stabilization by throttle valve positioner.

LEARN VALUE TPS _____ (range: not available)

Indicates the learning value for the throttle position sensor.

LEARN VALUE TPS(V) _____ (range: not available)

Indicates the learning voltage for throttle closed. This value is learned by the ECM and is used as the throttle closed learned position.

LIMITED DYNAMIC ACTIVE _____ (range: YES/NO)

Indicates whether the self diagnostic system has detected a fault in the lambda or lambda heater systems, even if no trouble codes are stored in the fault code memory.

LIMITED OPERATION(LIMP) _____ (range: YES/NO)

Indicates whether the ECM is operating in limited operation strategy (LOS or limp home mode), which can automatically supply substitute values when sensor failure occurs, so a sensor can fail and not necessarily affect driveability. Reading should normally be NO.

LOS MODE _____ (range: YES/NO)

Indicates whether the ECM is operating in limited operation strategy (LOS or limp home mode), which can automatically supply substitute values when sensor failure occurs, so a sensor can fail and not necessarily affect driveability. Reading should normally be NO.

LRN IDLING STABILIZATION(kg/h) _____ (range: not available)

Indicates the learned value of the idle control system. It shows the volume of air the ECM is commanding in kilograms per hour.

MAF IDLE(g/s) _____ (range: not available)

Indicates the amount of extra air mass required to keep the engine idle speed correct when a change in load occurs, such as when the air conditioning or the rear heater is switched on.

MAF ISC TRIM(%) _____ (range: not available)

Indicates the amount of air that bypasses the throttle at idle. The motor that drives the IAC valve returns a value of 0 to 255 to the ECM. The ECM then converts this value into an airflow value as a percentage of the total airflow.

MAF-SENSOR(V) _____ (range: not available)

Indicates the actual voltage signal from the Mass Air Flow (MAF) sensor. This voltage is used by the ECM to calculate the maximum amount of air being drawn into the engine.

MAF TRIM(g/s) _____ (range: not available)

Indicates the amount of extra air mass required to keep the engine idle speed correct when a change in load occurs, such as when the air conditioning or the rear heater is switched on.

MAP(%) _____ (range: not available)

Indicates intake manifold vacuum as a percentage. The ECM uses the figure in calculations to determine engine load.

MAP(V)

MAP(mbar) _____ (range: not available)

Indicates either actual voltage from the Manifold Absolute Pressure (MAP) sensor, or a pressure in mbar as calculated by the ECM based on the MAP sensor signal. The voltage is low when the absolute pressure is low and high when the absolute pressure is high.

On turbocharged engines, this value is used to control the amount of boost that the turbocharger delivers.

MAP-CONTROLLED IDLE SPEED _____ (range: not available)

Indicates the pre-mapped working range of the idle speed control (ISC). It shows the idle stabilization characteristics the ECM should use for a given set of operating conditions.

MASS AIR FLOW(g/s) _____ (range: not available)

Indicates mass air flow (MAF) in grams per second. Most port fuel injection engines have an airflow sensor to measure the mass or weight of air entering the engine. The airflow sensor delivers a signal that indicates the mass airflow in grams per second at any given instant. The ECM uses the signal from the airflow sensor and other sensors to determine the air/fuel ratio needed by the engine and the amount of fuel to be injected.

MASS AIR FLOW(V) _____ (range: not available)

Indicates the actual voltage being read by the Mass Air Flow (MAF) sensor. This voltage is used by the ECM to calculate the maximum amount of air being drawn into the engine.

MASS AIR FLOW(ACTUAL)(g/s) _____ (range: not available)

Indicates the actual amount of air flowing into the engine as grams per second.

Used on 2.0L 5.9.2 systems for measurement of reverse airflow at MAF sensor using two temperature sensors. Normal valve overlap and intake manifold design may cause reversion of airflow which results in incorrect rich mixture. Two similarly heated temperature sensors are ECM monitored in the MAF to detect differential temperatures.

MASS AIR FLOW(DESIRED)(g/s) _____ (range: not available)

Indicates the maximum quantity of air that should be drawn into the engine under the present operating conditions in grams per second.

MAX VALUE THR ADJUSTER(%) _____ (range: not available)

Indicates the throttle valve adjuster maximum stop position for start up and base idle.

MAX VALUE THR ADJUSTER(V) _____ (range: not available)

Indicates the throttle valve adjuster maximum position as voltage.

MIN VALUE THR ADJUSTER(%) _____ (range: not available)

Indicates the throttle valve adjuster minimum stop position for start up and basic idle.

MIN VALUE THR ADJUSTER(V) _____ (range: not available)

Indicates the throttle valve adjuster minimum stop position for start up and basic idle.

MISFIRES PER 200 REVS(CYL.1)

MISFIRES PER 200 REVS(CYL.2)

MISFIRES PER 200 REVS(CYL.3)

MISFIRES PER 200 REVS(CYL.4)

MISFIRES PER 200 REVS(CYL.5)

MISFIRES PER 200 REVS(CYL.6)

MISFIRES PER 200 REVS(CYL.7)

MISFIRES PER 200 REVS(CYL.8)

MISFIRES PER 200 REVS(ALL CYL) _____ (range: not available)

Indicates the number of misfires detected for the selected cylinder per 200 crankshaft revolutions (vehicle must be driven).

MIXTURE _____ (range: RICH/LEAN)

Indicates the general rich or lean condition of the exhaust as measured by the lambda O2S.

Exhaust oxygen content is related to oxygen content in the intake air/fuel mixture and thus indicates intake air/fuel ratio. The O2S is the primary sensor that indicates whether the engine is running rich or lean. The O2S must be hot and the ECM must be in closed loop before the ECM will respond to the sensor signal.

MIXTURE CORR(CANP ACTIVE) _____ (range: YES/NO)

Indicates the current mixture correction with canister purge valve active.

MIXTURE CORRECTION _____ (range: not available)

Indicates the operation and Short-term correction of the fuel delivery. It shows whether the ECM is commanding a rich or lean mixture.

The number can range from 0 to 255 with 128 as the midpoint. A number above 128 indicates that the ECM has commanded a temporary rich mixture correction. A number below 128 indicates that the ECM has commanded a temporary lean mixture correction.

These Short-term correction numbers are also used by the ECM to learn a fuel correction pattern or trend and are stored in the learned mixture or lambda values. Fuel correction operates only in closed loop. In open loop, a fixed value displays.

MIXTURE CORRECTION(%) _____ (range: not available)

Indicates the operation and Short-term correction of the fuel delivery. It shows whether the ECM is commanding a rich or lean mixture.

A number above 0% indicates that the ECM has commanded a temporary rich mixture correction. A number below 0% indicates that the ECM has commanded a temporary lean mixture correction.

These Short-term correction numbers are also used by the ECM to learn a fuel correction pattern or trend and are stored in the learned mixture or lambda values. Fuel correction operates only in closed loop. In open loop, a fixed value displays.

MODE HALL-REFERENCE SIGNAL _____ (range: not available)

Indicates the position of the reference signal (missing teeth) in the Hall-effect sensor window.

O2 ACTIVE _____ (range: YES/NO)

Indicates whether the lambda regulation part of the ECM is active or not (open/closed loop), this depends on the lambda sensor temperature and operating conditions of the engine. Under full load conditions, the ECM goes into open loop.

O2 ADP & ACTUAL VALUE(%) _____ (range: not available)

Indicates the operation and Short-term correction of the actual fuel delivery. It shows whether the ECM is commanding a rich or lean mixture.

A number above 0% indicates that the ECM has commanded a temporary rich mixture correction. A number below 0% indicates that the ECM has commanded a temporary lean mixture correction. These Short-term correction numbers are also used by the ECM to learn a fuel correction pattern or trend and are stored in the learned mixture or lambda values. Fuel correction operates only in closed loop. In open loop, a fixed value displays.

O2 CONTROL MODE _____ (range: ACTIVE/NOT ACTIVE)

Indicates the current operating mode of the lambda system.

O2 CORR(CANP ACTIVATED) _____ (range: not available)

Indicates the required correction of the lambda figure when the canister purge system (CANP) is in operation. It shows whether the charge coming from the CANP is very rich or lean and therefore the ECM needs to reduce or increase the amount of fuel delivery.

The number theoretically can range from 0.0 to 1.9 with 1.0 as the midpoint. A number above 1.0 indicates an ECM command for a temporary rich mixture correction. A number below 1.0 indicates an ECM command for a temporary lean mixture correction.

O2 CORR(CANP ACTIVATED)(%) _____ (range: not available)

Indicates the required correction of the lambda figure when the canister purge system (CANP) is in operation. It shows the percentage the ECM needs to reduce or increase the amount of fuel delivery.

A number above 0% indicates an ECM command for a temporary rich mixture correction. A number below 0% indicates an ECM command for a temporary lean mixture correction.

O2 CTRL(BANK 1)(%)**O2 CTRL(BANK 2)(%)** _____ (range: not available)

Indicates the operation and Short-term correction of the fuel delivery for cylinders 1 to 3 (Bank 1) or 4 to 6 (Bank 2). It shows whether the ECM is commanding a rich or lean mixture.

O2 CTRL & ACT(BANK 1)(%)**O2 CTRL & ACT(BANK 2)(%)** _____ (range: not available)

Indicates the overall operation and Long-term correction of fuel delivery for cylinders 1 to 3 (Bank 1) or 4 to 6 (Bank 2). They show whether the ECM is commanding an overall rich or lean mixture. Fuel correction operates only in closed loop. In open loop, a fixed value displays.

A number above 0% indicates that the ECM has commanded a temporary rich mixture correction. A number below 0% indicates that the ECM has commanded a temporary lean mixture correction. These Short-term correction numbers are also used by the ECM to learn a fuel correction pattern or trend and are stored in the learned mixture or lambda values.

O2 CTRL FACTOR(BANK 1)**O2 CTRL FACTOR(BANK 2)** _____ (range: not available)

Indicates the operation and Short-term correction of fuel delivery for cylinders 1 to 3 (Bank 1) or 4 to 6 (Bank 2). It shows whether the ECM is commanding a rich or lean mixture. The number theoretically can range from 0.0 to 1.9 with 1.0 as the midpoint. A number above 1.0 indicates that the ECM has commanded a temporary rich mixture correction. A number below 1.0 indicates that the ECM has commanded a temporary lean mixture correction.

These Short-term correction numbers are also used by the ECM to learn a fuel correction pattern or trend and are stored in the learned mixture or lambda values. Fuel correction operates only in closed loop. In open loop, a fixed value displays.

Table 6-1 Normal ranges and factory names for O2 control factor parameters

Factory Data Name	Normal Value Working Range
O2 SENSOR LAMBDA FACTOR	Range: 0.5–1.5; Normal Value: 1.0 ±0.3 is base mid-point; For 2.8 (AAA) spec: 0.80–1.20
O2 SENSOR LAMBDA FACTOR	Range: 0.5–1.5; Normal Value: 1.0 ±0.3 is base mid-point
LAMBDA FACT IDLE ADAPT; LAMBDA FACT PART ADAPT; LAMBDA FACT ADAPTMED/FULL LOAD	Range: 0.5–1.5; Normal Value: 1.0 ±0.3 (0.7–1.3) is base mid-point; For 2.0L (ABA) IDLE ADAPT: 0.87–1.2; For 2.8L (AAA) IDLE ADAPT: 0.53–1.47; Part Load: 0.80–1.20; Low Load: 0.53–1.47

O2 CTRL FACTOR(CYL 1-3)(%)

O2 CTRL FACTOR(CYL 4-6)(%) _____ (range: not available)

Indicates the operation and Short-term correction of fuel delivery for cylinders 1 to 3 (Bank 1) or 4 to 6 (Bank 2). They show whether the ECM is commanding a rich or lean mixture.

A number above 0% indicates that the ECM has commanded a temporary rich mixture correction. A number below 0% indicates that the ECM has commanded a temporary lean mixture correction.

These Short-term correction numbers are also used by the ECM to learn a fuel correction pattern or trend and are stored in the learned mixture or lambda values.

O2 CTRL READY _____ (range: YES/NO)

Indicates whether the lambda circuit is ready to reliably measure the exhaust oxygen content.

O2 INTEGRATOR _____ (range: not available)

Indicates the operation and Short-term correction of the fuel delivery. It shows whether the ECM is commanding a rich or lean mixture.

The number can range from 0 to 255 with 128 as the midpoint. A number above 128 indicates that the ECM has commanded a temporary rich mixture correction. A number below 128 indicates that the ECM has commanded a temporary lean mixture correction.

These Short-term correction numbers are also used by the ECM to learn a fuel correction pattern or trend and are stored in the learned mixture or lambda values. Fuel correction operates only in closed loop. In open loop, a fixed value displays.

O2 LOOP CLOSED _____ (range: YES/NO)

Indicates whether the lambda regulation part of the ECM is in closed loop. This depends on the lambda sensor temperature and operating conditions of the engine. Under full load conditions, the ECM goes into open loop.

O2 REGULATION _____ (range: not available)

Indicates the operation and Short-term correction of the fuel delivery. It shows whether the ECM is commanding a rich or lean mixture.

The number theoretically can range from 0.00 to 1.99 with 1.00 as the midpoint, but in practice the number only ranges from 0.9 to 1.1. A number above 1.0 indicates that the ECM has commanded a temporary rich mixture correction. A number below 1.0 indicates that the ECM has commanded a temporary lean mixture correction.

These Short-term correction numbers are also used by the ECM to learn a fuel correction pattern or trend and are stored in the learned mixture or lambda values. Fuel correction operates only in closed loop. In open loop, a fixed value displays.

O2 REGULATION(%)**O2 REGULATION(BANK 1)(%)****O2 REGULATION(BANK 2)(%)** _____ (range: not available)

Indicates the operation and Short-term correction of the fuel delivery. It shows whether the ECM is commanding a rich or lean mixture.

A number above 0% indicates that the ECM has commanded a temporary rich mixture correction. A number below 0% indicates that the ECM has commanded a temporary lean mixture correction. These Short-term correction numbers are also used by the ECM to learn a fuel correction pattern or trend and are stored in the learned mixture or lambda values. Fuel correction operates only in closed loop. In open loop, a fixed value displays.

O2 REGULATION ACTIVE _____ (range: YES/NO)

Indicates whether the lambda regulation part of the ECM is active or not (open/closed loop). This depends on the lambda sensor temperature and operating conditions of the engine. Under full load conditions, the ECM goes into open loop.

O2 REGULATION ON STOP _____ (range: YES/NO)

Indicates whether the lambda regulation part of the ECM is active or not (open/closed loop). This depends on the lambda sensor temperature and operating conditions of the engine. Under full load conditions, the ECM goes into open loop.

O2 SENSOR(V)**O2 SENSOR 1(V)****O2 SENSOR 2(V)****O2 SENSOR(BANK 1)(V)****O2 SENSOR(BANK 1)(V)****O2 SENSOR(BANK 2)(V)****O2 SENSOR(BANK 2)(V)** _____ (range: not available)

Indicates oxygen sensor (O2S) voltage. The O2S is the primary sensor that indicates whether the engine is running rich or lean. An O2S can have a range of 0.0 to 1.0V or 0.0 to 5.0V.

O2 SENSOR 1 and O2 SENSOR 2 refer to cylinder Bank 1 or cylinder Bank 2 respectively.

The most common O2Ss generate a voltage signal that ranges from 0.0 to 1.0V. A high signal (0.48 to 1.00V) indicates a rich mixture; a low signal (0.0 to 0.48) indicates a lean mixture. In normal operation, the O2S voltage ranges from 0.1 to 1.0V. The O2S must be hot, and the ECM must be in closed loop before the ECM will respond to the sensor signal.

Some models, such as the VW 2001 2.0L with the AEG engine and the new 2002 Passat W8 (BDP), use a 0–5V O2S. Rich is high voltage; lean is low voltage. Other models may use a Linear Air/Fuel Ratio Sensor (A/F sensor) which measures the exact air/fuel mixture, the signal does not constantly switch between low and high. The voltage displayed (display group 33 in Table 6-2 below) for these is an ECM computed value where 1.5V = 1 lambda or the ideal fuel mixture ratio of 14.7:1. Higher voltage indicates correction for rich mixture and lower voltage indicates a correction for a lean mixture. Under normal load, the voltage should vary around 1.5V, which means the mixture is right at stoichiometric or Lambda = 1. During deceleration from 3000 RPM,

the mixture is lean and the voltage should go higher than 1.5V. Under full load acceleration, the mixture is rich and the signal should go low, 1V or lower.

Table 6-2 Display group 33

Display Group	Sensor	Bank 1, Sensor 1	Bank 1, Sensor 2	Bank 2, Sensor 1	Bank 2, Sensor 2
33	Linear oxygen sensor control value	Control value (%)	Sensor voltage before CAT of a broadband sensor (V)	Control value (%)	Sensor voltage before CAT of a broadband sensor (V)

O2 SENSOR HEATER _____ (range: ON/OFF)

Indicates whether the preheating of the O2 sensor is ON or OFF.

O2 SENSOR HEATER(BK1-SNS1) _____ (range: ON/OFF)

Indicates if the before CAT O2S on Bank 1 heater is turned on.

O2 SENSOR HEATER(BK1-SNS2) _____ (range: ON/OFF)

Indicates if the before CAT O2S on Bank 2 heater is turned on.

O2 SENSOR HEATER(BK2-SNS1) _____ (range: ON/OFF)

Indicates if the preheating of the after CAT O2S is ON or OFF (Bank 1).

O2 SENSOR HEATER(BK2-SNS2) _____ (range: ON/OFF)

Indicates if the preheating of the after CAT O2S is ON or OFF (Bank 2).

O2 SENSOR HEATER AFTER CAT _____ (range: ON/OFF)

Indicates if the preheating of the after CAT O2S is ON or OFF.

O2 SENSOR HEATER BEFORE CAT _____ (range: ON/OFF)

Indicates if the preheating of the before CAT O2S is ON or OFF.

O2 SENSOR READY _____ (range: YES/NO)

Indicates whether the lambda regulation part of the ECM is ready or not (open/closed loop). This depends on the lambda sensor temperature and operating conditions of the engine. Under full load conditions, the ECM goes into open loop.

O2 VALUE _____ (range: not available)

Indicates the operation and short term correction of the fuel delivery. It shows whether the ECM is commanding a rich or lean mixture.

The number theoretically can range from 0.00 to 1.99 with 1.00 as the midpoint. A number above 1.0 indicates that the ECM has commanded a temporary rich mixture correction. A number below 1.0 indicates that the ECM has commanded a temporary lean mixture correction.

These short term correction numbers are also used by the ECM to learn a fuel correction pattern or trend and are stored in the learned mixture or lambda values. Fuel correction operates only in closed loop. In open loop, a fixed value displays.

O2 VALUE(ACTUAL)(%)

O2 VALUE(BANK 1)(%)

O2 VALUE(BANK 2)(%) _____ (range: not available)

Indicates the operation and Short-term correction of the fuel delivery for the stated cylinders. They show whether the ECM is commanding a rich or lean mixture.

A number above 0% indicates that the ECM has commanded a temporary rich mixture correction.

A number below 0% indicates that the ECM has commanded a temporary lean mixture correction.

These Short-term correction numbers are also used by the ECM to learn a fuel correction pattern or trend and are stored in the learned mixture or lambda values. Fuel correction operates only in closed loop. In open loop, a fixed value displays.

OIL TEMPERATURE(°C/°F) _____ (range: not available)

Indicates engine oil temperature in degrees.

OPERATING MODE _____ (range: not available)

Indicates the current operating mode of the engine system.

OVERRUN _____ (range: YES/NO)

Indicates whether the current engine operating condition is overrun.

PARK/NEUTRAL POSITION _____ (range: P-N/-R-DL)

Indicates whether an automatic transmission is in park or neutral, or in one of the drive ranges. It should read: P-N if the transmission is in either park or neutral R-DL if the transmission is in any forward gear or in reverse.

PARK/NEUTRAL POSITION _____ (range: P/N /NOT P/N)

Indicates whether an automatic transmission is in park or neutral (reads P/N), or in one of the drive ranges (reads NOT P/N).

PART LOAD DETECTED _____ (range: YES/NO)

Indicates whether the ECM has determined that the engine is currently at part load. It is used during some adaptive learning processes.

PHASE POSITION BK1(°CA)

PHASE POSITION BK2(°CA) _____ (range: not available)

Indicates the position of the camshaft of Bank 1 or 2 in degrees.

PHASE POSITION HALL SNS(°) _____ (range: not available)

Indicates the position of the Hall-effect sensor in degrees.

PRESS CNTRL(%) _____ (range: not available)

Indicates the duty cycle of the pressure control valve of the fuel pump.

REAR HEATER MODE

REAR HEATER SWITCH _____ (range: ON/OFF)

Indicates the feedback signal from the Heated Rear Screen switch.

REDUCTION TORQUE(ACTUAL)(Nm)

Indicates the actual torque output after reductions (flywheel torque). Torque reductions are made by retarding the ignition point or by briefly switching off the fuel injectors.

RELATIVE AIR MASS(%) _____ (range: not available)

Indicates the relative air mass in percentage.

RETARDED IGNITION POINT _____ (range: YES/NO)

Indicates whether the ignition retard is active by, for example, the knock control system.

RETARDED IGNITION POINT(°) _____ (range: not available)

Indicates the amount of ignition timing retard in degrees that is required to enable smooth gear changes on an automatic transmission system.

RETARDING STEPS _____ (range: not available)

Indicates the torque reduction steps being currently applied by the traction control system.

RTD SIGNAL A/T ACTIVE _____ (range: YES/NO)

Indicates whether the automatic transmission (A/T) retard is active. With the vehicle stationary and signal inactive (NO), A/T has R selected and with the signal active (YES), A/T has 2, 3, D, P or N selected.

With the vehicle moving (above 10 MPH or 14 KM/H) and the signal inactive (NO), ignition timing retardation for A/T downshift is selected and with the signal active (YES), ignition timing retardation for A/T upshift is selected.

SECONDARY AIR MASS(g/s) _____ (range: not available)

Indicates the amount of output air from the secondary air pump in grams per second.

SIGNAL FROM A/T _____ (range: YES/NO)

Indicates whether the ECM is receiving a signal from the automatic transmission.

SLIDE VALVE SENSOR(MAX)(V) _____ (range: not available)

Indicates the voltage feedback signal used by the ECM to determine the injection pump governor maximum voltage (start position) and is used during start up.

SLIDE VALVE SENSOR(MIN)(V) _____ (range: not available)

Indicates the voltage feedback signal used by the ECM to determine the injection pump governor minimum voltage (stop position) and is used before start up.

START OF DELIVERY(°) _____ (range: not available)

Indicates the commencement of injection point that the ECM commands. The figure is degrees of crankshaft angle and can be + for BTDC or - for ATDC.

START OF DELIVERY(ACTUAL)(°) _____ (range: not available)

Indicates the actual commencement of injection. The figure is degrees of crankshaft angle and can be + for BTDC or - for ATDC. The signal is from the injector pump cam ring position sensor.

START OF DELIVERY(DESIRED)(°) _____ (range: not available)

Indicates the desired commencement of injection point. The figure is degrees of crankshaft angle and can be + for BTDC or - for ATDC.

START SYNCHRONIZATION(°) _____ (range: not available)

Indicates the start synchronization in degrees.

STATUS FUEL COOLING(%) _____ (range: not available)

Indicates the percentage that the fuel is cooled.

SUM MISFIRES _____ (range: not available)

Indicates the total amount of misfires detected.

TEETH COUNT TILL HALL-SIG SHIFT +TO - _____ (range: not available)

Indicates the number of teeth on the crankshaft sender wheel until the Hall-effect sensor on the camshaft switches the polarity of the sensor from positive (+) to negative (-). This is so the ECM knows the difference between compression stroke and exhaust stroke.

THR ADJ SENSOR, MAX LRN OK/EXEC _____ (range: YES/NO)

Indicates the current state of the learning process for the TP sensor maximum position stop.

THR ADJ SENSOR, MIN LRN OK/EXEC _____ (range: YES/NO)

Indicates the current state of the learning process for the TP sensor minimum position stop.

THR ADJ/TPS BALANCE OK/EXEC _____ (range: YES/NO)

Indicates if the signal from the throttle position (TP) sensor is equalized to the signal from the throttle stop position sensor. (The ECM recognizes both signals as being the same.)

THR ADJUSTER(LIMP)(%)

THR POS SENSOR(AV)(LIMP)(V) _____ (range: not available)

Indicates the signal used by the ECM to set the throttle valve adjuster average voltage when in limp home mode. Reading may be as a percentage of opening or voltage.

THR POS SENSOR(THR STOP)(V) _____ (range: not available)

Indicates the signal voltage of the throttle position sensor at idle.

THR VALVE ADJUSTER ANGLE(V) _____ (range: not available)

Indicates the voltage signal from the throttle adjuster potentiometer (throttle position).

THR VALVE ANGLE(ABSOLUTE)(°) _____ (range: not available)

Indicates the actual throttle valve angle.

THR VALVE ANGLE(LEARN)(°) _____ (range: not available)

Indicates the learned throttle valve angle when the idle switch is closed or when the throttle is slightly open.

THROTTLE ADJUSTER MODE _____ (range: IDLING/PART TRHROTTL)

Indicates the current throttle adjuster mode.

THROTTLE POSITION(IDLE)(V) _____ (range: not available)

Indicates the voltage from the throttle position sensor at idle.

THROTTLE POSITION SENSOR(V) _____ (range: not available)

Indicates the voltage from the throttle position sensor. The throttle position (TP) sensor produces a voltage signal proportional to the throttle position. The signal tells the ECM how wide the throttle is open: low voltage at closed throttle, high voltage at WOT.

The full range of the TP sensor voltage readings available to the ECM is 0 to approximately 5.1 V. A typical TP sensor voltage range might be approximately 0.5 V at idle to 4.5 V at WOT.

THROTTLE VALVE ADJUSTER(V) _____ (range: not available)

Indicates the voltage from the throttle position sensor. The throttle position (TP) sensor produces a voltage signal proportional to the throttle position.

THROTTLE VALVE ADJUSTER ANGLE(°) _____ (range: not available)

Indicates the position in degrees that the throttle returns to when the accelerator is released.

THROTTLE VALVE ADJUSTER MAX(V)

THROTTLE VALVE ADJUSTER MAX(%)

THROTTLE VALVE ADJUSTER MIN(V)

THROTTLE VALVE ADJUSTER MIN(%) _____ (range: not available)

Indicates the throttle valve adjuster maximum position.

THROTTLE VALVE ANGLE(°) _____ (range: not available)

Indicates the ECM calculated amount of throttle opening in degrees.

THROTTLE VALVE CLOSED _____ (range: YES/NO)

Indicates whether the ECM has detected the throttle valve is closed or open. This value is used in conjunction with other parameters when the ECM is applying learned idle values.

THROTTLE VALVE POSITION(%) _____ (range: not available)

Indicates the amount of throttle opening as a percentage.

THROTTLE VALVE POSITION 1(%)
THROTTLE VALVE POSITION 1(°)
THROTTLE VALVE POSITION 2(%)
THROTTLE VALVE POSITION 2(°) _____ (range: not available)

Indicates the position of the throttle valve on Banks 1 and 2.

TIME COUNTER(O2) _____ (range: not available)

Indicates a time counter that starts counting upwards when the diagnosis conditions for EGR are met and counts backwards when the diagnosis conditions for EGR are not met.

TIME COUNTER 1 _____ (range: not available)

Indicates a time counter that starts counting upwards when the diagnosis conditions for the EGR are met and counts backwards when the diagnosis conditions for the EGR are not met. Time counter 1 is increased by 1 when counter 2 reaches the value of 255. This value is only valid if the vehicle has an EGR system. If no EGR, then 0 will be displayed.

TIME COUNTER 2 _____ (range: not available)

Indicates a time counter that starts counting upwards when the diagnosis conditions for the EGR are met and counts backwards when the diagnosis conditions for the EGR are not met. Time counter 2 is increased by 1 when counter 1 reaches the value of 255. This value is only valid if the vehicle has an EGR system. If no EGR, then 0 will be displayed.

TORQUE (ACTUAL)(Nm) _____ (range: not available)

Indicates the actual torque output after reductions (flywheel torque).

TORQUE(DESIRE)(Nm) _____ (range: not available)

Indicates the actual torque output before reductions (flywheel torque).

TORQUE(DESIRE, BY A/T-ECU)(Nm)

TORQUE FROM A/T(Nm) _____ (range: not available)

Indicates the maximum torque output before reductions (flywheel torque) that the automatic transmission can use for smooth gear change.

TORQUE FROM ENGINE(Nm) _____ (range: not available)

Indicates the amount of torque the engine produces, it is used when gear changes are made.

TORQUE REDUCTION(Nm)

TORQUE REDUCTION _____ (range: ACTIVE/NOT ACTIVE)

Indicates the amount of torque the engine produces, it is used when gear changes are made.

TPS FULL RANGE(V) _____ (range: not available)

Indicates the voltage from throttle position (TP) sensor full range potentiometer. This is one of two potentiometers incorporated into one TP sensor unit. The signal is for the whole range (from idle to full throttle).

TPS LOW RANGE(V) _____ (range: not available)

Indicates the voltage from throttle position (TP) sensor low range potentiometer. This is one of two potentiometers incorporated into one TP sensor unit. The signal is for the whole range (from idle to full throttle).

TPS, MAX LRN OK/EXEC _____ (range: YES/NO)

Indicates the current state of the learning process for the TP sensor maximum position stop.

TPS, MIN LRN OK/EXEC _____ (range: YES/NO)

Indicates the current state of the learning process for the TP sensor minimum position stop.

TROUBLE CODE STORED IN MEMORY _____ (range: YES/NO)

Indicates whether the self diagnostic system has detected a fault. It reads YES if a fault is detected and reads NO at all other times.

UNPLAUSIBLE SIGNAL THR ADJ _____ (range: YES/NO)

Indicates whether the ECM can reconcile the relationship between the throttle position sensor and the throttle stop position sensor.

VEHICLE SPEED _____ (range: not available)

Indicates vehicle speed, which is calculated by the ECM based on the vehicle speed sensor (VSS) pulses. The ECM uses vehicle speed primarily for torque converter clutch engagement, although it also is an important value for electronic cruise control systems.

This induction sensor detects the information regarding vehicle speed by means of the pulse rotor at the input gear. This information is used for the decision as to which gear should be engaged, cruise control system and torque converter slip control.

**NOTE:**

If signal fails, the control unit uses the engine speed as a substitute signal and the lockup clutch is no longer closed.

VEHICLE SPEED CTRL _____ (range: TACHO/SPEEDO)

Indicates whether a speedometer or a speed recorder (tachograph) is fitted to the vehicle.

VOLTAGE THR ADJ OUT OF RANGE _____ (range: YES/NO)

Indicates that ECM can not reconcile the relationship between the throttle position sensor and the throttle stop position sensor.

WARM UP CAT _____ (range: YES/NO)

Indicates whether the ECM is operating in warm up CAT mode. Warm-up is achieved by retarding the ignition point to after TDC and enriching the mixture.

WARM UP CAT(%) _____ (range: not available)

Indicates whether the ECM is allowing extra fuel into the CAT to speed warm-up. Warm-up is achieved by retarding the ignition point to AFTER TDC and enriching the mixture.

WARN. SIGNAL INSTR. PANEL: REFUEL _____ (range: not available)

Indicates whether the fuel level is low or not.

6.3 Diesel Engine Parameters

Volkswagen Turbo Direct Injection (TDI) diesel came out in 1996. Previous ECO and Umwelt diesel engines were not electronically-controlled. The control system has more than 25 performance maps and characteristic curves for all possible performance variations based on torque, fuel consumption, and emissions.

ACCELERATOR PEDAL POSITION(%) _____ (range: not available)

Indicates accelerator pedal position (APP). The APP sensor is one of the main inputs for determining fuel quantity. The APP sensor is a potentiometer that contains an idle switch and a kickdown switch. With failure, the engine runs at fast idle.

BATTERY VOLTAGE BELOW 9V _____ (range: YES/NO)

Indicates whether the ECM has recognized a battery voltage below 9V and is used by the glow plug start system.

BOOST PRESSURE(DESIRED)(mbar)

BOOST PRESSURE(ACTUAL)(mbar)

INTAKE AIR TEMPERATURE(°) _____ (range: not available)

Indicates intake air pressure and temperature based on the MAP sensor and IAT sensor signals. Both sensors are combined in the intake air duct between the charge cooler and intake manifold and are used to calculate intake air density and turbocharger boost pressure. Atmospheric pressure at sea level = 1000 millibar; boost pressure increases to a positive pressure above atmospheric. Desired and actual should read fairly close to each other.

COOLANT TEMPERATURE(°) _____ (range: not available)

Indicates temperature based on the signal of the engine coolant temperature (ECT) sensor, which is the main input for determining fuel quantity and injector timing based on engine temperature. If ECT fails, the ECM substitutes the value from the Fuel Temperature Sensor.

COOLANT/AIRTMP SNS DEFECT _____ (range: YES/NO)

Indicates whether a fault has been recognized in the coolant or air temperature systems and is used by the glow plug start system.

COOLANT TMP >70°C/OR AIR TEMP >5°C _____ (range: YES/NO)

Indicates whether the coolant or air temperature are above the set temperatures and is used by the glow plug start system. (range: not available)

ENGINE CRANKED IN LAST 10S _____ (range: YES/NO)

Indicates whether the engine has been cranked in the last 10 seconds and is used by the glow plug start system.

ENGINE SPEED(RPM) _____ (range: not available)

Indicates engine speed based on the signal from the RPM sensor, which supplies a Top Dead Center signal for each cylinder. If this sensor fails, the engine will not run.

FUEL CONS. AUX HEATER(l/h) _____ (range: not available)

Indicates the amount of fuel that is used by the external heater.

FUEL CONSUMPTION(l/h) _____ (range: not available)

Indicates fuel consumption (as calculated by the ECM) in liters per hour.

FUEL CONSUMPTION ISC(g/s) _____ (range: not available)

Indicates the calculated fuel usage adaptation by the idle stabilization control unit. Value is in grams per second.

FUEL TEMPERATURE(°) _____ (range: not available)

Indicates the reading from the fuel temperature sensor. Fuel quantity calculation requires coolant temperature and fuel density. Uses substituted values in the event of sensor failure.

GLOW(s) _____ (range: not available)

Indicates the time in seconds the glow plug start system is active.

GLOW TIME(s) _____ (range: not available)

Indicates the time in seconds the glow plug start system is active.

INJ DIFF CYL 1 TO AVERAGE(mg/S)

INJ DIFF CYL 2 TO AVERAGE(mg/S)

INJ DIFF CYL 3 TO AVERAGE(mg/S)

INJ DIFF CYL 4 TO AVERAGE(mg/S) _____ (range: not available)

TDI Diesels are equipped with an Idle speed smooth running control system. To smooth out power differences between individual cylinders, the identified cylinder is given more (+x.xx mg/S) or less fuel (-x.xx mg/S), until the engine runs evenly again. Individual cylinder power output is compared to being more or less powerful than the number 3 cylinder.

INJ DIFF CYL 1 TO 3(mg/S)

INJ DIFF CYL 1 TO 4(mg/S)

INJ DIFF CYL 1 TO 5(mg/S)

INJ DIFF CYL 2 TO 3(mg/S)

INJ DIFF CYL 2 TO 4(mg/S)

INJ DIFF CYL 2 TO 5(mg/S)

INJ DIFF CYL 3 TO 4(mg/S)

INJ DIFF CYL 3 TO 5(mg/S)

INJ DIFF CYL 4 TO 3(mg/S)

INJ DIFF CYL 4 TO 5(mg/S)

INJ DIFF CYL 5 TO 3(mg/S)

INJ DIFF CYL 5 TO 4(mg/S)

INJ DIFF CYL 6 TO 3(mg/S) _____ (range: not available)

Indicates the difference of fuel injected in milligrams per stroke between the two identified cylinders.

INJ QUANTITY(mg/S) _____ (range: not available)

Indicates the quantity of fuel that has been injected under the present operating conditions. The value is in milligrams per cylinder stroke.

INJ QUANTITY(DESIRED)(mg/S)

Indicates the maximum quantity of fuel that can be injected under the present operating conditions after all corrections are applied. The value is in milligrams per cylinder stroke.

INJ QUANTITY(DRIVER)(mg/S)

INJ QUANTITY(TORQUE)(mg/S)

INJ QUANTITY(SMOKE)(mg/S)

INJ QUANTITY(CRUISE)(mg/S) _____ (range: not available)

Indicates injection quantity based on the driver's requirement, injection quantity limited according to specific RPM/torque limitation, injection quantity limited for smoke prevention, and injection quantity with cruise control system activated, respectively. DRIVER is the APP sensor input from the driver commanding more or less fuel. TORQUE is the RPM/load restrictions (torque) placed on the engine influencing fuel demand. SMOKE is a calculation from the Smoke Map to ensure fuel quantity does not exceed a preset amount to prevent black smoke. CRUISE calculation is from various inputs indicating engine fuel delivery for cruise conditions.

INJ QUANTITY(TCS)(mg/S) _____ (range: not available)

Indicates the maximum quantity of fuel that can be injected under the present operating conditions with regards to the Traction Control System (TCS) map. The value is in milligrams per cylinder stroke.

INJ QUANTITY(TORQUE A/T)(mg/S) _____ (range: not available)

Indicates the maximum quantity of fuel that can be injected under the present operating conditions, limited by the automatic transmission during gear change. The value is in milligrams per cylinder stroke.

MAF 1(mg/S)**MAF 2(mg/S) _____ (range: not available)**

Indicates the amount of air measured by the manifold airflow sensor in cylinder banks 1 and 2.

MAF DES(mg/S) _____ (range: not available)

Indicates the desired amount of airflow calculated by the ECM.

MASS AIR FLOW(mg/S) _____ (range: not available)

Indicates the amount of air drawn into the engine under the present operating conditions. The value is in milligrams per cylinder stroke. The figure is only valid while the EGR is active.

MASS AIR FLOW(DESIRED)(mg/S)**MASS AIR FLOW(ACTUAL)(mg/S) _____ (range: not available)**

Indicates the desired and actual reading of the MAF sensor. The MAF sensor uses Reverse Flow detection using two temperature sensors to measure intake air flow upstream and downstream of a heating element. The downstream sensor will measure higher temperature because the air is warmed as it passes the heating element. Change in temperature signals the ECM to factor out the reverse flow. Uses substitute values if sensor fails. The fixed value may result in part throttle performance problems. Normal value range for Mass Air Flow at idle is 230 to 370 (mg/S). Mass Air Flow desired and actual should read fairly close to each other.

REL.HEAT HIGH**REL.HEAT LOW _____ (range: YES/NO)**

Indicates whether the coolant or air temperature is above or below the set temperatures and is used by the glow plug start system.

RELAY HEATER HIGH**RELAY HEATER LOW _____ (range: ON/OFF)**

Indicates the current output state of the glow plug start system relay circuits.

SLIDE VALVE SENSOR(V)

Indicates the voltage of the modulating piston replacement sensor. Part of the Injection Pump, the Quantity adjuster regulates the quantity of fuel injected; an electromagnetic swivelling positioner, ECM duty cycle controlled. The rotational angle of an eccentric shaft attached to the quantity adjuster is measured by the modulating piston displacement sensor (slide valve sensor) The sensor variable voltage directly correlates to how much fuel is delivered. Normal range is 1.45 to 2.0 V. Below 1.450 V, mixture is too rich; Above 2.0 V, mixture is too lean.

Slide Valve Sensor Min. V range is 0.500 to 0.970 V. Slide Valve Sensor Max V range is 4.150 to 4.740 V.

START OF DELIVERY(DESIRED)**START OF DELIVERY(ACTUAL)****DC(DUTY CYCLE)START OF DELIVERY _____ (range: not available)**

Injector #3 is equipped with a Needle Lift Sensor to detect the start of injection. The sensor signals the actual opening time of the injector which acts as ECM feedback to confirm that the proper map for start of injection. The ECM calculates the start of injection from the time difference between the needle lift sensor and the TDC signal input from the RPM sensor. This is compared to a programmed map (DESIRED vs. ACTUAL) and corrected to the specified value if they differ.

Normal values for START OF DELIVERY (DESIRED) are 2° ATDC to 3 ° BTDC at idle. Normal values for START OF DELIVERY (ACTUAL) are 2° ATDC to 3° BTDC at idle and 8–14° at WOT (2900–3100 RPM).

DC (DUTY CYCLE) START OF DELIVERY (Cold Start Injector) controls the start of injection timing by regulating the pressure for the injection timing piston. The injection pump contains a mechanical injection timing device which requires engine speed dependent fuel pressure to advance or retard injection timing. The cold start injector is duty cycle controlled, precisely regulating the pressure to the timing piston. Normal range is 3 to 80% at idle and 70 to 95% at full throttle.

START QUANTITY(mg/S) _____ (range: not available)

Indicates the quantity of fuel that has to be injected under the present starting conditions because ECM input reading may not be correct under start conditions. The value is in milligrams per cylinder stroke.

6.4 Transmission Parameters

These parameters are ECM signals to and from various actuators and sensors in the transmission.

A/C KICKDOWN _____ (range: ACTIVATED/NOT ACTIVATED)

Indicates the state of A/C (A/C). Only activated after the kickdown downshift. The TCM is linked to the switch unit for solenoid coupling in the event of a manual A/C, whereas it is connected to the A/C control module and indicating unit on vehicles with digital A/C.



NOTE:

Shifting down a gear with the kickdown switch actuated results in a brief disconnection of the A/C compressor for up to 8 seconds to provide more power on acceleration.

ACTUAL SELECTED GEAR _____ (range: variable)

Indicates the TCM commanded gear. Vehicles with an electronic program switch in the TCM, the "ECO", or "Sport" program will be automatically selected by the TCM according to the speed at which the accelerator pedal is depressed. The displayed parameters are 1H, 2H, 3H, 4M. Vehicles with an electronic program in the transmission range program switch display parameters 1H, 2H, 3H, 3LT1, 3M, 3LT2, 4M. There are some transaxles that have the capability to display 1H, 1M, 2H, 2M, 3H, 3M, 4H, 4M, 5H, 5M. Different phases of this transaxle have a different shift solenoid firing order and may display parameters UNKNOWN.

- H = hydraulic (torque converter not locked up)
- M = mechanical (torque converter locked up)
- LT1 = load splitting (used momentarily for shift smoothness between 3H and 3M shift)
- LT2 = load splitting (used momentarily for shift smoothness between 3M and 4M shift)

LT1 and LT2 are used only with 095, 096, 097, and 098 phase 0 transmissions and may not be detected by the scan tool.

ACTUAL SOLENOID(A) _____ (range: 0.0 to 1.1A)

Indicates the actual amperage of solenoid # 6 (EPC) timing valve and pressure regulation on 095, 096, 097, 098, 01M, 01N and 01P transmissions. Readings should be 0.0 (A) at WOT and 1.1 (A) at closed throttle. Actual solenoid (A) should read close to required solenoid (A).

A/T _____ (range: YES/NO)

Indicates whether an automatic transmission is fitted.

A/T(RPM)

A/T INPUT(RPM) _____ (range: 0 to maximum RPM)

Indicates the transmission input shaft RPM.

A/T INPUT(RPM) _____ (range: 0 to maximum RPM)
01V

Indicates transmission input speed.

Table 6-3 *Transmission input speed*

Gear	Rpm
R*	Approx. 0–10
R	Approx. 0–2000
1M*	Approx. 0–10
1M, 1H	Approx. 0–1200
2H	Approx. 0–4000
3H	Approx. 0–5800
4H	Approx. 0–8200
5H	Approx. 0–8200
* Vehicle stationary	

A/T INPUT(RPM) _____ (range: 0 to 8200 RPM)
01N

Indicates transmission input speed based on an input speed sensor that is positioned in the transmission housing. It detects the speed of the large sun wheel in the planetary gear so the control unit can accurately calculate reduction in engine torque during the gearshift by retarding the ignition angle to control the clutch and brake application during a shift.

A/T OUTPUT(RPM) _____ (range: 0 to maximum RPM)

Indicates transmission output shaft speed (OSS) based on the OSS sensor. The OSS sensor is on inductive pickup.

A/T SWITCH _____ (range: P/N /NOT P/N)

Indicates the Park/Neutral Position (PNP) switch status, which indicates whether an automatic transmission is in park or neutral, or in one of the drive ranges.

ATF TEMPERATURE(°C) _____ (range: variable)

Indicates the temperature of the transmission fluid based on the transmission fluid temperature (TFT) sensor. It is monitored to prevent the transmission from overheating. It is located on the valve body within the solenoid wiring harness.

BATTERY VOLTAGE _____ (range: 9.0 to 16.0 volts)

Indicates battery voltage on terminal 15 of the TCM on a 01V transmission. The TCM monitors battery voltage to make sure it can operate safely. The safe parameter is 10.8 to 16.0 volts.

BRAKE LIGHT SWITCH _____ (range: OPERATED/NOT OPERATED)

Indicates the state of brake switch. It reads OPERATED when the switch is on; and NOT OPERATED when the switch is off.

ENGINE TORQUE(Nm) _____ (range: variable)

Indicates the ECM calculated engine torque, which is based on the injection time and passed on to the TCM.

In the event of a faulty signal gear, selection is always implemented at maximum modulation pressure, emergency operation 1. Gear shifting is affected with a throttle-valve opening angle of 30%. There is no kickdown.

ENGINE TORQUE MAX _____ (range: variable)

Indicates the maximum engine torque that the TCM will allow on a 01V transmission. The TCM reduces engine torque required during shifts.

GEAR POSITION _____ (range: variable)

Indicates which gear the transmission is in.

HILL FACTOR(%) _____ (range: 0 to 100%)

Indicates the TCM calculation of driving conditions on 01M and 01N transmissions. When driving on level road (less than $\pm 3\frac{1}{2}$ degrees), the TCM will function in economy mode. When there is road resistance, such as wind load, towing, increased vehicle load or uphill driving (more than $3\frac{1}{2}$ degrees), shift points change to provide more engine RPM and power. When road resistance decreases, such as going downhill, the TCM automatically selects a suitable lower gear. Engine braking is provided with the selector lever in "D" and reduces the need for braking when driving downhill. When road resistance returns to normal, shifting characteristic also return to normal.

KICKDOWN SWITCH _____ (range: ON/OFF)

Indicates the state of the kickdown switch. The kickdown switch is integrated into the Bowden accelerator cable. It is used to detect situations where the accelerator pedal is depressed beyond the full-throttle point. With the kickdown switch actuated, the A/C compressor is disengaged to provide more power on acceleration.

**NOTE:**

On vehicles with a TDI engine, the TCM receives the kickdown signal from the acceleration pedal position (APP) sensor.

KICKDOWN SWITCH _____ (range: ON/OFF)

Indicates the state of the kickdown switch on 01M, 01F, and 01K transmissions. The kickdown switch is integrated into the Bowden accelerator cable. It is used to detect situations where the accelerator pedal is depressed beyond the full-throttle point.

**NOTE:**

On vehicles with a TDI engine, the TCM receives the kickdown signal from the APP sensor that is located in the bracket for the bell crank. It is an EDC sensor that supplies the kickdown signal on vehicles with TDI engines.

LOCK-UP SLIP _____ (range: 0 to 99%)

Indicates the amount of torque converter clutch regulated slip. It normally reads 0–30% slip when lockup occurs.

LOCK-UP SLIP _____ (range: 0 to stall)

Indicates condition of the torque converter lockup clutch on a 01V transmission. With the TCC solenoid in the open state, lockup slip, or torque converter slip speed should be between 0 RPM and stall speed. With the TCC solenoid in the control state, lockup slip speed should be 20 to 120 RPM (last gear shift at least 20 seconds ago). With the TCC solenoid in the closed state, lockup speed should be 0 to 10 RPM. Engine torque is mechanically transmitted to the transmission during torque converter lockup.

LOCK-UP SLIP _____ (range: 0 to stall)

Indicates torque converter lockup slip on a 01P transmission. When in the hydraulic gears, the torque converter lockup must be open with 0 to stall RPM slip. With engine speed 2000–3000

RPM in the mechanical gears, gear completed, the torque converter lockup clutch must be closed and the accelerator pedal value held constant with 0 to 130 RPM slip.

PRESSURE CTRL(A) _____ (range: variable)

Indicates the pressure control amperage of the #4 solenoid. It controls the pressure for actuation of shift elements (modulation pressure) as a function of engine speed, engine torque, and transmission oil temperature.

REQUIRED SOLENOID(A) _____ (range: 0.0 to 1.0A)

Indicates the specified current the TCM would like to see through solenoid A, which is the electronic pressure control (EPC) solenoid, on 095, 096, 097, 098, 01M, 01N, and 01P transmissions. It should read 0.0 at WOT and 1.0 at closed throttle. This value should closely match Actual solenoid (A). Code set if actual and required vary by 0.050 A or more.

REQUIRED SOLENOID #4

REQUIRED SOLENOID #5

REQUIRED SOLENOID #6

REQUIRED SOLENOID #7 _____ (range: 0.0 to 1.0A)

Indicates the specified current the TCM would like to see through solenoids #4, 5, 6, and 7 on a 01V transmission. It should read 0.0 at WOT and 1.0 at closed throttle. This value should closely match Actual solenoid (A). Code set if actual and required vary by 0.050 A or more.

Table 6-4 Shift element positions—01V transmission

Gear	1-N88	2-N89	3-N90	4-N91	5-N92	6-N93	7-N94
Reverse	*			*		*	
Neutral	*	*		*		*	
D, 1st	*	*		*		*	
D, 2nd	*	*		*	*	*	
D, 3rd		*	*_*	*	*		
D, 4th			*_*	*			
D, 5th	*		*_*	*	*		
2, 1st	*			*		*	
D, 5th to 4th	*		*	*	*		*

* = Component is actuated, - = Component is not actuated

SHIFT LEVER LOCK _____ (range: not available)

Indicates the status of the shift lever lock. It prevents involuntary movement of the selector lever positions P and N if the brake pedal is not depressed.

SOLENOID #1

SOLENOID #2

SOLENOID #3

SOLENOID #4

SOLENOID #5

SOLENOID #7 _____ (range: ACT/N.ACT)

Indicates the state of the shift solenoids, and should read ACT (active) when the solenoid is on, and N.ACT (not active) when the solenoid is off.

For 01F and 01K transmissions, the solenoid valves #1 and #2 govern the selection of various gears in line with actuation by TCM. Solenoid valve #3 creates the necessary prerequisites (pressure) for proper switching of the solenoid valves #1, #2 while driving.

Table 6-5 Solenoid valve activation—01F and 01K transmissions

Gear	Sv 1 (n88)	Sv 2 (n89)	Sv 3 (N90)
Park	N.ACT	ACT	ACT
Reverse	N.ACT	N.ACT	N.ACT
Neutral	N.ACT	ACT	ACT
First	N.ACT	ACT	N.ACT
Second	ACT	ACT	N.ACT
Third	ACT	N.ACT	N.ACT
Fourth	N.ACT	N.ACT	N.ACT
3-4*			ACT

* Brief actuation on shifting from 3rd/4th gear.



NOTE:

Solenoid #4 is timing valve and is responsible for pressure regulation (See “PRESSURE CTRL(A)” on page 143).

For 095, 096, 097, and 098 transmissions, the solenoid valves #1, #2, #3, and #4 govern the selection of various gears in line with actuation by the TCM. Solenoid valves #5 and #7 create the necessary prerequisites (pressure) for proper clutch apply and release.

Table 6-6 Solenoid valve activation—095, 096, 097, and 098 transmissions

Gear	Solenoid #1	Solenoid #2	Solenoid #3	Solenoid #4
Drive 1st				ACT
Drive 2nd		ACT		ACT
D 3rd H				
D 3rd LT1*			ACT	ACT
D 3rd M*			ACT	
D 3rd LT2*	ACT		ACT	
D 4th M	ACT	ACT	ACT	ACT
Reverse				

H = hydraulic, M = mechanical, LT1 & LT2 = load splitting

* LT1, D3M, and LT2 are only used with phase 0 transmissions. Also, LT1 and LT2 are momentary TCM commands and may not be detected by the scan tool.



NOTE:

Solenoid #6 is timing valve and is responsible for pressure regulation (See “ACTUAL SOLENOID(A)” on page 140).
Solenoid #4 becomes TCC activation with phase 2.

For 01M, 01N, and 01P transmissions, the solenoid valves #1, #2, and #3 govern the selection of various gears in line with actuation by the TCM. Solenoid valves #5 and #7 create the necessary prerequisites (pressure) for proper clutch apply and release.

Table 6-7 Solenoid valve activation—01M, 01N, and 01P transmissions

Gear	Solenoid #1	Solenoid #2	Solenoid #3	Solenoid #4	Solenoid #5	Solenoid #7
P	ACT		ACT			
R	ACT		ACT			
R ¹			ACT			
N	ACT		ACT			
D 1			ACT		X	
D 2 H		ACT	ACT			
D 2 M		ACT	ACT	ACT		
D 3 H						ACT
D 3 M						ACT
D 4 H	ACT	ACT				ACT
D 4 M	ACT	ACT				ACT

X = variable switching condition, H = hydraulic, M = mechanical, ¹ = Vehicle stationary,

NOTE:



Solenoid #4 is a modulation type for torque converter lockup that does not read amps. This solenoid shows ACT or N.ACT. To look at how much modulation is taken place, see "LOCK-UP SLIP" on page 142.

Solenoid #6 is timing valve and is responsible for pressure regulation. See "ACTUAL SOLENOID(A)" on page 140.

SPORT FACTOR(%) _____ (range: 0 to 100%)

Indicates the percentage of sport driving on a 01N transmission. High values move the shift points to higher speeds.

TCS STATUS _____ (range: TCS ACTIVE)

Indicates the traction control system (TCS) status on a 01V transmission. When TCS ACTIVE displays, traction control is activated from TCS control module. When the display is blank, the traction control system is not activated.

THROTTLE VALVE POSITION _____ (range: 0 to 100%)

Indicates the accelerator pedal position (APP). The readout constantly increases from closed throttle position to WOT.

THROTTLE VALVE POSITION(V) _____ (range: 0.156V to 4.680V)

Indicates the throttle valve position sensor voltage on a 01P transmission. When accelerating from idling to WOT, the voltage figure increases constantly. With the vehicle stationary, idling should be min. 0.165, max 0.8V, and WOT should read minimum 3.5 to maximum 4.680V.

NOTE:



Diesel engine voltage may differ slightly.

TIPTRONIC

Indicates the selected gear range of a Tiptronic transmission. Tiptronic transmissions have an additional selector gate on the right of the transmission shifter selector gate or steering wheel paddles. Tiptronic makes it possible to manually shift up a gear by moving the selector lever or steering wheel paddles to plus (+) or manually shift down a gear by moving the selector lever or steering wheel paddles to negative (-). This mode is for drivers who prefer manual gear shifting. The transmission will upshift automatically to prevent inadvertent over-revving of the engine. Also, the driver cannot downshift to a lower gear if the engine RPM would exceed red-line by downshifting. In addition, the transmission will downshift to first automatically when the vehicle comes to a stop, even if the driver does not remember to downshift. This transmission is designed to handle high torque output.

The left-hand gate is for electronically controlled automatic shifting with adaptive control. This is a function of various sensors and is transparent to the driver. Shift points are automatically regulated to provide three distinct operating characteristics:

- Comfort driving for maximum fuel economy (shift points are kept low).
- Average driving (shift points are raised slightly).
- High-performance driving (shift points are increased to allow the engine to rev higher between gearshifts).

TIPTRONIC SWITCH _____ (range: N/A (+) upshift (-) downshift)

Indicates the upshift (+) or downshift (-) position of the tiptronic shifter.

TORQUE(Nm) _____ (range: variable)

Indicates the torque of the TCM calculated by the ECM.

TORQUE MAX(Nm) _____ (range: 0 to maximum torque)

Indicates the maximum torque of the TCM calculated by the ECM.

TORQUE RAISE _____ (range: 1-2,17)

Indicates torque increase in the converter while driving on a 01V transmission. It is calculated by the TCM from torque converter slip speed.

TORQUE REDUC _____ (range: not available)

Indicates if there is a torque reduction or not.

VEHICLE SPEED _____ (range: 0 to maximum speed)

Indicates vehicle speed on 01F and 01K transmissions based on the vehicle speed sensor mounted in the transmission housing. This information is used for the decision as to which gear should be engaged, cruise control system and torque converter slip control.

**NOTE:**

If the signal fails, the control unit uses the engine speed as a substitute signal and lockup clutch is no longer closed.

VEHICLE SPEED SENSOR(V) _____ (range: 2.20 to 2.52V)

Indicates vehicle speed sensor voltage on 097, 01N and 098 transmissions. With the vehicle stationary, voltage should read 2.20 min. and 2.52 max.

WHEEL LEFT FRONT(RPM) _____ (range: 0 to vehicle speed)
WHEEL RIGHT FRONT(RPM)
WHEEL RIGHT REAR(RPM)
WHEEL LEFT REAR(RPM)

Indicates vehicle speed from wheel speed sensor through the ABS controller on 018 and 01K transmissions. The ABS unit recognizes the wheel speeds from the signals provided by the speed sensors. These signals are passed from ABS control unit to the control unit for the automatic transmission. The TCM averages the 4 signals and detects output speed.



NOTE:

Should one wheel-speed signal fail, the transmission output speed is determined from the three remaining signals. The TCM switches to emergency operation 2 if more than one speed sensor signal fails.

6.5 Transmission Expert Mode Parameters

Expert Mode displays all data groups and on some models data may not be available, but still may show data in some form. Data is filtered in regulator data groups and should be verified before suspecting a scan tool or vehicle problem.

Accelerator Pedal Value _____ (range: 0 to 100%)

Indicates the accelerator pedal position (APP). When accelerating from idle to WOT, the accelerator pedal percentage should increase.

Actual Engine Torque _____ (range: variable)

Indicates actual engine torque. This 01V transmission parameter is viewed from Expert Mode in display group 009, display field 1. With the vehicle driven, the actual engine torque signal is passed from the engine control module (ECM) to the transmission control module (TCM) via CAN bus wiring.

Adaptation of start-from-stop behavior forward _____ (range: ADP OK/RUNNING)

This 01J transmission data parameter is viewed from Expert Mode in display group 010, display field 2. The parameter should read either ADP OK or RUNNING. ADP (“adaptation”) means adapting to an internal specified value. If the ADP value does not read OK with transmission fluid temperature higher than 140°F (60° C) and no codes in memory, drive forward briefly and then brake to a stop again. Repeat until the display reads ADP OK.

- Display field 3 is transaxle temperature.
- Display field 1 is adaptation of clutch curve forward and can be ignored.
- Display field 4 is specified clutch torque and can be ignored.

Adaptation of start-from-stop characteristics Reverse _____ (range: ADP OK/RUNNING)

This 01J transmission parameter is viewed from Expert Mode in display group 011, display field 2. The parameter should read either ADP OK or RUNNING. ADP (“adaptation”) means adapting to an internal specified value. If ADP value does not read OK, with transmission fluid temperature higher than 140°F (60°C) and no codes in memory, drive in reverse briefly and then brake to a stop again. Repeat until the display reads ADP OK.

- Display field 3 is transaxle temperature.
- Display field 1 is adaptation of clutch curve forward and can be ignored.
- Display field 4 is specified clutch torque and can be ignored.

DRIVING SLIP CTRL _____ (range: ACT/N.ACT)

Indicates whether the traction control system is activated (ACT) or not activated (N.ACT) on a 01M transmission.

Dynamic Code Number _____ (range: variable)

Indicates a code for the 01V transmission that can only be viewed from Expert Mode in display group 002, display field 1. This data group has five number sets to indicate vehicle characteristics and customer driving conditions. The first set of three numbers is determined by driving style and operating conditions (acceleration, accelerator pedal movement, speed, and load).

With normal driving conditions, a reading of 0 equals minimum value (very economic), 240 equals maximum value (very sporty). High values move shift points to higher engine speeds. The second set of three numbers indicated whether the warm-up program is active (min./max numbers are not available) and may read 241. The third set of three numbers determines whether the anti-slip regulation (ASR) is active and may read 242 (min./max numbers are not available). Shifting should be avoided whenever possible. The fourth set of three numbers determines whether the

tiptronic recognition is activated and may read 243 (min./max numbers are not available). The fifth set of three numbers indicates the cruise control system characteristic map and may read 244 (min./max numbers are not available). This parameter is only available for vehicles in the USA and may not be applicable on some models.

FUEL CONSUMPTION SIGNAL _____ (range: not available)

Indicates fuel consumption on a 01V transmission when viewed in Expert Mode display group 009, display field 4. Fuel consumption signal displays the injection period on vehicles equipped with a data bus. Injection period is read in milliseconds and varies by engine, speed, and load.

GEAR SELECTED _____ (range: 1H+/- to 4M +/-)

Indicates the current gear on 01M, 01N, and 01P transmissions when viewed in Expert Mode data group 007, display field 1. The + or – sign relates to the lockup slip of the torque converter clutch. A plus sign (“+”) indicates that the engine speed (pump speed) is greater than the turbine speed, and so the vehicle is under traction. A minus sign (“-”) indicates that the engine speed is less than the turbine speed, and so the vehicle in overrun.

On-Board Diagnostic _____ (range: 0 to 1)

Indicates the on-board diagnostic display information from left to right. This display group can be viewed in Expert Mode display group 004, display field 4. The display indicates malfunction (1 = switched on 0 = switched off), trip (1 = complete 0 = not complete), transmission warm-up (1 = complete 0 = not complete), engine start (1 = recognized 0 = not recognized).

Overrun/engine pulling signal _____ (range: overrun/engine pulling)

Indicates whether an 01V transmission is in overrun or normal mode when viewed from Expert Mode in display group 008, display field 4. If in overrun, the transaxle has engine braking. With no display normal driving, the engine is delivering power.

SELECTOR OUTPUTS _____ (range: 0 and 1)

Indicates engine management status (0 = turned off, 1 = turned on) on a 098 transmission when viewed from Expert Mode in display group 005, display field 2 (first set of binary numbers). The second set of numbers are unknown at this time. The third set of numbers are the shift lock solenoid (0 = turned off, 1 = turned on). The fourth set of numbers are unknown at this time. The fifth set of numbers are the cruise control (0 = turned off, 1 = turn on). The sixth set of numbers are the air conditioner (0 = turned off, 1 = on). The seventh set of numbers are the Park/Neutral signal selector lever (0 = 1, 2, 3, D; 1 = P, N).

Torque converter lockup clutch _____ (range: tcc open/tcc control/tcc closed)

Indicates the percentage of TCC solenoid activation on a 01V transmission when viewed from Expert Mode in display group 007, display field 3. When the parameter reads TCC OPEN, there is no torque converter clutch operation, with TCC CONTROL, the torque converter clutch is partially applied, with TCC CLOSED, the torque converter clutch is fully applied.

Torque converter slip speed _____ (range: 0 to stall speed)

Indicates the torque converter slip speed on a 01V transmission when viewed in Expert Mode in display group 007, display field 3, display fields 4.

6.6 ABS Parameters

EDS CUT OFF _____ (range: not available)

Indicates if the EDS fuel cut off is switched on or off.

HANDBRAKE _____ (range: not available)

Indicates if the handbrake is activated or not.

POWER SUPPLY ECU(V) _____ (range: not available)

Indicates the power supply of the ECM.

ROTATIONAL SPEED(°/s) _____ (range: not available)

Indicates the rotation speed of the steering wheel in degrees per second.

STEERING ANGLE(°) _____ (range: not available)

Indicates the position of the steering wheel in degrees.

TCS SWITCH _____ (range: ON/OFF)

Indicates a feedback signal from the Traction Control System (TCS) switch.

TORQUE(%) _____ (range: not available)

Indicates the total torque in percentage.

TORQUE LOSS(Nm) _____ (range: not available)

Indicates the total torque loss in the ABS system in Newton meters.

TRANSVERSE ACCELERATION(m/s²)

Indicates the transverse acceleration.

WHEEL LEFT FRONT

WHEEL RIGHT FRONT

WHEEL LEFT REAR

WHEEL RIGHT REAR _____ (range: not available)

Indicates wheel speed.

A.1 Terms

The following terms are used throughout this manual to explain certain operations and displays:

blink code	A type of vehicle control system that has no serial data. Any trouble codes the control system set are extracted either by flashing the malfunction indicator lamp (MIL) or using a special breakout box.
bonnet	European for "hood."
code	A numerical code, generated by the vehicle control system to indicate a fault has occurred in a particular subsystem, circuit, or part.
cursor	The arrow that appears on menus and some other displays. In most displays, the cursor moves as you scroll.
fix	To lock a single line of the display in a fixed position on the screen to prevent it from scrolling. Data readings remain live while the parameter categories are fixed.
frame	One complete data package, or transmission cycle, from an electronic control module (ECM) that provides serial data of control system operating parameters.
hold	To capture and hold a single data frame for review or printing.
movie	A vehicle data record whose length depends on the number of selected data parameters.
menu	A list of vehicle tests or programs from which a selection can be made.
parameter	A measured value of control system input or output operation. Parameters include voltage signals, as well as temperature, pressure, speed, and other data.
release	To unlock a fixed line and allow it to scroll.
screen	Any given 4-line display.

A.2 Acronyms

The following acronyms are used in diagnostic trouble code definitions displayed by the scan tool or used in this manual.

4WD	4 wheel drive
ABS	antilock brake system
A/C	air conditioning
AIR	secondary Air Injection (OBD-II)
APP	accelerator pedal position

ASC	anti-spin control
ASR	anti-slip regulation
A/T	automatic transmission
B1S1	bank 1, sensor 1 (passenger side pre-catalytic, upstream oxygen sensor)
B1S2	bank 1, sensor 2 (passenger side post-catalytic, downstream oxygen sensor)
B2S1	bank 2, sensor 1 (driver side pre-catalytic, upstream oxygen sensor)
B2S2	bank 2, sensor 2 (driver side post-catalytic, downstream oxygen sensor)
BDC	bottom dead center
CA	California
CAN	controller area network
CAT	catalytic converter
CCS	cruise control system
CMP	camshaft position
CPI	central point injection
CPP	clutch pedal position
CTP	closed throttle position
CVT	continuously variable transmission
DA	drivers airbag
DIS	digital idle speed control
DLC	data link connector
DP	driver pretensioner
DLC	data link connector
DSA	driver side airbag
DSL	diesel engine
DTC	diagnostic trouble code
DTM	output diagnostic test mode
ECM	engine control module
ECT	electronic coolant temperature
ECU	electronic control unit
EDL	electronic differential lock
EDS	pressure regulator
EFI	electronic fuel injection
EGR	exhaust gas recirculation
EMS	engine management system
EPC	electronic power control
ESP	electronic stability control
EVAP	evaporative emissions system

FL	front left (wheel)
FR	front right (wheel)
FT	fuel trim
IAT	intake air temperature
ISC	idle speed control
L4	4 cylinder longitudinal mounted engine
LDP	leak detection pump
LEV	low emission vehicle
MAF	mass airflow sensor
MAP	manifold absolute pressure
MBAR	millibar; 1000 millibar = 14.5 psi
MIL	malfunction indicator lamp
MPI	multipoint injection
MSR	engine drag torque control
M/T	manual transmission
MV	magnetic valve(s)
O2S	oxygen sensor
PA	passenger airbag
PNP	park/neutral position
PP	passenger pretensioner
PSA	passenger side airbag
RL	rear left (wheel)
RR	rear right (wheel)
SAI	secondary air injection
SFI	sequential fuel injection
SULEV	super ultra low emission vehicle
TCC	torque converter clutch
TCM	transmission control module
TCS	traction control system
TDC	top dead center
TDI	turbo direct injection
TLEV	transitional low emission vehicle
TP	throttle position
TWC	three way catalytic converter
ULEV	ultra low emission vehicle
V6	6-cylinder V-type engine
WOT	wide open throttle
ZEV	zero emission vehicle

This chapter contains information for troubleshooting specific problems that may arise when using the scan tool.

B.1 Communication Problems

When the scan tool is unable to establish communication with the control module in the vehicle under test, or when the communication is interrupted, a message will display. If this happens, wait to see whether the communication is established again or interrupted. If communication is interrupted again, press **N** to abort.



NOTE:

Switching the ignition off-and-on and reentering the ID may reset communication.

Note the following regarding communication problems with VW/Audi vehicles:

- When testing a VW/Audi with certain ECMs, communication problems may occur when the engine speed is above 2000 RPM. In this case, communication cannot be established. Once communication has been established, the engine may be revved above 2000 RPM.
- If testing ABS/EDS/ESP/TCS systems, problems may occur if the vehicle speed exceeds 12 MPH (19 KPH). Communication will be stopped or cannot be established.

B.2 The Aftermarket Radio Problem

Between 1997 and 1998, VW and Audi started using radios with self-diagnostic capabilities in most models. The scan tool can communicate with the radio, which allows you to set various options, like whether a CD player is connected, an amplified or conventional antenna, or other installed options.

B.2.1 The Problem

VW brought the "K-Line", the wire on which all of the vehicle control modules communicate with the scan tool, to a pin in the connector on which older radios used to return B+ back into the harness. So if you were to take the non-diagnostics capable radio out of a 1997 GTI and put it in a 1998 where there should be a diagnostics-capable one, it fits perfectly, but the K-Line ends up shorted to power.

Many aftermarket radios have adapter harnesses that plug into the vehicle radio connector. Unfortunately, some of the aftermarket harnesses faithfully reproduce the older, non-diagnostics radios with a loop of wire between B+ and the pin where the K-Line is on newer models. The radio will work fine until you connect a scan tool.

The vehicle is not affected if the K-Line is shorted to B+. The K-Line is not used for intra-vehicle communications, however, the scan tool initializes a communications session by pulling the K-Line to ground. The K-Line normally has some voltage on it, but through a high-impedance source. If the K-Line has “full” B+ on it, it can damage the scan tool output driver for the K-Line.

B.2.2 Testing for this Problem

You can test for this problem yourself without removing the radio.

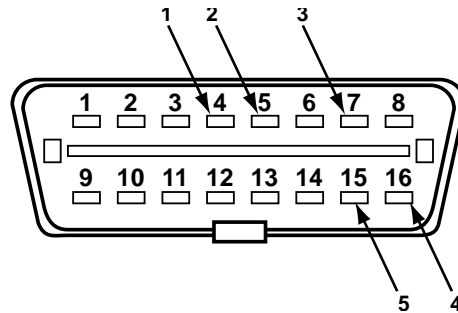

- 1— Chassis ground
- 2— Signal ground
- 3— K-Line
- 4— L-Line
- 5— B+

Figure B-1 16-pin OBD-II data link connector (DLC)



To test this problem with a voltmeter, such as the Snap-on® Vantage® graphing meter:

1. Measure the voltage between pins 4 and 7 of the DLC with the ignition and radio on.
If the reading is below 9V, your K-Line is fine. If the reading is above 9V, the results are inconclusive and you need to proceed to the next step.
2. Put a 1K-ohm resistor between pins 4 and 7 of the DLC.
3. Use the voltmeter to measure the voltage between 4 and 7 (in parallel with the resistor).
If it is under 1V, you don't have the problem. If it remains near 12V (the resistor will get hot!) you do have this problem and you will need to fix it (see the procedure for fixing this problem on page 156).



To test this problem without a voltmeter:

1. Temporarily place a 1K-ohm resistor between pins 4 and 7 of the DLC and ensure it is making contact with both pins (Figure B-1).
If the resistor gets hot, your K-Line is shorted to B+. If it does not get hot, you do not have a problem. Do NOT install this resistor in the port. You are simply using it to check and see if the K-Line has 12V.
2. If the resistor gets hot, then pull it out and fix the problem by disconnecting the K-Line from the stereo wiring harness.



To repair the problem:

1. Remove the radio.
2. Make sure that the K-Line in the radio wiring harness (black 8-pin multi-connector III-T8) has been removed from the connector and taped back to the harness (Figure B-2).

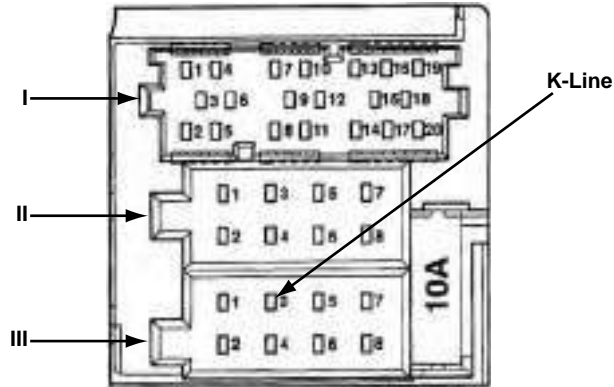
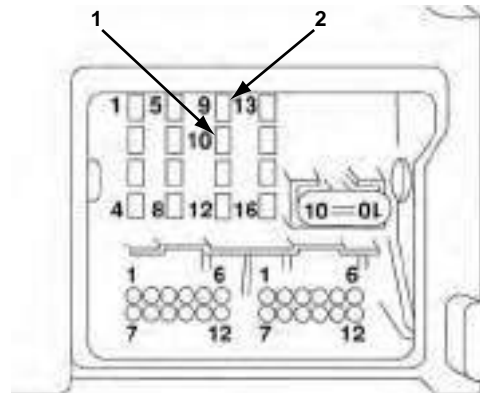

Figure B-2 K-Line on the radio wiring harness black 8-pin multi-connector III-T8



NOTE:

Some 2002 and newer Volkswagens come with the double-DIN “Premium VI” radio. This radio does not have a K-Line connection, but rather has a CAN-high and CAN-low. Although the connector is completely different and it should not be possible to have the “Aftermarket Radio Problem” with these newer cars, if you use an aftermarket radio, it would be best to make sure that nothing is connected to these pins in the radio harness. The back of the Premium VI radio is shown in Figure B-3.



- 1— CAN-
- 2— CAN+

Figure B-3 Back of Premium VI radio

Fuel Control Learning Adaptation Values

VW/Audi uses a type of fuel control called “adaptive learning.” This is defined as the ability of the engine management system to continuously modify the fuel mixture to account for changing operating conditions.

OBD-II terms for fuel control are “short-term” and “long-term” fuel trim (FT).

- **Short term** means the correction responds directly to the oxygen sensor (O2S) input.
- **Long term FT** is designed to maintain short term FT in a balanced state, equal range of control on either side of rich or lean.

The following sections explain OBD-II short and long term FT terminology applied to VW/Audi fuel control terminology. VW/Audi use Bosch Motronic engine management systems. For VW, Adaptive Learning started with the Motronic 2.9 engine management system in 1993. Each new system increased the adaptation sophistication (M2.9, M5.0, M5.9.2, M7.0, M7.1, M7.5.1). For these systems, two central fuel control terms require explanation:

- **Additive** for idle adaptation.
- **Multiplicative** for part throttle or cruise adaptation.

C.1 Long-Term Fuel Control

Both Additive and Multiplicative adaptation are a form of long term fuel control. Each is a coarse type of FT control, allowing short term FT to maintain a midpoint balance between rich and lean.

C.1.1 Additive Adaptation

Additive means adding or subtracting equal amounts of fuel to every fuel block cell regardless of the programmed base injection pulse value. It works very effectively for idle mixture related problems, but its effect is minimal at the higher engine speeds. For example, vacuum leaks greatly affect fuel mixture at idle but become less severe at higher RPM. The important distinction is that the amount of fuel correction is not dependent upon the original base in each fuel memory cell.

Additive adaptation indicates a fine-tuning, long-term correction or adaptation that the ECM is applying to the fuel injection pulse width. Although these minute adjustments affect the entire engine speed range, they are most noticeable at idle or during lower pulse-width operating conditions. A positive value indicates increased fuel injection duration, and a negative value indicates a decreased fuel injection duration.

When the short term correction value, reaches its upper or lower limit, the ECM resets short term correction and moves the long term FT value up or down by one count. The short term FT moves quickly, while the long term FT moves slowly. The short and long term FT continue to work together until the fuel mixture problem is corrected, or until the long term FT reaches its upper or lower limit. When the long term FT reaches its limit, the ECM sets a DTC, and usually defaults into open loop operation. The factory term “Additive Mixture Adaptation” refers to the fact that the ECM

is adding directly to the injector opening time for all memory cells. However, data is only updated under certain idle conditions. Be aware that Idle and Part Load Multiplicative work together to establish the long term FT.

C.1.2 Multiplicative Adaptation

Multiplicative means multiplying or taking the preprogrammed cell base value and multiplying that number by either a correction factor or percent. Here, the correction amount increased or decreased in each memory block cell is dependent on each cell's base injection pulse. This form of adaptation is required to compensate for fuel control-type problems that get worse with increased engine speed (i.e., a faulty injector). Short term FT in VW/Audi language is usually called O2 regulation or O2 control. The readings are constantly changing, directly responding to oxygen sensor (O2S) input. Normal readings are usually in the $\pm 10\%$ range with 0 as the midpoint. If it gets too far off, Long-term additive or multiplicative adjusts the window back to the midpoint (balanced state).

Multiplicative adaptation correction indicates the long-term FT correction that the ECM is applying to the air/fuel mixture during closed loop operation over the middle to upper range of engine operation. VW/Audi use the term "Multiplicative Mixture Adaptation" because it is a percent correction factor based on the individual base injection value for each memory cell. Cells are constantly updated based on feedback operation. If any cell stores an update that is beyond the neutral feedback value, a correction is then factored into the injector pulse-width calculation. To maintain the optimal air/fuel ratio of 14.7:1 for catalytic converter (CAT) efficiency, the ECM monitors the O2Ss and calculated load. From this information, the ECM calculates a percent value that indicates how much to enrich or dilute the fuel mixture. Sometimes, the ECM makes fine tuning adjustments across the complete fuel map by adjusting the IDLE (Additive) FUEL TRIM (for example, when a fine adjustment is needed across the range to compensate for fuel injector drift).

C.1.3 Examples of Display Groups for Long Term FT Adaptive Value

Depending on the year, vehicle, engine, and engine code, you may see some combination of the following long term FT parameters:

- ADPVALUEO2(ADD)(%)
- ADPVALUEO2(IDLE)(ADD)(%)
- ADPVALUEO2(MUL)(%)
- ADPVALUEO2(P/T)(ADD)(%)
- LEARNO2(ACTUAL)(BANK1)(%)
- LEARNO2(ACTUAL)(BANK2)(%)
- LEARNO2(BANK1)
- LEARNO2(BANK1)(ADD)(%)
- LEARNO2(BANK1)(IDLE)(%)
- LEARNO2(BANK1)(MUL)(%)
- LEARNO2(BANK1)(P/T)(%)
- LEARNO2(BANK2)
- LEARNO2(BANK2)(%)

- LEARNO2(BANK2)(ADD)(%)
- LEARNO2(BANK2)(IDLE)(%)
- LEARNO2(BANK2)(MUL)(%)
- LEARNO2(BANK2)(P/T)(%)
- LEARNO2(BK1-SNS1)(IDLE)(%)
- LEARNO2(BK1-Sensible/T)(%)
- LEARNO2(BK2-SNS1)(IDLE)(%)
- LEARNO2(BK2-SNS1)(P/T)(%)
- LEARNO2(FULL)
- LEARNO2(IDLE)
- LEARNO2(IDLE)(%)
- LEARNO2(IDLE)(ADD)(%)
- LEARNO2(IDLE)(ADD)(%)
- LEARNO2(IDLE)(ms)
- LEARNO2(IDLE)(MUL)(%)
- LEARNO2(P/T)
- LEARNO2(P/T)(%)
- LEARNO2(P/T)(ADD)(%)
- LEARNO2(P/Tumult)(%)
- LEARNO2(P/T-WOT)
- LEARNO2(PART)(MUL)(%)
- LEARNVALUEMIXTUREADAPTATION
- LEARNVALUEMIXTURECORR(%)
- LEARNVALUEMIXTURECORR(ms)
- LEARNVALUEO2(P/T)(ADD)(%)
- LRNO2BEFORECAT(P/T)(ADD)(%)
- LRNO2BEFORECAT(IDLE)(ADD)(%)
- LRNO2BEFORECAT(P/T)(ADD)(%)
- LEARNVALUEO2(IDLE)(ADD)(%)
- LEARNVALUEO2(P/T)(MUL)(%)
- ADPVALUEMIXTURE(BANK1)(%)
- LRNO2BEFORECAT(IDLE)(ADD)(%)
- LEARNMIXT(BANK1)(IDLE)(%)
- LEARNMIXT(BANK1)(P/T)(%)
- LEARNMIXT(BANK1)(P/T1)(%)
- LEARNMIXT(BANK1)(P/T2)(%)
- LEARNMIXT(BANK1)(P/T3)(%)
- LEARNMIXT(BANK2)(IDLE)(%)
- LEARNMIXT(BANK2)(P/T)(%)
- LEARNMIXT(BANK2)(P/T1)(%)
- LEARNMIXT(BANK2)(P/T2)(%)
- LEARNMIXT(BANK2)(P/T3)(%)

- LEARNMIXTURE(BANK1)(%)
- LEARNMIXTURE(BANK2)(%)

Below is a typical display group, Group (32), "LEARN VALUES O2".

- LEARN VALUE O2(BK 1)(IDLE)(%)
- LEARN VALUE O2(BK 2)(IDLE)(%)
- LEARN VALUE O2(BK 1)(P/T)(%)
- LEARN VALUE O2(BK 2)(P/T)(%)

C.1.4 Important Tips for Long Term Fuel Control

- The value typically ranges from -10 to +10. A normal operating engine should fluctuate only slightly. If more than $\pm 7\%$, perform a mixture diagnosis. Technicians report MAF sensor problems with readings of $\pm 5\%$.
- Use Basic Settings for faster adaptation relearn. Take short road test (usually 2–3 miles) with the scan tool hooked up in Basic Settings. For relearn, make sure the engine is at normal operating temperature (coolant minimum temperature of 167°F [75°C] and a maximum intake air temperature of 194°F [90°C]). For idle relearn, let the engine idle in Basic Settings for a few minutes. For road test in Basic Settings, perform multiple accelerations and decelerations, as well as a part throttle cruise. Check to see that learn values are back within normal range. If OK, clear the codes. Field technicians report faster relearn and verification of repair by not clearing codes until correct fuel control has been confirmed). Finish by setting all Readiness Codes, and then one more final road test (see "Basic Settings and Fuel Trim Accelerated Learning" on page 48).
- Some vehicles may have part throttle learning divided into 3 different parts: (P/T1, P/T2, P/T3). Check to see that each part is in proper specification.
- For most systems that have FT control using $\pm 25\%$ maximum range, readings above or below 14 sets a DTC and turns on the MIL.

C.2 Short-Term Fuel Control

Short term FT is usually called O2 regulation or O2 control. The readings are constantly changing, directly responding to O2S input. Normal readings usually are in the $\pm 10\%$ range with 0 as the midpoint. If it gets too far off, Long-term additive or multiplicative adjusts the window back to the midpoint (balanced state).

C.2.1 Examples Short Term FT O2 Regulation

Depending on the year, vehicle, engine and then engine code you may see some combination of the following short term FT parameters:

- ADPVALUEMIXTURE(BANK1)
- ADPVALUEMIXTURE(BANK2)
- ADPVALUEMIXTURE(BANK2)(%)
- ADPVALUEO2

- LEARNVALUEO2
- O2CONTROL(BANK1)(%)
- O2CONTROL(BANK2)(%)
- O2CONTROLFACTOR(BK1)
- O2CONTROLFACTOR(BK1)(%)
- O2CONTROLFACTOR(BK2)
- O2CONTROLFACTOR(BK2)(%)
- O2REGULATION(BK1-SNS1)(%)
- O2REGULATIONBEFORECAT(%)
- O2SENSOR(BK1-SNS1)(V)
- DYNAMIC FACTOR O2-SNSBEFORECAT
- O2CONTROL(BANK1)(%)
- O2CONTROL(BANK2)(%)
- O2CONTROLDEVIATION(%)
- O2INTEGRATOR

Below is a typical short term FT display group, Group O2 REGULATION BEFORE CAT

- O2 SENSOR(BANK 1,BEFORE CAT)(V)
- O2 SENSOR(BANK 2,BEFORE CAT)(V)
- O2 REGULATION (BANK 1)(%)
- O2 REGULATION (BANK 2)(%)

These parameters are equivalent to the short term FT correction during closed loop operation. This correction is based on the O2S input for a given engine load and speed. The ECM monitors engine operating conditions and calculates short-term and long-term adaptations to correct for engine wear.

The value typically range is ± 10 . A normal operating engine should see this value fluctuate by at least 2%. If it fluctuates by more than 7%, perform a fuel mixture diagnosis.



NOTE:

Some vehicles use a calculated value called *factor*. The parameter names are ADP VALUE O2 and DYNAMIC FACTORO2, SNS BEFORE CAT. Normal range is 0.5–1.5; 1.0 \pm 0.3 is base midpoint; for 2.8L (AAA), the range is 0.80–1.20.

Positive values indicate the ECM is enriching the air/fuel mixture, and negative values indicate the ECM is leaning the mixture.

During open loop operation, the ECM runs at a base program without correction and the parameter displays a fixed 0% value. The ECM adjusts the air/fuel mixture by changing the fuel injector pulse width.

C.2.2 Important Tips for Short-Term Fuel Control

- On some OBD-I (1991–1995) vehicles, values for short term FT, LEARN O2 (IDLE), LEARN O2 (P/T), or LEARN O2 (FULL), may be mislabeled as reading in percentage. In actuality, they are reading a numeric factor of 1.0 midpoint \pm 0.5 (0.5 to 1.5). For 2.8L AAA engine, the range is 0.80–1.20.

- Range: 0.5 - 1.5 Normal Value: 1.0 ± 0.3 (0.7–1.3) is base midpoint
- For 2.0L (ABA) IDLE ADAPT: 0.87–1.2
- For 2.8L (AAA) IDLE ADAPT: 0.53–1.47
- Part Load: 0.80–1.20
- Low Load: 0.53–1.47
- Adaptation values may be erased if the car battery goes low or is disconnected.
- Additive adaptation is used mostly to correct idle mixture, however, it may also be used at higher RPM for fine adjustment (may see different additive values at different RPM). With relearn, it is normal for Additive adaptation to respond quickly. Multiplicative learning typically requires more learning time and vehicle must be driven on an extended road test under various driving conditions.
- For most systems that have FT control using $\pm 25\%$ maximum range, readings above or below 14 sets a DTC and turn on MIL.

C.3 Oxygen Sensor Voltage

Typical displays to view O2S voltage are either 001–004 (basic) or 026/033. You may see some combination of the following parameters:

- O2SENSOR(V)
- O2SENSOR1(V)
- O2SENSOR2(V)
- O2SENSOR(BANK1)(V)
- O2SENSOR(BANK1,AFTERCAT)(V)
- O2SENSOR(BANK1,BEFORECAT)(V)
- O2SENSOR(BANK2)(V)
- O2SENSOR(BANK2,AFTERCAT)(V)
- O2SENSOR(BANK2,BEFORECAT)(V)
- O2SENSOR(BK1-SNS1)(V)
- O2SENSORAFTERCAT(V)
- O2SENSORAFTERCATBK1(V)
- O2SENSORAFTERCATBK2(V)
- O2SENSORBEFORECAT(V)

These parameters indicate the amount of oxygen in the exhaust gas. High oxygen levels indicate a lean air/fuel mixture, while low oxygen levels indicate a rich air/fuel mixture. When the O2Ss are at operating temperature and the system is operating in closed loop, the ECM constantly adjusts the air/fuel mixture to achieve a 14.7:1 ratio. The ECM uses O2S signals to determine how rich or lean the engine is running and to correct the mixture.

C.4 Early Vehicle Oxygen Sensor Reading

Many early vehicles, model years 1990–93, with limited display groups may not read O2S or O2 control. However, you can use Expert Mode and select display group 000. O2V reads in binary

format (0–255). There is no consistency, but Channel 5 often reads the O₂ signal. Look for this number to be constantly varying up and down by at least 14 digits. If Channel 5 is not active, it may be an application that only displays an O₂ short term FT factor. In this case, check channel 4. The O₂ control factor will also output a binary 0–255 number with 128 as the midpoint. Numbers less than 128 indicate a rich mixture correction. Numbers higher than 128 indicate a lean mixture correction. Look for fast fluctuations at different RPM and load conditions which indicate an active O₂S (use DVOM to test O₂S directly). Above is for those vehicles with display group 000 only. On vehicles with additional display groups but still not displaying O₂V directly, look at the O₂ Factor which reads 1.0 as the base point. Higher numbers indicate correction for a mixture too lean and lower numbers indicate a correction for a mixture too rich. A typical normal range is 1.0 ±0.3.

The following sections are display examples for late model OBD-II O₂S and CAT tests.

C.4.1 Example: Motronic 2.9 (1993–1995)

The following example concerns reading engine data display Group 000.

Display group 000 has 10 channels or display fields, listed below.

1. Coolant temperature
2. Engine load
3. RPM
4. O₂ factor
5. Idle Adapt
6. Part throttle adapt
7. Low load adapt
8. IAC adapt
9. Not used
10. IGN timing

The display fields are output in binary numbers. To understand the binary number, visualize a clock with 0 at the top center. The number 128 is at the center bottom. The binary clock counts from 0 to 255.

The number can theoretically range from 0 to 255 with 0 as the midpoint. A number of 13 to 128 indicates that the ECM has commanded an overall lean mixture correction. A number of 128 to 243 indicates that the ECM has commanded an overall rich mixture correction.

C.5 Late Model Oxygen Sensor Reading

Some late models are using 0–5V O₂Ss. Rich is high voltage; lean is low voltage. For example, a VW 2001 2.0L with the AEG engine and the 2002 Passat W8 (BDP). Other late model vehicles may be using a Linear Air/Fuel Ratio sensor (A/F sensor) which measures the exact air/fuel mixture (not like a standard Zirconium O₂S switching constantly between rich and lean). The voltage displayed (display group 33 in Table C-1 below) for these is an ECM computed value where 1.5V = 1 lambda or the ideal fuel mixture ratio of 14.7:1. Higher voltage indicates correction for a rich mixture and lower voltage indicates a correction for a lean mixture. Under normal load, the A/F sensor voltage should vary around 1.5V, which means the mixture is right at stoichiometric

or $\lambda = 1$. During deceleration from 3000 RPM, the mixture is lean and the A/F sensor voltage should go higher than 1.5V. Under full load acceleration, the mixture is rich and the A/F sensor voltage should go low, 1V or lower.

Table C-1 *Display groups 31 and 33*

Display Group	Sensor	Bank 1, Sensor 1	Bank 1, Sensor 2	Bank 2, Sensor 1	Bank 2, Sensor 2
31	Linear oxygen sensors	Lambda actual value	Lambda specified value		
33	Linear oxygen sensor control value	Control value (%)	Sensor voltage before CAT of a broadband sensor (V)	Control value (%)	Sensor voltage before CAT of a broadband sensor (V)



NOTE:

The broadband lambda probe linear Air Fuel Ratio Sensor acquires and evaluates lambda values differently to the step type zirconium O₂S. The lambda value (display group 31 in Table C-1) is determined from a change of current, not from a change of voltage.

C.5.1 Oxygen Sensor Aging Test

The O₂S Aging Test is a Readiness Code test, typically display groups 34 or 35 for O₂S before CAT, and display groups 36 or 43 for O₂S after CAT.

Typical display Group, DIAGN AGING O₂ BEFORE CAT

- ENGINE SPEED(rpm)
- EXHAUST GAS TEMPERATURE
- DYNAMIC FACTOR
- DIAGNOSE STATUS

Depending on the year, vehicle, engine, and engine code, you may see some combination of the following O₂S Aging Test Parameter list:

- AGINGTESTO2(BK1-SNS2)
- AGINGTESTO2(BK2-SNS2)
- AGINGTESTO2AFTERCATBK1
- AGINGTESTO2AFTERCATBK2
- AGINGTESTO2-SNSAFTERCAT
- AGINGTESTO2-SNSBEFORECAT
- DIAGNOSESTATUS
- DYNAMICFACTOR
- DYNAMICFACTORO2-SNSBEFORECAT

These parameters indicate the Readiness Code for the O₂S Aging test. The test measures the O₂S cycling time between a rich to lean transition back to rich transition. This measurement then translates into the aging condition of the O₂S. If the specified allowable time is exceeded, DIAGNOSESTATUS will read NOT OK. A typical normal range for the cycling time period duration (DYNAMICFACTOR) is 0.1–1.8 seconds (typical functional range is 0–3.3 seconds).

C.5.2 Oxygen Sensor Control-Dwell Time Test

Below is a typical display group example, DIAGN O2 CONTROL SYSTEM.

- ENGINE LOAD(%)
- O2 SENSOR(BANK 1, AFTER CAT)(V)
- CORR.BETW O2-SNS 1+2 BK1(ms)
- DIAGNOSE STATUS

These parameters indicate the relationship of the before CAT O2S and the after CAT O2S. The after CAT O2S has the authority to override the before the CAT O2S. The reason for this is in case the before CAT O2S performance deteriorates to the point of jeopardizing the CAT, the after CAT O2 control can take over control preventing possible CAT damage. The after CAT O2S also can correct for slight changes in the mixture if it detects displacement of the before CAT voltage curve. It takes control by holding the before CAT O2 control at its higher or lower point for a specific time (dwell time). If this time is in the positive range (i.e., 50 ms), then the mixture is shifted to the rich direction. If the time is negative (i.e., -50 ms), then the mixture is shifted to the lean direction.



NOTE:

If the value is above +200 ms, then there is a possible leak in the exhaust system.

C.5.3 CAT Test Parameters

Below is a typical display group 46/47, DIAGNOSE CATALYST BANK 1.

- ENGINE SPEED(rpm)
- CATALYST TEMPERATURE
- CATALYST EFFICIENCY
- DIAGNOSE STATUS

The engine management ECM compares the voltage(s) of the upstream or before CAT O2S to the voltage(s) of the downstream or after the CAT O2S. The result is called the amplitude ratio between the two sensors and indicates the CAT test result in either percent or amplitude ratio. A good CAT amplitude ratio range is 0.00 –0.32.

Table C-2 provides O2S and fuel control display fields available in Expert Mode.

Table C-2 Display fields for O2S and Fuel control available in Expert Mode (part 1 of 5)

Display Group	Sensor	Bank 1, Sensor 1	Bank 1, Sensor 2	Bank 2, Sensor 1	Bank 2, Sensor 2
30	Oxygen sensor, status (2-bank system)	XXX ¹	XXX ¹	XXX ¹	XXX ¹
	Oxygen sensor, status (1-bank system)	XXX ¹	XXX ¹		
	X values: (1) Control Active, (2) Sensor Ready, (3) Sensor Heater ON				
¹ Condition attained = 1; Condition not attained = 0					

Table C-2 *Display fields for O2S and Fuel control available in Expert Mode (part 2 of 5)*

Display Group	Sensor	Bank 1, Sensor 1	Bank 1, Sensor 2	Bank 2, Sensor 1	Bank 2, Sensor 2
31	Knock sensor voltage	(V)	(V)	(V)	(V)
	Oxygen sensor voltage	(V)	(V)		
	Linear oxygen sensors (2-bank system)	Lambda actual value	Lambda specified value	Lambda actual value	Lambda specified value
	Linear oxygen sensors (1-bank system)	Lambda actual value	Lambda specified value		
32	Oxygen sensors learning values (maximum value) (2-bank systems)	Idle (%)	Partial load (%)	Idle (%)	Partial load (%)
	Oxygen sensors learning values (maximum value) (1-bank systems)	Idle (%)	Partial load (%)		
33	Lambda control value (2-bank system)	Control value (%)	Oxygen sensor voltage (V)	Control value (%)	Oxygen sensor voltage (V)
	Lambda control value (1-bank system)	Control value (%)	Oxygen sensor voltage (V)		
	Linear oxygen sensor control value	Control value (%)	Sensor voltage before CAT of a broadband sensor (V)	Control value (%)	Sensor voltage before CAT of a broadband sensor (V)
34	Oxygen sensor aging test Bank 1 or Bank 3 before CAT, short trip	RPM (1/min.)	Exhaust gas/ CAT temperature (°C)	Length of period (s)	Result (Test ON/Test OFF/ B1-S1 OK/ B1-S1 not OK/ B3-S1 OK/ B3-S1 not OK)
	Oxygen sensor aging test Bank 1 or Bank 3 before CAT for linear oxygen sensors, short trip	RPM (1/min.)	Exhaust gas/ CAT temperature (°C)	Dynamic factor	Result (Test ON/Test OFF/ B1-S1 OK/ B1-S1 not OK/ B3-S1 OK/ B3-S1 not OK)
¹ Condition attained = 1; Condition not attained = 0					

Table C-2 Display fields for O2S and Fuel control available in Expert Mode (part 3 of 5)

Display Group	Sensor	Bank 1, Sensor 1	Bank 1, Sensor 2	Bank 2, Sensor 1	Bank 2, Sensor 2
35	Oxygen sensor aging test Bank 2 or Bank 4 before CAT, short trip	RPM (1/min.)	Exhaust gas/CAT temperature (°C)	Length of period (s)	Result (Test ON/Test OFF/ B2-S1 OK/ B2-S1 not OK/ B4-S1 OK/ B4-S1 not OK)
	Oxygen sensor aging test Bank 2 or Bank 4 before CAT for linear oxygen sensors, short trip	RPM (1/min.)	Exhaust gas/CAT temperature (°C)	Dynamic factor	Result (Test ON/Test OFF/ B2-S1 OK/ B2-S1 not OK/ B4-S1 OK/ B4-S1 not OK)
	Oxygen sensor aging test Bank 2 before CAT				
36	Oxygen sensor readiness after CAT, short trip (2-bank system)	Sensor voltage (V)	Result (Test ON/Test OFF/ B1-S2 OK/ B1-S2 not OK/ B3-S2 OK/ B3-S2 not OK)	Sensor voltage (V)	Result (Test ON/Test OFF/ B2-S2 OK/ B2-S2 not OK/ B4-S2 OK/ B4-S2 not OK)
	Oxygen sensor readiness after CAT, short trip (1-bank system)	Sensor voltage (V)	Result (Test ON/Test OFF/ B1-S2 OK/ B1-S2 not OK)		
37	Oxygen sensors, short trip	Load (%)	Oxygen sensor voltage after CAT (V)	TV shift (ms)	Result (Test ON/Test OFF/ Sys. OK/Sys. not OK)
	Linear oxygen sensors, short trip	Load (%)	Oxygen sensor voltage after CAT (V)	Lambda	Result (Test ON/Test OFF/ Sys. OK/Sys. not OK)
38	Oxygen sensors, short trip	Load (%)	Oxygen sensor voltage after CAT (V)	TV shift (ms)	Result (Test ON/Test OFF/ Sys. OK/Sys. not OK)
	Linear oxygen sensors, short trip	Load (%)	Oxygen sensor voltage after CAT (V)	Lambda	Result (Test ON/Test OFF/ Sys. OK/Sys. not OK)
	Oxygen sensors (1-bank systems)	NOT USED			
39	Sensor exchange after CAT, short trip	Air mass (g/s)	Sensor voltage (V)	Sensor voltage (V)	Result (Test ON/Test OFF/ Sys. OK/Sys. not OK)
¹ Condition attained = 1; Condition not attained = 0					

Table C-2 Display fields for O2S and Fuel control available in Expert Mode (part 4 of 5)

Display Group	Sensor	Bank 1, Sensor 1	Bank 1, Sensor 2	Bank 2, Sensor 1	Bank 2, Sensor 2
40	Oxygen sensor heaters resistor (combined wires of heaters)	Heater resistor (Ω)	Condition (Heater before CAT ON/Heater before CAT OFF)	Heater resistor (Ω)	Condition (Heater before CAT ON/Heater before CAT OFF)
	(1-bank systems)	NOT USED			
41	Oxygen sensor heater	Heater resistor (Ω)	Condition (Heater before CAT ON/Heater before CAT OFF/Sensor 1 (%))	Heater resistor (Ω)	Condition (Heater before CAT ON/Heater before CAT OFF)
42	Oxygen sensor heaters (separate wires of heaters)	Heater resistor (Ω)	Condition (Heater before CAT ON/Heater before CAT OFF/Sensor 1 (%))	Heater resistor (Ω)	Condition (Heater before CAT ON/Heater before CAT OFF)
43	Oxygen sensor aging after CAT, linear oxygen sensors, short trip	RPM (U/min.)	Exhaust gas/ CAT temperature ($^{\circ}\text{C}$)	Oxygen sensor voltage (V)	Result (Test ON/Test OFF/ B1-S2 OK/ B1-S2 not OK/ B3-S2 OK/ B3-S2 not OK)
44	Oxygen sensor aging after CAT, short trip	RPM (U/min.)	Exhaust gas/ CAT temperature ($^{\circ}\text{C}$)	Oxygen sensor voltage (V)	Result (Test ON/Test OFF/ B2-S2 OK/ B2-S2 not OK/ B4-S2 OK/ B4-S2 not OK)
45					
46	CAT conversion test Bank 1 or Bank 3, short trip	RPM (1/min.)	CAT temperature ($^{\circ}\text{C}$)	Measuring value CAT conversion	Result (Test ON/Test OFF/ CAT B1 OK/ CAT B1 not OK/ CAT B3 OK/ CAT B2 no OK)
47	CAT conversion test Bank 2 or Bank 4, short trip	RPM (1/min.)	CAT temperature ($^{\circ}\text{C}$)	Measuring value CAT conversion	Result (Test ON/Test OFF/ CAT B2 OK/ CAT B2 not OK/ CAT B4 OK/ CAT B4 no OK)
	CAT conversion test Bank 2 (1-bank systems)	NOT USED			
¹ Condition attained = 1; Condition not attained = 0					

Table C-2 Display fields for O2S and Fuel control available in Expert Mode (part 5 of 5)

Display Group	Sensor	Bank 1, Sensor 1	Bank 1, Sensor 2	Bank 2, Sensor 1	Bank 2, Sensor 2
48	Thermal CAT diagnosis Bank 1, short trip	Operating system BDE XXXXXXXX ¹	Number of test steps (-)	Exothermal temp. increase (K)	Result (Test ON/Test OFF/Sys. OK/Sys. not OK)
	X values: (1) With bit homogenous knock protection, (2) Not used, (3) Not used, (4) Layer CAT heating double inject., (5) Layer, (6) Homogenous layer double inject., (7) Homogenous lean, (8) Homogenous				
49	Thermal CAT diagnosis Bank 2, short trip	Operating system BDE XXXXXXXX ¹	Number of test steps (-)	Exothermal temp. increase (K)	Result (Test ON/Test OFF/Sys. OK/Sys. not OK)
	X values: (1) With bit homogenous knock protection, (2) Not used, (3) Not used, (4) Layer CAT heating double inject., (5) Layer, (6) Homogenous layer double inject., (7) Homogenous lean, (8) Homogenous				
¹ Condition attained = 1; Condition not attained = 0					

Index

A

ABS systems 72
 basic settings brake bleeding 75
actuator tests 43
 important notes for testing 45
aftermarket radio problem 11, 154
application charts
 ABS (Audi types and system descriptions) 74
 ABS (VW types and system descriptions) 73
 ABS (VW) 72
 engine (Audi) 37
 engine (early Audi) 40
 engine (early VW) 36
 engine (VW) 32
 transmission (types and descriptions) 53
 transmissions 57
 VW/Audi software 30

B

basic settings 41
 ABS 75
 adaptive learned values 48
 crankshaft sensor learn 49
 Expert Mode 20, 22
 fuel trim accelerated learning 48
 ignition timing 47
 kickdown function 46
 menu choices 46
 problems with 50
 standard mode 45
 throttle body adaptation 46
 transmission testing 63

C

checking for codes (test drive) 40
coding and programming
 VW 1996–99 mechanical keys 80

D

data display (ignition off) 42
data groups (pre-selected) 43
data parameters
 ABS 150
 diesel engine 136
 gas engine 105
 listed alphabetically 93
 transmission 140
 transmission Expert Mode 148
display data groups 23

DL-16 11

E

early Audi engine systems 37
early VW engine systems 36
ECU coding 23
ECU ID information 21
electronic throttle 67
 emergency running or limp-home mode 71
electronic throttle systems 67
 adaptation 67
 types of 69
engine ID codes 5
engine systems
 important notes for fault codes 41
 system coverage 36
 systems covered 32
engine trouble codes 41
Expert Mode 18–29
 automatic system test 16
 important warnings 18
 selecting 11
 VW/Audi software applications 30

F

false codes 41
fuel control 157
 additive adaptation 157
 early vehicle O2S 162
 Expert Mode display groups 164
 late model O2S 163
 multiplicative adaptation 158
 O2 factor 161
 oxygen sensor voltage 162
fuel control learning 157
functional tests
 Initiate Actuator Tests 43
 Review ECU ID 45
 Service Interval Reset 50

I

Immobilizer 75
 ECU replacement 77, 78
 FAQ 82
 key coding 77
 remote key matching 81
 sample remote key option settings 81
 types of 75

K

keys
actuator tests 22, 45
adaptations 27
basic settings 47, 49
electronic throttle adaptation 67
Personality Keys™. See Personality Keys™
types used with immobilizer systems 75
KW2000 protocol 27

L

login access numbers 28
long-term fuel control 157

M

multiple code clearing 40

P

Personality Keys™ 11
programming. See coding and programming

R

remote key option settings 81

S

Safety iii-iv
safety
information iii
scan tool VW/Audi coverage 30
service reset
electronic 51
manual 50
service reset/preset functions 52
short-term fuel control 160

T

test adapters 11
DL-16 11
VW-1 11
testing
ABS systems 72
engine systems 32
transmission systems 53
transmission systems 53
application chart 57
basic settings 63
emergency operation 66
fail-safe functions 65
important tips for fault codes 62
series 01F, 01K 61
series 01N 60
series 095, 096, 01M 60
solenoid firing 64

V

vehicle connectors
VW locations 13
VW-1 11

W

Work Shop Code (WSC) 21