

2010 Cadillac SRX Owner Manual

| | | | | | |
|---------------------------------------|------|---|------|--|------|
| Keys, Doors and Windows . . . | 1-1 | Instruments and Controls | 4-1 | Climate Controls | 7-1 |
| Keys and Locks | 1-2 | Instrument Panel Overview | 4-4 | Climate Control Systems | 7-1 |
| Doors | 1-13 | Controls | 4-6 | Air Vents | 7-6 |
| Vehicle Security | 1-17 | Warning Lights, Gauges, and | | | |
| Exterior Mirrors | 1-20 | Indicators | 4-13 | Driving and Operating | 8-1 |
| Interior Mirrors | 1-22 | Information Displays | 4-29 | Driving Information | 8-2 |
| Windows | 1-23 | Vehicle Messages | 4-33 | Starting and Operating | 8-17 |
| Roof | 1-27 | Vehicle Personalization | 4-41 | Engine Exhaust | 8-24 |
| Seats and Restraints | 2-1 | OnStar® System | 4-46 | Automatic Transmission | 8-25 |
| Head Restraints | 2-2 | Universal Remote System | 4-48 | Drive Systems | 8-30 |
| Front Seats | 2-4 | Lighting | 5-1 | Brakes | 8-30 |
| Rear Seats | 2-11 | Exterior Lighting | 5-1 | Ride Control Systems | 8-34 |
| Safety Belts | 2-13 | Interior Lighting | 5-6 | Cruise Control | 8-37 |
| Airbag System | 2-28 | Infotainment System | 6-1 | Object Detection Systems | 8-40 |
| Child Restraints | 2-43 | Introduction | 6-1 | Fuel | 8-46 |
| Storage | 3-1 | Radio | 6-11 | Towing | 8-52 |
| Storage Compartments | 3-1 | Audio Players | 6-19 | Conversions and Add-Ons | 8-61 |
| Additional Storage Features | 3-3 | Rear Seat Infotainment | 6-36 | | |
| Roof Rack System | 3-10 | Phone | 6-47 | | |

2010 Cadillac SRX Owner Manual

| | | | |
|------------------------------------|-------|-----------------------------------|-------|
| Vehicle Care | 9-1 | Technical Data | 11-1 |
| General Information | 9-2 | Vehicle Identification | 11-1 |
| Vehicle Checks | 9-4 | Vehicle Data | 11-2 |
| Headlamp Aiming | 9-31 | Customer Information | 12-1 |
| Bulb Replacement | 9-34 | Customer Information | 12-1 |
| Electrical System | 9-44 | Reporting Safety Defects | 12-14 |
| Wheels and Tires | 9-52 | Vehicle Data Recording and | |
| Jump Starting | 9-101 | Privacy | 12-15 |
| Towing | 9-105 | Index | i-1 |
| Appearance Care | 9-109 | | |
| Service and Maintenance ... | 10-1 | | |
| General Information | 10-1 | | |
| Scheduled Maintenance | 10-2 | | |
| Recommended Fluids, | | | |
| Lubricants, and Parts | 10-6 | | |
| Maintenance Records | 10-9 | | |



GENERAL MOTORS, GM, the GM Emblem, CADILLAC, the CADILLAC Crest and Wreath, and the name SRX are registered trademarks of General Motors LLC.

This manual describes features that may or may not be on your specific vehicle either because they are options that you did not purchase or due to changes subsequent to the printing of this owner manual.

Please refer to the purchase documentation relating to your specific vehicle to confirm each of the features found on your vehicle. For vehicles first sold in Canada, substitute the name “General Motors of Canada Limited” for Cadillac Motor Car Division wherever it appears in this manual.

Canadian Vehicle Owners

Propriétaires Canadiens

A French language copy of this manual can be obtained from your dealer or from:

On peut obtenir un exemplaire de ce guide en français auprès du concessionnaire ou à l'adresse suivante:

Helm, Incorporated
P.O. Box 07130
Detroit, MI 48207

1-800-551-4123
Numéro de poste 6438 de langue
française
www.helminc.com

Using this Manual

To quickly locate information about the vehicle use the Index in the back of the manual. It is an alphabetical list of what is in the manual and the page number where it can be found.

Danger, Warnings, and Cautions

Warning messages found on vehicle labels and in this manual describe hazards and what to do to avoid or reduce them.

Danger indicates a hazard with a high level of risk which will result in serious injury or death.

Warning or **Caution** indicates a hazard that could result in injury or death.

WARNING

These mean there is something that could hurt you or other people.

Notice: This means there is something that could result in property or vehicle damage. This would not be covered by the vehicle's warranty.



A circle with a slash through it is a safety symbol which means "Do Not," "Do not do this," or "Do not let this happen."

Symbols

The vehicle has components and labels that use symbols instead of text. Symbols are shown along with the text describing the operation or information relating to a specific component, control, message, gauge, or indicator.

 : This symbol is shown when you need to see your owner manual for additional instructions or information.

 : This symbol is shown when you need to see a service manual for additional instructions or information.

Vehicle Symbol Chart

Here are some additional symbols that may be found on the vehicle and what they mean. For more information on the symbol, refer to the Index.

 : Adjustable Pedals

 : Airbag Readiness Light

 : Air Conditioning

 : Antilock Brake System (ABS)

 : Audio Steering Wheel Controls or OnStar®

 : Brake System Warning Light

 : Charging System

 : Cruise Control

 : Engine Coolant Temperature

 : Exterior Lamps

 : Fog Lamps

 : Fuel Gauge

 : Fuses

 : Headlamp High/Low-Beam Changer

 : LATCH System Child Restraints

 : Malfunction Indicator Lamp

 : Oil Pressure

 : Outside Power Foldaway Mirrors

 : Power

 : Remote Vehicle Start

 : Safety Belt Reminders

 : Tire Pressure Monitor

 : Traction Control/StabiliTrak

 : Windshield Washer Fluid

Keys, Doors and Windows

Keys and Locks

| | |
|--|------|
| Keys | 1-2 |
| Remote Keyless Entry (RKE) System | 1-3 |
| Remote Keyless Entry (RKE) System Operation | 1-3 |
| Remote Vehicle Start | 1-9 |
| Door Locks | 1-11 |
| Power Door Locks | 1-11 |
| Safety Locks | 1-12 |

Doors

| | |
|-------------------------|------|
| Liftgate (Manual) | 1-13 |
| Liftgate (Power) | 1-14 |

Vehicle Security

| | |
|-------------------------------|------|
| Vehicle Security | 1-17 |
| Anti-Theft Alarm System | 1-17 |
| Immobilizer | 1-19 |
| Immobilizer Operation | 1-19 |

Exterior Mirrors

| | |
|------------------------------|------|
| Convex Mirrors | 1-20 |
| Power Mirrors | 1-20 |
| Folding Mirrors | 1-21 |
| Heated Mirrors | 1-22 |
| Automatic Dimming Mirror ... | 1-22 |
| Park Tilt Mirrors | 1-22 |

Interior Mirrors

| | |
|--|------|
| Manual Rearview Mirror | 1-22 |
| Automatic Dimming Rearview Mirror | 1-23 |

Windows

| | |
|---------------------|------|
| Windows | 1-23 |
| Power Windows | 1-24 |
| Sun Visors | 1-27 |

Roof

| | |
|---------------|------|
| Sunroof | 1-27 |
|---------------|------|

1-2 Keys, Doors and Windows

Keys and Locks

Keys

WARNING

Leaving children in a vehicle with the keyless access transmitter is dangerous for many reasons, children or others could be badly injured or even killed. They could operate the power windows or other controls or even make the vehicle move. The windows will function with the keyless access transmitter in the vehicle and they could be seriously injured or killed if caught in the path of a closing window. Do not leave the keyless access transmitter in a vehicle with children.



This key, located inside the Remote Keyless Entry (RKE) transmitter, is used for the driver door and glove box.



To remove the key, press the button near the bottom of the transmitter, and pull the key out. Never pull the key out without pressing the button.

See your dealer if a new key is needed.

Notice: If the keys get locked in the vehicle, it may have to be damaged to get them out. Always carry a spare key.

Contact Roadside Service if you are locked out of the vehicle. See *Roadside Service on page 12-6*.

Remote Keyless Entry (RKE) System

See *Radio Frequency Statement on page 12-17* for information regarding Part 15 of the Federal Communications Commission (FCC) rules and Industry Canada Standards RSS-210/220/310.

If there is a decrease in the RKE operating range:

- Check the distance. The transmitter may be too far from the vehicle.
- Check the location. Other vehicles or objects may be blocking the signal.

- Check the transmitter's battery. See "Battery Replacement" later in this section.
- If the transmitter is still not working correctly, see your dealer or a qualified technician for service.

Remote Keyless Entry (RKE) System Operation

The Remote Keyless Entry (RKE) transmitter functions will work up to 60 m (195 feet) away from the vehicle.

Keep in mind that other conditions, such as those previously stated, can impact the performance of the transmitter.





With Remote Start and Power Liftgate Shown, Without Similar

🔒 (Lock): Press to lock all doors. The turn signal indicators may flash and/or the horn may sound to indicate locking, see "Locking Feedback" under *Vehicle Personalization on page 4-41*.

If the driver door is open when 🔒 is pressed, all doors lock except the driver door, if enabled through the vehicle personalization. If the passenger door is open when 🔒 is pressed, all doors lock.

1-4 Keys, Doors and Windows



Pressing  may also arm the theft-deterrent system. See *Anti-Theft Alarm System on page 1-17*.



 (Unlock): Press to unlock the driver door or all doors, see “Door Unlock Options” under *Vehicle Personalization on page 4-41*. When remotely unlocking the vehicle at night the fog lamps and reverse lamps will come on for about 20 seconds to light your approach to the vehicle. The turn signal indicators may flash and/or the horn may sound to indicate unlocking. See “Unlock Feedback” under *Vehicle Personalization on page 4-41*.

Memory seat positions may be recalled when unlocking the vehicle. See “Memory Remote Recall” under *Vehicle Personalization on page 4-41* for more information.

On some models, pressing and holding  will open all of the vehicle's windows. See *Power Windows on page 1-24*.

Pressing  will disarm the theft-deterrent system. See *Anti-Theft Alarm System on page 1-17*.

 (Remote Start): For vehicles with this feature, press  and then press and hold  within three seconds to start the engine from outside the vehicle using the RKE transmitter. See *Remote Vehicle Start on page 1-9* for additional information.

 (Vehicle Locator/Panic Alarm): Press and release one time to locate the vehicle. The exterior lamps flash and the horn chirps. Press and hold  for three seconds to sound the panic alarm. The horn sounds and the turn signal lamps flash for 30 seconds, or until  is pressed again or the vehicle is started.

 (Remote Liftgate Release): Press until the liftgate begins to move to open or close the power liftgate.

Keyless Access Operation

Some vehicles have the keyless access system that lets you lock and unlock the doors and access the liftgate without removing the remote transmitter from your pocket, purse, briefcase, etc. The keyless entry transmitter must be within 1 m (3 feet) of the door being opened. If the vehicle has this feature, there will be a body colored touch pad on the outside front door handles.

Keyless Unlocking

With the transmitter within 1 m (3 feet), approach the front door and pull the handle. If the transmitter is recognized, the door will unlock and open.

Entering any door other than the driver door will always cause all of the doors to unlock. This is not customizable.

To customize which doors unlock when the driver's door is opened, see “Passive Unlock” under *Vehicle Personalization on page 4-41*.

Keyless Locking

If the vehicle has the keyless access system, this feature allows you to select whether the doors automatically lock during normal vehicle exit. When the vehicle is turned off and all doors become closed, the vehicle will determine how many keyless access transmitters remain in the vehicle interior. If at least one keyless access transmitter has been removed from the interior of the vehicle, the doors will lock after several seconds.

If there are two keyless access transmitters in the vehicle and one is removed, the other will be locked in. A person approaching the outside of the locked vehicle without an authorized keyless access transmitter will not be able to open the door, even with the transmitter in the vehicle.

You may temporarily disable the keyless locking feature by pressing and holding the power door unlock button on the instrument panel for several seconds with a door open. Keyless locking will then remain disabled until the door lock switch is pressed, or until the vehicle is turned on.

To customize whether the doors automatically lock when you exit the vehicle, see "Passive Locking" under *Vehicle Personalization* on page 4-41.

Lock Sensor



When all doors are closed and the ignition is off, the vehicle can be locked by pressing this area on the door handle. This feature will be available for several minutes after the vehicle has been turned off.

1-6 Keys, Doors and Windows

Keyless Liftgate Opening

Press the touch pad on the liftgate handle to open the liftgate if the keyless entry transmitter is within range.

Programming Transmitters to the Vehicle

Only keyless entry transmitters programmed to the vehicle will work. If a transmitter is lost or stolen, a replacement can be purchased and programmed through your dealer. The vehicle can be reprogrammed so that lost or stolen transmitters no longer work. Each vehicle can have up to eight transmitters matched to it.

Programming with a Recognized Transmitter (Keyless Access Vehicles Only)

A new transmitter can be programmed to the vehicle when there is one recognized transmitter.

To program, the vehicle must be off and all of the transmitters, both currently recognized and new, must be with you.

1. Place the recognized transmitter(s) in the cupholder.
2. Insert the vehicle key of the new transmitter into the key lock cylinder located on the outside of the driver door and turn the key to the unlock position five times within ten seconds.

The Driver Information Center (DIC) displays READY TO LEARN ELECTRONIC KEY #2, 3, 4, ETC.



3. Place the new transmitter into the transmitter pocket. The transmitter pocket is inside the center console storage area located between the driver and front passenger seats. The storage area will need to be opened and the storage tray lifted up to access the transmitter pocket.

4. Press the ignition. When the transmitter is learned the DIC display will show that it is ready to program the next transmitter.
5. Remove the transmitter from the transmitter pocket and press  on the transmitter.

To program additional transmitters, repeat Steps 3 through 5.

When all additional transmitters are programmed, press and hold the ignition for 5 seconds to exit programming mode.

Programming without a Recognized Transmitter (Keyless Access Vehicles Only)

If there are no currently recognized transmitters available, follow this procedure to program up to eight transmitters. This feature is not available in Canada. This procedure will take approximately 30 minutes to complete. The vehicle must be off and all of the transmitters you wish to program must be with you.

1. Insert the vehicle key of the transmitter into the key lock cylinder located on the outside of the driver door and turn the key to the unlock position five times within ten seconds.

The Driver Information Center (DIC) displays REMOTE LEARN PENDING, PLEASE WAIT.

2. Wait for ten minutes until the DIC displays PRESS ENGINE START BUTTON TO LEARN and then press the ignition.
The DIC displays will again show REMOTE LEARN PENDING, PLEASE WAIT.
3. Repeat Step 2 two additional times. After the third time all previously known transmitters will no longer work with the vehicle. Remaining transmitters can be relearned during the next steps.
The DIC display should now show READY FOR REMOTE # 1.

1-8 Keys, Doors and Windows

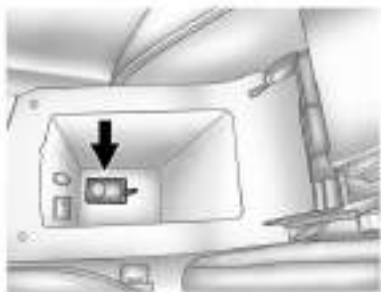

4. Place the new transmitter into the transmitter pocket. The transmitter pocket is inside the center console storage area located between the driver and front passenger seats. The storage area will need to be opened and the storage tray lifted up to access the transmitter pocket.
5. Press the ignition. When the transmitter is learned the DIC display will show that it is ready to program the next transmitter.

6. Remove the transmitter from the transmitter pocket and press  on the transmitter.

To program additional transmitters, repeat Steps 4 through 6.

When all additional transmitters are programmed, press and hold the ignition for 5 seconds to exit programming mode.

Starting the Vehicle with a Low Transmitter Battery

If the transmitter battery is weak, the DIC may display “No Remote Detected” when you try to start the vehicle. The REPLACE BATTERY IN REMOTE KEY message may also be displayed at this time.

To start the vehicle:

1. Open the center console storage area and the storage tray.

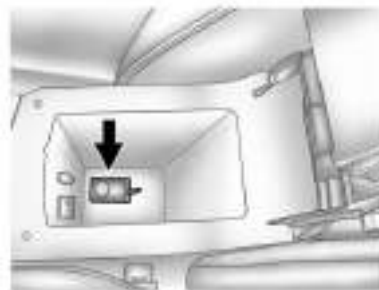

2. Place the transmitter in the transmitter pocket.
3. With the vehicle in P (Park) or N (Neutral), press the brake pedal and the START button.

Replace the transmitter battery as soon as possible.

Battery Replacement

Notice: When replacing the battery, do not touch any of the circuitry on the transmitter. Static from your body could damage the transmitter.

Replace the battery if the REPLACE BATTERY IN REMOTE KEY message displays in the DIC.

1. Press the button near the bottom of the transmitter and pull the key out.



2. Use the key blade to separate the two halves of the transmitter.
3. Remove the old battery. Do not use a metal object.
4. Insert the new battery, positive side facing down. Replace with a CR2032 or equivalent battery.
5. Snap the transmitter back together.

Remote Vehicle Start

If available, this feature allows you to start the engine from outside the vehicle.

(Remote Vehicle Start):

This button will be on the RKE transmitter if the vehicle has remote start.

Vehicles with an automatic climate control system will automatically change to a heating or cooling mode depending on the outside temperature during a remote start. When the ON/RUN/START ignition mode is selected, the climate control system will return to its setting from when the vehicle was last turned off.



1-10 Keys, Doors and Windows

Laws in some local communities may restrict the use of remote starters. For example, some laws may require a person using remote start to have the vehicle in view. Check local regulations for any requirements.

There are other conditions which can affect the performance of the transmitter, see *Remote Keyless Entry (RKE) System on page 1-3* for additional information.

Starting the Engine Using Remote Start

To start the engine using the remote start feature:

1. Press  on the RKE transmitter.
2. Within three seconds, press and hold  until the turn signal lamps flash. This confirms the request to remote start the vehicle has been received. If the vehicle's lamps are not visible, press and hold  for at least two seconds.

During the remote start the vehicle's doors will be locked and the parking lamps will remain on as long as the engine is running.

3. Press the brake pedal and select the ON/RUN/START ignition mode to drive the vehicle.

The engine will shut off after 10 minutes unless a time extension is done or the ignition is put in ON/RUN/START.

Extending Engine Run Time

For a 10 minute extension, repeat Steps 1 and 2 while the engine is still running. The remote start can only be extended once.

When the remote start is extended, the second 10 minute period will start immediately.

For example, if the vehicle has been running for five minutes, and 10 minutes are added, the engine will run for a total of 15 minutes.

A maximum of two remote starts or remote start attempts are allowed between ignition cycles.

The vehicle's ignition must be changed to ON/RUN/START and then back to OFF before the remote start procedure can be used again.

Shutting the Engine Off After a Remote Start

To cancel a remote start:

- Press  until the parking lamps turn off.
- Turn on the hazard warning flashers.
- Turn the ignition on and then back off.

Conditions in Which Remote Start Will Not Work

The remote start will not operate if:

- The ignition is in any mode other than OFF.
- The transmitter is in the vehicle.
- The hood is not closed.

- The hazard warning flashers are on.
- There is an emission control system malfunction.
- The engine coolant temperature is too high.
- The oil pressure is low.
- Two remote vehicle starts have already been used.
- The vehicle is not in P (Park).

Door Locks

WARNING

Unlocked doors can be dangerous.

- Passengers, especially children, can easily open the doors and fall out of a moving vehicle. The chance of being thrown out of the vehicle in a crash is increased if the doors are not locked.

(Continued)

WARNING (Continued)

So, all passengers should wear safety belts properly and the doors should be locked whenever the vehicle is driven.

- Young children who get into unlocked vehicles may be unable to get out. A child can be overcome by extreme heat and can suffer permanent injuries or even death from heat stroke. Always lock the vehicle whenever leaving it.
- Outsiders can easily enter through an unlocked door when you slow down or stop your vehicle. Locking your doors can help prevent this from happening.

To lock or unlock a door, use the Remote Keyless Entry (RKE) transmitter from the outside.

From inside the vehicle with the doors locked, pull once on the door handle to unlock it, and a second time to open it.

Power Door Locks

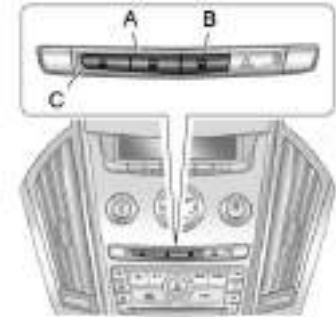

The power door lock switches are located on the instrument panel.



 **(Unlock):** Press (A) to unlock the doors.

 **(Lock):** Press (B) to lock the doors.

1-12 Keys, Doors and Windows

Lockout Deterrent



Lockout deterrent decreases the chances that the keys may be accidentally locked in the vehicle.

When door locking is requested by pressing  on the instrument panel or  on the keyless access transmitter and the driver door is open, all doors will lock and the driver door will immediately unlock. The driver door must be closed when  is pressed for all doors to remain locked.

This feature can be programmed to provide the lockout deterrent feature only when the ignition mode is ACC/ACCESSORY, or ON/RUN/START. See “Power Door Locks” in *Vehicle Personalization on page 4-41*.

Delayed Locking

When this feature is enabled and the doors are locked with the power lock switch on the instrument panel, three chimes sound to signal that the delayed locking feature is in use. All doors lock five seconds after the last door is closed.

When the delayed locking feature is in use, pressing  on the instrument panel or  on the keyless access transmitter will override the feature and lock all doors immediately.

This feature can be programmed by using the Driver Information Center (DIC). See “Delayed Door Lock” in *Vehicle Personalization on page 4-41*. The delayed locking feature is only available if “Unlocked Door Anti-Lockout” is disabled.

Safety Locks

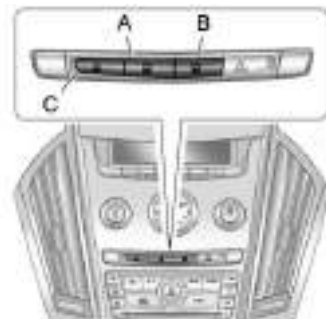

Rear door security locks prevent passengers from opening the rear doors from the inside.

Press the button (C) to activate the safety locks. Once activated, the LED light in the switch illuminates.

Pressing the button again deactivates the safety locks.

See *Power Door Locks on page 1-11*.

Doors

Liftgate (Manual)

WARNING

Exhaust gases can enter the vehicle if it is driven with the liftgate, trunk/hatch open, or with any objects that pass through the seal between the body and the trunk/hatch or liftgate. Engine exhaust contains Carbon Monoxide (CO) which cannot be seen or smelled. It can cause unconsciousness and even death.

(Continued)

WARNING (Continued)

If the vehicle must be driven with the liftgate, or trunk/hatch open:

- Close all of the windows.
- Fully open the air outlets on or under the instrument panel.
- Adjust the Climate Control system to a setting that brings in only outside air and set the fan speed to the highest setting. See Climate Control System in the Index.
- If the vehicle is equipped with a power liftgate, disable the power liftgate function.

For more information about carbon monoxide, see *Engine Exhaust* on page 8-24.

Notice: If you open the liftgate without checking for overhead obstructions such as a garage door, you could damage the liftgate or the liftgate glass. **Always check to make sure the area above and behind the liftgate is clear before opening it.**

For vehicles without keyless access, unlock the vehicle before opening the liftgate.

Press the touchpad located in the handle of the liftgate, above the license plate, and lift up to open.

Do not press the touchpad while closing the liftgate. This will cause the liftgate to be unlatched.

Always close the liftgate before driving.

1-14 Keys, Doors and Windows

Liftgate (Power)

Power Liftgate Operation

WARNING

Exhaust gases can enter the vehicle if it is driven with the liftgate, trunk/hatch open, or with any objects that pass through the seal between the body and the trunk/hatch or liftgate. Engine exhaust contains Carbon Monoxide (CO) which cannot be seen or smelled. It can cause unconsciousness and even death.

If the vehicle must be driven with the liftgate, or trunk/hatch open:

- Close all of the windows.
- Fully open the air outlets on or under the instrument panel.

(Continued)

WARNING (Continued)

- Adjust the Climate Control system to a setting that brings in only outside air and set the fan speed to the highest setting. See Climate Control System in the Index.
- If the vehicle is equipped with a power liftgate, disable the power liftgate function.

For more information about carbon monoxide, see *Engine Exhaust* on page 8-24.



On vehicles with a power liftgate the switch is located on the driver door. The vehicle must be in P (Park) to use the power feature. The taillamps flash when the power liftgate moves.

WARNING

You or others could be injured if caught in the path of the power liftgate. Make sure there is no one in the way of the liftgate as it is opening and closing.

Notice: If you open the liftgate without checking for overhead obstructions such as a garage door, you could damage the liftgate or the liftgate glass. Always check to make sure the area above and behind the liftgate is clear before opening it.

Choose the power liftgate mode by turning the dial on the switch until the indicator lines up with the desired position.

The three modes are:



MAX : The liftgate power opens to the full open height.

3/4 : The liftgate power opens to a reduced open height that can be set by the vehicle operator in a range of approximately 3/4 open to full open. Use this setting to prevent the liftgate from opening into overhead obstructions such as a garage door or roof mounted cargo during power operation. The liftgate can still be opened fully manually.

OFF: The liftgate only operates manually in this position.

Manual operation of a liftgate that also has power operation requires more effort than with a standard manual liftgate.

In either the MAX or the 3/4 mode, the liftgate can be power opened and closed by:

- Pressing  on the Remote Keyless Entry (RKE) transmitter until the liftgate starts moving. See *Remote Keyless Entry (RKE) System Operation on page 1-3*.
- Pressing  on the center of the mode switch on the driver door, with the driver door unlocked.
- Pressing the touchpad switch on the liftgate outside handle, with all doors unlocked, to open the liftgate.



Press and release  on the liftgate adjacent to the latch to close the liftgate.

Pressing any liftgate button, or the touchpad switch while the liftgate is moving, stops it. Pressing the button or RKE switch again reverses the direction. There is a minimum distance that the power liftgate must already be open for the system to hold it open. If movement is stopped below that minimum, the liftgate closes.

Do not force the liftgate open or closed during a power cycle.

1-16 Keys, Doors and Windows

The power liftgate may be temporarily disabled under extreme temperatures or low battery conditions. If this occurs, the liftgate can still be operated manually.

If you shift the transmission out of P (Park) while the power function is in progress, the liftgate power function will continue to completion. If you shift the transmission out of P (Park) and accelerate before the power liftgate latch is closed, the liftgate may reverse to the open position. Cargo could fall out of the vehicle. Always make sure the power liftgate is closed and latched before you drive away.

If you power open the liftgate and the liftgate support struts have lost pressure, the turn signals flash and a chime sounds. The liftgate stays open temporarily, then slowly closes. See your dealer for service before using the liftgate.

Obstacle Detection Features

If the liftgate encounters an obstacle during a power open or close cycle, a warning chime will sound and the liftgate will automatically reverse direction to the full closed or open position. After removing the obstruction, the power liftgate operation can be used again. If the liftgate encounters multiple obstacles on the same power cycle, the power function will deactivate. The Power Liftgate Unavailable warning message in the Driver Information Center (DIC) will display. After removing the obstructions, the liftgate will resume normal power operation.

The vehicle has pinch sensors located on the side edges of the liftgate. If an object is caught between the liftgate and the body and presses against this sensor, the liftgate will reverse direction and open fully. The liftgate will remain open until it is activated again or closed manually.

Setting the Power Liftgate 3/4 Mode

To change the liftgate stop position:

1. Turn the liftgate switch to either the MAX, or the 3/4 mode position and power open the liftgate.
2. Stop the liftgate movement at the desired height by pressing any liftgate switch. Manually adjust the liftgate position if required.
3. Press and hold the button on the liftgate adjacent to the latch until the turn signals flash and a beep sounds to indicate that the new setting is recorded.

When power opened with the 3/4 mode selected, the liftgate stops at the new set position.

If you do not hear the audible and visual feedback when setting the intermediate stop position, you are attempting to set the height below the 3/4 open height minimum (approximately 5 feet). The liftgate cannot be set below that minimum and the new setting will not be recorded.

Manual Operation of Power Liftgate

To change the liftgate to manual operation, turn the mode switch to the OFF position.

With the power liftgate disabled and all of the doors unlocked, the liftgate can be manually opened and closed. Manual efforts of a vehicle equipped with a power liftgate will be higher than a standard non-power liftgate.

To open the liftgate, press the touchpad on the handle on the outside of the liftgate, and lift the gate open. To close the liftgate, use the pull cup to lower the liftgate and close. With the power liftgate disabled, the liftgate electric latch will still power latch once contact is made with the striker. Always close the liftgate before driving.

If the RKE button is pressed while power operation is disabled, the turn signals flash and the liftgate will not move.

The liftgate has an electric latch. If the battery is disconnected or has low voltage, the liftgate will not open. The liftgate will resume operation when the battery is reconnected and charged.

Vehicle Security

This vehicle has theft-deterrent features; however, they do not make it impossible to steal.

Anti-Theft Alarm System

This vehicle has an anti-theft alarm system.

The LED light, located on the instrument panel near the windshield, indicates the status of the system.

Arming the System

To arm the system,

1. Close all doors, liftgate and hood.
2. Lock the vehicle using the transmitter, or the power door lock button. The LED on the instrument panel should come on and stay on for about 30 seconds.

1-18 Keys, Doors and Windows

3. After 30 seconds, the alarm system will arm, and the LED will begin to slowly flash indicating the alarm is operating.

If a door, the hood, or liftgate is opened without first unlocking with the transmitter, the vehicle's turn signals will flash and the horn will sound for about 30 seconds. The alarm system will then re-arm to monitor for the next unauthorized event.

The theft-deterrent alarm system will not activate if the doors are locked with the vehicle's key. You can start the vehicle with a recognized transmitter in the vehicle if the alarm has been set off.

Disarming the System

To disarm the system, either unlock the doors using the transmitter, or start the vehicle with a recognized transmitter in the vehicle.

To avoid setting off the alarm by accident:

- Lock the vehicle with the transmitter after all occupants have left the vehicle and all doors are closed.
- Always unlock a door with the transmitter. Unlocking a door any other way will not disarm the alarm.

If you set off the alarm by accident, turn off the alarm by pressing the unlock button on the transmitter. The alarm will not stop if you try to unlock a door any other way.

How to Detect a Tamper Condition

If  is pressed and the horn chirps three times, an attempted break-in has occurred while the system was armed.

If the alarm has been activated, the "Theft Attempted" message will appear on the DIC. See *Key and Lock Messages on page 4-37* for additional information.

Immobilizer

See *Radio Frequency Statement on page 12-17* for information regarding Part 15 of the Federal Communications Commission (FCC) rules and Industry Canada Standards RSS-210/220/310.

Immobilizer Operation

This vehicle has a passive theft-deterrent system.

The system does not have to be manually armed or disarmed.

The vehicle is automatically immobilized when the vehicle is turned off.

The immobilization system is disarmed when the pushbutton start is activated to enter the ACC/ACCESSORY mode or the ON/RUN/START mode and a valid transmitter is present in the vehicle.



The security light, located in the instrument panel cluster, comes on if there is a problem with arming or disarming the theft-deterrent system.

The system has one or more keyless entry transmitters that are matched to an immobilizer control unit in your vehicle. Only a correctly matched keyless entry transmitter will start the vehicle. If the keyless entry transmitter is ever damaged, you may not be able to start your vehicle.

When trying to start the vehicle, the security light comes on briefly when the ignition is turned on.

If the engine does not start and the security light stays on there is a problem with the system. Turn the ignition off and try again.

If the vehicle will not change ignition modes (ACC/ACCESSORY, ON/RUN/START, OFF), and the keyless entry transmitter appears to be undamaged, try another keyless entry transmitter. Or, you may try placing the transmitter in the transmitter pocket located in the center console. See “No Remote Detected” under *Key and Lock Messages on page 4-37*.

If the ignition modes will not change with the other transmitter, your vehicle needs service. If the ignition does change modes, the first transmitter may be faulty. See your dealer who can service the theft-deterrent system and have a new keyless entry transmitter programmed to the vehicle.

It is possible for the immobilizer system to learn new or replacement keyless entry transmitters. Up to eight keyless entry transmitters can be programmed for the vehicle. To program additional transmitters, see "Programming Transmitters to the Vehicle" *Remote Keyless Entry (RKE) System Operation on page 1-3.*

Do not leave the key or device that disarms or deactivates the theft deterrent system in the vehicle.

Exterior Mirrors

Convex Mirrors

WARNING

A convex mirror can make things, like other vehicles, look farther away than they really are. If you cut too sharply into the right lane, you could hit a vehicle on the right. Check the inside mirror or glance over your shoulder before changing lanes.

The passenger side mirror is convex shaped. A convex mirror's surface is curved so more can be seen from the driver seat.

Power Mirrors

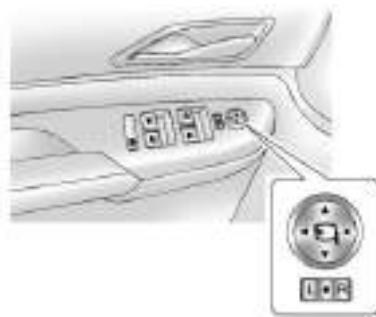

Controls for the outside power mirrors are located on the driver door.

To adjust the mirror:

1. Move the selector switch to L (left) or R (right) to choose the driver or passenger mirror.
2. Press the arrows on the control pad to move each mirror to the desired direction.
3. Return the selector switch to the center position.

Folding Mirrors

Manual Foldaway Mirrors

Vehicles with manual fold mirrors are folded inward toward the vehicle to prevent damage when going through an automatic car wash. Push the mirror outward to return it to the original position.

Power Foldaway Mirrors



Vehicles with power folding mirrors have controls located on the driver door.

To fold the mirrors:

1. With the selector switch in the O position, push the control pad down arrow. Both mirrors will automatically fold.
2. Press the control pad down arrow again to return the mirrors to their original position.

Resetting the Power Foldaway Mirrors

Reset the power foldaway mirrors if:

- The mirrors are accidentally obstructed while folding.
- They are accidentally manually folded/unfolded.
- The mirrors do not stay in the unfolded position.
- The mirrors vibrate at normal driving speeds.

Fold and unfold the mirrors one time using the mirror controls to reset them to their normal position. A noise may be heard during the resetting of the power foldaway mirrors. This sound is normal after a manual folding operation.

Heated Mirrors

 **(Rear Window Defogger):**
Press to heat the mirrors.

See “Rear Window Defogger” under *Dual Automatic Climate Control System on page 7-1* for more information.

Automatic Dimming Mirror

If the vehicle has the automatic dimming mirror, the driver outside mirror automatically adjusts for the glare of headlamps behind you.

Park Tilt Mirrors

If the vehicle has the memory package, the outside mirrors have a park tilt feature. This feature automatically tilts the outside mirrors to a preselected position when the vehicle is in R (Reverse). This allows the driver to view the curb for parallel parking.

The passenger and driver mirrors return to their original position when the vehicle is shifted out of R (Reverse), or the ignition is turned off or to OFF/LOCK.

This feature can be turned on or off through the Driver Information Center (DIC). See *Vehicle Personalization on page 4-41*.

Interior Mirrors

Manual Rearview Mirror

Hold the inside rearview mirror in the center and move it for a clearer view behind the vehicle. Adjust the mirror to avoid glare from the headlamps behind you. Push the tab forward for daytime use and pull it for nighttime use.

Vehicles with OnStar® have three additional control buttons located at the bottom of the mirror. See your dealer for more information on the system and how to subscribe to OnStar. See the OnStar Owner's Guide for more information about the services OnStar provides.

Automatic Dimming Rearview Mirror

The vehicle may have an automatic dimming inside rearview mirror. Automatic dimming reduces the glare from the headlamps of the vehicle behind you. The dimming feature comes on and the indicator light illuminates each time the vehicle is started.

Vehicles with OnStar have three additional control buttons located at the bottom of the mirror. See your dealer for more information on the system and how to subscribe to OnStar. See the OnStar Owner's Guide for more information about the services OnStar provides.

Cleaning the Mirror

Do not spray glass cleaner directly on the mirror. Use a soft towel dampened with water.

Windows

WARNING

Leaving children, helpless adults, or pets in a vehicle with the windows closed is dangerous. They can be overcome by the extreme heat and suffer permanent injuries or even death from heat stroke. Never leave a child, a helpless adult, or a pet alone in a vehicle, especially with the windows closed in warm or hot weather.



Power Windows

WARNING

Leaving children in a vehicle with the keyless access transmitter is dangerous for many reasons, children or others could be badly injured or even killed. They could operate the power windows or other controls or even make the vehicle move. The windows will function with the keyless access transmitter in the vehicle and they could be seriously injured or killed if caught in the path of a closing window. Do not leave the keyless access transmitter in a vehicle with children.

When there are children in the rear seat use the window lockout button to prevent unintentional operation of the windows.



Driver side shown

The power window controls are located on each of the side doors.

The driver door also has switches that control the passenger and rear windows.

The power windows:

- Can be operated with the ignition in ACC/ACCESSORY or ON/RUN/START.
- Can be operated within 10 minutes of switching the ignition off. See *Retained Accessory Power (RAP)* on page 8-20.
- Will stop operation when any door is opened.

Operate the switch for the desired window by pressing to open and pulling to close.

Pushing or pulling the switch part of the way will open or close the window as long as the switch is operated.

Express-Down/Up Windows

Windows that have the express-down/up feature allow the windows to be lowered and raised fully without holding the window switch. Press the window switch fully and release it to activate the express-down feature. Pull the window switch fully up and release it to activate the express-up feature. The express mode can be canceled at any time by briefly pressing, or pulling the switch.

Programming the Power Windows

Programming the power windows may be necessary if the vehicle's battery has been disconnected or discharged

If the window will not express up after power has been restored and a message is displayed in the Driver Information Center:

1. Close all doors
2. Place the ignition in ACC/ACCESSORY or ON/RUN/START.
3. From any partial open position, close the window and continue to press the switch briefly after the window has fully closed.

Obstacle Detection Feature

The Obstacle Detection Feature is part of the express-up feature and is active:

1. In the middle and upper portions of the window opening.
2. During window up movements.
3. In ignition OFF during all window up movements and during express-up window movements in ignition ON/RUN/START.

If there is something blocking the window during automatic closing, the window will reverse direction for a short distance. Weather conditions such as extreme cold and/or ice may cause the window to auto-reverse. The window will return to normal operation once the object or condition is removed.

1-26 Keys, Doors and Windows

If conditions prevent the window from closing and the window continues to auto-reverse, it is possible to close the window with the ignition in ON/RUN/START by holding the window switch in the partially or fully pulled up position. Release of the switch from the partially pulled up position will cause the window to stop. Release of the switch from the fully pulled up position will activate the express-up and related obstacle detection features.

Overload

If the windows are repeatedly operated within a short time, the window operation is disabled for a short time.

Opening the Windows From Outside the Vehicle



The vehicle may have remote operating windows that can be opened from outside the vehicle by pressing and holding the unlock button on the Keyless Access Transmitter to open all the windows.

Window Lockout



 **(Window Lockout):** The window lockout switch is located on the driver door. This feature prevents the rear passenger windows from operating, except from the driver position. Press the switch to turn the lockout feature on or off. An indicator light shows the feature is on.

Sun Visors

Pull the sun visor down to block glare. Detach the sun visor from the center mount and slide it along the rod from side-to-side to cover the driver or passenger side of the front window. Swing the sun visor to the side to cover the side window. It can be moved along the rod from side-to-side in this position also.

Roof

Sunroof

On vehicles with a sunroof, the switches are located on the headliner above the rearview mirror. The ignition must be in ON/RUN/START, ACC/ACCESSORY, or in Retained Accessory Power (RAP) to operate the sunroof. See *Ignition Positions* on page 8-18 and *Retained Accessory Power (RAP)* on page 8-20.

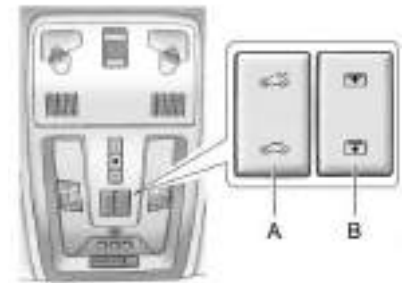

- A. Sunroof Switch
- B. Sunshade Switch

Press the back of the sunroof switch (A) to open the sunroof. When the switch is pressed to the first stop the sunroof will open to the vent position. Press the switch to the second stop to express open the sunroof to an automatically adjusted comfort position.

1-28 Keys, Doors and Windows

Press the switch to the second stop again to open the glass further, up to the full open position. If more venting is needed when the sunroof is open, adjust the sunroof to the comfort position or open one of the windows slightly.

Press the front of the switch to close the sunroof. The first stop will close the sunroof at a desired position at normal speed, and the second stop will express close the roof.

Do not keep the sunroof open for long periods of time while the vehicle is not in use. Excessive debris may collect in the tracks and possibly plug the water draining system.

Press the back of the sunshade switch (B) to open the sunshade. Press the front of the switch to the first stop to close the sunshade to a desired position at a normal speed. Press the switch forward to the second stop to express close the sunshade.

Fully close the glass before fully closing the sunshade.

Express-open/Express-close

Press and release the front or rear of the sunroof switch (A) to express-open or express-close the sunroof.

Anti-Pinch Feature

If an object is in the path of the sunroof when it is closing, the anti-pinch feature detects the object and stops the sunroof from closing at the point of the obstruction. The sunroof then returns to the full-open position.

Dirt and debris may collect on the sunroof seal or in the tracks that could cause an issue with sunroof operation, noise or plug the water drainage system. Periodically open the sunroof and remove any obstacles or loose debris. Wipe the sunroof seal and roof sealing area using a clean cloth, mild soap, and water. Do not remove grease from sunroof.

Seats and Restraints

Head Restraints

Head Restraints 2-2

Front Seats

Seat Adjustment 2-4

Power Seat Adjustment 2-4

Lumbar Adjustment 2-6

Thigh Support Adjustment 2-7

Reclining Seatbacks 2-7

Heated Front Seats 2-8

Heated and Ventilated Front

Seats 2-10

Rear Seats

Rear Seats 2-11

Heated Rear Seats 2-12

Rear Seat

Pass-Through Door 2-13

Safety Belts

Safety Belts 2-13

How to Wear Safety Belts

Properly 2-17

Lap-Shoulder Belt 2-22

Safety Belt Use During

Pregnancy 2-26

Safety Belt Extender 2-26

Safety System Check 2-26

Safety Belt Care 2-27

Replacing Safety Belt System

Parts After a Crash 2-27

Airbag System

Airbag System 2-28

Where Are the Airbags? 2-30

When Should an Airbag

Inflate? 2-32

What Makes an Airbag

Inflate? 2-33

How Does an Airbag

Restrain? 2-33

What Will You See After an

Airbag Inflates? 2-34

Passenger Sensing

System 2-36

Servicing the Airbag-Equipped

Vehicle 2-40

Adding Equipment to the

Airbag-Equipped Vehicle ... 2-41

Airbag System Check 2-42

Replacing Airbag System

Parts After a Crash 2-42

Child Restraints

Older Children 2-43

Infants and Young

Children 2-45

Child Restraint Systems 2-48

Where to Put the Restraint ... 2-50

Lower Anchors and Tethers

for Children (LATCH

System) 2-52

Replacing LATCH System

Parts After a Crash 2-57

Securing Child Restraints

(Rear Seat) 2-57

Securing Child Restraints

(Front Passenger Seat) 2-59

Head Restraints

Front Seats

The vehicle's front seats have adjustable head restraints in all outboard seating positions.

WARNING

With head restraints that are not installed and adjusted properly, there is a greater chance that occupants will suffer a neck/spinal injury in a crash. Do not drive until the head restraints for all occupants are installed and adjusted properly.



Adjust the head restraint so that the top of the restraint is at the same height as the top of the occupant's head. This position reduces the chance of a neck injury in a crash.

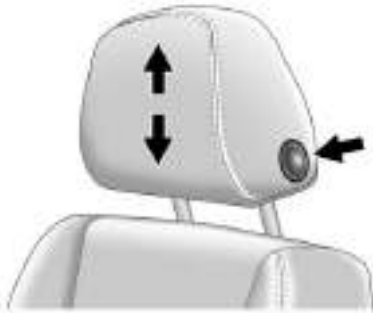

1. To raise or lower the head restraint, press the release button while pulling up or pushing down on the head restraint.
2. Release the button then pull up or push down on the head restraint to make sure it is locked in place.

The front head restraints are designed not to be removed.

Rear Seats

The rear seats have adjustable head restraints in the outboard seating positions.



1. Pull the head restraint up to raise it.
2. To lower the head restraint, press the release button while pushing the head restraint down.

3. Release the button.
4. Push down on the head restraint to make sure it is locked in place.



The center seating position has an integrated headrest that can be adjusted the same way as the head restraints.

If you are installing a child restraint in the rear seat, see “Securing a Child Restraint Designed for the LATCH System” under *Lower Anchors and Tethers for Children (LATCH System)* on page 2-52.

Front Seats

Seat Adjustment



⚠ WARNING

You can lose control of the vehicle if you try to adjust a manual driver seat while the vehicle is moving.

(Continued)

WARNING (Continued)

The sudden movement could startle and confuse you, or make you push a pedal when you do not want to. Adjust the driver seat only when the vehicle is not moving.

To adjust the seat:

1. Pull the handle located at the front of the seat.
2. Move the seat forward or backward to adjust the seat position.
3. Release the handle to stop the seat from moving.

Power Seat Adjustment



Driver Seat Shown

- A. Power Seat Adjustment
- B. Seatback Adjustment
- C. Lumbar Adjustment

On vehicles with power seats, the controls are on the outboard side of the seats.

Adjust the power seat by moving the control (A) forward or rearward. The front or rear of the seat can be

adjusted up or down by moving the front or rear of the control up and down.

Adjust the seatback by moving the control (B) forward or rearward. See *Reclining Seatbacks on page 2-7* for more information.

Adjust the lumbar support by using the control (C). See *Lumbar Adjustment on page 2-6* for more information.

Memory Seats



On vehicles with the memory feature, the controls on the outboard side of the driver seat are used to save and recall memory settings for the driver seat, outside mirrors, and adjustable throttle and brake pedals, if the vehicle has this feature.

Storing Memory Positions

To save into memory:

1. Adjust the driver seat and seatback recliner, both outside mirrors, and pedals, if available.
2. Press and hold MEM (Memory).
3. While holding MEM, press “1” until a beep sounds.
4. Repeat for a second driver using “2.”

To recall the memory positions, press and hold “1” or “2.” The driver seat, outside mirrors, and adjustable pedals, if available, move to the stored positions. Releasing “1” or “2” before the stored position is reached stops the recall.

Memory Remote Recall

The memory feature can recall the driver seat, outside mirrors, and pedals, if available, to stored positions when entering the vehicle.

To activate memory remote recall, unlock the driver door with the Remote Keyless Entry (RKE)

transmitter, and open the driver door. On vehicles equipped with Keyless Access, opening the driver door will activate the recall. If the driver door is already open, pressing the unlock button on the transmitter will activate the recall. The driver seat, outside mirrors, and pedals, if available, move to the memory position associated with the transmitter used to unlock the vehicle. Every time the ignition is placed in OFF, the positions of the driver seat, outside mirrors, and pedals, if available, are stored to the keyless entry transmitter used to start the vehicle.

The automatic recall feature can be turned on or off using the vehicle personalization menu. See “Remote Memory Recall” under *Vehicle Personalization on page 4-41* for more information.

To stop recall movement, press one of the memory, power mirror, or power seat controls, or the adjustable pedal switch, if available.

2-6 Seats and Restraints

If something has blocked the driver seat and/or the adjustable pedals, if available, while recalling a memory position, the recall may stop. Remove the obstruction; then press and hold the appropriate manual control for the memory item that is not recalling for two seconds. Try recalling the memory position again by pressing the appropriate memory button. If the memory position is still not recalling, see your dealer for service.

Easy Exit Driver Seat

The easy exit driver seat feature can move the seat rearward to allow extra room to exit the vehicle.

To activate the easy exit driver seat, place the ignition in OFF and open the driver door. If the driver door is already open, placing the ignition in OFF will activate the easy exit driver seat.

Easy exit driver seat can be turned on or off using the vehicle personalization menu. See “Easy Exit Driver Seat” under *Vehicle Personalization* on page 4-41 for more information.

To stop recall movement, press one of the memory, power mirror, or power seat controls, or the adjustable pedal switch, if available.

If something has blocked the driver seat while recalling the exit position, the recall may stop. Remove the obstruction; then press and hold the appropriate manual control for the memory item that is not recalling for two seconds. Try recalling the exit position again. If the exit position is still not recalling, see your dealer for service.

Lumbar Adjustment

Power Lumbar



Seats with power lumbar have controls located on the outboard side of the seats. See *Power Seat Adjustment* on page 2-4 for more information.

Adjust lumbar support by using the rocker switch on the outboard side of the driver seat.

Release the switch when the seatback reaches the desired level of lumbar support.

Thigh Support Adjustment



On vehicles with this feature, adjust the manual leg extension by pulling up on the lever, pulling or pushing on the support to lengthen or shorten it. Release the lever to lock it in place.

Reclining Seatbacks

Manual Reclining Seatbacks

WARNING

You can lose control of the vehicle if you try to adjust a manual driver seat while the vehicle is moving. The sudden movement could startle and confuse you, or make you push a pedal when you do not want to. Adjust the driver seat only when the vehicle is not moving.

WARNING

If either seatback is not locked, it could move forward in a sudden stop or crash. That could cause injury to the person sitting there. Always push and pull on the seatbacks to be sure they are locked.

Vehicles with manual reclining seatbacks have a lever on the outboard side of the seat. Lift the lever and move the seatback to the desired position, then release the lever. The seatback should not move when pushed or pulled.

Power Reclining Seatbacks



On vehicles with power reclining seatbacks, the switch is located on the outboard side of the seat. See *Power Seat Adjustment on page 2-4* for more information.

2-8 Seats and Restraints

Move the switch forward or rearward to adjust the seatback.

WARNING

Sitting in a reclined position when the vehicle is in motion can be dangerous. Even when buckled up, the safety belts cannot do their job when reclined like this.

The shoulder belt cannot do its job because it will not be against your body. Instead, it will be in front of you. In a crash, you could go into it, receiving neck or other injuries.

The lap belt cannot do its job either. In a crash, the belt could go up over your abdomen. The belt forces would be there, not at your pelvic bones. This could cause serious internal injuries.

(Continued)

WARNING (Continued)

For proper protection when the vehicle is in motion, have the seatback upright. Then sit well back in the seat and wear the safety belt properly.



Do not have a seatback reclined if your vehicle is moving.



Heated Front Seats

WARNING

If you cannot feel temperature change or pain to the skin, the seat heater may cause burns even at low temperatures. To reduce the risk of burns, people with such a condition should use care when using the seat heater, especially for long periods of time. Do not place anything on the seat that insulates against heat, such as a blanket, cushion, cover or similar item. This may cause the seat heater to overheat. An overheated seat heater may cause a burn or may damage the seat.



On vehicles with heated front seats, the buttons are on the center console. To operate the heated seats the ignition must be in ON/RUN/START.

Press  or  to heat the driver or passenger seat cushion and seatback.

Press the button once for the highest setting. With each press of the button, the heated seat will change to the next lower setting, and then to the off setting. The lights indicate three for the highest setting and one for the lowest.

The passenger seat may take longer to heat up.

Remote Start Heated Seats

When it is cold outside, the heated seats can be turned on automatically during a remote vehicle start. The heated seats will be canceled when the ignition is turned on. Press the button to use the heated seats after the vehicle is started.

The heated seat indicator lights on the button do not turn on during a remote start.

The heated seat temperature performance of an unoccupied seat may be reduced. This is normal.

The heated seats will not turn on during a remote start unless the heated seat feature is enabled in the vehicle personalization menu. See *Remote Vehicle Start on page 1-9* and “Remote Start Auto Heated Seats” under *Vehicle Personalization on page 4-41* for more information.



Heated and Ventilated Front Seats

WARNING

If you cannot feel temperature change or pain to the skin, the seat heater may cause burns even at low temperatures. See the Warning under *Heated Front Seats* on page 2-8.



On vehicles with the heated and ventilated seat feature, the controls are on the center console. To operate the heated and ventilated seats the ignition must be in ON/RUN/START.

Press  to heat the seat or  to cool the seat.

Press the button once for the highest setting. With each press of the button, the seat will change to the next lower setting, and then to the off setting. The lights indicate three for the highest setting and one for the lowest.

The passenger seat may take longer to heat up.

Remote Start Heated and Ventilated Seats

During a remote start, the heated or ventilated seats can be turned on automatically. They are canceled when the ignition is turned on. Press the button to use the heated or ventilated seats after the vehicle is started.

The heated or ventilated seat indicator lights on the button do not turn on during a remote start.

The heated seat temperature performance of an unoccupied seat may be reduced. This is normal.

The heated or ventilated seats will not turn on during a remote start unless they are enabled in the vehicle personalization menu. See *Remote Vehicle Start* on page 1-9 and “Remote Start Auto Heated Seats” or “Remote Start Auto Seat Cool” under *Vehicle Personalization* on page 4-41 for more information.

Rear Seats

Split Folding Seatbacks

With this feature, either side of the rear seatback can be folded down for more cargo space.

WARNING

If either seatback is not locked, it could move forward in a sudden stop or crash. That could cause injury to the person sitting there. Always push and pull on the seatbacks to be sure they are locked.

WARNING

A safety belt that is improperly routed, not properly attached, or twisted will not provide the protection needed in a crash.

(Continued)

WARNING (Continued)

The person wearing the belt could be seriously injured. After raising the rear seatback, always check to be sure that the safety belts are properly routed and attached, and are not twisted.

Folding the Seatbacks

Notice: Folding a rear seat with the safety belts still fastened may cause damage to the seat or the safety belts. Always unbuckle the safety belts and return them to their normal stowed position before folding a rear seat.

To fold the seatback:

1. The rear safety belts must be unbuckled and the front seatbacks are not reclined.
2. Make sure that there is nothing under, in front of, or on the seat.



3. Lift the lever located on the top of the seatback. The rear seat lock indicator (A) extends when the seatback is unlocked.
4. Fold the seatback forward. The rear seat lock indicator (A) retracts when the seatback is locked.

Keep the seat in the upright, locked position when not in use.

2-12 Seats and Restraints

Raising the Seatbacks

To raise the seatback:

1. Lift the lever located on top of the seatback. Raise the seatback and release the lever. The rear seat lock indicator (A) extends when the seatback is unlocked.
2. Tilt the seatback rearward until it locks in the upright position. The rear seat lock indicator (A) retracts when the seatback is locked.

Reclining the Seatbacks

To recline the seatback:

1. Lift and hold the lever located on top of the seatback. The rear seat lock indicator (A) extends when the seatback is unlocked.
2. Tilt the seatback rearward, then release the lever when the seatback is in the desired position. The rear seat lock indicator (A) retracts when the seatback is locked.

Heated Rear Seats

WARNING

If you cannot feel temperature change or pain to the skin, the seat heater may cause burns even at low temperatures. See the *Warning* under *Heated Front Seats* on page 2-8.

On vehicles with heated rear seats, the switches are located on the Rear Seat Audio (RSA) controls.

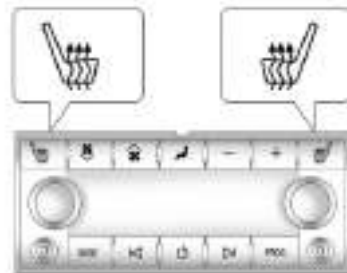

With the ignition in ON/RUN/START, press either button  for the corresponding seat. The LED light illuminates when the feature is on.

Only the outboard seats are heated.

An indicator on the RSA screen turns on and the seat cushion and seatback heat up. With each press of the switch the heated seat changes to the next lower setting and then off. The bars indicate three for the highest setting and one for the lowest.

Rear Seat Pass-Through Door

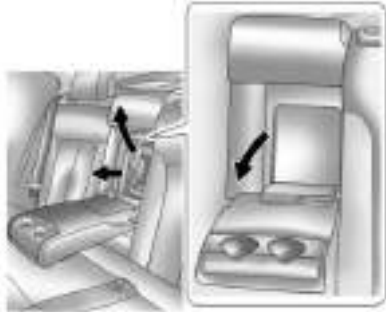

The vehicle may have a rear seat pass-through door located in the center of the rear seatback. Fold down the center armrest and push down on the latch to open the door.

Safety Belts

This section of the manual describes how to use safety belts properly. It also describes some things not to do with safety belts.

⚠ WARNING

Do not let anyone ride where a safety belt cannot be worn properly. In a crash, if you or your passenger(s) are not wearing safety belts, the injuries can be much worse. You can hit things inside the vehicle harder or be ejected from the vehicle. You and your passenger(s) can be seriously injured or killed. In the same crash, you might not be, if you are buckled up. Always fasten your safety belt, and check that your passenger(s) are restrained properly too.

⚠ WARNING

It is extremely dangerous to ride in a cargo area, inside or outside of a vehicle. In a collision, people riding in these areas are more likely to be seriously injured or killed. Do not allow people to ride in any area of your vehicle that is not equipped with seats and safety belts. Be sure everyone in your vehicle is in a seat and using a safety belt properly.

This vehicle has indicators as a reminder to buckle the safety belts. See *Safety Belt Reminders on page 4-17* for additional information.

In most states and in all Canadian provinces, the law requires wearing safety belts. Here is why:

You never know if you will be in a crash. If you do have a crash, you do not know if it will be a serious one.

2-14 Seats and Restraints

A few crashes are mild, and some crashes can be so serious that even buckled up, a person would not survive. But most crashes are in between. In many of them, people who buckle up can survive and sometimes walk away. Without safety belts they could have been badly hurt or killed.

After more than 40 years of safety belts in vehicles, the facts are clear. In most crashes buckling up does matter ... a lot!

Why Safety Belts Work

When you ride in or on anything, you go as fast as it goes.



Take the simplest vehicle. Suppose it is just a seat on wheels.



Put someone on it.



Get it up to speed. Then stop the vehicle. The rider does not stop.



The person keeps going until stopped by something. In a real vehicle, it could be the windshield...



or the instrument panel...



or the safety belts!

With safety belts, you slow down as the vehicle does. You get more time to stop. You stop over more distance, and your strongest bones take the forces. That is why safety belts make such good sense.

2-16 Seats and Restraints

Questions and Answers About Safety Belts

Q: Will I be trapped in the vehicle after a crash if I am wearing a safety belt?

A: You *could* be — whether you are wearing a safety belt or not. But your chance of being conscious during and after an accident, so you *can* unbuckle and get out, is *much* greater if you are belted. And you can unbuckle a safety belt, even if you are upside down.

Q: If my vehicle has airbags, why should I have to wear safety belts?

A: Airbags are supplemental systems only; so they work *with* safety belts — not instead of them. Whether or not an airbag is provided, all occupants still have to buckle up to get the most protection. That is true not only in frontal collisions, but especially in side and other collisions.

Q: If I am a good driver, and I never drive far from home, why should I wear safety belts?

A: You may be an excellent driver, but if you are in a crash — even one that is not your fault — you and your passenger(s) can be hurt. Being a good driver does not protect you from things beyond your control, such as bad drivers.

Most accidents occur within 40 km (25 miles) of home. And the greatest number of serious injuries and deaths occur at speeds of less than 65 km/h (40 mph).

Safety belts are for everyone.

How to Wear Safety Belts Properly

This section is only for people of adult size.

Be aware that there are special things to know about safety belts and children. And there are different rules for smaller children and infants. If a child will be riding in the vehicle, see *Older Children on page 2-43* or *Infants and Young Children on page 2-45*. Follow those rules for everyone's protection.

It is very important for all occupants to buckle up. Statistics show that unbelted people are hurt more often in crashes than those who are wearing safety belts.

Occupants who are not buckled up can be thrown out of the vehicle in a crash. And they can strike others in the vehicle who are wearing safety belts.

First, before you or your passenger(s) wear a safety belt, there is important information you should know.

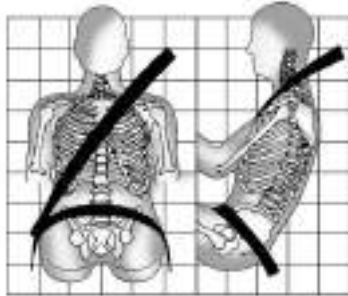

Sit up straight and always keep your feet on the floor in front of you. The lap part of the belt should be worn low and snug on the hips, just touching the thighs.

In a crash, this applies force to the strong pelvic bones and you would be less likely to slide under the lap belt. If you slid under it, the belt would apply force on your abdomen. This could cause serious or even fatal injuries. The shoulder belt should go over the shoulder and across the chest. These parts of the body are best able to take belt restraining forces.

The shoulder belt locks if there is a sudden stop or crash.

2-18 Seats and Restraints

Q: What is wrong with this?

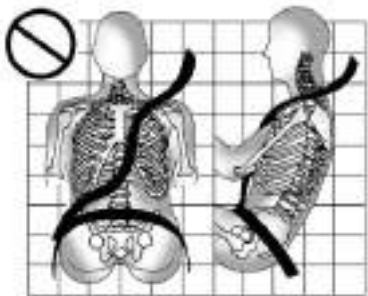

A: The shoulder belt is too loose. It will not give as much protection this way.

WARNING

You can be seriously hurt if your shoulder belt is too loose. In a crash, you would move forward too much, which could increase injury. The shoulder belt should fit snugly against your body.

Q: What is wrong with this?

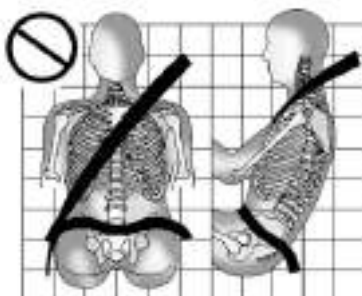

A: The lap belt is too loose. It will not give nearly as much protection this way.

WARNING

You can be seriously hurt if your lap belt is too loose. In a crash, you could slide under the lap belt and apply force on your abdomen. This could cause serious or even fatal injuries. The lap belt should be worn low and snug on the hips, just touching the thighs.

Q: What is wrong with this?

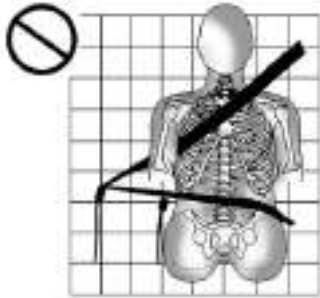

A: The belt is buckled in the wrong buckle.

⚠ WARNING

You can be seriously injured if your belt is buckled in the wrong place like this. In a crash, the belt would go up over your abdomen. The belt forces would be there, not on the pelvic bones. This could cause serious internal injuries. Always buckle your belt into the buckle nearest you.

Q: What is wrong with this?



A: The belt is over an armrest.

2-20 Seats and Restraints

WARNING

You can be seriously injured if your belt goes over an armrest like this. The belt would be much too high. In a crash, you can slide under the belt. The belt force would then be applied on the abdomen, not on the pelvic bones, and that could cause serious or fatal injuries. Be sure the belt goes under the armrests.

Q: What is wrong with this?

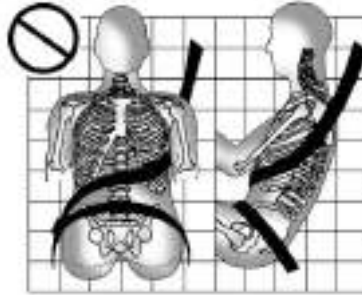

A: The shoulder belt is worn under the arm. It should be worn over the shoulder at all times.

WARNING

You can be seriously injured if you wear the shoulder belt under your arm. In a crash, your body would move too far forward, which would increase the chance of head and neck injury. Also, the belt would apply too much force to the ribs, which are not as strong as shoulder bones. You could also severely injure internal organs like your liver or spleen. The shoulder belt should go over the shoulder and across the chest.

Q: What is wrong with this?

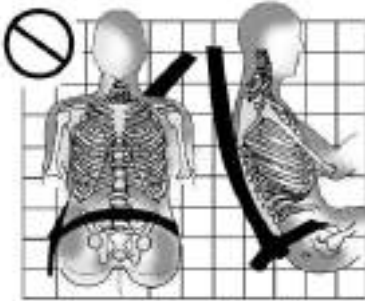

A: The belt is behind the body.

⚠ WARNING

You can be seriously injured by not wearing the lap-shoulder belt properly. In a crash, you would not be restrained by the shoulder belt. Your body could move too far forward increasing the chance of head and neck injury. You might also slide under the lap belt. The belt force would then be applied right on the abdomen. That could cause serious or fatal injuries. The shoulder belt should go over the shoulder and across the chest.

Q: What is wrong with this?

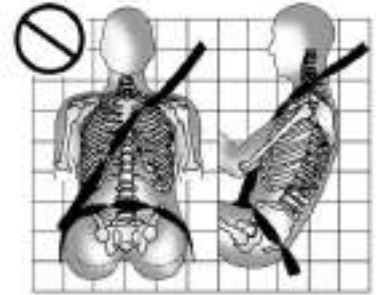

A: The belt is twisted across the body.

⚠ WARNING

You can be seriously injured by a twisted belt. In a crash, you would not have the full width of the belt to spread impact forces. If a belt is twisted, make it straight so it can work properly, or ask your dealer to fix it.

2-22 Seats and Restraints

Lap-Shoulder Belt

All seating positions in the vehicle have a lap-shoulder belt.

The following instructions explain how to wear a lap-shoulder belt properly.

1. Adjust the seat, if the seat is adjustable, so you can sit up straight. To see how, see “Seats” in the Index.

2. Pick up the latch plate and pull the belt across you. Do not let it get twisted.

The lap-shoulder belt may lock if you pull the belt across you very quickly. If this happens, let the belt go back slightly to unlock it. Then pull the belt across you more slowly.

If the shoulder portion of a passenger belt is pulled out all the way, the child restraint locking feature may be engaged. If this happens, let the belt go back all the way and start again.



3. Push the latch plate into the buckle until it clicks.

Pull up on the latch plate to make sure it is secure. If the belt is not long enough, see *Safety Belt Extender on page 2-26*.

Position the release button on the buckle so that the safety belt could be quickly unbuckled if necessary.

4. If equipped with a shoulder belt height adjuster, move it to the height that is right for you. See “Shoulder Belt Height Adjustment” later in this section for instructions on use and important safety information.



5. To make the lap part tight, pull up on the shoulder belt.

It may be necessary to pull stitching on the safety belt through the latch plate to fully tighten the lap belt on smaller occupants.



To unlatch the belt, just push the button on the buckle. For outboard seating positions, slide the latch plate up the safety belt webbing when the safety belt is not in use. The latch plate should rest on the stitching on the safety belt, near the guide loop.

Before a door is closed, be sure the safety belt is out of the way. If a door is slammed against a safety belt, damage can occur to both the safety belt and the vehicle.

Shoulder Belt Height Adjuster

The vehicle has a shoulder belt height adjuster for the driver and right front passenger seating positions.

Adjust the height so that the shoulder portion of the belt is centered on the shoulder. The belt should be away from the face and neck, but not falling off the shoulder. Improper shoulder belt height adjustment could reduce the effectiveness of the safety belt in a crash.



Move the height adjuster up to the desired position by pushing up on the height adjuster.

After the height adjuster is set to the desired position, try to move it up or down without pressing the release button (A) to make sure it has locked into position. Press the release button to lower the height adjuster.

2-24 Seats and Restraints

Safety Belt Pretensioners

This vehicle has safety belt pretensioners for front outboard occupants. Although the safety belt pretensioners cannot be seen, they are part of the safety belt assembly. They can help tighten the safety belts during the early stages of a moderate to severe frontal and near frontal crash and will deploy in side, rear and rollover events if the threshold conditions for pretensioner activation are met.

Pretensioners work only once. If the pretensioners activate in a crash, they will need to be replaced, and probably other new parts for the vehicle's safety belt system. See *Replacing Safety Belt System Parts After a Crash* on page 2-27.

Rear Safety Belt Comfort Guides

This vehicle may have rear shoulder belt comfort guides for the outboard passenger positions in the rear seat. If not, they are available through your dealer. The guides may provide added safety belt comfort for older children who have outgrown booster seats and for some adults. When installed on a shoulder belt, and properly adjusted, the comfort guide positions the belt away from the neck and head.

Here is how to install a comfort guide to the safety belt:

1. Remove the guide from its storage pocket on the side of the seat.



2. Place the guide over the belt, and insert the two edges of the belt into the slots of the guide.

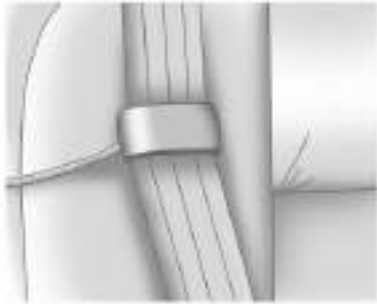

3. Be sure that the belt is not twisted and it lies flat. The elastic cord must be under the belt and the guide on top.

⚠ WARNING

A safety belt that is not properly worn may not provide the protection needed in a crash. The person wearing the belt could be seriously injured. The shoulder belt should go over the shoulder and across the chest. These parts of the body are best able to take belt restraining forces.



4. Buckle, position, and release the safety belt as described previously in this section. Make sure that the shoulder belt crosses the shoulder.

To remove and store the comfort guide, squeeze the belt edges together so that the safety belt can be removed from the guide. Slide the guide back into its storage pocket located on the side of the seat.

Safety Belt Use During Pregnancy

Safety belts work for everyone, including pregnant women. Like all occupants, they are more likely to be seriously injured if they do not wear safety belts.



A pregnant woman should wear a lap-shoulder belt, and the lap portion should be worn as low as possible, below the rounding, throughout the pregnancy.

The best way to protect the fetus is to protect the mother. When a safety belt is worn properly, it is more likely that the fetus will not be hurt in a crash. For pregnant women, as for anyone, the key to making safety belts effective is wearing them properly.

Safety Belt Extender

If the vehicle's safety belt will fasten around you, you should use it.

But if a safety belt is not long enough, your dealer will order you an extender. When you go in to order it, take the heaviest coat you will wear, so the extender will be long enough for you. To help avoid personal injury, do not let someone else use it, and use it only for the seat it is made to fit. The extender has been designed for adults. Never use it for securing child seats. To wear it, attach it to the regular safety belt. For more information, see the instruction sheet that comes with the extender.

Safety System Check

Now and then, check that the safety belt reminder light, safety belts, buckles, latch plates, retractors, and anchorages are working properly. Look for any other loose or damaged safety belt system parts that might keep a safety belt system from doing its job. See your dealer to have it repaired. Torn or frayed safety belts may not protect you in a crash. They can rip apart under impact forces. If a belt is torn or frayed, get a new one right away.

Make sure the safety belt reminder light is working. See *Safety Belt Reminders on page 4-17* for more information.

Keep safety belts clean and dry. See *Safety Belt Care on page 2-27*.

Safety Belt Care

Keep belts clean and dry.

 **WARNING**

Do not bleach or dye safety belts. It may severely weaken them. In a crash, they might not be able to provide adequate protection. Clean safety belts only with mild soap and lukewarm water.

Replacing Safety Belt System Parts After a Crash

 **WARNING**

A crash can damage the safety belt system in the vehicle. A damaged safety belt system may not properly protect the person using it, resulting in serious injury or even death in a crash. To help make sure the safety belt systems are working properly after a crash, have them inspected and any necessary replacements made as soon as possible.

After a minor crash, replacement of safety belts may not be necessary. But the safety belt assemblies that were used during any crash may have been stressed or damaged. See your dealer to have the safety belt assemblies inspected or replaced.

New parts and repairs may be necessary even if the safety belt system was not being used at the time of the crash.

Have the safety belt pretensioners checked if the vehicle has been in a crash, or if the airbag readiness light stays on after you start the vehicle or while you are driving. See *Airbag Readiness Light on page 4-18*.

Airbag System

The vehicle has the following airbags:

- A frontal airbag for the driver.
- A frontal airbag for the right front passenger.
- A seat-mounted side impact airbag for the driver.
- A seat-mounted side impact airbag for the right front passenger.
- A roof-rail airbag for the driver and the passenger seated directly behind the driver.
- A roof-rail airbag for the right front passenger and the passenger seated directly behind the right front passenger.

All of the airbags in the vehicle will have the word AIRBAG embossed in the trim or on an attached label near the deployment opening.

For frontal airbags, the word AIRBAG will appear on the middle part of the steering wheel for the driver and on the instrument panel for the right front passenger.

With seat-mounted side impact airbags, the word AIRBAG will appear on the side of the seatback closest to the door.

With roof-rail airbags, the word AIRBAG will appear along the trim.

Even if you do not have a right front passenger seat in the vehicle there is still an active frontal airbag in the right side of the instrument panel. Do not place cargo in front of this airbag.

WARNING

Be sure that cargo is not near an airbag. In a crash, an inflating airbag might force that object toward a person. This could cause severe injury or even death. Secure objects away from the area in which an airbag would inflate. For more information, see *Where Are the Airbags?* on page 2-30 and *Vehicle Load Limits* on page 8-11.

Airbags are designed to supplement the protection provided by safety belts. Even though today's airbags are also designed to help reduce the risk of injury from the force of an inflating bag, all airbags must inflate very quickly to do their job.

Here are the most important things to know about the airbag system:

 **WARNING**

You can be severely injured or killed in a crash if you are not wearing your safety belt — even if you have airbags. Airbags are designed to work with safety belts, but do not replace them. Also, airbags are not designed to deploy in every crash. In some crashes safety belts are your only restraint. See *When Should an Airbag Inflate?* on page 2-32.

Wearing your safety belt during a crash helps reduce your chance of hitting things inside the vehicle or being ejected from it. Airbags are “supplemental restraints” to the safety belts. Everyone in your vehicle should wear a safety belt properly — whether or not there is an airbag for that person.

 **WARNING**

Airbags inflate with great force, faster than the blink of an eye. Anyone who is up against, or very close to, any airbag when it inflates can be seriously injured or killed. Do not sit unnecessarily close to the airbag, as you would be if you were sitting on the edge of your seat or leaning forward. Safety belts help keep you in position before and during a crash. Always wear your safety belt, even with airbags. The driver should sit as far back as possible while still maintaining control of the vehicle.

Occupants should not lean on or sleep against the door or side windows in seating positions with seat-mounted side impact airbags and/or roof-rail airbags.

 **WARNING**

Children who are up against, or very close to, any airbag when it inflates can be seriously injured or killed. Airbags plus lap-shoulder belts offer protection for adults and older children, but not for young children and infants. Neither the vehicle’s safety belt system nor its airbag system is designed for them. Young children and infants need the protection that a child restraint system can provide. Always secure children properly in your vehicle. To read how, see *Older Children* on page 2-43 or *Infants and Young Children* on page 2-45.



There is an airbag readiness light on the instrument panel cluster, which shows the airbag symbol.

The system checks the airbag electrical system for malfunctions. The light tells you if there is an electrical problem. See *Airbag Readiness Light* on page 4-18 for more information.

Where Are the Airbags?



The driver frontal airbag is in the middle of the steering wheel.



The right front passenger frontal airbag is in the instrument panel on the passenger side.



Driver Side shown, Passenger Side similar

The seat-mounted side impact airbags for the driver and right front passenger are in the side of the seatbacks closest to the door.



Driver Side shown, Passenger Side similar

The roof-rail airbags for the driver, right front passenger, and second row outboard passengers are in the ceiling above the side windows.

⚠ WARNING

If something is between an occupant and an airbag, the airbag might not inflate properly or it might force the object into that person causing severe injury or even death. The path of an inflating airbag must be kept clear. Do not put anything between an occupant and an airbag, and do not attach or put anything on the steering wheel hub or on or near any other airbag covering.

Do not use seat accessories that block the inflation path of a seat-mounted side impact airbag.

Never secure anything to the roof of a vehicle with roof-rail airbags by routing a rope or tie down through any door or window opening. If you do, the path of an inflating roof-rail airbag will be blocked.

When Should an Airbag Inflate?

Frontal airbags are designed to inflate in moderate to severe frontal or near-frontal crashes to help reduce the potential for severe injuries mainly to the driver's or right front passenger's head and chest. However, they are only designed to inflate if the impact exceeds a predetermined deployment threshold. Deployment thresholds are used to predict how severe a crash is likely to be in time for the airbags to inflate and help restrain the occupants.

Whether the frontal airbags will or should deploy is not based on how fast your vehicle is traveling. It depends largely on what you hit, the direction of the impact, and how quickly your vehicle slows down.

Frontal airbags may inflate at different crash speeds. For example:

- If the vehicle hits a stationary object, the airbags could inflate at a different crash speed than if the vehicle hits a moving object.
- If the vehicle hits an object that deforms, the airbags could inflate at a different crash speed than if the vehicle hits an object that does not deform.
- If the vehicle hits a narrow object (like a pole), the airbags could inflate at a different crash speed than if the vehicle hits a wide object (like a wall).
- If the vehicle goes into an object at an angle, the airbags could inflate at a different crash speed than if the vehicle goes straight into the object.

Thresholds can also vary with specific vehicle design.

Frontal airbags are not intended to inflate during vehicle rollovers, rear impacts, or in many side impacts.

In addition, the vehicle has dual-stage frontal airbags. Dual-stage airbags adjust the restraint according to crash severity. The vehicle has electronic frontal sensors, which help the sensing system distinguish between a moderate frontal impact and a more severe frontal impact. For moderate frontal impacts, dual-stage airbags inflate at a level less than full deployment. For more severe frontal impacts, full deployment occurs.

The vehicle has seat-mounted side impact and roof-rail airbags. See *Airbag System on page 2-28*. Seat-mounted side impact and roof-rail airbags are intended to inflate in moderate to severe side crashes. In addition, these roof-rail airbags are intended to inflate during a rollover. Seat-mounted side impact and roof-rail airbags will

inflate if the crash severity is above the system's designed threshold level. The threshold level can vary with specific vehicle design.

Seat-mounted side impact airbags are not intended to inflate in frontal impacts, near-frontal impacts, rollovers, or rear impacts. Roof-rail airbags are not intended to inflate in rear impacts. A seat-mounted side impact airbag is intended to deploy on the side of the vehicle that is struck. Both roof-rail airbags will deploy when either side of the vehicle is struck, or if the sensing system predicts that the vehicle is about to roll over, or in a severe frontal impact.

If the vehicle does not have a right front passenger seat and a rear seat, only the driver frontal airbag will deploy in a frontal impact.

In any particular crash, no one can say whether an airbag should have inflated simply because of the damage to a vehicle or because of what the repair costs were. For

frontal airbags, inflation is determined by what the vehicle hits, the angle of the impact, and how quickly the vehicle slows down. For seat-mounted side impact and roof-rail airbags, deployment is determined by the location and severity of the side impact. In a rollover event, roof-rail airbag deployment is determined by the direction of the roll.

What Makes an Airbag Inflate?

In a deployment event, the sensing system sends an electrical signal triggering a release of gas from the inflator. Gas from the inflator fills the airbag causing the bag to break out of the cover and deploy. The inflator, the airbag, and related hardware are all part of the airbag module.

Frontal airbag modules are located inside the steering wheel and instrument panel. For vehicles with seat-mounted side impact airbags,

there are airbag modules in the side of the front seatbacks closest to the door. For vehicles with roof-rail airbags, there are airbag modules in the ceiling of the vehicle, near the side windows that have occupant seating positions.

How Does an Airbag Restrain?

In moderate to severe frontal or near frontal collisions, even belted occupants can contact the steering wheel or the instrument panel. In moderate to severe side collisions, even belted occupants can contact the inside of the vehicle.

Airbags supplement the protection provided by safety belts. Frontal airbags distribute the force of the impact more evenly over the occupant's upper body, stopping the occupant more gradually. Seat-mounted side impact and roof-rail airbags distribute the force of the impact more evenly over the occupant's upper body.

2-34 Seats and Restraints

Rollover capable roof-rail airbags are designed to help contain the head and chest of occupants in the outboard seating positions in the first and second rows. The rollover capable roof-rail airbags are designed to help reduce the risk of full or partial ejection in rollover events, although no system can prevent all such ejections.

But airbags would not help in many types of collisions, primarily because the occupant's motion is not toward those airbags. See *When Should an Airbag Inflate?* on page 2-32 for more information.

Airbags should never be regarded as anything more than a supplement to safety belts.

What Will You See After an Airbag Inflates?

After the frontal airbags and seat-mounted side impact airbags inflate, they quickly deflate, so quickly that some people may not even realize an airbag inflated. Roof-rail airbags may still be at least partially inflated for some time after they deploy. Some components of the airbag module may be hot for several minutes. For location of the airbag modules, see *What Makes an Airbag Inflate?* on page 2-33.

The parts of the airbag that come into contact with you may be warm, but not too hot to touch. There may be some smoke and dust coming from the vents in the deflated airbags. Airbag inflation does not prevent the driver from seeing out of the windshield or being able to steer the vehicle, nor does it prevent people from leaving the vehicle.

WARNING

When an airbag inflates, there may be dust in the air. This dust could cause breathing problems for people with a history of asthma or other breathing trouble. To avoid this, everyone in the vehicle should get out as soon as it is safe to do so. If you have breathing problems but cannot get out of the vehicle after an airbag inflates, then get fresh air by opening a window or a door. If you experience breathing problems following an airbag deployment, you should seek medical attention.

The vehicle has a feature that may automatically unlock the doors, turn on the interior lamps and hazard warning flashers, and shut off the fuel system after the airbags inflate.

You can lock the doors, turn off the interior lamps and hazard warning flashers by using the controls for those features.

 **WARNING**

A crash severe enough to inflate the airbags may have also damaged important functions in the vehicle, such as the fuel system, brake and steering systems, etc. Even if the vehicle appears to be drivable after a moderate crash, there may be concealed damage that could make it difficult to safely operate the vehicle.

Use caution if you should attempt to restart the engine after a crash has occurred.

In many crashes severe enough to inflate the airbag, windshields are broken by vehicle deformation. Additional windshield breakage may also occur from the right front passenger airbag.

- Airbags are designed to inflate only once. After an airbag inflates, you will need some new parts for the airbag system. If you do not get them, the airbag system will not be there to help protect you in another crash. A new system will include airbag modules and possibly other parts. The service manual for your vehicle covers the need to replace other parts.
- The vehicle has a crash sensing and diagnostic module which records information after a crash. See *Vehicle Data Recording and Privacy on page 12-15* and *Event Data Recorders on page 12-16*.
- Let only qualified technicians work on the airbag systems. Improper service can mean that an airbag system will not work properly. See your dealer for service.

Passenger Sensing System

The vehicle has a passenger sensing system for the right front passenger position. The passenger airbag status indicator will be visible on the overhead console when the vehicle is started.



United States



Canada

The words ON and OFF, or the symbol for on and off, are visible during the system check. If you are

using remote start, if equipped, to start the vehicle from a distance, you may not see the system check. When the system check is complete, either the word ON or OFF, or the symbol for on or off, will be visible. See *Passenger Airbag Status Indicator* on page 4-19.

The passenger sensing system turns off the right front passenger frontal airbag and seat-mounted side impact airbag under certain conditions. The driver airbags and the roof-rail airbags are not affected by the passenger sensing system.

The passenger sensing system works with sensors that are part of the right front passenger seat. The sensors are designed to detect the presence of a properly-seated occupant and determine if the right front passenger frontal airbag and seat-mounted side impact airbag should be enabled (may inflate) or not.

According to accident statistics, children are safer when properly secured in a rear seat in the correct child restraint for their weight and size.

We recommend that children be secured in a rear seat, including: an infant or a child riding in a rear-facing child restraint; a child riding in a forward-facing child seat; an older child riding in a booster seat; and children, who are large enough, using safety belts.

A label on the sun visor says, "Never put a rear-facing child seat in the front." This is because the risk to the rear-facing child is so great, if the airbag deploys.

 **WARNING**

A child in a rear-facing child restraint can be seriously injured or killed if the right front passenger airbag inflates. This is because the back of the rear-facing child restraint would be very close to the inflating airbag. A child in a forward-facing child restraint can be seriously injured or killed if the right front passenger airbag inflates and the passenger seat is in a forward position.

Even if the passenger sensing system has turned off the right front passenger frontal airbag and seat-mounted side impact airbag (if equipped), no system is fail-safe. No one can guarantee that an airbag will not deploy under some unusual circumstance, even though the airbag(s) are off.

(Continued)

WARNING (Continued)

Secure rear-facing child restraints in a rear seat, even if the airbag(s) are off. If you secure a forward-facing child restraint in the right front seat, always move the front passenger seat as far back as it will go. It is better to secure the child restraint in a rear seat.

If the vehicle does not have a rear seat that will accommodate a rear-facing child restraint, a rear-facing child restraint should not be installed in the vehicle, even if the airbag is off.

The passenger sensing system is designed to turn off the right front passenger airbag and seat-mounted side impact airbag if:

- The right front passenger seat is unoccupied.
- The system determines that an infant is present in a rear-facing infant seat.
- The system determines that a small child is present in a child restraint.
- The system determines that a small child is present in a booster seat.
- A right front passenger takes his/her weight off of the seat for a period of time.
- The right front passenger seat is occupied by a smaller person, such as a child who has outgrown child restraints.
- Or, if there is a critical problem with the airbag system or the passenger sensing system.

2-38 Seats and Restraints

When the passenger sensing system has turned off the right front passenger frontal airbag and seat-mounted side impact airbag, the off indicator will light and stay lit to remind you that the airbags are off. See *Passenger Airbag Status Indicator on page 4-19*.

The passenger sensing system is designed to turn on (may inflate) the right front passenger frontal airbag and seat-mounted side impact airbag anytime the system senses that a person of adult size is sitting properly in the right front passenger seat.

When the passenger sensing system has allowed the airbags to be enabled, the on indicator will light and stay lit to remind you that the airbags are active.

For some children who have outgrown child restraints and for very small adults, the passenger sensing system may or may not turn off the right front passenger frontal airbag and seat-mounted side impact airbag, depending upon the person's seating posture and body build. Everyone in the vehicle who has outgrown child restraints should wear a safety belt properly — whether or not there is an airbag for that person.

WARNING

If the airbag readiness light ever comes on and stays on, it means that something may be wrong with the airbag system. To help avoid injury to yourself or others, have the vehicle serviced right away. See *Airbag Readiness Light on page 4-18* for more information, including important safety information.

If the On Indicator is Lit for a Child Restraint

If a child restraint has been installed and the on indicator is lit:

1. Turn the vehicle off.
2. Remove the child restraint from the vehicle.
3. Remove any additional items from the seat such as blankets, cushions, seat covers, seat heaters, or seat massagers.
4. Reinstall the child restraint following the directions provided by the child restraint manufacturer and refer to "Securing a Child Restraint in the Right Front Seat Position" under *Securing Child Restraints (Rear Seat)* on page 2-57 or *Securing Child Restraints (Front Passenger Seat)* on page 2-59.

5. If, after reinstalling the child restraint and restarting the vehicle, the on indicator is still lit, turn the vehicle off. Then slightly recline the vehicle seatback and adjust the seat cushion, if adjustable, to make sure that the vehicle seatback is not pushing the child restraint into the seat cushion.

Also make sure the child restraint is not trapped under the vehicle head restraint. If this happens, adjust the head restraint. See *Head Restraints on page 2-2*.

6. Restart the vehicle.

If the on indicator is still lit, secure the child restraint in a rear seat position in the vehicle, and check with your dealer.

If no rear seat is available, do not install a child restraint in this vehicle.

If the Off Indicator is Lit for an Adult-Size Occupant



If a person of adult-size is sitting in the right front passenger seat, but the off indicator is lit, it could be because that person is not sitting properly in the seat. If this happens,

use the following steps to allow the system to detect that person and enable the right front passenger frontal airbag and seat-mounted side impact airbag:

1. Turn the vehicle off.
2. Remove any additional material from the seat, such as blankets, cushions, seat covers, seat heaters, or seat massagers.
3. Place the seatback in the fully upright position.
4. Have the person sit upright in the seat, centered on the seat cushion, with legs comfortably extended.
5. Restart the vehicle and have the person remain in this position for two to three minutes after the on indicator is lit.

2-40 Seats and Restraints

Additional Factors Affecting System Operation

Safety belts help keep the passenger in position on the seat during vehicle maneuvers and braking, which helps the passenger sensing system maintain the passenger airbag status. See “Safety Belts” and “Child Restraints” in the Index for additional information about the importance of proper restraint use.

A thick layer of additional material, such as a blanket or cushion, or aftermarket equipment such as seat covers, seat heaters, and seat massagers can affect how well the passenger sensing system operates. We recommend that you not use seat covers or other aftermarket equipment except when approved by GM for your specific vehicle. See *Adding Equipment to the Airbag-Equipped Vehicle on page 2-41* for more information about modifications that can affect how the system operates.

WARNING

Stowing of articles under the passenger seat or between the passenger seat cushion and seatback may interfere with the proper operation of the passenger sensing system.

Servicing the Airbag-Equipped Vehicle

Airbags affect how the vehicle should be serviced. There are parts of the airbag system in several places around the vehicle. Your dealer and the service manual have information about servicing the vehicle and the airbag system. To purchase a service manual, see *Service Publications Ordering Information on page 12-13*.

WARNING

For up to 10 seconds after the ignition is turned off and the battery is disconnected, an airbag can still inflate during improper service. You can be injured if you are close to an airbag when it inflates. Avoid yellow connectors. They are probably part of the airbag system. Be sure to follow proper service procedures, and make sure the person performing work for you is qualified to do so.

Adding Equipment to the Airbag-Equipped Vehicle

Q: Is there anything I might add to or change about the vehicle that could keep the airbags from working properly?

A: Yes. If you add things that change the vehicle's frame, bumper system, height, front end or side sheet metal, they may keep the airbag system from working properly. Changing or moving any parts of the front seats, safety belts, the airbag sensing and diagnostic module, steering wheel, instrument panel, roof-rail airbag modules, ceiling headliner or pillar garnish trim, overhead console, front sensors, side impact sensors, rollover sensor module, airbag wiring, or cargo restraint system and convenience net can affect the operation of the airbag system.

In addition, the vehicle has a passenger sensing system for the right front passenger position, which includes sensors that are part of the passenger seat. The passenger sensing system may not operate properly if the original seat trim is replaced with non-GM covers, upholstery or trim, or with GM covers, upholstery or trim designed for a different vehicle. Any object, such as an aftermarket seat heater or a comfort enhancing pad or device, installed under or on top of the seat fabric, could also interfere with the operation of the passenger sensing system. This could either prevent proper deployment of the passenger airbag(s) or prevent the passenger sensing system from properly turning off the passenger airbag(s). See *Passenger Sensing System on page 2-36*.

If you have questions, call Customer Assistance. The phone numbers and addresses for Customer Assistance are in Step Two of the Customer Satisfaction Procedure in this manual. See *Customer Satisfaction Procedure on page 12-1*.

If the vehicle has rollover roof-rail airbags, see *Different Size Tires and Wheels on page 9-70* for additional important information.

Q: Because I have a disability, I have to get my vehicle modified. How can I find out whether this will affect my airbag system?

A: If you have questions, call Customer Assistance. The phone numbers and addresses for Customer Assistance are in Step Two of the Customer Satisfaction Procedure in this manual. See *Customer Satisfaction Procedure on page 12-1*.

In addition, your dealer and the service manual have information about the location of the airbag sensors, sensing and diagnostic module and airbag wiring.

Airbag System Check

The airbag system does not need regularly scheduled maintenance or replacement. Make sure the airbag readiness light is working. See *Airbag Readiness Light on page 4-18* for more information.

Notice: If an airbag covering is damaged, opened, or broken, the airbag may not work properly. Do not open or break the airbag coverings. If there are any opened or broken airbag covers, have the airbag covering and/or airbag module replaced. For the location of the airbag modules, see *What Makes an Airbag Inflate?* on page 2-33. See your dealer for service.

Replacing Airbag System Parts After a Crash



A crash can damage the airbag systems in your vehicle. A damaged airbag system may not work properly and may not protect you and your passenger(s) in a crash, resulting in serious injury or even death. To help make sure your airbag systems are working properly after a crash, have them inspected and any necessary replacements made as soon as possible.

If an airbag inflates, you will need to replace airbag system parts. See your dealer for service.

If the airbag readiness light stays on after the vehicle is started or comes on when you are driving, the airbag system may not work properly. Have the vehicle serviced right away. See *Airbag Readiness Light* on page 4-18 for more information.

Child Restraints

Older Children



Older children who have outgrown booster seats should wear the vehicle's safety belts.

The manufacturer's instructions that come with the booster seat state the weight and height limitations for that

booster. Use a booster seat with a lap-shoulder belt until the child passes the fit test below:

- Sit all the way back on the seat. Do the knees bend at the seat edge? If yes, continue. If no, return to the booster seat.
- Buckle the lap-shoulder belt. Does the shoulder belt rest on the shoulder? If yes, continue. If no, try using the rear safety belt comfort guide. See "Rear Safety Belt Comfort Guides" under *Lap-Shoulder Belt* on page 2-22 for more information. If the shoulder belt still does not rest on the shoulder, then return to the booster seat.
- Does the lap belt fit low and snug on the hips, touching the thighs? If yes, continue. If no, return to the booster seat.
- Can proper safety belt fit be maintained for the length of the trip? If yes, continue. If no, return to the booster seat.

2-44 Seats and Restraints

Q: What is the proper way to wear safety belts?

A: An older child should wear a lap-shoulder belt and get the additional restraint a shoulder belt can provide. The shoulder belt should not cross the face or neck. The lap belt should fit snugly below the hips, just touching the top of the thighs. This applies belt force to the child's pelvic bones in a crash. It should never be worn over the abdomen, which could cause severe or even fatal internal injuries in a crash.

Also see "Rear Safety Belt Comfort Guides" under *Lap-Shoulder Belt on page 2-22*.

According to accident statistics, children and infants are safer when properly restrained in a child restraint system or infant restraint system secured in a rear seating position.

In a crash, children who are not buckled up can strike other people who are buckled up, or can be thrown out of the vehicle. Older children need to use safety belts properly.

WARNING

Never do this.

Never allow two children to wear the same safety belt. The safety belt can not properly spread the impact forces. In a crash, the two children can be crushed together and seriously injured. A safety belt must be used by only one person at a time.



⚠ WARNING

Never do this.

Never allow a child to wear the safety belt with the shoulder belt behind their back. A child can be seriously injured by not wearing the lap-shoulder belt properly. In a crash, the child would not be restrained by the shoulder belt. The child could move too far forward increasing the chance of head and neck injury. The child might also slide under the lap belt. The belt force would then be applied right on the abdomen. That could cause serious or fatal injuries. The shoulder belt should go over the shoulder and across the chest.



Infants and Young Children

Everyone in a vehicle needs protection! This includes infants and all other children. Neither the distance traveled nor the age and size of the traveler changes the need, for everyone, to use safety restraints. In fact, the law in every state in the United States and in every Canadian province says children up to some age must be restrained while in a vehicle.

⚠ WARNING

Children can be seriously injured or strangled if a shoulder belt is wrapped around their neck and the safety belt continues to tighten. Never leave children unattended in a vehicle and never allow children to play with the safety belts.

Airbags plus lap-shoulder belts offer protection for adults and older children, but not for young children and infants. Neither the vehicle's safety belt system nor its airbag system is designed for them. Every time infants and young children ride in vehicles, they should have the protection provided by appropriate child restraints.

2-46 Seats and Restraints

Children who are not restrained properly can strike other people, or can be thrown out of the vehicle.

WARNING

Never do this.

Never hold an infant or a child while riding in a vehicle. Due to crash forces, an infant or a child will become so heavy it is not possible to hold it during a crash. For example, in a crash at only 40 km/h (25 mph), a 5.5 kg (12 lb) infant will suddenly become a 110 kg (240 lb) force on a person's arms. An infant should be secured in an appropriate restraint.



WARNING

Never do this.

Children who are up against, or very close to, any airbag when it inflates can be seriously injured or killed. Never put a rear-facing child restraint in the right front seat. Secure a rear-facing child

(Continued)

WARNING (Continued)

restraint in a rear seat. It is also better to secure a forward-facing child restraint in a rear seat. If you must secure a forward-facing child restraint in the right front seat, always move the front passenger seat as far back as it will go.



Q: What are the different types of add-on child restraints?

A: Add-on child restraints, which are purchased by the vehicle's owner, are available in four basic types. Selection of a particular restraint should take into consideration not only the child's weight, height, and age but also whether or not the restraint will be compatible with the motor vehicle in which it will be used.

For most basic types of child restraints, there are many different models available. When purchasing a child restraint, be sure it is designed to be used in a motor vehicle. If it is, the restraint will have a label saying that it meets federal motor vehicle safety standards.

The restraint manufacturer's instructions that come with the restraint state the weight and

height limitations for a particular child restraint. In addition, there are many kinds of restraints available for children with special needs.

 **WARNING**

To reduce the risk of neck and head injury during a crash, infants need complete support. This is because an infant's neck is not fully developed and its head weighs so much compared with the rest of its body. In a crash, an infant in a rear-facing child restraint settles into the restraint, so the crash forces can be distributed across the strongest part of an infant's body, the back and shoulders. Infants should always be secured in rear-facing child restraints.

 **WARNING**

A young child's hip bones are still so small that the vehicle's regular safety belt may not remain low on the hip bones, as it should. Instead, it may settle up around the child's abdomen. In a crash, the belt would apply force on a body area that is unprotected by any bony structure. This alone could cause serious or fatal injuries. To reduce the risk of serious or fatal injuries during a crash, young children should always be secured in appropriate child restraints.

Child Restraint Systems



(A) Rear-Facing Infant Seat

A rear-facing infant seat (A) provides restraint with the seating surface against the back of the infant.

The harness system holds the infant in place and, in a crash, acts to keep the infant positioned in the restraint.



(B) Forward-Facing Child Seat

A forward-facing child seat (B) provides restraint for the child's body with the harness.

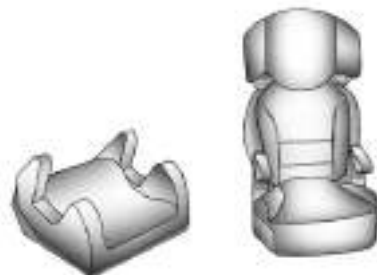

(C) Booster Seats

A booster seat (C) is a child restraint designed to improve the fit of the vehicle's safety belt system. A booster seat can also help a child to see out the window.

Securing an Add-On Child Restraint in the Vehicle

WARNING

A child can be seriously injured or killed in a crash if the child restraint is not properly secured in the vehicle. Secure the child restraint properly in the vehicle using the vehicle's safety belt or LATCH system, following the instructions that came with that child restraint and the instructions in this manual.

To help reduce the chance of injury, the child restraint must be secured in the vehicle. Child restraint systems must be secured in vehicle seats by lap belts or the lap belt portion of a lap-shoulder belt, or by the LATCH system. See *Lower Anchors and Tethers for Children (LATCH System)* on page 2-52 for more information. Children can be endangered in a crash if the child restraint is not properly secured in the vehicle.

When securing an add-on child restraint, refer to the instructions that come with the restraint which may be on the restraint itself or in a booklet, or both, and to this manual. The child restraint instructions are important, so if they are not available, obtain a replacement copy from the manufacturer.

Keep in mind that an unsecured child restraint can move around in a collision or sudden stop and injure people in the vehicle. Be sure to properly secure any child restraint in the vehicle — even when no child is in it.

Securing the Child Within the Child Restraint

WARNING

A child can be seriously injured or killed in a crash if the child is not properly secured in the child restraint. Secure the child properly following the instructions that came with that child restraint.

Where to Put the Restraint

According to accident statistics, children and infants are safer when properly restrained in a child restraint system or infant restraint system secured in a rear seating position.

We recommend that children and child restraints be secured in a rear seat, including: an infant or a child riding in a rear-facing child restraint; a child riding in a forward-facing child seat; an older child riding in a booster seat; and children, who are large enough, using safety belts.

A label on your sun visor says, "Never put a rear-facing child seat in the front." This is because the risk to the rear-facing child is so great, if the airbag deploys.

WARNING

A child in a rear-facing child restraint can be seriously injured or killed if the right front passenger airbag inflates. This is because the back of the rear-facing child restraint would be very close to the inflating airbag. A child in a forward-facing child restraint can be seriously injured or killed if the right front passenger airbag inflates and the passenger seat is in a forward position.

Even if the passenger sensing system has turned off the right front passenger frontal airbag, no system is fail-safe. No one can guarantee that an airbag will not deploy under some unusual circumstance, even though it is turned off.

(Continued)

WARNING (Continued)

Secure rear-facing child restraints in a rear seat, even if the airbag is off. If you secure a forward-facing child restraint in the right front seat, always move the front passenger seat as far back as it will go. It is better to secure the child restraint in a rear seat.

See *Passenger Sensing System* on page 2-36 for additional information.

When securing a child restraint in a rear seating position, study the instructions that came with your child restraint to make sure it is compatible with this vehicle.

If the vehicle does not have a rear seat that will accommodate a rear-facing child restraint, we recommend that rear-facing child restraints not be transported in the vehicle, even if the airbag is off.

Child restraints and booster seats vary considerably in size, and some may fit in certain seating positions better than others. Always make sure the child restraint is properly secured.

Depending on where you place the child restraint and the size of the child restraint, you may not be able to access adjacent safety belt assemblies or LATCH anchors for additional passengers or child restraints. Adjacent seating positions should not be used if the child restraint prevents access to or interferes with the routing of the safety belt.

Wherever you install a child restraint, be sure to secure the child restraint properly.

Keep in mind that an unsecured child restraint can move around in a collision or sudden stop and injure people in the vehicle. Be sure to properly secure any child restraint in your vehicle — even when no child is in it.

If you need to secure more than one child restraint in the rear seat, review the following illustrations.

Configurations for Use of Child Restraints

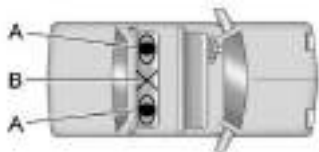

- A. Child restraint using LATCH
- B. Occupant prohibited

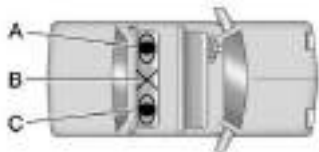

- A. Child restraint using LATCH
- B. Occupant prohibited
- C. Child restraint or occupant using safety belt

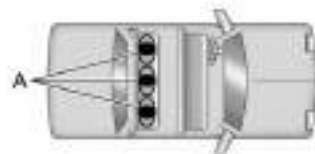

- A. Child restraint or occupant using safety belt

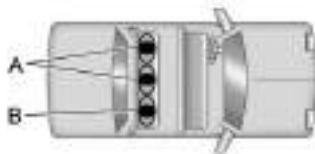

- A. Child restraint or occupant using safety belt
- B. Child restraint using LATCH

Lower Anchors and Tethers for Children (LATCH System)

The LATCH system holds a child restraint during driving or in a crash. This system is designed to make installation of a child restraint easier. The LATCH system uses anchors in the vehicle and attachments on the child restraint that are made for use with the LATCH system.

Make sure that a LATCH-compatible child restraint is properly installed using the anchors, or use the vehicle's safety belts to secure the restraint, following the instructions that came with that restraint, and also the instructions in this manual. When installing a child restraint with a top tether, you must also use either the lower anchors or the safety belts to properly secure the child restraint. A child restraint must never be installed using only the top tether and anchor.

In order to use the LATCH system in your vehicle, you need a child restraint that has LATCH attachments. The child restraint manufacturer will provide you with instructions on how to use the child restraint and its attachments. The following explains how to attach a child restraint with these attachments in your vehicle.

Not all vehicle seating positions or child restraints have lower anchors and attachments or top tether anchors and attachments.

Lower Anchors

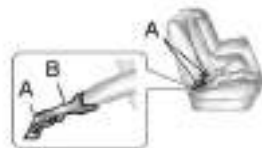

Lower anchors (A) are metal bars built into the vehicle. There are two lower anchors for each LATCH

seating position that will accommodate a child restraint with lower attachments (B).

Top Tether Anchor

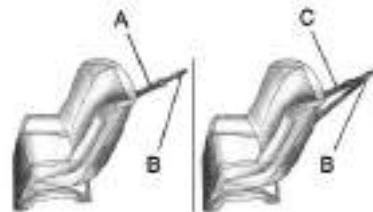

A top tether (A, C) anchors the top of the child restraint to the vehicle. A top tether anchor is built into the vehicle. The top tether attachment (B) on the child restraint connects to the top tether anchor in the vehicle in order to reduce the forward movement and rotation of the child restraint during driving or in a crash.

Your child restraint may have a single tether (A) or a dual tether (C). Either will have a single attachment (B) to secure the top tether to the anchor.

Some child restraints that have a top tether are designed for use with or without the top tether being attached. Others require the top tether always to be attached. In Canada, the law requires that forward-facing child restraints have a top tether, and that the tether be attached. Be sure to read and follow the instructions for your child restraint.

Lower Anchor and Top Tether Anchor Locations

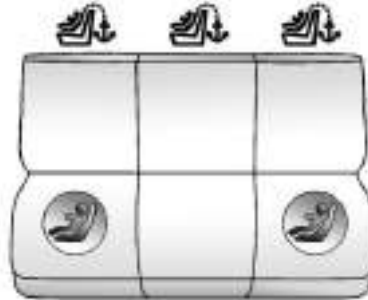

Rear Seat

 **(Top Tether Anchor):** Seating positions with top tether anchors.

 **(Lower Anchor):** Seating positions with two lower anchors.



To assist you in locating the lower anchors, each seating position with lower anchors has two labels, near the crease between the seatback and the seat cushion.



To assist you in locating the top tether anchors, the top tether anchor symbol is located on the cover.



Top Tether Anchors

The top tether anchors for each rear seating position are located under the covers, on the back of the rear seatback. Be sure to use an anchor located on the same side of the vehicle as the seating position where the child restraint will be placed.

Do not secure a child restraint in a position without a top tether anchor if a national or local law requires that the top tether be attached, or if

the instructions that come with the child restraint say that the top tether must be attached.

According to accident statistics, children and infants are safer when properly restrained in a child restraint system or infant restraint system secured in a rear seating position. See *Where to Put the Restraint on page 2-50* for additional information.

Securing a Child Restraint Designed for the LATCH System

WARNING

If a LATCH-type child restraint is not attached to anchors, the child restraint will not be able to protect the child correctly. In a crash, the child could be seriously injured or killed. Install a LATCH-type child restraint properly using the

(Continued)

WARNING (Continued)

anchors, or use the vehicle's safety belts to secure the restraint, following the instructions that came with the child restraint and the instructions in this manual.

WARNING

Do not attach more than one child restraint to a single anchor. Attaching more than one child restraint to a single anchor could cause the anchor or attachment to come loose or even break during a crash. A child or others could be injured. To reduce the risk of serious or fatal injuries during a crash, attach only one child restraint per anchor.

 **WARNING**

Children can be seriously injured or strangled if a shoulder belt is wrapped around their neck and the safety belt continues to tighten. Buckle any unused safety belts behind the child restraint so children cannot reach them. Pull the shoulder belt all the way out of the retractor to set the lock, if your vehicle has one, after the child restraint has been installed.

Notice: Do not let the LATCH attachments rub against the vehicle's safety belts. This may damage these parts. If necessary, move buckled safety belts to avoid rubbing the LATCH attachments.

Do not fold the empty rear seat with a safety belt buckled. This could damage the safety belt or the seat. Unbuckle and return the safety belt to its stowed position, before folding the seat.

Make sure to attach the child restraint at the proper anchor location.

This system is designed to make installation of child restraints easier. When using lower anchors, do not use the vehicle's safety belts. Instead use the vehicle's anchors and child restraint attachments to secure the restraints. Some restraints also use another vehicle anchor to secure a top tether.

1. Attach and tighten the lower attachments to the lower anchors. If the child restraint does not have lower attachments or the desired seating position does not have lower anchors, secure the child restraint with the top tether and the safety belts.

Refer to your child restraint manufacturer instructions and the instructions in this manual.

- 1.1. Find the lower anchors for the desired seating position.
- 1.2. Put the child restraint on the seat.
- 1.3. Attach and tighten the lower attachments on the child restraint to the lower anchors.
2. If the child restraint manufacturer recommends that the top tether be attached, attach and tighten the top tether to the top tether anchor, if equipped. Refer to the child restraint instructions and the following steps:
 - 2.1. Find the top tether anchor and open its cover to expose the anchor.

2-56 Seats and Restraints

- 2.2. Route, attach and tighten the top tether according to your child restraint instructions and the following instructions:



If the rear outboard seating position you are using has an adjustable head restraint and you are using a dual tether, route the tether around the head restraint.



If the rear outboard seating position you are using has an adjustable head restraint and you are using a single tether, raise the head restraint and route the tether under the head restraint and in between the head restraint posts.



If the rear center seating position you are using has an adjustable headrest and you are using a dual tether, lower the headrest down to its stowed position and route the tether over the headrest.



If the rear center seating position you are using has an adjustable headrest and you are using a single tether, lower the headrest to its stowed position and route the tether over the headrest.

3. Push and pull the child restraint in different directions to be sure it is secure.

Replacing LATCH System Parts After a Crash

WARNING

A crash can damage the LATCH system in the vehicle. A damaged LATCH system may not properly secure the child restraint, resulting in serious injury or even death in a crash. To help make sure the LATCH system is working properly after a crash, see your dealer to have the system inspected and any necessary replacements made as soon as possible.

If the vehicle has the LATCH system and it was being used during a crash, new LATCH system parts may be needed.

New parts and repairs may be necessary even if the LATCH system was not being used at the time of the crash.

Securing Child Restraints (Rear Seat)

When securing a child restraint in a rear seating position, study the instructions that came with the child restraint to make sure it is compatible with this vehicle.

If the child restraint has the LATCH system, see *Lower Anchors and Tethers for Children (LATCH System)* on page 2-52 for how and where to install the child restraint using LATCH. If a child restraint is secured in the vehicle using a safety belt and it uses a top tether, see *Lower Anchors and Tethers for Children (LATCH System)* on page 2-52 for top tether anchor locations.

Do not secure a child seat in a position without a top tether anchor if a national or local law requires that the top tether be anchored, or if the instructions that come with the child restraint say that the top strap must be anchored.

2-58 Seats and Restraints

In Canada, the law requires that forward-facing child restraints have a top tether, and that the tether be attached.

If the child restraint does not have the LATCH system, you will be using the safety belt to secure the child restraint in this position. Be sure to follow the instructions that came with the child restraint. Secure the child in the child restraint when and as the instructions say.

If more than one child restraint needs to be installed in the rear seat, be sure to read *Where to Put the Restraint on page 2-50*.

1. Put the child restraint on the seat.
2. Pick up the latch plate, and run the lap and shoulder portions of the vehicle's safety belt through or around the restraint. The child restraint instructions will show you how.



3. Push the latch plate into the buckle until it clicks.
Position the release button on the buckle so that the safety belt could be quickly unbuckled if necessary.



4. Pull the rest of the shoulder belt all the way out of the retractor to set the lock.



5. To tighten the belt, push down on the child restraint, pull the shoulder portion of the belt to tighten the lap portion of the belt and feed the shoulder belt back into the retractor. When installing a forward-facing child restraint, it may be helpful to use your knee to push down on the child restraint as you tighten the belt.

6. If the child restraint has a top tether, follow the child restraint manufacturer's instructions regarding the use of the top tether. See *Lower Anchors and Tethers for Children (LATCH System)* on page 2-52 for more information.
7. Push and pull the child restraint in different directions to be sure it is secure.

To remove the child restraint, unbuckle the vehicle safety belt and let it return to the stowed position. If the top tether is attached to a top tether anchor, disconnect it.

Securing Child Restraints (Front Passenger Seat)

This vehicle has airbags. A rear seat is a safer place to secure a forward-facing child restraint. See *Where to Put the Restraint* on page 2-50.

In addition, the vehicle has a passenger sensing system which is designed to turn off the right front passenger frontal airbag under certain conditions. See *Passenger Sensing System* on page 2-36 and *Passenger Airbag Status Indicator* on page 4-19 for more information, including important safety information.

2-60 Seats and Restraints

A label on the sun visor says, "Never put a rear-facing child seat in the front." This is because the risk to the rear-facing child is so great, if the airbag deploys.

WARNING

A child in a rear-facing child restraint can be seriously injured or killed if the right front passenger airbag inflates. This is because the back of the rear-facing child restraint would be very close to the inflating airbag. A child in a forward-facing child restraint can be seriously injured or killed if the right front passenger airbag inflates and the passenger seat is in a forward position.

(Continued)

WARNING (Continued)

Even if the passenger sensing system has turned off the right front passenger frontal airbag, no system is fail-safe. No one can guarantee that an airbag will not deploy under some unusual circumstance, even though it is turned off.

Secure rear-facing child restraints in a rear seat, even if the airbag is off. If you secure a forward-facing child restraint in the right front seat, always move the front passenger seat as far back as it will go. It is better to secure the child restraint in a rear seat.

See *Passenger Sensing System* on page 2-36 for additional information.

If the vehicle does not have a rear seat that will accommodate a rear-facing child restraint, a rear-facing child restraint should not be installed in the vehicle, even if the airbag is off.

If the child restraint has the LATCH system, see *Lower Anchors and Tethers for Children (LATCH System)* on page 2-52 for how and where to install the child restraint using LATCH. If a child restraint is secured using a safety belt and it uses a top tether, see *Lower Anchors and Tethers for Children (LATCH System)* on page 2-52 for top tether anchor locations.

Do not secure a child seat in a position without a top tether anchor if a national or local law requires that the top tether be anchored, or if the instructions that come with the child restraint say that the top strap must be anchored.

In Canada, the law requires that forward-facing child restraints have a top tether, and that the tether be attached.

You will be using the lap-shoulder belt to secure the child restraint in this position. Follow the instructions that came with the child restraint.

1. Move the seat as far back as it will go before securing the forward-facing child restraint.

When the passenger sensing system has turned off the right front passenger frontal airbag and seat-mounted side impact airbag, the off indicator on the passenger airbag status indicator should light and stay lit when you start the vehicle. See *Passenger Airbag Status Indicator* on page 4-19.

2. Put the child restraint on the seat.

3. Pick up the latch plate, and run the lap and shoulder portions of the vehicle's safety belt through or around the restraint. The child restraint instructions will show you how.



4. Push the latch plate into the buckle until it clicks.
Position the release button on the buckle, so that the safety belt could be quickly unbuckled if necessary.



5. Pull the shoulder belt all the way out of the retractor to set the lock. When the retractor lock is set, the belt can be tightened but not pulled out of the retractor.

2-62 Seats and Restraints



6. To tighten the belt, push down on the child restraint, pull the shoulder portion of the belt to tighten the lap portion of the belt, and feed the shoulder belt back into the retractor. When installing a forward-facing child restraint, it may be helpful to use your knee to push down on the child restraint as you tighten the belt.

Try to pull the belt out of the retractor to make sure the retractor is locked. If the retractor is not locked, repeat Steps 5 and 6.

If the vehicle does not have a rear seat and the child restraint has a top tether, follow the child restraint manufacturer's instructions regarding the use of the top tether. See *Lower Anchors and Tethers for Children (LATCH System)* on page 2-52 for more information.

7. Before placing a child in the child restraint, make sure it is securely held in place. To check, grasp the child restraint at the safety belt path and attempt to move it side-to-side and back-and-forth. When the child restraint is properly installed, there should be no more than 2.5 cm (1 in) of movement.

If the airbags are off, the off indicator in the passenger airbag status indicator will come on and stay on when the vehicle is started.

If a child restraint has been installed and the on indicator is lit, see "If the On Indicator is Lit for a Child Restraint" under *Passenger Sensing System* on page 2-36 for more information.

To remove the child restraint, unbuckle the vehicle safety belt and let it return to the stowed position.

Storage

Storage Compartments

| | |
|------------------------------|-----|
| Glove Box | 3-1 |
| Cupholders | 3-1 |
| Front Storage | 3-2 |
| Armrest Storage | 3-2 |
| Center Console Storage | 3-2 |

Additional Storage Features

| | |
|-------------------------------|------|
| Cargo Cover | 3-3 |
| Cargo Tie Downs | 3-4 |
| Cargo Management System | 3-5 |
| Cargo Net | 3-8 |
| Convenience Net | 3-10 |

Roof Rack System

| | |
|------------------------|------|
| Roof Rack System | 3-10 |
|------------------------|------|

Storage Compartments

Glove Box

Lift the glove box handle up to open it. Use the key to lock and unlock the glove box.

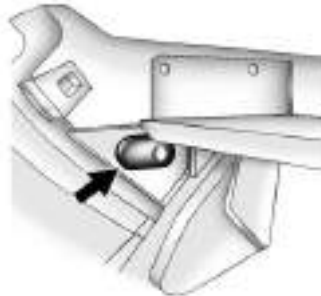

The glove box is air conditioned and can be used to store items at a lower temperature. The vehicle air conditioning must be turned on for the maximum cool air to enter the

glove box. Move the slide control across the small hole to turn the cool air flow off. Close the opening to keep cold air from entering the vehicle.

Cupholders



This vehicle has a cupholder equipped with a divider that can be adjusted to accommodate large containers or small containers.

3-2 Storage

For large containers, push the button to move aside the divider and make the cupholder deeper. For small containers, push down on the top edge of the divider to lock it back in place to make the cupholder shorter.

Front Storage



A storage area is located in front of the shift lever. Push upward on the top of the door and release. The door automatically opens.

There is an accessory power outlet. See *Power Outlets* on page 4-11.

Armrest Storage

For vehicles with a rear seat armrest, pull the rear seat armrest forward to access cupholders with removable liners and a storage area. Pull the lever to access the storage area.

Center Console Storage

Vehicles have an armrest and an upper storage tray in the center console.

The armrest on top of the center console can be adjusted to a rearward, middle, and forward position. Slide the top of the armrest to adjust to the desired position.

To open the center console with armrest, move the armrest to the full rearward position to access the buttons.

For either center console, the storage area has a storage tray and a main storage. Push the driver side

button to access the storage tray. Push the passenger side button to access the main storage.

There is an accessory power outlet and input jacks for auxiliary audio devices. See *Power Outlets* on page 4-11 and *Auxiliary Devices (Radio with CD)* on page 6-28 or *Auxiliary Devices (Radio with CD/DVD and MEM)* on page 6-34.



Push the button to open the storage area located at the rear of the center console.

Additional Storage Features

Cargo Cover

For vehicles with the dual position cargo cover, it can be used to cover items in the cargo area of the vehicle.

Install the cargo cover

1. Hold the cartridge so that the pull-out shade faces the rear of the vehicle.
2. Align the cartridge over the pins on the trim panels of the vehicle.
3. Push down on the cartridge to snap it into place.
4. Unroll the shade towards the rear of the vehicle.
5. The shade can be set in two positions. It can be set in a half way open (A) position for loading objects into the rear compartment.
6. Pull cargo cover down to lower (B) position to conceal objects in the rear compartment.
7. Align the pins with the channels on both sides.



3-4 Storage

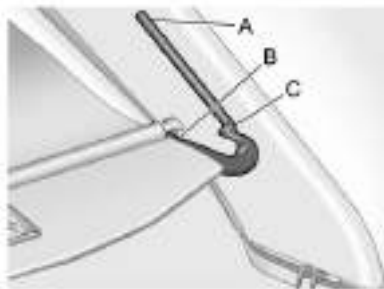

8. Insert the shade's pin into the bent slot (B) and slide it to the first stop (C) to totally conceal the cargo area. The shade can also be positioned at second stop (A) to partially cover cargo.

Remove the cargo cover

1. Remove the cover from the channels and carefully roll it back up.



2. Slide the button on the top to release the cartridge.
3. Pull up to remove the cartridge from the pins.

WARNING

An improperly stored cargo cover could be thrown about the vehicle during a collision or sudden maneuver. Someone could be injured. If the cover is removed, always store it in the proper storage location. When it is replaced, always be sure that it is securely reattached.

Cargo Tie Downs

For vehicles equipped with cargo tie-downs, the four tie-downs are located in the rear compartment of the vehicle. Use the tie-downs to secure small loads.

Cargo Management System



To open the cargo management system, press on the bottom of handle assembly to unlatch it and lift up on the handle.



A prop rod locks to hold the cover up when opened.

Four hooks are located on the inside cover and can be used for storing items.

There may be additional storage compartments on each side of the cargo management system. Lift the panel up to open.

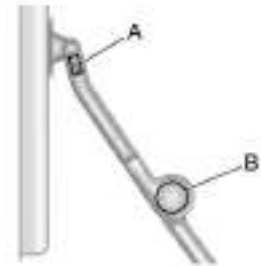

Press the red push button (B) on the prop rod to close the cover.

3-6 Storage

Storing the Cargo Management System Cover

Access the rear areas of the cargo management system:

WARNING

An improperly latched and closed cargo cover, or cargo cover left in the open position, could be thrown about the vehicle during a crash or sudden maneuver. Someone could be injured. Be sure to return the cover to the closed position and latch before driving. If the cover is removed, always store it outside of the vehicle. When it is replaced, always be sure that it is securely reattached.

1. Open the cover.



2. Release the prop rod from the inside cover by sliding downward on the red clip (A).
Unhook the prop rod from the pin on the inside cover. Store the unhooked prop rod by folding it into the cargo management compartment.

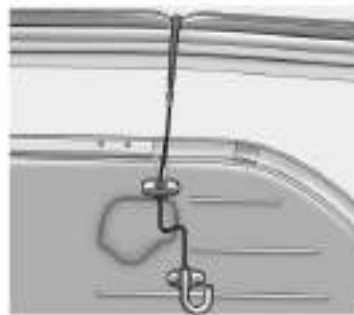

3. Store the cargo management system cover by hooking it onto the weatherstrip.

D-Ring Sliders

There are four D-Ring sliders that move along rails on both sides of the cargo management area. These can be used as tie-downs when storing cargo.

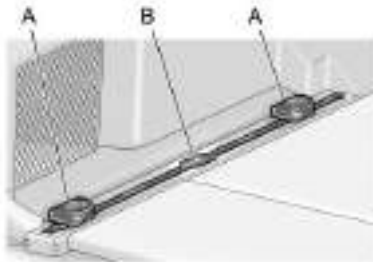

Installing D-Ring Sliders

To install the D-Ring sliders (A), insert it into the channel (B) located in the middle of both rails.

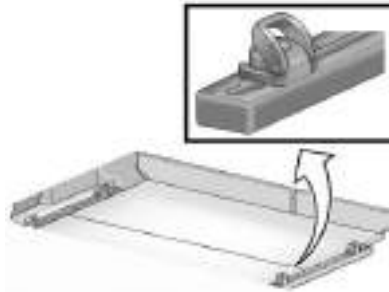

The loop of the D-Ring slider must be facing inward towards the storage area and the ring must be in the up position for proper usage.

Push the button to move the D-Ring slider either towards the front or the rear of the vehicle. The rings can be locked into various positions along the rail.

U-Rail

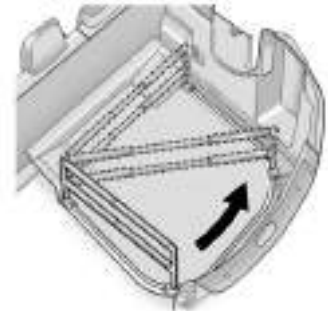

For vehicles with a U-Rail system, move the gate around the u-shaped track to store and secure cargo in place.

3-8 Storage

Storing the U-Rail Gate

Remove the gate from the U-Rail by pressing the button and lifting upward.



1. Lift the cargo management system cover.
2. Release the cover from the prop rod as described in previous steps.

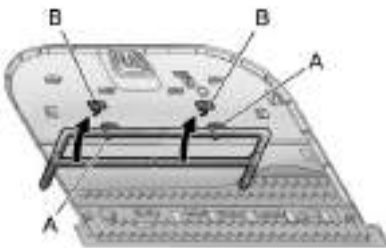

3. Insert the top of the gate into the lower two clips (A).
4. Flip the bottom of the gate up and insert into the upper two clips (B).

Cargo Net

WARNING

Do not stack items higher than the upper end of the cargo net or hang anything from the net. Avoid items that have sharp edges or that apply excessive force to the net. If items are not properly stored, damage to the net could occur and items can be thrown about the vehicle. You or other could be injured. Always store items behind the net.

For vehicles equipped with a cargo net, it can be used to store light loads, keeping them from falling over or being thrown into the cabin during heavy braking.

The net should not be overloaded or used to store heavy loads.

There are four openings in the headliner, two located behind the front seats and two behind the rear seats.



1. Insert the top corners of the cargo net into the large opening in the headliner and secure by sliding them into the small opening.
2. The rear seat backs should be folded down, when the net is installed in the headliner opening located behind the front seats.



3. Mount the cargo net to the rear seat tethers located on the back of the folded down rear seats and pull on the straps to tighten the net.
4. When the net is installed in the headliner opening located behind the rear seats, the rear seat backs should be upright.



5. Mount the cargo net to the cargo tie-downs located on the lower side panels.

3-10 Storage

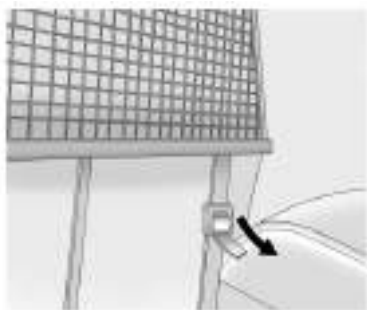

6. Pull on the straps to tighten the net.

Cargo Net Storage

The cargo net can be removed from the vehicle and stored in the cargo management system.

1. Disconnect the net from the roof openings and the tethers.
2. Press the red button on the center of the net to fold it in half.

3. Roll up the cargo net, storing it into the attached vinyl bag.
4. Open the cargo management system lid.
5. For vehicles with an inflator kit, store the cargo net in the available space next to the kit.

Convenience Net

This vehicle may have a convenience net located in the rear of the vehicle. Attach it to the cargo tie-downs for storing small loads.

Do not use the net to store heavy loads.

Roof Rack System

WARNING

If something is carried on top of the vehicle that is longer or wider than the roof rack— like paneling, plywood, or a mattress— the wind can catch it while the vehicle is being driven. The item being carried could be violently torn off, and this could cause a collision, and damage the vehicle. Never carry something longer or wider than the roof rack on top of the vehicle unless using a GM Certified accessory carrier.

For vehicles with a roof rack, the rack can be used to load items. For roof racks that do not have cross rails included, GM Certified cross rails can be purchased as an accessory. See your dealer for additional information.

Notice: Loading cargo on the roof rack that weighs more than 100 kg (220 lbs) or hangs over the rear or sides of the vehicle may damage the vehicle. Load cargo so that it rests evenly between the crossrails, making sure to fasten cargo securely.



To prevent damage or loss of cargo when driving, check to make sure cross rails and cargo are securely fastened. Loading cargo on the roof rack will make the vehicle's center of gravity higher.

Avoid high speeds, sudden starts, sharp turns, sudden braking or abrupt maneuvers, otherwise it may result in loss of control. If driving for a long distance, on rough roads, or at high speeds, occasionally stop the vehicle to make sure the cargo remains in its place. Do not exceed the maximum vehicle capacity when loading the vehicle. For more information on vehicle capacity and loading, see *Vehicle Load Limits on page 8-11*.

Instruments and Controls

Instrument Panel Overview

Instrument Panel Overview 4-4

Controls

| | |
|------------------------------------|------|
| Steering Wheel Adjustment ... | 4-6 |
| Steering Wheel Controls | 4-6 |
| Horn | 4-7 |
| Windshield Wiper/Washer | 4-7 |
| Rear Window Wiper/ Washer | 4-9 |
| Headlamp Washer | 4-9 |
| Compass | 4-10 |
| Clock (Analog Clock) | 4-10 |
| Clock (Digital Clock) | 4-10 |
| Power Outlets | 4-11 |
| Cigarette Lighter | 4-12 |
| Ashtrays | 4-13 |

Warning Lights, Gauges, and Indicators

| | |
|---|------|
| Warning Lights, Gauges, and Indicators | 4-13 |
| Instrument Cluster | 4-14 |
| Speedometer | 4-15 |
| Odometer | 4-15 |
| Tachometer | 4-15 |
| Fuel Gauge | 4-15 |
| Fuel Economy Gauge | 4-16 |
| Turbo Gauge (2.8L Only) | 4-16 |
| Engine Coolant Temperature Gauge | 4-17 |
| Safety Belt Reminders | 4-17 |
| Airbag Readiness Light | 4-18 |
| Passenger Airbag Status Indicator | 4-19 |
| Charging System Light | 4-20 |
| Malfunction Indicator Lamp | 4-20 |
| Brake System Warning Light | 4-23 |

| | |
|--|------|
| Electric Parking Brake Light | 4-24 |
| Antilock Brake System (ABS) Warning Light | 4-24 |
| Traction Off Light | 4-25 |
| StabiliTrak [®] OFF Light | 4-25 |
| Traction Control System (TCS)/StabiliTrak [®] Light | 4-25 |
| Tire Pressure Light | 4-26 |
| Engine Oil Pressure Light ... | 4-26 |
| Fuel Economy Light | 4-27 |
| Low Fuel Warning Light | 4-27 |
| Security Light | 4-28 |
| High-Beam on Light | 4-28 |
| Adaptive Forward Lighting (AFL) Light | 4-28 |
| Front Fog Lamp Light | 4-28 |
| Lamps on Reminder | 4-29 |
| Cruise Control Light | 4-29 |

Information Displays

| | |
|--|------|
| Driver Information Center (DIC) | 4-29 |
|--|------|

4-2 Instruments and Controls

Vehicle Messages

| | |
|--|------|
| Vehicle Messages | 4-33 |
| Battery Voltage and Charging Messages | 4-33 |
| Brake System Messages | 4-34 |
| Compass Messages | 4-34 |
| Cruise Control Messages | 4-34 |
| Door Ajar Messages | 4-35 |
| Engine Cooling System Messages | 4-35 |
| Engine Oil Messages | 4-36 |
| Engine Power Messages | 4-36 |
| Fuel System Messages | 4-36 |
| Key and Lock Messages | 4-37 |
| Lamp Messages | 4-37 |
| Object Detection System Messages | 4-38 |
| Ride Control System Messages | 4-38 |
| Airbag System Messages | 4-39 |
| Safety Belt Messages | 4-39 |

| | |
|---|------|
| Anti-Theft Alarm System Messages | 4-39 |
| Service Vehicle Messages ... | 4-39 |
| Starting the Vehicle Messages | 4-39 |
| Tire Messages | 4-40 |
| Transmission Messages | 4-40 |
| Vehicle Reminder Messages | 4-41 |
| Washer Fluid Messages | 4-41 |

Vehicle Personalization

| | |
|-------------------------------|------|
| Vehicle Personalization | 4-41 |
|-------------------------------|------|

OnStar® System

| | |
|----------------------|------|
| OnStar® System | 4-46 |
|----------------------|------|

Universal Remote System

| | |
|--|------|
| Universal Remote System ... | 4-48 |
| Universal Remote System Programming | 4-49 |
| Universal Remote System Operation | 4-52 |

4-4 Instruments and Controls

Instrument Panel Overview

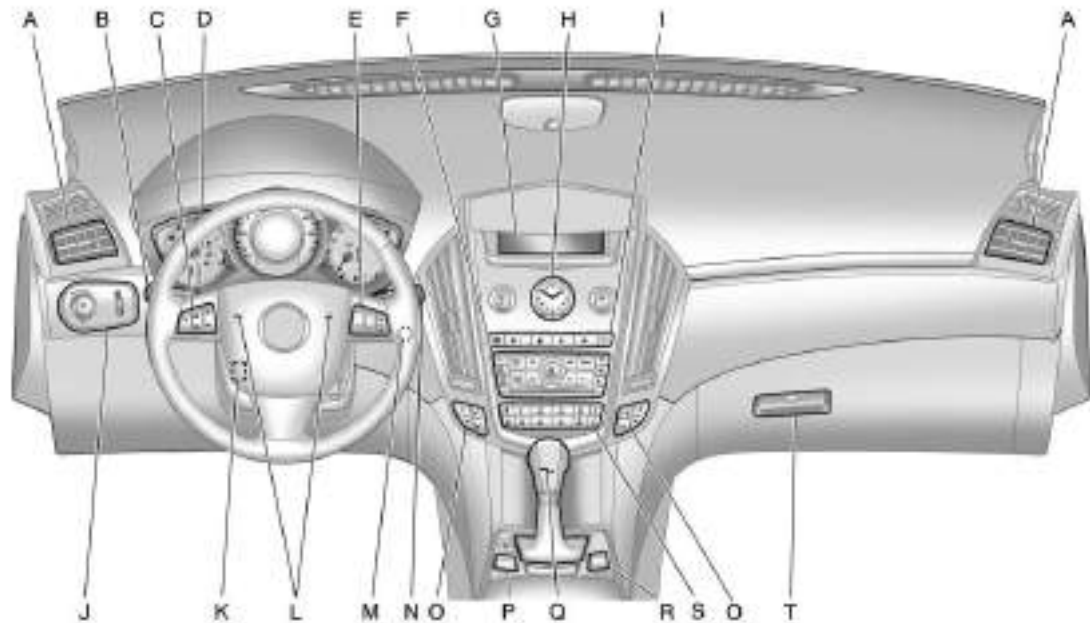

- A. *Air Vents on page 7-6.*
- B. *Turn and Lane-Change Lever. See Turn and Lane-Change Signals on page 5-5. Driver Information Center (DIC) Controls. See Driver Information Center (DIC) on page 4-29.*
- C. *Cruise Control on page 8-37.*
- D. *Instrument Cluster on page 4-14.*
- E. *Steering Wheel Controls on page 4-6.*
- F. *AM-FM Radio on page 6-11.*
- G. *Driver Information Center (DIC) Display. See Driver Information Center (DIC) on page 4-29.*
- H. *Clock (Analog Clock) on page 4-10 or Clock (Digital Clock) on page 4-10.*
- I. *Safety Locks on page 1-12. Power Door Locks on page 1-11. Hazard Warning Flashers on page 5-5.*
- J. *Exterior Lamp Controls on page 5-1. Front Fog Lamps on page 5-6 (If Equipped). Instrument Panel Illumination Control on page 5-6.*
- K. *Steering Wheel Adjustment on page 4-6.*
- L. *Horn on page 4-7.*
- M. *Start/Stop Button. See Starting the Gasoline Engine on page 8-20.*
- N. *Windshield Wiper/Washer on page 4-7. Rear Window Wiper/Washer on page 4-9.*
- O. *Heated Front Seats on page 2-8 (If Equipped). Heated and Ventilated Front Seats on page 2-10 (If Equipped).*
- P. *Parking Brake on page 8-31.*
- Q. *Shift Lever. See Shifting Into Park on page 8-22.*
- R. *StabiliTrak[®] System on page 8-35. Ultrasonic Parking Assist on page 8-40 (If Equipped). Economy Mode (If Equipped). See Fuel Economy Mode on page 8-29.*
- S. *Dual Automatic Climate Control System on page 7-1.*
- T. *Glove Box on page 3-1.*

Controls

Steering Wheel Adjustment



To adjust the steering wheel:

1. Pull the lever down.
2. Move the steering wheel up or down.
3. Pull or push the steering wheel closer or away from you.

4. Pull the lever up to lock the steering wheel in place.

Do not adjust the steering wheel while driving.

Steering Wheel Controls

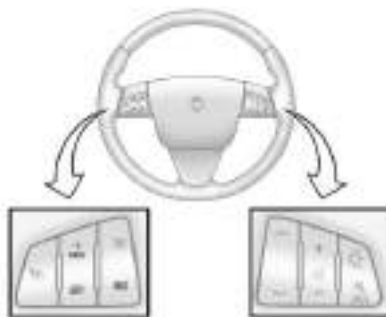

For vehicles with audio steering wheel controls, some audio controls can be adjusted at the steering wheel.

^ / v : Press the ^ button to select the next favorite radio station or next CD, DVD, if equipped, or MP3 track.

Press the v button to select the previous favorite radio station or previous CD, DVD, if equipped, or MP3 track.

+ - (Volume): Press + to increase the volume, press - to decrease the volume.

☎ / 🗨 (Push to Talk): For vehicles with an OnStar®, Bluetooth, or navigation system, press to interact with those systems. See *OnStar® System on page 4-46*, *Bluetooth (Overview) on page 6-47* or *Bluetooth (Infotainment Controls) on page 6-48* or *Bluetooth (Voice Recognition) on page 6-52* or *Bluetooth (Navigation) on page 6-63*, or the separate navigation manual for more information.

 (End Call / Mute): Press to silence the vehicle speakers only. Press again to turn the sound on. For vehicles with OnStar[®] or Bluetooth systems, press to reject an incoming call, or end a current call.

SRCE: Press to select an audio source.

Horn

Press near the horn symbols or press on the steering wheel pad to sound the horn.

Windshield Wiper/Washer



The windshield wiper/washer lever is located on the right side of the steering column. With the ignition in ACC/ACCESSORY or ON/RUN/START, move the windshield wiper lever to select the wiper speed.

- 2: Fast wipes.
- 1: Slow wipes.

(Adjustable Interval Wipes):

Turn the  band up for more frequent wipes or down for less frequent wipes. If the vehicle has Rainsense[™], see following Rainsense[™] information.



 (Off): Turns the wipers off.

 (Mist): Single wipe, briefly move the wiper lever down. Several wipes, hold the wiper lever down.

Clear snow and ice from the wiper blades before using them. If frozen to the windshield, carefully loosen or thaw them. Damaged blades should be replaced. See *Wiper Blade Replacement* on page 9-29.

Heavy snow or ice can overload the wiper motor.

4-8 Instruments and Controls

Wipe Parking

If the ignition is turned LOCK/OFF while the wipers are on 1, 2 or , they will immediately stop.

If the windshield wiper lever is then moved to OFF before the driver door is opened or within 10 minutes, the wipers will restart and move to the base of the windshield.



If the ignition is turned to LOCK/OFF while the wipers are performing wipes due to windshield wash, the wipers continue to run until they reach the base of the windshield.

Rainsense™

For vehicles with Rainsense, a sensor located near the top center of the windshield detects the amount of water on the windshield and automatically controls the frequency of the windshield wiper.

Keep this area of the windshield clear of debris to allow for best system performance.



 (**Rainsense Wipe Sensitivity Control**): Move the windshield wiper lever to . Turn the band on the wiper lever to adjust the sensitivity.

Turn the band up for more sensitivity to moisture.

Turn the band down for less sensitivity to moisture.

To deactivate Rainsense, move the windshield wiper lever out of  position.

Wiper Arm Assembly Protection

When using an automatic car wash, move the windshield wiper lever to the OFF position. This disables the automatic Rainsense windshield wiper and/or rear wipers.

With Rainsense, if the transmission is in N (Neutral) and the vehicle speed is very slow, the wipers will automatically stop at the base of the windshield.

The wiper operations return to normal when the transmission is no longer in N (Neutral) or the vehicle speed has increased.

Windshield Washer

Pull the lever toward you to spray washer fluid on the windshield. The spray continues until the lever is released. The wipers will run a few times. See *Washer Fluid* on page 9-23 for information on filling the windshield washer fluid reservoir.

WARNING

In freezing weather, do not use your washer until the windshield is warmed. Otherwise the washer fluid can form ice on the windshield, blocking your vision.

Rear Window Wiper/Washer

The rear wiper controls are on the end of the windshield wiper lever.



Press the upper or lower portion of the button to control the rear wiper and rear wiper delay.

The system turns off when the button is returned to the middle position.

 **(Rear Wiper):** For continuous rear window wiper.

 **(Rear Wiper Delay):** Sets a delay between wiper.

 **(Rear Washer):** Push the windshield wiper lever forward to spray washer fluid on the rear window. The lever automatically returns to its original position when released.

Reverse Gear Wipes

If the rear wiper control is off, the rear wiper will automatically operate continuously when the shift lever is in R (Reverse) and the front windshield wiper is performing low or high speed wipes. If the rear wiper control is off, the shift lever is in R (Reverse) and the front windshield wiper is performing interval wipes, then the rear wiper automatically performs interval wipes.

The windshield washer reservoir is used for the windshield and the rear window. Check the fluid level in the

reservoir if either washer is not working. See *Washer Fluid* on page 9-23.

WARNING

In freezing weather, do not use your washer until the windshield is warmed. Otherwise the washer fluid can form ice on the windshield, blocking your vision.

Headlamp Washer

For vehicles with headlamp washers, they are located to the side of the headlamps.

The headlamps must be on in order to use the headlamp washers. If the headlamps are not on, only the windshield will be washed.

Pull the wiper lever towards you and hold briefly to activate. The headlamp washers will spray once, pause, and spray again. The headlamp washer will spray again after five windshield wash cycles.

4-10 Instruments and Controls

See *Washer Fluid* on page 9-23 for information on filling the windshield washer fluid.

WARNING

In freezing weather, do not use your washer until the windshield is warmed. Otherwise the washer fluid can form ice on the windshield, blocking your vision.

Compass

The vehicle may have a compass display on the Driver Information Center (DIC). The compass receives its heading and other information from Global Positioning System (GPS) antenna, StabiliTrak, and vehicle speed information.

Avoid covering the GPS antenna for long periods of time with objects that may interfere with the antenna's ability to receive a satellite signal.

See *Multi-Band Antenna* on page 6-18 for the location of the vehicle's antennas. The compass system is designed to operate for a certain number of miles or degrees of turn before needing a signal from the GPS satellites. When the compass display shows CAL, drive the vehicle for a short distance in an open area where it can receive a GPS signal. The compass system will automatically determine when GPS signal is restored and provide a heading again. See *Compass Messages* on page 4-34 for more information on the messages that may be displayed for the compass.

Clock (Analog Clock)

The analog clock is located on the instrument panel above the radio. The clock is not connected with any other vehicle system and runs by itself. To adjust the clock:

1. Locate the adjustment buttons directly below the clock face.

2. Push and hold either adjustment button to advance or reverse the clock hands. Holding the buttons down will cause the clock to advance faster. Release the buttons before reaching the desired time.
3. Push and release the buttons to increase the time by one minute increments until the desired time is reached.

Clock (Digital Clock)

The infotainment system controls are used to access the time and date settings through the menu system. See *Operation on page 6-7* for information about how to use the menu system. See the separate navigation system manual for instructions on how to operate the digital clock for the navigation system.

To turn the digital clock on or off:

1. Press the CONFIG button.
2. Select Time and Date Settings.
3. Select Clock Displayed.
4. Press MENU/SELECT to turn the clock on or off.

Setting the Time and Date

1. Press the CONFIG button.
2. Select Time and Date Settings.
3. Select Set Time or Set Date.
4. Turn the MENU/SELECT knob to adjust the highlighted value.
5. Press the MENU/SELECT knob to select the next value.
6. To save the time or date and return to the Time and Date Settings menu, press the ↩ BACK button at any time or press the MENU/SELECT knob after adjusting the minutes or year.

Setting the 12/24 Hour Format

1. Press the CONFIG button.
2. Select Time and Date Settings.
3. Highlight 12/24 Hour Format.
4. Press the MENU/SELECT knob to select the 12 hour or 24 hour display format.

Setting the Month & Day Format

1. Press the CONFIG button.
2. Select Time and Date Settings.
3. Highlight Month & Day Format.
4. Press the MENU/SELECT knob to select MM/DD (month/day) or DD/MM (day/month).

Setting the Auto Time Adjust

1. Press the CONFIG button.
2. Select Time and Date Settings.
3. Highlight Auto Time Adjust.
4. Press the MENU/SELECT knob to turn Auto Time Adjust on or off.

Power Outlets

The accessory power outlets can be used to plug in electrical equipment, such as a cellular telephone.

The vehicle has four accessory power outlets. The power outlets located below the climate control system inside the front storage bin, inside the center floor console, and on the rear of the center floor console are powered while the vehicle is in ON/RUN/START or ACC/ACCESSORY mode, or until the driver door is opened within 10 minutes of turning off the vehicle.

The power outlet located in the rear cargo area is powered at all times.

4-12 Instruments and Controls

There is a small cap that must be removed to access the accessory power outlet. When not using the outlet be sure to cover it with the protective cap.

Notice: Leaving electrical equipment plugged in for an extended period of time while the vehicle is off will drain the battery. Power is always supplied to the outlets. Always unplug electrical equipment when not in use and do not plug in equipment that exceeds the maximum 20 ampere rating.

Certain accessory power plugs may not be compatible to the accessory power outlet and could result in blown vehicle or adapter fuses. If you experience a problem, see your dealer for additional information on the accessory power outlets.

Notice: Adding any electrical equipment to the vehicle can damage it or keep other components from working as they should. The repairs would not be covered by the vehicle warranty. Do not use equipment exceeding maximum amperage rating of 20 amperes. Check with your dealer before adding electrical equipment.

Follow the proper installation instructions that are included with any electrical equipment you install.

Notice: Improper use of the power outlet can cause damage not covered by the vehicle warranty. Do not hang any type of accessory or accessory bracket from the plug because the power outlets are designed for accessory power plugs only.

Cigarette Lighter

There may be a cigarette lighter located under the climate control system, inside the front storage bin.

To activate the cigarette lighter, push it into the heating element and let go. The lighter pops out when it is ready to be used.

Notice: Holding a cigarette lighter in while it is heating does not let the lighter back away from the heating element when it is hot. Damage from overheating can occur to the lighter or heating element, or a fuse could be blown. Do not hold a cigarette lighter in while it is heating.

Ashtrays

There may be an ashtray located under the climate control system on the instrument panel. Press the door to release the ashtray.

To empty the ashtray, remove it from the instrument panel by holding the edges and pulling straight out. To reinstall, push the tray back into place.

There may also be ashtrays located on the center floor console behind the shift lever and in the rear doors.

Notice: If papers, pins, or other flammable items are put in the ashtray, hot cigarettes or other smoking materials could ignite them and possibly damage the vehicle. Never put flammable items in the ashtray.

Warning Lights, Gauges, and Indicators

Warning lights and gauges can signal that something is wrong before it becomes serious enough to cause an expensive repair or replacement. Paying attention to the warning lights and gauges could prevent injury.

Warning lights come on when there could be a problem with a vehicle function. Some warning lights come on briefly when the engine is started to indicate they are working.

Gauges can indicate when there could be a problem with a vehicle function. Often gauges and warning lights work together to indicate a problem with the vehicle.

When one of the warning lights comes on and stays on while driving, or when one of the gauges shows there may be a problem, check the section that explains what to do. Follow this manual's advice. Waiting to do repairs can be costly and even dangerous.

4-14 Instruments and Controls

Instrument Cluster



United States version shown, Canada similar

Speedometer

The speedometer shows the vehicle's speed in either kilometers per hour (km/h) or miles per hour (mph).

Odometer

The odometer shows how far the vehicle has been driven, in either kilometers or miles.

This vehicle has a tamper-resistant odometer. If the vehicle needs a new odometer installed, the new one is set to the mileage of the old odometer. If this is not possible, it is set at zero and a label is put on the driver's door to show the old mileage reading.

Tachometer

The tachometer displays the engine speed in revolutions per minute (rpm).

Notice: If the engine is operated with the tachometer in the shaded warning area, the vehicle could be damaged, and the damages would not be covered by the vehicle warranty. Do not operate the engine with the tachometer in the shaded warning area.

Fuel Gauge

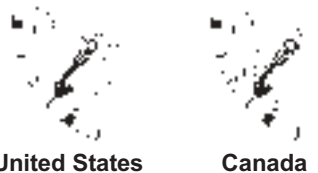

When the ignition is on, the fuel gauge indicates about how much fuel is left in the tank.

An arrow on the fuel gauge indicates the side of the vehicle the fuel door is on.

When the indicator nears empty, the low fuel light comes on. There still is a little fuel left, but the vehicle should be refueled soon.

Here are four things that some owners ask about. None of these show a problem with the fuel gauge:

- At the service station, the fuel pump shuts off before the gauge reads full.
- It takes a little more or less fuel to fill up than the gauge indicated. For example, the gauge may have indicated the tank was half full, but it actually took a little more or less than half the tank's capacity to fill the tank.
- The gauge moves a little while turning a corner or speeding up.
- The gauge takes a few seconds to stabilize after the ignition is turned on, and goes back to empty when the ignition is turned off.

Fuel Economy Gauge



US

For vehicles equipped with this gauge, it shows the fuel economy that the vehicle is currently achieving.

MIN: Is the minimum fuel economy. This least efficient fuel economy usually occurs during quick accelerations or when idling.

MAX: Is the maximum fuel economy. The best fuel economy usually occurs during coasting.

This gauge moves often as it is an instantaneous calculation based on current driving conditions.

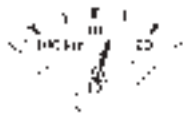

Canada

The gauge shows the fuel usage that the vehicle is currently achieving in liters per 100 kilometers (l/100 km).

20: Is the minimum fuel economy. This least efficient fuel economy usually occurs during quick accelerations or when idling.

l/100: Is the maximum fuel economy. The best fuel economy usually occurs during coasting.

This gauge moves often as it is an instantaneous calculation based on current driving conditions.

Turbo Gauge (2.8L Only)



For vehicles with a turbo gauge, it indicates when the vehicle is using turbo power.

When the needle is in the white area, left of center of the gauge, turbo is not being used.

As the accelerator peddle is pressed the needle may move to the right of center indicating turbo power. Under normal conditions the needle will not display a reading in the red.

Once the driver eases off the accelerator pedal or the transmission shifts, the needle moves back to the left of center of the gauge.

Engine Coolant Temperature Gauge



United States

Canada

This gauge measures the temperature of the vehicle's engine.

If the indicator needle moves into the shaded area, the engine is too hot. A temperature indicator light will turn on.

If the vehicle has been operating under normal driving conditions, and the temperature indicator light comes on, pull off the road, stop the vehicle and turn off the engine as soon as possible.

Safety Belt Reminders

Driver Safety Belt Reminder Light

There is a driver safety belt reminder light on the instrument panel cluster.



When the engine is started this light and a chime come on and stay on for several seconds to remind drivers to fasten their safety belts. The light also begins to flash.

This cycle repeats if the driver remains unbuckled and the vehicle is moving.

If the driver safety belt is already buckled, neither the light nor chime come on.

Passenger Safety Belt Reminder Light



When the engine is started this light and the chime come on and stay on for several seconds to remind the passenger to fasten their safety belt. The light also begins to flash.

This cycle repeats if the passenger remains unbuckled and the vehicle is moving.

If the passenger safety belt is buckled, neither the chime nor the light comes on.

4-18 Instruments and Controls

The front passenger safety belt warning light and chime may turn on if an object is put on the seat such as a briefcase, handbag, grocery bag, laptop or other electronic device. To turn off the warning light and or chime, remove the object from the seat or buckle the safety belt

Second Row Passenger Belt Reminder Light



When the engine is started and the Trip/Fuel display is chosen, three gray seatbelt symbols come on and stay on for several seconds on the top of the Driver information Center (DIC) to remind passengers to fasten their safety belts.

If the Vehicle Information display is selected, a full page screen displays at start-up that has the three seatbelt symbols.

Once the passenger seatbelt is buckled, the corresponding seat belt symbol in the DIC turns green. There are no seat position sensors in the seat. If a seatbelt is not initially buckled, the cluster continues to show the gray seatbelt icon.

While the vehicle is moving, if a second row passenger that was previously buckled becomes unbuckled, a full screen warning displays with the corresponding seat belt indicator flashing red. A chime may sound.

Acknowledge warning messages by pressing any of the DIC switches.

Airbag Readiness Light

This light shows if there is an electrical problem. The system check includes the airbag sensor, the pretensioners, the airbag modules, the wiring, and the crash sensing and diagnostic module. For more information on the airbag system, see *Airbag System* on page 2-28.



The airbag readiness light comes on and stays on for several seconds when the vehicle is started. Then the light goes out.

⚠ WARNING

If the airbag readiness light stays on after the vehicle is started or comes on while driving, it means the airbag system might not be working properly. The airbags in the vehicle might not inflate in a crash, or they could even inflate without a crash. To help avoid injury, have the vehicle serviced right away.

Passenger Airbag Status Indicator

The vehicle has a passenger sensing system. See *Passenger Sensing System* on page 2-36 for important safety information. The overhead console has a passenger airbag status indicator.



United States



Canada

When the vehicle is started, the passenger airbag status indicator will light ON and OFF, or the symbol for on and off, for several seconds as a system check. If you are using remote start, if equipped, to start the vehicle from a distance you may not see the system check.

Then, after several more seconds, the status indicator will light either ON or OFF, or either the on or off symbol to let you know the status of the right front passenger frontal and seat-mounted side impact airbag.

If the word ON or the on symbol is lit on the passenger airbag status indicator, it means that the right front passenger frontal airbag and seat-mounted side impact airbag are enabled (may inflate).

If the word OFF or the off symbol is lit on the passenger airbag status indicator, it means that the passenger sensing system has turned off the right front passenger frontal and seat-mounted side impact airbag.

4-20 Instruments and Controls

If, after several seconds, both status indicator lights remain on, or if there are no lights at all, there may be a problem with the lights or the passenger sensing system. See your dealer for service.

WARNING

If the airbag readiness light ever comes on and stays on, it means that something may be wrong with the airbag system. To help avoid injury to yourself or others, have the vehicle serviced right away. See *Airbag Readiness Light on page 4-18* for more information, including important safety information.

Charging System Light

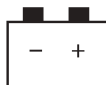

The charging system light comes on briefly when the ignition is turned on, but the engine is not running, as a check to show the light is working. The light turns off when the engine is started. If it does not, have the vehicle serviced by your dealer.

If the light stays on, or comes on while driving, there may be a problem with the electrical charging system. Have it checked by your dealer. Driving while this light is on could drain the battery.

When this light comes on, the Driver Information Center (DIC) also displays a message.

See *Battery Voltage and Charging Messages on page 4-33*.

If a short distance must be driven with the light on, be sure to turn off all accessories, such as the radio and air conditioner.

Malfunction Indicator Lamp

A computer system called OBD II (On-Board Diagnostics-Second Generation) monitors operation of the fuel, ignition, and emission control systems. It ensures that emissions are at acceptable levels for the life of the vehicle, helping to produce a cleaner environment.



This light comes on when the ignition is on, but the engine is not running, as a check to show it is working. If it does not, have the vehicle serviced by your dealer.

If the check engine light comes on and stays on, while the engine is running, this indicates that there is an OBD II problem and service is required.

Malfunions often are indicated by the system before any problem is apparent. Being aware of the light can prevent more serious damage to the vehicle. This system assists the service technician in correctly diagnosing any malfunction.

Notice: If the vehicle is continually driven with this light on, after a while, the emission controls might not work as well, the vehicle fuel economy might not be as good, and the engine might not run as smoothly. This could lead to costly repairs that might not be covered by the vehicle warranty.

Notice: Modifications made to the engine, transmission, exhaust, intake, or fuel system of the vehicle or the replacement of the original tires with other than those of the same Tire Performance Criteria (TPC) can affect the vehicle's emission controls and can cause this light to come on. Modifications to these systems could lead to costly repairs not covered by the vehicle warranty. This could also result in a failure to pass a required Emission Inspection/Maintenance test. See *Accessories and Modifications* on page 9-3.

This light comes on during a malfunction in one of two ways:

Light Flashing: A misfire condition has been detected. A misfire increases vehicle emissions and could damage the emission control system on the vehicle. Diagnosis and service might be required.

The following can prevent more serious damage to the vehicle:

- Reduce vehicle speed.
- Avoid hard accelerations.
- Avoid steep uphill grades.
- If towing a trailer, reduce the amount of cargo being hauled as soon as it is possible.

If the light continues to flash, when it is safe to do so, stop the vehicle. Find a safe place to park the vehicle. Turn the vehicle off, wait at least 10 seconds, and restart the engine. If the light is still flashing, follow the previous steps and see your dealer for service as soon as possible.

4-22 Instruments and Controls

Light On Steady: An emission control system malfunction has been detected on the vehicle. Diagnosis and service might be required.

An emission system malfunction might be corrected.

- Make sure the fuel cap is fully installed. See *Filling the Tank on page 8-50*. The diagnostic system can determine if the fuel cap has been left off or improperly installed. A loose or missing fuel cap allows fuel to evaporate into the atmosphere. A few driving trips with the cap properly installed should turn the light off.
- If the vehicle has been driven through a deep puddle of water, the vehicle's electrical system might be wet. The condition is usually corrected when the electrical system dries out. A few driving trips should turn the light off.

- Make sure to fuel the vehicle with quality fuel. Poor fuel quality causes the engine not to run as efficiently as designed and may cause: stalling after start-up, stalling when the vehicle is changed into gear, misfiring, hesitation on acceleration, or stumbling on acceleration. These conditions might go away once the engine is warmed up.

If one or more of these conditions occurs, change the fuel brand used. It will require at least one full tank of the proper fuel to turn the light off.

See *Gasoline Specifications on page 8-47*.

If none of the above have made the light turn off, your dealer can check the vehicle. The dealer has the proper test equipment and diagnostic tools to fix any mechanical or electrical problems that might have developed.

Emissions Inspection and Maintenance Programs

Some state/provincial and local governments have or might begin programs to inspect the emission control equipment on the vehicle. Failure to pass this inspection could prevent getting a vehicle registration.

Here are some things to know to help the vehicle pass an inspection:

- The vehicle will not pass this inspection if the check engine light is on with the engine running, or if the ignition is placed in ON/RUN and the light is not on.

- The vehicle will not pass this inspection if the OBD II (on-board diagnostic) system determines that critical emission control systems have not been completely diagnosed by the system. The vehicle would be considered not ready for inspection. This can happen if the battery has recently been replaced or if the battery has run down. The diagnostic system is designed to evaluate critical emission control systems during normal driving. This can take several days of routine driving. If this has been done and the vehicle still does not pass the inspection for lack of OBD II system readiness, your dealer can prepare the vehicle for inspection.

Brake System Warning Light

The vehicle brake system consists of two hydraulic circuits. If one circuit is not working, the remaining circuit can still work to stop the vehicle. For normal braking performance, both circuits need to be working.

If the warning light comes on, there is a brake problem. Have the brake system inspected right away.



Metric



English

The brake indicator light should come on briefly as the engine is started. If it does not come on have the vehicle serviced by your dealer.

WARNING

The brake system might not be working properly if the brake system warning light is on. Driving with the brake system warning light on can lead to a crash. If the light is still on after the vehicle has been pulled off the road and carefully stopped, have the vehicle towed for service.

If the light comes on while driving, a chime sounds. Pull off the road and stop. The pedal might be harder to push or go closer to the floor. It might also take longer to stop. If the light is still on, have the vehicle towed for service. See *Towing the Vehicle on page 9-105*.

Electric Parking Brake Light



Metric



English

For vehicles with the Electric Park Brake (EPB), this light should come on briefly as the engine is started. If it does not come on, have the vehicle serviced by your dealer.

The park brake status light comes on when the brake is applied. If the light continues flashing after the park brake is released, or while driving, there is a problem with the Electric Parking Brake system. A SERVICE PARKING BRAKE message may also display in the Driver Information Center (DIC). See *Brake System Messages on page 4-34* for more information.

If the light does not come on, or remains flashing, see your dealer.



For vehicles with the Electric Park Brake (EPB), the brake warning light should come on briefly when as the engine is started. If it does not come on, have the vehicle serviced by your dealer.

If this light comes on there is a problem with a system on the vehicle that is causing the park brake system to work at a reduced level. The vehicle can still be driven, but should be taken to a dealer as soon as possible. See *Parking Brake on page 8-31* for more information.

Antilock Brake System (ABS) Warning Light



This light comes on briefly when the engine is started.

If the light does not come on, have it fixed so it will be ready to warn if there is a problem.

If the ABS light comes on and stays on while driving, stop as soon as possible and turn the ignition off. Start the engine again to reset the system. If the light still stays on after driving at a speed of at least 20 km/h (13 mph), or comes on again while driving, see your dealer retailer for service. A chime may also sound when the light comes on steady.

If both ABS and brake warning lights are on, the vehicle's antilock brakes are not functioning and there is a problem with the regular brakes. See your dealer for service.

See *Brake System Warning Light* on page 4-23.

See *Brake System Messages* on page 4-34 for all brake related DIC messages.

Traction Off Light



This light comes on when the Traction Control System (TCS) has been turned off by pressing and releasing the traction control button.

This light along with the StabiliTrak OFF light come on when StabiliTrak is turned off.

If the Traction Control System (TCS) is off wheelspin is not limited. Adjust driving accordingly.

See *Traction Control System (TCS)* on page 8-34 and *StabiliTrak® System* on page 8-35 for more information.

StabiliTrak® OFF Light



This light comes on when the StabiliTrak system is turned off by pressing the StabiliTrak/TCS button. If the Traction Control System (TCS) is off, wheel spin is not limited.

When the StabiliTrak system is off, the system does not assist in controlling the vehicle. Adjust driving accordingly.

Turn on the TCS and the StabiliTrak system and the warning light turns off.

See *Traction Control System (TCS)* on page 8-34 and *StabiliTrak® System* on page 8-35 for more information.

Traction Control System (TCS)/StabiliTrak® Light



The StabiliTrak system or the Traction Control System (TCS) indicator/warning light comes on briefly while starting the engine.

If it does not, have the vehicle serviced by your dealer. If the system is working normally the indicator light will then go off.

The indicator/warning light flashes while the StabiliTrak or TCS system is working to control the vehicle on a low traction surface.

If the TCS/StabiliTrak warning light comes on and stays on while driving, try to reset the system. Stop and turn off the engine for at least 15 seconds. Then start the engine again. If this light still comes on and stays on, the vehicle needs service.

The vehicle is safe to drive, but StabiliTrak is not active, adjust driving accordingly.

See *Traction Control System (TCS) on page 8-34* and *StabiliTrak® System on page 8-35* for more information.

Tire Pressure Light



For vehicles with a Tire Pressure Monitor System, this light comes on briefly when the engine is started. It provides information about tire pressures and the Tire Pressure Monitor System.

When the Light is On Steady

This indicates that one or more of the tires are significantly underinflated.

A tire pressure message can accompany the light. See *Tire Messages on page 4-40* for more information. Stop as soon as possible, and inflate the tires to the pressure value shown on the Tire and Loading Information Label. See *Tire Pressure on page 9-59* for more information.

When the Light Flashes First and Then is On Steady

This indicates that there may be a problem with the Tire Pressure Monitor System. The light flashes for about a minute and stays on steady for the remainder of the ignition cycle. This sequence repeats with every ignition cycle. See *Tire Pressure Monitor Operation on page 9-62* for more information.

Engine Oil Pressure Light



Do not keep driving if the oil pressure is low. The engine can become so hot that it catches fire. Someone could be burned. Check the oil as soon as possible and have the vehicle serviced.

Notice: Lack of proper engine oil maintenance can damage the engine. The repairs would not be covered by the vehicle warranty. Always follow the maintenance schedule for changing engine oil.



The oil pressure light should come on briefly as the engine is started. If it does not come on have the vehicle serviced by your dealer.

If the light comes on and stays on, it means that oil is not flowing through the engine properly. The vehicle could be low on oil and might have some other system problem. See your dealer.

Fuel Economy Light

eco

For vehicles with the fuel economy mode light, it comes on when the eco (economy) switch, located next to the shifter, is pressed. Press the switch again to turn off the light and exit the fuel saver mode. See *Driving for Better Fuel Economy on page 8-2* for more information.

Low Fuel Warning Light



This light is located near the fuel gauge and comes on briefly when the ignition is turned on as a check to show it is working.

It also comes on when the fuel tank is low on fuel. The light turns off when fuel is added. If it does not, have the vehicle serviced.

Security Light



This light flashes when the security system is activated.

For more information, see *Vehicle Security* on page 1-17.

High-Beam on Light



This light comes on when the high-beam headlamps are in use.

See *Headlamp High/Low-Beam Changer* on page 5-2 for more information.

Adaptive Forward Lighting (AFL) Light



This light comes on solid when there is a problem with the Adaptive Forward Lighting system and flashes when the system is switching between lighting modes. See *Adaptive Forward Lighting (AFL)* on page 5-3 for more information.

Front Fog Lamp Light



The fog lamp light comes on when the fog lamps are in use.

The light goes out when the fog lamps are turned off. See *Front Fog Lamps* on page 5-6 for more information.

Lamps on Reminder



For vehicles with the lamps on reminder light, it comes on when the lights are in use.

Cruise Control Light



The cruise control light is white whenever the cruise control is set, and turns green when the cruise control is active.

The light turns off when the cruise control is turned off. See *Cruise Control on page 8-37* for more information.

Information Displays

Driver Information Center (DIC)

The vehicle may have a Driver Information Center (DIC). The DIC displays information about your vehicle. It also displays warning messages if a system problem is detected. See *Vehicle Messages on page 4-33* for more information. All messages appear in the DIC display located in the center of the instrument panel cluster.

The vehicle may also have features that can be customized through the controls on the radio. See *Vehicle Personalization on page 4-41* for more information.

4-30 Instruments and Controls

DIC Operation and Displays

The DIC has different displays which can be accessed by using the DIC buttons located on the turn signal lever located on the left side of the steering wheel. The DIC displays trip, fuel, vehicle system information, and warning messages if a system problem is detected.

The bottom of the DIC display shows what position the shift lever is in and the odometer. The direction the vehicle is driving will be shown on the top of the display.

DIC Buttons



MENU: Press this button to get to the Trip/Fuel Menu and the Vehicle Information Menu.

△ ▽ (Thumbwheel): Use the thumbwheel to scroll through the items in each menu. A small marker will move up or down the side of the display as you scroll through the items. This shows where each item is in the menu.

SET (Set/Clear): Use this button to set or clear the menu item when it is displayed.

Trip/Fuel Menu Items

Press the MENU button on the turn signal lever until Trip/Fuel Information Menu is displayed. Use the thumbwheel to scroll through the following menu items:

- Trip
- Average Fuel Economy or Average Fuel Economy and Instantaneous Fuel Economy
- Fuel Range
- Fuel Used
- Average Vehicle Speed
- Elapsed Time

- Navigation Turn by Turn
- Speed and Curve Assist
- Digital Speedometer
- Blank

Trip

The Trip display shows the current distance traveled, in either kilometers (km) or miles (mi), since the trip odometer was last reset.

The trip odometer can be reset to zero by pressing the trip reset stem or the SET button while the trip odometer display is showing.

Average Fuel Economy or Average Fuel Economy and Instantaneous Fuel Economy

The Average Fuel Economy display shows the approximate average liters per 100 kilometers (L/100 km) or miles per gallon (mpg). This number is calculated based on the number of L/100 km (mpg) recorded since the last time this menu item was reset.

The Average Fuel Economy can be reset by pressing SET while the Average Fuel Economy display is showing.

The Instantaneous Fuel Economy display shows the current fuel economy in either liters per 100 kilometers (L/100 km) or miles per gallon (mpg). This number reflects only the fuel economy that the vehicle has right now and changes frequently as driving conditions change. Unlike average economy, this display cannot be reset.

Fuel Range

The Fuel Range display shows the approximate distance the vehicle can be driven without refueling. The fuel range estimate is based on an average of the vehicle's fuel economy over recent driving history and the amount of fuel remaining in the fuel tank. Fuel range cannot be reset.

Fuel Used

The Fuel Used display shows the approximate gallons (gal) or liters (L) of fuel that has been used since last reset. The fuel used can be reset by pressing the SET button while the Fuel Used display is showing.

Average Vehicle Speed

The Average Vehicle Speed display shows the average speed of the vehicle in miles per hour (mph) or kilometers per hour (km/h). This average is calculated based on the various vehicle speeds recorded since the last reset of this value. The average speed can be reset by pressing the SET button while the Average Vehicle Speed display is showing.

Elapsed Time

This display can be used as a timer. To start the timer, press SET while Elapsed Time is displayed. The display will show the amount of time that has passed since the timer was last reset. To stop the timer, press SET briefly while Elapsed Time is displayed. To reset the timer to zero, press and hold SET.

Turn by Turn

This display is used for the OnStar or Navigation System Turn-by-Turn guidance. See *OnStar® System on page 4-46* or the Navigation manual, if the vehicle has navigation, for more information.

Speed and Curve Assist

This display will show the speed limit or the advised speed as determined by the information on the map disc in the navigation system. If there is no map disc in the navigation system, this display will not be available.

4-32 Instruments and Controls

Digital Speedometer

The speedometer shows how fast the vehicle is moving in either miles per hour (mph) or kilometers per hour (km/h). The speedometer cannot be reset.

Blank Display

This display shows no information.

Vehicle Information Menu Items

Press the MENU button on the turn signal lever until Vehicle Information Menu is displayed. Use the thumbwheel to scroll through the following menu items:

- Unit
- Tire Pressure
- Remaining Oil Life
- Battery Voltage
- Blank

Unit

Move the thumbwheel up or down to switch between US or Metric when the Unit display is active. Press SET to confirm the setting. This will change the displays on the cluster and DIC to either English (US) or metric measurements.

Tire Pressure

The display will show a vehicle with the approximate pressures of all four tires. Tire pressure is displayed in either pounds per square inch (psi) or in kilopascal (kPa). See *Tire Pressure Monitor System on page 9-61* and *Tire Pressure Monitor Operation on page 9-62* for more information.

Remaining Oil Life

This display shows an estimate of the oil's remaining useful life. If Remaining Oil Life 99% is displayed, that means 99% of the current oil life remains.

When the remaining oil life is low, the CHANGE ENGINE OIL SOON message will appear on the display. See *Engine Oil Messages on page 4-36*. The oil should be changed as soon as possible. See *Engine Oil on page 9-10*. In addition to the engine oil life system monitoring the oil life, additional maintenance is recommended in the Maintenance Schedule in this manual. See *Scheduled Maintenance on page 10-2* for more information.

Remember, the Oil Life display must be reset after each oil change. It will not reset itself. Also, be careful not to reset the Oil Life display accidentally at any time other than when the oil has just been changed. It cannot be reset accurately until the next oil change. To reset the engine oil life system press the SET button while the Oil Life display is active. See *Engine Oil Life System on page 9-12*.

Battery Voltage

This display, available on some vehicles, shows the current battery voltage. If the voltage is in the normal range, the value will display. For example, the display may read Battery Voltage 15.0 Volts. The vehicle's charging system regulates voltage based on the state of the battery. The battery voltage can fluctuate while viewing this information on the DIC. This is normal. See *Charging System Light on page 4-20* for more information. If there is a problem with the battery charging system, the DIC will display a message. See *Battery Voltage and Charging Messages on page 4-33*.

Blank Display

This display shows no information.

Compass

The vehicle may have a compass display in the Driver Information Center (DIC). See *Compass on page 4-10*.

Vehicle Messages

Messages displayed on the DIC indicate the status of the vehicle or some action that may be needed to correct a condition. Multiple messages may display one after the other.

The messages that do not require immediate action can be acknowledged and cleared by pressing SET/CLR. The messages that require immediate action cannot be cleared until that action is performed. All messages should be taken seriously and clearing the messages does not correct the problem.

Battery Voltage and Charging Messages

BATTERY SAVER ACTIVE

This message displays when the vehicle has detected that the battery voltage is dropping beyond a reasonable point. The battery saver system starts reducing certain features of the vehicle that you may be able to notice. At the point that features are disabled, this message is displayed. It means that the vehicle is trying to save the charge in the battery. Turn off unnecessary accessories to allow the battery to recharge.

LOW BATTERY

This message is displayed when the battery voltage is low. See *Battery on page 9-27* for more information.

SERVICE BATTERY CHARGING SYSTEM

This message is displayed when there is a fault in the battery charging system. Take the vehicle to your dealer for service.

Brake System Messages

BRAKE FLUID LOW

This message is displayed when the brake fluid level is low. See *Brake Fluid* on page 9-25.

BRAKES OVERHEATED

This message is displayed when the brakes are becoming overheated. You may see this when driving on hills. Shift to a lower gear.

STEP ON BRAKE TO RELEASE PARK BRAKE

This message is displayed if you attempt to release the electric parking brake without the brake pedal applied. See *Parking Brake* on page 8-31 for more information.

RELEASE PARKING BRAKE

This message is displayed if the electric parking brake is on while the vehicle is in motion. Release it before you attempt to drive. See *Parking Brake* on page 8-31 for more information.

SERVICE BRAKE ASSIST

This message may be displayed when there is a problem with the brake boost assist system. When this message is displayed, the brake boost assist motor might be heard operating and you might notice pulsation in the brake pedal. This is normal under these conditions. Take the vehicle to your dealer for service.

SERVICE PARKING BRAKE

This message is displayed when there is a problem with the parking brake. Take the vehicle to your dealer for service.

Compass Messages

CAL

This message is displayed when the compass needs to be calibrated. See *Compass* on page 4-10.

Three dashes will be displayed if the compass needs service. See your dealer for service.

Cruise Control Messages

APPLY BRAKE BEFORE CRUISE

If this message displays when attempting to activate cruise control, apply the brake and then try again.

CRUISE SET TO XXX

This message will display when the cruise control is set and it will show the speed it was set to. See *Cruise Control* on page 8-37 for more information.

Door Ajar Messages

DOOR OPEN

A door open symbol will be displayed on the DIC showing which door is open. If the vehicle has been shifted out of P (Park), a Door Open message will also be displayed. Close the door completely.

HOOD OPEN

This message will display along with a hood open symbol when the hood is open. Close the hood completely.

POWER LIFTGATE UNAVAILABLE

This message will display if the power liftgate encounters multiple obstacles on the same power cycle. After removing the obstructions, the liftgate will resume normal power operation.

REAR ACCESS OPEN

This message will display along with a symbol when the liftgate is open. Close the liftgate completely.

Engine Cooling System Messages

A/C OFF DUE TO HIGH ENGINE TEMP

This message displays when the engine coolant becomes hotter than the normal operating temperature. To avoid added strain on a hot engine, the air conditioning compressor automatically turns off. When the coolant temperature returns to normal, the air conditioning compressor turns back on. You can continue to drive the vehicle.

If this message continues to appear, have the system repaired by your dealer as soon as possible to avoid damage to the engine.

COOLANT LEVEL LOW ADD COOLANT

This message will display if the coolant is low; see *Engine Coolant* on page 9-17.

ENGINE OVERHEATED — IDLE ENGINE

This message displays when the engine coolant temperature is too hot. Stop and allow the vehicle to idle until it cools down.

ENGINE OVERHEATED — STOP ENGINE

This message displays and a continuous chime sounds if the engine cooling system reaches unsafe temperatures for operation. Stop and turn off the vehicle as soon as it is safe to do so to avoid severe damage. This message clears when the engine has cooled to a safe operating temperature.

HIGH COOLANT TEMPERATURE

This message displays if the coolant temperature is hot; see *Engine Overheating* on page 9-20.

Engine Oil Messages

CHANGE ENGINE OIL SOON

This message displays when the engine oil needs to be changed. When you change the engine oil, be sure to reset the Oil Life System. See *Engine Oil Life System* on page 9-12 and *Driver Information Center (DIC)* on page 4-29 for information on how to reset the system. See *Engine Oil* on page 9-10 and *Scheduled Maintenance* on page 10-2 for more information.

ENGINE OIL HOT, IDLE ENGINE

This message displays when the engine oil temperature is too hot. Stop and allow the vehicle to idle until it cools down.

ENGINE OIL LOW — ADD OIL

This message displays when the engine oil level is too low. Check the oil level. See *Engine Oil* on page 9-10.

OIL PRESSURE LOW — STOP ENGINE

This message displays if low oil pressure levels occur. Stop the vehicle as soon as safely possible and do not operate it until the cause of the low oil pressure has been corrected. Check the oil as soon as possible and have the vehicle serviced by your dealer.

Engine Power Messages

ENGINE POWER IS REDUCED

This message displays when the vehicle's engine power is reduced. Reduced engine power can affect the vehicle's ability to accelerate. If this message is on, but there is no reduction in performance, proceed to your destination. The performance may be reduced the next time the vehicle is driven.

The vehicle may be driven at a reduced speed while this message is on, but maximum acceleration and speed may be reduced. Anytime this message stays on, the vehicle should be taken to your dealer for service as soon as possible.

Fuel System Messages

FUEL LEVEL LOW

This message displays when the vehicle is low on fuel. Refuel as soon as possible.

TIGHTEN GAS CAP

This message displays when the fuel cap is not on tight. Tighten the fuel cap.

Key and Lock Messages

NO REMOTE DETECTED

This message displays when trying to start the vehicle if the keyless access system does not detect a RKE transmitter. The transmitter battery may be weak. See “Starting the Vehicle with a Low Transmitter Battery” under *Remote Keyless Entry (RKE) System Operation* on page 1-3.

NO REMOTE PRESS BRAKE TO RESTART

This message is displayed if the remote is no longer detected in the vehicle. Press the brake pedal to restart the vehicle.

NUMBER OF KEYS PROGRAMMED

This message displays when programming new keys to the vehicle.

REMOTE LEFT IN VEHICLE

This message displays when leaving the vehicle with the RKE transmitter still inside.

REPLACE BATTERY IN REMOTE KEY

This message displays when the battery in the RKE transmitter needs to be replaced.

Lamp Messages

AFL (ADAPTIVE FORWARD LIGHTING) LAMPS NEED SERVICE

This message displays when the Adaptive Forward Lighting (AFL) system is disabled and needs service. See your dealer. See *Adaptive Forward Lighting (AFL)* on page 5-3 for more information.

AUTOMATIC LIGHT CONTROL ON

This message is displayed when the automatic light control has been turned on. See *Automatic Headlamp System* on page 5-3.

AUTOMATIC LIGHT CONTROL OFF

This message is displayed when the automatic light control has been turned off. See *Automatic Headlamp System* on page 5-3.

XXX TURN INDICATOR FAILURE

When one of the turn signals is out, this message displays to show which bulb needs to be replaced. See your dealer to have the front turn signal bulbs replaced. See *Turn Signal Lamps* on page 9-40 and *Replacement Bulbs* on page 9-43 for more information on the rear turn signal bulb replacement.

TURN SIGNAL ON

This message is displayed if the turn signal has been left on. Turn off the turn signal.

Object Detection System Messages

PARK ASSIST OFF

This message is displayed when the park assist system has been turned off. See *Ultrasonic Parking Assist on page 8-40*.

SERVICE PARK ASSIST

This message is displayed if there is a problem with the park assist system. Take the vehicle to your dealer for service.

Ride Control System Messages

SERVICE REAR AXLE

This message displays when there is a problem with the All-Wheel Drive (AWD) System. See your dealer for service.

SERVICE STABILITRAK

This message displays if there is a problem with the StabiliTrak[®] system. If this message appears, try to reset the system. Stop; turn off the engine for at least 15 seconds; then start the engine again. If this message still comes on, it means there is a problem. See your dealer for service. The vehicle is safe to drive, however, you do not have the benefit of StabiliTrak, so reduce your speed and drive accordingly.

SERVICE SUSPENSION SYSTEM

This message displays if there is a problem with the selective ride control. See *Selective Ride Control on page 8-37*.

SERVICE TRACTION CONTROL

This message displays when there is a problem with the Traction Control System (TCS). If this message appears, try to reset the system. Stop, turn off the engine for at least 15 seconds, and then try to start the engine again. If this message still comes on, it means there is a problem. When this message is displayed, the system will not limit wheel spin. Adjust your driving accordingly. See your dealer for service.

Airbag System Messages

SERVICE AIRBAG

This message is displayed if there is a problem with the airbag system. Take the vehicle to your dealer for service.

Safety Belt Messages

BUCKLE SEATBELT

This message displays as a reminder when the safety belt is not buckled.

Anti-Theft Alarm System Messages

THEFT ATTEMPTED

This message displays if the vehicle detects a tamper condition.

Service Vehicle Messages

SERVICE AC SYSTEM

This message is displayed if there is a problem with the air conditioning system. Take the vehicle to your dealer for service.

SERVICE POWER STEERING

This message is displayed if there is a problem with the power steering system. Take the vehicle to your dealer for service.

SERVICE VEHICLE SOON

This message is displayed if there is a problem with the vehicle. Take the vehicle to your dealer for service.

Starting the Vehicle Messages

PRESS BRAKE TO START VEHICLE

This message is displayed when attempting to start the vehicle without first pressing the brake pedal.

SERVICE KEYLESS START SYSTEM

This message is displayed if there is a problem with the keyless start system. Take the vehicle to your dealer for service.

Tire Messages

SERVICE TIRE MONITOR SYSTEM

This message displays if there is a problem with the Tire Pressure Monitor System (TPMS). See *Tire Pressure Monitor Operation on page 9-62* for more information.

TIRE LEARNING ACTIVE

This message displays when the system is learning new tires. See *Tire Pressure Monitor Operation on page 9-62* for more information.

TIRE LOW ADD AIR TO TIRE

On vehicles with the Tire Pressure Monitor System (TPMS), this message displays when the pressure in one or more of the vehicle tires is low.

This message also displays “Left Front”, “Right Front”, “Left Rear”, or “Right Rear” to indicate the location of the low tire.

The low tire pressure warning light will also come on. See *Tire Pressure Light on page 4-26*.

If a tire pressure message appears on the DIC, stop as soon as you can. Inflate the tires by adding air until the tire pressure is equal to the values shown on the Tire Loading Information label. See *Tires on page 9-52*, *Vehicle Load Limits on page 8-11*, and *Tire Pressure on page 9-59*.

You can receive more than one tire pressure message at a time. To read the other messages that may have been sent at the same time, press the set/reset button. The DIC also shows the tire pressure values. See *Driver Information Center (DIC) on page 4-29*.

Transmission Messages

SERVICE TRANSMISSION

This message displays if there is a problem with the transmission. See your dealer.

SHIFT TO PARK

This message displays when the transmission needs to be shifted to P (Park). This may appear when attempting to remove the key if the vehicle is not in P (Park).

TRANSMISSION HOT — IDLE ENGINE

This message displays and a chime sounds if the transmission fluid in the vehicle gets hot. Driving with the transmission fluid temperature high can cause damage to the vehicle. Stop the vehicle and let it idle to allow the transmission to cool. This message clears when the fluid temperature reaches a safe level.

Vehicle Reminder Messages

ICE POSSIBLE DRIVE WITH CARE

This message is displayed when ice conditions are possible.

TURN WIPER CONTROL TO INTERMITTENT FIRST

This message is displayed when attempting to adjust the intermittent wiper speed without intermittent selected on the wiper control. See *Windshield Wiper/Washer on page 4-7*.

Washer Fluid Messages

WASHER FLUID LOW ADD FLUID

This message will be displayed when the washer fluid level is low. For information on filling the washer fluid, see *Washer Fluid on page 9-23*.

Vehicle Personalization

The audio system controls are used to access the personalization menus for customizing vehicle features. Not all features are available on every vehicle. Only the features available on a particular vehicle will be displayed on that vehicle.

CONFIG (Configuration): Press to access the Configuration Settings Menu.

MENU / SELECT Knob: Press the center of this knob to enter the menus and select menu items. Turn the knob to scroll through the menus.

← BACK: Press to exit or move backwards in a menu.

Entering the Personalization Menus

1. Press CONFIG to access the Configuration Settings menu.
2. Turn the MENU / SELECT knob to highlight Vehicle Settings.
3. Press the center of the MENU / SELECT knob to select the Vehicle Settings menu.

The following list of menu items will be available:

- Climate and Air Quality
- Comfort and Convenience
- Language
- Lighting
- Power Door Locks
- Remote Locking, Unlocking, Starting
- Return to Factory Settings

Turn the MENU / SELECT knob to highlight the menu. Press the knob to select it. Each of the menus is detailed in the following information.

4-42 Instruments and Controls

Climate and Air Quality

Select the Climate and Air Quality menu and the following will be displayed:

- Auto Fan Speed
- Air Quality Sensor
- Remote Start Auto Seat Cool
- Remote Start Auto Heated Seats
- Auto Defog
- Auto Rear Defog

Auto Fan Speed

This will allow you to select the automatic fan speed.

Press the MENU / SELECT knob when Auto Fan Speed is highlighted to open the menu. Turn the knob to highlight High, Medium, or Low. Press the knob to confirm the selection and move back to the last menu.

Air Quality Sensor

This will allow you to select whether the system will operate at high or low sensitivity. Only vehicles with the dual zone climate control will have this option.

Press the MENU / SELECT knob when Air Quality Sensor is highlighted to open the menu. Turn the knob to highlight High or Low Sensitivity. Press the knob to confirm the selection and move back to the last menu.

Remote Start Auto Seat Cool

When on, this feature will turn the vented seats on when using remote start on warm days.

Press the MENU / SELECT knob when Remote Start Auto Seat Cool is highlighted. Turn the knob to select On or Off. Press the knob to confirm and go back to the last menu.

Remote Start Auto Heated Seats

When on, this feature will turn the heated seats on when using remote start on cold days.

Press the MENU / SELECT knob when Remote Start Auto Heated Seats is highlighted. Turn the knob to select On or Off. Press the knob to confirm and go back to the last menu.

Auto Defog

This will allow you to turn the auto defog on or off.

Press the MENU / SELECT knob when Auto Defog is highlighted to open the menu. Turn the knob to highlight On or Off. Press the knob to confirm the selection and move back to the last menu.

Auto Rear Defog

This will allow you to turn the auto rear defog on or off.

Press the MENU / SELECT knob when Auto Rear Defog is highlighted to open the menu. Turn the knob to highlight On or Off. Press the knob to confirm the selection and move back to the last menu.

Comfort and Convenience

Select the Comfort and Convenience menu and the following will be displayed:

- Easy Exit Driver Seat
- Chime Volume
- Reverse Tilt Mirror
- Auto Wipe in Reverse Gear

Easy Exit Driver Seat

This allows you to turn the easy exit driver seat feature on or off.

Press the MENU / SELECT knob when Easy Exit Driver Seat is highlighted. Turn the knob to select On or Off. Press the knob to confirm and go back to the last menu.

Chime Volume

This allows the selection of the chime volume level.

Press the MENU / SELECT knob when Chime Volume is highlighted. Turn the knob to select Normal or High. Press the knob to confirm and go back to the last menu.

Reverse Tilt Mirror

This allows you to turn the reverse tilt mirror feature on or off.

Press the MENU / SELECT knob when Reverse Tilt Mirror is highlighted. Turn the knob to select Driver & Passenger or Off. Press the knob to confirm and go back to the last menu.

Auto Wipe in Reverse Gear

When on, the rear window wiper will turn on automatically when the vehicle is shifted into R (Reverse).

Press the MENU / SELECT knob when Auto Wipe in Reverse Gear is highlighted. Turn the knob to select On or Off. Press the knob to confirm and go back to the last menu.

Language

Select the Language menu and the following will be displayed:

- English
- French
- Spanish

Turn the MENU / SELECT knob to select the language. Press the knob to confirm and go back to the last menu.

4-44 Instruments and Controls

Lighting

Select the Lighting menu and the following will be displayed:

- Vehicle Locator Lights
- Exit Lighting

Vehicle Locator Lights

This allows the vehicle locator lights to be turned on or off.

Press the MENU / SELECT knob when Vehicle Locator Lights is highlighted. Turn the knob to select On or Off. Press the knob to confirm and go back to the last menu.

Exit Lighting

This allows the selection of how long the exterior lamps stay on when leaving the vehicle when it is dark outside.

Press the MENU / SELECT knob when Exit Lighting is highlighted. Turn the knob to select Off, 30 Seconds, 1 Minute, or 2 Minutes. Press the knob to confirm and go back to the last menu.

Power Door Locks

Select Power Door Locks and the following will be displayed:

- Unlocked Door Anti Lock Out
- Auto Door Unlock
- Delayed Door Lock

Unlocked Door Anti Lock Out

When on, this feature will keep the driver door from locking when the door is open. If off is selected, the Delayed Door Lock menu will be available and the door will lock as programmed through this menu.

Press the MENU / SELECT knob when Auto Door Unlock is highlighted. Turn the knob to select On or Off. Press the knob to confirm and go back to the last menu.

Auto Door Unlock

This allows selection of which of the doors will automatically unlock when the vehicle is shifted into P (Park).

Press the MENU / SELECT knob when Auto Door Unlock is highlighted. Turn the knob to select All Doors, Driver Door, or Off. Press the knob to confirm and go back to the last menu.

Delayed Door Lock

When on, this feature will delay the locking of the doors until five seconds after the last door is closed. You will hear three chimes to signal delayed locking is in use. Pressing either the power lock button or the lock button on the RKE transmitter twice will override the delayed locking feature and immediately lock all of the doors.

Press the MENU / SELECT knob when Delayed Door Lock is highlighted. Turn the knob to select On or Off. Press the knob to confirm and go back to the last menu.

Remote Lock/Unlock/Start

Select Remote Lock/Unlock/Start and the following will be displayed:

- Unlock Feedback (Lights)
- Locking Feedback
- Door Unlock Options
- Passive Door Lock
- Passive Door Unlock
- Memory Remote Recall

Unlock Feedback (Lights)

When on, the exterior lamps will flash when unlocking the vehicle with the RKE transmitter.

Press the MENU / SELECT knob when Unlock Feedback (Lights) is highlighted. Turn the knob to select Flash Lights or Off. Press the knob to confirm and go back to the last menu.

Locking Feedback

This allows selection of what type of feedback is given when locking the vehicle with the RKE transmitter.

Press the MENU / SELECT knob when Locking Feedback is highlighted. Turn the knob to select Lights and Horn, Lights Only, Horn Only, or Off. Press the knob to confirm and go back to the last menu.

Door Unlock Options

This allows selection of which doors will unlock when pressing the unlock button on the RKE transmitter.

Press the MENU / SELECT knob when Door Unlock Options is highlighted. Turn the knob to select All Doors or Driver Door Only. When set to Driver Door Only, the driver door will unlock the first time the unlock button is pressed and all doors will unlock when the button is pressed a second time.

When set to All Doors, all of the doors will unlock at the first press of the unlock button. Press the knob to confirm and go back to the last menu.

Passive Door Lock

If the vehicle has the keyless access system, when enabled, this feature allows the doors to lock after several seconds if all doors are closed and at least one keyless access transmitter has been removed from the interior of the vehicle. It does not matter how far away that the transmitter is from the vehicle. This feature can also be configured to chirp the horn when the doors are passively locked.

Press the MENU/SELECT knob when Passive Door Lock is highlighted. Turn the knob to select On With Chirp, On, or Off. Press the knob to confirm and go back to the last menu.

Passive Door Unlock

If the vehicle has the keyless access system, this feature allows you to select which doors will automatically unlock when you open the driver's door with the keyless access transmitter present.

Press the MENU/SELECT knob when Passive Door Unlock is highlighted. Turn the knob to select All Doors or Driver Door. Press the knob to confirm and go back to the last menu.

Memory Remote Recall

This allows the Memory Remote Recall feature to be turned on or off.

Press the MENU / SELECT knob when Memory Remote Recall is highlighted. Turn the knob to select On or Off. Press the knob to confirm and go back to the last menu.

Return to Factory Settings

Select Return to Factory Settings to return all of the vehicle personalization to the default settings. Turn the knob to select Yes or No. Press the knob to confirm and go back to the last menu.

OnStar[®] System





OnStar[®] uses several innovative technologies and live advisors to provide a wide range of safety, security, navigation, diagnostics, and calling services.

Automatic Crash Response

In a crash, built in sensors can automatically alert an OnStar advisor who is immediately connected to the vehicle to see if you need help.

How OnStar Service Works

 : This blue button connects you to a specially trained OnStar advisor to verify your account information and to answer questions.

 : Push this red emergency button to get priority help from specially trained OnStar emergency advisors.

 : Push this button for hands-free, voice-activated calling and to give voice commands for turn-by-turn navigation.

Crisis Assist, Stolen Vehicle Assistance, Vehicle Diagnostics, Remote Door Unlock, Roadside Assistance, Turn-by-Turn Navigation and Hands-Free Calling are available on most vehicles. Not all OnStar services are available on all vehicles.

For more information see the OnStar Owner's Guide or visit www.onstar.com (U.S.) or www.onstar.ca (Canada), contact OnStar at 1-888-4-ONSTAR (1-888-466-7827) or TTY



1-877-248-2080, or press  to speak with an OnStar advisor 24 hours a day, 7 days a week.

For a full description of OnStar services and system limitations, see the OnStar Owner's Guide in the glove box.

OnStar service is subject to the OnStar terms and conditions included in the OnStar Subscriber Information.

OnStar service cannot work unless the vehicle is in a place where OnStar has an agreement with a wireless service provider for service in that area. OnStar service also cannot work unless the vehicle is in a place where the wireless service provider OnStar has hired for that

area has coverage, network capacity and reception when the service is needed, and technology that is compatible with the OnStar service. Not all services are available everywhere, particularly in remote or enclosed areas, or at all times.

The OnStar system can record and transmit vehicle information. This information is automatically sent to an OnStar call center when  is pressed,  is pressed, or if the airbags or ACR system deploy. This information usually includes the vehicle's GPS location and, in the event of a crash, additional information regarding the crash that the vehicle was involved in (e.g. the direction from which the vehicle was hit). When the virtual advisor feature of OnStar hands-free calling is used, the vehicle also sends OnStar the vehicle's GPS location so they can provide services where it is located.

Location information about the vehicle is only available if the GPS satellite signals are unobstructed and available.

The vehicle must have a working electrical system, including adequate battery power, for the OnStar equipment to operate. There are other problems OnStar cannot control that may prevent OnStar from providing OnStar service at any particular time or place. Some examples are damage to important parts of the vehicle in a crash, hills, tall buildings, tunnels, weather or wireless phone network congestion.

OnStar Steering Wheel Controls

This vehicle may have a Talk/Mute button that can be used to interact with OnStar hands-free calling. See *Steering Wheel Controls on page 4-6* for more information.

On some vehicles, the mute button can be used to dial numbers into voice mail systems, or to dial phone extensions. See the OnStar Owner's Guide for more information.

Your Responsibility

Increase the volume of the radio if the OnStar advisor cannot be heard.

If the light next to the OnStar buttons is red, the system may not be functioning properly.

Press  and request a vehicle diagnostic. If the light appears clear (no light is appearing), your OnStar subscription has expired and all services have been deactivated.

Press  to confirm that the OnStar equipment is active.

Universal Remote System

See *Radio Frequency Statement on page 12-17* for information regarding Part 15 of the Federal Communications Commission (FCC) rules and Industry Canada Standards RSS-210/220/310.

Universal Remote System Programming



If the vehicle has this feature, you will see these buttons with one LED indicator next to them in the headliner.

This system provides a way to replace up to three remote control transmitters used to activate devices such as garage door openers, security systems, and home automation devices.

Do not use the Universal Home Remote with any garage door opener that does not have the stop and reverse feature. This includes any garage door opener model manufactured before April 1, 1982.

Read the instructions completely before attempting to program the Universal Home Remote. Because of the steps involved, it may be helpful to have another person available to assist you with programming the Universal Home Remote.

Keep the original hand-held transmitter for use in other vehicles as well as for future Universal Home Remote programming. It is also recommended that upon the sale of the vehicle, the programmed Universal Home Remote buttons should be erased for security purposes. See “Erasing Universal Home Remote Buttons” later in this section.

When programming a garage door, park outside of the garage. Park directly in line with and facing the garage door opener motor-head or gate motor-head. Be sure that people and objects are clear of the garage door or gate that is being programmed.

It is recommended that a new battery be installed in your hand-held transmitter for quicker and more accurate transmission of the radio-frequency signal.

Programming the Universal Home Remote System

For questions or help programming the Universal Home Remote System, call 1-800-355-3515 or go to www.homelink.com.

Programming a garage door opener involves time-sensitive actions, so read the entire procedure before starting. Otherwise, the device will time out and the procedure will have to be repeated.

4-50 Instruments and Controls

To program up to three devices:

1. Hold the end of your hand-held transmitter about 3 to 8 cm (1 to 3 inches) away from the Universal Home Remote buttons while keeping the indicator light in view. The hand-held transmitter was supplied by the manufacturer of your garage door opener receiver (motor-head unit).
2. At the same time, press and hold both the hand-held transmitter button and one of the three Universal Home Remote buttons to be used to operate the garage door. Do not release the Universal Home Remote button or the hand-held transmitter button until the indicator light changes from a slow to a rapidly flashing light. You now may release both buttons.

Some entry gates and garage door openers may require substitution of Step 2 with the procedure noted in “Gate Operator and Canadian Programming” later in this section.

3. Press and hold for five seconds the newly-trained Universal Home Remote button (selected button from Step 2) while observing the indicator light and garage door activation.
 - If the indicator light stays on continuously or the garage door starts to move when the Universal Home Remote button is pressed and released, then the programming is complete. There is no need to continue programming Steps 4 through 6.

- If the Universal Home Remote indicator light blinks rapidly for two seconds, then turns to a constant light and the garage door does not move, continue with the programming Steps 4 through 6.

It may be helpful to have another person to assist with the remaining Steps 4 through 6.



“Learn” or “Smart” Buttons

4. After Steps 1 through 3 have been completed, locate the “Learn” or “Smart” button inside the garage on the garage door opener receiver (motor-head unit). The name and color of the button may vary by manufacturer.
5. Firmly press and release the “Learn” or “Smart” button. After you press this button, you will have 30 seconds to complete Step 6.

6. Immediately return to the vehicle. Firmly press and hold for two seconds the Universal Home Remote button, selected in Step 2 to control the garage door, and then release it. If the garage door does not move or the lamp on the garage door opener receiver (motor-head unit) does not flash, press and hold the same button a second time for two seconds, and then release it. Again, if the door does not move or the garage door lamp does not flash, press and hold the same button a third time for two seconds, and then release.

The Universal Home Remote should now activate the garage door.

To program the remaining two Universal Home Remote buttons, begin with Step 1 of “Programming the Universal Home Remote System”.

Gate Operator and Canadian Programming

If you have questions or need help programming the Universal Home Remote System, call 1-800-355-3515 or go to www.homelink.com.

Canadian radio-frequency laws require transmitter signals to time out or quit after several seconds of transmission. This may not be long enough for Universal Home Remote to pick up the signal during programming. Similarly, some U.S. gate operators are manufactured to time out in the same manner.

If you live in Canada, or you are having difficulty programming a gate operator or garage door opener by using the “Programming Universal Home Remote” procedures, regardless of where you live, replace Step 2 under “Programming Universal Home Remote” with the following:

2. Continue to press and hold the Universal Home Remote button while you press and release every two seconds (cycle) the hand-held transmitter button until the frequency signal has been successfully accepted by the Universal Home Remote. The Universal Home Remote indicator light will flash slowly at first and then rapidly. Proceed with Step 3 under “Programming Universal Home Remote” to complete.

Universal Remote System Operation

Using Universal Home Remote

Press and hold the appropriate Universal Home Remote button for at least half of a second. The indicator light will come on while the signal is being transmitted.

Erasing Universal Home Remote Buttons

All programmed buttons should be erased when the vehicle is sold or the lease ends.

To erase all programmed buttons on the Universal Home Remote device:

1. Press and hold down the two outside buttons until the indicator light begins to flash, after 10 seconds.
2. Release both buttons.

Reprogramming a Single Universal Home Remote Button

To reprogram any of the three Universal Home Remote buttons:

1. Press and hold the desired Universal Home Remote button. Do not release the button.
2. The indicator light will begin to flash after 20 seconds. Without releasing the button, proceed with Step 1 of the section “Programming Universal Home Remote”.

If you have questions or need help programming the Universal Home Remote System, call 1-800-355-3515 or go to www.homelink.com. You may also call the customer assistance phone number under *Customer Assistance Offices on page 12-3*.

Lighting

Exterior Lighting

- Exterior Lamp Controls 5-1
- Headlamp High/Low-Beam
Changer 5-2
- Flash-to-Pass 5-2
- Daytime Running
Lamps (DRL) 5-2
- Automatic Headlamp
System 5-3
- Adaptive Forward
Lighting (AFL) 5-3
- Twilight Sentinel 5-4
- Hazard Warning Flashers 5-5
- Turn and Lane-Change
Signals 5-5
- Front Fog Lamps 5-6

Interior Lighting

- Instrument Panel Illumination
Control 5-6
- Cargo Lamp 5-6
- Courtesy Lamps 5-6
- Dome Lamps 5-6
- Reading Lamps 5-6

Exterior Lighting

Exterior Lamp Controls



The exterior lamps control is located on the instrument panel to the outboard side of the steering column.

It controls the following systems:

- Headlamps
- Taillamps
- Parking Lamps
- License Plate Lamps
- Instrument Panel Lights
- Fog Lamps

The exterior lamps control has four positions:

⏻ (Off): Briefly turn to this position to turn the automatic light control off or on again.

AUTO (Automatic): Turns the headlamps on automatically at normal brightness, together with the following:

- Parking Lamps
- Taillamps
- License Plate Lamps
- Instrument Panel Lights

5-2 Lighting

 **(Parking Lamps):** Turns the parking lamps on together with the following:

- Taillamps
- License Plate Lamps
- Instrument Panel Lights

 **(Headlamps):** Turns the headlamps on together with the following lamps listed below. A warning chime sounds if the driver's door is opened when the ignition switch is off and the headlamps are on.

- Parking Lamps
- Taillamps
- License Plate Lamps
- Instrument Panel Lights

 **(Front Fog Lamps):** For vehicles with fog lamps, press to turn the lamps on or off.

See *Front Fog Lamps* on page 5-6.

Headlamp High/Low-Beam Changer

 **Headlamp High/Low Beam Changer:** Push the turn signal/lane change lever away from you to turn the high beams on.

Pull the lever toward you to return to low beams.



This indicator light turns on in the instrument panel cluster when the high beam headlamps are on.

Flash-to-Pass

The flash-to-pass feature works with the low beams or Daytime Running Lamps (DRL) on or off.

To flash the high beams, pull the turn signal/lane change lever all the way toward you, then release it.

Daytime Running Lamps (DRL)

Daytime Running Lamps (DRL) make it easier for others to see the front of your vehicle during the day. Fully functional daytime running lamps are required on all vehicles first sold in Canada.

A light sensor on top of the instrument panel makes the DRL work, so be sure it is not covered.

The DRL system makes the low-beam headlamps come on at a reduced brightness or for vehicles with High Intensity Discharge (HID) headlamps, the DRL lights will come on when the following conditions are met:

- The ignition is in the ON/RUN mode.
- The exterior lamps control is in AUTO.
- The engine is running.

When the DRL are on, only the low-beam headlamps, at a reduced level of brightness, will be on. The high-beam headlamps, taillamps, sidemarker, instrument panel and other lamps will not be on.

The headlamps automatically change from DRL to the regular headlamps depending on the darkness of the surroundings.

The other lamps that come on with the headlamps will also come on.

When it is bright enough outside, the headlamps go off and the DRL come on.

To turn the DRL lamps off or on again, turn the exterior lamps control to the off position and then release. For vehicles first sold in Canada, the DRL lamps cannot be turned off.

Automatic Headlamp System

When it is dark enough outside and the exterior lamps control is in the automatic position, the headlamps come on automatically. See *Exterior Lamp Controls on page 5-1*.

The vehicle has a light sensor located on top of the instrument panel. Make sure it is not covered, or the headlamps will be on when they are not needed.

The system may also turn on the headlamps when driving through a parking garage or tunnel.

Adaptive Forward Lighting (AFL)

For vehicles with Xenon headlamps, the Adaptive Forward Lighting System (AFL) adjusts the headlamps to provide greater road illumination in various driving conditions.

To enable AFL, set the exterior lamp control to the AUTO position. Moving the control out of the AUTO position will deactivate the system. AFL will operate when the vehicle speed is greater than 3 km/h (2 mph). AFL will not operate when the transmission is in R (Reverse). AFL is not immediately operable after starting the vehicle; driving a short distance is required to calibrate the AFL. See *Exterior Lamp Controls on page 5-1*.

5-4 Lighting

Curve Lighting

The Xenon light beam pivots based on the steering wheel position and vehicle speed of at least 10 km/h (6 mph). The headlamps shine at an angle of up to 15 degrees to the right or left of the direction of travel.

Motorway Lighting

If the vehicle is traveling straight continuously at high speeds, the light beam automatically raises slightly to increase the headlamp range.

City Lighting

If the vehicle speed is less than 50 km/h (31 mph), the headlamp range is automatically reduced.

Twilight Sentinel

This feature automatically turns the lamps on and off. A light sensor on top of the instrument panel makes the Twilight Sentinel[®] work, so be sure it is not covered.

With Twilight Sentinel[®] the following will happen:

- When it is dark enough outside, the Daytime Running Lamps (DRL) go off, and the headlamps and parking lamps come on. The other lamps that come on with the headlamps also come on.
- When it is bright enough outside, the headlamps go off, and the DRL come on, as long as the exterior lamp switch is in the AUTO position.

If the vehicle is started in a dark garage, the automatic headlamp system comes on immediately. If it is light outside when the vehicle leaves the garage, there is a slight delay before the automatic headlamp system changes to the

DRL. During that delay, the instrument panel cluster may not be as bright as usual. Make sure the instrument panel brightness control is in full bright position. See *Instrument Panel Illumination Control* on page 5-6 for more information.

The vehicle can be idled with the lamps off, even when it is dark outside. After starting the vehicle, turn the exterior lamp control to off, then release it. The lamps will remain off until the control is turned to off again.

Twilight Sentinel[®] also provides exterior illumination as you leave the vehicle. If Twilight Sentinel[®] has turned on the lamps when the ignition is turned off, the lamps remain on until:

- The exterior lamp control is moved from  to the parking lamp position, or
- the delay time selected has elapsed.

See *Vehicle Personalization on page 4-41* to select the delay time. You can also select no delay time.

If the ignition is turned off with the exterior lamp control in the parking lamp or headlamp position, the Twilight Sentinel[®] delay will not occur. The lamps will turn off as soon as the control is turned off.

The regular headlamp system should be turned on when needed.

Hazard Warning Flashers

 **Hazard Warning Flasher:**
Press this button located on the instrument panel near the audio system, to make the front and rear turn signal lamps flash on and off. This warns others that you are having trouble. Press again to turn the flashers off.

Turn and Lane-Change Signals



An arrow on the instrument panel cluster will flash in the direction of the turn or lane change.

Move the lever all the way up or down to signal a turn.

Raise or lower the lever until the arrow starts to flash to signal a lane change. The turn signal flashes three times.

The lever returns to its starting position when it is released.

If after signaling a turn or lane change the arrow flashes rapidly or does not come on, a signal bulb may be burned-out.

Have the bulbs replaced. If the bulb is not burned out, check the fuse. See *Fuses and Circuit Breakers on page 9-44* for more information.

Front Fog Lamps

For vehicles with front fog lamps, the button is located on the exterior lamp control, on the outboard side of the steering wheel.

The ignition and the low-beam headlamps must be on to turn on the fog lamps.

: Press to turn the fog lamps on or off. An indicator light on the instrument panel cluster comes on when the fog lamps are on.

The fog lamps come on together with the parking lamps.

If the high-beam headlamps are turned on, the fog lamps will turn off. If the high-beam headlamps are turned off, the fog lamps will turn back on again.

Some localities have laws that require the headlamps to be on along with the fog lamps.

Interior Lighting

Instrument Panel Illumination Control

This feature controls the brightness of the instrument panel lights. The thumbwheel is located next to the exterior lamp control.



(Instrument Panel

Brightness): Turn the thumbwheel up or down to brighten or dim the instrument panel lights.

Cargo Lamp

The cargo lamp is located over the rear compartment and is controlled by the dome lamp. See *Dome Lamps on page 5-6*.

Courtesy Lamps

The courtesy lamps come on automatically when any door is opened and the dome lamp is in the door position.

Dome Lamps

To change the dome lamp settings, press the following:

 **(Dome Lamp Override):** Turns the lamp off, even when a door is open.

 **(Door):** The lamp comes on automatically when a door is opened.

 **(On):** Turns the dome lamp on.

Reading Lamps

There are reading lamps located on the overhead console and over the rear passenger doors. These lamps come on automatically when any door is opened.

To manually turn the reading lamps on or off:

For the overhead console reading lamps, press the button next to each lamp.

For the rear passenger reading lamps, press the lamp lens.

Infotainment System

Introduction

| | |
|---|-----|
| Introduction | 6-1 |
| Theft-Deterrent Feature | 6-2 |
| Overview (Radio with CD) | 6-3 |
| Overview (Radio with CD/DVD and MEM) | 6-5 |
| Operation | 6-7 |

Radio

| | |
|--------------------------|------|
| AM-FM Radio | 6-11 |
| Satellite Radio | 6-14 |
| Radio Reception | 6-18 |
| Multi-Band Antenna | 6-18 |

Audio Players

| | |
|---|------|
| CD Player (Radio with CD) | 6-19 |
| CD/DVD Player | 6-21 |
| Mass Storage Media (MEM) | 6-25 |
| Auxiliary Devices (Radio with CD) | 6-28 |
| Auxiliary Devices (Radio with CD/DVD and MEM) | 6-34 |

Rear Seat Infotainment

| | |
|---|------|
| Rear Seat Entertainment (RSE) System | 6-36 |
| Rear Seat Audio (RSA) System | 6-45 |

Phone

| | |
|--|------|
| Bluetooth (Overview) | 6-47 |
| Bluetooth (Infotainment Controls) | 6-48 |
| Bluetooth (Voice Recognition) | 6-52 |
| Bluetooth (Navigation) | 6-63 |

Introduction

Read the following pages to become familiar with the audio system's features.

WARNING

Taking your eyes off the road for extended periods could cause a crash resulting in injury or death to you or others. Do not give extended attention to entertainment tasks while driving.

This system provides access to many audio and non-audio listings.

6-2 Infotainment System

To minimize taking your eyes off the road while driving, do the following while the vehicle is parked:

- Become familiar with the operation and controls of the audio system.
- Set up the tone, speaker adjustments, and preset radio stations.

For more information, see *Defensive Driving* on page 8-3.

This vehicle's infotainment system may be equipped with a noise reduction system which can work improperly if the audio amplifier, engine calibrations, exhaust system, microphones, radio, or speakers are modified or replaced. This could result in more noticeable engine noise at certain speeds.

Notice: Contact your dealer before adding any equipment.

Adding audio or communication equipment could interfere with the operation of the vehicle's engine, radio, or other systems, and could damage them. Follow federal rules covering mobile radio and telephone equipment.

The vehicle has Retained Accessory Power (RAP). With RAP, the audio system can be played even after the ignition is turned off. See *Retained Accessory Power (RAP)* on page 8-20 for more information.

Navigation System



For vehicles with a navigation system, see the separate Navigation System Manual.

Theft-Deterrent Feature

The theft-deterrent feature works by learning a portion of the Vehicle Identification Number (VIN) to the infotainment system. The infotainment system does not operate if it is stolen or moved to a different vehicle.

Overview (Radio with CD)



- A. VOL/ 
 - Turns the system on or off and adjusts the volume.
- B. Buttons 1 to 6
 - Radio: Saves and selects favorite stations.
- C. TUNE
 - Radio: Manually selects radio stations.
 - CD: Selects tracks.
- D. FAV
 - Radio: Opens the favorites list.
- E.  SEEK
 - Radio: Seeks the previous station.
 - CD: Selects the previous track or rewinds within a track.

6-4 Infotainment System

F. SEEK

- Radio: Seeks the next station.
- CD: Selects the next track or fast forwards within a track.

G. CD Eject

- Removes a disc from the CD slot.

H. CD

- Selects the CD player when listening to a different audio source.

I. RADIO/BAND

- Changes the band while listening to the radio.
- Selects the radio when listening to a different audio source.

J. /||

- CD: Pauses the CD.

K. CD Slot

- Insert a CD.

L. MENU/SELECT

- Press: Selects menu items.
- Turn: Opens menus, highlights menu items, or sets numeric values while in a menu.

M. BACK

- Menu: Moves one level back.
- Character Input: Deletes the last character.

N. CONFIG

- Open the settings menu.

O. PHONE

- Opens the phone main menu.
- Mutes the audio system.

P. TONE

- Opens the tone menu.

Q. AUX

- Selects a connected external audio source.

R. INFO

- Radio: Shows available information about the current station.
- CD: Shows available information about the current track.

Overview (Radio with CD/DVD and MEM)



- A. VOL/ 
 - Turns the system on or off and adjusts the volume.
- B. Buttons 1 to 6
 - Radio: Saves and selects favorite stations.
 - MEM: Saves and selects favorite tracks and playlists.
- C. TUNE/INFO
 - Radio: Manually selects radio stations and shows available information about the current station.
 - CD: Selects tracks and shows available information about the current track.
 - MEM: Selects tracks and shows available information about the current track.

6-6 Infotainment System

D. FAV

- Radio: Opens the favorites list.
- MEM: Opens the favorites list.

E. ⏮ SEEK

- Radio: Seeks the previous station.
- CD/DVD: Selects the previous track or rewinds within a track.
- MEM: Selects the previous track or rewinds within a track.

F. ⏭ SEEK

- Radio: Seeks the next station.
- CD/DVD: Selects the next track or fast forwards within a track.
- MEM: Selects the next track or fast forwards within a track.

G. CD Eject

- Removes a disc from the CD slot.

H. RADIO/BAND

- Changes the band while listening to the radio.
- Selects the radio when listening to a different audio source.

I. MEM/DVD/AUX

- Selects MEM, CD/DVD, USB, or a connected auxiliary audio or auxiliary audio/video source.

J. /||

- Radio: Pauses time shifted content.
- CD/DVD: Pauses CD/DVD-A and DVD-V playback. Stops DVD-V playback.
- MEM: Pauses MEM playback.

K. CD/DVD Slot

- Insert a disc.

L. MENU/SELECT

- Press: Selects menu items.
- Turn: Open menus, highlights menu items, or sets numeric values while in a menu.

M. TONE

- Opens the tone menu.

N. BACK

- Menu: Moves one level back.
- Character Input: Deletes the last character.

O. CONFIG

- Open the settings menu.

P. DEL

- MEM: Delete the current track from MEM.

Q. ● REC

- CD/DVD: Records content from audio CDs and MP3/WMA CDs.
- AUX: Records content from USB mass storage devices.

R. PHONE

- Opens the phone main menu.
- Mutes the audio system.

Operation

Controls

The infotainment system is operated by using the pushbuttons, multifunction knobs, menus that are shown on the display, and steering wheel controls, if equipped.

Turning the System On or Off

VOL/  (Volume/Power): Press to turn the system on and off.

Automatic Switch-Off

If the infotainment system has been turned on after the ignition is turned off, the system will turn off automatically after ten minutes.

Volume Control

VOL/  (Volume/Power): Turn to adjust the volume.

PHONE: For vehicles with OnStar[®], press and hold PHONE to mute the infotainment system. Press and hold PHONE again, or turn the VOL/  knob to cancel mute.

For vehicles without OnStar[®], press PHONE to mute the infotainment system. Press PHONE again, or turn the VOL/  knob to cancel mute.

Menu System

Controls

The MENU/SELECT knob and the  BACK button are used to navigate the menu system.

MENU/SELECT: Press to:

- Select or activate the highlighted menu option.
- Confirm a set value.
- Turn a system setting on or off.

Turn to:

- Enter the menu system.
- Highlight a menu option.
- Select a value.

6-8 Infotainment System

⏪ **BACK:** Press to:

- Exit a menu.
- Return from a submenu screen to the previous menu screen.
- Delete the last character in a sequence.

Selecting a Menu Option



1. Turn the MENU/SELECT knob to move the highlighted bar.
2. Press the MENU/SELECT button to select the highlighted option.

Submenus



An arrow on the right-hand edge of the menu indicates that it has a submenu with other options.

Activating a Setting



1. Turn the MENU/SELECT knob to highlight the setting.
2. Press the MENU/SELECT button to activate the setting.

Setting a Value

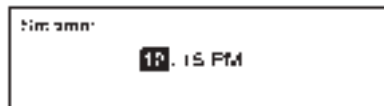

1. Turn the MENU/SELECT knob to change the current value of the setting.
2. Press the MENU/SELECT button to confirm the setting.

Turning a Function On or Off



1. Turn the MENU/SELECT knob to highlight the function.
2. Press the MENU/SELECT button to turn the function on or off.

Entering a Character Sequence

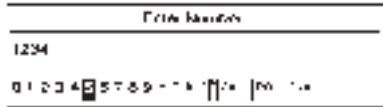

1. Turn the MENU/SELECT knob to highlight the character.
2. Press the MENU/SELECT button to select the character.

Press the BACK button to delete the last character in the sequence or press and hold to delete the entire character sequence.

Audio Settings

The audio settings can be set for each radio band and each audio player source.

To quickly reset an audio setting value to 0:

1. Press the TONE button.
2. Select the audio setting.

3. Press and hold the MENU/SELECT button until the value changes to 0.

Press the BACK button to go back to the Tone Settings menu.

Adjusting the Treble, Midrange, and Bass

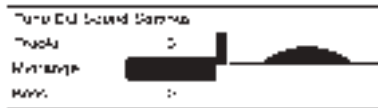

1. Press the TONE button.
2. Select Treble, Midrange, or Bass.
3. Select the value.

Press the BACK button to go back to the Tone Settings menu.

Adjusting the Fader and Balance

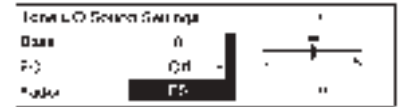

1. Press the TONE button.
2. Select Fader or Balance.
3. Select the value.

Press the BACK button to go back to the Tone Settings menu.

Adjusting the EQ (Equalizer)

For vehicles that have an equalizer:

1. Press the TONE button.
2. Select EQ.
3. Select the setting.

Press the BACK button to go back to the Tone Settings menu.

6-10 Infotainment System

DSP (Digital Signal Processing) Settings

For vehicles with DSP, it is used to provide a choice of different listening experiences.

- *2.0 Normal* - Select this setting to adjust the audio for normal mode. This provides the best sound quality for all seating positions.
- *Centerpoint* - Centerpoint® signal processing circuitry. This setting creates a surround sound listening experience from stereo CDs and satellite radio.

For more information on Bose® Centerpoint® signal processing circuitry, please visit www.bose.com/centerpoint.

- *5.1 Surround* - The infotainment system used in conjunction with the Bose® 5.1 Cabin Surround® sound system for the vehicle includes digital 5.1 decoding. This technology unlocks the full benefit of digital 5.1 recordings, so digitally encoded music and movie soundtracks can be presented faithfully and accurately. If the video screens or Rear Seat Audio (RSA) is on, 5.1 Surround is not available.

To adjust the DSP settings:

1. Press the TONE button.
2. Select DSP.
3. Select the setting.

Press the ↩ BACK button to go back to the Tone Settings menu.

System Settings

Configuring the Number of Favorite Pages



To configure the number of available favorite pages:

1. Press the CONFIG button.
2. Select Radio Settings.
3. Select Radio Favorites.
4. Select the number of available favorite pages.
5. Press the ↩ BACK button to go back to the System Configuration menu.

Auto Volume

The auto volume feature automatically adjusts the radio volume to compensate for road and wind noise as the vehicle speeds up or slows down, so that the volume level is consistent.

The level of volume compensation can be selected, or the auto volume feature can be turned off.

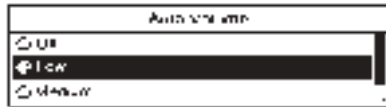

1. Press the CONFIG button.
2. Select Radio Settings.
3. Select Auto Volume.
4. Select the setting.
5. Press the ↩ BACK button to go back to the System Configuration menu.

Maximum Startup Volume

The maximum volume played when the radio is first turned on can be set.



1. Press the CONFIG button.
2. Select Radio Settings.
3. Select Maximum Startup Volume.
4. Select the setting.
5. Press the ↩ BACK button to go back to the System Configuration menu.

Radio

AM-FM Radio

Control Buttons

The buttons used to control the radio are:

RADIO/BAND: Press to turn the radio on and choose between AM, FM, and XM™, if equipped.

MENU/SELECT: Press and turn to navigate the available menus.

TUNE: Turn to search for stations.

INFO: Press to display additional information that may be available for the current song.

▶▶ SEEK/◀◀ SEEK: Press to search for stations.

FAV: Press to open the favorites list.

1 to 6: Press to select preset stations.

▶/|| (Play/Pause): Press to pause time shifted content, if equipped.

RDS (Radio Data System)

The radio may have RDS. The RDS feature is available for use only on FM stations that broadcast RDS information. This feature only works when the information from the radio station is available. In rare cases, a radio station could broadcast incorrect information that causes the radio features to work improperly. If this happens, contact the radio station.

While the radio is tuned to an FM-RDS station, the station name or call letters display.

Radio Menus

Radio menus are available for AM and FM.

Turn the MENU/SELECT knob to open the main radio menu for that frequency.

Selecting a Band

Press the RADIO/BAND button to choose AM, FM, or XM™, if equipped. The last station that was playing starts playing again.

Selecting a Station

Seek Tuning (Radio with CD)

If the radio station is not known:

Briefly press **◀◀ SEEK** or **▶▶ SEEK**. To automatically search for the next available station. If a station is not found, the radio switches to a more sensitive search level. If a station still is not found, the frequency that was last active begins to play.

If the radio station is known:

Press and hold **◀◀ SEEK** or **▶▶ SEEK** until the station on the display is reached, then release the button.

Seek Tuning (Radio with CD/DVD and MEM)

Briefly press **◀◀ SEEK** or **▶▶ SEEK**, to automatically search for the next available station. If a station is not found, the radio switches to a more sensitive search level. If a station still is not found, the frequency that was last active begins to play.

Manual Tuning

Turn the TUNE knob to select the frequency on the display.

Favorites List

1. Turn the MENU/SELECT knob.
2. Select Favorites List.
3. Select the station.

Station Lists

1. Turn the MENU/SELECT knob.
2. Select AM or FM Station List. All receivable stations in the current reception area are displayed. If a station list has not been created, an automatic station search is done.
3. Select the station.

Category Lists

Most stations that broadcast an RDS program type code specify the type of programming transmitted. Some stations change the program type code depending on the content. The system stores the RDS stations sorted by program type in the FM category list.

To search for a programming type determined by station:

1. Turn the MENU/SELECT knob.
2. Select FM category list. A list of all programming types available displays.

3. Select the programming type. A list of stations that transmit programming of the selected type displays.
4. Select the station.
The category lists are updated when the station lists are updated.

Updating Station & Category Lists

If stations stored in the station list can no longer be received.

1. Turn the MENU/SELECT knob.
2. Select Update AM or FM Station List, if the stations stored in the station list are no longer received. A station search will be completed and the first station in the updated list will play.

To cancel the station search, press the MENU/SELECT knob.

Storing a Station as a Favorite

Stations from all bands can be stored in any order in the favorite pages.

Up to six stations can be stored in each favorite page and the number of available favorite pages can be set.

Storing Stations

To store the station to a position in the list, press the corresponding button 1 to 6 until a beep is heard.

Retrieving Stations

Press the FAV button to open a favorite page or to switch to another favorite page. Briefly press one of the 1 to 6 buttons to retrieve the station.

Time Shifting (Radio with CD/DVD and MEM)

The radio with MEM time shift feature can rewind 20 minutes of FM/AM content. While listening to the radio, the content from the current station is always being buffered.

Press the **▶/||** button to pause the radio. The radio displays the time shift status bar. The status bar shows the amount of content that is stored in the buffer and the current pause point.

To resume playback from the current pause point, press the **▶/||** button again. The radio is no longer live, but played from the time shift buffer. A status bar displays below the station number.

Press and hold the **◀◀** SEEK or **▶▶** SEEK buttons to fast forward or rewind through the time shift buffer.

Hold **▶▶** SEEK until the end of the recorded buffer resumes live playback.

Press and release the **◀◀** SEEK or **▶▶** SEEK buttons to jump forward or back 30 seconds in the time shift buffer.

When the radio station is changed, the buffer is cleared and automatically restarted for the current station. Content from a previously tuned station is no longer available.

The time shift feature is not available while recording or with other sources of playback.

Pausing AM/FM with the Vehicle Turned Off

If AM/FM is paused when the vehicle is turned off, the radio continues to buffer the current radio station for up to 20 minutes. If the vehicle is turned back on within 20 minutes, the radio resumes playback from the paused point.

Satellite Radio

Vehicles with an XM™ Satellite Radio tuner and a valid XM Satellite Radio subscription can receive XM programming.

XM Satellite Radio Service

XM is a satellite radio service that is based in the 48 contiguous United States and 10 Canadian provinces. XM Satellite Radio has a wide variety of programming and commercial-free music, coast-to-coast, and in digital-quality sound. A service fee is required to receive the XM service. For more information, contact XM at www.xmradio.com or call 1-800-929-2100 in the U.S. and www.xmradio.ca or call 1-877-438-9677 in Canada.

Control Buttons

The buttons used to control the XM radio are:

RADIO/BAND: Press to turn the radio on and choose between AM, FM, and XM™, if equipped.

◀◀ SEEK / ▶▶ SEEK: Press to go to the previous or next channel.

FAV: Press to open the favorites list.

1-6: Press to select a favorite.

TUNE: Turn to select channel.

INFO: Press to display additional information that may be available about the current song.

▶/|| (Play/Pause): Press to pause time shifted content, if equipped.

Selecting the XM Band

Press the RADIO/BAND button to choose between the AM, FM and XM bands. The last channel played in that band begins to play when that band is selected.

XM Categories

XM channels are organized in categories.

Removing or Adding Categories

Channels in a category that have been removed can still be accessed by using the ◀◀ SEEK or ▶▶ SEEK buttons, or the TUNE knob.

To add or remove categories:

1. Press the CONFIG button.
2. Select Radio Settings.
3. Select XM Categories.
4. Turn the MENU/SELECT knob to highlight the category.
5. Press the MENU/SELECT knob to remove or add the category.

Selecting an XM Channel

XM channels can be selected by using ◀◀ SEEK, ▶▶ SEEK, the TUNE knob, or the menu system.

Selecting a Channel Using

◀◀ SEEK or ▶▶ SEEK (Radio with CD)

- Press and release ◀◀ SEEK or ▶▶ SEEK to go to the previous or next channel.
- Press and hold ◀◀ SEEK or ▶▶ SEEK to scroll through the previous or next channel until the channel is reached.

Selecting a Channel Using

◀◀ SEEK or ▶▶ SEEK (Radio with CD/DVD and MEM)

Press and release ◀◀ SEEK or ▶▶ SEEK to go to the previous or next channel.

Selecting a Channel Using the TUNE Knob

To select an XM channel using the TUNE knob:

Turn the TUNE knob to highlight an XM channel, the channel is selected after a short delay.

To select a channel using the menu:

1. Turn the menu knob and select Channel List.
2. Select the desired channel.

Selecting a Channel Using the Menu System

1. Turn the menu knob.
2. Select XM Category List.
3. Select the category.
4. Select the channel.

Storing an XM Channel as a Favorite

Channels from all bands can be stored in any order in the favorite pages.

Up to six channels can be stored in each favorite page and the number of available favorite pages can be set.

Storing a Channel as a Favorite

To store the channel to a position in the list, press and hold the corresponding 1 to 6 button until the channel can be heard again.

Retrieving Channels

Press the FAV button to open a favorite page or to change to another favorite page. Briefly press one of the 1 to 6 buttons to retrieve the channel.

Time Shifting (Radio with CD/DVD and MEM)

The radio with MEM time shift feature can rewind 20 minutes of XM content. While listening to the radio, the content from the current channel is always being buffered.

Press the ▶/|| button to pause the radio. The radio displays the time shift status bar. The status bar shows the amount of content that is stored in the buffer and the current pause point.

To resume playback from the current pause point, press the ▶/|| button again. The radio is no longer live, but played from the time shift buffer. A status bar displays below the channel number.

Press and hold the ◀◀ SEEK or ▶▶ SEEK buttons to fast forward or rewind through the time shift buffer. Hold ▶▶ SEEK until the end of the recorded buffer resumes live playback.

Press and release the ◀◀ SEEK or ▶▶ SEEK buttons to go to the next or previous song in the time shift buffer.

When the channel is changed, the buffer is cleared and automatically restarted for the current channel. Content from a previously tuned station is no longer available.

The time shift feature is not available while recording or with other sources of playback.

Pausing XM with the Vehicle Turned Off

If XM is paused when the vehicle is turned off, the radio continues to buffer the current radio station for up to 20 minutes. If the vehicle is turned back on within 20 minutes, the radio resumes playback from the paused point.

XM Messages

XL (Explicit Language

Channels): These channels, or any others, can be blocked by request, by calling 1-800-852-XXXM (9696).

XM Updating: The encryption code in the receiver is being updated, no action is required. This process should take no longer than 30 seconds.

Loading XM: The audio system is acquiring and processing audio and text data, no action is needed. This message should disappear shortly.

Channel Off Air: This channel is not currently in service. Tune in to another channel.

Channel Unauth : This channel is blocked or cannot be received with your XM Subscription package.

Channel Unavailable: This previously assigned channel is no longer assigned. Tune to another station.

No Artist Info: The system is working properly. No artist information is available at this time on this channel.

No Title Info: The system is working properly. No song title information is available at this time on this channel.

No CAT Info: The system is working properly. No category information is available at this time on this channel.

No Information: The system is working properly. No text or informational messages are available at this time on this channel.

No XM Signal: The system is working properly. The vehicle may be in a location that where the XM signal is being blocked. When the vehicle is moved into an open area, the signal should return.

CAT Not Found: The system is working properly. There are no channels available for the selected category.

XM Radio ID: If tuned to channel 0, this message alternates with the XM Radio 8 digit radio ID label. This label is needed to activate the service.

Unknown: If this message is received when tuned to channel 0, there could be a receiver fault. Consult with your dealer.

Check Antenna: If this message does not clear within a short period of time, the receiver could have a fault. Consult with your dealer.

XM Not Available: If this message does not clear within a short period of time, the receiver could have a fault. Consult with your dealer.

Radio Reception

Frequency interference and static can occur during normal radio reception if items such as cell phone chargers, vehicle convenience accessories, and external electronic devices are plugged into the accessory power outlet. If there is interference or static, unplug the item from the accessory power outlet.

FM

FM signals only reach about 16 to 65 km (10 to 40 miles). Although the radio has a built-in electronic circuit that automatically works to reduce interference, some static can occur, especially around tall buildings or hills, causing the sound to fade in and out.

AM

The range for most AM stations is greater than for FM, especially at night. The longer range can cause station frequencies to interfere with each other. Static can occur when things like storms and power lines interfere with radio reception. When this happens, try reducing the treble on the radio.

XM™ Satellite Radio Service

XM Satellite Radio Service gives digital radio reception from coast-to-coast in the 48 contiguous United States, and in Canada. Just as with FM, tall buildings or hills can interfere with satellite radio signals, causing the sound to fade in and out. In addition, traveling or standing under heavy foliage, bridges, garages, or tunnels may cause loss of the XM signal for a period of time.

Cellular Phone Usage

Cellular phone usage can cause interference with the vehicle's radio.

Multi-Band Antenna

The multi-band antenna is located on the roof of the vehicle. The antenna is used for the AM/FM radio, OnStar, the XM Satellite Radio Service System, and GPS (Global Positioning System); if the vehicle has these features. Keep the antenna clear of obstructions for clear reception. If the vehicle has a sunroof and it is open, the performance of the AM/FM radio, OnStar, XM system, and GPS can be affected.

Audio Players

CD Player (Radio with CD)

The CD player can play audio CDs and MP3 CDs.

The CD player will not play 8 cm (3 in) CDs.

Care of CDs

Sound quality can be reduced due to disc quality, recording method, quality of the music recorded, and how the disc has been handled. Handle discs carefully and store them in their original cases or other protective cases away from direct sunlight and dust. If the bottom surface of a disc is damaged, the disc may not play properly or at all. Do not touch the bottom surface of a disc while handling it; this could damage the surface. Pick up discs by grasping the outer edges or the edge of the hole and the outer edge.

If the bottom surface of a disc is dirty, take a soft lint free cloth, or dampen a clean soft cloth in a mild neutral detergent solution mixed with water, and clean it. Wipe the disc from the center to the outer edge.

Care of the CD Player

Do not add a label to a disc, as it could get caught in the CD player. If a label is needed, label the top of the recorded disc with a marking pen.

Do not use disc lens cleaners because they could contaminate the lens of the disc optics and damage the CD player.

Notice: If a label is added to a CD, or more than one CD is inserted into the slot at a time, or an attempt is made to play scratched or damaged CDs, the CD player could be damaged.

While using the CD player, use only CDs in good condition without any label, load one CD at a time, and keep the CD player and the loading slot free of foreign materials, liquids, and debris.

Control Buttons

The buttons used to control the CD player are:

CD: Press to use the CD player.

▶▶ SEEK/◀◀ SEEK : Press to select tracks or to fast forward or rewind within a track.

INFO: Press to display additional information about the current track that may be available.

TUNE: Turn to select tracks.

MENU/SELECT: Turn to enter the menu, press to select an item.

⏏ (Eject): Press to eject the disc.

⏸/|| : Press to pause a CD or MP3 track, press again to resume playback.

Inserting a CD

With the printed side facing up, insert a disc into the CD slot until it is drawn in.

Removing a CD

Press the  button.

The disc is pushed out of the CD slot.

If the disc is not removed after it is ejected, it is pulled back in after a few seconds.



Playing a CD or MP3 CD

Press the CD button, if there is a disc in the player, it begins playing.

Information about the disc and current track is shown on the display depending on the data stored.

Selecting a CD Track

Using the control buttons:

- Press the  SEEK or  SEEK button to select the previous or next track.
- Turn the TUNE knob.



Using the CD Menu:

1. Turn the MENU/SELECT knob.
2. Select Tracks list.
3. Select the track.

Playing Tracks in Random Order



Turn the MENU/SELECT knob and then set Shuffle Songs to On.

Fast Forward and Rewind

Press and hold  SEEK or  SEEK to fast forward or rewind within the current track.

Selecting an MP3 Track

Using the control buttons:

- Press the  SEEK or  SEEK button to select the previous or next track.
- Turn the TUNE knob.

Using the CD Menu:

1. Turn the MENU/SELECT knob.
2. Select Playlists / Folders.
3. Select the playlist or folder.
4. Select the track.

Searching for MP3 Tracks

The search feature may take some time to display the information after reading the disc due to the amount of information stored on the disc. FM automatically plays while the disc is being read.

Tracks can be searched by:

- Playlists
- Artists
- Albums
- Song Titles
- Genres
- Folder View

To search for tracks:

1. Turn the MENU/SELECT knob.
2. Select Search.
3. Select: Playlists, Artists, Albums, Song Titles, Genres, or Folder View.
4. Select the track.

CD/DVD Player

The CD/DVD player can play CDs, DVD-As, MP3/WMA CDs, MP3/WMA DVDs, and DVD-Vs.

The CD/DVD player will not play 8 cm (3 in) discs.

Care of CDs and DVDs

Sound quality can be reduced due to disc quality, recording method, quality of the music recorded, and how the disc has been handled.

Handle discs carefully and store them in their original cases or other protective cases away from direct sunlight and dust. If the bottom surface of a disc is damaged, the disc may not play properly or at all. Do not touch the bottom surface of a disc while handling it; this could damage the surface. Pick up discs by grasping the outer edges or the edge of the hole and the outer edge.

If the bottom surface of a disc is dirty, take a soft lint free cloth, or dampen a clean soft cloth in a mild neutral detergent solution mixed with water, and clean it. Wipe the disc from the center to the outer edge.

Care of the CD/DVD Player

Do not add a label to a disc, as it could get caught in the CD/DVD player. If a label is needed, label the top of the recorded disc with a marking pen.

Do not use disc lens cleaners because they could contaminate the lens of the disc optics and damage the CD/DVD player.

Notice: If a label is added to a CD, or more than one CD is inserted into the slot at a time, or an attempt is made to play scratched or damaged CDs, the CD player could be damaged. While using the CD player, use only CDs in good condition without any label, load one CD at a time, and keep the CD player and the loading slot free of foreign materials, liquids, and debris.

Control Buttons

The buttons used to control the CD/DVD player are:

6-22 Infotainment System

MEM/DVD/AUX: Press to choose between the MEM, CD/DVD, and AUX.

▶▶ SEEK/◀◀ SEEK : Press to select tracks or to fast forward or rewind within a track.

INFO: Press to display additional information about the disc that may be available.

TUNE: Turn to select tracks.

MENU/SELECT: Turn to enter the menu and press to select an item.

⏏ (Eject): Press to eject the disc.

▶/|| : Press to pause a CD, DVD-A, or DVD-V, press again to resume playback. Press and hold to stop a DVD-V disc.

Inserting a CD or DVD

With the printed side facing up, insert a disc into the slot until it is drawn in.

Removing a CD or DVD

Press the **⏏** button.

The disc is pushed out of the CD/DVD slot.

If the disc is not removed after it is ejected, it is pulled back in after a few seconds.

Playing a CD or DVD-A Disc

Press the MEM/DVD/AUX button if there is a disc in the player, it begins playing.

Information about the disc and current track is shown on the display depending on the data stored.

Selecting CD or DVD-A Tracks

Using the control buttons:

- Press the **◀◀ SEEK** or **▶▶ SEEK** button to select the previous or next track.
- Turn the TUNE knob.

Using the menu:

1. Turn the MENU/SELECT knob.
2. Select Tracks List.
3. Select the track.

Pausing a CD or DVD-A Track

Press the **▶/||** button to pause a CD or DVD-A track. Press the **▶/||** button again to continue playing the track.

Playing CD or DVD-A Tracks in Random Order

Turn the MENU/SELECT knob and then set Shuffle Songs to On.

Fast Forward and Rewind

Press and hold **▶▶ SEEK** or **◀◀ SEEK** to fast forward or rewind within the current track.

Playing an MP3 CD or DVD

Files that are not stored in folders are displayed in the root directory (disc).

The search rate increases if the MENU/SELECT knob is continuously turned while searching in a list.

Selecting an MP3 Track

Using the control buttons:

- Press ◀◀ SEEK or ▶▶ SEEK to select the previous or next track.
- Turn the TUNE knob.

Using the CD or DVD Menu:

1. Turn the MENU/SELECT knob.
2. Select Folder List.
3. Select the folder.
4. Select the track.

Searching for MP3s on a CD or DVD

It is normal for the search feature to take some time to display the information after reading the disc due to the amount of information stored on the disc. The infotainment system automatically switches to FM while the disc is being read.

Files that do not have any meta data stored in the ID3 tag display as Unknown.

Tracks can be searched for by:

- Playlists
- Artists
- Albums
- Song Titles
- Genres

The number of objects in each category is shown in parentheses after the category.

To search for tracks:

1. Turn the MENU/SELECT knob.
2. Select Search.
3. Select: Playlists, Artists, Albums, Song Titles, or Genres.
4. Select the track. The search rate increases if the menu knob is continuously turned while searching in a list.

Playing MP3 Tracks in Random Order

Turn the MENU/SELECT knob and then set Shuffle Songs to On.

Recording an Audio or MP3 CD to MEM

See *Mass Storage Media (MEM)* on page 6-25 for more information.

Playing a DVD-V

See *Rear Seat Entertainment (RSE) System* on page 6-36 for information about how to control a Video DVD using the wireless remote control.

Selecting a Chapter

Using the control buttons:

- Press **◀◀** SEEK or **▶▶** SEEK to select the previous or next chapter.
- Turn the TUNE knob.

Using DVD Menu:

1. Turn the MENU/SELECT knob.
2. Select Chapter List.
3. Select the chapter.

Selecting a Title

1. Turn the MENU/SELECT knob.
2. Select Title List.
3. Select the title.

Changing the Audio Stream

1. Turn the MENU/SELECT knob.
2. Select Audio Stream.
3. Select Change Audio Stream.
4. Press MENU/SELECT to change the selection.

Select Cancel to exit the menu.

Pausing a DVD

1. Turn the MENU/SELECT knob.
2. Select Pause, to pause the disc. Select un-pause to start playback.

Navigating the DVD-V Disc Menu

Use the following actions to navigate the title menu on a DVD-V Disc.

- Select / Enter
- Cursor UP
- Cursor DOWN

- Cursor RIGHT
- Cursor LEFT
- Up Menu

Use the following actions to navigate the menu on a DVD-V Disc while playing chapters.

- Pause (Play)
- Chapter List
- Title List
- DVD/DVD — DVD on both video screens
- DVD/AUX — Left video screen / Right AUX input
- AUX/DVD — Left AUX input / Right video screen
- AUX/AUX — AUX input on both video screens

To navigate the menu:

1. Turn the MENU/SELECT knob.
2. Select the action.

Mass Storage Media (MEM)

Infotainment systems with MEM storage are able to record up to 1.1 GB (gigabyte) of music from Audio CDs, MP3/WMA/AAC discs, and USB storage devices. The MEM player can also time shift audio from AM, FM, and XM™ radio.

Music or content that is stored in MEM that you did not create, or have the right to distribute, must be deleted before the sale or end of the lease of the vehicle.

Control Buttons

The buttons used to control the MEM player are:

MEM/DVD/AUX: Press to select the MEM player.

▶▶ SEEK/◀◀ SEEK : Press to select tracks or to fast forward or rewind within a track.

INFO: Press to display additional information about the MEM track that may be available. Turn to select tracks.

▶/|| : Press to pause the track currently playing, press again to resume playback.

● REC: Press to record music from a CD or USB drive.

DEL: Press to delete the current track from MEM.

FAV (Favorites): Press to display MEM favorites.

1 to 6: Press to select a track or playlist stored in that numeric position.

Recording From Audio CDs

The infotainment system can record the current song playing or all songs from an audio CD to MEM. A status bar appears on the top of the display when the recording process starts and disappears when the process has ended. Copy protected CDs cannot be recorded to MEM.

Recording to MEM

Press **● REC**, then select “Record Current Song” or “Record All Songs on Disc”. If the track has started playing, the system will restart the track and begin recording from the beginning of the track. When the song recording is completed, the message “Song Recorded to MEM” displays, and there may be a slight pause.

Songs recorded to MEM are stored as the current date, disc and track number.

Re-recording a Previously Recorded Disc

If the disc or track has already been recorded to MEM, the message “The Song(s) is Already Recorded” displays.

Stopping the Recording

Press the ● REC button while recording from an audio CD to display the stop recording option. Select “Stop Recording Song to MEM”.

Renaming Recorded Discs

Discs that have been recorded to MEM can be renamed.

1. Turn the MENU/SELECT knob.
2. Select Rename Recorded Discs.
3. Select the disc.
4. Select Album or Artist to rename either one.
5. Use the menu knob to enter the character sequence. See *Operation on page 6-7* for more information.

Recording From MP3/WMA Discs or USB Storage Devices

USB Host Support

The USB connector uses the USB standards, 1.1 and 2.0.

USB Supported Devices

- USB Flash Drives
- Portable USB Hard Drives

Recording to MEM

Press ● REC, then select “Record Current Song” or “Record All Songs on Disc”.

The information stored by MEM is titled according to the ID3 tag associated with it.

Re-recording a Previously Recorded Disc

If the disc or track has already been recorded to MEM the message “The Song(s) is Already Recorded” displays.

Stopping the Recording

Press the ● REC button while recording from an MP3/WMA CD or USB storage device to display the stop recording option. Select “Stop Recording Song to MEM”

Deleting Tracks From MEM

Individual tracks and all tracks can be deleted from MEM.

To delete individual tracks, press and release the DEL button while the track is playing.

To delete all tracks from MEM, press and hold the DEL button while a track is playing.

Playing From MEM

Playing Back a Previously Recorded CD

Turn the TUNE knob to select a track if MEM is already playing from the previously recorded disc.

1. Select Recorded Disc List.
2. Select the disc.
3. Select the track.

Searching For a Track

Tracks can be searched for by:

- Playlists
- Artists
- Albums
- Song Titles
- Genres

The number of objects in each category is shown in parentheses after the category.

To search for tracks:

1. Turn the MENU/SELECT knob.
2. Select Search.
3. Select: Playlists, Artists, Albums, Song Titles, or Genres.
4. Select the track. The search rate increases if the MENU/SELECT knob is continuously turned while searching in a list.

Shuffle Songs

Select the Shuffle Songs option from the MEM menu to randomly play back tracks stored in MEM.

Configuring MEM Favorites

During MEM playback, press the FAV button to change between favorite categories. The favorite categories are:

- Playlists
- Artists
- Albums
- Genres

To remove MEM favorites categories:

1. Press the CONFIG button.
2. Select Radio Settings.
3. Select MEM Favorites.
4. Remove the check mark from the box to remove that MEM favorites category.

Replace the check mark to re-add the removed category.

Saving MEM Tracks as Favorites

Favorites can be saved by pressing and holding one of the 1 to 6 buttons. Favorites can be stored according to the following list:

Playlist: Adds currently playing track to the playlist selected.

Artist: Saves the artist associated with the currently playing track in the indicated favorites position.

Album: Saves the album associated with the currently playing track in the indicated favorites position.

Genre: Saves the genre associated with the currently playing track in the indicated favorites position.

Creating Playlists

To create a playlist using tracks stored in MEM:

1. Select Playlist from the MEM favorites.
2. Select the track to be stored in the playlist.
3. Press and hold one of the 1 to 6 buttons until the track can be heard again to store the track.
4. Repeat steps 1 through 3 to store additional tracks in the playlist.

Auxiliary Devices (Radio with CD)

The optional AUX input allows portable devices to connect to the vehicle using the 3.5 mm (1/8 in) input jack, the USB port or Bluetooth® wireless technology, if equipped.

Portable devices are controlled by using the menu system described in *Operation on page 6-7*.



The AUX input is located in the center console.

3.5 mm Auxiliary Input Jack

Connect a 3.5 mm (1/8 in) cable to the 3.5 mm auxiliary input jack to use a portable audio player.

Playback of an audio device that is connected to the 3.5 mm auxiliary input jack can only be controlled using the controls on the device.

Adjusting the Volume

Turn the VOL/  knob to adjust the volume of the infotainment system after the volume level has been set on the portable audio device.

USB Port

For vehicles with a USB port, the following devices may be connected and controlled by the infotainment system.

- iPods
- PlaysForSure Devices (PFD)
- USB Drives
- Zunes

Not all iPods, PFDs, USB Drives, and Zunes are compatible with the infotainment system.

Connecting and Controlling an iPod™

Not all iPod's can be controlled by the infotainment system.

Connecting an iPod

Connect the iPod to the USB port.

Searching For a Track

Tracks can be searched for by:

- Playlists
- Artists
- Albums
- Song Titles
- Podcasts
- Genres
- Audiobooks
- Composers

To search for tracks:

1. Turn the MENU/SELECT knob.
2. Select Search.
3. Select: Playlists, Artists, Albums, Song Titles, Podcasts, Genres, Audiobooks, or Composers.
4. Select the track.

Shuffle

Turn the MENU/SELECT knob and set Shuffle Songs (Random) to On or Off, then press the  BACK button to return the main screen.

On: Plays tracks in the current folder in random order.

Off: Plays tracks in the current folder in sequential order.

Repeat

Turn the MENU/SELECT knob and set Repeat to On or Off, then press the  BACK button to return the main screen.

On: Repeats the current track.

Off: Playback starts from the beginning of the current track after the last track finishes.

Connecting and Controlling a PlaysForSure Device (PFD) or Zune™

Connecting a PFD or Zune

Connect the PFD or Zune to the USB port.

Searching For a Track

Tracks can be searched for by:

- Playlists
- Artists
- Albums
- Song Titles
- Podcasts
- Genres

To search for tracks:

1. Turn the MENU/SELECT knob.
2. Select Search.
3. Select: Playlists, Artists, Albums, Song Titles, Podcasts, or Genres.
4. Select the track.

Shuffle Functionality

Turn the MENU/SELECT knob and set Shuffle Songs (Random) to On or Off.

On: Plays current tracks in random order.

Off: Plays current tracks in sequential order.

Repeat Functionality

Turn the MENU/SELECT knob and set Repeat to On or Off.

Repeat On: Repeats the current track.

Repeat Off: Playback starts from the beginning of the current track after the last track finishes.

Connecting and Controlling a USB Drive

The infotainment system can only play back .mp3 and .wma files from a USB drive.

Only the first 2,500 songs are recognized on the device.

When a device is not supported, the message “No supported data found. You can safely disconnect the device” appears.

Connecting a USB Drive

Connect the USB drive to the USB port.

Searching For a Track

It is normal for the search feature to take some time to display the information after reading the device due to the amount of information stored.

Files that do not have any meta data stored in the ID3 tag display as Unknown.

Tracks can be searched for by:

- Playlists*
- Artists
- Albums
- Song Titles
- Genres
- Folder View

*This only displays if a playlist is found on the device.

To search for tracks:

1. Turn the MENU/SELECT knob.
2. Select Search.
3. Select: Playlists, Artists, Albums, Song Titles, Genres, or Folder View.
4. Select the track.

Shuffle Functionality

Turn the MENU/SELECT knob and set Shuffle Songs (Random) to On or Off.

On: Plays current tracks in random order.

Off: Plays current tracks in sequential order.

Repeat Functionality

Turn the MENU/SELECT knob and set Repeat to On or Off.

Repeat On: Repeats the current track.

Repeat Off: Playback starts from the beginning of the current track after the last track finishes.

Connecting a Bluetooth® Device

Before a Bluetooth device can be connected to the infotainment system, it must first be paired to the system. Not all Bluetooth devices can be paired to the infotainment system. Before pairing the Bluetooth device, become familiar with its user guide for Bluetooth functions. The system only connects to Bluetooth devices that support A2DP (Advanced Audio Distribution Profile) version 1.2.

A Bluetooth phone with MP3 capability can not be paired to the vehicle as a phone and an MP3 player at the same time.

6-32 Infotainment System

Pairing Information:

- Up to five devices can be paired to the system.
- The pairing process is disabled when the vehicle is moving.
- The infotainment system automatically links with the first available paired device in the order the device was paired.
- Only one paired device can be connected to the infotainment system at a time.
- Pairing should only need to be completed once, unless changes to the pairing information have been made or the device is deleted.

Bluetooth Setup Menu

The Bluetooth Setup menu can be accessed with or without a device attached to the USB port.

To select the Bluetooth Setup menu when a device is attached to the USB port and active:

1. Turn the MENU/SELECT knob while in the iPod, Zune, PFD, or USB device main menu.
2. Select Bluetooth Music Setup.

To select the Bluetooth Music Setup menu when a device is not attached to the USB port, or when a device is attached to the USB port but not active:

1. Press the AUX button until AUX is the active source.
2. Turn the MENU/SELECT knob.
3. Select Bluetooth Music Setup.

To select the Bluetooth Music Setup menu when a Bluetooth device is connected and active:

1. Turn the MENU/SELECT knob.
2. Select Bluetooth Music Setup.

Pairing a Device

1. Select Connect To New Device from the Bluetooth Music Setup menu.
2. The system asks a series of Yes/No questions to determine what type of device is being paired.
3. After the system determines what type of Bluetooth device is being paired, the Bluetooth device will need to be put into discovery mode.

4. Some devices may require a PIN number in order to complete the pairing process. Locate the device named “GMusicConnect” in the list on the Bluetooth device and follow the instructions on the device to enter the four digit PIN number provided by the infotainment system.

Connecting to a Device

Once a device is paired to the infotainment system, it can be connected to the infotainment system.

To connect a paired device when no other device is connected to the infotainment system:

1. Select the Select Device option from the Bluetooth Music Setup menu.
2. Select the new device.

To connect a paired device when another device is connected to the infotainment system:

1. Select the Select Device option from the Bluetooth Music Setup menu.
2. Select the new device.
3. The active device is disconnected from the system and the new device is connected.

Removing a Device

1. Select Remove Device from the Bluetooth Music Setup menu.
2. Select the device.
3. The device is removed from the system.

Before connecting to the removed device again, it will need to be paired to the infotainment system.

Changing the Default PIN

To change the default PIN:

1. Select Change Default PIN from the Bluetooth Music Setup menu.
2. Select one of the pre-defined PIN numbers, or select Other to create a PIN.

To create a PIN:

1. Select the length of the PIN number.
2. Enter the character sequence.

Messages

The following messages may appear on the infotainment screen.

Poor Bluetooth Signal Quality:

This message displays when the Bluetooth signal strength is low.

This Feature is Unavailable While Vehicle is Moving:

This message displays when an action is not allowed while the vehicle is moving.

Controlling a Bluetooth® Device

Bluetooth devices that support AVRCP (Audio/Video Remote Control Profile) version 1.0 may be able to be controlled by the infotainment system.

Press and release
◀◀ SEEK / ▶▶ SEEK to skip tracks.

Other Information

The Bluetooth® word mark and logos are owned by the Bluetooth® SIG, Inc. and any use of such marks by General Motors is under license. Other trademarks and trade names are those of their respective owners.

See *Radio Frequency Statement on page 12-17* for FCC information.

Auxiliary Devices (Radio with CD/DVD and MEM)

The optional AUX input allows portable devices to be connected using the 3.5 mm (1/8 in) input jack or the USB port.

Portable devices are controlled by using the menu system described in *Operation on page 6-7*.



The AUX input is located in the center console.

3.5 mm Auxiliary Input Jack

Connect a 3.5 mm (1/8 in) cable to the 3.5 mm auxiliary input jack to use a portable audio player.

Playback of an audio device that is connected to the 3.5 mm auxiliary input jack can only be controlled using the controls on the device.

Adjusting the Volume

Turn the VOL/  knob to adjust the volume of the infotainment system after the volume level has been set on the portable audio device.

USB Port

The following devices may be connected to the USB port and controlled by the infotainment system.

- iPods
- USB Mass Storage Devices

Not all iPods or USB Mass Storage Devices are compatible with the infotainment system.

Connecting and Controlling an iPod™

Not all iPod's can be controlled by the infotainment system.

Connecting an iPod

Connect the iPod to the USB port.

Selecting a Track

Using the control buttons:

- Press ◀◀ SEEK or ▶▶ SEEK to select the previous or next track.
- Turn the TUNE knob to select a track in the current sub menu. The track will start to play.

Playing Tracks in Random Order

Turn the MENU/SELECT knob and set Shuffle Songs to On or Off.

Shuffle On: Plays current tracks in random order.

Shuffle Off: Plays current tracks in sequential order.

Searching For a Track

Tracks can be searched for by:

- Playlists
- Artists
- Albums
- Song Titles
- Genres
- Composers
- Audiobooks

The number of objects in each category is shown in parentheses after the category.

To search for tracks:

1. Turn the MENU/SELECT knob.
2. Select Search.
3. Select: Playlists, Artists, Albums, Song Titles, Genres, Composers, or Audiobooks.
4. Select the track. The search rate increases if the MENU/SELECT knob is continuously turned while searching in a list.

Connecting and Controlling a USB Drive

Files that are not stored in folders are displayed in the root directory (USB).

Connecting a USB Drive

Connect the USB drive to the USB port.

Disconnecting a USB Drive

A USB drive should be ejected from the USB port before disconnecting it. To eject a USB drive:

1. Turn the MENU/SELECT knob.
2. Select USB Eject.

Playing Tracks in Random Order

Turn the MENU/SELECT knob and then set Shuffle Songs to On.

Selecting a Track

Using the control buttons:

- Press ◀◀ SEEK or ▶▶ SEEK to select the previous or next track.
- Turn the TUNE knob to select a track in the current sub menu. The track will start to play.

Selecting a track in a different folder:

1. Turn the MENU/SELECT knob.
2. Select Folder List.
3. Select the folder.
4. Select the track.

Searching for Tracks

It is normal for the search feature to take some time to display the information after reading the device due to the amount of information stored.

Files that do not have any meta data stored in the ID3 tag display as Unknown.

Tracks can be searched by:

- Playlists
- Artists
- Albums
- Song Titles
- Genres

The number of objects in each category is shown in parentheses after the category.

To search for tracks:

1. Turn the MENU/SELECT knob.
2. Select Search.
3. Select: Playlists, Artists, Albums, Song Titles, or Genres.
4. Select the track. The search rate increases if the MENU/SELECT knob is continuously turned while searching in a list.

Recording Tracks to MEM

See *Mass Storage Media (MEM)* on page 6-25 for more information.

Rear Seat Infotainment

Rear Seat Entertainment (RSE) System

The vehicle may have a DVD Rear Seat Entertainment (RSE) system. The RSE system works with the vehicle's infotainment system. The DVD player is part of the front radio. The RSE system includes a radio with a DVD player, two rear seat video display screens, audio/video jacks, two wireless headphones, and a remote control. See *CD/DVD Player* on page 6-21 or the separate navigation system manual for more information on the vehicle's DVD system.

Before Driving

The RSE is for rear seat passengers only. The driver cannot safely view the video screen while driving.

In severe or extreme weather conditions the RSE system may not work until the temperature is within the operating range. The operating range is above -20°C (-4°F) and below 60°C (140°F). If the temperature is outside of this range, heat or cool the vehicle until it is within the operating range.

Global Off

Depending on the infotainment system, the RSE system may have a Global Off feature. The Global Off feature disables all RSE system features. Press and hold the radio power button for more than three seconds for Global Off to disable the RSE features.

A padlock icon may display on the infotainment screen when the Global Off feature is on. On some infotainment systems, the Global Off feature can be turned off by performing one of the following:

- Press and hold the radio power button for more than three seconds.
- Insert or eject any disc.
- Insert a DVD video disc.
- Press the Remote Control power button.
- Press the MEM/DVD/AUX button or the $\blacktriangleright/\parallel$ button when a DVD video disc is in the player.
- Press the SRC button on the steering wheel when a DVD video disc is in the player.
- Cycle the ignition.

Headphones

RSE includes two 2-channel wireless headphones. Channel 1 is dedicated to the DVD player, and Channel 2 is dedicated to RSA selections. The headphones are used to listen to various multi-media. If the vehicle is not equipped with RSA, then channel 2 is dedicated to any external auxiliary device connected to the rear A/V jacks. The wireless headphones have an On/Off button, channel 1/2 switch, and a volume control. Turn the headphones off when not in use.

Push the On/Off button to turn on the headphones. A light on the headphones comes on. If the light does not come on, check the batteries. Intermittent sound or static can also indicate weak batteries. See "Battery Replacement" later in this section for more information.

Infrared transmitters are on the top of the left seatback video screen. The headphones shut off automatically to save the battery power if the RSE system and RSA are shut off or if the headphones are out of range of the transmitters for more than three minutes. Moving too far forward or stepping out of the vehicle, can cause the headphones to lose the signal or have static.

The headphones may automatically turn off after four hours of continuous use.

To adjust the volume on the headphones, use the volume control.

For best audio performance, the headphones must be worn correctly, with the headband over the top of the head. L (Left) and R (Right) are above the ear pads and are indicators as to how the headphones should be placed on the head.

Notice: Do not store the headphones in heat or direct sunlight. This could damage the headphones and repairs will not be covered by the warranty. Storage in extreme cold can weaken the batteries. Keep the headphones stored in a cool, dry place.

If the foam ear pads become worn or damaged, they can be replaced separately from the headphones. See your dealer for more information.

Battery Replacement

To change the batteries:

1. Loosen the screw to the battery door located on the left side of the headphones.
2. Slide the battery door open.
3. Replace the two AAA batteries.
4. Replace the battery door and tighten the screw.

Remove the batteries if the headphones are not going to be used for a long period of time.

Audio/Video (A/V) Jacks

The A/V jacks may be located on the rear of the floor console. They allow audio or video cables to be connected from an auxiliary device such as a camcorder or a video game system.

The A/V jacks are color coded:

- Yellow for video input.
- White for left audio input.
- Red for right audio input.

Power for auxiliary devices is not supplied by the radio system.

To use the auxiliary inputs of the RSE system:

1. Connect the auxiliary device cables to the A/V jacks.
2. Power on both the auxiliary device and the RSE video screen.

Changing the Source on the Video Display Screens







The image from the auxiliary device can be switched between the video display screens.

To change the display:

1. Press the AUX button on the remote control to change the source of both video screens from the DVD player to the auxiliary device.
2. Press the AUX button a second time to change the left video screen source to the DVD player and the right video screen to the auxiliary device.
3. Press the AUX button a third time to change the left video screen source to the auxiliary device and the right video screen to the DVD player.
4. Press the AUX button a fourth time to change the source of both video screens to the DVD player.

How to Change the RSE Video Screen Settings

The screen display mode, brightness, and language can be changed from the setup menu using the remote control. To change a setting:

1. Press .
2. Use , , ,  and  select the settings.
3. Press  again to exit the setup menu.

Audio Output

Audio from the DVD player or auxiliary inputs can be heard through the following:

- Wireless Headphones
- Vehicle Speakers
- Vehicle wired headphone jacks on the rear seat audio system, if the vehicle has this feature.

The RSE system transmits the audio signal to the wireless headphones if an audio signal is available. See “Headphones” earlier in this section for more information.

Audio can be heard from the wired headphone jacks on the RSA system by selecting the desired source from the RSA system, if the vehicle has this feature.

The front seat passengers are able to listen to playback from the A/V jacks through the vehicle speakers by selecting Rear A/V as the source on the radio.

Video Screens

The video screens are located in the back of the driver and front passenger seats.



To use the video screen:

1. Push the release button located on the seatback console.
2. Move the screen to the desired viewing position.

Push the video screen down into its locked position when it is not in use. The screen turns off automatically.

Only the left RSE seatback console contains the infrared transmitters for the wireless headphones, they may be visible as eight illuminated LEDs. These LEDs are not on the right video screen. Both seatback consoles contain an infrared receiver for the remote control. They are located at the top of each console.

Notice: Avoid directly touching the video screen, as damage may occur. See “Cleaning the Video Screen” later in this section for more information.

Video Screen Input Jack

Each video screen is equipped with a video input jack to allow video cables to be connected from an auxiliary device such as a camcorder or a video game system. This signal will override any video provided by the RSE system; either the DVD or Auxiliary A/V jack source. The RSE system must be on for this input to operate.

Remote Control

To use the remote control, aim it at the transmitter window at either seatback console and press the button. Direct sunlight or very bright light could affect the ability of the RSE transmitter to receive signals from the remote control. Check the batteries if the remote control does not seem to be working. See “Battery Replacement” later in this section. Objects blocking the line of sight could also affect the function of the remote control.

If a CD, DVD, or MP3 disc is in the Radio DVD slot, the remote control  button can be used to turn on the video screen display and start the disc. The infotainment system can also turn on the video screen display. See *CD/DVD Player on page 6-21* or the separate navigation system manual for more information.

Notice: Storing the remote control in a hot area or in direct sunlight can damage it, and the repairs will not be covered by the warranty. Storage in extreme cold can weaken the batteries. Keep the remote control stored in a cool, dry place.

Remote Control Buttons

 **(Power):** Press to turn the video screens on and off.

 **(Illumination):** Press to turn the remote control backlight on. The backlight times out after several seconds if no other button is pressed.

 **(Title):** Press to return to the main menu of the DVD. This function could vary for each disc.

 **(Main Menu):** Press to access the DVD menu. The DVD menu is different on every DVD. Use the navigation arrows to move the cursor. After making a selection press the enter button. This button only operates when using a DVD.

 **(Menu Navigation Arrows):** Use the arrow buttons to navigate through a menu.

 **(Enter):** Press to select the highlighted choice in any menu.





 **(Display Menu):** Press to adjust the brightness, screen display mode, and display the language menu.

 **(Return):** Press to exit the current active menu and return to the previous menu. This button operates only when the display menu or a DVD menu is active.

 **(Stop):** Press to stop playing, rewinding, or fast forwarding a DVD. Press twice to return to the beginning of the DVD.

 **(Play/Pause):** Press to start playing a DVD. Press to pause a DVD while it is playing. Press again to continue playing.



6-42 Infotainment System



Depending on the infotainment system in the vehicle, DVD playback may be slowed down by pressing  || then . Reverse slow play by pressing  || then . Press  || again to cancel slow play.

(Previous Track/Chapter):

Press to go to the start of the current track or chapter. Press again to go to the previous track or chapter. This button may not work when the DVD is playing the copyright information or the previews.

 **(Next Track/Chapter):** Press to go to the beginning of the next chapter or track. This button might not work when the DVD is playing the copyright information or the previews.

 **(Fast Reverse):** Press to quickly reverse the DVD or CD. To stop fast reversing a DVD video, press  ||. To stop fast reversing a DVD audio or CD, release . This button might not work when the DVD is playing the copyright information or the previews.

 **(Fast Forward):** Press to fast forward the DVD or CD. To stop fast forwarding a DVD video, press  ||. To stop fast forwarding a DVD audio or CD, release . This button might not work when the DVD is playing the copyright information or the previews.

 **(Audio):** Press to change audio tracks on DVDs that have this feature when the DVD is playing.

 **(Subtitles):** Press to turn ON/OFF subtitles and to move through subtitle options when a DVD is playing.

AUX (Auxiliary): Press to switch the video displays between the DVD player and an auxiliary source.

 **(Camera):** Press to change the camera angle on DVDs that have this feature when the DVD is playing.

 **(Clear) (If Available):** Press this button within three seconds after inputting a numeric selection, to clear all numeric inputs.

 **10 (Double Digit Entries) (If Available):** Press this button to select chapter or track numbers greater than 9. Press this button before inputting the number.

1 through 0 (Numeric Keypad): The numbered keypad provides the capability of direct chapter or track number selection.

Replacing the Remote Control

If the remote control becomes lost or damaged, a new universal remote control can be purchased. Use a Toshiba® code set for replacement universal remote controls.

Battery Replacement

To change the remote control batteries:

1. Slide back the rear cover on the remote control.
2. Replace the two batteries in the compartment.
3. Replace the battery cover.

Remove the batteries from the remote control if unused for an extended period of time.

Tips and Troubleshooting Chart

| Problem | Recommended Action |
|---|--|
| No power. | The ignition might not be turned ON/RUN or in ACC/ACCESSORY. |
| The picture does not fill the screen. There are black borders on the top and bottom or on both sides or it looks stretched out. | Check the display mode settings in the setup menu by pressing the display menu button on the remote control. |
| In auxiliary mode, the picture moves or scrolls. | Check the auxiliary input connections at both devices. |
| The remote control does not work. | Check to make sure there is no obstruction between the remote control and the transmitter window. Check the batteries to make sure they are not dead or installed incorrectly. |
| After stopping the player, I push Play but sometimes the DVD starts where I left off and sometimes at the beginning. | If the stop button was pressed one time, the DVD player resumes playing where the DVD was stopped. If the stop button was pressed two times the DVD player begins to play from the beginning of the DVD. |

Tips and Troubleshooting Chart (cont'd)

| Problem | Recommended Action |
|---|---|
| The auxiliary source is running but there is no picture or sound. | Check that the RSE video screen is in the auxiliary source mode by pressing the AUX button on the remote control. Check the auxiliary input connections at both devices. |
| Sometimes the wireless headphone audio cuts out or buzzes. | Check for obstructions, low batteries, reception range, and interference from cellular telephone towers or by using a cellular telephone in the vehicle. Check that the headphones are on correctly using the L (left) and R (right) on the headphones. Check that the headphones are positioned properly with the headband across the top of the head. |
| I lost the remote and/or the headphones. | See your dealer for assistance. |
| The DVD is playing, but there is no picture or sound. | Check that the RSE video screen is sourced to the DVD player by pressing the AUX button on the remote control. |

DVD Display Error Messages

The DVD display error message depends on which radio the vehicle has. The video screen may display one of the following:

Disc Load/Eject Error or Mechanical Error: There are disc load or eject problems.

Disc Format Error or Unknown Format: The disc is inserted with the disc label wrong side up, or if the disc is damaged.

Disc Region Error or Disc Error: The disc is not from a correct region.

No Disc Inserted: No disc is present when the  EJECT or MEM/DVD/AUX button is pressed on the radio.

DVD Distortion

Video distortion can occur when operating cellular phones, scanners, CB radios, Global Position Systems (GPS)*, two-way radios, mobile fax, or walkie talkies.

It might be necessary to turn off the DVD player when operating one of these devices in or near the vehicle.

*Excludes the OnStar[®] System.

Cleaning the RSE Seatback Console

Use only a clean cloth dampened with clean water to clean the RSE seatback console surface.

Cleaning the Video Screens

Use only a clean cloth dampened with clean water. Use care when touching or cleaning the screens as damage could result.

Rear Seat Audio (RSA) System

Vehicles with this feature allow the rear seat passengers to listen to and control any of the music sources: radio, CDs, DVDs, or other auxiliary sources. RSA can only control music sources that the front seat passengers are listening to, except on radios where dual control is allowed.

RSA can function when the front radio is off.  displays on the infotainment system when RSA is on.

Audio can be heard through wired headphones (not included) plugged into the jacks on the RSA. If the vehicle has a Rear Seat Entertainment system with wireless headphones, audio can also be heard on Channel 2 of the wireless headphones.

To listen to a portable audio device through the RSA, attach the portable audio device to the auxiliary input, if available. Turn the device on, then choose the front auxiliary input with the RSA SRCE button.

6-46 Infotainment System



Power: Press to turn the RSA on or off.

Volume: Turn to increase or decrease the volume of the wired headphones. The left knob controls the left headphones and the right knob controls the right. Use the volume control on headphones for wireless headphones.

SRCE (Source): Press to select between the radio, CD, and if these features are available: DVD, front or rear auxiliary, HDD, USB. The front radio may override the rear selection as required.

Seek: While listening to the radio, press to go to the previous or to the next station and stay there. If the front seat passengers are listening to the radio, this function may be inactive on some radios.

Press and hold \leftarrow or \rightarrow until "Tune" displays. Continue to press \leftarrow or \rightarrow to tune to an individual station. Tune stays active until \leftarrow or \rightarrow has not been pressed for several seconds.

If the front seat passengers are listening to the radio, this function may be inactive on some radios.



While listening to a disc, press \rightarrow to go to the next track or chapter on the disc. Press \leftarrow to go back to the start of the current track or chapter if more than ten seconds have played. If the front seat passengers are listening to a disc, this function may be inactive on some radios. Press and hold \leftarrow or \rightarrow to fast reverse or fast forward.

When a DVD video menu is being displayed, press \leftarrow or \rightarrow to cursor up or down on the menu. Hold \leftarrow or \rightarrow to cursor left or right on the menu.

PROG (Program): Press to go to the next preset radio station or channel set on the main radio. If the front seat passengers are listening to the radio, this function may be inactive on some radios.

When a CD or DVD audio disc is playing, press PROG to go to the beginning of the disc or display disc info. If the front seat passengers are listening to a disc, this function may be inactive on some radios.

When a disc is playing in the CD or DVD changer, press and hold PROG to select the next disc, if multiple discs are loaded. If the front seat passengers are listening to a disc, this function may be inactive on some radios.

The PROG button may be used to access the menu of an MP3. Once in the menu, use  or  to make selections.

When a DVD video menu is displayed, press PROG, or press and hold PROG to perform the menu function, ENTER.

Phone



Bluetooth (Overview)



Vehicles with a Bluetooth system can use a Bluetooth capable cell phone with a Hands Free Profile to make and receive phone calls. The infotainment system and voice recognition are used to control the system. The system can be used while in ON/RUN or ACC/ACCESSORY. The range of the Bluetooth system can be up to 9.1 m (30 ft). Not all phones support all functions and not all phones work with the Bluetooth system. See www.gm.com/bluetooth for more information about compatible phones.

Bluetooth Controls

Use the buttons located on the infotainment system and the steering wheel to operate the Bluetooth system.

Steering Wheel Controls

 /  (Push To Talk) : Press to answer incoming calls, to confirm system information, and to start voice recognition.

 /  (End Call / Mute): Press to end a call, reject a call, or to cancel an operation.

Infotainment System Controls

For information about how to navigate the menu system using the infotainment controls, see *Operation on page 6-7*.

PHONE: Press to enter the Phone main menu.

Voice Recognition

The voice recognition system uses commands to control the system and dial phone numbers.

Noise: The system may not recognize voice commands if there is too much background noise.

When to Speak: A tone sounds to indicate that the system is ready for a voice command. Wait for the tone and then speak.

How to Speak: Speak clearly in a calm and natural voice.

Audio System

When using the Bluetooth system, sound comes through the vehicle's front audio system speakers and overrides the audio system. Use the VOL/  knob during a call to change the volume level. The adjusted volume level remains in memory for later calls. The system maintains a minimum volume level.

Other Information

The Bluetooth® word mark and logos are owned by the Bluetooth® SIG, Inc. and any use of such marks by General Motors is under license. Other trademarks and trade names are those of their respective owners.

See *Radio Frequency Statement on page 12-17* for Federal Communications Commission and Industry Canada Standards information.

Bluetooth (Infotainment Controls)

For information about how to navigate the menu system using the infotainment controls, see *Operation on page 6-7*.

Pairing

A Bluetooth enabled cell phone must be paired to the Bluetooth system first and then connected to the vehicle before it can be used.

See the cell phone manufacturer user guide for Bluetooth functions before pairing the cell phone. If a Bluetooth phone is not connected, calls will be made using OnStar® Hands-Free Calling, if available. Refer to the OnStar Owner's Guide for more information.

A Bluetooth phone with MP3 capability can not be connected to the vehicle as a phone and an MP3 player at the same time.

The pairing process can be started by using the voice recognition system or the controls on the infotainment system.

Pairing Information:

- Up to five cell phones can be paired to the Bluetooth system.
- The pairing process is disabled when the vehicle is moving.
- The Bluetooth system links with the first available paired cell phone based on the order shown in the device list.

- Only one paired cell phone can be connected to the Bluetooth system at a time.
- Pairing should only need to be completed once, unless changes to the pairing information have been made or the phone is deleted.

To link to a different paired phone, see “Linking to a Different Phone” later in this section.

Pairing a Phone

1. Press the CONFIG button.
2. Select Phone Settings.
3. Select Bluetooth.
4. Select Pair Device (Phone).
A four digit PIN number appears on the display.

If the “Add new GPS device” option is selected, the system will start a search for Bluetooth “Handsfree” profile devices just like if “Add new Phone” was selected . The additional GPS location feature which would

provide the vehicle's GPS location through the Bluetooth Serial Port Profile is not available.

5. Start the Pairing process on the cell phone that will be paired to the vehicle. Reference the cell phone manufacturers user guide for information on this process.

Locate the device named “General Motors” in the list on the cellular phone and follow the instructions on the cell phone to enter the four digit PIN number provided by the system.

6. The system prompts for a name for the phone and confirms the name provided. This name is used to indicate which phone is connected.
7. The system responds with “<Phone name> has been successfully paired” after the pairing process is complete.
8. Repeat Steps 1 through 7 to pair additional phones.

Listing All Paired and Connected Phones

1. Press the CONFIG button.
2. Select Phone Settings.
3. Select Bluetooth.
4. Select Device List.

Deleting a Paired Phone

1. Press the CONFIG button.
2. Select Phone Settings.
3. Select Bluetooth.
4. Select Device List.
5. Select the phone to delete and follow the on screen prompts.

Linking to a Different Phone

In order to link to a different phone, the new phone must be in the vehicle and available to be connected to the bluetooth system before the process is started.

1. Press the CONFIG button.
2. Select Phone Settings.
3. Select Bluetooth.
4. Select Device List.
5. Select the new phone to link to and follow the on screen prompts.

If delete is selected, the highlighted phone will be deleted.

Making a Call

Radio with CD

1. Press the PHONE button twice.
2. Enter the character sequence. See "Entering a Character Sequence" in *Operation on page 6-7* for more information.
3. Select Call to start dialing the number.

Radio with CD/DVD/MEM

1. Press the PHONE button.
2. Select Enter number.
3. Enter the character sequence. See "Entering a Character Sequence" in *Operation on page 6-7* for more information.
4. Select Call to start dialing the number.

Accepting or Declining a Call

When an incoming call is received, the infotainment system mutes and a ring tone is heard in the vehicle.

Accepting a Call

Turn the MENU/SELECT knob to "Answer" and press the MENU/SELECT knob to accept the call.

Declining a Call

Turn the MENU/SELECT knob to "Decline" and press the MENU/SELECT knob to decline the call.

Call Waiting

Call waiting must be supported on the bluetooth phone and enabled by the wireless service carrier to work.

Accepting a Call

Turn the MENU/SELECT knob to “Answer” and press the MENU/SELECT knob to accept the call.

Declining a Call

Turn the MENU/SELECT knob to “Decline” and press the MENU/SELECT knob to decline the call.

Switching Between Calls (Call Waiting Calls Only)

To switch between calls:

1. Turn or press the MENU/SELECT knob.
2. Select Switch Call from the menu.

Conference Calling

Conference calling and three way calling must be supported on the bluetooth phone and enabled by the wireless service carrier to work.

To start a conference while in a current call:

1. Turn or press the MENU/SELECT knob.
2. Select Enter Number.
3. Enter the character sequence then select call. See “Entering a Character Sequence” in *Operation on page 6-7* for more information.
4. After the call has been placed, turn or press the MENU/SELECT knob and choose Merge Calls.
5. To add more callers to the conference call, repeat steps 1 through 4. The amount of callers that can be added are limited by your wireless service carrier.

Ending a Call

Turn or press the MENU/SELECT knob and select Hang Up.

Muting a Call

To Mute a Call

Turn or press the MENU/SELECT knob and select Mute Call.

To Cancel Mute

Turn or press the MENU/SELECT knob and select Mute Call.

Dual Tone Multi-Frequency (DTMF) Tones

The in-vehicle Bluetooth system can send numbers during a call. This is used when calling a menu driven phone system.

1. Turn or press the MENU/SELECT knob and select Enter Number.
2. Enter the character sequence, see “Entering a Character Sequence” in *Operation on page 6-7* for more information.

Bluetooth (Voice Recognition)

Pairing

A Bluetooth cell phone must be paired to the Bluetooth system and then connected to the vehicle before it can be used. See the cell phone manufacturers user guide for Bluetooth functions before pairing the cell phone. If a Bluetooth phone is not connected, calls will be made using OnStar® Hands-Free Calling, if available. Refer to the OnStar Owner's Guide for more information.

The pairing process can be started by using the voice recognition system or the controls on the infotainment system.



A Bluetooth phone with MP3 capability can not be paired to the vehicle as a phone and an MP3 player at the same time.

Pairing Information:

- Up to five cell phones can be paired to the Bluetooth system.
- The pairing process is disabled when the vehicle is moving.
- The Bluetooth system links with the first available paired cell phone based on the order shown in the device list.
- Only one paired cell phone can be connected to the Bluetooth system at a time.
- Pairing only needs to be completed once, unless the pairing information changes or the phone is deleted.

To link to a different paired phone, see Linking to a Different Phone later in this section.

Pairing a Phone

1. Press  / . The system responds with a tone. After the tone say "Hands Free". The system responds "Ready" followed by a tone.
2. Say "Bluetooth". The system responds "Bluetooth ready" followed by a tone.
3. Say "Pair". The system responds with instructions and a four-digit PIN number. The PIN number will be used in Step 4.

4. Start the Pairing process on the cell phone that will be paired to the vehicle. Reference the cell phone manufacturers user guide for information on this process.

Locate the device named "General Motors" in the list on the cell phone and follow the instructions on the cell phone to enter the four-digit PIN number that was provided in Step 3.
5. The system prompts for a name for the phone. This name will be used to indicate which phone is connected. The system confirms the name.
6. The system responds with "<Phone name> has been successfully paired" after the pairing process is complete.
7. Repeat Steps 1 through 7 for additional phones to be paired.



Listing All Paired and Connected Phones

1. Press Ⓜ / ۞. The system responds with a tone. After the tone say "Hands Free". The system responds "Ready" followed by a tone.
2. Say "Bluetooth". The system responds "Bluetooth ready" followed by a tone.
3. Say "List". The system lists all the paired Bluetooth devices. The system will respond "is connected" if a phone is connected to the vehicle.

Deleting a Paired Phone

1. Press Ⓜ / ۞. The system responds with a tone. After the tone say "Hands Free". The system responds "Ready" followed by a tone.
2. Say "Bluetooth". The system responds "Bluetooth ready" followed by a tone.
3. Say "Delete". The system asks which phone to delete followed by a tone.
4. Say the name of the phone to be deleted. If the phone name is unknown, use the "List" command for a list of all paired phones. The system responds "Would you like to delete <phone name>? Yes or No" followed by a tone.
5. Say "Yes" to delete the phone. The system responds "OK, deleting <phone name>".

Linking to a Different Phone

1. Press  / . The system responds with a tone. After the tone say “Hands Free”. The system responds “Ready” followed by a tone.
2. Say “Bluetooth”. The system responds “Bluetooth ready” followed by a tone.
3. Say “Change phone”. The system responds “Please wait while I search for other phones”.
 - If another phone is found, the response will be “<Phone name> is now connected”.
 - If another phone is not found, the original phone remains connected.

Storing Name Tags



The system can store up to thirty phone numbers as name tags that are shared between the Bluetooth and OnStar systems.

The system uses the following commands to store and retrieve phone numbers:

- Store
- Digit Store
- Directory

Using the Store Command

The store command allows a phone number to be stored without entering the digits individually.



1. Press  / . The system responds with a tone. After the tone say “Hands Free”. The system responds “Ready” followed by a tone.
2. Say “Store”. The system responds “Store, number please” followed by a tone.

3. Say the complete phone number to be stored at once with no pauses.
 - If the system recognizes the number the response is “OK, Storing”.
 - If the system does not recognize the phone number, the response is “Store <Phone number>”. “Please say yes or no”. If the number is correct, say “Yes”. If the number is not correct, say “No”. The system will ask for the number again.
4. After the system stores the phone number, it responds “Please say the name tag” followed by a tone.

5. Say a name tag for the phone number. The name tag is recorded and the system responds “About to store <name tag>. Does that sound OK?”.
 - If the name tag does not sound correct, say “No” and repeat Step 5.
 - If the name tag sounds correct, say “Yes” and the name tag is stored. After the number is stored the system returns to the main menu.

Using the Digit Store Command

The digit store command allows a phone number to be stored by entering the digits individually.



1. Press  / . The system responds with a tone. After the tone say “Hands Free”. The system responds “Ready” followed by a tone.

2. Say “Digit Store”. The system responds with “Please say the first digit to store” followed by a tone.
3. Say the first digit to be stored. The system will repeat back the digit it heard followed by a tone. Continue entering digits until the number to be stored is complete.
 - If an unwanted number is recognized by the system, say “Clear” at any time to clear the last number.
 - To hear all of the numbers recognized by the system, say “Verify” at any time.
4. After the complete number has been entered, say “Store”. The system responds “Please say the name tag” followed by a tone.

- Say a name tag for the phone number. The name tag is recorded and the system responds "About to store <name tag>. Does that sound OK?".
 - If the name tag does not sound correct, say "No" and repeat Step 5.
 - If the name tag sounds correct, say "Yes" and the name tag is stored. After the number is stored the system returns to the main menu.

Using the Directory Command

The directory command lists all of the name tags stored by the system. To use the directory command:

- Press  / . The system responds with a tone. After the tone say "Hands Free". The system responds "Ready" followed by a tone.

- Say "Directory". The system responds "Directory" and lists all stored name tags. The system returns to the main menu when the list is complete.

Deleting Name Tags



The system uses the following commands to delete name tags:

- Delete
- Delete all name tags

Using the Delete Command

The delete command is used to delete specific name tags.

To delete name tags:

- Press  / . The system responds with a tone. After the tone say "Hands Free". The system responds "Ready" followed by a tone.
- Say "Delete". The system responds "Delete, please say the name tag" followed by a tone.



- Say the name tag to be deleted. The system responds "Would you like to delete, <name tag>? Please say yes or no".

- If the name tag is correct, say "Yes" to delete the name tag. The system responds with "OK, deleting <name tag>, returning to the main menu."
- If the name tag is incorrect, say "No". The system responds with "No. OK, let's try again, please say the name tag."

Using the Delete All Name Tags Command

The delete all name tags command deletes all stored phone book name tags and route name tags for OnStar if stored.

To delete all name tags:



1. Press  / . The system responds with a tone. After the tone say "Hands Free". The system responds "Ready" followed by a tone.
2. Say "Delete all name tags". The system responds "You are about to delete all name tags stored in your phone directory and your route destination directory. Are you sure you want to do this? Please say yes or no."
 - Say "Yes" to delete all name tags.
 - Say "No" to cancel the function and return to the main menu.

Making a Call

Calls can be made using the following commands:



- Dial
- Digit Dial
- Call
- Re-dial

Using the Dial Command

1. Press  / . The system responds with a tone. After the tone say "Hands Free". The system responds "Ready" followed by a tone.
2. Say "Dial". The system responds "Dial using <phone name>." "Number please" followed by a tone.



3. Say the entire number without pausing.
 - If the system recognizes the number, it responds with "OK, Dialing" and dials the number.
 - If the system does not recognize the number, it confirms the numbers followed by a tone. If the number is correct, say "Yes". The system responds "OK, Dialing" and dials the number. If the number is not correct, say "No". The system will ask for the number again.

Using the Digit Dial Command

1. Press  / . The system responds with a tone. After the tone say "Hands Free". The system responds "Ready" followed by a tone.
2. Say "Digit Dial". The system responds "Digit dial using <phone name>, please say the first digit to dial" followed by a tone.
3. Say the digits to be dialed one at a time. The system repeats back the digit it heard followed by a tone.

4. Continue entering digits until the number to be dialed is complete. After the whole number has been entered, say "Dial". The system responds "OK, Dialing" and dials the number.
 - If an unwanted number is recognized by the system, say "Clear" at any time to clear the last number.
 - To hear all of the numbers recognized by the system, say "Verify" at any time.



Using the Call Command

1. Press  / . The system responds with a tone. After the tone say "Hands Free". The system responds "Ready" followed by a tone.

2. Say "Call". The system responds "Call using <phone name>. Please say the name tag" followed by a tone.
3. Say the name tag of the person to call.
 - If the system recognizes the name tag it responds "OK, calling, <name tag>" and dials the number.
 - If the system does not recognize the name tag, it confirms the name tag followed by a tone. If the name tag is correct, say "Yes". The system responds with "OK, calling, <name tag>" and dials the number. If the name tag is not correct, say "No". The system will ask for the name tag again.

Once connected, the person called will be heard through the audio speakers.





Using the Re-dial Command

1. Press  / . The system responds with a tone. After the tone say "Hands Free". The system responds with "Ready" followed by a tone.
2. After the tone, say "Re-dial". The system responds "Re-dial using <phone name>" and dials the last number called from the connected Bluetooth phone.

Once connected, the person called will be heard through the audio speakers.







Receiving a Call

When an incoming call is received, the audio system mutes and a ring tone is heard in the vehicle.

- Press  /  to answer the call.
- Press  /  to ignore a call.





Call Waiting

Call waiting must be supported on the Bluetooth phone and enabled by the wireless service carrier.

- Press  /  to answer an incoming call when another call is active. The original call is placed on hold.
- Press  /  again to return to the original call.
- To ignore the incoming call, no action is required.
- Press  /  to disconnect the current call and switch to the call on hold.

Three-Way Calling

Three-Way Calling must be supported on the Bluetooth phone and enabled by the wireless service carrier.

1. While on a call press  / . The system responds with "Ready" followed by a tone.
2. Say "Three-way call". The system responds with "Three-way call, please say dial or call".
3. Use the dial or call command to dial the number of the third party to be called.
4. Once the call is connected, press  /  to link all the callers together.



Ending a Call

Press  /  to end a call.



Muting a Call

During a call, all sounds from inside the vehicle can be muted so that the person on the other end of the call cannot hear them.

To Mute a call

1. Press  . The system responds "Ready" followed by a tone.
2. Say "Mute Call". The system responds "Call muted".

To Cancel Mute



1. Press  . The system responds "Ready" followed by a tone.
2. After the tone, say "Mute Call". The system responds "Resuming call".

Transferring a Call

Audio can be transferred between the in-vehicle Bluetooth system and the cell phone.



To Transfer Audio to the Cell Phone

During a call with the audio in the vehicle:

1. Press  . The system responds "Ready" followed by a tone.
2. Say "Transfer Call." The system responds "Transferring call" and the audio transfers to the cell phone.

To Transfer Audio to the In-Vehicle Bluetooth System



The cell phone must be paired and connected with the Bluetooth system before a call can be transferred. The connection process can take up to two minutes after the key is turned to ON/RUN or ACC/ACCESSORY.

Press   during a call with the audio on the cell phone. If the audio does not transfer to the vehicle, use the audio transfer feature on the cell phone. See the cell phone manufacturer's guide for more information.

Voice Pass-Thru

Voice Pass-Thru allows access to the voice recognition commands on the cell phone. See the cell phone manufacturers user guide to see if the cell phone supports this feature.



To access contacts stored in the cell phone:

1. Press  / . The system responds with a tone. After the tone say "Hands Free". The system responds "Ready" followed by a tone.
2. Say "Bluetooth". The system responds "Bluetooth ready" followed by a tone.
3. Say "Voice". The system responds "OK, accessing <phone name>".
 - The cell phone's normal prompt messages will go through its cycle according to the phone's operating instructions.

Dual Tone Multi-Frequency (DTMF) Tones



The in-vehicle Bluetooth system can send numbers and the numbers stored as name tags during a call. Use this feature when calling a menu driven phone system. Account numbers can also be stored for use.

Sending a Number During a Call

1. Press  . The system responds "Ready" followed by a tone.
2. Say "Dial". The system responds "Say a number to send tones" followed by a tone.

3. Say the number to send.
 - If the system recognizes the number it responds "OK, Sending Number" and the dial tones are sent and the call continues.
 - If the system does not recognize the number it responds "Dial Number, please say yes or no?" followed by a tone. If the number is correct, say "Yes". The system responds "OK, Sending Number" and the dial tones are sent and the call continues.

Sending a Stored Name Tag During a Call

1. Press  . The system responds “Ready” followed by a tone.
2. Say “Send name tag.” The system responds “Say a name tag to send tones” followed by a tone.

3. Say the name tag to send.

- If the system recognizes the number it responds “OK, Sending <name tag>” and the dial tones are sent and the call continues.
- If the system does not recognize the name tag it responds “Dial <name tag>, please say yes or no?” followed by a tone. If the name tag is correct, say “Yes”. The system responds with “OK, Sending <name tag>” and the dial tones are sent and the call continues.

Clearing the System

Unless information is deleted out of the in-vehicle Bluetooth system, it will be retained indefinitely. This includes all saved name tags in the phone book and phone pairing information. For information on how to delete this information, see the previous sections on Deleting a Paired Phone and Deleting Name Tags.

Bluetooth (Navigation)

For information about how to navigate the menu system using the infotainment controls, see “Overview” under Introduction, in the Navigation supplement.

Bluetooth Pairing

To make calls with a Bluetooth cell phone through your vehicle, it must be paired to the vehicle's Bluetooth system first and then connected to the vehicle before it can be used. Refer to the cell phone manufacturer's user guide for Bluetooth pairing instructions. If a Bluetooth phone is off or not connected, calls will automatically be made using the OnStar[®] Hands-Free Calling feature, if available. Refer to the OnStar owner's guide for more information about OnStar Hands-Free Calling.

A Bluetooth phone with MP3 capability cannot be connected to the vehicle as a phone and an MP3 player at the same time.

The pairing process can be started by using the voice recognition system or the controls on the infotainment system.

Pairing Information:

- Up to five cell phones can be paired to the Bluetooth system.
- The pairing process is disabled when the vehicle is moving.
- The Bluetooth system links with the first available paired cell phone based on the order shown in the device list.
- Only one paired cell phone can be connected to the vehicle's Bluetooth system at a time.
- Pairing should only need to be completed once, unless changes to the pairing information have been made or the phone is deleted.

To link to a different paired phone, see “Linking to a Different Phone” later in this section.

Pairing a Phone

1. Press the CONFIG control button repeatedly until the Phone menu is shown or press the Phone tab on the screen.

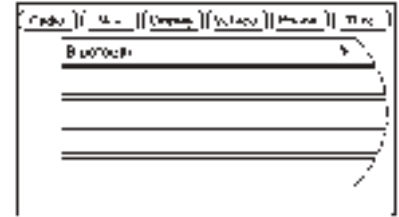

2. Select the Bluetooth submenu.

6-64 Infotainment System

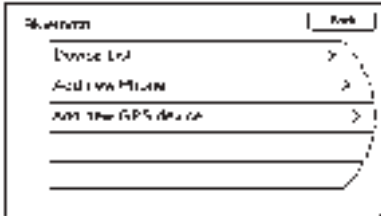

3. Select "Add New Phone", the pairing process will begin searching for Bluetooth devices on your cellular phone. See the cell phone manufacturer's user guide for information on this process.

If the "Add new GPS device" option is selected, the system will start a search for Bluetooth "Handsfree" profile devices just like if you had selected "Add new Phone".

The additional GPS location feature provides the vehicle's GPS location through the Bluetooth Serial Port Profile is not available.

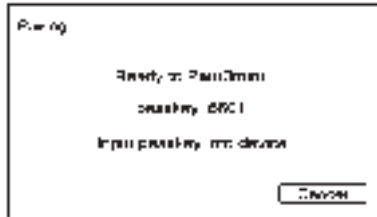

On the cell phone, locate the device name, such as "Your Vehicle". If in another country, the device's name may have a GM acronym for that country.

Follow the instructions given on the cell phone or follow the voice prompts, to enter the four digit PIN number that has been provided.

4. The system voice prompt requests that you say the name you want used for the phone that is being paired. Use a name that best describes the phone. The system voice prompt then repeats the name you provided for confirmation, say "Yes".
5. The system responds with "phone name has been successfully paired" after the pairing process is complete.

Listing All Paired and Connected Phones

1. Press the CONFIG control button repeatedly until the Phone menu is shown or press the Phone tab displayed on the screen.

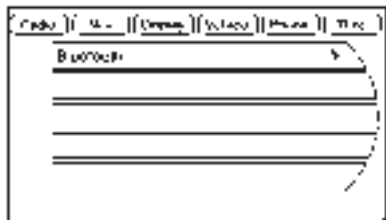

2. Select the Bluetooth submenu.



3. Select the Device List submenu.

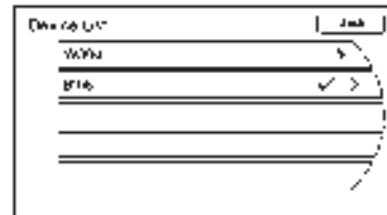

A list of all previously paired phones will be displayed. If there is a currently connected phone, a check mark will appear on the right side of the Phone name.

6-66 Infotainment System

Deleting a Paired Phone

1. Press the CONFIG control button repeatedly until the Phone menu is shown or press the Phone tab on the screen.

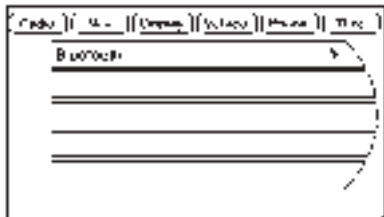

2. Select the Bluetooth submenu.



3. Select the Device List submenu.

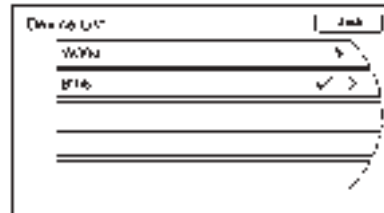

4. Select the phone to be deleted and then follow the on screen prompts to delete the device from the system.

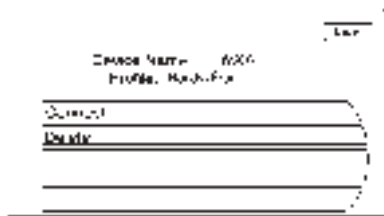

- Once a phone has been deleted, the only way to connect back to that phone is to pair the phone again. See "Bluetooth Pairing" earlier before the process is started.

Linking to a Different Phone

In order to link to a different phone, the new phone must be in the vehicle and available to be connected to the Bluetooth system before the process is started.

- Press the CONFIG control button repeatedly until the Phone menu is shown or press the Phone tab on the screen.

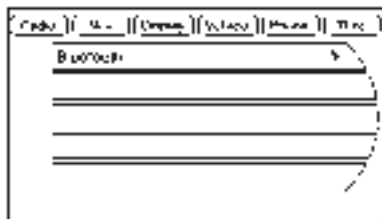

- Select the Bluetooth submenu.



- Select the Device List submenu.

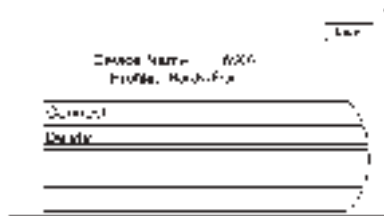

4. Select the phone to be linked and then follow the on screen prompts.

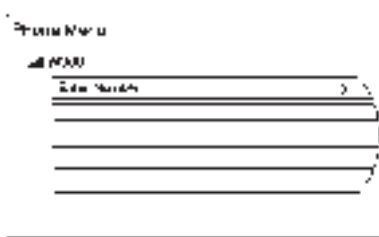

5. The Phone menu will be displayed with the name of the phone linked.

Making a Call

Press  located on the faceplate of the infotainment system, to access the phone menu.

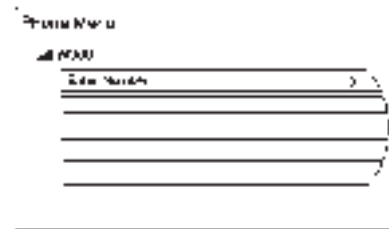

Enter Number

Use this option to enter a phone number and make a call. To do this:

1. Press the Enter Number selection. A dial pad displays on the Navigation screen.

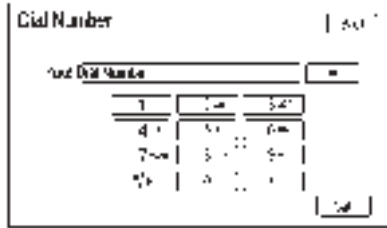



2. Enter the desired number by touching the appropriate buttons on the screen or using the rotary knob.
3. Press the CALL button to make the call.

Accepting or Declining an Incoming Call



When an incoming call is received, the infotainment system mutes any audio being played and sounds a ring tone.

Accepting a Call

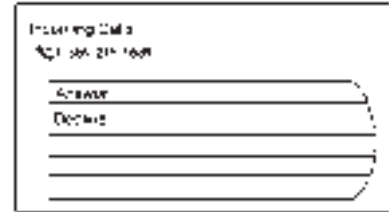
Press   on the steering wheel control to answer the incoming call or press the Answer option to answer the call.



Declining a Call

Press  /  on the steering wheel controls or select the Decline option to decline the call.

Call Waiting

Call waiting must be supported on the Bluetooth phone and enabled by the wireless service carrier to work.

Switching Calls (Only Available with Call Waiting)

This feature allows you to switch between calls, making one call active and placing the other on hold.



Switch Call: Turn or press the menu select knob to “Switch Call” and press Enter or press the “Switch Call” option.

Conference Calling

Conference and three-way calling must be supported on the Bluetooth phone and enabled by the wireless service carrier to work.

To start a conference while in a current call:

1. Press  on the faceplate until the Phone main screen is shown with the current active call.

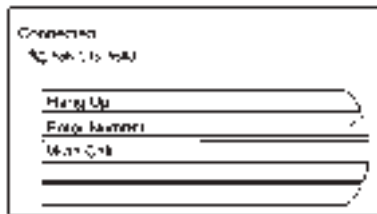

2. Select the “Enter Number” option.

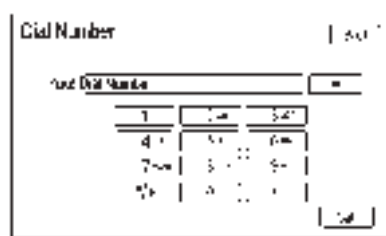

3. Make another call. The first call will be placed on hold while the second call is dialing and connected.
4. To make a conference call, select the “Merge Calls” option which will merge both calls into one conference call.
5. To add more callers to the conference call, repeat Steps 2 through 4. The amount of callers that can be added are limited by your wireless service carrier.

Ending a Call

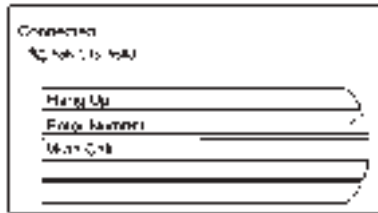

1. Press the  control button.
2. Select Hang Up.

Mute or UnMute a Call

1. Press the  control button.
2. Select the Mute call option to mute the call.
3. Select the Mute call option again to unmute the call.

Dual Tone Multi-Frequency (DTMF) Tones

The in-vehicle Bluetooth system can send numbers during a call, this is used when calling a menu driven phone system.

1. Press the  control button.

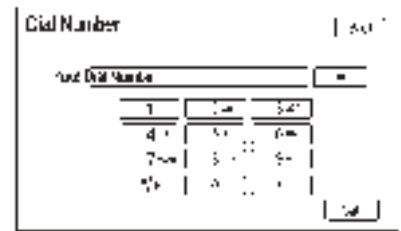

2. Select "Enter Number" option and enter the number sequence.

The DTMF Tones will be generated on the network as you enter each number.

Climate Controls

Climate Control Systems

Dual Automatic Climate Control System 7-1
 Rear Climate Control System 7-5

Air Vents

Air Vents 7-6

Climate Control Systems

Dual Automatic Climate Control System

The heating, cooling, and ventilation for the vehicle can be controlled with this system.

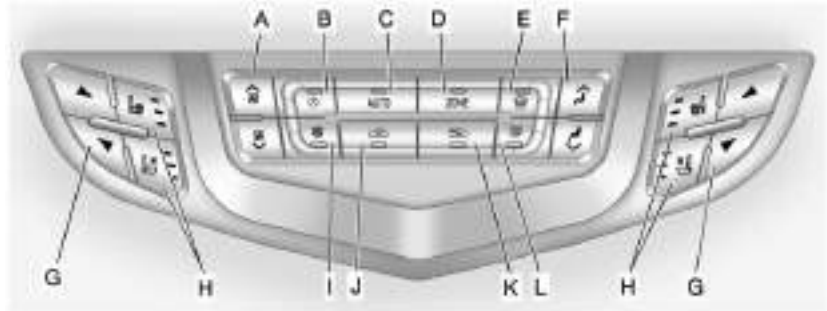

- | | |
|--|---|
| <ul style="list-style-type: none"> A. Fan Control B. Power C. AUTO D. ZONE E. Defrost | <ul style="list-style-type: none"> F. Air Delivery Mode Control G. Driver and Passenger Temperature Control H. Driver and Passenger Heated and Ventilated Seats I. Air Conditioning |
|--|---|

7-2 Climate Controls

- J. Recirculation
- K. Outside Air
- L. Rear Window Defogger

Automatic Operation

The system automatically controls the fan speed, air delivery, air conditioning and recirculation in order to heat or cool the vehicle to the desired temperature.

When the indicator light is on, the system is in full automatic operation. If the air delivery mode or fan setting is manually adjusted, the auto indicator turns off and displays will show the selected settings.

To place the system in automatic mode do the following:

1. Press AUTO.
2. Set the temperature. Allow the system time to stabilize. Then adjust the temperature as needed for best comfort.

English units can be changed to metric units through the Driver Information Center (DIC). See *Vehicle Personalization on page 4-41*.

 **(Driver and Passenger Temperature Control):** The temperature can be adjusted separately for the driver and the passenger. Press to increase or decrease the temperature.

ZONE: Press to link all climate zone settings to the driver settings. The ZONE indicator light turns off. When the passenger settings are adjusted, the ZONE indicator light is on.

Manual Operation

 **(Power):** Press to turn the climate control system on or off.

 **(Fan Control):** Press to increase or decrease the fan speed. Pressing either button cancels automatic operation and the system

goes into manual mode. Press AUTO to return to automatic operation.

 **(Air Delivery Mode Control):** Press to change the direction of the airflow. The current mode appears in the display screen. Changing the mode cancels the automatic operation and the system goes into manual mode. Press AUTO to return to automatic operation.

To change the current mode, select one of the following:

 **(Vent):** Air is directed to the instrument panel outlets.

 **(Bi-Level):** Air is divided between the instrument panel outlets and the floor outlets.

 **(Tri-Level):** Air is divided between the windshield, instrument panel, and floor outlets.

 **(Floor):** Air is directed to the floor outlets.

 **(Defog):** Clears the windows of fog or moisture. Air is directed to the windshield and floor outlets.

 **(Upper):** Air is directed to the windshield outlets.

 **(Hi-Level):** Air is divided between the windshield and instrument panel outlets.

 **(Defrost):** Clears the windshield of fog or frost more quickly. Air is directed to the windshield.

 **(Air Conditioning):** Press to turn the automatic air conditioning on or off. If the fan is turned off or the outside temperature falls below freezing, the air conditioner will not run.

Press AUTO to return to automatic operation and the air conditioner runs as needed. When the indicator light is on, the air conditioner runs automatically to cool the air inside the vehicle or to dry the air needed to defog the windshield faster.

 **(Recirculation):** Press to turn on recirculation. An indicator light comes on. Air is recirculated to quickly cool the inside of the vehicle or prevent outside air and odors from entering.

Automatic Air Recirculation:

When the AUTO indicator light is on, the air is automatically recirculated as needed to help quickly cool the inside of the vehicle.

The climate control system may have a sensor to detect air pollution. In auto recirculation control, the Air Quality Control system may operate. To adjust the sensitivity of the Air Quality Control, see Climate and Air Quality under *Vehicle Personalization on page 4-41*.

Auto Defog: The climate control system may have a sensor to automatically detect high humidity inside the vehicle. When high humidity is detected, the climate control system may adjust to outside air supply and turn on the air conditioner. If the climate control system does not detect possible window fogging, it returns to normal operation. To turn Auto Defog off or on, see Climate and Air Quality under *Vehicle Personalization on page 4-41*.

 **(Outside Air):** Press to turn on outside air. An indicator light comes on. Outside air is circulated through the vehicle.

7-4 Climate Controls

Rear Window Defogger

(Rear Window Defogger):

Press to turn the rear window defogger on or off.

The rear window defogger turns off automatically after about 10 minutes. If turned on again it runs for about 5 minutes before turning off. At higher speeds, the rear window defogger may stay on continuously.

The rear window defogger can be set to automatic operation, see Climate and Air Quality under *Vehicle Personalization* on page 4-41. When auto rear defog is selected, the rear window defogger turns on automatically when the interior temperature is cold and the outside temperature is about 40°F and below. The auto rear defogger turns off automatically after about 10 minutes. At higher speeds, the rear window defogger may stay on continuously.

The heated outside rearview mirrors turn on when the rear window defogger button is on and helps to clear fog or frost from the surface of the mirror. See *Heated Mirrors* on page 1-22.

Notice: Do not try to clear frost or other material from the inside of the front windshield and rear window with a razor blade or anything else that is sharp. This may damage the rear window defogger grid and affect your radio's ability to pick up stations clearly. The repairs wouldn't be covered by your warranty.

Heated and Ventilated Seats:

Press to heat or ventilate the seat. See *Heated and Ventilated Front Seats* on page 2-10.

Remote Start Climate Control

Operation: For vehicles with the remote vehicle start feature, the climate control system may run when the vehicle is started remotely. The system uses the driver's previous settings to heat or cool the inside of the vehicle. See *Remote Vehicle Start* on page 1-9.

The rear window defogger turns on if it is cold outside.

Sensors

The solar sensor located on top of the instrument panel near the windshield, monitors the solar heat.

The climate control system uses the sensor information to adjust the temperature, fan speed, recirculation, and air delivery mode for best comfort.

If the sensor is covered the automatic climate control system may not work properly.

Rear Climate Control System

For vehicles with the rear heat and air conditioning controls, they are integrated with the rear seat audio controls located in the center console.

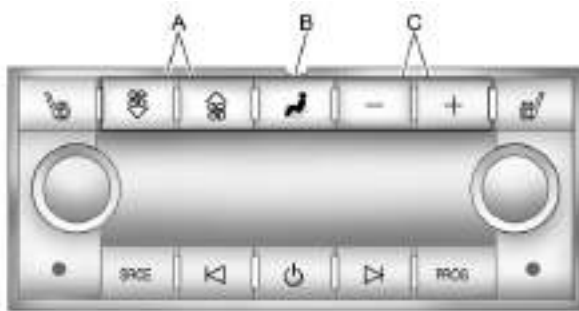

Rear Climate Control with Rear Seat Audio Controls

- A. Fan Control
- B. Air Delivery Mode Control
- C. Temperature Control

ZONE: When the rear climate control is turned on from the rear, the ZONE indicator light will turn on. Press the ZONE button on the front climate control system to turn off the rear blower and match the rear settings to the front. The ZONE indicator light and rear climate control display will turn off.

The rear climate control can be turned off by pressing the  button.

Independent Mode: This mode directs rear seating airflow according to the settings of the rear controls.

The front climate control system must be on for the rear climate control to work. To turn on the rear climate control from rear seating, press any rear climate control button.

The rear climate control will not work if the front climate control system is in defrost.

7-6 Climate Controls

Automatic Operation

AUTO: Press  until the AUTO setting is selected to control the rear temperature, air delivery, and fan speed automatically.

Manual Operation

 **(Fan Control):** Press these buttons on the rear seat audio control panel to increase or decrease the airflow. Pressing the fan up button when the system is off will turn the system on. The air delivery mode remains in its previous setting.

+/- (Temperature Control): Press these buttons to adjust the temperature of the air flowing into the passenger area. Press the + button for warmer air and press the - button for cooler air.

 **(Air Delivery Mode Control):** Press the mode button to change the direction of the airflow in the vehicle. Multiple presses will cycle through the delivery selections.

Air Vents

Move the sliding knob on the air outlets up and down or left and right to direct the airflow. Use the thumbwheels near the air outlets to open or close off the airflow.

Operation Tips

- Clear away any ice, snow, or leaves from air inlets at the base of the windshield that could block the flow of air into the vehicle.
- Keep the path under the front seats clear of objects to help circulate the air inside of the vehicle more effectively.
- Use of non-GM approved hood deflectors can adversely affect the performance of the system. Check with your dealer before adding equipment to the outside of the vehicle.

Driving and Operating

Driving Information

| | |
|-------------------------------|------|
| Driving for Better Fuel | |
| Economy | 8-2 |
| Defensive Driving | 8-3 |
| Drunk Driving | 8-3 |
| Control of a Vehicle | 8-4 |
| Braking | 8-4 |
| Steering | 8-5 |
| Off-Road Recovery | 8-6 |
| Loss of Control | 8-6 |
| Driving on Wet Roads | 8-7 |
| Highway Hypnosis | 8-8 |
| Hill and Mountain Roads | 8-8 |
| Winter Driving | 8-9 |
| If the Vehicle is Stuck | 8-11 |
| Vehicle Load Limits | 8-11 |

Starting and Operating

| | |
|--|------|
| New Vehicle Break-In | 8-17 |
| Adjustable Throttle and Brake Pedal | 8-18 |
| Ignition Positions | 8-18 |

| | |
|---|------|
| Retained Accessory Power (RAP) | 8-20 |
| Starting the Gasoline Engine | 8-20 |
| Engine Heater | 8-22 |
| Shifting Into Park | 8-22 |
| Shifting Out of Park | 8-23 |
| Parking Over Things That Burn | 8-24 |

Engine Exhaust

| | |
|---|------|
| Engine Exhaust | 8-24 |
| Running the Vehicle While Parked | 8-25 |

Automatic Transmission

| | |
|------------------------------|------|
| Automatic Transmission | 8-25 |
| Manual Mode | 8-28 |
| Fuel Economy Mode | 8-29 |

Drive Systems

| | |
|-----------------------|------|
| All-Wheel Drive | 8-30 |
|-----------------------|------|

Brakes

| | |
|--------------------------------------|------|
| Antilock Brake System (ABS) | 8-30 |
| Parking Brake | 8-31 |
| Brake Assist | 8-33 |
| Hill Start Assist (HSA) | 8-33 |

Ride Control Systems

| | |
|--|------|
| Traction Control System (TCS) | 8-34 |
| StabiliTrak® System | 8-35 |
| Limited-Slip Rear Axle | 8-37 |
| Selective Ride Control | 8-37 |

Cruise Control

| | |
|----------------------|------|
| Cruise Control | 8-37 |
|----------------------|------|

Object Detection Systems

| | |
|-----------------------------------|------|
| Ultrasonic Parking Assist | 8-40 |
| Rear Vision Camera (RVC) | 8-43 |

Fuel

| | |
|--|------|
| Fuel | 8-46 |
| Recommended Fuel | 8-47 |
| Gasoline Specifications | 8-47 |
| California Fuel Requirements | 8-48 |
| Fuels in Foreign Countries | 8-48 |
| Fuel Additives | 8-48 |
| Filling the Tank | 8-50 |
| Filling a Portable Fuel Container | 8-51 |

8-2 Driving and Operating

Towing

| | |
|-----------------------------|------|
| General Towing | |
| Information | 8-52 |
| Driving Characteristics and | |
| Towing Tips | 8-52 |
| Trailer Towing | 8-56 |
| Towing Equipment | 8-60 |
| Trailer Sway | |
| Control (TSC) | 8-61 |

Conversions and Add-Ons

| | |
|-------------------|------|
| Add-On Electrical | |
| Equipment | 8-61 |

Driving Information

Driving for Better Fuel Economy

Driving habits can affect fuel mileage. Here are some driving tips to get the best fuel economy possible.

- Avoid fast starts and accelerate smoothly.
- Brake gradually and avoid abrupt stops.
- Avoid idling the engine for long periods of time.

- When road and weather conditions are appropriate, use cruise control, if equipped.
- Always follow posted speed limits or drive more slowly when conditions require.
- Keep vehicle tires properly inflated.
- Combine several trips into a single trip.
- Replace the vehicle's tires with the same TPC Spec number molded into the tire's sidewall near the size.
- Follow recommended scheduled maintenance.

Defensive Driving

Defensive driving means “always expect the unexpected.” The first step in driving defensively is to wear your safety belt, see *Safety Belts on page 2-13*.

WARNING

Assume that other road users (pedestrians, bicyclists, and other drivers) are going to be careless and make mistakes. Anticipate what they might do and be ready. In addition:

- Allow enough following distance between you and the driver in front of you.
- Focus on the task of driving.

Driver distraction can cause collisions resulting in injury or possible death. These simple defensive driving techniques could save your life.

Drunk Driving

WARNING

Drinking and then driving is very dangerous. Your reflexes, perceptions, attentiveness, and judgment can be affected by even a small amount of alcohol. You can have a serious — or even fatal — collision if you drive after drinking. Do not drink and drive or ride with a driver who has been drinking. Ride home in a cab; or if you are with a group, designate a driver who will not drink.

Death and injury associated with drinking and driving is a global tragedy.

Alcohol affects four things that anyone needs to drive a vehicle: judgment, muscular coordination, vision, and attentiveness.

Police records show that almost 40 percent of all motor vehicle-related deaths involve alcohol. In most cases, these deaths are the result of someone who was drinking and driving. In recent years, more than 17,000 annual motor vehicle-related deaths have been associated with the use of alcohol, with about 250,000 people injured.

For persons under 21, it is against the law in every U.S. state to drink alcohol. There are good medical, psychological, and developmental reasons for these laws.

The obvious way to eliminate the leading highway safety problem is for people never to drink alcohol and then drive.

Medical research shows that alcohol in a person's system can make crash injuries worse, especially injuries to the brain, spinal cord, or heart.

8-4 Driving and Operating

This means that when anyone who has been drinking — driver or passenger — is in a crash, that person's chance of being killed or permanently disabled is higher than if the person had not been drinking.

Control of a Vehicle

The following three systems help to control the vehicle while driving — brakes, steering, and accelerator. At times, as when driving on snow or ice, it is easy to ask more of those control systems than the tires and road can provide. Meaning, you can lose control of the vehicle. See *Traction Control System (TCS) on page 8-34* and *StabiliTrak® System on page 8-35*.

Adding non-dealer/non-retailer accessories can affect vehicle performance. See *Accessories and Modifications on page 9-3*.

Braking

See *Brake System Warning Light on page 4-23*.

Braking action involves perception time and reaction time. Deciding to push the brake pedal is perception time. Actually doing it is reaction time.

Average reaction time is about three-fourths of a second. But that is only an average. It might be less with one driver and as long as two or three seconds or more with another. Age, physical condition, alertness, coordination, and eyesight all play a part. So do alcohol, drugs, and frustration. But even in three-fourths of a second, a vehicle moving at 100 km/h (60 mph) travels 20 m (66 ft). That could be a lot of distance in an emergency, so keeping enough space between the vehicle and others is important.

And, of course, actual stopping distances vary greatly with the surface of the road, whether it is

pavement or gravel; the condition of the road, whether it is wet, dry, or icy; tire tread; the condition of the brakes; the weight of the vehicle; and the amount of brake force applied.

Avoid needless heavy braking. Some people drive in spurts — heavy acceleration followed by heavy braking — rather than keeping pace with traffic. This is a mistake. The brakes might not have time to cool between hard stops. The brakes will wear out much faster with a lot of heavy braking. Keeping pace with the traffic and allowing realistic following distances eliminates a lot of unnecessary braking. That means better braking and longer brake life.

If the engine ever stops while the vehicle is being driven, brake normally but do not pump the brakes. If the brakes are pumped, the pedal could get harder to push down. If the engine stops, there will still be some power brake assist but it will be used when the brake is

applied. Once the power assist is used up, it can take longer to stop and the brake pedal will be harder to push.

Adding non-dealer accessories can affect vehicle performance. See *Accessories and Modifications* on page 9-3.

Steering

Power Steering

If power steering assist is lost because the engine stops or the power steering system is not functioning, the vehicle can be steered but it will take more effort.

Steering Tips

It is important to take curves at a reasonable speed.

Traction in a curve depends on the condition of the tires and the road surface, the angle at which the curve is banked, and vehicle speed. While in a curve, speed is the one factor that can be controlled.

If there is a need to reduce speed, do it before entering the curve, while the front wheels are straight.

Try to adjust the speed so you can drive through the curve. Maintain a reasonable, steady speed. Wait to accelerate until out of the curve, and then accelerate gently into the straightaway.

Steering in Emergencies

There are times when steering can be more effective than braking. For example, you come over a hill and find a truck stopped in your lane, or a car suddenly pulls out from nowhere, or a child darts out from between parked cars and stops right in front of you. These problems can be avoided by braking — if you can stop in time. But sometimes you cannot stop in time because there is no room. That is the time for evasive action — steering around the problem.

The vehicle can perform very well in emergencies like these. First apply the brakes. See *Braking* on

page 8-4. It is better to remove as much speed as possible from a collision. Then steer around the problem, to the left or right depending on the space available.



An emergency like this requires close attention and a quick decision. If holding the steering wheel at the recommended 9 and 3 o'clock positions, it can be turned a full 180 degrees very quickly without removing either hand. But you have to act fast, steer quickly, and just as quickly straighten the wheel once you have avoided the object.

8-6 Driving and Operating

The fact that such emergency situations are always possible is a good reason to practice defensive driving at all times and wear safety belts properly.

Off-Road Recovery

The vehicle's right wheels can drop off the edge of a road onto the shoulder while driving.



If the level of the shoulder is only slightly below the pavement, recovery should be fairly easy. Ease off the accelerator and then, if there

is nothing in the way, steer so that the vehicle straddles the edge of the pavement. Turn the steering wheel 8 to 13 cm (3 to 5 inches), about one-eighth turn, until the right front tire contacts the pavement edge. Then turn the steering wheel to go straight down the roadway.

Loss of Control

Let us review what driving experts say about what happens when the three control systems — brakes, steering, and acceleration — do not have enough friction where the tires meet the road to do what the driver has asked.

In any emergency, do not give up. Keep trying to steer and constantly seek an escape route or area of less danger.

Skidding

In a skid, a driver can lose control of the vehicle. Defensive drivers avoid most skids by taking reasonable care suited to existing conditions, and by not overdriving those conditions. But skids are always possible.

The three types of skids correspond to the vehicle's three control systems. In the braking skid, the wheels are not rolling. In the steering or cornering skid, too much speed or steering in a curve causes tires to slip and lose cornering force. And in the acceleration skid, too much throttle causes the driving wheels to spin.

If the vehicle starts to slide, ease your foot off the accelerator pedal and quickly steer the way you want the vehicle to go. If you start steering quickly enough, the vehicle may straighten out. Always be ready for a second skid if it occurs.

Of course, traction is reduced when water, snow, ice, gravel, or other material is on the road. For safety, slow down and adjust your driving to these conditions. It is important to slow down on slippery surfaces because stopping distance is longer and vehicle control more limited.

While driving on a surface with reduced traction, try to avoid sudden steering, acceleration, or braking, including reducing vehicle speed by shifting to a lower gear. Any sudden changes could cause the tires to slide. You might not realize the surface is slippery until the vehicle is skidding. Learn to recognize warning clues — such as enough water, ice, or packed snow on the road to make a mirrored surface — and slow down when you have any doubt.

Remember: Antilock brakes help avoid only the braking skid.

Driving on Wet Roads

Rain and wet roads can reduce vehicle traction and affect your ability to stop and accelerate. Always drive slower in these types of driving conditions and avoid driving through large puddles and deep-standing or flowing water.

WARNING

Wet brakes can cause crashes. They might not work as well in a quick stop and could cause pulling to one side. You could lose control of the vehicle.

After driving through a large puddle of water or a car/vehicle wash, lightly apply the brake pedal until the brakes work normally.

(Continued)

WARNING (Continued)

Flowing or rushing water creates strong forces. Driving through flowing water could cause your vehicle to be carried away. If this happens, you and other vehicle occupants could drown. Do not ignore police warnings and be very cautious about trying to drive through flowing water.

Hydroplaning

Hydroplaning is dangerous. Water can build up under your vehicle's tires so they actually ride on the water. This can happen if the road is wet enough and you are going fast enough. When your vehicle is hydroplaning, it has little or no contact with the road.

There is no hard and fast rule about hydroplaning. The best advice is to slow down when the road is wet.

8-8 Driving and Operating

Other Rainy Weather Tips

Besides slowing down, other wet weather driving tips include:

- Allow extra following distance.
- Pass with caution.
- Keep windshield wiping equipment in good shape.
- Keep the windshield washer fluid reservoir filled.
- Have good tires with proper tread depth. See *Tires on page 9-52*.
- Turn off cruise control.

Highway Hypnosis

Always be alert and pay attention to your surroundings while driving. If you become tired or sleepy, find a safe place to park your vehicle and rest.

Other driving tips include:

- Keep the vehicle well ventilated.
- Keep interior temperature cool.
- Keep your eyes moving — scan the road ahead and to the sides.
- Check the rearview mirror and vehicle instruments often.

Hill and Mountain Roads

Driving on steep hills or through mountains is different than driving on flat or rolling terrain. Tips for driving in these conditions include:

- Keep the vehicle serviced and in good shape.
- Check all fluid levels and brakes, tires, cooling system, and transmission.
- Shift to a lower gear when going down steep or long hills.

WARNING

If you do not shift down, the brakes could get so hot that they would not work well. You would then have poor braking or even none going down a hill. You could crash. Shift down to let the engine assist the brakes on a steep downhill slope.

⚠ WARNING

Coasting downhill in N (Neutral) or with the ignition off is dangerous. The brakes will have to do all the work of slowing down and they could get so hot that they would not work well. You would then have poor braking or even none going down a hill. You could crash. Always have the engine running and the vehicle in gear when going downhill.

- Stay in your own lane. Do not swing wide or cut across the center of the road. Drive at speeds that let you stay in your own lane.
- Top of hills: Be alert — something could be in your lane (stalled car, accident).

- Pay attention to special road signs (falling rocks area, winding roads, long grades, passing or no-passing zones) and take appropriate action.

Winter Driving**Driving on Snow or Ice**

Drive carefully when there is snow or ice between the tires and the road, creating less traction or grip. Wet ice can occur at about 0°C (32°F) when freezing rain begins to fall, resulting in even less traction. Avoid driving on wet ice or in freezing rain until roads can be treated with salt or sand.

Drive with caution, whatever the condition. Accelerate gently so traction is not lost. Accelerating too quickly causes the wheels to spin and makes the surface under the tires slick, so there is even less traction.

Try not to break the fragile traction. If you accelerate too fast, the drive wheels will spin and polish the surface under the tires even more.

The *Antilock Brake System (ABS)* on page 8-30 improves vehicle stability during hard stops on slippery roads, but apply the brakes sooner than when on dry pavement.

Allow greater following distance on any slippery road and watch for slippery spots. Icy patches can occur on otherwise clear roads in shaded areas. The surface of a curve or an overpass can remain icy when the surrounding roads are clear. Avoid sudden steering maneuvers and braking while on ice.

Turn off cruise control, if equipped, on slippery surfaces.

8-10 Driving and Operating

Blizzard Conditions

Being stuck in snow can be a serious situation. Stay with the vehicle unless there is help nearby. If possible, use the *Roadside Service on page 12-6*. To get help and keep everyone in the vehicle safe:

- Turn on the hazard warning flashers.
- Tie a red cloth to an outside mirror.

WARNING

Snow can trap engine exhaust under the vehicle. This may cause exhaust gases to get inside. Engine exhaust contains Carbon Monoxide (CO) which cannot be seen or smelled. It can cause unconsciousness and even death.

(Continued)

WARNING (Continued)

If the vehicle is stuck in the snow:

- Clear away snow from around the base of your vehicle, especially any that is blocking the exhaust pipe.
- Check again from time to time to be sure snow does not collect there.
- Open a window about 5 cm (2 in) on the side of the vehicle that is away from the wind to bring in fresh air.
- Fully open the air outlets on or under the instrument panel.
- Adjust the climate control system to a setting that circulates the air inside the vehicle and set the fan speed to the highest setting. See Climate Control System in the Index.

(Continued)

WARNING (Continued)

For more information about carbon monoxide, see *Engine Exhaust on page 8-24*.

Snow can trap exhaust gases under your vehicle. This can cause deadly CO (Carbon Monoxide) gas to get inside. CO could overcome you and kill you. You cannot see it or smell it, so you might not know it is in your vehicle. Clear away snow from around the base of your vehicle, especially any that is blocking the exhaust.

Run the engine for short periods only as needed to keep warm, but be careful.

To save fuel, run the engine for only short periods as needed to warm the vehicle and then shut the engine off and close the window most of the way to save heat.

Repeat this until help arrives but only when you feel really uncomfortable from the cold. Moving about to keep warm also helps.

If it takes some time for help to arrive, now and then when you run the engine, push the accelerator pedal slightly so the engine runs faster than the idle speed. This keeps the battery charged to restart the vehicle and to signal for help with the headlamps. Do this as little as possible to save fuel.

If the Vehicle is Stuck

Slowly and cautiously spin the wheels to free the vehicle when stuck in sand, mud, ice, or snow.

If stuck too severely for the traction system to free the vehicle, turn the traction system off and use the rocking method.

WARNING

If the vehicle's tires spin at high speed, they can explode, and you or others could be injured. The vehicle can overheat, causing an engine compartment fire or other damage. Spin the wheels as little as possible and avoid going above 55 km/h (35 mph) as shown on the speedometer.

For information about using tire chains on the vehicle, see *Tire Chains* on page 9-74.

Rocking the Vehicle to Get it Out

Turn the steering wheel left and right to clear the area around the front wheels. Turn off any traction system. Shift back and forth between R (Reverse) and a forward gear, spinning the wheels as little as possible. To prevent transmission wear, wait until the wheels stop spinning before shifting gears.

Release the accelerator pedal while shifting, and press lightly on the accelerator pedal when the transmission is in gear. Slowly spinning the wheels in the forward and reverse directions causes a rocking motion that could free the vehicle. If that does not get the vehicle out after a few tries, it might need to be towed out. If the vehicle does need to be towed out, see *Towing the Vehicle* on page 9-105.

Vehicle Load Limits

It is very important to know how much weight the vehicle can carry. This weight is called the vehicle capacity weight and includes the weight of all occupants, cargo and all nonfactory-installed options.

8-12 Driving and Operating

Two labels on the vehicle show how much weight it may properly carry, the Tire and Loading Information label and the Certification label.

WARNING

Do not load the vehicle any heavier than the Gross Vehicle Weight Rating (GVWR), or either the maximum front or rear Gross Axle Weight Rating (GAWR). If you do, parts on the vehicle can break, and it can change the way the vehicle handles. These could cause you to lose control and crash. Also, overloading can shorten the life of the vehicle.

Tire and Loading Information Label

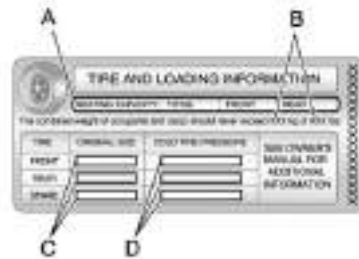

Label Example

A vehicle specific Tire and Loading Information label is attached to the vehicle's center pillar (B-pillar). With the driver's door open, you will find the label attached near the door lock post. The Tire and Loading Information label shows the number of occupant seating

positions (A), and the maximum vehicle capacity weight (B) in kilograms and pounds.

The Tire and Loading Information label also shows the tire size of the original equipment tires (C) and the recommended cold tire inflation pressures (D). For more information on tires and inflation see *Tires on page 9-52* and *Tire Pressure on page 9-59*.

There is also important loading information on the Certification label. It tells you the Gross Vehicle Weight Rating (GVWR) and the Gross Axle Weight Rating (GAWR) for the front and rear axle. See "Certification Label" later in this section.

Steps for Determining Correct Load Limit

1. Locate the statement “The combined weight of occupants and cargo should never exceed XXX kg or XXX lbs” on your vehicle's placard.
2. Determine the combined weight of the driver and passengers that will be riding in your vehicle.
3. Subtract the combined weight of the driver and passengers from XXX kg or XXX lbs.
4. The resulting figure equals the available amount of cargo and luggage load capacity. For example, if the “XXX” amount equals 1400 lbs and there will be five 150 lb passengers in your vehicle,

the amount of available cargo and luggage load capacity is 650 lbs ($1400 - 750$ (5×150) = 650 lbs).

5. Determine the combined weight of luggage and cargo being loaded on the vehicle. That weight may not safely exceed the available cargo and luggage load capacity calculated in Step 4.
6. If your vehicle will be towing a trailer, the load from your trailer will be transferred to your vehicle. Consult this manual to determine how this reduces the available cargo and luggage load capacity of your vehicle.

See *Trailer Towing on page 8-56* for important information on towing a trailer, towing safety rules and trailering tips.



Example 1

- A. Vehicle Capacity Weight for Example 1 = 453 kg (1,000 lbs).
- B. Subtract Occupant Weight @ 68 kg ($150 \text{ lbs} \times 2 = 136 \text{ kg}$ (300 lbs)).
- C. Available Occupant and Cargo Weight = 317 kg (700 lbs).

8-14 Driving and Operating

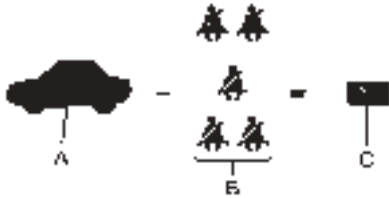

Example 2

- A. Vehicle Capacity Weight for Example 2 = 453 kg (1,000 lbs).
- B. Subtract Occupant Weight @ 68 kg (150 lbs) $\times 5 = 340$ kg (750 lbs).
- C. Available Cargo Weight = 113 kg (250 lbs).



Example 3

- A. Vehicle Capacity Weight for Example 3 = 453 kg (1,000 lbs).
 - B. Subtract Occupant Weight @ 91 kg (200 lbs) $\times 5 = 453$ kg (1,000 lbs).
 - C. Available Cargo Weight = 0 kg (0 lbs).
- Refer to the vehicle's Tire and Loading Information label for specific information about the

vehicle's capacity weight and seating positions. The combined weight of the driver, passengers, and cargo should never exceed the vehicle's capacity weight.

Certification Label

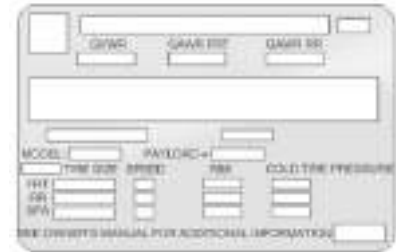

Label Example

A vehicle specific Certification/Tire label is attached to the rear edge of the driver's door. The label shows the size of the vehicle's original tires and the

inflation pressures needed to obtain the gross weight capacity of the vehicle. This is called Gross Vehicle Weight Rating (GVWR). The GVWR includes the weight of the vehicle, all occupants, fuel, and cargo.

The Certification/Tire label also tells you the maximum weights for the front and rear axles, called Gross Axle Weight Rating (GAWR). To find out the actual loads on the front and rear axles, you need to go to a weigh station and weigh the vehicle.

Your dealer can help you with this. Be sure to spread out the load equally on both sides of the center line.

Never exceed the GVWR for the vehicle, or the GAWR for either the front or rear axle.

If the vehicle is carrying a heavy load, it should be spread out. See “Steps for Determining Correct Load Limit” earlier in this section.

 **WARNING**

Do not load the vehicle any heavier than the Gross Vehicle Weight Rating (GVWR), or either the maximum front or rear Gross Axle Weight Rating (GAWR). If you do, parts on the vehicle can break, and it can change the way the vehicle handles. These could cause you to lose control and crash. Also, overloading can shorten the life of the vehicle.

Your warranty does not cover parts or components that fail because of overloading.

8-16 Driving and Operating

The label will help you decide how much cargo and installed equipment your truck can carry.

Using heavier suspension components to get added durability might not change your weight ratings. Ask your dealer to help you load your vehicle the right way.

If you put things inside your vehicle – like suitcases, tools, packages, or anything else – they will go as fast as the vehicle goes. If you have to stop or turn quickly, or if there is a crash, they will keep going.

WARNING

Things you put inside the vehicle can strike and injure people in a sudden stop or turn, or in a crash.

- Put things in the cargo area of the vehicle. In the cargo area, put them as far forward as you can. Try to spread the weight evenly.
- Never stack heavier things, like suitcases, inside the vehicle so that some of them are above the tops of the seats.

(Continued)

WARNING (Continued)

- Do not leave an unsecured child restraint in the vehicle.
- When you carry something inside the vehicle, secure it whenever you can.
- Do not leave a seat folded down unless you need to.

Starting and Operating

New Vehicle Break-In

Notice: The vehicle does not need an elaborate break-in. But it will perform better in the long run if you follow these guidelines:

- Do not drive at any one constant speed, fast or slow, for the first 805 km (500 miles). Do not make full-throttle starts. Avoid downshifting to brake or slow the vehicle.

- During the first 1 000 km (600 miles), avoid using more than moderate acceleration in lower gears and avoid vehicle speeds above 110 km/h (68 mph).
- Between the first 1 000 km (600 miles) and 5 000 km (3,000 miles), heavy acceleration in lower gears can be used. Vehicle speeds above 110 km/h (68 mph) should be limited to five minutes per use.

- Avoid making hard stops for the first 322 km (200 miles) or so. During this time the new brake linings are not yet broken in. Hard stops with new linings can mean premature wear and earlier replacement. Follow this breaking-in guideline every time you get new brake linings.
- Do not tow a trailer during break-in. See *Driving Characteristics and Towing Tips* on page 8-52 for the trailer towing capabilities of your vehicle and more information.

Following break-in, engine speed and load can be gradually increased.

Adjustable Throttle and Brake Pedal

If the vehicle has this feature, the position of the throttle and brake pedals can be adjusted.



The switch used to adjust the pedals is located on the right side of the steering column, below the wiper stalk. Pull the switch toward you to move the pedals further from the floor, or push the switch away from you to move the pedals closer to the floor.

Adjust the throttle and brake pedals while the vehicle is in P (Park) without pressing on the pedals. The pedals cannot be adjusted while the vehicle is in R (Reverse) or when cruise control is engaged. The throttle and brake pedals can also be adjusted while driving.

Ignition Positions



The vehicle has an electronic keyless ignition with push-button start.

Pressing the button cycles it through three modes, ACC/ACCESSORY, ON/RUN/START and STOPPING THE ENGINE/OFF.

If the push-button start is not working, the vehicle may be near a strong radio antenna signal causing interference to the keyless entry system. See *Driver Information Center (DIC)* on page 4-29 for more information.

To shift out of P (Park), the vehicle must be in ACC/ACCESSORY or ON/RUN mode and the brake pedal must be applied.

STOPPING THE ENGINE/OFF (No LED Lights): When the vehicle is stopped, press the engine START/STOP button once to turn the engine off.

If the vehicle is in P (Park), the ignition will turn OFF, and Retained Accessory Power (RAP) will remain active. See *Retained Accessory Power (RAP)* on page 8-20 for more information.

If the vehicle is not in P (Park), the ignition will return to ACC/ACCESSORY and display the message SHIFT TO PARK in the Driver Information Center (DIC). See *Driver Information Center (DIC) on page 4-29* for more information. When the vehicle is shifted into P (Park), the ignition system will switch to OFF.

Do not turn the engine off when the vehicle is moving. This will cause a loss of power assist in the brake and steering systems and disable the airbags.

In an emergency:

1. Brake using a firm and steady pressure. Do not pump the brakes repeatedly. This may deplete power assist, requiring increased brake pedal force.

2. Shift the vehicle to N (Neutral). This can be done while the vehicle is moving. After shifting to N (Neutral), firmly apply the brakes and steer the vehicle to a safe location.
3. Come to a complete stop, shift to P (Park), and turn the ignition to LOCK/OFF. On vehicles with an automatic transmission, the shift lever must be in P (Park) to turn the ignition switch to the LOCK/OFF position.
4. Set the parking brake. See *Parking Brake on page 8-31*

ACC/ACCESSORY (Amber LED

Light): This mode allows you to use some electrical accessories when the engine is off.

With the ignition off, pressing the button one time without the brake pedal applied, will place the ignition system in ACC/ACCESSORY.

The ignition will switch from ACC/ACCESSORY to OFF after five minutes to prevent battery run down.

ON/RUN/START (Green LED

Light): This mode is for driving and starting. With the ignition off, and the brake pedal applied, pressing the button once will place the ignition system in ON/RUN/START. Once engine cranking begins, release the button. Engine cranking will continue until the engine starts. See *Starting the Gasoline Engine on page 8-20* for more information. The ignition will then remain in ON/RUN.

Retained Accessory Power (RAP)

These vehicle accessories can be used for up to 10 minutes after the engine is turned off:

- Audio System
- Power Windows
- Sunroof (if equipped)
- Power outlets under the climate control system, inside the center floor console, and on the rear of the center floor console.

Power to the audio system will continue to operate for up to 10 minutes or until the driver door is opened.

Power to the power windows, sunroof and outlets under the climate control system, inside the center floor console, and on the rear of the center floor console will continue to operate for up to 10 minutes or until any door is opened.

All these features will work when the vehicle is in ON/RUN/START.

Starting the Gasoline Engine

Place the transmission in the proper gear by moving the shift lever to P (Park) or N (Neutral). To restart the engine when the vehicle is already moving, use N (Neutral).

Notice: Do not try to shift to P (Park) if the vehicle is moving. If you do, you could damage the transmission. Shift to P (Park) only when the vehicle is stopped.

The keyless access transmitter must be inside the vehicle for the ignition to work.

Cell phone chargers can interfere with the operation of the Keyless Access System. Battery chargers should not be plugged in when starting or turning off the engine.

To start the vehicle:

Starting Procedure

1. With the brake pedal applied, press the START button located on the instrument panel. See *Ignition Positions on page 8-18*.
2. When the engine begins cranking, let go of the button and the engine cranks automatically until it starts.

If the transmitter is not in the vehicle or something is interfering with the transmitter, the Driver Information Center (DIC) will display No Remote Detected. See *Driver Information Center (DIC) on page 4-29* for more information.

If the battery in the keyless access transmitter needs replacing, the DIC displays Replace Battery In Remote Key. The vehicle can still be driven. See *Remote Keyless Entry (RKE) System Operation on page 1-3* for more information.

3. Do not race the engine immediately after starting it. Operate the engine and transmission gently until the oil warms up and lubricates all moving parts.
4. If the engine does not start and no DIC message is displayed, wait 15 seconds before trying again to let the cranking motor cool down.

If the engine does not start after 5-10 seconds, especially in very cold weather (below -18°C or 0°F), it could be flooded with too much gasoline. Try pushing the accelerator pedal all the way to the floor while cranking for up to 15 seconds.

Notice: Cranking the engine for long periods of time, by pressing the START button immediately after cranking has ended, can overheat and damage the cranking motor, and drain the battery. Wait at least 15 seconds between each try, to allow the cranking motor to cool down.

When the engine starts, let go of the accelerator. If the vehicle starts briefly but then stops again, do the same thing. This clears the extra gasoline from the engine.

The vehicle has a Computer-Controlled Cranking System. This feature assists in starting the engine and protects components. Once cranking has been initiated, the engine continues

cranking for a few seconds or until the vehicle starts. If the engine does not start, cranking automatically stops after 15 seconds to prevent cranking motor damage. To prevent gear damage, this system also prevents cranking if the engine is already running.

Notice: The engine is designed to work with the electronics in the vehicle. If you add electrical parts or accessories, you could change the way the engine operates. Before adding electrical equipment, check with your dealer. If you do not, the engine might not perform properly. Any resulting damage would not be covered by the vehicle warranty.

Engine Heater

The engine coolant heater, if available, can help in cold weather conditions at or below -18°C (0°F) for easier starting and better fuel economy during engine warm-up. Plug in the coolant heater at least four hours before starting the vehicle. An internal thermostat in the plug-end of the cord will prevent engine coolant heater operation at temperatures above -18°C (0°F).

To Use The Engine Coolant Heater

1. Turn off the engine.
2. Open the hood and unwrap the electrical cord. The cord is located near the air cleaner.
3. Plug it into a normal, grounded 110-volt AC outlet.

WARNING

Plugging the cord into an ungrounded outlet could cause an electrical shock. Also, the wrong kind of extension cord could overheat and cause a fire. You could be seriously injured. Plug the cord into a properly grounded three-prong 110-volt AC outlet. If the cord will not reach, use a heavy-duty three-prong extension cord rated for at least 15 amps.

4. Before starting the engine, be sure to unplug and store the cord as it was before to keep it away from moving engine parts. If you do not it could be damaged.

The length of time the heater should remain plugged in depends on several factors. Ask a dealer in the area where you will be parking the vehicle for the best advice on this.

Shifting Into Park

WARNING

It can be dangerous to get out of the vehicle if the shift lever is not fully in P (Park) with the parking brake firmly set. The vehicle can roll. If you have left the engine running, the vehicle can move suddenly. You or others could be injured. To be sure the vehicle will not move, even when you are on fairly level ground, use the steps that follow.

1. Hold the brake pedal down and set the parking brake.
See Parking Brake on page 8-31 for more information.
2. Move the shift lever into P (Park) by pushing the lever all the way toward the front of the vehicle.
3. Turn the ignition off.

Leaving the Vehicle With the Engine Running

WARNING

It can be dangerous to leave the vehicle with the engine running. The vehicle could move suddenly if the shift lever is not fully in P (Park) with the parking brake firmly set. And, if you leave the vehicle with the engine running, it could overheat and even catch fire. You or others could be injured. Do not leave the vehicle with the engine running.

If you have to leave the vehicle with the engine running, be sure the vehicle is in P (Park) and the parking brake is firmly set before you leave it. After you have moved the shift lever into P (Park), hold down the regular brake pedal.

See if you can move the shift lever away from P (Park) without first pulling it toward you. If you can, it means that the shift lever was not fully locked into P (Park).

Torque Lock

Torque lock is when the weight of the vehicle puts too much force on the parking pawl in the transmission. This happens when parking on a hill and shifting the transmission into P (Park) is not done properly and then it is difficult to shift out of P (Park). To prevent torque lock, set the parking brake and then shift into P (Park). To find out how, see "Shifting Into P (Park)" listed previously.

If torque lock does occur, your vehicle may need to be pushed uphill by another vehicle to relieve the parking pawl pressure, so you can shift out of P (Park).

Shifting Out of Park

This vehicle is equipped with an electronic shift lock release system. The shift lock release is designed to prevent movement of the shift lever out of P (Park), unless the ignition is in ON/RUN or ACC/ACCESSORY and the brake pedal is applied.

The shift lock release is always functional except in the case of an uncharged or low voltage (less than 9 volt) battery.

If the vehicle has an uncharged battery or a battery with low voltage, try charging or jump starting the battery. See *Jump Starting on page 9-101*.

To shift out of P (Park):

1. Apply the brake pedal.
2. Press the shift lever button.
3. Move the shift lever to the desired position.

8-24 Driving and Operating

If you still are unable to shift out of P (Park):

1. Fully release the shift lever button.
2. Hold the brake pedal down and press the shift lever button again.
3. Move the shift lever to the desired position.

If you still cannot move the shift lever from P (Park), consult your dealer or a professional towing service.

Parking Over Things That Burn

WARNING

Things that can burn could touch hot exhaust parts under the vehicle and ignite. Do not park over papers, leaves, dry grass, or other things that can burn.

Engine Exhaust

WARNING

Engine exhaust contains Carbon Monoxide (CO) which cannot be seen or smelled. Exposure to CO can cause unconsciousness and even death.

Exhaust may enter the vehicle if:

- The vehicle idles in areas with poor ventilation (parking garages, tunnels, deep snow that may block underbody airflow or tail pipes).
- The exhaust smells or sounds strange or different.
- The exhaust system leaks due to corrosion or damage.

(Continued)

WARNING (Continued)

- The vehicle's exhaust system has been modified, damaged or improperly repaired.
- There are holes or openings in the vehicle body from damage or after-market modifications that are not completely sealed.

If unusual fumes are detected or if it is suspected that exhaust is coming into the vehicle:

- Drive it only with the windows completely down.
- Have the vehicle repaired immediately.

Never park the vehicle with the engine running in an enclosed area such as a garage or a building that has no fresh air ventilation.

Running the Vehicle While Parked

It is better not to park with the engine running. But if you ever have to, here are some things to know.

WARNING

Idling a vehicle in an enclosed area with poor ventilation is dangerous. Engine exhaust may enter the vehicle. Engine exhaust contains Carbon Monoxide (CO) which cannot be seen or smelled. It can cause unconsciousness and even death. Never run the engine in an enclosed area that has no fresh air ventilation. For more information, see *Engine Exhaust* on page 8-24.

WARNING

It can be dangerous to get out of the vehicle if the automatic transmission shift lever is not fully in P (Park) with the parking brake firmly set. The vehicle can roll. Do not leave the vehicle when the engine is running unless you have to. If you have left the engine running, the vehicle can move suddenly. You or others could be injured. To be sure the vehicle will not move, even when you are on fairly level ground, always set the parking brake and move the shift lever to P (Park).

Follow the proper steps to be sure the vehicle will not move. See *Shifting Into Park* on page 8-22.

If parking on a hill and pulling a trailer, see *Driving Characteristics and Towing Tips* on page 8-52.

Automatic Transmission

The shift lever is located on the center console between the front seats.



There are several different positions for the shift lever.

8-26 Driving and Operating

P (Park): This position locks the front wheels. It is the best position to use when you start the engine because the vehicle cannot move easily.

WARNING

It is dangerous to get out of the vehicle if the shift lever is not fully in P (Park) with the parking brake firmly set. The vehicle can roll.

Do not leave the vehicle when the engine is running unless you have to. If you have left the engine running, the vehicle can move suddenly. You or others could be injured. To be sure the vehicle will not move, even when you are on fairly level ground, always set the parking brake and move the shift lever to P (Park). See *Shifting Into Park* on page 8-22. If you are pulling a trailer, see *Driving Characteristics and Towing Tips* on page 8-52.

Make sure the shift lever is fully in P (Park) before starting the engine. The vehicle has an automatic transmission shift lock control system. You must fully apply the regular brakes first and then press the shift lever button before you can shift from P (Park) when the ignition is in ON/RUN. If you cannot shift out of P (Park), ease pressure on the shift lever and push the shift lever all the way into P (Park) as you maintain brake application. Then press the shift lever button and move the shift lever into another gear. See *Shifting Out of Park* on page 8-23.

Notice: Shifting to R (Reverse) while the vehicle is moving forward could damage the transmission. The repairs would not be covered by the vehicle warranty. Shift to R (Reverse) only after the vehicle is stopped.

R (Reverse): Use this gear to back up.

At low vehicle speeds, R (Reverse) can be used to rock the vehicle back and forth to get out of snow, ice, or sand without damaging your transmission. See *If the Vehicle is Stuck* on page 8-11 for additional information.

N (Neutral): In this position, the engine does not connect with the wheels. To restart when the vehicle is already moving, use N (Neutral) only. You can also use N (Neutral) when the vehicle is being towed.

 **WARNING**

Shifting into a drive gear while the engine is running at high speed is dangerous. Unless your foot is firmly on the brake pedal, the vehicle could move very rapidly. You could lose control and hit people or objects. Do not shift into a drive gear while the engine is running at high speed.

Notice: Shifting out of P (Park) or N (Neutral) with the engine running at high speed may damage the transmission. The repairs would not be covered by the vehicle warranty. Be sure the engine is not running at high speed when shifting the vehicle.

D (Drive): This position is for normal driving. It provides the best fuel economy. If you need more power for passing, and you are:

- Going less than 35 mph (55 km/h), push the accelerator pedal about halfway down.
- Going about 35 mph (55 km/h) or more, push the accelerator all the way down.

The transmission will shift down to a lower gear and have more power.

Downshifting the transmission in slippery road conditions could result in skidding, see Skidding under *Loss of Control* on page 8-6.

Notice: Spinning the tires or holding the vehicle in one place on a hill using only the accelerator pedal may damage the transmission. If you are stuck, do not spin the tires. When stopping on a hill, use the brakes to hold the vehicle in place.

Manual Mode

Driver Shift Control (DSC)

Notice: If you drive the vehicle at high RPMs without upshifting while using Driver Shift Control (DSC), you could damage the vehicle. Always upshift when necessary while using DSC.

Driver Shift Control (DSC) allows you to shift an automatic transmission similar to a manual transmission. To use the DSC feature:

1. Move the shift lever to the left from D (Drive) to M (Manual Mode).

If you do not move the shift lever forward or rearward, the vehicle will be in Sport Mode. When you are in Sport Mode the vehicle will still shift automatically. The transmission may remain in a gear longer than it would in the normal driving mode based on braking, throttle input, and vehicle lateral acceleration.

An S will be displayed in the DIC.

Within Sport Mode there is a further performance feature called Performance Mode Lift Foot (PMLF) Mode. The feature is activated automatically when sports oriented driving is detected, based on cornering and on/off throttle application. PMLF allows the transmission to hold the current gear instead of upshifting when the throttle is lifted.

2. To enter M (Manual Mode), press the shift lever forward to upshift or rearward to downshift.

An M will be displayed in the DIC.



The tachometer display on the instrument panel cluster will show which gear the vehicle is in. The number indicates the requested gear range when moving the shift lever forward or rearward. See *Tachometer* on page 4-15 for more information.

While using the DSC feature, the vehicle will have firmer, quicker shifting. You can use this for sport driving or when climbing or descending hills, to stay in gear longer, or to down shift for more power or engine braking.

The transmission will only allow you to shift into gears appropriate for the vehicle speed and engine Revolutions Per Minute (RPM). The transmission will not automatically shift to the next lower gear if the engine RPM is too high, nor to the next higher gear when the maximum engine RPM is reached.

If shifting is prevented for any reason, the currently selected gear will flash multiple times, indicating that the transmission has not shifted gears.

While in the DSC mode, the transmission will automatically downshift when the vehicle comes to a stop. This will allow for more power during take-off.

When accelerating the vehicle from a stop in snowy and icy conditions, you may want to shift into second gear. A higher gear ratio allows you to gain more traction on slippery surfaces.

Fuel Economy Mode

The vehicle may have a fuel economy mode. When engaged, fuel economy mode can improve the vehicle's fuel economy.



Pressing the eco button by the shift lever will engage fuel economy mode. When activated, the eco light in the instrument cluster will come on. See *Fuel Economy Light* on page 4-27. Pressing the button a second time will turn fuel economy mode off.

When fuel economy mode is on:

- The transmission will upshift sooner, and downshift later.
- The torque converter will lock-up sooner, and stay on longer.
- The gas pedal will be less sensitive.
- The vehicle's computers will more aggressively shut off fuel to the engine under deceleration.

Drive Systems

All-Wheel Drive

Vehicles with this feature always send engine power to all four wheels. It is fully automatic, and adjusts itself as needed for road conditions.

When using a compact spare tire on an AWD vehicle, the system automatically detects the compact spare and disables AWD. To restore AWD operation and prevent excessive wear on the system, replace the compact spare with a full-size tire as soon as possible. See *Compact Spare Tire* on page 9-100 for more information.

Brakes

Antilock Brake System (ABS)

This vehicle has the Antilock Brake System (ABS), an advanced electronic braking system that helps prevent a braking skid.

When the engine is started and the vehicle begins to drive away, ABS checks itself. A momentary motor or clicking noise might be heard while this test is going on, and it might even be noticed that the brake pedal moves a little. This is normal.



If there is a problem with ABS, this warning light stays on. See *Antilock Brake System (ABS) Warning Light* on page 4-24.

If driving safely on a wet road and it becomes necessary to slam on the brakes and continue braking to avoid a sudden obstacle, a computer senses that the wheels are slowing down. If one of the wheels is about to stop rolling, the computer will separately work the brakes at each wheel.

ABS can change the brake pressure to each wheel, as required, faster than any driver could. This can help the driver steer around the obstacle while braking hard.

As the brakes are applied, the computer keeps receiving updates on wheel speed and controls braking pressure accordingly.

Remember: ABS does not change the time needed to get a foot up to the brake pedal or always decrease stopping distance. If you get too close to the vehicle in front of you, there will not be enough time to apply the brakes if that vehicle suddenly slows or stops. Always leave enough room up ahead to stop, even with ABS.

Using ABS

Do not pump the brakes. Just hold the brake pedal down firmly and let ABS work. You might hear the ABS pump or motor operating and feel the brake pedal pulsate, but this is normal.

Braking in Emergencies

ABS allows the driver to steer and brake at the same time. In many emergencies, steering can help more than even the very best braking.

Parking Brake

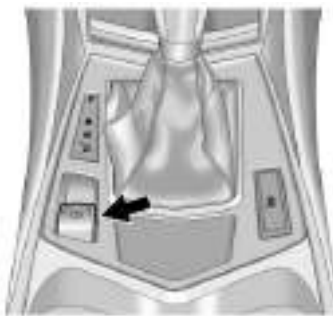

The vehicle has an Electric Parking Brake (EPB). The switch for the EPB is in the center console. The EPB can always be activated, even if the ignition is OFF. To avoid draining the battery, do not cycle the EPB too often without the engine running. The EPB can be left applied while the vehicle is parked.

The system has a Park Brake Status light and a Park Brake Warning light. See *Brake System Warning Light* on page 4-23. There are also three Driver Information Center (DIC) messages. See *Driver Information Center (DIC)* on page 4-29 for more information. In case of insufficient electrical power, the EPB cannot be applied or released.

Before leaving the vehicle, check the park brake status lamp to insure the park brake is applied.

EPB Apply

The EPB can be applied any time the vehicle is stopped. The EPB is applied by momentarily lifting up on the EPB switch. Once fully applied, the park brake status light will be on. While the brake is being applied, the status lamp will flash until full apply is reached. If the light does not come on, or remains flashing, you need to have the vehicle serviced. Do not drive the vehicle if the park brake status light is flashing. See your dealer. See *Brake System Warning Light* on page 4-23 for more information.

If the EPB is applied while the vehicle is in motion, a chime will sound, and the DIC message “Release Park Brake” will be displayed. The vehicle will decelerate as long as the switch is held in the up position. Releasing the EPB switch during the deceleration will release the parking brake. If the switch is held in the up position until the vehicle comes to a stop, the EPB will remain applied.

If the park brake status light flashes continuously, the EPB is only partially applied or released, or there is a problem with the EPB. The DIC message “Service Parking Brake” will be displayed. If this light flashes continuously, release the EPB, and attempt to apply it again. If this light continues to flash, do not drive the vehicle. See your dealer.

If the park brake warning light is on, the EPB has detected an error in another system and is operating with reduced functionality. To apply the EPB when this light is on, lift up on the EPB switch and hold it in the up position. Full application of the parking brake by the EPB system may take a longer period of time than normal when this light is on. Continue to hold the switch until the park brake status light remains on. If the park brake warning light is on, see your dealer.

If the EPB fails to apply, the rear wheels should be blocked to prevent vehicle movement.

EPB Release

To release the EPB, place the ignition in the ON/RUN position, apply and hold the brake pedal, and push down momentarily on the EPB switch. If you attempt to release the EPB without the brake pedal applied, a chime will sound, and the DIC message “Step On Brake to Release Park Brake” will be displayed. The EPB is released when the park brake status light is off.

If the park brake warning light is on, the EPB has detected an error in another system and is operating with reduced functionality. To release the EPB when this light is on, push down on the EPB switch and hold it in the down position.

EPB release may take a longer period of time than normal when this light is on. Continue to hold the switch until the park brake status light is off. If the light is on, see your dealer.

Notice: Driving with the parking brake on can overheat the brake system and cause premature wear or damage to brake system parts. Make sure that the parking brake is fully released and the brake warning light is off before driving.

Automatic EPB Release

The EPB will automatically release if the vehicle is running, placed into gear and an attempt is made to drive away. Avoid rapid acceleration when the EPB is applied, to preserve park brake lining life.

If you are towing a trailer and parking on a hill, see *Driving Characteristics and Towing Tips* on page 8-52 for more information.

Brake Assist

This vehicle has a brake assist feature designed to assist the driver in stopping or decreasing vehicle speed in emergency driving conditions. This feature uses the stability system hydraulic brake control module to supplement the power brake system under conditions where the driver has quickly and forcefully applied the brake pedal in an attempt to quickly stop or slow down the vehicle. The stability system hydraulic brake control module increases brake pressure at each corner of the vehicle until the ABS activates. Minor brake pedal pulsation or pedal movement during this time is normal and the driver should continue to apply the brake pedal as the driving situation dictates. The brake assist feature will automatically disengage when the brake pedal is released or brake pedal pressure is quickly decreased.

Hill Start Assist (HSA)

This vehicle has a Hill Start Assist (HSA) feature, which may be useful when the vehicle is stopped on a grade. This feature is designed to prevent the vehicle from rolling, either forward or rearward, during vehicle drive off. After driver completely stops and holds the vehicle in a complete standstill on a grade, HSA will be automatically activated. During the transition period between when the driver releases the brake pedal and starts to accelerate to drive off on a grade, HSA holds the braking pressure to ensure that there is no rolling back. The brakes will automatically release when the accelerator pedal is applied within the two second window. It will not activate if the vehicle is in a drive gear and facing downhill or if the vehicle is facing uphill and in R (Reverse).

Ride Control Systems

Traction Control System (TCS)

The vehicle may have a Traction Control System (TCS) that limits wheel spin. On a front-wheel-drive vehicle, the system operates if it senses that one or both of the front wheels are spinning or beginning to lose traction. On an All-Wheel-Drive (AWD) vehicle, the system will operate if it senses that any of the wheels are spinning or beginning to lose traction. When this happens, the system brakes the spinning wheel(s) and/or reduces engine power to limit wheel spin.

The system may be heard or felt while it is working, but this is normal.

TCS automatically comes on whenever the vehicle is started. To limit wheel spin, especially in slippery road conditions, the system should always be left on. But, TCS can be turned off if needed.



TCS/StabiliTrak Light

 flashes to indicate that the traction control system is active.

If there is a problem detected with TCS, "Service Traction Control" is displayed on the Driver Information Center (DIC). See *Ride Control System Messages on page 4-38*.

When this message is displayed and  comes on and stays on, the vehicle is safe to drive but the system is not operational. Driving should be adjusted accordingly.

If  comes on and stays on, reset the system by:

1. Stopping the vehicle.
2. Turning the engine off and waiting 15 seconds.
3. Starting the engine.

If  still comes on and stays on, the vehicle needs service.

Notice: Do not repeatedly brake or accelerate heavily when TCS is off. The vehicle's driveline could be damaged.





TCS/StabiliTrak Button

 is located on the console.



TCS Off Light

TCS can be turned off by pressing and releasing . When TCS is turned off,  comes on and the system will not limit wheel spin.

Driving should be adjusted accordingly. Press and release  again to turn the system back on.

When TCS is turned off on AWD vehicles, the system may still make noise. This is normal and necessary with AWD hardware.

It may be necessary to turn the system off if the vehicle gets stuck in sand, mud or snow and rocking the vehicle is required. See *If the Vehicle is Stuck* on page 8-11 for more information. See also *Winter Driving* on page 8-9 for information on using TCS when driving in snowy or icy conditions.

Adding non-GM accessories can affect the vehicle's performance. See *Accessories and Modifications* on page 9-3 for more information.

StabiliTrak[®] System

The vehicle may have a vehicle stability enhancement system called StabiliTrak. It is an advanced computer controlled system that assists with directional control of the vehicle in difficult driving conditions.

StabiliTrak activates when the computer senses a difference between the intended path and the direction the vehicle is actually traveling. StabiliTrak selectively applies braking pressure at any one of the vehicle's brakes to help steer the vehicle in the intended direction.

StabiliTrak comes on automatically whenever the vehicle is started. To assist with directional control of the vehicle, the system should always be left on.



TCS/StabiliTrak Light

When the stability control system activates,  flashes on the instrument panel. This also occurs when traction control is activated. A noise may be heard or vibration may be felt in the brake pedal. This is normal. Continue to steer the vehicle in the intended direction.

If there is a problem detected with StabiliTrak, "Service StabiliTrak" is displayed on the Driver Information Center (DIC). See *Ride Control System Messages on page 4-38*.

When this message is displayed and  comes on and stays on, the vehicle is safe to drive but the system is not operational. Driving should be adjusted accordingly.

If  comes on and stays on, reset the system by:

1. Stopping the vehicle.
2. Turning the engine off and waiting 15 seconds.
3. Starting the engine.

If  still comes on and stays on, the vehicle needs service.



TCS/StabiliTrak Button





 is located on the console.



StabiliTrak Off Light



TCS Off Light

StabiliTrak can be turned off if needed by pressing and holding  until  and  come on the instrument panel. When StabiliTrak is turned off, the system will not assist with directional control of the vehicle or limit wheel spin. Driving should be adjusted accordingly. Press and release  again to turn the system back on.

If cruise control is being used when StabiliTrak activates, cruise control will automatically disengage. Press the cruise control button to reengage when road conditions allow. See *Cruise Control on page 8-37* for more information.

Limited-Slip Rear Axle

Vehicles with a limited-slip rear axle can give more traction on snow, mud, ice, sand, or gravel. When traction is low, this feature allows the drive wheel with the most traction to move the vehicle. The limited-slip rear axle also gives the driver enhanced control when cornering hard or completing a maneuver, such as a lane change.

Selective Ride Control

The vehicle may have a ride control system called Selective Ride Control. The setting can be changed at any time. Based on road conditions, steering wheel angle and the vehicle speed, the system automatically adjusts to provide the best handling while providing a smooth ride. The Tour and Sport modes will feel similar on a smooth road.

To switch from TOUR to SPORT mode, move the shift lever to the left while the transmission is in D (Drive)

TOUR: Use for normal city and highway driving. This setting provides a smooth, soft ride.

SPORT: Use where road conditions or personal preference demand more control. This setting provides more “feel”, or response to road conditions through increased steering effort and suspension control. Transmission shift points and shift firmness are also enhanced. See *Manual Mode on page 8-28* in Automatic Transmission.

If there is a problem detected with Selective Ride Control, “Service Suspension System” displays on the Driver Information Center (DIC). See *Ride Control System Messages on page 4-38*. Driving should be adjusted accordingly.

Cruise Control



WARNING

Cruise control can be dangerous where you cannot drive safely at a steady speed. So, do not use the cruise control on winding roads or in heavy traffic.

Cruise control can be dangerous on slippery roads. On such roads, fast changes in tire traction can cause excessive wheel slip, and you could lose control. Do not use cruise control on slippery roads.

With cruise control, a speed of about 40 km/h (25 mph) or more can be maintained without keeping your foot on the accelerator. Cruise control does not work at speeds below about 40 km/h (25 mph).

If the brakes are applied, the cruise control shuts off.

8-38 Driving and Operating

If the vehicle has the StabiliTrak[®] system and begins to limit wheel spin while using cruise control, the cruise control automatically disengages. See *StabiliTrak[®] System* on page 8-35 or *Traction Control System (TCS)* on page 8-34. When road conditions allow the cruise control to be safely used, you can apply the cruise control again.



Cruise Control

The cruise control buttons are located on the left side of the steering wheel.

 **(On/Off):** Press to turn the system on and off.

+ RES (Resume/Accelerate): Press briefly to make the vehicle resume to a previously set speed or press and hold to accelerate.

-SET (Set/Coast): Press to set the speed and activate cruise control or make the vehicle decelerate.

 **(Cancel):** Press to disengage cruise control without erasing the set speed from memory.

Setting Cruise Control

If the cruise button is on when not in use, it could get bumped and go into cruise when not desired. Keep the cruise control switch off when cruise is not being used.

The cruise control light on the instrument panel cluster comes on after the cruise control has been set to the desired speed.

1. Press .
2. Get up to the desired speed.
3. Press and release the -SET button located on the steering wheel.
4. Take your foot off the accelerator.

Resuming a Set Speed

If the cruise control is set at a desired speed and then the brakes are applied, the cruise control is disengaged without erasing the set speed from memory.

Once the vehicle speed reaches about 40 km/h (25 mph) or more, press the +RES button on the steering wheel. The vehicle returns to the previous set speed and stays there.

Increasing Speed While Cruise Control is at a Set Speed

If the cruise control system is already activated,

- Press and hold the +RES button on the steering wheel until the desired speed is reached, then release it.
- To increase vehicle speed in small amounts, press the +RES button. Each time this is done, the vehicle goes about 1.6 km/h (1 mph) faster.

Reducing Speed While Cruise Control is at a Set Speed

If the cruise control system is already activated,

- Press and hold the -SET button on the steering wheel until the desired lower speed is reached, then release it.

- To slow down in small amounts, press the -SET button on the steering wheel briefly. Each time this is done, the vehicle goes about 1.6 km/h (1 mph) slower.

Passing Another Vehicle While Using Cruise Control



Use the accelerator pedal to increase the vehicle speed. When you take your foot off the pedal, the vehicle will slow down to the previous set cruise speed.

Using Cruise Control on Hills

How well the cruise control will work on hills depends upon the vehicle speed, load, and the steepness of the hills. When going up steep hills, you might have to step on the accelerator pedal to maintain the vehicle speed. When going downhill, you might have to brake or shift to a lower gear to keep the vehicle speed down. If the brake is applied the cruise control disengages.

Ending Cruise Control

There are three ways to end cruise control:

- Step lightly on the brake pedal.
- Press the  button on the steering wheel.
- Press the  button on the steering wheel.

Erasing Speed Memory

The cruise control set speed is erased from memory by pressing the  button or if the ignition is turned off.

Object Detection Systems

Ultrasonic Parking Assist

For vehicles with the Ultrasonic Front and Rear Parking Assist (UFRPA) system, it assists the driver with parking and avoiding objects. UFRPA operates at speeds less than 8 km/h (5 mph), and the sensors on the front and rear bumper detect objects up to 1.2 m (4 ft) in front of the vehicle and 2.5 m (8 ft) behind the vehicle, and at least 25.4 cm (10 in) off the ground.

WARNING

The Ultrasonic Front and Rear Park Assist (UFRPA) system does not replace driver vision. It cannot detect:

- objects that are below the bumper, underneath the vehicle, or if they are too close or far from the vehicle
- children, pedestrians, bicyclists, or pets.

If you do not use proper care before moving forward and while backing; vehicle damage, injury, or death could occur. Even with UFRPA, always check in front of the vehicle before moving forward and behind the vehicle before backing up. While moving forward and backing, be sure to look for objects and check the vehicle's mirrors.

How the System Works

When the vehicle is shifted into R (Reverse) the front and rear sensors are automatically turned on, after the vehicle is shifted out of R (Reverse), the rear sensors are turned off and the front sensors stay on until the vehicle is above a certain speed. The front sensors may also be turned on by pressing the park assist button located next to the shift lever without shifting into R (Reverse) while the vehicle is traveling at a low speed. See "Turning the System On and Off" later in this section.

When the vehicle is in N (Neutral), the system may be active. If the vehicle is in a car wash, the sensors may detect objects in the car wash. See "Turning the System On and Off" later in this section to turn the system off.

High-toned beeps heard from the front speakers are for objects detected near the front bumper. Low-toned beeps heard from the rear speakers are for objects detected near the rear bumper.

When an object is detected, high or low-tone beeps are heard. As the vehicle gets closer to an object, the time between the beeps becomes shorter. When the distance is less than 30 cm (11.8 in), beeping is continuous. The distance may be less during warmer or humid weather.

PARK ASSIST OFF displays on the Driver Information Center (DIC) to indicate that UFRPA is off. The message disappears after a short period of time.

Front Display



The front display is located in the instrument panel in the center of the speedometer and has four bars to provide distance and system information.

The following describes how the UFRPA front display lights appear as the vehicle gets closer to a detected object:

| Description | Metric | English |
|----------------------------------|--------|---------|
| one amber bar | 1.2 m | 4 ft |
| two amber bars | 1.0 m | 40 in |
| three amber bars | 0.6 m | 23 in |
| three amber bars and one red bar | 0.3 m | 1 ft |

Turning the System On and Off

The UFRPA system can be turned on and off by pressing the park assist button located next to the shift lever.



The park assist button lights up when the system is on and turns off when it has been disabled.

When the System Does Not Seem to Work Properly

If UFRPA does not turn on due to a temporary condition, the message PARK ASSIST OFF displays on the DIC, and the light on the park assist button turns off. This can occur under the following conditions:

- The ultrasonic sensors are not clean. Keep the vehicle's bumpers free of mud, dirt, snow, ice and slush. For cleaning instructions, see *Exterior Care* on page 9-109.
- A trailer was attached to the vehicle, or an object was hanging out of the liftgate during the last drive cycle. Once the attached object is removed, UFRPA will return to normal operation.

- If an object is attached to the front of the vehicle.
- A tow bar is attached to the vehicle.
- The vehicle's bumper is damaged. Take the vehicle to your dealer to repair the system.
- Other conditions may affect system performance, such as vibrations from a jackhammer or the compression of air brakes on a very large truck.

If the system is still disabled, after driving forward at least 25 km/h (15 mph), take the vehicle to your dealer.

Rear Vision Camera (RVC)

The vehicle may have a Rear Vision Camera system. Read this entire section before using it.

The rear vision camera system can assist the driver when backing up by displaying a view of the area behind the vehicle.

WARNING

The Rear Vision Camera (RVC) system does not replace driver vision. RVC does not:

- Detect objects that are outside the camera's field of view, below the bumper, or underneath the vehicle.
- Detect children, pedestrians, bicyclists, or pets.

(Continued)

WARNING (Continued)

Do not back the vehicle by only looking at the RVC screen, or use the screen during longer, higher speed backing maneuvers or where there could be cross-traffic. Your judged distances using the screen will differ from actual distances.

If you do not use proper care before backing up, you could hit a vehicle, child, pedestrian, bicyclist, or pet, resulting in vehicle damage, injury, or death. Even though the vehicle has the RVC system, always check carefully before backing up by checking behind and around the vehicle.

An image appears on the navigation screen with the message "Check Surroundings for Safety" when the vehicle is shifted into R (Reverse). The navigation screen goes to the previous screen after approximately 10 seconds once the vehicle is shifted out of R (Reverse).

To cancel the delay, do one of the following:

- Press a hard key on the navigation system.
- Shift in to P (Park).
- Reach a vehicle speed of 8 km/h (5 mph).

8-44 Driving and Operating

Turning the Rear Vision Camera System On or Off

To turn the rear vision camera system on or off:

1. Shift into P (Park).
2. Press the CONFIG button.
3. Select Display.

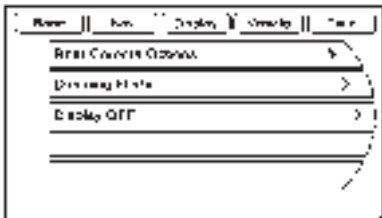

4. Select Camera. When a check mark appears next to the Camera option, then the RVC system is on.

Symbols

The navigation system may have a feature that lets the driver view symbols on the navigation screen while using the rear vision camera. The Ultrasonic Rear Park Assist (URPA) system must not be disabled to use the caution symbols. The error message “Rear Parking Assist Symbols Unavailable” may display if URPA has been disabled and the symbols have been turned on. See *Ultrasonic Parking Assist on page 8-40*.

The symbols appear and may cover an object when viewing the navigation screen when an object is detected by the URPA system.

To turn the symbols on or off:

1. Shift into P (Park).
2. Press the CONFIG button.
3. Select Display.
4. Select Symbols. When a check mark appears next to the Symbols option, symbols will appear.

Guidelines

The RVC system has a guideline overlay that can help the driver align the vehicle when backing into a parking spot.

To turn the guidelines on or off:

1. Shift into P (Park).
2. Press the CONFIG button.
3. Select Display.
4. Select Guidelines. When a check mark appears next to the Guidelines option, guidelines will appear.

Rear Vision Camera Error Messages

SERVICE REAR VISION CAMERA SYSTEM: This message can display when the system is not receiving information it requires from other vehicle systems.

If any other problem occurs or if a problem persists, see your dealer.

Rear Vision Camera Location



The camera is located above the license plate.
 The area displayed by the camera is limited.

It does not display objects that are close to either corner or under the bumper and can vary depending on vehicle orientation or road conditions. The distance of the image that appears on the screen is different from the actual distance.
 The following illustration shows the field of view that the camera provides.

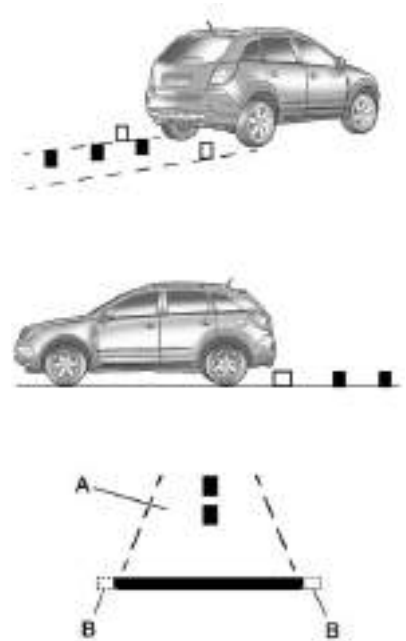

- A. View displayed by the camera.
- B. Corner of the rear bumper.

When the System Does Not Seem To Work Properly

The rear vision camera system may not work properly or display a clear image if:

- The RVC is turned off. See “Turning the Rear Camera System On or Off” earlier in this section.
- It is dark.
- The sun or the beam of headlights is shining directly into the camera lens.
- Ice, snow, mud, or anything else builds up on the camera lens. Clean the lens, rinse it with water, and wipe it with a soft cloth.
- The back of the vehicle is in an accident, the position and mounting angle of the camera can change or the camera can be affected. Be sure to have the camera and its position and mounting angle checked at your dealer.

Fuel

Use of the recommended fuel is an important part of the proper maintenance of this vehicle. To help keep the engine clean and maintain optimum vehicle performance, we recommend the use of gasoline advertised as TOP TIER Detergent Gasoline.

Look for the TOP TIER label on the fuel pump to ensure gasoline meets enhanced detergency standards developed by auto companies. A list of marketers providing TOP TIER Detergent Gasoline can be found at www.toptiergas.com.



The 8th digit of the Vehicle Identification Number (VIN) shows the code letter or number that identifies the vehicle's engine.

The VIN is at the top left of the instrument panel. See *Vehicle Identification Number (VIN)* on page 11-1.

Recommended Fuel

If the vehicle has the 3.0L V6 engine (VIN Code Y), use regular unleaded gasoline with a posted octane rating of 87 or higher. If the octane rating is less than 87, an audible knocking noise, commonly referred to as spark knock, might be heard when driving. If this occurs, use a gasoline rated at 87 octane or higher as soon as possible. If heavy knocking is heard when using gasoline rated at 87 octane or higher, the engine needs service.

If the vehicle has the 2.8L V6 engine (VIN Code 4), use premium unleaded gasoline with a posted octane rating of 91 or higher. For best performance, use premium unleaded gasoline with a posted octane rating of 93. In an emergency, you can use regular unleaded gasoline with an octane rating of 87 or higher. If 87 octane fuel is used, do not perform any aggressive driving maneuvers such as wide open throttle applications. You might also hear audible spark knock during acceleration. Refill the tank with premium fuel as soon as possible to avoid damaging the engine. If heavy knocking is heard when using gasoline rated at 91 octane or higher, the engine needs service.

Gasoline Specifications

At a minimum, gasoline should meet ASTM specification D 4814 in the United States or CAN/CGSB-3.5 or 3.511 in Canada. Some gasolines contain an octane-enhancing additive called methylcyclopentadienyl manganese tricarbonyl (MMT). We recommend against the use of gasolines containing MMT. See *Fuel Additives* on page 8-48 for additional information.

California Fuel Requirements

If the vehicle is certified to meet California Emissions Standards, it is designed to operate on fuels that meet California specifications. See the underhood emission control label. If this fuel is not available in states adopting California emissions standards, the vehicle will operate satisfactorily on fuels meeting federal specifications, but emission control system performance might be affected. The malfunction indicator lamp could turn on and the vehicle might fail a smog-check test. See *Malfunction Indicator Lamp on page 4-20*. If this occurs, return to your authorized dealer for diagnosis. If it is determined that the condition is caused by the type of fuel used, repairs might not be covered by the vehicle warranty.

Fuels in Foreign Countries

If you plan on driving in another country outside the United States or Canada, the proper fuel might be hard to find. Never use leaded gasoline or any other fuel not recommended in the previous text on fuel. Costly repairs caused by use of improper fuel would not be covered by the vehicle warranty.

To check the fuel availability, ask an auto club, or contact a major oil company that does business in the country where you will be driving.

Fuel Additives

To provide cleaner air, all gasolines in the United States are now required to contain additives that help prevent engine and fuel system deposits from forming, allowing the emission control system to work properly. In most cases, nothing should have to be added to the fuel. However, some gasolines contain only the minimum amount of additive required to meet U.S. Environmental Protection Agency regulations. To help keep fuel injectors and intake valves clean, or if the vehicle experiences problems due to dirty injectors or valves, look for gasoline that is advertised as TOP TIER Detergent Gasoline. Look for the TOP TIER label on the fuel pump to ensure gasoline meets enhanced detergency standards developed by the auto companies. A list of marketers providing TOP TIER Detergent Gasoline can be found at www.toptiergas.com.

For customers who do not use TOP TIER Detergent Gasoline regularly, one bottle of GM Fuel System Treatment PLUS, added to the fuel tank at every engine oil change, can help clean deposits from fuel injectors and intake valves. GM Fuel System Treatment PLUS is the only gasoline additive recommended by General Motors. It is available at your dealer.

Gasolines containing oxygenates, such as ethers and ethanol, and reformulated gasolines might be available in your area. We recommend that you use these gasolines, if they comply with the specifications described earlier.

However, E85 (85% ethanol) and other fuels containing more than 10% ethanol must not be used in vehicles that were not designed for those fuels.

Notice: This vehicle was not designed for fuel that contains methanol. Do not use fuel containing methanol. It can corrode metal parts in the fuel system and also damage plastic and rubber parts. That damage would not be covered under the vehicle warranty.

Some gasolines that are not reformulated for low emissions can contain an octane-enhancing additive called methylcyclopentadienyl manganese tricarbonyl (MMT); ask the attendant where you buy gasoline whether the fuel contains MMT. We recommend against the use of such gasolines. Fuels containing MMT can reduce the life of spark plugs and the performance of the emission control system could be affected. The malfunction indicator lamp might turn on. If this occurs, return to your dealer for service.

Filling the Tank

WARNING

Fuel vapor burns violently and a fuel fire can cause bad injuries. To help avoid injuries to you and others, read and follow all the instructions on the fuel pump island. Turn off the engine when refueling. Do not smoke near fuel or when refueling the vehicle. Do not use cellular phones. Keep sparks, flames, and smoking materials away from fuel. Do not leave the fuel pump unattended when refueling the vehicle. This is against the law in some places. Do not re-enter the vehicle while pumping fuel. Keep children away from the fuel pump; never let children pump fuel.



The tethered fuel cap is located behind a hinged fuel door on the passenger side of the vehicle.

To open the fuel door, push the rearward center edge in and release and it will open.

To remove the fuel cap, turn it slowly counterclockwise.

While refueling, hang the tethered fuel cap from the hook on the fuel door.

When reinstalling the cap, turn it clockwise until it clicks once, otherwise the Malfunction Indicator

Lamp could turn on. See *Malfunction Indicator Lamp on page 4-20*.

WARNING

Fuel can spray out on you if you open the fuel cap too quickly. If you spill fuel and then something ignites it, you could be badly burned. This spray can happen if the tank is nearly full, and is more likely in hot weather. Open the fuel cap slowly and wait for any hiss noise to stop. Then unscrew the cap all the way.

Be careful not to spill fuel. Do not top off or overfill the tank and wait a few seconds after you have finished pumping before removing the nozzle. Clean fuel from painted surfaces as soon as possible. See *Exterior Care on page 9-109*.

When replacing the fuel cap, turn it clockwise until it clicks once. Make sure the cap is fully installed.

The diagnostic system can determine if the fuel cap has been left off or improperly installed. This would allow fuel to evaporate into the atmosphere. See *Malfunction Indicator Lamp* on page 4-20.

 **WARNING**

If a fire starts while you are refueling, do not remove the nozzle. Shut off the flow of fuel by shutting off the pump or by notifying the station attendant. Leave the area immediately.

Notice: If a new fuel cap is needed, be sure to get the right type of cap from your dealer. The wrong type fuel cap might not fit properly, might cause the malfunction indicator lamp to light, and could damage the fuel tank and emissions system. See *Malfunction Indicator Lamp* on page 4-20.

Filling a Portable Fuel Container

 **WARNING**

Never fill a portable fuel container while it is in the vehicle. Static electricity discharge from the container can ignite the fuel vapor. You can be badly burned and the vehicle damaged if this occurs. To help avoid injury to you and others:

- Dispense fuel only into approved containers.
- Do not fill a container while it is inside a vehicle, in a vehicle's trunk, pickup bed, or on any surface other than the ground.

(Continued)

WARNING (Continued)

- Bring the fill nozzle in contact with the inside of the fill opening before operating the nozzle. Contact should be maintained until the filling is complete.
- Do not smoke while pumping fuel.
- Do not use a cellular phone while pumping fuel.

Towing

General Towing Information

Only use towing equipment that has been designed for the vehicle. Contact your dealer or trailering dealer for assistance with preparing the vehicle for towing a trailer.

See the following trailer towing information in this section:

- For information on driving while towing a trailer, see “Driving Characteristics and Towing Tips.”
- For maximum vehicle and trailer weights, see “Trailer Towing.”
- For information on equipment to tow a trailer, see “Towing Equipment.”

For information on towing a disabled vehicle, see *Towing the Vehicle on page 9-105*. For information on towing the vehicle behind another

vehicle such as a motorhome, see *Recreational Vehicle Towing on page 9-105*.

Driving Characteristics and Towing Tips

WARNING

The driver can lose control when pulling a trailer if the correct equipment is not used or the vehicle is not driven properly. For example, if the trailer is too heavy, the brakes may not work well — or even at all. The driver and passengers could be seriously injured. The vehicle may also be damaged; the resulting repairs would not be covered by the vehicle warranty. Pull a trailer only if all the steps in this section have been followed. Ask your dealer for advice and information about towing a trailer with the vehicle.

The vehicle can tow a trailer when equipped with the proper trailer towing equipment. For trailering capacity, see *Trailer Towing on page 8-56*. Trailering changes handling, acceleration, braking, durability and fuel economy. With the added weight, the engine, transmission, wheel assemblies and tires are forced to work harder and under greater loads. The trailer also adds wind resistance, increasing the pulling requirements. For safe trailering, correctly use the proper trailering equipment.

The following information has important trailering tips and rules for your safety and that of your passengers. Read this section carefully before pulling a trailer.

Pulling A Trailer

Here are some important points:

- There are many laws, including speed limit restrictions that apply to trailering. Check for legal requirements.

- Do not tow a trailer at all during the first 1 600 km (1,000 miles) the new vehicle is driven. The engine, axle or other parts could be damaged.
- During the first 800 km (500 miles) that a trailer is towed, do not drive over 80 km/h (50 mph) and do not make starts at full throttle. This reduces wear on the vehicle.
- The vehicle can tow in D (Drive). Use a lower gear if the transmission shifts too often.
- Do not use the Fuel Saver Mode when towing.
- Obey speed limit restrictions. Do not drive faster than the maximum posted speed for trailers, or no more than 90 km/h (55 mph), to reduce wear on the vehicle.

Driving with a Trailer

Towing a trailer requires experience. Get familiar with handling and braking with the added trailer weight. The vehicle is now longer and not as responsive as the vehicle is by itself.

Check all trailer hitch parts and attachments, safety chains, electrical connectors, lamps, tires and mirror adjustments. If the trailer has electric brakes, start the vehicle and trailer moving and then apply the trailer brake controller by hand to be sure the brakes are working.

During the trip, check regularly to be sure that the load is secure, and the lamps and trailer brakes are working properly.

Towing with a Stability Control System

When towing, the sound of the stability control system might be heard. The system is reacting to the vehicle movement caused by the trailer, which mainly occurs during cornering. This is normal when towing heavier trailers.

Following Distance

Stay at least twice as far behind the vehicle ahead as you would when driving the vehicle without a trailer. This can help to avoid situations that require heavy braking and sudden turns.

Passing

More passing distance is needed when towing a trailer. Because the rig is longer, it is necessary to go farther beyond the passed vehicle before returning to the lane.

Backing Up

Hold the bottom of the steering wheel with one hand. To move the trailer to the left, move that hand to the left. To move the trailer to the right, move your hand to the right. Always back up slowly and, if possible, have someone guide you.

Making Turns

Notice: Making very sharp turns while trailering could cause the trailer to come in contact with the vehicle. The vehicle could be damaged. Avoid making very sharp turns while trailering.

When turning with a trailer, make wider turns than normal so the trailer will not strike soft shoulders, curbs, road signs, trees or other objects. Use the turn signal well in advance and avoid jerky or sudden maneuvers.

Turn Signals When Towing a Trailer

The turn signal indicators on the instrument panel flash whenever signaling a turn or lane change. Properly hooked up, the trailer lamps also flash, telling other drivers the vehicle is turning, changing lanes or stopping.

When towing a trailer, the arrows on the instrument panel flash for turns even if the bulbs on the trailer are burned out. Check occasionally to be sure the trailer bulbs are still working.

Driving On Grades

Reduce speed and shift to a lower gear before starting down a long or steep downgrade. If the transmission is not shifted down, the brakes might have to be used so much that they would get hot and no longer work well.

The vehicle can tow in D (Drive). Use a lower gear if the transmission shifts too often.

When towing at high altitude on steep uphill grades, engine coolant boils at a lower temperature than at normal altitudes. If the engine is turned off immediately after towing at high altitude on steep uphill grades, the vehicle could show signs similar to engine overheating. To avoid this, let the engine run while parked, preferably on level ground, with the transmission in P (Park) for a few minutes before turning the engine off. If the overheat warning comes on, see *Engine Overheating on page 9-20*.

Parking on Hills

 **WARNING**

Parking the vehicle on a hill with the trailer attached can be dangerous. If something goes wrong, the rig could start to move. People can be injured, and both the vehicle and the trailer can be damaged. When possible, always park the rig on a flat surface.

If parking the rig on a hill:

1. Press the brake pedal, but do not shift into P (Park) yet. Turn the wheels into the curb if facing downhill or into traffic if facing uphill.
2. Have someone place chocks under the trailer wheels.
3. When the wheel chocks are in place, release the brake pedal until the chocks absorb the load.
4. Reapply the brake pedal. Then apply the parking brake and shift into P (Park).
5. Release the brake pedal.

Leaving After Parking on a Hill

1. Apply and hold the brake pedal while you:
 - Start the engine.
 - Shift into a gear.
 - Release the parking brake.
2. Let up on the brake pedal.
3. Drive slowly until the trailer is clear of the chocks.
4. Stop and have someone pick up and store the chocks.

Maintenance When Trailer Towing

The vehicle needs service more often when pulling a trailer. See the Maintenance Schedule for more information. Things that are especially important in trailer operation are automatic transmission fluid, engine oil, axle lubricant, belts, cooling system and brake system. Inspect these before and during the trip.

Check periodically to see that all hitch nuts and bolts are tight.

Engine Cooling When Trailer Towing

The cooling system may temporarily overheat during severe operating conditions. See *Engine Overheating on page 9-20*.

Trailer Towing

Before pulling a trailer, there are three important considerations that have to do with weight:

- The weight of the trailer
- The weight of the trailer tongue
- The total weight on the vehicle's tires

Weight of the Trailer

How heavy can a trailer safely be?

It depends on how the rig is used. For example, speed, altitude, road grades, outside temperature and how much the vehicle is used to pull a trailer are all important. It can depend on any special equipment on the vehicle, and the amount of tongue weight the vehicle can carry. See "Weight of the Trailer Tongue" later in this section for more information.

Maximum trailer weight is calculated assuming only the driver is in the tow vehicle and it has all the required trailering equipment. The weight of additional optional equipment, passengers and cargo in the tow vehicle must be subtracted from the maximum trailer weight.

Use the following chart to determine how much the vehicle can weigh, based upon the vehicle model and options.

| Vehicle | Maximum Trailer Weight | GCWR* |
|--|------------------------|----------------------|
| 2.8L Engine, AWD | 1 588 kg (3,500 lbs) | 3 725 kg (8,212 lbs) |
| 3.0L Engine, FWD | 1 134 kg (2,500 lbs) | 3 187 kg (7,025 lbs) |
| 3.0L Engine, FWD with Trailering Package | 1 588 kg (3,500 lbs) | 3 640 kg (8,025 lbs) |
| 3.0L Engine, AWD | 1 134 kg (2,500 lbs) | 3 271 kg (7,212 lbs) |
| 3.0L Engine, AWD with Trailering Package | 1 588 kg (3,500 lbs) | 3 725 kg (8,212 lbs) |

*The Gross Combination Weight Rating (GCWR) is the total allowable weight of the completely loaded vehicle and trailer including any passengers, cargo, equipment and conversions. The GCWR for the vehicle should not be exceeded.

Ask your dealer for trailering information or advice. See *Customer Assistance Offices on page 12-3* for more information.

Weight of the Trailer Tongue

The tongue load (A) of any trailer is an important weight to measure because it affects the total gross weight of the vehicle. The Gross Vehicle Weight (GVW) includes the curb weight of the vehicle, any cargo carried in it, and the people who will be riding in the vehicle. If there are a lot of options, equipment, passengers or cargo in

the vehicle, it will reduce the tongue weight the vehicle can carry, which will also reduce the trailer weight the vehicle can tow. If towing a trailer, the tongue load must be added to the GVW because the vehicle will be carrying that weight, too. See *Vehicle Load Limits on page 8-11* for more information about the vehicle's maximum load capacity.

8-58 Driving and Operating

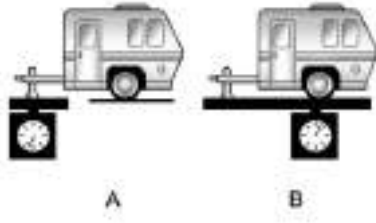

If a weight-carrying hitch or a weight-distributing hitch is being used, the trailer tongue (A) should weigh 10-15 percent of the total loaded trailer weight (B).

After loading the trailer, weigh the trailer and then the tongue, separately, to see if the weights are proper. If they are not, adjustments might be made by moving some items around in the trailer.

Trailering may be limited by the vehicle's ability to carry tongue weight. Tongue weight cannot cause the vehicle to exceed the GVWR (Gross Vehicle Weight Rating) or the RGAWR (Rear Gross Axle Weight Rating). The effect of additional weight may reduce the trailering capacity more than the total of the additional weight.

Consider the following example:

A vehicle model base weight is 2 495 kg (5,500 lbs); 1 270 kg (2,800 lbs) at the front axle and 1 225 kg (2,700 lbs) at the rear axle.

It has a GVWR of 3 266 kg (7,200 lbs), a RGAWR of 1 814 kg (4,000 lbs) and a GCWR (Gross Combination Weight Rating) of 6 350 kg (14,000 lbs). The trailer rating should be:

| | |
|----------------------------|----------------|
| 6350 kg (14,000 lbs) | GCWR |
| 2495 kg (5,500 lbs) | Vehicle Weight |
| <u>3855 kg (8,500 lbs)</u> | Trailer Rating |

Expect tongue weight to be at least 10 percent of trailer weight (386 kg (850 lbs)) and because the weight is applied well behind the rear axle, the effect on the rear axle is greater than just the weight itself, as much as 1.5 times as much. The weight at the rear axle could be 386 kg (850 lbs) X 1.5 = 578 kg (1,275 lbs).

Since the rear axle already weighs 1 225 kg (2,700 lbs), adding 578 kg (1,275 lbs) brings the total to 1 803 kg (3,975 lbs). This is very close to, but within the limit for RGAWR as well. The vehicle is set to trailer up to 3 856 kg (8,500 lbs).

If the vehicle has many options and there is a front seat passenger and two rear seat passengers with some luggage and gear in the vehicle as well. 136 kg (300 lbs) could be added to the front axle weight and 181 kg (400 lbs) to the rear axle weight. The vehicle now weighs:

| | | |
|----------------------|--------------------|-------|
| 1 279 kg (2,820 lbs) | + 196 kg (433 lbs) | Front |
| 1 225 kg (2,700 lbs) | + 181 kg (400 lbs) | Rear |
| <hr/> | | |
| 2 812 kg (6,200 lbs) | | Total |

Weight is still below 3 266 kg (7,200 lbs) and you might think 318 additional kilograms (700 lbs) should be subtracted from the

trailer capacity to stay within GCWR limits. The maximum trailer would only be 3 538 kg (7,800 lbs). You may go further and think the tongue weight should be limited to less than 454 kg (1,000 lbs) to avoid exceeding GVWR. But the effect on the rear axle must still be considered. Because the rear axle now weighs 1 406 kg (3,100 lbs), 408 kg (900 lbs) can be put on the rear axle without exceeding RGAWR. The effect of tongue weight is about 1.5 times the actual weight. Dividing the 408 kg (900 lbs) by 1.5 leaves only 272 kg (600 lbs) of tongue weight that can be handled. Since tongue weight is usually at least 10 percent of total loaded trailer weight, expect that the largest trailer the vehicle can properly handle is 2 722 kg (6,000 lbs).

It is important that the vehicle does not exceed any of its ratings — GCWR, GVWR, RGAWR, Maximum Trailer Rating or Tongue Weight. The only way to be sure it is not exceeding any of these ratings is to weigh the vehicle and trailer.

Total Weight on the Vehicle's Tires

Be sure the vehicle's tires are inflated to the upper limit for cold tires. These numbers can be found on the Certification label or see *Vehicle Load Limits on page 8-11* for more information. Make sure not to go over the GVW limit for the vehicle, or the GAWR, including the weight of the trailer tongue. If using a weight distributing hitch, make sure not to go over the rear axle limit before applying the weight distribution spring bars.

Towing Equipment

Hitches

It is important to have the correct hitch equipment. Crosswinds, large trucks going by and rough roads are a few reasons why the right hitch is needed.

- The rear bumper on the vehicle is not intended for hitches. Do not attach rental hitches or other bumper-type hitches to it. Use only a frame-mounted hitch that does not attach to the bumper.
- Will any holes be made in the body of the vehicle when the trailer hitch is installed? If there are, then be sure to seal the holes later when the hitch is removed. If the holes are not sealed, dirt, water, and deadly carbon monoxide (CO) from the exhaust can get into the vehicle. See *Engine Exhaust* on page 8-24.

Hitch Cover



The vehicle may have a hitch cover. To remove the hitch cover:

1. Turn the fasteners on the lower tabs 90 degrees counterclockwise.
2. Lift the lower edge of the cover about 45 degrees.
3. Pull the cover downward to disengage the upper attachments.

To reinstall the hitch cover:

1. Hold the cover at a 45 degree angle to the vehicle and push the upper tabs in the hitch cover into the slots in the fascia.
2. Move the bottom of the cover forward until the lower tabs line up with the lower fascia slots.
3. Snap the hitch cover into place by pushing the upper corners forward.
4. Turn the fasteners on the lower tabs 90 degrees clockwise to lock the cover in place.

Safety Chains

Always attach chains between the vehicle and the trailer. Cross the safety chains under the tongue of the trailer to help prevent the tongue from contacting the road if it becomes separated from the hitch. Always leave just enough slack so the rig can turn. Never allow safety chains to drag on the ground.

Trailer Brakes

A loaded trailer that weighs more than 450 kg (1,000 lbs) needs to have its own brake system that is adequate for the weight of the trailer. Be sure to read and follow the instructions for the trailer brakes so they are installed, adjusted and maintained properly.

Because the vehicle has anti-lock brakes, do not tap into the vehicle's brake system. If you do, both brake systems will not work well, or at all.

Trailer Wiring Harness

All of the electrical circuits required for the trailer lighting system can be accessed at a connector mounted to the frame, behind the rear bumper cover.

Trailer Sway Control (TSC)

The vehicle has a Trailer Sway Control (TSC) feature as part of the StabiliTrak system. If TSC detects that the trailer is swaying, the vehicle's brakes are automatically applied.



When TSC is applying the brakes, the TCS/StabiliTrak indicator light flashes to notify the driver to reduce speed. See *Traction Control System (TCS)/StabiliTrak® Light on page 4-25*. If the trailer continues to sway, StabiliTrak will reduce engine torque to help slow the vehicle.

TSC will not function if StabiliTrak is turned off.

Conversions and Add-Ons

Add-On Electrical Equipment

Notice: Do not add anything electrical to the vehicle unless you check with your dealer first. Some electrical equipment can damage the vehicle and the damage would not be covered by the vehicle's warranty. Some add-on electrical equipment can keep other components from working as they should.

Add-on equipment can drain the vehicle 12-volt battery, even if the vehicle is not operating.

The vehicle has an airbag system. Before attempting to add anything electrical to the vehicle, see *Servicing the Airbag-Equipped Vehicle on page 2-40* and *Adding Equipment to the Airbag-Equipped Vehicle on page 2-41*.

Vehicle Care

General Information

| | |
|--|-----|
| General Information | 9-2 |
| California Proposition 65 Warning | 9-2 |
| California Perchlorate Materials Requirements | 9-3 |
| Accessories and Modifications | 9-3 |

Vehicle Checks

| | |
|---------------------------------------|------|
| Doing Your Own Service Work | 9-4 |
| Hood | 9-5 |
| Engine Compartment Overview | 9-6 |
| Engine Cover | 9-9 |
| Engine Oil | 9-10 |
| Engine Oil Life System | 9-12 |
| Automatic Transmission Fluid | 9-13 |
| Engine Air Cleaner/Filter | 9-14 |
| Cooling System | 9-16 |
| Engine Coolant | 9-17 |
| Engine Overheating | 9-20 |
| Power Steering Fluid | 9-22 |
| Washer Fluid | 9-23 |

| | |
|--|------|
| Brakes | 9-24 |
| Brake Fluid | 9-25 |
| Battery | 9-27 |
| All-Wheel Drive | 9-27 |
| Starter Switch Check | 9-28 |
| Park Brake and P (Park) Mechanism Check | 9-28 |
| Wiper Blade Replacement ... | 9-29 |

Headlamp Aiming

| | |
|-----------------------|------|
| Headlamp Aiming | 9-31 |
|-----------------------|------|

Bulb Replacement

| | |
|--|------|
| Bulb Replacement | 9-34 |
| Halogen Bulbs | 9-34 |
| High Intensity Discharge (HID) Lighting | 9-35 |
| Headlamps | 9-35 |
| Turn Signal Lamps | 9-40 |
| Back-Up Lamps | 9-41 |
| License Plate Lamp | 9-42 |
| Replacement Bulbs | 9-43 |

Electrical System

| | |
|-------------------------------------|------|
| Electrical System Overload | 9-44 |
| Fuses and Circuit Breakers | 9-44 |

| | |
|--|------|
| Engine Compartment Fuse Block | 9-45 |
| Instrument Panel Fuse Block | 9-48 |
| Rear Compartment Fuse Block | 9-49 |

Wheels and Tires

| | |
|---|------|
| Tires | 9-52 |
| Tire Sidewall Labeling | 9-53 |
| Tire Designations | 9-55 |
| Tire Terminology and Definitions | 9-56 |
| Tire Pressure | 9-59 |
| Tire Pressure for High-Speed Operation | 9-60 |
| Tire Pressure Monitor System | 9-61 |
| Tire Pressure Monitor Operation | 9-62 |
| Tire Inspection | 9-66 |
| Tire Rotation | 9-66 |
| When It Is Time for New Tires | 9-68 |
| Buying New Tires | 9-68 |
| Different Size Tires and Wheels | 9-70 |
| Uniform Tire Quality Grading | 9-71 |

9-2 Vehicle Care

| | |
|---|-------|
| Wheel Alignment and Tire Balance | 9-73 |
| Wheel Replacement | 9-73 |
| Tire Chains | 9-74 |
| If a Tire Goes Flat | 9-74 |
| Tire Sealant and Compressor Kit (Without Selector Switch) | 9-76 |
| Tire Sealant and Compressor Kit (With Selector Switch) | 9-84 |
| Storing the Tire Sealant and Compressor Kit | 9-93 |
| Tire Changing | 9-93 |
| Compact Spare Tire | 9-100 |
| Jump Starting | |
| Jump Starting | 9-101 |
| Towing | |
| Towing the Vehicle | 9-105 |
| Recreational Vehicle Towing | 9-105 |
| Appearance Care | |
| Exterior Care | 9-109 |
| Interior Care | 9-113 |

General Information

For service and parts needs, visit your dealer. You will receive genuine GM parts and GM-trained and supported service people.

Genuine GM parts have one of these marks:

ACDelco.

Genuine  Parts

 **Goodwrench.**

 **Accessories**

California Proposition 65 Warning

Most motor vehicles, including this one, contain and/or emit chemicals known to the State of California to cause cancer and birth defects or other reproductive harm. Engine exhaust, many parts and systems, many fluids, and some component wear by-products contain and/or emit these chemicals.

California Perchlorate Materials Requirements

Certain types of automotive applications, such as airbag initiators, seat belt pretensioners, and lithium batteries contained in remote keyless transmitters, may contain perchlorate materials. Special handling may be necessary. For additional information, see www.dtsc.ca.gov/hazardouswaste/perchlorate.

Accessories and Modifications

Adding non-dealer accessories to the vehicle can affect vehicle performance and safety, including such things as airbags, braking, stability, ride and handling, emissions systems, aerodynamics, durability, and electronic systems like antilock brakes, traction control, and stability control. Some of these accessories could even cause malfunction or damage not covered by the vehicle warranty.

Damage to vehicle components resulting from the installation or use of non-GM certified parts, including control module modifications, is not covered under the terms of the vehicle warranty and may affect remaining warranty coverage for affected parts.

GM Accessories are designed to complement and function with other systems on the vehicle. Your GM dealer can accessorize the vehicle using genuine GM Accessories. When you go to your GM dealer and ask for GM Accessories, you will know that GM-trained and supported service technicians will perform the work using genuine GM Accessories.

Also, see *Adding Equipment to the Airbag-Equipped Vehicle* on page 2-41.

Vehicle Checks

Doing Your Own Service Work

 **WARNING**

You can be injured and the vehicle could be damaged if you try to do service work on a vehicle without knowing enough about it.

- Be sure you have sufficient knowledge, experience, the proper replacement parts, and tools before attempting any vehicle maintenance task.

(Continued)

WARNING (Continued)

- Be sure to use the proper nuts, bolts, and other fasteners. English and metric fasteners can be easily confused. If the wrong fasteners are used, parts can later break or fall off. You could be hurt.

If doing some of your own service work, use the proper service manual. It tells you much more about how to service the vehicle than this manual can. To order the proper service manual, see *Service Publications Ordering Information on page 12-13*.

This vehicle has an airbag system. Before attempting to do your own service work, see *Servicing the Airbag-Equipped Vehicle on page 2-40*.

Keep a record with all parts receipts and list the mileage and the date of any service work performed. See *Maintenance Records on page 10-9*.

Hood

To open the hood:



1. Pull the release handle with the above symbol on it. It is located below the instrument panel to the left of the steering wheel.



2. Move the secondary hood release lever up to release the striker. The lever is located near the middle of the hood.
3. Lift the hood.

Before closing the hood, be sure all the filler caps are on properly.

Engine Compartment Overview

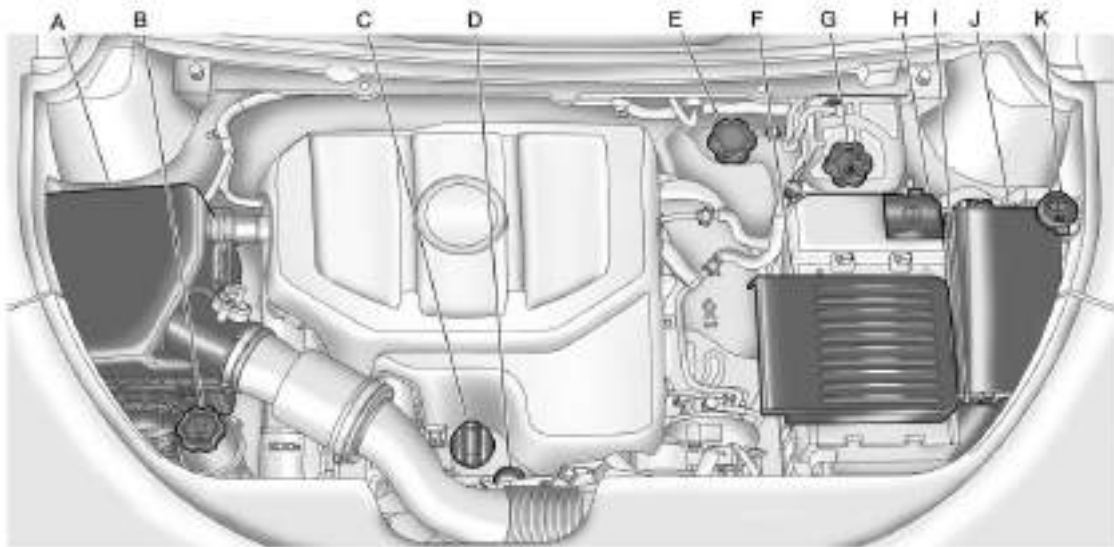

2.8 L V6 Engine

- A. *Engine Air Cleaner/Filter on page 9-14.*
- B. *Power Steering Reservoir and Cap. See Power Steering Fluid on page 9-22.*
- C. *Engine Oil Fill Cap. See Engine Oil on page 9-10.*
- D. *Engine Oil Dipstick (Out of View). See Engine Oil on page 9-10.*
- E. *Brake Master Cylinder Reservoir. See Brakes on page 9-24.*
- F. *Battery (Out of View). See Battery on page 9-27.*
- G. *Engine Coolant Surge Tank and Pressure Cap. See Engine Coolant on page 9-17.*
- H. *Remote Positive (+) Terminal. See Jump Starting on page 9-101.*
- I. *Remote Negative (-) Terminal (Out of View). See Jump Starting on page 9-101.*
- J. *Engine Compartment Fuse Block on page 9-45.*
- K. *Windshield Washer Fluid Reservoir. See Washer Fluid on page 9-23.*

9-8 Vehicle Care

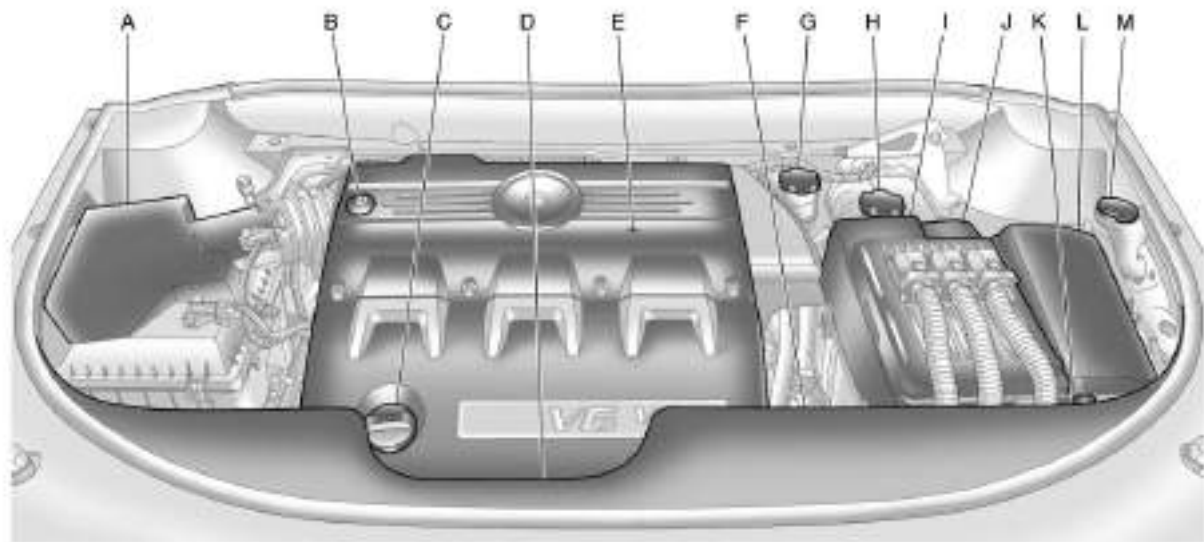

3.0 L V6 Engine

- A. *Engine Air Cleaner/Filter on page 9-14.*
- B. *Power Steering Reservoir and Cap (Under engine cover). See Power Steering Fluid on page 9-22.*
- C. *Engine Oil Fill Cap. See Engine Oil on page 9-10.*
- D. *Engine Oil Dipstick (Out of View). See Engine Oil on page 9-10.*
- E. *Engine Cover on page 9-9.*
- F. *Transmission Fluid Cap and Dipstick. See Automatic Transmission Fluid on page 9-13.*
- G. *Brake Master Cylinder Reservoir. See Brakes on page 9-24.*
- H. *Engine Coolant Surge Tank and Pressure Cap. See Engine Coolant on page 9-17.*
- I. *Battery (Out of View). See Battery on page 9-27.*
- J. *Remote Positive (+) Terminal. See Jump Starting on page 9-101.*
- K. *Remote Negative (-) Terminal (Out of View). See Jump Starting on page 9-101.*
- L. *Engine Compartment Fuse Block on page 9-45.*
- M. *Windshield Washer Fluid Reservoir. See Washer Fluid on page 9-23.*

Engine Cover

Engine Cover (3.0 L V6)

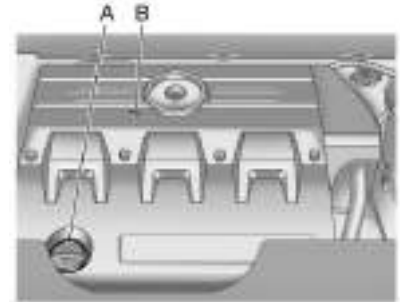

To remove:

1. Remove the oil fill cap (A).
2. Raise the engine cover (B) to release from the retainers.
3. Lift and remove the engine cover.
4. Reverse Steps 1 through 3 to reinstall engine cover.

Engine Oil

Checking Engine Oil

It is a good idea to check the engine oil level at each fuel fill. In order to get an accurate reading, the oil must be warm and the vehicle must be on level ground.

The engine oil dipstick handle is a yellow loop. See *Engine Compartment Overview on page 9-6* for the location of the engine oil dipstick.

1. Turn off the engine and give the oil several minutes to drain back into the oil pan. If this is not done, the oil dipstick might not show the actual level.
2. Pull out the dipstick and clean it with a paper towel or cloth, then push it back in all the way. Remove it again, keeping the tip down, and check the level.

When to Add Engine Oil

If the oil is below the cross-hatched area at the tip of the dipstick, add at least one liter/quart of the recommended oil. This section explains what kind of oil to use. For engine oil crankcase capacity, see *Capacities and Specifications on page 11-2*.

Notice: Do not add too much oil. If the engine has so much oil that the oil level gets above the cross-hatched area that shows the proper operating range, the engine could be damaged.



See *Engine Compartment Overview on page 9-6* for the location of the engine oil fill cap.

Add enough oil to put the level somewhere in the proper operating range. Push the dipstick all the way back in when through.

What Kind of Engine Oil to Use

Look for three things:

- GM4718M

This vehicle's engine requires a special oil meeting GM Standard GM4718M. Oils meeting this standard may be identified as synthetic. However, not all synthetic oils will meet this GM standard. Use only an oil that meets GM Standard GM4718M.

Notice: Using oils that do not have the GM4718M Standard designation can cause engine damage not covered by the vehicle warranty.

- SAE 5W-30

SAE 5W-30 is best for the vehicle. These numbers on an oil container show its viscosity, or thickness. Do not use other viscosity oils such as SAE 20W-50.

- American Petroleum Institute (API) starburst symbol



Oils meeting these requirements should have the starburst symbol on the container. This symbol indicates that the oil has been certified by the American Petroleum Institute (API).

This vehicle's engine was filled at the factory with a Mobil 1[®] synthetic oil meeting all requirements for this vehicle.

Substitute Engine Oil: When adding oil to maintain engine oil level, oil meeting GM Standard GM4718M might not be available. You can add substitute oil designated SAE 5W-30 with the starburst symbol at all temperatures. Substitute oil not meeting GM Standard GM4718M should not be used for an oil change.

Engine Oil Additives / Engine Oil Flushes

Do not add anything to the oil. The recommended oils with the starburst symbol that meet GM standards are all that is needed for good performance and engine protection.

Engine oil system flushes are not recommended and could cause engine damage not covered by the vehicle warranty.

Engine Oil Life System

When to Change Engine Oil

This vehicle has a computer system that indicates when to change the engine oil and filter. This is based on engine revolutions and engine temperature, and not on mileage. Based on driving conditions, the mileage at which an oil change is indicated can vary considerably. For the oil life system to work properly, the system must be reset every time the oil is changed.

When the system has calculated that oil life has been diminished, it indicates that an oil change is necessary. A "Change Engine Oil Soon" message comes on. See *Engine Oil Messages on page 4-36*. Change the oil as soon as possible within the next 1 000 km (600 miles). It is possible that,

if driving under the best conditions, the oil life system might not indicate that an oil change is necessary for over a year. However, the engine oil and filter must be changed at least once a year and at this time the system must be reset. Your dealer has trained service people who will perform this work using genuine parts and reset the system. It is also important to check the oil regularly and keep it at the proper level.

If the system is ever reset accidentally, the oil must be changed at 5 000 km (3,000 miles) since the last oil change. Remember to reset the oil life system whenever the oil is changed.

How to Reset the Engine Oil Life System

Reset the system whenever the engine oil is changed so that the system can calculate the next engine oil change. To reset the system:

1. Using the DIC MENU button and thumbwheel on the turn signal lever, display "Oil Life Remaining" on the DIC. See *Driver Information Center (DIC) on page 4-29* and *Engine Oil Messages on page 4-36*.
2. Press the SET button to reset the oil life at 100%.

Be careful not to reset the oil life display accidentally at any time other than after the oil is changed. It cannot be reset accurately until the next oil change.

The oil life system can also be reset as follows:

1. Turn the ignition to ON/RUN with the engine off.
2. Fully press and release the accelerator pedal three times within five seconds.

If the “Change Engine Oil Soon” message is not on, the system is reset.

The system is reset when the “Change Engine Oil Soon” message is off.

What to Do with Used Oil

Used engine oil contains elements that can be unhealthy for your skin and could even cause cancer. Do not let used oil stay on your skin. Clean your skin and nails with soap and water, or a good hand cleaner. Wash or properly dispose of clothing or rags. See the manufacturer's warnings about the use and disposal of oil products.

Used oil can be a threat to the environment. If you change your own oil, be sure to drain all the oil from the filter before disposal. Never dispose of oil by putting it in the trash, pouring it on the ground, into sewers, or into streams or bodies of water. Recycle it by taking it to a place that collects used oil.

Automatic Transmission Fluid

How to Check Automatic Transmission Fluid

It is not necessary to check the transmission fluid level. A transmission fluid leak is the only reason for fluid loss. If a leak occurs, take the vehicle to your dealer service department and have it repaired as soon as possible.

There is a special procedure for checking and changing the transmission fluid. Because this procedure is difficult, you should have this done at your dealer service department. Contact your dealer for additional information or the procedure can be found in the service manual. To purchase a service manual, see *Service Publications Ordering Information on page 12-13*.

Change the fluid and filter at the intervals listed in *Scheduled Maintenance on page 10-2*, and be sure to use the fluid listed in *Recommended Fluids and Lubricants on page 10-6*.

Engine Air Cleaner/Filter

See *Engine Compartment Overview on page 9-6* for the location of the engine air cleaner/filter.

When to Inspect the Engine Air Cleaner/Filter

Inspect the air cleaner/filter at the Maintenance II intervals and replace it at the first oil change after each 80 000 km (50,000 mile) interval.

See *Scheduled Maintenance on page 10-2* for more information. If driving in dusty/dirty conditions, inspect the filter at each engine oil change.

How to Inspect the Engine Air Cleaner/Filter

To inspect the air cleaner/filter, remove the filter from the vehicle and lightly shake the filter to release loose dust and dirt. If the filter remains caked with dirt, a new filter is required. Never use compressed air to clean the filter.

To inspect or replace the engine air cleaner/filter:

1. Open the hood. See *Hood on page 9-5*.
2. Locate the air filter housing on the front of the passenger side of the engine compartment. See *Engine Compartment Overview on page 9-6*.

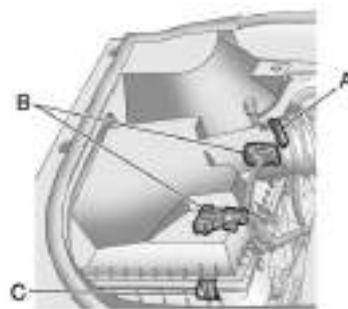

3.0 L V6 Shown, 2.8 L V6 Similar

- A. Air Duct Clamp
 - B. Electrical Connectors
 - C. Retaining Clips
3. Disconnect the outlet duct by loosening the air duct clamp (A).
 4. Disconnect the electrical connectors (B).
 5. Lift the retaining clips (C) on the air filter housing.

- Turn and tilt cover slightly upwards and slide cover away from outside edge of vehicle. Remove the air filter.



- A. Cover Cut Outs
- B. Air Filter Tabs

- To install the air filter, place filter inside box where the pleats fit in between the tabs located inside the lower box. Ensure that the cover cut outs (A) on both sides match the air filter tabs (B) on both sides.

- Replace air cleaner cover by inserting tabs appropriately into slots. Lower cover to meet bottom of box. Place clips on retention features and clip closed.
- Retighten the air duct clamp.
- Reconnect the electrical connectors.

⚠ WARNING

Operating the engine with the air cleaner/filter off can cause you or others to be burned. The air cleaner not only cleans the air; it helps to stop flames if the engine backfires. Use caution when working on the engine and do not drive with the air cleaner/filter off.

Notice: If the air cleaner/filter is off, dirt can easily get into the engine, which could damage it. Always have the air cleaner/filter in place when you are driving.

Notice: Installing an air cleaner different than the one recommended in Maintenance Replacement Parts may cause engine damage not covered by the vehicle warranty.

Cooling System

When it is safe to lift the hood:

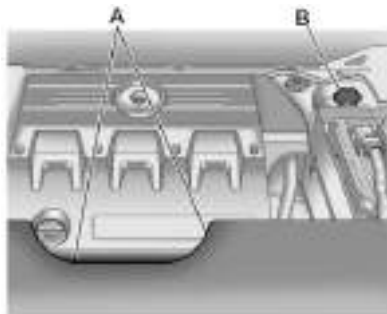

3.0 L V6 Engine Shown, 2.8 L V6 Engine Similar

- A. Engine Cooling Fans
- B. Engine Coolant Surge Tank and Pressure Cap

WARNING

An electric engine cooling fan under the hood can start up even when the engine is not running and can cause injury. Keep hands, clothing, and tools away from any underhood electric fan.

If the coolant inside the coolant surge tank is boiling, do not do anything else until it cools down. The vehicle should be parked on a level surface.

The coolant level should be between the MIN and MAX lines. If it is not, the vehicle may have a leak at the radiator hoses, heater hoses, radiator, water pump, or somewhere else in the cooling system.

WARNING

Heater and radiator hoses, and other engine parts, can be very hot. Do not touch them. If you do, you can be burned.

Do not run the engine if there is a leak. If you run the engine, it could lose all coolant. That could cause an engine fire, and you could be burned. Get any leak fixed before you drive the vehicle.

If there seems to be no leak, with the engine on, check to see if the electric engine cooling fan is running. If the engine is overheating, the fan should be running. If it is not, the vehicle needs service. Turn off the engine.

Notice: Using coolant other than DEX-COOL® can cause premature engine, heater core, or radiator corrosion. In addition, the engine coolant could require changing sooner, at 50 000 km (30,000 miles) or 24 months, whichever occurs first. Any repairs would not be covered by the vehicle warranty. Always use DEX-COOL (silicate-free) coolant in the vehicle.

Engine Coolant

The cooling system in the vehicle is filled with DEX-COOL® engine coolant. This coolant is designed to remain in the vehicle for five years or 240 000 km (150,000 miles), whichever occurs first.

The following explains the cooling system and how to check and add coolant when it is low. If there is a problem with engine overheating, see *Engine Overheating* on page 9-20

What to Use

WARNING

Adding only plain water or some other liquid to the cooling system can be dangerous. Plain water and other liquids, can boil before the proper coolant mixture will. The vehicle's coolant warning system is set for the proper coolant mixture. With plain water or the wrong mixture, the engine could get too hot but you would not get the overheat warning. The engine could catch fire and you or others could be burned. Use a 50/50 mixture of clean, drinkable water and DEX-COOL coolant.

Use a 50/50 mixture of clean, drinkable water and DEX-COOL® coolant. If using this mixture, nothing else needs to be added. This mixture:

- Gives freezing protection down to -37°C (-34°F), outside temperature.
- Gives boiling protection up to 129°C (265°F), engine temperature.
- Protects against rust and corrosion.
- Will not damage aluminum parts.
- Helps keep the proper engine temperature.

Notice: If an improper coolant mixture is used, the engine could overheat and be badly damaged. The repair cost would not be covered by the vehicle warranty. Too much water in the mixture can freeze and crack the engine, radiator, heater core, and other parts.

Checking Coolant

The vehicle must be on a level surface when checking the coolant level.

Check to see if coolant is visible in the coolant surge tank. If the coolant inside the coolant surge tank is boiling, do not do anything else until it cools down. If coolant is visible but the coolant level is not at the indicated mark, add a 50/50 mixture of clean, drinkable water and DEX-COOL[®] coolant at the coolant surge tank, but be sure the cooling system is cool before this is done. See *Engine Overheating on page 9-20* for more information.

The coolant surge tank is located in the engine compartment on the driver side of the vehicle. See *Engine Compartment Overview on page 9-6* for more information on location.

How to Add Coolant to the Coolant Surge Tank

Notice: This vehicle has a specific coolant fill procedure. Failure to follow this procedure could cause the engine to overheat and be severely damaged.

If no problem is found, check to see if coolant is visible in the coolant surge tank. If coolant is visible but the coolant level is not at the indicated level mark, add a 50/50 mixture of clean, drinkable water and DEX-COOL[®] coolant at the coolant surge tank, but be sure the cooling system, including the coolant surge tank pressure cap, is cool before you do it.

WARNING

Steam and scalding liquids from a hot cooling system can blow out and burn you badly. They are under pressure, and if you turn the coolant surge tank pressure cap — even a little — they can come out at high speed. Never turn the cap when the cooling system, including the coolant surge tank pressure cap, is hot. Wait for the cooling system and coolant surge tank pressure cap to cool if you ever have to turn the pressure cap.

⚠ WARNING

Adding only plain water or some other liquid to the cooling system can be dangerous. Plain water and other liquids, can boil before the proper coolant mixture will. The vehicle's coolant warning system is set for the proper coolant mixture. With plain water or the wrong mixture, the engine could get too hot but you would not get the overheat warning. The engine could catch fire and you or others could be burned. Use a 50/50 mixture of clean, drinkable water and DEX-COOL coolant.

Notice: In cold weather, water can freeze and crack the engine, radiator, heater core and other parts. Use the recommended coolant and the proper coolant mixture.

⚠ WARNING

You can be burned if you spill coolant on hot engine parts. Coolant contains ethylene glycol and it will burn if the engine parts are hot enough. Do not spill coolant on a hot engine.



2.8 L V6 Engine

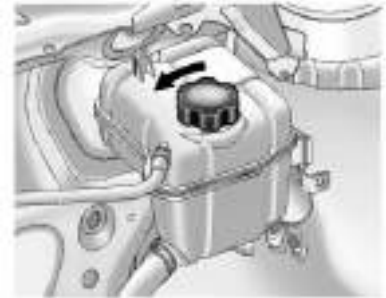

3.0 L V6 Engine

1. Remove the coolant surge tank pressure cap when the cooling system, including the coolant surge tank pressure cap and upper radiator hose, is no longer hot.

Turn the pressure cap slowly counterclockwise about one-quarter of a turn. If you hear a hiss, wait for that to stop. This will allow any pressure still left to be vented out the discharge hose.

2. Then keep turning the pressure cap slowly and remove it.
3. Fill the coolant surge tank with the proper DEX-COOL[®] coolant mixture to the indicated level mark.
4. With the coolant surge tank pressure cap off, start the engine and let it run until you can feel the upper radiator hose getting hot. Watch out for the engine cooling fan.

By this time, the coolant level inside the coolant surge tank may be lower. If the level is lower, add more of the proper DEX-COOL[®] coolant mixture to the coolant surge tank until the level reaches the indicated level mark.
5. Then replace the pressure cap. Be sure the pressure cap is hand-tight.

Check the level in the coolant surge tank when the cooling system has cooled down. If the coolant is not at the proper level, repeat Steps 1 through 3 and reinstall the pressure cap. If the coolant still is not at the proper level when the system cools down again, see your dealer.

Engine Overheating

The vehicle has an indicator to warn of engine overheating.

There is an engine coolant temperature warning light on the vehicle's instrument panel. See *Engine Coolant Temperature Gauge on page 4-17*.

You may decide not to lift the hood when this warning appears, but instead get service help right away. See *Roadside Service on page 12-6*.

If you do decide to lift the hood, make sure the vehicle is parked on a level surface.

Then check to see if the engine cooling fans are running. If the engine is overheating, both fans should be running. If they are not, do not continue to run the engine and have the vehicle serviced.

Notice: Engine damage from running the engine without coolant is not covered by the warranty.

Notice: If the engine catches fire because of being driven with no coolant, your vehicle can be badly damaged. The costly repairs would not be covered by the vehicle warranty.

If Steam Is Coming From The Engine Compartment



Steam from an overheated engine can burn you badly, even if you just open the hood. Stay away from the engine if you see or hear steam coming from it. Just turn it off and get everyone away from the vehicle until it cools down. Wait until there is no sign of steam or coolant before you open the hood.

If you keep driving when your engine is overheated, the liquids in it can catch fire. You or others could be badly burned. Stop your engine if it overheats, and get out of the vehicle until the engine is cool.

If No Steam Is Coming From The Engine Compartment

If an engine overheat warning is displayed but no steam can be seen or heard, the problem may not be too serious. Sometimes the engine can get a little too hot when the vehicle:

- Climbing a long hill on a hot day.
- Stopping after high-speed driving.
- Idling for long periods in traffic.
- Towing a trailer.

If the overheat warning displays with no sign of steam:

1. Turn the air off.
2. Turn the heater on to the highest temperature and to the highest fan speed. Open the windows as necessary.
3. In heavy traffic, let the engine idle in N (Neutral) while stopped. If it is safe to do so, pull off the road, shift to P (Park) or N (Neutral) and let the engine idle.

If the temperature overheat gauge is no longer in the overheat zone or an overheat warning no longer displays, the vehicle can be driven. Continue to drive the vehicle slow for about 10 minutes. Keep a safe vehicle distance from the car in front of you. If the warning does not come back on, continue to drive normally.

If the warning continues, pull over, stop, and park the vehicle right away.

If there is no sign of steam, idle the engine for three minutes while parked. If the warning is still displayed, turn off the engine until it cools down.

Power Steering Fluid



See *Engine Compartment Overview on page 9-6* for reservoir location.

When to Check Power Steering Fluid

It is not necessary to regularly check power steering fluid unless a leak is suspected in the system or unusual noise is heard. A fluid loss in this system could indicate a problem. Have the system inspected and repaired.

How to Check Power Steering Fluid

To check the power steering fluid:

1. Turn the key off and let the engine compartment cool down.
2. Remove the engine cover, if required. See *Engine Cover on page 9-9*.
3. Wipe the cap and the top of the reservoir clean.
4. Unscrew the cap and wipe the dipstick with a clean rag.
5. Replace the cap and completely tighten it.
6. Remove the cap again and look at the fluid level on the dipstick.

The level should be within the HOT mark. If necessary, add only enough fluid to bring the level within the mark.

What to Use

To determine what kind of fluid to use, see *Recommended Fluids and Lubricants* on page 10-6. Always use the proper fluid.

Washer Fluid

What to Use

When windshield washer fluid is needed, be sure to read the manufacturer's instructions before use. If operating the vehicle in an area where the temperature may fall below freezing, use a fluid that has sufficient protection against freezing.

Adding Washer Fluid

The WASHER FLUID LOW ADD FLUID message appears on the Driver Information Center (DIC) when the fluid level is low.



Open the cap with the washer symbol on it. Add washer fluid up to the fill mark. See *Engine Compartment Overview* on page 9-6 for reservoir location.

Notice:

- **When using concentrated washer fluid, follow the manufacturer's instructions for adding water.**
- **Do not mix water with ready-to-use washer fluid. Water can cause the solution to freeze and damage the washer fluid tank and other parts of the washer system. Also, water does not clean as well as washer fluid.**
- **Fill the washer fluid tank only three-quarters full when it is very cold. This allows for fluid expansion if freezing occurs, which could damage the tank if it is completely full.**
- **Do not use engine coolant (antifreeze) in the windshield washer. It can damage the windshield washer system and paint.**

Brakes

This vehicle has disc brakes. Disc brake pads have built-in wear indicators that make a high-pitched warning sound when the brake pads are worn and new pads are needed. The sound can come and go or be heard all the time the vehicle is moving, except when applying the brake pedal firmly.

 **WARNING**

The brake wear warning sound means that soon the brakes will not work well. That could lead to a crash. When the brake wear warning sound is heard, have the vehicle serviced.

Notice: Continuing to drive with worn-out brake pads could result in costly brake repair.

Some driving conditions or climates can cause a brake squeal when the brakes are first applied or lightly applied. This does not mean something is wrong with the brakes.

Properly torqued wheel nuts are necessary to help prevent brake pulsation. When tires are rotated, inspect brake pads for wear and evenly tighten wheel nuts in the proper sequence to torque specifications in *Capacities and Specifications on page 11-2*.

Brake linings should always be replaced as complete axle sets.

Brake Pedal Travel

See your dealer if the brake pedal does not return to normal height, or if there is a rapid increase in pedal travel. This could be a sign that brake service might be required.

Brake Adjustment

Every time the brakes are applied, with or without the vehicle moving, the brakes adjust for wear.

Replacing Brake System Parts

The braking system on a vehicle is complex. Its many parts have to be of top quality and work well together if the vehicle is to have really good braking. The vehicle was designed and tested with top-quality brake parts. When parts of the braking system are replaced, be sure to get new, approved replacement parts. If this is not done, the brakes might not work properly. For example, installing disc brake pads that are wrong for the vehicle, can change the balance between the front and rear brakes — for the worse. The braking performance expected can change in many other ways if the wrong replacement brake parts are installed.

Brake Fluid



The brake master cylinder reservoir is filled with DOT 3 brake fluid as indicated on the reservoir cap. See *Engine Compartment Overview on page 9-6* for the location of the reservoir.

There are only two reasons why the brake fluid level in the reservoir might go down:

- The brake fluid level goes down because of normal brake lining wear. When new linings are installed, the fluid level goes back up.
- A fluid leak in the brake hydraulic system can also cause a low fluid level. Have the brake hydraulic system fixed, since a leak means that sooner or later the brakes will not work well.

Do not top off the brake fluid. Adding fluid does not correct a leak. If fluid is added when the linings are worn, there will be too much fluid when new brake linings are installed. Add or remove brake fluid, as necessary, only when work is done on the brake hydraulic system.

 **WARNING**

If too much brake fluid is added, it can spill on the engine and burn, if the engine is hot enough. You or others could be burned, and the vehicle could be damaged. Add brake fluid only when work is done on the brake hydraulic system.

When the brake fluid falls to a low level, the brake warning light comes on. See *Brake System Warning Light* on page 4-23.

What to Add

Use only new DOT 3 brake fluid from a sealed container. See *Recommended Fluids and Lubricants* on page 10-6.

Always clean the brake fluid reservoir cap and the area around the cap before removing it. This helps keep dirt from entering the reservoir.

 **WARNING**

With the wrong kind of fluid in the brake hydraulic system, the brakes might not work well. This could cause a crash. Always use the proper brake fluid.

Notice:

- **Using the wrong fluid can badly damage brake hydraulic system parts. For example, just a few drops of mineral-based oil, such as engine oil, in the brake hydraulic system can damage brake hydraulic system parts so badly that they will have to be replaced. Do not let someone put in the wrong kind of fluid.**
- **If brake fluid is spilled on the vehicle's painted surfaces, the paint finish can be damaged. Be careful not to spill brake fluid on the vehicle. If you do, wash it off immediately.**

Battery

Refer to the replacement number shown on the original battery label when a new battery is needed. See *Engine Compartment Overview on page 9-6* for battery location.

 **DANGER**

Battery posts, terminals, and related accessories contain lead and lead compounds, chemicals known to the State of California to cause cancer and reproductive harm. Wash hands after handling.

Vehicle Storage

 **WARNING**

Batteries have acid that can burn you and gas that can explode. You can be badly hurt if you are not careful. See *Jump Starting on page 9-101* for tips on working around a battery without getting hurt.

Infrequent Usage: Remove the black, negative (-) cable from the battery to keep the battery from running down.

Extended Storage: Remove the black, negative (-) cable from the battery or use a battery trickle charger.

All-Wheel Drive

Transfer Case

When to Check and Change Lubricant

The transfer case is filled with oil during manufacture, which then does not require changing. It is not necessary to regularly check the transfer case fluid unless there is a leak suspected or an unusual noise is heard. A fluid loss could indicate a problem. It is recommended to have the transfer case serviced at your dealer by trained service technicians.

Starter Switch Check

 **WARNING**

When you are doing this inspection, the vehicle could move suddenly. If the vehicle moves, you or others could be injured.

1. Before starting this check, be sure there is enough room around the vehicle.
2. Firmly apply both the parking brake and the regular brake. See *Parking Brake* on page 8-31.
Do not use the accelerator pedal, and be ready to turn off the engine immediately if it starts.

3. Try to start the engine in each gear. The vehicle should start only in P (Park) or N (Neutral). If the vehicle starts in any other position, contact your dealer for service.

Park Brake and P (Park) Mechanism Check

 **WARNING**

When you are doing this check, the vehicle could begin to move. You or others could be injured and property could be damaged. Make sure there is room in front of the vehicle in case it begins to roll. Be ready to apply the regular brake at once should the vehicle begin to move.

Park on a fairly steep hill, with the vehicle facing downhill. Keeping your foot on the regular brake, set the parking brake.

- To check the parking brake's holding ability: With the engine running and the transmission in N (Neutral), slowly remove foot pressure from the regular brake pedal. Do this until the vehicle is held by the parking brake only.
- To check the P (Park) mechanism's holding ability: With the engine running, shift to P (Park). Then release the parking brake followed by the regular brake.

Contact your dealer if service is required.

Wiper Blade Replacement

Windshield wiper blades should be inspected for wear or cracking. See *Scheduled Maintenance on page 10-2* for more information.

It is a good idea to clean or replace the wiper blade assembly on a regular basis or when worn. For proper windshield wiper blade length and type, see *Maintenance Replacement Parts on page 10-8*.

Notice: Allowing the wiper blade arm to touch the windshield when no wiper blade is installed could damage the windshield. Any damage that occurs would not be covered by your warranty. Do not allow the wiper blade arm to touch the windshield.

Front Wiper Blade Replacement

To replace the wiper blade assembly:

1. Pull the windshield wiper assembly away from the windshield.

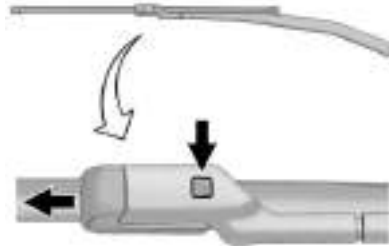

2. Press the button in the middle of the wiper arm connector, and pull the wiper blade away from the arm connector.

3. Remove the wiper blade.
4. Reverse steps 1 through 3 for wiper blade replacement.

Rear Wiper Blade Replacement

The rear wiper blade and wiper arm have a cover for protection. The cover must be removed before the wiper blade can be replaced.

To remove the cover:



1. Slide a plastic tool under cover and push upward to unsnap.

9-30 Vehicle Care

2. Slide cover towards wiper blade tip to unhook from blade assembly.
3. Remove the cover.
4. After wiper blade replacement, ensure that cover hook slides into slot in blade assembly.
5. Snap cover down to secure.

To remove the wiper blade:

1. Lift the wiper arm away from the windshield.

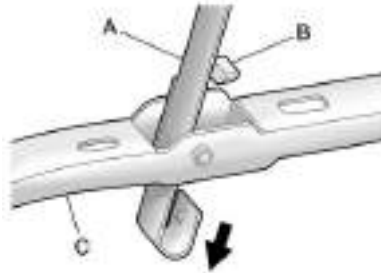

- A. Wiper Arm
- B. Release Lever
- C. Blade Assembly

2. Push the release lever (B) to disengage the hook and push the wiper arm (A) out of the blade assembly (C).
3. Push the new blade assembly securely on the wiper arm until the release lever clicks into place.
4. Replace wiper cover.

Headlamp Aiming

The headlamp aiming system has been preset at the factory.

If the vehicle is damaged in an accident, the aim of the headlamps can be affected and adjustment could be necessary.

It is recommended that a dealer adjust the headlamps. To re-aim the headlamps yourself, use the following procedure.

The vehicle should be properly prepared as follows:

- The vehicle should be placed so the headlamps are 7.6 m (25 ft) from a light-colored wall.
- The vehicle must have all four tires on a level surface which is level all the way to the wall.
- The vehicle should be placed so it is perpendicular to the wall.
- The vehicle should not have any snow, ice, or mud on it.

- The vehicle should be fully assembled and all other work stopped while headlamp aiming is being performed.
- The vehicle should be normally loaded with a full tank of fuel and one person or 75 kg (160 lbs) sitting on the driver seat.
- Tires should be properly inflated.

Headlamp aiming is done with the vehicle's low-beam headlamps. The high-beam headlamps will be correctly aimed if the low-beam headlamps are aimed properly.

9-32 Vehicle Care

To adjust the vertical aim:

1. Open the hood. See *Hood* on page 9-5 for more information.



Base Vehicle



Up-level Vehicle

2. Locate the aim point at the center inner projector condensing lens of the low-beam headlamp, not the outer lens.
3. Measure the distance from the ground to the aim dot on the low-beam headlamp. Record the distance.

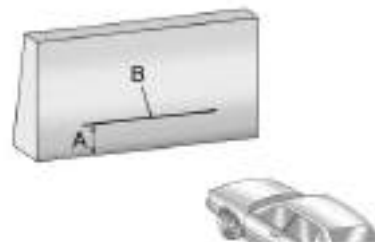

4. At the wall, measure from the ground upward (A) to the recorded distance from Step 3 and mark it.
5. Draw or tape a horizontal line (B) on the wall the width of the vehicle at the height of the mark in Step 4.

Notice: Do not cover a headlamp to improve beam cut-off when aiming. Covering a headlamp may cause excessive heat build-up which may cause damage to the headlamp.

6. Turn on the low-beam headlamps and place a piece of cardboard or equivalent in front of the headlamp not being adjusted. This allows only the beam of light from the headlamp being adjusted to be seen on the flat surface.

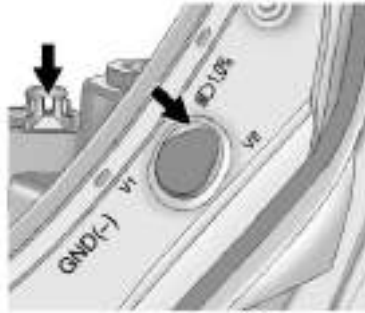

7. Locate the vertical headlamp adjusters, which are under the hood near each headlamp assembly.

For the vehicle equipped with a base level lamp (halogen bulb), there will be one vertical headlamp adjuster (V1).



For the vehicle equipped with an up-level headlamp (HID), there will be two vertical headlamp adjusters (V1 and V2).

Some vehicles have funnel-shaped caps on the adjusters for easier access of a Number 2 Phillips screwdriver to turn the adjusters.

- For the base vehicle, turn the vertical adjuster (V1) until the headlamp beam is aimed to the horizontal tape line. Turn it clockwise or counterclockwise to raise or lower the angle of the beam.

For the up-level vehicle, turn the vertical adjusters (V1 and V2) simultaneously until the headlamp beam is aimed to the horizontal tape line. Turn them clockwise or counterclockwise to raise or lower the angle of the beam.

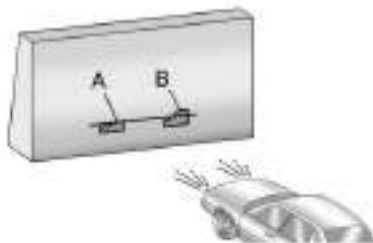

- Make sure that the light from the headlamp is positioned at the bottom edge of the horizontal tape line. The lamp on the left (A) shows the correct headlamp aim. The lamp on the right (B) shows the incorrect headlamp aim.
- Repeat Steps 7 through 9 for the opposite headlamp.

Bulb Replacement

For the proper type of replacement bulbs, see *Replacement Bulbs on page 9-43*.

For any bulb changing procedure not listed in this section, contact your dealer.

Halogen Bulbs

WARNING

Halogen bulbs have pressurized gas inside and can burst if you drop or scratch the bulb. You or others could be injured. Be sure to read and follow the instructions on the bulb package.

High Intensity Discharge (HID) Lighting

⚠ WARNING

The low beam high intensity discharge lighting system operates at a very high voltage. If you try to service any of the system components, you could be seriously injured. Have your dealer or a qualified technician service them.

The up-level vehicle has HID headlamps. After an HID headlamp bulb has been replaced, the beam might be a slightly different shade than it was originally. This is normal.

Headlamps



Base Headlamp Assembly (Front View Passenger Side)

- A. Low-Beam Headlamp/Daytime Running Lamp (DRL)
- B. High-Beam Headlamp
- C. Turn Signal Lamp

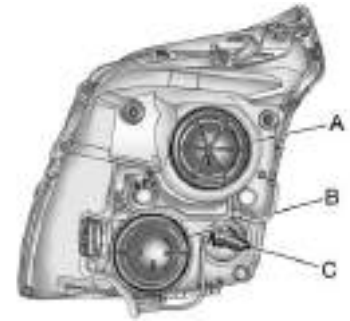

Base Headlamp Assembly (Rear View Passenger Side)

- A. Low-Beam Headlamp/Daytime Running Lamp (DRL)
- B. High-Beam Headlamp
- C. Turn Signal Lamp



**Up-Level Headlamp Assembly
(Front View Driver Side)**

- A. High/Low-Beam Headlamp
(To be replaced at dealer only)
- B. Daytime Running Lamp (DRL)
- C. Turn Signal Lamp



**Up-Level Headlamp Assembly
(Rear View Driver Side)**

- A. High/Low-Beam Headlamp
(To be replaced at dealer only)
- B. Daytime Running Lamp (DRL)
- C. Turn Signal Lamp

Driver Side

The removal of the underhood electrical center is required for the replacement of one of these bulbs:

1. Open the hood. See *Hood* on page 9-5.

⚠ WARNING

Liquids from environment or spillage and/or tools placed on top of or used in the underhood electrical center while the cover is removed can pose a risk of electrical shock/burn to anyone in the vicinity. These conditions can also cause damage to electrical components on the vehicle. Keep liquids and tools away from the underhood electrical center when the cover is removed.

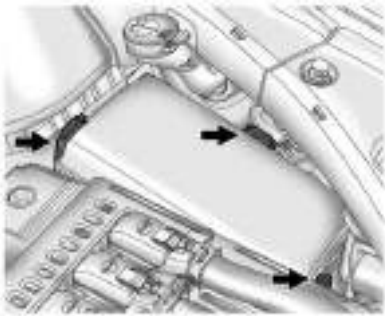

2. Unlatch three clips and lift up the underhood electrical center cover to remove.

Passenger Side

The removal of the air filter/cleaner assembly and base is required for the replacement of one of these bulbs:

1. Open the hood. See *Hood* on page 9-5.

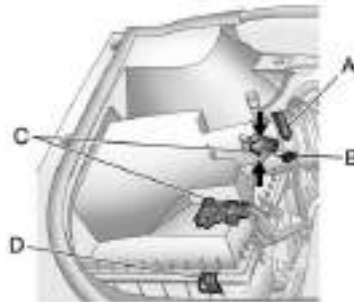

- A. Air Duct Clamp
- B. Connector Lock
- C. Sensor Connectors
- D. Retaining Clips

2. Disconnect the outlet duct by loosening the air duct clamp (A).

3. Remove the connector lock (B) located at the bottom of the sensor connector (C).
4. Press on the top and bottom of the sensor connectors (C) and remove.
5. Lift the three retaining clips (D) on the air filter housing.
6. Turn and tilt cover slightly upwards and slide cover away from outside edge of vehicle. Lift the cover away from base.

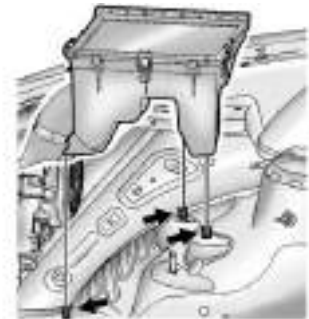

7. Lift the air cleaner/filter base to disengage from three pins.

Low-Beam Headlamps/Daytime Running Lamps (DRL), High-Beam Headlamps (Base)



1. Remove the top cap for the low-beam headlamp/DRL bulb replacement from the back of the headlamp assembly.



2. Remove the bottom cap for the high-beam headlamp bulb replacement from the back of the headlamp assembly.
3. Disconnect electrical connector.
4. Remove the bulb socket from the headlamp assembly.
5. Replace the bulb in the bulb socket.

6. Install the bulb socket in the headlamp assembly.
7. Connect the electrical connector.
8. Install the cap with the down arrow pointing down in the back of the headlamp assembly.
9. For driver side, reinstall the underhood electrical center cover by latching three clips.
10. For passenger side, reinstall the air filter/cleaner assembly base by pushing to seat. Verify the base is seated securely, then install the engine air filter/cleaner assembly.

High/Low-Beam Headlamps (Up-Level)

The high/low beam headlamps on the up-level are High Intensity Discharge (HID) and should be replaced at the dealer.

Daytime Running Lamp (DRL) (Up-Level)

To replace the Front Turn Signal Lamp:



1. Remove the bottom cap for the DRL bulb replacement from the back of the headlamp assembly.
2. Disconnect electrical connector.

3. Remove the DRL bulb socket from the headlamp assembly.
4. Replace the bulb in the bulb socket.
5. Install the bulb socket in the headlamp assembly.
6. Connect the electrical connector.
7. Install the cap with the down arrow pointing down in the back of the headlamp assembly.
8. For driver side, reinstall the underhood electrical center cover by latching three clips.
9. For passenger side, reinstall the air filter/cleaner assembly base by pushing to seat. Verify the base is seated securely, then install the engine air filter/cleaner assembly.

Front Turn Signal Lamp (Base and Up-Level)

To replace the Front Turn Signal Lamp:

1. Remove the turn signal lamp bulb socket from the headlamp assembly.
2. Remove the turn signal lamp bulb from the socket.
3. Replace the bulb in the bulb socket.
4. Install the bulb socket in the headlamp assembly.
5. For driver side, reinstall the underhood electrical center cover by latching three clips.
6. For passenger side, reinstall the air filter/cleaner assembly base by pushing to seat. Verify the base is seated securely, then install the engine air filter/cleaner assembly.

Turn Signal Lamps

To replace one of these bulbs:

1. Open the liftgate. See *Liftgate (Manual)* on page 1-13 or *Liftgate (Power)* on page 1-14.



- A. Push Pin
- B. Taillamp Cover

2. Pull on push pin (A) to release the taillamp cover (B).
3. Remove the taillamp cover from the lamp assembly by pulling rearward from the top to unfasten from snap tabs.



4. Remove the two screws from the taillamp assembly.
5. Pull the taillamp assembly straight back to remove.



- A. Turn Signal Lamp
 - B. Back-Up Bulb/Socket
6. Turn the turn signal lamp (A) bulb socket counterclockwise to remove it from the taillamp assembly.
 7. Pull the bulb straight out from the socket.

8. Press a new bulb into the socket, insert it into the taillamp assembly and turn the bulb socket clockwise until it clicks.
9. Reinstall the taillamp assembly and tighten the screws.
10. Reinstall the taillamp cover by snapping it into place.
11. Push the push pin to secure the taillamp cover.

Back-Up Lamps

To replace one of these bulbs:

1. Open the liftgate. See *Liftgate (Manual)* on page 1-13 or *Liftgate (Power)* on page 1-14.



- A. Push Pin
- B. Taillamp Cover

2. Pull on push pin (A) to release the taillamp cover (B).
3. Remove the taillamp cover from the lamp assembly by pulling rearward from the top to unfasten from snap tabs.



4. Remove the two screws from the taillamp assembly.
5. Pull the taillamp assembly straight back to remove.

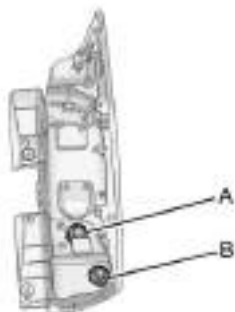

- A. Turn Signal Lamp
- B. Back-Up Bulb/Socket

6. Disconnect the wire harness from the back-up bulb/socket (B).

7. Turn the back-up bulb socket counterclockwise to remove it from the taillamp assembly.
8. Press a new bulb/socket into the taillamp assembly and turn the bulb/socket clockwise until it clicks.
9. Reinstall the taillamp assembly and tighten the screws.
10. Reinstall the taillamp cover by snapping it into place.
11. Push the push pin to secure the taillamp cover.

License Plate Lamp

To replace one of these bulbs:

1. Open the liftgate. See *Liftgate (Manual)* on page 1-13 or *Liftgate (Power)* on page 1-14 for more information.



Passenger side shown, driver side similar

2. Push the left end of the lamp assembly towards the right.
3. Turn the lamp assembly down to remove from liftgate.

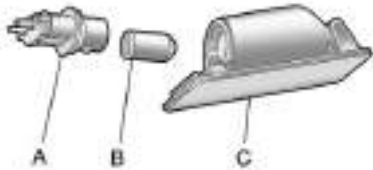

- A. Bulb Socket
- B. Bulb
- C. Lamp Assembly

4. Turn the bulb socket (A) counterclockwise to remove from lamp assembly (C).

5. Pull the bulb (B) straight out of the bulb socket.
6. Push the replacement bulb straight into the bulb socket and turn the bulb socket clockwise to install into lamp assembly.
7. Turn the lamp assembly into the liftgate engaging the clip side first.
8. Push on the lamp side opposite the clip until the lamp assembly snaps into place.

Replacement Bulbs

| Exterior Lamp | Bulb Number |
|-----------------------|-------------|
| Daytime Running Lamp | 7443 |
| Fog Lamp | H10 |
| Headlamp High-Beam | 9005 |
| Headlamp Low-Beam | H10 |
| License Plate Lamp | 194 |
| Turn Signal Front | 7440 |
| Tail/Turn Signal Rear | 7440 |

For replacement bulbs not listed here, contact your dealer.

Electrical System

Electrical System Overload

The vehicle has fuses and circuit breakers to protect against an electrical system overload.

When the current electrical load is too heavy, the circuit breaker opens and closes, protecting the circuit until the current load returns to normal or the problem is fixed. This greatly reduces the chance of circuit overload and fire caused by electrical problems.

Fuses and circuit breakers protect the following in the vehicle:

- Headlamp Wiring
- Windshield Wiper Motor
- Power Windows and Other Power Accessories

Replace a bad fuse with a new one of the identical size and rating.

If there is a problem on the road and a fuse needs to be replaced, the same amperage fuse can be borrowed. Choose some feature of the vehicle that is not needed to use and replace it as soon as possible.

Headlamp Wiring

An electrical overload may cause the lamps to go on and off, or in some cases to remain off. Have the headlamp wiring checked right away if the lamps go on and off or remain off.

Windshield Wipers

If the wiper motor overheats due to heavy snow or ice, the windshield wipers will stop until the motor cools and will then restart.

Although the circuit is protected from electrical overload, overload due to heavy snow or ice may cause wiper linkage damage.

Always clear ice and heavy snow from the windshield before using the windshield wipers.

If the overload is caused by an electrical problem and not snow or ice, be sure to get it fixed.

Fuses and Circuit Breakers

The wiring circuits in the vehicle are protected from short circuits by a combination of fuses and circuit breakers. This greatly reduces the chance of damage caused by electrical problems.

To check a fuse, look at the silver-colored band inside the fuse. If the band is broken or melted, replace the fuse. Be sure to replace a bad fuse with a new one of the identical size and rating.

Fuses of the same amperage can be temporarily borrowed from another fuse location, if a fuse goes out. Replace the fuse as soon as you can.

To identify and check fuses, circuit breakers, and relays, see *Engine Compartment Fuse Block* on page 9-45 and *Rear Compartment Fuse Block* on page 9-49.

Engine Compartment Fuse Block

To remove the fuse block cover, press the clips on the cover and lift it straight up.

The vehicle might not have all the fuses and features listed.

Notice: Spilling liquid on any electrical component on the vehicle may damage it. Always keep the covers on any electrical component.

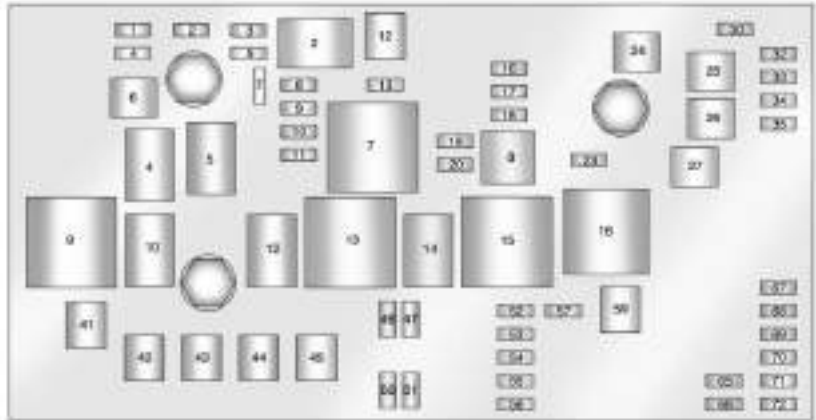

Engine Compartment Fuse Block

| J-Case Fuses | Usage |
|--------------|----------------------------|
| 6 | Wiper |
| 12 | Vacuum Pump |
| 24 | Anitlock Brake System Pump |

| J-Case Fuses | Usage |
|--------------|--------------------------|
| 25 | Rear Electrical Center 1 |
| 26 | Rear Electrical Center 2 |
| 27 | Not Used |

9-46 Vehicle Care

| J-Case Fuses | Usage |
|--------------|--------------------|
| 41 | Cooling Fan 2 |
| 42 | Starter |
| 43 | Not Used |
| 44 | Not Used |
| 45 | Cooling Fan 1 |
| 59 | Secondary AIR Pump |

| Mini Fuses | Usage |
|------------|-------------------------------------|
| 1 | Engine Control Module Battery |
| 2 | Transmission Control Module Battery |
| 3 | Mass Air Flow Sensor |
| 4 | Not Used |
| 5 | Engine Control Module Run Crank |

| Mini Fuses | Usage |
|------------|---|
| 7 | Post-Catalytic Converter O2 Sensor |
| 8 | Pre-Catalytic Converter O2 Sensor |
| 9 | Engine Control Module Powertrain |
| 10 | Fuel Injectors—Even |
| 11 | Fuel Injectors—Odd |
| 13 | Washer |
| 16 | Instrument Panel Cluster/Malfunction Indicator Lamp/ Ignition |
| 17 | Air Quality Sensor |
| 18 | Headlamp Washer |
| 19 | Transmission Control Module Run Crank |
| 20 | Rear Electrical Center Run Crank |

| Mini Fuses | Usage |
|------------|---|
| 23 | Heater Motor |
| 30 | Switch Back Light |
| 32 | Battery Sense (Regulated Voltage Control) |
| 33 | Adaptive Forward Lighting / Adaptive Headlamp Leveling Module |
| 34 | Body Control Module 7 |
| 35 | Electronic Brake Control Module |
| 46 | Low Beam Headlamp-Right |
| 47 | Low Beam Headlamp-Left |
| 50 | Front Fog Lamps |
| 51 | Horn |
| 52 | Fuel System Control Module |

| Mini Fuses | Usage |
|------------|------------------------------------|
| 53 | Headlamp Level |
| 54 | Sensing Diagnostic Module Ignition |
| 55 | High Beam Headlamp-Right |
| 56 | High Beam Headlamp-Left |
| 57 | Ignition Steering Column Lock |
| 65 | Trailer Right Stop Lamp |
| 66 | Trailer Left Stop Lamp |
| 67 | Spare |

| Mini Fuses | Usage |
|------------|-------|
| 68 | Spare |
| 69 | Spare |
| 70 | Spare |
| 71 | Spare |
| 72 | Spare |

| Mini Relays | Usage |
|-------------|--------------------|
| 7 | Powertrain |
| 9 | Cooling Fan 2 |
| 13 | Cooling Fan 1 |
| 15 | Run/Crank |
| 16 | Secondary AIR Pump |

| Micro Relays | Usage |
|--------------|---------------|
| 2 | Vacuum Pump |
| 4 | Wiper Control |
| 5 | Wiper Speed |
| 10 | Starter |
| 12 | Cool Fan 3 |
| 14 | Low Beam/HID |

| U Micro Relays | Usage |
|----------------|-----------------|
| 8 | Headlamp Washer |

Instrument Panel Fuse Block

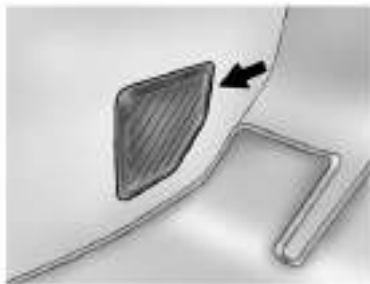

The instrument panel fuse block is located in the center console between the driver and passenger seats. To access the fuses, open the fuse panel door from the passenger side by pulling it out.

To reinstall the door, push the door back into its original location.



Instrument Panel Fuse Block

| Mini Fuses | Usage |
|------------|---|
| DISPLY | Display |
| S/ROOF | Sun Roof |
| SPARE | Spare |
| UHP | Universal Handsfree Phone |
| RDO | Radio |
| APO - IP | Auxiliary Power Outlet - Instrument Panel |
| APO - CNSL | Auxiliary Power Outlet - Floor Console |
| BCM 3 | Body Control Module 3 |
| BCM 4 | Body Control Module 4 |
| BCM 5 | Body Control Module 5 |
| ONSTAR | OnStar® System |

| Mini Fuses | Usage |
|------------|---------------------------------|
| RAIN SNSR | Rain Sensor |
| BCM 6 | Body Control Module 6 |
| ESCL | Electronic Steering Column Lock |
| AIRBAG | Sensing and Diagnostic Module |
| DLC | Data Link Connection |
| IPC | Instrument Panel Cluster |
| SPARE | Not Used |
| BCM 1 | Body Control Module 1 |
| BCM 2 | Body Control Module 2 |

| Mini Fuses | Usage |
|------------|--|
| AMP/RDO | Amplifier/Radio |
| HVAC | Heating Ventilation & Air Conditioning |

| J—Case Fuses | Usage |
|--------------|-----------------------|
| BCM 8 | Body Control Module 8 |
| FRT BLWR | Front Blower |

| Relays | Usage |
|------------------|--|
| LOGIC RLY | Logistics Relay |
| RAP/ ACCY RLY | Retained Accessory Power/ Accessory Relay |

Rear Compartment Fuse Block



The rear compartment fuse block is located in the cargo area, on the driver side of the vehicle behind the lower trim panel. To open, turn the latch with a flat bladed tool and pull the trim panel from the edges to fold it down.

The vehicle may not be equipped with all of the fuses and relays shown.

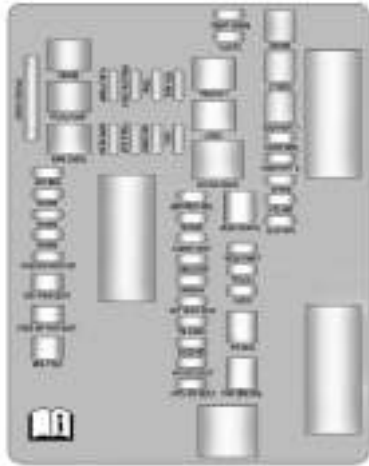

Rear Compartment Fuse Block

| Fuses | Usage |
|------------------|-----------------------------------|
| SPARE FUSES | Spare Fuses |
| AOS MDL | Automatic Occupant Sensing Module |
| SPARE | Not Used |
| SPARE | Not Used |
| SPARE | Not Used |
| PASS DR WDO SW | Passenger Door Window Switch |
| DRV PWR SEAT | Driver Power Seat |
| PASS DR PWR SEAT | Passenge/Driver Power Seats |
| MDL TRLR | Trailer Module |
| RPA MDL | Rear Parking Assist Module |
| RDM | Rear Drive Module |
| PRK LPS TRLR | Trailer Park Lamps |
| FUEL PUMP | Fuel Pump |

| Fuses | Usage |
|---------------|-----------------------------------|
| * SEC | Security |
| INFOTMNT | Infotainment |
| * TRLR EXP | Trailer Export |
| WPR REAR | Rear Wiper |
| MIR WDO MDL | Mirror Window Module |
| * SPARE | Not Used |
| CNSTR VENT | Canister Vent |
| LGM LOGIC | Lift Gate Module Logic |
| CAMERA | Rear Vision Camera |
| FRT VENT SEAT | Front Ventilated Seats |
| TRLR MDL | Trailer Module |
| SADS MDL | Semi Active Damping System Module |
| RR HTD SEAT | Rear Heated Seats |

| Fuses | Usage |
|-----------------|---------------------------------|
| FRT HTD SEAT | Front Heated Seats |
| THEFT HORN | Theft Horn |
| * LGATE | Liftgate |
| REAR DEFOG | Rear Defog |
| * BCM THEFT | Body Control Module Theft |
| * TRLR 2 | Trailer 2 |
| UGDO | Universal Garage Door Opener |
| RT WDO | Right Window |
| PRK BRK MDL | Park Brake Module |

| Fuses | Usage |
|-----------------|---------------------------|
| SPARE | Not Used |
| LT WDO | Left Window |
| IGN/ THEFT 1 | Ignition/Theft 1 |
| LGATE MDL | Liftgate Module |
| IGN/ THEFT 2 | Ignition/Theft 2 |
| SPARE | Not Used |
| HTD MIR | Heated Mirror |
| AUX PWR | Auxiliary Power Outlet |

| Relays | Usage |
|----------------|-------------------------|
| SPARE | Not Used |
| * FUEL PUMP | Fuel Pump |
| WPR CONTRL | Wiper Control |
| * RUN RLY | Run Relay |
| LOGIC | Logistic Relay |
| DEFOG REAR | Rear Window Defogger |

*-Denotes up-level content.

Wheels and Tires

Tires

Your new vehicle comes with high-quality tires made by a leading tire manufacturer. If you ever have questions about your tire warranty and where to obtain service, see your vehicle Warranty booklet for details. For additional information refer to the tire manufacturer.

WARNING

Poorly maintained and improperly used tires are dangerous.

- Overloading your tires can cause overheating as a result of too much flexing. You could have an air-out and a serious accident. See *Vehicle Load Limits on page 8-11*.
- Underinflated tires pose the same danger as overloaded tires. The resulting accident could cause serious injury. Check all tires frequently to maintain the recommended pressure. Tire pressure should be checked when your tires are cold. See *Tire Pressure on page 9-59*.

(Continued)

WARNING (Continued)

- Overinflated tires are more likely to be cut, punctured or broken by a sudden impact — such as when you hit a pothole. Keep tires at the recommended pressure.
- Worn, old tires can cause accidents. If your tread is badly worn, or if your tires have been damaged, replace them.

See *Tire Pressure for High-Speed Operation on page 9-60* for inflation pressure adjustment for high speed driving.

Tire Sidewall Labeling

Useful information about a tire is molded into its sidewall. The examples below show a typical passenger vehicle tire and a compact spare tire sidewall.

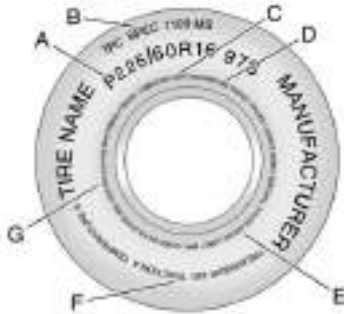

Passenger (P-Metric) Tire Example

(A) Tire Size: The tire size is a combination of letters and numbers used to define a particular tire's width, height, aspect ratio, construction type,

and service description. See the "Tire Size" illustration later in this section for more detail.

(B) TPC Spec (Tire Performance Criteria Specification): Original equipment tires designed to GM's specific tire performance criteria have a TPC specification code molded onto the sidewall. GM's TPC specifications meet or exceed all federal safety guidelines.

(C) DOT (Department of Transportation): The Department of Transportation (DOT) code indicates that the tire is in compliance with the U.S. Department of Transportation Motor Vehicle Safety Standards.

(D) Tire Identification Number (TIN): The letters and numbers following the DOT (Department of Transportation) code is the

Tire Identification Number (TIN). The TIN shows the manufacturer and plant code, tire size, and date the tire was manufactured. The TIN is molded onto both sides of the tire, although only one side may have the date of manufacture.

(E) Tire Ply Material: The type of cord and number of plies in the sidewall and under the tread.

(F) Uniform Tire Quality Grading (UTQG): Tire manufacturers are required to grade tires based on three performance factors: treadwear, traction, and temperature resistance. For more information see *Uniform Tire Quality Grading* on page 9-71.

(G) Maximum Cold Inflation Load Limit: Maximum load that can be carried and the maximum pressure needed to support that load.

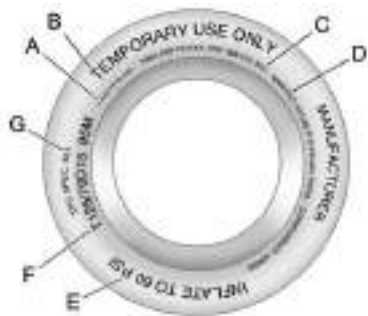

Compact Spare Tire Example

(A) Tire Ply Material: The type of cord and number of plies in the sidewall and under the tread.

(B) Temporary Use Only: The compact spare tire or temporary use tire has a tread life of approximately 5 000 km (3,000 miles) and should not be driven at speeds over 105 km/h (65 mph). The compact spare tire is for emergency use when a regular road tire has lost air and

gone flat. If your vehicle has a compact spare tire, see *Compact Spare Tire* on page 9-100 and *If a Tire Goes Flat* on page 9-74.

(C) Tire Identification Number (TIN):

The letters and numbers following the DOT (Department of Transportation) code is the Tire Identification Number (TIN). The TIN shows the manufacturer and plant code, tire size, and date the tire was manufactured. The TIN is molded onto both sides of the tire, although only one side may have the date of manufacture.

(D) Maximum Cold Inflation Load Limit:

Maximum load that can be carried and the maximum pressure needed to support that load.

(E) Tire Inflation: The temporary use tire or compact spare tire should be inflated to 420 kPa (60 psi). For more information on tire pressure and inflation see *Tire Pressure* on page 9-59.

(F) Tire Size: A combination of letters and numbers define a tire's width, height, aspect ratio, construction type, and service description. The letter T as the first character in the tire size means the tire is for temporary use only.

(G) TPC Spec (Tire Performance Criteria Specification):

Original equipment tires designed to GM's specific tire performance criteria have a TPC specification code molded onto the sidewall. GM's TPC specifications meet or exceed all federal safety guidelines.

Tire Designations

Tire Size

The following illustration shows an example of a typical passenger vehicle tire size.

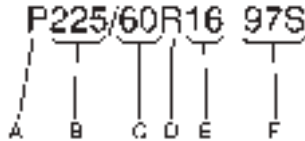

(A) Passenger (P-Metric) Tire:

The United States version of a metric tire sizing system. The letter P as the first character in the tire size means a passenger vehicle tire engineered to standards set by the U.S. Tire and Rim Association.

(B) Tire Width: The three-digit number indicates the tire section width in millimeters from sidewall to sidewall.

(C) Aspect Ratio: A two-digit number that indicates the tire height-to-width measurements. For example, if the tire size aspect ratio is 60, as shown in item C of the illustration, it would mean that the tire's sidewall is 60 percent as high as it is wide.

(D) Construction Code: A letter code is used to indicate the type of ply construction in the tire. The letter R means radial ply construction; the letter D means diagonal or bias ply construction; and the letter B means belted-bias ply construction.

(E) Rim Diameter: Diameter of the wheel in inches.

(F) Service Description: These characters represent the load index and speed rating of the tire. The load index represents the load carrying capacity a tire is certified to carry. The speed rating is the maximum speed a tire is certified to carry a load.

Tire Terminology and Definitions

Air Pressure: The amount of air inside the tire pressing outward on each square inch of the tire. Air pressure is expressed in psi (pounds per square inch) or kPa (kilopascal).

Accessory Weight: This means the combined weight of optional accessories. Some examples of optional accessories are, automatic transmission, power steering, power brakes, power windows, power seats, and air conditioning.

Aspect Ratio: The relationship of a tire's height to its width.

Belt: A rubber coated layer of cords that is located between the plies and the tread. Cords may be made from steel or other reinforcing materials.

Bead: The tire bead contains steel wires wrapped by steel cords that hold the tire onto the rim.

Bias Ply Tire: A pneumatic tire in which the plies are laid at alternate angles less than 90 degrees to the centerline of the tread.

Cold Tire Pressure: The amount of air pressure in a tire, measured in psi (pounds per square inch) or kPa (kilopascal) before a tire has built up heat from driving. See *Tire Pressure on page 9-59*.

Curb Weight: The weight of a motor vehicle with standard and optional equipment including the maximum capacity of fuel, oil, and coolant, but without passengers and cargo.

DOT Markings: A code molded into the sidewall of a tire signifying that the tire is in compliance with the U.S. Department of Transportation (DOT) motor vehicle safety standards. The DOT code includes the Tire Identification Number (TIN), an alphanumeric designator which can also identify the tire manufacturer, production plant, brand, and date of production.

GVWR: Gross Vehicle Weight Rating. See *Vehicle Load Limits on page 8-11*.

GAWR FRT: Gross Axle Weight Rating for the front axle. See *Vehicle Load Limits on page 8-11*.

GAWR RR: Gross Axle Weight Rating for the rear axle. See *Vehicle Load Limits on page 8-11*.

Intended Outboard Sidewall: The side of an asymmetrical tire, that must always face outward when mounted on a vehicle.

Kilopascal (kPa): The metric unit for air pressure.

Light Truck (LT-Metric) Tire: A tire used on light duty trucks and some multipurpose passenger vehicles.

Load Index: An assigned number ranging from 1 to 279 that corresponds to the load carrying capacity of a tire.

Maximum Inflation Pressure: The maximum air pressure to which a cold tire can be inflated. The maximum air pressure is molded onto the sidewall.

Maximum Load Rating: The load rating for a tire at the maximum permissible inflation pressure for that tire.

Maximum Loaded Vehicle Weight: The sum of curb weight, accessory weight, vehicle capacity weight, and production options weight.

Normal Occupant Weight: The number of occupants a vehicle is designed to seat multiplied by 68 kg (150 lbs). See *Vehicle Load Limits on page 8-11*.

Occupant Distribution: Designated seating positions.

Outward Facing Sidewall: The side of an asymmetrical tire that has a particular side that faces outward when mounted on a vehicle. The side of the tire that contains a whitewall, bears white lettering, or bears manufacturer, brand, and/or model name molding that is higher or deeper than the same moldings on the other sidewall of the tire.

Passenger (P-Metric) Tire: A tire used on passenger cars and some light duty trucks and multipurpose vehicles.

Recommended Inflation Pressure: Vehicle manufacturer's recommended tire inflation pressure as shown on the tire placard. See *Tire Pressure on page 9-59* and *Vehicle Load Limits on page 8-11*.

Radial Ply Tire: A pneumatic tire in which the ply cords that extend to the beads are laid at 90 degrees to the centerline of the tread.

Rim: A metal support for a tire and upon which the tire beads are seated.

Sidewall: The portion of a tire between the tread and the bead.

Speed Rating: An alphanumeric code assigned to a tire indicating the maximum speed at which a tire can operate.

Traction: The friction between the tire and the road surface. The amount of grip provided.

Tread: The portion of a tire that comes into contact with the road.

Treadwear Indicators: Narrow bands, sometimes called wear bars, that show across the tread of a tire when only 1.6 mm (1/16 inch) of tread remains. See *When It Is Time for New Tires* on page 9-68.

UTQGS (Uniform Tire Quality Grading Standards): A tire information system that provides consumers with ratings for a tire's traction, temperature, and treadwear. Ratings are determined by tire manufacturers using government testing procedures. The ratings are molded into the sidewall of the tire. See *Uniform Tire Quality Grading* on page 9-71.

Vehicle Capacity Weight: The number of designated seating positions multiplied by 68 kg (150 lbs) plus the rated cargo load. See *Vehicle Load Limits* on page 8-11.

Vehicle Maximum Load on the Tire: Load on an individual tire due to curb weight, accessory weight, occupant weight, and cargo weight.

Vehicle Placard: A label permanently attached to a vehicle showing the vehicle's capacity weight and the original equipment tire size and recommended inflation pressure. See "Tire and Loading Information Label" under *Vehicle Load Limits* on page 8-11.

Tire Pressure

Tires need the correct amount of air pressure to operate effectively.

Notice: Do not let anyone tell you that under-inflation or over-inflation is all right. It is not. If your tires do not have enough air (under-inflation), you can get the following:

- Too much flexing
- Too much heat
- Tire overloading
- Premature or irregular wear
- Poor handling
- Reduced fuel economy

If your tires have too much air (over-inflation), you can get the following:

- Unusual wear
- Poor handling
- Rough ride
- Needless damage from road hazards

A vehicle specific Tire and Loading Information label is attached to your vehicle. This label shows your vehicle's original equipment tires and the correct inflation pressures for your tires when they are cold. The recommended cold tire inflation pressure, shown on the label, is the minimum amount of air pressure needed to support your vehicle's maximum load carrying capacity.

For additional information regarding how much weight your vehicle can carry, and an example of the Tire and Loading Information label, see *Vehicle Load Limits on page 8-11*. How you load your vehicle affects vehicle handling and ride comfort. Never load your vehicle with more weight than it was designed to carry.

When to Check

Check your tires once a month or more. Do not forget to check the compact spare tire, if the vehicle has one. The compact spare should be at 60 psi (420 kPa). For additional information regarding the compact spare tire, see *Compact Spare Tire on page 9-100*.

How to Check

Use a good quality pocket-type gauge to check tire pressure. You cannot tell if your tires are properly inflated simply by looking at them. Radial tires may look properly inflated even when they are under-inflated. Check the tire's inflation pressure when the tires are cold. Cold means your vehicle has been sitting for at least three hours or driven no more than 1.6 km (1 mile).

Remove the valve cap from the tire valve stem. Press the tire gauge firmly onto the valve to get a pressure measurement. If the cold tire inflation pressure matches the recommended pressure on the Tire and Loading Information label, no further adjustment is necessary. If the inflation pressure is low, add air until you reach the recommended amount.

If you overfill the tire, release air by pushing on the metal stem in the center of the tire valve. Re-check the tire pressure with the tire gauge.

Be sure to put the valve caps back on the valve stems. They help prevent leaks by keeping out dirt and moisture.

Tire Pressure for High-Speed Operation



Driving at high speeds, 160 km/h (100 mph) or higher, puts an additional strain on tires. Sustained high-speed driving causes excessive heat build up and can cause sudden tire failure. You could have a crash and you or others could be killed. Some high-speed rated tires require inflation pressure adjustment for high speed operation. When speed limits and road conditions are such that a vehicle can be driven at high speeds, make sure the tires are rated for high speed operation, in excellent condition, and set to the correct cold tire inflation pressure for the vehicle load.

Vehicles with P235/65R18, P235/55R20, or 235/55R20 size tires require inflation pressure adjustment when driving your vehicle at speeds of 100 mph (160 km/h) or higher. Set the cold inflation pressure to the maximum inflation pressure shown on the tire sidewall, or 44 psi (300 kPa), whichever is lower. When you end this high-speed driving, return the tires to the cold tire inflation pressure shown on the Tire and Loading Information label. See *Vehicle Load Limits on page 8-11* and *Tire Pressure on page 9-59*.

You will find the maximum load and inflation pressure molded on the tire's sidewall, in small letters, near the rim flange. It will read something like this: Maximum load 690 kg (1521 lbs) 300 kPa (44 psi) Max. Press.

Tire Pressure Monitor System

The Tire Pressure Monitor System (TPMS) uses radio and sensor technology to check tire pressure levels. The TPMS sensors monitor the air pressure in your tires and transmit tire pressure readings to a receiver located in the vehicle.

Each tire, including the spare (if provided), should be checked monthly when cold and inflated to the inflation pressure recommended by the vehicle manufacturer on the vehicle placard or tire inflation pressure label. (If your vehicle has tires of a different size than the size indicated on the vehicle placard or tire inflation pressure label, you should determine the proper tire inflation pressure for those tires.)

As an added safety feature, your vehicle has been equipped with a tire pressure monitoring system (TPMS) that illuminates a low tire pressure telltale when one or more of your tires is significantly under-inflated.

Accordingly, when the low tire pressure telltale illuminates, you should stop and check your tires as soon as possible, and inflate them to the proper pressure. Driving on a significantly under-inflated tire causes the tire to overheat and can lead to tire failure. Under-inflation also reduces fuel efficiency and tire tread life, and may affect the vehicle's handling and stopping ability.

Please note that the TPMS is not a substitute for proper tire maintenance, and it is the driver's responsibility to maintain correct tire pressure, even if under-inflation has not reached the level to trigger illumination of the TPMS low tire pressure telltale.

Your vehicle has also been equipped with a TPMS malfunction indicator to indicate when the system is not operating properly. The TPMS malfunction indicator is combined with the low tire pressure telltale. When the system detects a malfunction, the telltale will flash for approximately one minute and then remain continuously illuminated. This sequence will continue upon subsequent vehicle start-ups as long as the malfunction exists.

When the malfunction indicator is illuminated, the system may not be able to detect or signal low tire pressure as intended. TPMS malfunctions may occur for a variety of reasons, including the installation of replacement or alternate tires or wheels on the vehicle that prevent the TPMS from functioning properly. Always check the TPMS malfunction telltale after replacing one or more tires or wheels on your vehicle to ensure that the replacement or alternate tires and wheels allow the TPMS to continue to function properly.

See *Tire Pressure Monitor Operation* on page 9-62 for additional information.

Federal Communications Commission (FCC) and Industry Canada

See *Radio Frequency Statement on page 12-17* for information regarding Part 15 of the Federal Communications Commission (FCC) rules and Industry Canada Standards RSS-210/220/310.

Tire Pressure Monitor Operation

This vehicle may have a Tire Pressure Monitor System (TPMS). The TPMS is designed to warn the driver when a low tire pressure condition exists. TPMS sensors are mounted onto each tire and wheel assembly, excluding the spare tire and wheel assembly. The TPMS sensors monitor the air pressure in the vehicle's tires and transmit the tire pressure readings to a receiver located in the vehicle.



When a low tire pressure condition is detected, the TPMS illuminates the low tire pressure warning light located on the instrument panel cluster. If the warning light comes on, stop as soon as possible and inflate the tires to the recommended pressure shown on the tire loading information label. See *Vehicle Load Limits* on page 8-11.

At the same time a message to check the pressure appears on the Driver Information Center (DIC) display. The low tire pressure warning light and the DIC warning message come on at each ignition cycle until the tires are inflated to the correct inflation pressure. Using the DIC, tire pressure levels can be viewed by the driver. For additional

information and details about the DIC operation and displays see *Driver Information Center (DIC)* on page 4-29.

The low tire pressure warning light may come on in cool weather when the vehicle is first started, and then turn off as you start to drive. This could be an early indicator that the air pressure in the tire(s) are getting low and need to be inflated to the proper pressure.

A Tire and Loading Information label, attached to your vehicle, shows the size of your vehicle's original equipment tires and the correct inflation pressure for your vehicle's tires when they are cold. See *Vehicle Load Limits* on page 8-11, for an example of the Tire and Loading Information label and its location on your vehicle. Also see *Tire Pressure* on page 9-59.

Your vehicle's TPMS can warn you about a low tire pressure condition but it does not replace normal tire maintenance. See *Tire Inspection* on page 9-66, *Tire Rotation* on page 9-66 and *Tires* on page 9-52.

Notice: Using non-approved tire sealants could damage the Tire Pressure Monitor System (TPMS) sensors. TPMS sensor damage caused by using an incorrect tire sealant is not covered by the vehicle warranty. Always use the GM approved tire sealant available through your dealer.

Factory-installed Tire Inflator Kits use a GM approved liquid tire sealant. Using non-approved tire sealants could damage the TPMS sensors. See *Tire Sealant and Compressor Kit (Without Selector Switch)* on page 9-76 or *Tire Sealant and Compressor Kit (With Selector Switch)* on page 9-84 for information regarding the inflator kit materials and instructions.

TPMS Malfunction Light and Message

The TPMS will not function properly if one or more of the TPMS sensors are missing or inoperable. When the system detects a malfunction, the low tire warning light flashes for about one minute and then stays on for the remainder of the ignition cycle. A DIC warning message is also displayed. The low tire warning light and DIC warning message come on at each ignition cycle until the problem is corrected. Some of the conditions that can cause the malfunction light and DIC message to come on are:

- One of the road tires has been replaced with the spare tire. The spare tire does not have a TPMS sensor. The TPMS malfunction light and DIC message should go off once you re-install the road tire containing the TPMS sensor.

- The TPMS sensor matching process was started but not completed or not completed successfully after rotating the vehicle's tires. The DIC message and TPMS malfunction light should go off once the TPMS sensor matching process is performed successfully. See "TPMS Sensor Matching Process" later in this section.
- One or more TPMS sensors are missing or damaged. The DIC message and the TPMS malfunction light should go off when the TPMS sensors are installed and the sensor matching process is performed successfully. See your dealer for service.
- Replacement tires or wheels do not match your vehicle's original equipment tires or wheels. Tires and wheels other than those recommended for your vehicle could prevent the TPMS from functioning properly. See *Buying New Tires on page 9-68*.
- Operating electronic devices or being near facilities using radio wave frequencies similar to the TPMS could cause the TPMS sensors to malfunction.

If the TPMS is not functioning it cannot detect or signal a low tire condition. See your dealer for service if the TPMS malfunction light and DIC message comes on and stays on.

TPMS Sensor Matching Process

Each TPMS sensor has a unique identification code. Any time you rotate your vehicle's tires or replace one or more of the TPMS sensors, the identification codes will need to be matched to the new tire/wheel position. The sensors are matched to the tire/wheel positions in the following order: driver side front tire, passenger side front tire, passenger side rear tire, and driver side rear tire using a TPMS diagnostic tool. See your dealer for service.

The TPMS sensors can also be matched to each tire/wheel position by increasing or decreasing the tire's air pressure. If increasing the

tire's air pressure, do not exceed the maximum inflation pressure indicated on the tire's sidewall.

To decrease air-pressure out of a tire you can use the pointed end of the valve cap, a pencil-style air pressure gauge, or a key.

You have two minutes to match the first tire/wheel position, and five minutes overall to match all four tire/wheel positions. If it takes longer than two minutes, to match the first tire and wheel, or more than five minutes to match all four tire and wheel positions the matching process stops and you need to start over.

The TPMS sensor matching process is outlined below:

1. Set the parking brake.
2. Place the vehicle power mode in ON/RUN/START. See *Ignition Positions on page 8-18*.
3. Select the vehicle information menu using the menu button.
4. Select the tire pressure screen using the up/down thumbwheel.
5. Press and hold SET to begin the sensor matching process.
6. Press SET to confirm selection. The horn sounds twice to signal the receiver is in relearn mode and TIRE LEARNING ACTIVE message displays on the DIC screen.

7. Start with the driver side front tire.
8. Remove the valve cap from the valve cap stem. Activate the TPMS sensor by increasing or decreasing the tire's air pressure for five seconds, or until a horn chirp sounds. The horn chirp, which may take up to 30 seconds to sound, confirms that the sensor identification code has been matched to this tire and wheel position.
9. Proceed to the passenger side front tire, and repeat the procedure in Step 8.
10. Proceed to the passenger side rear tire, and repeat the procedure in Step 8.
11. Proceed to the driver side rear tire, and repeat the procedure in Step 8. The horn sounds two times to indicate the sensor identification code has been matched to the driver side rear tire, and the TPMS sensor matching process is no longer active. The TIRE LEARNING ACTIVE message on the DIC display screen goes off.
12. Press STOP to turn the ignition off.
13. Set all four tires to the recommended air pressure level as indicated on the Tire and Loading Information label.
14. Put the valve caps back on the valve stems.

Tire Inspection

We recommend that you regularly inspect your vehicle's tires, including the spare tire, if the vehicle has one, for signs of wear or damage. See *When It Is Time for New Tires* on page 9-68 for more information.

Tire Rotation

Tires should be rotated every 8 000 to 13 000 km (5,000 to 8,000 miles). See *Scheduled Maintenance* on page 10-2.

The purpose of a regular tire rotation is to achieve a uniform wear for all tires on the vehicle. This will ensure that the vehicle continues to perform most like it did when the tires were new.

Any time you notice unusual wear, rotate the tires as soon as possible and check wheel alignment. Also check for damaged tires or wheels. See *When It Is Time for New Tires on page 9-68* and *Wheel Replacement on page 9-73*.

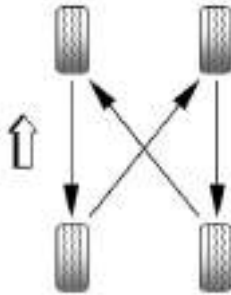

When rotating the vehicle's tires, always use the correct rotation pattern shown here.

Do not include the compact spare tire in the tire rotation.

After the tires have been rotated, adjust the front and rear inflation pressures as shown on the Tire and Loading Information label. See *Tire Pressure on page 9-59* and *Vehicle Load Limits on page 8-11*.

Reset the Tire Pressure Monitor System. See *Tire Pressure Monitor Operation on page 9-62*.

Make certain that all wheel nuts are properly tightened. See "Wheel Nut Torque" under *Capacities and Specifications on page 11-2*.

WARNING

Rust or dirt on a wheel, or on the parts to which it is fastened, can make wheel nuts become loose after time. The wheel could come off and cause an accident. When changing a wheel, remove any rust or dirt from places where the wheel attaches to the vehicle. In an emergency, use a cloth or a paper towel to do this; but be sure to use a scraper or wire brush later, if needed, to get all the rust or dirt off. See *If a Tire Goes Flat on page 9-74*.

When It Is Time for New Tires

Various factors, such as maintenance, temperatures, driving speeds, vehicle loading, and road conditions influence when you need new tires.

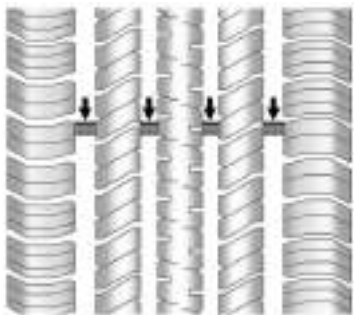

One way to tell when it is time for new tires is to check the treadwear indicators, which appear when the tires have only 1.6 mm (1/16 inch) or less of tread remaining.

The vehicle needs new tires if any of the following statements are true:

- You can see the indicators at three or more places around the tire.
- You can see cord or fabric showing through the tire's rubber.
- The tread or sidewall is cracked, cut, or snagged deep enough to show cord or fabric.
- The tire has a bump, bulge, or split.
- The tire has a puncture, cut, or other damage that cannot be repaired well because of the size or location of the damage.

The rubber in tires degrades over time. This is also true for the spare tire, if the vehicle has one, even if it is not being used. Multiple conditions affect how fast this aging takes place, including temperatures, loading conditions, and inflation pressure maintenance. With proper care and maintenance tires typically

wear out before they degrade due to age. If you are unsure about the need to replace the tires as they get older, consult the tire manufacturer for more information.

Buying New Tires

GM has developed and matched specific tires for your vehicle. The original equipment tires installed on your vehicle, when it was new, were designed to meet General Motors Tire Performance Criteria Specification (TPC Spec) system rating. If you need replacement tires, GM strongly recommends that you get tires with the same TPC Spec rating. This way, your vehicle will continue to have tires that are designed to give the same performance and vehicle safety, during normal use, as the original tires.

GM's exclusive TPC Spec system considers over a dozen critical specifications that impact the overall performance of your vehicle, including brake system performance, ride and handling, traction control, and tire pressure monitoring performance. GM's TPC Spec number is molded onto the tire's sidewall near the tire size. If the tires have an all-season tread design, the TPC Spec number will be followed by an MS for mud and snow. See *Tire Sidewall Labeling on page 9-53* for additional information.

GM recommends replacing tires in sets of four. This is because uniform tread depth on all tires will help keep your vehicle performing most like it did when the tires were new. Replacing less than a full set of tires can affect the braking and handling performance of your vehicle.

See *Tire Inspection on page 9-66* and *Tire Rotation on page 9-66* for information on proper tire rotation.

 **WARNING**

Mixing tires could cause you to lose control while driving. If you mix tires of different sizes, brands, or types (radial and bias-belted tires), the vehicle may not handle properly, and you could have a crash. Using tires of different sizes, brands, or types may also cause damage to your vehicle. Be sure to use the correct size, brand, and type of tires on all wheels. It is all right to drive with your compact spare temporarily, as it was developed for use on your vehicle. See *Compact Spare Tire on page 9-100*.

 **WARNING**

If you use bias-ply tires on the vehicle, the wheel rim flanges could develop cracks after many miles of driving. A tire and/or wheel could fail suddenly, causing a crash. Use only radial-ply tires with the wheels on the vehicle.

If you must replace your vehicle's tires with those that do not have a TPC Spec number, make sure they are the same size, load range, speed rating, and construction type (radial and bias-belted tires) as your vehicle's original tires.

Vehicles that have a tire pressure monitoring system could give an inaccurate low-pressure warning if non-TPC Spec rated tires are installed on your vehicle. Non-TPC Spec rated tires may give a low-pressure warning that is higher or lower than the proper warning level you would get with TPC Spec rated tires. See *Tire Pressure Monitor System on page 9-61*.

Your vehicle's original equipment tires are listed on the Tire and Loading Information Label. See *Vehicle Load Limits on page 8-11*, for more information about the Tire and Loading Information Label and its location on your vehicle.

Different Size Tires and Wheels

If you add wheels or tires that are a different size than your original equipment wheels and tires, this could affect the way your vehicle performs, including its braking, ride and handling characteristics, stability, and resistance to rollover. Additionally, if your vehicle has electronic systems such as antilock brakes, rollover airbags, traction control, and electronic stability control, the performance of these systems can be affected.

WARNING

If you add different sized wheels, your vehicle may not provide an acceptable level of performance and safety if tires not recommended for those wheels are selected. You may increase the chance that you will crash and suffer serious injury. Only use GM specific wheel and tire systems developed for your vehicle, and have them properly installed by a GM certified technician.

See *Buying New Tires on page 9-68* and *Accessories and Modifications on page 9-3* for additional information.

Uniform Tire Quality Grading

Quality grades can be found where applicable on the tire sidewall between tread shoulder and maximum section width. For example:

Treadwear 200 Traction AA Temperature A

The following information relates to the system developed by the United States National Highway Traffic Safety Administration (NHTSA), which grades tires by treadwear, traction, and temperature performance. This applies only to vehicles sold in the United States. The grades are molded on the sidewalls of most passenger car tires. The Uniform Tire Quality Grading

(UTQG) system does not apply to deep tread, winter-type snow tires, space-saver, or temporary use spare tires, tires with nominal rim diameters of 10 to 12 inches (25 to 30 cm), or to some limited-production tires.

While the tires available on General Motors passenger cars and light trucks may vary with respect to these grades, they must also conform to federal safety requirements and additional General Motors Tire Performance Criteria (TPC) standards.

All Passenger Car Tires Must Conform to Federal Safety Requirements In Addition To These Grades.

Treadwear

The treadwear grade is a comparative rating based on the wear rate of the tire when tested under controlled conditions on a specified government test course. For example, a tire graded 150 would wear one and a half (1½) times as well on the government course as a tire graded 100. The relative performance of tires depends upon the actual conditions of their use, however, and may depart significantly from the norm due to variations in driving habits, service practices and differences in road characteristics and climate.

Traction – AA, A, B, C

The traction grades, from highest to lowest, are AA, A, B, and C. Those grades represent the tire's ability to stop on wet pavement as measured under controlled conditions on specified government test surfaces of asphalt and concrete. A tire marked C may have poor traction performance. Warning: The traction grade assigned to this tire is based on straight-ahead braking traction tests, and does not include acceleration, cornering, hydroplaning, or peak traction characteristics.

Temperature – A, B, C

The temperature grades are A (the highest), B, and C, representing the tire's resistance to the generation of heat and its ability to dissipate heat when tested under controlled conditions on a specified indoor laboratory test wheel. Sustained high temperature can cause the material of the tire to degenerate and reduce tire life, and excessive temperature can lead to sudden tire failure. The grade C corresponds to a level of performance which all passenger car tires must meet

under the Federal Motor Safety Standard No. 109. Grades B and A represent higher levels of performance on the laboratory test wheel than the minimum required by law. Warning: The temperature grade for this tire is established for a tire that is properly inflated and not overloaded. Excessive speed, underinflation, or excessive loading, either separately or in combination, can cause heat buildup and possible tire failure.

Wheel Alignment and Tire Balance

The tires and wheels on the vehicle were aligned and balanced carefully at the factory to give the longest tire life and best overall performance. Adjustments to wheel alignment and tire balancing will not be necessary on a regular basis. However, if there is unusual tire wear or the vehicle pulls to one side or the other, the alignment should be checked. If the vehicle vibrates when driving on a smooth road, the tires and wheels might need to be rebalanced. See your dealer for proper diagnosis.

Wheel Replacement

Replace any wheel that is bent, cracked, or badly rusted or corroded. If wheel nuts keep coming loose, the wheel, wheel bolts, and wheel nuts should be replaced. If the wheel leaks air, replace it, except some aluminum wheels, which can sometimes be repaired. See your dealer if any of these conditions exist.

Your dealer will know the kind of wheel you need.

Each new wheel should have the same load-carrying capacity, diameter, width, offset, and be mounted the same way as the one it replaces.

If you need to replace any of the wheels, wheel bolts, wheel nuts, or Tire Pressure Monitor System (TPMS) sensors, replace them only with new GM original equipment parts. This way, you will be sure to have the right wheel, wheel bolts, wheel nuts, and TPMS sensors for the vehicle.

WARNING

Using the wrong replacement wheels, wheel bolts, or wheel nuts on your vehicle can be dangerous. It could affect the braking and handling of your vehicle, make your tires lose air and make you lose control. You could have a collision in which you or others could be injured. Always use the correct wheel, wheel bolts, and wheel nuts for replacement.

Notice: The wrong wheel can also cause problems with bearing life, brake cooling, speedometer or odometer calibration, headlamp aim, bumper height, vehicle ground clearance, and tire or tire chain clearance to the body and chassis.

See *If a Tire Goes Flat* on page 9-74 for more information.

Used Replacement Wheels

 **WARNING**

Putting a used wheel on the vehicle is dangerous. You cannot know how it has been used or how far it has been driven. It could fail suddenly and cause a crash. If you have to replace a wheel, use a new GM original equipment wheel.

Tire Chains

 **WARNING**

Do not use tire chains. There is not enough clearance. Tire chains used on a vehicle without the proper amount of clearance can cause damage to the brakes, suspension or other vehicle parts.

(Continued)

WARNING (Continued)

The area damaged by the tire chains could cause you to lose control of the vehicle and you or others may be injured in a crash.

Use another type of traction device only if its manufacturer recommends it for use on the vehicle and tire size combination and road conditions. Follow that manufacturer's instructions. To help avoid damage to the vehicle, drive slowly, readjust or remove the device if it is contacting the vehicle, and do not spin the vehicle's wheels. If you do find traction devices that will fit, install them on the front tires.

If a Tire Goes Flat

It is unusual for a tire to blowout while you are driving, especially if you maintain your vehicle's tires properly. If air goes out of a tire, it is much more likely to leak out slowly. But if you should ever have a blowout, here are a few tips about what to expect and what to do:

If a front tire fails, the flat tire creates a drag that pulls the vehicle toward that side. Take your foot off the accelerator pedal and grip the steering wheel firmly. Steer to maintain lane position, and then gently brake to a stop well out of the traffic lane.

A rear blowout, particularly on a curve, acts much like a skid and may require the same correction you would use in a skid. In any rear blowout remove your foot from the accelerator pedal. Get the vehicle under control by steering the way you want the vehicle to go.

It may be very bumpy and noisy, but you can still steer. Gently brake to a stop, well off the road if possible.

 **WARNING**

Lifting a vehicle and getting under it to do maintenance or repairs is dangerous without the appropriate safety equipment and training. If a jack is provided with the vehicle, it is designed only for changing a flat tire. If it is used for anything else, you or others could be badly injured or killed if the vehicle slips off the jack. If a jack is provided with the vehicle, only use it for changing a flat tire.

If a tire goes flat, avoid further tire and wheel damage by driving slowly to a level place. Turn on the hazard warning flashers. See *Hazard Warning Flashers* on page 5-5.

 **WARNING**

Changing a tire can be dangerous. The vehicle can slip off the jack and roll over or fall on you or other people. You and they could be badly injured or even killed. Find a level place to change your tire. To help prevent the vehicle from moving:

1. Set the parking brake firmly.
2. Put an automatic transmission shift lever in P (Park), or shift a manual transmission to 1 (First) or R (Reverse).
3. Turn off the engine and do not restart while the vehicle is raised.
4. Do not allow passengers to remain in the vehicle.

(Continued)

WARNING (Continued)

To be certain the vehicle will not move, put blocks at the front and rear of the tire farthest away from the one being changed. That would be the tire on the other side, at the opposite end of the vehicle.

This vehicle may come with a jack and spare tire or a tire sealant and compressor kit. To use the jacking equipment to change a spare tire safely, follow the instructions below. Then see *Tire Changing* on page 9-93. To use the tire sealant and compressor kit, see *Tire Sealant and Compressor Kit (Without Selector Switch)* on page 9-76 or *Tire Sealant and Compressor Kit (With Selector Switch)* on page 9-84.

9-76 Vehicle Care

When the vehicle has a flat tire (B), use the following example as a guide to assist you in the placement of wheel blocks (A).



A. Wheel Block

B. Flat Tire

The following information explains how to repair or change a tire.

Tire Sealant and Compressor Kit (Without Selector Switch)

System Identification

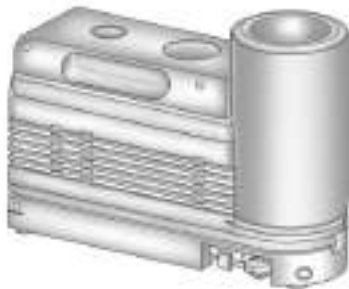

If the vehicle has the tire sealant and compressor kit shown above, see the operating instructions that follow.



If the vehicle has the tire sealant and compressor kit shown above, follow the operating instructions under "Tire Sealant and Compressor Kit (With Selector Switch)."

 **WARNING**

Idling a vehicle in an enclosed area with poor ventilation is dangerous. Engine exhaust may enter the vehicle. Engine exhaust contains Carbon Monoxide (CO) which cannot be seen or smelled. It can cause unconsciousness and even death. Never run the engine in an enclosed area that has no fresh air ventilation. For more information, see *Engine Exhaust* on page 8-24.

 **WARNING**

Over-inflating a tire could cause the tire to rupture and you or others could be injured. Be sure to read and follow the tire sealant and compressor kit instructions and inflate the tire to its recommended pressure. Do not exceed the recommended pressure.

 **WARNING**

Storing the tire sealant and compressor kit or other equipment in the passenger compartment of the vehicle could cause injury. In a sudden stop or collision, loose equipment could strike someone. Store the tire sealant and compressor kit in its original location.

If this vehicle has a tire sealant and compressor kit, there may not be a spare tire, tire changing equipment, and on some vehicles there may not be a place to store a tire.

The tire sealant and compressor can be used to temporarily seal punctures up to ¼ inch (6 mm) in the tread area of the tire. It can also be used to inflate an under inflated tire.

If the tire has been separated from the wheel, has damaged sidewalls, or has a large puncture, the tire is too severely damaged for the tire sealant and compressor kit to be effective. See *Roadside Service* on page 12-6.

Read and follow all of the tire sealant and compressor kit instructions.

The kit includes:

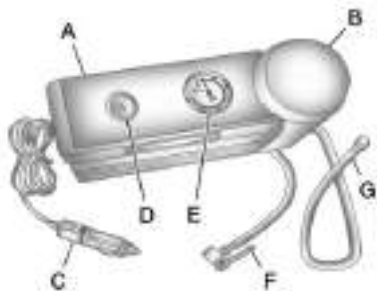

- A. Air Compressor
- B. Tire Sealant Canister
- C. Power Plug
- D. On/Off Button
- E. Pressure Gauge
- F. Air Only Hose (Black)
- G. Sealant/Air Hose (Clear)

Tire Sealant

Read and follow the safe handling instructions on the label adhered to the sealant canister.

Check the tire sealant expiration date on the sealant canister. The sealant canister should be replaced before its expiration date. Replacement sealant canisters are available at your local dealer. See "Removal and Installation of the Sealant Canister" following.

There is only enough sealant to seal one tire. After usage, the sealant canister and sealant/air hose assembly must be replaced. See "Removal and Installation of the Sealant Canister" following.

Using the Tire Sealant and Compressor Kit to Temporarily Seal and Inflate a Punctured Tire

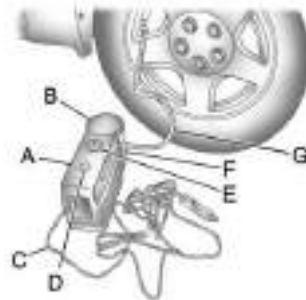

When using the tire sealant and compressor kit during cold temperatures, warm the kit in a heated environment for 5 minutes. This will help to inflate the tire faster.

Always do a safety check first. See *If a Tire Goes Flat on page 9-74*.

1. Remove the tire sealant and compressor kit from its storage location. See *Storing the Tire Sealant and Compressor Kit on page 9-93*.
Make sure the on/off button (D) is in the off (O) position.
2. Unwrap the sealant/air hose (G) and the power plug (C).
3. Place the kit on the ground.
Make sure the tire valve stem is positioned close to the ground so the hose will reach it.
4. Remove the valve stem cap from the flat tire by turning it counterclockwise.

5. Attach the sealant/air hose (G) onto the tire valve stem. Turn it clockwise until it is tight.
6. Plug the power plug (C) into the accessory power outlet in the vehicle. Unplug all items from other accessory power outlets. See *Power Outlets on page 4-11*.
If the vehicle has an accessory power outlet, do not use the cigarette lighter.
If the vehicle only has a cigarette lighter, use the cigarette lighter.
Do not pinch the power plug cord in the door or window.
7. Start the vehicle. The vehicle must be running while using the air compressor.

8. Press the on/off (D) button to turn the tire sealant and compressor kit on.

The compressor will inject sealant and air into the tire.

The pressure gauge (E) will initially show a high pressure while the compressor pushes the sealant into the tire. Once the sealant is completely dispersed into the tire, the pressure will quickly drop and start to rise again as the tire inflates with air only.

9. Inflate the tire to the recommended inflation pressure using the pressure gauge (E). The recommended inflation pressure can be found on the Tire and Loading Information label. See *Tire Pressure on page 9-59*.

The pressure gauge (E) may read higher than the actual tire pressure while the compressor is on. Turn the compressor off to get an accurate pressure reading. The compressor may be turned on/off until the correct pressure is reached.

Notice: If the recommended pressure cannot be reached after approximately 25 minutes, the vehicle should not be driven farther. The tire is too severely damaged and the tire sealant and compressor kit cannot inflate the tire. Remove the power plug from the accessory power outlet and unscrew the inflating hose from the tire valve. See *Roadside Service on page 12-6*.

10. Press the on/off button (D) to turn the tire sealant and compressor kit off.

The tire is not sealed and will continue to leak air until the vehicle is driven and the sealant is distributed in the tire, therefore, Steps 11 through 17 must be done immediately after Step 10.

Be careful while handling the tire sealant and compressor kit as it could be warm after usage.

11. Unplug the power plug (C) from the accessory power outlet in the vehicle.
12. Turn the sealant/air hose (G) counterclockwise to remove it from the tire valve stem.
13. Replace the tire valve stem cap.
14. Replace the sealant/air hose (G), and the power plug (C) back in their original location.



15. If the flat tire was able to inflate to the recommended inflation pressure, remove the maximum speed label from the sealant canister (B) and place it in a highly visible location.

The label is a reminder not to exceed 55 mph (90 km/h) until the damaged tire is repaired or replaced.

16. Return the equipment to its original storage location in the vehicle.
17. Immediately drive the vehicle 5 miles (8 km) to distribute the sealant in the tire.

18. Stop at a safe location and check the tire pressure. Refer to Steps 1 through 11 under “Using the Tire Sealant and Compressor Kit without Sealant to Inflate a Tire (Not Punctured).”

If the tire pressure has fallen more than 10 psi (68 kPa) below the recommended inflation pressure, stop driving the vehicle. The tire is too severely damaged and the tire sealant cannot seal the tire. See *Roadside Service on page 12-6*.

If the tire pressure has not dropped more than 10 psi (68 kPa) from the recommended inflation pressure, inflate the tire to the recommended inflation pressure.

19. Wipe off any sealant from the wheel, tire or vehicle.
20. Dispose of the used sealant canister (B) and sealant/air hose (G) assembly at a local dealer or in accordance with local state codes and practices.
21. Replace it with a new canister available from your dealer.
22. After temporarily sealing a tire using the tire sealant and compressor kit, take the vehicle to an authorized dealer within a 100 miles (161 km) of driving to have the tire repaired or replaced.

Using the Tire Sealant and Compressor Kit without Sealant to Inflate a Tire (Not Punctured)

To use the air compressor to inflate a tire with air only and not sealant:

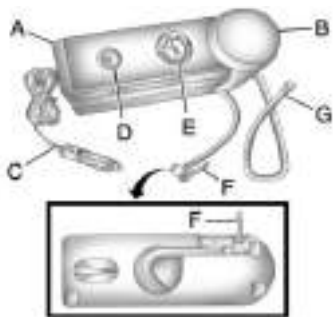

Always do a safety check first. See *If a Tire Goes Flat on page 9-74*.

1. Remove the tire sealant and compressor kit from its storage location. See *Storing the Tire Sealant and Compressor Kit on page 9-93*.

2. Unlock the air only hose (F) from the sealant canister (B) by pulling up on the lever.
3. Pull the air only hose (F) from the sealant canister (B).
4. Remove the power plug (C) from the air compressor (A).
5. Place the kit on the ground.

Make sure the tire valve stem is positioned close to the ground so the hose will reach it.

6. Remove the tire valve stem cap by turning it counterclockwise.
7. Attach the air only hose (F) onto the tire valve stem and press the lever down to secure it.

8. Plug the power plug (C) into the accessory power outlet in the vehicle. Unplug all items from other accessory power outlets. See *Power Outlets on page 4-11*.

If the vehicle has an accessory power outlet, do not use the cigarette lighter.

If the vehicle only has a cigarette lighter, use the cigarette lighter.

Do not pinch the power plug cord in the door or window.

9. Start the vehicle. The vehicle must be running while using the air compressor.
10. Press the on/off (D) button to turn the compressor on.
The compressor will inflate the tire with air only.

11. Inflate the tire to the recommended inflation pressure using the pressure gauge (E). The recommended inflation pressure can be found on the Tire and Loading Information label. See *Tire Pressure on page 9-59*.

The pressure gauge (E) may read higher than the actual tire pressure while the compressor is on. Turn the compressor off to get an accurate reading. The compressor may be turned on/off until the correct pressure is reached.

12. Press the on/off button (D) to turn the tire sealant and compressor kit off.

Be careful while handling the tire sealant and compressor kit as it could be warm after usage.

13. Unplug the power plug (C) from the accessory power outlet in the vehicle.
14. Disconnect the air only hose (F) from the tire valve stem, by turning it counterclockwise, and replace the tire valve stem cap.
15. Replace the air only hose (F) and the power plug (C) back in its original location.
16. Place the equipment in the original storage location in the vehicle.

Removal and Installation of the Sealant Canister

To remove the sealant canister:



1. Unlock the air only hose (F) from the sealant canister (B) by pulling up on the lever.
2. Pull the air only hose (F) from the sealant canister (B).
3. Unwrap the sealant/air hose (G) from the compressor (A).



4. Turn the sealant canister (B) so the inflator filling hose is aligned with the slot in the compressor.
5. Lift the sealant canister (B) from the compressor and replace with a new sealant canister. See your dealer for more information.

To install a new sealant canister:

1. Align the sealant/air hose (G) with the slot in the air compressor.
2. Push the sealant canister (B) down and turn it clockwise.
3. Wrap the sealant/air hose (G) around the air compressor channel to stow it in its original location.
4. Push the air compressor inflator hose (F) onto the sealant canister inlet and push the lever down.

Tire Sealant and Compressor Kit (With Selector Switch)

System Identification



If the vehicle has the tire sealant and compressor kit shown above, see the operating instructions that follow.

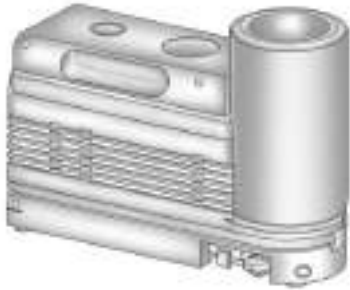

If the vehicle has the tire sealant and compressor kit shown above, follow the operating instructions under "Tire Sealant and Compressor Kit (Without Selector Switch).

⚠ WARNING

Idling a vehicle in an enclosed area with poor ventilation is dangerous. Engine exhaust may enter the vehicle. Engine exhaust contains Carbon Monoxide (CO) which cannot be seen or smelled. It can cause unconsciousness and even death. Never run the engine in an enclosed area that has no fresh air ventilation. For more information, see *Engine Exhaust* on page 8-24.

⚠ WARNING

Over-inflating a tire could cause the tire to rupture and you or others could be injured. Be sure to read and follow the tire sealant and compressor kit instructions and inflate the tire to its recommended pressure. Do not exceed the recommended pressure.

⚠ WARNING

Storing the tire sealant and compressor kit or other equipment in the passenger compartment of the vehicle could cause injury. In a sudden stop or collision, loose equipment could strike someone. Store the tire sealant and compressor kit in its original location.

9-86 Vehicle Care

If this vehicle has a tire sealant and compressor kit, there may not be a spare tire, tire changing equipment, and on some vehicles there may not be a place to store a tire.

The tire sealant and compressor can be used to temporarily seal punctures up to ¼ inch (6 mm) in the tread area of the tire. It can also be used to inflate an under inflated tire.

If the tire has been separated from the wheel, has damaged sidewalls, or has a large puncture, the tire is too severely damaged for the tire sealant and compressor kit to be effective. See *Roadside Service* on page 12-6.

Read and follow all of the tire sealant and compressor kit instructions.

The kit includes:



- A. Selector Switch (Sealant/Air or Air Only)
- B. On/Off Button
- C. Pressure Gauge
- D. Pressure Deflation Button (If equipped)
- E. Tire Sealant Canister
- F. Sealant/Air Hose (Clear)
- G. Air Only Hose (Black)
- H. Power Plug

Tire Sealant

Read and follow the safe handling instructions on the label adhered to the sealant canister.

Check the tire sealant expiration date on the sealant canister. The sealant canister should be replaced before its expiration date. Replacement sealant canisters are available at your local dealer. See "Removal and Installation of the Sealant Canister" following.

There is only enough sealant to seal one tire. After usage, the sealant canister and sealant/air hose assembly must be replaced. See "Removal and Installation of the Sealant Canister" following.

Using the Tire Sealant and Compressor Kit to Temporarily Seal and Inflate a Punctured Tire

Follow the directions closely for correct sealant usage.



When using the tire sealant and compressor kit during cold temperatures, warm the kit in a heated environment for 5 minutes. This will help to inflate the tire faster.

Always do a safety check first. See *If a Tire Goes Flat on page 9-74*. Do not remove any objects that have penetrated the tire.

1. Remove the tire sealant and compressor kit from its storage location. See *Storing the Tire Sealant and Compressor Kit on page 9-93*.
2. Unwrap the sealant/air hose (F) and the power plug (H).
3. Place the kit on the ground.

Make sure the tire valve stem is positioned close to the ground so the hose will reach it.

4. Remove the valve stem cap from the flat tire by turning it counterclockwise.

5. Attach the sealant/air hose (F) onto the tire valve stem. Turn it clockwise until it is tight.
6. Plug the power plug (H) into the accessory power outlet in the vehicle. Unplug all items from other accessory power outlets. See *Power Outlets on page 4-11*.

If the vehicle has an accessory power outlet, do not use the cigarette lighter.

If the vehicle only has a cigarette lighter, use the cigarette lighter.

Do not pinch the power plug cord in the door or window.
7. Start the vehicle. The vehicle must be running while using the air compressor.
8. Turn the selector switch (A) counterclockwise to the Sealant + Air position.
9. Press the on/off (B) button to turn the tire sealant and compressor kit on.

The compressor will inject sealant and air into the tire.

The pressure gauge (C) will initially show a high pressure while the compressor pushes the sealant into the tire. Once the sealant is completely dispersed into the tire, the pressure will quickly drop and start to rise again as the tire inflates with air only.

10. Inflate the tire to the recommended inflation pressure using the pressure gauge (C). The recommended inflation pressure can be found on the Tire and Loading Information label. See *Tire Pressure on page 9-59*.

The pressure gauge (C) may read higher than the actual tire pressure while the compressor is on. Turn the compressor off to get an accurate pressure reading. The compressor may be turned on/off until the correct pressure is reached.

Notice: If the recommended pressure cannot be reached after approximately 25 minutes, the vehicle should not be driven farther. The tire is too severely damaged and the tire sealant and compressor kit cannot inflate the tire. Remove the power plug from the accessory power outlet and unscrew the inflating hose from the tire valve. See *Roadside Service on page 12-6*.

11. Press the on/off button (B) to turn the tire sealant and compressor kit off.

The tire is not sealed and will continue to leak air until the vehicle is driven and the sealant is distributed in the tire, therefore, Steps 12 through 18 must be done immediately after Step 11.

Be careful while handling the tire sealant and compressor kit as it could be warm after usage.

12. Unplug the power plug (H) from the accessory power outlet in the vehicle.
13. Turn the sealant/air hose (F) counterclockwise to remove it from the tire valve stem.
14. Replace the tire valve stem cap.
15. Replace the sealant/air hose (F), and the power plug (H) back in their original location.



16. If the flat tire was able to inflate to the recommended inflation pressure, remove the maximum speed label from the sealant canister (E) and place it in a highly visible location.

- The label is a reminder not to exceed 55 mph (90 km/h) until the damaged tire is repaired or replaced.
17. Return the equipment to its original storage location in the vehicle.
 18. Immediately drive the vehicle 5 miles (8 km) to distribute the sealant in the tire.
 19. Stop at a safe location and check the tire pressure. Refer to Steps 1 through 11 under “Using the Tire Sealant and Compressor Kit without Sealant to Inflate a Tire (Not Punctured).”

If the tire pressure has fallen more than 10 psi (68 kPa) below the recommended inflation pressure, stop driving the vehicle. The tire is too severely damaged and the tire sealant cannot seal the tire. See *Roadside Service on page 12-6*.

- If the tire pressure has not dropped more than 10 psi (68 kPa) from the recommended inflation pressure, inflate the tire to the recommended inflation pressure.
20. Wipe off any sealant from the wheel, tire, and vehicle.
 21. Dispose of the used sealant canister (E) and sealant/air hose (F) assembly at a local dealer or in accordance with local state codes and practices.
 22. Replace it with a new canister available from your dealer.
 23. After temporarily sealing a tire using the tire sealant and compressor kit, take the vehicle to an authorized dealer within a 100 miles (161 km) of driving to have the tire repaired or replaced.

Using the Tire Sealant and Compressor Kit without Sealant to Inflate a Tire (Not Punctured)

To use the air compressor to inflate a tire with air only and not sealant:



Always do a safety check first. See *If a Tire Goes Flat* on page 9-74.

1. Remove the tire sealant and compressor kit from its storage location. See *Storing the Tire Sealant and Compressor Kit* on page 9-93.
2. Unwrap the air only hose (G) and the power plug (H).
3. Place the kit on the ground.
Make sure the tire valve stem is positioned close to the ground so the hose will reach it.
4. Remove the tire valve stem cap from the flat tire by turning it counterclockwise.
5. Attach the air only hose (G) onto the tire valve stem by turning it clockwise until it is tight.

6. Plug the power plug (H) into the accessory power outlet in the vehicle. Unplug all items from other accessory power outlets. See *Power Outlets on page 4-11*.
If the vehicle has an accessory power outlet, do not use the cigarette lighter.
If the vehicle only has a cigarette lighter, use the cigarette lighter.
Do not pinch the power plug cord in the door or window.
7. Start the vehicle. The vehicle must be running while using the air compressor.
8. Turn the selector switch (A) clockwise to the Air Only position.

9. Press the on/off (B) button to turn the compressor on.
The compressor will inflate the tire with air only.
10. Inflate the tire to the recommended inflation pressure using the pressure gauge (C). The recommended inflation pressure can be found on the Tire and Loading Information label. See *Tire Pressure on page 9-59*.
The pressure gauge (C) may read higher than the actual tire pressure while the compressor is on. Turn the compressor off to get an accurate reading. The compressor may be turned on/off until the correct pressure is reached.

- If you inflate the tire higher than the recommended pressure you can adjust the excess pressure by pressing the pressure deflation button (D), if equipped, until the proper pressure reading is reached. This option is only functional when using the air only hose (G).
11. Press the on/off button (B) to turn the tire sealant and compressor kit off.
Be careful while handling the tire sealant and compressor kit as it could be warm after usage.
 12. Unplug the power plug (H) from the accessory power outlet in the vehicle.

9-92 Vehicle Care

13. Disconnect the air only hose (G) from the tire valve stem, by turning it counterclockwise, and replace the tire valve stem cap.
14. Replace the air only hose (G) and the power plug (H) and cord back in its original location.
15. Place the equipment in the original storage location in the vehicle.



The tire sealant and compressor kit has an accessory adapter located in a compartment on the bottom of its housing that may be used to inflate air mattresses, balls, etc.

Removal and Installation of the Sealant Canister

To remove the sealant canister:

1. Unwrap the sealant hose.
2. Press the canister release button.
3. Pull up and remove the canister.
4. Replace with a new canister which is available from your dealer.
5. Push the new canister into place.

Storing the Tire Sealant and Compressor Kit



With Selector Switch



Without Selector Switch

This vehicle may have a tire sealant and compressor kit in place of a jack or spare tire. It is located in a foam container in the rear compartment storage area. See *Cargo Management System* on page 3-5.

Tire Changing

Removing the Spare Tire and Tools

To access the spare tire and tools:

1. Open the liftgate. See *Liftgate (Manual)* on page 1-13 or *Liftgate (Power)* on page 1-14.



2. Press on the bottom of the handle assembly to unlatch it and lift up on the handle.

The prop rod locks into place when open.



3. Remove the spare tire cover.



4. Remove the nut retaining the spare tire.
5. Remove the spare tire and place it next to the tire being changed.

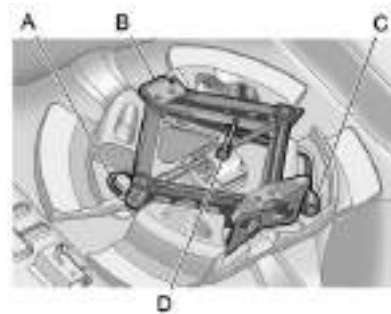

6. Remove the wing nut (D).
7. Remove the extension (A), jack (B) and wheel wrench (C) and place them near the tire being changed.

Removing the Flat Tire and Installing the Spare Tire

Take off the wheel cover or center cap, if the vehicle has one, to reach the wheel bolts.

1. Do a safety check before proceeding. See *If a Tire Goes Flat* on page 9-74 for more information.
2. Turn the wheel wrench counterclockwise to loosen and remove the wheel nut caps.
Do not try to remove plastic caps from the cover or center cap.
3. Pull the cover or center cap away from the wheel. Store the wheel cover in the cargo area until you have the flat tire repaired or replaced.



4. Turn the wheel wrench counterclockwise to loosen all the wheel nuts, but do not remove them yet.
5. Place the jack near the flat tire.

Notice: Make sure that the jack lift head is in the correct position or you may damage your vehicle. The repairs would not be covered by your warranty.

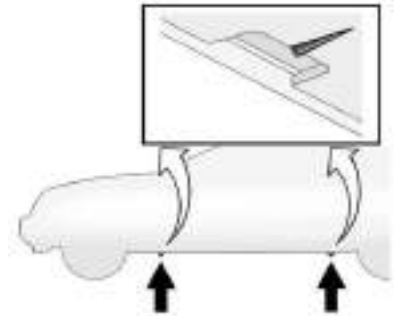

6. Position the jack lift head at the jack location nearest the flat tire. The jacking location is indicated by a V-shaped notch in the plastic molding. The jack must not be used in any other position.



7. Insert the hooked end of the extension handle through the jack and the flat end through the wheel wrench.

⚠ WARNING

Getting under a vehicle when it is jacked up is dangerous. If the vehicle slips off the jack, you could be badly injured or killed. Never get under a vehicle when it is supported only by a jack.

⚠ WARNING

Raising your vehicle with the jack improperly positioned can damage the vehicle and even make the vehicle fall. To help avoid personal injury and vehicle damage, be sure to fit the jack lift head into the proper location before raising the vehicle.

⚠ WARNING

Lifting a vehicle and getting under it to do maintenance or repairs is dangerous without the appropriate safety equipment and training. If a jack is provided with the vehicle, it is designed only for changing a flat tire. If it is used for anything else, you or others could be badly injured or killed if the vehicle slips off the jack. If a jack is provided with the vehicle, only use it for changing a flat tire.

8. Turn the extension with the wheel wrench clockwise to raise the jack lift head until the jack just fits under the vehicle.

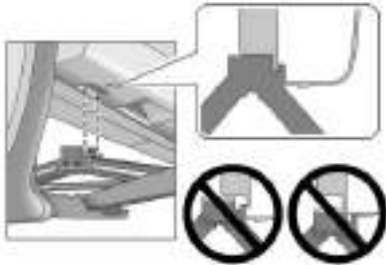

9. Raise the vehicle by turning the wheel wrench clockwise until the slots in the jack head fit into the metal flange located behind the triangle on the plastic moulding.

Notice: Using a jack to raise the vehicle without positioning it correctly could damage your vehicle. When raising your vehicle on a jack, be sure to position it correctly under the frame and avoid contact with the plastic molding.

10. Put the compact spare tire near you.

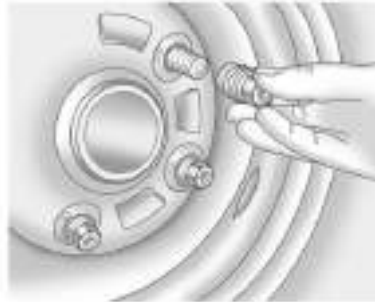

Remove all of the wheel nuts.

11. Remove the flat tire.

⚠ WARNING

Rust or dirt on a wheel, or on the parts to which it is fastened, can make wheel nuts become loose after time. The wheel could come off and cause an accident. When changing a wheel, remove any

(Continued)

WARNING (Continued)

rust or dirt from places where the wheel attaches to the vehicle. In an emergency, use a cloth or a paper towel to do this; but be sure to use a scraper or wire brush later, if needed, to get all the rust or dirt off. See *If a Tire Goes Flat* on page 9-74.



12. Remove any rust or dirt from the wheel bolts, mounting surfaces, and spare wheel.

9-98 Vehicle Care

- Place the compact spare tire on the wheel-mounting surface.

WARNING

Never use oil or grease on bolts or nuts because the nuts might come loose. The vehicle's wheel could fall off, causing a crash.

- Reinstall the wheel nuts. Tighten each nut by hand until the wheel is held against the hub.
- Lower the vehicle by turning the jack handle counterclockwise.

WARNING

Wheel nuts that are improperly or incorrectly tightened can cause the wheels to become loose or come off. The wheel nuts should be tightened with a torque wrench to the proper torque specification after replacing. Follow the torque specification supplied by the aftermarket manufacturer when using accessory locking wheel nuts. See *Capacities and Specifications* on page 11-2 for original equipment wheel nut torque specifications.

Notice: Improperly tightened wheel nuts can lead to brake pulsation and rotor damage. To avoid expensive brake repairs, evenly tighten the wheel nuts in the proper sequence and to the proper torque specification. See *Capacities and Specifications* on page 11-2 for the wheel nut torque specification.



- Tighten the wheel nuts firmly in a crisscross sequence, as shown.
- Lower the jack all the way and remove the jack from under the vehicle.
- Tighten the wheel nuts firmly with the wheel wrench.

When reinstalling the wheel cover or center cap on the full-size tire, tighten all five plastic caps hand snug with the aid of the wheel wrench and tighten them with the wheel wrench an additional one-quarter of a turn.

Notice: Wheel covers will not fit on your vehicle's compact spare. If you try to put a wheel cover on the compact spare, the cover or the spare could be damaged.

Storing a Flat or Spare Tire and Tools

⚠ WARNING

Storing a jack, a tire, or other equipment in the passenger compartment of the vehicle could cause injury. In a sudden stop or collision, loose equipment could strike someone. Store all these in the proper place.

To store the flat or spare tire and tools:

1. Open the liftgate. See *Liftgate (Manual)* on page 1-13 or *Liftgate (Power)* on page 1-14 for more information.
2. Put back all tools as they were stored in the rear storage compartment and put the compartment cover back on. For more information, see “Storing the Compact Spare Tire and Tools” next in this section.
3. Install the cargo cover. For more information, see *Cargo Management System* on page 3-5.
4. Place the tire, lying flat, in the rear storage compartment.



5. Attach the strap to the cargo tie-down in the rear of the vehicle.



6. Route the strap through the wheel, as shown.
7. Attach the strap to the other cargo tie-down in the rear of the vehicle.
8. Tighten the strap.

The compact spare is for temporary use only. Replace the compact spare tire with a full-size tire as soon as you can.

Compact Spare Tire

WARNING

Driving with more than one compact spare tire at a time could result in loss of braking and handling. This could lead to a crash and you or others could be injured. Use only one compact spare tire at a time.

If this vehicle has a compact spare tire, it was fully inflated when the vehicle was new; however, it can lose air after a time. Check the inflation pressure regularly. It should be 420 kPa (60 psi).

After installing the compact spare on the vehicle, stop as soon as possible and make sure the spare tire is correctly inflated. The compact spare is made to perform well at speeds up to 105 km/h (65 mph) for distances up to 5 000 km (3,000 miles), so you can finish your trip and have the full-size

tire repaired or replaced at your convenience. Of course, it is best to replace the spare with a full-size tire as soon as possible. The spare tire will last longer and be in good shape in case it is needed again.

Notice: When the compact spare is installed, do not take the vehicle through an automatic car wash with guide rails. The compact spare can get caught on the rails which can damage the tire, wheel and other parts of the vehicle.

Do not use the compact spare on other vehicles.

Do not mix the compact spare tire or wheel with other wheels or tires. They will not fit. Keep the spare tire and its wheel together.

Notice: Tire chains will not fit the compact spare. Using them can damage the vehicle and can damage the chains too. Do not use tire chains on the compact spare.

Jump Starting

For more information about the vehicle battery, see *Battery* on page 9-27.

If the vehicle battery has run down, you may want to use another vehicle and some jumper cables to start your vehicle. Be sure to use the following steps to do it safely.



WARNING

Batteries can hurt you. They can be dangerous because:

- They contain acid that can burn you.
- They contain gas that can explode or ignite.
- They contain enough electricity to burn you.

If you do not follow these steps exactly, some or all of these things can hurt you.

Notice: Ignoring these steps could result in costly damage to the vehicle that would not be covered by the warranty.

Trying to start the vehicle by pushing or pulling it will not work, and it could damage the vehicle.

1. Check the other vehicle. It must have a 12-volt battery with a negative ground system.

Notice: If the other vehicle's system is not a 12-volt system with a negative ground, both vehicles can be damaged. Only use vehicles with 12-volt systems with negative grounds to jump start your vehicle.

2. Get the vehicles close enough so the jumper cables can reach, but be sure the vehicles are not touching each other. If they are, it could cause a ground connection you do not want. You would not be able to start your vehicle, and the bad grounding could damage the electrical systems.

To avoid the possibility of the vehicles rolling, set the parking brake firmly on both vehicles involved in the jump start procedure. Put the transmission in P (Park) before setting the parking brake.

Notice: If you leave the radio or other accessories on during the jump starting procedure, they could be damaged. The repairs would not be covered by the warranty. Always turn off the radio and other accessories when jump starting the vehicle.

3. Turn off the ignition on both vehicles. Unplug unnecessary accessories plugged into the cigarette lighter or the accessory power outlet. Turn off the radio and all lamps that are not needed. This will avoid sparks, helping save both batteries and the radio.
4. Open the hood on the other vehicle and locate the positive (+) and negative (-) terminal locations on that vehicle.

Open the hood on your vehicle and find the remote positive (+) and remote negative (-) jump starting terminals.

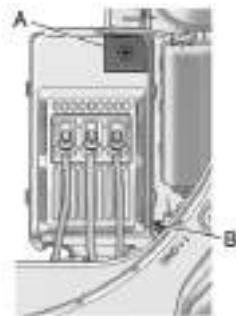

Your vehicle is equipped with a remote positive (+) terminal (A) and a remote negative (-) terminal (B). The remote positive (+) terminal is located in the engine compartment on the driver side of the vehicle, above the rear of the battery. The remote negative (-) terminal is a stud located in the engine compartment on the driver side of the vehicle, on the front tie bar. See *Engine Compartment Overview* on page 9-6 for more information on location.

To uncover the remote positive (+) terminal, lift open the access panel on the battery cover indicated by the (+) sign.

WARNING

An electric fan can start up even when the engine is not running and can injure you. Keep hands, clothing and tools away from any underhood electric fan.

 **WARNING**

Using an open flame near a battery can cause battery gas to explode. People have been hurt doing this, and some have been blinded. Use a flashlight if you need more light.

Be sure the battery has enough water. You do not need to add water to the battery installed in your new vehicle. But if a battery has filler caps, be sure the right amount of fluid is there. If it is low, add water to take care of that first. If you do not, explosive gas could be present.

Battery fluid contains acid that can burn you. Do not get it on you. If you accidentally get it in your eyes or on your skin, flush the place with water and get medical help immediately.

 **WARNING**

Fans or other moving engine parts can injure you badly. Keep your hands away from moving parts once the engine is running.

5. Check that the jumper cables do not have loose or missing insulation. If they do, you could get a shock. The vehicles could also be damaged.

Before you connect the cables, here are some basic things you should know. Positive (+) will go to positive (+) or to a remote positive (+) terminal if the vehicle has one. Negative (-) will go to a heavy, unpainted metal engine part or to a remote negative (-) terminal if the vehicle has one.

- Do not connect positive (+) to negative (-) or you will get a short that would damage the battery and maybe other parts. Do not connect the negative (-) cable to the negative (-) terminal on the dead battery because this can cause sparks.
6. Connect the red positive (+) cable to the positive (+) terminal on the vehicle with the dead battery. Use a remote positive (+) terminal if the vehicle has one.
 7. Do not let the other end touch metal. Connect it to the positive (+) terminal of the good battery. Use a remote positive (+) terminal if the vehicle has one.

9-104 Vehicle Care

8. Now connect the black negative (-) cable to the negative (-) terminal of the good battery. Use a remote negative (-) terminal if the vehicle has one.

Do not let the other end touch anything until the next step. The other end of the negative (-) cable does not go to the dead battery. It goes to a heavy, unpainted metal engine part or to a remote negative (-) terminal on the vehicle with the dead battery.

9. Connect the other end of the negative (-) cable away from the dead battery, but not near engine parts that move. The electrical connection is just as good there, and the chance of sparks getting back to the battery is much less.

Your vehicle has a remote (-) terminal for this purpose.

10. Now start the vehicle with the good battery and run the engine for a while.
11. Try to start the vehicle that had the dead battery. If it will not start after a few tries, it probably needs service.

Notice: If the jumper cables are connected or removed in the wrong order, electrical shorting may occur and damage the vehicle. The repairs would not be covered by the vehicle warranty. Always connect and remove the jumper cables in the correct order, making sure that the cables do not touch each other or other metal.

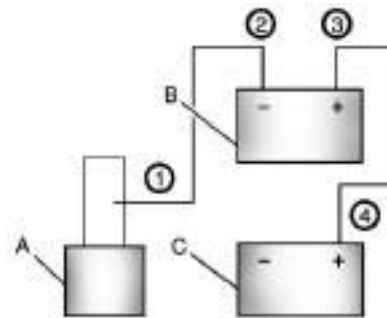

Jumper Cable Removal

- A. Heavy, Unpainted Metal Engine Part or Remote Negative (-) Terminal
- B. Good Battery or Remote Positive (+) and Remote Negative (-) Terminals
- C. Dead Battery or Remote Positive (+) Terminal

To disconnect the jumper cables from both vehicles, do the following:

1. Disconnect the black negative (-) cable from the vehicle that had the dead battery.
2. Disconnect the black negative (-) cable from the vehicle with the good battery.
3. Disconnect the red positive (+) cable from the vehicle with the good battery.
4. Disconnect the red positive (+) cable from the other vehicle.
5. Close the access panel on the battery cover, if applicable.

Towing

Towing the Vehicle

To avoid damage, the disabled vehicle should be towed with all four wheels off the ground. Consult your dealer or a professional towing service if the disabled vehicle must be towed.

To tow the vehicle behind another vehicle for recreational purposes — such as behind a motorhome, see Recreational Vehicle Towing following.

Recreational Vehicle Towing

Recreational vehicle towing means towing the vehicle behind another vehicle — such as behind a motor home. The two most common types of recreational vehicle towing are known as dinghy towing and dolly towing. Dinghy towing is towing the vehicle with all four wheels on the ground. Dolly towing is towing the vehicle with two wheels on the ground and two wheels up on a device known as a dolly.

Here are some important things to consider before recreational vehicle towing:

- What is the towing capacity of the towing vehicle? Be sure to read the tow vehicle manufacturer's recommendations.
- What is the distance that will be travelled? Some vehicles have restrictions on how far and how long they can tow.
- Is the proper towing equipment going to be used? See your dealer or trailering professional for additional advice and equipment recommendations.
- Is the vehicle ready to be towed? Just as preparing the vehicle for a long trip, make sure the vehicle is prepared to be towed.

Dinghy Towing

Front-wheel-drive and all-wheel-drive vehicles may be dinghy towed from the front. These vehicles can also be towed by placing them on a platform trailer with all four wheels off of the ground. For other towing options, see "Dolly Towing" following in this section.

Vehicles with an 2.8 L V 6 engine can be dinghy towed only for service and are restricted to a maximum distance of 100 km (60 miles) and not to exceed 80 km/h (50 mph).

Vehicles with the 3.0 L V 6 engine can be dinghy towed without distance restrictions.

Notice: If 105 km/h (65 mph) is exceeded while towing the vehicle, it could be damaged. Never exceed 105 km/h (65 mph) while towing the vehicle.

For vehicles being dinghy towed, the vehicle should be run at the beginning of each day and at each RV fuel stop for about five minutes. This will ensure proper lubrication of transmission components.



To tow the vehicle from the front with all four wheels on the ground:

1. Position the vehicle that will be towed and secure it to the towing vehicle.
2. Open the drivers door.

3. With the vehicle OFF, press the brake pedal and press the START/STOP switch to start the engine (the green LED on the switch will illuminate).
4. Put the vehicle in N (Neutral).
5. Press the START/STOP switch again. The engine will stop, the DIC will display Shift to Park and the amber LED on the switch illuminates. See *Transmission Messages on page 4-40*.
6. Remove the following fuses: BCM 1, BCM 2 and BCM 3. The START/STOP switch LED's will be off. See *Instrument Panel Fuse Block on page 9-48*.
7. Close the drivers door.

Notice: If the vehicle is towed without performing each of the steps listed under “Dinghy Towing,” the automatic transmission could be damaged. Be sure to follow all steps of the dinghy towing procedure prior to and after towing the vehicle.

Once the destination has been reached:

1. Shift the vehicle to P (Park).
2. Reinstall the BCM fuses. See *Instrument Panel Fuse Block on page 9-48*.
3. Disconnect the vehicle from the tow vehicle.

Notice: Too much or too little fluid can damage the transmission. Be sure that the transmission fluid is at the proper level before towing with all four wheels on the ground.

Notice: Do not tow a vehicle with the front drive wheels on the ground if one of the front tires is a compact spare tire. Towing with two different tire sizes on the front of the vehicle can cause severe damage to the transmission.

Dolly Towing (All-Wheel-Drive Vehicles)

All-wheel-drive vehicles should not be towed with two wheels on the ground. To properly tow these vehicles, they should be placed on a platform trailer with all four wheels off of the ground or dinghy towed from the front. See Dinghy Towing earlier in this section.

**Dolly Towing
(Front-Wheel-Drive Vehicles)**



To tow the vehicle from the front with the rear wheels on the ground, do the following:

1. Put the front wheels on a dolly.
2. Move the shift lever to P (Park).
See [Shifting Into Park](#) on page 8-22.

3. Set the parking brake.
4. Secure the vehicle to the dolly.
5. Follow the dolly manufacturer's instructions for preparing the vehicle and dolly for towing.
6. Release the parking brake.

Towing the Vehicle From the Rear



Notice: Towing the vehicle from the rear could damage it. Also, repairs would not be covered by the vehicle warranty. Never have the vehicle towed from the rear.

Appearance Care

Exterior Care

Cleaning Exterior Lamps/Lenses

Use only lukewarm or cold water, a soft cloth, and a car washing soap to clean exterior lamps and lenses. Follow instructions under "Washing the Vehicle" later in this section.

Finish Care

Occasional waxing or mild polishing of the vehicle by hand may be necessary to remove residue from the paint finish. Approved cleaning products can be obtained from your dealer.

If the vehicle has a basecoat/clearcoat paint finish, the clearcoat gives more depth and gloss to the colored basecoat. Always use waxes and polishes that are non-abrasive and made for a basecoat/clearcoat paint finish.

Notice: Machine compounding or aggressive polishing on a basecoat/clearcoat paint finish may damage it. Use only non-abrasive waxes and polishes that are made for a basecoat/clearcoat paint finish on the vehicle.

Foreign materials such as calcium chloride and other salts, ice melting agents, road oil and tar, tree sap, bird droppings, chemicals from industrial chimneys, etc., can damage the vehicle's finish if they remain on painted surfaces. Wash the vehicle as soon as possible. If necessary, use non-abrasive cleaners that are marked safe for painted surfaces to remove foreign matter.

Exterior painted surfaces are subject to aging, weather, and chemical fallout that can take their toll over a period of years. To keep the paint finish looking new, keep the vehicle garaged or covered whenever possible.

Protecting Exterior Bright Metal Parts

Bright metal parts should be cleaned regularly to keep their luster. Wash with water or use chrome polish on chrome or stainless steel trim, if necessary.

Use special care with aluminum trim. To avoid damaging protective trim, never use auto or chrome polish, steam, or caustic soap to clean aluminum. A coating of wax, rubbed to high polish, is recommended for all bright metal parts.

Washing the Vehicle

To preserve the vehicle's finish, keep it clean by washing it often.

Do not wash the vehicle in direct sunlight and use a car washing soap.

Notice: Certain cleaners contain chemicals that can damage the emblems or nameplates on the vehicle. Check the cleaning product label. If it states that it should not be used on plastic parts, do not use it on the vehicle or damage may occur and it would not be covered by the warranty.

Do not use cleaning agents that are petroleum based or that contain acid or abrasives, as they can damage the paint, metal, or plastic on the vehicle. Approved cleaning products can be obtained from your dealer. Follow all manufacturer directions regarding correct product usage, necessary safety precautions, and appropriate disposal of any vehicle care product.

Rinse the vehicle well, before washing and after, to remove all cleaning agents completely. If they are allowed to dry on the surface, they could stain.

Dry the finish with a soft, clean chamois or an all-cotton towel to avoid surface scratches and water spotting.

High pressure car washes could cause water to enter the vehicle. Avoid using high pressure washes closer than 30 cm (12 in) to the surface of the vehicle. Use of power washers exceeding 8,274 kPa (1,200 psi) can result in damage or removal of paint and decals.

Notice: Conveyor systems on some automatic car washes could damage the vehicle. There may not be enough clearance for the undercarriage. Check with the car wash manager before using the automatic car wash.

Weatherstrips

Silicone grease on weatherstrips will make them last longer, seal better, and not stick or squeak. Apply silicone grease with a clean cloth. During very cold, damp weather frequent application may be required. See *Recommended Fluids and Lubricants* on page 10-6.

Wheels and Trim — Aluminum or Chrome

The vehicle may have either aluminum or chrome-plated wheels.

Keep the wheels clean using a soft, clean cloth with mild soap and water. Rinse with clean water. After rinsing thoroughly, dry with a soft, clean towel. A wax may then be applied.

Notice: Chrome wheels and other chrome trim may be damaged if the vehicle is not washed after driving on roads that have been sprayed with magnesium, calcium or sodium chloride. These chlorides are used on roads for conditions such as ice and dust. Always wash the vehicle's chrome with soap and water after exposure.

Notice: Using strong soaps, chemicals, abrasive polishes, cleaners, brushes, or cleaners that contain acid on aluminum or chrome-plated wheels, could damage the surface of the wheel(s). The repairs would not be covered by the vehicle warranty. Use only approved cleaners on aluminum or chrome-plated wheels.

The surface of these wheels is similar to the painted surface of the vehicle. Do not use strong soaps, chemicals, abrasive polishes, abrasive cleaners, cleaners with acid, or abrasive cleaning brushes on them because the surface could be damaged. Do not use chrome polish on aluminum wheels.

Notice: Using chrome polish on aluminum wheels could damage the wheels. The repairs would not be covered by the vehicle warranty. Use chrome polish on chrome wheels only.

Use chrome polish only on chrome-plated wheels, but avoid any painted surface of the wheel, and buff off immediately after application.

Notice: Driving the vehicle through an automatic car wash that has silicone carbide tire cleaning brushes, could damage the aluminum or chrome-plated wheels. The repairs would not be covered by the vehicle warranty. Never drive a vehicle that has aluminum or chrome-plated wheels through an automatic car wash that uses silicone carbide tire cleaning brushes.

Windshield and Wiper Blades

Clean the outside of the windshield with glass cleaner.

Clean the rubber blades using a lint-free cloth or paper towel soaked with windshield washer fluid or a mild detergent. Wash the windshield thoroughly when cleaning the blades. Bugs, road grime, sap, and a buildup of vehicle wash/wax treatments may cause wiper streaking. Replace the wiper blades if they are worn or damaged.

Wipers can be damaged by:

- Extreme dusty conditions
- Sand and salt
- Heat and sun
- Snow and ice, without proper removal

Tires

Use a stiff brush with tire cleaner to clean the tires.

Notice: Using petroleum-based tire dressing products on the vehicle may damage the paint finish and/or tires. When applying a tire dressing, always wipe off any overspray from all painted surfaces on the vehicle.

Sheet Metal Damage

If the vehicle is damaged and requires sheet metal repair or replacement, make sure the body repair shop applies anti-corrosion material to parts repaired or replaced to restore corrosion protection.

Original manufacturer replacement parts will provide the corrosion protection while maintaining the vehicle warranty.

Finish Damage

Any stone chips, fractures, or deep scratches in the finish should be repaired right away. Bare metal will corrode quickly and may develop into major repair expense.

Minor chips and scratches can be repaired with touch-up materials available from your dealer. Larger areas of finish damage can be corrected in your dealer's body and paint shop.

Underbody Maintenance

Chemicals used for ice and snow removal and dust control can collect on the underbody. If these are not removed, corrosion and rust can develop on the underbody parts such as fuel lines, frame, floor pan, and exhaust system even though they have corrosion protection.

At least every spring, flush these materials from the underbody with plain water. Clean any areas where mud and debris can collect. Dirt packed in close areas of the frame should be loosened before being flushed. Your dealer or an underbody car washing system can do this.

Chemical Paint Spotting

Some weather and atmospheric conditions can create a chemical fallout. Airborne pollutants can fall upon and attack painted surfaces on the vehicle. This damage can take two forms: blotchy, ring-shaped discolorations, and small, irregular dark spots etched into the paint surface.

Interior Care

The vehicle's interior will continue to look its best if it is cleaned often. Dust and dirt can accumulate on the upholstery and cause damage to the carpet, fabric, leather, and plastic surfaces. Stains should be removed quickly as extreme heat could cause them to set rapidly.

Lighter colored interiors may require more frequent cleaning.

Newspapers and garments that can transfer color to home furnishings can also transfer color to the vehicle's interior.

Remove dust from small buttons and knobs with a small brush with soft bristles.

Your dealer has products for cleaning the vehicle's interior. When cleaning the vehicle's interior, only use cleaners specifically designed for the surfaces that are being cleaned. Permanent damage can

result from using cleaners on surfaces for which they were not intended. Apply the cleaner directly to the cleaning cloth to prevent over-spray. Remove any accidental over-spray from other surfaces immediately.

Notice: Using abrasive cleaners when cleaning glass surfaces on the vehicle, could scratch the glass and/or cause damage to the rear window defogger. When cleaning the glass on the vehicle, use only a soft cloth and glass cleaner.

Cleaners can contain solvents that can become concentrated in the vehicle's interior. Before using cleaners, read and adhere to all safety instructions on the label. While cleaning the vehicle's interior, maintain adequate ventilation by opening the vehicle's doors and windows.

Do not clean the interior using the following cleaners or techniques:

- Never use a knife or any other sharp object to remove a soil from any interior surface.
- Never use a stiff brush. It can cause damage to the vehicle's interior surfaces.
- Never apply heavy pressure or rub aggressively with a cleaning cloth. Use of heavy pressure can damage the interior and does not improve the effectiveness of soil removal.

- Use only mild, neutral-pH soaps. Avoid laundry detergents or dishwashing soaps with degreasers. Using too much soap will leave a residue that leaves streaks and attracts dirt. For liquid cleaners, about 20 drops per 3.78 L (1 gal) of water is a good guide.
- Do not heavily saturate the upholstery while cleaning.
- Damage to the vehicle's interior may result from the use of many organic solvents such as naphtha, alcohol, etc.

Fabric/Carpet

Use a vacuum cleaner with a soft brush attachment to remove dust and loose dirt. A canister vacuum with a beater bar in the nozzle may only be used on floor carpet and carpeted floor mats. For soils, always try to remove them first with plain water or club soda. Before cleaning, gently remove as much of the soil as possible using one of the following techniques:

- For liquids: gently blot the remaining soil with a paper towel. Allow the soil to absorb into the paper towel until no more can be removed.
- For solid dry soils: remove as much as possible and then vacuum.

To clean:

1. Saturate a lint-free, clean white cloth with water or club soda.
2. Remove excess moisture.
3. Start on the outside edge of the soil and gently rub toward the center. Continue cleaning, using a clean area of the cloth each time it becomes soiled.
4. Continue to gently rub the soiled area.
5. If the soil is not completely removed, use a mild soap solution and repeat the cleaning process with plain water.

If any of the soil remains, a commercial fabric cleaner or spot lifter may be necessary. Test a small hidden area for colorfastness before using a commercial upholstery cleaner or spot lifter. If the locally cleaned area gives any impression that a ring formation may result, clean the entire surface.

A paper towel can be used to blot excess moisture from the fabric or carpet after the cleaning process.

Leather

To remove dust, a soft cloth dampened with water can be used. If a more thorough cleaning is necessary, a soft cloth dampened with a mild soap solution can be used. Allow the leather to dry naturally. Do not use heat, steam, spot lifters or spot removers, or shoe polish on leather. Many commercial leather cleaners and coatings that are sold to preserve and protect leather may permanently change the appearance and feel of the leather and are not recommended. Do not use silicone or wax-based products, or those containing organic solvents to clean the vehicle's interior because they can alter the appearance by increasing the gloss in a non-uniform manner.

Instrument Panel, Vinyl, and Other Plastic Surfaces

To remove dust, a soft cloth dampened with water can be used. If a more thorough cleaning is necessary, a clean soft cloth dampened with a mild soap solution can be used to gently remove dust and dirt. Never use spot lifters or removers on plastic surfaces. Many commercial cleaners and coatings that are sold to preserve and protect soft plastic surfaces may permanently change the

appearance and feel of the interior and are not recommended. Do not use silicone or wax-based products, or those containing organic solvents to clean the vehicle's interior because they can alter the appearance by increasing the gloss in a non-uniform manner.

Some commercial products may increase gloss on the instrument panel. The increase in gloss may cause annoying reflections in the windshield and even make it difficult to see through the windshield under certain conditions.

Care of Safety Belts

Keep belts clean and dry.



Do not bleach or dye safety belts. It may severely weaken them. In a crash, they might not be able to provide adequate protection. Clean safety belts only with mild soap and lukewarm water.

Service and Maintenance

General Information

General Information 10-1

Scheduled Maintenance

Scheduled Maintenance 10-2

Recommended Fluids, Lubricants, and Parts

Recommended Fluids and Lubricants 10-6

Maintenance Replacement Parts 10-8

Maintenance Records

Maintenance Records 10-9

General Information

Notice: Maintenance intervals, checks, inspections, recommended fluids, and lubricants are necessary to keep this vehicle in good working condition. Damage caused by failure to follow scheduled maintenance might not be covered by the vehicle warranty.

As the vehicle owner, you are responsible for the scheduled maintenance in this section. We recommend having your dealer perform these services. Proper vehicle maintenance helps to keep the vehicle in good working condition, improves fuel economy, and reduces vehicle emissions for better air quality.

Because of all the different ways people use vehicles, maintenance needs vary. The vehicle might need more frequent checks and services.

Please read the information under Scheduled Maintenance. To keep the vehicle in good condition, see your dealer.

The maintenance schedule is for vehicles that:

- Carry passengers and cargo within recommended limits on the Tire and Loading Information label. See *Vehicle Load Limits* on page 8-11.
- Are driven on reasonable road surfaces within legal driving limits.
- Use the recommended fuel. See *Recommended Fuel* on page 8-47.

WARNING

Performing maintenance work can be dangerous. Some jobs can cause serious injury. Perform maintenance work only if you have the required know-how and the proper tools and equipment. If in doubt, see your dealer to have a qualified technician do the work. See *Doing Your Own Service Work* on page 9-4.

At your dealer, you can be certain that you will receive the highest level of service available. Your dealer has specially trained service technicians, uses genuine replacement parts, as well as, up to date tools and equipment to ensure fast and accurate diagnostics.

The proper replacement parts, fluids, and lubricants to use are listed in *Recommended Fluids and Lubricants* on page 10-6 and *Maintenance Replacement Parts* on page 10-8. We recommend the use of genuine parts from your dealer.

Rotation of New Tires

To maintain ride, handling, and performance of the vehicle, it is important that the first rotation service for new tires be performed when they have 8 000 to 13 000 km (5,000 to 8,000 miles). See *Tire Rotation* on page 9-66.

Scheduled Maintenance

When the Change Engine Oil Soon Message Displays

Change engine oil and filter. See *Engine Oil* on page 9-10. An *Emission Control Service*.

When the “Change Engine Oil Soon” message displays, service is required for the vehicle as soon as possible, within the next 1 000 km/600 miles. If driving under the best conditions, the engine oil life system might not indicate the need for vehicle service for more than a year. The engine oil and filter must be changed at least once a year and the oil life system must be reset. Your dealer has trained service technicians who will perform this work and reset the system.

If the engine oil life system is reset accidentally, service the vehicle within 5 000 km/3,000 miles since the last service. Reset the oil life system whenever the oil is changed. See *Engine Oil Life System* on page 9-12.

Every Engine Oil Change

- Change engine oil and filter. See *Engine Oil* on page 9-10. *An Emission Control Service*.
- Engine coolant level check. See *Engine Coolant* on page 9-17.
- Engine cooling system inspection. Visual inspection of hoses, pipes, fittings, and clamps and replacement, if needed.
- Windshield washer fluid level check. See *Washer Fluid* on page 9-23.
- Windshield wiper blade inspection for wear, cracking, or contamination and windshield and wiper blade cleaning, if contaminated. See *Exterior Care* on page 9-109. Worn or damaged wiper blade replacement. See *Wiper Blade Replacement* on page 9-29.
- Tire inflation check. See *Tire Pressure* on page 9-59.
- Tire wear inspection. See *Tire Inspection* on page 9-66.
- Rotate tires. See *Tire Rotation* on page 9-66.
- Fluids visual leak check (or every 12 months, whichever occurs first). A leak in any system must be repaired and the fluid level checked.
- Engine air cleaner filter inspection. See *Engine Air Cleaner/Filter* on page 9-14.
- Brake system inspection (or every 12 months, whichever occurs first).
- Steering and suspension inspection. Visual inspection for damaged, loose, or missing parts or signs of wear.
- Body hinges and latches, key lock cylinders, folding seat hardware, and sunroof (if equipped) lubrication. See *Recommended Fluids and Lubricants* on page 10-6. More frequent lubrication may be required when vehicle is exposed to a corrosive environment. Applying silicone grease on weatherstrips with a clean cloth makes them last longer, seal better, and not stick or squeak.
- Restraint system component check. See *Safety System Check* on page 2-26.
- Automatic transmission fluid level check and adding fluid, if needed. See *Automatic Transmission Fluid* on page 9-13.

10-4 Service and Maintenance

Additional Required Services

At Each Fuel Stop

- Engine oil level check. See *Engine Oil* on page 9-10.
- Engine coolant level check. See *Engine Coolant* on page 9-17.
- Windshield washer fluid level check. See *Washer Fluid* on page 9-23.

Once a Month

- Tire inflation check. See *Tire Pressure* on page 9-59.
- Tire wear inspection. See *Tire Inspection* on page 9-66.

Once a Year

- See *Starter Switch Check* on page 9-28.
- See *Park Brake and P (Park) Mechanism Check* on page 9-28.
- Exhaust system and nearby heat shields inspection for loose or damaged components.
- Accelerator pedal check for damage, high effort, or binding. Replace if needed.
- If the vehicle has a Tire Sealant and Compressor Kit, check the sealant expiration date printed on the instruction label of the kit. See *Tire Sealant and Compressor Kit (Without Selector Switch)* on page 9-76 or *Tire Sealant and Compressor Kit (With Selector Switch)* on page 9-84.

First Engine Oil Change After Every 40 000 km/25,000 Miles

- Fuel system inspection for damage or leaks.
- Passenger compartment air filter replacement (or every 12 months, whichever occurs first). More frequent replacement may be required if vehicle is driven regularly under dusty conditions.

First Engine Oil Change After Every 80 000 km/50,000 Miles

- Engine air cleaner filter replacement. See *Engine Air Cleaner/Filter* on page 9-14.
- Automatic transmission fluid change (severe service) for vehicles mainly driven in heavy city traffic in hot weather, in hilly or mountainous terrain, when frequently towing a trailer, or used for taxi, police, or delivery service. See *Automatic Transmission Fluid* on page 9-13.

First Engine Oil Change After Every 160 000 km/100,000 Miles

- Automatic transmission fluid change (normal service). See *Automatic Transmission Fluid* on page 9-13.
- Spark plug replacement. An *Emission Control Service*.

First Engine Oil Change After Every 240 000 km/150,000 Miles

- Engine cooling system drain, flush, and refill, cooling system and cap pressure check, and cleaning of outside of radiator and air conditioning condenser (or every 5 years, whichever occurs first). See *Cooling System* on page 9-16. An *Emission Control Service*.
- Engine accessory drive belt inspection for fraying, excessive cracks, or obvious damage and replacement, if needed. An *Emission Control Service*.

Recommended Fluids, Lubricants, and Parts

Recommended Fluids and Lubricants

| Usage | Fluid/Lubricant |
|--|---|
| Engine Oil | The engine requires a special engine oil meeting GM Standard GM4718M. Oils meeting this standard can be identified with the American Petroleum Institute (API) Certified for Gasoline Engines starburst symbol. However, not all synthetic API oils with the starburst symbol will meet this GM standard. Look for and use only an oil that meets GM Standard GM4718M. For the proper viscosity, see <i>Engine Oil on page 9-10</i> . |
| Engine Coolant | 50/50 mixture of clean, drinkable water and use only DEX-COOL [®] Coolant. See <i>Engine Coolant on page 9-17</i> . |
| Hydraulic Brake System | DOT 3 Hydraulic Brake Fluid (GM Part No. U.S. 88863461, in Canada 88863462). |
| Windshield Washer | Optikleen [®] Washer Solvent. |
| Hydraulic Power Steering System | DEXRON [®] -VI Automatic Transmission Fluid. |
| Automatic Transmission (3.0L V6 Engine) | DEXRON [®] -VI Automatic Transmission Fluid. |

| Usage | Fluid/Lubricant |
|---|--|
| Automatic Transmission (2.8L V6 Engine) | AW-1 Automatic Transmission Fluid (GM Part No. U.S. 19256039, in Canada 19256040). |
| Chassis Lubrication | Chassis Lubricant (GM Part No. U.S. 12377985, in Canada 88901242) or lubricant meeting requirements of NLGI #2, Category LB or GC-LB. |
| Key Lock Cylinders | Multi-Purpose Lubricant, Superlube (GM Part No. U.S. 12346241, in Canada 10953474). |
| Hood Latch Assembly, Secondary Latch, Pivots, Spring Anchor, and Release Pawl | Lubriplate Lubricant Aerosol (GM Part No. U.S. 12346293, in Canada 992723) or lubricant meeting requirements of NLGI #2, Category LB or GC-LB. |
| Hood, Door, and Folding Seat Hinges | Multi-Purpose Lubricant, Superlube (GM Part No. U.S. 12346241, in Canada 10953474). |
| Power Liftgate Actuator Ball Joint | Multi-Purpose Lubricant (GM Part No. U.S. 89021668, in Canada 89021674). |
| Weatherstrip Conditioning | Weatherstrip Lubricant (GM Part No. U.S. 3634770, in Canada 10953518) or Dielectric Silicone Grease (GM Part No. U.S. 12345579, in Canada 992887). |

10-8 Service and Maintenance

Maintenance Replacement Parts

Replacement parts identified below by name, part number, or specification can be obtained from your dealer.

| Part | GM Part Number | ACDelco Part Number |
|--|----------------|---------------------|
| Engine Air Cleaner/Filter | 20897358 | A3147C |
| Engine Oil Filter | | |
| 2.8L V6 Engine | 12593333 | PF457G |
| 3.0L V6 Engine | 89017524 | PF48 |
| Passenger Compartment Air Filter Element | 13271191 | CF176 |
| Spark Plugs | | |
| 2.8L V6 Engine | 12622561 | 41-109 |
| 3.0L V6 Engine | 12622561 | 41-109 |
| Wiper Blades | | |
| Driver Side – 65.0 cm (25.6 in) | 25979378 | — |
| Passenger Side – 42.5 cm (16.7 in) | 25979379 | — |
| Rear – 30.0 cm (11.8 in) | 20825882 | — |

Technical Data

Vehicle Identification

| | |
|---|------|
| Vehicle Identification Number (VIN) | 11-1 |
| Service Parts Identification Label | 11-1 |

Vehicle Data

| | |
|-------------------------------------|------|
| Capacities and Specifications | 11-2 |
| Engine Drive Belt Routing | 11-4 |

Vehicle Identification

Vehicle Identification Number (VIN)



This legal identifier is in the front corner of the instrument panel, on the left side of the vehicle. It can be seen through the windshield from outside. The VIN also appears on the Vehicle Certification and Service Parts labels and certificates of title and registration.

Engine Identification

The eighth character in the VIN is the engine code. This code identifies the vehicle's engine, specifications, and replacement parts. See "Engine Specifications" under *Capacities and Specifications* on page 11-2 for the vehicle's engine code.

Service Parts Identification Label

This label, on the inside of the glove box, has the following information:

- Vehicle Identification Number (VIN)
- Model designation
- Paint information
- Production options and special equipment

Do not remove this label from the vehicle.

Vehicle Data

Capacities and Specifications

| Application | Capacities | |
|------------------------------------|--|----------|
| | Metric | English |
| Air Conditioning Refrigerant R134a | For the air conditioning system refrigerant charge amount, see the refrigerant label located under the hood. See your dealer for more information. | |
| Engine Cooling System | | |
| 2.8L V6 Engine | 12.4 L | 13.1 qt |
| 3.0L V6 Engine | 11.9 L | 12.6 qt |
| Engine Oil with Filter | | |
| 2.8L V6 Engine | 5.7 L | 6.0 qt |
| 3.0L V6 Engine | 5.7 L | 6.0 qt |
| Fuel Tank | 79.5 L | 21.0 gal |

| Application | Capacities | |
|--|-------------------|----------------|
| | Metric | English |
| Transmission Fluid | | |
| 2.8L V6 6-Speed Automatic (Transmission Requires No Fluid Replacement) | — | — |
| 3.0L V6 6-Speed Automatic* (Drain and Refill) | 9.0 L | 9.5 qt |
| Wheel Nut Torque | 150 N•m | 110 ft lb |
| *See <i>Automatic Transmission Fluid on page 9-13</i> for information on checking fluid level. | | |
| All capacities are approximate. When adding, be sure to fill to the approximate level, as recommended in this manual. Recheck fluid level after filling. | | |

Engine Specifications

| Engine | VIN Code | Transmission | Spark Plug Gap |
|---------------|-----------------|---------------------|-----------------------|
| 2.8L V6 (LAU) | 4 | Automatic | 1.10 mm (0.043 in) |
| 3.0L V6 (LF1) | Y | Automatic | 1.10 mm (0.043 in) |

Engine Drive Belt Routing

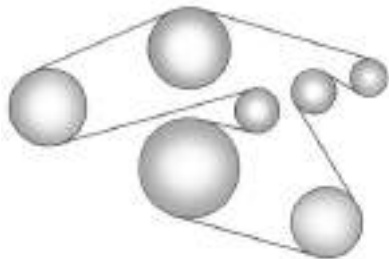

2.8L, 3.0L V6 Engines

Customer Information

Customer Information

| | |
|--|-------|
| Customer Satisfaction Procedure | 12-1 |
| Customer Assistance Offices | 12-3 |
| Customer Assistance for Text Telephone (TTY) Users | 12-4 |
| Online Owner Center | 12-4 |
| GM Mobility Reimbursement Program | 12-5 |
| Roadside Service | 12-6 |
| Scheduling Service Appointments | 12-8 |
| Courtesy Transportation Program | 12-9 |
| Collision Damage Repair ... | 12-10 |
| Service Publications Ordering Information | 12-13 |

Reporting Safety Defects

| | |
|--|-------|
| Reporting Safety Defects to the United States Government | 12-14 |
| Reporting Safety Defects to the Canadian Government | 12-15 |
| Reporting Safety Defects to General Motors | 12-15 |

Vehicle Data Recording and Privacy

| | |
|---|-------|
| Vehicle Data Recording and Privacy | 12-15 |
| Event Data Recorders | 12-16 |
| OnStar® | 12-17 |
| Navigation System | 12-17 |
| Radio Frequency Identification (RFID) | 12-17 |
| Radio Frequency Statement | 12-17 |

Customer Information

Customer Satisfaction Procedure

Your satisfaction and goodwill are important to your dealer and to Cadillac. Normally, any concerns with the sales transaction or the operation of the vehicle will be resolved by the dealer's sales or service departments. Sometimes, however, despite the best intentions of all concerned, misunderstandings can occur. If your concern has not been resolved to your satisfaction, the following steps should be taken:

STEP ONE: Discuss your concern with a member of dealership management. Normally, concerns can be quickly resolved at that level. If the matter has already been reviewed with the sales, service or parts manager, contact the owner of the dealership or the general manager.

12-2 Customer Information

STEP TWO : If after contacting a member of dealership management, it appears your concern cannot be resolved by the dealership without further help, in the United States, call the Cadillac Customer Assistance Center, 24 hours a day, at 1-800-458-8006. In Canada, call the Canadian Cadillac Customer Communication Centre at 1-888-446-2000.

We encourage you to call the toll-free number in order to give your inquiry prompt attention. Have the following information available to give the Customer Assistance Representative:

- Vehicle Identification Number (VIN). This is available from the vehicle registration or title, or the plate at the top left of the instrument panel and visible through the windshield.
- Dealership name and location.
- Vehicle delivery date and present mileage.

When contacting Cadillac, remember that your concern will likely be resolved at a dealer's facility. That is why we suggest following Step One first.

STEP THREE (U.S. Owners):

Both General Motors and your dealer are committed to making sure you are completely satisfied with your new vehicle. However, if you continue to remain unsatisfied after following the procedure outlined in Steps One and Two, you can file with the Better Business Bureau (BBB) Auto Line Program to enforce your rights.

The BBB Auto Line Program is an out of court program administered by the Council of Better Business Bureaus to settle automotive disputes regarding vehicle repairs or the interpretation of the New Vehicle Limited Warranty. Although you may be required to resort to this informal dispute resolution program prior to filing a court action, use of the program is free of charge and

your case will generally be heard within 40 days. If you do not agree with the decision given in your case, you may reject it and proceed with any other venue for relief available to you.

You may contact the BBB Auto Line Program using the toll-free telephone number or write them at the following address:

BBB Auto Line Program
Council of Better Business
Bureaus, Inc.
4200 Wilson Boulevard
Suite 800
Arlington, VA 22203-1838

Telephone: 1-800-955-5100
www.dr.bbb.org/goauto

This program is available in all 50 states and the District of Columbia. Eligibility is limited by vehicle age, mileage and other factors. General Motors reserves the right to change eligibility limitations and/or discontinue its participation in this program.

STEP THREE (Canadian Owners):**General Motors Participation in the Mediation/Arbitration Program**

In the event that you do not feel your concerns have been addressed after the following the procedure outlined in Steps One and Two. General Motors of Canada Limited wants you to be aware of its participation in a no-charge mediation/Arbitration program. General Motors of Canada Limited has committed to binding arbitration of owner disputes involving factory-related vehicle service claims. The program provides for the review of the facts involved by an impartial third party arbiter, and may include an informal hearing before the arbiter. The program is designed so that the entire dispute settlement process, from the time you file your complaint to the final decision, should be completed in approximately 70 days. We believe

our impartial program offers advantages over courts in most jurisdictions because it is informal, quick, and free of charge.

For further information concerning eligibility in the Canadian Motor Vehicle Arbitration Plan (CAMVAP), call toll-free 1-800-207-0685, or call the General Motors Customer Communication Centre, 1-800-263-3777 (English), 1-800-263-7854 (French), or write to the Mediation/Arbitration Program at the following address:

Mediation/Arbitration Program
c/o Customer Communication
Centre
General Motors of Canada Limited
Mail Code: CA1-163-005
1908 Colonel Sam Drive
Oshawa, Ontario L1H 8P7

Your inquiry should be accompanied by the Vehicle Identification Number (VIN).

Customer Assistance Offices

Cadillac encourages customers to call the toll-free number for assistance. However, if a customer wishes to write or e-mail Cadillac, the letter should be addressed to:

United States

Cadillac Customer Assistance
Center
Cadillac Motor Car Division
P.O. Box 33169
Detroit, MI 48232-5169
www.Cadillac.com

1-800-458-8006
1-800-833-2622 (For Text
Telephone devices (TTYs))
Roadside Assistance:
1-800-882-1112

12-4 Customer Information

From Puerto Rico:

1-800-496-9992 (English)
1-800-496-9993 (Spanish)

From U.S. Virgin Islands:

1-800-496-9994

Canada

General Motors of Canada Limited
Canadian Cadillac Customer
Communication Centre,
Mail Code: CA1-163-005
1908 Colonel Sam Drive
Oshawa, Ontario L1H 8P7
www.gm.ca

1-888-446-2000
1-800-263-3830 (For Text
Telephone devices (TTYs))
Roadside Assistance:
1-800-882-1112

Overseas

Please contact the local General
Motors Business Unit.

Mexico, Central America and Caribbean Islands/Countries (Except Puerto Rico and U.S. Virgin Islands)

General Motors de Mexico,
S. de R.L. de C.V.
Customer Assistance Center
Av. Ejercito Nacional #843
Col. Granada
C.P. 11520, Mexico, D.F.

01-800-466-0805
Long Distance: 011-52-53 29 0805

Customer Assistance for Text Telephone (TTY) Users

To assist customers who are deaf,
hard of hearing, or speech-impaired
and who use Text Telephones
(TTYs), Cadillac has TTY equipment
available at its Customer Assistance
Center. Any TTY user can
communicate with Cadillac by
dialing: 1-800-833-2622. TTY users
in Canada can dial 1-800-263-3830.

Online Owner Center

Cadillac Owner Center (U.S.) —

www.cadillacownercenter.com

Information and services
customized for your specific
vehicle — all in one convenient
place.

- Digital owner manual, warranty information, and more
- Store online service and maintenance records
- Cadillac dealer locator for service nationwide
- Exclusive privileges and offers
- Recall notices for your specific vehicle
- OnStar and GM Cardmember Services Earnings summaries

Other Helpful Links:

Cadillac — www.cadillac.com

Cadillac Merchandise —
www.cadillaccollection.com

Help Center — www.cadillac.com/helpcenter

- FAQ
- Contact Us

**My GM Canada
(Canada) — www.gm.ca**

My GM Canada is a password-protected section of www.gm.ca where you can save information on GM vehicles, get personalized offers, and use handy tools and forms with greater ease.

Here are a few of the valuable tools and services you will have access to:

- **My Showroom:** Find and save information on vehicles and current offers in your area.
- **My Dealers:** Save details such as address and phone number for each of your preferred GM dealers.
- **My Driveway:** Access quick links to parts and service estimates, check trade-in values, or schedule a service appointment by adding the vehicles you own to your driveway profile.
- **My Preferences:** Manage your profile and use tools and forms with greater ease.

To sign up, visit the My GM Canada section within www.gm.ca.

**GM Mobility
Reimbursement Program**

This program is available to qualified applicants for cost reimbursement of eligible aftermarket adaptive equipment required for your vehicle, such as hand controls or a wheelchair/scooter lift for the vehicle.

For more information on the limited offer, visit www.gmmobility.com or call the GM Mobility Assistance Center at 1-800-323-9935. Text Telephone (TTY) users, call 1-800-833-9935.

12-6 Customer Information

General Motors of Canada also has a Mobility Program. Call 1-800-GM-DRIVE (463-7483) for details. TTY users call 1-800-263-3830.

Roadside Service

In the United States or Canada, call **1-800-882-1112**.

Text Telephone (TTY), U.S. only, call **1-888-889-2438**.

Service is available 24 hours a day, 365 days a year.

Calling for Service

When calling Roadside Service, have the following information ready:

- Your name, home address, and home telephone number
- Telephone number of your location

- Location of the vehicle
- Model, year, color, and license plate number of the vehicle
- Odometer reading, Vehicle Identification Number (VIN), and delivery date of the vehicle
- Description of the problem

Coverage

Services are provided up to 5 years/160 000 km (100,000 miles), whichever comes first.

In the U.S., anyone driving the vehicle is covered. In Canada, a person driving the vehicle without permission from the owner is not covered.

Roadside Service is not a part of the New Vehicle Limited Warranty. Cadillac and General Motors of Canada Limited reserve the right to make any changes or discontinue the Roadside Service program at any time without notification.

Cadillac and General Motors of Canada Limited reserve the right to limit services or payment to an owner or driver if they decide the claims are made too often, or the same type of claim is made many times.

Cadillac Owner Privileges™

- **Emergency Fuel Delivery:** Delivery of enough fuel for the vehicle to get to the nearest service station.
- **Lock-Out Service:** Service to unlock the vehicle if you are locked out. A remote unlock may be available if you have OnStar. For security reasons, the driver must present identification before this service is given.

- **Emergency Tow From a Public Road or Highway:** Tow to the nearest Cadillac dealer for warranty service, or if the vehicle was in a crash and cannot be driven. Assistance is also given when the vehicle is stuck in the sand, mud, or snow.
- **Flat Tire Change:** Service to change a flat tire with spare tire. The spare tire, if equipped, must be in good condition and properly inflated. It is your responsibility for the repair or replacement of the tire if it is not covered by the warranty.
- **Battery Jump Start:** Service to jump start a dead battery.
- **Trip Routing Service:** Detailed maps of North America are provided when requested either with the most direct route or the most scenic route. Additional travel information is also available. Allow three weeks for delivery.
- **Trip Interruption Benefits and Service:** If your trip is interrupted due to a warranty failure, incidental expenses may be reimbursed during the 5 years/160 000 km (100,000 miles) Powertrain warranty period. Items considered are hotel, meals, and rental car.

Cadillac Technician Roadside Service (U.S. only)

Cadillac's exceptional Roadside Service is more than an auto club or towing service. It provides every Cadillac owner in the United States with the advantage of contacting a Cadillac advisor and, where available, a Cadillac trained dealer technician who can provide on-site service.

A dealer technician will travel to your location within a 30 mile radius of a participating Cadillac dealership. If beyond this radius, we will arrange to have your car towed to the nearest Cadillac dealership.

Each technician travels with a specially equipped service vehicle complete with the necessary Cadillac parts and tools required to handle most roadside repairs.

Services Not Included in Roadside Service

- Impound towing caused by violation of any laws.
- Legal fines.
- Mounting, dismounting, or changing of snow tires, chains, or other traction devices.
- Towing or services for vehicles driven on a non-public road or highway.

12-8 Customer Information

Services Specific to Canadian-Purchased Vehicles

- **Fuel delivery:** Reimbursement is approximately \$5 Canadian. Diesel fuel delivery may be restricted. Propane and other fuels are not provided through this service.
- **Lock-Out Service:** Vehicle registration is required.
- **Trip Routing Service:** Limit of six requests per year.
- **Trip Interruption Benefits and Service:** Pre-authorization, original detailed receipts, and a copy of the repair orders are required. Once authorization has been received, the Roadside Service advisor will help you make arrangements and explain how to receive payment.

- **Alternative Service:** If assistance cannot be provided right away, the Roadside Service advisor may give you permission to get local emergency road service. You will receive payment, up to \$100, after sending the original receipt to Roadside Service. Mechanical failures may be covered, however any cost for parts and labor for repairs not covered by the warranty are the owner responsibility.

Scheduling Service Appointments

When your vehicle requires warranty service, contact your dealer and request an appointment. By scheduling a service appointment and advising your service consultant of your transportation needs, your dealer can help minimize your inconvenience.

If your vehicle cannot be scheduled into the service department immediately, keep driving it until it can be scheduled for service, unless, of course, the problem is safety related. If it is, please call your dealership, let them know this, and ask for instructions.

If the dealer requests you to bring the vehicle for service, you are urged to do so as early in the work day as possible to allow for the same day repair.

Courtesy Transportation Program

To enhance your ownership experience, we and our participating dealers are proud to offer Courtesy Transportation, a customer support program for vehicles with the Bumper to Bumper (Base Warranty Coverage period in Canada), extended powertrain, and/or hybrid-specific warranties in both the U.S. and Canada.

Several Courtesy Transportation options are available to assist in reducing your inconvenience when warranty repairs are required.

Courtesy Transportation is not a part of the New Vehicle Limited Warranty. A separate booklet entitled "Warranty and Owner Assistance Information" furnished with each new vehicle provides detailed warranty coverage information.

Transportation Options

Warranty service can generally be completed while you wait. However, if you are unable to wait, GM helps to minimize your inconvenience by providing several transportation options. Depending on the circumstances, your dealer can offer you one of the following:

Shuttle Service

Shuttle service is the preferred means of offering Courtesy Transportation. Dealers may provide shuttle service to get you to your destination with minimal interruption of your daily schedule. This includes one-way or round-trip shuttle service within reasonable time and distance parameters of the dealer's area.

Public Transportation or Fuel Reimbursement

If your vehicle requires overnight warranty repairs, and public transportation is used instead of the dealer's shuttle service, the expense must be supported by original receipts and can only be up to the maximum amount allowed by GM for shuttle service. In addition, for U.S. customers, should you arrange transportation through a friend or relative, limited reimbursement for reasonable fuel expenses may be available. Claim amounts should reflect actual costs and be supported by original receipts. See your dealer for information regarding the allowance amounts for reimbursement of fuel or other transportation costs.

12-10 Customer Information

Courtesy Rental Vehicle

Your dealer may arrange to provide you with a courtesy rental vehicle or reimburse you for a rental vehicle that you obtain if your vehicle is kept for an overnight warranty repair. Rental reimbursement will be limited and must be supported by original receipts. This requires that you sign and complete a rental agreement and meet state/provincial, local, and rental vehicle provider requirements. Requirements vary and may include minimum age requirements, insurance coverage, credit card, etc. You are responsible for fuel usage charges and may also be responsible for taxes, levies, usage fees, excessive mileage, or rental usage beyond the completion of the repair.

It may not be possible to provide a like vehicle as a courtesy rental.

Additional Program Information

All program options, such as shuttle service, may not be available at every dealer. Please contact your dealer for specific information about availability. All Courtesy Transportation arrangements will be administered by appropriate dealer personnel.

General Motors reserves the right to unilaterally modify, change, or discontinue Courtesy Transportation at any time and to resolve all questions of claim eligibility pursuant to the terms and conditions described herein at its sole discretion.

Collision Damage Repair

If your vehicle is involved in a collision and it is damaged, have the damage repaired by a qualified technician using the proper equipment and quality replacement parts. Poorly performed collision repairs diminish your vehicle's resale value, and safety performance can be compromised in subsequent collisions.

Collision Parts

Genuine GM Collision parts are new parts made with the same materials and construction methods as the parts with which your vehicle was originally built. Genuine GM Collision parts are your best choice to ensure that your vehicle's designed appearance, durability, and safety are preserved. The use of Genuine GM parts can help maintain your GM New Vehicle Limited Warranty.

Recycled original equipment parts may also be used for repair. These parts are typically removed from vehicles that were total losses in prior crashes. In most cases, the parts being recycled are from undamaged sections of the vehicle. A recycled original equipment GM part may be an acceptable choice to maintain your vehicle's originally designed appearance and safety performance; however, the history of these parts is not known. Such parts are not covered by your GM New Vehicle Limited Warranty, and any related failures are not covered by that warranty.

Aftermarket collision parts are also available. These are made by companies other than GM and may not have been tested for your vehicle. As a result, these parts may fit poorly, exhibit premature

durability/corrosion problems, and may not perform properly in subsequent collisions. Aftermarket parts are not covered by your GM New Vehicle Limited Warranty, and any vehicle failure related to such parts is not covered by that warranty.

Repair Facility

GM also recommends that you choose a collision repair facility that meets your needs before you ever need collision repairs. Your dealer may have a collision repair center with GM-trained technicians and state-of-the-art equipment, or be able to recommend a collision repair center that has GM-trained technicians and comparable equipment.

Insuring Your Vehicle

Protect your investment in your GM vehicle with comprehensive and collision insurance coverage. There are significant differences in the quality of coverage afforded by various insurance policy terms. Many insurance policies provide reduced protection to your GM vehicle by limiting compensation for damage repairs by using aftermarket collision parts. Some insurance companies will not specify aftermarket collision parts. When purchasing insurance, we recommend that you ensure that your vehicle will be repaired with GM original equipment collision parts. If such insurance coverage is not available from your current insurance carrier, consider switching to another insurance carrier.

12-12 Customer Information

If your vehicle is leased, the leasing company may require you to have insurance that ensures repairs with Genuine GM Original Equipment Manufacturer (OEM) parts or Genuine Manufacturer replacement parts. Read your lease carefully, as you may be charged at the end of your lease for poor quality repairs.

If a Crash Occurs

If there has been an injury, call emergency services for help. Do not leave the scene of a crash until all matters have been taken care of. Move the vehicle only if its position puts you in danger, or you are instructed to move it by a police officer.

Give only the necessary information to police and other parties involved in the crash.

For emergency towing see *Roadside Service on page 12-6.*

Gather the following information:

- Driver's name, address, and telephone number
- Driver's license number
- Owner's name, address, and telephone number
- Vehicle license plate number
- Vehicle make, model, and model year
- Vehicle Identification Number (VIN)
- Insurance company and policy number
- General description of the damage to the other vehicle

Choose a reputable repair facility that uses quality replacement parts. See "Collision Parts" earlier in this section.

If the airbag has inflated, see *What Will You See After an Airbag Inflates? on page 2-34.*

Managing the Vehicle Damage Repair Process

In the event that your vehicle requires damage repairs, GM recommends that you take an active role in its repair. If you have a pre-determined repair facility of choice, take your vehicle there, or have it towed there. Specify to the facility that any required replacement collision parts be original equipment parts, either new Genuine GM parts or recycled original GM parts. Remember, recycled parts will not be covered by your GM vehicle warranty.

Insurance pays the bill for the repair, but you must live with the repair. Depending on your policy limits, your insurance company may initially value the repair using aftermarket parts. Discuss this with your repair professional, and insist on Genuine GM parts. Remember, if your vehicle is leased, you may be

obligated to have the vehicle repaired with Genuine GM parts, even if your insurance coverage does not pay the full cost.

If another party's insurance company is paying for the repairs, you are not obligated to accept a repair valuation based on that insurance company's collision policy repair limits, as you have no contractual limits with that company. In such cases, you can have control of the repair and parts choices as long as the cost stays within reasonable limits.

Service Publications Ordering Information

Service Manuals

Service Manuals have the diagnosis and repair information on the engines, transmission, axle, suspension, brakes, electrical, steering, body, etc.

Service Bulletins

Service Bulletins give additional technical service information needed to knowledgeable service General Motors cars and trucks. Each bulletin contains instructions to assist in the diagnosis and service of your vehicle.

Owner Information

Owner publications are written specifically for owners and intended to provide basic operational information about the vehicle. The Owner Manual includes the Maintenance Schedule for all models.

In-Portfolio: Includes a Portfolio, Owner Manual, and Warranty Booklet.

RETAIL SELL PRICE:
\$35.00 (U.S.) plus handling and shipping fees

Without Portfolio: Owner Manual only.

RETAIL SELL PRICE:
\$25.00 (U.S.) plus handling and shipping fees

Current and Past Models

Technical Service Bulletins and Manuals are available for current and past model GM vehicles.

ORDER TOLL FREE:

**1-800-551-4123 Monday - Friday
8:00 AM - 6:00 PM Eastern Time**

For Credit Card Orders Only (VISA-MasterCard-Discover), visit Helm, Inc. at: www.helminc.com

Or you can write to:

Helm, Incorporated
P.O. Box 07130
Detroit, MI 48207

Prices are subject to change without notice and without incurring obligation. Allow ample time for delivery.

Note to Canadian Customers: All listed prices are quoted in U.S. funds. Canadian residents are to make checks payable in U.S. funds.

Reporting Safety Defects

Reporting Safety Defects to the United States Government

If you believe that your vehicle has a defect which could cause a crash or could cause injury or death, you should immediately inform the National Highway Traffic Safety Administration (NHTSA) in addition to notifying General Motors.

If NHTSA receives similar complaints, it may open an investigation, and if it finds that a safety defect exists in a group of vehicles, it may order a recall and remedy campaign.

However, NHTSA cannot become involved in individual problems between you, your dealer, or General Motors.

To contact NHTSA, you may call the Vehicle Safety Hotline toll-free at 1-888-327-4236 (TTY: 1-800-424-9153); go to <http://www.safercar.gov>; or write to:

Administrator, NHTSA
1200 New Jersey Avenue, S.E.
Washington, D.C. 20590

You can also obtain other information about motor vehicle safety from <http://www.safercar.gov>.

Reporting Safety Defects to the Canadian Government

If you live in Canada, and you believe that your vehicle has a safety defect, notify Transport Canada immediately, in addition to notifying General Motors of Canada Limited. Call them at 1-800-333-0510 or write to:

Transport Canada
Road Safety Branch
2780 Sheffield Road
Ottawa, Ontario K1B 3V9

Reporting Safety Defects to General Motors

In addition to notifying NHTSA (or Transport Canada) in a situation like this, notify General Motors.

Call 1-800-458-8006, or write:

Cadillac Customer Assistance Center
Cadillac Motor Car Division
P.O. Box 33169
Detroit, MI 48232-5169

In Canada, call 1-888-446-2000, or write:

Canadian Cadillac Customer Communication Centre,
Mail Code: CA1-163-005
General Motors of Canada Limited
1908 Colonel Sam Drive
Oshawa, Ontario L1H 8P7

Vehicle Data Recording and Privacy

Your GM vehicle has a number of sophisticated computers that record information about the vehicle's performance and how it is driven. For example, your vehicle uses computer modules to monitor and control engine and transmission performance, to monitor the conditions for airbag deployment and deploy airbags in a crash and, if so equipped, to provide antilock braking to help the driver control the vehicle. These modules may store data to help your dealer technician service your vehicle. Some modules may also store data about how you operate the vehicle, such as rate of fuel consumption or average speed. These modules may also retain the owner's personal preferences, such as radio pre-sets, seat positions, and temperature settings.

Event Data Recorders

This vehicle has an Event Data Recorder (EDR). The main purpose of an EDR is to record, in certain crash or near crash-like situations, such as an airbag deployment or hitting a road obstacle, data that will assist in understanding how a vehicle's systems performed. The EDR is designed to record data related to vehicle dynamics and safety systems for a short period of time, typically 30 seconds or less. The EDR in this vehicle is designed to record such data as:

- How various systems in your vehicle were operating
- Whether or not the driver and passenger safety belts were buckled/fastened

- How far, if at all, the driver was pressing the accelerator and/or brake pedal
- How fast the vehicle was traveling

This data can help provide a better understanding of the circumstances in which crashes and injuries occur.

Important: EDR data is recorded by your vehicle only if a non-trivial crash situation occurs; no data is recorded by the EDR under normal driving conditions and no personal data (e.g., name, gender, age, and crash location) is recorded.

However, other parties, such as law enforcement, could combine the EDR data with the type of personally identifying data routinely acquired during a crash investigation.

To read data recorded by an EDR, special equipment is required, and access to the vehicle or the EDR is needed. In addition to the vehicle manufacturer, other parties, such as law enforcement, that have the special equipment, can read the information if they have access to the vehicle or the EDR.

GM will not access this data or share it with others except: with the consent of the vehicle owner or, if the vehicle is leased, with the consent of the lessee; in response to an official request by police or similar government office; as part of GM's defense of litigation through the discovery process; or, as required by law. Data that GM collects or receives may also be used for GM research needs or may be made available to others for research purposes, where a need is shown and the data is not tied to a specific vehicle or vehicle owner.

OnStar®

If your vehicle is equipped with an active OnStar system, that system may also record data in crash or near crash-like situations. The OnStar Terms and Conditions provides information on data collection and use and is available in the OnStar glove box kit, at www.onstar.com (U.S.) or www.onstar.ca (Canada), or by pressing the  button and speaking to an advisor.

Navigation System

If your vehicle has a navigation system, use of the system may result in the storage of destinations, addresses, telephone numbers, and other trip information. Refer to the navigation system operating manual for information on stored data and for deletion instructions.

Radio Frequency Identification (RFID)

RFID technology is used in some vehicles for functions such as tire pressure monitoring and ignition system security, as well as in connection with conveniences such as key fobs for remote door locking/unlocking and starting, and in-vehicle transmitters for garage door openers. RFID technology in GM vehicles does not use or record personal information or link with any other GM system containing personal information.

Radio Frequency Statement

This vehicle has systems that operate on a radio frequency that comply with Part 15 of the Federal Communications Commission (FCC) rules and with Industry Canada Standards RSS-210/220/310.

Operation is subject to the following two conditions:

1. The device may not cause interference.
2. The device must accept any interference received, including interference that may cause undesired operation of the device.

Changes or modifications to any of these systems by other than an authorized service facility could void authorization to use this equipment.

A

Accessories and
Modifications 9-3

Accessory Power 8-20

Adaptive Forward
Lighting (AFL) 5-3

Add-On Electrical
Equipment 8-61

Adding Equipment to the
Airbag-Equipped Vehicle 2-41

Adjustable Throttle and
Brake Pedal 8-18

Adjustments
Lumbar, Front Seats 2-6
Thigh Support 2-7

Air Cleaner/Filter, Engine 9-14

Air Vents 7-6

Airbag System
Check 2-42
How Does an Airbag
Restrain? 2-33
Passenger Sensing
System 2-36

Airbag System (cont.)
What Makes an Airbag
Inflate? 2-33
What Will You See After
an Airbag Inflates? 2-34
When Should an Airbag
Inflate? 2-32
Where Are the Airbags? 2-30

Airbags
Adding Equipment to the
Vehicle 2-41
Passenger Status Indicator 4-19
Readiness Light 4-18
Servicing Airbag-Equipped
Vehicles 2-40
System Check 2-28

Alarm System
Anti-Theft 1-17

All-Wheel Drive 8-30, 9-27

AM-FM Radio 6-11

Antenna
Multi-Band 6-18

Anti-Theft
Alarm System 1-17
Alarm System Messages 4-39

Antilock Brake
System (ABS) 8-30
Warning Light 4-24

Appearance Care
Exterior 9-109
Interior 9-113

Armrest Storage 3-2

Ashtrays 4-13

Audio Players 6-19
CD 6-19
CD/DVD 6-21

Audio System
Radio Reception 6-18
Rear Seat (RSA) 6-45
Theft-Deterrent Feature 6-2

Automatic
Dimming Mirrors 1-22
Headlamp System 5-3

Automatic Transmission 8-25
Fluid 9-13
Manual Mode 8-28

Auxiliary Devices 6-28, 6-34

B

| | |
|---|------------------------|
| Battery | 9-27 |
| Jump Starting | 9-101 |
| Voltage and Charging Messages | 4-33 |
| Blade Replacement, Wiper | 9-29 |
| Bluetooth | 6-47, 6-48, 6-52, 6-63 |
| Brake Pedal and Adjustable Throttle | 8-18 |
| Brakes | 9-24 |
| Antilock | 8-30 |
| Assist | 8-33 |
| Fluid | 9-25 |
| Parking | 8-31 |
| System Messages | 4-34 |
| Braking | 8-4 |
| Break-In, New Vehicle | 8-17 |
| Bulb Replacement | 9-43 |
| Back-Up Lamps | 9-41 |
| Halogen Bulbs | 9-34 |
| Headlamp Aiming | 9-31 |
| Headlamps | 9-34, 9-35 |

| | |
|--|------|
| Bulb Replacement (cont.) High Intensity Discharge (HID) Lighting | 9-35 |
| License Plate Lamps | 9-42 |
| Turn Signal Lamps | 9-40 |
| Buying New Tires | 9-68 |

C

| | |
|---|------------|
| Calibration | 4-10 |
| California Fuel Requirements | 8-48 |
| Perchlorate Materials Requirements | 9-3 |
| Warning | 9-2 |
| Camera, Rear Vision | 8-43 |
| Canadian Vehicle Owners | iii |
| Capacities and Specifications | 11-2 |
| Carbon Monoxide Engine Exhaust | 8-24 |
| Liftgate | 1-13, 1-14 |
| Winter Driving | 8-9 |

| | |
|---|------------|
| Cargo Cover | 3-3 |
| Management System | 3-5 |
| Tie Downs | 3-4 |
| Cargo Lamp | 5-6 |
| Cargo Net | 3-8 |
| Cautions, Danger, and Warnings | iv |
| CD DVD Player | 6-21 |
| CD Player | 6-19 |
| Center Console Storage | 3-2 |
| Chains, Tire | 9-74 |
| Charging System Light | 4-20 |
| Check Engine Light | 4-20 |
| Child Restraints Infants and Young Children | 2-45 |
| Lower Anchors and Tethers for Children | 2-52 |
| Older Children | 2-43 |
| Securing | 2-57, 2-59 |
| Systems | 2-48 |
| Where to Put the Restraint ... | 2-50 |

Cigarette Lighter 4-12
 Circuit Breakers 9-44
 Cleaning
 Exterior Care 9-109
 Interior Care 9-113
 Climate Control Systems
 Dual Automatic 7-1
 Rear 7-5
 Clock 4-10
 Cluster, IP 4-14
 Collision Damage Repair 12-10
 Compact Spare Tire 9-100
 Compass 4-10
 Compass Messages 4-34
 Compressor Kit, Tire
 Sealant 9-76, 9-84
 Control of a Vehicle 8-4
 Convenience Net 3-10
 Convex Mirrors 1-20
 Coolant
 Engine 9-17
 Engine Temperature
 Gauge 4-17
 Cooling System 9-16
 Engine Messages 4-35
 Courtesy Lamps 5-6

Courtesy Transportation
 Program 12-9
 Covers
 Cargo 3-3
 Engine 9-9
 Cruise Control 8-37
 Light 4-29
 Messages 4-34
 Cupholders 3-1
 Customer Assistance 12-4
 Offices 12-3
 Text Telephone (TTY)
 Users 12-4
 Customer Information
 Service Publications
 Ordering Information 12-13
 Customer Satisfaction
 Procedure 12-1

D

Damage Repair, Collision 12-10
 Danger, Warnings, and
 Cautions iv
 Data Recorders, Event 12-16
 Daytime Running
 Lamps (DRL) 5-2

Defensive Driving 8-3
 Devices, Auxiliary 6-28, 6-34
 Dome Lamps 5-6
 Door
 Ajar Messages 4-35
 Locks 1-11
 Power Locks 1-11
 Rear Seat Pass-Through 2-13
 Drive Systems
 All-Wheel Drive 8-30, 9-27
 Driver Information
 Center (DIC) 4-29
 Driving
 Better Fuel Economy 8-2
 Characteristics and
 Towing Tips 8-52
 Defensive 8-3
 Drunk 8-3
 Highway Hypnosis 8-8
 Hill and Mountain Roads 8-8
 If the Vehicle is Stuck 8-11
 Loss of Control 8-6
 Off-Road Recovery 8-6
 Vehicle Load Limits 8-11
 Winter 8-9

| | |
|---------------------------------------|------|
| Dual Automatic Climate Control System | 7-1 |
| DVD | |
| Rear Seat Entertainment System | 6-36 |
| DVD/CD Player | 6-21 |

E

| | |
|-------------------------------|------|
| ECO Button | 8-29 |
| Economy Mode | |
| Fuel | 8-29 |
| Electric Parking Brake Light | 4-24 |
| Electrical Equipment, Add-On | 8-61 |
| Electrical System | |
| Engine Compartment Fuse Block | 9-45 |
| Fuses and Circuit Breakers | 9-44 |
| Instrument Panel Fuse Block | 9-48 |
| Overload | 9-44 |
| Rear Compartment Fuse Block | 9-49 |

| | |
|-------------------------------------|-------|
| Engine | |
| Air Cleaner/Filter | 9-14 |
| Check and Service Engine Soon Light | 4-20 |
| Compartment Overview | 9-6 |
| Coolant | 9-17 |
| Coolant Temperature Gauge | 4-17 |
| Cooling System | 9-16 |
| Cooling System Messages | 4-35 |
| Cover | 9-9 |
| Drive Belt Routing | 11-4 |
| Exhaust | 8-24 |
| Gasoline Starting | 8-20 |
| Overheating | 9-20 |
| Power Messages | 4-36 |
| Pressure Light | 4-26 |
| Running While Parked | 8-25 |
| Engine Oil | |
| Life System | 9-12 |
| Messages | 4-36 |
| Equipment, Towing | 8-60 |
| Event Data Recorders | 12-16 |
| Extender, Safety Belt | 2-26 |
| Exterior Lamp Controls | 5-1 |

F

| | |
|--------------------------|------|
| Filter | |
| Engine Air Cleaner | 9-14 |
| Flash-to-Pass | 5-2 |
| Flashers, Hazard Warning | 5-5 |
| Flat Tire | 9-74 |
| Flat Tire, Changing | 9-93 |
| Fluid | |
| Automatic Transmission | 9-13 |
| Brakes | 9-25 |
| Power Steering | 9-22 |
| Washer | 9-23 |
| Fog Lamps | |
| Front | 5-5 |
| Folding Mirrors | 1-21 |
| Front Fog Lamps Light | 4-28 |
| Front Seats | |
| Adjustment | 2-4 |
| Heated | 2-8 |
| Heated and Ventilated | 2-10 |
| Front Storage | 3-2 |
| Fuel | 8-46 |
| Additives | 8-48 |
| Economy Driving | 8-2 |
| Economy Light | 4-27 |

Fuel (cont.)

Filling a Portable Fuel
 Container 8-51
 Filling the Tank 8-50
 Fuels in Foreign Countries 8-48
 Gasoline Specifications 8-47
 Gauge 4-15
 Low Fuel Warning Light 4-27
 Recommended 8-47
 Requirements, California 8-48
 System Messages 4-36
 Fuel Economy Gauge 4-16
 Fuel Economy Mode 8-29
 Fuses
 Engine Compartment Fuse
 Block 9-45
 Fuses and Circuit
 Breakers 9-44
 Instrument Panel Fuse
 Block 9-48
 Rear Compartment Fuse
 Block 9-49

G

Garage Door Opener 4-48
 Programming 4-49
 Gasoline
 Specifications 8-47
 Gasoline Engine, Starting 8-20
 Gauge
 Turbo 4-16
 Gauges
 Engine Coolant
 Temperature 4-17
 Fuel 4-15
 Fuel Economy 4-16
 Odometer 4-15
 Speedometer 4-15
 Tachometer 4-15
 Warning Lights and
 Indicators 4-13
 General Information
 Service and Maintenance 10-1
 Towing 8-52
 Vehicle Care 9-2
 Glove Box 3-1
 GM Mobility Reimbursement
 Program 12-5

H

Halogen Bulbs 9-34
 Hazard Warning Flashers 5-5
 Head Restraints 2-2
 Headlamps 9-35
 Adaptive Forward
 Lighting (AFL) 5-3
 Aiming 9-31
 Automatic 5-3
 Bulb Replacement 9-34
 Daytime Running
 Lamps (DRL) 5-2
 Flash-to-Pass 5-2
 High Intensity Discharge
 (HID) Lighting 9-35
 High-Beam On Light 4-28
 High/Low Beam Changer 5-2
 Lamps On Reminder 4-29
 Turn Signal Lamps 9-40
 Twilight Sentinel 5-4
 Washer 4-9
 Heated
 Rear Seats 2-12

| | |
|---|------|
| Heated and Ventilated Front Seats | 2-10 |
| Heated Front Seats | 2-8 |
| Heated Mirrors | 1-22 |
| High-Beam On Light | 4-28 |
| High-Speed Operation | 9-60 |
| Highway Hypnosis | 8-8 |
| Hill and Mountain Roads | 8-8 |
| Hill Start Assist (HSA) | 8-33 |
| Hood | 9-5 |
| Horn | 4-7 |
| How to Wear Safety Belts Properly | 2-17 |

I

| | |
|--|----------|
| Ignition Positions | 8-18 |
| Immobilizer | 1-19 |
| Infants and Young Children, Restraints | 2-45 |
| Instrument Cluster | 4-14 |
| Instrument Panel Overview | 4-4 |
| Introduction | iii, 6-1 |

J

| | |
|---------------------|-------|
| Jump Starting | 9-101 |
|---------------------|-------|

K

| | |
|---|------|
| Key and Lock Messages | 4-37 |
| Keyless Entry Remote (RKE) System | 1-3 |
| Keyless Entry System | 1-3 |
| Keys | 1-2 |

L

| | |
|-------------------------------|------|
| Labeling, Tire Sidewall | 9-53 |
| Lamp Messages | 4-37 |
| Lamps Cargo | 5-6 |
| Courtesy | 5-6 |
| Daytime Running (DRL) | 5-2 |
| Dome | 5-6 |
| Exterior Controls | 5-1 |
| Front Fog | 5-5 |
| License Plate | 9-42 |
| Malfunction Indicator | 4-20 |
| On Reminder | 4-29 |
| Reading | 5-6 |

| | |
|---|------------|
| Lap-Shoulder Belt | 2-22 |
| LATCH System Replacing Parts After a Crash | 2-57 |
| Latch, Lower Anchors and Tethers for Children | 2-52 |
| Liftgate Carbon Monoxide | 1-13, 1-14 |
| Light Electric Parking Brake | 4-24 |
| StabiliTrak® OFF | 4-25 |
| Lighter, Cigarette | 4-12 |
| Lighting Adaptive Forward | 5-3 |
| Illumination Control | 5-6 |
| Lights Airbag Readiness | 4-18 |
| Antilock Brake System (ABS) Warning | 4-24 |
| Charging System | 4-20 |
| Cruise Control | 4-29 |
| Engine Oil Pressure | 4-26 |
| Flash-to-Pass | 5-2 |

Lights (cont.)
 Front Fog Lamps4-28
 Fuel Economy4-27
 High-Beam On4-28
 High/Low Beam Changer 5-2
 Low Fuel Warning4-27
 Safety Belt Reminders4-17
 Security4-28
 Tire Pressure4-26
 Traction Control System
 (TCS)/StabiliTrak®4-25
 Traction Off4-25
 Limited-Slip Rear Axle 8-37
 Locks
 Door 1-11
 Power Door 1-11
 Safety 1-12
 Loss of Control 8-6
 Low Fuel Warning Light4-27
 Lower Anchors and Tethers
 for Children (LATCH
 SYSTEM) 2-52
 Lumbar Adjustment 2-6
 Front Seats 2-6

M

Maintenance
 Records10-9
 Maintenance Schedule
 Recommended Fluids and
 Lubricants10-6
 Scheduled Maintenance10-2
 Malfunction Indicator Lamp 4-20
 Manual Mode 8-28
 Mass Storage Media (MEM) ... 6-25
 Messages
 Airbag System4-39
 Anti-Theft Alarm System4-39
 Battery Voltage and
 Charging4-33
 Brake System4-34
 Compass4-34
 Door Ajar4-35
 Engine Cooling System4-35
 Engine Oil4-36
 Engine Power4-36
 Fuel System4-36
 Key and Lock4-37
 Lamp4-37
 Object Detection System4-38
 Ride Control System4-38

Messages (cont.)
 Safety Belt4-39
 Service Vehicle4-39
 Starting the Vehicle4-39
 Tire4-40
 Transmission4-40
 Vehicle4-33
 Vehicle Reminder4-41
 Washer Fluid4-41
 Mirrors
 Automatic Dimming1-22
 Automatic Dimming
 Rearview1-23
 Convex1-20
 Folding1-21
 Heated1-22
 Manual Rearview1-22
 Park Tilt1-22
 Power1-20
 Monitor System, Tire
 Pressure 9-61
 Multi-Band Antenna 6-18

N

- Navigation System
 - Vehicle Data Recording and Privacy 12-17
- Net
 - Cargo 3-8
- Net, Convenience 3-10
- New Vehicle Break-In 8-17

O

- Object Detection System
 - Messages 4-38
- Odometer 4-15
- Off-Road
 - Recovery 8-6
- Oil
 - Engine 9-10
 - Engine Oil Life System 9-12
 - Messages 4-36
 - Pressure Light 4-26
- Older Children, Restraints 2-43
- Online Owner Center 12-4
- OnStar® System 4-46
- Operation, Infotainment System 6-7

- Outlets
 - Power 4-11
- Overheating, Engine 9-20
- Overview
 - Instrument Panel 4-4
- Overview, Infotainment System 6-3, 6-5

P

- Park
 - Shifting Into 8-22
 - Shifting Out of 8-23
- Park Tilt Mirrors 1-22
- Parking
 - Assist, Ultrasonic 8-40
 - Brake 8-31
 - Brake and P (Park) Mechanism Check 9-28
 - Over Things That Burn 8-24
- Passenger Airbag Status Indicator 4-19
- Passenger Sensing System 2-36
- Perchlorate Materials
 - Requirements, California 9-3

- Phone
 - Bluetooth 6-47, 6-48, 6-52, 6-63

- Power
 - Door Locks 1-11
 - Mirrors 1-20
 - Outlets 4-11
 - Retained Accessory (RAP) .. 8-20
 - Seat Adjustment 2-4
 - Steering Fluid 9-22
 - Windows 1-24
- Pregnancy, Using Safety Belts 2-26
- Privacy
 - Radio Frequency Identification (RFID) 12-17
- Program
 - Courtesy Transportation 12-9
- Proposition 65 Warning, California 9-2

R

- Radio Frequency Identification (RFID) 12-17
- Statement 12-17

Radios
 AM-FM Radio 6-11
 CD/DVD Player 6-21
 Reception 6-18
 Satellite 6-14
 Reading Lamps 5-6
 Rear Axle
 Limited-Slip 8-37
 Rear Climate Control System ... 7-5
 Rear Seat Audio (RSA)
 System 6-45
 Rear Seat Entertainment
 System 6-36
 Rear Seat Audio (RSA) 6-45
 Rear Seat
 Pass-Through Door 2-13
 Rear Seats 2-11
 Heated 2-12
 Rear Vision Camera (RVC) 8-43
 Rear Window Washer/Wiper 4-9
 Rearview Mirrors 1-22
 Automatic Dimming 1-23
 Reclining Seatbacks 2-7
 Recommended Fluids and
 Lubricants 10-6
 Recommended Fuel 8-47

Records
 Maintenance 10-9
 Recreational Vehicle
 Towing 9-105
 Reimbursement Program,
 GM Mobility 12-5
 Remote Keyless Entry (RKE)
 System 1-3
 Remote Vehicle Start 1-9
 Replacement Bulbs 9-43
 Replacement Parts
 Airbags 2-42
 Maintenance 10-8
 Replacing Airbag System 2-42
 Replacing LATCH System
 Parts After a Crash 2-57
 Replacing Safety Belt
 System Parts After a
 Crash 2-27
 Reporting Safety Defects
 Canadian Government 12-15
 General Motors 12-15
 U.S. Government 12-14
 Retained Accessory
 Power (RAP) 8-20

Ride Control Systems
 Limited Slip Rear Axle 8-37
 Messages 4-38
 Selective 8-37
 Roadside Service 12-6
 Roof
 Sunroof 1-27
 Roof Rack System 3-10
 Rotation, Tires 9-66
 Routing, Engine Drive Belt 11-4
 Running the Vehicle While
 Parked 8-25

S

Safety Belts 2-13
 Care 2-27
 Extender 2-26
 How to Wear Safety Belts
 Properly 2-17
 Lap-Shoulder Belt 2-22
 Messages 4-39
 Reminders 4-17
 Replacing After a Crash 2-27
 Use During Pregnancy 2-26

| | | | |
|----------------------------|------------|------------------------------|------|
| Safety Defects Reporting | | StabiliTrak® OFF Light | 4-25 |
| Canadian Government | 12-15 | StabiliTrak® System | 8-35 |
| General Motors | 12-15 | Start Assist, Hills | 8-33 |
| U.S. Government | 12-14 | Start Vehicle, Remote | 1-9 |
| Safety Locks | 1-12 | Starter Switch Check | 9-28 |
| Safety System Check | 2-26 | Starting the Gasoline | |
| Satellite Radio | 6-14 | Engine | 8-20 |
| Scheduled Maintenance | 10-2 | Starting the Vehicle | |
| Scheduling Appointments | 12-8 | Messages | 4-39 |
| Sealant Kit, Tire | 9-76, 9-84 | Steering | 8-5 |
| Seats | | Fluid, Power | 9-22 |
| Adjustment, Front | 2-4 | Wheel Adjustment | 4-6 |
| Head Restraints | 2-2 | Wheel Controls | 4-6 |
| Heated and Ventilated | | Storage | |
| Front | 2-10 | Mass Media (MEM) | 6-25 |
| Heated Front | 2-8 | Storage Areas | |
| Heated, Rear | 2-12 | Armrest | 3-2 |
| Lumbar Adjustment, Front | 2-6 | Cargo Cover | 3-3 |
| Power Adjustment, Front | 2-4 | Cargo Management System | 3-5 |
| Rear | 2-11 | Center Console | 3-2 |
| Reclining Seatbacks | 2-7 | Convenience Net | 3-10 |
| Securing Child | | Front | 3-2 |
| Restraints | 2-57, 2-59 | Glove Box | 3-1 |
| Security | | Roof Rack System | 3-10 |
| Light | 4-28 | Storing the Tire Sealant and | |
| Vehicle | 1-17 | Compressor Kit | 9-93 |
| Selective Ride Control | 8-37 | | |
| Service | | | |
| Accessories and | | | |
| Modifications | 9-3 | | |
| Doing Your Own Work | 9-4 | | |
| Engine Soon Light | 4-20 | | |
| Maintenance Records | 10-9 | | |
| Maintenance, General | | | |
| Information | 10-1 | | |
| Parts Identification Label | 11-1 | | |
| Publications Ordering | | | |
| Information | 12-13 | | |
| Scheduling Appointments | 12-8 | | |
| Vehicle Messages | 4-39 | | |
| Servicing the | | | |
| Airbag-Equipped Vehicle | 2-40 | | |
| Shifting | | | |
| Into Park | 8-22 | | |
| Out of Park | 8-23 | | |
| Signals, Turn and | | | |
| Lane-Change | 5-5 | | |
| Spare Tire | | | |
| Compact | 9-100 | | |
| Specifications and | | | |
| Capacities | 11-2 | | |
| Speedometer | 4-15 | | |

Stuck Vehicle 8-11
 Sun Visors 1-27
 Sunroof 1-27
 Symbols iv
 System
 Roof Rack 3-10

T

Tachometer 4-15
 Text Telephone (TTY) Users ... 12-4
 Theft-Deterrent Systems 1-19
 Immobilizer 1-19
 Thigh Support Adjustment 2-7
 Throttle, Adjustable 8-18
 Time 4-10
 Tires
 Buying New Tires 9-68
 Chains 9-74
 Changing 9-93
 Compact Spare 9-100
 Designations 9-55
 Different Size 9-70
 If a Tire Goes Flat 9-74

Tires (cont.)
 Inflation Monitor System 9-62
 Inspection 9-66
 Messages 4-40
 Pressure 9-60
 Pressure Light 4-26
 Pressure Monitor System 9-61
 Rotation 9-66
 Sealant and
 Compressor Kit 9-76, 9-84
 Sealant and Compressor
 Kit, Storing 9-93
 Sidewall Labeling 9-53
 Terminology and
 Definitions 9-56
 Uniform Tire Quality
 Grading 9-71
 Wheel Alignment and Tire
 Balance 9-73
 Wheel Replacement 9-73
 When It Is Time for New
 Tires 9-68

Towing
 Driving Characteristics 8-52
 Equipment 8-60
 General Information 8-52
 Recreational Vehicle 9-105
 Trailer 8-56
 Trailer Sway Control (TSC) ... 8-61
 Vehicle 9-105
 Traction
 Control System (TCS) 8-34
 Control System (TCS)/
 StabiliTrak® Light 4-25
 Limited-Slip Rear Axle 8-37
 Off Light 4-25
 Selective Ride Control 8-37
 Trailer
 Sway Control (TSC) 8-61
 Trailer Towing 8-56
 Transmission
 Automatic 8-25
 Fluid, Automatic 9-13
 Messages 4-40
 Transportation Program,
 Courtesy 12-9

| | |
|---------------------------------------|------|
| Turbo Gauge | 4-16 |
| Turn and Lane-Change Signals | 5-5 |
| Twilight Sentinel | 5-4 |

U

| | |
|---------------------------------------|------|
| Ultrasonic Parking Assist | 8-40 |
| Uniform Tire Quality Grading | 9-71 |
| Universal Remote System | 4-48 |
| Operation | 4-52 |
| Programming | 4-49 |
| Using this Manual | iv |

V

| | |
|-----------------------|-------|
| Vehicle | |
| Canadian Owners | iii |
| Control | 8-4 |
| Load Limits | 8-11 |
| Messages | 4-33 |
| Personalization | 4-41 |
| Remote Start | 1-9 |
| Security | 1-17 |
| Towing | 9-105 |

| | |
|--|------|
| Vehicle Care | |
| Storing the Tire Sealant and Compressor Kit | 9-93 |
| Tire Pressure | 9-59 |
| Vehicle Identification | |
| Number (VIN) | 11-1 |
| Service Parts Identification Label | 11-1 |
| Vehicle Reminder | |
| Messages | 4-41 |
| Ventilation, Air | 7-6 |
| Visors | 1-27 |

W

| | |
|---|------|
| Warning Lights, Gauges, and Indicators | 4-13 |
| Warnings | iv |
| Cautions and Danger | iv |
| Hazard Flashers | 5-5 |
| Washer Fluid | 9-23 |
| Washer Fluid Messages | 4-41 |
| Washer, Headlamps | 4-9 |

| | |
|---|------|
| Wheels | |
| Alignment and Tire Balance | 9-73 |
| Different Size | 9-70 |
| Replacement | 9-73 |
| When It Is Time for New Tires | 9-68 |
| Where to Put the Child Restraint | 2-50 |
| Windows | 1-23 |
| Power | 1-24 |
| Windshield | |
| Wiper/Washer | 4-7 |
| Winter Driving | 8-9 |
| Wiper Blade Replacement | 9-29 |
| Wipers | |
| Rear Washer | 4-9 |