



LYRIQ  
OWNER'S MANUAL

2023



## Contents

Introduction .....	1
Keys, Doors, and Windows .....	6
Seats and Restraints .....	32
Storage .....	77
Instruments and Controls .....	81
Lighting .....	114
Infotainment System .....	123
Climate Controls .....	151
Driving and Operating .....	157
Vehicle Care .....	247
Service and Maintenance .....	297
Technical Data .....	302
Customer Information .....	304
Reporting Safety Defects .....	312
OnStar .....	316
Connected Services .....	321
Index .....	324

Litho in U.S.A.

Part No. 23LYRIQ\_enUS\_15644413B\_2022JUL29\_D

## Introduction

### California Proposition 65 Warning



©2022 General Motors LLC. All Rights Reserved.

### Introduction



The names, logos, emblems, slogans, vehicle model names, and vehicle body designs appearing in this manual including, but not limited to, GM, the GM logo, the CADILLAC Emblem, CADILLAC, and LYRIQ are trademarks and/or service marks of General Motors LLC, its subsidiaries, affiliates, or licensors.

For vehicles first sold in Canada, substitute the name “General Motors of Canada Company” for Cadillac Motor Car Division wherever it appears in this manual.

This manual describes features that may or may not be on the vehicle because of optional equipment that was not purchased on the vehicle, model variants, country specifications, features/applications that may not be available in your region, or changes subsequent to the printing of this owner’s manual, including changes in standard or optional content.

Refer to the purchase documentation relating to your specific vehicle to confirm the features.

Keep this manual in the vehicle for quick reference.

### Canadian Vehicle Owners

A French language manual can be obtained from your dealer, at [www.helminc.com](http://www.helminc.com), or from:

#### Propriétaires Canadiens

On peut obtenir un exemplaire de ce guide en français auprès du concessionnaire ou à l'adresse suivante:

Helm, Incorporated  
Attention: Customer Service  
47911 Halyard Drive  
Plymouth, MI 48170  
USA

### Using this Manual

To quickly locate information about the vehicle, use the Index in the back of the manual. It is an alphabetical list of what is in the manual and the page number where it can be found.

### Danger, Warning, and Caution

Warning messages found on vehicle labels and in this manual describe hazards and what to do to avoid or reduce them.

#### **Danger**

Danger indicates a hazard with a high level of risk which will result in serious injury or death.

#### **Warning**

Warning indicates a hazard that could result in injury or death.

#### **Caution**

Caution indicates a hazard that could result in property or vehicle damage.





A circle with a slash through it is a safety symbol which means “Do not,” “Do not do this,” or “Do not let this happen.”

## Symbols

The vehicle has components and labels that use symbols instead of text. Symbols are shown along with the text describing the operation or information relating to a specific component, control, message, gauge, or indicator.

 : Shown when the owner’s manual has additional instructions or information.

 : Shown when the service manual has additional instructions or information.

 : Shown when there is more information on another page — “see page.”

### Vehicle Symbol Chart

Here are some additional symbols that may be found on the vehicle and what they mean. See the features in this manual for information.

 : Air Conditioning System

 : Air Conditioning Refrigerant Oil

 : Airbag Readiness Light

 : Antilock Brake System (ABS)

 : Brake System Warning Light

 : Dispose of Used Components Properly

 : Do Not Apply High Pressure Water

 : Energy Usage and Charge Mode Selection

 : Flame/Fire Prohibited

 : Flammable

 : First Responder

 : Forward Collision Alert

 : Fuse Block Cover Lock Location

 : Fuses

 : High Voltage

 : ISOFIX/LATCH System Child Restraints

 : Keep Fuse Block Covers Properly Installed

 : Lane Change Alert

 : Lane Departure Warning

 : Lane Keep Assist

 : Park Assist

 : Pedestrian Ahead Indicator

 : Power

 : Rear Cross Traffic Alert

 : Registered Technician

 : Remote Vehicle Start

 : Risk of Electrical Fire

 : Seat Belt Reminders

 : Service Vehicle Soon

 : Side Blind Zone Alert

 : Tire Pressure Monitor

 : Traction Control/StabiliTrak/Electronic Stability Control (ESC)

 : Under Pressure

 : Vehicle Ahead Indicator

 : Vehicle Ready

## Instrument Panel Overview

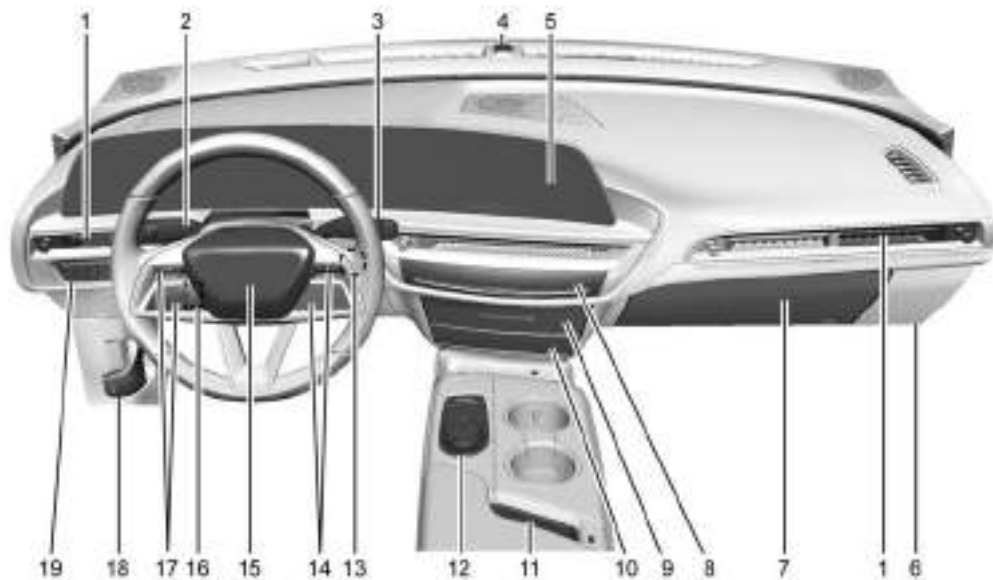

1. *Air Vents* ⇨ 154.
2. *Turn Signal Lever*. See *Turn and Lane-Change Signals* ⇨ 119.  
*Windshield Wiper/Washer* ⇨ 83.
3. *Shift Lever*. See *Electric Drive Unit* ⇨ 171.
4. *Light Sensor*. See *Automatic Headlamp System* ⇨ 116.
5. *Infotainment Display*. See *Introduction* ⇨ 123.  
*Instrument Cluster* ⇨ 89.
6. *Instrument Panel Fuse Block* ⇨ 266.
7. *Glove Box* ⇨ 77.
8. *Dual Automatic Climate Control System* ⇨ 151.
9. *Sliding Storage Tray*. See *Instrument Panel Storage* ⇨ 77 (If Equipped).
10. *Lower Storage*. See *Instrument Panel Storage* ⇨ 77 (If Equipped).
11. *Wireless Charging* ⇨ 86.
12. *Infotainment Controls*.
13. *Power Button* ⇨ 168 (Out of View).
14. *Radio Controls*. See *Steering Wheel Controls* ⇨ 125.
15. *Horn* ⇨ 82.
16. *Steering Wheel Adjustment* ⇨ 82 (Out of View).
17. *Adaptive Cruise Control (Advanced)* ⇨ 181.  
*Super Cruise* ⇨ 190.  
*Forward Collision Alert (FCA) System* ⇨ 216 (If Equipped).  
*Heated Steering Wheel* ⇨ 82.
18. *Hood Release*. See *Hood* ⇨ 250.
19. *Electric Parking Brake* ⇨ 175.  
*Lane Keep Assist (LKA)* ⇨ 224 (If Equipped).  
*Automatic Vehicle Hold (AVH)* ⇨ 177.  
*Instrument Panel Illumination Control* ⇨ 120.

## Keys, Doors, and Windows

### Keys and Locks

Keys .....	6
Remote Key .....	7
Remote Key Operation .....	7
Remote Start .....	12
Door Locks .....	13
Power Door Locks .....	15
Delayed Locking .....	15
Automatic Door Locks .....	15
Lockout Protection .....	15
Safety Locks .....	16
Digital Key .....	16

### Doors

Liftgate .....	16
----------------	----

### Vehicle Security

Vehicle Security .....	22
Vehicle Alarm System .....	22
Immobilizer .....	23
Immobilizer Operation .....	23

### Exterior Mirrors

Convex Mirrors .....	24
Power Mirrors .....	24
Folding Mirrors .....	25
Heated Mirrors .....	26

### Interior Mirrors

Interior Rearview Mirrors .....	26
Manual Rearview Mirror .....	26
Automatic Dimming Rearview Mirror ...	26
Rear Camera Mirror .....	26

### Windows

Windows .....	28
Power Windows .....	29
Sun Visors .....	30

### Roof

Sunroof .....	30
---------------	----

## Keys and Locks

### Keys



#### Warning

Leaving children in a vehicle with a remote key is dangerous and children or others could be seriously injured or killed. They could operate the power windows or other controls or make the vehicle move. The windows will function with the remote key in the vehicle, and children or others could be caught in the path of a closing window. Do not leave children in a vehicle with a remote key.



The mechanical key that is inside of the remote can be used for all locks.



To remove the mechanical key, press the button near the bottom of the remote key, and pull the key out. Never pull the mechanical key out without pressing the button.

If it becomes difficult to turn the key, inspect the key blade for debris. Periodically, clean the key with a brush or a pick.

See your dealer if a new key is needed.

If locked out of the vehicle, see *Roadside Assistance Program* ⇨ 307.

With an active OnStar or connected service plan, an OnStar Advisor may remotely unlock the vehicle. See *OnStar Overview* ⇨ 316.

## Remote Key

See *Radio Frequency Statement* ⇨ 312.

If there is a decrease in the Remote Keyless Entry (RKE) operating range:

- Check the distance. The transmitter may be too far from the vehicle.
- Check the location. Other vehicles or objects may be blocking the signal.
- Check the transmitter's battery. See "Battery Replacement" later in this section.
- If the transmitter is still not working correctly, see your dealer or a qualified technician for service.

## Remote Key Operation

The Keyless Access system allows for vehicle entry when the remote key is within 1 m (3 ft). See "Keyless Access Operation" following.

The remote key functions may work up to 60 m (197 ft) away from the vehicle.

Other conditions can impact the performance of the remote key. See *Remote Key* ⇨ 7.



 : Press to lock all doors.

If enabled, the turn signal indicators may flash and/or the horn may sound on the second press to indicate locking. To view available settings for this feature, touch the Settings icon on the infotainment home page. Select "Vehicle" to display the list of available options and select "Remote Lock, Unlock, Start".

If the driver door is open when  is pressed, all doors will lock and the driver door will immediately unlock, if enabled. To view available settings for this feature,





## 8 Keys, Doors, and Windows

touch the Settings icon on the infotainment home page. Select “Vehicle” to display the list of available options and select “Remote Lock, Unlock, Start”.

If the passenger door is open when  is pressed, all doors lock.

If equipped with auto mirror folding, double press and hold  for one second to fold the mirrors, if enabled. To view available settings for this feature, touch the Settings icon on the infotainment home page. Select “Vehicle” to display the list of available options and select “Comfort and Convenience”.

Pressing  may also arm the alarm system. See *Vehicle Alarm System* ⇨ 22.

 : Press to unlock the driver door. Press unlock again within three seconds to unlock all doors. The remote key can be programmed to unlock all doors on the first button press. To view available settings for this feature, touch the Settings icon on the infotainment home page. Select “Vehicle” to display the list of available options and select “Remote Lock, Unlock, Start”.



If enabled, the turn signal lamps flash twice to indicate that the unlocking has occurred. The exterior lamps may also be programmed to turn on. To view available settings for this feature, touch the Settings icon on the infotainment home page. Select “Vehicle” to display the list of available options and select “Remote Lock, Unlock, Start”.



If equipped with auto mirror unfolding, double press and hold  until the mirrors fully open. To view available settings for this feature, touch the Settings icon on the infotainment home page. Select “Vehicle” to display the list of available options and select “Comfort and Convenience”.

Pressing  will disarm the alarm system. See *Vehicle Alarm System* ⇨ 22.

 : Press twice to open or close the liftgate. Press once to stop the liftgate from moving. The vehicle must be in P (Park).

 : Press and release one time to initiate vehicle locator. The exterior lamps flash and the horn chirps three times.

Press and hold  for at least three seconds to sound the panic alarm. The horn sounds and the turn signals flash for about 30 seconds or until  is pressed again or the vehicle is started.

 : Press and release  and then immediately press and hold  for at least four seconds to start the vehicle’s heating or air conditioning systems and rear window defogger from outside the vehicle using the remote key. See *Remote Start* ⇨ 12.

### Keyless Access Operation

The Keyless Access system allows the doors and liftgate to be unlocked without pressing the remote key button. The remote key must be within 1 m (3 ft) of the liftgate or door being opened.

Doors can be programmed to the lock after exiting the vehicle through Passive locking or delayed locking. The remote key can also be used to lock the doors

Keyless Access can be programmed to unlock all doors on the first unlock button press from the driver door. To view available settings for this feature, touch the Settings icon on the infotainment home page. Select

“Vehicle” to display the list of available options and select “Remote Lock, Unlock, Start”.

### Keyless Unlocking from the Driver Door

When the doors are locked and the remote key is within 1 m (3 ft) of the driver door handle, pressing and holding the large end of the unlock button on the driver door handle will unlock and unlatch the driver door.





### Keyless Unlocking/Locking from Passenger Doors

When the doors are locked and the remote key is within 1 m (3 ft) of the door unlocking button, pressing and holding the large end of the unlock button on that door will unlatch the door and unlock all doors.



### Disable/Enable Keyless Unlocking of Exterior Door Handles and Liftgate

If equipped, keyless unlocking of the exterior door handles and liftgate can be disabled and enabled.

#### Disabling Keyless Unlocking:

With the vehicle off, press and hold  and  on the remote key at the same time for approximately three seconds. The turn signal lamps will flash four times quickly to indicate access is disabled. Using any exterior handle to unlock the doors or open the liftgate will cause the turn signal lamps to flash four times quickly, indicating access is disabled. If disabled, disarm the alarm system before starting the vehicle.

#### Enabling Keyless Unlocking:

With the vehicle off, press and hold  and  on the remote key at the same time for approximately three seconds. The turn signal lamps will flash twice quickly to indicate access is enabled.

#### Passive Locking



The Keyless Access system will lock the vehicle several seconds after all doors are closed, if the vehicle is off and at least one remote key has been removed from the interior or none remain in the interior.

If other electronic devices interfere with the remote key signal, the vehicle may not detect the remote key inside the vehicle.

If passive locking is enabled, the doors may lock with the remote key inside the vehicle. Do not leave the remote key in an unattended vehicle.

To view available settings for this feature, touch the Settings icon on the infotainment home page. Select “Vehicle” to display the list of available options and select “Power Door Locks”.

### Temporary Disable of Passive Locking

Temporarily disable passive locking by pressing and holding  on the interior door switch with a door open for at least four seconds, or until three chimes are heard. Passive locking will then remain disabled until  on the interior door is pressed, or until the vehicle is started.

### Remote Left In Vehicle Alert

When the vehicle is turned off and a remote key is left in the vehicle, the horn will chirp three times after all doors are closed.

To view available settings for this feature, touch the Settings icon on the infotainment home page. Select “Vehicle” to display the list of available options and select “Remote Lock, Unlock, Start”.

### Remote Removed From Vehicle Alert

If the vehicle is on with a door open, and then all doors are closed, the vehicle will check for remote keys inside. If a remote key is not detected, the Driver Information Center (DIC) will display NO KEY FOUND and the horn will chirp three times.

This occurs only once each time the vehicle is driven.

To view available settings for this feature, touch the Settings icon on the infotainment home page. Select “Vehicle” to display the list of available options and select “Remote Lock, Unlock, Start”.

### Keyless Liftgate Opening

Press the touch pad on the underside of the liftgate glass and lift up to open if the remote key is within 1 m (3 ft) and the doors are locked. If the doors are unlocked, the remote key is not required to open the liftgate. See *Liftgate* ⇨ 16.

### Key Access

To access a vehicle with a weak remote key battery, see *Door Locks* ⇨ 13.

### Programming Remote Keys to the Vehicle

Only remote keys programmed to the vehicle will work. If a remote key is lost or stolen, a replacement can be purchased and programmed through your dealer. The vehicle can be reprogrammed so that lost or stolen remote keys no longer work. Any remaining remote keys will need to be reprogrammed. Each vehicle can have up to eight remote keys matched to it.

### Starting the Vehicle with a Low Remote Key Battery

For improved Vehicle security, the remote key is equipped with a motion sensor. When starting the vehicle, if the remote key has been idle for an extended period of time, the DIC may display KEY IN SLEEP MODE, MOVE KEY, THEN START. Move the remote key slightly and try starting the vehicle.

If the remote key battery is weak or if there is interference with the signal, the DIC may display NO KEY FOUND, REPLACE BATTERY IN KEY or NO REMOTE KEY WAS DETECTED PLACE KEY IN KEY POCKET THEN START YOUR VEHICLE when starting the vehicle.

To start the vehicle:



1. Place the remote key in the rear cupholder with the buttons facing down.
2. With the vehicle in P (Park) or N (Neutral), press the brake pedal and press POWER . Replace the remote key battery as soon as possible.

**Battery Replacement**

** Warning**

Never allow children to play with the remote key. The remote key contains a small battery, which can be a choking hazard. If swallowed, internal burns can  
(Continued)

**Warning (Continued)**

occur, resulting in severe injury or death. Seek medical attention immediately if a battery is swallowed.

** Warning**

To avoid personal injury, do not touch metal surfaces on the remote key when it has been exposed to extreme heat. These surfaces can be hot to the touch at temperatures above 59 °C (138 °F).

**Caution**

When replacing the battery, do not touch any of the circuitry on the remote key. Static from your body could damage the remote key.

**Caution**

Always replace the battery with the correct type. Replacing the battery with an incorrect type could potentially create a risk of battery explosion. Dispose of  
(Continued)

**Caution (Continued)**

used batteries according to instructions and local laws. Do not attempt to burn, crush, or cut the used battery, and avoid exposing the battery to environments with extremely low air pressures or high temperatures.

**Caution**

If the remote key is not reassembled properly, liquids could enter the housing and damage the circuitry, resulting in a remote key malfunction and/or failure. To prevent damage, always follow the steps for remote key reassembly in this manual to ensure the remote key is sealed properly whenever the remote key is opened.

Replace the battery if the DIC displays REPLACE BATTERY IN KEY.

## 12 Keys, Doors, and Windows

The battery is not rechargeable. To replace the battery:



1. Press the button on the side of the remote key near the bottom and pull the mechanical key out. Never pull the mechanical key out without pressing the button.



2. Use the mechanical key blade in the slot to remove the battery cover by hand.



3. Remove the battery cover.

4. Pull the seal by pulling on the tab to access the battery.
5. Remove the old battery. Do not use a metal object.
6. Insert the new battery, positive side facing up. Replace with a CR2450 or equivalent battery.
7. Place the seal back into the groove around the battery compartment.
8. Replace the battery cover by snapping it back into the remote key.
9. Reinsert the mechanical key.

### Remote Start

This feature starts the heating or air conditioning systems and the rear window defogger from outside the vehicle.

If the outside temperature is below 7°C (45°F), and the rear window defogger is on, the area of the windshield beneath the windshield wipers will warm up to melt accumulated snow or ice.

Use remote start to heat or cool the interior when the vehicle is plugged in to maximize electric range by utilizing electricity from the electrical outlet. Normal system operation will return after the vehicle has been turned on.

 : This button is on the remote key.

The climate control system will use the previous settings during a remote start. The rear defog may come on during a remote start based on cold ambient conditions. The rear defog indicator light will not come on during a remote start.

Laws in some local communities may restrict the use of remote starters. For example, some laws require a person using remote start to have the vehicle in view. Check local regulations for any requirements.

The vehicle cannot be remote started if:

- The remote key is in the vehicle.
- The hood is open.
- The total 40 minutes of remote start time has been used.
- The hazard flashers are on.
- The vehicle is not in P (Park).
- The vehicle is already started.

If the battery level is low, do not use the remote start feature. The battery may fully deplete.

The remote key range may be less while the vehicle is running.

Other conditions may affect the range and performance of the remote key. See *Remote Key* ⇨ 7.

### Starting the Vehicle Using Remote Start

Press  twice on the remote key. The turn signal lamps will flash to confirm the remote start request was received. During the remote start, the parking lamps will remain on as long as the vehicle is on.

The vehicle will turn off after 20 minutes, unless you stop the remote start before remote start cycle has completed or the vehicle is turned on.

Press the brake pedal and press POWER  to drive the vehicle.

### Extending Remote Start Time

Remote start can be used for up to 40 minutes of total remote start time.

After two remote starts of 20 minutes, or multiple shorter time starts totaling 40 minutes have been used, the vehicle must be started and then turned off before the remote start can be used again.

### Canceling a Remote Start

To cancel a remote start, do one of the following:

- Press . The parking lamps will turn off.
- Turn on the hazard warning flashers.
- Turn the vehicle on and then off.

### Door Locks

#### Warning

Unlocked doors can be dangerous.



- Passengers, especially children, can easily open the doors and fall out of a moving vehicle. The doors can be unlocked and opened while the vehicle is moving. The chance of being thrown out of the vehicle in a crash is increased if the doors are not locked. So, all passengers should wear seat belts properly and the doors should be locked whenever the vehicle is driven.

(Continued)

### Warning (Continued)



- Young children who get into unlocked vehicles may be unable to get out. A child can be overcome by extreme heat and can suffer permanent injuries or even death from heat stroke. Always lock the vehicle whenever leaving it.
- Outsiders can easily enter through an unlocked door when you slow down or stop the vehicle. Locking the doors can help prevent this from happening.

To lock or unlock the doors from outside the vehicle:

- Use the key in the liftgate to lock and unlock the door without the remote key. See *Liftgate* ⇨ 16.
- Press  or  on the remote key to lock and unlock the doors.



To lock or unlock the doors from inside the vehicle:

- Press  or  on the power door lock switch.
- Pull the door handle up. It is located on the door trim. Pulling an interior door handle will unlock the door. Pull the front door handle once to unlock and open it. Pull the rear door handle once to unlock it and again to open it.

### Keyless Access

The remote key must be within 1 m (3 ft) of the liftgate or door being opened. Press and hold the button on the door handle to open. See “Keyless Access Operation” in *Remote Key Operation* ⇨ 7.

### Opening a Door from the Exterior

To open a front or rear passenger door from outside of the vehicle:



1. Press and hold the door handle button until the door begins to unlatch
2. Wait for the door to unlatch and partially open



- Grab the handle on the exterior door trim and pull to open

## Power Door Locks



 : Press to unlock the doors.

 : Press to lock the doors.



Locking and unlocking the doors will also unlock the liftgate. See *Liftgate* ⇨ 16.

## Delayed Locking

This feature delays the locking of the doors until five seconds after all doors are closed.

When  is pressed on the power door lock switch while the door is open, a chime will sound three times indicating delayed locking is active.

The doors will lock automatically five seconds after all doors are closed. If a door is reopened before that time, the five-second timer will reset when all doors are closed again.

Press  on the door lock switch again or press  on the remote key to lock the doors immediately.

To view available settings for this feature, touch the Settings icon on the infotainment home page. Select “Vehicle” to display the list of available options and select “Power Door Locks”.

## Automatic Door Locks

The doors will lock automatically when all doors are closed, the vehicle is on, and the shift switch is out of P (Park).

If a vehicle door is unlocked and then opened and closed, the doors will lock either when your foot is removed from the brake or the vehicle speed becomes faster than 13 km/h (8 mph).

To unlock the doors:

- Press  on a door.
- Shift the vehicle into P (Park).

Automatic door unlocking can be programmed. To view available settings for this feature, touch the Settings icon on the infotainment home page. Select “Vehicle” to display the list of available options and select “Power Door Locks”.

## Lockout Protection

This feature protects you from locking remote keys in the vehicle.

When the lock button is pressed and the vehicle is on, with the driver door open, all of the doors will lock and then the driver door will unlock.



If the vehicle is off and locking is requested while a door is open, when all doors are closed the vehicle will check for remote keys inside. If a remote key is detected and the number of remote keys inside has not reduced, the driver door will unlock and the horn will sound three times.

This can be manually overridden by pressing and holding  on the power door lock switch.

### Safety Locks

The rear door safety locks prevent passengers from opening the rear doors from inside the vehicle.

To activate the safety locks:

1. Touch the settings icon on the infotainment display.
2. Select Controls.
3. Touch DRIVE & PARK and then Child Safety Locks.
4. Select Off or On to activate or deactivate the safety locks.

### Digital Key

If equipped and enabled, the Digital Key feature allows you to access and operate the vehicle using a smartphone or other compatible device.

Only certain smartphones and devices support Digital Key. Please see [www.cadillac.com](http://www.cadillac.com) for a list of compatible devices.

If the smartphone battery is out of charge, the DIC will display NO KEY FOUND. Charge the smartphone battery as soon as possible.

#### Obtaining a Digital Key for a Device

Digital Key is only available with an OnStar account associated with the vehicle.

1. Log in to your Digital Key account in the MyCadillac mobile app.
2. Select the Digital Key menu option, and enroll your phone.
3. Once the phone is successfully activated, enter the vehicle with your phone and a remote key.
4. Select “Pair” in the phone app.
5. When the Digital Key is successfully created, a notification will display in the phone app.

### Using Your Digital Key



Digital Key allows you to:



- Automatically turn on exterior lighting when approaching the vehicle with your phone.
- Passively lock and unlock the vehicle’s doors, and access the front or rear compartments, without a remote key, or having to retrieve your phone from a pocket or bag.
- Start and drive with your phone present inside the vehicle.
- Share digital keys for the vehicle with other devices, remotely.

## Doors

### Liftgate

Caution
To avoid damage to the liftgate or liftgate glass, make sure the area above and behind the liftgate is clear before opening it.

To lock or unlock the liftgate from the outside, press  or  on the remote key.

To lock or unlock the liftgate from the inside, press  or  on the instrument panel.

### Power Liftgate Operation

#### Warning

You or others could be injured if caught in the path of the power liftgate. Make sure there is no one in the way of the liftgate as it is opening and closing.

#### Caution

Driving with an open and unsecured liftgate may result in damage to the power liftgate components.

### Power Liftgate Mode Selection

To view available settings from the infotainment screen, touch Settings > Vehicle > Comfort and Convenience > Power Rear Gate Opening.

Choose from the following selections:

**Maximum** : Opens to the maximum height.

**Custom** : Opens to a reduced height that can be set between a programmed height and fully open. See “Setting the Custom Opening Height” later in this section.

Use to prevent the liftgate from opening into overhead obstructions, such as a garage door or roof-mounted cargo. The liftgate can be manually opened all the way.

**Off** : Opens manually only.

Select Maximum or Custom to power open or close the liftgate.

To open or close the liftgate using the remote key, press  twice quickly until the liftgate moves.

### Operating the Power Liftgate from the Inside



To open or close the liftgate from the inside, press .

### Keyless Liftgate Opening

The remote key must be within 1 m (3 ft), when the doors are locked, to open the liftgate. If the doors are unlocked, the remote key is not required to open the liftgate.

Press the Cadillac emblem on the underside of the liftglass to power open the liftgate when the power liftgate mode is set to Maximum or Custom.

## 18 Keys, Doors, and Windows

Press the Cadillac emblem on the underside of the liftgate glass and lift up to open when the power liftgate mode is set to Off.

See “Power Liftgate Mode Selection” earlier in this section.



To open the liftgate, press the Cadillac emblem.



When closing the liftgate, press the button on the bottom of the gate.

Press any liftgate button, the Cadillac emblem, or  on the remote key while the liftgate is moving to stop it.

Pressing any liftgate button or pressing  twice quickly on the remote key restarts the operation in the reverse direction. Pressing the Cadillac emblem will restart the motion, but only in the opening direction.

### Caution

Manually operating the liftgate during a power open or close can damage the liftgate system. Always wait for the power operation to complete before manually operating the liftgate.

The power liftgate may be temporarily disabled in extremely low temperatures, or after repeated opening and closings over a short period of time. If this occurs, the liftgate can still be operated manually.

If the vehicle is shifted out of P (Park) while the power liftgate operation is in progress, the operation will continue to completion. If the vehicle is driven before the liftgate has completed moving, the liftgate may stop or reverse direction. Check for Driver Information Center (DIC) messages, and make sure that the liftgate is closed and latched before driving.

### Falling Liftgate Detection

If the power liftgate automatically closes after a power opening cycle, it indicates that the system is reacting to excess weight on the liftgate or a possible support strut failure. A repetitive chime will sound while the falling liftgate detection feature is

operating. Remove any excess weight. If the liftgate continues to automatically close after opening, see your dealer for service before using the power liftgate.

Interfering with the power liftgate motion or manually closing the liftgate too quickly after power opening may resemble a support strut failure. This could also activate the falling liftgate detection feature. Allow the liftgate to complete its operation and wait a few seconds before manually closing the liftgate.

### Obstacle Detection Features

If the liftgate encounters an obstacle during a power open or close cycle, the liftgate will automatically reverse direction and move a short distance away from the obstacle. After removing the obstruction, the power liftgate operation can be used again. If the liftgate encounters multiple obstacles on the same power cycle, the power function will deactivate. After removing the obstructions, manually close the liftgate. This will allow normal power operation functions to resume.

If the vehicle is locked while the liftgate is closing, and an obstacle is encountered that prevents the liftgate from completely closing, the horn will sound as an alert that the liftgate did not close.

### Setting the Custom Opening Height

To change the position the liftgate stops at when opening:

1. Select MAX or Custom mode and power open the liftgate.
2. Stop the liftgate movement at the desired height by pressing any liftgate button. Manually adjust the liftgate position if needed.
3. Press and hold  on the bottom edge of the liftgate next to the latch on the outside of the liftgate until the turn signals flash and a beep sounds. This indicates the setting has been recorded.

The liftgate cannot be set below a minimum programmable height. If there is no light flash or sound, then the height adjustment may be too low.

### Liftgate Key Lock Cylinder Access (In Case of Dead Battery)



To access the liftgate key lock cylinder, insert the mechanical key into the cylinder and turn to unlock. See *Keys* ⇨ 6.

### Free-Turning Locks

The key cylinder turns freely when either the wrong key is used, or the correct key is not fully inserted. The free-turning lock feature prevents the lock cylinder from being forced open. To reset the lock cylinder, ensure the correct key is fully inserted into the lock cylinder and then rotate the key until you feel the lock

cylinder click back into place. Remove the key and reinsert fully. Rotate the key to unlock the vehicle.

### Hands-Free Operation

#### Regulatory Information

**FCC Radiation Exposure Statement:** : This equipment has been evaluated to be installed and operated at a minimum distance of 3.78 cm between the device and your body. The vehicle design ensures this distance is maintained during normal use. Changes or modifications to any of these systems by other than an authorized service facility could void authorization to use this equipment.

**ISED Radiation Exposure Statement:** : This equipment complies with RSS-102 radiation exposure limits set forth for an uncontrolled environment. This equipment should be installed and operated with a minimum distance of 3.78 cm between the radiator and any part of your body. The vehicle design ensures this distance is maintained during normal use. Changes or modifications to any of these systems by other than an authorized service facility could void authorization to use this equipment.

See *Radio Frequency Statement* ⇨ 312. Contains FCC ID 2A06KA1003.

If equipped, the liftgate may be operated with a kicking motion near the center of the rear bumper at the location of the projected logo.

The remote key must be within 1 m (3 ft) of the rear bumper to operate the power liftgate hands-free.

The hands-free feature will not work while the liftgate is moving. To stop the liftgate while in motion use one of the liftgate switches.

The hands-free feature can be customized. To view available settings for this feature, touch the Settings icon on the infotainment home page. Select “Vehicle” to display the list of available options and select “Comfort and Convenience”. Choose from the following:

**On-Open and Close** : The kicking motion is activated to both open and close the liftgate.

**On-Open Only** : The kicking motion is activated to only open the liftgate.

**Off** : The feature is disabled.



To operate, move your foot in a forward kicking motion under the left side of the rear bumper, at the location of the projected logo, then pull it back. Then step back. The kick must come within 14 cm (6 in) of the rear bumper to activate.

- Do not sweep your foot side to side.
- Do not keep your foot under the bumper; the liftgate will not activate.
- Do not touch the liftgate until it has stopped moving.
- This feature may be temporarily disabled under some conditions. If the liftgate does not respond to the kick, open or

close the liftgate by another method or start the vehicle. The feature will be re-enabled.

When closing the liftgate using this feature, there will be a short delay. The taillamps will flash and a chime will sound. Step away from the liftgate before it starts moving.

### Projected Logo

If equipped, a vehicle logo will be projected for one minute onto the ground near the rear bumper when a remote key is detected within approximately 2 m (6 ft) from the rear bumper. The projected logo may not be visible under brighter daytime conditions.

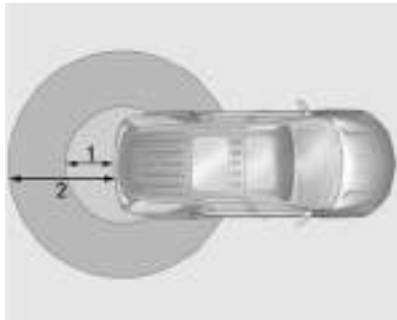

1. 1 m (3 ft) Hands-Free Operation Detection Zone
2. 2 m (6 ft) Projected Logo Detection Zone

The projected logo shows where to kick toward the rear bumper.

The projected logo will not be restarted using the same remote key unless it has been out of range for longer than 20 seconds.

If a remote key is again detected within approximately 2 m (6 ft) of the liftgate, or another kick has been detected, the one-minute timer will be reset.

The projected logo will not work under these conditions:

- The vehicle battery is low.
- The vehicle is not in P (Park).
- Hands Free Liftgate/Trunk Control is set to Off in vehicle personalization. To view available settings for this feature, touch the Settings icon on the infotainment home page. Select "Vehicle" to display the list of available options and select "Comfort and Convenience".
- Power liftgate is turned off.

- The vehicle remains parked for 72 hours or more, with no remote key use or Keyless Access operation. To re-enable, press any button on the remote key or open and close a vehicle door.

The projected logo will not work for a single remote key when a remote key:

- Has been left within approximately 5 m (15 ft) of the liftgate for several minutes.
- Has been left inside the vehicle and all vehicle doors are closed.
- Has approached the area outside of the liftgate five times within 10 minutes.

### Lens Cleaning



If equipped, use a soft clean cloth to clean the lens.

**Hands-Free Liftgate and Projected Logo Availability**

<b>Action</b>	<b>Hands-Free Liftgate</b>	<b>Projected Logo</b>
Remote key entering projected logo detection zone	Operative	On for one minute
Remote key left inside projected logo detection zone for minimum of 10 minutes	Operative	Off until remote key button press or a door is opened and closed
Remote key brought in and out of projected logo detection zone five times or more within 10 minutes	Operative	Off for one hour or until remote key button press or a door is opened and closed
Vehicle remains parked for more than 72 hours	Operative	Off until remote key button press or a door is opened and closed
Vehicle battery is low	Non-operative	Off
Vehicle is not in P (Park)	Non-operative	Off
Power liftgate is turned off	Non-operative	Off
Hands-free liftgate is disabled in vehicle personalization	Non-operative	Off

**Vehicle Security**

This vehicle has theft-deterrent features; however, they do not make the vehicle impossible to steal.

**Vehicle Alarm System****Arming the Alarm System**

1. Turn off the vehicle.

2. Lock the vehicle in one of three ways:

- Use the remote key.
- Use the Keyless Access system.
- With a door open, press  on the interior of the door.

3. After 30 seconds the alarm system will arm, and the indicator light will begin to slowly flash. Pressing  on the remote key a second time will bypass the 30-second delay and immediately arm the alarm system.

The vehicle alarm system will not arm if the doors are locked with the mechanical key.

If the driver door is opened without first unlocking with the remote key, the horn will chirp and the lights will flash to indicate pre-alarm. If the vehicle is not started, or the door is not unlocked by pressing  on the remote key during the 10-second pre-alarm, the alarm will be activated.

The alarm will also be activated if a passenger door, the tailgate, or the hood is opened without first disarming the system. When the alarm is activated, the turn signals flash and the horn sounds for about 30 seconds. The alarm system will then re-arm to monitor for the next unauthorized event.

### Disarming the Alarm System

To disarm the alarm system or turn off the alarm if it has been activated:

- Press  on the remote key.

- Unlock the vehicle using the Keyless Access system.

- Start the vehicle.

To avoid setting off the alarm by accident:

- Lock the vehicle after all occupants have exited.
- Always unlock a door with the remote key, or use the Keyless Access system.

Unlocking the driver door with the mechanical key will not disarm the system or turn off the alarm.

### How to Detect a Tamper Condition

If  is pressed on the remote key and the horn chirps three times, an alarm occurred previously while the alarm system was armed.

If the alarm has been activated, a message will appear on the Driver Information Center (DIC).

### Immobilizer

See *Radio Frequency Statement* ⇨ 312.

### Immobilizer Operation

This vehicle has a passive theft-deterrent system.

The system does not have to be manually armed or disarmed.

The vehicle is automatically immobilized when the vehicle is turned off.

The immobilization system is disarmed when the vehicle is turned and a valid remote key is present in the vehicle.



The security light, in the instrument cluster, comes on if there is a problem with arming or disarming the theft-deterrent system.

The system has one or more remote keys matched to an immobilizer control unit in the vehicle. Only a correctly matched remote key will start the vehicle. If the remote key is ever damaged, you may not be able to start your vehicle.

When trying to start the vehicle, the security light may come on briefly.

If the vehicle does not start and the security light stays on, there is a problem with the system. Turn the vehicle off and try again.



If the vehicle will not turn on or off, and the remote key appears to be undamaged, try another remote key. Or, you may try placing the remote key in the backup location. See *Remote Key Operation* ⇨ 7.

If the vehicle will not turn on or off with the other remote key or in the backup location, the vehicle needs service. If the vehicle does turn on or off, the first remote key may be faulty. See your dealer.

It is possible for the immobilizer system to learn new or replacement remote keys. Up to eight remote keys can be programmed for the vehicle. To program additional remote keys, see “Programming Remote Keys to the Vehicle” under *Remote Key Operation* ⇨ 7.

Do not leave the remote key or device that disarms or deactivates the theft-deterrent system in the vehicle.

## Exterior Mirrors

### Convex Mirrors

#### Warning





A convex mirror can make things, like other vehicles, look farther away than they really are. If you cut too sharply into the adjacent lane, you could hit a vehicle that is driving next to you. Check the inside mirror or glance over your shoulder before changing lanes.



The passenger side mirror is convex shaped so more can be seen from the driver's seat.

## Power Mirrors



To adjust the mirrors:



1. Press  or  to choose the driver or passenger mirror. An indicator will show the selected mirror.
2. Press one of the four arrows on the control pad while the indicator light on button  or  is illuminated, to move the mirror in the desired direction.
3. Adjust each outside mirror so that a little of the vehicle and the area behind it can be seen.

4. Press  or  again to deselect the mirror. If you do not deselect the mirror, the mirror adjustment will turn off after about one minute.

## Folding Mirrors



To adjust power folding mirrors:

1. Press  to fold the mirrors inward.
2. Press  again to return the mirrors to the driving position.

The outside mirrors may automatically unfold when the vehicle is driven above 20 km/h (12 mph), but may be folded with the power folding mirror switch. If the vehicle speed is driven above 40 km/h

(25 mph), they may automatically unfold and may not be refolded with the power folding mirror switch.

## Resetting the Power Folding Mirrors

Reset the power folding mirrors if:

- The mirrors are accidentally obstructed while folding.
- They are accidentally manually folded/unfolded.
- The mirrors do not stay in the unfolded position.
- The mirrors vibrate at normal driving speeds.
- One mirror folds while the other unfolds.



Fold and unfold the mirrors one time using the mirror controls to reset them to their normal position. A noise may be heard during the resetting of the power folding mirrors. This sound is normal after a manual folding operation.

If one mirror folds while the other unfolds, fold and unfold the mirrors three times using the mirror controls to reset them to their normal position. A noise may be heard during the resetting of the power folding mirrors. This sound is normal after a manual folding operation.

## Remote Mirror Folding

If the mirrors have been folded with the power folding mirror switch, they may not be unfolded by use of remote key.

If the mirrors have not been folded with the power folding mirror switch and the vehicle is in P (Park), they may be automatically folded/unfolded as follows:

- If doors are locked by pressing  on the remote key, the mirrors will fold. If doors are unlocked by pressing  on the remote key, the mirrors will unfold. See *Remote Key Operation* ⇨ 7.
- If doors are locked by pressing the door handle button, the mirrors will fold. If doors are unlocked by pressing the door handle button, the mirrors will unfold. See “Keyless Unlocking/Locking from the Driver Door” in *Remote Key Operation* ⇨ 7.
- If passive locking is enabled and doors are locked by that feature, the mirrors will fold. See “Passive Locking” in *Remote Key Operation* ⇨ 7.

## Lane Change Alert (LCA)

The vehicle may have LCA. See *Lane Change Alert (LCA)* ⇨ 222.

### Side Blind Zone Alert

The vehicle may have Side Blind Zone Alert. See *Side Blind Zone Alert (SBZA)* ⇨ 221.

### Turn Signal Indicator

The vehicle may have a turn signal indicator on the mirror housings. The indicator will flash when a turn signal or the hazard warning flashers are used.

### Heated Mirrors

If equipped with heated mirrors,  will be present on both side mirrors. The symbol does not illuminate when the heated mirrors are active.

The rear window defogger also heats the outside mirrors.

 **REAR** : Press to heat the outside rearview mirrors. See “Rear Window Defogger” under *Dual Automatic Climate Control System* ⇨ 151.

## Interior Mirrors

### Interior Rearview Mirrors

Adjust the rearview mirror for a clear view of the area behind your vehicle.

Do not spray glass cleaner directly on the mirror. Use a soft towel dampened with water.

### Manual Rearview Mirror

If equipped, push the tab forward for daytime use and pull it for nighttime use to avoid glare from the headlamps from behind.

### Automatic Dimming Rearview Mirror

If equipped, automatic dimming reduces the glare of headlamps from behind. The dimming feature comes on when the vehicle is started.

## Rear Camera Mirror

If equipped, this automatic dimming mirror provides a wide angle camera view of the area behind the vehicle.



Pull the tab to turn on the display. Push the tab to turn it off. When off, the mirror is automatic dimming. Adjust the mirror for a clear view of the area behind the vehicle while the display is off.



Press ✓ to scroll through the adjustment options.

Press ◀ and ▶ to adjust the settings using the indicators on the mirror. The indicators will remain visible for five seconds after the last button activation, and the settings will remain saved.

The adjustment options are:



- Brightness



- Zoom



- Tilt

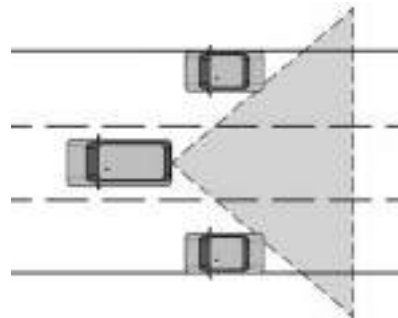

**⚠ Warning**

The Rear Camera Mirror (RCM) has a limited view. Portions of the road, vehicles, and other objects may not be seen. Do not drive or park the vehicle using only this camera. Objects may appear closer than they are. Check the outside mirrors or glance over your shoulder when making lane changes or merging. Failure to use proper care may result in injury, death, or vehicle damage.

**Troubleshooting**

See your dealer for service if a blue screen and  are displayed in the mirror, and the display shuts off. Also, push the tab as indicated to return to the automatic dimming mode.

The Rear Camera Mirror may not work properly or display a clear image if:

- There is glare from the sun or headlamps. This may obstruct objects from view. If needed, push the tab to turn off the display.
- Dirt, snow, or other debris blocks the camera lens. To clean the rear camera, see *Windshield Wiper/Washer* ⇨ 83 or clean the lens with a soft damp cloth.



- The camera's mounting on the vehicle has been damaged, and/or the position or the mounting angle of the camera has changed.

**Windows****⚠ Warning**

Never leave a child, a helpless adult, or a pet alone in a vehicle, especially with the windows closed in warm or hot weather.

They can be overcome by the extreme heat and suffer permanent injuries or even death from heat stroke.



The vehicle aerodynamics are designed to improve electric range performance. This may result in a pulsing sound when either rear window is down and the front windows are up. To reduce the sound, open a front window.

## Power Windows

### Warning

Children could be seriously injured or killed if caught in the path of a closing window. Never leave the remote key in a vehicle with children. When there are children in the rear seat, use the window lockout switch to prevent operation of the windows. See *Keys* ⇨ 6.



Press the switch to open the window. Pull the front of the switch up to close it.

The window switches on the driver door control all windows.

The power windows only operate with the vehicle on or in Service Mode, or when Retained Accessory Power (RAP) is active.

### Express Window Operation

The windows have an express feature which allows the windows to be lowered or raised without holding the switch. To automatically raise or lower the window, pull a window switch up or press it down all the way and release. Stop the window by pressing or pulling the switch in the same direction a

second time, or by briefly operating the switch to the first position in either direction.

### Remote Window Operation

If equipped, this feature allows all the windows to be opened remotely. If enabled in vehicle personalization, press and hold  on the remote key. To view available settings for this feature, touch the Settings icon on the infotainment home page. Select “Vehicle” to display the list of available options and select “Remote Lock, Unlock, Start”.

### Safety Function

This is for vehicles with the express-up feature. If any object is in the path of the window when the express-up feature is active, the window will stop and auto-reverse to a preset position. Weather conditions may cause the window to auto-reverse. The window switch may be held up to the second position to close the window. The window will return to normal operation once the obstruction or condition is removed.

### Safety Function Override

This is for vehicles with the express-up feature. If the battery on the vehicle has been recharged or disconnected, or is not working, the windows will need to be reprogrammed for the express-up feature to work. Before reprogramming, replace or recharge the vehicle's battery.

To program the driver window:

1. Close all doors with the vehicle on or in Service Mode.
2. Press and hold the power window switch until the window is fully open.
3. Pull the power window switch up until the window is fully closed.
4. Continue holding the switch up for approximately two seconds after the window is completely closed.

### Window Lockout

This feature prevents the rear passenger windows from operating, except from the driver position.

There is a button on the infotainment display used to enable or disable this feature.

### Sun Visors

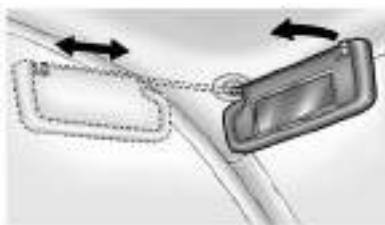

Pull the sun visor down to block glare. Detach the sun visor from the center mount to pivot to the side window or, if equipped, extend along the rod.

### Visor Vanity Mirror

The vehicle may have vanity mirrors and card holders on the back of the sun visors. Swing down the sun visor to expose the vanity mirror.

## Roof



### Sunroof





1. Sunroof Switch
2. Sunshade Switch



If equipped, the sunroof only operates when the vehicle is on or in Service Mode or when Retained Accessory Power (RAP) is active. See *Retained Accessory Power (RAP)* ⇨ 170



### Sunroof Switch Express-Open/

**Express-Close** : To express-open the sunroof, fully press and release  (1). Press the switch again to stop it. To express-close the sunroof, fully press and release  (1). Press the switch again to stop it.

**Open/Close (Manual Mode)** : To open the sunroof, press and hold  (1) until the sunroof reaches the desired position. Press and hold  (1) to close it.

**Vent** : From the closed position, press  (1) to vent the sunroof.

**Sunshade Switch Express-Open/Express-Close** : To express-open the sunshade, fully press and release  (2). To express-close the sunshade, fully press and release  (2). Press the switch again to stop it.

**Open/Close** : To open the sunshade, press and hold  (2) until the sunshade reaches the desired position. Press  (2) to close the sunshade.

When the sunroof is opened, an air deflector will automatically raise. The air deflector will retract when the sunroof is closed.

### Automatic Reversal System

The sunroof has an automatic reversal system that is only active when the sunroof is operated in express-close mode.

If an object is in the path while express closing, the reversal system will detect an object, stop, and open the sunroof again slightly.

If frost or other conditions prevent closing, override the feature by closing the sunroof in manual mode. To stop movement, release the switch.

In the event of closing difficulties like frost or other conditions, it is possible to override the reversal system. To override the reversal system, close in manual mode. To stop the movement, release the switch.



Dirt and debris may collect on the sunroof seal or in the track. This could cause an issue with sunroof operation or noise. It could also plug the water drainage system.

Periodically open the sunroof and remove any obstacles or loose debris. Wipe the sunroof seal and roof sealing area using a clean cloth, mild soap, and water. Do not remove grease from the sunroof.



## Seats and Restraints

### Head Restraints

Head Restraints .....	32
-----------------------	----

### Front Seats

Power Seat Adjustment .....	33
Reclining Seatbacks .....	34
Lumbar Adjustment .....	35
Massage .....	35
Memory Seats .....	36
Heated and Ventilated Front Seats .....	38

### Rear Seats

Rear Seats .....	40
Heated Rear Seats .....	42

### Seat Belts

Seat Belts .....	42
Buckle To Drive .....	43
How to Wear Seat Belts Properly .....	44
Lap-Shoulder Belt .....	46
Seat Belt Use During Pregnancy .....	48
Seat Belt Extender .....	49
Safety System Check .....	49
Seat Belt Care .....	49
Replacing Seat Belt System Parts after a Crash .....	50

### Airbag System

Airbag System .....	50
Where Are the Airbags? .....	52
When Should an Airbag Inflate? .....	53
What Makes an Airbag Inflate? .....	54
How Does an Airbag Restrain? .....	54
What Will You See after an Airbag Inflates? .....	54
Passenger Sensing System .....	55
Servicing the Airbag-Equipped Vehicle .....	58
Adding Equipment to the Airbag-Equipped Vehicle .....	59
Airbag System Check .....	59
Replacing Airbag System Parts after a Crash .....	60

### Child Restraints

Older Children .....	60
Infants and Young Children .....	61
Child Restraint Systems .....	63
Where to Put the Restraint .....	65
Lower Anchors and Tethers for Children (LATCH System) .....	66
Replacing LATCH System Parts After a Crash .....	72
Securing Child Restraints (With the Seat Belt in the Rear Seat) .....	72
Securing Child Restraints (With the Seat Belt in the Front Seat) .....	73

## Head Restraints

### Front Seats



#### Warning

With head restraints that are not installed and adjusted properly, there is a greater chance that occupants will suffer a neck/spinal injury in a crash. Do not drive until the head restraints for all occupants are installed and adjusted properly.

The vehicle's front seats have adjustable head restraints in the outboard seating positions.



Adjust the head restraint so that the top of the restraint is at the same height as the top of the occupant's head. This position reduces the chance of a neck injury in a crash.

The height of the head restraint can be adjusted.

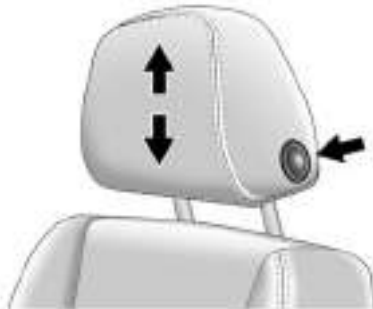

To raise or lower the head restraint, press the button located on the side of the head restraint, and pull up or push the head restraint down, and release the button. Pull and push on the head restraint after the button is released to make sure that it is locked in place.

The front seat outboard head restraints are not removable.

## Rear Seats

### Adjusting the Rear Head Restraint

The vehicle's rear seats have adjustable head restraints in all three seating positions.

The height of the head restraint can be adjusted. Pull the head restraint up to raise it. Try to move the head restraint to make sure that it is locked in place.



To lower the head restraint, press the button, located on the top of the seatback, and push the head restraint down. Try to move the head restraint after the button is released to make sure that it is locked in place.

Always adjust the head restraint so that the top of the restraint is at the same height as the top of the occupant's head.

Rear head restraints are not removable.

If you are installing a child restraint in the rear seat, see "Securing a Child Restraint Designed for the LATCH System" under *Lower Anchors and Tethers for Children (LATCH System)* ⇨ 66.

## Front Seats

### Power Seat Adjustment

#### Warning

You can lose control of the vehicle if you try to adjust a driver seat while the vehicle is moving. Adjust the driver seat only when the vehicle is not moving.

#### Warning

The power seats will work with the vehicle off. Children could operate the power seats and be injured. Never leave children alone in the vehicle.



To adjust the seat:

- Move the seat forward or rearward by sliding the control forward or rearward.
- Raise or lower the front part of the seat cushion by moving the front of the control up or down.
- Raise or lower the entire seat by moving the rear of the control up or down.

To adjust the seatback, see *Reclining Seatbacks* ⇨ 34.

To adjust the lumbar support, see *Lumbar Adjustment* ⇨ 35.

## Reclining Seatbacks

### Warning

Sitting in a reclined position when the vehicle is in motion can be dangerous. Even when buckled up, the seat belts cannot do their job.

The shoulder belt will not be against your body. Instead, it will be in front of you. In a crash, you could go into it, receiving neck or other injuries.

The lap belt could go up over your abdomen. The belt forces would be there, not at your pelvic bones. This could cause serious internal injuries.

For proper protection when the vehicle is in motion, have the seatback upright. Then sit well back in the seat and wear the seat belt properly.



Do not have a seatback reclined if the vehicle is moving.



- Move the control back to recline.
- Move the control forward to raise.

## Lumbar Adjustment



- Press and hold the front or rear of the control to increase or decrease lumbar support.
- If equipped, press and hold the top or bottom of the control to raise or lower lumbar support.

## Uplevel Seat Adjustment



To adjust lumbar support, if equipped:

- Rotate the center of the control to scroll to lumbar support on the infotainment display.
- Press  $>$  or  $<$  to adjust lumbar forward or rearward.
- Press  $\wedge$  or  $\vee$  to adjust lumbar up or down.

### Bolster Support

To adjust bolster support, if equipped:

- Rotate the center of the control to scroll to bolster support on the infotainment display.

- Press  $>$  or  $<$  to adjust the bolster outward or inward.

## Massage



If equipped, the vehicle must be on to use the massage feature.

To activate and adjust massage:

- Rotate the center of the control to scroll to massage on the infotainment display.
- Press  $\wedge$  or  $\vee$  to adjust massage type.
- $>$  or  $<$  to adjust the intensity.
- To turn massage off or to activate massage at last massage type and intensity settings, press the center of the control.

The massage feature will turn off after approximately 20 minutes. Press the center of the control to restart the massage feature.

## Memory Seats



### Overview

If equipped, the memory seat feature allows drivers to save their unique driving positions and a shared exit position. See “Saving Seating Positions” later in this section. The saved positions can be recalled manually by all drivers. See “Manually Recalling Seating Positions” later in this section. Drivers with remote key 1 and 2 can also recall them automatically. See “Auto Seat Entry Memory Recall” or “Auto Seat Exit Memory Recall”

later in this section. To enable automatic recalls, turn on Seat Entry Memory and/or Seat Exit Memory. See “Enabling Automatic Recalls” later in this section. The memory recalls may be cancelled at any time during the recall. See “Cancel Memory Seating Recalls” later in this section.

### Identifying Driver Number

The vehicle identifies the current driver by their remote key number 1–8. The current remote key number may be identified by Driver Information Center (DIC) welcome message, “You are driver x for memory recalls.” This message is displayed the first few times the vehicle is turned on when a different remote key is used. For Seat Entry Memory to work properly, save positions to the 1 or 2 memory button matching the driver number of this welcome message. To aid in identifying remote key IDs, it is recommended to only carry one remote key when entering the vehicle. Perform the following if the welcome message is not displayed:

1. Move all remote keys away from the vehicle.
2. Turn the vehicle on with another remote key. A DIC welcome message should display indicating the driver number of

the other remote key. Turn the vehicle off and remove the other remote key from the vehicle.

3. Turn the vehicle on with the initial remote key. The DIC welcome message should display the driver number of the initial remote key.

### Saving Seating Positions

Read these instructions completely before saving memory positions.



To save preferred driving positions to 1 and 2:

1. Turn the vehicle on. A DIC welcome message may indicate the driver number of the current remote key. See “Identifying Driver Number” previously in this section.
2. Adjust all available memory features to the desired driving position.
3. Press and release SET; a chime will sound.
4. Immediately upon releasing SET, press and hold memory button 1 or 2 matching the current driver’s remote key number until two chimes sound. If too much time passes between releasing SET and pressing 1 or 2, the two chimes will not

sound indicating memory position were not saved. Repeat Steps 3 and 4 to try again.

- Repeat Steps 1–4 for the other remote key 1 or 2 using the other 1 or 2 memory button.

It is recommended to save the preferred driving positions to both 1 and 2 if you are the only driver.

To save the common exit seating position to  that is used by all drivers for Manually Recalling Seating Positions and Auto Seat Exit Memory Recall features, repeat Steps 1–4 using , the exit button.

### Manually Recalling Seating Positions

Press and hold 1, 2, or  button until the recall is complete, to recall the positions previously saved to that button.

Manual Memory recall movement for 1, 2 or  buttons may be initiated and will complete to the saved memory position if the vehicle is in or out of P (Park).

### Enabling Automatic Recalls

- Seat Entry Memory moves the driver seat to the selected 1 or 2 position when the vehicle is started. Select Settings > Vehicle > Seating Position > Seat Entry Memory > ON or OFF. See “Auto Seat Entry Memory Recall” later in this section.
- Seat Exit Memory moves the driver seat to the preferred exit position of the  button when the vehicle is turned off and the door is opened. Select Settings > Vehicle > Seating Position > Seat Exit Memory > ON or OFF. See “Auto Seat Exit Memory Recall” later in this section.

### Auto Seat Entry Memory Recall

Seat Entry Memory will automatically begin movement to the seating positions of the 1 or 2 button corresponding to the driver's remote key number 1 or 2 detected by the vehicle when:

- The vehicle is turned ON.
- Seating positions have been previously saved to the same 1 or 2 button. See “Saving Seating Positions” previously in this section.
- Seat Entry Memory is enabled. See “Enabling Automatic Recalls” previously in this section.

- The vehicle is in P (Park).

Seat Entry Memory Recall will continue if the vehicle is shifted out of P (Park) prior to reaching the saved memory position.

If the saved memory seat position does not automatically recall, verify the recall is enabled. See “Enabling Automatic Recalls” previously in this section.

If the memory seat recalls to the wrong position, the driver's remote key number 1 or 2 may not match the memory button number positions they were saved to. Try the other remote key or try saving the positions to the other 1 or 2 memory button. See “Saving Seating Positions” previously in this section.

Automatic Seat Entry Memory recalls are only available for driver's remote key numbers 1 and 2. Remote keys 3–8 will not provide Seat Entry Memory recalls.

If equipped with Remote Auto Parking, the seat will automatically move to the seating position saved to the 1 or 2 button corresponding to the driver's remote key number 1 or 2 after leaving a parking space when you have entered the vehicle, closed the driver door, and applied the brake pedal. See *Automatic Parking Assist (APA)* ⇨ 210.

### Auto Seat Exit Memory Recall

Seat Exit Memory will begin movement to the seating position of the  button when:

- The vehicle is turned off and the driver door is open or opened within a short time.
- A seating position has been previously saved to the  memory button. See “Saving Seating Positions” previously in this section.
- Seat Exit Memory is enabled. See “Enabling Automatic Recalls” previously in this section.
- The vehicle is in P (Park).



Seat Exit Memory recall will continue if the vehicle is shifted out of P (Park) prior to reaching the saved memory position.

Seat Exit Memory is not linked to the driver's remote key. The seating position saved to  is used for all drivers.

If equipped with Remote Auto Parking, the seat will automatically move to the seating position saved to  after entering a parking space when APA is activated, the

vehicle is in P (Park), and the driver door is opened. See *Automatic Parking Assist (APA)* ⇨ 210.

### Cancel Memory Seating Recalls

- During any memory recall:  
Press a power seat control  
Press SET memory button
- During Manual memory recall:  
Release 1, 2, or  memory button
- During Auto Seat Entry Memory Recall:  
Turn the vehicle off  
Press SET, 1, 2, or  memory buttons
- During Auto Seat Exit Memory Recall:  
Press SET, 1, 2, or  memory buttons

### Obstructions

If something has blocked the seat while recalling a memory position, the recall may stop. Remove the obstruction and try the recall again. If the memory position still does not recall, see your dealer.

## Heated and Ventilated Front Seats



### Warning



If temperature change or pain to the skin cannot be felt, the seat heater may cause burns. To reduce the risk of burns, use care when using the seat heater, especially for long periods of time. Do not place anything on the seat that insulates against heat, such as a blanket, cushion, cover, or similar item. This may cause the seat heater to overheat. An overheated seat heater may cause a burn or may damage the seat.





**Heated and Ventilated Seat Buttons Shown,  
Heated Seat Buttons Similar**

If equipped, the buttons are located on the door panel. To operate, the vehicle must be on.

Press  or  to heat the driver or passenger seatback and cushion.

Press  or  to heat the driver or passenger seatback.

Press  or , if available, to ventilate the driver or passenger seat. A ventilated seat has a fan that pulls or pushes air through the seat. The air is not cooled.

When this feature is off, the heated and ventilated seat symbols on the buttons are white. When a heated seat is on, the symbol is red. When a ventilated seat is on, the symbol is blue.

Press the button once for the highest setting. With each press of the button, the seat will change to the next lower setting, and then to the off setting. The indicator lights next to the buttons indicate three for the highest setting and one for the lowest. If the heated seats are on high, the level may automatically be lowered after approximately 30 minutes.

The passenger seat may take longer to heat up.

#### **Auto Heated and Ventilated Seats**

When the vehicle is on, this feature will automatically activate the heated or ventilated seats at the level required by the vehicle's interior temperature.

The active high, medium, low, or off heated or ventilated seat level will be indicated by the manual heated or ventilated seat buttons on the door panel. Use the manual heated or ventilated seat buttons on the

door panel to turn auto heated or ventilated seats off. If the passenger seat is unoccupied, the auto heated or ventilated seats feature will not activate that seat. To enable or disable auto heated or ventilated seats, select Settings > Vehicle > Climate and Air Quality > Auto Cooled or Auto Heated Seats > ON or OFF.

#### **Remote Start Heated and Ventilated Seats**

During a remote start, the heated or ventilated seats, if equipped, can be turned on automatically. When it is cold outside, the heated seats turn on, and when it is hot outside the ventilated seats turn on. If the auto heated or ventilated seats feature, if equipped, is not turned on, the heated or ventilated seats may be canceled when the vehicle is turned on. If necessary, press the heated or ventilated seat button to use the heated or ventilated seats after the vehicle is started.

The heated or ventilated seat indicator lights may turn on during a remote start.

The temperature performance of an unoccupied seat may be reduced. This is normal.



To enable or disable remote start heated or ventilated seats, select Settings > Vehicle > Remote Lock, Unlock, and Start > Remote Start Auto Heat Seats or Remote Start Auto Cool Seats > ON or OFF. See *Remote Start* ⇨ 12.

## Rear Seats

### Rear Seat Reminder

The message REAR SEAT REMINDER LOOK IN REAR SEAT displays under certain conditions indicating there may be an item or passenger in the rear seat. Check before exiting the vehicle.

This feature will activate when a second row door is opened while the vehicle is on or up to 10 minutes before the vehicle is turned on. There will be an alert when the vehicle is turned off. The alert does not directly detect objects in the rear seat; instead, under certain conditions, it detects when a rear door is opened and closed, indicating that there may be something in the rear seat.

The feature is active only once each time the vehicle is turned on and off, and will require reactivation by opening and closing the second row doors. There may be an alert even when there is nothing in the rear seat; for example, if a child entered the vehicle through the rear door and left the vehicle without the vehicle being shut off.

The feature can be turned on or off. Select Settings > Vehicle > Rear Seat Reminder > ON or OFF.

### Reclining the Seatback

To recline the seatback:



1. Pull the reclining seatback handle.  
A tab near the seatback handle raises when the seatback is unlocked.
2. Move the seatback to the desired position, and then release the handle to lock the seatback in place.
3. Push and pull on the seatback to make sure it is locked.

### Folding the Seatback

Either side of the seatback can be folded for more cargo space. Fold a seatback only when the vehicle is not moving.

#### Caution

Folding a rear seat with the seat belts still fastened may cause damage to the seat or the seat belts. Always unbuckle the seat belts and return them to their normal stowed position before folding a rear seat.

To fold the seatback:



1. Stow the seat belt latch plate in the stowage slot.



2. Pull the handle on top of the seatback to unlock it.
3. Fold the seatback forward.  
Repeat the steps to fold the other seatback, if desired.



If equipped, the rear seatbacks can also be folded forward by pressing and holding the switches located in the rear cargo area.

The left switch folds the left seatback, and the right switch folds the right seatback.

### Raising the Seatback

#### Warning

If either seatback is not locked, it could move forward in a sudden stop or crash. That could cause injury to the person sitting there. Always push and pull on the seatbacks to be sure they are locked.

#### Warning

A seat belt that is improperly routed, not properly attached, or twisted will not provide the protection needed in a crash. The person wearing the belt could be seriously injured. After raising the rear seatback, always check to be sure that the seat belts are properly routed and attached, and are not twisted.

To raise a seatback:



1. Ensure the seat belt latch plate is in the stowage slot.
2. Lift the seatback up and push it rearward to lock it in place.  
A tab near the seatback handle retracts when the seatback is locked in place.
3. Push and pull the top of the seatback to be sure it is locked into position.
4. Repeat the steps to raise the other seatback, if necessary.

When the seat is not in use, it should be kept in the upright, locked position.



### Heated Rear Seats

#### Warning

If temperature change or pain to the skin cannot be felt, the seat heater may cause burns. See the *Warning under Heated and Ventilated Front Seats* ⇨ 38.



If equipped, the buttons are on the rear of the center console.

With the vehicle on, press  or  to heat the left or right outboard seat cushion and seatback. An indicator on the rear climate control display appears when this feature is on.

Press the button once for the highest setting. With each press of the button, the seat will change to the next lower setting, and then to the off setting. The indicator lights next to the buttons indicate three for the highest setting and one for the lowest.

If the heated seats are on high for approximately 30 minutes, their level may automatically be lowered.

### Seat Belts

This section describes how to use seat belts properly, and some things not to do.

#### Warning

Do not let anyone ride where a seat belt cannot be worn properly. In a crash, if you or your passenger(s) are not wearing seat belts, injuries can be much worse than if you are wearing seat belts. You can be seriously injured or killed by hitting things inside the vehicle harder or by being ejected from the vehicle. In addition, anyone who is not buckled up can strike other passengers in the vehicle.

(Continued)

**Warning (Continued)**

It is extremely dangerous to ride in a cargo area, inside or outside of a vehicle. In a collision, passengers riding in these areas are more likely to be seriously injured or killed. Do not allow passengers to ride in any area of the vehicle that is not equipped with seats and seat belts.

Always wear a seat belt, and check that all passenger(s) are restrained properly too.

This vehicle has indicators as a reminder to buckle the seat belts. See *Seat Belt Reminders* ⇨ 91.

**Why Seat Belts Work**

When riding in a vehicle, you travel as fast as the vehicle does. If the vehicle stops suddenly, you keep going until something stops you. It could be the windshield, the instrument panel, or the seat belts!

When you wear a seat belt, you and the vehicle slow down together. There is more time to stop because you stop over a longer distance and, when worn properly, your strongest bones take the forces from the seat belts. That is why wearing seat belts makes such good sense.

**Questions and Answers About Seat Belts**

- Q:** Will I be trapped in the vehicle after a crash if I am wearing a seat belt?
- A:** You *could* be — whether you are wearing a seat belt or not. Your chance of being conscious during and after a crash, so you *can* unbuckle and get out, is *much* greater if you are belted.
- Q:** If my vehicle has airbags, why should I have to wear seat belts?
- A:** Airbags are supplemental systems only. They work *with* seat belts — not instead of them. Whether or not an airbag is provided, all occupants still have to buckle up to get the most protection.
- Also, in nearly all states and in all Canadian provinces, the law requires wearing seat belts.

**Buckle To Drive**

If equipped, this feature delays the vehicle from shifting out of P (Park) when the driver seat belt is not buckled. The Buckle to Drive feature must be turned ON in the infotainment system to work. To turn the Buckle to Drive feature on or off, select Settings > Vehicle > Buckle to Drive. See *Teen Driver* ⇨ 146, if equipped.

If the vehicle is on and the brake pedal is pressed with the vehicle in P (Park) but the driver seat belt is not buckled, a message displays in the Driver Information Center (DIC) and the vehicle will be delayed from shifting out of P (Park). Buckle the driver seat belt to clear the message and shift out of P (Park). Shifting from P (Park) will be delayed once for each time the vehicle is started.

On some models, Buckle to Drive may also delay shifting out of P (Park) if a front passenger seat belt is unbuckled. A message displays in the DIC. Buckle the front passenger seat belt to clear the message and shift out of P (Park). This feature may delay the vehicle from shifting out of P (Park) if an object, such as a briefcase, handbag, grocery bag, laptop, or other electronic device, is on the front passenger seat. If this happens, remove the object from the seat or buckle the seat belt to shift out of P (Park).

If the driver, or on some vehicles, the present front passenger remains unbuckled, the DIC message will turn off after several seconds and the vehicle can be shifted out of P (Park). See “Seat Belts” and “Child

Restraints” in the Index for information about the importance of proper restraint use.

If the driver seat belt or the front passenger seat belt is unbuckled when driving, the seat belt reminder chime and light(s) will come on. See *Seat Belt Reminders* ⇨ 91. This feature may not function properly if the airbag readiness light is on. See *Airbag Readiness Light* ⇨ 92.

### How to Wear Seat Belts Properly

Follow these rules for everyone's protection.

There are additional things to know about seat belts and children, including smaller children and infants. If a child will be riding in the vehicle, see *Older Children* ⇨ 60 or *Infants and Young Children* ⇨ 61. Review and follow the rules for children in addition to the following rules.

It is very important for all occupants to buckle up. Statistics show that unbelted people are hurt more often in crashes than those who are wearing seat belts.

There are important things to know about wearing a seat belt properly.

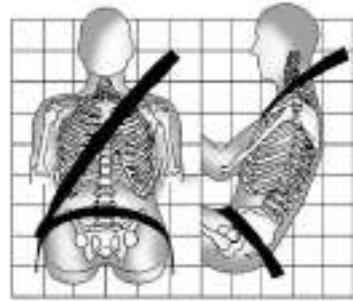

- Sit up straight and always keep your feet on the floor in front of you (if possible).
- Wear the lap part of the belt low and snug on the hips, just touching the thighs. In a crash, this applies force to the strong pelvic bones and you would be less likely to slide under the lap belt. If you slid under it, the belt would apply force on your abdomen. This could cause serious or even fatal injuries.
- Wear the shoulder belt over the shoulder and across the chest. These parts of the body are best able to take belt restraining forces. The shoulder belt locks if there is a sudden stop or crash.

**Warning**

You can be seriously injured, or even killed, by not wearing your seat belt properly.

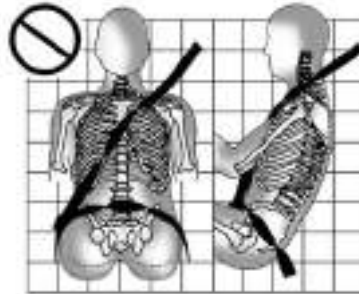
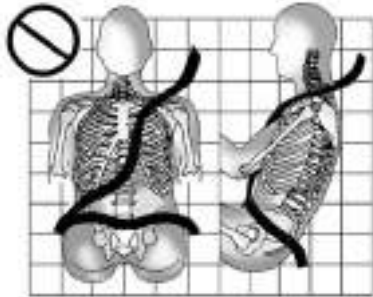

Never allow the lap or shoulder belt to become loose or twisted.

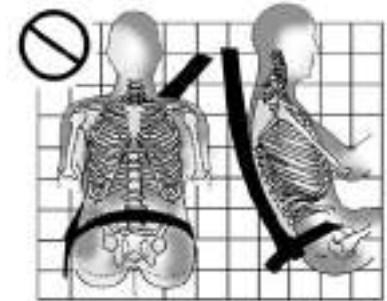
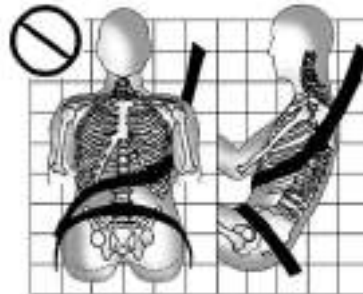

Never wear the shoulder belt under both arms or behind your back.

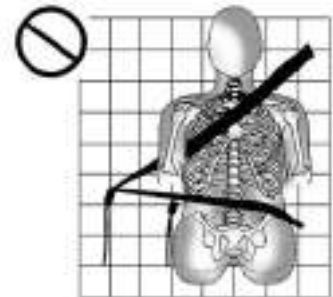

Always use the correct buckle for your seating position.



Never route the lap or shoulder belt over an armrest.

### Warning

The seat belt can be pinched if it is routed under plastic trim on the seat, such as trim around the rear seatback folding handle or side airbag. In a crash, pinched seat belts might not provide adequate protection. Never allow seat belts to be routed under plastic trim pieces.

### Warning

You can be seriously injured or killed if the shoulder belt is worn behind your back, under your legs, or wrapped around your neck. The shoulder belt can tighten but cannot be loosened if it is locked. The shoulder belt locks when it is pulled all the way out of the retractor. It unlocks when the shoulder belt is allowed to go all the way back into the retractor, but it cannot do this if it is wrapped around you. You may have to cut the seat belt if it is locked and tightened around you.

### Lap-Shoulder Belt

All seating positions in the vehicle have a lap-shoulder belt.

The following instructions explain how to wear a lap-shoulder belt properly.

1. Adjust the seat, if the seat is adjustable, so you can sit up straight. To see how, see "Seats" in the Index.



2. Pick up the latch plate and pull the belt across you. Do not let it get twisted.

The lap-shoulder belt may lock if you pull the belt across you very quickly. If this happens, let the belt go back slightly to unlock it. Then pull the belt across you more slowly.

If the shoulder portion of a passenger belt is pulled out all the way, the child restraint locking feature may be engaged. See *Child Restraint Systems* ⇨ 63. If this occurs, let the belt go back all the way and start again. If the locking feature stays engaged after letting the belt go back to stowed

position on the seat, move the seat rearward or recline the seat until the shoulder belt retractor lock releases.



If the webbing locks in the latch plate before it reaches the buckle, tilt the latch plate flat to unlock.



3. Push the latch plate into the buckle until it clicks.

Pull up on the latch plate to make sure it is secure. If the belt is not long enough, see *Seat Belt Extender* ⇨ 49.

Position the release button on the buckle so that the seat belt could be quickly unbuckled if necessary.

4. If equipped with a shoulder belt height adjuster, move it to the height that is right for you. See “Shoulder Belt Height Adjuster” later in this section for instructions on use and important safety information.



5. To make the lap part tight, pull up on the shoulder belt.





To unlatch the belt, push the button on the buckle. The belt should return to its stowed position.

Always stow the seat belt slowly. If the seat belt webbing returns quickly to the stowed position, the retractor may lock and cannot be pulled out. If this happens, pull the seat belt straight out firmly to unlock the webbing, and then release it. If the webbing is still locked in the retractor, see your dealer.

Before a door is closed, be sure the seat belt is out of the way. If a door is slammed against a seat belt, damage can occur to both the seat belt and the vehicle.

### Shoulder Belt Height Adjuster

The vehicle has a shoulder belt height adjuster for the driver and front outboard passenger seating positions.

Adjust the height so the shoulder portion of the belt is on the shoulder and not falling off of it. The belt should be close to, but not contacting, the neck. Improper shoulder belt height adjustment could reduce the effectiveness of the seat belt in a crash. See *How to Wear Seat Belts Properly* ⇨ 44.



Press the release button and move the height adjuster to the desired position. The adjuster can be moved up by pushing the slide/trim up. After the adjuster is set to the desired position, try to move it down without pressing the release button to make sure it has locked into position.

### Seat Belt Pretensioners

This vehicle has seat belt pretensioners for the front outboard occupants. Although the seat belt pretensioners cannot be seen, they are part of the seat belt assembly. They can help tighten the seat belts during the early stages of a moderate to severe frontal, near frontal, or rear crash if the threshold conditions for pretensioner activation are

met. Seat belt pretensioners can also help tighten the seat belts in a side crash or a rollover event.

Pretensioners work only once. If the pretensioners activate in a crash, the pretensioners and probably other parts of the vehicle's seat belt system will need to be replaced. See *Replacing Seat Belt System Parts after a Crash* ⇨ 50.

Do not sit on the outboard seat belt while entering or exiting the vehicle or at any time while sitting in the seat. Sitting on the seat belt can damage the webbing and hardware.

### Seat Belt Use During Pregnancy

Seat belts work for everyone, including pregnant women. Like all occupants, they are more likely to be seriously injured if they do not wear seat belts.



A pregnant woman should wear a lap-shoulder belt, and the lap portion should be worn as low as possible, below the rounding, throughout the pregnancy.

The best way to protect the fetus is to protect the mother. When a seat belt is worn properly, it is more likely that the fetus will not be hurt in a crash. For pregnant women, as for anyone, the key to making seat belts effective is wearing them properly.

### Seat Belt Extender

If the vehicle's seat belt will fasten around you, you should use it.

But if a seat belt is not long enough, your dealer will order you an extender. Only a GM dealer issued extender should be used. When you go in to order it, take the heaviest coat you will wear, so the extender will be long enough for you. To help avoid personal injury, do not let someone else use it, and use it only for the seat it is made to fit. The extender has been designed for adults. Never use it for securing child restraints. For more information on the proper use and fit of seat belt extenders see the instruction sheet that comes with the extender.

### Safety System Check

Periodically check the seat belt reminder, seat belts, buckles, latch plates, retractors, shoulder belt height adjusters (if equipped), and seat belt anchorages to make sure they are all in working order. Look for any other loose or damaged seat belt system parts that might keep a seat belt system from performing properly. See your dealer to have it repaired. Torn, frayed, or twisted seat belts may not protect you in a crash. Torn or frayed seat belts can rip apart under impact forces. If a belt is torn or frayed, have it replaced immediately. If a belt is twisted, it may be possible to untwist by

reversing the latch plate on the webbing. If the twist cannot be corrected, ask your dealer to fix it.

Make sure the seat belt reminder light is working. See *Seat Belt Reminders* ⇨ 91.

Keep seat belts clean and dry. See *Seat Belt Care* ⇨ 49.

### Seat Belt Care

Keep belts clean and dry.

Seat belts should be properly cared for and maintained.

Seat belt hardware should be kept dry and free of dust or debris. As necessary, exterior hard surfaces and seat belt webbing may be lightly cleaned with mild soap and water. Ensure there is not excessive dust or debris in the mechanism. If dust or debris exists in the system please see the dealer. Parts may need to be replaced to ensure proper functionality of the system.

#### **Warning**

Do not bleach or dye seat belt webbing. It may severely weaken the webbing. In a crash, they might not be able to

(Continued)

**Warning (Continued)**

provide adequate protection. Clean and rinse seat belt webbing only with mild soap and lukewarm water. Allow the webbing to dry.

## Replacing Seat Belt System Parts after a Crash

**Warning**

A crash can damage the seat belt system in the vehicle. A damaged seat belt system may not properly protect the person using it, resulting in serious injury or even death in a crash. To help make sure the seat belt systems are working properly after a crash, have them inspected and any necessary replacements made as soon as possible.

After a minor crash, replacement of seat belts may not be necessary. But the seat belt assemblies that were used during any crash may have been stressed or damaged. See your dealer to have the seat belt assemblies inspected or replaced.

New parts and repairs may be necessary even if the seat belt system was not being used at the time of the crash.

Have the seat belt pretensioners checked if the vehicle has been in a crash, or if the airbag readiness light stays on after you start the vehicle or while you are driving. See *Airbag Readiness Light* ⇨ 92.

## Airbag System

The vehicle has the following airbags:

- A frontal airbag for the driver
- A frontal airbag for the front outboard passenger
- A knee airbag for the driver
- A knee airbag for the front outboard passenger
- A seat-mounted side impact airbag for the driver
- A seat-mounted side impact airbag for the front outboard passenger
- A roof-rail airbag for the driver and the passenger seated directly behind the driver

- A roof-rail airbag for the front outboard passenger and the passenger seated directly behind the front outboard passenger

All vehicle airbags have the word AIRBAG on the trim or on a label near the deployment opening.

For frontal airbags, the word AIRBAG is on the center of the steering wheel for the driver and on the instrument panel for the front outboard passenger.

For knee airbags, the word AIRBAG is on the lower part of the instrument panel.

For seat-mounted side impact airbags, the word AIRBAG is on the side of the seatback or side of the seat closest to the door.

For roof-rail airbags, the word AIRBAG is on the ceiling or trim.

Airbags are designed to supplement the protection provided by seat belts. Even though today's airbags are also designed to help reduce the risk of injury from the force of an inflating bag, all airbags must inflate very quickly to do their job.

Here are the most important things to know about the airbag system:

### Warning

You can be severely injured or killed in a crash if you are not wearing your seat belt, even with airbags. Airbags are designed to work with seat belts, not replace them. Also, airbags are not designed to inflate in every crash. In some crashes seat belts are the only restraint. See *When Should an Airbag Inflate?* ⇨ 53.

Wearing your seat belt during a crash helps reduce your chance of hitting things inside the vehicle or being ejected from it. Airbags are “supplemental restraints” to the seat belts. Everyone in the vehicle should wear a seat belt properly, whether or not there is an airbag for that person.

### Warning

Because airbags inflate with great force and faster than the blink of an eye, anyone who is up against, or very close to, any airbag when it inflates can be seriously injured or killed. Do not sit unnecessarily close to any airbag, as you would be if sitting on the edge of the seat or leaning forward. Seat belts help keep you in position before and during a crash. Always wear a seat belt, even with airbags. The driver should sit as far back as possible while still maintaining control of the vehicle. The seat belts and the front outboard passenger airbags are most effective when you are sitting well back and upright in the seat with both feet on the floor.

Occupants should not lean on or sleep against the door or side windows in seating positions with seat-mounted side impact airbags and/or roof-rail airbags.

### Warning

Children who are up against, or very close to, any airbag when it inflates can be seriously injured or killed. Always secure children properly in the vehicle. To read how, see *Older Children* ⇨ 60 or *Infants and Young Children* ⇨ 61.



There is an airbag readiness light on the instrument cluster, which shows the airbag symbol.

The system checks the airbag electrical system for malfunctions. The light tells you if there is an electrical problem. See *Airbag Readiness Light* ⇨ 92.

## Where Are the Airbags?

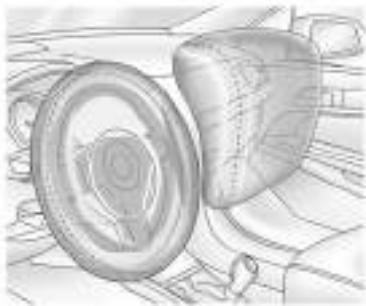

The driver frontal airbag is in the center of the steering wheel.

The front outboard passenger frontal airbag is in the passenger side instrument panel.



The driver knee airbag is below the steering column. The front outboard passenger knee airbag is below the glove box.



Driver Side Shown, Passenger Side Similar

The driver and front outboard passenger seat-mounted side impact airbags are in the side of the seatbacks closest to the door.



Driver Side Shown, Passenger Side Similar

The roof-rail airbags for the driver, front outboard passenger, and second row outboard passengers are in the ceiling above the side windows.

### Warning

If something is between an occupant and an airbag, the airbag might not inflate properly or it might force the object into that person causing severe injury or even death. The path of an inflating airbag

(Continued)

**Warning (Continued)**

must be kept clear. Do not put anything between an occupant and an airbag, and do not attach or put anything on the steering wheel hub or on or near any other airbag covering.

Do not use seat accessories that block the inflation path of a seat-mounted side impact airbag.

Never secure anything to the roof of a vehicle with roof-rail airbags by routing a rope or tie-down through any door or window opening. If you do, the path of an inflating roof-rail airbag will be blocked.

**When Should an Airbag Inflate?**

This vehicle is equipped with airbags. See *Airbag System* ⇨ 50. Airbags are designed to inflate if the impact exceeds the specific airbag system's deployment threshold. Deployment thresholds are used to predict how severe a crash is likely to be in time for the airbags to inflate and help restrain the occupants. The vehicle has electronic sensors that help the airbag system

determine the severity of the impact. Deployment thresholds can vary with specific vehicle design.

Frontal airbags are designed to inflate in moderate to severe frontal crashes to help reduce the potential for severe injuries, mainly to the driver's or front outboard passenger's head and chest.

Whether the frontal airbags will or should inflate is not based primarily on how fast the vehicle is traveling. It depends on what is hit, the direction of the impact, and how quickly the vehicle slows down.

Frontal airbags may inflate at different crash speeds depending on whether the vehicle hits an object straight on or at an angle, rigid or deformable, narrow or wide.

Frontal airbags are not intended to inflate during vehicle rollovers, in rear impacts, or in many side impacts.

In addition, the vehicle has advanced technology frontal airbags. Advanced technology frontal airbags adjust the restraint according to crash severity.

Knee airbags are designed to inflate in moderate to severe frontal impacts. Knee airbags are not designed to inflate during vehicle rollovers, in rear impacts, or in many side impacts.

Seat-mounted side impact airbags are designed to inflate in moderate to severe side crashes depending on the location of the impact. These airbags may also inflate in some moderate to severe frontal impacts. Seat-mounted side impact airbags are not designed to inflate in rollovers or rear impacts. A seat-mounted side impact airbag is designed to inflate on the side of the vehicle that is struck.

Roof-rail airbags are designed to inflate in moderate to severe side crashes depending on the location of the impact. In addition, these roof-rail airbags may inflate during a rollover or in a severe frontal impact. Roof-rail airbags are not designed to inflate in rear impacts. Both roof-rail airbags may inflate when either side of the vehicle is struck or if the sensing system predicts that the vehicle is about to roll over on its side, or in a severe frontal impact.

In any particular crash, no one can say whether an airbag should have inflated simply because of the vehicle damage or repair costs.

### **What Makes an Airbag Inflate?**

In a deployment event, the sensing system sends an electrical signal triggering a release of gas from the inflator. Gas from the inflator fills the airbag causing the bag to break out of the cover. The inflator, the airbag, and related hardware are all part of the airbag module.

For airbag locations, see *Where Are the Airbags?* ⇨ 52.

### **How Does an Airbag Restrain?**

In moderate to severe frontal or near frontal collisions, even belted occupants can contact the steering wheel or the instrument panel. In moderate to severe side collisions, even belted occupants can contact the inside of the vehicle.

Airbags supplement the protection provided by seat belts by distributing the force of the impact more evenly over the occupant's body.

Rollover capable roof-rail airbags are designed to help contain the head and chest of occupants in the outboard seating positions in the first and second rows. The rollover capable roof-rail airbags are designed to help reduce the risk of full or partial ejection in rollover events, although no system can prevent all such ejections.

But airbags would not help in many types of collisions, primarily because the occupant's motion is not toward those airbags. See *When Should an Airbag Inflate?* ⇨ 53.

Airbags should never be regarded as anything more than a supplement to seat belts.

### **What Will You See after an Airbag Inflates?**

After frontal, knee, and seat-mounted side impact airbags inflate, they quickly deflate, so quickly that some people may not even realize the airbags inflated. Roof-rail airbags may still be at least partially inflated for some time after they inflate. Some components of the airbag module may be hot for several minutes. For location of the airbags, see *Where Are the Airbags?* ⇨ 52.

The parts of the airbag that come into contact with you may be warm, but not too hot to touch. There may be some smoke and dust coming from the vents in the deflated airbags. Airbag inflation does not prevent the driver from seeing out of the windshield or being able to steer the vehicle, nor does it prevent people from leaving the vehicle.

#### **Warning**

When an airbag inflates, there may be dust in the air. This dust could cause breathing problems for people with a history of asthma or other breathing trouble. To avoid this, everyone in the vehicle should get out as soon as it is safe to do so. If you have breathing problems but cannot get out of the vehicle after an airbag inflates, then get fresh air by opening a window or a door. If you experience breathing problems following an airbag deployment, you should seek medical attention.

The vehicle has a feature that may automatically unlock the doors, turn on the interior lamps and hazard warning flashers after the airbags inflate. The feature may

also activate, without airbag inflation, after an event that exceeds a predetermined threshold. After turning the vehicle off and then on again, the doors can be locked, the interior lamps can be turned off, and the hazard warning flashers can be turned off using the controls for those features. If any of these systems are damaged in the crash they may not operate as normal.

### Warning

A crash severe enough to inflate the airbags may have also damaged important functions in the vehicle, such as the brake and steering systems, etc. Even if the vehicle appears to be drivable after a moderate crash, there may be concealed damage that could make it difficult to safely operate the vehicle.

Use caution if attempting to restart the vehicle after a crash has occurred.

Plug-in vehicles have a high voltage battery and a standard 12-volt battery.

If an airbag inflates or the vehicle has been in a crash, the sensing system may shut down the high voltage system. When this occurs, the high voltage battery is

disconnected and the vehicle will not start. Before the vehicle can be operated again, it must be serviced at your dealer.

In many crashes severe enough to inflate the airbag, windshields are broken by vehicle deformation. Additional windshield breakage may also occur from the front outboard passenger airbag.

- Airbags are designed to inflate only once. After an airbag inflates, you will need some new parts for the airbag system. If you do not get them, the airbag system will not be there to help protect you in another crash. A new system will include airbag modules and possibly other parts. The service manual for the vehicle covers the need to replace other parts.
- The vehicle has a crash sensing and diagnostic module which records information after a crash. See *Vehicle Data Recording and Privacy* ⇨ 313 and *Event Data Recorders* ⇨ 314.
- Let only qualified technicians work on the airbag system. Improper service can mean that an airbag system will not work properly. See your dealer for service.

## Passenger Sensing System

The vehicle has a passenger sensing system for the front outboard passenger position. The passenger airbag status indicator will light on the overhead console when the vehicle is started.



The words ON and OFF, and the symbols for on and off, will be visible during the system check. When the system check is complete, either the word ON or OFF, and the symbol for on or off, will be visible. See *Passenger Airbag Status Indicator* ⇨ 93.

The passenger sensing system turns off the front outboard passenger frontal airbag and knee airbag under certain conditions. No other airbag is affected by the passenger sensing system.

The passenger sensing system works with sensors that are part of the front outboard passenger seat and seat belt. The sensors are designed to detect the presence of a



properly seated occupant and determine if the front outboard passenger frontal airbag and knee airbag should be allowed to inflate or not.

According to accident statistics, children are safer when properly secured in a rear seat in the correct child restraint for their weight and size.

Whenever possible, children aged 12 and under should be secured in a rear seating position.

Never put a rear-facing child seat in the front. This is because the risk to the rear-facing child is so great, if the airbag inflates.

### Warning

A child in a rear-facing child restraint can be seriously injured or killed if the passenger frontal airbag inflates. This is because the back of the rear-facing child restraint would be very close to the inflating airbag. A child in a forward-facing child restraint can be seriously injured or killed if the passenger frontal airbag inflates and the passenger seat is in a forward position.

(Continued)

### Warning (Continued)

Even if the passenger sensing system has turned off the front outboard passenger airbag(s), no system is fail-safe. No one can guarantee that an airbag will not deploy under some unusual circumstance, even though the airbag(s) are off.

Never put a rear-facing child restraint in the front seat, even if the airbag is off. If securing a forward-facing child restraint in the front outboard passenger seat, always move the seat as far back as it will go. It is better to secure child restraints in the rear seat. Consider using another vehicle to transport the child when a rear seat is not available.

The passenger sensing system is designed to turn off the front outboard passenger frontal airbag and knee airbag if:

- The front outboard passenger seat is unoccupied.
- The system determines an infant is present in a child restraint.
- A front outboard passenger takes his/her weight off of the seat for a period of time.

When the passenger sensing system has turned off the front outboard passenger frontal airbag and knee airbag, the OFF indicator will light and stay lit as a reminder that the airbags are off. See *Passenger Airbag Status Indicator* ⇨ 93.

The passenger sensing system is designed to turn on the front outboard passenger frontal airbag and knee airbag, anytime the system senses that a person of adult size is sitting properly in the front outboard passenger seat.

When the passenger sensing system has allowed the airbags to be enabled, the ON indicator will light and stay lit as a reminder that the airbags are active.

For some children, including children in child restraints, and for very small adults, the passenger sensing system may or may not turn off the front outboard passenger frontal airbag and knee airbag, depending upon the person's seating posture and body build. Everyone in the vehicle who has outgrown child restraints should wear a seat belt properly — whether or not there is an airbag for that person.

### Warning

If the airbag readiness light ever comes on and stays on, it means that something may be wrong with the airbag system. To help avoid injury to yourself or others, have the vehicle serviced right away. See *Airbag Readiness Light* ⇨ 92 for more information, including important safety information.

### If the On Indicator Is Lit for a Child Restraint

The passenger sensing system is designed to turn off the front outboard passenger frontal airbag and knee airbag, if the system determines that an infant is present in a child restraint. If a child restraint has been installed and the ON indicator is lit:

1. Turn the vehicle off.
2. Remove the child restraint from the vehicle.
3. Remove any additional items from the seat such as blankets, cushions, seat covers, seat heaters, or seat massagers.

4. Reinstall the child restraint following the directions provided by the child restraint manufacturer and refer to *Securing Child Restraints (With the Seat Belt in the Front Seat)* ⇨ 73 or *Securing Child Restraints (With the Seat Belt in the Rear Seat)* ⇨ 72.

Make sure the seat belt retractor is locked by pulling the shoulder belt all the way out of the retractor when installing the child restraint, even if the child restraint is equipped with a seat belt lock off. When the retractor lock is set, the belt can be tightened but not pulled out of the retractor.

5. If, after reinstalling the child restraint and restarting the vehicle, the ON indicator is still lit, turn the vehicle off. Then slightly recline the vehicle seatback and adjust the seat cushion, if adjustable, to make sure that the vehicle seatback is not pushing the child restraint into the seat cushion. Also make sure the child restraint is not trapped under the vehicle head restraint. If this happens, adjust the head restraint. See *Head Restraints* ⇨ 32.
6. Restart the vehicle.

The passenger sensing system may or may not turn off the airbags for a child in a child restraint depending upon the child's size. It is better to secure the child restraint in a rear seat. Never put a rear-facing child restraint in the front seat, even if the ON indicator is not lit.

### If the Off Indicator Is Lit for an Adult-Sized Occupant



If a person of adult size is sitting in the front outboard passenger seat, but the OFF indicator is lit, it could be because that person is not sitting properly in the seat or that the child restraint locking feature is engaged. Use the following steps to allow

the system to detect that person and enable the front outboard passenger frontal airbag and knee airbag:

1. Turn the vehicle off.
2. Remove any additional material from the seat, such as blankets, cushions, seat covers, seat heaters, or seat massagers.
3. Place the seatback in the fully upright position.
4. Have the person sit upright in the seat, centered on the seat cushion, with legs comfortably extended.
5. If the shoulder portion of the belt is pulled out all the way, the child restraint locking feature will be engaged. This may unintentionally cause the passenger sensing system to turn the airbag off for some adult-sized occupants. If this happens, unbuckle the belt, let the belt go back all the way, and then buckle the belt again without pulling the belt out all the way.
6. Restart the vehicle and have the person remain in this position for two to three minutes after the ON indicator is lit.

### Warning

If the front outboard passenger airbag is turned off for an adult-sized occupant, the airbag will not be able to inflate and help protect that person in a crash, resulting in an increased risk of serious injury or even death. An adult-sized occupant should not ride in the front outboard passenger seat, if the passenger airbag OFF indicator is lit.

### Additional Factors Affecting System Operation

Seat belts help keep the passenger in position on the seat during vehicle maneuvers and braking, which helps the passenger sensing system maintain the passenger airbag status. See “Seat Belts” and “Child Restraints” in the Index for additional information about the importance of proper restraint use.

A thick layer of additional material, such as a blanket or cushion, or aftermarket equipment such as seat covers, seat heaters, and seat massagers can affect how well the passenger sensing system operates. We recommend that you not use seat covers or other aftermarket equipment except when

approved by GM for your specific vehicle. See *Adding Equipment to the Airbag-Equipped Vehicle* ⇨ 59 for more information about modifications that can affect how the system operates.

The ON indicator may be lit if an object, such as a briefcase, handbag, grocery bag, laptop, or other electronic device, is put on an unoccupied seat. If this is not desired, remove the object from the seat.

### Warning

Stowing articles under the passenger seat or between the passenger seat cushion and seatback may interfere with the proper operation of the passenger sensing system.

## Servicing the Airbag-Equipped Vehicle

Airbags affect how the vehicle should be serviced. There are parts of the airbag system in several places around the vehicle. Your dealer and the service manual have information about servicing the vehicle and the airbag system. To purchase a service manual, see *Publication Ordering Information* ⇨ 312.

**Warning**

For up to 10 seconds after the vehicle is turned off and the battery is disconnected, an airbag can still inflate during improper service. You can be injured if you are close to an airbag when it inflates. Avoid yellow connectors. They are probably part of the airbag system. Be sure to follow proper service procedures, and make sure the person performing work for you is qualified to do so.

**Adding Equipment to the Airbag-Equipped Vehicle**

Adding accessories that change the vehicle's frame, bumper system, height, front end, or side sheet metal may keep the airbag system from working properly.

The operation of the airbag system can also be affected by changing, including improperly repairing or replacing, any parts of the following:

- Airbag system, including airbag modules, front or side impact sensors, sensing and diagnostic module, or airbag wiring

- Front seats, including stitching, seams or zippers
- Seat belts
- Steering wheel, instrument panel, overhead console, ceiling trim, or pillar garnish trim
- Inner door seals, including speakers

Your dealer and the service manual have information about the location of the airbag modules and sensors, sensing and diagnostic module, and airbag wiring along with the proper replacement procedures.

In addition, the vehicle has a passenger sensing system for the front outboard passenger position, which includes sensors that are part of the passenger seat. The passenger sensing system may not operate properly if the original seat trim is replaced with non-GM covers, upholstery, or trim; or with GM covers, upholstery, or trim designed for a different vehicle. Any object, such as an aftermarket seat heater or a comfort-enhancing pad or device, installed under or on top of the seat fabric, could also interfere with the operation of the passenger sensing system. This could either prevent proper deployment of the passenger airbag(s) or prevent the passenger sensing

system from properly turning off the passenger airbag(s). See *Passenger Sensing System* ⇨ 55.

If the vehicle has rollover roof-rail airbags, see *Different Size Tires and Wheels* ⇨ 281 for additional important information.

If the vehicle must be modified because you have a disability and have questions about whether the modifications will affect the vehicle's airbag system, or if you have questions about whether the airbag system will be affected if the vehicle is modified for any other reason, call Customer Assistance. See *Customer Assistance Offices* ⇨ 306.

**Airbag System Check**

The airbag system does not need regularly scheduled maintenance or replacement. Make sure the airbag readiness light is working. See *Airbag Readiness Light* ⇨ 92.

**Caution**

If an airbag covering is damaged, opened, or broken, the airbag may not work properly. Do not open or break the airbag coverings. If there are any opened or broken airbag coverings, have the airbag

(Continued)

**Caution (Continued)**

covering and/or airbag module replaced. For the location of the airbags, see *Where Are the Airbags?* ⇨ 52. See your dealer for service.

## Replacing Airbag System Parts after a Crash

### Warning

A crash can damage the airbag systems in the vehicle. A damaged airbag system may not properly protect you and your passenger(s) in a crash, resulting in serious injury or even death. To help make sure the airbag systems are working properly after a crash, have them inspected and any necessary replacements made as soon as possible.

If an airbag inflates, you will need to replace airbag system parts. See your dealer for service.

If the airbag readiness light stays on after the vehicle is started or comes on when you are driving, the airbag system may not work properly. Have the vehicle serviced right away. See *Airbag Readiness Light* ⇨ 92.

## Child Restraints

### Older Children



Older children who have outgrown booster seats should wear the vehicle's seat belts. Refer to *How to Wear Seat Belts Properly* ⇨ 44.

The manufacturer instructions that come with the booster seat state the weight and height limitations for that booster. Use a booster seat with a lap-shoulder belt until the child passes the fit test below:

- Sit all the way back on the seat. Do the knees bend at the seat edge? If yes, continue. If no, return to the booster seat.
- Buckle the lap-shoulder belt. Does the shoulder belt rest on the shoulder? If yes, continue. If no, return to the booster seat.
- Does the lap belt fit low and snug on the hips, touching the thighs? If yes, continue. If no, return to the booster seat.
- Can proper seat belt fit be maintained for the length of the trip? If yes, continue. If no, return to the booster seat.

#### **Q: What is the proper way to wear seat belts?**

**A:** An older child should wear a lap-shoulder belt and get the additional restraint a shoulder belt can provide. The shoulder belt should not cross the face or neck. The lap belt should fit snugly below the hips, just touching the top of the thighs. This applies belt force to the child's pelvic bones in a crash. It should never

be worn over the abdomen, which could cause severe or even fatal internal injuries in a crash.

According to accident statistics, children are safer when properly restrained in a rear seating position.

In a crash, children who are not buckled up can strike other people who are buckled up, or can be thrown out of the vehicle. Older children need to use seat belts properly.

### Warning

Never allow more than one child to wear the same seat belt. The seat belt cannot properly spread the impact forces. In a crash, they can be crushed together and seriously injured. A seat belt must be used by only one person at a time.



### Warning

Never allow a child to wear the seat belt shoulder belt under both arms or behind their back. A child can be seriously injured by not wearing the lap-shoulder belt properly. In a crash, the child would not be restrained by the shoulder belt. The child could move too far forward increasing the chance of head and neck injury. The child might also slide under the lap belt. The belt force would then be applied right on the abdomen. That could cause serious or fatal injuries. The shoulder belt should go over the shoulder and across the chest.



## Infants and Young Children

Everyone in a vehicle needs protection! This includes infants and all other children. Neither the distance traveled nor the age and size of the traveler changes the need, for everyone, to use safety restraints. In fact, the law in every state in the United States and in every Canadian province says children up to some age must be restrained while in a vehicle.

**⚠ Warning**

Children can be seriously injured or killed if the shoulder belt is worn behind their back, under their legs, or wrapped around their neck. The shoulder belt can tighten but cannot be loosened if it is locked. The shoulder belt locks when it is pulled all the way out of the retractor. It unlocks when the shoulder belt is allowed to go all the way back into the retractor, but it cannot do this if it is wrapped around the child. Never leave children unattended in a vehicle and never allow children to improperly wear, or play with, the seat belts.

Every time infants and young children ride in vehicles, they should have the protection provided by appropriate child restraints. Neither the vehicle's seat belt system nor its airbag system is designed for them.

Children who are not restrained properly can strike other people, or can be thrown out of the vehicle.

**⚠ Warning**

Never hold an infant or a child while riding in a vehicle. Due to crash forces, an infant or a child will become so heavy it is not possible to hold it during a crash. For example, in a crash at only 40 km/h (25 mph), a 5.5 kg (12 lb) infant will suddenly become a 110 kg (240 lb) force on a person's arms. An infant or child should be secured in an appropriate child restraint.

**⚠ Warning**

Children who are up against, or very close to, any airbag when it inflates can be seriously injured or killed. Never put a rear-facing child restraint in the front outboard seat. Secure a rear-facing child restraint in a rear seat. It is also better to secure a forward-facing child restraint in a rear seat. If you must secure a forward-facing child restraint in the front outboard seat, always move the front passenger seat as far back as it will go.



Child restraints are devices used to restrain, seat, or position children in the vehicle and are sometimes called child seats or car seats.

There are three basic types of child restraints:

- Forward-facing child restraints
- Rear-facing child restraints
- Belt-positioning booster seats

The proper child restraint for your child depends on their size, weight, and age, and also on whether the child restraint is compatible with the vehicle in which it will be used.

For each type of child restraint, there are many different models available. When purchasing a child restraint, be sure it is designed to be used in a motor vehicle and is designed by a genuine child restraint manufacturer. If it is, the child restraint will have a label saying that it meets federal motor vehicle safety standards.

The instruction manual that is provided with the child restraint states the weight and height limitations for that particular child restraint. In addition, there are many kinds of child restraints available for children with special needs.

### Warning

To reduce the risk of neck and head injury in a crash, infants and toddlers should be secured in a rear-facing child restraint until age two, or until they reach the maximum height and weight limits of their child restraint.

### Warning

A young child's hip bones are still so small that the vehicle seat belt may not remain low on the hip bones, as it should. Instead, it may settle up around the child's abdomen. In a crash, the belt would apply force on a body area that is unprotected by any bony structure. This alone could cause serious or fatal injuries. To reduce the risk of serious or fatal injuries during a crash, young children should always be secured in an appropriate child restraint.

## Child Restraint Systems



### Rear-Facing Infant Restraint

A rear-facing child restraint provides restraint with the seating surface against the back of the infant.

The harness system holds the infant in place and, in a crash, acts to keep the infant positioned in the restraint.





**Forward-Facing Child Restraint**

A forward-facing child restraint provides restraint for the child's body with the harness.

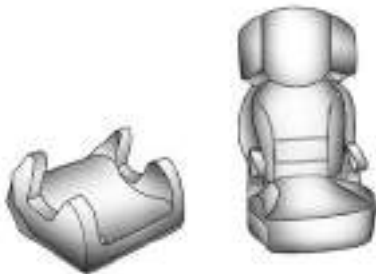

**Booster Seats**

A belt-positioning booster seat is used for children who have outgrown their forward-facing child restraint. Boosters are designed to improve the fit of the vehicle's seat belt system until the child is large enough for the vehicle seat belts to fit properly without a booster seat. See the seat belt fit test in *Older Children* ⇨ 60.

### Securing an Add-On Child Restraint in the Vehicle

#### **Warning**

A child can be seriously injured or killed in a crash if the child restraint is not properly secured in the vehicle. Secure the child restraint properly in the vehicle using the vehicle seat belt or LATCH system, following the instructions that came with that child restraint and the instructions in this manual.

To help reduce the chance of injury, the child restraint must be secured in the vehicle. Child restraints must be secured in vehicle seats by lap belts or the lap belt portion of a lap-shoulder belt, or by the LATCH system. See *Lower Anchors and Tethers for Children (LATCH System)* ⇨ 66 for more information. Never use a seat belt extender when installing a child restraint. Never use non-regulated aftermarket anchors or attachments to secure a child restraint. Children can be endangered in a crash if the child restraint is not properly secured in the vehicle.

When securing an add-on child restraint, refer to the following:

1. Instruction labels provided on the child restraint
2. Instruction manual provided with the child restraint
3. This vehicle owner's manual

The child restraint instructions are important, so if they are not available, obtain a replacement copy from the manufacturer.

Keep in mind that an unsecured child restraint can move around in a collision or sudden stop and injure people in the vehicle. Be sure to properly secure any child restraint in the vehicle — even when no child is in it.

In some areas Certified Child Passenger Safety Technicians (CPSTs) are available to inspect and demonstrate how to correctly use and install child restraints. In the U.S., refer to the National Highway Traffic Safety Administration (NHTSA) website to locate the nearest child safety seat inspection station. For CPST availability in Canada, check with Transport Canada or the Provincial Ministry of Transportation office.

### Securing the Child Within the Child Restraint

#### Warning

A child can be seriously injured or killed in a crash if the child is not properly secured in the child restraint. Secure the child properly following the instructions that came with that child restraint.

### Where to Put the Restraint

According to accident statistics, children and infants are safer when properly restrained in an appropriate child restraint secured in a rear seating position.

Whenever possible, children aged 12 and under should be secured in a rear seating position.

Never put a rear-facing child restraint in the front. This is because the risk to the rear-facing child is so great if the airbag deploys.

#### Warning

A child in a rear-facing child restraint can be seriously injured or killed if the front passenger airbag inflates. This is because the back of the rear-facing child restraint would be very close to the inflating airbag. A child in a forward-facing child restraint can be seriously injured or killed if the front passenger airbag inflates and the passenger seat is in a forward position.

Even if the passenger sensing system has turned off the front passenger frontal airbag, no system is fail-safe. No one can guarantee that an airbag will not deploy under some unusual circumstance, even though it is turned off.

Secure rear-facing child restraints in a rear seat, even if the airbag is off. If you secure a forward-facing child restraint in the front seat, always move the front passenger seat as far back as it will go. It is better to secure the child restraint in a rear seat.

See *Passenger Sensing System* ⇨ 55 for additional information.

When securing a child restraint with the seat belts in a rear seat position, study the instructions that came with the child restraint to make sure it is compatible with this vehicle.

Child restraints and booster seats vary considerably in size, and some may fit in certain seating positions better than others. Do not install a child restraint in any rear seating position where it cannot be installed securely.

Depending on where you place the child restraint and the size of the child restraint, you may not be able to access adjacent seat belts or LATCH anchors for additional passengers or child restraints. Adjacent seating positions should not be used if the child restraint prevents access to or interferes with the routing of the seat belt.

The seat in front of an installed child restraint should be adjusted to ensure proper installation according to the child restraint manual.

Wherever a child restraint is installed, be sure to follow the instructions that came with the child restraint and secure the child restraint properly.

Keep in mind that an unsecured child restraint can move around in a collision or sudden stop and injure people in the vehicle. Be sure to properly secure any child restraint in the vehicle — even when no child is in it.

### **Lower Anchors and Tethers for Children (LATCH System)**

The LATCH system secures a child restraint during driving or in a crash. LATCH attachments on the child restraint are used to attach the child restraint to the anchors in the vehicle. This system is designed to make installation of a child restraint easier.

In order to use the LATCH system in your vehicle, you need a child restraint that has LATCH attachments. LATCH-compatible rear-facing and forward-facing child seats can be properly installed using either the LATCH anchors or the vehicle's seat belts. Do not use both the seat belts and the LATCH anchorage system to secure a rear-facing or forward-facing child restraint.

Booster seats use the vehicle's seat belts to secure the child and the booster seat. If the manufacturer recommends that the booster seat be secured with the LATCH system, this can be done as long as the booster seat can be positioned properly and there is no interference with the proper positioning of the lap-shoulder belt on the child.

Make sure to follow the instructions that came with the child restraint, and also the instructions in this manual.

When installing a child restraint with a top tether, you must also use either the lower anchors or the seat belts to properly secure the child restraint. A child restraint must never be attached using only the top tether.

For a forward-facing 5-pt harness child restraint where the combined weight of the child and restraint are up to 29.5 kg (65 lb), use either the lower LATCH anchorages with the top tether anchorage, or the seat belt with the top tether anchorage. Where the combined weight of the child and restraint are greater than 29.5 kg (65 lb), use the seat belt with the top tether anchorage only.

**Recommended Methods for Attaching Child Restraints**

Restraint Type	Combined Weight of the Child + Child Restraint	Use Only Approved Attachment Methods Shown with an X			
		LATCH – Lower Anchors Only	Seat Belt Only	LATCH – Lower Anchors and Top Tether Anchor	Seat Belt and Top Tether Anchor
Rear-Facing Child Restraint	Up to 29.5 kg (65 lb)	X	X		
Rear-Facing Child Restraint	Greater than 29.5 kg (65 lb)		X		
Forward-Facing Child Restraint	Up to 29.5 kg (65 lb)			X	X
Forward-Facing Child Restraint	Greater than 29.5 kg (65 lb)				X

See *Securing Child Restraints (With the Seat Belt in the Front Seat)* ⇨ 73 or *Securing Child Restraints (With the Seat Belt in the Rear Seat)* ⇨ 72.

Child restraints built after March 2014 are labeled with the maximum child weight, with which the LATCH system can be used for installing the child restraint.

The following explains how to attach a child restraint with these attachments in the vehicle.

Not all vehicle seating positions have lower anchors. In this case, the seat belt must be used (with top tether where available) to secure the child restraint. See *Securing Child Restraints (With the Seat Belt in the Front Seat)* ⇨ 73 or *Securing Child Restraints (With the Seat Belt in the Rear Seat)* ⇨ 72.

## Lower Anchors

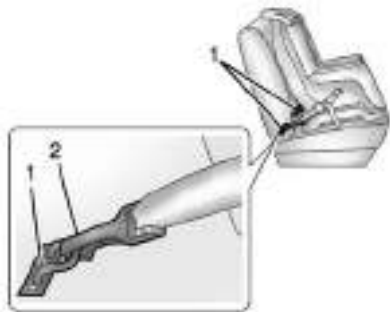

Lower anchors (1) are metal bars built into the vehicle. There are two lower anchors for each LATCH seating position that will accommodate a child restraint with lower attachments (2).

## Top Tether Anchor

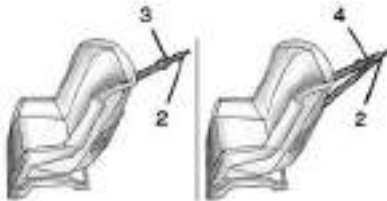

A top tether (3, 4) is used to secure the top of the child restraint to the vehicle. A top tether anchor is built into the vehicle. The top tether attachment hook (2) on the child restraint connects to the top tether anchor in the vehicle in order to reduce the forward movement and rotation of the child restraint during driving or in the event of a crash.

The child restraint may have a single tether (3) or a dual tether (4). Either will have a single attachment hook (2) to secure the top tether to the anchor.

Some child restraints with a top tether are designed for use with or without the top tether being attached. Others require the

top tether always to be attached. In Canada, the law requires that forward-facing child restraints have a top tether, and that the tether be attached. Be sure to read and follow the instructions for your child restraint.

## Lower Anchor and Top Tether Anchor Locations

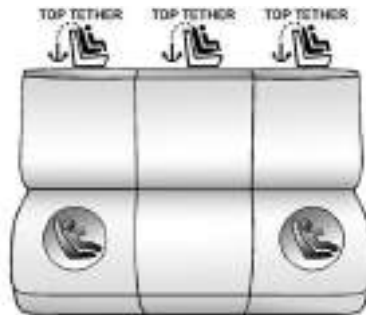

Rear Seat

TOP TETHER



: Seating positions with top tether anchors.



: Seating positions with two lower anchors.



To assist in locating the lower anchors, each second row anchor position has a label, near the crease between the seatback and the seat cushion.



To assist in locating the top tether anchors, the top tether anchor symbol is near the top tether anchors.



### Top Tether Anchors

The top tether anchors for each rear seating position are on the back of the rear seatback. Be sure to use an anchor located directly behind the seating position where the child restraint will be placed.

For models with a cargo cover, the top tether anchors are on the back of the rear seatbacks. Remove the cargo cover before installing the top tether. The cargo cover should remain off while the top tether is in

use. Be sure to use an anchor directly behind the seating position where the child restraint will be placed.

Do not secure a child restraint in a position without a top tether anchor if a national or local law requires that the top tether be attached, or if the instructions that come with the child restraint say that the top tether must be attached.

According to accident statistics, children and infants are safer when properly restrained in a child restraint system or infant restraint system secured in a rear seating position. See *Where to Put the Restraint* ⇨ 65 for additional information.

### Securing a Child Restraint Designed for the LATCH System

#### Warning

A child could be seriously injured or killed in a crash if the child restraint is not properly attached to the vehicle using either the LATCH anchors or the vehicle seat belt. Follow the instructions that came with the child restraint and the instructions in this manual.

**⚠ Warning**

To reduce the risk of serious or fatal injuries during a crash, do not attach more than one child restraint to a single anchor. Attaching more than one child restraint to a single anchor could cause the anchor or attachment to come loose or even break during a crash. A child or others could be injured.

**⚠ Warning**

Children can be seriously injured or strangled if a shoulder belt is wrapped around their neck. The shoulder belt can tighten but cannot be loosened if it is locked. The shoulder belt locks when it is pulled all the way out of the retractor. It unlocks when the shoulder belt is allowed to go all the way back into the retractor, but it cannot do this if it is wrapped around a child's neck. If the shoulder belt is locked and tightened around a child's neck, the only way to loosen the belt is to cut it.

(Continued)

**Warning (Continued)**

Buckle any unused seat belts behind the child restraint so children cannot reach them. Pull the shoulder belt all the way out of the retractor to set the lock, and tighten the belt behind the child restraint after the child restraint has been installed.

**Caution**

Do not let the LATCH attachments rub against the vehicle's seat belts. This may damage these parts. If necessary, move buckled seat belts to avoid rubbing the LATCH attachments.

Do not fold the rear seatback when the seat is occupied. Do not fold the empty rear seat with a seat belt buckled. This could damage the seat belt or the seat. Unbuckle and return the seat belt to its stowed position, before folding the seat.

If you need to secure more than one child restraint in the rear seat, see *Where to Put the Restraint* ⇨ 65.

1. Attach and tighten the lower attachments to the lower anchors. If the child restraint does not have lower attachments or the desired seating position does not have lower anchors, secure the child restraint with the top tether and the seat belt. Refer to the child restraint manufacturer instructions and the instructions in this manual.
  - 1.1. Find the lower anchors for the desired seating position.
  - 1.2. Put the child restraint on the seat.
  - 1.3. Attach and tighten the lower attachments on the child restraint to the lower anchors.
2. If the child restraint manufacturer recommends that the top tether be attached, adjust the top tether to its full length and attach it to the anchor. Refer to the child restraint instructions and the following steps:
  - 2.1. Find the top tether anchor.
  - 2.2. Route, attach and tighten the top tether according to your child restraint instructions and the following instructions:



- If the position you are using does not have a headrest or head restraint and you are using a single tether, route the tether over the seatback.



- If the position you are using does not have a headrest or head restraint and you are using a dual tether, route the tether over the seatback.



- If the position you are using has an adjustable headrest or head restraint, adjust it accordingly to allow proper fitment. If you are using a dual tether, route the tether around the headrest or head restraint posts.  
If the child restraint is installed next to a center seat, make sure the top tether does not interfere with the center seating position shoulder belt/retractor. If it does, find another suitable seating position to install the child restraint.



- If the position you are using has an adjustable headrest or head restraint, adjust it accordingly to allow proper fitment. If you are using a single tether, route the tether in between the headrest or head restraint posts.
3. Before placing a child in the child restraint, make sure it is securely held in place. To check, grasp the child restraint at the LATCH path and attempt to move it side to side and back and forth. There should be no more than 2.5 cm (1 in) of movement, for proper installation.



## Replacing LATCH System Parts After a Crash

### Warning

A crash can damage the LATCH system in the vehicle. A damaged LATCH system may not properly secure the child restraint, resulting in serious injury or even death in a crash. To help make sure the LATCH system is working properly after a crash, see your dealer to have the system inspected and any necessary replacements made as soon as possible.

If the vehicle has the LATCH system and it was being used during a crash, new LATCH system parts may be needed.

New parts and repairs may be necessary even if the LATCH system was not being used at the time of the crash.

## Securing Child Restraints (With the Seat Belt in the Rear Seat)

When securing a child restraint with the seat belts in a rear seat position, study the instructions that came with the child restraint to make sure it is compatible with this vehicle.

If the child restraint has the LATCH system, see *Lower Anchors and Tethers for Children (LATCH System)* ⇨ 66 for how and where to install the child restraint using LATCH. If a child restraint is secured in the vehicle using a seat belt and it uses a top tether, see *Lower Anchors and Tethers for Children (LATCH System)* ⇨ 66 for top tether anchor locations.

Do not secure a child seat in a position without a top tether anchor if a national or local law requires that the top tether be anchored, or if the instructions that come with the child restraint say that the top tether must be anchored.

In Canada, the law requires that forward-facing child restraints have a top tether, and that the tether be attached.

If the child restraint or vehicle seat position does not have the LATCH system, you will be using the seat belt to secure the child restraint. Be sure to follow the instructions that came with the child restraint.

If more than one child restraint needs to be installed in the rear seat, be sure to read *Where to Put the Restraint* ⇨ 65.

1. Put the child restraint on the seat.

2. Pick up the latch plate and run the lap and shoulder portions of the vehicle seat belt through or around the child restraint. Ensure the seat belt webbing is routed as directly as possible and is not caught on seat handles or plastic trim. The child restraint instructions will show you how.



3. Push the latch plate into the buckle until it clicks.

Position the release button on the buckle, away from the child restraint, so that the seat belt could be quickly unbuckled if necessary.

There must not be direct contact of the child restraint to the push button.



4. Pull the shoulder belt all the way out of the retractor to set the lock. When the retractor lock is set, the belt can be tightened but not pulled out of the retractor.

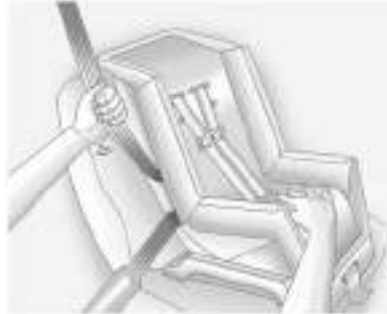

5. To tighten the belt, push down on the child restraint, pull the shoulder portion of the belt to tighten the lap portion of the belt, and feed the shoulder belt back into the retractor. When installing a forward-facing child restraint, it may be helpful to use your knee to push down on the child restraint as you tighten the belt.

Try to pull the belt out of the retractor to make sure the retractor is locked. If the retractor is not locked, repeat Steps 4 and 5.

6. If the child restraint has a top tether, follow the child restraint manufacturer's instructions regarding the use of the top tether. See *Lower Anchors and Tethers for Children (LATCH System)* ⇨ 66.
7. Before placing a child in the child restraint, make sure it is securely held in place. To check, grasp the child restraint at the seat belt path and attempt to move it side to side and back and forth. When the child restraint is properly installed, there should be no more than 2.5 cm (1 in) of movement.

To remove the child restraint, unbuckle the vehicle seat belt and let it return to the stowed position. If the top tether is attached to a top tether anchor, disconnect it.

### Securing Child Restraints (With the Seat Belt in the Front Seat)

This vehicle has airbags. A rear seat is a safer place to secure a forward-facing child restraint. See *Where to Put the Restraint* ⇨ 65.

In addition, the vehicle has a passenger sensing system which is designed to turn off the front outboard passenger frontal airbag and knee airbag under certain conditions.

See *Passenger Sensing System* ⇨ 55 and *Passenger Airbag Status Indicator* ⇨ 93 for more information, including important safety information.

Never put a rear-facing child seat in the front. This is because the risk to the rear-facing child is so great if the airbag deploys.

### Warning

A child in a rear-facing child restraint can be seriously injured or killed if the front outboard passenger frontal airbag inflates. This is because the back of the rear-facing child restraint would be very close to the inflating airbag. A child in a forward-facing child restraint can be seriously injured or killed if the front outboard passenger frontal airbag inflates and the passenger seat is in a forward position.

Even if the passenger sensing system has turned off the front outboard passenger airbag(s), no system is fail-safe. No one can guarantee that an airbag will not deploy under some unusual circumstance, even though the airbag(s) are off.

(Continued)

### Warning (Continued)

Secure rear-facing child restraints in a rear seat, even if the airbag(s) are off. If you secure a forward-facing child restraint in the front outboard passenger seat, always move the seat as far back as it will go. It is better to secure the child restraint in a rear seat.

See *Passenger Sensing System* ⇨ 55 for additional information.

If the child restraint uses a top tether, see *Lower Anchors and Tethers for Children (LATCH System)* ⇨ 66 for top tether anchor locations.

Do not secure a child seat in a position without a top tether anchor if a national or local law requires that the top tether be anchored, or if the instructions that come with the child restraint say that the top tether must be anchored.

In Canada, the law requires that forward-facing child restraints have a top tether, and that the tether be attached.

When using the lap-shoulder belt to secure the child restraint in this position, follow the instructions that came with the child restraint and the following instructions:

1. Move the seat as far back as it will go before securing the forward-facing child restraint. Move the seat upward or the seatback to an upright position, if needed, to get a tight installation of the child restraint. There must be finger clearance between the push button and the child restraint.

When the passenger sensing system has turned off the front outboard passenger frontal airbag and knee airbag, the OFF indicator on the passenger airbag status indicator should light and stay lit when you start the vehicle. See *Passenger Airbag Status Indicator* ⇨ 93.

2. Put the child restraint on the seat.
3. Pick up the latch plate and run the lap and shoulder portions of the vehicle seat belt through or around the restraint. Ensure the seat belt webbing is routed as direct as possible and is not caught on seat handles or plastic trim. The child restraint instructions will show you how.



Tilt the latch plate to adjust the belt if needed.



4. Push the latch plate into the buckle until it clicks.

Position the release button on the buckle, away from the child restraint, so that the seat belt could be quickly unbuckled if necessary.



5. Pull the shoulder belt all the way out of the retractor to set the lock. When the retractor lock is set, the belt can be tightened but not pulled out of the retractor.

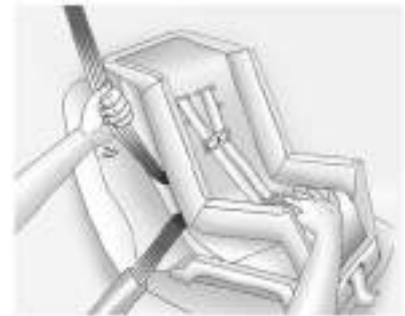

6. To tighten the belt, push down on the child restraint, pull the shoulder portion of the belt to tighten the lap portion of the belt, and feed the shoulder belt back into the retractor.

There must be finger clearance between the push button and the child restraint. If there is not clearance between the buckle push button and the child restraint, move the seat upward and repeat prior installation steps. Otherwise secure the child restraint in a rear seat.

When installing a forward-facing child restraint, it may be helpful to use your knee to push down on the child restraint as you tighten the belt.

Try to pull the belt out of the retractor to make sure the retractor is locked.

If the retractor is not locked, repeat Steps 5 and 6.

7. Before placing a child in the child restraint, make sure it is securely held in place. To check, grasp the child restraint at the seat belt path and attempt to move it side to side and back and forth. When the child restraint is properly installed, there should be no more than 2.5 cm (1 in) of movement.

If the airbags are off, the OFF indicator in the passenger airbag status indicator will come on and stay on when the vehicle is started.

If a child restraint has been installed and the ON indicator is lit, see “If the On Indicator Is Lit for a Child Restraint” under *Passenger Sensing System* ⇨ 55.

To remove the child restraint, unbuckle the vehicle seat belt and let it return to the stowed position.

## Storage

### Storage Compartments

Storage Compartments .....	77
Instrument Panel Storage .....	77
Glove Box .....	77
Cupholders .....	77
Center Console Storage .....	78

### Additional Storage Features

Cargo Cover .....	78
Cargo Tie-Downs .....	79
Cargo Management System .....	80

## Storage Compartments

### Warning

Do not store heavy or sharp objects in storage compartments. In a crash, these objects may cause the cover to open and could result in injury.

### Instrument Panel Storage



If equipped, there is an upper sliding drawer in the center of the instrument panel. Press to open.

## Glove Box

To open the glove box, press the Glove Box Release button on the controls home page of the infotainment screen or tap Controls > Doors & Windows > Glove Box Release.

If the vehicle is stationary, a Glove Box Release icon appears on the infotainment home screen. Tap the icon to open the glove box.

If the vehicle is off, you can still open the glove box. Press the volume button or the Multi-function Controller (MFC) to wake the infotainment home screen and access the virtual Glove Box Release button.

To close the glove box, push the glove box up until it latches.

If the 12-volt battery is dead, the glove box will not open. See *Jump Starting - North America* ⇨ 285.

## Cupholders

The front cupholders are in the center console.



If equipped, lower the armrest to access the rear cupholders.

### Center Console Storage



Lift the armrest up to access the storage area.

There is a USB port, an SD card reader, and an auxiliary power outlet. If equipped, the front of the console may also have an additional USB port.

## Additional Storage Features

### Cargo Cover

#### Warning

An unsecured cargo cover could strike people in a sudden stop or turn, or in a crash. Store the cargo cover securely or remove it from the vehicle.

#### Warning

Do not place objects on the cargo cover. Sudden stops or turns can cause objects to be thrown in the vehicle. You or others could be injured.



If equipped, use the cargo cover to cover items in the rear of the vehicle.

### Install the Cargo Cover

1. Hold the cartridge so that the retracted cargo cover faces the rear of the vehicle.
2. Align the cartridge over the slots on the trim panels of the vehicle.
3. Place one end of the cartridge into the slot and then compress to fit the other end into the remaining slot.
4. Unroll the cargo cover toward the rear of the vehicle.



5. Insert the cargo cover pins into the channels on both sides.

### Remove the Cargo Cover

Remove the cargo cover pins from the channels and let the cover retract. Compress the ends of the cartridge to remove it from the slots.

### Store the Cargo Cover

To store the cargo cover:



1. Press the buttons on both ends until locked.



2. Store under the load floor.

To reinstall, press the buttons to unlock the ends of the cover, and then follow the installation procedure.

### Cargo Tie-Downs



The vehicle has four cargo tie-downs in the rear compartment.



## Cargo Management System



There is storage under the load floor.



Press the handle and pull up the load floor to access.

### Caution

Overloading the cargo management system can cause damage to the vehicle. Do not place cargo that weighs more than 20 kg (44 lb) in the bin or on top of the plastic lid (if equipped).

## Instruments and Controls

### Controls

Steering Wheel Adjustment .....	82
Heated Steering Wheel .....	82
Horn .....	82
Pedestrian Safety Signal .....	82
Windshield Wiper/Washer .....	83
Compass .....	84
Clock .....	84
Power Outlets .....	84
Wireless Charging .....	86

### Warning Lights, Gauges, and Indicators

Warning Lights, Gauges, and Indicators .....	88
Instrument Cluster .....	89
Speedometer .....	90
Odometer .....	90
Trip Odometer .....	90
Battery Gauge (High Voltage) .....	90
Power Indicator Gauge .....	91
Seat Belt Reminders .....	91
Airbag Readiness Light .....	92
Passenger Airbag Status Indicator .....	93
Charging System Light (12-Volt Battery) .....	93
Low State of Charge Light .....	94
Charge Cord Connected Light .....	94
Battery Fault Light .....	94

Propulsion Power is Limited Light .....	94
Service Vehicle Soon Light .....	94
Brake System Warning Light .....	94
Electric Parking Brake Light .....	95
Service Electric Parking Brake Light .....	95
Antilock Brake System (ABS) Warning Light .....	96
Automatic Vehicle Hold (AVH) Light .....	96
Lane Keep Assist (LKA) Light .....	96
Automatic Emergency Braking (AEB) Disabled Light .....	97
Vehicle Ahead Indicator .....	97
Pedestrian Ahead Indicator .....	97
Traction Off Light .....	97
StabiliTrak OFF Light .....	98
Traction Control System (TCS)/StabiliTrak Light .....	98
Driver Mode Control Light .....	98
Tire Pressure Light .....	99
Security Light .....	99
Vehicle Ready Light .....	99
One-Pedal Driving Light .....	99
High-Beam On Light .....	100
Adaptive Forward Lighting (AFL) Light .....	100
Lamps On Reminder .....	100
Cruise Control Light .....	100
Door Ajar Light .....	101

### Information Displays

Charging .....	101
Driver Information Center (DIC) .....	108
Vehicle Information .....	109

### Vehicle Messages

Vehicle Messages .....	110
Propulsion Power Messages .....	110
Vehicle Speed Messages .....	111

### Universal Remote System

Universal Remote System .....	111
Universal Remote System Programming .....	111
Universal Remote System Operation .....	113

## Controls

### Steering Wheel Adjustment

#### Power Tilt and Telescoping Steering Wheel



To adjust the steering wheel:

1. Press the control up or down to tilt the steering wheel up or down.
2. Press the control rearward or forward to move the steering wheel closer or away from you.

Do not adjust the steering wheel while driving.

### Heated Steering Wheel



 : Press to turn the heated steering wheel on or off. An indicator next to the button is lit when the feature is turned on.

The steering wheel takes about three minutes to start heating.

#### Automatic Heated Steering Wheel

The heated steering wheel may turn on during a remote start along with the heated seats when it is cold outside. The heated steering wheel indicator may come on in remote start.

The heated steering wheel will turn on when the auto heated seat is activated. The heated steering wheel indicator will display the state of the steering wheel heat.

See *Heated and Ventilated Front Seats* ⇨ 38.

To turn this feature on or off, select Settings > Vehicle > Comfort and Convenience > Heated Steering Wheel > Select ON or OFF.

### Horn

To sound the horn, press  on the steering wheel.

### Pedestrian Safety Signal

The vehicle is equipped with automatic sound generation. The automatic sound is generated to indicate the vehicle presence to pedestrians. The sound changes if the vehicle is speeding up or slowing down. It is activated when the vehicle is shifted into a forward gear, N (Neutral), or R (Reverse), up to 34 km/h (21 mph).

## Windshield Wiper/Washer

This vehicle is equipped with Rainsense and a sensor near the top center of the windshield detects the amount of water on the windshield and controls the frequency of the windshield wiper based on the current sensitivity setting.

Keep this area of the windshield clear of debris to allow for best system performance.



Base Windshield/Washer Lever Shown

With the vehicle on, move the windshield wiper lever to select the wiper speed.

**OFF** : Use to turn the wipers off.

**LO** : Use for slow wipes.

**HI** : Use for fast wipes.

Turn the band to select the frequency of intermittent wipes between OFF and LO.

Clear snow and ice from the wiper blades and windshield before using them. If frozen to the windshield, carefully loosen or thaw them. Damaged blades should be replaced. See *Wiper Blade Replacement* ⇨ 258.

### ⚠ Warning

In freezing weather, do not use the washer until the windshield is warmed. Otherwise the washer fluid can form ice on the windshield, blocking your vision.

### ⚠ Warning

Before driving the vehicle, always clear snow and ice from the hood, windshield, washer nozzles, roof, and rear of the vehicle, including all lamps and windows. Reduced visibility from snow and ice buildup could lead to a crash.

### Wiper Arm Assembly Protection

When using an automatic car wash, move the windshield wiper lever to OFF. This disables the automatic Rainsense windshield wipers.

With Rainsense, if the vehicle is in N (Neutral) and the speed is very slow, the wipers will automatically stop at the base of the windshield.

The wiper operations return to normal when the vehicle is no longer in N (Neutral) or the vehicle speed has increased.

## Windshield Washer



>  : Push the button on the side of the windshield wiper lever once to spray washer fluid and activate the wipers.

>>  : Push the button on the side of the windshield wiper lever twice to spray washer fluid and activate the wipers. When the button is released, additional wipes may occur depending on how long the windshield washer had been activated. See *Washer Fluid* ⇨ 253 for information on filling the windshield washer fluid reservoir.

### Wiper Parking

If the vehicle is off while the wipers are on LO or HI, they will immediately stop.

If the windshield wiper lever is then moved to OFF before the driver door is opened or within 10 minutes, the wipers will restart and move to the base of the windshield.

If the vehicle is off while the wipers are performing wipes due to windshield washing or Rainsense, the wipers continue to run until they reach the base of the windshield.

### Rear Camera Washer



If equipped, turn the band to  to spray washer fluid on the rear camera lens. Release the band when done. See *Rear Camera Mirror* ⇨ 26.

### Compass

The vehicle may have a compass display on the Driver Information Center (DIC). The compass receives its heading and other information from the Global Positioning System (GPS) antenna, StabiliTrak/Electronic Stability Control (ESC), and vehicle speed information.

The compass system is designed to operate for a certain number of miles or degrees of turn before needing a signal from the GPS satellites. When the compass display shows CAL, drive the vehicle for a short distance in an open area where it can receive a GPS signal. The compass system will automatically determine when a GPS signal is restored and provide a heading again.

### Clock

Set the time and date using the infotainment system. See "Time/Date" under *Settings* ⇨ 144.

### Power Outlets

#### Power Outlets 12-Volt Direct Current

The vehicle has two 12-volt outlets that can be used to plug in electrical equipment, such as a cell phone or MP3 player.



Center Console



Rear Cargo Area

The power outlets are located:

- Inside of the center console.
- In the rear cargo area.

Lift the cover to access the outlet and replace when not in use.

### Warning

Power is always supplied to the rear cargo power outlet. Do not leave electrical equipment plugged in when the vehicle is not in use because the vehicle could catch fire and cause injury or death.

### Caution

Leaving electrical equipment plugged in for an extended period of time while the vehicle is off will drain the battery. Always unplug electrical equipment when not in use and do not plug in equipment that exceeds the maximum 15 amp rating.

Certain accessory plugs may not be compatible with the accessory power outlet and could overload vehicle and adapter fuses. If a problem is experienced, see your dealer.

When adding electrical equipment, be sure to follow the proper installation instructions included with the equipment. See *Add-On Electrical Equipment* ⇨ 245.

### Caution

Hanging heavy equipment from the power outlet can cause damage not covered by the vehicle warranty. The power outlets are designed for accessory power plugs only, such as cell phone charge cords.

### Power Outlet 110-Volt/120-Volt Alternating Current

If equipped with this power outlet it can be used to plug in electrical equipment that uses a maximum limit of 150 watts.



The power outlet is on the rear of the center console.

An indicator light on the outlet turns on to show it is in use. The light comes on when the vehicle is on, equipment requiring less than 150 watts is plugged into the outlet, and no system fault is detected.

The indicator light does not come on when the vehicle is off or if the equipment is not fully seated into the outlet.

If equipment is connected using more than 150 watts or a system fault is detected, a protection circuit shuts off the power supply and the indicator light turns off. To reset the circuit, unplug the item and plug it back in or turn the Retained Accessory Power

(RAP) off and then back on. See *Retained Accessory Power (RAP)* ⇨ 170. The power restarts when equipment using 150 watts or less is plugged into the outlet and a system fault is not detected.

The power outlet is not designed for and may not work properly, if the following are plugged in:

- Equipment with high initial peak wattage, such as compressor-driven refrigerators and electric power tools
- Other equipment requiring an extremely stable power supply, such as microcomputer-controlled electric blankets and touch sensor lamps
- Medical equipment

## Wireless Charging

If equipped and enabled, the vehicle has wireless charging in front of the center console storage bin. The system operates at 145 kHz and wirelessly charges one Qi compatible smartphone. The power output of the system is capable of charging at a rate up to 3 amp (15 W), as requested by the compatible smartphone. See *Radio Frequency Statement* ⇨ 312.

### Warning

Wireless charging may affect the operation of an implanted pacemaker or other medical devices. If you have one, it is recommended to consult with your doctor before using the wireless charging system.

The vehicle must be on, in accessory mode, or Retained Accessory Power (RAP) must be active. The wireless charging feature may not correctly indicate charging when the vehicle is in RAP, during a Bluetooth phone call, or when phone projection (e.g. Apple CarPlay / Android Auto) is active. See *Retained Accessory Power (RAP)* ⇨ 170.

The operating temperature is  $-40^{\circ}\text{C}$  ( $-40^{\circ}\text{F}$ ) to  $85^{\circ}\text{C}$  ( $185^{\circ}\text{F}$ ) for the charging system and  $0^{\circ}\text{C}$  ( $32^{\circ}\text{F}$ ) to  $35^{\circ}\text{C}$  ( $95^{\circ}\text{F}$ ) for the phone. A charging stopped alert may be displayed on the infotainment screen, if the wireless charger or smartphone are outside of normal operating temperature. Charging will automatically resume when a normal operating temperature is reached.

### Warning

Remove all objects from the charger before charging your compatible smartphone. Objects, such as coins, keys, rings, paper clips, or cards, between the smartphone and charger may become very hot.

On the rare occasion that the charging system does not detect an object, and the object gets wedged between the smartphone and charger, remove the smartphone and allow the object to cool before removing it from the charger, to prevent burns.





To charge a compatible smartphone:

1. Confirm the smartphone is capable of wireless charging.
2. Remove all objects from the charging pocket. The system may not charge if there are any objects between the smartphone and charger.
3. Place the smartphone face up against the rear of the charger.

To maximize the charge rate, ensure the smartphone is fully seated and centered in the holder with nothing under it.

A thick smartphone case may prevent the charger from working, or reduce the charging performance. See your dealer for additional information.

4. A green  will appear on the infotainment display, next to the phone icon. This indicates that the smartphone is detected.
5. If a smartphone is placed on the charger and  turns off or a yellow triangle appears, remove the smartphone and any objects from the pocket. Turn the smartphone 180 degrees and wait a few seconds before placing/aligning it on the pocket again.

6. If a smartphone is placed on the charger and a red circle appears, the charger and/or the smartphone is overheated. Remove the smartphone and any objects from the charger in order to cool the system.

The smartphone may become warm during charging. This is normal. In warmer temperatures, the speed of charging may be reduced.

For vehicles with wireless phone projection, the smartphone may overheat during wireless charging. The smartphone may slow down, stop charging, or shut down to protect the battery. The phone may need to be removed from its case to prevent overheating. The  may flash while the phone is cooling down enough for wireless charging to automatically resume. This is normal. Individual phone performance may vary.

### Software Acknowledgements

Certain Wireless Charging Module product from LG Electronics, Inc. ("LGE") contains the open source software detailed below. Refer to the indicated open source licenses (as are included following this notice) for the terms and conditions of their use.

### OSS Notice Information

To obtain the source code that is contained in this product, please visit <https://opensource.lge.com>. In addition to the source code, all referred license terms, warranty disclaimers and copyright notices are available for download. LG Electronics will also provide open source code to you on CD-ROM for a charge covering the cost of performing such distribution (such as the cost of media, shipping, and handling) upon email request to [opensource@lge.com](mailto:opensource@lge.com). This offer is valid for three (3) years from the date on which you purchased the product.



**Freescale-WCT library**

Copyright (c) 2012-2014 Freescale Semiconductor, Inc.. All rights reserved.

Redistribution and use in source and binary forms, with or without modification, are permitted provided that the following conditions are met:

1. Redistributions of source code must retain the above copyright notice, this list of conditions and the following disclaimer.
2. Redistributions in binary form must reproduce the above copyright notice, this list of conditions and the following disclaimer in the documentation and/or other materials provided with the distribution.
3. Neither the name of the copyright holder nor the names of its contributors may be used to endorse or promote products derived from this software without specific prior written permission.

THIS SOFTWARE IS PROVIDED BY THE COPYRIGHT HOLDERS AND CONTRIBUTORS "AS IS" AND ANY EXPRESS OR IMPLIED WARRANTIES, INCLUDING, BUT NOT LIMITED TO, THE IMPLIED WARRANTIES OF MERCHANTABILITY AND FITNESS FOR A PARTICULAR PURPOSE ARE DISCLAIMED. IN NO EVENT SHALL THE COPYRIGHT HOLDER OR CONTRIBUTORS BE LIABLE FOR ANY DIRECT, INDIRECT, INCIDENTAL, SPECIAL, EXEMPLARY, OR CONSEQUENTIAL DAMAGES (INCLUDING, BUT NOT LIMITED TO, PROCUREMENT OF SUBSTITUTE GOODS OR SERVICES; LOSS OF USE, DATA, OR PROFITS; OR BUSINESS INTERRUPTION) HOWEVER CAUSED AND ON ANY THEORY OF LIABILITY, WHETHER IN CONTRACT, STRICT LIABILITY, OR TORT (INCLUDING NEGLIGENCE OR OTHERWISE) ARISING IN ANY WAY OUT OF THE USE OF THIS SOFTWARE, EVEN IF ADVISED OF THE POSSIBILITY OF SUCH DAMAGE.

**Warning Lights, Gauges, and Indicators**

Warning lights and gauges can signal that something is wrong before it becomes serious enough to cause an expensive repair or replacement. Paying attention to the warning lights and gauges could prevent injury.

Some warning lights come on briefly when the propulsion system is started to indicate they are working. When one of the warning lights comes on and stays on while driving, or when one of the gauges shows there may be a problem, check the section that explains what to do. Waiting to do repairs can be costly and even dangerous.

## Instrument Cluster

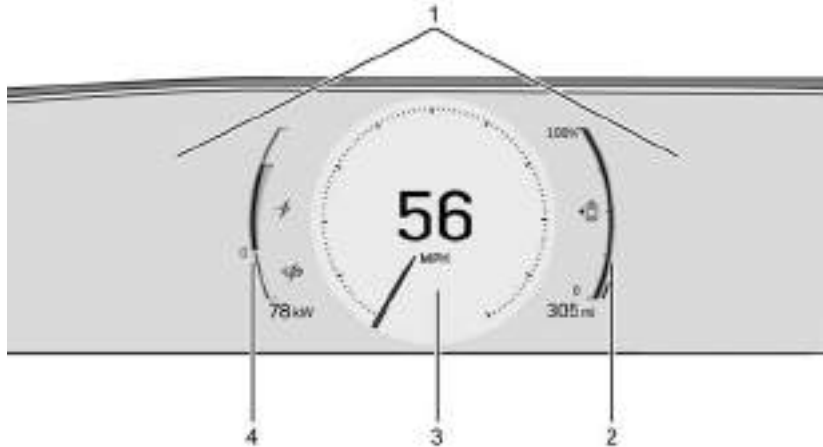

English Tour Mode Gauge View Shown, Others and Metric Similar

1. *Driver Information Center (DIC)* ⇨ 108
2. *Battery Gauge (High Voltage)* ⇨ 90
3. *Speedometer* ⇨ 90
4. *Power Indicator Gauge* ⇨ 91

### Reconfigurable Instrument Cluster

The instrument cluster display layout can be changed. There are two display configurations to choose from based on the driver mode selected: Tour, and Sport. To

see how to change the Driver Mode, see “Mode Activation” under *Driver Mode Control* ⇨ 180.

- Tour configuration displays the speedometer in the center of the display. The battery gauge is located on the right of the speedometer and the power indicator gauge is on the left of it. There are two DIC areas on the left and right of the display.
- Sport configuration displays the speedometer in the center of the display. The battery gauge is located below the speedometer and the power indicator gauge is above it. There are two DIC areas on the left and right of the display.

There are four selectable views:

**Gauge** : Displays information zones to the left and right of the speedometer.

**Energy** : Displays the energy usage of the vehicle.

**Map** : Displays a navigation map.

**Clean** : Displays no information zones.

To change the cluster configuration, touch  on the touchscreen to the left of the instrument cluster. Select the desired option from the list.

Selecting a different view could hide the vehicle information that is displayed in the information zones on the cluster. Once a view with information zones is selected the vehicle information that was last selected will then be displayed. See *Driver Information Center (DIC)* ⇨ 108 and *Vehicle Information* ⇨ 109.

### Control Panel



There is a touchscreen to the left of the instrument cluster. Use it for the following:

### Trip Information

Touch  to view distance and efficiency for the current trip. View other trip information by swiping right or left on the touchscreen.

Touch and hold  to reset the current trip.

### Instrument Cluster Layout

Touch  to view and select the available instrument cluster layouts.

### Display Settings

The following options can be turned on or off using the infotainment display. See *Settings* ⇨ 144.

### Speed Sign

Shows sign information, which comes from a roadway database in the onboard navigation, if equipped. The sign will show “- -” when there is no detected speed limit or the system is unavailable.

### Turn-by-Turn Graphics

When on, you will see turn-by-turn navigation graphics in the instrument cluster when a route is active. These graphics provide visual directions for upcoming maneuvers.

### Speedometer

The speedometer shows the vehicle speed in either kilometers per hour (km/h) or miles per hour (mph).

### Odometer

The odometer shows how far the vehicle has been driven, in either kilometers or miles.

### Trip Odometer

The trip odometer shows how far the vehicle has been driven since the trip odometer was last reset.

The trip odometer is accessed and reset through the Driver Information Center (DIC). See *Driver Information Center (DIC)* ⇨ 108.

### Battery Gauge (High Voltage)

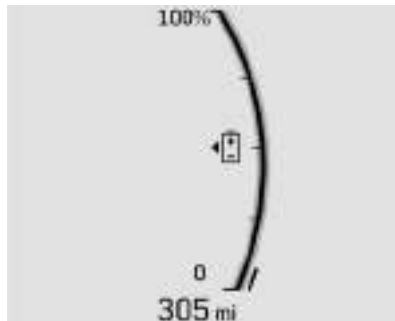

English Tour Mode Gauge View Shown,  
Others and Metric Similar

This displays the high voltage battery state of charge. The value at the bottom is an estimate of how far the vehicle can be driven on the remaining charge based on recent driving habits, conditions, and HVAC usage.

The fill bars shown inside of the gauge indicate the percentage range as estimated from current vehicle conditions and climate settings. The range estimate on the bottom also may be affected by climate settings, current vehicle conditions and ambient conditions. Estimated range may increase and decrease based on climate control energy consumption.

Driving aggressively through hard acceleration and/or braking events, excessive HVAC usage, using heated or cooled seats, battery preconditioning, and performance modes can affect vehicle range estimates.

When the high voltage battery state of charge level gets low, the gauge will change color to amber. When the charge is very low the gauge will change color to red, and the estimated range value on the bottom will change to LOW. Additional alerts may display and a sound may also be heard at low state of charge.

## Power Indicator Gauge

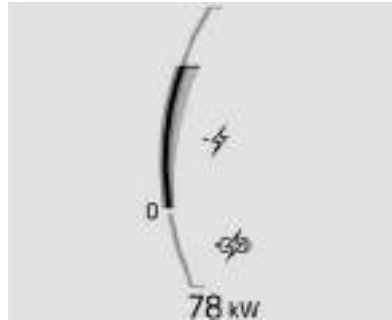

Tour Mode Gauge View Shown, Others Similar

The power indicator gauge is in the center of the display to the left of the speedometer in the Tour mode gauge view.

This gauge displays the instantaneous charge and consumption power of the high voltage battery. Maximum power consumption is available when the high voltage battery is fully charged. During normal operation, a slight reduction in consumption power may occur as the high voltage battery state of charge decreases.

## Regenerative Braking

When regenerative (regen) braking is active, the regen battery icon displays and will fill the lower section of the gauge. The power indicator gauge value shows the amount of instantaneous power being regenerated.

## Regenerative Power Limited

Regenerative power may be limited when the high voltage battery is near full charge or cold. This will affect the vehicle's maximum regenerative braking power.

## Seat Belt Reminders

### Driver Seat Belt Reminder Light

There is a driver seat belt reminder light on the instrument cluster.



When the vehicle is started, this light flashes and a chime may come on to remind the driver to fasten their seat belt. Then the light stays on solid until the belt is buckled.

This cycle may continue several times if the driver remains or becomes unbuckled while the vehicle is moving.

If the driver seat belt is buckled, neither the light nor the chime comes on.

### Front Passenger Seat Belt Reminder Light

The vehicle may have a front passenger seat belt reminder light near the passenger airbag status indicator.

See *Passenger Sensing System* ⇨ 55.



When the vehicle is started, this light flashes and a chime may come on to remind passengers to fasten their seat belt. Then the light stays on solid until the belt is buckled. This cycle continues several times if the front passenger remains or becomes unbuckled while the vehicle is moving.

If the front passenger seat belt is buckled, neither the chime nor the light comes on.

The front passenger seat belt reminder light and chime may turn on if an object is put on the seat such as a briefcase, handbag, grocery bag, laptop, or other electronic device. To turn off the reminder light and/or chime, remove the object from the seat or buckle the seat belt.

### Second Row Passenger Seat Belt Reminder Lights

The vehicle may have second row passenger seat belt reminder lights.



When the vehicle is started, these lights come on solid to remind rear passengers to fasten their seat belts. Then each light may stay on solid or flash, and a chime may come on if the rear passenger remains unbuckled, or becomes unbuckled, when the vehicle is moving. A shaded or green light indicates the seat belt is buckled.

If all rear seat positions are buckled, neither the chime nor the lights will come on.

The rear passenger seat belt reminder light and chime may come on if an object is put on the seat such as a briefcase, handbag, grocery bag, laptop, or other electronic device. To turn off the reminder light and/or chime, remove the object from the seat or buckle the seat belt.

### Airbag Readiness Light

This light shows if there is an electrical problem with the airbag system. It is located in the instrument cluster. The system check includes the airbag sensor(s), the passenger sensing system, the pretensioners, the airbag modules, the wiring, and the crash sensing and diagnostic module. For more information on the airbag system, see *Airbag System* ⇨ 50.



The airbag readiness light comes on for several seconds when the vehicle is started. If the light does not come on then, have it fixed immediately.

**⚠ Warning**

If the airbag readiness light stays on after the vehicle is started or comes on while driving, it means the airbag system might not be working properly. The airbags in the vehicle might not inflate in a crash, or they could even inflate without a crash. To help avoid injury, have the vehicle serviced right away.

If there is a problem with the airbag system, a Driver Information Center (DIC) message may also come on.

**Passenger Airbag Status Indicator**

The vehicle has a passenger sensing system. See *Passenger Sensing System* ⇨ 55 for important safety information. The overhead console has a passenger airbag status indicator.



When the vehicle is started, the passenger airbag status indicator will light ON and OFF, and the symbols for on and off, for several seconds as a system check. Then, after several more seconds, the status indicator will light either ON or OFF, and either the symbol for on or off, to let you know the status of the front outboard passenger frontal airbag and knee airbag.

If the word ON, and the on symbol, is lit on the passenger airbag status indicator, it means that the front outboard passenger frontal airbag and knee airbag are allowed to inflate.

If the word OFF, and the off symbol, is lit on the passenger airbag status indicator, it means that the passenger sensing system has turned off the front outboard passenger frontal airbag and knee airbag.

If, after several seconds, both status indicator lights remain on, or if there are no lights at all, or if the airbag readiness light is on, there may be a problem with the lights or the passenger sensing system. See your dealer for service right away.

**⚠ Warning**

If the airbag readiness light ever comes on and stays on, it means that something may be wrong with the airbag system. To help avoid injury to yourself or others, have the vehicle serviced right away. See *Airbag Readiness Light* ⇨ 92 for more information, including important safety information.

**Charging System Light (12-Volt Battery)**

The charging system light comes on briefly when the vehicle is started, as a check to show the light is working.

If the light stays on, or comes on while driving, there could be a problem with the electrical charging system. Have it checked by your dealer. Driving while this light is on could drain the 12-volt battery.

If a short distance must be driven with the light on, be sure to turn off all accessories, such as the radio. Find a safe place to stop the vehicle.

### Low State of Charge Light

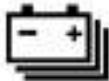

This light comes on when the vehicle state of charge is low. Proceed to a charging station to charge the vehicle.

### Charge Cord Connected Light



This light comes on when a charge cord is connected to the vehicle.

### Battery Fault Light



This light indicates a fault with the high voltage battery. A message may also display in the Driver Information Center (DIC). See your dealer for service.

### Propulsion Power is Limited Light

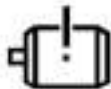

These lights display when the vehicle propulsion power is limited, which may affect the vehicle's ability to accelerate. The

vehicle may be driven while these lights are on, but maximum acceleration and speed may be limited.

### Service Vehicle Soon Light



This light comes on if a condition exists that may require the vehicle to be taken in for service.

If the light comes on, take the vehicle to your dealer for service as soon as possible.

### Brake System Warning Light



BRAKE

Metric

English

This light comes on briefly when the vehicle is turned on to show that the light is working. If it does not come on then, have it fixed so it will be ready to warn you if there is a problem.

If the light comes on and stays on, there is a brake problem. Have the brake system inspected right away. This light may come on if the brake fluid is low. See *Brake Fluid* ⇨ 254.

If the light comes on while driving, pull off the road and stop carefully. The brake system has electric brake boost. Vehicle speed may be limited when the brake system warning light comes on. The brake pedal might be harder to push, or the brake pedal may go closer to the floor. It could take longer to stop. If the light is still on, have the vehicle towed for service. See *Transporting a Disabled Vehicle* ⇨ 287.

### **Warning**

The brake system might not be working properly if the brake system warning light is on. Driving with the brake system warning light on can lead to a crash. If the light is still on after the vehicle has

(Continued)

### **Warning (Continued)**

been pulled off the road and carefully stopped, have the vehicle towed for service.

## **Electric Parking Brake Light**



**Metric**

**PARK**

**English**

This light comes on when the parking brake is applied. If the light continues flashing after the parking brake is released, or while driving, there is a problem with the Electric Parking Brake system. A message may also display in the Driver Information Center (DIC).

If the light does not come on, or remains flashing, see your dealer.

## **Service Electric Parking Brake Light**



This light should come on briefly when the vehicle is turned on. If it does not come on, have it fixed so it will be ready to warn if there is a problem.

If this light stays on or comes on while driving, there is a problem with the Electric Parking Brake (EPB). Take the vehicle to a dealer as soon as possible. In addition to the parking brake, other safety functions that utilize the EPB may also be degraded. A message may also display in the Driver Information Center (DIC). See *Electric Parking Brake* ⇨ 175.



## Antilock Brake System (ABS) Warning Light



This light comes on briefly when the vehicle is turned on to show that the light is working. If it does not come on then, have it fixed so it will be ready to warn you if there is a problem.

If the ABS warning light stays on, or comes on again while driving, the vehicle needs service. A chime may also sound when the light stays on.

If the ABS warning light is the only light on, the vehicle has regular brakes, but ABS is not functioning.

If both the ABS warning light and the brake system warning light are on, ABS is not functioning and there is a problem with the regular brakes. See your dealer for service.

See *Brake System Warning Light* ⇨ 94.

## Automatic Vehicle Hold (AVH) Light



This light comes on when AVH is actively holding the vehicle. See *Automatic Vehicle Hold (AVH)* ⇨ 177.

## Lane Keep Assist (LKA) Light



If equipped, the Lane Keep Assist Light may display the following colors:

- Blank: LKA is disabled.
- White: Appears when the vehicle starts. A steady white light indicates that LKA is not ready to assist.

- Green: Appears when LKA is turned on and ready to assist. LKA will gently turn the steering wheel if the vehicle approaches a detected lane marking.
- Amber: Appears when LKA is active. The light flashes amber as a Lane Departure Warning (LDW) alert to indicate that the lane marking has been unintentionally crossed. If the system detects you are steering intentionally (to pass or change lanes), the LDW alert may not display. The amber light also appears when the Blind Zone Steering Assist detects a potential crash with a moving vehicle in the lane you are entering. See *Blind Zone Steering Assist (BZSA)* ⇨ 224.

LKA will not assist or alert if the turn signal is active in the direction of lane departure, or if LKA detects that you are accelerating, braking, or actively steering. See *Lane Keep Assist (LKA)* ⇨ 224.

## Automatic Emergency Braking (AEB) Disabled Light



This indicator displays when you turn off Automatic Emergency Braking (AEB) or Front Pedestrian Braking (FPB).

This indicator will also display if AEB or FPB is unavailable due to malfunction, weather conditions, or if the windshield is not clean.

See *Automatic Emergency Braking (AEB)*  
⇨ 218.

See *Front Pedestrian Braking (FPB) System*  
⇨ 220.

## Vehicle Ahead Indicator



If equipped, this indicator will display green when a vehicle is detected ahead and amber when you are following a vehicle ahead much too closely.

See *Forward Collision Alert (FCA) System*  
⇨ 216.

## Pedestrian Ahead Indicator



If equipped, this indicator will display amber when a nearby pedestrian is detected in front of the vehicle.

See *Front Pedestrian Braking (FPB) System*  
⇨ 220.

## Traction Off Light



This light comes on briefly when the vehicle is turned on to show that the light is working. If it does not come on then, have it fixed so it will be ready to warn you if there is a problem.

The traction off light comes on when the Traction Control System (TCS) has been turned off. If StabiliTrak/Electronic Stability Control (ESC) is turned off, TCS is also turned off. To turn TCS and ESC off and on, see *Traction Control/Electronic Stability Control* ⇨ 179.

If TCS is off, wheel slip during acceleration is not limited unless necessary to help protect the driveline from damage. Adjust driving accordingly.

**StabiliTrak OFF Light**

This light comes on briefly when the vehicle is turned on to show that the light is working. If it does not come on then, have it fixed so it will be ready to warn you if there is a problem.

This light comes on when the StabiliTrak/Electronic Stability Control (ESC) system is turned off. If StabiliTrak/ESC is off, the Traction Control System (TCS) is also off. To turn ESC off and on, see *Traction Control/Electronic Stability Control* ⇨ 179.

If ESC and TCS are off, the systems do not assist in controlling the vehicle. Adjust driving accordingly.

**Traction Control System (TCS)/  
StabiliTrak Light**

This light comes on briefly when the vehicle is turned on to show that the light is working. If it does not come on then, have it fixed so it will be ready to warn you if there is a problem.

If the light is on and not flashing, the TCS and potentially the StabiliTrak/ESC system are not fully operational and may not assist in maintaining control. Adjust driving accordingly. If the condition persists, see your dealer as soon as possible. A Driver Information Center (DIC) message may display.

The light flashes when the TCS and/or the StabiliTrak/ESC system is actively working.

See *Traction Control/Electronic Stability Control* ⇨ 179.

**Driver Mode Control Light**

This light comes on when Normal Mode is selected.



This light comes on when Sport Mode is selected.



This light comes on when Snow/Ice Mode is selected.



This light comes on when My Mode is selected.

See *Driver Mode Control* ⇨ 180.

## Tire Pressure Light



If equipped with the Tire Pressure Monitor System (TPMS), this light comes on briefly when the vehicle is started. It provides information about tire pressures and the TPMS.

### When the Light Is On Steady

This indicates that one or more of the tires are significantly underinflated.

A Driver Information Center (DIC) tire pressure message may also display. Stop as soon as possible, and inflate the tires to the pressure value shown on the Tire and Loading Information label. See *Tire Pressure* ⇨ 274.

### When the Light Flashes First and Then Is On Steady

If the light flashes for about a minute and then stays on, there may be a problem with the TPMS. If the problem is not corrected, the light will come on every time the vehicle is started. See *Tire Pressure Monitor Operation* ⇨ 276.

## Security Light



The security light should come on briefly as the vehicle is started. If it does not come on, have the vehicle serviced by your dealer. If the system is working normally, the indicator light turns off.

If the light stays on and the vehicle does not start, there could be a problem with the theft-deterrent system.

## Vehicle Ready Light



The vehicle ready light comes on whenever the vehicle is parked and ready to be driven.

## One-Pedal Driving Light



This light comes on when One-Pedal Driving is active. See *One-Pedal Driving* ⇨ 174.

### High-Beam On Light



This light comes on when the high-beam headlamps are in use. See *Headlamp High/Low-Beam Changer* ⇨ 116.

### IntelliBeam Light



If equipped, this light comes on when the IntelliBeam system is enabled. See *Exterior Lamp Controls* ⇨ 114.

### Adaptive Forward Lighting (AFL) Light



This light comes on solid when there is a problem with the AFL system.

See *Adaptive Forward Lighting (AFL)* ⇨ 117.

### Lamps On Reminder



This light comes on when the exterior lamps are in use, except when only the Daytime Running Lamps (DRL) are active. See *Exterior Lamp Controls* ⇨ 114.

### Cruise Control Light



The cruise control light is white when the cruise control is on and ready, and turns green when the cruise control is set and active.

### Adaptive Cruise Control Light



This light is white when the Adaptive Cruise Control (ACC, if equipped) is on and ready, and turns green when the ACC is set and active.

### Curve Speed Control Light



If equipped, this light may illuminate green when ACC is actively controlling the vehicle speed and detects a sharp curve on the road ahead.

ACC automatically slows the vehicle down while navigating the curve and may increase speed out of the curve, but will not exceed the set speed.

See *Adaptive Cruise Control (Advanced)* ⇨ 181.

### Super Cruise Light



This light comes on to show the status of Super Cruise. See *Super Cruise* ⇨ 190.

### Door Ajar Light



This light comes on when a door is open or not securely latched. Before driving, check that all doors are properly closed.

## Information Displays

### Charging

#### Important Information about Electric Vehicle Charging

- Charging an electric vehicle can stress a building's electrical system more than a typical household appliance.
- Charge cord limits can vary from vehicle to vehicle, and increased charging rates can stress a building's electrical system.
- Before plugging into any electrical outlet, have a qualified electrician inspect and verify the electrical system (electrical outlet, wiring, junctions, and protection devices) for heavy-duty service at a 12 amp continuous load.

- Electrical outlets may wear out with normal usage or may be damaged over time, making them unsuitable for electric vehicle charging.
- Check the electrical outlet/plug while charging and discontinue use if the electrical outlet/plug is hot, then have the electrical outlet serviced by a qualified electrician.
- When outdoors, plug into an electrical outlet that is weatherproof while in use.
- Mount the charging cord to reduce strain on the electrical outlet/plug.
- Do not place the charge cord in a position where it is expected to be submerged in water.

#### **Danger**

Improper use of portable electric vehicle charge cords may cause a fire, electrical shock, or burns, and may result in damage to property, serious injury, or death.

- Do not use extension cords, multi-outlet power strips, splitters, grounding adapters, surge protectors, or similar devices.

(Continued)

**Danger (Continued)**

- Do not use an electrical outlet that is worn or damaged, or will not hold the plug firmly in place.
- Do not use an electrical outlet that is not properly grounded.
- Do not use an electrical outlet that is on a circuit with other electrical loads.

**Charging App**

The Charging app gives you access to features that will help you better understand and control how the vehicle manages charging, providing a central location to determine and review your charging preferences.

To launch the Charging app from the infotainment home screen, touch the Charging icon. There are four selections to choose from: Next Charging, Charge Assist, Schedule, and Settings. When you launch Charging for the first time, the Next Charge screen will display.

**Next Charge**

To view the current charging status in the infotainment display, touch .

On the Next Charge screen, there is a range of information associated with the next Charging session, as well as the ability to specify when you would like to charge the vehicle. The choices available to charge are Charge Now or Charge Later.

To create a charge schedule See “Creating a Charge Schedule” under “Schedule” below. The Charging screen shows and allows you to determine how the vehicle charges the next time it is plugged in.

**Charge Now**

Charge Now is the default charging mode for your vehicle. The vehicle begins charging immediately when it is plugged in and authenticated at the charging location.

With Charge Now selected, the Charging screen displays:

- Text explaining that the vehicle will charge immediately when plugged in.
- Charge Complete by/in: The estimated time at which the vehicle will reach the desired Charge Level.
- Target Charge Level Gauge: Sets the percentage at which the vehicle will stop charging. The gauge also displays an estimate of the vehicle's range upon completing the charging session.

**Warning**

Do not charge your vehicle's battery above an 80% charge if you are going to drive down long, steep grades such as mountain passes. This provides room in the battery for regenerative braking to supplement your conventional brakes during the descent. This is especially

(Continued)

**Warning (Continued)**

important when towing a trailer, which puts additional stress on your vehicle's braking system.

See *Hill and Mountain Roads* ⇨ 163 for important information about driving on grades.

The default charge level is 100% when plugged in. To set a different charge level, drag the circular marker on the Target Charge Level Gauge to the preferred value. To lower the desired Charge Level, drag the Charge Level marker counterclockwise, and to increase it drag the marker clockwise. The Charge Level can also be changed by tapping  $\wedge$  and  $\vee$  inside the gauge on the screen. The multifunction controller (MFC) on the center console can also be used to set the Charge Level by rotating clockwise or counterclockwise when the Target Charge Level Gauge is highlighted. The Range estimate updates once the desired Charge Level is set. To optimize battery health, the minimum allowable Charge Level is determined by the vehicle.

**Charge Later**

Instead of charging immediately to a desired Charge Level, you may choose to delay the charge to the vehicle and have it complete by your desired departure time. This may be a more economical choice and a more efficient use of energy when charging at home. To use this mode, touch the Charge Later tab from the Next Charge screen.

With Charge Later selected, the Charging screen displays:

- Text explaining that your vehicle will delay the planned charge to be ready by the time specified.
- Time Selector: Used to set the desired time at which the vehicle will finish charging and be ready for departure.

- Target Charge Level Gauge: Sets the percentage at which the vehicle will stop charging. The gauge also displays an estimate of the vehicle's range upon completing the charging session.
- Cabin Pre-Conditioning: Allows the vehicle to heat or cool the cabin to your desired temperature using energy from the charger. This means energy from the battery is not used to condition the cabin, ensuring the vehicle gets the maximum range from the charging session. Cabin pre-conditioning happens at the end of the charge, and right before the departure time.

To set the time at which the vehicle will complete the charge and be ready for departure:

Swipe up or down on each value within the Time Selector until the preferred time is selected. The time selector can also be modified using the multifunction controller (MFC) on the center console by turning the knob when the preferred value is highlighted. If the desired Charge Level cannot be reached by the selected time, a message will display that one of the two preferences will need to be adjusted.



To adjust desired Charge Level in Charge Later mode, see “Charge Now” earlier in this section.

Setting the Cabin Pre-Conditioning preference:

Touch the switch to turn on Cabin Pre-conditioning. Cabin Pre-Conditioning temperature can be adjusted by touching Cabin Pre-Conditioning on this screen, or in Settings.

### Active Charging



During an active charging session, the Charging screen displays and continuously updates the following items:

- Text indicating the vehicle's current charging status.
- Current Range: The range the vehicle is capable of driving at the current charge level.

- Range Increase Rate: How much range is accumulating per hour of charging.
- Charge Complete at/in: The estimated time at which the vehicle will reach the desired Charge Level.
- Target Charge Level Gauge: During an Active Charge, the gauge displays the vehicle's current Charge Level as a percentage and a colored section of the circular gauge to represent this value.

To update the desired Charge Level for the active charging session, drag the marker on the Target Charge Level Gauge.

Touching the Stop Charge button at any time ends the active charging session. For information on beginning a charging session, see *Plug-In Charging* ⇨ 228.

For Level 1 chargers, you can also select the appropriate Charge Cord Limit of either 8 amps or 12 amps. This determines how much current can flow from an electrical outlet to the vehicle battery. It also ensures proper charge time estimates.

When the Charge Cord Limit is changed from 8 amps to 12 amps on a 120V circuit a notification is displayed.

If no Home Charge Location is set, the Level 1 Cord Limit will revert to 8 amps every time the vehicle is shifted out of (P) Park.

Range and charge time estimates fluctuate depending on a number of factors such as Charge Cord Level/Limit, battery temperature, and outside air temperature. To learn more about the vehicle battery see *Plug-In Charging* ⇨ 228.

The peek-in charging screen can be used to monitor your vehicle's charge status when the vehicle is off, see *Instrument Cluster* ⇨ 89. To monitor the charging status remotely, download the myCadillac app on your mobile device.

### DC Fast Charging

The vehicle will immediately begin charging when plugged into a DC fast charging station. While DC Fast Charging, the vehicle will bypass any schedule or departure time selection. See *Plug-In Charging* ⇨ 228.

## Charge Assist

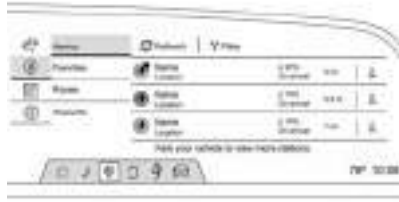

To find a charge station with the infotainment display, touch .

The choices available for Charge Assist include Nearby, Favorites, Routes, or Accounts. Additionally you can filter the list of shown charge stations by touching the icon above the list.

### Nearby

Station Details displays Station Info, Connectors and Station Photos.

This screen displays nearby stations. When a station name is selected, details of the selected charge station displays on the screen.

With Station Info selected, the screen displays:

- Name of the charge station.
- Number of ports available.
- Estimated charge percentage remaining upon arrival.
- Charge station address.
- Favorites button.
- Navigation button.

The Connector screen displays the connector types and availability. From here you can select a connector to see pricing details and charging speed. You can start a charging session by clicking on the Start Charging button.

Station Photos screen displays photos of the selected charge station.

### Favorites

This page is almost identical to the Nearby page but it displays a list of stations that you have selected as a favorite. You can favorite stations from the Station Details page.

## Routes

This screen allows you to access routes planned and saved on the myCadillac app. To activate a route, touch the navigation icon to start route guidance.

### Accounts

This screen allows you to view charge provider accounts that you have linked in the myCadillac app. This allows you to easily start charging without having to manage payment on-site. You can also choose to be notified when you are approaching one of your providers' stations.

### Schedule

Touch  to view the Schedule feature that allows a custom charging plan to be set for each day of the week. When the vehicle is plugged in at the Home Charge Location, the Schedule feature will automatically charge to the desired Charge Level and pre-condition the cabin by the time set in the Schedule. This feature acts as a more customizable Charge Later setting than the one on the Next Charge screen.

### Creating a Schedule



To create a schedule, touch the Create Schedule card on the left. If there is no Home Charge Location set, you will be prompted to create one.

The Charging Schedule dialog displays:

- Toggles for each day of the week.
- Charge to: A value selector for setting the desired Charge Level.
- Complete By: A time selector for setting the time the vehicle will reach the desired Charge Level.
- Cabin Pre-Conditioning: Allows the vehicle to heat or cool the cabin to the desired temperature by using energy from the charger.
- An **X** allowing you to close the Charging Schedule dialog.

- Save & Close button: Applies any changes made and exits the dialog.

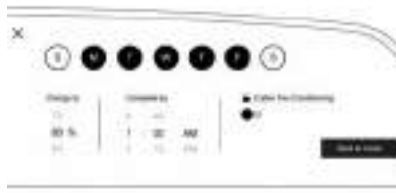

Days can be assigned to the schedule. Days of the week are represented in toggles containing their first letter. Touching each toggle illuminates the graphic, confirming that day is assigned that to the schedule. Touching a second time unassigns days from this schedule, dimming the toggle once again. Select all days you wish to adhere to the settings in this schedule. If there are multiple charge schedules, days must be unassigned from their current schedule before they can be assigned to a new one.

Once completed with the charging schedule, touch the Save & Close button to finish creating the schedule.

On days that are not assigned a schedule, the vehicle will begin charging to 100% as soon as it is plugged in, unless otherwise specified on the Charging screen.

Home Charge Schedule can be turned ON or OFF. To enable or disable all charging schedules, touch the toggle switch next to Home Charge Schedule on the Schedule screen.

### Modifying and Deleting Charge Schedules



To modify a schedule, touch the card on the Schedule screen. This will open a dialog. Make the desired changes and then touch the Save & Close button when finished. To delete the schedule, simply touch the Delete Schedule button, at which point you will be prompted to confirm your decision.

## Charge Settings



To view and change the Charge Settings, touch . Use the arrows to scroll through the list, or hold and drag the list.

This screen allows preferences to be set with regards to how the vehicle charges. Touching any item will display options for specifying their behavior.

The Settings screen displays:

### Home Charge Location

With a Home Charge Location set, the vehicle can determine whether it is plugged in at home, and will charge according to any existing schedules. The Home Charge Location can be changed or deleted at this screen.

The wireless service and GPS satellite technologies must be available and operating for features to function properly. These systems may not operate if the battery is disconnected, or if the vehicle has been off for an extended period of time. If GPS is unavailable, a message displays on the infotainment screen. GPS functionality may resume after the next time you drive the vehicle.

### Notifications

This section contains on/off preferences for multiple notifications triggered during the Charging session.

**Charge Status Feedback** : Provides an audible notification through horn chirps that accompany changes in the charging status.

**Charge Cord Unplugged Alert** : When on and your vehicle is locked, your vehicle will honk the horn and flash the lights if charge cord becomes unplugged.

**Charge Power Loss Alert** : When on, your vehicle will chirp for an extended period of time if charging power is cut off.

### DC Fast Charge Battery Conditioning

If equipped, adjusts the battery to the optimal temperature for quicker DC Fast Charging. This should be done before charging at a DC Fast Charger.

Depending on the outside and battery temperature, battery conditioning could take longer to reach the optimal temperature.

While en route to a DC Fast Charge station using Google Maps, DC Fast Charge Conditioning happens automatically if a DC Fast Charge station has been added to your route.

### Cabin Pre-Conditioning Temperature

Allows for the preferred cabin temperature to be set. During a planned charging session at the vehicle's Home Charge Location, the vehicle cabin is warmed or cooled to this temperature if set to ON in either the Charge Later screen, or in an active Schedule.

### Preferred Charge Times

Allows preferred charge time windows to be enabled for the Home Charge Location during both weekday and weekend planned charging sessions. It does so whether the vehicle is set to Charge Later, or observing a

scheduled charge. This allows for charging at a lower cost by prioritizing charging during the electrical provider's off-peak period. The vehicle will use these times to reach the desired Charge Level by the scheduled time. If the vehicle cannot reach the desired charge level within these times, it will charge as needed outside of this time window.

### Driver Information Center (DIC)

The DIC is displayed in the instrument cluster. It shows the status of many vehicle systems.

DIC information is broken down into three main zones:

**Control Panel** : A touchscreen display to left of the instrument cluster.

**Left Zone** : Displays on the instrument cluster to the left of the speedometer.

**Right Zone** : Displays on the instrument cluster to the right of the speedometer.



^ or v : Use to scroll to the previous or next selection.

✓ : Press to open a menu or select a menu item. Press and hold to reset certain displays.

### DIC Information Display Options

Select which info display to view by selecting show in cluster in the Vehicle Information on the infotainment display. See *Settings* ⇨ 144 or *Vehicle Information* ⇨ 109.

### DIC Information Displays

The following is the list of all possible DIC information displays and their locations. Some of the information displays may not be available for your particular vehicle.

#### Control Panel

**Trip 1 or Trip 2 and Average Efficiency** : The Trip display shows the current distance traveled, in either kilometers (km) or miles (mi), since the trip odometer was last reset. To reset the current trip, touch and hold the touchscreen display when trip odometer is displayed.

The Average Efficiency shows the approximate average kWh per 100 kilometers (kWh/100 km), kilometers per kilowatt hour kWh (km/kWh), or miles per kilowatt hour kWh(mi/kWh). This number is calculated based on the number of kWh/100 km, km/kWh, or mi/kWh recorded since the last time this menu item was reset. This number only reflects the approximate average electrical energy economy that the vehicle has at that moment, and changes as driving conditions change.

**Left Zone**

**Time/Date** : Displays current date and time information.

**Auto Lane Change** : Displays the status of a driver-requested lane change when Super Cruise is active. See *Super Cruise* ⇨ 190.

**Tire Pressure** : Displays the approximate pressures of all four tires. Tire pressure is displayed in either kilopascal (kPa) or in pounds per square inch (psi). If the pressure is low, the value for that tire is shown in amber. See *Tire Pressure Monitor System* ⇨ 275 and *Tire Pressure Monitor Operation* ⇨ 276.

**Energy Usage** : Displays energy usage of the Driving, Remote Start, and Climate and Conditioning vehicle systems as percentages of overall vehicle energy use.

**Energy Efficiency** : Displays a graph showing the energy efficiency that has been used by the vehicle over a recently driven distance.

**Right Zone**

**Audio Now Playing** : Displays the actively playing audio.

**Navigation** : Displays a variety of navigation information.

**Vehicle Information**

The following are all possible vehicle information features.

To access the vehicle information menu touch  from the list of home page icons displayed on the left side of the infotainment display. Vehicle information content is shown on cards that are grouped together in option tabs that are displayed on the infotainment display.

Touching a card on the infotainment display opens up a dialog box for that card. To select a desired option within a dialog box, touch the option and follow any message or alerts that may display. Some options may be unavailable while driving.

Touch Show in Cluster to send the desired card to the left zone of the instrument cluster. Touch Remove from Cluster to remove the selected card from the instrument cluster. See *Driver Information Center (DIC)* ⇨ 108.

**Options**

The following is the list of all possible cards and their locations. Some of the cards may not be available for your particular vehicle.

**Overview**

Displays an interactive 3-D rendered image of your vehicle that shows performance and health information.

**Tires**

**Tire Pressure** : Displays the approximate pressures of all four tires. Tire pressure is displayed in either kilopascal (kPa) or in pounds per square inch (psi). If the pressure is low, the value for that tire is shown in amber. See *Tire Pressure Monitor System* ⇨ 275 and *Tire Pressure Monitor Operation* ⇨ 276.

When selected, the following options may be chosen in the dialog: Relearn Tire Pressure, Turn Off/On Leak Detection, Reset Leak Detection, and Add to Driver Display. When enabled, you will receive alerts when a fast and/or slow tire leak is detected. The Leak Detection speeds shown are either Tire Leak or Fast Leak. When disabled, you will still receive low tire pressure alerts. However, you will stop receiving additional alerts when a tire is leaking air.

**Energy Info**

**Energy Usage** : Displays how energy is being used for the current drive since the last time the vehicle was started.

Percentages of the Driving, Remote Start, and Climate and Conditioning vehicle systems as overall vehicle energy use are shown. When selected, distance driven, total energy, energy usage bar diagram, and selectable categories are displayed. Select a category to learn more about how your vehicle uses energy from the battery.

When selected, Add to Driver Display may be chosen in the dialog.

**Energy Efficiency** : Displays a graph showing the energy efficiency that has been used by the vehicle over a recently driven distance. When selected, regenerated range, and instant efficiency is shown along with average efficiency in the dialog.

When selected, Add to Driver Display may be chosen in the dialog.

## Vehicle Messages

Messages displayed on the Driver Information Center (DIC) indicate the status of the vehicle or some action that may be needed to correct a condition. Multiple messages may appear one after another.

Vehicle status notifications are also sent to the infotainment display. Touching  on the bottom right corner of the infotainment display opens the notification drawer where all the active vehicle messages can be viewed. Depending on the message, you can schedule a service, find the nearest dealer, or find the nearest charging station. When there are active messages that can be viewed, a red dot appears on top of the notification icon on the infotainment display.

The messages that do not require immediate action can be acknowledged and cleared by pressing the thumbwheel. The messages that require immediate action cannot be cleared until that action is performed.

All messages should be taken seriously; clearing the message does not correct the problem.

If a SERVICE message appears, see your dealer.

Follow the instructions given in the messages. The system displays messages regarding the following topics:

- Service Messages
- Fluid Levels

- Vehicle Security
- Brakes
- Ride Control Systems
- Driver Assistance Systems
- Cruise Control
- Lighting and Bulb Replacement
- Wiper/Washer Systems
- Doors and Windows
- Seat Belts
- Airbag Systems
- Propulsion
- Tire Pressure
- Battery
- Steering

## Propulsion Power Messages

### REDUCED ACCELERATION DRIVE WITH CARE

This message displays when the vehicle's propulsion power is reduced. A reduction in propulsion power can affect the vehicle's ability to accelerate. If this message is on, but there is no observed reduction in performance, proceed to your destination. Under certain conditions, the performance may be reduced the next time the vehicle is driven. The vehicle may be driven while this

message is on, but maximum acceleration and speed may be reduced. Anytime this message stays on, or displays repeatedly, the vehicle should be taken to your dealer for service as soon as possible.

This message can be displayed when the high voltage battery charge level is low. This is normal behavior as the vehicle is limiting power due to reduced battery capability with a low charge.

Under certain operating conditions propulsion will be disabled. Try restarting after the vehicle has been off for two minutes.

### **PROPULSION POWER REDUCED DUE TO TEMPERATURE**

This message displays when the vehicle is on, the battery temperature is low, and when the vehicle's performance is limited. The duration of the limited vehicle performance depends, in part, on the high voltage battery charge level. If the high voltage battery charge level is relatively high, as the vehicle is driven, the battery temperature will increase, and the vehicle will return to normal operation. If the high

voltage battery charge level is relatively low the vehicle will not return to normal operation until charged.

Keep the vehicle plugged in, even when fully charged, to keep the high voltage battery temperature ready for the next drive. This is important when outside temperatures are extremely hot or cold.

### **Vehicle Speed Messages**

#### **SPEED LIMITED TO XXX KM/H (MPH)**

This message shows that the vehicle speed has been limited to the speed displayed. The limited speed is a protection for various propulsion and vehicle systems, such as lubrication, thermal, brakes, suspension, Teen Driver if equipped, or tires.

### **Universal Remote System**

See *Radio Frequency Statement* ⇨ 312.

#### **Universal Remote System Programming**

If equipped, the Universal Garage Door (Universal Remote) controls are located on the infotainment screen.

This system can replace up to eight remote control transmitters used to activate devices such as garage door openers, security systems, and home automation devices. These instructions refer to a garage door opener, but can be used for other devices.

Do not use the Universal Remote system with any garage door opener that does not have the stop and reverse feature. This includes any garage door opener model manufactured before April 1, 1982.

Keep the original hand-held transmitter for use in other vehicles as well as for future programming. Erase the programming when vehicle ownership is terminated. See "Erasing Universal Remotes."

To program a garage door opener, park outside directly in line with and facing the garage door opener receiver. Clear all people and objects away from the garage door.

Make sure the hand-held transmitter has a new battery for quick and accurate transmission of the radio-frequency signal.



## Programming the Universal Remote System

Programming involves time-sensitive actions and may time out, requiring the procedure to be repeated. Read these instructions completely before programming the Universal Remote system. It may help to have another person assist with the programming process.

1. On the infotainment home screen, navigate to the Universal Remote controls.
2. Hold the end of the hand-held transmitter about 3 to 8 cm (1 to 3 in) away from the rear-view mirror. The hand-held transmitter was supplied by the manufacturer of the garage door opener.
3. Select the “Add Remotes” option on the infotainment screen.
4. Press and hold the hand-held transmitter button. Do not release the hand-held transmitter button until “Signal Found” appears on the infotainment screen.
5. Once the signal is found, test the Universal Remote System by pressing the Test button. If your garage door moves, then programming was successful. You

may need to press the Test button several times. Indicate the successful programming of a remote by pressing the It Worked button. After successfully programming a remote, there is no need to complete Steps 6–10.

6. If your garage door does not react during testing, press the It Didn’t Work button and proceed to Step 7.  
The following steps require the location and pressing of the Learn or Smart button on the garage door opener receiver inside the garage. These steps may require a ladder and are time sensitive.
7. Locate the Learn or Smart button on the garage door opener receiver in the garage. The name and color may vary by manufacturer but is usually located near the antenna wire.
8. Press and release the Learn or Smart button on the garage door opener receiver. Step 9 must be completed within 30 seconds of pressing this button.
9. Press the Test button on the infotainment screen. If your garage door moves, then programming was successful. You may need to press the

Test button several times. Indicate successful programming by pressing the It Worked button.

10. If programming is not successful, press It Didn’t Work button and repeat Steps 8–9, or consult HomeLink by website or phone.

After your Universal Remote has been successfully programmed, you can change the name of the remote on the screen as desired.

Some garage door openers require a modification of Step 4. See “Radio Signals for Some Gate Operators.”

For questions or programming help, visit [www.homelink.com/gm](http://www.homelink.com/gm) for self-help videos or call 1-800-355-3515. For calls placed outside the U.S., Canada, or Puerto Rico, international rates will apply and may differ based on landline or mobile phone.

### Erasing Universal Remotes

To erase a programmed Universal Remote, select the remote on the infotainment screen. Then select “Delete.”

To erase ALL programmed Universal Remotes, select any remote on the infotainment screen. Then select “Delete All.”

### Radio Signals for Some Gate Operators

Some gate operators and radio-frequency laws require transmitter signals to time out or quit after several seconds of transmission. This may not be long enough for the Universal Remote system to pick up the signal during programming.

If programming did not work, replace Step 4 under “Programming the Universal Remote System,” with the following:

Press and release the hand-held transmitter button every two seconds until the signal has been found by the Universal Remote System. Proceed to Step 5 under “Programming the Universal Remote System” to complete programming.

## Universal Remote System Operation

### Using the Universal Remote System

Press the desired Universal Remote button on the infotainment screen.

### Reprogramming a Single Universal Remote System Button

To reprogram any of the system buttons:

1. Select the universal remote to be reprogrammed.
2. Select “Delete”.
3. Select “Add Remote”. Follow the instructions in *Universal Remote System Programming* ⇨ 111.

## Lighting

### Exterior Lighting

Exterior Lamp Controls .....	114
Exterior Lamps Off Reminder .....	116
Headlamp High/Low-Beam Changer ....	116
Flash-to-Pass .....	116
Daytime Running Lamps (DRL) .....	116
Automatic Headlamp System .....	116
Adaptive Forward Lighting (AFL) .....	117
Headlamp Leveling Control .....	118
Hazard Warning Flashers .....	119
Turn and Lane-Change Signals .....	119
Cornering Lamps .....	119

### Interior Lighting

Instrument Panel Illumination Control .....	120
Dome Lamps .....	120
Reading Lamps .....	120

### Lighting Features

Entry Lighting .....	121
Exit Lighting .....	121
Battery Load Management .....	121
Battery Power Protection .....	122
Exterior Lighting Battery Saver .....	122

## Exterior Lighting

### Exterior Lamp Controls

The exterior lamp controls, also known as headlights, are in the Controls App on the infotainment home screen. Select Controls > Lights > Headlights.

To operate, select the following options:

**Off** : Turns off the exterior lamps.

For vehicles first sold in Canada, the headlamps will automatically reactivate when the vehicle is shifted out of P (Park).

**Auto** : Automatically turns on the headlamps, parking lamps, taillamps, instrument panel lights, roof marker lamps (if equipped), license plate lamps, or Daytime Running Lamps (DRL), depending on outside lighting.

**Parking** : Turns on the parking lamps.

**On** : Turns on the headlamps and parking lamps.

### IntelliBeam System

If equipped, this system turns the high-beam headlamps on and off according to surrounding traffic conditions.

The system turns the high-beam headlamps on when it is dark enough and there is no other traffic present.

This light  appears on the instrument cluster when the IntelliBeam system is enabled.

#### Turning the IntelliBeam On and Off

To enable and disable the IntelliBeam system on the infotainment home screen, select Control App > Lights >  Auto High Beams when the headlights are set in the Auto position.

#### Driving with IntelliBeam

The system only activates the high beams when driving over 40 km/h (25 mph).

The blue high-beam on light appears on the instrument cluster when the high beams are on.

There is a sensor near the top center of the windshield that automatically controls the system. Keep this area of the windshield clear of debris to allow for best system performance.

The high-beam headlamps remain on, under the automatic control, until one of the following situations occurs:

- The system detects an approaching vehicle's headlamps.
- The system detects a preceding vehicle's taillamps.
- The outside light is bright enough that high-beam headlamps are not required.
- The vehicle speed drops below 20 km/h (12 mph).

The high beams may not turn off automatically if the system cannot detect another vehicle's lamps because of any of the following:

- The other vehicle's lamps are missing, damaged, obstructed from view, or otherwise undetected.
- The other vehicle's lamps are covered with dirt, snow, and/or road spray.

- The other vehicle's lamps cannot be detected due to dense exhaust, smoke, fog, snow, road spray, mist, or other airborne obstructions.
- The vehicle windshield is dirty, cracked, or obstructed by something that blocks the view of the light sensor.
- The vehicle is loaded such that the front end points upward, causing the light sensor to aim high and not detect headlamps and taillamps.
- The vehicle is being driven on winding or hilly roads.

The automatic high-beam headlamps may need to be disabled if any of the above conditions exist.

### Adaptive Headlight System

If equipped, the Adaptive Headlight system allows the high-beam headlamps to function as the main driving light at night.

The system turns on all the high-beam headlamp LED segments when it is dark enough and there is no other traffic present.

This light  displays on the instrument cluster when the Adaptive Headlight system is enabled.

### Turning the Adaptive Headlight System On and Off

To enable and disable the Adaptive Headlight system on the infotainment home screen, select Control App > Lights >  Auto High Beams when the headlights are set in the Auto position.

### Driving with Adaptive Headlight System

The system only activates the high beams when driving over 40 km/h (25 mph).

There is a sensor near the top center of the windshield that automatically detects the lights of oncoming and preceding vehicles. Keep this area of the windshield clear of debris to allow for best system performance.

The headlamp high-beam alters according to the traffic situation, preventing high beam light from glaring towards oncoming or preceding traffic. This gives the best light distribution without glaring other road users.

The Adaptive Headlight system remains on until one of the following situations occurs:

- The fog lamps are turned on.
- The system detects a preceding vehicle's taillamps.

- The vehicle speed drops below approximately 20 km/h (12 mph).

The high beams may not turn off automatically if the system cannot detect another vehicle lamps because of any of the following:

- The other vehicle's lamps are missing, damaged, obstructed from view, or otherwise undetected.
- The other vehicle's lamps are covered with dirt, snow, and/or road spray.
- The other vehicle's lamps cannot be detected due to dense exhaust, smoke, fog, snow, road spray, mist, or other airborne obstructions.
- The vehicle windshield is dirty, cracked, or obstructed by something that blocks the view of the light sensor.
- The vehicle is loaded in a way that the front end points upward, causing the light sensor to aim high and not detect headlamps and taillamps.
- The vehicle is being driven on winding or hilly roads.

The Adaptive Headlight system may need to be disabled if any of the above conditions exist.

## Exterior Lamps Off Reminder

A warning chime sounds if the driver door is opened while the vehicle is off and the exterior lamps are on.

## Headlamp High/Low-Beam Changer

Push the turn signal lever away from you and release, to turn the high beams on. To return to low beams, push the lever again or pull it toward you and release.



This indicator light turns on in the instrument cluster when the high-beam headlamps are on.

## Flash-to-Pass

To flash the high beams, pull the turn signal lever toward you, and release.

## Daytime Running Lamps (DRL)

DRL can make it easier for others to see the front of your vehicle during the day.

Fully functional DRL are required on all vehicles first sold in Canada.

The DRL come on when all of the following conditions are met:

- The vehicle is on.
- The exterior lamp control is in AUTO.
- The light sensor determines it is daytime.

The taillamps, instrument panel lights, and other lamps will not turn on when this feature is activated.

The DRL turn off when the headlamps are turned to  or the vehicle is off.

For vehicles first sold in Canada, the DRL can only be turned off when the vehicle is parked.

## Automatic Headlamp System

When the exterior lamp control is set to Auto and it is dark enough outside, the headlamps come on automatically.



There is a light sensor on top of the instrument panel. Do not cover the sensor.

The system may also turn on the headlamps when driving through a parking garage or tunnel.

If the vehicle is started in a dark garage, the automatic headlamp system comes on immediately. If it is light outside when the vehicle leaves the garage, there is a slight delay before the automatic headlamp system changes to the Daytime Running Lamps (DRL). During that delay, the instrument cluster may not be as bright as usual. Make sure the instrument panel brightness control is in the full bright position. See *Instrument Panel Illumination Control* ⇨ 120.

When it is bright enough outside, the headlamps will turn off or may change to DRL.

The automatic headlamp system turns off when the exterior lamp control is set to On or the vehicle is off.

### Lamps On with Wipers

If the windshield wipers are activated in daylight with the vehicle on and the exterior lamp control is set to Auto, the headlamps, parking lamps, and other exterior lamps come on. The transition time for the lamps coming on varies based on wiper speed. When the wipers are not operating, these lamps turn off. Set the exterior lamp control to On or Off to disable this feature.

### Adaptive Forward Lighting (AFL)

If equipped with the AFL system, the high-beam headlamps move horizontally while turning the steering wheel to provide greater road illumination around curves.



To activate AFL, set the exterior lamp control to the Auto position, and Adaptive Headlight system is active. See *Exterior Lamp Controls* ⇨ 114.

To adjust the AFL setting, go to the infotainment home screen and select Settings > Vehicle > Lighting.

Moving the exterior lamp controls out of the Auto position will deactivate the system. The high-beam headlamps can move horizontally when the vehicle speed is greater than 3 km/h (2 mph). Headlamps will not move horizontally when the electric drive unit is in R (Reverse).

If equipped, the AFL system automatically modifies the low-beam lighting patterns to the situation to enable optimal light performance for the driver. Light distribution and intensity of low-beam light are controlled based on exterior lighting conditions, vehicle location, and driving situations.

### Town Light



If equipped, the town light activates automatically at a speed up to 55 km/h (34 mph).

The light is wide and symmetrical. The special beam pattern is designed to prevent glare for other road users.

### Country Light



If equipped, the country light activates automatically at a speed above 55 km/h (34 mph).

The illumination of the current lane and the side of the road is improved, reducing glare to oncoming and preceding vehicles.

### Freeway/Motorway Light



If equipped, when driving faster than 90 km/h (55 mph) on freeways, the low-beam illumination is smaller and extended.

### Adverse Weather Light



If equipped, the adverse weather light activates automatically when driving in adverse weather conditions (heavy rain, snow, sleet, freezing rain, etc.).

The illumination is shifted more to the side of the road to highlight road signs, and reduces glare caused by reflecting of wet roads.

### Maneuvering Light



If equipped, the maneuvering light activates automatically at speeds less than 7 km/h (4 mph) when the vehicle is in R (Reverse). The maneuvering light illumination improves parking and maneuvering situations.

### Headlamp Leveling Control

#### Automatic Headlamp Leveling Control

If equipped, the inclination of the headlamps are automatically adjusted based on the vehicle load and driving conditions (such as acceleration, braking, towing, etc.).

## Hazard Warning Flashers



 : Press this button on the overhead console to make the front and rear turn signal lamps flash on and off. This warns others that you are having trouble. Press again to turn the flashers off.

The turn signals do not work while the hazard warning flashers are on.

The hazard warning flashers turn on automatically if the airbags deploy.

## Turn and Lane-Change Signals



Move the lever all the way up or down to signal a turn.

An arrow on the instrument cluster will flash in the direction of the turn or lane change.

Raise or lower the lever until the arrow starts to flash to signal a lane change. Hold it there until the lane change is complete. If the lever is moved momentarily to the lane change position, the arrow will flash three times. It will flash six times if Tow/Haul Mode is active.

The lever returns to its starting position when it is released.

If after signaling a turn or lane change, the arrow flashes rapidly or does not come on, a signal LED may be burned out.

See your dealer for service. If a LED is not burned out, check the fuse. See *Instrument Panel Fuse Block* ⇨ 266.

## Cornering Lamps

Cornering lamps automatically come on when all of the following occur:

- The low-beam headlamps are on.
- The turn signals are activated or the steering wheel is at a turning angle.
- The vehicle speed is below 40 km/h (25 mph).



## Interior Lighting

### Instrument Panel Illumination Control



This feature adjusts the brightness of all illuminated controls.

: Move the thumbwheel up or down to brighten or dim the lights.

The thumbwheel is functional at night, or when the headlamps or parking lamps are ON.

The display brightness automatically adjusts based on outdoor lighting.

**Night Mode:** At night, when the knob is turned all the way to the OFF position, the instrument cluster will show minimum feature content (digital speed, gear indication, and coolant temp) with muted colors to reduce light emissions for better visibility.

### Dome Lamps

The dome lamps automatically come on when any door is opened, on the remote key is pressed, or when the vehicle is turned off.

The dome lamps controls are in the Controls App on the infotainment home screen. Select Controls > Lights > Dome Lights.

**Dome Light** : Select to manually turn the dome lamps on or off.

### Reading Lamps

There are reading lamps on the overhead console and over the rear seats. These lamps come on when any door is opened, on the remote key is pressed, or when the vehicle is turned off.

To operate, the vehicle must be on or using Retained Accessory Power (RAP).



**Front Reading Lamps**

The front reading lamps are in the overhead console.

Touch the lamp lens to turn the front reading lamps on or off.



**Rear Reading Lamps**

The rear reading lamps are above and behind the rear seats.

Touch the lamp lens to turn the rear reading lamps on or off.

## Lighting Features

### Entry Lighting

The interior lamps turn on when pressing  on the remote key or opening any doors, and the dome lamp control is in the door position.

Some exterior lamps also turn on when pressing  on the remote key or opening any doors. Low-Beam lamps will only turn on briefly at night, or in areas with limited lighting.

All lamps will gradually fade out after about 30 seconds.

Entry lighting can be disabled manually by closing all doors, pressing  on the remote key, or starting the vehicle.

This feature can be changed. On the infotainment home page, select the Settings icon > Vehicle > Vehicle Locator Lights.

### Exit Lighting

Some exterior lamps and interior lamps turn on when the driver door is opened after the vehicle is turned off.

The exterior and interior lamps remain on for a set amount of time, then automatically turn off.

The interior lights turn on when the vehicle is turned off.

The exterior lamps turn off immediately by turning the exterior lamp control off.

This feature can be changed. On the infotainment home screen, select the Settings icon > Vehicle > Exit Lighting.

### Battery Load Management

The vehicle has Electric Power Management (EPM) that estimates the battery temperature and state of charge. It then adjusts the voltage for best performance and extended life of the 12-volt battery.

When the battery state of charge is low, the voltage is raised slightly to quickly increase the charge. When the state of charge is high, the voltage is lowered slightly to prevent over charging. As this adjustment occurs, you may see the voltage move up or down on the voltmeter gauge or voltage display on the Driver Information Center (DIC), if equipped. This is normal. If a problem occurs, an alert will be displayed.

If the electrical loads are very high, the battery can be discharged when the vehicle is stationary. A high electrical load occurs when several features are on, such as: headlamps, high beams, rear window defogger, climate control fan at high speed, heated seats, motor cooling fans, trailer loads, and loads plugged into accessory power outlets.

EPM works to prevent excessive discharge of the battery by balancing the electrical system output and the vehicle's electrical needs. In some cases, it can temporarily reduce the power demands of some accessories.



These actions occur in steps or levels without being noticeable. In rare cases at the highest levels of corrective action, this action may be noticeable to the driver. If so, a DIC battery voltage and charging message displays. It is recommended that the driver reduce the electrical loads as much as possible. See *Driver Information Center (DIC)*  108.

### **Battery Power Protection**

This feature helps prevent the battery from being drained if the interior courtesy lamps or reading lamps are accidentally left on. If any of these lamps are left on, they automatically turn off after 10 minutes when the vehicle is turned off. The lamps will not come back on again until one of the following occurs:

- The vehicle is started.
- The doors are closed and then re-opened.

### **Exterior Lighting Battery Saver**

The exterior lamps turn off about 10 minutes after the vehicle is turned off, if the parking lamps or headlamps have been manually left on. This protects against draining the battery. To restart the 10-minute timer, turn the exterior lamp control to the  position and then back to the  or  position.

To keep the lamps on for more than 10 minutes, the vehicle must be on.

# Infotainment System

## Introduction

Introduction .....	123
Overview .....	124
Steering Wheel Controls .....	125
Using the System .....	125
Software Updates .....	128

## Radio

AM-FM Radio .....	128
Satellite Radio .....	129
Radio Reception .....	130
Multi-Band Antenna .....	131

## Audio Players

Avoiding Untrusted Media Devices .....	131
USB Port .....	131
Bluetooth Audio .....	132

## Navigation

Using the Navigation System .....	133
Maps .....	134
Navigation Symbols .....	134
Destination .....	134
Global Positioning System (GPS) .....	135
Vehicle Positioning .....	136
Problems with Route Guidance .....	136

## Voice Recognition

Voice Recognition .....	136
-------------------------	-----

## Phone

Bluetooth (Overview) .....	138
Bluetooth (Pairing and Using a Phone) .....	139
Apple CarPlay and Android Auto .....	142

## Settings

Settings .....	144
Teen Driver .....	146

## Trademarks and License Agreements

Trademarks and License Agreements .....	148
--	-----

# Introduction

Read the following pages to become familiar with the features.

## Warning

Taking your eyes off the road for too long or too often while using any infotainment feature can cause a crash. You or others could be injured or killed. Do not give extended attention to infotainment tasks while driving. Limit your glances at the vehicle displays and focus your attention on driving. Use voice commands whenever possible.

The infotainment system has built-in features intended to help avoid distraction by disabling some features when driving. These features may gray out when they are unavailable. Many infotainment features are also available through the instrument cluster and steering wheel controls.

Before driving:

- Become familiar with the operation, center stack controls, steering wheel controls, and infotainment display.
- Set up the audio by presetting favorite stations, setting the tone, and adjusting the speakers.
- Set up phone numbers in advance so they can be called easily by pressing a single control or by using a single voice command.

See *Distracted Driving* ⇨ 159.

### Overview

#### Infotainment System

The infotainment system is controlled by using the infotainment display, multifunction controller (MFC) on the center console, steering wheel controls, and voice recognition, if available.

#### Infotainment Controls on the Multifunction Controller (MFC)

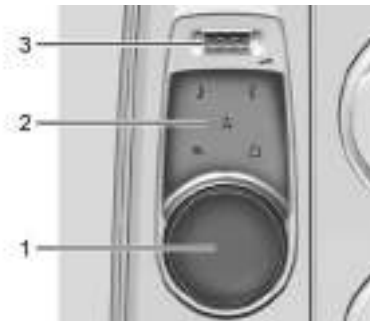

1. Primary Knob
  - Turn to highlight a feature. Press to activate the highlighted feature.
  - Move right/left or up/down to change the highlighted area on the display screen.
2. Selection Area
  - 🎵 (Radio/Audio)  
Press to open the active audio source page.
  - 📞 (Phone)  
Press to access the phone menu.

- ⬆️ (Navigation)  
Press to access the navigation screen (if equipped).
  - ↶️ (Back)  
Press to return to the previous display in a menu.
  - 🏠 (Home Page)  
Press to access the Home Page. See “Home Page” later in this section.
3. 🔌 (Power/Volume) Scroll Wheel
    - Press to turn the power on.
    - Press and hold when the system is on to turn the power off.
    - Press to mute/unmute the system when on.
    - Scroll up or down to increase or decrease the volume.

#### Home Page

The Home Page is where vehicle application icons are accessed. Some applications are disabled when the vehicle is moving.

Swipe left or right across the display or use the MFC to move the home page. Move the knob right/left to change the page or touch

on one of the page count indicators at the bottom of the screen to jump to a specific page.

### Managing Home Page Icons

1. Touch and hold any of the Home Page icons to enter edit mode. Edit mode is not available when the vehicle is moving.
2. Continue holding the icon and drag it to the desired position.
3. Release your finger to drop the icon in the desired position.
4. To move an application to another page, drag the icon to the edge of the display toward the desired page
5. Continue dragging and dropping application icons as desired.
6. Touch Done to save changes or Cancel to not save and exit edit mode.

There will always be 10 icons per page except on the last page. If an icon is moved from the first page to the second, then that icon from the second page will replace the one removed from the first.

### Steering Wheel Controls

If equipped, some audio controls can be adjusted at the steering wheel.



⏮ or ⏭ : Toggle up or down to increase or decrease the volume.

🎵 : Press show the audio sources list.

☎ : Press to answer an incoming phone call or show the recent phone call list when not in a call.

⏪ or ⏩ : Press to go to the next or previous favorite when listening to the radio. Press to go to the next or previous track when listening to a media source.

📞 : Press to reject an incoming phone call, end an active phone call, end a voice recognition session, or mute the audio when there is no phone call.

🗣 : Press initiate voice assistant.

### Using the System

#### Audio

Touch the Audio icon on the infotainment display or 🎵 on the Multifunction Controller (MFC) to display the active audio source page. Examples of available sources may include AM, FM, SXM (if equipped), USB, and Bluetooth.

#### Phone

Touch the Phone icon on the infotainment display or ☎ on the MFC to display the Phone menu. See *Bluetooth (Pairing and Using a Phone)* ⇨ 139 or *Bluetooth (Overview)* ⇨ 138.

#### Maps

Touch the Maps icon to display the Google Maps screen. See *Using the Navigation System* ⇨ 133.

### Google Assistant

Touch the Google Assistant icon to open the Google Assistant app. See *Voice Recognition* ⇨ 136.

### Google Play

Touch to download some of your favorite apps in your vehicle. Downloading apps on Google Play require you to sign into a Google Account with an active service plan with data. Some third-party apps require a separate account and, in some cases, a paid subscription for in-vehicle access.

### Apple CarPlay

Touch the Apple CarPlay icon to activate Apple CarPlay (if equipped) after a supported device is connected. See *Apple CarPlay and Android Auto* ⇨ 142.

### Android Auto

Touch the Android Auto icon to activate Android Auto (if equipped) after a supported device is connected. See *Apple CarPlay and Android Auto* ⇨ 142.

### Settings

Touch the Settings icon to display the Settings menu. See *Settings* ⇨ 144.

### Controls

Touch the Controls icon to display the Controls menu.

### Application Tray

The Application Tray is along the bottom of the display. It shows up to six applications.

### Infotainment Gestures

Use the following finger gestures to control the infotainment system.

#### Touch/Tap



Touch/tap is used to select an icon or option, activate an application, or change the location inside a map.

#### Touch and Hold



Touch and hold can be used to move or delete an application.

#### Drag

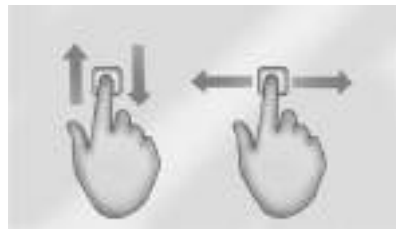

Drag is used to move applications on the Home Page, or to pan the map. To drag the item, it must be held and moved along the display to the new location. This can be

done up, down, right, or left. This feature is only available when vehicle is parked and not in motion.

### Nudge



Nudge is used to move items a short distance on a list or a map. To nudge, hold and move the selected item up or down to a new location.

### Fling or Swipe

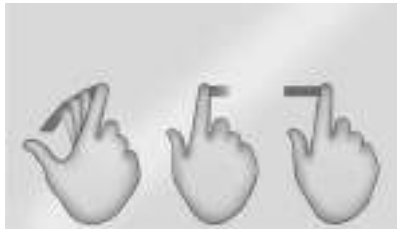

Fling or swipe is used to scroll through a list, pan the map, or change page views. Do this by placing a finger on the display then moving it rapidly up and down or right and left.

### Spread



Spread is used to zoom in on a map, certain images, or a web page. Place finger and thumb together on the display, then move them apart.

### Pinch



Pinch is used to zoom out on a map, certain images, or a web page. Place finger and thumb apart on the display, then move them together.

### Cleaning High Gloss Surfaces and Vehicle Information and Radio Displays

For vehicles with high gloss surfaces or vehicle displays, use a microfiber cloth to wipe surfaces. Before wiping the surface with the microfiber cloth, remove dirt that could scratch the surface. Then use the microfiber cloth by gently rubbing to clean. Never use window cleaners or solvents. Periodically hand wash the microfiber cloth separately, using mild soap. Do not use bleach or fabric softener. Rinse thoroughly and air dry before next use.



## Software Updates

### Over-the-Air Software Updates

If equipped, see “Updates” under *Settings*  
 ⇨ 144 for details on software updates.

## Radio

### AM-FM Radio

#### Playing the Radio

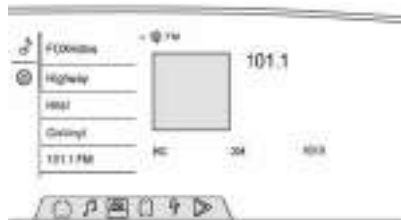

From the Home Page, touch the Audio icon to display the active audio source page. Touch ∨ from the top of the page to choose from AM, FM, SiriusXM, or Bluetooth.

#### Finding a Station

##### Seeking a Station

From the AM or FM screen, touch << or >> on the infotainment display to search for the previous or next strong station.

##### Tune



Touch |||| on the infotainment display to display the Tune screen. Enter a station using the keypad.

The keypad will gray out entries that do not contribute to a valid frequency and will automatically place a decimal point within the frequency number.

Touch ✕ to delete one number at a time.  
 Touch and hold ✕ to delete all numbers.

A valid AM or FM station will automatically tune to the new frequency and display the now playing screen.

The list of all available stations are on the right side of the Tune display to browse. Touch to go to that station or touch ☆ to save the station as a favorite.

#### Storing Radio Station Favorites

Favorites show in the area on the left of the display.

**AM, FM, or SiriusXM** : Favorites can be stored by touching Hold to Set on the left side of the screen.

The number of favorites is displayed automatically.

#### Audio Settings

From the now playing screen, touch ⚙ and the following may display:

**Equalizer** : Touch to adjust Bass, Midrange, or Treble using the options on the infotainment display.

**Fade/Balance** : Touch to adjust by using the controls on the infotainment display.

**Sound Mode** : Touch to select Front or Rear to provide the best sound for the front or rear seating positions.

Adjust the Surround controls to change from Stereo to Surround mode.

**Adaptive Volume** : Touch to turn On or Off.

**Manage Radio Favorites** : Touch to display a list of Audio favorites.

Favorites can be moved or deleted.

To move, touch and hold the move icon, and then drag up or down to rearrange the position.

**Radio Text** : This allows the Radio Data System (RDS) to be turned on or off.

Touch Off or On.

**Radio Categories** : When on, category information about current radio content will be shown.

### Radio Data System (RDS)

RDS relies on receiving specific RDS information from radio stations and only works when the information is available. It is possible that a radio station could broadcast information that causes the radio to work improperly.

In addition, RDS features are region and country of sale specific. This means specific RDS content may not be available in your listening area or in the country you operate the vehicle.

To turn RDS features on or off, see "Audio Settings" previously.

The following RDS features may be supported by radio broadcasters in your listening area:

#### RDS features

- Display radio station call letters
- Display messages from radio stations
- Provide radio station category information (when available)

### Satellite Radio

#### SiriusXM Radio Service

If equipped, vehicles with a valid SiriusXM radio subscription can receive SiriusXM programming.

SiriusXM radio has a wide variety of programming and commercial-free music, coast to coast, in digital-quality sound. In the U.S., see [www.siriusxm.com](http://www.siriusxm.com) or call 1-888-601-6296. In Canada, see [www.siriusxm.ca](http://www.siriusxm.ca) or call 1-877-438-9677.

When SiriusXM is active, the channel name, number, song title, and artist appear on the display.

#### SiriusXM with 360L

SiriusXM with 360L interface has enhanced in-vehicle listening experience for subscribers. The experience now offers more categories and system learned recommendations toward discovering more personalized content.

To use the full SiriusXM 360L program, including streaming content and listening recommendations, OnStar Connected Access is required. Connected vehicle services vary by model and require a complete working electrical system, cell reception, and GPS signal. An active connected plan is required.

Reference the SiriusXM user guide for use and subscription information.

## Finding a Channel

### Seeking a Channel



From the SiriusXM active source page, touch < CH or CH > to seek for the previous or next channel. Touch Hold to Set to save the channel as a favorite.



### Browsing Categories

Touch  to show the categories

Touching a category will show the channels associated with that category.

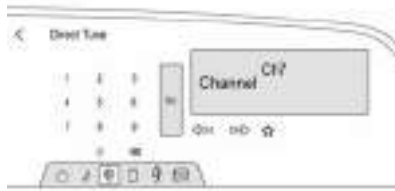
## Direct Tune



Access Direct Tune by touching  on the Linear Tuner screen. This will display the Direct Tune keypad. Navigate through all channels using < CH or CH > on the Direct Tune display. Directly enter a channel using the keypad and touch GO. When a new channel is entered, the information about that channel displays on the right side. This information will update with each new channel. Touch  to save the channel as a favorite.

### Favorites

Audio favorites are displayed on the left side of the active audio source page.

Favorites are stored by touching Hold to Set at the left side of the active audio source page.

## User Settings

From the SiriusXM source main page, touch  to display the following:

- Tune Start
- Location Services
- Help and Support

### Tune Start

Select on or off to have songs play from the start when tuning.

### Location Services

Select on or off to allow SiriusXM to see your location.

### Help and Support

Select to show the SiriusXM help website.

## Radio Reception

Unplug electronic devices from the accessory power outlets if there is interference or static in the radio.

### FM

FM signals only reach about 16 to 65 km (10 to 40 mi). Although the radio has a built-in electronic circuit that automatically works to

reduce interference, some static can occur, especially around tall buildings or hills, causing the sound to fade in and out.

## AM

The range for most AM stations is greater than for FM, especially at night. The longer range can cause station frequencies to interfere with each other. Static can also occur when things like storms and power lines interfere with radio reception. When this happens, try reducing the treble on the radio.

## SiriusXM Satellite Radio Service

If equipped, SiriusXM Satellite Radio Service provides digital radio reception. Tall buildings or hills can interfere with satellite radio signals, causing the sound to fade in and out. In addition, traveling or standing under heavy foliage, bridges, garages, or tunnels may cause loss of the SiriusXM signal for a period of time. Some cellular services may interfere with SXM reception causing loss of signal.

## Mobile Device Usage

Mobile device usage, such as making or receiving calls, charging, or just having the mobile device on may cause static interference in the radio. Unplug the mobile device or turn it off if this happens.

## Multi-Band Antenna

The roof antenna may be used for radio, navigation, and OnStar, depending on the equipped options. Keep clear of obstructions for clear reception. If the vehicle has a sunroof, and it is open, reception can also be affected.

## Audio Players

### Avoiding Untrusted Media Devices

When using media devices such as USB and mobile devices, consider the source. Untrusted media devices could contain files that affect system operation or performance and should be avoided.

## USB Port

Audio stored on a USB device may be listened to.

The vehicle may be equipped with three USB ports, one in the center console under the armrest, next to the wireless charger, and in the forward lower storage bin. These ports are for data. There may also be two USB charge ports at the rear of the center console.

### Caution

To avoid vehicle damage, unplug all accessories and disconnect all accessory cables from the vehicle when not in use. Accessory cables left plugged into the vehicle, unconnected to a device, could be damaged or cause an electrical short if the unconnected end comes in contact with liquids or another power source such as the accessory power outlet.

## Playing from a USB

A USB mass storage device can be connected to the USB port.

Audio extensions supported by the USB may include:

- MP3
- AAC
- OGG
- 3GP

- AMR
- FLAC
- WAVE
- MKV

### USB MP3 Player and USB Devices

The USB MP3 players and USB devices connected must comply with the USB Mass Storage Class specification (USB MSC).

To play a USB device:

1. Connect the USB.
2. Touch Audio from the Home Page.
3. Touch Source and select the USB icon or source option.

Use the following when playing an active USB source:

 : Touch to play the current media source.

 : Touch to pause playback of the current media source.

 :

- Touch to seek the beginning of the current or previous track.

 :

- Touch to seek the next track.

**Shuffle** : Touch the shuffle icon to play music in random order.

### USB Sound Menu

See “Infotainment System Sound Menu” under *AM-FM Radio* ⇨ 128.

### File System and Naming

File systems supported by the USB may include:

- FAT32
- NTFS

The songs, artists, albums, and genres are taken from the file’s song information and are only displayed if present. The radio displays the file name as the track name if the song information is not available.

### Media Playback and Mute

USB playback will be paused if the system is muted. If the steering wheel mute control is pressed again, playback will resume.

If the source is changed while in mute, playback resumes and audio will unmute.

## Bluetooth Audio

Music may be played from a paired Bluetooth device. See *Bluetooth (Pairing and Using a Phone)* ⇨ 139 or *Bluetooth (Overview)* ⇨ 138 for help pairing a device.

Volume and song selection may be controlled by using the infotainment controls or the mobile device. If Bluetooth is selected and no volume is present, check the volume setting on both your mobile device and the infotainment system.

Music can be launched by touching Bluetooth from the recent sources list on the left of the display or by touching the More option and then touching the Bluetooth device.

To play music via Bluetooth:

1. Power on the device, and pair to connect the device.
2. Once paired, touch Audio from the Home Page, then touch Source and touch the Bluetooth device.

### Bluetooth Sound Menu

See “Infotainment System Sound Menu” under *AM-FM Radio* ⇨ 128.

**FCC Radiation Exposure Statement**

This equipment has been evaluated to be installed and operated at a minimum distance of 6 cm between the device and your body. The vehicle design ensures this distance is maintained during normal use. Changes or modifications to any of these systems by other than an authorized service facility could void authorization to use this equipment.

**ISED Radiation Exposure Statement**

This equipment complies with RSS-102 radiation exposure limits set forth for an uncontrolled environment. This equipment should be installed and operated with a minimum distance of 6 cm between the radiator and any part of your body. The vehicle design ensures this distance is maintained during normal use. Changes or modifications to any of these systems by other than an authorized service facility could void authorization to use this equipment.

See *Radio Frequency Statement* ⇨ 312.

**Navigation****Using the Navigation System**

The Navigation software is provided by Google Maps. The information provided in this section is a general overview and is subject to change. For the latest functional information, see [g.co/mapsincar](http://g.co/mapsincar).

Accept the Terms and Conditions to use.

**Internet Connectivity**

Google Maps relies on a subscription data plan for full functionality, including availability of offline maps. With an applicable connected services plan, Google Maps can be used offline when driving through connectivity dead zones by auto-downloading offline maps prior to going offline.

**Profiles**

Sign in to a Google Account for personalized service. Information available in the Google Account will be shown.

To log into a profile, see *Accounts* under *Settings* ⇨ 144.

**Voice Assistant**

If equipped, Google Maps can be controlled by voice commands, see *Google Assistant* under *Voice Recognition* ⇨ 136.

**Language and Units**

To change the language, see *Settings* ⇨ 144.

To change the units, see *Instrument Cluster* ⇨ 89.

**Mute Settings**

During active route guidance, Google Maps can give audible voice directions, traffic alerts, or can be muted. In the Google Maps app, touch *Settings*, then *Mute* settings to access the options. Alternatively, audible voice directions and traffic alerts can be muted by tapping sound icon on the turn card during active navigation.

**Compass**

The Google Maps orientation can be changed between the direction currently traveling and pointing north. Touch the compass to switch between these options.

To recenter the map to the current location, touch the location icon.

### Super Cruise

If equipped, Super Cruise highlights routes in a specific outline. See *Super Cruise* ⇨ 190.

### Electric Vehicle (EV) Features with Google Maps

When vehicle data is shared with Google, some of the Maps features for EVs are as follows:

- Estimated battery charge level at arrival
- Estimated minimum charging time in order to reach destination

If the vehicle needs to be charged to reach a destination, charging stations may automatically be added to a route.

## Maps

### Auto-downloaded Maps

Google Maps downloads offline maps automatically for use when not connected to the Internet and for making map data available to vehicle features regardless of connectivity. These offline maps are only available when the vehicle has a subscription data plan.

To turn on auto-download:

1. Open Google Maps.

2. Touch Settings.
3. Touch Privacy Center, then select Offline maps.
4. Select Auto-download offline maps.
5. Check the Internet connection and wait for the download to finish.

### Downloading Offline Maps

1. Open Google Maps.
2. Touch Settings, then Offline maps.
3. Touch the square with the Select your own map icon.
4. Adjust the map to cover the desired area to download.
5. Touch Download.

### Navigation Symbols

The following are the most common symbols that may appear in Google Maps.



This indicates the vehicle's current location and direction on the map.



The destination pin marks the location of the final destination. Touch the pin to view the destination address or to add it or remove it from the Favorites list. Hide the information by touching the pin one more time. It will automatically time out if no action is taken.

A second pin in the menu is the route overview. Touch this pin to show more details of the destination or to remove the destination.

## Destination

### Searching for a Destination

A destination can be searched using Google Assistant.

To search for a destination without Google Assistant:

1. Open Google Maps.
2. Touch the Search field.
3. Enter the destination.

#### 4. Touch Start.

#### Alternate Routes

Alternate routes are displayed as separate lines. While in either turn-by-turn navigation or on the route overview, touch the suggested alternate route.

#### Adding a Stop on Route by Voice

1. While in turn-by-turn navigation, touch the Search icon at the bottom.
2. Touch the Google Assistant mic icon and say the destination to search by voice.
3. Select the desired search result from the list.
4. Touch Add stop.

#### Adding a Stop on Route by Category

1. While in turn-by-turn navigation, touch the Search icon at the bottom.
2. Select a category.
3. Select the desired search result from the list.
4. Touch Add stop.

#### Adding a Home or Work Address

To edit a home or work address, an account must be logged in. See *Accounts* under *Settings* ⇨ 144.

1. Open Google Maps.
2. Touch Settings and then touch Edit home or work.
3. Enter the address.

#### Search by Category

Destinations can be searched by category, such as restaurant or grocery store.

1. Open Google Maps.
2. Touch the search bar.
3. Touch Categories, then select a category.
4. Touch the desired location, then touch Start.

#### Avoid Tolls, Highways, or Ferries

1. Open Google Maps.
2. Touch Settings.
3. Select Route options.
4. Select the desired options and then touch close.

#### An Alternative Way for General Route Options

1. During active route guidance, touch Route Overview.
2. Select Route options.
3. Select the desired option and then touch close.

#### Traffic Layers

1. Open Google Maps.
2. Touch Settings.
3. Toggle between Traffic on or off.

#### Global Positioning System (GPS)

The current position of the vehicle is determined by using satellite signals and various vehicle signals.

At times, other interference such as the satellite condition, road configuration, condition of the vehicle, and/or other circumstances can affect the navigation system's ability to determine the accurate position of the vehicle.

This system might not be available or interference can occur if any of the following are true:

- Signals are obstructed by tall buildings, trees, large trucks, or a tunnel.
- Satellites are being repaired or improved.

For more information if the GPS is not functioning properly, see *Problems with Route Guidance* ⇨ 136.



## Vehicle Positioning

At times, the position of the vehicle on the map could be inaccurate due to one or more of the following reasons:

- The road system has changed.
- The vehicle is driving on slippery road surfaces such as sand, gravel, or snow.
- The vehicle is traveling on winding roads or long, straight roads.
- The vehicle is approaching a tall building or a large vehicle.
- The surface streets run parallel to a freeway.
- The vehicle has been transferred by a vehicle carrier or a ferry.
- The current position calibration is set incorrectly.
- The vehicle is traveling at high speed.
- The vehicle changes directions more than once, or the vehicle is turning on a turn table in a parking lot.
- The vehicle is entering and/or exiting a parking lot, garage, or a lot with a roof.
- The GPS signal is not received.
- A roof carrier is installed on the vehicle.
- Tire chains are installed on the vehicle.
- The tires are replaced or worn.

- The tire pressure for the tires is incorrect.
- This is the first navigation use after the map data is updated.
- The 12-volt battery has been disconnected for several days.
- The vehicle is driving in heavy traffic where driving is at low speeds, and the vehicle is stopped and started repeatedly.

## Problems with Route Guidance

Inappropriate route guidance can occur under one or more of the following conditions:

- The turn was not made on the road indicated.
- Route guidance might not be available when using automatic rerouting for the next right or left turn.
- The route might not be changed when using automatic rerouting.
- There is no route guidance when turning at an intersection.
- Automatic rerouting might display a route returning to the set waypoint if heading for a destination without passing through a set waypoint.

- The route prohibits the entry of a vehicle due to a regulation by time or season or any other regulation which may be given.
- Some routes might not be searched.
- The route to the destination might not be shown if there are new roads, if roads have recently changed, or if certain roads are not listed in Maps.

To recalibrate the vehicle's position on the map, park with the vehicle running for two to five minutes, until the vehicle position updates. Make sure the vehicle is parked in a location that is safe and has a clear view of the sky and away from large obstructions.



## Voice Recognition

If equipped, Google Assistant allows for hands-free use of media and messaging, navigation and climate control functionality in the vehicle. This feature can be started by pressing  on the steering wheel, touching Google Assistant on the Home screen, or by using the wake up words "Hey Google" or "OK Google."

However, not all features within these areas are supported by voice commands and requires the user to have a valid data subscription plan in order to use some of the Google Assistant features.

### Using Voice Recognition

Voice recognition becomes available once the system is initialized. This begins when the vehicle is turned on. Initialization may take a few moments.

1. Press  on the steering wheel controls, touch Google Assistant on the Home screen, or use the wake up words “Hey Google” or “OK Google” to activate voice recognition. Google Assistant must be set as the Default Assistant for the  and the wake word options to work.
2. Clearly speak one of the commands described later in this section.

### Canceling Google Assistant

- Press  on the steering wheel controls to cancel the Google Assistant request.

### Helpful Hints for Speaking Commands

Voice recognition identifies commands that are naturally stated in sentence form, or direct commands that state the application and the task.

For best results:

- Speak the command naturally, not too fast, not too slow.
- Use direct commands without a lot of extra words. For example, “Call <name> at work,” “Play” followed by the artist or song name, or “Play” followed by the radio station number.

Direct commands are more clearly understood by the system. An example of a direct command is “Call <number>.”

If a cell phone number was saved with a name and a place, the direct command should include both. For example “Call <name> at work.”

### Voice Recognition for the Radio

When voice is started, the voice recognition commands for AM, FM, SiriusXM (if equipped), and media apps (if supported) are available.

**“Play <AM frequency> AM”** : Tune to the radio station frequency identified in the command (like “nine fifty”).

**“Play <FM frequency> FM”** : Tune to the radio station frequency identified in the command (like “one oh one point one”).

**“Play channel <SXM channel number> on SiriusXM”** : Tune to the SiriusXM radio station channel number identified in the command. This command may require an online connection.

**“Play <SXM channel name> on Sirius XM”** : Tune to the SiriusXM radio station channel name identified in the command. This command may require an online connection.

**“Play <Media> on <Audio Source>”** : Play media like a song or channel using a specified audio source such as Pandora or Spotify. This command may require an online connection.

### Voice Recognition for the Phone

Make sure the phone is paired using Bluetooth to use the phone related voice commands.

**“Call <contact name>”** : Initiate a call to a stored contact. The command may include location if the contact has location numbers

stored. You must accept Personal Results permission during set up for access to the contacts.

“**Call < phone number>**” : Initiate a call to a phone number of seven digits or 10 digits.

“**Send a message to <contact name>**” : Send a message to a stored contact.

### Voice Recognition for Navigation

Navigation commands can be used to start, cancel route, or add way points/POI.

“**Navigate to <destination address>**” : Initiate navigation to the address in the command.

“**Find a <Place of Interest>**” : Find and initiate navigation to a POI in the command.

“**Add <destination> on my way**” : Adds a way-point to the current route.

“**Take me home**” : Starts navigation to Home location set in Google maps.

### Onboard Vehicle Commands

These commands can be used to adjust vehicle temperature, control window defrosters, etc.

“**Turn on the A/C**” : Turns on the air conditioning.

“**Set temperature to <desired number> degrees**” : Set to a specific temperature inside your vehicle.

### Phone Assistant Voice Recognition

While a device is connected via Bluetooth, Android Auto, or CarPlay, press and hold  on the steering wheel controls to pass through and launch the Voice Assistant on the connected mobile phone (e.g, Google assistant, Siri, etc.).

## Phone

### Bluetooth (Overview)

The Bluetooth-capable system can interact with many mobile devices to:

- Place and receive calls in a hands-free mode.
- Share the device’s address book or contact list with the vehicle.
- Stream audio (music, podcasts).
- Notify receipt of text messages.

To minimize driver distraction, before driving, and with the vehicle parked:

- Become familiar with the features of the mobile device. Organize the phone book and contact lists clearly and delete duplicate or rarely used entries.
- Review the controls and operation of the infotainment system.
- Pair mobile device(s) to the vehicle. The system may not work with all mobile devices. See “Pairing” later in this section.

Vehicles with a Bluetooth system can use a Bluetooth-capable mobile device with a Hands-Free Profile to make and receive phone calls. The infotainment system and voice recognition are used to control the system. The system can be used while the vehicle is on or in accessory mode. The range of the Bluetooth system can be up to 9.1 m (30 ft). Not all mobile devices support all functions and not all mobile devices work with the Bluetooth system. See *Online Account* ⇨ 306 for more information about compatible mobile devices.

### Controls

Use the controls on the infotainment display and the steering wheel to operate the Bluetooth system.

## Steering Wheel Controls

 : Press and release to answer incoming calls on your connected Bluetooth mobile device. Press and hold for mobile device assistant.

 : Press to end a call, decline a call, or cancel an operation. Press to mute or unmute the infotainment system when not on a call.

## Infotainment System Controls

For information about how to navigate the menu system using the infotainment controls, see *Using the System* ⇨ 125.

## Audio System

When using the Bluetooth mobile device system, sound comes through the vehicle's front audio system speakers and overrides the audio system. The volume level while on a mobile device call can be adjusted by pressing the steering wheel controls or the volume controls for the infotainment system. The adjusted volume level remains in memory for later calls. The volume cannot be lowered beyond a certain level.

## Bluetooth (Pairing and Using a Phone)

### Pairing

A Bluetooth-enabled mobile device must be paired to the Bluetooth system and then connected to the vehicle before it can be used. See the mobile device manufacturer's user guide for Bluetooth functions before pairing the device.

### Pairing Information

- Touch the Phone icon on the home page of the infotainment display.
- If no mobile device has been paired, a message on the infotainment display will show the Manage Phones option. Touch this option and the Phones screen will display. See "Pairing a Phone" later in this section.
- A Bluetooth smartphone with music capability can be paired to the vehicle as a smartphone and a music player at the same time.
- Up to 10 devices can be paired to the Bluetooth system.
- The pairing process is disabled when the vehicle is moving.

- Pairing only needs to be completed once, unless the pairing information on the cell phone changes or the cell phone is deleted from the system.
- If multiple paired cell phones are within range of the system, the system connects to the paired cell phone that is set to First to Connect. If there is no cell phone set to First to Connect, it will link to the cell phone which was used last. To link to a different paired cell phone, see "Linking to a Different Phone" later in this section.

### Pairing a Phone

1. Make sure Bluetooth has been enabled on the cell phone before starting the pairing process.
2. Touch the Phone icon on the Home Page.
3. If no mobile device is connected, touch Manage Phones and the Phones screen will display.

If another mobile device is connected already, touch Settings, Connections, and then Phones.

4. Touch Add Phone.

If a previously added phone is disconnected, the "Add Phone" card will just be a "+" card.

5. Follow the on-screen prompts to pair the cell phone.
6. Follow the instructions on the cell phone to confirm the six-digit code showing on the infotainment display and touch Pair. The code on the cell phone and infotainment display needs to be acknowledged for a successful pair.
7. Start the pairing process on the cell phone to be paired to the vehicle. See the cell phone manufacturer's user guide for information on this process. Once the cell phone is paired, it will show as Connected.
8. If the vehicle name does not appear on your cell phone, there are a few ways to start the pairing process over:
  - Make sure there is not an entry for the vehicle under the previously connected list. If the vehicle and cell phone were previously paired and one still remembers the other, it will not identify as a new device when searching.
  - Turn the Bluetooth off and on the device.

- Go back to the beginning of the Phone menus on the infotainment display and restart the pairing process.
  - Turn the cell phone off and then back on.
  - Reset the cell phone, but this step should be done as a last effort.
9. If the cell phone prompts to accept connection or allow phone book download, touch Always Accept and Allow. The phone book may not be available if not accepted.
  10. To pair additional cell phones, touch Settings, Connections, and then Phones.

#### **First to Connect Paired Phones**

If multiple paired cell phones are within range of the system, the system connects to the paired cell phone that is set as First to Connect. To enable a paired cell phone as the First to Connect phone:

1. Make sure the cell phone is turned on.
2. Touch the Settings icon on the home page.
3. Touch Connections.
4. Touch Phone.

5. Touch Options under the connected phone.
6. Touch First to Connect from the cell phone's settings menu. The settings will be enabled for that device.

Cell phones and mobile devices can be added, removed, connected, and disconnected. A sub-menu will display whenever a request is made to add or manage cell phones and mobile devices.

#### **Accessing the Device List Screen**

There are two ways to access the device list screen:

##### **Using the Settings Icon**

1. Touch the Settings icon on the Home Page or the Settings icon on the shortcut tray near the left of the display.
2. Touch Connections.
3. Touch Phones.

##### **Using the Phone Icon**

1. Touch the Phone icon on the Home Page or the Phone icon on the shortcut tray near the left of the display.
2. Touch  on the top right of the Phones screen.
3. Touch Connected Phone.

**Disconnecting a Connected Phone**

To disconnect a phone:

1. Open the Device List Screen. See “Accessing the Device List Screen” previously in this section.
2. Touch Option on the phone card to show the cell phone’s or mobile device’s settings.
3. Touch Disconnect.

**Deleting a Paired Phone**

To delete a paired phone:

1. Open the Device List Screen. See “Accessing the Device List Screen” previously in this section.
2. Touch Option on the phone card to show the cell phone’s or mobile device’s settings.
3. Touch Forget Phone.

**Linking to a Different Phone**

To link to a different cell phone, the new cell phone must be in the vehicle and paired to the Bluetooth system.

To link to a different phone:

1. Open the Device List Screen. See “Accessing the Device List Screen” previously in this section.

2. Touch the new cell phone to link to from the list of available phones. See “First to Connect Paired Phones” previously in this section.

**Switching to Handset or Hands-Free Mode**

To switch between handset or hands-free mode:

- While the active call is hands-free, touch the Audio Output option, then touch Phone to switch to the handset mode. The mute icon will not be available or functional while Handset mode is active.
- While the active call is on the handset, touch the Audio Output option, then touch Car Speakers to switch to the hands-free mode.

**Making a Call Using Contacts**

Calls can be made through the Bluetooth system using personal cell phone contact information for all cell phones that support the Phone Book feature. Become familiar with the cell phone settings and operation and that the phone is set to allow the sharing of contacts over Bluetooth with the vehicle. Verify the cell phone supports this

feature and that the phone is set to allow the sharing of contacts over Bluetooth with the vehicle..

The Contacts menu accesses the phone book stored in the cell phone.

To make a call using the Contacts menu:

1. Touch the Phone icon on the Home Page or on the shortcut tray near the left of the display.
2. Touch Contacts.
3. There are two methods to search for contacts:
  - Search bar – Touch the search icon on the top right of the Phones window and type the name or number of the contact on the keyboard. Search results will be displayed corresponding to the user input. Touch the name to call.
  - Scroll – Touch the list and scroll, or use the scrollbar on the left side of the Phones window. Touch the name to call.

**Making a Call Using the Recents Menu**

The Recents menu accesses the recents call list from your cell phone.

To make a call using the Recents menu:

1. Touch the Phone icon on the Home Page or on the shortcut tray near the left of the display.
2. Touch Recents.
3. Touch the name or number to call.

### **Making a Call Using the Keypad**

To make a call by dialing the numbers:

1. Touch the Phone icon on the Home Page or on the shortcut tray near the left of the display.
2. Touch Keypad and enter a phone number.
3. Touch the phone icon on the infotainment display to start dialing the number.

### **Searching Contacts Using the Keypad**

To search for contacts using the keypad:

1. Touch the Phone icon on the Home Page.
2. Touch Keypad and enter partial phone numbers or contact names using the digits on the keypad to search.

Results appear on the right side of the display. Touch one to place a call.

### **Accepting or Declining a Call**

When an incoming call is received, the infotainment system mutes and a ring tone is heard in the vehicle.

#### **Accepting a Call**

There are two ways to accept a call:

- Press  on the steering wheel controls.
- Touch Answer on the infotainment display.

#### **Declining a Call**

There are two ways to decline a call:

- Press  on the steering wheel controls.
- Touch Decline on the infotainment display.

### **Call Waiting**

Call waiting must be supported on the Bluetooth cell phone and enabled by the wireless service carrier to work.

#### **Accepting a Call**

Press  to answer, then touch Switch on the infotainment display.



#### **Declining a Call**

Press  to decline, then touch Decline on the infotainment display.

### **Switching Between Calls (Call Waiting Calls Only)**

To switch between calls, touch Phone on the Home Page to display Call View. While in Call View, touch the call information of the call on hold to change calls.

### **Ending a Call**

- Press  on the steering wheel controls.
- Touch  on the infotainment display, next to a call, to end only that call.

### **Dual Tone Multi-Frequency (DTMF) Tones**

The in-vehicle Bluetooth system can send numbers during a call. This is used when calling a menu-driven phone system. Use the Keypad to enter the number.

### **Apple CarPlay and Android Auto**

If equipped, Android Auto and/or Apple CarPlay capability may be available through a compatible smartphone. If available and connected, the Android Auto and Apple CarPlay icons will change from gray to white on the Home Page of the infotainment display.

To use Android Auto and/or Apple CarPlay:

#### For Wired Phone Projection

1. Download the Android Auto app to your smartphone from Google Play for phones running Android 9 and below. There is no app required for Apple CarPlay or newer versions of Android.
2. Connect your Android phone or Apple iPhone by using the factory-provided phone USB cable and plugging into a front USB data port. For best performance, it is highly recommended to use the device's factory-provided USB cable, which should be replaced after significant wear to maintain connection quality. Aftermarket or third-party cables may not work.
3. When the phone is first connected to activate Apple CarPlay or Android Auto, the "Terms and Conditions" consent will appear.
  - Touch Enable to launch Apple CarPlay or Android Auto.
  - Touch Disable to remove Apple CarPlay and Android Auto capability from the vehicle Settings menu. Other functions may still work.

#### For Wireless Phone Projection

1. Download the Android Auto app to your smartphone from Google Play for phones running Android 9 and below. There is no app required for Apple CarPlay or newer versions of Android.
2. For first time connection:
  - Connect the phone over Bluetooth. See *Bluetooth (Pairing and Using a Phone)* ⇨ 139 or *Bluetooth (Overview)* ⇨ 138.
3. Make sure Wi-Fi and Bluetooth is turned on the phone for wireless projection to work.
4. When the phone is first connected to activate Apple CarPlay or Android Auto, agree to the terms and conditions on the infotainment system. Touch Enable to launch Apple CarPlay or Android Auto.
5. Follow the instructions on the phone.

The Android Auto and Apple CarPlay icons on the Home Page will illuminate depending on the smartphone. Android Auto and/or Apple CarPlay may automatically launch. If not, touch the Android Auto or Apple CarPlay icon on the Home Page to launch.

To disconnect the phones wireless projection:



1. Select Settings from the Home Page.
2. Select Connections.
3. Select Phones.
4. Touch Options on the phone card.
5. Turn off Apple CarPlay or Android Auto.

Press  on the center stack to return to the Home Page.

Features are subject to change. For further information on how to set up Android Auto and Apple CarPlay in the vehicle, see your vehicles brand website.

Android Auto is provided by Google and is subject to Google's terms and privacy policy. Apple CarPlay is provided by Apple and is subject to Apple's terms and privacy policy. Data plan rates apply. For Android Auto support see <https://support.google.com/androidauto>. For Apple CarPlay support see [www.apple.com/ios/carplay/](http://www.apple.com/ios/carplay/). Apple or Google may change or suspend availability at any time. Google, Android, Android Auto, Google Maps and other marks are trademarks of Google LLC. Apple CarPlay is a trademark of Apple Inc.



Press  on the center stack to exit Android Auto or Apple CarPlay. To enter back into Android Auto or Apple CarPlay, press and hold  on the center stack.

Apple CarPlay and Android Auto can be disabled from the infotainment system. To do this, touch Home>Settings>Connections>Phones and then Phone Options on the phone card. Use the On/Off toggled to turn off Apple CarPlay or Android Auto for that phone.

## Settings

To access the Settings menus:

1. Touch Settings on the Home Page on the infotainment display.
2. Touch the desired category to display a list of available options.
3. Touch to select the desired feature setting.
4. Touch the options on the infotainment display to change a setting.
5. Touch  to go back.

The Settings menu may contain the following:

### Connections

The menu may contain the following:

#### Phones

Allows connecting to a different cell phone or mobile device source, disconnect a cell phone or media device, or delete a cell phone or media device.

#### Wi-Fi Networks

Shows connected and available Wi-Fi networks.

#### Wi-Fi Hotspot

Allows adjustment of different Wi-Fi features.

#### Vehicle-to-Phone Sharing

#### Trusted Device

Allows for setting a phone as your trusted device to establish a secure communication channel between your phone and vehicle that enables convenient features like instant profile unlocking and account sign in. When nearby, your trusted device is recognized automatically via a unique Bluetooth connection.

## Vehicle

The menu may contain the following:

### Driver Mode Customization

See *Driver Mode Control* ⇨ 180.

### Teen Driver

See *Teen Driver* ⇨ 146.

### Rear Seat Reminder

Allows for a chime and a message when the rear door has been opened before or during operation of the vehicle.

### Buckle to Drive

This feature can prevent shifting out of Park when the driver, and if applicable the front passenger, seat belt is not buckled. See *Buckle To Drive* ⇨ 43.

### Super Cruise Lane Change

See *Super Cruise* ⇨ 190.

### Climate and Air Quality

Adjusts different climate settings.

### Collision/Detection Systems

Adjusts different driver assistance system settings.

**Comfort and Convenience**

Adjusts different comfort and convenience settings.

**Lighting**

Adjusts different lighting settings.

**Power Door Locks**

Adjusts different door lock settings.

**Remote Lock, Unlock, and Start**

Adjusts different remote lock settings.

**Seating Position**

Adjusts different seating position settings.

**Apps and Permissions**

Shows a list of installed apps and the permissions used.

**Date / Time**

Allows setting of the clock.

**Display**

Allows adjustment of the infotainment display.

**Sounds**

Allows adjustment of the infotainment system sounds.

**Users**

Modifies the infotainment system's users.

**Accounts**

Allows adding or adjusting of the user accounts.

**Privacy**

This menu allows adjustment of the infotainment privacy settings.

**Storage**

This menu shows the storage info on the infotainment system.

**Security**

This menu allows adjustment of the infotainment security settings.

**System**

The menu may contain the following:

**Language**

This will set the display language used on the infotainment display.

**Keyboard and Speech**

Touch to change keyboard and speech settings.

**Units**

Touch to change units settings.

**Quick Startup**

This allows your infotainment system to quickly resume its last session.

**Reset Options**

Touch to change reset settings.

**TTY Mode**

Touch to turn off or on.

**About**

Touch to view the infotainment system software information.

**Legal Information**

Touch to view legal and license information.

**Updates**

This menu allows adjustment of the vehicle update settings.

**Google**

This menu allows adjustment of the Google settings.

## Teen Driver

If equipped, this allows multiple keys to be registered for beginner drivers to encourage safe driving habits. When the vehicle is started with a Teen Driver key, it will automatically activate certain safety systems, allow setting of some features, and limit the use of others. The Report Card will record vehicle data about driving behavior that can be viewed later. When the vehicle is started with a Teen Driver key, the Driver Information Center (DIC) displays a message that Teen Driver is active.

### To access:

1. Touch Settings on the Home Page, then touch Vehicle, and then Teen Driver.
2. Create a Personal Identification Number (PIN) by choosing a four-digit PIN. Re-enter the PIN to confirm. To change the PIN, touch Change PIN.

### The PIN is required to:

- Set up/Add or remove keys.
- Change Teen Driver settings.
- Change or clear the Teen Driver PIN.
- Access or delete Report Card data.

### Set up/Add keys to activate Teen Driver and assign restrictions to the key:

Any vehicle key can be registered, up to a maximum of eight keys. Label the Teen Driver key to tell it apart from the other keys.

### For a pushbutton start system:

1. Start the vehicle.
2. The vehicle must be in P (Park).
3. From the Settings menu, touch Vehicle and then Teen Driver.
4. Enter the PIN.
5. Place the remote key you wish to register in the transmitter pocket. The key does not need to be the one that started the vehicle. See *Remote Key Operation* ⇨ 7 for transmitter pocket location.
6. From the Teen Driver menu, touch Setup Keys or Add/Remove Teen Driver Keys.
  - If the remote key has not previously been registered, the option to add the key displays. Touch Add and a confirmation message displays. Teen Driver restrictions will be applied whenever this remote key is used to operate the vehicle.

- If the remote key has already been registered, the option to remove the key displays. If Remove is touched, the remote key is no longer registered. A confirmation message displays, and Teen Driver restrictions will not be applied if this remote key is used to operate the vehicle.

In vehicles with a pushbutton start system, if a Teen Driver and a non-Teen Driver key are both present at start up, the vehicle will recognize the non-Teen Driver key to start the vehicle. The Teen Driver settings will not be active.

### Manage Settings or Teen Driver Settings

Depending on the options of your vehicle, the following menu items may be displayed:

**Buckle to Drive** : When turned ON, Buckle to Drive prevents the driver from shifting out of P (Park) for a period of time after the brake pedal is pressed if the driver, or on some vehicles the detected passenger, has not buckled their seat belt. On some vehicles, Buckle to Drive is always ON when Teen Driver is active and is not configurable. See *Buckle To Drive* ⇨ 43.

**Audio Volume Limit** : Allows a maximum audio volume to be set. Turn the audio volume limit on or off. Use the arrows to choose the maximum allowable level for the audio volume. On some infotainment systems, touch Set Audio Volume Limit to choose the maximum allowable audio volume level.

**Set Audio Volume Limit** : Use the arrows to choose the maximum allowable level for the audio volume.

**Teen Driver Speed Limiter** : Limits the maximum speed of the vehicle. When the speed limiter is turned on and the vehicle is started with a Teen Driver key, the DIC displays a message that the top speed is limited.

On certain vehicles, when the Speed Limiter is turned ON, the vehicle's maximum acceleration will be limited. The DIC will display a message that the acceleration is limited.

**Teen Driver Speed Warning** : Displays a warning in the DIC when exceeding a selectable speed. Turn the speed warning on or off and choose the desired speed warning level. The speed warning does not limit the

speed of the vehicle. On some infotainment systems, touch Set Teen Driver Speed Warning to set the warning speed.

**Set Teen Driver Speed Warning** : Choose the desired speed warning level. The speed warning does not limit the speed of the vehicle.

**SiriusXM Explicit Content Filter** : Allows the SiriusXM Explicit Content Filter to be turned ON or OFF. When ON, the teen driver will not be able to listen to SiriusXM stations that contain explicit content, and the Explicit Content Filter selection in the Audio Settings will be unavailable for change.

#### **When Teen Driver is Active:**

- If equipped, the radio will mute when the driver seat belt, and in some vehicles the front passenger seat belt, is not buckled. The audio from any device paired to the vehicle will also be muted.
- An object placed on the front passenger seat, such as a briefcase, handbag, grocery bag, laptop, or other electronic device, could cause the passenger sensing system to falsely sense an unbuckled front passenger and mute the radio. If this happens, remove the object from the seat. See *Passenger Sensing System* ⇨ 55.

- Some safety systems, such as Automatic Emergency Braking, if equipped, cannot be turned off.
- The gap setting for Adaptive Cruise Control and alert timing for Forward Collision Alert, if equipped, cannot be changed.
- When trying to change a safety feature that is not configurable in Teen Driver, the feature may be grayed out or removed from the infotainment menu, or the DIC will display a message indicating that Teen Driver is active and the action is not available.
- Super Cruise, if equipped, is not available.
- Do not tow a trailer if equipped with Automatic Emergency Braking.

#### **Report Card**

The vehicle owner must secure the driver's consent to record certain vehicle data when the vehicle is driven with a registered Teen Driver key. There is one Report Card per vehicle. Data is only recorded when a registered Teen Driver key is used to operate the vehicle.

The Report Card data is collected from the time Teen Driver is activated or the last time the Report Card was reset. The following items may be recorded:

- Distance Driven – the total distance driven.
- Maximum Speed – the maximum vehicle speed detected.
- Overspeed Warnings – the number of times the speed warning setting was exceeded.
- Wide Open Throttle – the number of times the accelerator pedal was pressed nearly all the way down.
- Forward Collision Alerts (if equipped) – the number of times the driver was notified when approaching a vehicle ahead too quickly and at potential risk for a crash.
- Forward Automatic Braking, also called Automatic Emergency Braking (if equipped) – the number of times the vehicle detected that a forward collision was imminent and applied the brakes.
- Reverse Automatic Braking (if equipped) – the number of times the vehicle detected that a rearward collision was imminent and applied the brakes.

- Traction Control – the number of times the Traction Control System activated to reduce wheel spin or loss of traction.
- Stability Control – the number of events which required the use of electronic stability control.
- Antilock Braking System Active – The number of Antilock Brake System activations.
- Tailgating Alerts (if equipped) – the number of times the driver was alerted for following a vehicle ahead too closely.

#### **Report Card Data**

Cumulative Data is saved for all trips until the Report Card is reset or until the maximum count is exceeded. If the maximum count is exceeded for a Report Card line item, that item will no longer be updated in the Report Card until it is reset. Each item will report a maximum of 1,000 counts. The distance driven will report a maximum of 64,374 km (40,000 mi).

To delete Report Card data, do one of the following:

- From the Report Card display, touch Reset.

- Touch Clear PIN and All Teen Driver Keys from the Teen Driver menu. This will also unregister any Teen Driver keys and delete the PIN.

#### **Forgotten PIN**

See your dealer to reset the PIN.

## **Trademarks and License Agreements**

#### **FCC Information**

See *Radio Frequency Statement* ⇨ 312.



"Made for iPhone," means that an electronic accessory has been designed to connect specifically to iPhone, and has been certified by the developer to meet Apple performance standards. Apple is not responsible for the operation of this device or its compliance with safety and regulatory standards. Please note that the use of this accessory with iPhone may affect wireless

performance. iPhone are trademarks of Apple Inc., registered in the U.S. and other countries.



Trial length and service availability may vary by model, model year or trim. Service will automatically stop at the end of your trial subscription period unless you decide to continue service. If you do not wish to enjoy your trial, you can cancel by calling the number below. All SiriusXM services require a subscription, each sold separately by SiriusXM after the trial period. Service subject to the applicable SiriusXM Customer Agreement and Privacy Policy, visit [www.siriusxm.com](http://www.siriusxm.com) (USA) or [www.siriusxm.ca](http://www.siriusxm.ca) (Canada) to see complete terms and how to cancel which includes calling 1-866-635-2349 (USA) or 1-888-539-7474 (Canada). Some services and features are subject to device capabilities and location availability. Content varies by SiriusXM subscription package. All fees, content and features are subject to change.

SiriusXM with 360L: Some features, including steaming content and listening recommendations, require an active OnStar Connected Access plan and may vary by vehicle model. Content varies by SiriusXM subscription plan. GM connected vehicle services vary by vehicle model and require active service plan, working electrical system, cell reception and GPS signal. See [onstar.com](http://onstar.com) for details and limitations.

SiriusXM, Pandora, Stitcher and all related logos are trademarks of Sirius XM Radio Inc. and its respective subsidiaries.

SiriusXM satellite service is only available in the 48 contiguous United States (and Puerto Rico with limited availability) and Canada.

In Canada: Some deterioration of service may occur in extreme northern latitudes. This is beyond the control of SiriusXM.

Explicit Language Notice: Channels with frequent explicit language are indicated with an "XL" preceding the channel name. Family-friendly packages are available by contacting SiriusXM:

- USA Customers — See [www.siriusxm.com](http://www.siriusxm.com) or call 1-888-601-6296.
- Canada Customers — See [www.siriusxm.ca](http://www.siriusxm.ca) or call 1-877-438-9677.

It is prohibited to copy, decompile, disassemble, reverse engineer, hack, manipulate, or otherwise make available any technology or software incorporated in receivers compatible with the SiriusXM Satellite Radio System or that support the SiriusXM website, the Online Service or any of its content.

General Requirements:

1. A License Agreement from SiriusXM is required for any product that incorporates SiriusXM Technology and/or for use of any of the SiriusXM marks to be manufactured, distributed, or marketed in the SiriusXM Service Area.
2. For products to be distributed, marketed, and/or sold in Canada, a separate agreement is required with Sirius XM Canada Inc.



TouchSense Technology and TouchSense System 1000 Series Licensed from Immersion Corporation. TouchSense System 1000 protected under one or more of the U.S. Patents at the following address [www.immersion.com/patent-marking.html](http://www.immersion.com/patent-marking.html) and other patents pending.

### **Bluetooth**

The Bluetooth word mark and logos are owned by the Bluetooth SIG, Inc. and any use of such marks by General Motors is under license. Other trademarks and trade names are those of their respective owners.

### **Java**

Java is a registered trademark of Oracle and/or its affiliates.

### **MPEG4–AVC (H.264)**

THIS PRODUCT IS LICENSED UNDER THE AVC PATENT PORTFOLIO LICENSE FOR THE PERSONAL AND NON-COMMERCIAL USE OF A CONSUMER TO (i) ENCODE VIDEO IN COMPLIANCE WITH THE AVC STANDARD (“AVC VIDEO”) AND/OR (ii) DECODE AVC VIDEO THAT WAS ENCODED BY A CONSUMER ENGAGED IN A PERSONAL AND NON-COMMERCIAL ACTIVITY AND/OR WAS OBTAINED FROM A VIDEO PROVIDER LICENSED TO PROVIDE AVC VIDEO. NO

LICENSE IS GRANTED OR SHALL BE IMPLIED FOR ANY OTHER USE. ADDITIONAL INFORMATION MAY BE OBTAINED FROM MPEG LA, LLC. SEE [HTTPS://WWW.MPEGLA.COM](https://www.mpegla.com).

### **MPEG4–Visual**

USE OF THIS PRODUCT IN ANY MANNER THAT COMPLIES WITH THE MPEG-4 VISUAL STANDARD IS PROHIBITED, EXCEPT FOR USE BY A CONSUMER ENGAGING IN PERSONAL AND NON-COMMERCIAL ACTIVITIES.

### **MP3**

MPEG Layer-3 audio coding technology licensed from Fraunhofer IIS and Thomson.

### **WMV/WMA**

This product includes technology owned by Microsoft Corporation and under a license from Microsoft Licensing, GP. Use or distribution of such technology outside of this product is prohibited without a license from Microsoft Corporation and/or Microsoft Licensing, GP as applicable.

## Climate Controls

### Climate Control Systems

Dual Automatic Climate Control System ..... 151

### Air Vents

Air Vents ..... 154

### Maintenance

Passenger Compartment Air Filter ..... 155  
Service ..... 156

## Climate Control Systems

### Dual Automatic Climate Control System

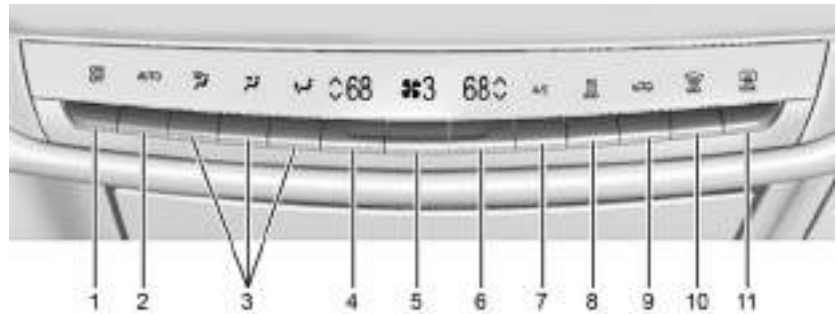

- |                               |                          |
|-------------------------------|--------------------------|
| 1. ON/OFF                     | 7. Air Conditioning      |
| 2. AUTO (Automatic Operation) | 8. HEAT                  |
| 3. Air Distribution           | 9. Recirculation         |
| 4. Driver Temperature         | 10. Max Defrost          |
| 5. Fan Control                | 11. Rear Window Defogger |
| 6. Passenger Temperature      |                          |



## Climate Control Display

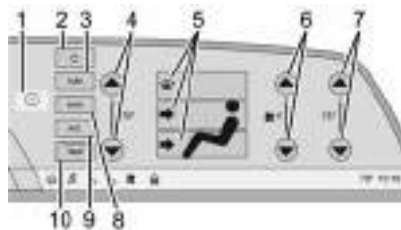

The fan, air delivery mode, air conditioning, temperature, and Sync settings can be controlled by touching CLIMATE on the infotainment Home Page or the climate button in the climate control display application tray.

1. Personalization Settings
2. On/Off (Power)
3. AUTO (Automatic Operation)
4. Driver Temperature
5. Air Delivery Mode Controls
6. Fan Control
7. Passenger Temperature
8. SYNC (Synchronized Temperature)
9. Air Conditioning
10. Heat

## Automatic Operation

The system automatically controls the fan speed, air delivery, and recirculation to heat or cool the vehicle to the desired temperature.

When AUTO is underlined, the system is in full automatic operation. Either AC or HEAT will be underlined to indicate the system is automatically cooling or heating. Turning off the indicated button turns off that function resulting in fan operation only. If the air delivery mode or fan setting is manually adjusted, the auto indicator turns off and the display shows the selected settings. Auto operation can be turned off individually for climate settings.

For automatic operation:

1. Press AUTO.
2. Set the temperature. Allow the system time to stabilize. Then adjust the temperature as needed for best comfort.

To improve efficiency and to warm or cool the vehicle faster, recirculation is automatically selected. The recirculation light will not come on. Press  to select recirculation; press it again to select outside air.

English units can be changed to metric units through the instrument cluster. Select Settings > Time, Date, and Unit > US or Metric.

**OFF** : Press OFF to turn the fan on or off. When OFF is selected, the system stops air from flowing into the cabin. If ON is selected or any other buttons are pressed, the climate control system will turn on and operate at the current setting.

$\wedge / \vee$  : The temperature can be adjusted separately for the driver and the passenger. Press to decrease or lift to increase the temperature. Press or lift and hold to rapidly increase or decrease the temperature. Press SYNC on the Climate Display to reset the Passenger Temperature to the Driver Temperature.

## Manual Operation

$\vee$    $\wedge$  : Press to decrease or lift to increase the fan speed. Press or lift and hold the fan controls to adjust speed more quickly. The fan speed setting displays. Any adjustment of the fan speed cancels automatic fan control and the fan can be controlled manually. Press AUTO to return to automatic operation.

To turn off the fan and climate control system, press OFF on the center stack climate controls. The airflow will be blocked from entering in all air delivery modes, except defrost.

The maximum automatic fan speed can be set to low, medium, or high. To adjust Auto Fan Speed, select Settings > Climate and Air Quality > Auto Fan Speed.

**Air Delivery Mode Control** : When the climate information is displayed, press the desired air delivery mode on the climate control display to change the direction of the airflow. The selected air delivery mode button is lit. Pressing any of the air delivery buttons cancels automatic air delivery control and the direction of the airflow can be controlled manually. Press AUTO to return to automatic operation.



To change the current mode, select one or more of the following:

 : Air is directed to the windshield, outboard a/c outlets, and side window outlets.

 : Air is directed to the instrument panel outlets.

 : Air is directed to the floor outlets.

 **HEAT** : Touch to turn the automatic heater on or off. An indicator light comes on to show that the heater is enabled. If the fan is turned off, the heater will not run. Press AUTO to return to automatic operation.

 **MAX** : Clears the windshield of fog or frost more quickly. Air is directed to the windshield. Press  **MAX** to turn on or off. Changing the air delivery mode also turns the defrost off.

**A/C** : Touch AC to turn the automatic air conditioning on or off. If the fan is turned off, the air conditioner will not run.

Press AUTO to return to automatic operation and the air conditioner runs as needed.

 : Press to alternate between recirculating air inside the vehicle or pulling in outside air. The indicator light on the button is lit when recirculation mode is active. This helps to quickly cool the air inside the vehicle and reduce the entry of outside air and odors.

Pressing this button cancels automatic recirculation. Press AUTO to return to automatic operation; recirculation runs automatically as needed.

Manual recirculation mode is not available when in Defrost.

The climate control system uses a sensor to automatically detect high humidity inside the vehicle. When high humidity is detected, the climate control system may adjust to outside air supply, turn on the heater and air conditioner, increase fan and temperature, and direct more air to the windshield. When the climate control system does not detect possible window fogging, it returns to normal operation. To turn Auto Defog off or on, select Settings > Climate and Air Quality > Auto Defog > Select ON or OFF. If Auto Defog is turned off, or fogging does not clear quickly enough, select  **MAX** to more quickly clear the windshield.

### Rear Window Defogger

 **REAR** : Press to turn the rear window defogger on or off. An indicator light on the button comes on to show that the rear window defogger is on.

The rear window defogger only works when the vehicle is on. If the outside temperature is below 7°C (45°F), and the rear window

defogger is on, the area of the windshield beneath the windshield wipers will warm up to melt accumulated snow or ice.

The rear window defogger can be set to automatic operation. When Auto Rear Defog is selected, the rear window defogger turns on automatically when the vehicle is first started in cold weather and turns off when the vehicle is warmed. To turn Auto Rear Defog off or on, select Settings > Climate and Air Quality > Auto Rear Defog > Select ON or OFF.

The heated outside rearview mirrors turn on when the rear window defogger button is on and help to clear fog or frost from the surface of the mirrors.

### Caution

Do not try to clear frost or other material from the inside of the front windshield and rear window with a razor blade or anything else that is sharp. This may damage the rear window defogger grid and affect the radio's ability to pick up stations clearly. The repairs would not be covered by the vehicle warranty.

### Sensor



The solar sensor, on top of the instrument panel near the windshield, monitors the solar heat.

The climate control system uses the sensor information to adjust the temperature, fan speed, recirculation, and air delivery mode for best comfort.

If the sensor is covered, the automatic climate control system may not work properly.

#### Remote Start Climate Control Operation :

The climate control system may run when the vehicle is started remotely. The system uses the driver's previous settings to heat or cool the inside of the vehicle. The rear defog

may come on during remote start based on cold ambient conditions. The rear defog indicator light does not come on during a remote start. If equipped with heated or cooled seats, they may come on during a remote start. See *Remote Start* ⇨ 12 and *Heated and Ventilated Front Seats* ⇨ 38.

#### Afterblow Feature

If equipped, under certain conditions, the fan may stay on or may turn on and off several times after you turn off and lock the vehicle. This is normal.

### Air Vents

Use the multi-function joystick control on the front center and side air vents to change the direction of the airflow.

Air vents blow warm air on the side windows in cold weather. If floor, defog, or defrost modes are selected, a small amount of air will come from the vents close to the window.

To fully open the front A/C vents, turn the multi-function joystick control knob until the indicator points straight up.

To close the front A/C vents, turn the multi-function joystick control until the indicator points to the nine o'clock position.

To close the rear A/C vents, move the sliding knobs to the full inboard position.

### Operation Tips

- Clear away any ice, snow, or leaves from air inlets at the base of the windshield that could block the flow of air into the vehicle.
- Clear snow off the hood to improve visibility and help decrease moisture drawn into the vehicle.
- Keep the path under the front seats clear of objects to help circulate the air inside of the vehicle more effectively.
- Use of non-GM approved hood deflectors can adversely affect the performance of the system. Check with your dealer before adding equipment to the outside of the vehicle.
- Do not attach any devices to the air vent slats. This will restrict airflow and may cause damage to the air vents.

## Maintenance

### Passenger Compartment Air Filter

The filter reduces the dust, pollen, and other airborne irritants from outside air that is pulled into the vehicle.

The filter should be replaced as part of routine scheduled maintenance. To find out what type of filter to use, see *Maintenance Replacement Parts* ⇨ 300.



1. Open the glove box door completely.



2. Press the sides of the glove box bin inward to clear the stoppers and turn downward to lower the bin.



3. Unhook the string dampener to fully remove the glove box bin.

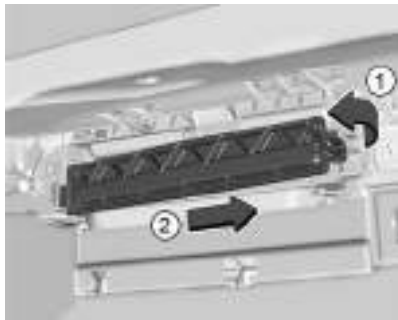

4. Release the clip (1) on the right side of the filter door and slide right (2), then remove the door. Remove the old filter.
5. Install the new air filter.
6. Reinstall the filter door.
7. Reverse the steps to reinstall the glove box.

See your dealer if additional assistance is needed.

## Service

All vehicles have a label underhood that identifies the refrigerant used in the vehicle. The refrigerant system should only be serviced by trained and certified technicians. The air conditioning evaporator should never be repaired or replaced by one from a salvage vehicle. It should only be replaced by a new evaporator to ensure proper and safe operation.

During service, all refrigerants should be reclaimed with proper equipment. Venting refrigerants directly to the atmosphere is harmful to the environment and may also create unsafe conditions based on inhalation, combustion, frostbite, or other health-based concerns.

The air conditioning system requires periodic maintenance. See *Maintenance Schedule* ⇨ 298.

## Driving and Operating

### Driving Information

Driving for Better Energy Efficiency	158
Distracted Driving	159
Defensive Driving	160
Impaired Driving	160
Control of a Vehicle	160
Braking	160
Steering	161
Off-Road Recovery	161
Loss of Control	162
Driving on Wet Roads	162
Hill and Mountain Roads	163
Winter Driving	163
If the Vehicle Is Stuck	164
Vehicle Load Limits	165

### Starting and Operating

New Vehicle Break-In	168
Power Button	168
Starting and Stopping the Vehicle	169
Retained Accessory Power (RAP)	170
Shifting Into Park	170
Shifting out of Park	170
Extended Parking	171

### Electric Drive Unit

Electric Drive Unit	171
One-Pedal Driving	174

### Drive Systems

All-Wheel Drive	175
-----------------	-----

### Brakes

Electric Brake Boost	175
Antilock Brake System (ABS)	175
Electric Parking Brake	175
Brake Assist	177
Hill Start Assist (HSA)	177
Automatic Vehicle Hold (AVH)	177
Regenerative Braking	178

### Ride Control Systems

Traction Control/Electronic Stability Control	179
Driver Mode Control	180

### Cruise Control

Adaptive Cruise Control (Advanced)	181
Super Cruise	190

### Driver Assistance Systems

Driver Assistance Systems	205
Assistance Systems for Parking or Backing	206

Rear Vision Camera (RVC)	206
Surround Vision System	207
Park Assist	209
Automatic Parking Assist (APA)	210
Reverse Automatic Braking (RAB)	213
Rear Pedestrian Alert	214
Rear Cross Traffic Alert (RCTA) System	216
Assistance Systems for Driving	216
Forward Collision Alert (FCA) System	216
Automatic Emergency Braking (AEB)	218
Front Pedestrian Braking (FPB) System	220
Side Blind Zone Alert (SBZA)	221
Lane Change Alert (LCA)	222
Blind Zone Steering Assist (BZSA)	224
Lane Keep Assist (LKA)	224
Surround Vision Recorder	226

### Charging

When to Charge	228
Plug-In Charging	228
Delayed Charging Override	232
Charging Status Feedback	233
Charge Cord	234
Utility Interruption of Charging	237
Electrical Requirements for Battery Charging	237

**Trailer Towing**

General Towing Information .....	237
Driving Characteristics and Towing Tips .....	237
Trailer Towing .....	240
Towing Equipment .....	243
Trailer Sway Control (TSC) .....	244

**Conversions and Add-Ons**

Add-On Electrical Equipment .....	245
-----------------------------------	-----

**Driving Information****Driving for Better Energy Efficiency**

Use the tips in the categories below to help maximize energy efficiency and range.

In colder temperatures, while these efficiency tips will help, the electric vehicle driving range will be lower due to higher energy usage including energy spent heating the cabin.

The Energy Usage card available on the Driver Information Center (DIC) estimates the influence of the main factors impacting vehicle range. It displays how energy is being used for the current drive since the last time the vehicle was started. See *Driver Information Center (DIC)* ⇨ 108 and *Vehicle Information* ⇨ 109.

**Acceleration/Braking/Coasting**

Avoid rapid accelerations and decelerations.

Use cruise control when appropriate.

Plan ahead for decelerations, and coast whenever possible. Do not rush to traffic signals, and do not shift to N (Neutral) to coast.

Use the One-Pedal Driving feature when appropriate to help recover energy during coasting and braking. One-Pedal mode recovers more energy while coasting and braking than D (Drive) mode. See *One-Pedal Driving* ⇨ 174.

Use the steering wheel Regen on Demand paddle during deceleration to help recover energy. See *Regenerative Braking* ⇨ 178.

**Terrain and Vehicle Speed**

Higher speeds and grade changes use more energy and can significantly reduce electric range.

**Climate Setting**

Using the heat and air conditioning systems decreases the energy available for electric driving. Optimal energy efficiency is achieved when the heat, air conditioning, and fan are turned off.

Use the heated and ventilated seat features (if equipped) instead of the climate control system. Heating and ventilating the seat uses less energy than heating and cooling the interior. See *Heated and Ventilating Front Seats* ⇨ 38 and *Heated Rear Seats* ⇨ 42.

Use the Remote Start Climate Control feature to heat or cool the interior while the vehicle is plugged in to use electricity from the electrical outlet instead of using energy from the battery. See *Remote Start* ⇨ 12.

In hot weather, avoid parking in direct sunlight. Use sunshades inside the vehicle.

Keep the inside of the windows clean to reduce fogging. Turn off the front defroster and rear defogger when they are not needed.

Avoid driving with the windows open at highway speeds.

Use the Battery Gauge on the Instrument Cluster to view the effect of climate control settings on your estimated range. See *Battery Gauge (High Voltage)* ⇨ 90.

### Outside Temperature

On colder days, it is best to plug in the vehicle overnight, and then remote start the vehicle.

Allow the vehicle to warm up for 20 minutes before driving.

## Vehicle Charging/Maintenance

### Charging

Keep the vehicle plugged in, even when fully charged, to keep the battery temperature ready for the next drive. This is important when outside temperatures are extremely hot or cold.

If possible, use a level 2 (240 volt) high power charge station for best results. This allows the interior of the vehicle and high voltage battery to warm to optimal temperature.

### Maintenance

Always keep the tires properly inflated and the vehicle properly aligned.

The weight of excess cargo in the vehicle affects efficiency and range. Avoid carrying more than is needed.

Avoid unnecessary use of electrical accessories. Power used for functions other than propelling the vehicle will reduce the available range.

Using a rooftop carrier will reduce efficiency due to additional weight and drag.

## Distracted Driving

Distraction comes in many forms and can take your focus from the task of driving. Exercise good judgment and do not let other activities divert your attention away from the road. Many local governments have enacted laws regarding driver distraction. Become familiar with the local laws in your area.

To avoid distracted driving, keep your eyes on the road, keep your hands on the steering wheel, and focus your attention on driving.

- Do not use a mobile phone in demanding driving situations. Use a hands-free method to place or receive necessary phone calls.
- Watch the road. Do not read, take notes, or look up information on mobile phones or other electronic devices.
- Designate a front seat passenger to handle potential distractions.
- Become familiar with vehicle features before driving, such as programming favorite radio stations and adjusting climate control and seat settings. Program all trip information into any navigation device prior to driving.



- Wait until the vehicle is parked to retrieve items that have fallen to the floor.
- Stop or park the vehicle to tend to children.
- Keep pets in an appropriate carrier or restraint.
- Avoid stressful conversations while driving, whether with a passenger or on a mobile phone.

 **Warning**

Taking your eyes off the road too long or too often could cause a crash resulting in injury or death. Focus your attention on driving.

Refer to the Infotainment section for more information on using that system, including pairing and using a mobile phone.

### Defensive Driving

Defensive driving means “always expect the unexpected.” The first step in driving defensively is to wear the seat belt. See *Seat Belts* ⇨ 42.

- Assume that other road users (pedestrians, bicyclists, and other drivers) are going to be careless and make mistakes. Anticipate what they may do and be ready.
- Allow enough following distance between you and the driver in front of you.
- Focus on the task of driving.

### Impaired Driving

Death and injury associated with impaired driving is a global tragedy.

 **Warning**

Drinking alcohol or taking drugs and then driving is very dangerous. Your reflexes, perceptions, attentiveness, and judgment can be affected by even a small amount of alcohol or drugs. You can have a serious — or even fatal — collision if you drive after drinking or taking drugs.

Do not drive while under the influence of alcohol or drugs, or ride with a driver who has been drinking or is impaired by drugs. Find alternate transportation home; or if you are with a group, designate a driver who will remain sober.

### Control of a Vehicle

Braking, steering, and accelerating are important factors in helping to control a vehicle while driving.

### Braking

Braking action involves perception time and reaction time. Deciding to push the brake pedal is perception time. Actually doing it is reaction time.

Average driver reaction time is about three-quarters of a second. In that time, a vehicle moving at 100 km/h (60 mph) travels 20 m (66 ft), which could be a lot of distance in an emergency.

Helpful braking tips to keep in mind include:

- Keep enough distance between you and the vehicle in front of you.
- Avoid needless heavy braking.
- Keep pace with traffic.

## Steering

### Caution

To avoid damage to the steering system, do not drive over curbs, parking barriers, or similar objects at speeds greater than 3 km/h (1 mph). Use care when driving over other objects such as lane dividers and speed bumps. Damage caused by misuse of the vehicle is not covered by the vehicle warranty.



## Electric Power Steering

The vehicle is equipped with an electric power steering system, which reduces the amount of effort needed to steer the vehicle. It does not have power steering fluid. Regular maintenance is not required.

If the vehicle experiences a system malfunction and loses power steering, greater steering effort may be required. Power steering assist also may be reduced if you turn the steering wheel as far as it can turn and hold it there with force for an extended period of time.

See your dealer if there is a problem.

### Curve Tips

- Take curves at a reasonable speed.
- Reduce speed before entering a curve.
- Maintain a reasonable steady speed through the curve.
- Wait until the vehicle is out of the curve before accelerating gently into the straightaway.

### Steering in Emergencies

- There are some situations when steering around a problem may be more effective than braking.

- Holding both sides of the steering wheel allows you to turn 180 degrees without removing a hand.
- The Antilock Brake System (ABS) allows steering while braking.

## Off-Road Recovery



The vehicle's right wheels can drop off the edge of a road onto the shoulder while driving. Follow these tips:

1. Ease off the accelerator and then, if there is nothing in the way, steer the vehicle so that it straddles the edge of the pavement.

2. Turn the steering wheel about one-eighth of a turn, until the right front tire contacts the pavement edge.
3. Turn the steering wheel to go straight down the roadway.

## Loss of Control

### Skidding

There are three types of skids that correspond to the vehicle's three control systems:

- Braking Skid — wheels are not rolling.
- Steering or Cornering Skid — too much speed or steering in a curve causes tires to slip and lose cornering force.
- Acceleration Skid — too much throttle causes the driving wheels to spin.

Defensive drivers avoid most skids by taking reasonable care suited to existing conditions, and by not overdriving those conditions. But skids are always possible.

If the vehicle starts to slide, follow these suggestions:

- Ease your foot off the accelerator pedal and steer the way you want the vehicle to go. The vehicle may straighten out. Be ready for a second skid if it occurs.

- Slow down and adjust your driving according to weather conditions. Stopping distance can be longer and vehicle control can be affected when traction is reduced by water, snow, ice, gravel, or other material on the road. Learn to recognize warning clues — such as enough water, ice, or packed snow on the road to make a mirrored surface — and slow down when you have any doubt.
- Try to avoid sudden steering, acceleration, or braking, including reducing vehicle speed by shifting to a lower gear. Any sudden changes could cause the tires to slide.

Remember: Antilock brakes help avoid only the braking skid.

### Driving on Wet Roads

Rain and wet roads can reduce vehicle traction and affect your ability to stop and accelerate. Always drive slower in these types of driving conditions and avoid driving through large puddles and deep-standing or flowing water.

### Warning

Wet brakes can cause crashes. They might not work as well in a quick stop and could cause pulling to one side. You could lose control of the vehicle.

After driving through a large puddle of water or a car/vehicle wash, lightly apply the brake pedal until the brakes work normally.

Flowing or rushing water creates strong forces. Driving through flowing water could cause the vehicle to be carried away. If this happens, you and other vehicle occupants could drown. Do not ignore police warnings and be very cautious about trying to drive through flowing water.

### Hydroplaning

Hydroplaning is dangerous. Water can build up under the vehicle's tires so they actually ride on the water. This can happen if the road is wet enough and you are going fast enough. When the vehicle is hydroplaning, it has little or no contact with the road.

There is no hard and fast rule about hydroplaning. The best advice is to slow down when the road is wet.

### Other Rainy Weather Tips

Besides slowing down, other wet weather driving tips include:

- Allow extra following distance.
- Pass with caution.
- Keep windshield wiping equipment in good shape.
- Keep the windshield washer fluid reservoir filled.
- Have good tires with proper tread depth. See *Tires* ⇨ 269.
- Turn off cruise control.

### Hill and Mountain Roads

#### Warning

Do not charge your vehicle's battery above an 80% charge if you are going to drive down long, steep grades such as mountain passes. This provides room in the battery for regenerative braking to supplement your conventional brakes during the descent. This is especially

(Continued)

#### Warning (Continued)

important when towing a trailer, which puts additional stress on your vehicle's braking system.

If the battery becomes full, regenerative braking will be limited or unavailable. The brakes will have to do all the work of slowing down the vehicle and could become too hot. Hot brakes may not be able to slow the vehicle enough to maintain speed and control. To help avoid the risk of a crash, limit the battery's charge and, if you experience brake fade or receive a brake warning, stop the vehicle and allow the brakes to cool.

See "Charge Now" under *Charging* ⇨ 101 for information on setting charge limits.

Driving on steep hills or through mountains is different than driving on flat or rolling terrain. Be sure to:

- Use regenerative braking to help slow the vehicle or maintain speed by keeping the vehicle in gear and limiting the initial battery charge to 80% or less. See *Regenerative Braking* ⇨ 178.

- When braking is necessary, use frequent, light taps of the brake pedal. This maximizes regenerative braking and minimizes the load on the vehicle brake system.
- Keep the vehicle serviced and in good shape.
- Check all fluid levels, brakes, tires, and cooling system.
- Drive at speeds that keep the vehicle in its own lane. Do not swing wide or cross the center line.
- Be alert on top of hills; something could be in your lane (e.g., stalled car, crash).
- Pay attention to special road signs (e.g., falling rocks area, winding roads, long grades, passing or no-passing zones) and take appropriate action.

### Winter Driving

#### Driving on Snow or Ice

#### Caution

To avoid damage to the wheels and brake components, always clear snow and ice from inside the wheels and underneath the vehicle before driving.

Snow or ice between the tires and the road creates less traction or grip, so drive carefully. Wet ice can occur at about 0°C (32°F) when freezing rain begins to fall. Avoid driving on wet ice or in freezing rain until roads can be treated.

#### For Slippery Road Driving:

- Turn off cruise control.
- If enabled, turn off One-Pedal Driving. See *One-Pedal Driving* ⇨ 174.
- If turned off, turn on the Traction Control and the Electronic Stability Control systems. See *Traction Control/Electronic Stability Control* ⇨ 179.
- Select the Snow/Ice driver mode. See *Driver Mode Control* ⇨ 180.
- Accelerate gently. Accelerating too quickly causes the wheels to spin and makes the surface under the tires slick.
- Allow greater following distance and watch for slippery spots. Icy patches can occur on otherwise clear roads in shaded areas. The surface of a curve or an overpass can remain icy when the surrounding roads are clear. Avoid sudden steering maneuvers and braking while on ice.

- Antilock Brake System (ABS) improves vehicle stability during hard stops, but the brakes should be applied sooner than when on dry pavement. See *Antilock Brake System (ABS)* ⇨ 175.

#### Blizzard Conditions

If you become stranded or cannot continue driving due to winter storm conditions, stop the vehicle in a safe place and signal for help. Stay with the vehicle unless there is help nearby.

If you stay in your vehicle while waiting, signal for help and keep everyone in the vehicle safe by turning on the hazard warning flashers and tying a red cloth to an outside mirror.

To conserve battery energy while waiting for help, run the vehicle for only short periods as needed to warm the vehicle and then shut the vehicle off and partially close the window. Moving about to keep warm also helps. For additional tips to help conserve battery energy in cold weather, see *Driving for Better Energy Efficiency* ⇨ 158.

#### If the Vehicle Is Stuck

Slowly and cautiously spin the wheels to free the vehicle when stuck in sand, mud, ice, or snow. See "Rocking the Vehicle to Get It Out" later in this section.

The Traction Control System (TCS) can often help to free a stuck vehicle. See *Traction Control/Electronic Stability Control* ⇨ 179. If stuck too severely for the TCS to free the vehicle, turn off the TCS and use the rocking method. See "Rocking the Vehicle to Get It Out" later in this section.

#### Warning

If the vehicle's tires spin at high speed, they can explode, and you or others could be injured. Spin the wheels as little as possible and avoid going above 56 km/h (35 mph).

#### Rocking the Vehicle to Get it Out

Turn the steering wheel left and right to clear the area around the front wheels. Turn off the TCS. Shift back and forth between R (Reverse) and a forward gear, spinning the wheels as little as possible. To prevent electric drive unit wear, wait until the wheels stop spinning before shifting gears.

Slowly spinning the wheels in the forward and reverse directions causes a rocking motion that could free the vehicle. If that does not get the vehicle out after a few tries, it might need to be towed out. See *Transporting a Disabled Vehicle* ⇨ 287.

## Vehicle Load Limits

It is very important to know how much weight the vehicle can carry. This weight is called the vehicle capacity weight and includes the weight of all occupants, cargo, and all nonfactory-installed options. Two labels on the vehicle may show how much weight it may properly carry, the Tire and Loading Information label and the Certification/Tire label.

### Warning

Do not load the vehicle any heavier than the Gross Vehicle Weight Rating (GVWR), or either the maximum front or rear Gross Axle Weight Rating (GAWR). This can cause systems to break and change the

(Continued)

### Warning (Continued)

way the vehicle handles. This could cause loss of control and a crash. Overloading can also reduce stopping performance, damage the tires, and shorten the life of the vehicle.

### Tire and Loading Information Label

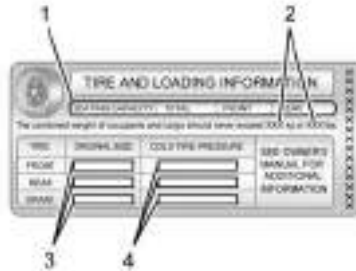

### Example Label

A vehicle-specific Tire and Loading Information label is attached to the center pillar (B-pillar). The tire and loading information label shows the number of occupant seating

positions (1), and the maximum vehicle capacity weight (2) in kilograms and pounds.

The Tire and Loading Information label also shows the size of the original equipment tires (3) and the recommended cold tire inflation pressures (4). For more information on tires and inflation see *Tires* ⇨ 269 and *Tire Pressure* ⇨ 274.

There is also important loading information on the vehicle Certification/Tire label. It may show the Gross Vehicle Weight Rating (GVWR) and the Gross Axle Weight Rating (GAWR) for the front and rear axle. See "Certification/Tire Label" later in this section.

### "Steps for Determining Correct Load Limit—

1. Locate the statement "The combined weight of occupants and cargo should never exceed XXX kg or XXX lbs." on your vehicle's placard.
2. Determine the combined weight of the driver and passengers that will be riding in your vehicle.

3. Subtract the combined weight of the driver and passengers from XXX kg or XXX lbs.
4. The resulting figure equals the available amount of cargo and luggage load capacity. For example, if the "XXX" amount equals 1400 lbs. and there will be five 150 lb passengers in your vehicle, the amount of available cargo and luggage load capacity is 650 lbs. (1400-750 (5 x 150) = 650 lbs.)
5. Determine the combined weight of luggage and cargo being loaded on the vehicle. That weight may not safely exceed the available cargo and luggage load capacity calculated in Step 4.
6. If your vehicle will be towing a trailer, load from your trailer will be transferred to your vehicle. Consult this manual to determine how this reduces the available cargo and luggage load capacity of your vehicle."

See *Trailer Towing* ⇨ 240 for important information on towing a trailer, towing safety rules and trailering tips.

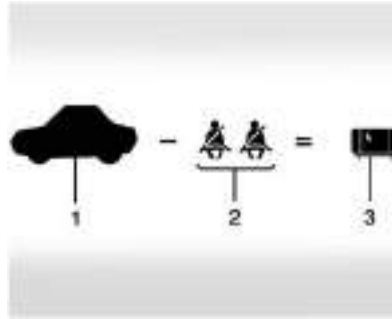

Example 1

1. Vehicle Capacity Weight for Example 1 = 453 kg (1,000 lbs).
2. Subtract Occupant Weight @ 68 kg (150 lbs) × 2 = 136 kg (300 lbs).
3. Available Occupant and Cargo Weight = 317 kg (700 lbs).

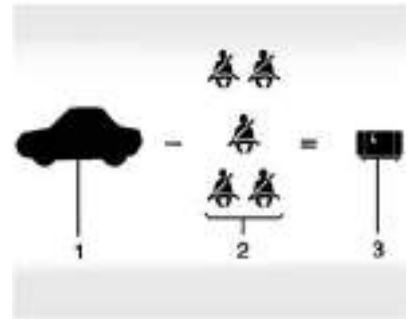

Example 2

1. Vehicle Capacity Weight for Example 2 = 453 kg (1,000 lbs).
2. Subtract Occupant Weight @ 68 kg (150 lbs) × 5 = 340 kg (750 lbs).
3. Available Cargo Weight = 113 kg (250 lbs).

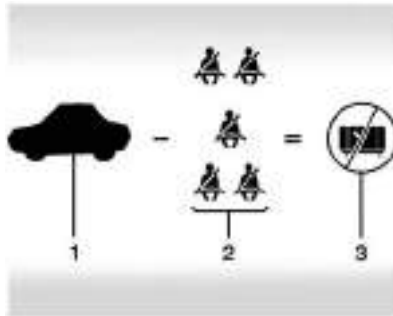

Example 3

1. Vehicle Capacity Weight for Example 3 = 453 kg (1,000 lbs).
2. Subtract Occupant Weight @ 91 kg (200 lbs)  $\times$  5 = 453 kg (1,000 lbs).
3. Available Cargo Weight = 0 kg (0 lbs).

Refer to the vehicle's tire and loading information label for specific information about the vehicle's capacity weight and seating positions. The combined weight of the driver, passengers, and cargo should never exceed the vehicle's capacity weight.

### Certification/Tire Label

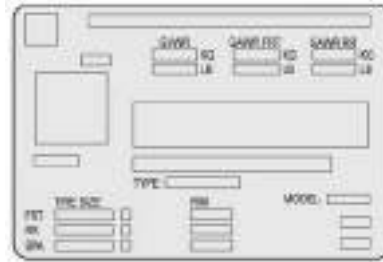

### Label Example

A vehicle-specific Certification/Tire label is attached to the center pillar (B-pillar).

The label may show the size of the vehicle's original tires and the inflation pressures needed to obtain the gross weight capacity of the vehicle. The label shows the gross weight capacity of the vehicle. This is called the Gross Vehicle Weight Rating (GVWR). The GVWR includes the weight of the vehicle, all occupants, and cargo.

The Certification/Tire label may also show the maximum weights for the front and rear axles, called the Gross Axle Weight Rating (GAWR). To find out the actual loads on the front and rear axles, weigh the vehicle at a weigh station. Your dealer can help with this. Be sure to spread the load equally on both sides of the centerline.

### Caution

Overloading the vehicle may cause damage. Repairs would not be covered by the vehicle warranty. Do not overload the vehicle.

### Warning

Things inside the vehicle can strike and injure people in a sudden stop or turn, or in a crash.

- Put things in the cargo area of the vehicle. In the cargo area, put them as far forward as possible. Try to spread the weight evenly.

(Continued)



**Warning (Continued)**

- Never stack heavier things, like suitcases, inside the vehicle so that some of them are above the tops of the seats.
- Do not leave an unsecured child restraint in the vehicle.
- Secure loose items in the vehicle.
- Do not leave a seat folded down unless needed.

**Starting and Operating****New Vehicle Break-In****Caution**

Avoid making hard stops for the first 322 km (200 mi). During this time the new brake linings are not yet broken in. Hard stops with new linings can mean premature wear and earlier replacement. Follow this breaking-in guideline every time you get new brake linings. Following break-in, vehicle speed and load can be gradually increased.



**Power Button**

The vehicle has an electronic pushbutton start.

The Remote Key must be in the vehicle for the system to operate. If the vehicle will not start, place the Remote Key in the transmitter pocket, inside the center console.

**ON/RUN** : This position is for starting and driving. With the vehicle off, and the brake pedal applied, pressing POWER  once will place the vehicle in ON/RUN. When the vehicle ready light is on in the instrument cluster, the vehicle is ready to be driven. This could take up to 15 seconds at extremely cold temperatures.

**Service Mode**

This power mode is available for service and diagnostics, and to verify the proper operation of the service vehicle soon light as may be required for inspection or maintenance purposes. With the vehicle off, and the brake pedal not applied, pressing and holding POWER  for more than five seconds will place the vehicle in Service Mode. The instruments and audio systems will operate as they do in ON/RUN, but the vehicle will not be able to be driven. The propulsion system will not start in Service Mode. Press POWER  again to turn the vehicle off.

**Caution**

Placing the vehicle in Service Mode will use the 12-volt battery. Do not use Service Mode for an extended period, or the vehicle may not start.

**STOPPING THE VEHICLE/OFF** : To turn the vehicle off, apply the brakes, press the button on top of the shift lever to shift to P (Park) and press POWER .

Alternatively, apply the brakes and press POWER . The electric drive unit will shift to P (Park) then shut off automatically.

Retained Accessory Power (RAP) will remain active until the driver door is opened.

If the vehicle must be shut off in an emergency:

1. Brake using a firm and steady pressure. Do not pump the brakes repeatedly. This may deplete power assist, requiring increased brake pedal force.
2. Shift the vehicle to N (Neutral). This can be done while the vehicle is moving. After shifting to N (Neutral), firmly apply the brakes and steer the vehicle to a safe location.
3. Come to a complete stop, shift to P (Park), and turn the vehicle off by pressing POWER .
4. Set the parking brake.

### Warning

Turning off the vehicle while moving may disable the airbags. While driving, only shut the propulsion system off in an emergency.

If the vehicle cannot be pulled over, and must be shut off while driving, press and hold POWER  for longer than two seconds, or press twice in five seconds.

## Starting and Stopping the Vehicle

### Starting Procedure

Press the P (Park) button on the shift lever, or move the shift lever into N (Neutral). The propulsion system will not start in any other position.

#### Caution

Do not try to shift to P (Park) if the vehicle is moving or the electric drive unit could be damaged. Shift to P (Park) only when the vehicle is stopped.

#### Caution

If you add electrical parts or accessories, you could change the way the vehicle operates. Any resulting damage would not be covered by the vehicle warranty.

The Remote Key must be in the vehicle. Press the brake pedal, then press and release POWER .

If the Remote Key is not in the vehicle or something is interfering with the Remote Key, a message displays in the Driver Information Center (DIC).

If the vehicle will not start due to a low Remote Key battery, the vehicle can still be driven. See *Remote Key Operation*  7.



A vehicle ready light displays on the instrument cluster when the vehicle is ready to be driven.

The instrument cluster also displays an active battery gauge when the vehicle is ready to be driven.

### Restarting Procedure

If the vehicle must be restarted while it is still moving, move the shift lever to N (Neutral) and press POWER  twice without pressing the brake pedal. The propulsion system will not restart in any other position.

A chime will sound if the driver door is opened while the vehicle is on. Always press POWER  to turn the vehicle off before exiting.

### Stopping Procedure

For information on how to turn the vehicle off, see *Power Button* ⇨ 168.

### Retained Accessory Power (RAP)

When the vehicle is turned from on to off, the following features (if equipped) will continue to function for up to 10 minutes, or until the driver door is opened.

- Infotainment System
- Power Windows (during RAP this functionality will be lost when any door is opened)
- Sunroof (during RAP this functionality will be lost when any door is opened)
- Auxiliary Power Outlet
- Audio System
- OnStar System

### Shifting Into Park

To shift into P (Park):

1. Hold the brake pedal down and set the parking brake. See *Electric Parking Brake* ⇨ 175.
2. Press the P (Park) switch at the end of the shift lever. See *Electric Drive Unit* ⇨ 171.
3. The P indicator on the shift lever will turn red when the vehicle is in P (Park).
4. Turn the vehicle off.

If the vehicle is shifted into P (Park) on a hill, the Electric Parking Brake (EPB) may apply automatically. The driver may not be able to release the EPB using the EPB switch. It should automatically release when the vehicle is shifted out of P (Park).

### Leaving the Vehicle with the Propulsion System On

#### Warning

It is dangerous to get out of the vehicle if the vehicle is not in P (Park) with the parking brake set. The vehicle can roll.

(Continued)

#### Warning (Continued)

Do not leave the vehicle when the propulsion system is on. If you have left the propulsion system on, the vehicle can move suddenly. You or others could be injured. To be sure the vehicle will not move, even when you are on fairly level ground, always set the parking brake and press the P (Park) button. See *Shifting Into Park* ⇨ 170.

If the vehicle must be left with the propulsion system on, be sure that the vehicle is in P (Park) with the parking brake set, before leaving the vehicle. After pressing the P (Park) button, hold down the regular brake pedal. If you cannot see the P (Park) indicator in the instrument cluster, it means that the vehicle has not shifted to P (Park).

### Shifting out of Park

This vehicle is equipped with an electric drive unit. To shift out of P (Park) the vehicle must be on, the brake pedal applied, and the charge cord unplugged.

Parking the vehicle in extreme cold for several days without the charge cord connected may cause the vehicle not to start. Plug the vehicle in to allow the high voltage battery to be warmed sufficiently.

To shift out of P (Park):

1. Apply the brake pedal.
2. Press POWER  to turn the vehicle on.
3. Verify that the vehicle is unplugged and the vehicle ready light is on.
4. Move the shift lever to the desired position.

After releasing the shift lever, it will return to the center position.

The P indicator will turn white and the gear indicator on the shift lever will turn red when the vehicle is no longer in P (Park).

If the vehicle cannot shift from P (Park), a Driver Information Center (DIC) message may be displayed. Check that the vehicle is on, the vehicle ready light is on, and the brake pedal is applied when you are attempting to shift out of P (Park). If all of these are met but the vehicle will not shift out of P (Park), see your dealer for service.

If equipped, the Buckle to Drive feature may prevent shifting from P (Park). See *Buckle To Drive* ⇨ 43.

## Extended Parking

It is best not to park with the propulsion system on. If the vehicle is left on, be sure it will not move.

See *Shifting Into Park* ⇨ 170.

If the vehicle is left parked and on with the remote key outside the vehicle, it will remain on for up to one hour.

If the vehicle is left parked and on with the remote key inside the vehicle, it will remain on for up to two hours.

The timer will reset if the vehicle is taken out of P (Park) while it is on.

See *Remote Key Operation* ⇨ 7 and *Digital Key* ⇨ 16.

## Electric Drive Unit



The vehicle uses an electric drive unit. The shift pattern is displayed on the front of the shift lever. The selected gear position will illuminate red on the shift lever, while all others will be displayed in white. If the shift is not immediate, as in very cold conditions, the indicator on the shift switch may blink until it is fully engaged.

P :



If the vehicle is on, the vehicle can be shifted into P (Park).

If POWER  $\odot$  is pressed twice while at a relatively high speed, the vehicle will turn off and automatically shift to N (Neutral). Once the vehicle is stopped, P (Park) can be selected.

### Warning

It is dangerous to get out of the vehicle if the P (Park) button is not pressed with the parking brake set. The vehicle can roll.

(Continued)

### Warning (Continued)

Do not leave the vehicle when the propulsion system is running. If you have left the propulsion system running, the vehicle can move suddenly. You or others could be injured. To be sure the vehicle will not move, even when you are on fairly level ground, always set the parking brake and press the P (Park) button.

When the vehicle is stopped, press POWER

$\odot$  to turn off the vehicle. The vehicle will shift to P (Park) automatically unless the vehicle is in N (Neutral), see “Car Wash Mode” later in this section.

The vehicle will not shift into P (Park) if it is moving too fast. Stop the vehicle and shift into P (Park).

To shift in and out of P (Park), see *Shifting Into Park* ⇨ 170 and *Shifting out of Park* ⇨ 170.

R : Use this gear to back up.

If the vehicle is shifted from either R (Reverse) to D (Drive) or D (Drive) to R (Reverse) while the speed is too high, the vehicle may shift to N (Neutral). Reduce the vehicle speed and try the shift again.

To shift into R (Reverse):

1. Bring the vehicle to a complete stop.
2. From the center position, move the shift lever rearward toward you, and then up. R is illuminated in red.
3. After releasing the shift lever, it will return to the center position.

To shift out of R (Reverse):

1. Bring the vehicle to a complete stop.
2. Shift to the desired gear.
3. After releasing the shift lever, it will return to the center position.

At low vehicle speeds, R (Reverse) can be used to rock the vehicle back and forth to get out of snow, ice, or sand without damaging the electric drive unit. See *If the Vehicle Is Stuck* ⇨ 164.

**N** : In this position, the propulsion system is inactive. If the vehicle is moving and turned off, restart the propulsion system in N (Neutral) only.

**Caution**

The vehicle is not designed to stay in N (Neutral) for extended periods of time. It will automatically shift into P (Park).

To shift into N (Neutral):

1. Move the shift lever rearward toward the driver.
  - If the vehicle is in P (Park), apply the brake pedal while moving the shift lever rearward.
  - The N indicator will illuminate red.
2. After releasing the shift lever, it will return to the center position.

To shift out of N (Neutral):

1. Bring the vehicle to a complete stop.
2. Hold the brake pedal down
3. Shift into the desired gear.

If the brake pedal is not applied, the vehicle may remain in N (Neutral).

**Car Wash Mode**

This vehicle includes a Car Wash Mode that allows the vehicle to remain in N (Neutral) for use in automatic car washes.

Car Wash Mode is not to be used for vehicle towing. If the vehicle needs to be towed, see *Transporting a Disabled Vehicle* ⇨ 287.

**Caution**

The vehicle is not designed to stay in N (Neutral) for extended periods of time. It will automatically shift into P (Park).

**Car Wash Mode (Vehicle On) - Driver In Vehicle**

To place the vehicle in N (Neutral) with the vehicle on and occupied:

1. Drive to the entrance of the car wash.
2. Apply the brake pedal.
3. Shift to N (Neutral).
4. Release the brake pedal. The vehicle is now ready for the car wash.

**Car Wash Mode (Vehicle On) - Driver Out of Vehicle**

To place the vehicle in N (Neutral) with the vehicle on and unoccupied:

1. Drive to the entrance of the car wash.
2. Apply the brake pedal.
3. Open the door.

4. Shift to N (Neutral), then release the brake pedal.
5. The indicator should continue to show N. If it does not, repeat Steps 2–4.
6. Exit the vehicle and close the door. The vehicle is now ready for the car wash.
7. The vehicle may automatically shift into P (Park) upon reentry.

**D** : This position is for normal driving. If more power is needed for passing, press the accelerator pedal down.

To shift into D (Drive):

1. Bring the vehicle to a complete stop.
2. From the center position, move the shift lever rearward toward you and then down.
  - If the vehicle is in P (Park), press the brake pedal while moving the shift lever.
  - D will illuminate red.
3. After releasing the shift lever, it will return to the center position.

To shift out of D (Drive):

1. Bring the vehicle to a complete stop.
2. Shift to the desired gear.

**Caution**

Spinning the tires excessively may damage the electric drive unit. The repair will not be covered by the vehicle warranty. If you are stuck, do not spin the tires.

When stopping on a steep hill, use the brakes to hold the vehicle in place.

When shifting to P (Park) on a hill, use the brakes to hold the vehicle then shift to P (Park).

**One-Pedal Driving**

One-Pedal Driving allows the use of the accelerator pedal to control the deceleration of the vehicle to a complete stop. Completely releasing the accelerator pedal will result in aggressive deceleration. Partially lifting off the accelerator pedal allows the deceleration of the vehicle to be adjusted as desired.

Use the brake pedal if emergency braking is required.

To view and configure One-Pedal Driving, from the infotainment display home screen, Select Controls > Drive & Park > One-Pedal Driving.

Select Off to disable One-Pedal Driving for traditional two-pedal driving, similar to a gasoline vehicle.

Select On to enable one-pedal driving where a moderate level of braking is applied when the accelerator pedal is released while driving.

Select High to enable one-pedal driving where a strong level of braking is applied when the accelerator pedal is released while driving.

When enabled, One-Pedal Driving applies in R (Reverse), D (Drive). This feature remains enabled until manually disabled by the driver. Press the accelerator pedal to the desired speed. The brake lamps will come on during substantial deceleration and when the vehicle is stopped.

If One-Pedal Driving is turned off while stopped, the vehicle will stay stopped. Press the brake pedal or accelerator pedal to return to two-pedal driving.

For faster access, One-Pedal Driving can be toggled on the Driver Mode screen. From the infotainment display home screen, select Drive Mode to open the Drive Mode screen.

Touch  to toggle One-Pedal Driving on or off. When turned on, One-Pedal Driving returns to the previously selected level. To change the level, press the Settings link in the pop-up box to go to the full One-Pedal Driving selection.

When possible, One-Pedal Driving uses regenerative braking to slow the vehicle for energy efficiency. Friction brakes may be used in some cases when regenerative braking is reduced. Friction brakes will be used to hold the vehicle after coming to a stop, and a noise may be noticed when the brakes apply.

When driving on slippery roads, it is recommended to turn off One-Pedal Driving. See *Winter Driving* ⇨ 163.

While using One-Pedal Driving, the Electric Parking Brake may apply in some circumstances. This can occur when:

- The driver exits the vehicle.
- The vehicle has remained stationary for five minutes.

To resume driving, press the accelerator pedal, and the Electric Parking Brake will automatically disengage.

## Drive Systems

### All-Wheel Drive

This vehicle may be equipped with advanced electric All-Wheel Drive (eAWD). The eAWD system delivers power to all four wheels, and the system adjusts automatically to the driving conditions. The eAWD system continuously varies the drive power to the front and rear wheels to maximize driving efficiency and improve driving dynamics. Your vehicle has exceptional driving capability, but care must always be taken to adjust driving style to the traffic and road conditions.

The vehicle eAWD settings may be customized for the driver mode selected. See *Driver Mode Control* ⇨ 180 for more information.

## Brakes

### Electric Brake Boost

Vehicles equipped with electric brake boost have hydraulic brake circuits that are electronically controlled when the brake pedal is applied during normal operation. The system performs routine tests and turns

off within a few minutes after the vehicle is turned off. Noise may be heard during this time. If the brake pedal is pressed during the tests or when the electric brake boost system is off, a noticeable change in pedal force and travel may be felt. This is normal.

### Antilock Brake System (ABS)

The Antilock Brake System (ABS) helps prevent a braking skid and maintain steering while braking hard.

ABS performs a system check when the vehicle is first driven. A momentary motor or clicking noise may be heard while this test is going on, and the brake pedal may move slightly. This is normal.



If there is a problem with ABS, this warning light stays on. See *Antilock Brake System (ABS) Warning Light* ⇨ 96.

ABS does not change the time needed to get a foot on the brake pedal and does not always decrease stopping distance. If you

get too close to the vehicle ahead, there will not be enough time to apply the brakes if that vehicle suddenly slows or stops. Always leave enough room ahead to stop, even with ABS.

### Using ABS

Do not pump the brakes. Just hold the brake pedal down firmly. Hearing or feeling ABS operate is normal.

### Braking in Emergencies

ABS allows steering and braking at the same time. In many emergencies, steering can help even more than braking.

### Electric Parking Brake





The Electric Parking Brake (EPB) can always be applied, even if the vehicle is off. In case of insufficient electrical power, the EPB cannot be applied or released. To prevent draining the battery, avoid unnecessary repeated cycles of the EPB.

The system has a red parking brake status light and an amber service parking brake warning light. See *Electric Parking Brake Light* ⇨ 95 and *Service Electric Parking Brake Light* ⇨ 95. There are also parking brake-related Driver Information Center (DIC) messages.

Before leaving the vehicle, check the red parking brake status light to ensure that the parking brake is applied.

### **EPB Apply**

To apply the EPB:

1. Be sure the vehicle is at a complete stop.
2. Press the EPB switch momentarily.

The red parking brake status light will flash and then stay on once the EPB is fully applied. If the red parking brake status light flashes continuously, then the EPB is only partially applied or there is a problem with the EPB. A DIC message will display. Release the EPB and try to apply it again. If the

light does not come on, or keeps flashing, have the vehicle serviced. Do not drive the vehicle if the red parking brake status light is flashing, see your dealer.

If the amber service parking brake warning light is on, press the EPB switch. Continue to hold the switch until the red parking brake status light remains on. If the amber service parking brake warning light is on, see your dealer.

If the EPB is applied while the vehicle is moving, the vehicle will decelerate as long as the switch is pressed. If the switch is pressed until the vehicle comes to a stop, the EPB will remain applied.

The vehicle may automatically apply the EPB in some situations when the vehicle is not moving. This is normal, and is done to periodically check the correct operation of the EPB system, or at the request of other safety functions that utilize the EPB.

If the EPB fails to apply, block the rear wheels to prevent vehicle movement.

### **EPB Release**

To release the EPB:

1. Turn the vehicle on.
2. Apply and hold the brake pedal.

3. Press the EPB switch momentarily.

The EPB is released when the red parking brake status light is off.

If the amber service parking brake warning light is on, release the EPB by pressing and holding the EPB switch. Continue to hold the switch until the red parking brake status light is off. If either light stays on after release is attempted, see your dealer.

### **Caution**

Driving with the parking brake on can overheat the brake system and cause premature wear or damage to brake system parts. Make sure that the parking brake is fully released and the brake warning light is off before driving.

### **Automatic EPB Release**

The EPB will automatically release if the vehicle is running, placed into gear, and an attempt is made to drive away. Avoid rapid acceleration when the EPB is applied, to preserve parking brake lining life.

## Brake Assist

Brake Assist detects rapid brake pedal applications due to emergency braking situations and provides additional braking to activate the Antilock Brake System (ABS) if the brake pedal is not pushed hard enough to activate ABS normally. Minor noise, brake pedal pulsation, and/or pedal movement during this time may occur. Continue to apply the brake pedal as the driving situation dictates. Brake Assist disengages when the brake pedal is released.

## Hill Start Assist (HSA)

### Warning

Do not rely on the HSA feature. HSA does not replace the need to pay attention and drive safely. You may not hear or feel alerts or warnings provided by this system. Failure to use proper care when driving may result in injury, death, or vehicle damage. See *Defensive Driving* ⇨ 160.

When the vehicle is stopped on a grade, Hill Start Assist (HSA) prevents the vehicle from rolling in an unintended direction during the transition from brake pedal release to

accelerator pedal apply. The brakes release when the accelerator pedal is applied. The brakes may also release under other conditions. Do not rely on HSA to hold the vehicle.

HSA is available when the vehicle is facing uphill in a forward gear, or when facing downhill in R (Reverse). The vehicle must come to a complete stop on a grade for HSA to activate.

## Automatic Vehicle Hold (AVH)



### Warning

Do not rely on this feature. It does not replace the need to pay attention and drive safely. You may not hear or feel alerts or warnings provided by this system. Failure to use proper care when driving may result in injury, death, or vehicle damage.

When Automatic Vehicle Hold (AVH) is turned on and the vehicle is braked to a stop, AVH prevents the vehicle from moving during the transition from brake pedal release to accelerator pedal apply. The brakes release when the accelerator pedal is applied. The brakes may also release under other conditions. Do not rely on AVH to hold the vehicle.

If the accelerator pedal is not applied within a few minutes, the Electric Parking Brake will apply. The parking brake will also apply if the driver door is opened or the driver seat belt is unfastened while AVH is holding the vehicle.

AVH can be turned on by pressing AUTO HOLD. The AVH indicator will come on. While AVH is holding the vehicle, the AVH indicator will change to green. See *Automatic Vehicle Hold (AVH) Light* ⇨ 96.

## Regenerative Braking

Regenerative braking takes some of the energy from the moving vehicle and turns it back into electrical energy. This energy is then stored back into the high voltage battery system, contributing to increased energy efficiency.

Regenerative power may be limited when the battery is near full charge or cold. See “Regenerative Power Limited” under *Power Indicator Gauge* ⇨ 91. Regenerative braking supplements your vehicle’s conventional brakes, especially when going downhill. See *Hill and Mountain Roads* ⇨ 163.

### Warning

Do not charge your vehicle’s battery above an 80% charge if you are going to drive down long, steep grades such as mountain passes. This provides room in the battery for regenerative braking to supplement your conventional brakes during the descent. This is especially important when towing a trailer, which puts additional stress on your vehicle’s braking system.

See “Charge Now” under *Charging* ⇨ 101 for information on setting charge limits. See *Hill and Mountain Roads* ⇨ 163 for important information about driving on grades.

The brake system uses regenerative braking, conventional hydraulic braking, or a combination of both as appropriate.

## Regen on Demand



Applying the Regen on Demand steering wheel paddle requests additional deceleration using regenerative braking. The deceleration request increases as the paddle is applied more. It works in D (Drive). The accelerator pedal can be used to manage deceleration while using Regen on Demand. See *One-Pedal Driving* ⇨ 174.

If the vehicle is brought to a complete stop while the Regen on Demand paddle is applied, the vehicle will not creep forward when the paddle is released. The accelerator pedal must be pressed to move the vehicle forward.

If the vehicle is on a steep grade, the brake pedal must be used to hold the vehicle.

When available regenerative braking power is limited, the hydraulic brakes may be applied to make up the difference.

Cruise control will turn off and the brake lamps may come on when this feature is activated.

Avoid using Regen on Demand under slippery road conditions. Use the brake pedal as the primary braking device.

## Ride Control Systems

### Traction Control/Electronic Stability Control

#### System Operation

The vehicle has a Traction Control System (TCS) and StabiliTrak/Electronic Stability Control (ESC). These systems help limit wheel spin and assist the driver in maintaining control, especially on slippery road conditions.

TCS activates if it senses any of the drive wheels are spinning or beginning to lose traction. When this happens, TCS applies the brakes to the spinning wheels and reduces vehicle power to limit wheel spin.

StabiliTrak/ESC activates when the vehicle senses a difference between the intended path and the direction the vehicle is actually traveling. StabiliTrak/ESC selectively applies braking pressure to one or more of the vehicle wheel brakes to assist the driver in keeping the vehicle on the intended path. Trailer Sway Control (TSC) is also on automatically when the vehicle is started. See *Trailer Sway Control (TSC)* ⇨ 244.

If cruise control is being used and traction control or StabiliTrak/ESC begins to limit wheel spin, cruise control will disengage. Cruise control may be turned back on when road conditions allow.

Both systems come on automatically when the vehicle is started and begins to move. The systems may be heard or felt while they are operating or while performing diagnostic checks. This is normal and does not mean there is a problem with the vehicle.

It is recommended to leave both systems on for normal driving conditions, but it may be necessary to turn TCS off if the vehicle gets stuck in sand, mud, ice, or snow. See *If the Vehicle Is Stuck* ⇨ 164 and “Turning the Systems Off and On” later in this section.



The indicator light for both systems is in the instrument cluster. This light:

- Flashes when TCS is limiting wheel spin
- Flashes when StabiliTrak/ESC is activated
- Turns on and stay on when either system is not working

See *Traction Control System (TCS)/StabiliTrak Light* ⇨ 98.

If either system fails to turn on or to activate, a message displays in the Driver Information Center (DIC), and  comes on and stays on to indicate that the system is inactive and is not assisting the driver in maintaining control. Adjust driving accordingly.

If  comes on and stays on:

1. Stop the vehicle.
2. Turn the vehicle off and wait 15 seconds.
3. Start the vehicle.
4. Drive the vehicle.

If  comes on and stays on, see your dealer as soon as possible.



### Turning the Systems Off and On

#### Caution



Do not repeatedly brake or accelerate heavily when TCS is off. The vehicle driveline could be damaged.

To turn Traction (TCS) on and off, in the virtual controls app on the infotainment home screen, select Virtual Controls > DRIVE & PARK > Traction Control. To turn StabiliTrak/ESC on or off, select  next to the Traction Control menu. The following options appear:

- Traction Control Off
- Traction Control and ESC Off
- Traction Control and ESC On

The traction off light  displays in the instrument cluster when the traction control is turned off. When the traction control is turned back on, the traction off light  displayed in the instrument cluster will turn off. See *Traction Off Light* ⇨ 97.

If TCS is actively limiting wheel spin when disabled, the system will not turn off until the wheels stop spinning.

To turn StabiliTrak/ESC off, select  next to the Traction Control menu. Select the Traction Control and ESC Off option. The StabiliTrak/ESC off light  will display in the instrument cluster. See *StabiliTrak OFF Light* ⇨ 98.

TCS cannot be on when StabiliTrak/ESC is off.

StabiliTrak/ESC will automatically turn on if the vehicle exceeds 56 km/h (35 mph) and cannot be turned off again until speed is reduced. Traction control will remain off.

The vehicle has a Trailer Sway Control (TSC) feature and a Hill Start Assist (HSA) feature. See *Trailer Sway Control (TSC)* ⇨ 244 or *Hill Start Assist (HSA)* ⇨ 177.

Entering Teen Driver will automatically enable both TCS and StabiliTrak/ESC, and prevent these safety features from being turned off. See *Teen Driver* ⇨ 146.

Adding accessories can affect the vehicle performance. See *Accessories and Modifications* ⇨ 248.

### Driver Mode Control

Driver Mode Control allows the driver to adjust the overall driving experience by selecting different modes. Driver Mode Control has the following modes: Tour, Sport, Snow/Ice, and a customizable mode: My mode. Driver mode availability and affected vehicle subsystems are dependent upon trim level, region, and optional features.

If the vehicle is in Tour mode, My mode, or Sport mode it will stay in that mode through future on/off cycles. If the vehicle is in Snow/Ice mode, it will return to Tour mode when the vehicle is restarted. When each mode is selected, a unique and persistent indicator is displayed in the instrument cluster.

## Mode Activation

To activate each mode, open the Drive Mode App on the infotainment home screen. Activate each mode by selecting the mode icon.

## Mode Descriptions

**Tour Mode** : Use for normal city and highway driving to provide a smooth ride. This setting provides balance between comfort and handling.

**Sport Mode** : Use where road conditions or personal preference demand a more controlled response. Sport mode improves vehicle handling and acceleration on dry pavement. When active, Sport mode modifies steering efforts, pedal tuning, electric vehicle sound enhancement (EVSE), adaptive cruise control, and suspension tuning, if equipped.

**Snow/Ice Mode** : Snow/Ice mode improves vehicle acceleration on snow covered roads. When active, Snow/Ice mode adjusts pedal tuning to optimize traction on slippery surfaces. This can affect the acceleration on dry asphalt. Snow/Ice mode also modifies electric All-Wheel Drive (eAWD) and steering.

**My Mode** : My mode is used to personalize everyday driving. This mode allows the driver to configure the vehicle subsystem settings to their driving preferences. My mode remains active across on/off cycles.

Through the infotainment display, the following vehicle subsystems may be available for customization in this mode:

**Acceleration Feel** : Relaxed, Tour, Sport

**Brake Feel** : Tour, Sport

**Steering** : Tour, Sport

**Motor Sound** : Tour, Sport

For a more detailed description of each selectable option, refer to “Drive Mode Customization.”

## Drive Mode Customization

The vehicle is equipped to modify the following settings based on vehicle content. Through the infotainment home screen, select Settings > Vehicle > Drive Mode Customization to personalize My mode. These settings will be retained over each on/off cycle, and do not have to be reset each time the vehicle is started.

**Acceleration Feel** : Choose how responsive you want acceleration to feel. You can adjust the accelerator pedal to provide increased power.

**Brake Feel** : Brake response settings adjust the brake pedal response. Brake pedal feel is less sensitive at lower settings and more sensitive at higher settings.

**Motor Sound** : Customize how your vehicle sounds when you are accelerating. Your electric motor remains quiet outside but the sound you hear inside changes as you drive faster or slower.

**Steering** : Choose how responsive you want the steering to feel. You can set the steering wheel to provide more feedback, which requires more steering effort.

## Cruise Control

### Adaptive Cruise Control (Advanced)

Adaptive Cruise Control (ACC) allows the cruise control set speed and following gap to be selected. Read this entire section before using this system. The following gap is the following time (or distance) between your vehicle and a vehicle detected directly

ahead in your path, moving in the same direction. If no vehicle is detected in your path, ACC works like regular cruise control. ACC uses a camera and radar sensor(s) to detect other vehicles. See *Radio Frequency Statement* ⇨ 312.

If a vehicle is detected in your path, ACC can apply acceleration or limited, moderate braking to maintain the selected following gap. To disengage ACC, apply the brake. If ACC is controlling the vehicle speed when the Traction Control System (TCS) or StabiliTrak/Electronic Stability Control (ESC) system activates, ACC may automatically disengage. See *Traction Control/Electronic Stability Control* ⇨ 179. When road conditions allow ACC to be safely used, ACC can be turned back on.

Disabling the TCS or StabiliTrak/ESC system will disengage and prevent engagement of ACC.

ACC can reduce the need for you to frequently brake and accelerate, especially when used on expressways, freeways, and interstate highways. When used on other roads, you may need to take over the control of braking or acceleration more often.

### **Warning**

ACC has limited braking ability and may not have time to slow the vehicle down enough to avoid a collision with another vehicle you are following. This can occur when vehicles suddenly slow or stop ahead, or enter your lane. Also see “Alerting the Driver” later in this section. Complete attention is always required while driving and you should be ready to take action and apply the brakes. See *Defensive Driving* ⇨ 160.

### **Warning**

ACC will not detect or brake for children, pedestrians, animals, or other objects.

Do not use ACC when:

- On winding and hilly roads or when the camera sensor is blocked by snow, ice, or dirt. The system may not detect a vehicle ahead. Keep the windshield and headlamps clean.
- When visibility is poor due to rain, snow, fog, dirt, insect residue, or dust; when other foreign objects obscure

(Continued)

### **Warning (Continued)**

the camera’s view; or when the vehicle in front or oncoming traffic causes additional environmental obstructions, such as road spray. ACC performance is limited under these conditions.

- On slippery roads where fast changes in tire traction can cause excessive wheel slip
- With extremely heavy cargo loaded in the cargo area or rear seat
- When towing a trailer



 : Press to turn the system on or off. The indicator turns white on the instrument cluster when ACC is turned on.

**RES+** : Press briefly to resume the previous set speed or to increase vehicle speed if ACC is already activated. To increase speed by about 1 km/h (1 mph), press RES+ to the first detent. To increase speed to the next 5 km/h (5 mph) mark on the speedometer, press RES+ to the second detent.

**SET-** : Press briefly to set the speed and activate ACC or to decrease vehicle speed if ACC is already activated. To decrease speed by about 1 km/h (1 mph), press SET- the first detent. To decrease speed to the next 5 km/h (5 mph) mark on the speedometer, press SET- to the second detent.

 : Press to disengage ACC without erasing the selected set speed.

 : Press to select a following gap setting for ACC of Far, Medium, or Near.

The speedometer reading can be displayed in either English or metric units. See *Instrument Cluster* ⇨ 89. The increment value used depends on the units displayed.



### Switching Between ACC and Regular Cruise Control

To switch between ACC and regular cruise control, press and hold . A Driver Information Center (DIC) message displays. See *Vehicle Messages* ⇨ 110.



ACC Indicator

Regular Cruise Control Indicator

When ACC is engaged, a green  indicator will be lit on the instrument cluster and the following gap will be displayed. When the regular cruise control is engaged, a green  indicator will be lit on the instrument cluster; the following gap will not display.



It is recommended to switch from ACC to regular cruise control only, when there are no vehicles ahead of your vehicle.

When the vehicle is turned on, the cruise control mode will be set to the last mode used before the vehicle was turned off.

### Warning

Always check the cruise control indicator on the instrument cluster to determine which mode cruise control is in before using the feature. If ACC is not active, the vehicle will not automatically brake for other vehicles, which could cause a crash if the brakes are not applied manually. You and others could be seriously injured or killed.

### Setting Adaptive Cruise Control

If  is on when not in use, it could get pressed and go into ACC when not desired. Keep  off when cruise is not being used.

Select the set speed desired for ACC. This is the vehicle speed when no vehicle is detected in your path.

While the vehicle is moving, ACC will not set at a speed below a minimum speed, although it can be resumed. If equipped with Super Cruise, this minimum speed is 5 km/h (3 mph), otherwise, it is 25 km/h (15 mph). The minimum allowable set speed is 25 km/h (15 mph).



To set ACC while moving:

1. Press .
2. Get up to the desired speed.
3. Press and release SET-.
4. Remove foot from the accelerator pedal.

After ACC is set, it may immediately apply the brakes if a vehicle ahead is detected closer than the selected following gap.

ACC can also be set while the vehicle is stopped if ACC is on and the brake pedal is applied.



The ACC indicator displays on the instrument cluster. When ACC is turned on, the indicator will be lit white. When ACC is engaged, the indicator will be lit green.

Be mindful of speed limits, surrounding traffic speeds, and weather conditions when selecting the set speed.

### Resuming a Set Speed

If the ACC is set at a desired speed and then the brakes are applied, ACC is disengaged without erasing the set speed from memory.

To begin using ACC again, press RES+ up briefly.

If the vehicle is moving more than 5 km/h (3 mph), it returns to the previous set speed.

If the vehicle is stopped with the brake pedal applied, press RES+ and release the brake pedal. ACC will hold the vehicle until RES+ or the accelerator pedal is pressed.

A green ACC indicator and the set speed display on the instrument cluster. The vehicle ahead indicator may be flashing if a vehicle ahead was present and moved. See “Approaching and Following a Vehicle” later in this section.

Once ACC has resumed, the vehicle speed will increase to the set speed under the following conditions:

- There is no vehicle ahead.
- The vehicle ahead is beyond the selected following gap.
- The vehicle speed is not being limited because of a sharp turn.

### Increasing Speed While ACC Is at a Set Speed

If ACC is already activated, do one of the following:

- Use the accelerator to get to the higher speed. Briefly press and release SET- and release the accelerator pedal. The vehicle will now cruise at the higher speed. When the accelerator pedal is pressed, ACC will not brake because it is overridden. While overridden, the ACC indicator will turn blue on the instrument cluster.
- Press and hold RES+ until the desired set speed is displayed, then release it.
- To increase speed in smaller increments, press RES+ to the first detent. For each press, the vehicle goes about 1 km/h (1 mph) faster.
- To increase speed in larger increments, press RES+ to the second detent. For each press, the vehicle speed increases to the next 5 km/h (5 mph) mark on the speedometer.

The set speed can also be increased while the vehicle is stopped if:

- stopped with the brake pedal applied, press RES+ until the desired set speed is displayed.

- ACC is holding the vehicle at a stop and there is another vehicle directly ahead, pressing RES+ will increase the set speed.
- and when pressing RES+ there is no longer a vehicle ahead or the vehicle ahead is pulling away and the brake is not applied with cause the ACC to resume.

When it is determined that there is no vehicle ahead or the vehicle ahead is beyond the selected following gap, then the vehicle speed will increase to the set speed.

#### Reducing Speed While ACC Is at a Set Speed

If ACC is already activated, do one of the following:

- Use the brake to get to the desired lower speed. Release the brake and press SET-. The vehicle will now cruise at the lower speed.
- Press and hold SET- until the desired lower speed is reached, then release it.
- To decrease speed in smaller increments, press SET- to the first detent. For each press, the vehicle goes about 1 km/h or (1 mph) slower.

- To decrease speed in larger increments, press SET- to the second detent. For each press, the vehicle speed decreases to the next 5 km/h (5 mph) mark on the speedometer.

The set speed can also be decreased while the vehicle is stopped.

If stopped with the brake applied, press or hold SET- until the desired set speed is displayed.

#### Selecting the Follow Distance Gap

When a slower moving vehicle is detected ahead within the selected following gap, ACC will adjust the vehicle's speed and attempt to maintain the follow distance gap selected.

Press  on the steering wheel to adjust the following gap. Each press cycles the gap button through three settings: Far, Medium, or Near.

When pressed, the current gap setting displays briefly on the instrument cluster. The gap setting will be maintained until it is changed.



Far Gap Setting



Medium Gap Setting





### Near Gap Setting

Since each gap setting corresponds to a following time (Far, Medium, or Near), the following distance will vary based on vehicle speed. The faster the vehicle speed, the further back your vehicle will follow a vehicle detected ahead. Consider traffic and weather conditions when selecting the following gap. The range of selectable gaps may not be appropriate for all drivers and driving conditions.

Changing the gap setting automatically changes the alert timing sensitivity (Far, Medium, or Near) for the Forward Collision Alert (FCA) feature. See *Forward Collision Alert (FCA) System* ⇨ 216.

### Courtesy Gap

Press and hold  on the steering wheel when vehicle is moving to temporarily increase the gap with the vehicle ahead to allow for merging traffic.

Press and hold  when stopped to cancel ACC from resuming automatically (if the stop is brief) and to remain stationary. This can be used to allow traffic to merge between you and the vehicle ahead. Press RES+ or the accelerator pedal to resume ACC.

Following distance gap will return to the original selection after hold.

### Alerting the Driver

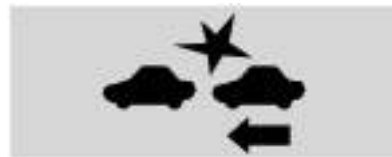

If ACC is engaged, driver action may be required when ACC cannot apply sufficient braking because of approaching a vehicle too rapidly.

When this condition occurs, the collision alert symbol will flash on the windshield. Either eight beeps will sound from the front, or both sides of the Safety Alert Seat will pulse five times. Touch the Settings icon on the infotainment home page. Select “Vehicle” to display the list of available options and select “Collision/Detection Systems”.

See *Defensive Driving* ⇨ 160.

### Approaching and Following a Vehicle



The vehicle ahead indicator is in the instrument cluster. It only displays when a vehicle is detected in your vehicle’s path moving in the same direction. If this symbol is not displaying, ACC will not respond to or brake for vehicles ahead.

ACC automatically slows the vehicle down and adjusts vehicle speed to follow a detected vehicle ahead at the selected following gap. The vehicle speed increases or decreases to follow a detected vehicle in

front of your vehicle when that vehicle is traveling slower than your vehicle set speed. It may apply limited braking, if necessary. When braking is active, the brake lamps will come on. The automatic braking may feel or sound different than if the brakes were applied manually. This is normal.

### Passing a Vehicle While Using ACC

If the set speed is high enough, and the left turn signal is used to pass a vehicle ahead in the selected following gap, ACC may assist by gradually accelerating the vehicle prior to the lane change.

#### Warning

When using ACC to pass a vehicle or perform a lane change, the following distance to the vehicle being passed may be reduced. ACC may not apply sufficient acceleration or braking when passing a vehicle or performing a lane change. Always be ready to manually accelerate or brake to complete the pass or lane change.

### Stationary or Very Slow-Moving Objects

#### Warning

ACC may not detect and react to stopped or slow-moving vehicles ahead of you. For example, the system may not brake for a vehicle it has never detected moving. This can occur in stop-and-go traffic or when a vehicle suddenly appears due to a vehicle ahead changing lanes. Your vehicle may not stop and could cause a crash. Use caution when using ACC. Your complete attention is always required while driving and you should be ready to take action and apply the brakes.

### Irregular Objects Affecting ACC

ACC may have difficulty detecting the following objects:

- Vehicles with cargo extending from the back end.
- Non-standard shaped vehicles, such as vehicle transport, vehicles with a side car fitted, or horse carriages.
- Objects that are close to the front of your vehicle.

### ACC Automatically Disengages

ACC may automatically disengage and the driver will need to manually apply the brakes to slow the vehicle if:

- The sensors are blocked.
- The Traction Control System (TCS) or StabiliTrak/ESC system has activated or been disabled.
- There is a fault in the system.
- The radar falsely reports blockage when driving in a desert or remote area with no other vehicles or roadside objects.
- A DIC message may display to indicate that ACC is temporarily unavailable.

The ACC indicator will turn white when ACC is no longer active.

In some cases, when ACC is temporarily unavailable, regular cruise control may be used. See “Switching Between ACC and Regular Cruise Control” previously in this section. Always consider driving conditions before using either cruise control system.

### Notification to Resume ACC

ACC will maintain a follow gap behind a detected vehicle and slow your vehicle to a stop behind that vehicle.

If the stopped vehicle ahead has driven away and ACC has not resumed, the vehicle ahead indicator will flash as a reminder to check traffic ahead before proceeding. In addition, the left and right sides of the Safety Alert Seat will pulse three times, or three beeps will sound. Touch the Settings icon on the infotainment home page. Select "Vehicle" to display the list of available options and select "Alert Type" and "Adaptive Cruise Go Notifier" in "Collision/Detection Systems".

If equipped with Driver Attention System (DAS), when the vehicle ahead drives away, and DAS determines that the driver's attention is on the road ahead, ACC resumes automatically. See "Attention to the Road" under *Super Cruise* ⇨ 190. If necessary, press RES+ or the accelerator pedal to resume ACC. If stopped for more than two minutes or if the driver door is opened and the driver seat belt is unbuckled, the ACC automatically applies the Electric Parking Brake (EPB) to hold the vehicle. The EPB status light will turn on. See *Electric Parking Brake* ⇨ 175.

A DIC warning message may display indicating to shift to P (Park) before exiting the vehicle. See *Vehicle Messages* ⇨ 110.

 **Warning**

If ACC has stopped the vehicle, and if ACC is disengaged, turned off, or canceled, the vehicle will no longer be held at a stop. The vehicle can move. When ACC is holding the vehicle at a stop, always be prepared to manually apply the brakes.

 **Warning**

Leaving the vehicle without placing it in P (Park) can be dangerous. Do not leave the vehicle while it is being held at a stop by ACC. Always place the vehicle in P (Park) and turn it off before leaving the vehicle.

**ACC Override**

If using the accelerator pedal while ACC is active, the ACC indicator turns blue on the instrument cluster indicating ACC braking will not occur. ACC will resume operation when the accelerator pedal is not being pressed.

 **Warning**

The ACC will not automatically apply the brakes if your foot is resting on the accelerator pedal. You could crash into a vehicle ahead of you.

**Curves in the Road**

 **Warning**

On curves, ACC may not detect a vehicle ahead in your lane. You could be startled if the vehicle accelerates up to the set speed, especially when following a vehicle exiting or entering exit ramps. You could lose control of the vehicle or crash. Do not use ACC while driving on an entrance or exit ramp. Always be ready to use the brakes if necessary.

 **Warning**

On curves, ACC may respond to a vehicle in another lane, or may not have time to react to a vehicle in your lane. You could crash into a vehicle ahead of you, or lose control of your vehicle. Give extra

(Continued)

**Warning (Continued)**

attention in curves and be ready to use the brakes if necessary. Select an appropriate speed while driving in curves.

ACC may operate differently in a sharp curve. It may briefly reduce the vehicle speed if the curve is too sharp.

The curve speed control indicator  may illuminate green when ACC is actively controlling the vehicle speed and detects a sharp curve on the road ahead.

ACC automatically slows the vehicle down while navigating the curve and may increase speed out of the curve, but will not exceed the set speed.

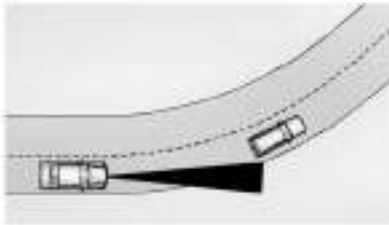

When following a vehicle and entering a curve, ACC may not detect the vehicle ahead and accelerate to the set speed. When this happens, the vehicle ahead indicator will not appear.



ACC may detect a vehicle that is not in your lane and apply the brakes.

ACC may occasionally provide an alert and/or braking that is considered unnecessary. It could respond to vehicles in different lanes or stationary objects when entering or exiting a curve. This is normal operation. The vehicle does not need service.

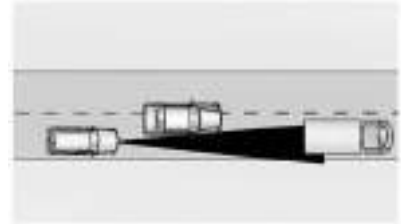
**Other Vehicle Lane Changes**

ACC will not detect a vehicle ahead until it is completely in the lane. The brakes may need to be manually applied.

**Objects Not Directly in Front of Your Vehicle**

The detection of objects in front of the vehicle may not be possible if:

- The vehicle or object ahead is not within your lane.
- The vehicle ahead is shifted, not centered, or is shifted to one side of the lane.

**Driving in Narrow Lanes**

Vehicles in adjacent traffic lanes or roadside objects may be incorrectly detected when located along the roadway.

### Do Not Use ACC on Hills





Do not use ACC when driving on steep hills. ACC will not detect a vehicle ahead.

### Do Not Use ACC When Towing a Trailer

ACC should not be used when towing a trailer.

### Disengaging ACC

There are four ways to disengage ACC:

- Step lightly on the brake pedal.
- Press .
- Press .
- Press the Regen On Demand paddle.

### Erasing Speed Memory

The ACC set speed is erased from memory if  is pressed or if the vehicle is turned off.

### Weather Conditions Affecting ACC

System operation may be limited under snow, heavy rain, or road spray conditions.

### Accessory Installations and Vehicle Modifications

Do not install or place any object around the front camera windshield area that would obstruct the front camera view.

Do not install objects on top of the vehicle that overhang and obstruct the front camera, such as a canoe, kayak, or other items that can be transported.

Do not modify the hood, headlamps, or fog lamps, as this may limit the camera's ability to detect an object.

### Warning

Stickers or accessories attached on or around the front or rear fascia of your vehicle can impair the radar sensors resulting in vehicle damage or personal injury. Your vehicle could brake suddenly. Do not attach anything on or around the front or rear fascia, including the license plate, the bumper, or the grille. Use only GM genuine accessories.

Do not attach anything to the front or rear fascia as this may interfere with the radar sensor operation.

### Cleaning the Sensing System

The camera sensor on the windshield behind the rearview mirror, and the sensors on the front of the vehicle can become blocked by snow, ice, dirt, mud, or debris. This area needs to be cleaned for ACC to operate properly.

If ACC will not operate, regular cruise control may be available. See “Switching Between ACC and Regular Cruise Control” previously in this section. Always consider driving conditions before using either cruise control system.

For cleaning instructions, see “Washing the Vehicle” under *Exterior Care* ⇨ 289.

### Super Cruise

If equipped, Super Cruise can steer to maintain lane position under certain conditions on Super Cruise-enabled roads that are separated from opposing traffic.

Super Cruise can also steer to perform a lane change under certain conditions on Super Cruise-enabled roads. A lane change can be initiated by the driver using the turn signal lever.

The Super Cruise System may initiate a lane change maneuver in following scenarios:

- To pass slower traffic
- When the current lane is ending ahead
- To return to the initial lane

See “Super Cruise Lane Change” later in this section and *Turn and Lane-Change Signals* ⇨ 119.

### Warning

Super Cruise can only assist to maintain lane position, or steer to change lanes, when driving on compatible roads. You must supervise the driving task and monitor the road conditions. You may need to respond to traffic events by steering, braking, or accelerating. See Defensive Driving.

Super Cruise is:

- Not a self-driving system

(Continued)

### Warning (Continued)

- Not a crash avoidance or warning system
- Not a substitute for proper supervision of the driving task.

Super Cruise uses the following to detect the current lane position and lane markings ahead on compatible roads under certain conditions:

- Cameras
- Global Positioning System (GPS) sensing
- A high-precision map
- GPS-enhancement data downloaded through OnStar

Super Cruise works with Adaptive Cruise Control (ACC), which controls acceleration and braking while Super Cruise is enabled and operating. Review and understand both this section and the ACC section before using Super Cruise. See *Adaptive Cruise Control (Advanced)* ⇨ 181.

An active Connected Service plan that includes Super Cruise Services is required to use Super Cruise.

### Warning

Super Cruise does not perform all aspects of driving, nor does it do everything a driver can do. Super Cruise only steers to maintain vehicle position in the current lane or, under some circumstances, to change lanes. Super Cruise can only be used with Adaptive Cruise Control.

Super Cruise does:

- Not prevent crashes or warn of possible crashes.
- Not steer to avoid stopped or slow-moving vehicles, cross-traffic, construction barriers or cones, motorcycles, children, pedestrians, animals, or other objects on the road.
- Not steer in response to vehicles or objects next to your vehicle, including vehicles attempting to enter your lane.
- Not respond to traffic lights, stop signs, or other traffic control devices.
- Not respond to crossing traffic.
- Not make turns.
- Not steer to merge onto or to exit highways.

(Continued)



**Warning (Continued)**

- Not detect, steer to avoid, or steer through construction zones.
- Not function on surface streets.
- Not respond to crossing or oncoming traffic.
- Not function in city driving conditions.

 **Warning**

Some state and local laws may require hands to be kept on the steering wheel at all times. Only remove your hands from the steering wheel if Super Cruise is engaged, it is safe to do so, and it is permitted by state and local laws.

 **Warning**

Failure to supervise the driving task and to respond appropriately, even while Super Cruise is operating, can cause a crash. Super Cruise may not respond as you would to all driving situations and may not maintain lane position under all conditions.

(Continued)

**Warning (Continued)**

It is extremely important to pay attention to the operation of the vehicle, even while using Super Cruise. Do not use a hand-held device while driving, even with Super Cruise engaged. To prevent serious injury or death:

- Always remain properly seated in the driver seat with your seat belt fastened.
- Never remove your hands from the steering wheel when Super Cruise is not operating.
- Always make sure traffic conditions are safe before using Super Cruise.
- Always keep the entire vehicle and the sensors clean. Sensors are on the front, sides, and rear of the vehicle.
- Always observe posted speed limits. Only use Super Cruise at or below the posted speed limit.

Super Cruise should not be used in complex or uncertain driving conditions, including:

- Not in construction zones.

(Continued)

**Warning (Continued)**

- Not when approaching or exiting toll plazas.
- Not when approaching an intersection that is controlled with a traffic light, stop sign, or other traffic control device.
- Not when lane markings are not present or cannot be detected. For example, there is too much glare, weather conditions are poor, or lanes are poorly marked.
- Not on slippery or icy roads.
- Not in adverse weather conditions, including rain, sleet, fog, ice, or snow.
- Not on winding or hilly roads.
- Not for city driving.
- Not during heavy or emergency braking.
- Not on surface streets.
- Not on a road shoulder, service drive, or under an elevated freeway.
- Not when towing a trailer.
- Not in a highway exit lane.

When Super Cruise is Available



Super Cruise Indicator

Super Cruise is designed to operate only when:

- ACC is on. See *Adaptive Cruise Control (Advanced)* ⇨ 181.
- Teen Driver is not active.
- The GPS detects the vehicle is on a compatible highway.
- Both the camera and the radar sensors are functioning and not covered, obstructed, or damaged.
- The Driver Attention System (DAS) detects the driver's head and eyes are directed toward the road.
- The lane markings are clearly visible and able to be detected by the system.



Poor Conditions



Poor Conditions

Using Super Cruise

**Warning**

To prevent serious injury or death, only remove your hands from the steering wheel if the steering wheel light bar, and are green. Super Cruise may  
(Continued)

**Warning (Continued)**

not begin steering immediately, even when Super Cruise is available and has been pressed.



To engage:

- Press to turn on ACC. Make sure the white indicator displays in the instrument cluster. See *Adaptive Cruise Control (Advanced)* ⇨ 181.
- When Super Cruise is available, the white will display in the instrument cluster.

- Press . ACC will set the speed at the current vehicle speed. If ACC has a previously set speed, it may resume at that speed.

When engaged and not steering the vehicle, the steering wheel light bar flashes blue, and  will be blue. The driver is in control of steering and Super Cruise is not steering the vehicle.

When the vehicle is positioned in the center of the lane, the steering wheel light bar and  display will turn green, indicating Super Cruise is steering the vehicle.

When Super Cruise controls the steering, traffic and other conditions and laws permit, and it is safe to do so, your hands can be taken off the steering wheel.

Always pay attention to the road and the operation of the vehicle. Always monitor and be attentive of surrounding traffic, including vehicles that may cross the road in front of your vehicle.

Super Cruise steering can be overridden with manual steering at any time. When Super Cruise is engaged, always be prepared to take immediate action — including steering, accelerating, and braking quickly, if necessary.

Super Cruise, when engaged, will enable Forward Collision System to Alert and Brake.

### Steering Manually and Changing Lanes

The vehicle can always be manually steered, even with Super Cruise engaged; for example, when changing lanes.

When the steering wheel is moved manually, the steering wheel light bar pulses blue and  on the instrument cluster turns blue to indicate Super Cruise is not steering the vehicle.

When ready to allow Super Cruise to resume steering again, position the vehicle in the center of the lane, hold the steering wheel until the steering wheel light bar turns green, and then release the steering wheel when it is safe to do so.

### **Warning**

To help prevent crashes before making a lane change:

- Always check mirrors.
- Glance over your shoulder.
- Use the turn signals.

### Super Cruise Lane Change

#### On Demand Lane Changes

Super Cruise can steer to perform a single lane change under certain conditions when requested by the driver or initiated by the Super Cruise System.

To request a lane change:

1. Verify the lane next to your vehicle is clear and conditions are safe to make a lane change.
2. Use the turn signal lever to activate the turn signal in the direction of the desired lane change.
3. Return the turn signal lever to the neutral position after the lane change. See *Turn and Lane-Change Signals* ⇨ 119.
4. To cancel a lane change, return the turn signal lever to the neutral position, move the lever in the opposite direction of the lane change, or steer manually at any time.

### Automatic Lane Changes

Super Cruise System may initiate a single lane change when enabled through Vehicle Personalization under following conditions:

- The Super Cruise System may initiate an automatic lane change to the left to pass a slower moving vehicle ahead and a subsequent lane change to right to return to your original lane.
- Super Cruise System may initiate an automatic lane change to left or right when current lane is ending ahead.
- To cancel a Super Cruise lane change, move the turn signal lever or steer manually at any time..

If Super Cruise detects that traffic is clear, Super Cruise will steer the vehicle to perform the lane change. A message appears on the Driver Information Center (DIC) during the lane change to provide more information on the status of the lane change.

Super Cruise Lane Change functionality is only available on Super Cruise capable Divided Roads.

Super Cruise Lane Change may be disabled when a trailer or other accessories (e.g. bike rack, cargo tray, etc.) are detected.

Do not use Super Cruise Lane Change when towing a trailer.

The Super Cruise Lane Change feature can be customized to be Off, On Demand Lane Change, or On Demand Lane Change & Automatic Lane Change through the vehicle personalization menu. Touch the Settings icon on the infotainment home page. Select "Vehicle" to display the list of available options and select "Super Cruise Lane Change".

#### Warning

Super Cruise Lane Change may not detect a vehicle in an adjacent lane. Always supervise the driving task and monitor traffic conditions when using the Super Cruise Lane Change feature. Only request a lane change when traffic conditions are safe for a lane change, and always be ready to manually steer the vehicle. See "Steering Manually and Changing Lanes" listed previously in this section.

### Take Over Alert

#### Warning

Super Cruise will not maintain the vehicle's speed while the steering wheel light bar is flashing red. If the steering wheel light bar flashes red, immediately resume manual steering to prevent serious injury or death. If you do not resume manual steering, the vehicle will begin to slow in the same lane and eventually come to a complete stop on the road.

Any time the steering wheel light bar flashes red, resume manual steering immediately.

To begin steering manually, hold the steering wheel firmly (with both hands) using the highlighted regions as shown in the picture below.



The instrument cluster light , will also turn red and a message will display in the Driver Information Center (DIC). In addition, beeps will sound, or the Safety Alert Seat will vibrate. Touch the Settings icon on the infotainment home page. Select “Vehicle” to display the list of available options and select “Collision/Detection Systems”. After you begin steering manually, then Super Cruise will disengage.

The red flashing steering wheel light bar could occur under any of the following conditions:

- Lane markings are poor, or visibility is limited.
- The Driver Attention System (DAS) does not detect that the driver's head and eyes are directed toward the road.
- ACC is canceled.
- The vehicle is on a tight curve, or the lanes are too wide, or the vehicle goes into a curve too fast.
- The compatible road ends.
- The vehicle is approaching an intersection controlled by a traffic light, stop sign, or other traffic control device.
- A Super Cruise system fault occurs.
- Super Cruise is unable to complete the lane change maneuver.

### Attention to the Road

#### Warning

Super Cruise is a driver assistance system and cannot accurately detect or predict all situations. Super Cruise is not a crash avoidance system. To prevent serious injury or death, you must supervise the driving task and monitor the road conditions. You may need to respond to traffic events by steering, braking, or accelerating. See *Defensive Driving* ⇨ 160. Super Cruise also cannot determine whether you are awake, asleep, impaired, or properly focused on safe driving. The vehicle could crash into other vehicles, drive out of the lane, or drive off the road. Complete attention is always required while driving, even while using Super Cruise. Be prepared to take over steering or apply the brakes at any time.

 **Warning**

To prevent serious injury or death, be alert and pay special attention when passing highway exits, entrances, and crossings with Super Cruise, and be ready to take control of the vehicle when necessary. Changes in lane markings around exits and entrances can momentarily cause Super Cruise to not detect the correct lane. If this occurs, Super Cruise may attempt steering inputs to bring the vehicle back into the correct lane and, in rare circumstances, could over-correct and cause the vehicle to momentarily cross into a lane next to your vehicle unless you manually steer to maintain your lane position.

The Driver Attention System (DAS) on the steering column continually monitors driver head and eye position to estimate driver attention to the road. The camera does not record or share pictures, audio, or video.

Sunglasses, hats, or other types of clothing that change the shape of the head may interfere with camera performance. To improve camera performance, raise or lower the steering wheel, or change the seat position.

Pay close attention to the road ahead to avoid these three increasing alerts:

First Alert	<ul style="list-style-type: none"><li>• If the steering wheel light bar flashes green, the system has detected that your head and eyes may not be directed toward the road.</li><li>• The flashing will stop when the system detects that your head and eyes appear to be directed toward the road.</li></ul>
Second Alert	<ul style="list-style-type: none"><li>• If the steering wheel light bar flashes green for too long, Super Cruise will alert the driver to take control of steering immediately by flashing the light bar red. Also, either beeps will sound or the Safety Alert Seat will vibrate. Touch the Settings icon on the infotainment home page. Select “Vehicle” to display the list of available options and select “Collision/Detection Systems.”</li><li>• Take over steering, then Super Cruise will disengage.</li><li>• To re-engage Super Cruise, press . See “Using Super Cruise” previously in this section.</li></ul>
Third Alert	<ul style="list-style-type: none"><li>• If the steering wheel light bar flashes red for too long, a voice command will tell you to take control of the vehicle.</li><li>• Take control of the steering immediately; ACC and Super Cruise will disengage.</li><li>• A DIC message will indicate that Super Cruise is locked out. Super Cruise cannot be re-engaged until the vehicle is turned off and back on.</li><li>• Continued failure to take over steering will cause the vehicle to brake to a stop and OnStar will be called. The brake lamps and hazard warning flashers will come on.</li><li>• Take control of the vehicle and continue driving.</li></ul>

### Stationary or Very Slow-Moving Objects; Cross-Traffic

#### Warning

Super Cruise is not a crash avoidance system and will not steer or brake to avoid a crash. Super Cruise does not steer to prevent a crash with stopped or slow-moving vehicles. You must supervise the driving task and may need to steer and brake to prevent a crash, especially in stop-and-go traffic or when a vehicle suddenly enters your lane. Always pay attention when using Super Cruise. Failure to do so could result in a crash involving serious injury or death.

### Curves in the Road

#### Warning

The vehicle could drift out of your lane of travel. To prevent crashes, always be ready to manually steer.

Super Cruise may not detect your lane on curves in the road. Super Cruise may not detect the markings that show your lane.

(Continued)

#### Warning (Continued)

You may not have time to react to a vehicle in the lane next to your vehicle while on curves in the road.

Super Cruise may operate differently in sharp curves. It may drift out of your lane of travel if the curve is too sharp.

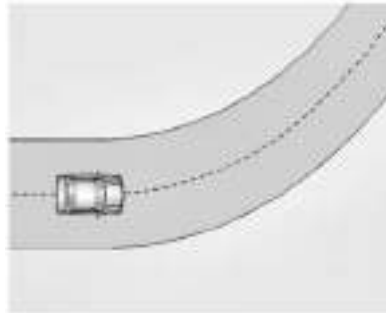

When entering a curve, Super Cruise may not detect the lane markings and may not adjust the steering enough to stay in your lane of travel. When this happens, you will need to steer the vehicle.

Super Cruise may detect other lane markings that are not in your lane and may or may not steer appropriately to maintain your lane.



Super Cruise may occasionally provide an alert and/or steering that is considered unnecessary. It could respond to lane markings in different lanes, signs, guardrails, and other stationary objects when entering or exiting a curve. This is normal operation. The vehicle does not need service.



**Other Vehicles Entering Your Lane**

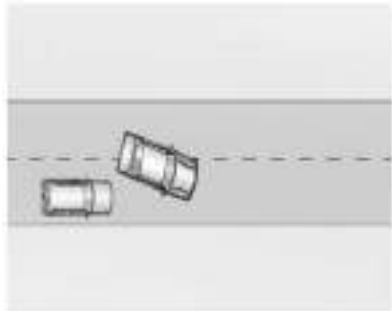

Super Cruise may not detect a vehicle that enters your lane, or may not brake fast enough to avoid a crash. You must manually brake and steer the vehicle.

**Intersections; Vehicles Crossing the Road Ahead**

Super Cruise will not brake the vehicle when approaching an intersection that is controlled by a traffic light or stop sign. Super Cruise will not detect vehicles crossing the road ahead, including at intersections, and will not automatically steer or brake to prevent a collision. You must manually brake and steer the vehicle.

**Towing a Trailer**

Do not use Super Cruise when towing a trailer. For towing capability, see *General Towing Information* ⇨ 237.

**Super Cruise on Hills**

Do not use Super Cruise while driving on steep hills.

**Super Cruise Indicator Light Summary**



The steering wheel light bar and instrument cluster light provide the following important information about Super Cruise operation:

Steering Wheel Light Bar	Instrument Cluster Light	Super Cruise Description
Off	Off	Super Cruise is off. There is no automatic steering. Operate the vehicle manually.
Off	White	Super Cruise is available and can be engaged.
Solid Green	Solid Green	Super Cruise is steering. Pay attention to the road and vehicle operation.
Flashing Blue	Solid Blue	Super Cruise is not steering. Operate the vehicle manually. See “Steering Manually and Changing Lanes” previously in this section.
Flashing Green	Solid Green	Super Cruise has detected you are not paying sufficiently close attention to the road. Pay attention to the road. See “Attention to the Road” previously in this section.
Flashing Red	Solid Red	Take over steering immediately. Super Cruise will disengage. See “Take Over Alert” previously in this section.



### Disengaging Super Cruise

There are two ways to disengage Super Cruise:

- Press  while your hands are on the steering wheel. The Super Cruise steering will disengage.

- Press the brake pedal or the regen on demand paddle while your hands are on the steering wheel. Both Super Cruise steering and Adaptive Cruise Control will disengage.

### Super Cruise Messages

If  does not appear,  can be pressed to display a DIC message as to why the system is unavailable.

Immediately after a disengagement, pressing the  within 10 seconds will display a DIC message with the reason for Super Cruise disengagement.

## Super Cruise Message Summary

Subscription Required	The owner's required Connected Services subscription may have ended.
Press OnStar Button	Press the blue OnStar button in your vehicle to speak with an OnStar representative who can help determine the issue, and what actions to take.
Unavailable Turn on Adaptive Cruise Control	Adaptive Cruise Control must be on before Super Cruise can be enabled. <ul style="list-style-type: none"> <li>• Set speed is not required before enabling Super Cruise.</li> <li>• Adaptive Cruise Control is not required to be engaged before enabling Super Cruise.</li> </ul>
Unavailable Approved Roads Only	Super Cruise is disabled because the vehicle is being driven on a road that is not compatible.
Unavailable Lane Ending	Super Cruise is disabled because the driving lane is ending.
Unavailable Poor Weather Conditions	Super Cruise is disabled due to inclement weather conditions affecting system performance.
Unavailable No Road Information	<ul style="list-style-type: none"> <li>• There is no map information available for that portion of the road. Recent road reconstruction may turn off Super Cruise for that section of road until new map information is available.</li> <li>• The vehicle is not on the correct type of road. A controlled access freeway or compatible divided highway is required for Super Cruise.</li> <li>• There are lanes entering or exiting on both the left and right side of the road.</li> </ul>

Super Cruise Message Summary (cont'd)

Unavailable Sensors Can't Find Lane Lines	<ul style="list-style-type: none"> <li>• Rain or snow is inhibiting the system's ability to see lane lines.</li> <li>• Direct sunlight is on the front camera at dawn or dusk.</li> <li>• There are missing or poor lane line markings on the road.</li> <li>• There is sun glare on the road surface.</li> <li>• There is heavy rain, puddles, or road spray.</li> </ul>
Unavailable Sensor Can't See Face Clearly	<ul style="list-style-type: none"> <li>• Sun is shining into the Driver Attention System (DAS) camera.</li> <li>• Dawn or dusk sun glare is on the driver's face.</li> <li>• Cups, food, hands, or other objects are obscuring the DAS view of the driver's face.</li> <li>• The steering column is pointed too high or low for the DAS to see the driver. Adjust the steering column or the seat if the message occurs frequently.</li> </ul>
Unavailable Looking Away From Road for Too Long	The DAS system detects that the driver is not looking at the road.
Unavailable Driving Too Fast	The vehicle is traveling faster than 137 km/h (85 mph). The maximum Super Cruise speed in curves will vary based on how sharp the curve is. The vehicle will automatically decrease speed if needed.
Unavailable Driving in Exit Lane	The Super Cruise system has detected that the vehicle is in an exit lane.
Unavailable GPS Signal Lost	<ul style="list-style-type: none"> <li>• There is poor reception in isolated areas.</li> <li>• Reception is being blocked by buildings or other large structures.</li> </ul>
Unavailable You Have Taken Vehicle Control	<ul style="list-style-type: none"> <li>• The brake pedal is being pressed.</li> <li>• The Adaptive Cruise Control has been canceled or turned off.</li> </ul>

**Super Cruise Message Summary (cont'd)**

Unavailable Sensor Blocked	Clear snow, ice, dirt, or other contaminants from the front and rear areas of the vehicle.
Unavailable Sharp Curve	Some curves are too sharp to be navigated by the Super Cruise system. Super Cruise will be available after the curve is traveled.
Super Cruise Unavailable	Super Cruise is unavailable for reasons not described in other messages.
Super Cruise Locked Out See Owner's Manual	The driver did not take control of the vehicle when prompted by the Super Cruise system. The Super Cruise system will be disabled until the vehicle is turned off and back on.

**Map Updates**

Super Cruise map information must be periodically updated at least once every seven months to determine whether Super Cruise is available on certain roads.

**Data Download**

If the vehicle is equipped with OnStar and has an active service plan, additional data may be collected through the OnStar system. This includes information about: the vehicle's operation; a crash involving the vehicle; the use of the vehicle and its

features; and, in certain situations, the location and approximate GPS speed of the vehicle. Refer to the OnStar Terms and Conditions and Privacy Statement on the OnStar website.

**Location Services**

This setting enables or disables sharing of vehicle location outside the vehicle for certain purposes. Even if the Location Services setting is disabled, vehicle location information will continue to be shared for emergency services and Super Cruise, if equipped.

**System Care**

The camera on the steering column has a lens cover that may become dirty over time and affect camera performance. Clean the lens cover with a soft cloth sprayed with glass cleaner. Wipe the lens gently, then dry it. Never use abrasive cloths/cleaners or corrosive chemicals of any kind on the lens cover.

Super Cruise uses the front radar, front camera, and 360 degree cameras for its operation. Clean surfaces are required for Super Cruise operation. See *Adaptive Cruise Control (Advanced)* ⇨ 181, “Surround Vision Camera” under *Assistance Systems for Parking or Backing* ⇨ 206, and *Lane Keep Assist (LKA)* ⇨ 224 for care information.

### Caution

The Super Cruise system is a highly sophisticated system and should only be serviced by technicians with the proper training, tools, and safety instructions, which your dealer has. Without proper training and tools the vehicle may become damaged.

## Driver Assistance Systems

This vehicle may have features that work together to help avoid crashes or reduce crash damage while driving, backing, and parking. Read this entire section before using these systems.

### Warning

Do not rely on the Driver Assistance Systems. These systems do not replace the need for paying attention and driving safely. You may not hear or see alerts or warnings provided by these systems. Failure to use proper care when driving may result in injury, death, or vehicle damage. See *Defensive Driving* ⇨ 160.

Under many conditions, these systems will not:

- Detect children, pedestrians, bicyclists, or animals.
- Detect vehicles or objects outside the area monitored by the system.
- Work at all driving speeds.
- Warn you or provide you with enough time to avoid a crash.
- Work under poor visibility or bad weather conditions.
- Work if the detection sensor is not cleaned or is covered by ice, snow, mud, or dirt.

(Continued)

### Warning (Continued)

- Work if the detection sensor is covered up, such as with a sticker, magnet, or metal plate.
- Work if the area surrounding the detection sensor is damaged or not properly repaired.

Complete attention is always required while driving, and you should be ready to take action and apply the brakes and/or steer the vehicle to avoid crashes.

### Warning

Stickers or accessories attached on or around the front or rear fascia of your vehicle can impair the radar sensors resulting in vehicle damage or personal injury. Your vehicle could brake suddenly. Do not attach anything on or around the front or rear fascia, including the license plate, the bumper, or the grille. Use only GM genuine accessories.

### Audible Alert or Safety Alert Seat

Some driver assistance features alert the driver of obstacles by beeping. To view available settings from the infotainment screen, touch Settings > Vehicle > Comfort and Convenience.

If equipped with the Safety Alert Seat, the driver seat cushion may provide a vibrating pulse alert instead of beeping. To view available settings from the infotainment screen, touch Settings > Vehicle > Collision/Detection Systems.

### Cleaning

Depending on vehicle options, keep these areas of the vehicle clean to ensure the best driver assistance feature performance. Driver Information Center (DIC) messages may display when the systems are unavailable or blocked.



- Front and rear bumpers and the area below the bumpers
- Front grille and headlamps
- Front camera lens in the front grille or near the front emblem

- Front side and rear side panels
- Outside of the windshield in front of the rearview mirror
- Side camera lens on the bottom of the outside mirrors
- Rear side corner bumpers
- Rear Vision Camera above the license plate

### Radio Frequency

This vehicle may be equipped with driver assistance systems that operate using radio frequency. See *Radio Frequency Statement* ⇨ 312.

### Assistance Systems for Parking or Backing

If equipped, the Rear Vision Camera (RVC), Rear Park Assist (RPA), Surround Vision, and Rear Cross Traffic Alert (RCTA) may help the driver park or avoid objects. Always check around the vehicle when parking or backing.

### Rear Vision Camera (RVC)

When the vehicle is shifted into R (Reverse), the RVC displays an image of the area behind the vehicle in the infotainment display. The previous screen displays when the vehicle is shifted out of R (Reverse) after

a short delay. To return to the previous screen sooner, press  on the center stack, shift into P (Park), or reach a vehicle speed of approximately 12 km/h (8 mph).

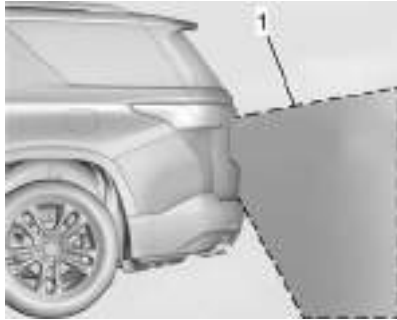

1. View Displayed by the Camera

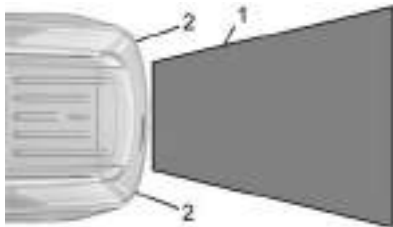

1. View Displayed by the Camera

## 2. Corners of the Rear Bumper

Displayed images may be farther or closer than they appear. The area displayed is limited and objects that are close to either corner of the bumper or under the bumper do not display.

A warning triangle may display to show that RPA has detected an object. This triangle changes from amber to red and increases in size the closer the object.

If  or a service message appears on the infotainment display, there may be a camera malfunction. See your dealer.

### Warning

The camera(s) do not display children, pedestrians, bicyclists, crossing traffic, animals, or any other object outside of the cameras' field of view, below the bumper, or under the vehicle. Shown distances may be different from actual distances. Do not drive or park the vehicle using only these camera(s). Always check behind and around the vehicle before driving. Failure to use proper care may result in injury, death, or vehicle damage.

## Surround Vision System

If equipped, Surround Vision displays an image of the area surrounding the vehicle, along with the front or rear camera views on the infotainment display. The front camera is in the grille or near the front emblem, the side cameras are on the bottom of the outside mirrors, and the rear camera is above the license plate.

The Surround Vision system can be accessed by selecting CAMERA in the infotainment display or when the vehicle is shifted into R (Reverse). To return to the previous screen sooner, when not in R (Reverse) press Home or Back on the infotainment system, shift into P (Park), or reach a vehicle speed of approximately 12 km/h (8 mph) while in D (Drive).

### Warning

The Surround Vision Cameras have blind spots and will not display all objects near the corners of the vehicle. Folding side mirrors that are out of position will not display surround view correctly. Always check around the vehicle when parking or backing.





1. Views Displayed by the Surround Vision Cameras
2. Area Not Shown

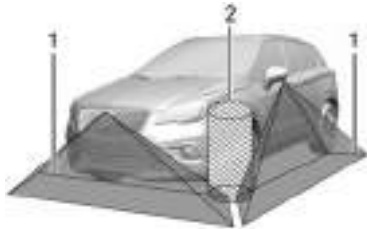

1. Views Displayed by the Surround Vision Cameras
2. Area Not Shown

**Warning**

The camera(s) do not display children, pedestrians, bicyclists, crossing traffic, animals, or any other object outside of the cameras' field of view, below the bumper, or under the vehicle. Shown distances may be different from actual distances. Do not drive or park the vehicle using only these camera(s). Always check behind and around the vehicle before driving. Failure to use proper care may result in injury, death, or vehicle damage.

**Camera Views**



Touch the camera view buttons along the bottom of the infotainment display.

**Front/Rear Standard View** : Displays an image of the area in front or behind the vehicle. Touch Front/Rear Standard View on the infotainment display when a camera view is active. Touching the button multiple times will toggle between front and rear camera views.

If equipped, the front view camera also displays when the Park Assist system detects an object within 30 cm (12 in).

**Front/Rear Overhead View** : Displays a front or rear overhead view of the vehicle. Touching the button will toggle between the two views.

**Side Forward/Rearward View** : Displays a view that shows objects next to the front or rear sides of the vehicle. Touch Side Forward/Rearward View on the infotainment display when a camera view is active. Touching the button multiple times will toggle between forward and rearward views. Park Assist and Rear Cross Traffic Alert overlays are not available when Side Forward/Rearward view is active.

**Guidance Lines** : Displays available guidelines. a grayed-out button indicates that guidelines are not available. When enabled, the guidelines will display when the vehicle is shifted in R (Reverse).

**Top Down View** : Displays an image of the area surrounding the vehicle, along with the rear camera view in the infotainment display. The rear camera view will be replaced by the front camera view after shifting from R (Reverse) to a forward gear, or when the vehicle is moving forward slower than approximately 12 km/h (8 mph).

### Park Assist

The vehicle may be equipped with Front and Rear Park Assist (FRPA). Under certain conditions, the Park Assist system can assist the driver during backing and parking maneuvers when the vehicle is driven at no more than 9 km/h (6 mph). An illuminated indicator in the Park Assist button indicates the system is ready.

Sensors located in the bumpers measure the distance between the vehicle and objects using sonar technology. These sensors are designed to detect certain objects up to

2.5 m (8 ft) behind and 1.2 m (4 ft) in front of your vehicle that are taller than 25 cm (10 in).

Different environmental conditions may affect whether and how far the Park Assist system can detect objects. Keep the sensors clean of mud, dirt, snow, ice, and slush; and clean sensors after a car wash in freezing temperatures. Sensors that are not clean may not detect objects or may cause the system to alert when not required.

#### Warning

The Park Assist System is no substitute for careful and attentive driving. The Park Assist system does not detect children, pedestrians, bicyclists, animals, or objects located below the bumper or that are too close or too far from the vehicle. It is not available at speeds greater than 9 km/h (6 mph). To prevent injury, death, or vehicle damage, even with Park Assist, always check the area around the vehicle and check all mirrors before moving forward or backing.

### How the System Works

The vehicle may have a Park Assist amphitheatre-like display on the cluster with bars that represent the estimated location of a detected object and the vehicle's distance from the object. As a detected object becomes closer, more bars light up and change color from yellow to amber to red.

When an object is first detected in the rear, one beep will be heard from the rear, or the driver's seat will pulse two times, if equipped with Safety Alert Seat. When an object is very close, five beeps will sound from the front or rear (depending on the object's location), or the driver's seat will pulse five times. Beeps for front are higher pitched than the rear.



**Turning the System On and Off**

The Park Assist System can be turned on or off using the infotainment system. To view available settings for this feature, touch the Settings icon on the infotainment home page. Select “Vehicle” to display the list of available options and select “Collision/ Detection Systems”.

The **PA** button is used to turn on or off the Park Assist, which also turns on or off the Backing Warning and Reverse Automatic Braking (RAB) at the same time. When the system is turned off, a system off message is shown on the display. This message disappears after a short period of time.

Turn off Park Assist when towing a trailer to prevent unwanted beeps and when a bike rack is attached to ensure proper operation.

**When the System Does Not Seem to Work Properly**

If a service message displays, check the following conditions:

- The sensors may not be clean. Keep the vehicle's front and rear bumpers free of mud, dirt, snow, ice, and slush. For cleaning instructions, see *Exterior Care* ⇨ 289.

- The Park Assist sensors may be covered by frost or ice. Frost or ice can form around and behind the sensors and may not always be seen; this can occur after washing the vehicle in cold weather. The message may not clear until the frost or ice has melted.

If a service message displays and the above conditions do not exist, take the vehicle to your dealer for repairs.

If the Park Assist System does not activate due to a temporary condition, a system off message is shown on the display. This can occur under the following conditions:

- The driver has disabled the system.
- An object is currently blocking the rear sensors (for example, bike rack, tailgate, trailer hitch, etc.). Once the object is removed, Park Assist will return to normal operation.
- The bumper is damaged. Take the vehicle to your dealer for repairs.
- Other conditions, such as vibrations from a jackhammer or the compression of air brakes on a very large truck, are affecting system performance.

**Automatic Parking Assist (APA)****Enhanced Automatic Parking Assist (APA)**

If equipped, under certain conditions APA with Braking can use sensors based on sonar technology along the vehicle's front, rear and sides to detect a parking spot, and automatically park or unpark the vehicle with some driver assistance. The vehicle will automatically maneuver into a detected spot moving at or near idle speed. It does this by automatically steering, braking, accelerating, and gear shifting. The driver must always be prepared to apply braking or additional acceleration, as needed. A display and audible beeps help to guide the parking maneuvers.

 **Warning**

APA may not always detect objects in the parking space, objects that are not rigid (e.g. shrubs and chain-link fences), objects below the bumper, objects high off the ground (e.g. flatbed trucks), hanging objects, objects below ground level (e.g. large potholes), or moving objects (e.g. pedestrians, cyclists, vehicles). Always verify that the parking space is

(Continued)

**Warning (Continued)**

appropriate for parking a vehicle. APA may not respond to changes in the parking space, such as movement of an adjacent vehicle, or a person or object entering the parking space. APA does not detect or avoid traffic that is behind or alongside of the vehicle. Always be prepared to stop the vehicle during the parking maneuver.

**How to Activate Automatic Parking**

To activate APA, press **P** on the infotainment screen for the system to begin searching for a parking space while driving forward at no greater than 30 km/h (18 mph). APA searches for parking spaces, to the left or right of the vehicle, up to the sensors' ranges of 1.5 m (5 ft). To search for a parking space to the left, turn on the left turn signal or, if available, change the side selection in the infotainment display. To choose or change the parking mode, make a selection on the infotainment display.

APA cannot park in all empty parking spots. The parking spot must:

- Be sufficiently large to fit the vehicle comfortably.
- Have an adjacent vehicle, wall, or pillar for the system to align to.

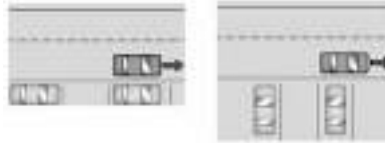

After completely passing an eligible parking spot, a beep sounds and a notification to stop the vehicle is displayed in the driver information center. Generally, APA selects the nearest empty parking spot behind the vehicle, but under some conditions may select a space that is further back. Slow down and bring the vehicle to a complete stop to begin.

Follow the displayed instructions. When the vehicle is ready to begin the maneuver, the steering wheel will vibrate briefly as a reminder to remove hands from the steering wheel. After the vibration stops, check your

surroundings and release the brakes to begin automatic parking. As the vehicle automatically steers, brakes, accelerates, and shifts gears into the parking spot, continue to check your surroundings. Be prepared to stop to avoid vehicles, pedestrians, or objects.

A progress bar displays the status of the parking maneuver. Once automatic parking is finished and the vehicle has come to a full stop, APA will beep and display a message indicating parking is complete.

**Automatic Parking****How to Activate Automatic Unparking**

To activate APA, press **P** on the infotainment screen after turning the vehicle on and leaving it in P (Park). A screen will be displayed with unparking options. Similar

to automatic parking, follow the displayed instructions and check surroundings as the vehicle un parks.

Once automatic un parking is finished and the vehicle has come to a full stop, FINAL POSITION - PRESS BRAKES will display. Press and hold the brakes. APA will beep and display TAKE CONTROL. The vehicle is now ready to exit the parking spot free of obstructions. Take control to drive away.



**Automatic Unparking**

### How to Cancel Automatic Parking/Unparking

To cancel automatic parking or automatic unparking at any time, press **P** or **X** on the infotainment display. Be prepared to resume full control of the vehicle. APA holds the vehicle until the parking brake or brake

is applied, or the vehicle is shifted into P (Park). To start driving away, press the brakes and shift into D (Drive).

Certain vehicle conditions and driver interferences may also cancel automatic parking:

- The driver manually steers the vehicle.
- The maximum allowed speed is exceeded.
- There is a failure with the APA system.
- Electronic stability control or antilock brakes are activated.
- The parking brake is applied.
- Driver unbuckles the seat belt and opens the door.

### System Limitations

Automatic Parking Assist has certain limitations. The system cannot:

- Continue to operate if the maneuver speed exceeds 5 km/h (3 mph).
- Detect whether a parking space is legal or restricted.
- Detect pavement markings or lines.
- Park the vehicle closely lined up with the vehicle next to it, particularly if the spot is approached at an angle or if the parking space is angled.
- Park exactly centered in a very large spot.

- Always detect short curbs.
- Operate while towing any trailer.
- Function the vehicle is raised or lowered by air suspension, if equipped.

### When the System Does Not Seem to Work Properly

If the vehicle does not reverse into the expected parking space, the system could be maneuvering the vehicle into a previously detected space.

### Remote Auto Parking

If equipped, the vehicle can complete the automatic parking maneuvers while the driver authorizes the maneuver via the myCadillac app on a compatible mobile phone outside of the vehicle. The driver can also activate an automatic parallel or perpendicular unparking maneuver via the myCadillac app. The driver must always be prepared to cancel the automatic maneuver if necessary.

Remote Auto Parking works the same way and has the same limitations as the standard APA feature described above. The main difference is that you must instead exit the vehicle and use the myCadillac app.

 **Warning**

When using the remote parking feature, stay within a short distance and visually monitor the vehicle until parking is complete. Do not leave the vehicle unsupervised during remote parking.

### How to Activate Remote Auto Parking

To activate Remote Auto Parking, press  on the infotainment screen for the system to begin searching for a parking space while driving forward at no greater than 30 km/h (18 mph). APA searches for parking spaces to the left or right of the vehicle up to the sensors' ranges of 1.5 m (5 ft). To choose or change the parking mode or side, make a selection in the infotainment display.

After completely passing an eligible parking spot, a beep sounds and a notification to stop the vehicle is displayed in the driver information center. Generally, Remote Auto Parking selects the nearest empty parking spot behind the vehicle, but under some conditions may select a space that is further back. Slow down and bring the vehicle to a complete stop to begin.

Follow the instructions in the vehicle's infotainment display. Select the option to supervise the maneuver remotely. When prompted, check all your belongings and exit the vehicle. Press and hold the authorization button on the myCadillac app to allow the maneuver to complete. As the vehicle automatically steers, brakes, accelerates, and shifts gears into the parking spot, stay in close proximity of the vehicle, and check surroundings. Be prepared to release the authorization button, or cancel the maneuver, to avoid vehicles, pedestrians, or objects.

Once automatic parking is finished and the vehicle has come to a full stop, a message will be displayed indicating parking is complete.

### How to Activate Remote Unparking

To activate the unparking maneuver remotely, launch Remote Auto Parking from myCadillac app. A screen will be displayed for unparking options. Similar to automatic parking, follow the displayed instructions, press and hold the authorization button, check surroundings as the vehicle unparks.

Once automatic unparking is finished and the vehicle has come to a full stop, a message will be displayed indicating

unparking is complete. The vehicle is now positioned such that the path to exit the parking spot is free of obstructions. Enter the vehicle to start driving away.

### How to Cancel Remote Automatic Parking or Automatic Unparking

To cancel automatic parking or automatic unparking at any time, press the cancel button on the myCadillac app. Remote Auto Parking applies the parking brake and shifts into P (Park) to hold the vehicle.

### Reverse Automatic Braking (RAB)

#### Backing Warning and Reverse Automatic Braking (RAB)

Vehicles with Adaptive Cruise Control (ACC) have the Backing Warning System and Reverse Automatic Braking (RAB) system. When in R (Reverse), Backing Warning alerts of rear objects at vehicle speeds greater than 8 km/h (5 mph), and RAB may automatically brake hard at speeds between 1–32 km/h (0.5–20 mph).

The Backing Warning System will beep once from the rear when an object is first detected, or pulse twice on both sides of the Safety Alert Seat. When the system detects a potential crash, beeps will be heard from

the rear, or five pulses will be felt on both sides of the Safety Alert Seat. There may also be a brief, sharp application of the brakes.

 **Warning**

The Backing Warning System only operates at speeds greater than 8 km/h (5 mph). It does not detect children, pedestrians, bicyclists, animals, or objects below the bumper or that are too close or too far from the vehicle. In some situations, such as at higher backing speeds, there may not be enough time for the short, sharp application of the vehicle brake system to occur. To prevent injury, death, or vehicle damage, even with the Backing Warning System, always check the area around the vehicle and check all mirrors before backing.

When the vehicle is in R (Reverse), if the system detects the vehicle is backing too fast to avoid a crash with a detected object behind your vehicle in your path, it may automatically brake hard to a stop to help avoid or reduce the harm caused by a backing crash.

 **Warning**

RAB may not avoid many types of backing crashes. Do not wait for the automatic braking to apply. This system is not designed to replace driver braking and only works in R (Reverse) when an object is detected directly behind the vehicle. It may not brake or stop in time to avoid a crash. It will not brake for objects when the vehicle is moving at very low speeds. It does not detect children, pedestrians, bicyclists, animals, or objects below the bumper or that are too close or too far from the vehicle. To prevent injury, death, or vehicle damage, even with RAB, always check the area around the vehicle before and while backing.

Pressing the brake pedal after the vehicle comes to a stop will release RAB. If the brake pedal is not pressed soon after the stop, the Electric Parking Brake (EPB) may be set. When it is safe, press the accelerator pedal firmly at any time to override RAB.

 **Warning**

There may be instances where unexpected or undesired automatic braking occurs. If this happens, either press the brake pedal or firmly press the accelerator pedal to release the brakes from the RAB system. Before releasing the brakes, check the RVC and check the area around the vehicle to make sure it is safe to proceed.

Unexpected braking events are possible with a static installed accessory, such as a bike rack or hitch-mounted cargo carrier.

### Rear Pedestrian Alert

If equipped, and under certain conditions, this feature can provide alerts for a pedestrian within the system's range directly behind the vehicle. This feature only works in R (Reverse) below 12 km/h (8 mph), and detects pedestrians up to 8 m (26 ft) away during daytime driving. During nighttime driving, feature performance is very limited.



### Rear Pedestrian Alert Indicator

When a pedestrian is detected within the system's range directly behind the vehicle, this symbol flashes amber on the infotainment display, along with five beeps from the rear, or if equipped, two pulses from both sides of the driver seat. When a pedestrian is detected close to the vehicle, the symbol flashes red on the infotainment display, along with ten beeps from the rear, or if equipped, seven pulses from both sides of the driver seat.

### Warning

Rear Pedestrian Alert does not automatically brake the vehicle. It also does not provide an alert unless it detects a pedestrian, and it may not detect all pedestrians if:

- The pedestrian is not directly behind the vehicle, fully visible to the Rear Vision Camera (RVC), or standing upright.
- The pedestrian is part of a group.
- The pedestrian is a child.
- Visibility is poor, including nighttime conditions, fog, rain, or snow.
- The RVC is blocked by dirt, snow, or ice.
- The RVC, taillamps, or back-up lamps are not cleaned or in proper working condition.
- The vehicle is not in R (Reverse).

(Continued)

### Warning (Continued)

To help avoid death or injury, always check for pedestrians around the vehicle before backing up. Be ready to take action and apply the brakes. See *Defensive Driving* ⇨ 160. Keep the RVC, taillamps, and back-up lamps clean and in good repair.

Rear Pedestrian Alert can be set to Off or Alert. To view available settings for this feature, touch the Settings icon on the infotainment home page. Select "Vehicle" to display the list of available options and select "Collision/Detection Systems".

If equipped, alerts can be set to beeps or seat pulses. To view available settings for this feature, touch the Settings icon on the infotainment home page. Select "Vehicle" to display the list of available options and select "Collision/Detection Systems".



## Rear Cross Traffic Alert (RCTA) System

If equipped, Rear Cross Traffic Alert (RCTA) displays a red warning triangle with a left or right pointing arrow on the infotainment display to warn of traffic coming from the left or right. This system detects objects coming from up to 20 m (65 ft) from the left or right side of the vehicle. When an object is detected, either three beeps sound from the left or right or three Safety Alert Seat pulses occur on the left or right side, depending on the direction of the detected vehicle.

Use caution while backing up when towing a trailer, as the RCTA detection zones that extend out from the back of the vehicle do not move farther back when a trailer is attached to the vehicle.

### Driving With a Trailer

Use caution while backing up when towing a trailer. The RCTA feature is automatically disabled when a trailer is attached to the vehicle.

## Rear Cross Traffic Braking (RCTB)

If equipped, the RCTB system shows a triangle with an arrow on the infotainment display to warn of traffic behind your vehicle that may cross your vehicle's path while in R (Reverse). In addition, beeps will sound, or the driver seat will pulse. If a collision is imminent, RCTB will provide automatic braking and bring the vehicle to a full stop to avoid crash.

### Turning the Features On or Off

The  button on the center stack is used to turn on or off the Front and Rear Park Assist, and Backing Warning and Reverse Automatic Braking (RAB) systems at the same time. The indicator light next to the button comes on when the features are on and turns off when the features have been disabled.

RCTA can be turned on or off using the infotainment system. To view available settings for this feature, touch the Settings icon on the infotainment home page. Select "Vehicle" to display the list of available options and select "Collision/Detection Systems".

## Assistance Systems for Driving

If equipped, when driving the vehicle in a forward gear, Forward Collision Alert (FCA), Lane Departure Warning (LDW), Lane Keep Assist (LKA), Side Blind Zone Alert (SBZA), Lane Change Alert (LCA), Automatic Emergency Braking (AEB), and/or the Front Pedestrian Braking (FPB) System can help to avoid a crash or reduce crash damage.

## Forward Collision Alert (FCA) System

If equipped, the FCA system may help to avoid or reduce the harm caused by front-end crashes. When approaching a vehicle ahead too quickly, FCA provides a red flashing alert on the windshield and rapidly beeps or pulses the driver seat. FCA also lights an amber visual alert if following another vehicle much too closely.

FCA detects vehicles within a distance of approximately 110 m (360 ft) and operates at all speeds.

**Warning**

FCA is a warning system and does not apply the brakes. When approaching a slower-moving or stopped vehicle ahead too rapidly, or when following a vehicle too closely, FCA may not provide a warning with enough time to help avoid a crash. It also may not provide any warning at all. FCA does not warn of pedestrians, animals, signs, guardrails, bridges, construction barrels, or other objects. Be ready to take action and apply the brakes. See *Defensive Driving* → 160.

FCA can be disabled through vehicle personalization. To view available settings for this feature, touch the Settings icon on the infotainment home page. Select “Vehicle” to display the list of available options and select “Collision/Detection Systems”.

**Detecting the Vehicle Ahead**

FCA warnings will not occur unless the FCA system detects a vehicle ahead. When a vehicle is detected, the vehicle ahead indicator will display green. Vehicles may not be detected on curves, highway exit ramps, or hills, due to poor visibility; or if a vehicle ahead is partially blocked by pedestrians or other objects. FCA will not detect another vehicle ahead until it is completely in the driving lane.

**Warning**

FCA does not provide a warning to help avoid a crash, unless it detects a vehicle. FCA may not detect a vehicle ahead if the FCA sensor is blocked by dirt, snow, or ice, or if the windshield is damaged. It may also not detect a vehicle on winding or hilly roads, or in conditions that can limit visibility such as fog, rain,  
(Continued)

**Warning (Continued)**

or snow, or if the headlamps or windshield are not cleaned or in proper condition. Keep the windshield, headlamps, and FCA sensors clean and in good repair.

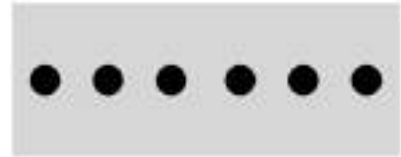
**Collision Alert**

When your vehicle approaches another detected vehicle too rapidly, the red FCA display will flash on the windshield. Also, eight rapid high-pitched beeps will sound from the front, or both sides of the Safety Alert Seat will pulse five times. Continue to apply the brake pedal as needed.

**Tailgating Alert**

The vehicle ahead indicator will display amber when you are following a vehicle ahead much too closely.

**Selecting the Alert Timing**

The Collision Alert control is on the steering wheel. Press  to set the FCA timing to Far, Medium, or Near. The first button press shows the current setting on the DIC. Additional button presses will change this setting. The chosen setting will remain until it is changed and will affect the timing of both the Collision Alert and the Tailgating Alert features. The timing of both alerts will vary based on vehicle speed. The faster the

vehicle speed, the farther away the alert will occur. Consider traffic and weather conditions when selecting the alert timing. The range of selectable alert timings may not be appropriate for all drivers and driving conditions.

If your vehicle is equipped with Adaptive Cruise Control (ACC), changing the FCA timing setting automatically changes the following gap setting (Far, Medium, or Near).

**Following Distance Indicator**

If equipped, the following distance to a moving vehicle ahead in your path is indicated in following time in seconds on the Driver Information Center (DIC). The minimum following time is 0.5 seconds away. If there is no vehicle detected ahead, or the vehicle ahead is out of sensor range, dashes will be displayed.

**Unnecessary Alerts**

FCA may provide unnecessary alerts for turning vehicles, vehicles in other lanes, objects that are not vehicles, or shadows. These alerts are normal operation and the vehicle does not need service.

**Cleaning the System**

If the FCA system does not seem to operate properly, this may correct the issue:

- Clean the outside of the windshield in front of the rearview mirror.
- Clean the entire front of the vehicle.
- Clean the headlamps.

**Automatic Emergency Braking (AEB)**

The AEB system may help avoid or reduce the harm caused by front-end crashes. AEB also includes Intelligent Brake Assist (IBA). When the system detects a vehicle ahead in your path that is traveling in the same direction that you may be about to crash into, it can provide a boost to braking or automatically brake the vehicle. This can help avoid or lessen the severity of crashes when driving in a forward gear. Depending on the situation, the vehicle may automatically brake moderately or hard. This automatic emergency braking can only occur if a vehicle is detected. This is shown by the FCA vehicle ahead indicator being lit. See *Forward Collision Alert (FCA) System* ⇨ 216.

The system works when driving in a forward gear above 4km/h (2 mph). It can detect vehicles up to approximately 60 m (197 ft).

### Warning

AEB is an emergency crash preparation feature and is not designed to avoid crashes. Do not rely on AEB to brake the vehicle. AEB will not brake outside of its operating speed range and only responds to detected vehicles.

AEB may not:

- Detect a vehicle ahead on winding or hilly roads.
- Detect all vehicles, especially vehicles with a trailer, tractors, muddy vehicles, etc.
- Detect a vehicle when weather limits visibility, such as in fog, rain, or snow.
- Detect a vehicle ahead if it is partially blocked by pedestrians or other objects.

Complete attention is always required while driving, and you should be ready to take action and apply the brakes and/or steer the vehicle to avoid crashes.

AEB may slow the vehicle to a complete stop to try to avoid a potential crash. If this happens, AEB may engage the Electric Parking Brake (EPB) to hold the vehicle at a stop. Release the EPB or firmly press the accelerator pedal.

### Warning

AEB may automatically brake the vehicle suddenly in situations where it is unexpected and undesired. It could respond to a turning vehicle ahead, guardrails, signs, and other non-moving objects. To override AEB, firmly press the accelerator pedal, if it is safe to do so.

### Intelligent Brake Assist (IBA)

IBA may activate when the brake pedal is applied quickly by providing a boost to braking based on the speed of approach and distance to a vehicle ahead.

Minor brake pedal pulsations or pedal movement during this time is normal and the brake pedal should continue to be applied as needed. IBA will automatically disengage only when the brake pedal is released.

### Warning

IBA may increase vehicle braking in situations when it may not be necessary. You could block the flow of traffic. If this occurs, take your foot off the brake pedal and then apply the brakes as needed.

### Warning

Using AEB or IBA while towing a trailer could cause you to lose control of the vehicle and crash. Turn the system to Alert or Off when towing a trailer.

AEB and IBA can be disabled through vehicle personalization. To view available settings for this feature, touch the Settings icon on the infotainment home page. Select “Vehicle” to display the list of available options and select “Collision/Detection Systems”.

A system unavailable message may display if:

- The front of the vehicle or windshield is not clean.
- Heavy rain or snow is interfering with object detection.

- There is a problem with the StabiliTrak system.

The AEB system does not need service.

### Front Pedestrian Braking (FPB) System

If equipped, the FPB system may help avoid or reduce the harm caused by front-end crashes with pedestrians near the forward path of the vehicle when driving in a forward gear. FPB displays an amber indicator, , when a nearby pedestrian is detected ahead. When approaching a detected pedestrian too quickly, FPB provides a red flashing alert on the windshield and rapidly beeps or pulses the driver seat. FPB can provide a boost to braking or automatically brake the vehicle. This system includes Intelligent Brake Assist (IBA), and the Automatic Emergency Braking (AEB) system may also respond to pedestrians. See *Automatic Emergency Braking (AEB)* ⇨ 218.

The FPB system can detect and alert to pedestrians in a forward gear at speeds between 8 km/h (5 mph) and 80 km/h (50 mph). During daytime driving, the system detects pedestrians up to a distance

of approximately 40 m (131 ft). During nighttime driving, system performance is very limited.

#### Warning

FPB does not provide an alert or automatically brake the vehicle, unless it detects a pedestrian. FPB may not detect pedestrians, including children:

- When the pedestrian is not directly ahead, fully visible, or standing upright, or when part of a group.
- Due to poor visibility, including nighttime conditions, fog, rain, or snow.
- If the FPB sensor is blocked by dirt, snow, or ice.
- If the headlamps or windshield are not cleaned or in proper condition.

Be ready to take action and apply the brakes. For more information, see *Defensive Driving* ⇨ 160. Keep the windshield, headlamps, and FPB sensor clean and in good repair.

FPB can be set to Off, Alert, or Alert and Brake through vehicle personalization. To view available settings for this feature, touch the Settings icon on the infotainment home page. Select “Vehicle” to display the list of available options and select “Collision/Detection Systems”.

### Detecting the Pedestrian Ahead



FPB alerts and automatic braking will not occur unless the FPB system detects a pedestrian. When a nearby pedestrian is detected in front of the vehicle, the pedestrian ahead indicator will display amber.

### Front Pedestrian Alert



When the vehicle approaches a pedestrian ahead too rapidly, the red FPB alert display will flash on the windshield. Eight rapid high-pitched beeps will sound from the front, or both sides of the Safety Alert Seat will pulse five times. When this Pedestrian Alert occurs, the brake system may prepare for driver braking to occur more rapidly which can cause a brief, mild deceleration. Continue to apply the brake pedal as needed. Cruise control may be disengaged when the Front Pedestrian Alert occurs.

### Automatic Braking

If FPB detects it is about to crash into a pedestrian directly ahead, and the brakes have not been applied, FPB may automatically brake moderately or brake hard. This can help to avoid some very low speed pedestrian crashes or reduce pedestrian injury. FPB can automatically brake to detected pedestrians between 8 km/h (5 mph) and 80 km/h (50 mph). Automatic braking levels may be reduced under certain conditions, such as higher speeds.

If this happens, Automatic Braking may engage the Electric Parking Brake (EPB) to hold the vehicle at a stop. Release the EPB. A firm press of the accelerator pedal will also release Automatic Braking and the EPB.

If equipped with the Night Vision system, pedestrians detected by the Night Vision system will not cause automatic braking to occur.

### Warning

FPB may alert or automatically brake the vehicle suddenly in situations where it is unexpected and undesired. It could falsely alert or brake for objects similar in shape or size to pedestrians, including shadows. This is normal operation and the vehicle does not need service. To override Automatic Braking, firmly press the accelerator pedal, if it is safe to do so.

Automatic Braking can be disabled through vehicle personalization. To view available settings for this feature, touch the Settings icon on the infotainment home page. Select “Vehicle” to display the list of available options and select “Collision/Detection Systems”.

### Warning

Using the Front Pedestrian Braking system while towing a trailer could cause you to lose control of the vehicle and crash. Turn the system to Alert or Off when towing a trailer.

### Cleaning the System

If FPB does not seem to operate properly, cleaning the outside of the windshield in front of the rearview mirror may correct the issue.

### Side Blind Zone Alert (SBZA)

If equipped, the SBZA system is a lane-changing aid that assists drivers with avoiding crashes that occur with moving vehicles in the side blind zone, or blind spot areas. When the vehicle is in a forward gear, the left or right side mirror display will light up if a moving vehicle is detected in that blind zone. If the turn signal is activated and a vehicle is also detected on the same side, the display will flash as an extra warning not to change lanes. Since this system is part of the Lane Change Alert (LCA) system, read the entire LCA section before using this feature.

## Lane Change Alert (LCA)

If equipped, the LCA system is a lane-changing aid that assists drivers with avoiding lane change crashes that occur with moving vehicles in the side blind zone (or spot) areas or with vehicles rapidly approaching these areas from behind. The LCA warning display will light up in the corresponding outside mirror and will flash if the turn signal is on.

Side Blind Zone Alert (SBZA) is included as part of the LCA system.

### Warning

LCA does not alert the driver to vehicles outside of the system detection zones, pedestrians, bicyclists, or animals. It may not provide alerts when changing lanes under all driving conditions. Failure to use proper care when changing lanes may result in injury, death, or vehicle damage. Before making a lane change, always check mirrors, glance over your shoulder, and use the turn signals.

### LCA Detection Zones

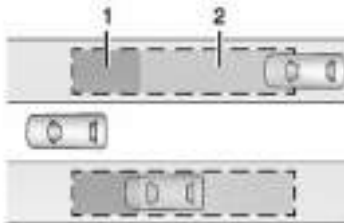

1. SBZA Detection Zone
2. LCA Detection Zone

The LCA sensor covers a zone of approximately one lane over from both sides of the vehicle, or 3.5 m (11 ft). The height of the zone is approximately between 0.5 m (1.5 ft) and 2 m (6 ft) off the ground. The Side Blind Zone Alert (SBZA) warning area starts at approximately the middle of the vehicle and goes back 5 m (16 ft). Drivers are also warned of vehicles rapidly approaching from up to 70 m (230 ft) behind the vehicle.

### How the System Works

The LCA symbol lights up in the side mirrors when the system detects a moving vehicle in the next lane over that is in the side blind zone or rapidly approaching that zone from behind. A lit LCA symbol indicates it may be unsafe to change lanes. Before making a lane change, check the LCA display, check mirrors, glance over your shoulder, and use the turn signals.



Left Side Mirror  
Display



Right Side Mirror  
Display

When the vehicle is started, both outside mirror LCA displays will briefly come on to indicate the system is operating. When the vehicle is in a forward gear, the left or right side mirror display will light up if a moving vehicle is detected in the next lane over in that blind zone or rapidly approaching that zone. If the turn signal is activated in the

same direction as a detected vehicle, this display will flash as an extra warning not to change lanes.

LCA can be disabled through vehicle personalization. To view available settings from the infotainment screen, touch Settings > Vehicle > Collision/Detection Systems. If LCA is disabled by the driver, the LCA mirror displays will not light up.

### When the System Does Not Seem to Work Properly

The LCA system requires some driving for the system to calibrate to maximum performance. This calibration may occur more quickly if the vehicle is driven on a straight highway road with traffic and roadside objects (e.g., guardrails, barriers).

LCA displays may not come on when passing a vehicle quickly or for a stopped vehicle. LCA may alert to objects attached to the vehicle, such as a bicycle, or object extending out to either side of the vehicle. Attached objects may also interfere with the detection of vehicles. This is normal system operation; the vehicle does not need service.

LCA may not always alert the driver to vehicles in the next lane over, especially in wet conditions or when driving on sharp

curves. The system does not need to be serviced. The system may light up due to guardrails, signs, trees, shrubs, and other non-moving objects. This is normal system operation; the vehicle does not need service.

LCA may not operate when the LCA sensors in the left or right corners of the rear bumper are covered with mud, dirt, snow, ice, or slush, or in heavy rainstorms. For cleaning instructions, see "Washing the Vehicle" under *Exterior Care* ⇨ 289. If the DIC still displays the system unavailable message after cleaning both sides of the vehicle toward the rear corners of the vehicle, see your dealer.

If the LCA displays do not light up when moving vehicles are in the side blind zone or rapidly approaching this zone and the system is clean, the system may need service. Take the vehicle to your dealer.

### Driving with a Trailer

If equipped with Lane Change Alert (LCA), the LCA detection zones that extend back from the side of the vehicle do not move further back when a trailer is towed.

Use caution while changing lanes when towing a trailer.

### Bicycle Detection

If equipped, the system may detect a bicyclist approaching from the side or rear of the vehicle.

If this occurs, a chime will sound in the direction of the detection, and the Safety Alert Seat will pulse if enabled through vehicle settings. To view available settings from the infotainment screen, touch Settings > Vehicle > Collision/Detection Systems.

Bicyclist Detection is available when the vehicle is in D (Drive), P (Park), and for a short time after the vehicle is turned off.

If the vehicle detects a bicyclist when it is off, a DIC message may display and alert to the direction of the detection. In some cases, an Unavailable message may display. This is normal and does not mean that the system is broken.

### Detection Zones

When the vehicle is in P (Park) or is turned off, a bicyclist can be detected 11 m (36 ft) behind the vehicle or 10 m (33 ft) to the side of the vehicle.

When the vehicle is in D (Drive), a bicyclist can be detected 3 m (10 ft) behind the vehicle or to the side of the vehicle.



**Turning the Feature On or Off**



Bicyclist Detection can be turned on or off through vehicle settings. To view available settings from the infotainment screen, touch Settings > Vehicle > Collision/Detection Systems.

**Blind Zone Steering Assist (BZSA)**

If equipped, the Blind Zone Steering Assist (BZSA) system can detect a potential crash with a moving vehicle in the lane you are entering. It provides a brief, urgent turn of the steering wheel to alert you to take action to avoid a collision.

BZSA works with the Lane Keep Assist (LKA). BZSA operates when the vehicle is in a forward gear, and only when LKA is enabled and able to assist. See *Lane Keep Assist (LKA)* ⇨ 224.

BZSA will provide a steering correction when your vehicle is about to leave the current lane of travel, with the possibility of a collision with a vehicle in the adjacent lane. This steering correction happens closer to the center of the lane and has a stronger steering correction than LKA. Unlike LKA, the steering correction with BZSA will happen even if your turn signal is on in the direction of lane departure.

In addition to the BZSA steering intervention, the  will turn amber, six beeps or six seat pulses will occur, if equipped with Safety Alert Seat, and  or  will flash on the outside rear view mirror.

** Warning**

**Do not rely on Blind Zone Steering Assist (BZSA) to prevent crashes. This system does not replace the need to pay attention and drive safely. Failure to use proper care when driving may result in vehicle damage, injury, or death.**

- BZSA performance may be affected by weather and road conditions.
- BZSA does not provide steering assistance to avoid a vehicle that is in, or has entered, your lane of travel.
- BZSA will not prevent a towed trailer from crossing into the adjacent lane. Always monitor the trailer position while towing to ensure it is in the same lane as your vehicle. BZSA is only designed to detect when your vehicle unintentionally crosses detected lane lines.

**Lane Keep Assist (LKA)**

If equipped, LKA may help avoid crashes due to unintentional lane departures. This system uses a camera to detect lane markings. The LKA may be ready to assist at speeds between 60 km/h (37 mph) and 180 km/h (112 mph). On some vehicles, the system will instead operate above 50 km/h (31 mph). LKA may assist by gently turning the steering wheel if the vehicle approaches a detected lane marking. It may also provide a Lane Departure Warning (LDW) alert if the vehicle crosses a detected lane marking. This system is not intended to keep the vehicle centered in the lane. LKA will not assist and alert if the turn signal is active, or if it detects that you are accelerating, braking or actively steering. LKA can be overridden by turning the steering wheel. If the system detects you are steering intentionally across a lane marker, the LDW will not be given. Do not expect the LDW to occur when you are intentionally crossing a lane marker.

 **Warning**

The LKA system does not continuously steer the vehicle. It may not keep the vehicle in the lane or give a Lane Departure Warning (LDW) alert, even if a lane marking is detected.

The LKA and LDW systems may not:

- Provide an alert or enough steering assist to avoid a lane departure or crash.
- Detect lane markings under poor weather or visibility conditions. This can occur if the windshield or headlamps are blocked by dirt, snow, or ice; if they are not in proper condition; or if the sun shines directly into the camera.
- Detect road edges.
- Detect lanes on winding or hilly roads.

If LKA only detects lane markings on one side of the road, it will only assist or provide an LDW alert when approaching the lane on the side where it has detected a lane marking. Even with LKA and LDW, you must steer the vehicle.

(Continued)

**Warning (Continued)**

Always keep your attention on the road and maintain proper vehicle position within the lane, or vehicle damage, injury, or death could occur. Always keep the windshield, headlamps, and camera sensors clean and in good repair. Do not use LKA in bad weather conditions or on roads with unclear lane markings, such as construction zones.

 **Warning**

Using LKA on slippery roads could cause loss of control of the vehicle and a crash. Turn the system off.





 **Warning**

LKA will not alert the driver if a towed trailer crosses into an adjacent lane of travel. Serious injury or property damage may occur if the trailer moves into another lane. Always monitor the trailer position while towing to make sure it is within the same lane as the tow vehicle.

**How the System Works**

LKA uses a camera sensor installed on the windshield ahead of the rearview mirror to detect lane markings. It may provide brief steering assist if it detects an unintended lane departure. It may further provide an audible alert or the driver seat may pulse indicating that a lane marking has been crossed. The system does not provide a Lane Departure Warning (LDW) when intentionally steering across a lane marker.

To turn LKA on and off, press  on the center console. If equipped, the indicator light on the button comes on when LKA is on and turns off when LKA is disabled. On some vehicles, a long press of over three seconds is required to turn LKA off.

When on,  is white, if equipped, indicating that the system is not ready to assist.  is green if LKA is ready to assist. LKA may assist by gently turning the steering wheel if the vehicle approaches a detected lane marking.  is amber when assisting. It may also provide a Lane Departure Warning (LDW) alert by flashing  amber if the vehicle crosses a detected lane marking. Additionally, there may be

three beeps, or the driver seat may pulse three times, on the right or left, depending on the lane departure direction.

### Take Steering

The LKA system does not continuously steer the vehicle. If LKA does not detect active driver steering, an alert and chime may be provided. Steer the vehicle to dismiss. LKA may become temporarily unavailable after repeated take steering alerts.

### When the System Does Not Seem to Work Properly

The system performance may be affected by:

- Close vehicles ahead
- Sudden lighting changes, such as when driving through tunnels
- Banked roads
- Roads with poor lane markings, such as two-lane roads

If the LKA system is not functioning properly when lane markings are clearly visible, cleaning the windshield may help.

A camera blocked message may display if the camera is blocked. Some driver assistance systems may have reduced performance or not work at all. An LKA or

LDW unavailable message may display if the systems are temporarily unavailable. This message could be due to a blocked camera. The LKA system does not need service. Clean the outside of the windshield behind the rearview mirror.

LKA assistance and/or LDW alerts may occur due to tar marks, shadows, cracks in the road, temporary or construction lane markings, or other road imperfections. This is normal system operation; the vehicle does not need service. Turn LKA off if these conditions continue.

### Surround Vision Recorder

If equipped, this system records the 360° camera views to an SD card. Only images are recorded, no sound. An SD card will be needed for this system. The minimum recommended SD card specifications are at least 64GB with exFAT file system, Class V30 or greater.

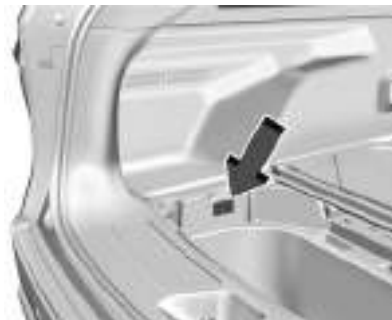

Insert the SD card into the card reader in the rear compartment. Disable the system from the playback screen before removing the SD card from the reader. Do not remove the card while recording is enabled. This could corrupt the video file and/or the SD card.

Other files should not be stored on the same SD card as the surround vision recorder files. Storing other files on the same card may increase recording start up and playback time or result in a loss of data.



**To Activate :** Touch Video Recorder on the Home Page. Touch the red dot. The red dot will illuminate when the video recorder is on. It will remain on until it has been turned off. Recording will start after exiting the playback screen. Advise other drivers and occupants of the vehicle that video images are being recorded.

**To Deactivate :** Touch Video Recorder on the Home Page. Touch the red dot.

Select from the following when the vehicle is in P (Park).

**Exit :** Touch X to exit this application and return to the previous app.

**Video List :** Touch to display a list of the most recent and saved videos. Touch the delete button next to the name to delete a saved video.

**Rewind :** Touch to rewind the video. Touch again up to three times to increase speed. Touch a fourth time to stop rewinding.

**Play/Pause :** Touch to play or pause a recorded video.

**Fast Forward :** Touch to fast forward the video. Touch again up to three times to increase speed. Touch a fourth time to stop fast forward.

**Save :** Touch to save a video. This protects the video from being erased. Once the SD card is full, the oldest files will be overwritten unless they have been saved.

**Camera Views :** When opening the Video Recorder, the previous file will show all camera views and can be played. Icons in the upper right corner of each view indicate which camera. Touch one of the views to zoom to only that camera view. Touch again to return to all camera views. Press X at any time to exit the video recorder app.

The latest recorded video file can be played. In addition:

- The recorded video is stored in five-minute-long files.

- All files can be viewed on the playback app or when the SD card is read by a personal computer (PC).
- Once the SD card is full, the oldest files will be overwritten.

**To Delete Data :** Remove the SD card from the vehicle and insert into a PC to manually delete the file.

Error messages can occur if:

- No SD card is present.
- An empty SD card is present.
- The video files are the wrong format.
- The video files are corrupt.
- The SD card is full.
- There is a system error.

Other files should not be stored on the same SD card as the surround vision recorder files. Storing other files on the same card may increase recording start up and playback time or result in a loss of data. An error message may be displayed if no surround vision recorded video file is available for playback.

## Charging

### When to Charge

When the high voltage battery is low, the following charging messages may display on the Driver Information Center (DIC):

**CHARGE VEHICLE SOON** : The battery needs to be charged soon.

**REDUCED ACCELERATION DRIVE WITH CARE** : The accelerator pedal response is reduced and the remaining range value changes to LOW, charge the vehicle immediately. See *Propulsion Power Messages* ⇨ 110.

**OUT OF ENERGY, CHARGE VEHICLE NOW** : The battery charge is fully depleted. The vehicle will slow to a stop. Brake and steering assist will continue operating. Once stopped, turn the vehicle off.

### Plug-In Charging

Plug-in charge times vary based on the battery condition, charge level, and the outside temperature. See *Charging* ⇨ 101 for charge mode selection.

Do not allow the vehicle to remain in temperature extremes for long periods without being driven or plugged in. When

temperatures are below 0 °C (32 °F) and above 32 °C (90 °F), plug in the vehicle to maximize high voltage battery life.

In extreme temperature conditions, a full charge will take additional time.

Charging will slow down as the battery fills up. Charge the battery to 80% for daily driving, or when driving in mountainous terrain. The vehicle can be charged above 80% for long trips when not driving in mountainous terrain.

It is normal to hear fans, pumps, and electrical devices clicking while the vehicle is turned off and charging.

The vehicle does not require indoor charging area ventilation before, during, or after charging.

The vehicle cannot be driven while the charge cord is plugged into the vehicle.

#### Caution

To avoid damage to the vehicle, make sure the charging cord plug is in good condition, is not worn or damaged, and is connected securely to the vehicle's charging port. If vehicle charging is

(Continued)

#### Caution (Continued)

intermittent, disconnect the cord and inspect for damage. An excessively worn or damaged AC or DC charging cord plug may result in an intermittent connection and potential damage to the vehicle's charging port.

There are several infotainment screens that will display depending on the current charging status. See *Charging* ⇨ 101.

### Charging Override

A CHARGING OVERRIDE/INTERRUPTION OCCURRED message may display to indicate that a charging override or interruption has occurred due to one or more of the following events:

- Override of the charge settings by the owner.
- Unintended interruption of AC power at the vehicle's charge port.
- Interruption of charging by the utility company.

## AC Charging (If Equipped)

A loss of AC power alert may sound for a short time if AC power is lost for over one minute. This sound alert can be turned off. See *Charging* ⇨ 101.



AC Charge Cord Vehicle Plug

### To Start AC Charging

1. Put the vehicle in P (Park).



2. Push the top right corner of the charge port door and release to open the door.

In cold weather conditions, ice may form around the charge port door. Remove ice from the area before attempting to open or close the charge port door.



### Without Super Cruise, With Super Cruise Similar

3. Open the liftgate, lift the load floor cover, and remove the charge cord.
4. Plug the charge cord into the electrical outlet. To verify the charge cord status, see *Electrical Requirements for Battery Charging* ⇨ 237 and *Charge Cord* ⇨ 234. For instructions to set cord limit settings for a charge session, see *Charging* ⇨ 101.

5. Plug in the AC charge cord into the vehicle charge port. Make sure the AC vehicle plug is fully connected to the AC charge port. If it is not properly connected, the vehicle may not be charged.
6. Verify that the charge status light turns on and an audible chirp occurs. See *Charging Status Feedback* ⇨ 233.

### To End AC Charging

1. Unlock the charge cord from the vehicle by pressing the button on the top of the charge cord plug. Unplug the charge cord from the vehicle. The charge port door will automatically close when the charge cord is unplugged.



2. Press the button to manually close the charge port door.
3. Unplug the charge cord from the electrical outlet.
4. Place the charge cord into the storage compartment.

### DC Charging

#### DC Charging Station Hardware

The vehicle can be charged using DC charging equipment typically found at service stations and other public locations.

Check the charging station DC vehicle plug for compatibility with the DC charge port on this vehicle. This vehicle is compatible with a Combined Charging System 1 (CCS1) connector.

When recharging at a DC charge station, the charging cable connected to the vehicle must be less than 10 m (33 ft) in length to meet functionality and regulatory requirements.

#### Warning

Do not use the charging station if the handle has defects such as cracks, exposed wires, burnt or missing pins, or any other damage. A damaged handle may result in personal injury and/or damage to the vehicle, the charging port or other property.

For maximum charging performance, and to prevent charging interruptions or damage to the high voltage battery and vehicle:

- Remove your hands from the charging handle once it has been plugged in. If not done, this can cause a charging interruption.
- Ensure that the charge cord plug clicks.

Follow the steps listed on the charging station to perform a DC vehicle charge.

If for any reason DC charging does not begin or is interrupted, check the DC charging station display for messages. Unplug the cord to restart the DC charging process.

### To Start DC Charging

1. Put the vehicle in P (Park).
2. Press the Electric Parking brake (EPB) switch. See *Electric Parking Brake* ⇨ 175.



3. Push the rearward edge of the charge port door and release to open the door.

In cold weather conditions, ice may form around the charge port door. The charge port door may not open on the first attempt. Remove ice from the area and repeat attempting to open the charge port door.



4. Unlatch the DC charging dust cover and lower it fully.
5. Plug in the DC charge cord into the vehicle charge port. Make sure that the DC vehicle plug is fully connected to the DC charge port. If it is not properly connected, the vehicle may not be charged. Check the Driver Information Center (DIC) to make sure the vehicle plug is connected properly.

6. Follow the steps listed on the charging station to start charging.
7. When charging is active, the DC vehicle plug is locked to the DC charge port and cannot be disconnected.
8. Verify that the charge status light turns on and an audible chirp occurs. See *Charging Status Feedback* ⇨ 233.

### Caution

Do not attempt to disconnect the DC vehicle plug while charging is active. This action may damage the vehicle or charging station hardware.

### To Stop DC Charging — Automatic

When the vehicle no longer needs power from the charging station, it stops charging and the DC vehicle plug unlocks from the DC charge port.

Energy can still be consumed from the charging station when the vehicle displays and indicators show that the battery is fully charged. This is to ensure the battery is in optimal temperature operating range to maximize vehicle range. See *Charging* ⇨ 101.



### To End DC Charging

When the vehicle is fully charged, charging automatically stops and the plug unlocks. You can also manually stop charging using the button on the DC vehicle plug, the controls at the charging station or by tapping "Stop" on the Charging page on your infotainment screen.

If the vehicle plug does not unlock from the vehicle charge port after a charge, contact Roadside Assistance. See *Roadside Assistance Program* ⇨ 307.

1. Unplug the DC vehicle plug from the DC charge port on the vehicle and close the dust cover.
2. The charge port door will automatically close when the charge cord is unplugged.



3. Press the button to manually close the charge port door.
4. Manually disengage the Electric Parking Brake (EPB) before driving the vehicle.

### To Stop AC or DC Charging

Controls on the charging station can be used to stop the charge process at any time.

To stop charging when inside the vehicle, use the Stop Charge button on the Charging screen. See "Active Charging" under *Charging* ⇨ 101.

### Delayed Charging Override

To temporarily override a delayed charge event, unplug the charge cord from the charge port and then plug it back in within five seconds. A single audible chirp will sound and charging will begin immediately.

To cancel a temporary override, unplug the charge cord, wait for 10 seconds, and then plug the charge cord back in. A double audible chirp will sound and charging will be delayed.

See *Charging* ⇨ 101 for advanced charge scheduling options.

## Charging Status Feedback

The vehicle is equipped with a charge status light.



When the charge cord is plugged in, a color appears to indicate the charging status.

Refer to the table for charging status feedback:

Charge Status Light Color	Sound	Action/Reason
Solid Blue	–	Initial connection is successful.
Pulsing Blue	Two audible chirps	Charging is delayed by charging screen or by a total utility interruption. Charging will begin later. See <i>Utility Interruption of Charging</i> ⇨ 237. Utility Override (“Demand Response”).
Blinking Green (the longer the blink, the higher the state of charge)	One audible chirps	Vehicle is actively charging.
Solid Green	None	Charging is complete.
Pulsing Red	None	Error Check the charge cord connection. There may be no power supplied to the vehicle.

Charge Status Light Color	Sound	Action/Reason
None (upon plug-in)	None	Check the charge cord connection.
None (after blue and green lights up)	None	Check the charge cord connection. If the connection is good, this may indicate a power failure or a total utility interruption, and charging will begin later. It may also occur if a high voltage charging system fault is detected. See <i>Utility Interruption of Charging</i> ⇨ 237 or <i>Service Vehicle Soon Light</i> ⇨ 94.
None	Three audible chirps when the driver door is opened	The charge port door is open.
Flashing Green (the longer the blink, the higher the state of charge)	Four audible chirps	The currently set departure time cannot be met. May be due to charging power level or charge schedule setting factors. Refer to the charging screen for actual charge completion time. See <i>Charging</i> ⇨ 101.

## Charge Cord

### IMPORTANT SAFETY INSTRUCTIONS



This symbol indicates risk of electrical shock.

See *Radio Frequency Statement* ⇨ 312.

The vehicle comes with a portable charge cord used to charge the high voltage battery. The charge cord is stored under the load floor in the rear cargo area.



1. 120 Volt Wall Plug (240 Volt Plug Similar)
2. Charge Cord Status Indicator
3. Vehicle Plug Latch
4. Release Button

### Important Information about Portable Electric Vehicle Charging

- Charging an electric vehicle can stress a building's electrical system more than a typical household appliance.
- Before plugging into any electrical outlet, have a qualified electrician inspect and verify the electrical system (electrical outlet, wiring, junctions, and protection devices) for heavy-duty service at a 12 amp continuous load for 120 Volt charge and 32 amp for 240 Volt Charge.
- Electrical outlets may wear out with normal usage or may be damaged over time, making them unsuitable for electric vehicle charging.
- Check the electrical outlet/plug while charging and discontinue use if the electrical outlet/plug is hot, then have the electrical outlet serviced by a qualified electrician.

- When outdoors, plug into an electrical outlet that is weatherproof while in use.
- Mount the charge cord to reduce strain on the electrical outlet/plug.
- Do not place the charge cord in a position where it may be submerged in water.

### Danger

Improper use of portable electric vehicle charge cords may cause a fire, electrical shock, or burns, and may result in damage to property, serious injury, or death.

- Do not use extension cords, multi-outlet power strips, splitters, grounding adapters, surge protectors, or similar devices.
- Do not use an electrical outlet that is worn or damaged, or will not hold the plug firmly in place.
- Do not use an electrical outlet that is not properly grounded.
- Do not use an electrical outlet that is on a circuit with other electrical loads.

### Warning

When using electric products, basic precautions should always be followed, including the following:

- Read all the safety warnings and instructions before using this product. Failure to follow the warnings and the instructions may result in electric shock, fire, and/or serious injury.
- Never leave children unattended near the vehicle while the vehicle is charging and never allow children to play with the charge cord.
- If the plug provided does not fit the electrical outlet, do not modify the plug. Arrange for a qualified electrician to inspect the electrical outlet.
- Do not put fingers into the electric vehicle connector.

### Warning

- To reduce the risk of fire, installations shall comply with the requirements of National Electric Code, ANSI/NFPA 70 (USA), Canadian Electrical Code CSA

(Continued)

**Warning (Continued)**

22.1 and IEC 60364 – Electrical installations in buildings, depending on the region in which the unit is being installed. The installer shall comply with any additional local requirements mandated by the country and/or municipality.

- Do not use this product if the flexible power cord or the electric vehicle cable is frayed, has broken insulation, or shows any other signs of damage.
- For Canada only: Not for use in commercial garages.
- Do not use this product if the enclosure or the vehicle plug is broken, cracked, open, or shows any other indication of damage.
- The plug must be plugged into an appropriate electrical outlet that is properly installed in accordance with all local codes and ordinances. Do not modify the plug provided with the product. If the plug does not fit the electrical outlet, have a proper electrical outlet installed by a qualified electrician. If ground is missing, the

(Continued)

**Warning (Continued)**

charge cord indicators will indicate an electrical system fault and the vehicle may not charge.

**Charge Cord Status Indicators**

After plugging in the charge cord, it will perform a quick self test.

Verify the charge cord status. The charge cord uses a combination of red, blue, and yellow indicators to display the status of the charge cord.

If the status indicator is not lit, ensure the electrical outlet has power.

**Charge Level Selection**

Charge level selection can be made using the Charging tab in the Energy Application on the infotainment display. For instructions to set cord limit settings for a charge session, see *Charging* ⇨ 101.

** Warning**

Using a charge level that exceeds the electrical circuit or electrical outlet capacity may start a fire or damage the

(Continued)

**Warning (Continued)**

electrical circuit. Use the lowest charge level until a qualified electrician inspects the electrical circuit capacity. Use the lowest charge level if the electrical circuit or electrical outlet capacity is not known.

**Grounding Instructions**

The charge circuit must be grounded. If the charge circuit should malfunction or break down, grounding provides a path of least resistance for the electric current to reduce the risk of electric shock. This product is equipped with a cord that has an equipment grounding conductor and a grounding plug. The plug must be plugged into an appropriate outlet that is properly installed and grounded in accordance with all local codes and ordinances.

** Warning**

Improper connection of the charge cord ground may cause electrical shock. Check with a qualified electrician if there is doubt as to whether the charge circuit is properly grounded. Do not modify the

(Continued)

**Warning (Continued)**

plug provided with the product. If it will not fit the electrical outlet, have a proper electrical outlet installed by a qualified electrician.

**FCC Information**

See *Radio Frequency Statement* ⇨ 312.

**Utility Interruption of Charging**

This vehicle responds to requests through the utility company to limit or completely block electrical power grid use. This feature is inactive during DC charging. A utility interruption will lengthen the vehicle charge time.

When electrical grid power is completely blocked, the vehicle will not charge until the utility interruption has expired. The vehicle should be left plugged in so that the vehicle will automatically resume charging.

Changing the charge mode to Charge Now or performing a delayed charging override will not disable a utility interruption.

A message will display on the instrument cluster indicating that a utility interruption has occurred.

**Electrical Requirements for Battery Charging**

This vehicle is compatible with most vehicle charging equipment that complies with one or more of the following standards:

- SAE J1772
- SAE J2847-2
- IEC 61851-1
- IEC 61851-22
- IEC 61851-23
- IEC 61851-24
- IEC 62196-1
- IEC 62196-2
- IEC 62196-3

The portable charge cord requires a circuit capacity as follows:

**Minimum** : 120 volt system – 15 amps

**Maximum** : 240 volt system – 50 amps

**Caution**

Do not use portable or stationary backup generating equipment to charge the vehicle. This may cause damage to the vehicle's charging system. Only charge the vehicle from utility supplied power.

**Trailer Towing****General Towing Information**

Only use towing equipment that has been designed for the vehicle. Contact your dealer or trailering dealer for assistance with preparing the vehicle to tow a trailer. Read the entire section before towing a trailer.

To tow a disabled vehicle, see *Transporting a Disabled Vehicle* ⇨ 287. To tow the vehicle behind another vehicle such as a motor home, see *Recreational Vehicle Towing* ⇨ 289.

**Driving Characteristics and Towing Tips** **Warning**

You can lose control when towing a trailer if the correct equipment is not used or the vehicle is not driven properly. For example, if the trailer is too heavy or the trailer brakes are inadequate for the load, the vehicle may not stop as expected. You and others could be seriously injured. The vehicle may also be damaged, and the repairs would not be

(Continued)

**Warning (Continued)**

covered by the vehicle warranty. Pull a trailer only if all the steps in this section have been followed. Ask your dealer for advice and information about towing a trailer with the vehicle.

**Driving with a Trailer**

Trailer is different than just driving the vehicle by itself. Trailering affects handling, acceleration, braking, and durability. Successful and safe trailering requires proper use of the correct equipment.

The following information has many time-tested, important trailering tips and safety rules. Many of these are important for your safety and that of your passengers. Read this section carefully before towing a trailer.

When towing a trailer:

- Become familiar with and follow all state and local laws that apply to trailer towing. These requirements vary from state to state.

- State laws may require the use of extended side view mirrors. Even if not required, you should install extended side view mirrors if your visibility is limited or restricted while towing.
- Do not tow a trailer during the first 800 km (500 mi) of vehicle use to prevent damage to vehicle.
- During the first 800 km (500 mi) of trailer towing, do not drive over 80 km/h (50 mph) and do not make starts at full throttle.
- Vehicles can tow in D (Drive).

If equipped, the following driver assistance features should be turned off when towing a trailer:

- Park Assist
- Automatic Parking Assist (APA)
- Reverse Automatic Braking (RAB)

If equipped, the following driver assistance features should be turned to alert or off when towing a trailer, unless equipped with Super Cruise:

- Automatic Emergency Braking (AEB)
- Front Pedestrian Braking (FPB)

If equipped with Lane Change Alert (LCA), the LCA detection zones that extend back from the side of the vehicle do not move further back when a trailer is towed. Use caution while changing lanes when towing a trailer.

If equipped with Rear Cross Traffic Alert (RCTA), use caution while backing up when towing a trailer, as the RCTA detection zones that extend out from the back of the vehicle do not move further back when a trailer is towed.

Towing a trailer requires experience. The combination of the vehicle and trailer is longer and not as responsive as the vehicle itself. Become familiar with handling and braking of the combination by driving on a level road surface before driving on public roads.

The trailer structure, the tires, and the brakes must be all be rated to carry the intended cargo. Inadequate trailer equipment can cause the combination to operate in an unexpected or unsafe manner. Before driving, inspect all trailer hitch parts and attachments, safety chains, electrical connectors, lamps, tires, and mirrors. See *Towing Equipment* ⇨ 243. If the trailer has electric brakes, start the combination

moving and then manually apply the trailer brake controller to check the trailer brakes work. During the trip, occasionally check that the cargo and trailer are secure and that the lamps and any trailer brakes are working.

### Towing with a Stability Control System

When towing, the stability control system might be heard. The system reacts to vehicle movement caused by the trailer, which mainly occurs during cornering. This is normal when towing heavier trailers.

### Following Distance

Stay at least twice as far behind the vehicle ahead as you would when driving without a trailer to help to avoid heavy braking and sudden turns.

### Passing

More passing distance is needed when towing a trailer. The combination of the vehicle and trailer will not accelerate as quickly and is much longer than the vehicle alone. It is necessary to go much farther beyond the passed vehicle before returning to the lane. Pass on level roadways. Avoid passing on hills if possible.

### Backing Up

Hold the bottom of the steering wheel with one hand. To move the trailer to the left, move that hand to the left. To move the trailer to the right, move that hand to the right. Always back up slowly and, if possible, have someone guide you.

### Making Turns

#### Caution

Turn more slowly and make wider arcs when towing a trailer to prevent damage to your vehicle. Making very sharp turns could cause the trailer to contact the vehicle.

Make wider turns than normal when towing, so trailer will not go over soft shoulders, over curbs, or strike road signs, trees, or other objects. Always signal turns well in advance. Do not steer or brake suddenly.

### Driving on Grades

Reduce speed and maintain gear before starting down a long or steep downhill grade. See *Hill and Mountain Roads* ⇨ 163.

The vehicle can tow in D (Drive).

### Viewing Systems

If equipped, the viewing systems on the vehicle can improve visibility while hitching, backing up, and driving with a trailer. See *Driver Assistance Systems* ⇨ 205.

### Parking on Hills

#### Warning

To prevent serious injury or death, always park your vehicle and trailer on a level surface when possible.

When parking your vehicle and your trailer on a hill:

1. Press and hold the brake pedal, but do not shift into P (Park). Turn the wheels toward the curb if facing downhill or toward traffic if facing uphill.



2. Have someone place chocks under the trailer wheels.
3. When the wheel chocks are in place, gradually release the brake pedal to allow the chocks to absorb the load of the trailer.
4. Reapply the brake pedal. Then apply the electric parking brake and shift into P (Park).
5. Release the brake pedal.

### **Leaving After Parking on a Hill**

1. Apply and hold the brake pedal.
  - Start the vehicle.
  - Shift into a gear.
  - Release the parking brake.
2. Let up on the brake pedal.
3. Drive slowly until the trailer is clear of the chocks.
4. Stop and have someone pick up and store the chocks.

### **Maintenance when Trailer Towing**

The vehicle needs service more often when used to tow trailers. See *Maintenance Schedule* ⇨ 298. It is especially important to check the cooling system and brake system before and during each trip.

Check periodically that all nuts and bolts on the trailer hitch are tight.

### **Cooling the Vehicle when Trailer Towing**

The cooling system may temporarily overheat during severe operating conditions. See *Cooling System* ⇨ 252.

### **Trailer Towing**

#### **Caution**

Towing a trailer improperly can damage the vehicle and result in costly repairs not covered by the vehicle warranty. To tow a trailer correctly, follow the directions in this section and see your dealer for important information about towing a trailer with the vehicle.

Trailer is different than just driving the vehicle by itself. Trailering means changes in handling, acceleration, braking, and durability. Successful, safe trailering takes correct equipment, and it has to be used properly.

The following information has many time-tested, important trailering tips and safety rules. Many of these are important for your safety and that of your passengers. Read this section carefully before pulling a trailer.

### **Trailer Weight**

#### **Warning**

Never exceed the towing capacity for your vehicle.

Safe trailering requires monitoring the weight, speed, altitude, road grades, outside temperature, dimensions of the front of the trailer, and how frequently the vehicle is used to tow a trailer.

## Trailer Weight Ratings

When towing a trailer, the combined weight of the vehicle, vehicle contents, trailer, and trailer contents must be below all of the maximum weight ratings for the vehicle, including:

- Gross Combined Weight Rating (GCWR)
- Gross Vehicle Weight Rating (GVWR)
- Maximum Trailer Weight Rating
- Maximum Trailer Tongue Weight Rating
- Gross Axle Weight Rating-Rear (GAWR-RR)

See “Weight-Distributing Hitch and Adjustment” under *Towing Equipment* ⇨ 243 to determine if equalizer bars are required to obtain the maximum trailer weight rating.

See “Trailer Brakes” under *Towing Equipment* ⇨ 243 to determine if brakes are required based on the trailer weight.

The only way to be sure the weight is not exceeding any of these ratings is to weigh the tow vehicle and trailer combination, fully loaded for the trip, getting individual weights for each of these items.

### Warning

You and others could be seriously injured or killed if the trailer is too heavy or the trailer brakes are inadequate for the load. The vehicle may be damaged, and the repairs would not be covered by the vehicle warranty.

Only tow a trailer if all the steps in this section have been followed. Ask your dealer for advice and information about towing a trailer.

## Gross Combined Weight Rating (GCWR)

GCWR is the total allowable weight of the completely loaded vehicle and trailer including any fuel, passengers, cargo, equipment, and accessories. Do not exceed the GCWR for your vehicle. The GCWR for the vehicle is on the Tow Rating Chart following.

## Gross Vehicle Weight Rating (GVWR)

For information about the vehicle's maximum load capacity, see *Vehicle Load Limits* ⇨ 165. When calculating the GVWR with a trailer attached, the trailer tongue weight must be included as part of the weight the vehicle is carrying.

## Maximum Trailer Weight

The maximum trailer weight rating is calculated assuming the tow vehicle has a driver, a front seat passenger, and all required trailering equipment. This value represents the heaviest trailer the vehicle can tow, but it may be necessary to reduce the trailer weight to stay within the GCW, GVWR, maximum trailer tongue load, or GAWR-RR for the vehicle.

Use the tow rating chart to determine how much the trailer can weigh, based on the vehicle model and options.

Vehicle	Maximum Trailer Weight with Trailer Brakes†	GCWR*
LYRIQ RWD/AWD	1580 kg (3,500 lb)	4435 kg (9,777 lb)

† For trailers without trailer brakes the maximum trailer weight is 1580 kg (3,500 lb). See *Towing Equipment* ⇨ 243.  
 \* The Gross Combination Weight Rating (GCWR) is the total allowable weight of the completely loaded vehicle and trailer including any passengers, cargo, equipment, and conversions. Do not exceed the GCWR for the vehicle.

### Maximum Trailer Tongue Weight

The Maximum Trailer Tongue Weight Rating is the allowable trailer tongue weight that the vehicle can support using a conventional trailer hitch. It may be necessary to reduce the overall trailer weight to stay within the maximum trailer tongue weight rating while still maintaining the correct trailer load balance.

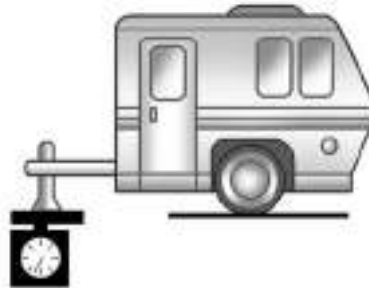

Do not exceed a maximum trailer tongue weight of 159 kg (350 lb).

The trailer tongue weight contributes to the Gross Vehicle Weight (GVW). GVW includes the CURB WEIGHT of your vehicle, any passengers, cargo, equipment and the trailer

tongue weight. Vehicle options, passengers, cargo, and equipment reduce the maximum allowable tongue weight the vehicle can carry, which also reduces the maximum allowable trailer weight.

### Trailer Load Balance

The correct trailer load balance must be maintained to ensure trailer stability. Incorrect load balance is a leading cause of trailer sway.

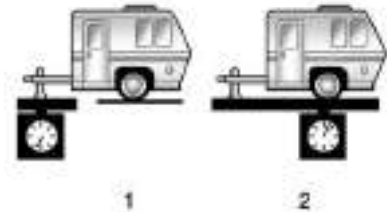

The trailer tongue weight (1) should be 10–15% of the loaded trailer weight (2). Some specific trailer types, such as boat trailers, fall outside of this range. Always refer to the trailer owner’s manual for the

recommended trailer tongue weight for each trailer. Never exceed the maximum loads for your vehicle, hitch and trailer.

The trailer load balance percentage is calculated as: weight (1) divided by weight (2) times 100.

After loading the trailer, separately weigh the trailer and then the trailer tongue and calculate the trailer load balance percentage to see if the weights and distribution are appropriate for your vehicle. If the trailer weight is too high, it may be possible to transfer some of the cargo into your vehicle. If the trailer tongue weight is too high or too low, it may be possible to rearrange some of the cargo inside of the trailer.

Do not exceed the maximum allowable tongue weight for your vehicle. Use the shortest hitch extension available to position the hitch ball closer to your vehicle. This will help reduce the effect of the trailer tongue weight on the trailer hitch and the rear axle.

If a cargo carrier is used in the trailer hitch receiver, choose a carrier that positions the load as close to the vehicle as possible. Make sure the total weight, including the carrier, is no more than half of the maximum allowable tongue weight for the vehicle or 227 kg (500 lb), whichever is less.

### Rear Gross Axle Weight Rating (GAWR-RR)

The GAWR-RR is the total weight that can be supported by the rear axle of the vehicle. Do not exceed the GAWR-RR for the vehicle, with the tow vehicle and trailer fully loaded for the trip including the weight of the trailer tongue. If using a weight-distributing hitch, do not exceed the GAWR-RR before applying the weight distribution spring bars.

For additional assistance with trailering or additional information, see your dealer.

### Towing Equipment

Always use the correct hitch equipment for your vehicle. Crosswinds, large trucks going by, and rough roads can affect the trailer and the hitch.

Proper hitch equipment for your vehicle helps maintain control of the vehicle-trailer combination. Many trailers can be towed using a weight-carrying hitch with a coupler latched to the hitch ball, or a tow eye latched to a pintle hook. Other trailers may require a weight-distributing hitch that uses spring bars to distribute the trailer tongue weight between your vehicle and trailer

axles. See “Maximum Trailer Tongue Weight Rating” under *Trailer Towing* ⇨ 240 for weight limits with various hitch types.

Never attach rental hitches or other bumper-type hitches. Only use frame-mounted hitches that do not attach to the bumper.

Consider using mechanical sway controls with any trailer. Ask a trailering professional about sway controls or refer to the trailer manufacturer's recommendations and instructions.

### Tires

- Do not tow a trailer while using a compact spare tire on the vehicle.
- Tires must be properly inflated to support loads while towing a trailer. See *Tires* ⇨ 269 for instructions on proper tire inflation.

### Safety Chains

Always attach chains between the vehicle and the trailer, and attach the chains to the holes on the trailer hitch platform. Instructions about safety chains may be provided by the hitch manufacturer or by the trailer manufacturer.

Cross the safety chains under the tongue of the trailer to help prevent the tongue from contacting the road if it becomes separated from the hitch. Always leave just enough slack so the combination can turn. Never allow safety chains to drag on the ground.

### **Trailer Brakes**

Loaded trailers over 450 kg (1,000 lb) must be equipped with brake systems and with brakes for each axle. Trailer braking equipment conforming to Canadian Standards Association (CSA) requirement CAN3-D313, or its equivalent, is recommended.

State or local regulations may require trailers to have their own braking system if the loaded weight of the trailer exceeds certain minimums that can vary from state to state. Read and follow the instructions for the trailer brakes so they are installed, adjusted, and maintained properly. Never attempt to tap into your vehicle's hydraulic brake system. If you do, both the vehicle anti-lock brakes and the trailer brakes may not function, which could result in a crash.

### **Trailer Lamps**

Always check that all trailer lamps are working at the beginning of each trip, and periodically on longer trips.

### **Turn Signals When Towing a Trailer**

When properly connected, the trailer turn signals will illuminate to indicate the vehicle is turning, changing lanes, or stopping. When towing a trailer, the arrows on the instrument cluster will illuminate even if the trailer is not properly connected or the bulbs are burned out.

### **Trailer Sway Control (TSC)**

Vehicles with StabiliTrak/Electronic Stability Control (ESC) have a Trailer Sway Control (TSC) feature. Trailer sway is unintended side-to-side motion of a trailer while towing. If the vehicle is towing a trailer and the TSC detects that sway is increasing, the vehicle brakes are selectively applied at each wheel, to help reduce excessive trailer sway.



If TSC is enabled, the Traction Control System (TCS)/StabiliTrak warning light will flash on the instrument cluster. Reduce vehicle speed by gradually removing your foot from the accelerator. If trailer sway continues, StabiliTrak can help slow the vehicle down. TSC will not function if StabiliTrak is turned off. See *Traction Control/Electronic Stability Control* ⇨ 179.

 **Warning**

Trailer sway can result in a crash and in serious injury or death, even if the vehicle is equipped with TSC.

If the trailer begins to sway, reduce vehicle speed by gradually removing your foot from the accelerator. Then pull over to check the trailer and vehicle to help correct possible causes, including an improperly or overloaded trailer, unrestrained cargo, improper trailer hitch configuration, or improperly inflated or incorrect vehicle or trailer tires. See *Towing Equipment* ⇨ 243 for trailer ratings and hitch setup recommendations.

**Trailer Tires**

Special Trailer (ST) tires differ from vehicle tires. Trailer tires are designed with stiff sidewalls to help prevent sway and to support heavy loads. These features can make it difficult to determine if the trailer tire pressures are low only based on a visual inspection.

Always check all trailer tire pressures before each trip when the tires are cool. Low trailer tire pressure is a leading cause of trailer tire blow-outs.

Trailer tires deteriorate over time. The trailer tire sidewall will show the week and year the tire was manufactured. Many trailer tire manufacturers recommend replacing tires more than six years old.

Overloading is another leading cause of trailer tire blow-outs. Never load your trailer with more weight than the tires are designed to support. The load rating is located on the trailer tire sidewall.

Always know the maximum speed rating for the trailer tires before driving. This may be significantly lower than the vehicle tire speed rating. The speed rating may be on the trailer tire sidewall. If the speed rating is not shown, the default trailer tire speed rating is 105 km/h (65 mph).

**Conversions and Add-Ons****Add-On Electrical Equipment** **Warning**

The Data Link Connector (DLC) is used for vehicle service and Emission Inspection/Maintenance testing. See *Service Vehicle Soon Light* ⇨ 94. A device connected to the DLC — such as an aftermarket fleet or driver-behavior tracking device — may interfere with vehicle systems. This could affect vehicle operation and cause a crash. Such devices may also access information stored in the vehicle's systems.

**Caution**

Some electrical equipment can damage the vehicle or cause components to not work and would not be covered by the vehicle warranty. Always check with your dealer before adding electrical equipment.

Add-on equipment can drain the vehicle's 12-volt battery, even if the vehicle is not operating.

When adding electrical equipment, it should only be connected using the accessory power outlets. The maximum power that can be supplied by one accessory power outlet or spread across all three is 200 watts or 15 amps. Exceeding 200 watts or 15 amps may cause erratic vehicle operation.

The vehicle has an airbag system. Before attempting to add anything electrical to the vehicle, see *Servicing the Airbag-Equipped Vehicle* ⇨ 58 and *Adding Equipment to the Airbag-Equipped Vehicle* ⇨ 59.

## Vehicle Care

### General Information

General Information .....	248
California Perchlorate Materials Requirements .....	248
Accessories and Modifications .....	248

### Vehicle Checks

Doing Your Own Service Work .....	249
Hood .....	250
Underhood Compartment Overview .....	251
Cooling System .....	252
Washer Fluid .....	253
Brakes .....	253
Brake Fluid .....	254
Battery - North America .....	255
Park Brake and P (Park) Mechanism Check .....	257
Wiper Blade Replacement .....	258
Windshield Replacement .....	258
Gas Strut(s) .....	258

### Headlamp Aiming

Front Headlamp Aiming .....	259
-----------------------------	-----

### Bulb Replacement

Bulb Replacement .....	259
LED Lighting .....	259

### Electrical System

High Voltage Devices and Wiring .....	260
Electrical System Overload .....	260
Fuses and Circuit Breakers .....	261
Underhood Compartment Fuse Block .....	262
Instrument Panel Fuse Block .....	266

### Wheels and Tires

Tires .....	269
All-Season Tires .....	270
Winter Tires .....	270
Self-Sealing Tires .....	270
Low-Profile Tires .....	271
Tire Sidewall Labeling .....	271
Tire Designations .....	272
Tire Terminology and Definitions .....	272
Tire Pressure .....	274
Tire Pressure Monitor System .....	275
Tire Pressure Monitor Operation .....	276
Tire Inspection .....	278
Tire Rotation .....	279
When It Is Time for New Tires .....	280
Buying New Tires .....	280
Different Size Tires and Wheels .....	281
Uniform Tire Quality Grading .....	282
Wheel Alignment and Tire Balance .....	283
Wheel Replacement .....	283
Tire Chains .....	284
If a Tire Goes Flat .....	284

### Jump Starting

Jump Starting - North America .....	285
-------------------------------------	-----

### Towing the Vehicle

Transporting a Disabled Vehicle .....	287
Recreational Vehicle Towing .....	289

### Appearance Care

Exterior Care .....	289
Interior Care .....	293
Floor Mats .....	296



## General Information

For service and parts needs, visit your dealer. You will receive genuine GM parts and GM-trained and supported service people.

Genuine GM parts have one of these marks:



## California Perchlorate Materials Requirements

Certain types of automotive applications, such as airbag initiators, seat belt pretensioners, and lithium batteries contained in electronic keys, may contain perchlorate materials. Perchlorate Material – special handling may apply. See [www.dtsc.ca.gov/hazardouswaste/perchlorate](http://www.dtsc.ca.gov/hazardouswaste/perchlorate).

## Accessories and Modifications

Adding non-dealer accessories or making modifications to the vehicle can affect vehicle performance and safety, including such things as airbags, braking, stability, ride and handling, emissions systems, aerodynamics, durability, Driver Assistance Systems, and electronic systems like antilock brakes, traction control, and stability control. These accessories or modifications could even cause malfunction or damage not covered by the vehicle warranty.

Damage to suspension components caused by modifying vehicle height outside of factory settings will not be covered by the vehicle warranty.

Damage to vehicle components resulting from modifications or the installation or use of non-GM certified parts, including control module or software modifications, is not covered under the terms of the vehicle warranty and may affect remaining warranty coverage for affected parts.

GM Accessories are designed to complement and function with other systems on the vehicle. See your dealer to accessorize the vehicle using genuine GM Accessories installed by a dealer technician.

Also, see *Adding Equipment to the Airbag-Equipped Vehicle* ⇨ 59.

## Vehicle Checks

### Doing Your Own Service Work

#### Warning

Never try to do your own service on high voltage battery components. You can be injured and the vehicle can be damaged if you try to do your own service work. Service and repair of these high voltage battery components should only be performed by a trained dealer technician with the proper knowledge and tools.

Exposure to high voltage can cause shock, burns, and even death. The high voltage components in the vehicle can only be serviced by technicians with special training.

High voltage components are identified by labels. Do not remove, open, take apart, or modify these components. High voltage cable or wiring has orange covering. Do not probe, tamper with, cut, or modify high voltage cable or wiring.

#### Warning

Unexpected wheel motion and/or direction when one or more wheels are off the ground for service work may result in injury. The vehicle may:

- Allow the wheels to rotate unexpectedly in either direction regardless of mode selection.
- Allow the wheels to rotate in reaction to attempts to rotate the tire(s) manually.
- Resist attempts to rotate the wheels manually.

Before lifting the vehicle to do your own service work, turn the vehicle off or place the vehicle in the Service Mode. To place the vehicle in Service Mode, with the vehicle off and the brake pedal not applied, press and hold POWER for more than five seconds.

#### Warning

It can be dangerous to work on your vehicle if you do not have the proper knowledge, service manual, tools, or parts. Always follow owner's manual procedures and consult the service manual for your vehicle before doing any service work.

If doing some of your own service work, use the proper service manual. It tells you much more about how to service the vehicle than this manual can. To order the proper service manual, see *Publication Ordering Information* ⇨ 312.

This vehicle has an airbag system. Before attempting to do your own service work, see *Servicing the Airbag-Equipped Vehicle* ⇨ 58.

Keep a record with all parts receipts and list the mileage and the date of any service work performed. See *Maintenance Records* ⇨ 301.

## Hood

### Warning

Components under the hood can get hot. To help avoid the risk of burning unprotected skin, never touch these components until they have cooled, and always use a glove or towel to avoid direct skin contact.

#### To open the hood:

1. Pull the hood release handle on the lower left side of the instrument panel.



2. Release the handle, then pull the handle again to fully open the hood.

3. Go to the front of the vehicle and lift the hood open.

#### To close the hood:

1. Be sure all filler caps are on properly, and all tools are removed.
2. Lower the hood down until the strut system is no longer holding up the hood.
3. Allow the hood to fall. Check to make sure the hood is latched completely. Repeat this process with additional force if necessary.
4. If the hood does not latch, a message will display on the Driver Information Center (DIC) indicating the vehicle will not shift out of (P) Park. To override this function, press and hold the brake pedal until override completion message is displayed on DIC.

### Warning

Do not drive the vehicle if the hood is not latched completely. The hood could open fully, block your vision, and cause a crash. You or others could be injured. Always close the hood completely before driving.

## Underhood Compartment Overview



1. Windshield Washer Fluid Reservoir. See *Washer Fluid* ⇨ 253.
2. Hood Latch.
3. Brake Fluid Reservoir. See *Brake Fluid* ⇨ 254.

## Cooling System

It is not necessary to regularly check coolant unless a leak is suspected or an unusual noise is heard. A coolant loss could indicate a problem. Have it inspected and repaired by your dealer.

During vehicle operation and also during charging, the high voltage battery cells in the vehicle are kept within a normal operating temperature range. If the temperature rises above this temperature, the battery cooling system turns on the air conditioning compressor and cools the coolant until the correct temperature is reached. If the temperature falls below this temperature, a high voltage heater, located outside the battery on a cradle, heats the coolant until the correct temperature is reached.

The cooling system allows the vehicle to maintain the correct working temperature.

## Checking Coolant

The coolant needs to be replaced at the appropriate interval. See *Maintenance Schedule* ⇨ 298.

The coolant reservoir is in the underhood compartment. See *Underhood Compartment Overview* ⇨ 251.

To access the coolant reservoir under the hood, the right side access cover needs to be removed.

1. Park on a level surface and turn the vehicle off.
2. Open the hood. See *Hood* ⇨ 250.



3. The coolant reservoir is under a cover and side extension/shield in the underhood compartment. Unclip the right side of the shield and remove the right side access cover.



4. After the system has completely cooled, check that the coolant level in the reservoir.



5. If the coolant level is not visible or needs to be adjusted within the reservoir, contact your dealer.

## Washer Fluid

### What to Use

When windshield washer fluid is needed, be sure to read the manufacturer's instructions before use. If operating the vehicle in an area where the temperature may fall below freezing, use a fluid that has sufficient protection against freezing.

### Adding Washer Fluid

If the vehicle is equipped with a washer fluid level indicator, and the washer fluid reservoir is low, a message displays on the Driver Information Center (DIC). See *Driver Information Center (DIC)* ⇨ 108 for more information.



Open the cap with the washer symbol on it. Add washer fluid until the tank is full. See *Underhood Compartment Overview* ⇨ 251 for reservoir location.

### Caution

- Do not use washer fluid that contains any type of water repellent coating. This can cause the wiper blades to chatter or skip.
- Do not use engine coolant (antifreeze) in the windshield washer. It can damage the windshield washer system and paint.

(Continued)

### Caution (Continued)

- Do not mix water with ready-to-use washer fluid. Water can cause the solution to freeze and damage the washer fluid tank and other parts of the washer system.
- When using concentrated washer fluid, follow the manufacturer instructions for adding water.
- Fill the washer fluid tank only three-quarters full when it is very cold. This allows for fluid expansion if freezing occurs, which could damage the tank if it is completely full.

## Brakes

Disc brake linings have built-in wear indicators that make a high-pitched warning sound when the brake linings are worn and new linings are needed. The sound can come and go or can be heard all the time when the vehicle is moving, except when applying the brake pedal firmly.

**Warning**

The brake wear warning sound means that soon the brakes will not work well. That could lead to a crash. When the brake wear warning sound is heard, have the vehicle serviced.

**Caution**

Continuing to drive with worn-out brake linings could result in costly brake repairs.

Some driving conditions or climates can cause a brake squeal when the brakes are first applied, clearing up following several applications. This does not mean something is wrong with the brakes.

Properly torqued wheel nuts are necessary to help prevent brake pulsation. When tires are rotated, inspect brake linings for wear and evenly tighten wheel nuts in the proper sequence to torque specifications. See *Capacities and Specifications* ⇨ 303.

Brake pads should be replaced as complete axle sets.

**Brake Pedal Travel**

See your dealer if the brake pedal does not return to normal height, or if there is a rapid increase in pedal travel. This could be a sign that brake service may be required.

**Replacing Brake System Parts**

Always replace brake system parts with new, approved replacement parts. If this is not done, the brakes may not work properly. The braking performance can change in many ways if the wrong brake parts are installed or if parts are improperly installed.

**Brake Fluid**

The brake master cylinder reservoir is filled with GM approved DOT 4 brake fluid as indicated on the reservoir cap. See *Underhood Compartment Overview* ⇨ 251 for the location of the reservoir.

**Checking Brake Fluid**

With the vehicle in P (Park) on a level surface, the brake fluid level should be between the minimum and maximum marks on the brake fluid reservoir.

There are only two reasons why the brake fluid level in the reservoir may go down:

- Normal brake lining wear. When new linings are installed, the fluid level goes back up.
- A fluid leak in the brake hydraulic system. Have the brake hydraulic system fixed. With a leak, the brakes will not work well.

Always clean the brake fluid reservoir cap and the area around the cap before removing it.

Do not top off the brake fluid. Adding fluid does not correct a leak. If fluid is added when the linings are worn, there will be too much fluid when new brake linings are installed. Add or remove fluid, as necessary, only when work is done on the brake hydraulic system.

When the brake fluid falls to a low level, the brake warning light comes on. See *Brake System Warning Light* ⇨ 94.

Brake fluid absorbs water over time which degrades the effectiveness of the brake fluid. Replace brake fluid at the specified intervals to prevent increased stopping distance. See *Maintenance Schedule* ⇨ 298.

### What to Add

Use only GM approved DOT 4 brake fluid from a clean, sealed container. See *Recommended Fluids and Lubricants* ⇨ 300.

#### Warning

The wrong or contaminated brake fluid could result in damage to the brake system. This could result in the loss of braking leading to a possible injury. Always use the proper GM approved brake fluid.

#### Caution

If brake fluid is spilled on the vehicle's painted surfaces, the paint finish can be damaged. Immediately wash off any painted surface.

## Battery - North America

This vehicle has a high voltage battery and a standard 12-volt battery.

See your dealer if either the 12-volt or high voltage battery needs service.

### 12-Volt Battery

The original equipment battery is maintenance free. Do not remove the cap and do not add fluid.

Do not disconnect the 12-volt battery during storage.

Refer to the replacement number shown on the original battery label when a new 12-volt battery is needed. The vehicle has an Absorbent Glass Mat (AGM) 12-volt battery. Installation of a standard 12-volt battery will result in reduced 12-volt battery life.

Some 12-volt chargers have an AGM battery setting. This setting limits the charge voltage to 14.8 volts and helps extend the battery life. If available, use the AGM setting when charging the battery.

#### Warning

**WARNING:** Battery posts, terminals and related accessories can expose you to chemicals including lead and lead compounds, which are known to the State of California to cause cancer and birth defects or other reproductive harm. Wash hands after handling. For more information go to [www.P65Warnings.ca.gov](http://www.P65Warnings.ca.gov).

See *California Proposition 65 Warning* ⇨ 1.

### High Voltage Battery

Only a trained service technician should inspect, test, or replace the high voltage battery. The dealer has information on how to recycle the high voltage battery. There is also information available at <https://www.recyclemybattery.com>.

#### Warning

Damage to the high voltage battery or high voltage system can create a risk of electric shock, overheating, or fire.

(Continued)



**Warning (Continued)**

If the vehicle is damaged from a moderate to severe crash, flood, fire, or other event, the vehicle should be inspected as soon as possible. Until the vehicle has been inspected, store it outside at least 15 m (50 ft) from any structure or anything that can burn. Ventilate the vehicle by opening a window or a door.

Contact Customer Assistance as soon as possible to determine whether an inspection is needed. See *Customer Assistance Offices* ⇨ 306.

If the vehicle is in a crash, the sensing system may shut down the high voltage system. When this occurs, the high voltage battery is disconnected and the vehicle will not start. The SERVICE VEHICLE SOON message in the Driver Information Center (DIC) will display. Before the vehicle can operate again, it must be serviced at your dealer. If a crash occurs or an airbag(s) inflates, see “If a Crash Occurs” under *Collision Damage Repair* ⇨ 310 and *What Will You See after an Airbag Inflates?* ⇨ 54 for additional information.

Keep the vehicle plugged in, even when fully charged, to keep the high voltage battery temperature ready for the next drive. This is important when outside temperatures are extremely hot or cold.

Propulsion power may be reduced in extremely cold temperatures, or if the high voltage battery is too cold. The message BATTERY TOO COLD, PLUG IN TO WARM will display. If the message displays, a level 2 charger is required to heat the battery to a minimum temperature to enable propulsion or charging.

A vehicle cover, which can reduce sun loading on the vehicle and improve high voltage battery life, is available from your dealer.

See *Radio Frequency Statement* ⇨ 312.

**Federal Communications Commission (FCC) Radiation Exposure Statement**

This equipment has been evaluated to be installed and operated at a minimum distance of 5.7 cm (2.2 in) between the device and your body. The vehicle design ensures this distance is maintained during normal use. Changes or modifications to any

of these systems by other than an authorized service facility could void authorization to use this equipment.

**Innovation, Science, and Economic Development (ISED) Radiation Exposure Statement**

This equipment complies with RSS-102 radiation exposure limits set forth for an uncontrolled environment. This equipment should be installed and operated with a minimum distance of 5.7 cm (2.2 in) between the radiator and any part of your body. The vehicle design ensures this distance is maintained during normal use. Changes or modifications to any of these systems by other than an authorized service facility could void authorization to use this equipment.

**Vehicle Storage**

The best way to store the vehicle for any length of time is to plug in the charge cord and leave it plugged in. The vehicle monitors and maintains the 12-volt battery daily. It is okay to leave the vehicle plugged in for extended periods of time. Once charged to full, very little energy is required to maintain the 12-volt battery and high voltage battery.

If it is not possible to charge the vehicle with the charge cord left plugged in, be sure to fully charge the high voltage battery before storing. The vehicle will stop maintenance of the 12-volt battery if the high voltage battery state of charge gets too low.

When storing the vehicle on a long-term basis:

- Keep the high voltage battery state of charge at 30%.
- Attach an AGM/VRLA compatible battery tender or trickle charger to the 12-volt battery.
- Keep the remote key more than 3 m (10 ft) away from the vehicle.

### 12-volt Battery

#### Warning

Batteries have acid that can burn you and gas that can explode. You can be badly hurt if you are not careful. Always wear eye protection. See *Jump Starting - North America* ⇨ 285 for tips on working around a battery without getting hurt.

Do not disconnect the 12-volt battery during storage.

A trickle charger may be attached to the 12-volt battery terminals or trickle charge from the underhood remote positive (+) and negative (-) terminals. See *Jump Starting - North America* ⇨ 285 for location of these terminals.

#### Caution

The vehicle is equipped with an AGM/VRLA 12-volt battery, which can be damaged by using the incorrect type of trickle charger. An AGM/VRLA-compatible charger must be used, with the appropriate setting selected. Follow the trickle charger manufacturer instructions.

With a trickle charger connected to the 12-volt battery, the vehicle will still monitor the 12-volt battery daily, but it will not use energy from the high voltage battery for maintenance.

### High Voltage Battery

After extended storage, it is possible that the vehicle may not operate. If this happens, the high voltage battery may need to be plugged in and charged.

## Park Brake and P (Park) Mechanism Check

#### Warning

When you are doing this check, the vehicle could begin to move. You or others could be injured and property could be damaged. Make sure there is room in front of the vehicle in case it begins to roll. Be ready to apply the regular brake at once should the vehicle begin to move.

Park on a fairly steep hill, with the vehicle facing downhill. Keeping your foot on the regular brake, set the Electric Parking Brake (EPB).

- To check the EPB's holding ability: With the propulsion system active and the electric drive unit in N (Neutral), slowly remove foot pressure from the regular brake pedal. Do this until the vehicle is held by the EPB only.
- To check the P (Park) mechanism's holding ability: With the propulsion system active, shift to P (Park). Then release the EPB and slowly remove foot pressure from the regular brake pedal.

Contact your dealer if service is required.

## Wiper Blade Replacement

Windshield wiper blades should be replaced periodically. See the *Maintenance Schedule* ⇨ 298.

Replacement blades come in different types and are removed in different ways. For proper type and length, see *Maintenance Replacement Parts* ⇨ 300.

### Caution

Allowing the wiper arm to touch the windshield when no wiper blade is installed could damage the windshield. Any damage that occurs would not be covered by the vehicle warranty. Do not allow the wiper arm to touch the windshield.

To replace the windshield wiper blade:

1. Pull the windshield wiper assembly away from the windshield.

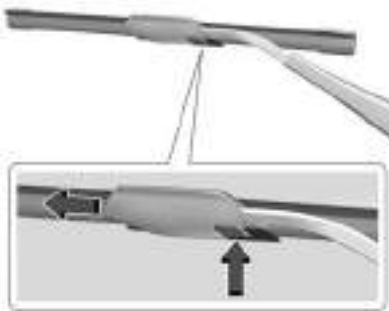

2. Press the button in the middle of the wiper arm connector, and pull the wiper blade away from the arm connector.
3. Remove the wiper blade.
4. Reverse Steps 1–3 for wiper blade replacement.

## Windshield Replacement

### Driver Assistance Systems

If the windshield needs to be replaced and the vehicle is equipped with a front camera sensor for the Driver Assistance Systems, a GM replacement windshield is recommended. The replacement windshield must be installed according to GM specifications for proper alignment. If it is

not, error messages may display, or these systems may not work properly or at all. See your dealer for proper windshield replacement.

### Acoustic and Heated Wiper Park (HWP) Windshield

The vehicle is equipped with an acoustic and HWP windshield. If the windshield needs replacement, make sure to use a GM compatible acoustic and HWP windshield to retain its features

### Gas Strut(s)

Your vehicle may be equipped with gas strut(s) to provide assistance in lifting and holding open the hood/trunk/liftgate system in full open position.

### Warning

If the gas struts that hold open the hood, trunk, and/or liftgate fail, you or others could be seriously injured. Take the vehicle to your dealer for service immediately. Visually inspect the gas struts for signs of wear, cracks, or other damage periodically. Check to make sure the hood/trunk/liftgate is held open with

(Continued)

**Warning (Continued)**

enough force. If struts are failing to hold the hood/trunk/liftgate, do not operate. Have the vehicle serviced.

**Caution**

Do not apply tape or hang any objects from gas struts. Also do not push down or pull on gas struts. This may cause damage to the vehicle.

See *Maintenance Schedule* ⇨ 298.



**Hood**



**Trunk**



**Liftgate**

**Headlamp Aiming****Front Headlamp Aiming**

Headlamp aim has been preset and should need no further adjustment.

If the vehicle is damaged in a crash, the headlamp aim may be affected. If adjustment to the headlamps is necessary, see your dealer.

**Bulb Replacement**

For the proper type of replacement bulbs, or any bulb changing procedure not listed in this section, contact your dealer.

**Caution**

Do not replace incandescent bulbs with aftermarket LED replacement bulbs. This can cause damage to the vehicle electrical system.

**LED Lighting**

This vehicle has several LED lamps. For replacement of any LED lighting assembly, contact your dealer.

## Electrical System

### High Voltage Devices and Wiring

#### Warning

Exposure to high voltage can cause shock, burns, and even death. The high voltage components in the vehicle can only be serviced by technicians with special training.

High voltage components are identified by labels. Do not remove, open, take apart, or modify these components. High voltage cable or wiring has orange covering or labels. Do not probe, tamper with, cut, or modify high voltage cable or wiring.

### Electrical System Overload

The vehicle has fuses and circuit breakers to protect against an electrical system overload.

When the current electrical load is too heavy, the circuit breaker opens and closes, protecting the circuit until the current load returns to normal or the problem is fixed.

This greatly reduces the chance of circuit overload and fire caused by electrical problems.

Fuses and circuit breakers protect the wires that provide the power to the devices in your vehicle.

If there is a problem on the road and a fuse needs to be replaced, the same amperage fuse can be borrowed. Choose some feature of the vehicle that is not needed to use and replace it as soon as possible.

To check a fuse, look at the band inside the fuse. If the band is broken or melted, replace the fuse. Be sure to replace a bad fuse with a fuse of the identical size and rating.



### Replacing a Blown Fuse

1. Turn off the vehicle.
2. Locate the fuse puller in the underhood compartment fuse block.



3. Use the fuse puller to remove the fuse from the top or side, as shown above.

4. If the fuse must be replaced immediately, borrow a replacement fuse with the same amperage from the fuse block. Choose a vehicle feature that is not needed to safely operate the vehicle. Repeat Steps 2–3.
5. Insert the replacement fuse into the empty slot of the blown fuse.

At the next opportunity, see your dealer to replace the blown fuse.

### Headlamp Wiring

An electrical overload may cause the lamps to go on and off, or in some cases to remain off. Have the headlamp wiring checked right away if the lamps go on and off or remain off.

### Windshield Wipers

If the wiper motor overheats due to heavy snow or ice, the windshield wipers will stop until the motor cools and will then restart.

Although the circuit is protected from electrical overload, overload due to heavy snow or ice may cause wiper linkage damage. Always clear ice and heavy snow from the windshield before using the windshield wipers.

If the overload is caused by an electrical problem and not snow or ice, be sure to get it fixed.

### Fuses and Circuit Breakers

The wiring circuits in the vehicle are protected from short circuits by a combination of fuses and circuit breakers. This greatly reduces the chance of damage caused by electrical problems.

**⚠ Danger**

Fuses and circuit breakers are marked with their ampere rating. Do not exceed the specified amperage rating when replacing fuses and circuit breakers. Use of an oversized fuse or circuit breaker can result in a vehicle fire. You and others could be seriously injured or killed.



 **Warning**

Installation or use of fuses that do not meet GM's original fuse specifications is dangerous. The fuses could fail, and result in a fire. You or others could be injured or killed, and the vehicle could be damaged.

See *Accessories and Modifications* ⇨ 248 and *General Information* ⇨ 248.

To check or replace a blown fuse, see *Electrical System Overload* ⇨ 260.

## Underhood Compartment Fuse Block

### To Access:

1. Open the hood. See *Hood* ⇨ 250.



2. The Underhood Compartment Fuse Block is under a cover and side extension/shield in the underhood compartment. Unclip right side of shield and remove the right side access cover.



3. Remove the M6 bolt to access the fuse block.

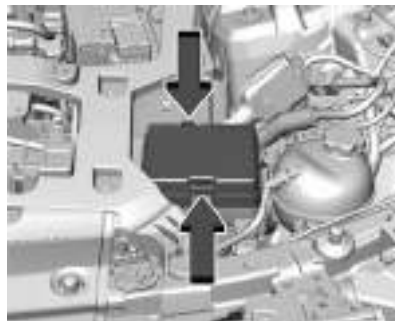

4. To open the fuse block cover, press the clips at the side and back and pull the cover up.

**Caution**

Spilling liquid on any electrical component on the vehicle may damage it. Always keep the covers on any electrical component.

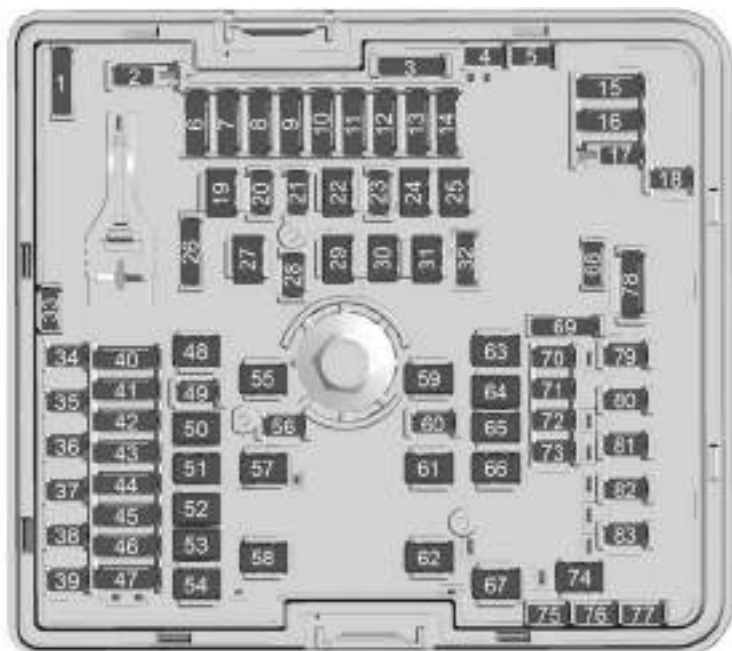

A fuse puller is in the underhood compartment fuse block.

The vehicle may not be equipped with all of the fuses and features shown.



Fuses	Usage	Fuses	Usage	Fuses	Usage
1	Spare		Motor: PECP & Motor: ESSCP – Power Electronics	19	–
2	–	9	Coolant Pump and Energy Storage System	20	–
3	Spare		Coolant Pump	21	CHARGE PORT DR MTR – Charge Port Door Motor
4	Spare	10	–		AC/DC INV MDL – Alternate Current/Direct Current Inverter Module
5	Spare	11	–	22	
	MSM/MBM – Memory Seat Module/Memory Bolster Module		ECP_S & OBCM 2 – Elec- trification Control Processor (Traction Power Inverter Module 2) & On Board Charging Module 2	23	–
6	–	12		24	–
	Motor: PEEV/PCEV & ECFV/ CHFV – Primary Evaporator Expansion Valve/Secondary Evaporator Expansion Valve and External Condenser Flow Valve/Condensing Heater Flow Valve	13	–	25	–
7		14	–	26	Spare
	MTR MAIN COOL VLV & ACEC – Motor Main Coolant Valve and Air Condition Electric Compressor	15	TRLR PRK LAMPS – Trailer Park Lamps	27	–
8			–	28	ETC MDL – Electronic Toll Control Module
		16	TRLR REV LAMP – Trailer Reverse Lamp	29	–
			–		Rear Cargo APO – Rear Cargo Auxiliary Power Outlet
		17	–	30	
			GLBX DR RELSE – Glove Box Release	31	TRLR INTERFACE MDL BATT SOURCE 1 – Trailer Interface Module Battery Source 1
		18		32	Spare

Fuses	Usage
33	Spare
34	ELM 5 – Exterior Lighting Module 5
35	ELM 4 – Exterior Lighting Module 4
36	–
37	–
38	ELM 7 – Exterior Lighting Module 7
39	ELM 3 – Exterior Lighting Module 3
40	ECP_E_Batt SOURCE 1 & ECP_E_Batt SOURCE 3 – Electrification Control Processor (Traction Power Inverter Module 1) Source 3 and 1
41	DSP & AIR SPRINGS 2 – Door Switch Panel and Suspension Control Leveling 2

Fuses	Usage
42	SEAT POS SW & VKM SNSR/RLH SNSR – Seat Position Switch and Virtual Key Module Sensor/Rain Light Humidity Sensor
43	SCL & CHIM MDL – Steering Column Lock and Charge Interface Module
44	PSM & AERO SH – Power Sounder Module and Aero Shutter
45	RFA MDL & HFC MDL – Remote Function Actuator Module and Handsfree Closure Module
46	AFL/AHL & PFA Module – Adaptive Forward Lighting/Automatic Headlamp Leveling and Pedestrian Friendly Alert Module
47	LIT GRILLE/FR PRK EMBLEM & SADS – Lit Grille/Front Park Emblem and Semi Active Damping System
48	PWR T/GATE – Power Tailgate

Fuses	Usage
49	–
50	MTR WDW LIFTER LT – Motor Window Lifter
51	AIR SPRINGS 1 – Suspension Control Leveling 1
52	MTR WDW LIFTER RT – Motor Window Lifter Right
53	FRT WPR – Front Wiper
54	TRLR HEAVYDUTY/TRLR EUROPE – Trailer Battery
55	–
56	FOLD SEAT RT MTR – Fold Seat Right Motor
57	EBCM– Electronic Brake Control Module
58	FRT BLWR MTR – Front Blower Motor
59	–
60	Horn
61	Rear Defog
62	REAR BLWR MTR – Rear Blower Motor

Fuses	Usage
63	MTR S/ROOF & SUNSHD – Motor Sunroof and Motor Sunshade
64	PWR SEAT DRVR – Power Seat Driver
65	PWR SEAT PASS DRVR – Power Seat Passenger Driver
66	CRFM – Condenser Radiator Fan Module
67	Heated Wiper
68	Spare
69	Spare
70	RELAY'S COIL
71	REAR HTD/SEAT 2 – Rear Heated Seat 2
72	FRT HTD/SEAT 1 – Front Heated Seat 1
73	FOLD SEAT LT MTR – Fold Seat Left Motor
74	TRLR INTERFACE MDL BATT SOURCE 2 – Trailer Interface Module Battery Source 2

Fuses	Usage
75	Spare
76	Spare
77	Spare
78	TRLR ST/TRN LT & TRLR RT – Trailer Stop Turn Left and Trailer Stop Turn Right
79	REAR HTD/SEAT 1 – Rear Heated Seat 1
80	FRT HTD/SEAT 2 – Front Heated Seat 2
81	OUT OF PRK DSBL – Out of Park Disable
82	Wash Pump (Front)
83	Camera Wash

### Instrument Panel Fuse Block

The instrument panel fuse block is to the right of the glove box.



#### To Access the Fuses:

1. Remove the panel, starting at the top.
2. Once the panel clips disengage, the tabs along the bottom of the door can disengage from the instrument panel to remove the door.

To reinstall the door, place the bottom tabs into the slots, and rotate the door into position, engaging the clips.

See your dealer if additional assistance is needed.



The vehicle may not be equipped with all of the fuses and features shown.

Fuses	Usage	Fuses	Usage
F1	–	F12	–
F2	APO/CIGAR LTR – Auxiliary Power Outlet Instrument Panel/Cigar Lighter	F13	EUROPE-TRLR CON & ECP_E/ECP_S/VICM – RUN/CRANK Europe – Trailer Control and Electrification Control Processor (Traction Power Inverter 1 and 2)/ Vehicle Integration Control Module
F3	–	F14	HEADLAMPS – RUN/CRANK Headlamps
F4	USB PORT/APO AC 150W – Universal Serial Bus Port/ Auxiliary Power Outlet Alternating Current 150W	F15	HDLP RT –Headlamp Right
F5	STRG COL LOCK – RUN/CRANK Steering Column Lock	F16	STRG COL/CLOCK SPRING – Steering Column Lock/Clock Spring
F6	ELM 1– Exterior Lighting Module 1	F17	SEAT FAN PASS & SEAT FAN DRVR – RUN/CRANK Seat Fan Passenger and Seat Fan Driver
F7	AMP-BASE – Amplifier-Base	F18	VCD & SRR –Virtual Cockpit Display and Short Range Radar
F8	RT DR LATCH – Right Door Latch		
F9	LT DR LATCH – Left Door Latch		
F10	STRG COL POS MDL – Steering Column Position Module		
F11	ACP 4 –ADAS Compute Platform 4		

Fuses	Usage	Fuses	Usage	Fuses	Usage
F19	MISC 2 & MISC 1 – RUN/ CRANK Miscellaneous 2 Switch Bank/Electronic Toll Collection/Interior Particulate Matter Sensor/ Reflective Light Auxiliary Display and Miscellaneous 1 Electronic Brake Control Module/Exterior Lighting Module/Sensing and Diagnostic Module/Inside Rear View Mirror	F23	T/LAMP RT & T/LAMP LT – Tail Lamp Right and Tail Lamp Left	F26	ECP_E_BATT 2/ACEC & HUD/HVAC DISPLAY – Elec- trification Control Processor Battery 2/Air Condition Electric Compressor and Heads-Up Display/Heating, Ventilation and Air Conditioning Display
F20	BCM 1 & VICM – Body Control Module 1 and Vehicle Integration Control Module	F24	UPA/APA/SBZA & SDM/ AOS – Universal Park Assist/Automatic Park Assist/Side Blind Zone Alert and Sensing Diagnostic Module/Automatic Occupant Sensing Module	F27	BCM 3 – Body Control Module 3
F21	LRR-RR & EPBS/ESM – Long Range Radar – Rear and Electric Park Brake Switch/ Electronic Transmission Range Select Shifter Module	F25	ACP 2/EOCM_LC/FCM/MFC & DMS/CGM/DLC/VDM – ADAS Compute Platform 2/ External Object Calculating Module/Front Camera Module/Multi Function Control and Driver Monitoring System/Central Gateway Module/ Diagnostic Link Connector/ Vehicle Data Monitor	F28	BCM 2 – Body Control Module 2
F22	VKM/VKBM/AUX JACK & ACP3 – Virtual Key Module/Virtual Key Backup Module/Auxiliary Jack			F29	AMP-UPLEVEL – Amplifier- Uplevel
				F30	BCM 4 – Body Control Module 4
				F31	VPM/SD CARD/ILSS/OHC – Video Processing Module/ SD Card/Indicator Light and Solar Sensor/Over Head Console
				F32	HSWM – Heated Steering Wheel Module

Fuses	Usage
F33	LRR FR/LIDAR – Long Range Radar Front/Light Detection and Ranging
F34	ELM 2 – Exterior Lighting Module 2
F35	HDLP LT – Headlamp Left
F36	VCU BATT 1 – Virtual Cockpit Unit Battery 1
F37	TCP (OnStar) – Telematics Communication Platform
F38	WCM – Wireless Charger Module
F39	HI VOLTAGE SYS LCKOUT – High Voltage System Lockout
F40	VCU Batt 2 – Virtual Cockpit Unit Battery 2
F41	ELM 6 – Exterior Lighting Module 6
F42	–

## Wheels and Tires

### Tires

Every new GM vehicle has high-quality tires made by a leading tire manufacturer. See the warranty manual for information regarding the tire warranty and where to get service. For additional information refer to the tire manufacturer.

#### Warning

- Poorly maintained and improperly used tires are dangerous.
- Overloading the tires can cause overheating as a result of too much flexing. There could be a blowout and a serious crash. See *Vehicle Load Limits* ⇨ 165.
- Underinflated tires pose the same danger as overloaded tires. The resulting crash could cause serious injury. Check all tires frequently to  
(Continued)

#### Warning (Continued)

maintain the recommended pressure. Tire pressure should be checked when the tires are cold.

- Overinflated tires are more likely to be cut, punctured, or broken by a sudden impact — such as when hitting a pothole. Keep tires at the recommended pressure.
- Worn or old tires can cause a crash. If the tread is badly worn, replace them.
- Replace any tires that have been damaged by impacts with potholes, curbs, etc.
- Improperly repaired tires can cause a crash. Only your dealer or an authorized tire service center should repair, replace, dismount, and mount the tires.

(Continued)

**Warning (Continued)**

- Do not spin the tires in excess of 56 km/h (35 mph) on slippery surfaces such as snow, mud, ice, etc. Excessive spinning may cause the tires to explode.

**All-Season Tires**

This vehicle may come with all-season tires. These tires are designed to provide good overall performance on most road surfaces and weather conditions. Original equipment tires designed to GM's specific tire performance criteria have a TPC specification code molded onto the sidewall. Original equipment all-season tires can be identified by the last two characters of this TPC code, which will be "MS."

Consider installing winter tires on the vehicle if frequent driving on snow or ice-covered roads is expected. All-season tires provide adequate performance for most winter driving conditions, but they may not offer the same level of traction or performance as winter tires on snow or ice-covered roads. See *Winter Tires* ⇨ 270.

**Winter Tires**

This vehicle was not originally equipped with winter tires. Winter tires are designed for increased traction on snow and ice-covered roads. Consider installing winter tires on the vehicle if frequent driving on ice or snow covered roads is expected. See your dealer for details regarding winter tire availability and proper tire selection. Also, see *Buying New Tires* ⇨ 280.

With winter tires, there may be decreased dry road traction, increased road noise, and shorter tread life. After changing to winter tires, be alert for changes in vehicle handling and braking.

If using winter tires:

- Use tires of the same brand and tread type on all four wheel positions.
- Use only radial ply tires of the same size, load range, and speed rating as the original equipment tires.

Winter tires with the same speed rating as the original equipment tires may not be available for H, V, W, Y, and ZR speed rated tires. If winter tires with a lower speed rating are chosen, never exceed the tire's maximum speed capability.

**Self-Sealing Tires**

This vehicle may have self-sealing tires. These tires have a material inside that can seal punctures from common road hazards, such as nails and screws, in the tread area. The tire may lose air pressure if the sidewall is damaged or the tread puncture is too large. If the Tire Pressure Monitor System indicates the tire pressure is low, inspect the tire for damage and inflate it to the recommended pressure. If the tire is unable to maintain the recommended pressure, contact the nearest authorized GM servicing facility immediately for inspection and repair or replacement. To locate the nearest GM servicing facility, call GM Customer Assistance.

**Caution**

Do not drive on a deflated self-sealing tire as this could damage the tire. Make sure the tire is inflated to the recommended pressure or have it immediately repaired or replaced.

When tire replacement is needed replace with a self-sealing tire, because the vehicle does not come with a spare tire or tire changing equipment.

## Low-Profile Tires

If the vehicle has 265/50R20 or 275/40R22 size tires, they are classified as low-profile tires.

### Caution

Low-profile tires are more susceptible to damage from road hazards or curb impact than standard profile tires. Tire and/or wheel assembly damage can occur when coming into contact with road hazards like potholes, or sharp edged objects, or when sliding into a curb. The warranty does not cover this type of damage. Keep tires set to the correct inflation pressure and when possible, avoid contact with curbs, potholes, and other road hazards.

## Tire Sidewall Labeling

Useful information about a tire is molded into its sidewall. The example shows a typical passenger tire sidewall.

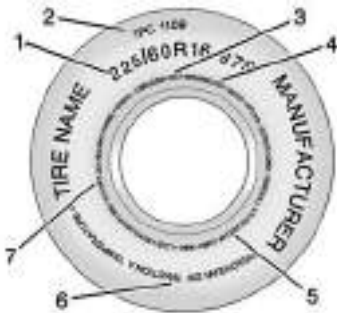

Passenger Tire Example

**(1) Tire Size** : The tire size is a combination of letters and numbers used to define a particular tire's width, height, aspect ratio, construction type, and service description. See the "Tire Size" illustration later in this section.

**(2) TPC Spec (Tire Performance Criteria Specification)** : Original equipment tires designed to GM's specific tire performance criteria have a TPC specification code molded onto the sidewall. GM's TPC specifications meet or exceed all federal safety guidelines.

**(3) DOT (Department of Transportation)** : The Department of Transportation (DOT) code indicates that the tire is in compliance with the U.S. Department of Transportation Motor Vehicle Safety Standards.

**DOT Tire Date of Manufacture** : The last four digits of the TIN indicate the tire manufactured date. The first two digits represent the week and the last two digits, the year. For example, the third week of the year 2020 would have a 4-digit DOT date of 0320. Week 01 is the first full week (Sunday through Saturday) of each year.

**(4) Tire Identification Number (TIN)** : The letters and numbers following the DOT code are the Tire Identification Number (TIN). The TIN shows the manufacturer and plant code, tire size, and date the tire was manufactured. The TIN is molded onto both sides of the tire, although only one side may have the date of manufacture.



**(5) Tire Ply Material** : The type of cord and number of plies in the sidewall and under the tread.

**(6) Uniform Tire Quality Grading (UTQG)** : Tire manufacturers are required to grade tires based on three performance factors: treadwear, traction, and temperature resistance. For more information, see *Uniform Tire Quality Grading* ⇨ 282.

**(7) Maximum Cold Inflation Load Limit** : Maximum load that can be carried and the maximum pressure needed to support that load.

## Tire Designations

### Tire Size

The example shows a typical passenger vehicle tire size.

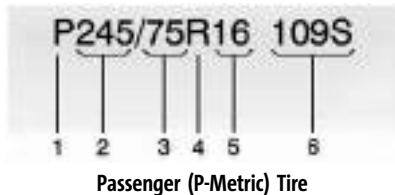

**(1) Passenger (P-Metric) Tire** : The United States version of a metric tire sizing system. The letter "P" as the first character in the tire size means a passenger vehicle tire engineered to standards set by the U.S. Tire and Rim Association.

**(2) Tire Width** : The 3-digit number indicates the tire section width in millimeters from sidewall to sidewall.

**(3) Aspect Ratio** : A 2-digit number that indicates the tire height-to-width measurements. For example, if the tire size aspect ratio is 75, as shown in item (3) of the illustration, it would mean that the tire's sidewall is 75 percent as high as it is wide.

**(4) Construction Code** : A letter code is used to indicate the type of ply construction in the tire. The letter "R" means radial ply construction; the letter "D" means diagonal or bias ply construction.

**(5) Rim Diameter** : Diameter of the wheel in inches.

**(6) Service Description** : These characters represent the load index and speed rating of the tire. The load index represents the load carrying capacity a tire is certified to carry. The speed rating is the maximum speed a tire is certified to carry a load.

## Tire Terminology and Definitions

**Air Pressure** : The amount of air inside the tire pressing outward on each square inch of the tire. Air pressure is expressed in kPa (kilopascal) or psi (pounds per square inch).

**Aspect Ratio** : The relationship of a tire's height to its width.

**Belt** : A rubber coated layer of cords that is located between the plies and the tread. Cords may be made from steel or other reinforcing materials.

**Bead** : The tire bead contains steel wires wrapped by steel cords that hold the tire onto the rim.

**Bias Ply Tire** : A pneumatic tire in which the plies are laid at alternate angles less than 90 degrees to the centerline of the tread.

**Cold Tire Pressure** : The amount of air pressure in a tire, measured in kPa (kilopascal) or psi (pounds per square inch) before a tire has built up heat from driving. See *Tire Pressure* ⇨ 274.

**DOT Markings** : A code molded into the sidewall of a tire signifying that the tire is in compliance with the U.S. Department of Transportation (DOT) Motor Vehicle Safety Standards. The DOT code includes the Tire Identification Number (TIN), an alphanumeric designator which can also identify the tire manufacturer, production plant, brand, and date of production.

**GVWR** : Gross Vehicle Weight Rating. See *Vehicle Load Limits* ⇨ 165.

**GAWR FRT** : Gross Axle Weight Rating for the front axle. See *Vehicle Load Limits* ⇨ 165.

**GAWR RR** : Gross Axle Weight Rating for the rear axle. See *Vehicle Load Limits* ⇨ 165.

**Intended Outboard Sidewall** : The side of an asymmetrical tire, that must always face outward when mounted on a vehicle.

**Kilopascal (kPa)** : The metric unit for air pressure.

**Light Truck (LT-Metric) Tire** : A tire used on light duty trucks and some multipurpose passenger vehicles.

**Load Index** : An assigned number ranging from 1 to 279 that corresponds to the load carrying capacity of a tire.

**Maximum Inflation Pressure** : The maximum air pressure to which a cold tire can be inflated. The maximum air pressure is molded onto the sidewall.

**Maximum Load Rating** : The load rating for a tire at the maximum permissible inflation pressure for that tire.

**Occupant Distribution** : Designated seating positions.

**Outward Facing Sidewall** : The side of an asymmetrical tire that has a particular side that faces outward when mounted on a vehicle. The side of the tire that contains a whitewall, bears white lettering, or bears manufacturer, brand, and/or model name molding that is higher or deeper than the same moldings on the other sidewall of the tire.

**Passenger (P-Metric) Tire** : A tire used on passenger cars and some light duty trucks and multipurpose vehicles.

**Recommended Inflation Pressure** : Vehicle manufacturer's recommended tire inflation pressure as shown on the tire placard. See *Tire Pressure* ⇨ 274 and *Vehicle Load Limits* ⇨ 165.

**Radial Ply Tire** : A pneumatic tire in which the ply cords that extend to the beads are laid at 90 degrees to the centerline of the tread.

**Rim** : A metal support for a tire and upon which the tire beads are seated.

**Sidewall** : The portion of a tire between the tread and the bead.

**Speed Rating** : An alphanumeric code assigned to a tire indicating the maximum speed at which a tire can operate.

**Traction** : The friction between the tire and the road surface. The amount of grip provided.

**Tread** : The portion of a tire that comes into contact with the road.

**Treadwear Indicators** : Narrow bands, sometimes called wear bars, that show across the tread of a tire when only 1.6 mm (1/16 in) of tread remains. See *When It Is Time for New Tires* ⇨ 280.

**UTQGS (Uniform Tire Quality Grading Standards)** : A tire information system that provides consumers with ratings for a tire's traction, temperature, and treadwear. Ratings are determined by tire manufacturers using government testing procedures. The ratings are molded into the sidewall of the tire. See *Uniform Tire Quality Grading* ⇨ 282.

**Vehicle Capacity Weight** : The number of designated seating positions multiplied by 68 kg (150 lbs) plus the rated cargo load. See *Vehicle Load Limits* ⇨ 165.

**Vehicle Maximum Load on the Tire** : Load on an individual tire due to curb weight, accessory weight, occupant weight, and cargo weight.

**Vehicle Placard** : A label permanently attached to a vehicle showing the vehicle's capacity weight and the original equipment tire size and recommended inflation pressure. See "Tire and Loading Information Label" under *Vehicle Load Limits* ⇨ 165.

## Tire Pressure

Tires need the correct amount of air pressure to operate effectively.

## Warning

Neither tire underinflation nor overinflation is good. Underinflated tires, or tires that do not have enough air, can result in:

- Tire overloading and overheating, which could lead to a blowout
- Premature or irregular wear
- Poor handling
- Reduced fuel economy for internal combustion engine vehicles
- Reduced range for electric vehicles

Overinflated tires, or tires that have too much air, can result in:

- Unusual wear
- Poor handling
- Rough ride
- Needless damage from road hazards

The Tire and Loading Information label on the vehicle indicates the original equipment tires and the correct cold tire inflation pressures. The recommended pressure is the minimum air pressure needed to support the vehicle's maximum load carrying capacity. See *Vehicle Load Limits* ⇨ 165.

How the vehicle is loaded affects vehicle handling and ride comfort. Never load the vehicle with more weight than it was designed to carry.

### When to Check

Check the pressure of the tires once a month or more.

### How to Check

Use a good quality pocket-type gauge to check tire pressure. Proper tire inflation cannot be determined by looking at the tire. Check the tire inflation pressure when the tires are cold, meaning the vehicle has not been driven for at least three hours or no more than 1.6 km (1 mi).

Remove the valve cap from the tire valve stem. Press the tire gauge firmly onto the valve to get a pressure measurement. If the cold tire inflation pressure matches the recommended pressure on the Tire and Loading Information label, no further adjustment is necessary. If the inflation pressure is low, add air until the recommended pressure is reached. If the inflation pressure is high, press on the metal stem in the center of the tire valve to release air.

Recheck the tire pressure with the tire gauge.

Put the valve caps back on the valve stems to keep out dirt and moisture. Use only valve caps designed for the vehicle by GM. TPMS sensors could be damaged and would not be covered by the vehicle warranty.

### Tire Pressure Monitor System

The Tire Pressure Monitor System (TPMS) uses radio and sensor technology to check tire pressure levels. The TPMS sensors

monitor the air pressure in your tires and transmit tire pressure readings to a receiver located in the vehicle.

Each tire, including the spare (if provided), should be checked monthly when cold and inflated to the inflation pressure recommended by the vehicle manufacturer on the vehicle placard or tire inflation pressure label. (If your vehicle has tires of a different size than the size indicated on the vehicle placard or tire inflation pressure label, you should determine the proper tire inflation pressure for those tires.)

As an added safety feature, your vehicle has been equipped with a tire pressure monitoring system (TPMS) that illuminates a low tire pressure telltale when one or more of your tires is significantly under-inflated.

Accordingly, when the low tire pressure telltale illuminates, you should stop and check your tires as soon as possible, and inflate them to the proper pressure. Driving on a significantly under-inflated tire causes the tire to overheat and can lead to tire failure. Under-inflation also reduces energy efficiency and tire tread life, and may affect the vehicle's handling and stopping ability.

Please note that the TPMS is not a substitute for proper tire maintenance, and it is the driver's responsibility to maintain correct tire pressure, even if under-inflation has not reached the level to trigger illumination of the TPMS low tire pressure telltale.

Your vehicle has also been equipped with a TPMS malfunction indicator to indicate when the system is not operating properly. The TPMS malfunction indicator is combined with the low tire pressure telltale. When the system detects a malfunction, the telltale will flash for approximately one minute and then remain continuously illuminated. This sequence will continue upon subsequent vehicle start-ups as long as the malfunction exists.

When the malfunction indicator is illuminated, the system may not be able to detect or signal low tire pressure as intended. TPMS malfunctions may occur for a variety of reasons, including the installation of replacement or alternate tires or wheels on the vehicle that prevent the TPMS from functioning properly. Always check the TPMS malfunction telltale after replacing one or more tires or wheels on

your vehicle to ensure that the replacement or alternate tires and wheels allow the TPMS to continue to function properly.

See *Tire Pressure Monitor Operation* ⇨ 276.

See *Radio Frequency Statement* ⇨ 312.

## Tire Pressure Monitor Operation

This vehicle may have a Tire Pressure Monitor System (TPMS). The TPMS is designed to warn the driver when a low tire pressure condition exists. TPMS sensors are mounted onto each tire and wheel assembly, excluding the spare tire and wheel assembly. The TPMS sensors monitor the air pressure in the tires and transmit the tire pressure readings to a receiver located in the vehicle.



When a low tire pressure condition is detected, the TPMS illuminates the low tire pressure warning light located on the instrument cluster. If the warning light comes on, stop as soon as possible and

inflate the tires to the recommended pressure shown on the Tire and Loading Information label. See *Vehicle Load Limits* ⇨ 165.

A message to check the pressure in a specific tire displays in the Driver Information Center (DIC). The low tire pressure warning light and the DIC warning message come on each time the vehicle is turned on until the tires are inflated to the correct inflation pressure. If the vehicle has DIC buttons, tire pressure levels can be viewed. For additional information and details about the DIC operation and displays, see *Driver Information Center (DIC)* ⇨ 108.

The low tire pressure warning light may come on in cool weather when the vehicle is first started, and then turn off as the vehicle is driven. This could be an early indicator that the air pressure is getting low and needs to be inflated to the proper pressure.

A Tire and Loading Information label shows the size of the original equipment tires and the correct inflation pressure for the tires when they are cold. See *Vehicle Load Limits* ⇨ 165, for an example of the Tire and Loading Information label and its location. Also see *Tire Pressure* ⇨ 274.

The TPMS can warn about a low tire pressure condition but it does not replace normal tire maintenance. See *Tire Inspection* ⇨ 278, *Tire Rotation* ⇨ 279, and *Tires* ⇨ 269.

### Caution

Tire sealant materials are not all the same. A non-approved tire sealant could damage the TPMS sensors. TPMS sensor damage caused by using an incorrect tire sealant is not covered by the vehicle warranty. Always use only the GM approved tire sealant available through your dealer or included in the vehicle.

### TPMS Malfunction Light and Message

The TPMS will not function properly if one or more of the TPMS sensors are missing or inoperable. When the system detects a malfunction, the low tire pressure warning light flashes for about one minute and then stays on for the remainder of the time the vehicle is on. A DIC warning message also displays. The malfunction light and DIC warning message will come on each time the vehicle is turned on until the problem is corrected. Some of the conditions that can cause these to come on are:

- One of the road tires has been replaced with the spare tire. The spare tire does not have a TPMS sensor. The malfunction light and the DIC message should go off after the road tire is replaced and the sensor matching process is performed successfully. See "TPMS Sensor Matching Process" later in this section.
- The TPMS sensor matching process was not done or not completed successfully after rotating the tires. The malfunction light and the DIC message should go off after successfully completing the sensor matching process. See "TPMS Sensor Matching Process" later in this section.
- One or more TPMS sensors are missing or damaged. The malfunction light and the DIC message should go off when the TPMS sensors are installed and the sensor matching process is performed successfully. See your dealer for service.
- Replacement tires or wheels do not match the original equipment tires or wheels. Tires and wheels other than those recommended could prevent the TPMS from functioning properly. See *Buying New Tires* ⇨ 280.

- Operating electronic devices or being near facilities using radio wave frequencies similar to the TPMS could cause the TPMS sensors to malfunction.

If the TPMS is not functioning properly, it cannot detect or signal a low tire pressure condition. See your dealer for service if the TPMS malfunction light and DIC message come on and stay on.

### Tire Fill Alert (If Equipped)

This feature provides visual and audible alerts outside the vehicle to help when inflating an underinflated tire to the recommended cold tire pressure.

When the low tire pressure warning light comes on:

1. Park the vehicle in a safe, level place.
2. Set the parking brake firmly.
3. Place the vehicle in P (Park).
4. Add air to the tire that is underinflated. The turn signal lamp will flash.  
When the recommended pressure is reached, the horn sounds once and the turn signal lamp will stop flashing and briefly turn solid.

Repeat these steps for all underinflated tires that have illuminated the low tire pressure warning light.

### Warning

Overinflating a tire could cause the tire to rupture and you or others could be injured. Do not exceed the maximum pressure listed on the tire sidewall. See *Tire Sidewall Labeling* ⇨ 271 and *Vehicle Load Limits* ⇨ 165.

If the tire is overinflated by more than 35 kPa (5 psi), the horn will sound multiple times and the turn signal lamp will continue to flash for several seconds after filling stops. To release and correct the pressure, while the turn signal lamp is still flashing, briefly press the center of the valve stem. When the recommended pressure is reached, the horn sounds once.

If the turn signal lamp does not flash within 15 seconds after starting to inflate the tire, the tire fill alert has not been activated or is not working.

If the hazard warning flashers are on, the tire fill alert visual feedback will not work properly.

The TPMS will not activate the tire fill alert properly under the following conditions:

- There is interference from an external device or transmitter.
- The air pressure from the inflation device is not sufficient to inflate the tire.
- There is a malfunction in the TPMS.
- There is a malfunction in the horn or turn signal lamps.
- The identification code of the TPMS sensor is not registered to the system.
- The battery of the TPMS sensor is low.

If the tire fill alert does not operate due to TPMS interference, move the vehicle about 1 m (3 ft) back or forward and try again.

If the tire fill alert feature is not working, use a tire pressure gauge.

### TPMS Sensor Matching Process — Auto Learn Function

Each TPMS sensor has a unique identification code. The identification code needs to be matched to a new tire/wheel position after rotating the tires or replacing one or more of the TPMS sensors. When a tire is installed, the vehicle must be stationary for about 20 minutes before the system recalculates. The following relearn

process takes up to 10 minutes, driving at a minimum speed of 20 km/h (12 mph).

A dash (-) or pressure value will display in the DIC. See *Driver Information Center (DIC)* ⇨ 108. A warning message displays in the DIC if a problem occurs during the relearn process.

### Tire Inspection

We recommend that the tires, including the spare tire, if the vehicle has one, be inspected for signs of wear or damage at least once a month.

Replace the tire if:

- The indicators at three or more places around the tire can be seen.
- There is cord or fabric showing through the tire's rubber.
- The tread or sidewall is cracked, cut, or snagged deep enough to show cord or fabric.
- The tire has a bump, bulge, or split.
- The tire has a puncture, cut, or other damage that cannot be repaired well because of the size or location of the damage.

## Tire Rotation

Tires should be rotated according to the interval listed in the maintenance schedule. See *Maintenance Schedule* ⇨ 298.

Tires are rotated to achieve a more uniform wear for all tires. The first rotation is the most important.

Anytime unusual wear is noticed, rotate the tires as soon as possible, check for proper tire inflation pressure, and check for damaged tires or wheels. If the unusual wear continues after the rotation, check the wheel alignment. See *When It Is Time for New Tires* ⇨ 280 and *Wheel Replacement* ⇨ 283.

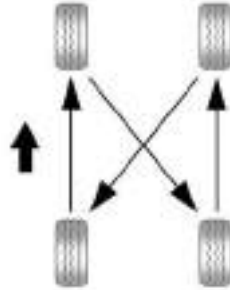

Use this rotation pattern when rotating the tires.

Adjust the front and rear tires to the recommended inflation pressure on the Tire and Loading Information label after the tires have been rotated. See *Tire Pressure* ⇨ 274 and *Vehicle Load Limits* ⇨ 165.

Reset the Tire Pressure Monitor System. See *Tire Pressure Monitor Operation* ⇨ 276.

Check that all wheel nuts are properly tightened. See “Wheel Nut Torque” under *Capacities and Specifications* ⇨ 303.

### Warning

Rust or dirt on a wheel, or on the parts to which it is fastened, can cause wheel nuts to become loose over time. The wheel could come off and cause a crash. When changing a wheel, remove any rust or dirt from places where the wheel attaches to the vehicle. In an emergency, a cloth or paper towel can be used; however, use a scraper or wire brush later to remove all rust or dirt.

Lightly coat the inner diameter of the wheel hub opening with wheel bearing grease after a wheel change or tire rotation to prevent corrosion or rust build-up.

### Warning

Do not apply grease to the wheel mounting surface, wheel conical seats, or the wheel nuts or bolts. Grease applied to these areas could cause a wheel to become loose or come off, resulting in a crash.



## When It Is Time for New Tires

Factors, such as maintenance, temperatures, driving speeds, vehicle loading, and road conditions affect the wear rate of the tires.

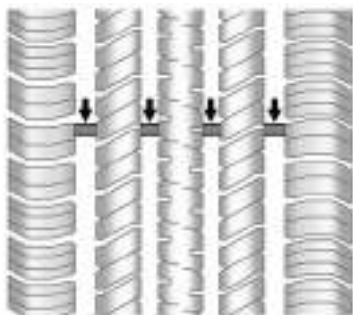

Treadwear indicators are one way to tell when it is time for new tires. Treadwear indicators appear when the tires have only 1.6 mm (1/16 in) or less of tread remaining. See *Tire Inspection* ⇨ 278 and *Tire Rotation* ⇨ 279.

The rubber in tires ages over time. This also applies to the spare tire, if the vehicle has one, even if it is never used. Multiple factors including temperatures, loading conditions, and inflation pressure maintenance affect how fast aging takes place. GM recommends

that tires, including the spare if equipped, be replaced after six years, regardless of tread wear. To identify the age of a tire, use the tire manufacture date, which is the last four digits of the DOT Tire Identification Number (TIN) molded into one side of the tire sidewall. The last four digits of the TIN indicate the tire manufactured date. The first two digits represent the week and the last two digits, the year. For example, the third week of the year 2020 would have a 4-digit DOT date of 0320. Week 01 is the first full week (Sunday through Saturday) of each year.

### Vehicle Storage

Tires age when stored normally mounted on a parked vehicle. Park a vehicle that will be stored for at least a month in a cool, dry, clean area away from direct sunlight to slow aging. This area should be free of grease, gasoline, or other substances that can deteriorate rubber.

Parking for an extended period can cause flat spots on the tires that may result in vibrations while driving. When storing a vehicle for at least a month, remove the tires or raise the vehicle to reduce the weight from the tires.

## Buying New Tires

GM has developed and matched specific tires for the vehicle. The original equipment tires installed were designed to meet General Motors Tire Performance Criteria Specification (TPC Spec) system rating. When replacement tires are needed, GM strongly recommends buying tires with the same TPC Spec rating.

GM's exclusive TPC Spec system considers over a dozen critical specifications that impact the overall performance of the vehicle, including brake system performance, ride and handling, traction control, and tire pressure monitoring performance. GM's TPC Spec number is molded onto the tire's sidewall near the tire size. If the tires have an all-season tread design, the TPC Spec number will be followed by MS for mud and snow. See *Tire Sidewall Labeling* ⇨ 271 for additional information.

GM recommends replacing worn tires in complete sets of four. Uniform tread depth on all tires will help to maintain the performance of the vehicle. Braking and handling performance may be adversely affected if all the tires are not replaced at the same time. If proper rotation and maintenance have been done, all four tires should wear out at about the same time. However, if it is necessary to replace only one axle set of worn tires, place the new tires on the rear axle. See *Tire Rotation* ⇨ 279.

### Warning

Tires could explode during improper service. Attempting to mount or dismount a tire could cause injury or death. Only your dealer or authorized tire service center should mount or dismount the tires.

### Warning

Mixing tires of different sizes (other than those originally installed on the vehicle), brands, tread patterns, or types may cause loss of vehicle control, resulting in a crash or other vehicle damage. Use the correct size, brand, and type of tire on all wheels.

### Warning

Using bias-ply tires on the vehicle may cause the wheel rim flanges to develop cracks after many miles of driving. A tire and/or wheel could fail suddenly and cause a crash. Use only radial-ply tires with the wheels on the vehicle.

Winter tires with the same speed rating as the original equipment tires may not be available for H, V, W, Y and ZR speed rated tires. Never exceed the winter tires' maximum speed capability when using winter tires with a lower speed rating.

If the vehicle tires must be replaced with a tire that does not have a TPC Spec number, make sure they are the same size, load range, speed rating, and construction (radial) as the original tires.

The Tire and Loading Information label indicates the original equipment tires on the vehicle. See *Vehicle Load Limits* ⇨ 165.

## Different Size Tires and Wheels

If wheels or tires are installed that are a different size than the original equipment wheels and tires, vehicle performance, including its braking, ride and handling characteristics, stability, and resistance to rollover may be affected. If the vehicle has electronic systems such as antilock brakes, rollover airbags, traction control, electronic stability control, or All-Wheel Drive, the performance of these systems can also be affected.

**⚠ Warning**

If different sized wheels are used, there may not be an acceptable level of performance and safety if tires not recommended for those wheels are selected. This increases the chance of a crash and serious injury. Only use GM specific wheel and tire systems developed for the vehicle, and have them properly installed by a GM certified technician.

See *Buying New Tires* ⇨ 280 and *Accessories and Modifications* ⇨ 248.

**Uniform Tire Quality Grading**

The following information relates to the system developed by the United States National Highway Traffic Safety Administration (NHTSA), which grades tires by treadwear, traction, and temperature performance. This applies only to vehicles sold in the United States. The grades are molded on the sidewalls of most passenger car tires. The Uniform Tire Quality Grading (UTQG) system does not apply to deep tread, winter tires, compact spare tires,

tires with nominal rim diameters of 10 to 12 inches (25 to 30 cm), or to some limited-production tires.

While the tires available on General Motors passenger cars and light trucks may vary with respect to these grades, they must also conform to federal safety requirements and additional General Motors Tire Performance Criteria (TPC) standards.

Quality grades can be found where applicable on the tire sidewall between tread shoulder and maximum section width. For example:

**Treadwear 200 Traction AA Temperature A**

All Passenger Car Tires Must Conform to Federal Safety Requirements In Addition To These Grades.

**Treadwear**

The treadwear grade is a comparative rating based on the wear rate of the tire when tested under controlled conditions on a specified government test course. For example, a tire graded 150 would wear one and one-half (1½)

times as well on the government course as a tire graded 100. The relative performance of tires depends upon the actual conditions of their use, however, and may depart significantly from the norm due to variations in driving habits, service practices and differences in road characteristics and climate.

**Traction**

The traction grades, from highest to lowest, are AA, A, B, and C. Those grades represent the tire's ability to stop on wet pavement as measured under controlled conditions on specified government test surfaces of asphalt and concrete. A tire marked C may have poor traction performance. **Warning:** The traction grade assigned to this tire is based on straight-ahead braking traction tests, and does not include acceleration, cornering, hydroplaning, or peak traction characteristics.

## Temperature

The temperature grades are A (the highest), B, and C, representing the tire's resistance to the generation of heat and its ability to dissipate heat when tested under controlled conditions on a specified indoor laboratory test wheel. Sustained high temperature can cause the material of the tire to degenerate and reduce tire life, and excessive temperature can lead to sudden tire failure. The grade C corresponds to a level of performance which all passenger car tires must meet under the Federal Motor Safety Standard No. 109. Grades B and A represent higher levels of performance on the laboratory test wheel than the minimum required by law. **Warning:** The temperature grade for this tire is established for a tire that is properly inflated and not overloaded. Excessive speed, underinflation, or excessive loading, either separately or in combination, can cause heat buildup and possible tire failure.

## Wheel Alignment and Tire Balance

The tires and wheels were aligned and balanced at the factory to provide the longest tire life and best overall performance. Adjustments to wheel alignment and tire balancing are not necessary on a regular basis. Consider an alignment check if there is unusual tire wear or the vehicle is significantly pulling to one side or the other. Some slight pull to the left or right, depending on the crown of the road and/or other road surface variations such as troughs or ruts, is normal. If the vehicle is vibrating when driving on a smooth road, the tires and wheels may need to be rebalanced. See your dealer for proper diagnosis.

## Wheel Replacement

Replace any wheel that is bent, cracked, or badly rusted or corroded. If wheel nuts keep coming loose, the wheel, wheel bolts, and wheel nuts should be replaced. If the wheel leaks air, replace it. Some aluminum wheels can be repaired. See your dealer if any of these conditions exist.

Your dealer will know the kind of wheel that is needed.

Each new wheel should have the same load-carrying capacity, diameter, width, offset, and be mounted the same way as the one it replaces.

Replace wheels, wheel bolts, wheel nuts, or Tire Pressure Monitor System (TPMS) sensors with new GM original equipment parts.

### Warning

Using the wrong replacement wheels, wheel bolts, or wheel nuts can be dangerous. It could affect the braking and handling of the vehicle. Tires can lose air and cause loss of control, resulting in a crash. Always use the correct wheel, wheel bolts, and wheel nuts for replacement.

### Warning

Replacing a wheel with a used one is dangerous. How it has been used or how far it has been driven may be unknown.

(Continued)

**Warning (Continued)**

It could fail suddenly and cause a crash. When replacing wheels, use a new GM original equipment wheel.

**Caution**

The wrong wheel can also cause problems with bearing life, brake cooling, speedometer or odometer calibration, headlamp aim, bumper height, vehicle ground clearance, and tire or tire chain clearance to the body and chassis.

**Tire Chains****Caution**

If the vehicle is equipped with tire size 265/50R20, use tire winter traction devices only where legal and only when necessary. Only use textile traction devices, such as tire snow socks, that are the proper size for the tires. Traction devices must be installed only on the tires of the drive axle. Drive slowly and follow the traction device manufacturer's  
(Continued)

**Caution (Continued)**

instructions. Driving too fast or spinning the wheels can damage the traction device.

**If a Tire Goes Flat**

It is unusual for a tire to blow out while driving, especially if the tires are maintained properly. If air goes out of a tire, it is much more likely to leak out slowly. See *Tires* ⇨ 269 for additional information. But if there ever is a blowout, here are a few tips about what to expect and what to do:

If a front tire fails, the flat tire creates a drag that pulls the vehicle toward that side. Take your foot off the accelerator pedal and grip the steering wheel firmly. Steer to maintain lane position, and then gently brake to a stop, well off the road, if possible.

A rear blowout, particularly on a curve, acts much like a skid and may require the same correction as used in a skid. Stop pressing the accelerator pedal and steer to straighten the vehicle. It may be very bumpy and noisy. Gently brake to a stop, well off the road, if possible.

The vehicle has no spare tire, no tire changing equipment, and no place to store a tire.

If the vehicle has self-sealing tires, see *Self-Sealing Tires* ⇨ 270. Tread punctures typically will not cause tires to lose air. However, if the vehicle does get a flat tire, there is no spare tire, tire changing equipment, or place to store a tire. Contact Roadside Assistance for help.

 **Warning**

Driving on a flat tire will cause permanent damage to the tire. Re-inflating a tire after it has been driven on while severely underinflated or flat may cause a blowout and a serious crash. Never attempt to re-inflate a tire that has been driven on while severely underinflated or flat. Have your dealer or an authorized tire service center repair or replace the flat tire as soon as possible.

If a tire goes flat, avoid further tire and wheel damage by driving slowly to a level place, well off the road, if possible. Turn on the hazard warning flashers. See *Hazard Warning Flashers* ⇨ 119.

## Jump Starting

### Jump Starting - North America

For more information about the vehicle battery, see *Battery - North America* ⇨ 255.

If the battery has run down, try to use another vehicle and some jumper cables to start your vehicle. Be sure to use the following steps to do it safely.

#### Warning

**WARNING:** Battery posts, terminals and related accessories can expose you to chemicals including lead and lead compounds, which are known to the State of California to cause cancer and birth defects or other reproductive harm. Wash hands after handling. For more information go to [www.P65Warnings.ca.gov](http://www.P65Warnings.ca.gov).

See *California Proposition 65 Warning* ⇨ 1.

#### Warning

Batteries can hurt you. They can be dangerous because:

- They contain acid that can burn you.
- They contain gas that can explode or ignite.
- They contain enough electricity to burn you.

Use eye protection when handling the battery. If you do not follow these steps exactly, some or all of these things can hurt you.

#### Caution

The vehicle is equipped with an AGM/VRLA 12-volt battery, which can be damaged by using the incorrect type of trickle charger. An AGM/VRLA-compatible charger must be used, with the appropriate setting selected. Follow the trickle charger manufacturer instructions.

#### Caution

Ignoring these steps could result in costly damage to the vehicle that would not be covered by the vehicle warranty. Trying to start the vehicle by pushing or pulling it will not work, and it could damage the vehicle.

#### Caution

If the jumper cables are connected or removed in the wrong order, electrical shorting may occur and damage the vehicle. The repairs would not be covered by the vehicle warranty. Always connect and remove the jumper cables in the correct order, making sure that the cables do not touch each other or other metal.

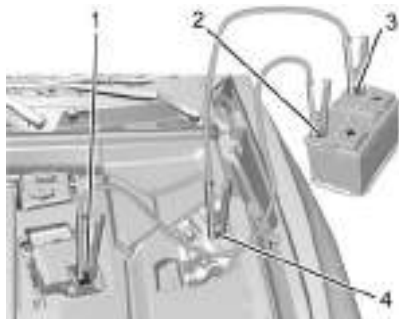

### Connection Points and Sequence

1. Discharged Battery Positive (+) Terminal
2. Good Battery Positive (+) Terminal
3. Good Battery Negative (-) Terminal
4. Discharged Battery Negative (-) Grounding Point

The discharged battery positive (+) terminal and the discharged battery negative (-) grounding point are on the driver side of the vehicle.

The good battery negative (-) terminal and the good battery positive (+) terminal are on the battery of the vehicle providing the jump start.

The discharged battery positive (+) terminal and the discharged Battery Negative (-) Grounding Point are under a covers. Remove the cover to expose the terminal.

1. Check the other vehicle. It must have a 12-volt battery with a negative ground system.

#### Caution

If the other vehicle does not have a 12-volt system with a negative ground, both vehicles can be damaged. Only use a vehicle that has a 12-volt system with a negative ground for jump starting.

2. Get the vehicles close enough so the jumper cables can reach, but make sure the vehicles are not touching each other.

#### Caution

If the vehicles touch each other while jump starting, a ground connection may occur that disables your vehicle and/or damages the electrical systems of one or both vehicles.

To avoid the possibility of the vehicles rolling, set the parking brake firmly on both vehicles involved in the jump start

procedure. Put the vehicles into P (Park). If the other vehicle has a manual transmission, put the vehicle in N (Neutral) before setting the parking brakes.

3. Turn off both vehicles. Unplug unnecessary accessories plugged into the cigarette lighter or the accessory power outlet. Turn off the radio and all lamps that are not needed.

#### Caution

If any accessories are left on or plugged in during the jump starting procedure, they could be damaged. The repairs would not be covered by the vehicle warranty. Whenever possible, turn off or unplug all accessories on either vehicle when jump starting.

4. Open the hood. See *Hood* ⇨ 250.



5. To open the lid, pull the handle to disengage the clips and remove the cover.

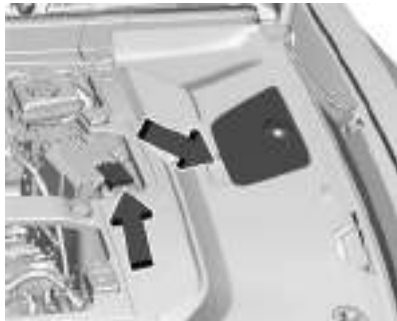

6. Remove the covers of the positive and negative terminals.
7. Locate the battery positive (+) terminal and negative (-) grounding point.
8. Check that the jumper cables do not have loose or missing insulation. If they do, you could get a shock. The vehicles could be damaged too.
9. Connect one end of the red positive (+) cable to the discharged battery positive (+) terminal. Do not let the other end touch metal.
10. Connect the other end of the red positive (+) cable to the good battery positive (+) terminal.
11. Connect one end of the black negative (-) cable to the good battery negative (-) terminal.  
Do not let the other end touch anything until the next step.
12. Connect the other end of the negative (-) cable to the discharged battery negative (-) grounding point.
13. Now start the vehicle with the good battery and keep the vehicle running for a while.

14. Try to start the vehicle that had the dead battery. If it will not start after a few tries, it probably needs service.

### Jumper Cable Removal

Reverse the sequence exactly when removing the jumper cables.

After starting the disabled vehicle and removing the jumper cables, allow it to idle for several minutes.

## Towing the Vehicle

### Transporting a Disabled Vehicle

#### Caution

Incorrectly transporting a disabled vehicle may cause damage to the vehicle. Use proper tire straps to secure the vehicle to the flatbed tow truck. Do not strap or hook to any frame, underbody, or suspension component not specified below. Do not move vehicles with drive axle tires on the ground. Damage is not covered by the vehicle warranty.



**Caution**

The vehicle may be equipped with an electric parking brake and/or an electronic shifter. In the event of a loss of 12-volt battery power, the electric parking brake cannot be released, and the vehicle cannot be shifted to N (Neutral). Tire skates or dollies must be used under the non-rolling tires to prevent damage while loading/unloading the vehicle. Dragging the vehicle will cause damage not covered by the vehicle warranty.

**Caution**

The vehicle may be equipped with a tow eye. Improper use of the tow eye may cause damage to the vehicle and is not covered by the vehicle warranty. If equipped, use the tow eye to load the vehicle onto a flatbed tow truck from a flat road surface, or to move the vehicle a very short distance at a walking pace. The tow eye is not designed for off-road recovery. The vehicle must be in N (Neutral) with the electric parking brake released when using the tow eye.

Contact a professional towing service if the disabled vehicle must be transported. GM recommends a flatbed tow truck to transport a disabled vehicle. Use ramps to help reduce approach angles, if necessary.

If equipped, a tow eye may be located near the spare tire or emergency jack. Do not use the tow eye to pull the vehicle from the snow, mud, sand, or ditch. Tow eye threads may have right or left-hand threads. Use caution when installing or removing the tow eye.

The vehicle must be in N (Neutral) and the electric parking brake must be released when loading the vehicle onto a flatbed tow truck.

- If the vehicle is equipped with car wash mode and has 12-volt battery power, refer to “Car Wash Mode” under *Electric Drive Unit* ⇨ 171 to place the vehicle in N (Neutral).
- If the 12-volt battery is dead and/or the vehicle will not start, the vehicle will not move. Try to jump start the vehicle. Refer to *Jump Starting - North America* ⇨ 285 and if the jump start is successful, retry the “Car Wash Mode” procedure.

- If jump starting is unsuccessful, the vehicle will not move. Tire skates or dollies must be used under the non-rolling tires to prevent vehicle damage.

**Front Tow Eye Attachment Point**

1. Carefully open the cover in the fascia by using the small notch that conceals the tow eye socket.



2. Install the tow eye into the socket and turn it until it is fully tightened. When the tow eye is removed, reinstall the cover with the notch in the original position.

## Recreational Vehicle Towing

### Caution

Dolly towing or dinghy towing may damage the vehicle. Always put the vehicle on a flatbed truck or trailer.

The vehicle was neither designed nor intended to be towed with any of its wheels on the ground. If your vehicle is disabled and needs to be towed, see *Transporting a Disabled Vehicle* ⇨ 287.

## Appearance Care

### Exterior Care

#### Locks

Locks are lubricated at the factory. Use a de-icing agent only when absolutely necessary, and have the locks greased after using. See *Recommended Fluids and Lubricants* ⇨ 300.

#### Washing the Vehicle

To preserve the vehicle's finish, wash it often and out of direct sunlight.

### Caution

Do not use petroleum-based, acidic, or abrasive cleaning agents as they can damage the vehicle's paint, metal, or plastic parts. If damage occurs, it would not be covered by the vehicle warranty. Approved cleaning products can  
(Continued)

### Caution (Continued)

be obtained from your dealer. Follow all manufacturer directions regarding correct product usage, necessary safety precautions, and appropriate disposal of any vehicle care product.

### Caution

Avoid using high-pressure washes closer than 30 cm (12 in) to the surface of the vehicle. Use of power washers exceeding 8 274 kPa (1,200 psi) can result in damage or removal of paint and decals.

If using an automatic car wash, follow the car wash instructions. The windshield wiper and rear window wiper, if equipped, must be off. Remove any accessories that may be damaged or interfere with the car wash equipment.

Rinse the vehicle well, before washing and after, to remove all cleaning agents completely. If they are allowed to dry on the surface, they could stain.

Dry the finish with a soft, clean chamois or an all-cotton towel to avoid surface scratches and water spotting.

### Cleaning Underhood Components

#### Caution

Do not power wash any component under the hood that has this  symbol.

This could cause damage that would not be covered by the vehicle warranty.

Solvents or aggressive cleaners may harm underhood components. Avoid using these chemicals. Water is recommended.

A pressure washer may be used, but use care when handling. The following criteria must be followed:

- Water pressure must be kept below 14,000 KPa (2,000 PSI).
- Water temperature must be below 80 °C (180 °F).
- Spray nozzle with a 40 degree wide angle spray pattern or wider must be used.
- Nozzle must be kept at least 30 cm (1 ft) away from all surfaces.

### Finish Care

Application of aftermarket clearcoat sealant/wax materials is not recommended. If painted surfaces are damaged, see your

dealer to have the damage assessed and repaired. Foreign materials such as calcium chloride and other salts, ice melting agents, road oil and tar, tree sap, bird droppings, chemicals from industrial chimneys, etc., can damage the vehicle's finish if they remain on painted surfaces. Wash the vehicle as soon as possible. If necessary, use non-abrasive cleaners that are marked safe for painted surfaces to remove foreign matter.

Occasional hand waxing or mild polishing should be done to remove residue from the paint finish. See your dealer for approved cleaning products.

Do not apply waxes or polishes to uncoated plastic, vinyl, rubber, decals, simulated wood, or flat paint as damage can occur.

#### Caution

Machine compounding or aggressive polishing on a basecoat/clearcoat paint finish may damage it. Use only non-abrasive waxes and polishes that are made for a basecoat/clearcoat paint finish on the vehicle.

To keep the paint finish looking new, keep the vehicle garaged or covered whenever possible.

### Protecting Exterior Bright Metal Moldings

#### Caution

Failure to clean and protect the bright metal moldings can result in a hazy white finish or pitting. This damage would not be covered by the vehicle warranty.

The bright metal moldings on the vehicle are aluminum, chrome, or stainless steel. To prevent damage always follow these cleaning instructions:

- Be sure the molding is cool to the touch before applying any cleaning solution.
- Use only approved cleaning solutions for aluminum, chrome, or stainless steel. Some cleaners are highly acidic or contain alkaline substances and can damage the moldings.
- Always dilute a concentrated cleaner according to the manufacturer's instructions.
- Do not use cleaners that are not intended for automotive use.

- Use a nonabrasive wax on the vehicle after washing to protect and extend the molding finish.

### Cleaning Exterior Lamps/Lenses, Emblems, Decals, and Stripes

Use only lukewarm or cold water, a soft cloth, and a car washing soap to clean exterior lamps, lenses, emblems, decals, and stripes. Follow instructions under "Washing the Vehicle" previously in this section.

Lamp covers are made of plastic, and some have a UV protective coating. Do not clean or wipe them when dry.

Do not use any of the following on lamp covers:

- Abrasive or caustic agents.
- Washer fluids and other cleaning agents in higher concentrations than suggested by the manufacturer.
- Solvents, alcohols, or other harsh cleaners.
- Ice scrapers or other hard items.
- Aftermarket appearance caps or covers while the lamps are illuminated, due to excessive heat generated.

<b>Caution</b>
Failure to clean lamps properly can cause damage to the lamp cover that would not be covered by the vehicle warranty.

<b>Caution</b>
Using wax on low gloss black finish stripes can increase the gloss level and create a non-uniform finish. Clean low gloss stripes with soap and water only.

### Air Intakes

Clear debris from the air intakes, between the hood and windshield, when washing the vehicle.

### Windshield and Wiper Blades

Clean the outside of the windshield with glass cleaner.

Clean rubber blades using a lint-free cloth or paper towel soaked with windshield washer fluid or a mild detergent. Wash the windshield thoroughly when cleaning the blades. Bugs, road grime, sap, and a buildup of vehicle wash/wax treatments may cause wiper streaking.

Replace the wiper blades if they are worn or damaged. Damage can be caused by extreme dusty conditions, sand, salt, heat, sun, snow, and ice.

### Weatherstrips

Apply weatherstrip lubricant on weatherstrips to make them last longer, seal better, and not stick or squeak. Lubricate weatherstrips at least once a year. Hot, dry climates may require more frequent application. Black marks from rubber material on painted surfaces can be removed by rubbing with a clean cloth. See *Recommended Fluids and Lubricants* ⇨ 300.

### Tires

Use a stiff brush with tire cleaner to clean the tires.

<b>Caution</b>
Using petroleum-based tire dressing products on the vehicle may damage the paint finish and/or tires. When applying a tire dressing, always wipe off any overspray from all painted surfaces on the vehicle.

## Wheels and Wheel Trim

Use a soft, clean cloth with mild soap and water to clean the wheels. After rinsing thoroughly with clean water, dry with a soft, clean towel. A wax may then be applied.

### Caution

Chrome wheels and chrome wheel trim may be damaged if the vehicle is not washed after driving on roads that have been sprayed with magnesium chloride or calcium chloride. These are used on roads for conditions such as dust and ice. Always wash the chrome with soap and water after exposure.

### Caution

To avoid surface damage on wheels and wheel trim, do not use strong soaps, chemicals, abrasive polishes, cleaners, or brushes. Use only GM approved cleaners. Do not drive the vehicle through an automatic car wash that uses silicon carbide tire/wheel cleaning brushes.

(Continued)

### Caution (Continued)

Damage could occur and the repairs would not be covered by the vehicle warranty.

## Brake System

Visually inspect brake lines and hoses for proper hook-up, binding, leaks, cracks, chafing, etc. Inspect disc brake pads for wear and rotors for surface condition. Inspect all other brake parts.

## Steering, Suspension, and Chassis Components

Visually inspect steering, suspension, and chassis components for damaged, loose, or missing parts or signs of wear at least once a year.

Inspect power steering for proper electrical connections, binding, cracks, chafing, etc.

Visually check constant velocity joint boots and axle seals for leaks.

## Body Component Lubrication

Lubricate all key lock cylinders, hood hinges, and liftgate hinges unless the components are plastic. Applying silicone grease on

weatherstrips with a clean cloth will make them last longer, seal better, and not stick or squeak.

## Underbody Maintenance

At least twice a year, spring and fall, use plain water to flush any corrosive materials from the underbody. Take care to thoroughly clean any areas where mud and other debris can collect.

Do not directly power wash the transfer case and/or front/rear axle output seals. High pressure water can overcome the seals and contaminate the fluid. Contaminated fluid will decrease the life of the transfer case and/or axles and should be replaced.

## Sheet Metal Damage

If the vehicle is damaged and requires sheet metal repair or replacement, make sure the body repair shop applies anti-corrosion material to parts repaired or replaced to restore corrosion protection.

Original manufacturer replacement parts will provide the corrosion protection while maintaining the vehicle warranty.

### Finish Damage

Quickly repair minor chips and scratches with touch-up materials available from your dealer to avoid corrosion. Larger areas of finish damage can be corrected in your dealer's body and paint shop.

### Chemical Paint Spotting

Airborne pollutants can fall upon and attack painted vehicle surfaces causing blotchy, ring-shaped discolorations, and small, irregular dark spots etched into the paint surface. See "Finish Care" previously in this section.

### Interior Care

To prevent dirt particle abrasions, regularly clean the vehicle's interior. Before using cleaners, read and follow all safety instructions on the label. While cleaning the interior, open the doors and windows to get proper ventilation. Newspapers or dark garments can transfer color to the vehicle's interior.

<b>Caution</b>
Immediately remove cleaners, hand lotions, sunscreen, and insect repellent from all interior surfaces or permanent damage may result.

<b>Caution</b>
Use cleaners specifically designed for the surfaces being cleaned to prevent permanent damage to the vehicle. Apply all cleaners directly to a cleaning cloth. Do not spray cleaners on any switches or controls.

When using liquid soap cleaners, follow the directions on the specific cleaner or soap solution for dilution instructions.

<b>Caution</b>
To prevent damage: <ul style="list-style-type: none"> <li>• Never use a razor or any other sharp object to remove soil from any interior surface</li> <li>• Never use a brush with stiff bristles.</li> </ul> <p style="text-align: right;">(Continued)</p>

<b>Caution (Continued)</b>
<ul style="list-style-type: none"> <li>• Never rub any surface aggressively or with too much pressure.</li> <li>• Do not get any exposed electrical components wet.</li> <li>• Do not use laundry detergents or dishwashing soaps with degreasers. Do not use solutions that contain strong or caustic soap.</li> <li>• Do not heavily saturate the upholstery when cleaning.</li> <li>• Do not use solvents or cleaners containing solvents.</li> <li>• Do not use disinfecting wipes that are scented or contain bleach. Do not use wipes or cleaners that show a color transfer to the wipe or change the appearance of the interior surface when used.</li> <li>• Do not use scented or gel-type hand sanitizers. If hand sanitizer comes in contact with interior surfaces of the vehicle, blot immediately and clean with a soft cloth dampened with a mild soap and water solution.</li> </ul>

## Interior Glass

To clean, use a microfiber cloth fabric dampened with water. Wipe droplets left behind with a clean dry cloth. If necessary, use a commercial glass cleaner after cleaning with plain water.

### Caution

To prevent scratching, never use abrasive cleaners on automotive glass. Abrasive cleaners or aggressive cleaning may damage the rear window defogger.

Cleaning the windshield with water during the first three to six months of ownership will reduce tendency to fog.

## Speaker Covers

Vacuum around a speaker cover gently, so that the speaker will not be damaged. Clean spots with water and mild soap.

## Coated Moldings

Coated moldings should be cleaned.

- When lightly soiled, wipe with a sponge or soft, lint-free cloth dampened with water.
- When heavily soiled, use warm soapy water.

## Vinyl/Rubber

If equipped with vinyl floor and rubber floor mats, use a soft cloth and/or brush dampened with water to remove dust and loose dirt. For more thorough cleaning, use a mild soap and water solution.

### Warning

Do not use cleaners that contain silicone, wax-based products, or cleaners that increase gloss on vinyl/rubber floor and mats. These cleaners can permanently change the appearance and feel of the vinyl/rubber and can make the floor slippery. Your foot could slip while operating the vehicle, and you could lose control, resulting in a crash. You or others could be injured.

## Fabric/Carpet/Suede

Start by vacuuming the surface using a soft brush attachment. If a rotating vacuum brush attachment is being used, only use it on the floor carpet. Before cleaning, gently remove as much of the soil as possible:

- Gently blot liquids with a paper towel. Continue blotting until no more soil can be removed.

- For solid soils, remove as much as possible prior to vacuuming.

To clean:

1. Saturate a clean, lint-free colorfast cloth with water. Microfiber cloth is recommended to prevent lint transfer to the fabric or carpet.
2. Remove excess moisture by gently wringing until water does not drip from the cleaning cloth.
3. Start on the outside edge of the soil and gently rub toward the center. Fold the cleaning cloth to a clean area frequently to prevent forcing the soil into the fabric.
4. Continue gently rubbing the soiled area until there is no longer any color transfer from the soil to the cleaning cloth.
5. If the soil is not completely removed, use a mild soap solution followed only by plain water.

If the soil is not completely removed, it may be necessary to use a commercial upholstery cleaner or spot lifter. Test a small hidden area for colorfastness before using a

commercial upholstery cleaner or spot lifter. If ring formation occurs, clean the entire fabric or carpet.

After cleaning, use a paper towel to blot excess moisture.

### Cleaning High Gloss Surfaces and Vehicle Information and Radio Displays

Use a microfiber cloth on high gloss surfaces or vehicle displays. First, use a soft bristle brush to remove dirt that can scratch the surface. Then gently clean by rubbing with a microfiber cloth. Never use window cleaners or solvents. Periodically hand wash the microfiber cloth separately, using mild soap. Do not use bleach or fabric softener. Rinse thoroughly and air dry before next use.

#### Caution

Do not attach a device with a suction cup to the display. This may cause damage and would not be covered by the vehicle warranty.

### Instrument Panel, Leather, Vinyl, Other Plastic Surfaces, Low Gloss Paint Surfaces, and Natural Open Pore Wood Surfaces

Use a soft bristle brush to remove dust from knobs and crevices on the instrument cluster. Use a soft microfiber cloth dampened with water to remove dust and loose dirt. For a more thorough cleaning, use a soft microfiber cloth dampened with a mild soap and water solution.

#### Caution

Soaking or saturating leather, especially perforated leather, as well as other interior surfaces, may cause permanent damage. Wipe excess moisture from these surfaces after cleaning and allow them to dry naturally. Never use heat, steam, or spot removers. Do not use liquids that contain alcohol or solvents on leather seats. Do not use cleaners that contain silicone or wax-based products. Cleaners containing these solvents can permanently change the appearance and feel of leather or soft trim, and are not recommended.

Do not use cleaners that increase gloss, especially on the instrument panel. Reflected glare can decrease visibility through the windshield under certain conditions.

#### Caution

Use of air fresheners may cause permanent damage to plastics and painted surfaces. If an air freshener comes in contact with any plastic or painted surface in the vehicle, blot immediately and clean with a soft cloth dampened with a mild soap solution. Damage caused by air fresheners would not be covered by the vehicle warranty.

### Cargo Cover and Convenience Net

If equipped, wash with warm water and mild detergent. Do not use chlorine bleach. Rinse with cold water, and then dry completely.

### Care of Seat Belts

Keep belts clean and dry.



**Warning**

Do not bleach or dye seat belt webbing. It may severely weaken the webbing. In a crash, they might not be able to provide adequate protection. Clean and rinse seat belt webbing only with mild soap and lukewarm water. Allow the webbing to dry.

**Floor Mats****Warning**

If a floor mat is the wrong size or is not properly installed, it can interfere with the pedals. Interference with the pedals can cause unintended acceleration and/or increased stopping distance which can cause a crash and injury. Make sure the floor mat does not interfere with the pedals.

Use the following guidelines for proper floor mat use:

- The original equipment floor mats are designed for your vehicle. If the floor mats need to be replaced, it is recommended that GM-certified floor mats are purchased. Non-GM floor mats may not fit properly and may interfere with the pedals. Always check that the floor mats do not interfere with the pedals.
- Do not use a floor mat if the vehicle is not equipped with a floor mat retainer on the driver side floor.
- Use the floor mat with the correct side up. Do not turn it over.
- Do not place anything on top of the driver side floor mat.
- Use only a single floor mat on the driver side.
- Do not place one floor mat on top of another.

**Removing and Replacing the Floor Mats**

The driver side floor mat is held in place by two button-type retainers.

The passenger side floor mat is held in place by two button-type retainers.



1. Pull up on the rear of the floor mat to unlock each retainer and remove.
2. Reinstall by lining up the floor mat retainer openings over the carpet retainers and snapping into position.
3. Make sure the floor mat is properly secured in place. Verify the floor mat does not interfere with the pedals.

**Cleaning Rubber Floor Mats (All-Weather Mats and Floor Liners)**

See "Vinyl/Rubber" under *Interior Care*  
 ⇨ 293 for important cleaning information.

## Service and Maintenance

### General Information

General Information ..... 297

### Maintenance Schedule

Maintenance Schedule ..... 298

### Multi-Point Vehicle Inspection (MPVI)

Multi-Point Vehicle  
Inspection (MPVI) ..... 299

### Owner Checks and Services

Owner Checks and Services ..... 299

### Recommended Fluids, Lubricants, and Parts

Recommended Fluids and  
Lubricants ..... 300  
Maintenance Replacement Parts ..... 300

### Maintenance Records

Maintenance Records ..... 301

## General Information

Your vehicle is an important investment. This section describes the required maintenance for the vehicle. Follow this schedule to help protect against major repair expenses resulting from neglect or inadequate maintenance. It may also help to maintain the value of the vehicle if it is sold. It is the responsibility of the owner to have all required maintenance performed.

Your dealer has trained technicians who can perform required maintenance using genuine replacement parts. They have up-to-date tools and equipment for fast and accurate diagnostics. Many dealers have extended evening and Saturday hours, courtesy transportation, and online scheduling to assist with service needs.

Your dealer recognizes the importance of providing competitively priced maintenance and repair services. With trained technicians, the dealer is the place for routine maintenance such as tire rotations and additional maintenance items like tires, brakes, batteries, and wiper blades.

### Caution

Damage caused by improper maintenance can lead to costly repairs and may not be covered by the vehicle warranty. Maintenance intervals, checks, inspections, recommended fluids, and lubricants are important to keep the vehicle in good working condition.

Do not have chemical flushes that are not approved by GM performed on the vehicle. The use of flushes, solvents, cleaners, or lubricants that are not approved by GM could damage the vehicle, requiring expensive repairs that are not covered by the vehicle warranty.

The Tire Rotation and Required Services are the responsibility of the vehicle owner. It is recommended to have your dealer perform these services every 12 000 km/7,500 mi. Proper vehicle maintenance helps to keep the vehicle in good working condition.

The Additional Required Services are for vehicles that:

- Carry passengers and cargo within recommended limits on the Tire and Loading Information label. See *Vehicle Load Limits* ⇨ 165.

- Are driven on reasonable road surfaces within legal driving limits.

### **Warning**

Performing maintenance work can be dangerous and can cause serious injury. Perform maintenance work only if the required information, proper tools, and equipment are available. If they are not, see your dealer to have a trained technician do the work. See *Doing Your Own Service Work* ⇨ 249.

## Maintenance Schedule

### Rotate Tires and Perform Required Services Every 12 000 km (7,500 mi)

- Rotate the tires. Rotating the tires helps achieve a more uniform wear. The first rotation is the most important. Anytime you notice unusual tire wear, rotate the tires as soon as possible, check for proper tire inflation pressure, and check for damage to tires or wheels. If unusual wear continues after a rotation, check the wheel alignment.

See *When It Is Time for New Tires* ⇨ 280 and *Wheel Replacement* ⇨ 283.

- Perform the Multi-Point Vehicle Inspection. See *Multi-Point Vehicle Inspection (MPVI)* ⇨ 299.
- Lubricate body components. See *Exterior Care* ⇨ 289.

### Additional Required Services — Normal Service

#### Every 36 000 km (22,500 mi)

Replace the passenger compartment air filter. Or every 24 months, whichever comes first. More frequent passenger compartment air filter replacement may be needed if driving in areas with heavy traffic, poor air quality, high dust levels, or environmental allergens. Passenger compartment air filter replacement may also be needed if there is reduced airflow, window fogging, or odors. Your GM dealer can help determine when to replace the filter.

#### Every 161 000 km (100,000 mi)

Replace the hood and/or body lift support gas struts. Or every 10 years, whichever comes first. See *Gas Strut(s)* ⇨ 258.

#### Every 240 000 km (150,000 mi)

Drain and fill the coolant circuits. Or every five years, whichever comes first. See *Cooling System* ⇨ 252.

### Severe Conditions Requiring More Frequent Maintenance\*

- Mainly driven in heavy city traffic in hot weather.
- Mainly driven in hilly or mountainous terrain.
- Frequently towing a trailer.
- Used for high speed or competitive driving.
- Used for taxi, police, or delivery service.

### Additional Required Services — Severe Service

#### Every 72 000 km (45,000 mi)

- Change electric drive unit fluid. See *Recommended Fluids and Lubricants* ⇨ 300.

### Owner Checks and Services

#### Every Five Years

Replace the brake fluid every five years. See *Brake Fluid* ⇨ 254.

**Every Seven Years**

Replace the air conditioning desiccant every seven years. This service helps the longevity and efficient operation of the air conditioning system. This service can be complex. See your dealer.

**Multi-Point Vehicle Inspection (MPVI)**

A Multi Point Vehicle Inspection (MPVI) completed by a GM dealer technician is a maintenance assessment of your vehicle. The benefit of the MPVI is to identify and inform the customer of service items that require immediate attention and those that may require attention in the future.

The technician will perform the following checks on your vehicle. For a complete list of checks, inspections, and services, see your dealer.

Some items may not apply to your vehicle and/or region.

**Diagnostics**

- OnStar active, if equipped
- Service history/recall check

**Exterior Lights**

- Visual inspection

**Windshield and Wipers**

- Visual inspection

**Battery**

- Battery visual inspection
- Battery test results
- Battery cables and connections

**Systems, Fluids, and Visible Leak Inspection**

- Electric Drive Unit
- Drive axle
- Transfer case
- Power electronics cooling system
- Windshield washer fluid

**Tire Inspection**

- Tire pressure, tread depth, and wear
- Rotation, if applicable
- Alignment check, optional
- Reset tire pressure monitor
- Check tire sealant expiration date, if equipped
- Check spare tire, if equipped

**Brakes**

- Check brake system

**Visible and Functional Inspections**

- Seat belt components
- Accelerator pedal
- Passenger compartment air filter, if equipped
- Hoses
- Shocks and struts
- Steering components
- Axle boots or driveshaft and u-joints
- Compartment lift struts, if equipped
- Floor mats secured, no interference with pedals
- Horn
- Starter switch

**Lubricate**

- Chassis components

**Owner Checks and Services**

- At least twice a year, have underbody flushing service performed. See "Underbody Maintenance" in *Exterior Care* ⇨ 289.

## Recommended Fluids, Lubricants, and Parts

### Recommended Fluids and Lubricants

Fluids and lubricants identified below by name or specification, including fluids or lubricants not listed here, can be obtained from your dealer.

Usage	Fluid/Lubricant
Electric Drive Unit	DEXRON ULV Automatic Transmission Fluid.
Hydraulic Brake System	GM approved DOT 4 Hydraulic Brake Fluid.
Key Lock Cylinders, Hood and Liftgate Hinges	Multi-Purpose Lubricant, Superlube. See your dealer.
Vehicle Coolant Circuits	Use only ACDelco Premix (50/50 mixture of de-ionized water and DEX-COOL Coolant). See your dealer.
Windshield Washer	Automotive windshield washer fluid that meets regional freeze protection requirements.

### Maintenance Replacement Parts

Replacement parts identified below by name, part number, or specification can be obtained from your dealer.

Part	GM Part Number	ACDelco Part Number
Passenger Compartment Air Filter	13540923	CF206C
Wiper Blades		
Driver Side – 66 cm (26 in)	84732989	—
Passenger Side – 46 cm (18 in)	84732990	—



## Technical Data

### Vehicle Identification

Vehicle Identification Number (VIN) ...	302
Service Parts Identification .....	302

### Vehicle Data

Capacities and Specifications .....	303
-------------------------------------	-----

## Vehicle Identification

### Vehicle Identification Number (VIN)

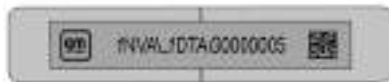

This legal identifier is in the front corner of the instrument panel, on the driver side of the vehicle. It can be seen through the windshield from outside. The Vehicle Identification Number (VIN) also appears on the Vehicle Certification label and certificates of title and registration.

## Service Parts Identification

There may be a large barcode on the certification label on the center pillar that you can scan for the following information:

- Vehicle Identification Number (VIN)
- Model designation
- Paint information
- Production options

If there is not a large barcode on this label, then you will find this same information on a label inside of the trunk.

## Vehicle Data

### Capacities and Specifications

The following approximate capacities are given in metric and English conversions.

Refer to *Recommended Fluids and Lubricants* ⇨ 300 for more information.

Application	Capacities	
	Metric	English
Air Conditioning Refrigerant	For the air conditioning system refrigerant charge type and amount, see the refrigerant label under the hood. See your dealer for more information.	
Cooling Systems*		
RWD	11.5 L	12.2 qt
AWD	11.8 L	12.5 qt
Wheel Nut Torque	190 N•m	140 lb ft
All capacities are approximate. When adding, be sure to fill to the approximate level, as recommended in this manual. Recheck fluid level after filling.		
*Cooling systems capacity values are based on the individual cooling system and its components.		



## Customer Information

### Customer Information

Customer Satisfaction Procedure .....	304
Customer Assistance Offices .....	306
Customer Assistance for Text Telephone (TTY) Users .....	306
Online Account .....	306
GM Mobility Reimbursement Program .....	307
Roadside Assistance Program .....	307
Scheduling Service Appointments .....	309
Courtesy Transportation Program .....	309
Collision Damage Repair .....	310
Publication Ordering Information .....	312
Radio Frequency Statement .....	312

### Reporting Safety Defects

Reporting Safety Defects to the United States Government .....	312
Reporting Safety Defects to the Canadian Government .....	313
Reporting Safety Defects to General Motors .....	313

### Vehicle Data Recording and Privacy

Vehicle Data Recording and Privacy .....	313
Cybersecurity .....	314
Event Data Recorders .....	314
OnStar .....	315
Infotainment System .....	315

## Customer Information

### Customer Satisfaction Procedure

Your satisfaction and goodwill are important to your dealer and to Cadillac. Normally, any concerns with the sales transaction or the operation of the vehicle will be resolved by your dealer's sales or service departments. Sometimes, however, despite the best intentions of all concerned, misunderstandings can occur. If your concern has not been resolved to your satisfaction, the following steps should be taken:

**STEP ONE** : Discuss your concern with a member of dealership management. Normally, concerns can be quickly resolved at that level. If the matter has already been reviewed with the sales, service or parts manager, contact the owner of your dealership or the general manager.

**STEP TWO** : If after contacting a member of dealership management, it appears your concern cannot be resolved by your dealership without further help, in the U.S., call the Cadillac Customer Assistance Center at 1-800-458-8006. In Canada, call the Canadian Cadillac Customer Care Centre at 1-888-446-2000.

We encourage you to call the toll-free number in order to give your inquiry prompt attention. Have the following information available to give the Customer Assistance representative:

- Vehicle Identification Number (VIN). This is available from the vehicle registration or title, or the plate at the top left of the instrument panel and visible through the windshield.
- Dealership name and location.
- Vehicle delivery date and present mileage.

When contacting Cadillac, remember that your concern will likely be resolved at a dealer's facility. That is why we suggest following Step One first.

**STEP THREE — U.S. Owners :** Both General Motors and your dealer are committed to making sure you are completely satisfied with the new vehicle. However, if you continue to remain unsatisfied after following the procedure outlined in Steps One and Two, you can file with the Better Business Bureau (BBB) AUTO LINE Program to enforce your rights.

The BBB AUTO LINE Program is an out-of-court program administered by BBB National Programs, Inc. to settle automotive disputes regarding vehicle repairs or the interpretation of the New Vehicle Limited Warranty. Although you may be required to resort to this informal dispute resolution program prior to filing a court action, use of the program is free of charge and your case will generally be heard within 40 days. If you do not agree with the decision given in your case, you may reject it and proceed with any other venue for relief available to you.

You may contact the BBB AUTO LINE Program using the toll-free telephone number or write them at the following address:

BBB AUTO LINE a Division of  
BBB National Programs, Inc.  
1676 International Drive  
Suite 550  
McLean, VA 22102

Telephone: 1-800-955-5100  
[www.bbbauto.org](http://www.bbbauto.org)

This program is available in all 50 states and the District of Columbia. Eligibility is limited by vehicle age, mileage, and other factors. General Motors reserves the right to change eligibility limitations and/or discontinue its participation in this program.

**STEP THREE — Canadian Owners :** In the event that you do not feel your concerns have been addressed after following the procedure outlined in Steps One and Two, General Motors of Canada Company wants you to be aware of its participation in a no-charge mediation/arbitration program. General Motors of Canada Company has committed to binding arbitration of owner disputes involving factory-related vehicle service claims. The program provides for the review of the facts involved by an impartial third party arbiter, and may include an informal hearing before the arbiter. The program is designed so that the entire dispute settlement process, from the time you file your complaint to the final decision, should be completed in about 70 days. We believe our impartial program offers advantages over courts in most jurisdictions because it is informal, quick, and free of charge.

For further information concerning eligibility in the Canadian Motor Vehicle Arbitration Plan (CAMVAP), call toll-free 1-800-207-0685, or call the Cadillac Customer Care Centre, 1-888-446-2000, or write to:

General Motors Cadillac Customer Care Centre  
General Motors of Canada Company  
500 Wentworth Street W  
Oshawa, ON L1J 0C5

The inquiry should be accompanied by the Vehicle Identification Number (VIN).

### Customer Assistance Offices

Cadillac is committed to assisting customers. Visit us online at [www.cadillac.com/support](http://www.cadillac.com/support) (U.S.) or [www.my.cadillac.ca](http://www.my.cadillac.ca) (Canada) to chat with us or find answers to commonly asked questions, tips, vehicle how-to instructions, and available support services.

Need more help? Use the phone numbers or mailing addresses below for additional assistance.

### United States and Puerto Rico

Cadillac Customer Assistance Center  
Cadillac Motor Car Division  
P.O. Box 33169  
Detroit, MI 48232-5169

1-800-458-8006  
TTY: Dial 711 relay service and contact  
1-800-833-2438  
Roadside Assistance: 1-800-224-1400

### Canada

Cadillac Customer Care Centre  
General Motors of Canada Company  
500 Wentworth Street W  
Oshawa, ON L1J 0C5

1-888-446-2000 (English/French)  
Cadillac Roadside Assistance: 1-800-882-1112

### Overseas

Contact the local General Motors Business Unit.

### Customer Assistance for Text Telephone (TTY) Users

To assist customers who are deaf, hard of hearing, or speech-impaired and/or who use Text Telephones (TTYs), Cadillac is able to





assist. Please dial the national 711 relay service and contact 1-800-833-2438. TTY users in Canada can dial 1-800-263-3830.

### Online Account

#### Create a Cadillac Account (U.S.) at [cadillac.com](http://cadillac.com)

Learn more about your vehicle features, shop for and manage your connected services and OnStar plans, and access diagnostic information specific to your vehicle.

#### Membership Benefits

-  : Download owner's manuals and view vehicle-specific how-to videos.
-  : View maintenance schedules, alerts, and Vehicle Diagnostic Information. Schedule service appointments.
-  : View service records from your dealership and add your own.
-  : Select a dealer and view locations, maps, phone numbers, and hours.
-  : Track your vehicle's warranty information.

 : View active recalls or search by Vehicle Identification Number (VIN). See *Vehicle Identification Number (VIN)* ⇨ 302.

 : Manage your profile and payment information. View your GM Rewards Card earnings and My Cadillac Rewards points.

 : Chat with online help representatives.

Visit [cadillac.com](http://cadillac.com) and create an account today.

### Cadillac Owner Centre (Canada) [mycadillac.ca](http://mycadillac.ca)

Visit the Cadillac Owner Centre at [mycadillac.ca](http://mycadillac.ca) (English) or [my.cadillac.ca](http://my.cadillac.ca) (French) to access similar benefits to the U.S. site.

### GM Mobility Reimbursement Program

GENERAL MOTORS MOBILITY



This program is available to qualified applicants for cost reimbursement, up to certain limits, of eligible aftermarket adaptive equipment required for the vehicle, such as hand controls or a wheelchair/scooter lift for the vehicle.

To learn about the GM Mobility program, see [www.gmmobility.com](http://www.gmmobility.com) or call the GM Mobility Assistance Center at 1-800-323-9935. Text Telephone (TTY) users, please dial the national 711 relay service and contact 1-800-323-9935.

General Motors of Canada also has a Mobility program. See [cadillaccanada.ca](http://cadillaccanada.ca), or call 1-800-GM-DRIVE (800-463-7483) for details. TTY users call 1-800-263-3830.

### Roadside Assistance Program

U.S.: 1-800-224-1400.

Canada: 1-800-882-1112.

Text Telephone (TTY) Users (U.S. Only):  
1-888-889-2438.

Service is available 24 hours a day, 365 days a year.

### Calling for Assistance

When calling Roadside Assistance, have the following information ready:

- Your name, home address, and home telephone number
- Telephone number of your location
- Location of the vehicle
- Model, year, color, and license plate number of the vehicle
- Odometer reading and Vehicle Identification Number (VIN)
- Description of the problem

### Coverage

Tow services are covered under the EV Component Coverage warranty. For details on additional Roadside coverage, contact Cadillac Roadside Assistance.

In the U.S., anyone driving the vehicle is covered. In Canada, a person driving the vehicle without permission from the owner is not covered.

Roadside Assistance is not a part of the New Vehicle Limited Warranty. General Motors North America and Cadillac reserve the right to make any changes or discontinue the Roadside Assistance program at any time without notification.

General Motors North America and Cadillac reserve the right to limit services or payment to an owner or driver if they decide the claims are made too often, or the same type of claim is made many times.

### **Cadillac Owner Privileges™**

- **Lock-Out Service:** Service to unlock the vehicle if you are locked out. A remote unlock may be available if you have OnStar. For security reasons, the driver must present identification before this service is given.
- **Emergency Tow from a Public Road or Highway:** Tow to the nearest certified Cadillac EV dealer for warranty service, or if the vehicle was in a crash and cannot be driven. Assistance is not given when the vehicle is stuck in the sand, mud, or snow. If the vehicle is out of charge, Roadside will tow the vehicle to the nearest charging station or to the customer's home, whichever is closest.
- **Flat Tire Change:** If the tire has been separated from the wheel, has damaged sidewalls, or has a large puncture, the tire is too severely damaged for the self-sealing tire to be effective and the vehicle will have to be towed. It is the

owner's responsibility for the repair or replacement of the tire if it is not covered by the warranty.

- **Battery Jump Start:** Service to jump start a dead battery.
- **Trip Interruption Benefits and Service:** If your trip is interrupted due to a warranty failure, incidental expenses may be reimbursed. Items considered are hotel, meals, and rental car or a vehicle being delivered back to the customer, up to 500 miles. Contact Cadillac Roadside Assistance for Trip Interruption eligibility at the time of vehicle disablement.

### **Cadillac Technician Roadside Assistance (U.S. Only)**

Cadillac's exceptional Roadside Assistance is more than an auto club or towing service. It provides every Cadillac owner in the United States with the advantage of contacting a Cadillac advisor and, where available, a Cadillac trained dealer technician who can provide on-site service.

A dealer technician will travel to your location within a 30-mile radius of a participating Cadillac dealership. If beyond this radius, we will arrange to have your car towed to the nearest Cadillac dealership.

Each technician travels with a specially equipped service vehicle complete with the necessary Cadillac parts and tools required to handle most roadside repairs.

### **Services Not Included in Roadside Assistance**

- Impound towing caused by violation of any laws
- Legal fines
- Mounting, dismounting, or changing of snow tires, chains, or other traction devices

Service is not provided if a vehicle is in an area that is not accessible to the service vehicle or is not a regularly traveled or maintained public road, which includes ice and winter roads. Off-road use is not covered.

### **Services Specific to Canadian-Purchased Vehicles**

- **Lock-Out Service:** Vehicle registration is required.
- **Trip Interruption Benefits and Service:** Must be over 150 km (93 mi) from where the trip was started to qualify. Pre-authorization, original detailed receipts, and a copy of the repair orders

are required. Once authorization has been received, the Roadside Assistance advisor will help to make arrangements and explain how to receive payment.

- **Alternative Service:** If assistance cannot be provided right away, the Roadside Assistance advisor may give you permission to get local emergency road service. You will receive payment, up to \$100, after sending the original receipt to Roadside Assistance. Mechanical failures may be covered, however any cost for parts and labor for repairs not covered by the warranty are the owner responsibility.

## Scheduling Service Appointments

When the vehicle requires warranty service, contact your dealer and request an appointment. By scheduling a service appointment and advising the service consultant of your transportation needs, your dealer can help minimize your inconvenience.

If the vehicle cannot be scheduled into the service department immediately, keep driving it until it can be scheduled for service, unless, of course, the problem is

safety related. If it is, please call your dealership, let them know this, and ask for instructions.

If your dealer requests you to bring the vehicle for service, you are urged to do so as early in the work day as possible to allow for same-day repair.

## Courtesy Transportation Program

To enhance your ownership experience, we and our participating dealers are proud to offer Courtesy Transportation, a customer support program for vehicles with the Bumper-to-Bumper (Base Warranty Coverage period in Canada), Federal Emission, Extended Powertrain or Electric specific warranties in both the U.S. and Canada.

Several Courtesy Transportation options are available to assist in reducing inconvenience when warranty repairs are required.

Courtesy Transportation is not a part of the New Vehicle Limited Warranty. A separate manual entitled "Limited Warranty and Owner Assistance Information" produced for new vehicles provides detailed warranty coverage information.

## Transportation Options

Warranty service can generally be completed while you wait. However, if you are unable to do so, your dealer may offer the following transportation options:

### Shuttle Service

This includes one-way or round-trip shuttle service within reasonable time and distance parameters of your dealer's area.

### Public Transportation or Fuel Reimbursement

If overnight warranty repairs are needed, and public transportation is used, the expense must be supported by original receipts and within the maximum amount allowed by GM. If U.S. customers arrange their own transportation, limited reimbursement for reasonable fuel expenses may be available. Claim amounts should reflect actual costs and be supported by original receipts. See your dealer for information.

### Courtesy Rental Vehicle

For an overnight warranty repair, the dealer may provide an available courtesy rental vehicle or provide for reimbursement of a rental vehicle. Reimbursement is limited and must be supported by original receipts as

well as a signed and completed rental agreement and meet state/provincial, local, and rental vehicle provider requirements. Requirements vary and may include minimum age requirements, insurance coverage, credit card, etc. Additional fees such as fuel, rental vehicle insurance, taxes, levies, usage fees, excessive mileage, or rental usage beyond the completion of the repair are also your responsibility.

It may not be possible to provide a like vehicle as a courtesy rental.

### **Additional Program Information**

All program options, such as shuttle service, may not be available at every dealer. Contact your dealer for specific availability.

General Motors reserves the right to unilaterally modify, change, or discontinue Courtesy Transportation at any time and to resolve all questions of claim eligibility pursuant to the terms and conditions described herein at its sole discretion.

### **Collision Damage Repair**

If the vehicle is involved in a collision and it is damaged, have the damage repaired by a qualified technician using the proper equipment and quality replacement parts.

Poorly performed collision repairs diminish the vehicle resale value, and safety performance can be compromised in subsequent collisions.

### **Collision Parts**

Genuine GM Collision parts are new parts made with the same materials and construction methods as the parts with which the vehicle was originally built. Genuine GM Collision parts are the best choice to ensure that the vehicle's designed appearance, durability, and safety are preserved. The use of Genuine GM parts can help maintain the GM New Vehicle Limited Warranty.

Recycled original equipment parts may also be used for repair. These parts are typically removed from vehicles that were total losses in prior crashes. In most cases, the parts being recycled are from undamaged sections of the vehicle. A recycled original equipment GM part may be an acceptable choice to maintain the vehicle's originally designed appearance and safety performance; however, the history of these parts is not known. Such parts are not covered by the GM New Vehicle Limited Warranty, and any related failures are not covered by that warranty.

Aftermarket collision parts are also available. These are made by companies other than GM and may not have been tested for the vehicle. As a result, these parts may fit poorly, exhibit premature durability/corrosion problems, and may not perform properly in subsequent collisions. Aftermarket parts are not covered by the GM New Vehicle Limited Warranty, and any vehicle failure related to such parts is not covered by that warranty.

### **Repair Facility**

GM also recommends that you choose a collision repair facility that meets your needs before you ever need collision repairs. Your dealer may have a collision repair center with GM-trained technicians and state-of-the-art equipment, or be able to recommend a collision repair center that has GM-trained technicians and comparable equipment.

### **Insuring the Vehicle**

Protect your investment in the GM vehicle with comprehensive and collision insurance coverage. There are significant differences in the quality of coverage afforded by various insurance policy terms. Many insurance policies provide reduced protection to the

GM vehicle by limiting compensation for damage repairs by using aftermarket collision parts. Some insurance companies will not specify aftermarket collision parts. When purchasing insurance, we recommend that you ensure that the vehicle will be repaired with GM original equipment collision parts. If such insurance coverage is not available from your current insurance carrier, consider switching to another insurance carrier.

If the vehicle is leased, the leasing company may require you to have insurance that ensures repairs with Genuine GM Original Equipment Manufacturer (OEM) parts or Genuine Manufacturer replacement parts. Read the lease carefully, as you may be charged at the end of the lease for poor quality repairs.

### If a Crash Occurs

If there has been an injury, call emergency services for help. Do not leave the scene of a crash until all matters have been taken care of. Move the vehicle only if its position puts you in danger, or you are instructed to move it by a police officer.

Give only the necessary information to police and other parties involved in the crash.

For emergency towing see *Roadside Assistance Program* ⇨ 307.

Gather the following information:

- Driver name, address, and telephone number
- Driver license number
- Owner name, address, and telephone number
- Vehicle license plate number
- Vehicle make, model, and model year
- Vehicle Identification Number (VIN)
- Insurance company and policy number
- General description of the damage to the other vehicle

Choose a reputable repair facility that uses quality replacement parts. See “Collision Parts” earlier in this section.

In a crash, the sensing system may shut down the high voltage system. See *Battery - North America* ⇨ 255 for important safety information. If an airbag has inflated, see *What Will You See after an Airbag Inflates?* ⇨ 54.

If the vehicle is damaged from a crash, flood, fire, or other event it may be necessary to have the vehicle inspected. See *Battery - North America* ⇨ 255 for important safety information.

### Managing the Vehicle Damage Repair Process

In the event that the vehicle requires damage repairs, GM recommends that you take an active role in its repair. If you have a pre-determined repair facility of choice, take the vehicle there, or have it towed there. Specify to the facility that any required replacement collision parts be original equipment parts, either new Genuine GM parts or recycled original GM parts. Remember, recycled parts will not be covered by the GM vehicle warranty.

Insurance pays the bill for the repair, but you must live with the repair. Depending on your policy limits, your insurance company may initially value the repair using aftermarket parts. Discuss this with the repair professional, and insist on Genuine GM parts. Remember, if the vehicle is leased, you may be obligated to have the vehicle repaired with Genuine GM parts, even if your insurance coverage does not pay the full cost.



If another party's insurance company is paying for the repairs, you are not obligated to accept a repair valuation based on that insurance company's collision policy repair limits, as you have no contractual limits with that company. In such cases, you can have control of the repair and parts choices as long as the cost stays within reasonable limits.

## Publication Ordering Information

### Service Manuals

Service manuals have the diagnosis and repair information on the engine/propulsion, transmission, axle, suspension, brakes, electrical system, steering system, body, etc.

### Customer Literature

Owner's manuals are written specifically for owners and are intended to provide basic operational information about the vehicle. The owner's manual includes the Maintenance Schedule for all models.

Customer literature publications available for purchase include owner's manuals, warranty manuals, and portfolios. Portfolios include an owner's manual, warranty manual, if applicable, and zip lock bag or pouch.

### Current and Past Models

Service manuals and customer literature are available for many current and past model year GM vehicles.

To order, call 1-800-551-4123 Monday–Friday, 8:00 a.m.–6:00 p.m. Eastern Time

For credit card orders only (VISA, MasterCard, or Discover), see Helm, Inc. at: [www.helminc.com](http://www.helminc.com).

To order by mail, write to:

Helm, Incorporated  
Attention: Customer Service  
47911 Halyard Drive  
Plymouth, MI 48170

Make checks payable in U.S. funds.

### Radio Frequency Statement

This vehicle uses license-exempt transmitters / receivers / systems that operate on a radio frequency that complies with Part 15/Part 18 of the Federal Communications Commission (FCC) rules and with Innovation, Science and Economic Development (ISED) Canada's license-exempt RSS(s) / RSP-100 / ICES-GEN.

Operation is subject to the following two conditions:

1. The device may not cause harmful interference.
2. The device must accept any interference received, including interference that may cause undesired operation of the device.

Changes or modifications to any of these systems by other than an authorized service facility could void authorization to use this equipment.

## Reporting Safety Defects

### Reporting Safety Defects to the United States Government

If you believe that your vehicle has a defect which could cause a crash or could cause injury or death, you should immediately inform the National Highway Traffic Safety Administration (NHTSA) in addition to notifying General Motors.

If NHTSA receives similar complaints, it may open an investigation, and if it finds that a safety defect exists in a group of vehicles, it may order a recall

and remedy campaign. However, NHTSA cannot become involved in individual problems between you, your dealer, or General Motors.

To contact NHTSA, you may call the Vehicle Safety Hotline toll-free at 1-888-327-4236 (TTY: 1-800-424-9153); go to <https://www.safercar.gov>; or write to:

Administrator, NHTSA  
1200 New Jersey Avenue, S.E.  
Washington, D.C. 20590

You can also obtain other information about motor vehicle safety from <https://www.safercar.gov>.

## Reporting Safety Defects to the Canadian Government

If you live in Canada, and you believe that the vehicle has a safety defect, notify Transport Canada immediately, and notify General Motors of Canada Company. Call Transport Canada at 1-800-333-0510; go to:

[www.tc.gc.ca/recalls](http://www.tc.gc.ca/recalls) (English)

[www.tc.gc.ca/rappels](http://www.tc.gc.ca/rappels) (French)

or write to:

Transport Canada  
Motor Vehicle Safety Directorate  
Defect Investigations and Recalls  
Division  
80 Noel Street  
Gatineau, QC J8Z 0A1

## Reporting Safety Defects to General Motors

In addition to notifying NHTSA (or Transport Canada) in a situation like this, notify General Motors.

In the U.S., call 1-800-458-8006, or write:

Cadillac Customer Assistance Center  
Cadillac Motor Car Division  
P.O. Box 33169  
Detroit, MI 48232-5169

In Canada, call 1-888-446-2000, or write:

Canadian Cadillac Customer Care Centre  
General Motors of Canada Company  
500 Wentworth Street W  
Oshawa, ON L1J 0C5

In Mexico, call 800-466-0805 or  
800-212-234-5522.

In other Central America and Caribbean Countries, call 52-555-901-2369.

## Vehicle Data Recording and Privacy

The vehicle has a number of computers that record information about the vehicle's performance and how it is driven or used. For example, the vehicle uses computer modules to monitor and control electric drive unit performance, to monitor the conditions for airbag deployment and to deploy them in a crash, and, if equipped, to provide antilock braking to help the driver control the vehicle. These modules may store data to help the dealer technician service the vehicle or to help GM improve safety or features. Some modules may also store data about how the vehicle is operated, such as rate of energy consumption or average speed. These modules may retain personal preferences, such as radio presets, seat positions, and temperature settings.

## Cybersecurity

GM collects information about the use of your vehicle including operational and safety related information. We collect this information to provide, evaluate, improve, and troubleshoot our products and services and to develop new products and services. The protection of vehicle electronics systems and customer data from unauthorized outside electronic access or control is important to GM. GM maintains appropriate security standards, practices, guidelines and controls aimed at defending the vehicle and the vehicle service ecosystem against unauthorized electronic access, detecting possible malicious activity in related networks, and responding to suspected cybersecurity incidents in a timely, coordinated and effective manner. Security incidents could impact your safety or compromise your private data. To minimize security risks, please do not connect your vehicle electronic systems to unauthorized devices or connect your vehicle to any unknown or untrusted networks (such as Bluetooth, WIFI or similar technology). In the event you suspect any security incident impacting your data or the safe operation of your vehicle, please stop operating your vehicle and contact your dealer.

## Event Data Recorders

This vehicle is equipped with an Event Data Recorder (EDR). The main purpose of an EDR is to record, in certain crash or near crash-like situations, such as an air bag deployment or hitting a road obstacle, data that will assist in understanding how a vehicle's systems performed. The EDR is designed to record data related to vehicle dynamics and safety systems for a short period of time, typically 30 seconds or less. The EDR in this vehicle is designed to record such data as:

- How various systems in your vehicle were operating;
- Whether or not the driver and passenger safety belts were buckled/fastened;
- How far (if at all) the driver was depressing the accelerator and/or brake pedal; and,
- How fast the vehicle was traveling.

These data can help provide a better understanding of the circumstances in which crashes and injuries occur.

### Note

EDR data are recorded by your vehicle only if a non-trivial crash situation occurs; no data are recorded by the EDR under normal

driving conditions and no personal data (e.g., name, gender, age, and crash location) are recorded. However, other parties, such as law enforcement, could combine the EDR data with the type of personally identifying data routinely acquired during a crash investigation.

To read data recorded by an EDR, special equipment is required, and access to the vehicle or the EDR is needed. In addition to the vehicle manufacturer, other parties, such as law enforcement, that have the special equipment, can read the information if they have access to the vehicle or the EDR.

GM will not access these data or share it with others except: with the consent of the vehicle owner or, if the vehicle is leased, with the consent of the lessee; in response to an official request by police or similar government office; as part of GM's defense of litigation through the discovery process; or, as permitted by law. Data that GM collects or receives may also be used for GM research needs or may be made available to others for research purposes, where a need is shown and the data is not tied to a specific vehicle or vehicle owner.

## OnStar

If the vehicle is equipped with OnStar and has an active service plan, additional data may be collected and transmitted through the OnStar system. This includes information about the vehicle's operation; collisions involving the vehicle; the use of the vehicle and its features, including infotainment; and the location and approximate GPS speed of the vehicle. Refer to the OnStar Terms and Conditions and Privacy Statement on the OnStar website.

See *OnStar Additional Information* ⇨ 317.

## Infotainment System

If the vehicle is equipped with a navigation system as part of the infotainment system, use of the system may result in the storage of destinations, addresses, telephone numbers, and other trip information. See the infotainment section for information on stored data and for deletion instructions.

## OnStar

### OnStar Overview

OnStar Overview ..... 316

### OnStar Services

Emergency ..... 317

Security ..... 317

### OnStar Additional Information

OnStar Additional Information ..... 317

## OnStar Overview



 Voice Command Button

 Blue OnStar Button

 Red Emergency Button

This vehicle may be equipped with a comprehensive, in-vehicle system that can connect to an OnStar Advisor for Emergency, Security, Navigation, Connections, and Diagnostics Services. OnStar services may require a paid service plan and data plan. OnStar requires the vehicle battery and electrical system, cellular service, and GPS satellite signals to be available and operating. OnStar acts as a link to existing emergency service providers. OnStar may collect information about you and your vehicle, including location information. See OnStar User Terms, Privacy Statement, and Software Terms for more details including system limitations at [www.onstar.com](http://www.onstar.com) (U.S.) or [www.onstar.ca](http://www.onstar.ca) (Canada).

The OnStar system status light is next to the OnStar buttons. If the status light is:

- Solid Green: System is ready.
- Flashing Green: On a call.
- Red: Indicates a problem.
- Off: System is off. Press  twice to speak with an OnStar Advisor.

Press  or call 1-888-4ONSTAR (1-888-466-7827) to speak to an Advisor.

Functionality of the Voice Command button may vary by vehicle and region.

Press  to answer or hang up an Advisor-initiated call.

Press  to connect to an Advisor to:

- Verify account information or update contact information.
- Get driving directions.
- Receive a Diagnostic check of the vehicle's key operating systems.
- Receive Roadside Assistance.
- Manage Wi-Fi Settings, if equipped.

Press  to get a priority connection to an OnStar Advisor available 24/7 to:

- Get help for an emergency.

- Be a Good Samaritan or respond to an AMBER Alert.
- Get assistance in severe weather or other crisis situations and find evacuation routes.

## OnStar Services

### Emergency

Emergency Services require an active safety and security plan. With Automatic Crash Response, built-in sensors can automatically alert a specially trained OnStar Advisor who is immediately connected in to the vehicle to help.

Press **908** for a priority connection to an OnStar Advisor who can contact emergency service providers, direct them to your exact location, and relay important information.

With OnStar Crisis Assist, specially trained Advisors are available 24 hours a day, 7 days a week, to provide a central point of contact, assistance, and information during a crisis.

With Roadside Assistance, Advisors can locate a nearby service provider to help with a flat tire or a battery jump.

### Security

If equipped, OnStar provides these services:

- With Stolen Vehicle Assistance, OnStar Advisors can use GPS to pinpoint the vehicle and help authorities quickly recover it.
- With Remote Ignition Block, if equipped, OnStar can block the vehicle from being restarted.
- With Stolen Vehicle Slowdown, if equipped, OnStar can work with law enforcement to gradually slow the vehicle down.

### Theft Alarm Notification

If equipped, if the doors are locked and the vehicle alarm sounds, a notification by text, e-mail, or phone call will be sent. If the vehicle is stolen, an OnStar Advisor can work with authorities to recover the vehicle.

## OnStar Additional Information

### In-Vehicle Audio Messages

Audio messages may play important information at the following times:

- Prior to vehicle purchase. Press **On** to set up an account.
- After change in ownership and at 90 days.

### Transferring Service

Press **On** to request account transfer eligibility information. The Advisor can cancel or change account information.

### Selling/Transferring the Vehicle

Call 1-888-4ONSTAR (1-888-466-7827) immediately to terminate your OnStar or connected services if the vehicle is disposed of, sold, transferred, or if the lease ends.

### Reactivation for Subsequent Owners

Press **On** and follow the prompts to speak to an Advisor as soon as possible. The Advisor will update vehicle records and explain OnStar or connected service options.

## How OnStar Service Works

Automatic Crash Response, Emergency Services, Crisis Assist, Stolen Vehicle Assistance, Remote Services, and Roadside Assistance are available on most vehicles. Not all OnStar services are available everywhere or on all vehicles. For more information, a full description of OnStar services, system limitations, and OnStar User Terms, Privacy Statement, and Software Terms:

- Call 1-888-4ONSTAR (1-888-466-7827).
- See [www.onstar.com](http://www.onstar.com) (U.S.).
- See [www.onstar.ca](http://www.onstar.ca) (Canada).
- Call TTY 1-877-248-2080.
- Press  to speak with an Advisor.

OnStar or connected services cannot work unless the vehicle is in a place where OnStar has an agreement with a wireless service provider for service in that area. The wireless service provider must also have coverage, network capacity, reception, and technology compatible with OnStar or connected services. Service involving location information about the vehicle cannot work unless GPS signals are available, unobstructed, and compatible with the OnStar hardware. OnStar or connected

services may not work if the OnStar equipment is not properly installed or it has not been properly maintained. If equipment or software is added, connected, or modified, OnStar or connected services may not work. Other problems beyond the control of OnStar — such as hills, tall buildings, tunnels, weather, electrical system design and architecture of the vehicle, damage to the vehicle in a crash, or wireless phone network congestion or jamming — may prevent service.

See *Radio Frequency Statement* ⇨ 312.

## Services for People with Disabilities

Advisors provide services to help with physical disabilities and medical conditions.

Press  to help:

- Find a hotel, restaurant, etc., that meets accessibility needs.
- Provide directions to the closest hospital or pharmacy in urgent situations.

## TTY Users

OnStar has the ability to communicate to deaf, hard-of-hearing, or speech-impaired customers while in the vehicle. The available

TTY system provides in-vehicle access to all OnStar services, except Virtual Advisor and OnStar Turn-by-Turn Navigation.

If equipped, access TTY by touching Settings > System > TTY from the infotainment home screen. When TTY mode is active, you can make and receive phone calls using the infotainment display.

## OnStar Personal Identification Number (PIN)

A PIN is needed to access some OnStar services. The PIN will need to be changed the first time when speaking with an Advisor. To change the OnStar PIN, contact an OnStar Advisor by pressing  or calling 1-888-4ONSTAR.

## Warranty

OnStar equipment may be warranted as part of the vehicle warranty.

## Languages

The vehicle can be programmed to respond in multiple languages. Press  and ask for an Advisor. Advisors are available in English, Spanish, and French. Available languages may vary by country.

## Potential Issues

OnStar cannot perform Remote Door Unlock or Stolen Vehicle Assistance after the vehicle has been off continuously for an extended period of time without being started. To find out the duration of time that applies for the vehicle, contact an OnStar Advisor by pressing  or calling 1-888-4ONSTAR. If the vehicle has not been started for an extended period of time, OnStar can contact Roadside Assistance or a locksmith to help gain access to the vehicle.

## Global Positioning System (GPS)

- Obstruction of the GPS can occur in a large city with tall buildings; in parking garages; around airports; in tunnels and underpasses; or in an area with very dense trees. If GPS signals are not available, the OnStar system should still operate to call OnStar. However, OnStar could have difficulty identifying the exact location.
- In emergency situations, OnStar can use the last stored GPS location to send to emergency responders.

A temporary loss of GPS can cause loss of the ability to send a Turn-by-Turn Navigation route. The Advisor may give a verbal route or may ask for a call back after the vehicle is driven into an open area.

## Cellular and GPS Antennas

Cellular reception is required for OnStar to send remote signals to the vehicle. Do not place items over or near the antenna to prevent blocking cellular and GPS signal reception.

## Unable to Connect to OnStar Message

If there is limited cellular coverage or the cellular network has reached maximum capacity, this message may come on. Press  to try the call again or try again after driving a few miles into another cellular area.

## Vehicle and Power Issues

OnStar services require a vehicle electrical system, wireless service, and GPS satellite technologies to be available and operating for features to function properly. These systems may not operate if the battery is discharged or disconnected.

## Add-on Electrical Equipment

The OnStar system is integrated into the electrical architecture of the vehicle. Do not add any electrical equipment. See *Add-On Electrical Equipment* ⇨ 245. Added electrical equipment may interfere with the operation of the OnStar system and cause it to not operate.

## Vehicle Software Updates

OnStar or GM may remotely deliver software updates or changes to the vehicle without further notice or consent. These updates or changes may enhance or maintain safety, security, or the operation of the vehicle or the vehicle systems. Software updates or changes may affect or erase data or settings that are stored in the vehicle, such as saved navigation destinations or pre-set radio stations. Neither OnStar nor GM is responsible for any affected or erased data or settings. These updates or changes may also collect personal information. Such collection is described in the OnStar privacy statement or separately disclosed at the time of installation. These updates or changes may also cause a system to automatically communicate with GM servers to collect information about vehicle system status,



identify whether updates or changes are available, or deliver updates or changes. An active OnStar agreement constitutes consent to these software updates or changes and agreement that either OnStar or GM may remotely deliver them to the vehicle.

### **Privacy**

The complete OnStar Privacy Statement may be found at [www.onstar.com](http://www.onstar.com) (U.S.), or [www.onstar.ca](http://www.onstar.ca) (Canada). We recommend that you review it. If you have any questions, call 1-888-4ONSTAR (1-888-466-7827) or press  to speak with an Advisor. Users of wireless communications are cautioned that the privacy of any information sent via wireless cellular communications cannot be assured. Third parties may unlawfully intercept or access transmissions and private communications without consent.

### **OnStar – Software Acknowledgements**

To obtain the source code under GPL, LGPL, MPL, and other open source licenses, that is contained in this product, please visit [www.opensourceautomotive.com/an/GM](http://www.opensourceautomotive.com/an/GM). In addition to the source code, all referred license terms, warranty disclaimers, and copyright notices are available for download.

This offer is valid for a period of three years after our last shipment of this product. This offer is valid to anyone in receipt of this information.

\*Provided through Continental Automotive Systems, Inc., who is solely responsible for provisions of related OSS compliance.

## Connected Services

### Connected Services

Navigation .....	321
Connections .....	321
Diagnostics .....	323

## Connected Services

### Navigation

Navigation requires a specific OnStar or connected service plan.

Press  to receive Turn-by-Turn directions or have them sent to the vehicle navigation screen, if equipped. A destination transfer from OnStar will show the detail view of the destination when it is transferred from OnStar to the Navigation application. See [www.onstar.com](http://www.onstar.com) for a coverage map. Services vary by model. Map coverage is available in the United States and Canada.

#### Turn-by-Turn Navigation

1. Press  to connect to an Advisor.
2. Request directions to be downloaded to the vehicle.

#### Send Destination to Vehicle

Directions can be sent to the vehicle navigation screen, if equipped.

Press , then ask the Advisor to download directions to the vehicle navigation system, if equipped. After the call ends, the navigation screen will provide prompts to

begin driving directions. Routes that are sent to the navigation screen can only be canceled through the navigation system.

See [www.onstar.com](http://www.onstar.com) (U.S.) or [www.onstar.ca](http://www.onstar.ca) (Canada).

### Connections

The following services help with staying connected.

For coverage maps, see [www.onstar.com](http://www.onstar.com) (U.S.) or [www.onstar.ca](http://www.onstar.ca) (Canada).

#### Ensuring Security

- Change the default passwords for the Wi-Fi hotspot and myCadillac mobile application. Make these passwords different from each other and use a combination of letters and numbers to increase the security.
- Change the default name of the SSID (Service Set Identifier). This is your network's name that is visible to other wireless devices. Choose a unique name and avoid family names or vehicle descriptions.

**Wi-Fi Hotspot, If Equipped**

The vehicle may have a built-in Wi-Fi hotspot that provides access to the Internet and web content at 4G LTE speed. Up to seven mobile devices can be connected. A data plan is required. Use the in-vehicle controls only when it is safe to do so.

1. To retrieve Wi-Fi hotspot information, tap the Wi-Fi Hotspot icon on the infotainment home screen.
2. The Wi-Fi settings will display the Wi-Fi hotspot name (SSID), password, and on some vehicles, the connection type (no Internet connection, 3G, 4G, 4G LTE), and signal quality (poor, good, excellent). The LTE icon shows connection to Wi-Fi. It is possible that the icon may not illuminate even though the vehicle has an active connection.
3. To change the SSID or password, press  or call 1-888-4ONSTAR to connect with an Advisor. On some vehicles, the SSID and password can be changed in the Wi-Fi Hotspot menu.

After initial set-up, your vehicle's Wi-Fi hotspot will connect automatically to your mobile devices. Manage data usage by turning Wi-Fi on or off on your mobile

device, using the myCadillac mobile app, or by contacting an OnStar Advisor. On some vehicles, Wi-Fi can also be managed from the Wi-Fi Hotspot menu.

**MyCadillac Mobile App, If Available**

Download the myCadillac mobile app to compatible Apple and Android smartphones. Cadillac users can access the following services from a smartphone:

- Remotely start/stop the vehicle, if factory-equipped.
- Lock/unlock doors, if equipped with automatic locks.
- Activate the horn and lamps.
- Check the vehicle's energy level, range or tire pressure, if factory-equipped with the Tire Pressure Monitor System.
- Send destinations to the vehicle.
- Locate the vehicle on a map (U.S. market only).
- Turn the vehicle's Wi-Fi hotspot on/off, manage settings, and monitor data consumption, if equipped.
- Locate a dealer and schedule service.
- Request Roadside Assistance.

- Set a parking reminder with pin drop, take a photo, make a note, and set a timer.
- Connect with Cadillac on social media.

Features are subject to change. For myCadillac mobile app information and compatibility, see [my.cadillac.com](http://my.cadillac.com).

An active OnStar or connected service plan may be required. A compatible device, factory-installed remote start, and power locks are required. Data rates apply. See [www.onstar.com](http://www.onstar.com) for details and system limitations.

**Remote Services**

Contact an OnStar Advisor to unlock the doors or sound the horn and flash the lamps.

**Marketplace**

OnStar Advisors can provide offers from restaurants and retailers on your route, help locate hotels, or book a room. These services vary by market.

## Diagnostics

By monitoring and reporting on the vehicle's key systems, OnStar Advanced Diagnostics, if equipped, provides a way to keep up on maintenance. Capabilities vary by model. See [www.onstar.com](http://www.onstar.com) for details and system limitations. Features are subject to change. For updates on feature capabilities, see [my.cadillac.com](http://my.cadillac.com). Message and data rates may apply.

## Index

<b>A</b>	
Accessories and Modifications .....	248
Accessory Power .....	170
Adaptive	
Cruise Control .....	181
Forward Lighting (AFL) .....	117
Forward Lighting (AFL) Light .....	100
Add-On Electrical Equipment .....	245
Additional	
OnStar Information .....	317
Adjustments	
Lumbar, Front Seats .....	35
Agreements	
Trademarks and License .....	148
Air	
Conditioning .....	151
Filter, Passenger Compartment .....	155
Vents .....	154
Airbag System .....	50
Check .....	59
How Does an Airbag Restrain? .....	54
Passenger Sensing System .....	55
What Makes an Airbag Inflate? .....	54
What Will You See after an Airbag Inflates? .....	54
When Should an Airbag Inflate? .....	53
Where Are the Airbags? .....	52
Airbags	
Adding Equipment to the Vehicle .....	59
Passenger Status Indicator .....	93
Readiness Light .....	92
Replacing System Parts after a Crash .....	60
Servicing Airbag-Equipped Vehicles .....	58
Alarm	
Vehicle Security .....	22
Alert	
Lane Change .....	222
Rear Cross Traffic .....	216
Rear Pedestrian .....	214
Side Blind Zone (SBZA) .....	221
All-Season Tires .....	270
All-Wheel Drive .....	175
AM-FM Radio .....	128
Antenna	
Multi-band .....	131
Antilock Brake System (ABS) .....	175
Warning Light .....	96
Appearance Care	
Exterior .....	289
Interior .....	293
Apple CarPlay and Android Auto .....	142
Assistance Program, Roadside .....	307
Assistance Systems	
Driving .....	216

Assistance Systems (cont'd)	
Parking and Backing .....	206
Audio	
Bluetooth .....	132
Automatic	
Door Locks .....	15
Emergency Braking (AEB) .....	218
Emergency Braking (AEB) Disabled	
Light .....	97
Headlamp System .....	116
Parking Assist (APA) .....	210
Vehicle Hold Light .....	96
Automatic Vehicle Hold (AVH) .....	177
Avoiding Untrusted Media Devices .....	131
<b>B</b>	
Battery	
Charging Electrical Requirements .....	237
Exterior Lighting Battery Saver .....	122
Fault Light .....	94
Gauge .....	90
Load Management .....	121
Power Protection .....	122
Battery - North America .....	255, 285
Blade Replacement, Wiper .....	258
Blind	
Zone Steering Assist (BZSA) .....	224

Bluetooth	
Audio .....	132
Overview .....	138, 139
Brake	
Fluid .....	254
System Warning Light .....	94
Brakes .....	253
Antilock .....	175
Brake Assist .....	177
Electric Brake Boost .....	175
Electric Parking Brake .....	175
Regenerative Braking .....	178
Braking .....	160
Automatic Emergency (AEB) .....	218
Reverse Automatic .....	213
Braking System	
Front Pedestrian (FPB) .....	220
Break-In, New Vehicle .....	168
Buckle To Drive .....	43
Bulb Replacement .....	259
Headlamp Aiming .....	259
Buying New Tires .....	280
<b>C</b>	
Calibration	
Compass .....	84

California	
Perchlorate Materials	
Requirements .....	248
California Proposition 65 Warning .....	1, 285
Camera	
Rear Vision (RVC) .....	206
Canadian Vehicle Owners .....	2
Capacities and Specifications .....	303
Car Wash Mode .....	171
Carbon Monoxide	
Liftgate .....	16
Winter Driving .....	163
Cargo	
Cover .....	78
Management System .....	80
Tie-Downs .....	79
Caution, Danger, and Warning .....	2
Center Console	
Storage .....	78
Chains, Tire .....	284
Charge	
Cord .....	234
Charge Cord Connected Light .....	94
Charging .....	101
Delay Override .....	232
Plug-In .....	228
Status Feedback .....	233
System Light .....	93

- Charging (cont'd)  
Utility Interruption ..... 237  
Wireless ..... 86
- Child Restraints  
Infants and Young Children ..... 61  
Lower Anchors and Tethers for  
Children ..... 66  
Older Children ..... 60  
Securing ..... 72, 73  
Systems ..... 63
- Child Safety Locks ..... 16
- Circuit Breakers ..... 261
- Cleaning  
Exterior Care ..... 289  
Interior Care ..... 293
- Climate Control Systems  
Dual Automatic ..... 151
- Clock ..... 84
- Cluster, Instrument ..... 89
- Collision Damage Repair ..... 310
- Compartment  
Underhood ..... 251
- Compartments  
Storage ..... 77
- Compass ..... 84
- Connected Services  
Connections ..... 321  
Diagnostics ..... 323
- Connected Services (cont'd)  
Navigation ..... 321
- Connections  
Connected Services ..... 321
- Control  
Traction and Electronic Stability ..... 179
- Control of a Vehicle ..... 160
- Controls  
Steering Wheel ..... 125
- Convex Mirrors ..... 24
- Cooling ..... 151
- Cooling System ..... 252
- Cornering Lamps ..... 119
- Courtesy Transportation Program ..... 309
- Cover  
Cargo ..... 78
- Cruise Control  
Adaptive ..... 181  
Light ..... 100  
Super ..... 190
- Cupholders ..... 77
- Customer Assistance  
Offices ..... 306  
Text Telephone (TTY) Users ..... 306
- Customer Information  
Publications Ordering Information ..... 312
- Customer Satisfaction Procedure ..... 304
- Cybersecurity ..... 314
- D**  
Damage Repair, Collision ..... 310  
Danger, Warning, and Caution ..... 2  
Dashboard ..... 4  
Data Collection  
Infotainment System ..... 315  
OnStar ..... 315  
Data Recorders, Event ..... 314  
Daytime Running Lamps (DRL) ..... 116  
Defensive Driving ..... 160  
Delayed Charging Override ..... 232  
Delayed Locking ..... 15  
Destination ..... 134  
Diagnostics  
Connected Services ..... 323  
Digital  
Key ..... 16  
Disabled Vehicle  
Transporting ..... 287  
Distracted Driving ..... 159  
Dome Lamps ..... 120  
Door  
Ajjar Light ..... 101  
Delayed Locking ..... 15  
Locks ..... 13  
Power Locks ..... 15  
Drive Systems  
All-Wheel Drive ..... 175

Drive Unit	
Electric .....	171
Driver	
Assistance Systems .....	205
Information Center (DIC) .....	108
Mode Control .....	180
Mode Control Light .....	98
Teen .....	146
Driving	
Assistance Systems .....	216
Characteristics and Towing Tips .....	237
Defensive .....	160
Distracted .....	159
Hill and Mountain Roads .....	163
If the Vehicle is Stuck .....	164
Impaired .....	160
Loss of Control .....	162
Off-Road Recovery .....	161
One-Pedal .....	174
Vehicle Load Limits .....	165
Wet Roads .....	162
Winter .....	163
Driving for Better Energy Efficiency .....	158
Dual	
Automatic Climate Control System .....	151

<b>E</b>	
Electric	
Brake Boost .....	175
Drive Unit .....	171
Parking Brake .....	175
Parking Brake Light .....	95
Electrical	
Equipment, Add-On .....	245
Requirements for Battery Charging ....	237
System Overload .....	260
Electrical System	
Fuses and Circuit Breakers .....	261
Instrument Panel Fuse Block .....	266
Emergency	
OnStar .....	317
Energy Efficiency	
Driving .....	158
Engine	
Cooling System .....	252
Entry Lighting .....	121
Equipment, Towing .....	243
Event Data Recorders .....	314
Exit Lighting .....	121
Extended Parking .....	171
Extender, Seat Belt .....	49
Exterior	
Lamp Controls .....	114
Lamps Off Reminder .....	116

Exterior (cont'd)	
Lighting Battery Saver .....	122
<b>F</b>	
Flash-to-Pass .....	116
Flashers, Hazard Warning .....	119
Flat Tire .....	284
Floor Mats .....	296
Fluid	
Brakes .....	254
Washer .....	253
Folding Mirrors .....	25
Forward	
Collision Alert (FCA) System .....	216
Frequency Statement	
Radio .....	312
Front	
Heated and Ventilated Seats .....	38
Pedestrian Braking (FPB) System .....	220
Fuses	
Fuses and Circuit Breakers .....	261
Instrument Panel Fuse Block .....	266
Underhood Compartment .....	262
<b>G</b>	
Garage Door Opener .....	111
Programming .....	111
Gas Strut(s) .....	258



Gauges			
Battery .....	90		
Odometer .....	90		
Power Indicator .....	91		
Speedometer .....	90		
Trip Odometer .....	90		
Warning Lights and Indicators .....	88		
General Information			
Service and Maintenance .....	297		
Towing .....	237		
Vehicle Care .....	248		
Global Positioning System (GPS) .....	135		
Glove Box .....	77		
GM Mobility Reimbursement			
Program .....	307		
Guidance			
Problems with the Route .....	136		
<b>H</b>			
Hazard Warning Flashers .....	119		
Head Restraints .....	32		
Headlamps			
Adaptive Forward Lighting (AFL) .....	117		
Aiming .....	259		
Automatic .....	116		
Bulb Replacement .....	259		
Daytime Running Lamps (DRL) .....	116		
Flash-to-Pass .....	116		
Headlamps (cont'd)			
High-Beam On Light .....	100		
High/Low Beam Changer .....	116		
Lamps On Reminder .....	100		
Leveling Control .....	118		
Heated			
Mirrors .....	26		
Rear Seats .....	42		
Steering Wheel .....	82		
Ventilated Front Seats .....	38		
Heating .....	151		
High Voltage Battery Gauge .....	90		
High Voltage Devices and Wiring .....	260		
High-Beam On Light .....	100		
Hill and Mountain Roads .....	163		
Hill Start Assist (HSA) .....	177		
Hood .....	250		
Horn .....	82		
How to Wear Seat Belts Properly .....	44		
HVAC .....	151		
<b>I</b>			
Immobilizer .....	23		
Indicator			
Pedestrian Ahead .....	97		
Vehicle Ahead .....	97		
Indicators			
Warning Lights and Gauges .....	88		
Infants and Young Children, Restraints .....	61		
Information			
Publication Ordering .....	312		
Vehicle .....	109		
Infotainment			
Using the System .....	125		
Infotainment System .....	315		
Inspection			
Multi-Point Vehicle .....	299		
Instrument Cluster .....	89		
Instrument Panel			
Storage Area .....	77		
Instrument Panel Overview .....	4		
Interior Rearview Mirrors .....	26		
Introduction .....	2, 123		
<b>J</b>			
Jump			
Starting - North America .....	285		
<b>K</b>			
Keys .....	6		
Digital .....	16		
Remote .....	7		
Remote Operation .....	7		

<b>L</b>		
Labeling, Tire Sidewall .....	271	
Lamps		
Cornering .....	119	
Daytime Running (DRL) .....	116	
Dome .....	120	
Exterior Controls .....	114	
Exterior Lamps Off Reminder .....	116	
Exterior Lighting Battery Saver .....	122	
Flash-to-Pass .....	116	
High/Low Beam Changer .....	116	
On Reminder .....	100	
Reading .....	120	
Lane		
Change Alert (LCA) .....	222	
Keep Assist (LKA) .....	224	
Keep Assist Light .....	96	
Lap-Shoulder Belt .....	46	
LATCH System		
Replacing Parts after a Crash .....	72	
LATCH, Lower Anchors and Tethers for		
Children .....	66	
LED Lighting .....	259	
Leveling Control		
Headlamp .....	118	
Liftgate .....	16	
Lighting		
Adaptive Forward .....	117	
Lighting (cont'd)		
Entry .....	121	
Exit .....	121	
Illumination Control .....	120	
LED .....	259	
Lights		
Adaptive Forward Lighting (AFL)		
Light .....	100	
Airbag Readiness .....	92	
Antilock Brake System (ABS)		
Warning .....	96	
Automatic Emergency Braking (AEB)		
Disabled .....	97	
Automatic Vehicle Hold .....	96	
Battery Fault .....	94	
Brake System Warning .....	94	
Charge Cord Connected .....	94	
Charging System .....	93	
Cruise Control Light .....	100	
Door Ajar .....	101	
Driver Mode Control .....	98	
Electric Parking Brake .....	95	
Gauges and Indicators .....	88	
High-Beam On .....	100	
Lane Keep Assist .....	96	
Low State of Charge .....	94	
One-Pedal Driving .....	99	
Seat Belt Reminders .....	91	
Lights (cont'd)		
Security .....	99	
Service Electric Parking Brake .....	95	
Service Vehicle Soon .....	94	
StabiliTrak OFF .....	98	
Tire Pressure .....	99	
Traction Control System		
(TCS)/StabiliTrak .....	98	
Traction Off .....	97	
Vehicle Ready .....	99	
Locks		
Automatic Door .....	15	
Delayed Locking .....	15	
Door .....	13	
Lockout Protection .....	15	
Power Door .....	15	
Safety .....	16	
Loss of Control .....	162	
Low State of Charge Light .....	94	
Low-Profile Tires .....	271	
Lower Anchors and Tethers for		
Children (LATCH System) .....	66	
Lumbar Adjustment .....	35	
Front Seats .....	35	

<b>M</b>			
Maintenance			
Records	301		
Maintenance Schedule	298		
Recommended Fluids and Lubricants	300		
Maps	134		
Massage			
Seats	35		
Media			
Avoiding Untrusted Devices	131		
Memory Seats	36		
Messages			
Propulsion Power	110		
Vehicle	110		
Vehicle Speed	111		
Mirrors			
Automatic Dimming Rearview	26		
Convex	24		
Folding	25		
Heated	26		
Interior Rearview	26		
Manual Rearview	26		
Power	24		
Rear Camera	26		
Mode			
Car Wash	171		
Driver Control	180		
		Monitor System, Tire Pressure	275
		Multi-band Antenna	131
		Multi-Point Vehicle Inspection (MPVI)	299
		<b>N</b>	
		Navigation	
		Connected Services	321
		Destination	134
		Symbols	134
		Using the System	133
		New Vehicle Break-In	168
		<b>O</b>	
		Odometer	90
		Trip	90
		Off-Road	
		Recovery	161
		Older Children, Restraints	60
		One-Pedal Driving	174
		One-Pedal Driving Light	99
		Online Account	306
		OnStar	315
		Additional Information	317
		Overview	316
		OnStar Emergency	317
		OnStar Security	317
		Outlets	
		Power	84
		Overview	124
		Overview (cont'd)	
		Instrument Panel	4
		Owner Checks and Services	299
		<b>P</b>	
		Park	
		Assist	206, 209
		Shifting Into	170
		Shifting Out of	170
		Parking	
		Brake and P (Park) Mechanism	
		Check	257
		Extended	171
		Parking Assist	
		Automatic	210
		Parking or Backing	
		Assistance Systems	206
		Passenger	
		Airbag Status Indicator	93
		Compartment Air Filter	155
		Sensing System	55
		Pedestrian Ahead Indicator	97
		Pedestrian Safety Signal	82
		Perchlorate Materials Requirements,	
		California	248
		Phone	
		Apple CarPlay and Android Auto	142
		Bluetooth	138, 139

Plug-In Charging .....	228
Port	
USB .....	131
Positioning	
Vehicle .....	136
Power	
Button .....	168
Door Locks .....	15
Indicator Gauge .....	91
Mirrors .....	24
Outlets .....	84
Protection, Battery .....	122
Retained Accessory (RAP) .....	170
Seat Adjustment .....	33
Windows .....	29
Pregnancy, Using Seat Belts .....	48
Privacy	
Vehicle Data Recording .....	313
Problems with Route Guidance .....	136
Program	
Courtesy Transportation .....	309
Proposition 65 Warning	
California .....	1
Proposition 65 Warning, California .....	285
Propulsion	
Power Messages .....	110
Publication Ordering Information .....	312

**R**

Radiator .....	252
Radio	
AM-FM Radio .....	128
Frequency Statement .....	312
Reception .....	130
Satellite .....	129
Reading Lamps .....	120
Ready Indicator .....	99
Rear	
Camera Mirror .....	26
Cross Traffic Alert (RCTA) System .....	216
Heated Seats .....	42
Pedestrian Alert .....	214
Seats .....	40
Vision Camera (RVC) .....	206
Rearview Mirrors .....	26
Automatic Dimming .....	26
Reclining Seatbacks .....	34
Recognition	
Voice .....	136
Recommended Fluids and Lubricants .....	300
Recorder	
Surround Video .....	226
Records	
Maintenance .....	301
Recreational Vehicle Towing .....	289
Regenerative Braking .....	178

Reimbursement Program, GM	
Mobility .....	307
Remote	
Key .....	7
Key Operation .....	7
Start .....	12
Replacement Parts	
Airbags .....	60
Maintenance .....	300
Replacing	
Airbag System .....	60
LATCH System Parts After a Crash .....	72
Seat Belt System Parts after a Crash .....	50
Reporting Safety Defects	
Canadian Government .....	313
General Motors .....	313
U.S. Government .....	312
Requirements	
Electrical Battery Charging .....	237
Restraints	
Where to Put .....	65
Retained Accessory Power (RAP) .....	170
Reverse Automatic Braking .....	213
Roads	
Driving, Wet .....	162
Roadside Assistance Program .....	307
Roof	
Sunroof .....	30

Rotation, Tires .....	279	Seats (cont'd)		Software Updates .....	128
<b>S</b>		Memory .....	36	Specifications and Capacities .....	303
Safety		Power Adjustment, Front .....	33	Speedometer .....	90
Locks .....	16	Rear .....	40	StabiliTrak	
Pedestrian Signal .....	82	Reclining Seatbacks .....	34	OFF Light .....	98
Safety Defects Reporting		Securing Child Restraints .....	72, 73	Start	
Canadian Government .....	313	Security		Remote .....	12
General Motors .....	313	Light .....	99	Start Assist, Hill .....	177
U.S. Government .....	312	OnStar .....	317	Starting and Stopping the Vehicle .....	169
Safety System Check .....	49	Vehicle .....	22	Status	
Satellite Radio .....	129	Vehicle Alarm .....	22	Charging Feedback .....	233
Scheduling Appointments .....	309	Self-Sealing Tires .....	270	Steering .....	161
Seat Belts .....	42	Service .....	156	Assist, Blind Zone (BZSA) .....	224
Buckle To Drive .....	43	Accessories and Modifications .....	248	Heated Wheel .....	82
Care .....	49	Doing Your Own Work .....	249	Wheel Adjustment .....	82
Extender .....	49	Electric Parking Brake Light .....	95	Wheel Controls .....	125
How to Wear Seat Belts Properly .....	44	Maintenance Records .....	301	Storage	
Lap-Shoulder Belt .....	46	Maintenance, General Information .....	297	Center Console .....	78
Reminders .....	91	Parts Identification .....	302	Compartments .....	77
Replacing after a Crash .....	50	Scheduling Appointments .....	309	Cupholders .....	77
Use During Pregnancy .....	48	Vehicle Soon Light .....	94	Glove Box .....	77
Seats		Servicing the Airbag .....	58	Instrument Panel Areas .....	77
Head Restraints .....	32	Settings .....	144	Storage Areas	
Heated and Ventilated, Front .....	38	Shifting		Cargo Cover .....	78
Heated, Rear .....	42	Into Park .....	170	Cargo Management System .....	80
Lumbar Adjustment, Front .....	35	Out of Park .....	170	Struts	
Massage .....	35	Side Blind Zone Alert (SBZA) .....	221	Gas .....	258
		Signals, Turn and Lane-Change .....	119	Stuck Vehicle .....	164

Sun Visors .....	30
Sunroof .....	30
Super Cruise .....	190
Surround Video Recorder .....	226
Surround Vision System .....	207
Symbols .....	3
Navigation .....	134
System	
Airbag .....	50
Driver Assistance .....	205
Forward Collision Alert (FCA) .....	216
Global Positioning .....	135
Infotainment .....	315
Rear Cross Traffic Alert .....	216
Surround Vision .....	207
<b>T</b>	
Teen Driver .....	146
Text Telephone (TTY) Users .....	306
Theft-Deterrent Systems .....	23
Immobilizer .....	23
Time .....	84
Tires .....	269
All-Season .....	270
Buying New Tires .....	280
Chains .....	284
Designations .....	272
Different Size .....	281

Tires (cont'd)	
If a Tire Goes Flat .....	284
Inspection .....	278
Low-Profile .....	271
Pressure .....	274
Pressure Light .....	99
Pressure Monitor Operation .....	276
Pressure Monitor System .....	275
Rotation .....	279
Self-Sealing .....	270
Sidewall Labeling .....	271
Terminology and Definitions .....	272
Uniform Tire Quality Grading .....	282
Wheel Alignment and Tire Balance .....	283
Wheel Replacement .....	283
When It Is Time for New Tires .....	280
Winter .....	270
Towing	
Driving Characteristics .....	237
Equipment .....	243
General Information .....	237
Recreational Vehicle .....	289
Trailer .....	240
Trailer Sway Control (TSC) .....	244
Traction	
Control System (TCS)/StabiliTrak	
Light .....	98
Control/Electronic Stability Control .....	179

Traction (cont'd)	
Off Light .....	97
Trademarks and License Agreements .....	148
Trailer	
Sway Control (TSC) .....	244
Towing .....	240
Transportation Program, Courtesy .....	309
Transporting	
a Disabled Vehicle .....	287
Trip Odometer .....	90
TTY Users	
Customer Assistance .....	306
Turn and Lane-Change Signals .....	119
<b>U</b>	
Underhood	
Compartment Fuse Block .....	262
Compartment Overview .....	251
Uniform Tire Quality Grading .....	282
Universal Remote System .....	111
Operation .....	113
Programming .....	111
Updates	
Software .....	128
USB Port .....	131
Using	
Infotainment System .....	125
Navigation System .....	133

Using (cont'd)	
This Manual .....	2
Utility Interruption of Charging .....	237

**V**

Vehicle	
Ahead Indicator .....	97
Alarm System .....	22
Automatic Hold .....	177
Automatic Hold Light .....	96
Canadian Owners .....	2
Control .....	160
Data Recording and Privacy .....	313
Identification Number (VIN) .....	302
Information .....	109
Load Limits .....	165
Messages .....	110
Positioning .....	136
Ready Light .....	99
Security .....	22
Service Soon Light .....	94
Speed Messages .....	111
Starting and Stopping .....	169
Symbols .....	3
Vehicle Care	
Tire Pressure .....	274
Ventilation, Air .....	154
Visors .....	30

Voice Recognition .....	136
Voltage Devices and Wiring .....	260

**W**

## Warning

Brake System Light .....	94
Caution and Danger .....	2
Hazard Flashers .....	119
Lights, Gauges, and Indicators .....	88
Washer Fluid .....	253

## Wheels

Alignment and Tire Balance .....	283
Different Size .....	281
Replacement .....	283
When It Is Time for New Tires .....	280
When to Charge .....	228
Where to Put the Restraint .....	65

Windows .....	28
Power .....	29

## Windshield

Replacement .....	258
Wiper/Washer .....	83

## Winter

Driving .....	163
Tires .....	270

## Wiper

Blade Replacement .....	258
Wireless Charging .....	86
Wiring, High Voltage Devices .....	260

## Scan to Access

### United States



- Owner's Manuals
- Warranty Information
- Connected Services
- My Cadillac Rewards
- myCadillac Mobile App
- How-To Videos
- Vehicle Diagnostics
- Scheduled Maintenance
- Vehicle Features
- Many Additional Resources

### Canada



---

### United States

Customer Assistance  
1-800-458-8006  
Roadside Assistance  
1-800-224-1400

**United States and Canada**  
Connected Services  
1-888-4-ONSTAR

### Canada

Customer Assistance  
1-888-446-2000  
Roadside Assistance  
1-800-882-1112



23LYRIQ\_enUS\_15644413B\_2022JUL29\_D

