

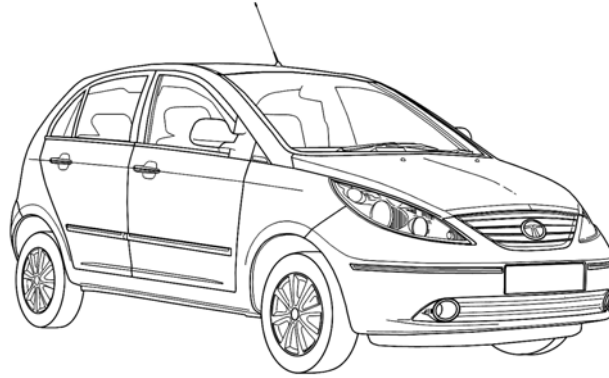

TATA INDICA VISTA & VISTA TECH

Owner's Manual



TATA MOTORS

Passenger Vehicle Business Unit (PVBU)

• Mumbai • Pune •

- This manual is structured so that it can be used for quick reference. For this reason, it should always be kept in the vehicle for ready access. In the event of the Vehicle being sold, please ensure that this manual is left in the vehicle for the reference of the new owner.
- All information, illustrations and specifications contained in this manual are based on the latest product information available at the time of publication.
- **TATA MOTORS LIMITED** reserves the right to make changes in design and specifications and/or to make additions or improvements in this product without obligation to install them on the vehicles previously sold.
- This owner's manual includes information on the operation and maintenance of various equipment installed on the different variants. Please note that this manual applies to all the models and explains all equipments including options not installed on your vehicle.
- All rights reserved. The information in this manual may not be reproduced or copied, in whole or in part, or in any form without written permission from **TATA MOTORS**.
- © **Copyright 2014 TATA MOTORS**

Dear Customer,

Welcome to the **TATA MOTORS** family.

We congratulate you on the purchase of your new vehicle and are privileged to have you as our valued customer. Your selection of our product exhibits the trust you have in us.

This manual will familiarize you with operational, maintenance and safety information of your new vehicle. We urge you to read this manual carefully and follow the recommendations to assure enjoyable and safe operation of your new vehicle.

We insist that all service and maintenance on your vehicle should be performed by an authorized **TATA MOTORS DEALER / TATA MOTORS Authorised Service centres (TASCs)** to ensure that only latest methods and genuine replacement parts are used for continued reliability, safety and performance of your vehicle.

You are welcome to contact our dealer or Customer assistance toll free no. in case of any query or support.

We wish you a safe and wonderful driving experience.

TATA MOTORS LIMITED

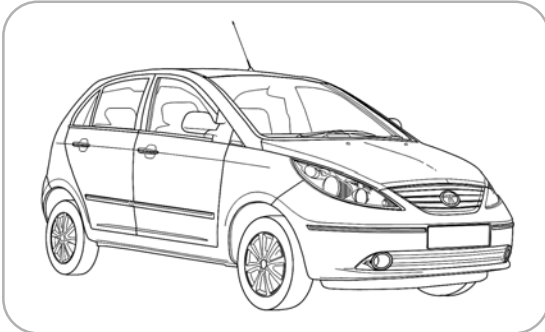



Your **Indica Vista** is the perfect blend of form and functionality.

Built on the new car platform from **TATA MOTORS**, the **Indica Vista** is bigger in size and interior space, but its contemporary styling and sharp lines give it a compact sporty look. The new petal-shaped headlamps add a dash of panache to the front and the vertically stacked tail lamps are unique in its class.

The contemporary styling continues in the interiors, with the stylish two-tone dashboard and the two DIN stereo system. Its central instrument cluster improves frontal visibility and allows the passengers to participate in the driving experience. The adjustable driver's seat and the tilt adjust steering wheel enable better driving posture while the best in class interior space results in unmatched comfort. The all new floor console comes with well-designed

utility spaces and the glove box can even accommodate a compact laptop.

The **Indica Vista** is also a leap in terms of technology. It is powered by new generation engines; the globally acclaimed advanced **QUADRAJET** Diesel Engine, the new turbocharged **TDi** diesel engine and also world class **SAFIRE** Petrol Engine with new synchromesh power train that will change the way you drive. Few of the variants of vista are fitted with SRS, ABS, Electrical outer rear view mirror, 4 spoke steering wheel with switches. Its improved semi-independent twist beam rear suspension and its bigger and wider tubeless tyres increase ride comfort.

By buying the **Indica Vista**, you automatically become a member of the Tata Motors loyalty program, which comes with special offers on service and accessories and includes membership to the Tata Group Empower loyalty program.

Finally, like all Tata cars, the **Indica Vista** is supported by a well-established network of service centers which will help you keep your car in the perfect condition.

Drive the Indica Vista. Discover how it changes everything.

1 SAFETY & SECURITY

Important Safety Notes	09
Safety Guidelines	09
Seat Belts	10
Child lock	13
Anti-theft Device - Immobilizer	14
Supplemental Restraint System - Air Bags	16
Anti-lock Braking System	18
Driving in Adverse Conditions	19

01

2 OPENING & CLOSING

Anti-theft Device-Immobilizer	22
Doors	25
Window Glasses	26
Bonnet	27
Fuel Lid	28
Trunk lid	28

02

3 INSTRUMENTS & CONTROLS

Cockpit	29
Instrument Cluster (Vista)	31
Instrument Cluster (Vista Tech)	41
Tale tells	55
On Board Diagnostic (OBD)	59
Combination Switch	60
Fascia Switches	64
Music System	65
Infotainment & Navigation System	66
Steering Wheel Switches	67
Lamps	68
Roof Lamp	70

03

CONTENTS

4 STOWAGE & FEATURES

Glove Box	71
Utility Pockets & Box	71
Cup Holders	71
Power Socket	72
Utility Tray	72
Roof Grab Handle	72
Luggage Space	72

04

5 CLIMATE CONTROLS

Air Flow Pattern	73
HVAC Controls	75
Basic Settings	77

05

6 STARTING & DRIVING

Pre-driving Checks	80
Fuel Saving Tips	82
Good Driving Practices	83
Running-In Period	83
Seat & Seat Adjustments	84
Rear View Mirrors	86
Sun Visors	87
Steering Wheel Height Adjustment	88
Steering Lock cum Ignition Switch	89
Starting & Stopping The Engine	90
Preparing to drive	90
Parking	91
Brakes & Braking	92

06

7 EMERGENCY & BREAK DOWN ASSISTANCE

If Unexpected Happens	93
Hazard Warning Switch	93
First Aid Kit	94
Advance Warning Triangle	94
Tool Kit	95
Jack & Handle	95
Flat Tyre Replacement	96
Jump Lead Start	98
Towing The Vehicle	100
Fuses & Fuse Replacement	102
Bulb Specifications & Bulb Replacement	109
24 X 7 On Road Assistance	113

8 MAINTENANCE & SERVICING

Engine Compartment	117
Engine Oil Level	121
Engine Coolant Level	121
Brake Fluid Level	122
Transaxle Oil Level	122
Windshield Washer Fluid Level	123
Spark Plug (Petrol Engine)	123
Tyres	124
Battery	127
Routine Service	128
Service Instructions	129
Service Schedule	130

9 TECHNICAL INFORMATION

Fuel Specification	133
Lubricants Specification	134
Coolant Specification	134
Fuel, Lubricants & Coolant Co-branding	135
Technical Specifications	136
Vehicle Dimensions	140
Identification Plates	142

10

CAR CARE & VALUE ADDED SERVICES

Car Care	144
Washing	144
Waxing	145
Polishing	145
Paint Care	146
Wiper Care	146
Vehicle Parking For Long Duration	147
Value Added Services	148

10

11

WARRANTY - TERMS AND CONDITIONS 157

12

ENVIRONMENT SAFETY 159

13

ALPHABETICAL INDEX 161

IMPORTANT SAFETY NOTES:

In this Owner's Manual, you will find the following safety notes.

NOTE

Indicates additional information that will assist you in gaining the optimum benefit and care for your vehicle.

WARNINGS

Indicates procedures or information that must be followed precisely in order to avoid the possibility of severe personal injury and serious damage to the vehicle.

SAFETY GUIDELINES:**Safe driving depends on:**

- How quickly you make decisions to avoid an accident.
- Your ability to concentrate.
- How well you can see and judge objects.

Few safe driving general tips are listed below.

- Take into account the traffic, road, and weather conditions, particularly with regard to stopping distance.
- Never drive under the influence of alcohol or drugs.
- Refrain from using a cell phone while driving.
- Fatigue is a result of physical or mental exertion that impairs judgement. Driver fatigue may be due to lack of adequate sleep, extended work hours, strenuous work or non-work activities or combination of

other factors. Take rest at regular intervals.

- If your vehicle is equipped with a navigation system, set and make changes to your travel route only with the vehicle parked.
- Program radio presets with the vehicle parked, and use your programmed presets to make radio use quicker and simpler

SEAT BELTS:

Seat-belt is a safety device designed to secure the occupant of the vehicle. Use of seat-belt reduces the chance of injury and severity of injury in case of an accident. **TATA MOTRS** strongly recommends that all the occupants should always wear seat-belts while travelling, irrespective of journey duration.

Your vehicle is equipped with seat belts, for front and rear seats as a part of occupant restraint system.

In normal driving, the belt lets you move freely in your seat. In case of an accident or sudden braking, inertia reel automatically tightens the belt to help restrain your body.

This vehicle has three point inertia reel type for front and rear seat belts in the out board positions and a lap belt for middle passenger on rear seat. The anchor end of the shoulder belt is adjustable to suit the height of the

passenger wearing it. The lap belt has a manually adjusted belt that fits across the hip bone. Make sure that your seat is adjusted to a good driving position and the back of the seat is upright.

Importance of Wearing Seat Belt :

1. It will help to keep you in the proper position when the air bag inflates.?
2. Reduces the risk of harm in rollover, side or rear impact collisions
3. Reduces the risk of harm in frontal/angular collisions that are not enough to activate the air bag.
4. Reduces the risk of being thrown from your vehicle in a collision.

NOTE

Do not bleach or dye seat belts as this may severely weaken them. In a crash they may not be able to provide adequate protection. Cleaning should be carried out using mild soap and water only.

WARNINGS

Make sure that the seat belts are not twisted which can cause injury in a collision as the full width of the belt isn't available to absorb the impact. This puts more force on the bones beneath the belt, which could cause serious injury.

The maximum protection which seat belts can offer is only achieved if you are correctly seated. The seat back should not be tilted too far back.

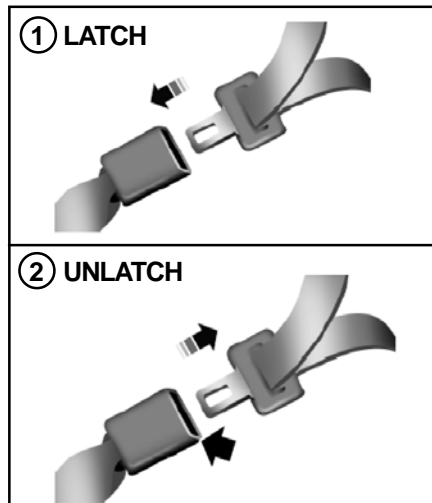
How to use seat belts:

1. Pull the belt tongue across your body and insert it into the buckle.
2. Check and ensure that the belt is not twisted.
3. Position the lap portion of the belt as low as possible across your hip bone.

4. Pull up the shoulder part of the belt to remove the slack. Make sure that the belt goes over your collar bones and across chest.
5. To unlatch the belt, press the red button on the buckle. Guide the belt to the pillar as it retracts.

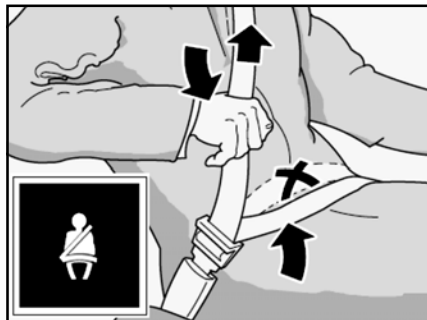
**WARNINGS**

1. The belts are meant (intended) for adult occupants only.
2. Each belt should be used by one occupant only. The belt must not be put round a child, seated on passengers lap.

3. When the belt has been in use in a serious accident or shows signs of severe fraying / damage or of having been cut, replace with an approved belt kit.
4. The belt must not be altered or modified during use and if required to be replaced, then it should be replaced, by **TATA MOTORS** Authorized Service outlets only.

Lap belt:

Pull the tongue to the desired length. Insert it into the buckle until you hear a click.

Adjust the belt length. To lengthen the belt, hold the tongue at a right angle to the webbing and pull. To shorten, pull the loose end of the webbing. To unfasten, depress the button in the buckle.

WARNING

Positioning the lap portion of the Seat Belt too high can be dangerous as in a collision; this would concentrate the impact force directly on the abdominal area, causing serious injury. Wear the lap portion of the belt snugly and as low as possible.

Pregnant Woman:

A pregnant woman should wear a Lap-shoulder belt and the lap portion should

be worn as low as possible, below the rounding, throughout the pregnancy. When a safety belt is worn properly, it is more likely that the foetus will not be hurt in a crash. Pregnant women should wear the lap part of the belt across the thighs and as snug across the hips as possible. Keep the belt low so that it does not come across the abdomen. By doing this, the strong bones of the hips will take the force if there is a collision.

**WARNING**

Be sure everyone in your vehicle is in a seat and using a seat belt properly.

CHILD RESTRAINTS :

Use child restraint system appropriate for the child until he / she becomes mature enough to properly wear the vehicle's seat-belts. You must carefully

SEAT BELTS & CHILD LOCK

consult the manufacturer's instructions which accompany the child restraint system, about the age and size of the child. The child restraint system should be installed in the rear seat.

NOTE

According to accident statistics, a child is safer when properly restrained in the rear seat than in the front seat. For optimum safety, children should travel in the rear of the vehicle at all times.

NOTE

Child restraint systems are available at authorized **TATA MOTORS** dealerships. **TATA MOTORS** recommends the use of a type which fits your vehicle. Before installation, always read the manufacturer's instructions.

CHILD LOCK:

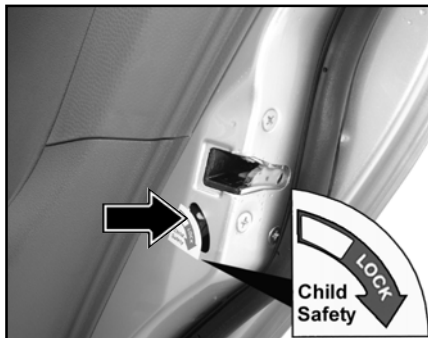

Both the rear doors of the car are provided with a child proof lock. Push the lock lever located on vertical face of the door near the lock downward before closing the door. The door which has been locked by activating the child lock cannot be opened from inside, it can be opened only from the outside.

NOTE

Deactivate the childproof lock when not required.

ANTI THEFT DEVICE- IMMOBILIZER:

Immobilizer system is designed to prevent car theft by electronically disabling the engine ignition system. The engine can be started only with car's original Immobilizer ignition key which has an electronic identification programmed code.

NOTE

Use only one E-key; the other should be kept in a safe location. Note down "key Tag no." information (and keep it safe) which is required while getting new / spare keys. Remember that it is not possible to prepare new/spare keys without the "key Tag number."

Take precaution about E-keys, as without it vehicle cannot be started.

Operation of Immobilizer system in Brief:

VEHICLE CONDITION	STATUS LAMP	VEHICLE STATE	MEANING/ FUNCTION OF THE STATE
Ignition OFF	Blinking	Locked	Vehicle Immobilized and Awaiting Electronic key
Ignition ON	OFF	Unlocked	Normal Condition Ready to start the vehicle
	ON	Locked	<ul style="list-style-type: none"> - Problem with key (Wrong Ekey used to start vehicle) - Problem with Immobilizer system contact Tata dealer to inspect the system

E-KEYS:

An E-Key is an electronic access and authorization system which is provided as a standard feature on your car. Your car is provided with two E-Keys. Each Key is specific to the immobilizer of your car.

Unlocking principle:

The transponder which is built into the ignition E-Key carries a unique identification code. The car unlocks when the code on the E-Key matches with the code on the Engine Management system (EMS).

Engine Starting :

When the key is inserted and the ignition is switched ON, all codes are communicated within concerned components (E-Key, Immobilizer and EMS). The engine will start only if all the codes match.

Loss of keys :

If one of the E-Key is lost, contact your nearest **TATA MOTORS** authorised dealer as soon as possible to have the lost key deactivated. The second original E-Key is required for making additional E-Keys.

If both the E-Keys are lost contact **TATA MOTORS** authorised dealer .

WARNING

1. Do not turn 'ON' ignition switch by using E-key with any type of metal wound around its grip or in contact with it. This may be detected as an abnormal condition by immobilizer and prevent the engine from starting.
2. Do not leave the E-key in areas of high temperature. The transponder in it will behave abnormally when reused.
3. Do not try to start the vehicle when the Immobilizer indicator

lamp on the instrument cluster is glowing. In this condition the vehicle will not start and the vehicle's battery will also be drained due to frequent cranking.

SUPPLEMENTAL RESTRAINT SYSTEM- AIR BAGS : (If fitted)

- The frontal air bags (driver and passenger) are safety devices designed to protect the occupants in the event of a medium or high intensity collision, which acts as a cushion (bag) between the occupant and the steering wheel.
- In the event of a collision, an ECU is so designed to process signals from the sensor, to detect the severity of collision and accordingly trigger the inflation of air bags. Air bags are not designed to inflate in rollover, rear side or slow speed angular crashes because the necessary protection can be achieved by the seat belt alone.
- Air bags(s) may only deploy when the ignition switch is ON. The inflating air bag deploys out of the steering wheel for the driver, and dash board for the passenger. This

action takes place in a fraction of second.

- The air bags are filled with a propellant gas (nitrogen). The movement of the driver and of the front passenger is cushioned when they make contact with the fully inflated airbag and the risk of injury to head and chest is reduced. The air bag then deflates subsequently to such an extent, after an accident, to again provide a clear view forward. You may hear a noise along with some smoke, dust and smell of burnt propellant immediately after the air bag has inflated. DO NOT PANIC as this is normal and is not an indication of fire in the vehicle.

Passenger Air Bag (PAB) switch provided on the left side of the dashboard should always be ACTIVE. If in case the front passenger seat is unoccupied, the PAB may be

prevented from deploying by turning the PAB switch to INACTIVE by using the ignition key.



WARNING

Always maintain an adequate distance between yourself and the airbags. Always grip the steering wheel on the rim, with your hands in the 3 o'clock and 9 o'clock positions, to minimize the risk of injury to the hands or arms in the event of the airbag being triggered.

WARNING

No part of your body (example feet, knees), objects and accessories should be within close proximity to the PAB module as it could obstruct the operation of the air bag.

Deployed air bags and seat belt pre-tensioners cannot protect you in another collision. Have the air bags, seat belt pre-tensioners, replaced by **TATA MOTORS** Authorized Service Centre immediately.

NOTE

In case of any frontal damage to your vehicle, have the SRS inspected by **TATA MOTORS** authorised service outlet to ensure it is in proper working condition.

Any maintenance performed on or near the components of the SRS must be performed only by a **TATA MOTORS** Authorized Service

Centre. Do not permit anyone else to do any service, inspection, maintenance or repair on any SRS components or wiring.

Improper work on the SRS system will result in inadvertent deployment of the air bag or could render the SRS inoperative.

ANTI- LOCK BRAKING SYSTEM (ABS): (If fitted)

ABS is a safety system that allows efficient braking without losing tractional control, prevents wheels from locking up and avoids uncontrolled skidding.

The Anti-Lock Braking System monitors the rotational speed of each wheel. During emergency braking ABS controls the braking force of each wheel. If it detects a wheel rotating significantly slower than the others, a condition indicative of impending wheel lock it actuates the valves to reduce hydraulic pressure to the brake at the affected wheel thereby reducing the brake force on that wheel. When ABS is active the driver will feel the brake pedal pulsate several times and a sound may be audible from the ABS module.

NOTE

If the ABS warning lamp lights up then there is a malfunction in the ABS system (the standard braking system will however function) and the vehicle should be driven cautiously to the nearest **TATA MOTORS** Authorized Service outlet.

WARNINGS

The fact that a vehicle is fitted with ABS must never tempt the driver into taking risks that could affect his/her safety or that of others. In all cases it remains the driver's responsibility to drive within safety margins, taking into consideration prevailing weather and traffic conditions.

DRIVING IN ADVERSE CONDITION:**Driving Through Water :**

Your vehicle's engine may get seriously damaged if attempted to drive through deep water.

If at all the situation demands that you have to drive through water then;

- Keep engine in fast idling and crawl the vehicle in low gear.
- After driving through water apply brakes several times to dry liners and to regain original braking.

- *Do not attempt to start the engine if vehicle gets flooded due to water. Tow the car to a safe place.*
- Take the vehicle to nearest **TATA MOTORS** authorised workshop to check entry of water in cylinders.
- If water has entered the engine, gearbox or transfer case, the lubricants will have to be replaced. Get the starter and alternator checked.

Driving on a Rainy Day :

- Check brakes, steering and windows. Check tyres for wear and tyre pressure.
- Check wiper blades for proper functioning.
- Avoid harsh braking and sharp turns. It may cause loss of control and lead to a skid.
- For slowing down, shift to lower gears and brake gently.
- Keep lights ON if visibility is poor.

Night Driving :

- Dip the head lamp for oncoming traffic during night driving.
- Maintain a speed such that you can stop within illuminated distance of head lamps.
- Use head lamp main/dip beam to alert other road users on turns/ cross roads etc.
- Use side indicators for lane change or turning.

- Put on hazard warning switch in case of hazardous parking or if your vehicle is disabled to warn the passing traffic.

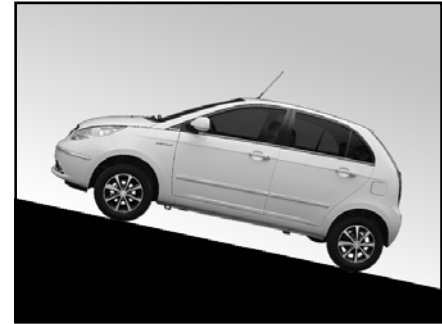
Climbing Sharp Gradients on Loose Surfaces :

- Start off smoothly in any suitable gear. Apply power smoothly so that there is no loss of traction by over-revving of the engine.
- Choose as smooth a slope as possible and select the appropriate gear so that gear changing in the middle of the climb is not required.
- Changing gears in the middle of the climb can cause loss of momentum and engine stalling. Shifting to a

lower gear has to be done cautiously to avoid loss of traction.

- Never move the vehicle diagonally across a hill. The danger is in loss of traction and sideways slippage, possibly resulting in tipping over. If unavoidable, choose as mild an angle as possible and keep the vehicle moving.
- If the wheels start to slip within few feet of the end of the climb, motion can be maintained by swinging the steered wheels left and right, thereby providing increased grip.
- If the vehicle stalls or losses headway while climbing a steep hill, make a quick shift to reverse and allow the vehicle to move back with the control of engine compression.

Descending Sharp Gradients :



- Depending on the severity of the gradient, shift into appropriate gear. Use engine braking judiciously without over-revving the engine.
- Brake application under such situations should be done very smoothly to avoid loss of control. Select appropriate gear so that gear changing or clutch disengagement is not involved while descending the gradient.

IMMOBILIZER SYSTEM:

(If provided)

Immobilizer system is designed to prevent car theft by electronically disabling the engine starting system. The engine can be started only with car's original Immobilizer ignition key which has an electronic identification programmed code.

Immobilizer system consists of following components :

- 1. Immobilizer unit (ICU):** Add-on part on the ignition switch fitted on steering column.
- 2. Two Electronic keys (E-key) :** To start the car.

NOTE

- 1) E-key of other cars will not start the engine.
- 2) *Customer should,*
 - a. *Use only one E-key .*
 - b. *The other E-key should be kept at safe location.*
 - c. *Note down "key Tag no." information (and keep it safe) which is required while getting new / spare keys. Please note that It is not possible to prepare new/spare keys without "key Tag no."*
 - d. *Take precaution about E-keys, as without it car cannot be started.*

Immobilizer system Brief :

The behavior of Immobilizer and car under “Ignition OFF and ON” conditions, is explained in table below with immobilizer status lamp (“lock” symbol on the instrument cluster)

CAR CONDITION	STATUS LAMP	CAR STATE	MEANING/ FUNCTION OF THE STATE
Ignition OFF	Blinking	Locked	Car Immobilized and Awaiting Electronic key
Ignition ON	OFF	Unlocked	Normal Condition Ready to start the car
	ON	Locked	<ul style="list-style-type: none"> - Problem with key (Wrong Ekey used to start car) - Problem with Immobilizer system contact Tata Motors dealer to inspect the system

NOTE : *Few of the variants of VISTA are not having immobilizer system.*

E-Keys :**Unlocking Principle :**

The E-keys are learned for a specific immobilizer and are unique to the car. The transponder is built into the ignition E-key carries a unique identification code. The Engine management system (EMS) and Immobilizer has a common secret code. Both these codes are used while unlocking the car.

When the key is inserted and the ignition is switched "ON", all the codes are communicated within the concerned components (E-key, Immobilizer and EMS). The engine starts only if all codes match. In case of a mismatch of the codes, the system prevents the engine from starting.

Loss of E- Keys :

If any one of the E-key is lost, **contact TATA dealer as soon as possible** to have the lost key deactivated and to have the new E-key. Please note that a second original E-key is required for making additional E-keys.

If both the E-keys are lost, contact the authorized TATA dealer.

NOTE**Do's and Don'ts of immobilizer system**

1. Do not turn ON the ignition switch by using an electronic key with any type of metal wound around its grip or in contact with it. This may be detected as an abnormal condition by the immobilizer and prevent the engine from starting.
2. Do not leave the electronic key in areas of high temperature. The transponder in the E-Key will behave abnormally when reused.
3. Do not try to start the car when the Immobiliser indicator lamp on the instrument cluster is glowing. In this condition, the car will not start and the car's battery will also be drained due to frequent cranking.

DOOR OPENING / CLOSING :**Front Doors (Driver and Co-driver)****Locking / unlocking doors with key from outside :**

Both front doors (drivers and co-driver) have separate locking facility. Front doors can be locked or unlocked from outside using the E-key.

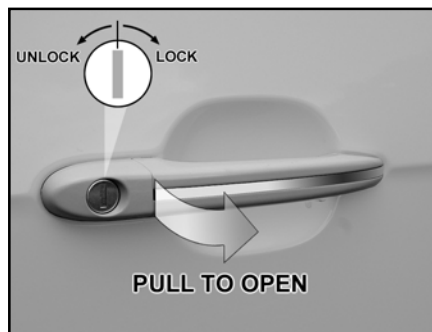

Insert the E-key and turn it anti-clockwise to open or clockwise to lock the door. Pull the Door handle to open an unlocked door.

Locking without a key from inside:

All the doors can also be locked or unlocked independently from inside by pressing or pulling the knob (1). **Press** to lock and **Pull** to unlock.

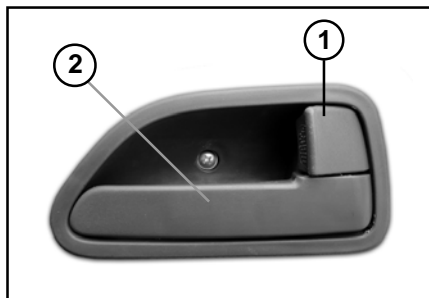
**NOTE**

When locking doors this way, do not leave the key inside the vehicle.

Opening the doors from inside :

All doors can be opened from inside. To open, pull the door opening lever (2).



Location of door opening / locking lever.

WINDOW GLASS OPENING & CLOSING :

Power Windows (if fitted) :

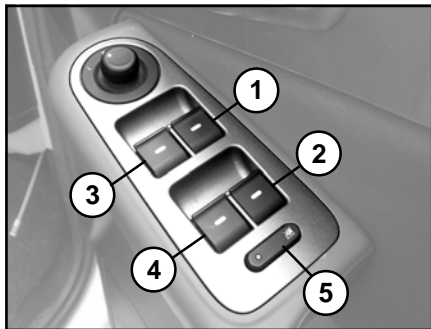

1. Front Right Hand Window Winding Switch
2. Rear Right Hand Window Winding Switch
3. Front Left Hand Window Winding Switch
4. Rear Left Hand Window Winding Switch
5. LOCK / UNLOCK Button

Glasses on all four windows of your vehicle can be operated by switches provided on the main control panel located on the driver's arm rest. They work only when the key is in the "IGN" position.

Glasses are wound up by pulling the switch and are lowered by pressing it down.

A safety locking arrangement has also been provided and can be activated by a push type switch located at the centre, below the window switches. It has two positions:

LOCK – When switch is pressed and red light comes ON.

UNLOCK – When switch is released
When the switch is in "LOCK" position, the rear window switches (located on rear doors) do not function. The rear window glasses can still be operated by using the switches on the driver's arm rest. Illumination on the rear window switch goes off when the switch is in locked condition. Press down the lock button to unlock.

Individual window winding switches have been provided on co-driver's door also.

WARNING

While raising the glass, take care to avoid fingers / hands getting trapped between glass and the frame.

Power window switch (On Rear Doors):

Individual window winding switches have been provided on the rear doors.

To close the door window glass, pull the knob up and to open, push the knob down



Window Winding Switch on Rear Door

Manual Window Winding :

In some versions, power windows are not provided. In such vehicles, use winder handle manually for lowering or raising up window glasses manually.

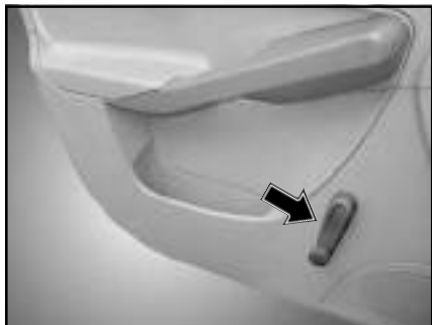

Winder Handle

BONNET - OPENING AND CLOSING:

Opening:

1. Ensure that the vehicle is in neutral gear with the parking brake applied.
2. Pull the bonnet release lever located under the right hand corner of the dash board. The bonnet will pop up slightly.
3. Raise the bonnet slightly and with your finger lift the secondary lock lever located under the bonnet centre.
4. Lift the bonnet up. Pull the bonnet stay rod from its clip and insert the free end into the slot in the bonnet, slide stay rod outward to secure.

Closing :

1. To close the bonnet disengage the stay rod and clamp it properly.
2. Lower the bonnet and drop it from a short height to shut.

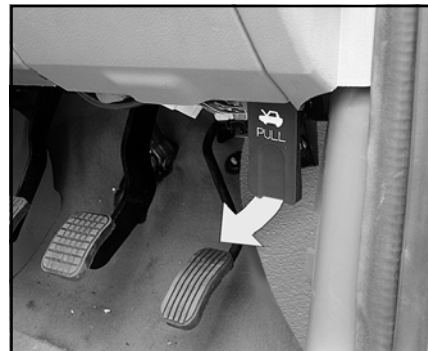

Location of Bonnet release lever



Bonnet release Lever

NOTE

Ensure that the bonnet is properly locked before driving. Do not press the bonnet onto the bonnet lock.

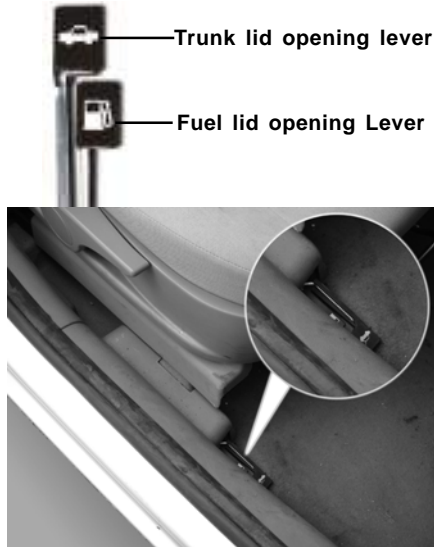
FUEL LID AND TRUNK LID OPENING & CLOSING :

Fuel Flap / Tail Gate Opening Lever

The fuel lid is located on the left rear side of the vehicle. This can be opened by pulling the opening lever located at the right hand side of the driver's side.

For closing, simply push the fuel flap till it gets locked.

WARNING

Fuel vapour is extremely hazardous. Always stop the engine before refueling and never refill near sparks or open flames.

NOTE

Remove the fuel filler cap slowly, and wait for any hissing to stop. If the cap is opened suddenly, the fuel may be under pressure and may spray out, causing injury.

Always use only original specification fuel cap or an approved equivalent available at Authorised Dealers. A wrong cap can result in serious malfunctioning of the fuel system and the emission control system.

Trunk lid opening & closing :

To open the trunk lid, pull the lever (Shown in fig.) located at the right hand side of the driver's side and lift the trunk lid.



It can also be opened by using door key. The lock is located on the trunk lid.

For closing, simply push the trunk lid downwards till it gets locked.

DASHBOARD (VISTA)

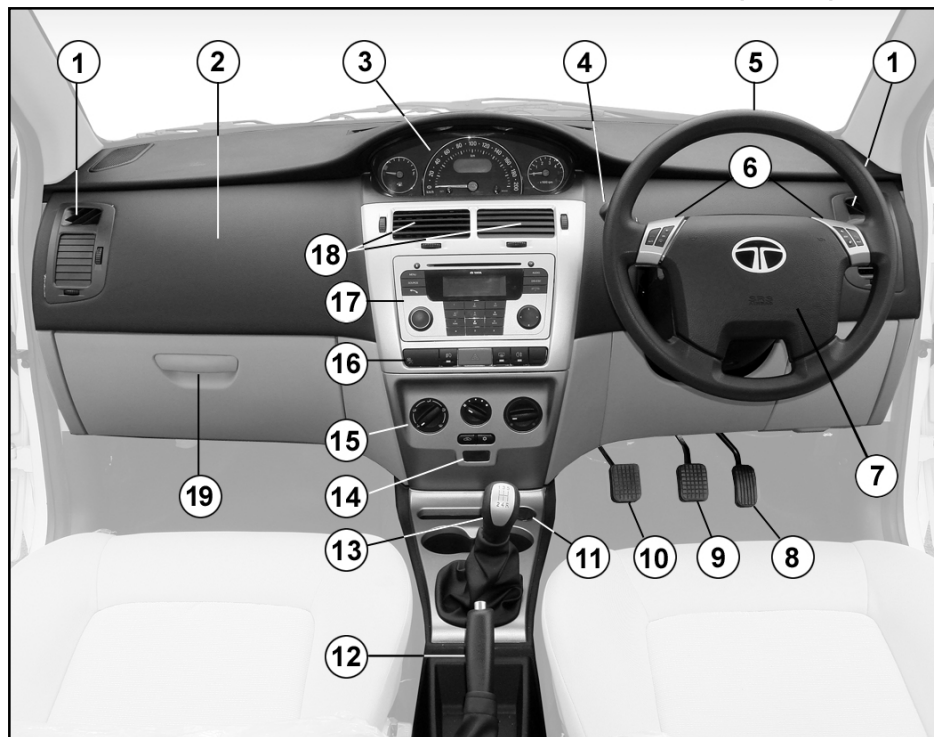

1.	A.C. Air vent (Side)
2.	Passenger Air Bag (if fitted)
3.	Instrument Cluster
4.	Combination Switch
5.	Steering Wheel
6.	Audio Controls on Steering Wheel
7.	Driver Air Bag (DAB) - if fitted
8.	Accelerator pedal
9.	Brake pedal
10.	Clutch pedal
11.	Plug Socket
12.	Parking Brake
13.	Gear lever
14.	USB/AUX Port
15.	AC / HVAC Control Panel
16.	Fascia Switches
17.	Music System-if fitted
18.	A.C. Vents (Central)
19.	Glove Box

The above shown image is for reference only.

DASHBOARD (VISTA TECH)



1.	A.C. Air vent (Side)
2.	Air Bag (Co-driver side) PAB
3.	Driver Information System
4.	Solar Sensor
5.	Instrument Cluster
6.	Steering Wheel
7.	Audio Controls on Steering Wheel
8.	Horn pad / Air Bag (DAB)
9.	Accelerator pedal
10.	Brake pedal
11.	Clutch pedal
12.	Plug Socket
13.	Parking Brake
14.	Cup Holder
15.	Gear lever
16.	HVAC Control Panel
17.	Facia Switches
18.	Music System
19.	A.C. Vents (Central)
20.	Glove Box

The above shown image is for reference only.

INSTRUMENT CLUSTER - DIESEL (As applicable)

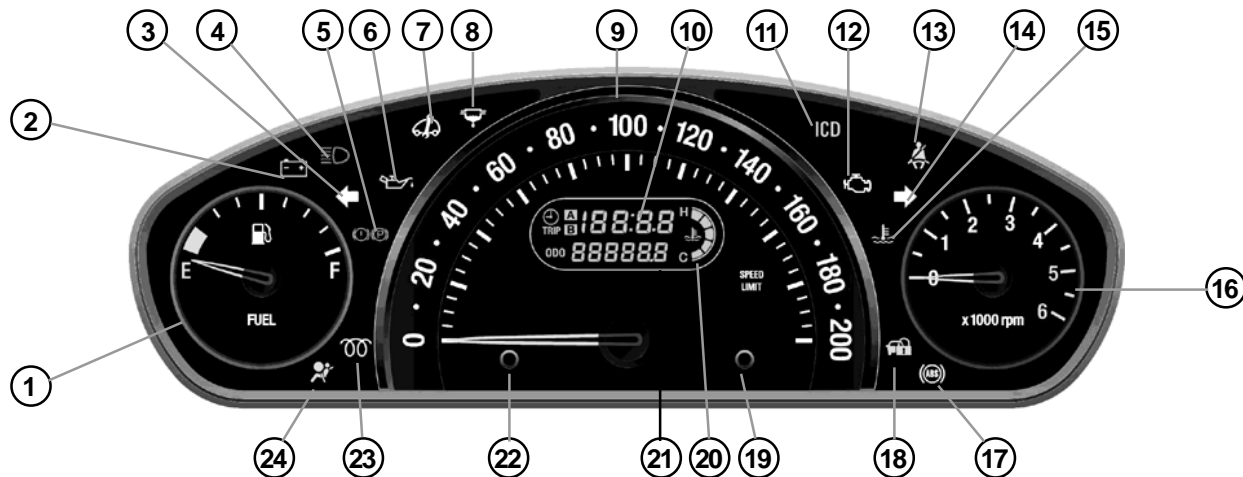

1	Fuel Gauge	9	Speedometer	17	ABS Indicator (If fitted)
2	Battery Charging Indicator	10	LCD (Digital Display)	18	Immobiliser Indicator
3	Turn Signal (Left)	11	ICD Indicator (Instrument Cluster Diagnostic)	19	"Mode" knob
4	High Beam Indicator	12	Engine Malfunction Indicator	20	Temperature Bar Graph
5	Parking Brake & Low Brake Fluid Indicator	13	Seat Belt Indicator	21	Odometer
6	Low Oil Indicator	14	Turn Signal (Right)	22	"Set" knob
7	Service Indicator	15	High Coolant Temp. Indicator	23	Glow Plug Indicator
8	Water In Fuel Indicator	16	RPM Meter	24	Air Bag Indicator (If fitted)

INSTRUMENT CLUSTER - DIESEL (As applicable)

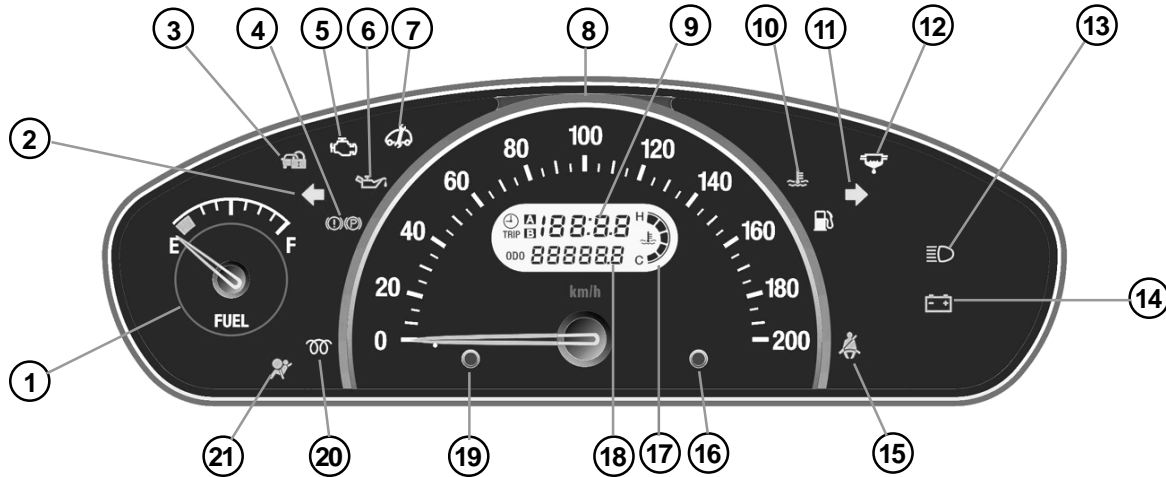

1	Fuel Gauge	8	Speedometer	15	Seat Belt Indicator
2	Turn Signal (Left)	9	LCD	16	"Mode" knob
3	Immobiliser Indicator	10	High Coolant Temp. Indicator	17	Temperature Bar Graph
4	Parking Brake / Low Brake Fluid Indicator	11	Turn Signal (Right)	18	Odometer
5	Engine Malfunction Indicator	12	Water In Fuel Indicator	19	"Set" knob
6	Low Oil Indicator	13	High Beam Indicator	20	Glow Plug Indicator
7	Service Indicator	14	Battery Charging Indicator	21	Air Bag Indicator (If fitted)

INSTRUMENT CLUSTER - PETROL (As applicable)

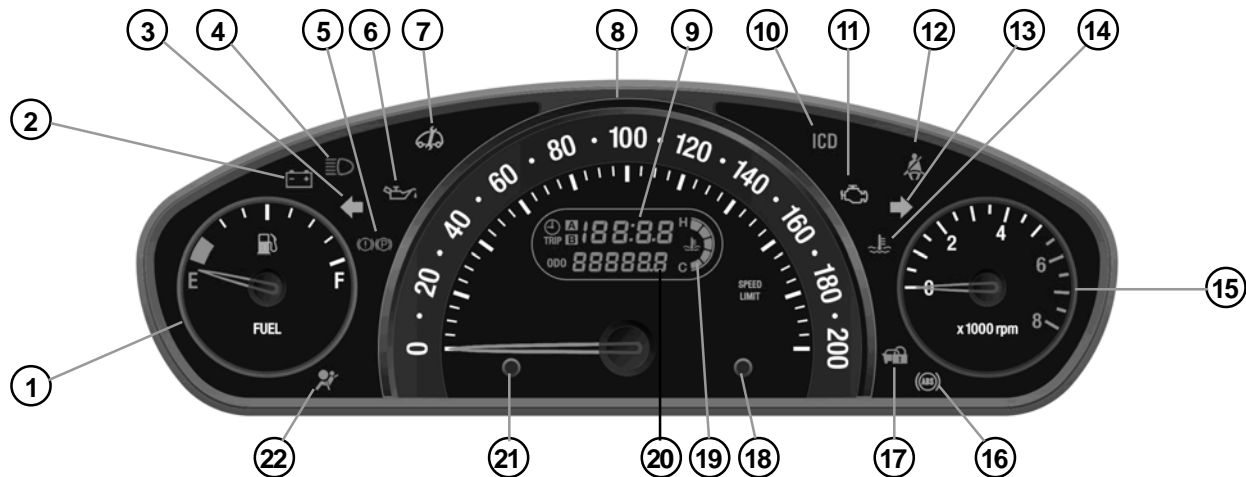

1	Fuel Gauge	9	LCD (Digital Display)	17	Immobiliser Indicator
2	Battery Charging Indicator	10	ICD Indicator (Instrument Cluster Diagnostic)	18	"Mode" knob
3	Turn Signal (Left)	11	Engine Malfunction Indicator	19	Temperature Bar Graph
4	High Beam Indicator	12	Seat Belt Indicator	20	Odometer
5	Parking Brake & Low Brake Fluid Indicator	13	Turn Signal (Right)	21	"Set" knob
6	Low Oil Indicator	14	High Coolant Temp. Indicator	22	Air Bag Indicator (If fitted)
7	Service Indicator	15	RPM Meter		
8	Speedometer	16	ABS Indicator (If fitted)		

INSTRUMENT CLUSTER - PETROL (As applicable)

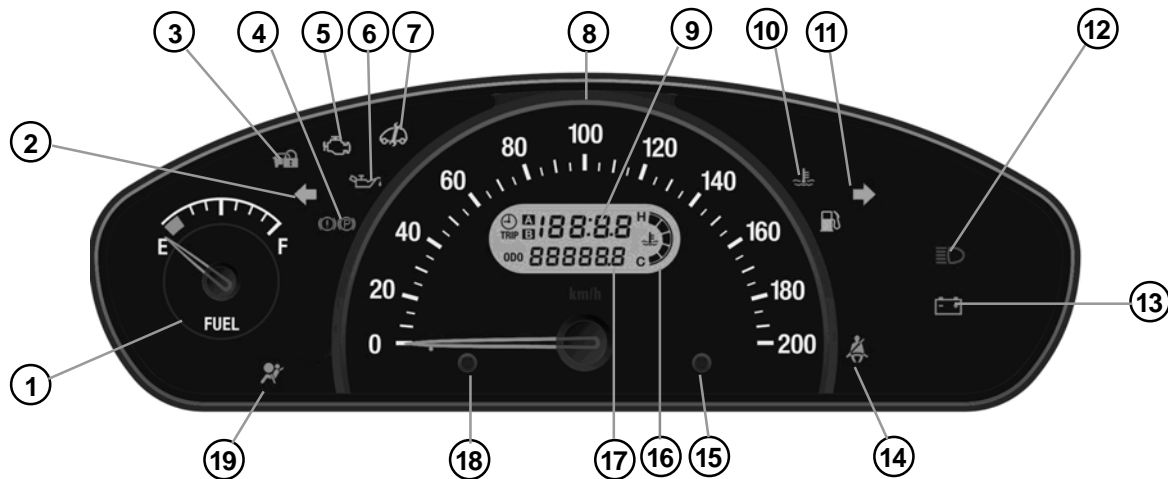

1	Fuel Gauge	8	Speedometer	15	"Mode" knob
2	Turn Signal (Left)	9	LCD	16	Temperature Bar Graph
3	Immobiliser Indicator	10	High Coolant Temp. Indicator	17	Odometer
4	Parking Brake / Low Brake Fluid Indicator	11	Turn Signal (Right)	18	"Set" knob
5	Engine Malfunction Indicator	12	High Beam Indicator	19	Air Bag Indicator
6	Low Oil Indicator	13	Battery Charging Indicator		
7	Service Indicator	14	Seat Belt Indicator		

The Instrument Cluster has the following features :

- Analogue Gauge : Speedometer, Tachometer / RPM Meter & Fuel gauge
- Bar Graph : Temperature (as a part of LCD display)
- LCD Display : Clock, Odometer & Trip meter (A & B)
- Tell tales
- Mode & Set switches

SR. NO.	FEATURES	DESCRIPTION
1	Speedo Meter	Vehicle Speed (In kmph)
2	RPM Meter	Engine Speed (In rpm)
3	Fuel Gauge	Fuel level in tank (Empty to Full)
4	Temperature Bar Graph	Engine temperature (Cold to Hot - 5 Bands)
5	Odometer	Total distance travelled.
6	Trip meter "A & B"	Distance travelled on each trip or between fuel fillings.
7	Clock	24 Hour format Digital clock.
8	Dimmer for cluster & LCD backlighting	4 levels (25%, 50%, 75% & 100%).
9	Over Temp. Warning	External Buzzer audio alarm (if fitted)

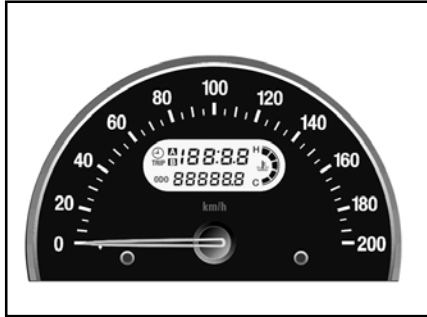
Speedometer:

The speedometer indicates the car speed in km/hr. Driving your car as per the recommended speeds will help you extract optimum fuel economy and enhanced engine life.

RPM meter / Tachometer (if provided) :

This meter, also called RPM meter shows at what speed your car's engine is running per minute. (rpm). If you change gears at appropriate engine rpm and speed, your car will give good fuel economy. Do not increase the

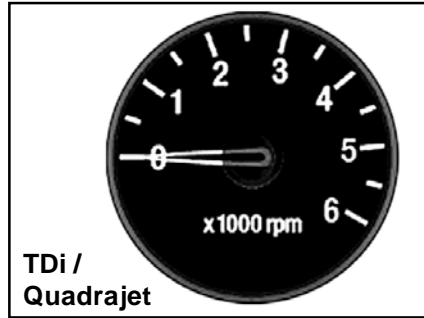
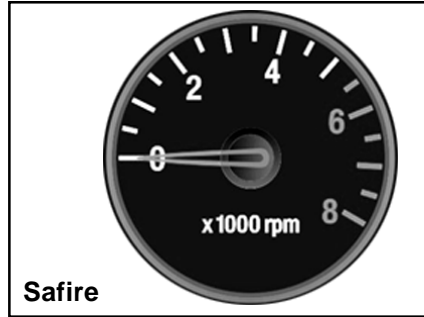
**TDi /
Quadrajt****Safire**

engine rpm unnecessarily, The permitted engine rpm upper limit is the start of coloured zone on the dial.

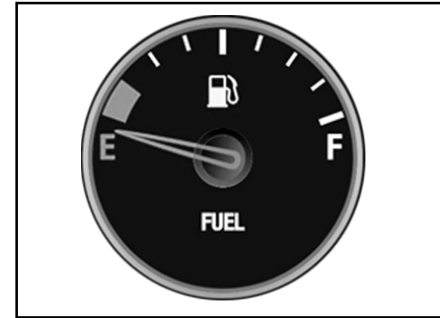
**Fuel Gauge:**

The fuel gauge indicates the approximate fuel level in the tank. Refill the fuel tank before the needle touches the coloured band on the gauge.. At this point, fuel level in tank is low and it is advised to get fuel filled immediately

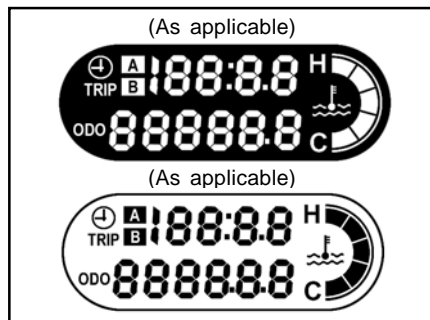

Multifunctional LCD, Digital clock, Odometer, Dimmer and Tripmeter (A and B) :

The instrument cluster's LCD has a two line display. The first line displays a clock in 24 hour format and the second line shows the odometer reading. The first line also displays Tripmeter A, Tripmeter B and intensity level when the Mode switch is pressed. The selection and control of functions are done through "MODES" and "SET" button (knobs) provided on either side of the LCD.

Odometer and Trip meter (on LCD):

The odometer records the total distance the car has been driven. The trip meter can be used to measure the distance traveled on each trip or between fuel fillings. Keep track of the odometer reading and follow the maintenance schedule regularly for meeting service requirements.

Range : 0 to 9999.9 km

Resolution : 0.1 km

Trip meter reading will over flow to "0.0" after it crosses 9999.9 kms.

You can select required function on LCD by using MODE and SET switches available on cluster, as indicated in the table below.

Please note that each switch has to be pressed and released to change the function.

Display selection by “Mode and Set” switches :

(HIGH END)

Sr. No.	Indication on LCD	With “Mode” switch	With “Set” switch
1	Digital Clock	Display changes to Trip A	Enters to clock setting mode (ref. 7.6)
2	Trip meter “A”	Display changes to Trip B	Resets Trip A distance (ref. 7.3)
3	Trip meter “B”	Display changes to Dimmer	Resets Trip B distance (ref. 7.3)
4	Dimmer	Display changes to Clock	Adjusts Dimming level (ref. 7.5)

(LOW END)

Sr. No.	Indication on LCD	With “Mode” switch	With “Set” switch
1	Digital Clock	Display changes to Trip A	Enters to clock setting mode (ref. 7.6)
2	Trip meter “A”	Display changes to Trip B	Resets Trip A distance (ref. 7.3)
3	Trip meter “B”	Display changes to Clock	Resets Trip B distance (ref. 7.3)

LCD FEATURES (VISTA) :**7.1 Multifunction LCD**

(As applicable)

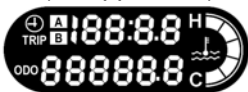
**Colour :** Blue Text with Black back ground.

(As applicable)

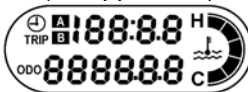
**Colour :** Black Text with Amber back ground.**7.2 Temperature Bar Graph**

Cold to Hot (5 Bars)

(As applicable)

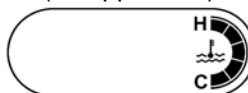

(As applicable)

**7.3 Trip meter (A and B)****Type :** 7 segments, 4 1/2 digits**Range :** 0 to 9999.9**Resolution :** 0.1 km

Trip meter reading shall over flow to "0.0" after it crosses 9999.9 kms.

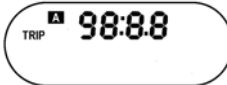
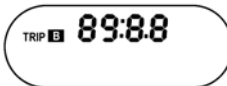
TRIP-A (As applicable)**TRIP-B** (As applicable)**TRIP-A** (As applicable)**TRIP-B** (As applicable)**Trip meter reset :**

Trip meter (A and B) can be reset by pressing the set switch slightly longer when particular Trip-meter is selected.

7.4 Dimmer for Cluster and LCD
(As applicable) :

LCD brightness level can be changed and it is shown by the number of Dashes on the display,

- 1 2 Dashes => 25 %
- 2 4 Dashes => 50 %
- 3 6 Dashes => 75 %
- 4 8 Dashes => 100 %



After selecting the dimming level, the display will show the next information (e.g. Clock) after 20 secs. Press the "Mode" switch earlier to see the next information.

7.5 Odometer :**Type :** 7 segments, 6 digits.**Range :** 0 to 999999**Resolution :** 1 km

The Odometer reading will not over flow to "0.0" when the maximum value is accumulated, the display will freeze to maximum value.

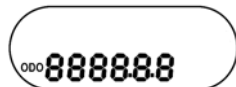
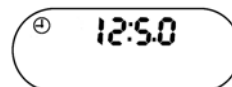
Odometer (As applicable)**Odometer** (As applicable)**7.6 Digital Clock :****Type :** 24 Hour format (7 segments, 4 digits).**Digital Clock** (As applicable)**Digital Clock** (As applicable)

Steps	Actions	Remarks
Press "Set" switch for 3 secs. when display is in clock mode.	"Hour" digits flash	Cluster enters into clock setting mode
Press and Release "Set" switch repeatedly	Display toggles between "Hours & Minutes" digits	Select required digits (Hours or Minutes) with "Set" switch.
Press "Mode" switch while selected digits are flashing	Increments displayed number	Select required value with "Mode" switch
Keep "Mode and Set" switches un-pressed	Display stops flashing	Selected value is for 5 secs.stored and enters into normal clock mode.

INSTRUMENT CLUSTER - DIESEL- VISTA TECH

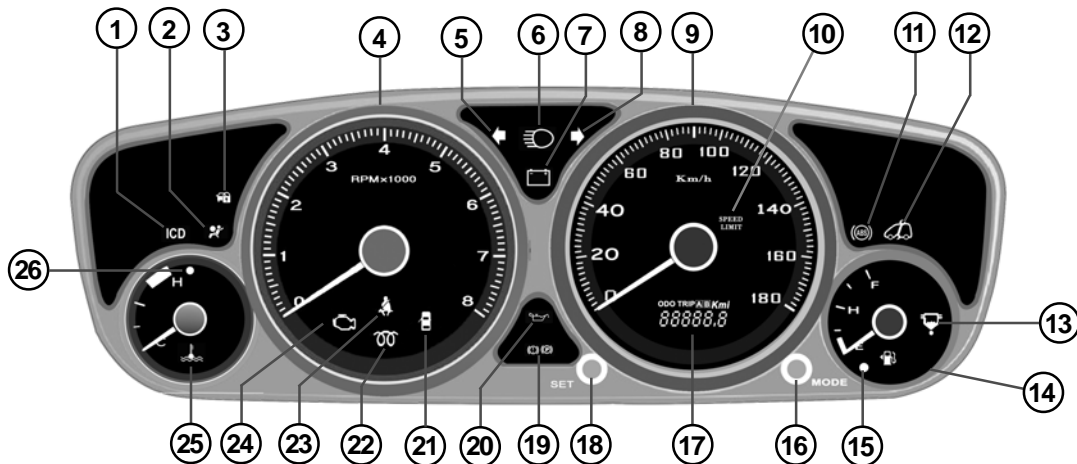

1.	ICD Indicator (Instrument Cluster Diagnostic)	10.	Speed Limit Indicator	19.	Parking Brake & Low Brake Fluid Indicator
2.	Air Bag Indicator	11.	ABS Indicator (if provided)	20.	Low Engine Oil Pressure Indicator
3.	Immobiliser Indicator	12.	Service Lamp	21.	Door Open Indicator
4.	Tachometer	13.	Water In Fuel Indicator	22.	Glow Plug Indicator
5.	Turn Signal (Left)	14.	Fuel Gauge	23.	Seat Belt Indicator
6.	High Beam Indicator	15.	Low Fuel Indicator	24.	Engine Malfunction Indicator (If fitted)
7.	Battery Charging Indicator	16.	"Mode" knob	25.	Temperature Gauge
8.	Turn Signal (Right)	17.	Multi functional LCD (Digital Display)	26.	High Temperature Warning Indicator
9.	Speedometer	18.	"Set" knob		

SPEEDOMETER:

The speedometer indicates the vehicle speed in km/hr. Driving your vehicle as per the recommended speeds will help you get optimum fuel economy and enhanced engine life.

RPM METER / TACHOMETER (if provided):

This meter indicates the engine rpm. Change the gears at appropriate engine rpm and speed to get good fuel economy and driving pleasure. Do not increase the engine rpm unnecessarily.

When engine RPM crosses 5000 RPM (Quadrajets) & 6000 RPM (Safire), the needle colour changes to RED. Avoid over-revving the engine.

FUEL GAUGE:

The fuel gauge indicates the approximate fuel level in the tank.

Refill the fuel tank before the needle touches the coloured band on the gauge. At this point, fuel level in tank is low and it is advised to get fuel filled immediately.

ENGINE COOLANT TEMPERATURE GAUGE :

The engine coolant temperature gauge indicates the approximate coolant temperature. If the coolant temperature reading is very high or if the high coolant temperature indicator comes ON, reduce the car's speed and switch OFF the AC.

Take the car to an authorised service station at the earliest.

NOTE

Overheating of engine can cause severe damage to the engine parts and can lead to seizure of engine parts.

Multifunctional LCD, Odometer, Dimmer and Tripmeter (A and B):
Applicable for VISTA TECH

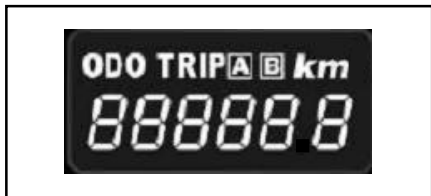

The instrument cluster's LCD has a two line display. The first line displays ODO, TRIP A, B (in Kms). The second line displays odometer reading, TRIP A, B reading as well as brightness intensity levels. The LCD also displays Tripmeter A, Tripmeter B and intensity level when the MODE knob is pressed. The selection and control of functions are done through 'MODE' and 'SET' knobs provided on either side of the gauge. Refer table.

Odometer and Trip meter (on LCD):

The odometer records the total

distance the car has been driven. The trip meter can be used to measure the distance travelled on each trip or between fuel fillings. Keep track of the odometer reading and follow the maintenance schedule regularly for meeting service requirements.

You can select required function on LCD by using MODE and SET knobs available on cluster, as indicated in the table below.

Please note that each knob has to be pressed and released to change the function.

Display selection by "MODE" and "SET" knobs :

Sr. No.	Indication on LCD	With "MODE" knob pressed	With "SET" knob pressed
1	Main Odometer	Display changes to Trip A	-----
2	Trip meter "A" Trip B	Display changes to (Ref. to A on next page)	Resets Trip A distance
3	Trip meter "B"	Display changes to Dimmer, if cluster Illumination is ON, else changes to Main Odometer	Resets Trip B distance (Ref. to B on next page)
4	Dimmer	Display changes to Main Odometer	Adjusts Dimming level (Ref. to C on next page)

LCD FEATURES (VISTA TECH) :**A. Multifunction LCD
(as applicable)**

Colour : White Text with Black background.

B. Trip meter (A and B)

Type: 7 segments, 4 1/2 digits

Range: 0 to 1999.9

Resolution : 0.1 km

Trip meter reading shall over flow to "0.0" after it crosses 1999.9 kms.

TRIP- A (as applicable)**TRIP- B (as applicable)****Trip meter reset**

Trip meter (A and B) can be reset by pressing the "SET" knob slightly longer when particular Trip meter is selected.

C. Dimmer for Cluster, LCD and Instrument panel illumination (as applicable)

You can adjust the LCD brightness that is best suited to you and it is shown by the number of Dashes on the display,

- 1 2 Dashes => 25 %
- 2 4 Dashes => 50 %
- 3 6 Dashes => 75 %
- 4 8 Dashes => 100 %



After selecting the dimming level, the display will show the next information (e.g. Main Odometer) after 20 secs. Press the "MODE" knob earlier to see the next information.

D. Odometer (as applicable)

Type: 7 segments, 6 digits.

Range: 0 to 99999.9

Resolution : 1 km

The Odometer reading will not over flow to "0.0" when the maximum value is accumulated, the display will freeze to maximum value.



DRIVER INFORMATION SYSTEM (as applicable):

The Driver Information System (DIS) is located at centre of the vehicle cockpit and has the following features :

1. Fuel Computer :

- Average Fuel Consumption (For Trip 'A' & 'B'),
- Range (Distance to Empty) and
- Instantaneous Fuel Consumption

2. Digital Clock**3. Outside Ambient Temperature****DIS FUNCTION :**

Sr. No.	Features	Description
1	Fuel Computer	Average Fuel Consumption (AVG) - For Trip 'A' & 'B'
		Range - Distance to Empty (DTE)
		Instantaneous Fuel Consumption (INST)
2	Digital Clock	12 Hour and 24 Hour Format
3	Outside Ambient Temperature	Outside Ambient Temp. display with °C and °F

Quadrajel, Safire**Default Settings (Factory Set)**

Sr. No.	DIS Features	Default Display	
		Functions	Unit
1	Fuel Computer	AVG For Trip -A	km/l
2	Digital Clock	12 Hours	AM
3	Outside Ambient Temperature	OAT	C

NOTICE

Whenever battery terminals are removed, unit returns to factory setting.

Fuel Computer

Fuel Computer information is available on DIS, as can be seen from figure below. Three types of information are available, which can be user selected through "MODE" and "SET" knobs provided.

Refer to "Knob Function".

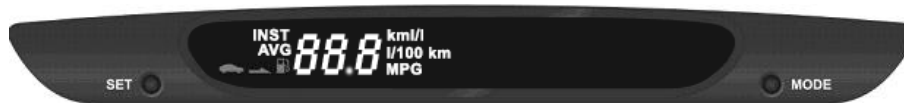

Sr. No.	Function	Text on Display	Distance Unit as km		Distance Unit as Mile
			Option - 1	Option - 2	Option
1	Average Fuel Consumption For Trip 'A'	AVG	km/l	l/100km	MPG
	Average Fuel Consumption For Trip 'B'	AVG	km/l	l/100km	MPG
2	Distance to Empty (Range)		km	-	Miles
3	Instantaneous Fuel Consumption	INST	km/l	l/100km	MPG

Instantaneous Fuel Consumption (INST):

Updates display "Instantaneous Fuel Consumption" at regular time intervals.

Instantaneous Fuel Consumption display is available in "km / l" or "l / 100 km" which can be user selected through "MODE" and "SET" knobs provided.

Refer to "Knob Function".

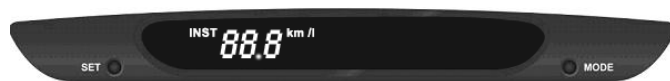
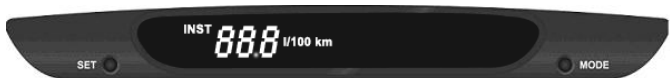
Instantaneous Fuel Consumption display in km / l**Instantaneous Fuel Consumption display in l/100km**

DIS displays "Instantaneous Fuel Consumption data" only when the following conditions are met -

DIS displays "- - km/l" when ign on & engine is off

DIS displays "0.0 km/l" when ign on & engine is on

DIS displays "Instantaneous Fuel consumption data "only when the below conditions are met:

A. Vehicle speed should be more than 10kmph.

B. Vehicle travelled distance should be more than 20meters.

Display Range: 0.0 to 99.9 (km/l or l/100km)

Resolution: 0.1 (km/l or l/100km)

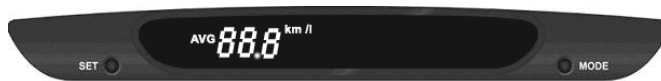
Average Fuel Consumption (AVG):**Average Fuel Consumption display in l/100 km**

The display will show the value of average fuel consumption since the last reset.

Average Fuel Consumption display is available in "km/l" or "l/100km" which can be selected by user by using "Mode & Set" switches.

Average Fuel consumption will get updated for every 10secs interval.

The Average Fuel Consumption data can be reset manually through “Set” switch provided in the cluster

After resetting the Average fuel consumption the display will indicate 0.0 and then will show a new average fuel consumption value after driving for some distance.

If previous data exist DIS will update the display once engine speed is >0rpm.

Display Range: 0.0 to 99.9 (km/l or l/100km)

Resolution: 0.1 (km/l or l/100km)

Refer to “Switch Function”.

Distance to Empty (DTE):



This feature shows the estimated distance user can drive with the remaining fuel in the tank. The value is calculated based on fuel economy user have achieved over few hundred kilometres or miles.

DIS displays actual DTE at every Ignition on cycle.

DTE is calculating using a running average fuel economy which is based on recent driving history for few hundred

km. This running average fuel economy value is not same as average fuel economy display.

This value tends to vary with change in drive pattern, vehicle speed, Traffic condition and different road conditions.

Display Range: 0 to 999 km

Resolution: 1 km

NOTICE

To get actual DTE value after fuel filling customer has do the ignition OFF to ON

Whenever battery terminals are removed, units return to default factory setting. (All data's will get reset). Again it shows the data on display after some distance travelled and data's will get stabilized after some few km depending upon the driving pattern.

Digital Clock

This feature has 24 hour or 12 hour display format, AM/PM indication is applicable for 12 hour clock function only, as can be seen from the adjoining figure, which can be user selected through "MODE" & "SET" knobs provided.

Digital Clock Display



Digital Clock AM Setting



Digital Clock PM Setting



DIGITAL CLOCK

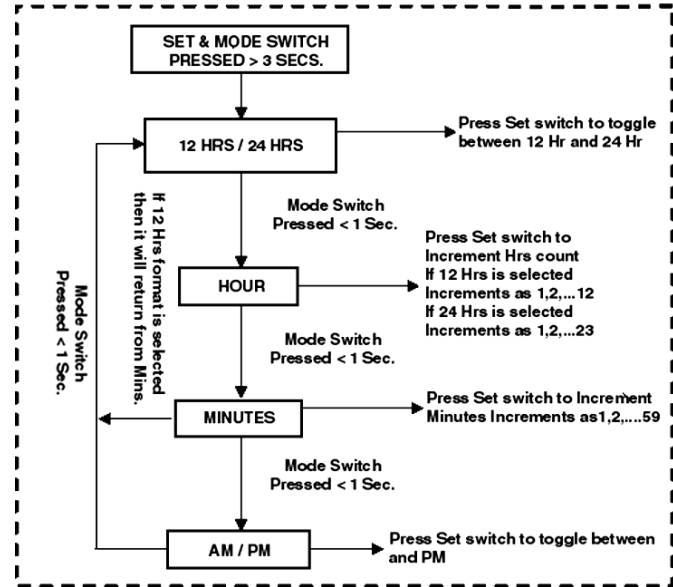

Outside Ambient Temperature Display:

Outside Ambient Temperature can be seen with °C or °F unit, which can be selected by user by using “MODE” and “SET” knobs.

Resolution: 1°C or °F

NOTE

The displayed “Outside Ambient Temperature” value may not be accurate when Vehicle speed is ≤ 30 km/h due to engine heat, exhaust from surrounding vehicles and heat reflection from road. The IC delays the OAT display update until it reaches the correct outside temperature. This may take several minutes.

Outside Ambient Temperature (Display in °C)**Outside Ambient Temperature (Display in °F)**

SWITCH FUNCTIONS :

User can select required function, using switches available on DIS, as indicated below. Please note that each switch has to be released & pressed to change the function.

DISPLAY SELECTION BY “MODE & SET” SWITCHES :

Sr. No.	Indication On instrument cluster LCD	Indication on DIS LCD	With “Mode” switch pressed on DIS	With “Set” switch pressed on cluster
1	Odo meter	Average Fuel Consumption A	Changes display to Range (Distance to Empty)	-
2	Trip meter A	Average Fuel Consumption A	Changes display to Range (Distance to Empty)	Resets Average Fuel Consumption data for Trip A
3	Trip meter B	Average Fuel Consumption B	Changes display to Range (Distance to Empty)	Resets Average Fuel Consumption data for Trip B
4	-	Range Distance to Empty	Changes display to Instantaneous Fuel Consumption	-
5	-	Instantaneous Fuel Consumption	Changes display to Average fuel consumption for trip A or Trip B based on Instrument cluster display.	

A. Instrument Cluster Display on Odo OR Trip-A :

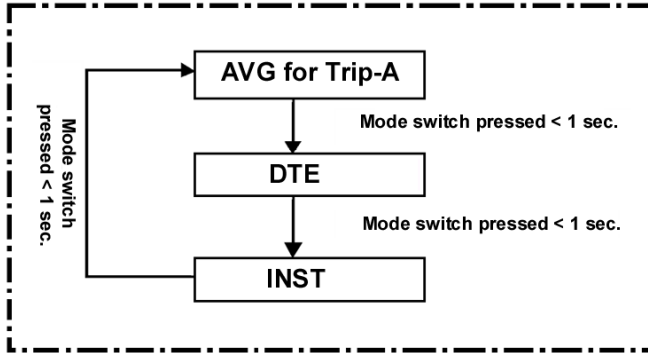

B. Instrument Cluster Display on Trip-B :

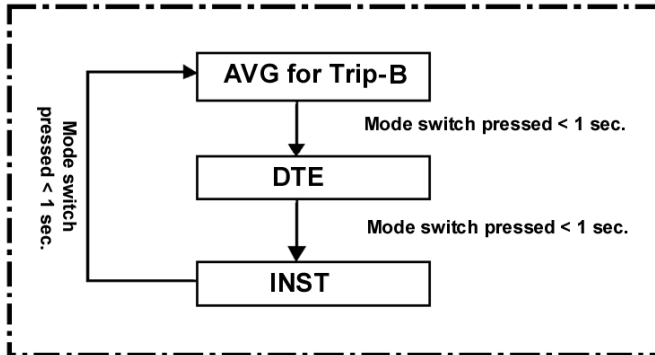







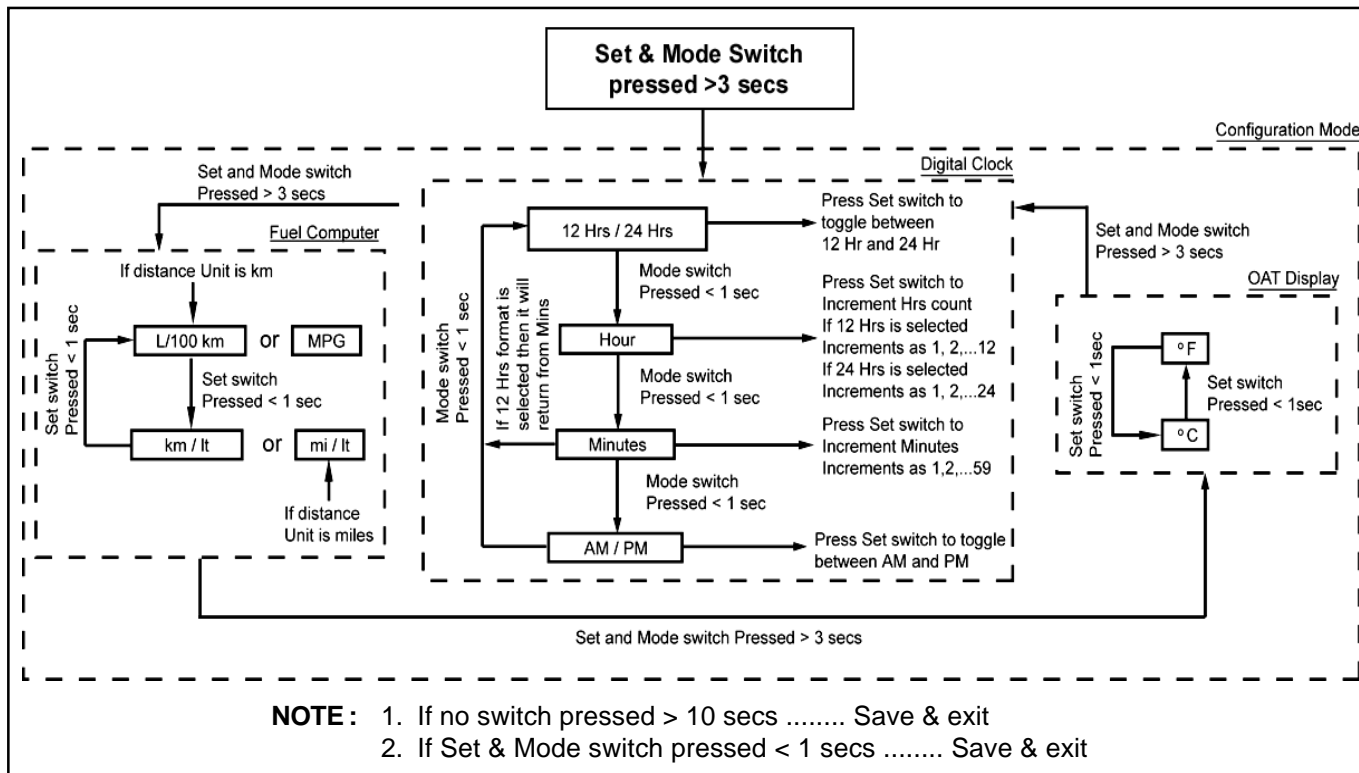



NOTICE



Use of 'MODE & SET' switches - Recognized as single key press, until it is released.





Flow chart for using “MODE” and “SET” knobs

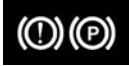

TELL TALES	COLOR	INDICATOR	REMARKS
Malfunction Indication Lamp	Amber		<ol style="list-style-type: none"> 1. Illuminates momentarily when ignition is switched 'ON' once engine is cranked, it goes OFF. 2. It remains 'ON' if there is malfunction in Engine system. Engine performance deteriorates while it is running. Avoid high speeds and Contact TATA MOTORS Authorized Service Centre for rectification.
Check Engine	Amber		<ol style="list-style-type: none"> 1. Illuminates momentarily when ignition is switched 'ON' once engine is cranked, it goes OFF. 2. Illuminates continuously if a fault arises in Engine Management System. Contact TATA MOTORS Authorized Service Centre.
Immobilizer not	Red		<ol style="list-style-type: none"> 1. Illuminates when the system disables engine start if the original key is not used. 2. Lamp blinks: vehicle is in immobilized condition when key is inserted. 3. Lamp ON: Problem with key/system. Contact TATA MOTORS Authorized Service Centre.
Water in fuel	Amber		<ol style="list-style-type: none"> 1. Illuminates momentarily when ignition is switched 'ON' once engine is cranked, it goes OFF. 2. Illuminates continuously if excess water is accumulated in the fuel filter. Contact TATA MOTORS Authorized Service Centre to drain the water immediately to avoid serious damage to the fuel injection system.

TELL TALES	COLOR	INDICATOR	REMARKS
Glow Plug	Amber		Illuminates momentarily when ignition is switched 'ON' to indicate that the glow plugs are active. It will continuously illuminate when engine is getting preheated. Start the engine only after the indicator goes off.
Turn Signal	Green		Indicates direction indicated by the turn signal. Blinks along with buzzer while operating left/right turn indicator only when ignition is switched 'ON'.
High Beam	Blue		Illuminates when the high beam headlamps are switched ON or flashed.
Front Fog	Green		Illuminates when front fog lamps are switched 'ON'.
Rear Fog	Amber		Illuminates when rear fog lamps are switched 'ON'.
Low Oil Pressure	Red		1. Illuminates momentarily when ignition is switched 'ON'. 2. Illuminates continuously if engine oil level is less than a pre-defined minimum level. Stop the vehicle as soon as safety permits and switch off the engine. Check engine oil level and top-up if required. Contact qualified TATA MOTORS assistance before starting the engine.

TELL TALES	COLOR	INDICATOR	REMARKS
Battery charging/ engine warning	Red		Illuminates momentarily when ignition is switched 'ON' once is cranked, it goes OFF. It will continuously illuminate when there is malfunction of charging system. Contact TATA MOTORS Authorized Service Centre
Park Brake cum Low Brake Fluid	Red		<ol style="list-style-type: none"> 1. Illuminates momentarily when ignition is switched 'ON' once engine is cranked, it goes OFF. 2. When brake fluid level is low. 3. When park brake is applied and goes OFF when it is released. 4. When ABS/EBD system has a fault.
Seat belt warning	Red		Indicates that seat belt is not fastened when ignition is 'ON'. It will flash along with buzzer for 6 secs when ignition is switched 'ON' and seat belt is not fastened. It will continue to flash until the car exceeds a speed of 20 kmph. After that, it will remain continuously ON along with a buzzer that will be audible for approx. for 100 secs. Then buzzer goes OFF but the indicator continues to remain ON until seat belts are fastened.
Airbag status	Red		Illuminates momentarily when ignition is switched 'ON' once engine is cranked, it goes OFF. It will continuously illuminate when there is malfunction of airbag (SRS) system. Contact TATA MOTORS Authorized Service Centre urgently.

TELL TALES	COLOR	INDICATOR	REMARKS
High Coolant Temperature	Red		Indicates that engine coolant temperature is very high. Illuminates when engine coolant temperature is very high and continuously flashes along with buzzer if engine coolant temp. is extremely high. Switch off the engine and allow to cool. Top-up coolant if coolant level is low. Contact TATA MOTORS Authorized Service Centre urgently.
Low Fuel	Amber		Illuminates momentarily when ignition is switched 'ON' once engine is cranked, it goes OFF. Illuminates continuously if fuel level is less than a pre-defined minimum level. Refill the fuel tank as soon as possible. IMPORTANT: The warning light flashes to indicate a fault in fuel system. Contact TATA MOTORS Authorized Service Centre urgently. NOTE: Driving with low fuel level condition can cause the engine to misfire and damage the catalytic converter (if equipped).
Door Open	Red		Illuminates when doors are open or when they are not completely closed. If the driver's side door is not closed properly, a beep will sound for a few secs. when the ignition is ON.
ABS	Amber		Illuminates momentarily when ignition is switched 'ON' once engine is cranked, it goes OFF. Illuminates continuously if there is any malfunction in ABS. Normal braking system will be operational without assistance of ABS. Contact TATA MOTORS Authorized Service Centre urgently.

ON BOARD DIAGNOSTIC (OBD) SYSTEM:

On board Diagnostics or OBD is an automotive term referring to a vehicle's self Diagnostic and reporting capability. The OBD system allows continuous diagnosis of the components of the vehicle correlated with emissions. This system warns the driver, by turning "ON" the Malfunction Indication lamp (MIL) on the instrument cluster, when a fault causes emission levels to increase.

The OBD system also has a diagnostic connector that can be interfaced with appropriate diagnostic tools, which makes it possible to read the fault codes stored in the Electronic Control Unit, together with a series of specific parameters for Engine operation and Diagnosis. This check can also be carried out by the traffic police.

To access the diagnostic connector (Fig.1), open the fuse box cover (Fig.2)

which is located on the cockpit at RHS of the steering wheel.

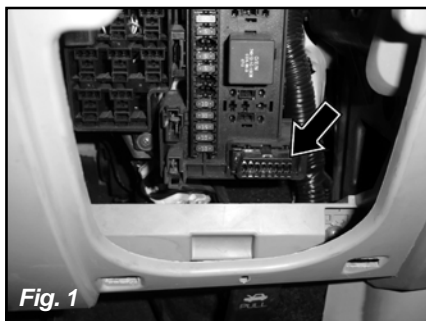

NOTE

In case the fault occurs and MIL comes ON, contact nearest **TATA MOTORS** authorized service center. After eliminating the inconvenience, to check the system completely, **TATA MOTORS** authorized service centers are obliged to run a bench test and if necessary, road tests which may also call for a long journey. The functioning of MIL lamp may also be checked by the traffic police using specific devices.

A) RIGHT HAND STALK**1) Head lamp leveling rotary switch:**

Inner rotary switch on right hand stalk is provided for head lamp leveling. Setting is done by rotating the knob to select one of the 3 level positions depending upon the loading of the car. Head lamp leveling can be done with head lamp in Low Beam and in ON position.

Setting should be done only when car is stationary

NOTICE

Since the leveling switch takes care of headlamp focus pattern under varying load conditions, it is advisable to select the correct position before starting a trip (depending on load)

2) Light stalk:

Outer rotary switch on right hand stalk is provided for selecting Position or Head lamp High/Low beam. It operates with Ignition switch in "IGN" position.

a) Head / Position lamp OFF.

Head lamp, position (Parking) lamp and tail lamp will be OFF in this position.

b) Position lamp in ON.

Position (Parking) lamp and tail lamp will be ON in this position.

c) Head / Position lamp ON.

Head lamp, position (Parking) lamp and tail lamp will be ON in this position. Toggling the lever (Stalk)

COMBI SWITCH (VISTA)

in upward direction changes the Low beam to High beam and vice versa. For High beam flash, pull the lever halfway. For keeping in High beam position pull up the lever further up to latch.

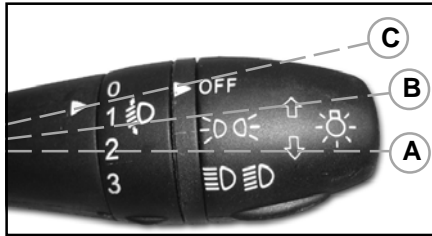
3) Light stalk (Turn Indicator):

Push the stalk upwards for changing lane or turning to Left and downwards for changing lane or turning to Right according to requirement. It has three positions.

A) Right turn indicator

B) Neutral position

C) Left Turn (Self cancellation / Manual return type)

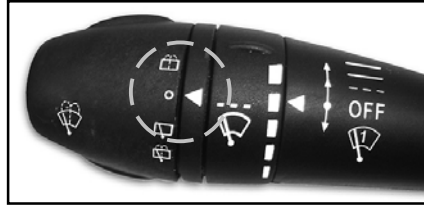
LEFT HAND STALK :**1) Rear windshield - Wipe & Wash rotary switch:**

Outer rotary switch on left hand stalk is provided for rear windshield wiper and wash. The top (1st) position denotes wash, which is spring loaded. After releasing, the switch returns to the OFF position. First position below OFF position is for Wipe and second position is for Wash + Wipe which is spring loaded.

2) Intermittent front wiper delay:

Inner rotary switch on left hand stalk is provided for intermittent front wiper delay. The switch has 5 delay timers for intermittent function.

**3) Front windshield-Wipe and Wash rotary switch:**

Pull the stalk upwards to operate intermittent wipe (- - -), Slow wipe (—) or fast wipe (—). Pull the stalk down for wipe and wash. Pull towards driver for Flick Wipe (spring return).

After wash function is activated, there will be three wipes of wiper. There will be one more wipe after 5 seconds to clean traces of water on wind screen.

LEFT HAND STALK: (If applicable)

Front windshield wash and wipe:

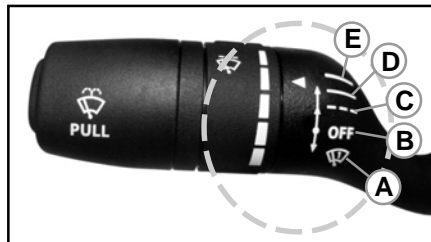

- A. Light Rain / Mist:** Push the switch down to operate front windshield wiper in case of light rain or mist.
- B. OFF Position**
- C. Intermittent wipe :** To operate intermittent wipe, lift the lever to position 'C'.

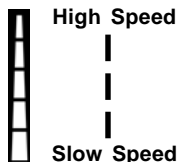

By rotating rotary switch, you can select desired wiper speed.

- D. Slow wipe :** To select 'SLOW' continuous wipe, lift the lever to position 'D'.
- E. Fast wipe :** To select 'FAST' continuous wipe, lift the lever to position 'D'

Rear wiper continuous 'ON':



Turn the rotary knob and align (5) position with arrow mark to operate rear intermittent wiper. Rear wiper will start wiping continuously.

To spray the washer fluid on the windshield:

1. When you pull the lever little longer, washer fluid will be sprayed on the windshield.

2. The windshield wipers operate for three cycles after the lever is released and one more cycle after five seconds.
3. When you crank the car's engine, the supply to washer motor is briefly cut off.

WARNING

If you operate wash and wipe function for more than 30 seconds the controller cuts off the supply to washer motors to avoid overheating.

RIGHT HAND STALK : (If applicable)

Turn signal



A. Right turn signal : Right indicator lamps and instrument cluster tell tale will come 'ON' if ignition is 'ON' and

indicator stalk is moved to downward. For changing lanes, lightly flip the stalk downwards.

B. Left turn signal :

Left indicator lamps and instrument cluster tell tale will come 'ON' if ignition is 'ON' and indicator stalk is moved to upward. For changing lanes, lightly flip the stalk upwards.

Depending on the number of occupants in the vehicle and the load it is carrying, the headlight axis may be higher than desired. If the vehicle is traveling on a hilly road, the headlights may directly hit the rearview mirror of the vehicle ahead or the windshield of the oncoming vehicle. The light axis can be lowered with the operation of the switch.

Head lamp levelling setting :

Head lamp levelling setting is done by rotating the knob to select one of the 3 levels marked on the knob depending upon the loading of the vehicle.

When traveling without a heavy load or on a flat road, select position 0.

Headlight beam:



A. OFF Potion:



B. Parking Lamp :

In this position, only Parking lamps are switched 'ON'.

C. High & Low Beam:

- To select the high beam function, push the lever forward. The high beam lights come on and the light illuminates.
- Pull the lever back to select the low beam.
- Pulling and releasing the lever flashes the headlight high beams on and off.

Lane change signal:

To signal a lane change, move the lever up or down to the point where the indicator light begins to flash, but the lever does not latch. The turn signal will flash three times automatically.

FASCIA SWITCHES :**Hazard Warning Switch:**

Hazard warning is used in case of breakdown especially during night and the car has to be parked at the side of the road. This switch can also be used when the car is operated in adverse conditions.

This switch can be operated without Ignition ON. Press hazard warning switch to switch ON all outside turn signal lights and indicators on cluster will flash simultaneously to warn the other road users about hazardous condition of the car. Press the switch again to switch OFF the hazard function.

⚠ CAUTION

Ensure that all turn signal indicators are working properly. Replace bulb if found fused.

**Front Fog Lamps :
(Unlatched switch)**

Fog lamps are provided on front bumper to improve visibility in foggy weather or during heavy rains. The front fog lamps can be switched ON with ignition ON and parking lamp ON and can remain on till the parking lamp is switched OFF.

**Rear Fog Lamps :
(Unlatched switch)**

Fog lamps are also provided on tail lamp cluster to improve visibility and warning in foggy weather or during heavy rains. The rear fog lamps can be switched on with parking lamp and front fog lamps ON and can remain ON till the parking lamp is switched OFF.

NOTICE

Use only during foggy conditions or heavy rains if required.

MUSIC SYSTEM (if fitted):

Music system is provided on the facia and the speakers are fitted on doors and tweeters on dashboard.



Music System

For operation and more information of music system please refer manufacturer's manual.

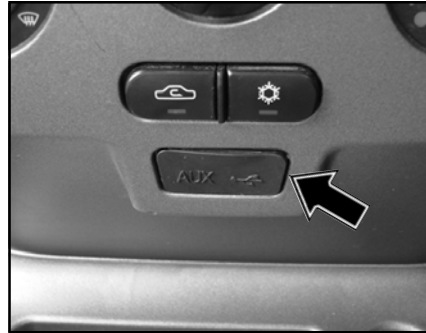
USB / AUX PORT:

USB and **AUX** Ports are provided just below the HVAC controls on the centre console.

Functions :

USB port: You can attach external memory devices like memory sticks / Pen Drives, I-Pods for playing music tracks stored in these devices through the car's music system.

AUX port: The AUX port can be used to attach devices like ear / head phones, extra speakers, etc.

TOUCH SCREEN MUSIC AND NAVIGATION SYSTEM : (If fitted)



A touch screen music system and navigation system is provided on the centre console above FATC panel. To operate this system, please refer operator's handbook, which is provided along with the Owner's Manual.

NOTICE

Do not cover navigation sensor, this may lead to improper functioning of navigation system.

USB/AUX port:

USB and AUX Ports are provided on the Music System on the centre console.



Functions :

USB port : You can attach external memory devices like memory sticks / Pen Drives, I-Pods for playing music tracks stored in these devices through the car's music system. **AUX port :** The AUX port is provided to connect Audio input devices for playing music tracks

stored in the devices through car's speakers.

NOTICE

The video input can also be connected to AUX port (For specific variants only) for playing video files. The video files can be played only when the vehicle is stationary (Hand brake applied)

Antenna:

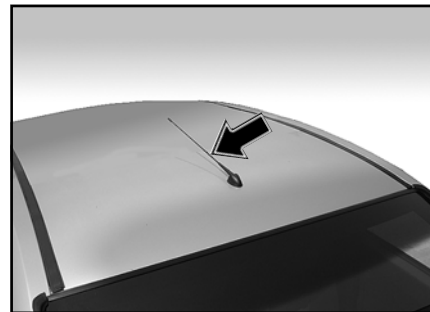

Antenna

Antenna is located on the roof, above the front windshield glass.



Speaker Location on doors

STEERING WHEEL SWITCHES (RHS) : (As applicable)

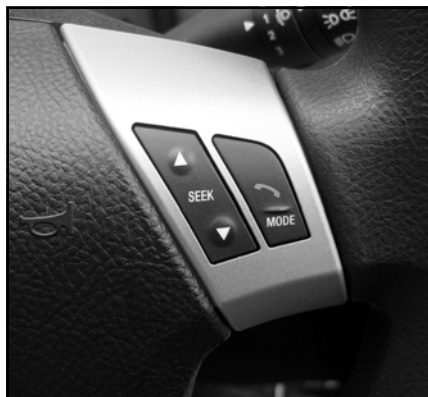

SEEK – To change radio channels or to select a song from a CD.

MODE – To pick up an in-coming phone call as well as to change the audio source (USB, AM, FM, CD).

STEERING WHEEL SWITCHES (LHS) : (As applicable)



VOL (Volume): To increase / decrease volume of music system / radio.

MUTE: To reject or hang up a phone call. It is also used to silent the volume of music system / radio.

NOTICE

For more information, please refer to the Music System Manual provided.

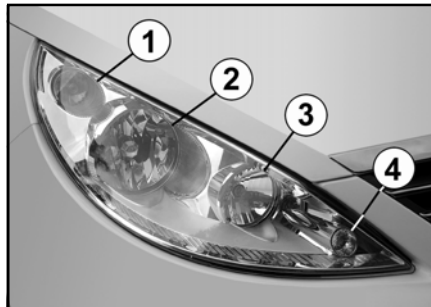
HEAD LAMP:

1. Turn Indicator
2. Head Lamp (High Beam)
3. Head Lamp (Low Beam)
4. Parking Lamp

Head lamps are clear lens type having multi focal reflector and are provided with H1 and H7 halogen lamp for providing straight ahead illumination of the road for the long distance or dip beam which illuminates the road immediately ahead for short distance visibility. It also contains side indicator lamp and a parking lamp.

TAIL LAMP:

The tail lamp assembly incorporates the following :

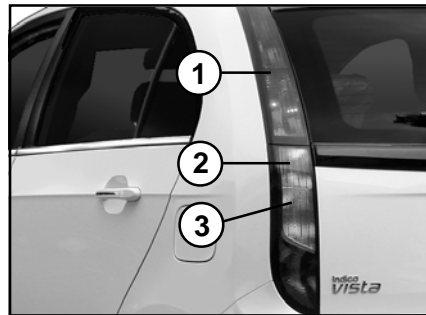

- 1 Brake / Parking Lamp
- 2 Direction Indicator
- 3 Reverse Lamp

SIDE REPEATER LAMP:

FOG LAMP (if fitted):

Front and rear fog lamps are provided for your convenience and they can be operated via the Facia switches that are located above the HVAC controls.

**Front Fog Lamp****Rear Fog Lamp****HIGH MOUNTED STOP LAMP :**

High mounted stop lamp is provided on the tail gate, and it glows whenever the brakes are applied.

REGISTRATION PLATE LAMPS :

Two concealed lamps are provided for illumination of the rear registration number plate.

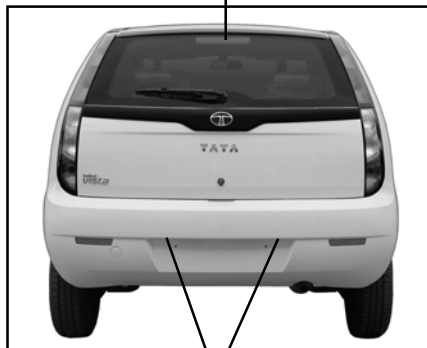
High Mounted Stop Lamp**Registration Plate Lamps**

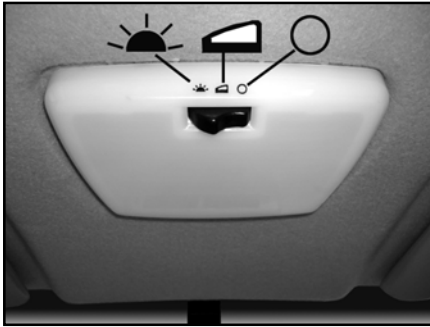
ROOF LAMP :**Front interior light with reading lamps :**

Interior roof lighting and reading lamps with inbuilt switches are provided on the roof near the rear view mirror.

The central rectangular switch has three positions:

ON - The lamp will come 'ON' as long as switch is in this position.

DOOR - In this position the lamp comes on with dimming when either

of the doors are opened. When the door is closed, the lamp will not go 'OFF' immediately, but remain 'ON' for 5-8 sec and goes OFF with dimming. This helps settling in the seat and inserting the key in the ignition switch. When the key is turned to the 'IGN' position, the lamp goes 'OFF' immediately.

OFF - In this position the lamp will not come 'ON' at all. Two rectangular shaped push type 'ON / OFF' switches are provided separately for the right and left reading lamps.

FRONT STOWAGE COMPARTMENT**A) GLOVE BOX**

The glove box is built into the dashboard, located over the front-seat passenger's footwell. It can be locked with the ignition key.

**1. Glove box Lever 2. Glove Box Flap**

To open Pull Lever (1) towards you and open the glove box flap (2) .

To close push the flap (2) back upwards until it engages.

B) UTILITY POCKET/BOX

Front utility pocket / box



Rear utility pocket / box

Utility Pockets are provided on all doors and it can be used to keep magazines/books etc.

C) CUP HOLDER

Front seat occupants are provided with two cup holders in the centre console situated ahead of the gear shift lever.



Cup holder

NOTE

The cup holders should be used for containers of the right size and which have lids. Avoid transporting of hot beverage as this would increase the risk of injury in the event of an accident.

D) POWER SOCKET**Power Socket for front passengers**

Power Socket is provided on the centre console ahead of the gear shift lever. Power socket can be used to tab 12V supply for operating external gadgets.

E) UTILITY TRAY (Co-driver Seat) :**Utility Tray**

A Sliding tray is provided below co-driver's seat. Important papers/documents can be kept here.

Always ensure that this tray is properly closed after use.

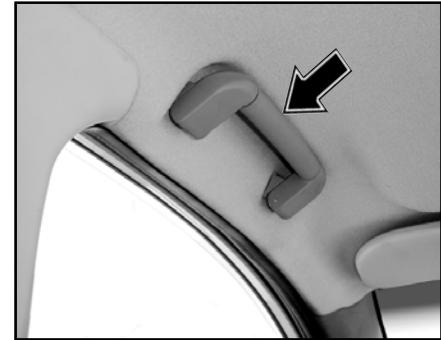
F) ROOF GRAB HANDLE**Roof Grab Handle**

These are provided on all seats except driver's seat. This helps in comfortable positioning of passengers during a journey.

G) LUGGAGE SPACE

Ample space is provided in the boot of your car. You can further increase the luggage space by folding the rear seat.

AIR FLOW PATTERN (VISTA)



AIR FLOW PATTERN (VISTA TECH)

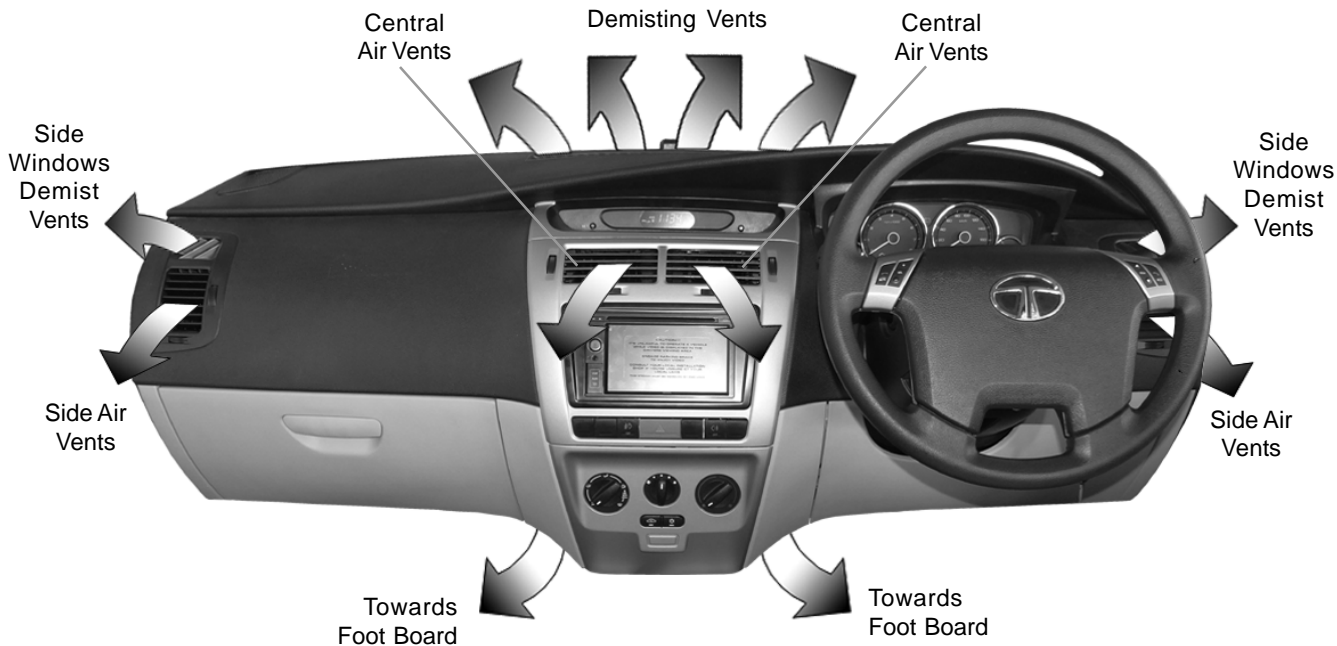

HVAC Controls :

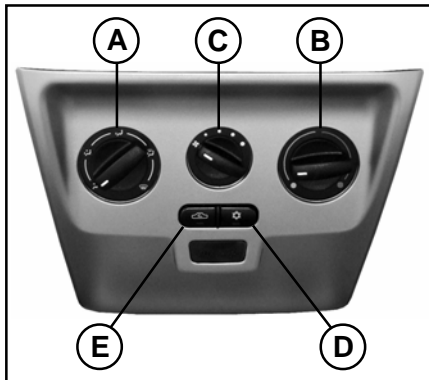

A	Air Direction Control Knob
B	Temperature Control Knob
C	Blower Speed Regulation Knob
D	A.C. ON/OFF Switch
E	Air Recirculation / Fresh Air Switch

(A) Air Direction Control Knob :

The air flow can be changed by turning the air direction control knob (A) to the desired direction.



VISTA



VISTA TECH EDITION

	Towards face
	Towards face and feet
	Towards feet
	Towards feet and windshield (Recommended for clearing mist on windshield)
	Air demist/defrost windshield (Recommended for clearing heavy fog or snow)

(B) Temperature-Control Knob :

The air temperature in the car can be controlled by operating the temperature control knob (B) on the control panel. The temperature can be increased by rotating the knob towards the red segment and decreased by rotating it towards the blue segment.

(C) Blower Speed Regulation Knob:

The HVAC system has a four speed blower. The blower speeds can be regulated by operating the blower knob (C) at the centre of the control panel.

(D) A.C. ON/OFF Switch :

The A.C. can be switched 'ON' by pressing the switch (D) on the A.C. control panel provided the blower is 'ON' and the engine is running. The indicator lamp will show that the A.C. is 'ON'.

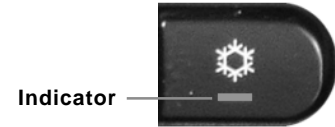
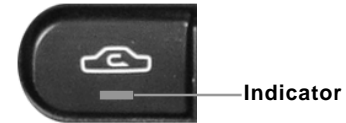
**E. Recirculation / Fresh Air Switch:**

- If HVAC is to be put into air recirculation mode, press switch 'E'. The indicator lamp will show air in recirculation.
- To put car in Fresh air mode release switch 'E'. Indicator lamp will be 'OFF'.

- In recirculation mode, air inside the car is circulated again and again. In Fresh air mode, air is taken from atmosphere and circulated in the car.

Recirculation mode can be used

- While driving in dusty condition
- To avoid traffic pollution
- To get quick cooling/heating as required.

Whenever discomfort is felt switch air circulation mode to fresh.

- The A.C. can be switched 'ON' only if the blower is 'ON' and engine is running. When A.C. is switched 'ON' engine idling RPM increases marginally, to adjust to the A.C. compressor load. When desired temperature is achieved A.C. trips 'OFF' automatically.
- The A.C. compressor gets switched 'OFF' automatically when engine gets overheated. The A.C. is automatically switched 'ON' when the engine gets cooled.

NOTICE

Before start of AC after long time, run the blower for 2 minutes.

NOTICE

Fresh air is taken from the grill opening provided at base of windshield glass outside the car. Keep these openings clear and free from fallen leaves etc.

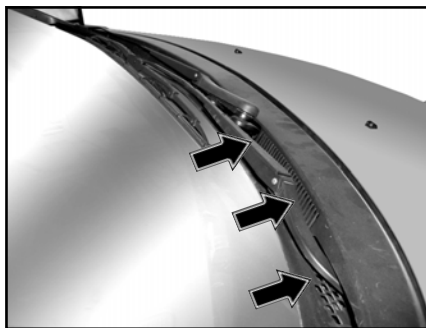

Operating the AC after a gap of more than a month of non use :

Start engine & let it warm up for at least 2 min. for idling speed to drop below 1000 rpm. Switch ON A.C. system with following settings :





- a) Blower switch : ON
- b) Blower speed : High
- c) Engine speed : Below 1000 rpm
- d) A.C. switch : ON

A.C. should be operated for at least 5 minutes before switching it off.

Following the above procedure once a month ensures proper lubrication of compressor parts. Avoid switching ON the A.C. at high engine speed as this may damage A.C. compressor.

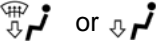
Get your A.C. system serviced at regular intervals ensures its optimum performance and prolong its life.

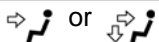
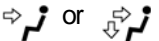
RECOMMENDED BASIC SETTINGS OF THE CONTROL ELEMENTS OF THE AIR CONDITIONING SYSTEM FOR THE RESPECTIVE OPERATING MODES (HVAC) :

FUNCTIONS	CONTROL KNOB POSITION			BUTTON POSITION	
	A. Air Flow Direction	B. Blower Speed	C. Air Temperature	D. Air Recirculation	E. AC ON / OFF
Normal heating		2 or 3	Desired temp.	Fresh air mode.	Switched OFF
Quick heating		Briefly 4, then 2 or 3	To the right up to the stop	Briefly switch ON to Fresh air mode then Recirculation mode	Switched OFF
Normal Cooling		1,2 or 3	Desired temperature	Recirculation mode	Switched ON
Quick Cooling		4	To the left up to the stop	Recirculation mode	Switched ON
Demisting		2 or 3	Desired temperature	Fresh air mode	Switched ON (Optional)
Defrosting		4	Desired temperature	Fresh air mode	Switched ON (Optional)

WARNING

- Never leave children or adults who would normally require the support of others alone in the vehicle.

On hot, sunny days, temperatures in a closed vehicle could quickly become high enough to cause severe or possibly fatal injuries to occupants.

- Do not use the recirculation mode for longer periods as “stale” air may result in fatigue in the driver and occupants, divert your attention and also cause the windows to mist up. Switch to “Fresh” air mode as soon as the windows begin misting up.
- Do not adjust the heating and air conditioning controls while driving so that full attention may be given to vehicle operation.

NOTE

- Condensation forms inside the air conditioning unit when the air conditioner is running, and is safely discharged underneath your vehicle. Traces of water on the ground are therefore normal.
- After parking in the sun, drive for 2 or 3 minutes with the windows open to vent hot air from the passenger compartment. Then, close the windows. This allows the air conditioner to cool the interior more quickly.
- The air conditioning system should be operated for approximately 10 minutes at least once a month. This helps prevent damage to the system due to lack of lubrication

PRE-DRIVING CHECKS:

CHECK	ADJUST	ENSURE
1. Tyre pressure and condition of tyres.	1. Adjust your seat position.	1. Bonnet is properly closed and locked.
2. Coolant level.	2. Check adjustment of all rear view mirrors.	2. All doors are properly closed and locked.
3. Engine oil level.	3. Check and adjust steering height.	3. Check that the items you may be carrying inside with you are stored properly or fastened securely
4. Brake fluid level.		4. Seat belts are fastened.
5. Water in windshield washer reservoir.		5. All mirrors, windows and outside lights are clean and viewable.
6. Battery electrolyte level.		6. All switches and lamps are working.
7. Ensure sufficient Fuel.		7. All the gauges and indicators in the instrument cluster are working.
		8. Gear shift lever is in neutral position.
		9. Park brake is released.

SAFETY CHECKS**Windshield/wiper/windshield washer**

Always keep windshield glass clean to avoid any distortion in visibility. Ensure proper working of wipers and condition of wiper blade. Ensure that windshield washer reservoir is full. Do not operate wiper alone when the windshield glass is dry, this would damage the windshield.

Headlights

Keep headlight lenses clean. Check for operation of headlamps in both high/low beam condition. Check for correct focusing of headlamps. Use only recommended type of bulbs. Do not use the high beam unless it is inevitable, as its dazzle may glare the driver of an oncoming vehicle, thus causing an accident.

Side indicators / Hazard warning

Ensure that all side indicators/hazard warning lights are always in working condition and they are used when required.

Horn

Ensure the horn is working properly. Horn provides safety to other road users by alerting your presence.

Brakes

Ensure brakes are working properly. Check brake fluid level in reservoir. Do not drive the vehicle when brake warning lamp is 'ON'.

Tyres

Check the condition of tyres for any abnormalities. Maintain correct tyre pressure, it is very important particularly when subjected to extreme conditions, such as high speed, high load and high outside temperature. Do

not use worn or bald tyres, especially on the front wheels.

First Aid Kit

A first aid kit is provided in your vehicle. This is for use in case of minor injuries. It should be regularly checked and updated.

Documents

Always carry vehicle registration papers, insurance, valid PUC certificate and driving licence with you.

FUEL SAVING TIPS :

Your vehicle's fuel economy is mainly dependent on your style of driving.

To operate your vehicle as economically as possible, use the following driving suggestions.

Avoid Excessive Idling :

Stop the engine and start it again, if you have to wait for more than a minute. e.g. At Traffic Signals.

Avoid fast starts and unnecessary stops :

Start off slowly from traffic lights or stop signs to prevent increased fuel consumption and shortening of engine life. Avoid unnecessary deceleration (stopping or slowing down) and then acceleration which uses more fuel.

Always maintain clean air-filter:

The amount of air supplied will reduce due to clogged air-filter, resulting in wastage of fuel due to incomplete combustion.

Avoid incorrect tyre pressure :

Under-inflated tyres result in increased running resistance of the tyres, leading to wastage of fuel.

(Refer tyre maintenance section)

Proper Driving Practices :

Keep a safe distance from other vehicles to avoid braking suddenly.

NOTE

Do not rest your foot on the clutch pedal. It does not allow full engine power to be transmitted to the vehicle and reduces clutch life.

Fuel economy speeds :

Gear	Speed (kmph)			
	TDi	Quadrjet	Safire	CR4
1st	20	20	20	15
2nd	30	30	30	30
3rd	40	30	40	45
4th	50	50	60	60
5th	60	70	70	80

GOOD DRIVING PRACTICES:

- Gear shifting should be gradual according to varying speeds. Avoid rapid acceleration and prolonged high speed running of the engine while using the new vehicle for the first 1500-1800 km of operation.
- Slow down before shifting to a lower gear. This will help for avoiding revving of the engine causing damage.
- Avoid frequent brake application which can cause overheating of brakes.
- Slow the vehicle speed while travelling in cross winds. This gives much better control over the vehicle.
- Avoid high speed when cornering or turning.
- Make sure that vehicle is completely stationary before you attempt to shift in reverse gear. This will avoid damage to the transaxle.

- Drive slowly on wet roads. Wet roads reduce vehicle traction and affect your ability to stop and accelerate.

When the vehicle leaves the roadway, do not steer sharply. Slow down slightly before pulling back into the travel lanes.

RUNNING-IN PERIOD :

Avoid rapid acceleration and prolonged high speed running of the engine while using the new vehicle for the first 1500-1800 km of operation.

Do not exceed the following road speeds during running in period.

Gear	(kmph)			
	TDi	Quadrajjet	Safire	CR4
1st	20	20	20	20
2nd	30	30	30	40
3rd	50	50	50	50
4th	80	80	80	80
5th	90	90	90	90

Before you shift to reverse gear, bring your vehicle to a complete stop and depress the clutch pedal fully.

Do not shift into reverse gear when the vehicle is moving forward.

While shifting the gears, it is recommended to shift at the speeds given in the table.

You can get extra braking from the engine when slowing down by shifting to a lower gear.

This can help you to maintain a safe speed and prevent your brakes from overheating while going down a steep hill.

NOTE

Avoid excessive revving up of engine rpm.

Idling the engine for long duration must be avoided.

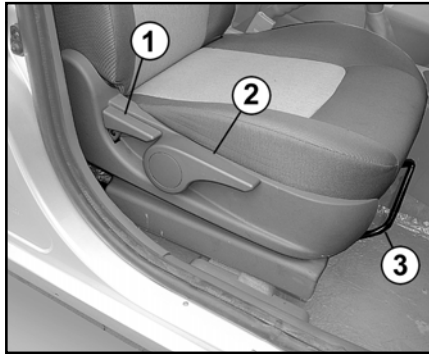
FRONT SEAT ADJUSTMENTS:

1. Seat Back Recliner Lever
2. Height Adjustment Lever
3. Lever for Forward and Backward movement

1. Seat Recliner :

To change the seat back rest angle, lean forward slightly and pull up the recliner (upper) lever. Relieve pressure on the seat backrest. Make sure that lever returns to its original position.

2. Height Adjustment :

The seat height adjuster (lower) lever is located on the outboard side of the seat. To raise the seat, pull the lever upward until the seat is at the desired height. To lower the seat, push the lever downward until the seat is at desired height.

3. Seat Slide :

To adjust the driver /co-driver seat forward or backward, pull the lift bar beneath the seat upwards and exert slight body pressure to position the seat in the desired direction. Release the lift bar to lock the position. Make sure that the seat is arrested properly once the lift bar is released. Push the seat forward and backward to check.

Head restraint :

Adjustable head restraints are provided to increase the height and fix at a desired comfortable position. To reduce the height press release

button to move downwards. Make sure that the top of restraint is at the same height as the top of the occupants head. This position reduces the chances of a neck injury in a crash.

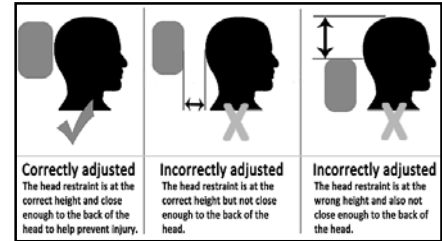
**WARNINGS**

Avoid driving the vehicle with the head restraint removed as it is a safety item. Do not attempt to adjust the head-restraint while driving the vehicle.

To avoid possible loss of vehicle control, all seat, head restraint, steering wheel and rear view mirror adjustments, as well as fastening of seat belts, must be done before setting the vehicle in motion.

Lumbar Support : (if fitted)

Lumbar support is provided on Driver's seat to give you maximum driving comfort. It is adjusted by the lever provided at the side of the seat backrest.

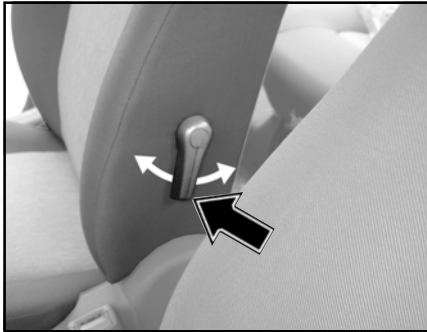

Lumbar Support

REAR SEAT ADJUSTMENTS:

Rear seats are provided with 60/40 split seats. These can be folded independently whenever required.

To fold the rear seat, pull the knob near the head restraints. Uplift the seat base and place it vertically, while the seat back-rest folds down completely to a flat area.

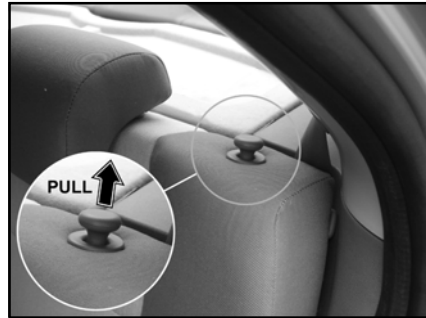

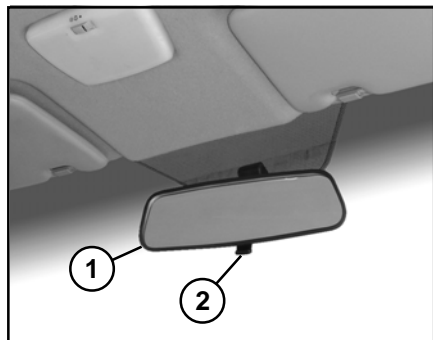
REAR VIEW MIRRORS:**Inside Rear View Mirrors (IRVM) :**

1. Inner Rear View Mirror

An antiglare mirror is fitted inside the vehicle. Provision has been made for two positions:

1. Normal position
2. Antiglare position

Use antiglare position only when necessary, as it reduces rear view clarity.

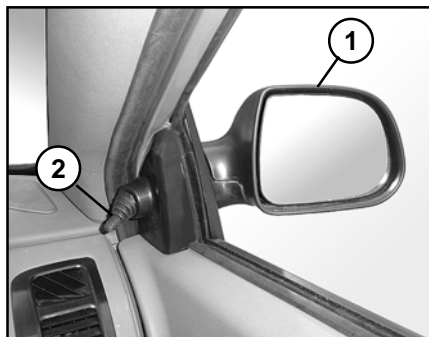
Outer Rear View Mirror :

1. Outer Rear View Mirror
2. Lever for adjustment

The rear view mirror is fitted on the door from outside and can be adjusted by the lever provided inside the door. In some versions the mirrors are provided on both the doors.

Motorised Outer Rear View Mirrors: (If fitted)

Operating knob

Your vehicle is equipped with motorized outer rear view mirrors fitted on both front doors and can be adjusted to the desired position with the help of a switch / knob mounted on the driver's side along with the window winding switches.

Using this switch / knob, the driver can adjust the vehicle's outer rear view mirrors without lowering the glasses and shifting from his / her position.

Steps to operate the Rear View Mirrors:

1. Move the main switch to the left 'dot' to adjust the left side rear view mirror and to the right 'dot' to adjust the right side rear view mirror.
2. Use the 4 positions of the knob (marked by a triangle) to adjust the rear view mirrors to correct angles.

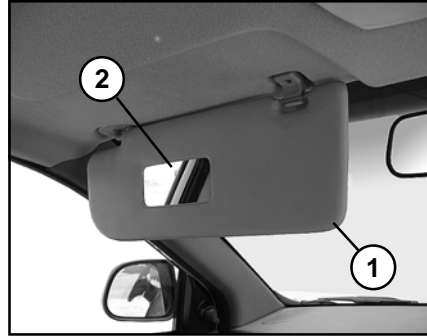
SUN VISORS:

1. Sun visor 2. Vanity Mirror

Two adjustable sun visors are provided inside the cab above the windshield to prevent sun glare. Lower the sun visors to protect the eyes from bright sunlight. The sun visors can also be moved sideways towards the door.

A vanity Mirror has been provided on the back of the Co-driver's sun visor.

NOTE

When not in use, keep the sunvisors in their original position or else, they may block driver's vision.

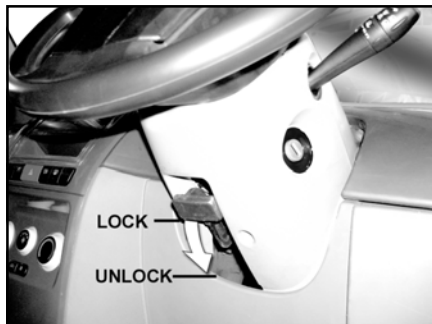
STEERING WHEEL HEIGHT ADJUSTMENT :

Steering Adjustment Lever

You can adjust the steering wheel position to suit your convenience.

Adjust the steering wheel position as follows before you start driving.

1. Adjust the seat to a comfortable position.
2. To adjust steering wheel position, push down the tilt lever as shown in fig to unlock steering column.
3. Move the steering wheel up or down to the desired position.

4. Lock tilt lever by pulling it up to the lock position. Make sure that steering wheel is securely locked by checking up and down direction.

NOTE

Steering wheel should be adjusted only when the vehicle is stationary.

STEERING LOCK CUM IGNITION SWITCH :

Key of ignition switch is common for door lock, steering lock and glove box lock.

The ignition switch is on the right side of the steering column. It has four positions. Turn the key clockwise for further functions.



1. **LOCK** - Steering Locked
2. **OFF** - 'KEY IN' position.
3. **IGN** - All electrical 'ON'
4. **START** - Engine Crank

1. LOCK:

The steering column is locked when the key is removed. You can insert or remove the key only in this position.

2. OFF:

The steering column is unlocked and activates electrical accessories (Music System etc.)

3. IGN:

All electricals and accessories ON.

4. START:

Press the clutch pedal fully and turn the key further clockwise to the START position, (spring loaded) to start the engine. As soon as the engine starts, release the ignition key, which returns to ON position. While cranking, all accessories will be momentarily 'OFF'.

NOTE

The Starter Protection System fitted in this vehicle does not allow you to

crank the engine until you fully press the clutch pedal.

Keep the clutch pedal fully pressed and crank the engine, if the engine cranks but fails to start then repeat the above procedure. Release the key as soon as the engine starts.

Ensure that the "MIL" lamp is "OFF". Do not press the accelerator pedal.

NOTE

The Starter Protection System switches off the starter when it is cranked for more than 10 secs. In such a case, get the key back to 'OFF' position & wait for 30 secs.

STOPPING THE ENGINE:

Before switching off the engine, run the engine in idle condition for at least 30 seconds and then switch off. This will allow the engine oil to lubricate the turbocharger, till its speed is fully reduced and also allow the unit to cool down.

The above precautions will ensure satisfactory life and performance from the turbocharger, till its speed is fully reduced and also allow the unit to cool down.

NOTE

If the engine fails to start, try to restart the engine after few minutes. Continuous cranking will cause damage to the starter motor. If the engine fails to start, Contact **TATA MOTORS** Authorized Service Centre.

PREPARING TO DRIVE:

- Release the parking brake.
- Check that all items that you may be carrying inside are fully secured.
- Ensure that all doors are locked properly
- Check & adjust seat.
- Fasten seat belt properly
- Ensure that all gauges and indicators lights are working.
- Check for blind areas being unobstructed in front and rear of the vehicle.
- Before driving off check in the rear view mirror, for approaching traffic.
- Switch on side indicator signal when getting into main stream of traffic.

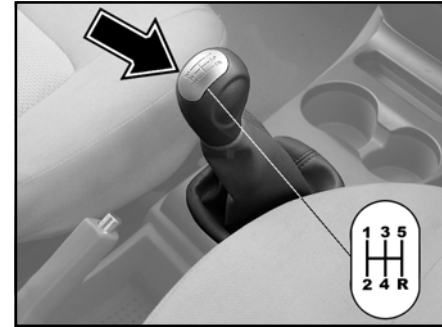
GEAR LEVER AND SHIFTING:

The gearshift lever is mounted on the center console between the two front seats. The gearshift pattern is as shown on the gear lever knob. Application of Gear shifting should always be done with clutch pedal pressed.

NOTE

The reverse gear should be engaged only when the vehicle is stationary. Wait for 5 seconds after declutching to ensure smooth engagement of the reverse gear.

PARKING BRAKE:

1. **Parking Brake Lever**
2. **Release Button**

Mechanical parking brake acting only on the rear wheels is provided on the vehicle. The parking brake lever is located behind the gearshift lever. To apply the parking brake, pull the lever up fully. The parking brakes tell tale illuminates on the instrument cluster. To release it, pull the lever up slightly, press the release button and push the lever down. Parking brakes tell tale on the instrument cluster will go 'OFF' when the lever is fully released.

NOTE

Apply the parking brake properly before leaving the vehicle and release it before moving.

VEHICLE PARKING:

- Park the vehicle in a safe place. Switch on the indicator signal before turning to park.
- Apply the parking brake.
- Ensure that all window glasses are closed and all lamps are turned 'OFF'.
- At night, put on the parking lights if required.
- Remove the key from the ignition switch.
- Place wheel chocks at the wheels if parked on a slope.

NOTE

When parking on a downhill gradient, place the gear lever in 'Reverse' position. While parking on uphill gradient, place the gear lever in the '1st' position.

BRAKES & BRAKING:

The brake system on your vehicle is an advanced dual circuit, diagonal split vacuum assisted hydraulic brake system.

It is equipped with:

- Brake booster : Assists the driver in braking with an ergonomic pedal force on brake pedal;
- Tandem Master Cylinder, for fail safe braking.
- Single pot calipers, for efficient energy absorption.
- Auto adjusted rear brakes which are designed for trouble free performance

WARNINGS

Never use the brake pedal as a footrest. Never depress the brake pedal and the accelerator pedal at the same time.

Water on brake discs and brake pads affects braking:

Driving in rain and slush or in a vehicle wash can cause water to collect on the brake discs and pads. This will cause a delay in braking effect when the pedal is depressed. To avoid such a delay when the brakes are needed, depress the pedal occasionally when driving through rain, slush etc.

This will remove the water from the brakes. Check that brake application feels normal. This should also be done after washing or starting in very damp or cold weather.

Severe strain on the brake system:

The brakes will be subject to severe strain when driving in mountains or hilly areas, or when towing. Vehicle speed is usually slower, which means that the cooling of the brakes is less efficient than when driving on level roads. To reduce the strain on the brakes, shift into a lower gear and let

the engine help with the braking. Do not forget that, if you are towing, the brakes will be subjected to a greater than normal load.

WARNINGS

If you shift gear down on a slippery road surface in an attempt to increase the engine's braking effect, the wheels could lose their grip. This may lead to increased danger of skidding and accidents. Do not shift down for additional engine braking on a slippery road surface.

NOTE

Occasional brake noise is normal. If a squeal metal-to-metal, continuous grinding sound is present; the brake linings may be worn-out and should be inspected by an authorized TATA MOTORS dealer or If the vehicle has continuous vibration or shudder in the steering wheel while braking, the vehicle should be inspected by authorized TATA MOTORS dealer.

IF UNEXPECTED HAPPENS TO THE VEHICLE:

If something unexpected happens with the vehicle, proceed as follows:

- Stop the vehicle at a safe place wherein it does not constitute an obstacle for other road users.
- Switch off the Engine. Apply parking brake.
- Switch on the hazard warning indicators to alert and warn other road users about hazardous situation.
- If the situation warrants use the following emergency equipment :
 - First aid kit
 - Jack and handle
 - Tool kit
 - Warning triangle
- Place a warning triangle behind the vehicle.
- Call the service centre and describe the problem.

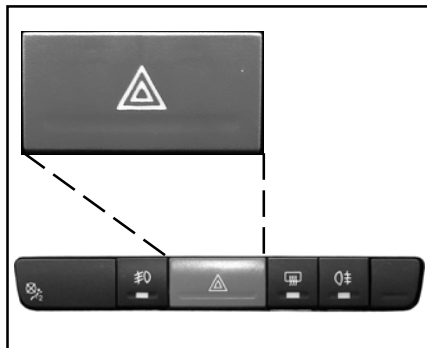
HAZARD WARNING SWITCH :

In case of a break-down at night, use hazard warning indicators. Try to park the vehicle on the side of the road to avoid collision or inconvenience for others

While driving in emergency or under adverse conditions, it is advisable to switch 'ON' Hazard warning indicators.

Hazard warning switch remains functional even while ignition switch is in OFF condition.

When the situation is under control switch off the hazard warning indicator.

NOTE

If indicator lamps do not blink or blink rapidly, it is an indication of problem in the electrical system or a fused indicator bulb. Get it rectified In case of a break-down, use hazard immediately.

EMERGENCY EQUIPMENTS :**NOTE**

You should be familiar with the location of the emergency equipment provided in the vehicle and how to use it.

Check all the emergency equipment periodically and ensure that it is in proper working condition and in its place.

FIRST AID KIT :

The first aid kit is kept inside the glove box compartment.

The kit contains items that can be used in case of minor injuries only.

NOTE

Check contents of the kit periodically and replenish consumed or expired items.

ADVANCE WARNING TRIANGLE :

An advance warning triangle is kept inside the pocket provided behind the rear seat back rest.

- Remove the advance warning triangle from the rear seat back rest pocket and assemble.

- Place the triangle on the road behind the vehicle where it is stranded.
- Distance between triangle and the vehicle must be at least 50 meters. in the same lane of traffic.

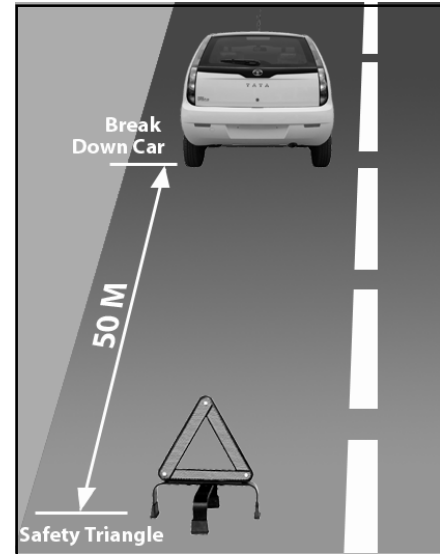

- Increase the distance to 150 meters if stranded on a highway or if the vehicle view is obscured.

NOTE

Remember that the distance between the warning triangle and the vehicle depends on local regulations.

TOOL KIT :

A tool kit is kept in luggage compartment at LH side.

NOTE

The tool kit should be properly secured after usage.

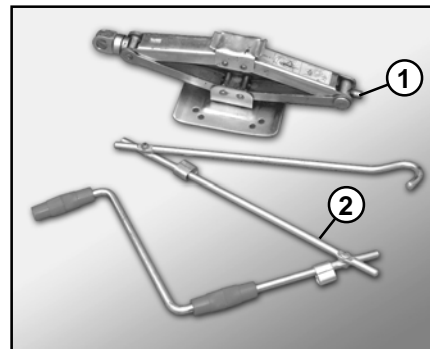
JACK AND HANDLE :

1. Scissor Jack 2. Handle

A scissors jack with handle is kept inside the luggage compartment mounted on the tail gate outer sill panel.

FLAT TYRE REPLACEMENT :

In case of a flat tyre, reduce vehicle speed gradually, keeping it in a straight line. Move cautiously off the road to safe place away from traffic.

Park the vehicle on a level and firm ground. Apply parking brake and engage 1st gear. Turn on Hazard warning switch. Keep advance-warning triangles at suitable distance in front and behind the vehicle as an indication of breakdown. Take out the tool kit, jack and handle from the vehicle.

Do not change the tyres (Removing and fitting) on wheels if you do not have suitable equipment and experience.

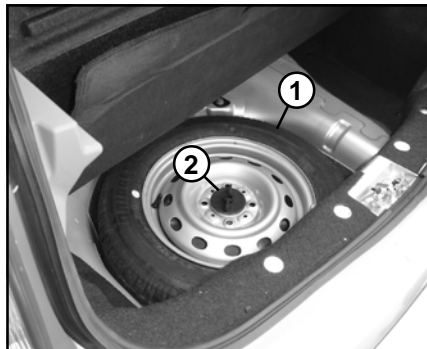
SPARE WHEEL :

1. Spare Wheel 2. Retaining Bolt

Spare wheel is located in the luggage compartment.

To access the spare wheel open the tail gate, fold and lift up the floor cover.

To remove the spare wheel, unscrew and remove retaining bolt, which is provide to hold the spare wheel. Lift and take out the spare wheel.

REMOVAL OF WHEEL CAP (if fitted):

Insert a piece of cloth between the spokes of the wheel cover and pull cover outward.

Take out detached wheel cover from the wheel rim. For installation, first match the slot at the wheel cover with the air feeling nozzle of the wheel. Apply equal pressure at the circumference of the wheel cover to fix it in the wheel rim.

CHANGING FLAT TYRE:

- Block the wheel which is diagonally opposite to the flat tyre.
- Take out wheel cover (if fitted).
- Slacken but do not remove the wheel nuts before raising the vehicle.



- Set the jack properly at correct jacking point as shown for front or rear wheel. The jacking points are located approximately 185mm from the front wheel and 260mm from the rear. Slowly lift the vehicle with the help of a jack handle.

Front jacking point**Rear jacking point****NOTE**

- Do not lift the vehicle with some one inside.
- Make sure the jack is positioned firmly on a level surface and correct jacking point.
- Never work under a raised vehicle that is supported only by a jack. This may cause a personnel injury.
- Never change a wheel on a slope; otherwise the vehicle could slip off.
- Do not use oil or grease on studs or nuts. Which cause the breakage and slip of the wheel stud.
- Do not start or run the vehicle while supported by a jack.
- Remove wheel-mounting nuts and take out flat tyre.
- Roll the spare wheel into position and align the holes in the wheel with studs.

- Then reinstall the wheel nuts and tighten them as much as you can by hand.

NOTE

- Before using the jack, please read the instructions on the sticker provided on the jack.
- Lower the jack completely then tighten the wheel nuts one by one using wheel spanner.
- Press fit the wheel cover back (if fitted).
- Restore all the tools and jack at their respective location.
- Place the flat tyre at spare wheel location as described.

NOTE

Check and correct the tyre pressure and nut tightness of the changed wheel as per recommendation at nearest service station. Get the flat tyre repaired at the earliest.

JUMP LEAD STARTING :

The engine with a discharged battery can be started by transferring electrical power from the battery of another vehicle.

This may be dangerous as any deviation from the following instructions could lead to personal injury resulting from any battery explosion, as well as damage to the electrical systems in both vehicles.

WARNING

Do not allow battery electrolyte to come in contact with eyes, skin, fabrics or painted surfaces. The electrolyte contains sulphuric acid which can cause injury and severe damage. Wear rubber gloves to avoid risk of contact.

Connecting procedure:

The engine can be started with another vehicle battery using jumper cables:

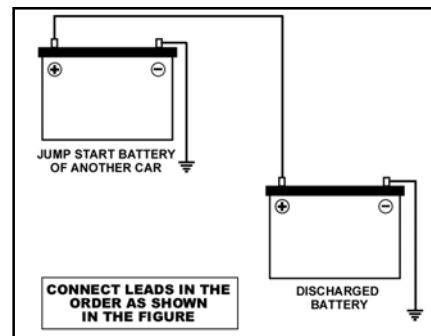

- Use a vehicle which has batteries of the same capacity and voltage (12 Volts).
- Turn off all electrical loads; check vehicle so that they are not touching each other and are in neutral.
- Connect the discharged batteries by using the cable for inter connection.

JUMP LEAD STARTING

- Also connect the booster batteries by using another cable for inter connection.
- Connect the jumper cables in the following sequence.
- Positive terminal of the discharge battery to Positive terminal of the booster battery.
- Negative terminal of the booster battery to the unpainted metal part of the discharge vehicle which is away from the discharge battery.
- After engine is started disconnect the cable in the reverse sequence of connection.

NOTE

Do not remove the battery cables from the terminals while the engine is running.

As far as possible avoid jump starting as this may damage the ECU.

WARNING

Do not connect –ve terminal of jump start battery to –ve terminal of discharged battery. This may lead to an explosion.

- After connecting the cables, start the engine of vehicle having booster batteries.
- Raise the engine speed of the vehicle slightly and then start engine of the discharge battery vehicle.

TOWING THE VEHICLE :

It is necessary to tow a disabled vehicle, certain precautions and procedures must be taken to prevent damage to the vehicle and/or components. Failure to use standard towing precautionary measures when lifting or towing a disabled vehicle could result in an unsafe operating condition.

To assure proper towing and to prevent accidental damage to your vehicle, **TATA MOTORS** recommended to done it from an authorized **TATA MOTORS** authorised dealer or a commercial tow-truck service.

WARNING

- Never ride in a vehicle that is being towed.
- Never get under your vehicle after it has been lifted by a tow truck.
- For towing a vehicle, the best way is to use a wrecker. Alternatively use a rigid tow bar.

- Switch 'ON' the hazard warning indicators of both the vehicles to warn other road users.
- Put the gearshift lever in the NEUTRAL position.
- Limit the speed to 20-30 kmph.
- In case of brake failure, use the parking brake to control the vehicle.
- Do not use flexible cable or rope for towing as your vehicle may crash into the towing vehicle, when it applies sudden brake.

NOTE

The power steering functions only when engine is running. Hence, during towing the steering will feel very heavy.

Recommended Towing :

We recommend that your vehicle be towed with the driving wheels off the ground or place the vehicle on a flat bed truck as shown.

WARNING

- Never tow your vehicle with the front wheels on the ground or four wheels on the ground (forward or backward), as this may cause serious and expensive damage to the transmission. If it is necessary to tow the vehicle with the rear wheels raised always use towing dollies under the front wheels.
- When towing with the rear wheels on the ground or on towing dollies, place the ignition switch in the ACC or ON position, and secure the steering wheel in the straight-ahead position with a rope or similar device.

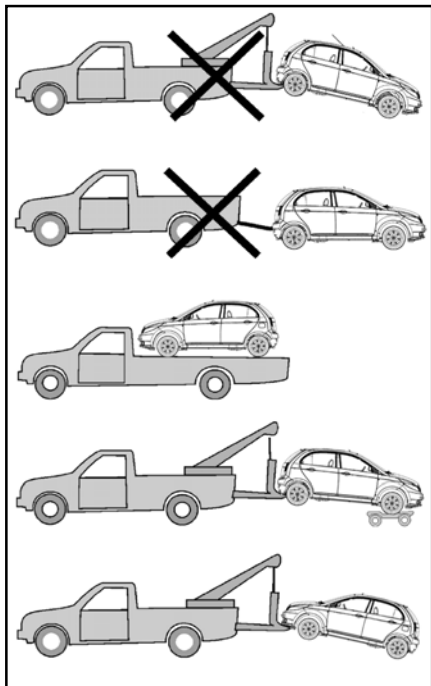
**Emergency towing :**

The towing hook is provided inside the tool bag kit which is kept in luggage area.

This tow hook must be screwed into the positions provided on front or rear bumper.

Front/Rear towing process:

- Open the tailgate and remove the towing hook from the tool bag.
- Remove the cover by pressing / pulling from bumper.
- Install the towing hook by turning it clockwise into the hole until it is fully install.
- After towing, remove the towing hook and install the cover.

Front & Rear Tow Hook Location:

Tow Hook Location at Front

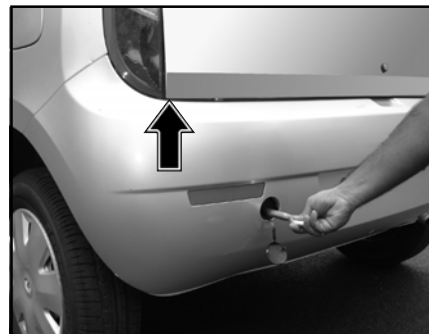

Tow Hook Location at Rear

FUSES :

If an electrical component fails to function, it is possible that a fuse has blown.

The fuse boxes are located in two different places, see the illustration below.

A label on each cover indicates the amperage and the electrical components that are connected to each fuse.

The easiest way to see if a fuse is blown is to remove it. Pull the fuse straight out. If a fuse is difficult to remove, you will find a special fuse removal tool (and several extra fuses) in the cabin compartment fuse box or engine compartment fuse box. If the fuse curved metal wire is broken then put a new fuse of the same color and amperage (written on the fuse). Spare fuses are stored in the fuse box in the engine compartment and the cabin compartment. If fuses burn out repeat-

edly, have the electrical system inspected by a trained and authorized service technician.

WARNING

Never use metal objects or fuses with higher amperage, doing so could seriously damage or overload the vehicle's electrical system.

ENGINE FUSE BOX
ALONG LH
WHEEL ARCH

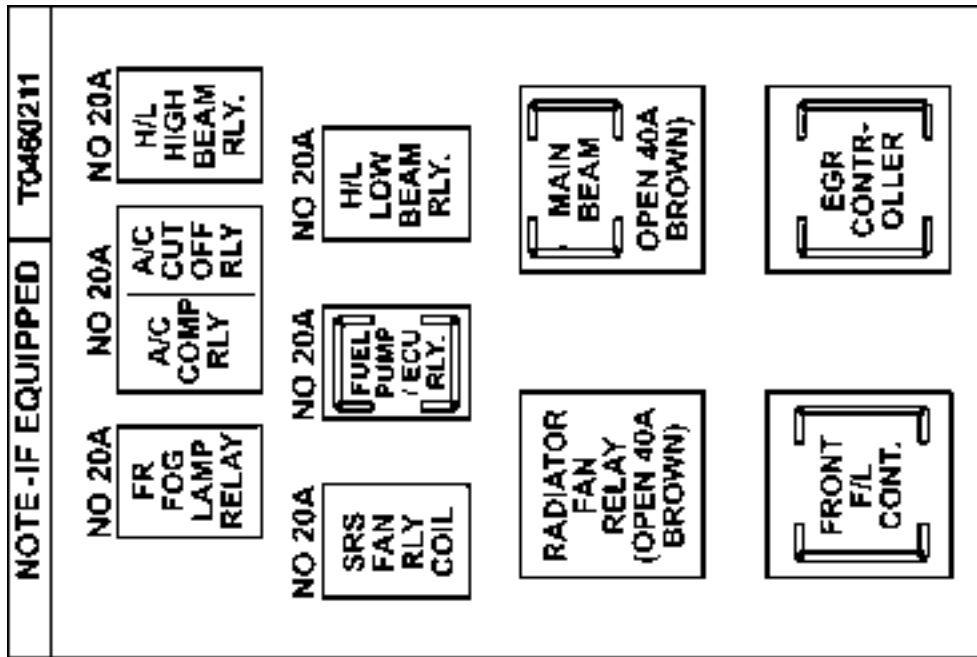
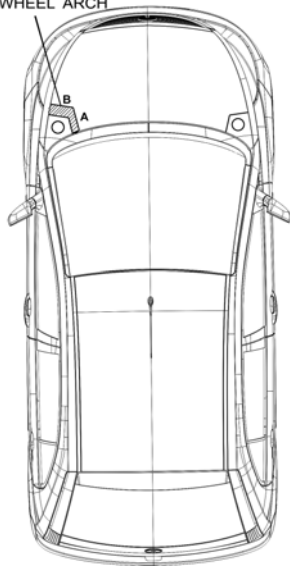

TDi / Quadrajel / Safire ENGINE COMPARTMENT FUSE BOX (A)

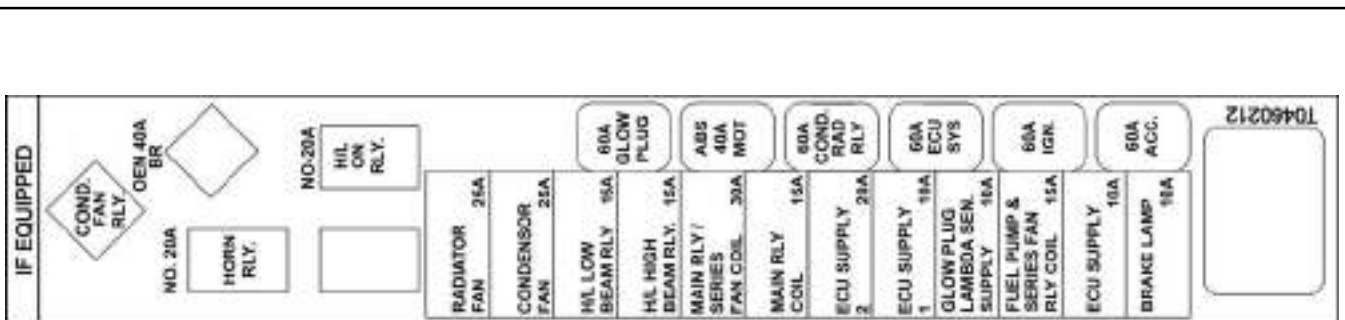

Quadrajet ENGINE COMPARTMENT FUSE BOX (B)

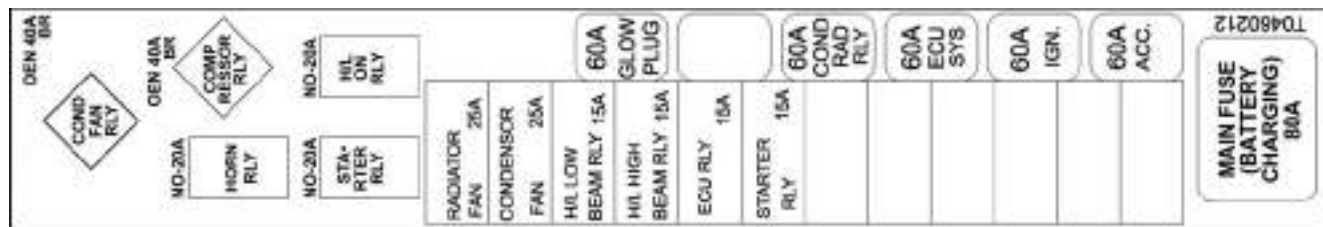

TDi ENGINE COMPARTMENT FUSE BOX (B)

ENGINE FUSE BOX

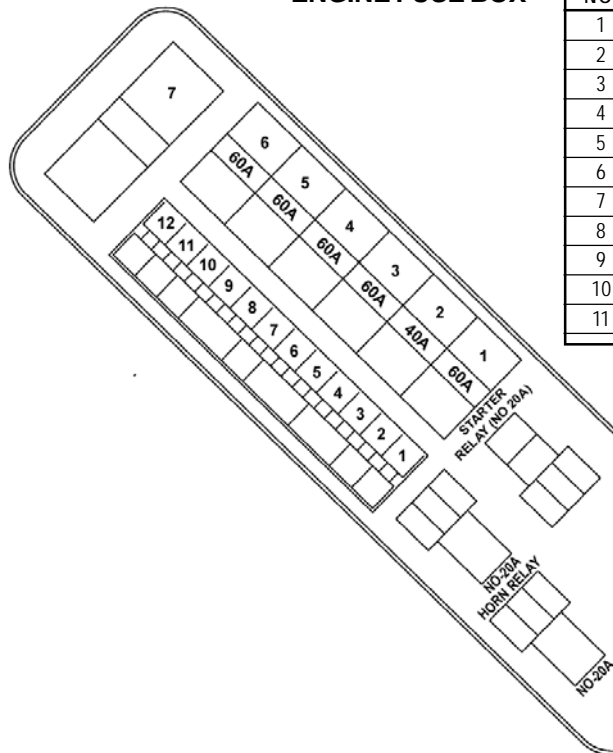

NO.	FUNCTION	FUSE
1	FAN HIGH SPEED	30A
2	FAN LOW SPEED	30A
3	HL LOW BEAM	15A
4	HL HIGH BEAM	15A
5	MAIN RELAY	30A
6	COIL MAIN RELAY	15A
7	COIL & SENSOR W/H	20A
8	FUEL FILTER & ECU	10A
9	GLOW PLUG TIMER	10A
10	FUEL PUMP RELAY	20A
11	ECU	10A

NO.	FUNCTION	FUSE
1	GLOW PLUG SUPPLY	60A
2	ABS	40A
3	FAN	60A
4	ALTERNATOR	60A
5	IGNITION	60A

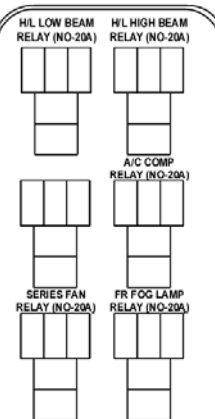
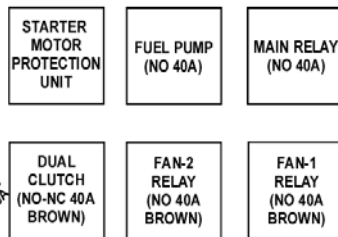

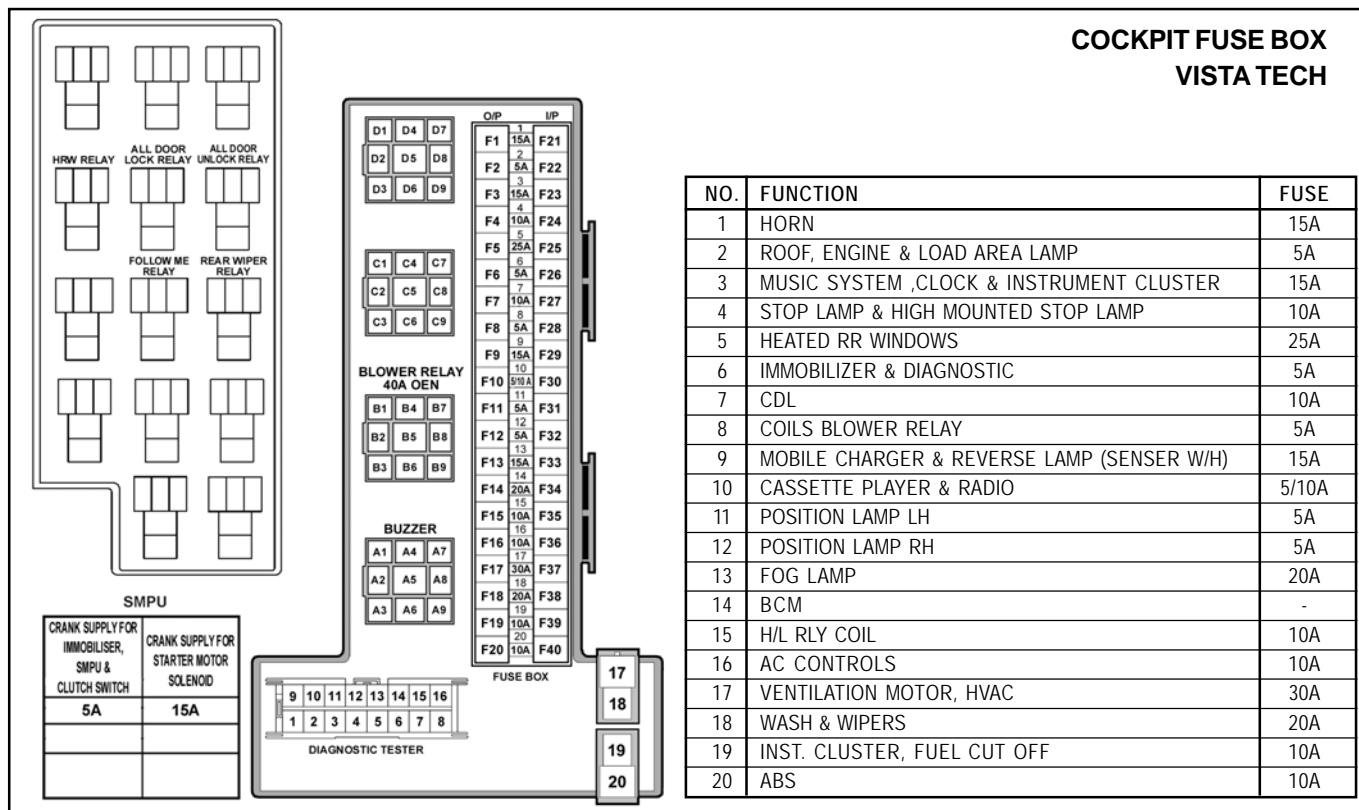

BULB SPECIFICATION :

Sr.No	Description	Rating	Type	Quantity
1	HIGH BEAM	12V , 55W	H1	2
2	LOW BEAM	12V , 55W	H7	2
3	PARKING LAMP	12V , 5W	W5W	2
4	FRONT TURN SIGNAL	12V , 21W	PY21	2
5	FRONT FOG LAMP	12V , 55W	H3	2
6	POSITION LAMP	12V , 5W	W5W	2
7	STOP + POSITION LAMP	12V , 21/5W	BA 15D DUAL	2
8	REAR TURN SIGNAL	12V , 21W	PY21	2
9	REVERSE LAMP	12V , 21W	BA15S	2
10	REAR FOG LAMP	12V , 21W	BA15S	2
11	REAR REGISTRATION PLATE LAMP	12V , 5W	W5W	2
12	SIDE REPEATER LAMP	12V , 5W	W5W	2
13	ROOF LAMP	12V , 10W	FESTOON BULB	1
14	ROOF SPOT LAMP	12V , 5W	W5W	2
15	HIGH MOUNTED STOP LAMP	12V , 16W	W16W	1
16	LOAD AREA LAMP	12V , 5W	W5W	1

Bulb Replacement :**Replacing the Headlight Bulb :**

Your vehicle's headlights have replaceable halogen bulbs. Headlight bulb can be replaced without even disturbing or removing the entire headlight unit.

WARNING**Handling Halogen Bulbs:**

It is dangerous if a halogen bulb breaks. These bulbs contain pressurized gas and if broken, will explode causing serious injury by the flying glass. Halogen bulbs can break if the glass portion is touched with bare hands, body oil could cause the bulb to heat unevenly and explode when lit. Never touch the glass portion of the bulb with your bare hands and always wear eye protection when handling or working around halogen bulbs. Always keep halogen bulbs out of the reach of children.

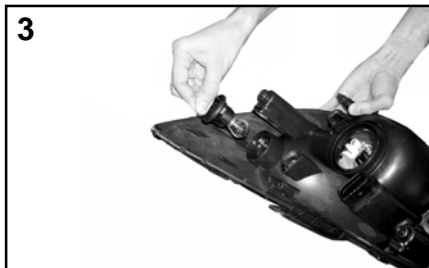
**Procedure :**

Make sure light stalk is in 'OFF' position and bulb is not hot.

1. Lift the engine bonnet to access the headlight bulb.
2. Remove the dust cover at the back of Headlamp **Fig.1**.

3. Disconnect the electrical connector **Fig.2**.

4. Press and release the bulb retaining spring **Fig.3**.

5. Swing the retaining spring out to free the headlight bulb from the socket by pulling it straight back.

6. Carefully remove the headlight bulb from the socket **Fig. 4.**
7. Replace the bulb.
8. Install in the reverse order of removal.

Replacing the Parking Bulb :

1. Make sure lighting stalk is in 'OFF' position.
2. Lift the engine bonnet. The parking bulb is located below the headlamp bulb on the assembly.
3. Pull the bulb holder from the socket.
4. Carefully remove the parking bulb from the socket by pulling it straight back.
5. Replace the bulb.
6. Install in the reverse order of removal.

Replacing Tail Lamp Bulb:

1. Make sure lighting stalk is in 'OFF' position.
2. Open the tail gate.
3. Remove the bolts (2 nos) holding the tail lamp cluster using a spanner. Take out the entire tail lamp assy. by disconnecting the connector.
4. Rotate and pull out the socket with bulb to be replaced.
5. Carefully remove the fused bulb from the socket by rotating and pulling it. **(Fig. 2 & 3)**
6. Replace the bulb.
7. Install in the reverse order of removal.

Replacing Reversing light lamp Bulb :

Replace the reverse light bulb by following the procedure just similar to "Replacing tail lamp bulb". Please refer the pictures.

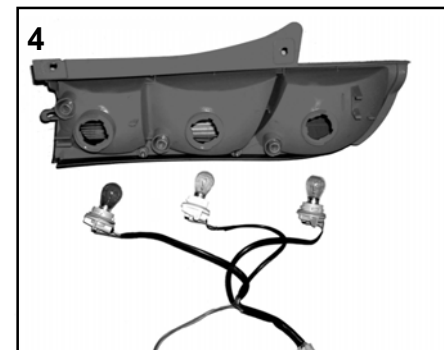

24 X 7 ROAD ASSISTANCE :**Dear Customer,**

It is our responsibility and our endeavour to ensure that you have our complete service backup if ever, wherever and whenever you need the same. When you have a road network that spans wide area, the probability of a breakdown happening within hailing distance of a **TATA MOTORS** Authorized Workshop is very low.

It is Precisely for this reason, we have tied up with My TVS, who will provide breakdown assistance including towing to the nearest **TATA MOTORS** Authorized Workshop through their Authorized Service Providers (ASP)

The **24X7 On Road Assistance** Program shall be automatically available to your vehicle for the duration of



Warranty period. The program shall also be available, if you avail the same post warranty.

Response Time ** for the On Road Assistance Program

Within City Limits	60 minutes
On State or National Highways	90 minutes
Ghat Roads and other places	120 minutes +/-

** (The response time will depend on the location, terrain, traffic density and the time of the day.)

Standard procedure when calling for On Road Assistance in case of a breakdown:

- Dial the toll free help line number – **1 800 209 7979**
- Identify your vehicle with the Vehicle chassis number that is available in the Owners Service manual.
- Explain your exact location with landmarks and tell us about the problem you face with the vehicle.
- Park your vehicle on the edge of the road, open the bonnet and put on the hazard warning signal.
- Place the advance warning triangle supplied with the vehicle approx. 3 m from the vehicle in the direction of on coming traffic.

COVERAGE UNDER THE 24 X 7 ON ROAD ASSISTANCE PROGRAM

I. The **24x7 On Road Assistance** Program Service covers the following services on your vehicle during warranty period.

- Wheel change through spare wheel.
- Arrangement of fuel. (Fuel cost will be chargeable at actual cost)
- Re-opening the vehicle in cases of key lock out.
- Rectification of electrical problems related to battery, fuses etc.
- On spot repairs for complaints repairable at site. ^
- Vehicle to vehicle towing or winching & towing for non accident cases up to the nearest **TATA MOTORS** authorized workshop. Towing charges at actual cost beyond the same to be paid to the ASP in cash. (Any ferry or toll charges levied in relation to the vehicle being towed to be paid by the customers in actuals in cash).

For accident cases, towing charges to be borne by the customer.

II. The **24x7 On Road Assistance** Program coverage on availing the 24X7 policy, post warranty is upto maximum of 6 instance of assistance in one year for both the plans- Basic and Premium. In the premium plan, this includes 1 instance of towing upto the nearest **TATA MOTORS** authorised workshop.

EXCLUSIONS

24x7 On Road Assistance Program does not apply to

- Cost of parts consumables and labour for such repairs not covered under warranty*. These charges are to be settled with ASP in cash.
- Toll or ferry charges paid by ASP in reaching to the breakdown site to be settled with ASP in actuals in cash.
- Cases involving accident, fire, theft, vandalism, riots, lightening, earthquake, windstorm, hail, tsunami, unusual weather conditions, other acts of God, flood, etc.
- Vehicles that are unattended, un-registered, impounded or abandoned.
- Breakdown/defects caused by misuse, abuse, negligence, alterations or modifications made to the vehicle.

- Lack of maintenance as per the maintenance schedule as detailed in the owner's manual.
- Cases involving racing, rallies, vehicle testing or practice for such events..

Disclaimer

- The service is not available in the some part of J&K and in Union Territories of Andaman & Nicobar Islands and Lakshwadeep.
- **The reach time is indicative & the actual reach time will be conveyed by the call centre at the time of breakdown call.
- The reach time can vary depending on the traffic density & time of the day.
- The reach time indicated does not account for delays due to but not limited to acts of God, laws, rules & regulations for time being in force, orders of statutory or Govt. authorities, industrial disputes, inclement weather, heavy down pour, floods, storms, natural calamities, road blocks due to accidents, general strife and law & order conditions viz. fire, arson, riots, strikes, terrorist attacks, war etc.

- ^ On spot repairs at breakdown site shall depend on nature of complaints & will be as per the discretion of the ASP.
- *The decision for free of charge repairs will be as per the warranty policy & procedures of **TATA MOTORS LTD.** and as per the interpretation of the same by ASP. You will be duly informed by the ASP & call centre for the change applicable if any.
- All charges wherever applicable need to be settled directly with the ASP.

EXCLUSION OF LIABILITIES :

- It is understood that **TATA MOTORS** shall be under no liability whatsoever in respect of any loss or damage arising directly or indirectly out of any delay in or non delivery of, defect/deficiency in service/parts provided by ASP.
- In case vehicle cannot be repaired on-site, customers are advised to use the towing facility for taking their vehicle to the nearest **TATA MOTORS** authorized workshop only. In no condition will the vehicle be towed to any unauthorized workshop. **TATA MOTORS** will not be responsible for any repairs carried out in such unauthorized workshop.
- Customer are advised to take acknowledgment from the ASP for the list of accessories/extra fittings and other belongings in the vehicle as well as the current condition related to dents/scratches breakages of parts/fitments of the vehicle at the time of ASP taking possession of the vehicle & to verify these items when delivery is taken back by them, Claim for loss of or damage to items, if any should be taken up with ASP directly. **TATA MOTORS** shall not be responsible for any such claims, damages/loss or any deficiency of service of the ASP.
- Vehicles will be handled, repaired & towed as per the customer's risk & **TATA MOTORS** shall not be liable for any damages / claims as a result of the same.
- Services entitled to the customers can be refused or cancelled on account of abusive behaviour, fraudulent representation, malicious intent and refusal to pay the charges for any charges related services and spare parts during service or on previous occasion on part of the customer.
- On site repairs may be temporary in nature. The completion of repairs does not certify the road worthiness of the vehicle. The customer is advised to ensure temporary repairs carried out onsite is followed by permanent repairs at **TATA MOTORS** Authorized Workshop at the earliest.
- Terms and conditions and service coverage, exclusions etc. are subject to change without notice.

ENGINE COMPARTMENT - TDi

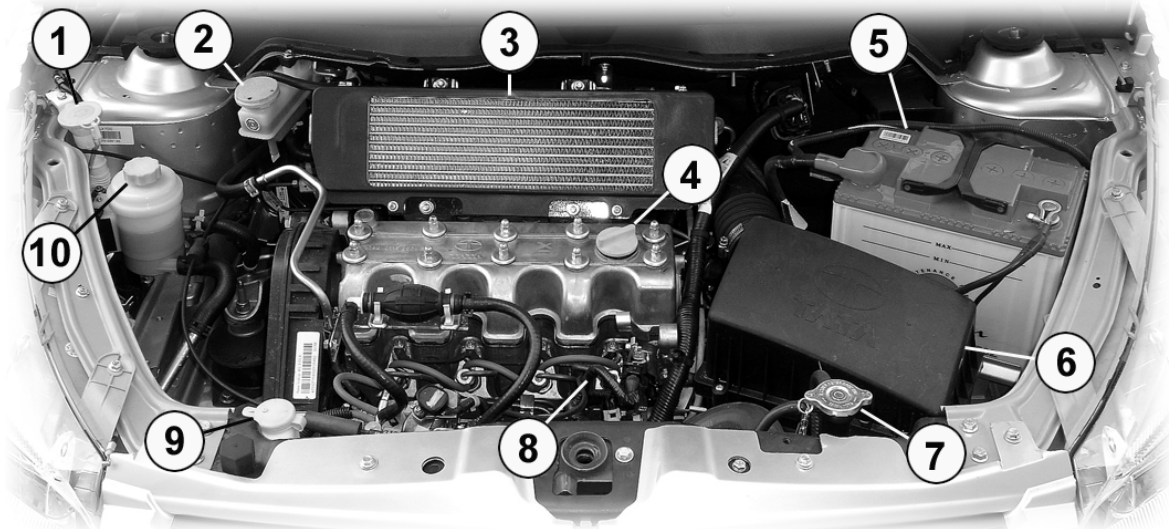

- | | | |
|------------------------------------|--------------------------|-------------------|
| 1. Wind shield washer container | 2. Brake fluid reservoir | 3. Intercooler |
| 4. Engine Oil Filling Cap | 5. Battery | 6. Air Filter |
| 7. Radiator Pressure Cap | 8. Dip Stick | 9. Auxiliary Tank |
| 10. Power Steering Fluid Reservoir | | |

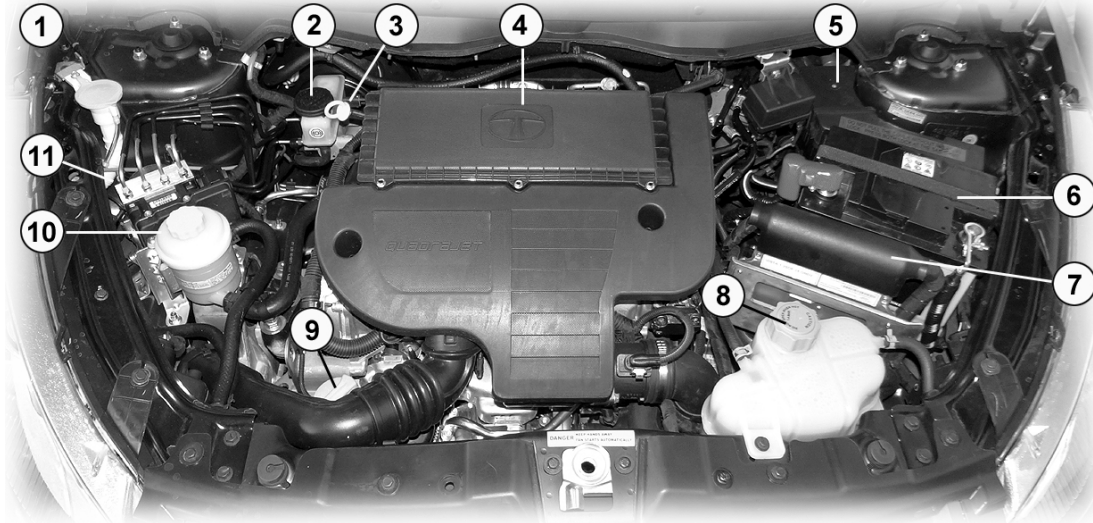
ENGINE COMPARTMENT - QUADRAJET

- | | | |
|---------------------------------|--------------------------|---------------------------|
| 1. Wind shield washer container | 2. Brake fluid reservoir | 3. Dipstick |
| 4. Air Filter | 5. Fuse Box | 6. Battery |
| 7. ECU | 8. Auxiliary tank | 9. Engine Oil Filling Cap |
| 10. Power steering reservoir | 11. ABS HCU | |

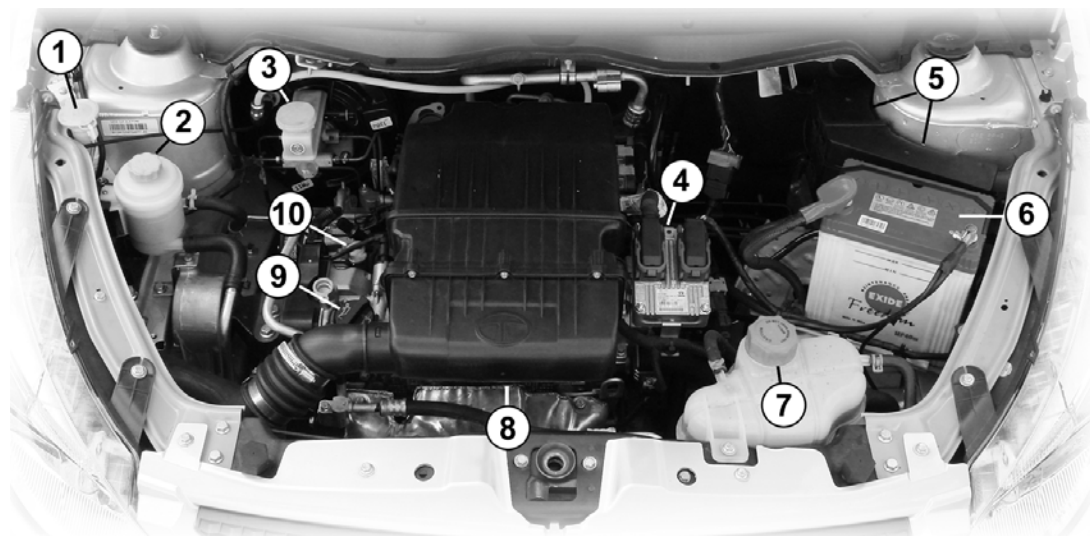
ENGINE COMPARTMENT - SAFIRE (65PS)

- | | | |
|--------------------------------|-----------------------------|---------------------------|
| 1. Windshield washer container | 2. Power steering reservoir | 3. Brake fluid reservoir |
| 4. ECU | 5. Fuse Box | 6. Battery |
| 7. Auxiliary tank | 8. Air Filter | 9. Engine Oil Filling Cap |
| | 10. Dip Stick | |

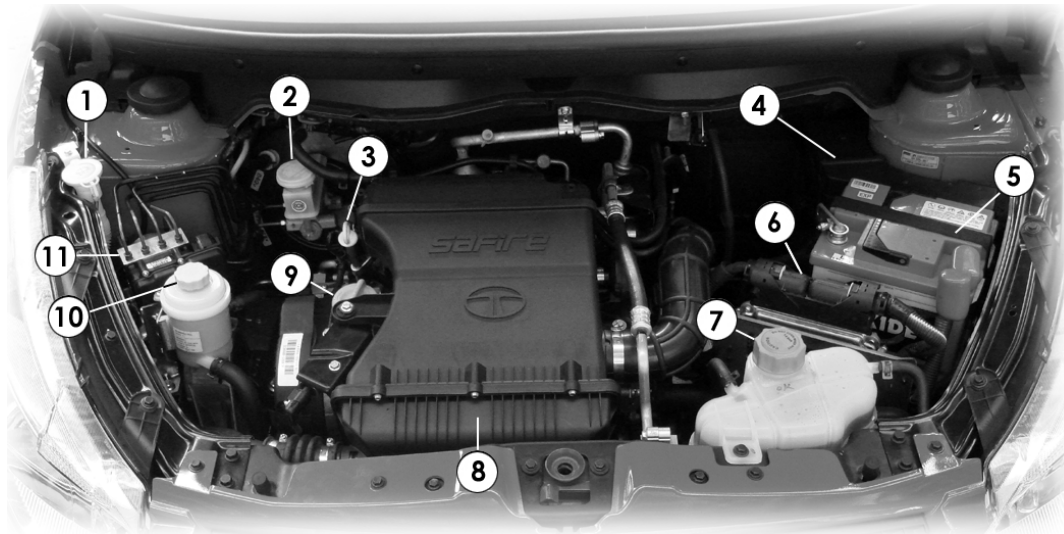
ENGINE COMPARTMENT - SAFIRE (90 PS)

- | | | |
|--------------------------------|--------------------------|---------------------------|
| 1. Windshield washer container | 2. Brake fluid reservoir | 3. Dip Stick |
| 4. Fuse Box | 5. Battery | 6. ECU |
| 7. Auxiliary tank | 8. Air Filter | 9. Engine Oil Filling Cap |
| 10. Power steering reservoir | 11. ABS HCU | |

ENGINE OIL LEVEL :

Warm up the engine to normal operating temperature.

Turn it off and wait for 5 minutes for the oil to return to the oil pan. Be sure the vehicle is on a level surface.

Pull out the dipstick, wipe it clean, and reinsert if fully.

Pull it out again and examine the oil level. It should be between 'MIN' and 'MAX' level. If not, top up with recommended engine oil.

For location of Engine oil filling cap & dip stick, please refer respective Engine compartment pages.

ENGINE COOLANT LEVEL :

Check the coolant level in the radiator auxiliary tank.

It should be in between maximum and minimum lines.

If the No loss tank is completely empty, please check the coolant level in radiator as follows :

WARNING

Do not remove radiator cap when engine is hot. It may spray hot coolant on you causing serious injuries.

1. Ensure engine and radiator are cool.
2. Turn the radiator cap anti-clockwise (without pressing it) until it stops. This will relieve the pressure, if any in the cooling system.
3. Remove the radiator cap by pushing down and turning anti-clockwise.

4. The level of coolant should be upto the base of the filler neck. Coolant should be added if it is low.
5. Secure the radiator cap in its place.
6. Add coolant into the auxiliary tank up to the high mark.
7. Put the cap back, on the auxiliary tank.

NOTE

Topping of the coolant should be done in the auxiliary tank only. Radiator cap should not be removed.

For location of Engine coolant container & filler cap, please refer respective Engine compartment pages.

BRAKE FLUID LEVEL :

The level of the brake fluid must be between the min. and max. marks on the side of the brake fluid container. If the level falls below the min. mark, add recommended brake fluid. (Refer chapter - Fuels, coolants and lubricants)

In case of spongy or hard pedal or low brake efficiency, please contact the nearest **TATA** authorised Service outlet.

NOTE

1. Do not allow brake fluid to make contact with the skin or eyes.
2. Do not allow brake fluid to splash or spill on the paint surface as it will damage the paint. In case of spillage, wipe it off immediately.

For location of Brake Fluid Container & filling cap , please refer respective Engine compartment pages.

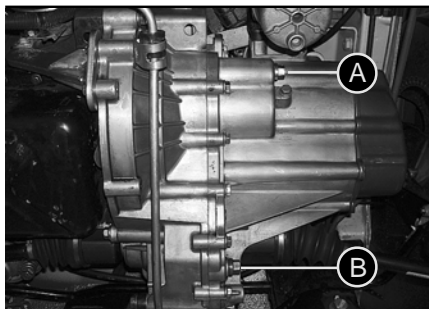
TRANSAXLE OIL LEVEL:**TRANSAXLE****A. OIL LEVEL PLUG B. DRAIN PLUG**

WINDSHIELD WASHER FLUID LEVEL:

Windshield washer fluid container is located behind the front right hand side panel and its filler neck is provided near auxiliary tank in the engine compartment.

NOTE

Do not add detergent or any solvent in the windshield washing water.

For location of Windshield Washer Container & filling cap , please refer respective Engine compartment pages.

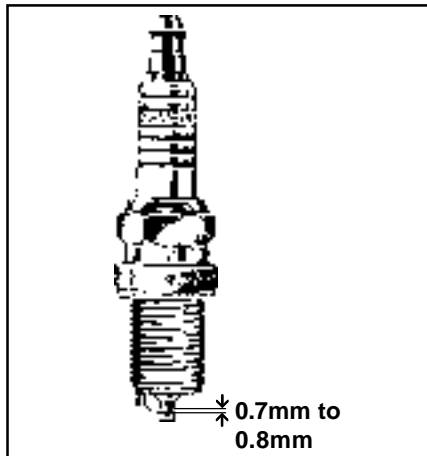
SPARK PLUG (PETROL) :

Spark Plug - BOSCH
 Spark Plug No. - FR6 DC4
 Spark Plug Gap - 0.7 mm to 0.8 mm

You should inspect the spark plugs periodically for carbon deposits. When carbon accumulates on the spark plug, a strong spark will not be produced. Remove carbon deposits using a spark plug cleaner.

Spark Plug Replacement :

1. Clean up any dirt or oil that is collected around the spark plug caps.
2. Pull out the spark plug cables by gripping at the connector.
3. Remove the spark plug with the help of a special socket.
4. Check and adjust the gap, it should be 0.7 mm to 0.8 mm.
5. Replace the spark plug if the gap is more than 1.2 mm.
6. Fix the spark plug and tighten it to the torque of 25 Nm (dry).
7. Fit the spark plug cable, until a 'click' sound is heard. Repeat the procedure for the other spark plugs.

NOTICE

Tighten the spark plug carefully. Overtightening can damage the threads in the cylinder head. A loose spark plug or loose spark plug cable can affect combustion and cause damage to engine and catalytic converter.

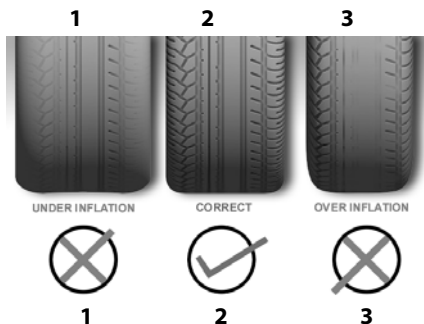
TYRES :

1.	Under inflation	Excessive Side Tread Wear
2.	Correct Tyre Tyre Wear	Pressure Uniform
3.	Over inflation	Excessive Centre Tread Wear

Check for inflation and condition of your vehicle tyres periodically.

Inflation :

Check the pressure in the tyres when they are cold.

You should have your own tyre pressure gauge and use it at all times. This makes it easier for you to tell if pressure loss is caused by a tyre problem and not by variation between gauges.

Keeping the tyres properly inflated gives you the best combination of riding comfort, handling, tyre life and better fuel efficiency.

Over inflation of tyres makes the vehicle ride bumpy and harsh. Tyres are more prone to uneven wear and damage from road hazards.

Under inflated tyres reduce your comfort in vehicle handling and are prone to failures due to high temperature. They also cause uneven wear and more fuel consumption.

Recommended Tyre Pressures

Veh Condition	Wheels	TYRE PRESSURE	
		PSI	Bar
Unladen	FAW	30-35	2.1-2.4
	RAW	28-32	1.9-2.2

NOTE

Lower air pressure (30, 28 psi is recommended if you prefer riding comfort.

NOTE

Every time you check inflation pressure, you should also examine tyres for damage, trapping of foreign objects in the treads and wear.

The recommended tyre pressure is mentioned as a permissible range in which tyre pressure can be adjusted. The higher value is recommended for getting better fuel economy and lower value is for better ride comfort.

For correct tyre pressure, please refer to sticker on right hand side "B" pillar below the chassis number.

NOTE

- If you notice bumps or bulges in the tread or the side of the tyre, replace the tyre.
- If there are cuts, splits or cracks in the side of the tyre, replace the tyre.
- Replace tyre if excessive tread wear or non uniform tyre wear is noticed.

Repairing a Tyre :

Mark the tyre position suitably (if original colour dot mark is not visible) with respect to valve stem hole to ensure that the tyre is refitted in the original location on the wheel rim.

Ensure that balancing weights are not disturbed during removal of tyres.

Check the balance weight prior to the removal of the tyre. If found loose, mark its location on the rim and refit properly.

Balance the wheel after every dismantling and assembly of tyre on the wheel rim.

While fitting wheels on the vehicle ensure that wheel pins are free from dust, scratches, dirt, dents, etc.

NOTE

Do not apply any oil on the wheel pins. Wipe off the oil if present.

Special care for tubeless tyres :

1. While removing tyre from wheel rim and mounting it back on wheel rim, take precautions not to damage tyre bead. Use tyre removal and assembly machines. Damage or cut on tyre bead may cause gradual loss of air and deflation of tyre.

2. Do not scratch inside of tubeless tyre with metallic or sharp object. Tubeless tyres are coated with impermeable layer of rubber from inside which holds the air inside the tyre. Removal of this layer due to scratching may cause gradual loss of air and deflation.
3. If wheel rim gets damaged in service, get the wheel rim repaired/ replaced immediately. Running the vehicle with damaged rim may cause deflation of tyre and subsequent dislodging of tyre from rim.
4. Maintain recommended inflation pressure. Over-inflation, in particular, may cause puncture or bursting of tyre.

NOTE

Life and wear pattern of tyres depends on various parameters like tyre pressure, wheel alignment, wheel balancing, tyre rotation, etc.

It also largely depends on car speed, load carried, usage, driving habits, road conditions, tyre quality, etc. In case fault is suspected to be due to poor quality of tyres, the same may be taken up with concerned tyre manufacturer.

Tyre Rotation :

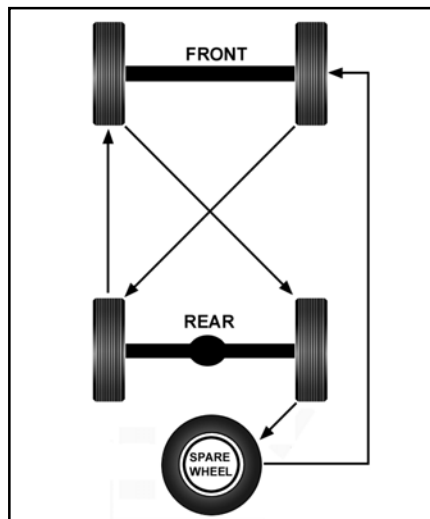

To help increase tyre life and distribute wear more evenly you should have tyres rotated at specified intervals or earlier depending on the operation of vehicle.

The illustrations shows how to rotate tyres when normal spare wheel is included in tyre rotation.

Wheel alignment :

Incorrect wheel alignment causes excessive and uneven tyre wear. Check wheel alignment at specified intervals. Wheel alignment values are given below :

	Front	Rear
Caster	$3.1' \pm 45'$	---
Camber	$30' \pm 30'$	$-52' \pm 1^0$
Toe in	-	$12' \pm 15'$
Toe Out	$0' \text{ to } -13'$	-

Check and maintain tyre pressure periodically to obtain longer tyre life.

Wheel Balancing :

Wheels of your vehicle are balanced for better ride comfort and longer tyre life. Balancing needs to be done whenever tyre is removed from rim.

1. Permissible imbalance for tyre with rim = 250 gm-cm max.
2. Total balance weight should be within 140 gms on each side.
3. Relocate the tyre if the weight required to balance is more than 140 gm.
4. Balance weights are available from 10 gms to 140 gms in steps of every 10 gms and from 15 gms to 135 gms in steps of every 10 gms.
5. Do not use more than one balance weight on one side.

BATTERY

BATTERY :

Check the battery for proper electrolyte level and corrosion on the terminals.

1. Check the battery for electrolyte level against the marking on the battery outer case.
2. Check the battery terminals for corrosion (a white or yellowish powder). To remove it, cover the terminals with a solution of baking soda. It will bubble up and turn brown.
3. When this stops, wash it off with plain water. Dry off the battery with a cloth or paper towel.
4. Coat the terminals with petroleum jelly to prevent future corrosion.

Use a proper wrench to loosen and remove cables from the terminals.

Always disconnect the negative (-ve) cable first and reconnect it last.

Clean the battery terminals with a terminal cleaning tool or wire brush.

Reconnect and tighten the cables, coat the terminals with petroleum jelly.

Ensure that the battery securely mounted.

If you need to connect the battery to a charger, disconnect both cables to prevent damage to the vehicle's electrical system.

NOTE

During normal operation, the battery generates gas which is explosive in nature. A spark or open flame can cause the battery to explode causing very serious injuries.

Keep all sparks and open flames and smoking materials away from the battery.

Getting electrolyte in your eyes or on the skin can cause severe burns. Wear protective clothing and a face

shield or have a skilled technician to do the battery maintenance.

The battery contains sulphuric acid (electrolyte) which is poisonous and highly corrosive in nature.

ROUTINE SERVICE BY OWNER OF THE VEHICLE :

We highly recommend that the following items are to be inspected at least once in a week.

1. Engine Oil Level
2. Engine coolant Level
3. Brake Fluid Level
4. Washer Fluid Level
5. Battery
6. Tyre inflation pressure

Do it Yourself Service

Improper or incomplete service may result in problems.

Several maintenance procedures can be done only by a qualified service technician with special tools. Improperly done 'do-it- yourself' maintenance during the warranty period may affect warranty coverage. If you're unsure about any servicing

or maintenance procedure, have it done by a **TATA MOTORS** Authorized Dealer / TASC.

WARNING**Maintenance procedures:**

Performing maintenance work on a vehicle can be dangerous. You can be seriously injured while performing some maintenance procedures. If you lack sufficient knowledge and experience or the proper tools and equipment to do the work, have it done by qualified technician.

SERVICE INSTRUCTIONS

The **TATA INDICA VISTA** has been manufactured to give you economical and trouble free performance. To achieve this please follow the instructions as stated.

Your vehicle is entitled to four free services (labour only). The free service coupons are attached to the sales invoice. Please present these coupons to the servicing dealer while availing free services.

- 1st free service** - At 1000-1500 km. OR 1 month whichever is earlier
- 2nd free service** - At 5000-5500 km. OR 6 months whichever is earlier
- 3rd free service** - At 15000-15500 km. OR 12 months whichever is earlier
- 4th free service** - At 30000-30500 km. OR 24 months whichever is earlier

All services other than free services are chargeable.

Servicing of the vehicle can be done at any **TATA MOTORS** Authorised Dealer Workshop, **TATA MOTORS** Authorised Service Centre (TASC) or **TATA MOTORS** Authorised Service Point (TASP). The details of their locations are given in this manual.

Warranty claims can be settled by any **TATA MOTORS** Authorised Dealer for all failures, while all warranty claims excluding the consideration on the replacement of major aggregates, can be settled by any TASC which is authorised for handling warranty claims. TASPs will not handle warranty repairs.

SR. NO.	MAINTENANCE SCHEDULE OPERATIONS	FREQUENCY (IN KMS)	1000-1500	5000-5500	10000- 10500	20000-20500	30000-30500	40000-40500	50000-50500	60000-60500	70000-70500	80000-80500	90000-90500	100000-100500
			1	6	12	24	36	48	60	72	84	96	108	120
	GENERAL (TDi / Quadrajel / Safire)	Period in months	1	6	12	24	36	48	60	72	84	96	108	120
1	Wash the vehicle & Clean Condenser Fins	EVERY Service	•	•	•	•	•	•	•	•	•	•	•	•
2	Drain water from Fuel Filter Bowl (applicable for TDi / Quadrajel *) * Whenever indicator comes 'ON'	EVERY Service	•	•	•	•	•	•	•	•	•	•	•	•
3	Check & Top up Fluids (If required):Coolant, Brake Fluid, Battery Electrolyte, Wind Screen washer fluid, Power Steering Oil (If fitted)	EVERY Service	•	•	•	•	•	•	•	•	•	•	•	•
4	Check fuel lines for leakage,	EVERY Service	•	•	•	•	•	•	•	•	•	•	•	•
5	Check clutch pedal height and cable	EVERY Service	•	•	•	•	•	•	•	•	•	•	•	•
6	All standard checks as per job card	EVERY Service	•	•	•	•	•	•	•	•	•	•	•	•
7	Check rubber boots & bushes for damages	30,000					•			•			•	
	ENGINE (TDi)													
1	Clean air filter element (more frequently for vehicle operating as TAXI) (5000 & there after every service)	10,000		•	•	•	•	•	•	•	•	•	•	•
2	Change engine oil and Oil filter (10,000 km Or 12 Months whichever is earlier)	10,000			•	•	•	•	•	•	•	•	•	•
3	Change fuel filter element	10,000			•	•	•	•	•	•	•	•	•	•
4	Check all Drive belts for tension, adjust if necessary (5000 & there after every service)	10,000		•	•	•	•	•	•	•	•	•	•	•
5	Check for the DTCs in the "Engine Control Unit". Take corrective action . if necessary. Clear the DTCs (5000 & there after every service)	10,000		•	•	•	•	•	•	•	•	•	•	•
6	Replace air filter element (more frequently for vehicle operating as TAXI)	40,000						•				•		
7	Change coolant (40,000 km or two years whichever is earlier)	40,000						•				•		
8	Replace timing belt	100,000												•

SR. NO.	MAINTENANCE SCHEDULE OPERATIONS	FREQUENCY (IN KMS)	1000-1500	5000-5500	10000- 10500	20000-20500	30000-30500	40000-40500	50000-50500	60000-60500	70000-70500	80000-80500	90000-90500	100000-100500
			1	6	12	24	36	48	60	72	84	96	108	120
	ENGINE (QUADRAJET)	Period in months	1	6	12	24	36	48	60	72	84	96	108	120
1	Clean air filter element (more frequently for vehicle operating as TAXI) (5000 & there after every service)	10,000		•	•	•	•	•	•	•	•	•	•	•
2	Change engine oil and Oil filter (10,000 km Or 12 Months whichever is earlier)	10,000			•	•	•	•	•	•	•	•	•	•
3	Check for the DTCs in the "Engine Control Unit". Take corrective action if necessary. (5000 & there after every service)	10,000		•	•	•	•	•	•	•	•	•	•	•
4	Change fuel filter	20,000				•		•		•		•		•
5	Replace air filter element (more frequently for vehicle operating as TAXI)	40,000						•				•		
6	Change coolant (40,000 km or two years whichever is earlier)	40,000						•				•		
7	Check DTC and clear all faults and erase the codes	EVERY Service	•	•	•	•	•	•	•	•	•	•	•	•
	ENGINE (SAFIRE)													
1	Clean air filter element (more frequently for vehicle operating as TAXI) (5000 & there after every service)	10,000		•	•	•	•	•	•	•	•	•	•	•
2	Change engine oil and Oil filter (10,000 km Or 12 Months whichever is earlier)	10,000			•	•	•	•	•	•	•	•	•	•
3	Replace fuel filter	10,000		•	•	•	•	•	•	•	•	•	•	
4	Check all external Drive belts for tension, adjust if necessary (5000 & there after every service)	10,000			•	•	•	•	•	•	•	•	•	•
5	Replace Spark Plugs and Check Ignition Cable	30,000					•			•			•	
6	Check for the DTCs in the "ECU". Take corrective action if necessary. Clear the DTCs. (5000 & there after every service)	10,000		•	•	•	•	•	•	•	•	•	•	•
7	Replace air filter element	40,000						•				•		

SR. NO.	MAINTENANCE SCHEDULE OPERATIONS	FREQUENCY (IN KMS)												
			1000-1500	5000-5500	10000- 10500	20000-20500	30000-30500	40000-40500	50000-50500	60000-60500	70000-70500	80000-80500	90000-90500	100000-100500
		Period in months	1	6	12	24	36	48	60	72	84	96	108	120
8	Change coolant (40,000 km or two years whichever is earlier)	40,000						•				•		
9	Replace timing belt	100,000												•
	TRANSAXLE													
1	Check oil level and top up if necessary (Quadrajel & Safire)	80,000										•		
2	Change transaxle oil (TDi)	20,000				•		•		•		•		•
	BRAKES													
1	Check front brake pads and rear brake linings. Replace if necessary	20,000				•		•		•		•		•
2	Change brake fluid (40,000 kms or 2 years whichever is earlier) Check brake system components for Leakages	40,000						•				•		
	WHEELS and TYRES													
1	Rotate tyres	20,000				•		•		•		•		•
	FRONT and REAR SUSPENSION													
1	Check and Adjust Wheel alignment and Balancing if required	20,000				•		•		•		•		•
	STEERING													
1	Change power steering oil	100,000												•
	ELECTRICAL													
1	Check headlamp focussing and adjust if necessary	30,000						•		•			•	
	A.C. SYSTEM													
1	Check Airconditioning / HVAC System for satisfactory performance, clean A/c Filter	EVERY Service	•	•	•	•	•	•	•	•	•	•	•	•

* Precautions to be taken while cleaning Engine Compartment: It is recommended to use Dry Low pressure Compressed Air and NOT Pressurised WATER

FUEL (DIESEL) :

Normal grade BS-III & BS IV compliant diesel conforming to IS1460 or EN 590 or equivalent is recommended to be used as fuel. It is always recommended to use BS-III & BS IV Compliant fuel to get optimum emission performance.

Do not use premium diesels available in the market for **example extra premium / Turbojet etc.**

Recommended Fuel Specification.

Parameter	Unit	BS III	BS IV
1 Cetane Number (min)	CN	51	51
2 Sulphur content mg/kg	3	50	50
3 Lubricity (HFRR) micon		460	460

NOTICE

Where oxidation catalytic converter is fitted, it is mandatory to use Diesel fuel with sulphur contents as given above. Use of any other diesel fuel can increase the pollutants.

At very low temperature, fluidity of diesel may become insufficient due to paraffin separation. It is therefore necessary to mix supplementary fuel with summer or winter grade diesel. The supplementary fuel to be used is kerosene or

aviation turbine fuel. Ratio for mixing of supplementary fuel and diesel are shown in the table.

Ambient Temperature upto Deg C.	Percentage	
	Summer grade diesel	Supplementary fuel
Upto 0	100	0
0 to -10	70	30
-10 to -15	50	50

Care should be taken that diesel and supplementary fuel are thoroughly mixed before filling.

Ambient Temperature upto Deg C.	Percentage	
	Winter grade diesel	Supplementary fuel
Upto -15	100	0
-15 to -20	70	30
-20 and below	50	50

WARNING

Do not mix gasoline or alcohol with diesel. This mixture can cause explosion.

FUEL (PETROL) :

Unleaded regular grade petrol conforming to IS2796-1994/ DIN 51607 (or equivalent) and RON not less than 91 (BSIV)/ RON not less than 87 (BS-III) is recommended to be used as fuel. It is always recommended to use correct fuel to get optimum emission performance.

NOTE

Always use petrol of a correct specification in a vehicle fitted with catalytic converter. Even single fill of leaded petrol will seriously damage the catalytic converter.

LUBRICANTS :

Engine oil : Recommended grade of engine oil conforming to SAE 15W40 API-CH-4 + MB 228.3 specification and range of ambient temperature at which these can be used are given in the table below :

Ambient temp. in deg.C	Engine oil grade
-10 deg. & above	SAE 20W/40 or SAE 20W/50
-15 deg. to 40 deg.	SAE 15W/40 or SAE 15W/50
-20 deg. to 40 deg.	SAE 10W/40 or SAE 10W/50
-35 deg. to 40 deg.	SAE 5W/30

Brand names : As per chart given in the manual.

Transaxle : Use recommended brand of 80W API GL-4 gear oil (MPFI) and Semi-synthetic SAE 75W85 (Quadrajel).

Grease for axle bearings : Lithium base grease IPOL IPLEX LC Grease 2

Brake fluid : SAE J 1703, DOT 3

Power Steering : ATF Dextron III - 210

COOLANTS :

Presence of dirt in coolant chokes up passages in radiator, cylinder head and crankcase, thereby causing overheating of engine.

To prevent rust formation and freezing of coolant inside the passages of radiator, crankcase and cylinder head use premixed coolant as recommended. It is recommended that the entire cooling system should be drained and filled with fresh premixed coolant.

Engine coolant antifreeze coolant as per class II, JIS K2234

Windscreen Washer Antifrost

Make - Antifrost- K
 Concentration - 1 : 5 For 0°C
 1 : 1 For 10°C
 2 : 5 For 16°C
 1 : 0 For 37°C

NOTE : We strongly recommend to refill your car's engine coolant only at a TATA Authorised service centre.

PLEASE USE ONLY FOLLOWING GENUINE OILS, COOLANTS , LUBRICANTS , ANTI RUST and SOUND DEADENING COATS, WINDSCREEN SEALANT, ADHESIVES and FUEL ADDITIVES BRANDED BY TATA MOTORS FOR OPTIMUM PERFORMANCE OF YOUR TATA INDICA VISTA

ITEM	SPECIFICATION	COMPANY AND BRAND	QTY
ENGINE OIL	SAE 15W40 API-CH4 + MB228.3	CASTROL - GTX Diesel HPCL - HP MILCY No.1 TGO EXXON Mobil - Super 1000 TM	5.5 Litres (TDi) 3.2 Ltrs (Quadrajt) 2.6 Ltrs (Safire 65PS) 3.2 Ltrs (Safire 90PS)
COOLANT (Pre-mixed) (Antifreeze agent + Soft water 50 : 50 ratio)	Class II / JIS K2234	S-CCI - Golden Cruiser Premium 1400 M HPCL - HP Thanda Raja P CASTROL - Radicool	5.4 Litres
TRANSAXLE (TDi)	Monograde SAE 80 W API - GL4	HPCL - HP Gear Oil EP 80 TATA Genuine oil	1.8 Litres
TRANSAXLE (QUADRAJET/ SAFIRE)	Semi-Synthetic SAE 75W85	PETRONAS Tutela ZC75FF	2.2 Litres
POWER STEERING OIL	ATF Dexron III -210	CASTROL - Castrol TQ DEX III HPCL - HP ATF DEX III EXXON Mobil - Mobil Multipurpose ATF	1.0 Litres
BRAKE / CLUTCH FLUID	SAE J 1703, DOT 4	CASTROL - Universal Brake Fluid DOT 4 S-CCI - Golden Cruiser Tata Genuine Brake Fluid DOT 4	As required

1. ENGINE

Model	TATA 475 IDT 1.4 TDi	1.3 QUADRAJET	TATA SAFIRE (65 PS)	TATA SAFIRE (90 PS)
Type	Four stroke, 4 cylinder, water cooled, indirect injection type, Turbo Intercooled diesel engine.	Four stroke, 4 cylinder, water cooled, Direct injection type, 1.3 Quadrajeto Turbo Intercooled diesel engine.	Four stroke, 4 cylinder, water cooled, Multi Point Fuel Injection (MPFI), 8V	Four stroke, 4 cylinder, water cooled, Multi Point Fuel Injection (MPFI), 16V
No. Of Cylinders	4 Inline	4 Inline	4 Inline	4 Inline
Bore / Stroke	75 mm x 79.5 mm	69.4 mm x 82 mm	72 mm X 72 mm	72 mm X 84 mm
Capacity	1405 cc .	1248 cc	1172 cc	1368 cc
Max. Engine Output	52 kW @ 4500 rpm	55.3 kW @ 4000 rpm	48 kW @ 5500 rpm (65 PS)	66.5 kW @ 6000 rpm (90 PS)
Max. Torque	135.4 Nm @ 2500 rpm	190 Nm @ 1750-3000 rpm	94 Nm @ 3000-3500 rpm	116 Nm @ 4750 rpm
Firing Order	1 - 3 - 4 - 2	1 - 3 - 4 - 2	1 - 3 - 4 - 2	1 - 3 - 4 - 2
Engine Oil Capacity	5.5 Litre.	3.2 Litre	2.6 Litres	3.2 Litre

2. CLUTCH

Type	Single Plate, Dry friction diaphragm			
Outside dia. of clutch lining	200 mm	215 mm	200 mm	200 mm
Friction Area	324 sq.cm	386 sq.cm.	324 sq.cm.	324 sq.cm.

3. TRANSAXLE

Type	TA-65 STAR (5 forward,1 Reverse)	C 549 (5 forward,1 Reverse)	C 549 (5 forward,1 Reverse)	C 549 (5 forward,1 Reverse)	
Gear Ratio	1st	3.42	3.909	4.273	4.273
	2nd	1.95	2.238	2.238	2.238
	3rd	1.13	1.444	1.520	1.520
	4th	0.78	1.029	1.156	1.156
	5th	0.636	0.767	0.919	0.872
	Reverse	3.58	3.909	3.909	3.909
	Final Drive	4.4	3.563	3.733	4.4

	TDi	QUADRAJET	SAFIRE (65PS)	SAFIRE (90PS)
--	-----	-----------	-----------------	-----------------

4. STEERING

Type	Hydraulic power assisted, Rack & Pinion steering gear with collapsible steering column			
Steering wheel	380 mm			

5. SUSPENSION

Front	Independent, Lower wishborne, McPherson Strut type			
Rear	Semi-Independent, Twist beam with coil spring and shock absorbers			
Antiroll Bar	At front			

6. BRAKES

Service Brakes	Vacuum assisted independent dual circuit, diagonal split hydraulic brakes through tandem master cylinder			
Front Brake	240 mm Disc Brakes	240 mm Disc Brakes	231 mm Disc Brakes	240 mm Disc Brakes
Rear Brake	200 mm Dum Brakes	200 mm Dum Brakes	180 mm Drum Brakes	200 mm Drum Brakes
Parlking Brake	Lever type, Console mounted, cable operated mechanical linkages acting on rear wheels			
Pressure Conscious Reduction Valve (PCRv)	Provided for rear brakes. No 'PCRv' for vehicles fitted with ABS			

7. ANTI-LOCK BRAKING SYSTEM (ABS)

System	ABS 8.1			
Type	4 Channel, 4 Wheel Speed Sensor integrated ABS			
Control	Microprocessor based ECU			

8. WHEELS & TYRES

Type	175/65 R 14 82T Tubeless	175/65 R 14 82T Tubeless	175/70 R 13 82T Tubeless	175/65 R 14 82T Tubeless
Wheel Rim	5J X 14" steel rims	5J X 14" steel rims	4.5J X 13" steel rims	5J X 14" steel rims
No. of wheels	Front -2, Rear-2, Spare-1			

	TDi	QUADRAJET	SAFIRE (65PS)	SAFIRE (90PS)
--	-----	-----------	-----------------	-----------------

9. FUEL TANK

Capacity	37 Litres
-----------------	-----------

10. BODY

Type	Hatch Back, Five doors, Steel monocoque body, Passenger Car
-------------	---

11. ELECTRICAL SYSTEM

System Voltage	12 volts (-ve earth)			
Alternator capacity	12V, 90 Amp	12V, 110 Amp	12V, 102 Amp	12V, 110 Amp
Battery	12V, 50 Ah	12V, 50 Ah	MF 40, 12V, 35 Ah	12V, 44 Ah

12. PERFORMANCE

Max. Speed	153 kmph	158 kmph	145 kmph	
-------------------	----------	----------	----------	--

13. MAIN CHASSIS DIMENSIONS AS PWER ISO:612 IN MM (NOMINAL) (TOLERANCE AS PER INTERE UROPE STVZO)

Wheel Base	2470
Track Front	1450
Track Rear	1440
Front Overhang	785 (Vista) / 840 (Vista Tech)
Rear Overhang	540
Overall Length	3795 (Vista) / 3850 (Vista Tech)
Max. Width	1695 (Over Body) / 1920 (Over ORVM)
Overall Height (Unladen)	1550
Min.Turning Circle Dia.	10 m
Min.Turning Clearance Circle	10.6 m
Ground Clearance	165

	TDi	QUADRAJET	SAFIRE (65PS)	SAFIRE (90PS)
--	-----	-----------	-----------------	-----------------

14. WEIGHTS (KG) (TOLERANCE AS PER INTEREUROPE STVZO)

Complete car cew Weight wheel & tools)	1135	1140	1075	1100
Gross Car Weight	1560	1565	1505	1505

15. LUGGAGE SPACE

Net inside loading space	232 Litres
-------------------------------------	------------

Vehicle Dimensions - VISTA

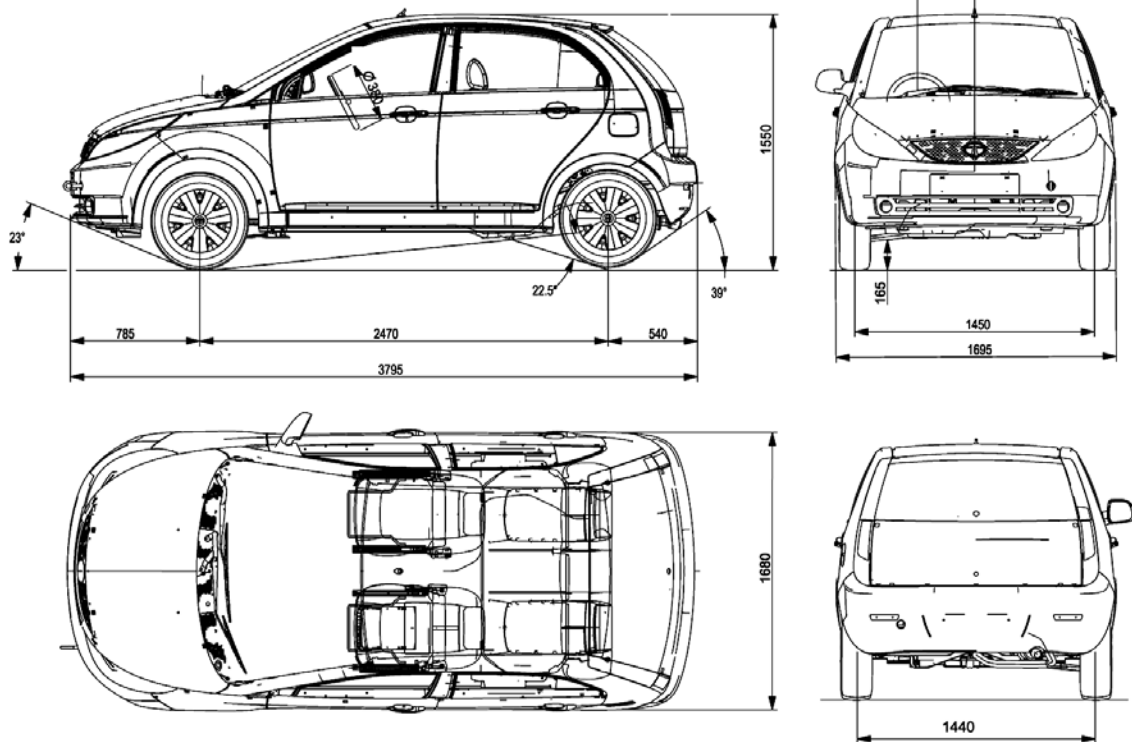

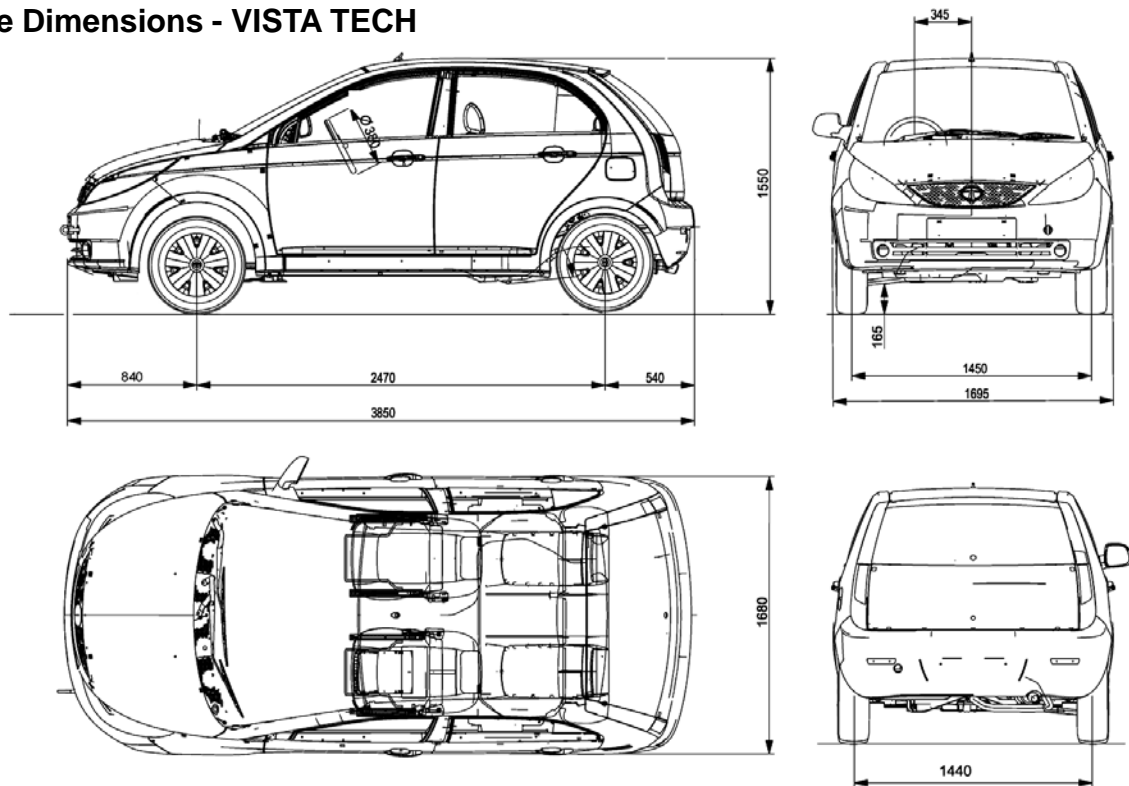
Vehicle Dimensions - VISTA TECH



Chassis No. on 'B' pillar

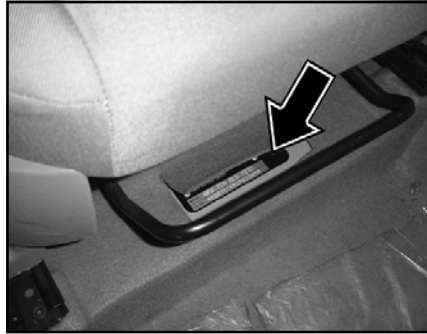

Chassis No. below Driver's seat

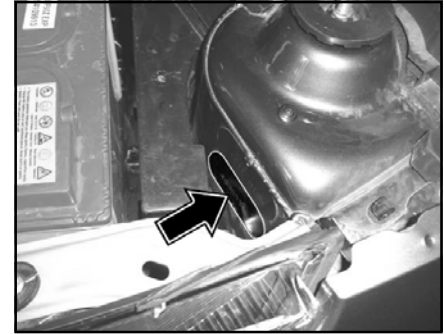

Cab No.

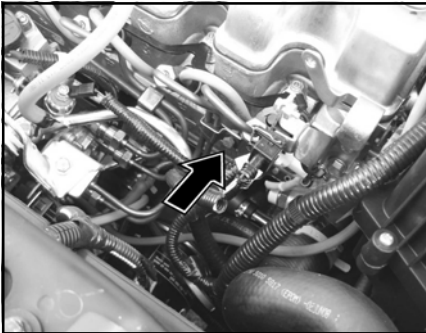

Engine Number (TDi)

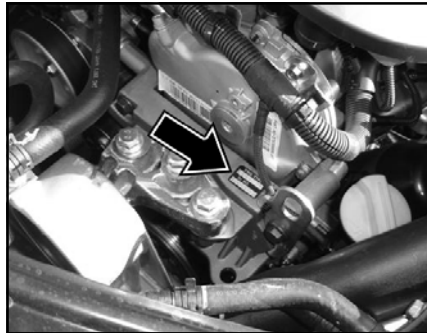

Engine Number (Quadrajel)

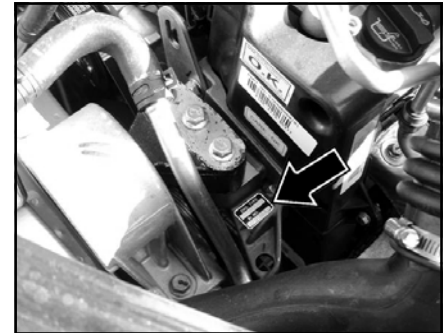

Engine Number (Safire)

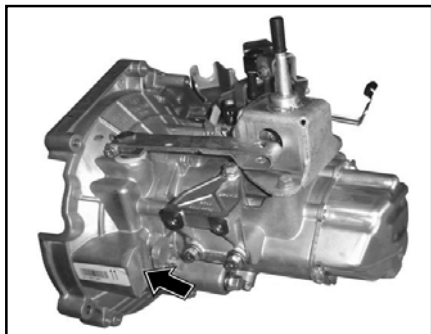

Transaxle (TA-65 STAR) No.

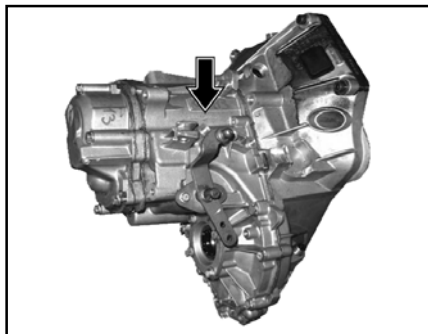

Transaxle (C-549) No.

CAR CARE :

Your Car is subjected to many external influences such as climate, road conditions, industrial pollution and proximity to the sea. These conditions demand regular care of the Car body. Dirt, insects, bird droppings, oil, grease, fuel and stone chippings should be removed as soon as possible.

WASHING :

Following these tips while washing your car.

HAND WASH :

1. Always wash your car in shade and the surface is at room temperature.
2. Wash with mild car wash soap like 'Car Shampoo' and use a soft bristle brush, sponge or soft cloth and rinse it frequently while washing. to avoid scratches.

3. To avoid scratches, please wear soft gloves . Remove finger rings, nails, wrist watch while washing.
4. To remove stubborn stains and contaminants like tar, use turpentine or cleaners like 'Stain remover' which are safe for paint surfaces.
5. Avoid substances like petrol, diesel, kerosene, benzene or other solvents that cause damage to paint.
6. Dry your car thoroughly to prevent any damp spots.
7. Rinse all surfaces thoroughly to prevent any traces of soap and other cleaners as this may lead to the formation of stains on the painted surface later.

WARNING

Do not direct high pressure washer fluid/ water jets (Pressure above 0.5

Bar) at electrical devices and connector during wasing. This is to prevent malfunction / failure of electrical system due to water ingress.

After drying the Car, inspect it for chips and scratches that could allow corrosion to start. Apply touch up paint where necessary.

Cleaning of Carpets :

Vacuum clean the carpet regularly to remove dirt. Dirt will make the carpet wear out faster. Periodically shampoo the carpet to keep it looking new.

Use carpet cleaners (preferably foam type). Follow the instructions that come with the cleaner. Apply it with a sponge or soft brush. Keep the carpeting as dry as possible by not adding water to the foam.

NOTE

Avoid wiping of painted surface in dry condition as it may leave scratches on the painted surface.

Cleaning of Windows, Front and Rear Glasses :

Clean the windows inside and outside with commercially available glass cleaners.

This will remove the haze that builds up on the inside of windows. Use a soft cloth or paper towels to clean all glass and plastic surfaces.

RFID TAG is pasted on front windshield from inside. It enables Electronic toll collection.



DO NOT TRY TO PEEL OFF RFID TAG

TML PART NO. 2816 5420 99 05
VENUS WINDSHIELD MOUNT AVI TAG

NOTE

Do not attempt to rip or tamper the tag. It will disable the functionality of the tag.

WAXING :

Waxing and polishing is recommended to maintain the gloss and wet-look appearance of your paint finish.

1. Use a good quality polish and wax for your car.
2. Re-wax your car when the water does not slip off the surface and collects over the surface in patches.

POLISHING :

Polishes and cleaners can restore shine to the painted surface that has oxidised and become dull. They normally contain mild abrasives and solvents that remove the top layer of

the finish coat. Polish your Car, if the finish does not regain its original shine after using wax.

PAINT CARE :

FOLLOWING GUIDELINES WILL HELP YOU TO PROTECT YOUR CAR FROM CORROSION EFFECTIVELY.

PROPER CLEANING :

In order to protect your car from corrosion it is recommended that you wash your car thoroughly and frequently in case :

- There is an heavy accumulation of dirt and mud especially on the underbody.
- It is driven in areas having high atmosphere pollution due to smoke, soot, dust, iron dust and other chemical pollutants.
- It is driven in coastal areas.
- The underbody must be thoroughly pressure washed after every three months.

In addition to regularly washing your car, the following precautions need to be taken.

PERIODIC INSPECTION :

- Regularly inspect your car for any damage in the paint film such as deep scratches and immediately get them repaired from an authorised service outlet, as these defects tend to accelerate corrosion.
- Inspect mud liners for damages.
- Keep all drain holes clear from clogging.

PROPER PARKING :

- Always park your car in shade to protect it from harsh sunlight or in a well-ventilated garage so that there is no dampness on any part of the car

WIPER CARE :

Wiper blade attack angle on windshield glass should be 90° i.e. perpendicular.

Remove wiper blade and root wiper arm on windshield glass in the centre position. Check the gap between arm strip and glass.

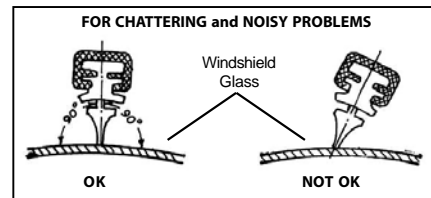

VEHICLE PARKING AT ONE PLACE FOR LONG DURATION (Non use maintenances) :

If you want to park your car at one place for long duration, following care is to be taken :

1. Park the Car in covered, dry and if possible well-ventilated premises. Engage a gear.
2. Remove the battery terminal cables (first remove the cable from the negative terminal).
3. Make sure the hand brake is not engaged.
4. Clean and protect the painted parts using protective wax.
5. Clean and protect the shiny metal parts using commercially available special compounds.
6. Sprinkle talcum powder on the rubber windscreen wiper and lift them off the glass.
7. Slightly open the windows.
8. Cover the Car with a cloth or perforated plastic sheet. Do not use sheets of imperforated plastic as they do not allow moisture on the Car body to evaporate.
9. Inflate the tyres to 0.5 bar above the normal specified pressure and check it at regular intervals.
10. Check the battery charge every six weeks.
11. Do not drain the engine cooling system.

TATA MOTORS recommends the purchase of Extended its warranty program.

Coverage : Mechanical + Electrical + Emission

Benifits :

- Insures you against unforeseen break down repair bills.
- Documentation is simple and hassle free.
- Near cashless & speedy claim settlement.

Term :

- **24 + 12 or 150000 kms** whichever occurs first
- **24 + 24 or 150000 kms** whichever occurs first

Extended Warranty available in the dealership from where you have purchased your vehicle. We strongly recommend purchase of Extended Warranty at time of purchase of your vehicle. Surcharge applicable on purchase of Extended Warranty after 90 days of purchase of vehicle. **Extended Warranty can be availed till 421 days from date of purchase of vehicle.** The Dealer Service Marketing Executive shall explain to you the Terms and conditions, Coverage and Owner's responsibility.

Extended Warranty Booklet & Cover Note :

The Extended Warranty booklet and cover note is the basis of the contract between **TATA MOTORS LIMITED** and the Owner of the vehicle shown on the Extended Warranty booklet. The Customer to retain this booklet and the same to be produced to the dealer while claiming benefits under Extended Warranty.



Note :

- The 12 / 24 month extended warranty does not follow the 24 month Manufacturer's warranty.
- The extended warranty comes into force once the manufacturer's warranty expires e.g. after 24 Months.
- It is more restrictive as by the time it comes into force the vehicle is already 24 months old.

What is covered ?

- Mechanical / Emission / Electrical break down as defined in this warranty and confirmed by the dealer within the stipulated terms and conditions.
- Tata Motors dealer shall either repair or replace any part found to be defective with a new part or an equivalent at no cost to the owner for parts or labour.
- Such defective parts which have been replaced will become property of **TATA MOTORS LIMITED**.
- Comprehensive list of parts covered is mentioned in the page 9-12 of the Extended Warranty Booklet.

What is not covered ?

Please refer the Extended Warranty Booklet for details of the exclusion list.

Owner's Responsibility :

- Proper use, maintenance and care of the vehicle in accordance with the instructions contained in the Owner's Manual and Service Booklet. The records of the same to be ensured in Owner's Manual.
- Retention of maintenance service bills.

I / We have been explained the Terms and conditions, Coverage and Owner's responsibility by the Dealer Service Marketing Executive.

I wish to avail / Do not wish to avail extended warranty policy.

Customer's Sign

Dealer's Sign

IFTEX / BG / BARDAHL Fuel Additive :***Fuel Additive with multiple benefits***

- For diesel cars: Iftex System D
- For Petrol cars: Iftex System G

Benefits:

- Cleans injector and fuel system.
- Maintains peak engine performance.
- Saves diesel / petrol and maintenance cost.
- Reduces smoke and harmful emission.
- Helps Smooth running of the engine
- Reduces deposit on intake manifold and combustion chamber.
- Reduces deposit on injector tips.

Approved for use in TATA VEHICLES. NOT RECOMMENDED FOR ON DICOR / QUADRAJET.

TREAT YOUR CAR TO EXPERIENCE, THE ULTIMATE PERFORMANCE

Directions of use :

- a) For Iftex, Use every 7000 kms for System G Extra / System D Extra. b) For System D / System G - Remove cap, squeeze lightly till dispenser fills to 10 ml mark. Add before filling up the tank. Use at the rate of 1 ml per litre of fuel. For best results, regular use is recommended.
- For BG, add one bottle to full fuel tank every 10000 kms. For Bardahl, add one bottle to full fuel tank every 3000 kms

I / We have been explained the Benefits of the Iftex Fuel additive by the Dealer Service Marketing Executive

I wish to buy / Do not wish to buy the Iftex Fuel Aditive

Customer Signature

Dealer Signature



Why are Corrosion Protection Waxes necessary?***Corrosion is caused by:***

Water / salt water acid rain & atmospheric fallouts.

Critical areas are:

Cavities: joints, crevices, spot welds, underbody

- Corrosion is the most important factor when we talk about the vehicle life. If you treat your car you can prolong the life.
- It is very dangerous to drive around in a corroded car.
- The corrosion creeps onto the car from the inside and from the outside. The most dangerous kind of corrosion is often not discovered until it is too late.

Benefits of Anti -Rust treatment :

- A professionally applied range of world class products offering real value to the new and used car customer.
- The treatment has been developed to withstand the harshest environmental and climatic conditions (rst. Pollutants, stone and gravel impact, etc)
- Insulate cabin space from external noises.
- Expensive tin work and Denting / Painting avoided.
- Higher resale value for the car.
- Higher safety – uncorroded vehicle
- Upto 60 months warranty & 10 free checkups available



Engine Wax Treatment :

Engine Wax is a beige coloured transparent lacquer coating on the engine compartment.

- Corrosion Prevention for the Engine compartment
- Neat, clean and New Look to Engine compartment
- No effect on MPFI vehicles
- Engine wax can withstand upto 200 degrees temp
- No need of cleaning the engine compartment with diesel once engine wax is sprayed
- Life of over a year

Sound Deadening System :

Door vibration deadeners - These pads when stuck on the insides of the sheet metal increase sheet metal rigidity, reduce vibrations and increase riding comfort.

- Used for reducing the sheet metal vibration in a vehicle.
- Product to be used once in the life of the vehicle - Life Time Warranty
- Effect is Life long i.e. until & unless pads are physically removed.
- Negligible increase in Weight & hence no effect on fuel consumption.
- Areas covered - four doors, rear quarter panels & dicky. In case of diesel vehicles, can be used in the bonnet.

TATA MOTORS has tied up with **M/s Wuerth** , **M/s Autokrom**, **M/s 3M India Ltd** & **M/s Bardahl** for these world class treatment at affordable prices. These treatments are available in all authorized workshops. The Dealer Service Marketing Executive will explain to you the benefits and terms and conditions of this treatment.

I / We have been explained the Benefits, Terms and conditions and the prices of these treatments by the Dealer Service Marketing Executive

I wish to avail / Do not wish to avail these treatment

Customer Signature

Dealer Signature

Vehicle Exterior Enrichment :***Why vehicles are painted?***

- For Corrosion protection of the metal surfaces.
- Ease of application from other corrosion protection treatments.
- Cheaper than other corrosion protection methods eg.galvanizing, anodizing.
- For decoration and identification.

Various Environmental Hazards affecting paints :

- Environmental hazards: destroy your vehicle's finish.
- Even as your new vehicle rolls off the assembly line, the paint is not protected.

The enemy :

Ultraviolet Rays, Pollution, Tree Sap, Bird Droppings, Car Wash Chemicals, Road Salt, Acid Rain.

Benefits: Vehicle Exterior Enrichment

- Removal of medium scratches, orange peel, oxidation , dust nibs etc & swirl marks from painted surface.
- Restoration of original gloss levels UV protection after gloss is restored.
- Cleaning & dressing of tyres, Bumpers & all exterior plastic moldings/trims.

Tata Motors has tied up with **M/s Autokrom, M/s 3M & M/s Wuerth** for this world class treatment at affordable prices. This treatment is available in all authorized workshops. The Dealer Service Marketing Executive will explain to you the benefits and terms and conditions of this treatment.

**WÜRTH**Auto
krom™

Vehicle Interior Enrichment

Why protect your new car's fabric interior ?

- Someone will soil your vehicle's fabric carpet or seats.
- A significant detractor from your vehicle's resale value.
- A permanent stain on your vehicle's interior fabric.

The enemy :

Drink Spills - Food Stains - Mud - Ultraviolet Rays Pets - Traffic

Benefits: Vehicle Interior Enrichment

- Removal of medium stains and dirt from all interior parts of the car i.e carpet, upholstery and roof lining.
- Cleaning of windshield and all windows (inside and outside)
- Dressing of all internal plastics (eg: door pad trims)and rubber parts.
- The treatment involves cleaning and dressing of All parts of the exposed interiors.
- Specialised protection for seat fabric from liquid spills.

TATA MOTORS has tied up with **M/s Wurth and M/s M/s Autokrom** for this world class treatment at affordable prices. This treatment is available in all authorized workshops. The Dealer Service Marketing Executive will explain to you the benefits and terms and conditions of this treatment.

I / We have been explained the Terms and conditions, Coverage and Owner's responsibility by the Dealer Service Marketing Executive.

I wish to avail / Do not wish to avail extended warranty

Customer's Sign

Dealer's Sign

Why de-carbonisation is required?

Carbon deposits accumulate over time in the entire fuel system, including the fuel lines, injector pump, fuel injectors, combustion chambers & intake valves. This causes rough idle, vibration at idle, loss of power, hesitation, misfire, decreased mileage, increased smoke, slowed throttle response.

Decarbonisation process is designed to remove these deposits

- Clean fuel injectors
- Clean throttle body
- Clean plenum and air-intake
- Clean intake valves and ports
- Remove combustion chamber deposits
- In maintaining correct balance of fuel and air in system



Resulting in

- Comprehensive clean-up of combustion chamber, induction system & fuel injector deposits
- Better fuel economy
- Increased engine performance and response
- Smooth Starts, idles and quieter run
- Better combustion & increased power
- Faster starting & warm-up
- Reduced emissions
- Reduced injector & pump wear, thereby resulting in savings in maintenance costs

It is approved for low sulphur diesel fuel and EGR equipped diesel engines

Please note: These are symptomatic treatments to be availed beyond 20000 kms and only when you have problems in your car as mentioned in first paragraph and are to be done only after **you give your consent** for carrying out these treatments

Engine Flush treatment helps in

- Safely and effectively cleaning and removing oxidised particles and fluid contamination left behind from previous oil changes
- Preventing further deposits
- Freeing sticky lifters and rings
- Chemically “tuning” the engine during driving
- Restoring pep and power
- Removing sludge from valve train
- Promoting fuel economy and improving overall engine operation

Special Products used for improving Compression

To fortify new oil and seal rings for optimum performance, special products from BG (RF7) and Bardhal (Special Duty) are added to new engine oil. This makes it suitable for petrol and diesel engine applications

Resulting in:

- Improved engine compression
- Increased power and increased fuel economy
- Reduced start-up wear
- Increased engine life, especially under severe service conditions
- Reduced emissions and oil consumption
- Improved power & performance of older engines
- Prevention of sludge, gum and varnish formation on engine parts both petrol & diesel engines

Please note: These are symptomatic treatments to be availed beyond 20000 kms and only when you have problems in your car as mentioned in first paragraph and are to be done only after you give your consent for carrying out these treatments

Tata Motors has tied up with **M/s HOEC Bardahl India Ltd and M/s BG** for these world class treatment at affordable prices. These treatments are available in all authorized workshops. The Dealer Service Marketing Executive will explain to you the benefits and terms and conditions of this treatment.

I / We have been explained the Benefits, Terms and conditions and the prices of these treatments by the Dealer Service

Marketing Executive

I wish to avail / Do not wish to avail these treatment

Customer's Sign

Dealer's Sign

We WARRANT each **Tata Indica Vista** car and parts thereof manufactured by us to be free from defect in material and workmanship subject to the following terms and conditions -

1. This warranty shall be for **24 months from the date of sale of the car or 75000 km whichever occurs earlier.**
2. Our obligation under this warranty shall be limited to repairing or replacing, free of charge, such parts of the car which, in our opinion, are defective, on the car being brought to us or to our dealers within the period. The parts so repaired or replaced shall also be warranted for quality and workmanship but such warranty shall be co-terminus with this original warranty.
3. Any part which is found to be defective and is replaced by us under the warranty shall be our property.
4. As for such parts as tyres, batteries, electrical equipment, Audio and / or Video equipment (if any) fuel injection equipment, etc. not manufactured by us but supplied by other parties, this warranty shall not apply, but buyers of the car shall be entitled to, so far as permissible by law, all such rights as we may have against such parties under their warranties in respect of such parts.
5. This warranty shall not apply if the car or any part thereof is repaired or altered otherwise than in accordance with our standard repair procedure or by any person other than from our sales or service establishments, our authorised dealers, service centres or service points in any way so as, in our judgement which shall be final and binding, to affect its reliability, nor shall it apply if, in our opinion which shall be final and binding, the car is subjected to misuse, negligence, improper or inadequate maintenance or accident or loading in excess of such carrying capacity as certified by us, or such services as prescribed in our Owner's Manual and Service Book are not carried out by the buyer through our sales or service establishments, our authorised dealers, service centres or service points.
6. This warranty shall not cover normal wear and tear or any inherent normal deterioration of the car or any of its parts arising from the actual use of the car or any damage due to negligent or improper operation or storage of the car. This warranty shall not apply to normal maintenance services like oils & fluid changes, head lamps focussing, fastener retightening,

- wheel balancing and alignment, tyre rotation, adjustment of valve clearance, fuel timing, ignition timing and consumables like bulbs, fuel filters & oil filters, etc. This warranty shall not apply to any damage or deterioration caused by environmental pollution or bird droppings. This warranty shall not apply to V-belts, hoses and gas leaks in case of air conditioned cars. Slight irregularities not recognised as affecting the function or quality of the vehicle or parts, such as slight noise or vibration, defects appearing only under particular or irregular operations are items considered characteristics of the vehicle.
7. This warranty shall be null and void if the car is subjected to abnormal use such as rallying, racing or participation in any other competitive sport. This warranty shall not apply to any repair or replacements as a result of accident or collision.
 8. This warranty is expressly in lieu of all warranties, whether by law or otherwise, expressed or implied, and all other obligations or liabilities on our part and we neither assume, nor authorise any person to assume on our behalf, any other liability arising from the sale of the car or any agreement in relation thereto.
 9. The buyer shall have no other rights except those set out above and have, in particular, no right to repudiate the sale, or any agreement or to claim any reduction in the purchase price of the car, or to demand any damages or compensation for losses, incidental or indirect, or inconvenience or consequential damages, loss of car, or loss of time, or otherwise, incurred or accrued.
 10. Any claim arising from this warranty shall be recognised only if it is notified in writing to us or to our authorised dealer without any delay soon after such defects as covered & ascertained under this warranty.
 11. This warranty shall stand terminated if the car is transferred or otherwise alienated by the buyer without our prior written consent.
 12. We reserve our rights to make any change or modification in design of the car or its parts or to introduce any improvement therein or to incorporate in the car any additional part or accessory at any time without incurring any obligation to incorporate the same in the cars previously sold.

TATA MOTORS

TATA MOTORS LTD. is committed to produce vehicles using environmentally sustainable technology. A number of features have been incorporated in Tata Motors passenger vehicles which have been designed to ensure environmental compatibility throughout the life cycle of the vehicle. We would like to inform you that your vehicle meets emission norms and this is being regularly validated at the manufacturing stages.

As a user you too can protect the environment by operating your vehicle in a proactive manner. A lot depends on your driving style and the way you maintain your vehicle. We have given a few tips for your guidance.

DRIVING

- Avoid frequent and violent acceleration.
 - Do not carry any unnecessary weight in the vehicle as it overloads the engine. Avoid using devices requiring high power consumption during slow city traffic condition.
 - Monitor the vehicle's fuel consumption regularly and if showing rising trend get the car immediately attended at the Company's Authorised Service Outlets.
- Switch off the engine during long stops at traffic jams or signals. If you need to keep the engine running, avoid unnecessary revving it up or stopping and starting.
 - It is not necessary to rev up the engine before turning it off as it unnecessarily burns the fuel.
 - Shift to higher gears as soon as it is possible. Use each gear upto 2/3rd of its maximum engine speed. A chart indicating gear shifting speeds is given in this book.

MAINTENANCE

- Ensure that recommended maintenance is carried out on the vehicle regularly at the Authorised Service Outlets.
- As soon as you see any leakages of oil or fuel in the vehicle we recommend to get it attended immediately.
- Use only recommended grades and specified quantity of lubricants.
- Get your vehicle checked for emission periodically by an authorised dealer

- Ensure that fuel filter, oil filter and breather are checked periodically and replaced, if required, as recommended by Tata Motors.
- Do not pour used oils or coolants into the sewage drains, garden soil or open streams. Dispose the used filters and batteries in compliance with the current legislation.
- Do not allow unauthorised person to tamper with engine settings or to carry modifications on the vehicle.
- Never allow the vehicle to run out of fuel.
- Parts like brake liners, clutch discs should be vacuum cleaned. Do not use compressed air for cleaning these parts which may spread dust in the atmosphere.
- **While carrying out servicing or repairs of your vehicle, you should pay keen attention to some of the important engine aggregates and wiring harness which greatly affect emission. These components are :**
 1. **Fuel injection equipments - pump & Injectors.**
 2. **Air Intake & Exhaust system, especially for leakages.**

3. **Cylinder head for valve leakage.**
4. **All filters such as air, oil and fuel filters (check periodically).**
5. **Turbocharger**
6. **Electrical connections**
7. **If the 'Service' lamp continuously glows, please take the vehicle to a TATA authorised service outlet.**
8. **Catalytic Converter**
9. **EMS wiring harness i.e. electrical connections to all sensors and actuators.**

This Owner's manual contains further information on driving precautions and maintenance care leading to environment protection. Please familiarise yourself with these aspects before driving.

A	
Advance Warning Triangle	94
Air Flow Pattern	73
Anti-lock Braking System	18
Anti-theft Device - Immobilizer	14
Anti-theft Device-Immobilizer	22
B	
Basic AC Settings	77
Battery	127
Bonnet	27
Brake Fluid Level	122
Brakes & Braking	92
Bulb Specifications & Bulb Replacement	109
C	
Car Care	144
Child lock	13
Cockpit	29
Combination Switch	60
Coolant Specification	134
Cup Holders	71

D	
Doors	25
Driving in Adverse Conditions	19
E	
Engine Compartment	117
Engine Coolant Level	121
Engine Oil Level	121
Environment Safety	159
F	
Fascia Switches	64
First Aid Kit	94
Flat Tyre Replacement	96
Fuel Lid	28
Fuel Saving Tips	82
Fuel Specification	133
Fuel, Lubricants & Coolant Co-branding	135
Fuses & Fuse Replacement	102
G	
Glove Box	69
Good Driving Practices	83

H	
Hazard Warning Switch	93
HVAC Controls	75
I	
Identification Plates	142
If Unexpected Happens	93
Important Safety Notes	09
Infotainment & Navigation System	66
Instrument Cluster (Vista Tech)	41
Instrument Cluster (Vista)	31
J	
Jack & Handle	95
Jump Lead Start	98
L	
Lamps	68
Lubricants Specification	134
Luggage Space	72
M	
Music System	65

O	
On Board Diagnostic (OBD)	59
On Road Assistance 24X7	113
P	
Paint Care	146
Parking	91
Polishing	145
Power Socket	72
Pre-driving Checks	80
Preparing to drive	90
R	
Rear View Mirrors	86
Roof Grab Handle	72
Roof Lamp	70
Routine Service	128
Running-In Period	83
S	
Safety Guidelines	09
Seat & Seat Adjustments	84
Seat Belts	10

Service Instructions	129
Service Schedule	130
Spark Plug (Petrol Engine)	123
Starting & Stopping The Engine	90
Steering Lock cum Ignition Switch	89
Steering Wheel Height Adjustment	88
Steering Wheel Switches	67
Sun Visors	87
Supplemental Restraint System -Air Bags	16
T	
Tale tells	55
Technical Specifications	136
Tool Kit	95
Towing The Vehicle	100
Transaxle Oil Level	122
Trunk lid	28
Tyres	124

U	
Utility Pockets & Box	71
Utility Tray	72
V	
Value Added Services	148
Vehicle Dimensions	140
Vehicle Parking For Long Duration	147
W	
Warranty-Terms & Conditions	157
Washing	144
Waxing	145
Window Glasses	26
Windshield Washer Fluid Level	123
Wiper Care	146