



TIGOR

OWNER'S MANUAL



TATA MOTORS

CUSTOMER ASSISTANCE

In our constant endeavor to provide assistance and complete service backup, TATA MOTORS has established an all India customer assistance centre.

In case you have a query regarding any aspect of your vehicle, our Customer Assistance Centre will be glad to assist you on our Toll Free no. **1800 209 7979**

You can also approach nearest TATA MOTORS dealer. A separate Dealer network address booklet is provided with the Owner's manual.

TATA MOTORS 24X7 Roadside Assistance Program offers technical help in the event of a breakdown. Call to the toll-free Roadside Assistance.

For additional information, refer to "**24X7 Roadside Assistance**" section in the Owner's manual.



Dear Customer,

Welcome to the TATA MOTORS family.

We congratulate you on the purchase of your new vehicle and are privileged to have you as our valued customer.

We urge you to read this Owner's Manual carefully and familiarize yourself with the equipment descriptions and operating instructions before driving.

Always carry out prescribed service / maintenance work as well as any required repairs at an authorized TATA MOTORS Dealers or Authorized Service Centre's (TASCs). Use only genuine parts for continued reliability, safety and performance of your vehicle.

You are welcome to contact our dealer or Customer Assistance toll free no. **(1800 209 7979)** in case of any query or support required.

We wish you a safe and pleasant driving experience.

TATA MOTORS

Bombay House, 24, Homi Modi Street,
Hutatma Chowk, Fort, Mumbai – 400001

IMPORTANT INFORMATION

- Before driving, read this Owner's manual carefully and familiarize yourself with your vehicle. For your own safety and a longer vehicle life, follow the instructions, 'Warnings' and 'Notes' in this manual. Ignoring them could result in damage to the vehicle or personal injury to you or others.
- The Owner's manual and other booklets are important documents and should always be kept in the vehicle. If you sell the vehicle, always pass on the documents to the new owner.
- This Owner's Manual describes all variants of the model and all standard/optional equipment of your vehicle available at the time of printing. Please note that your vehicle may not be equipped with all features described.
- TATA MOTORS Limited reserves the right to introduce changes in the design, equipment and technical features without any obligation to install them on the vehicles previously sold. The equipment in your vehicle may therefore differ from that shown in the descriptions and illustrations.
- Do not carry out any modification including fitment of non-genuine accessories on your vehicle. Safety, handling, performance and durability, may otherwise be adversely affected and may violate government regulations. TATA MOTORS Limited accepts no liability for damage resulting from the modifications or use of non-genuine accessories.
- All rights reserved. The information in this manual shall not be copied, translated or otherwise reproduced, in whole or in part, without written permission from TATA MOTORS.

© Copyright 2019 TATA MOTORS

CONTENTS

1	Safety		2	Opening & Closing		3	Dashboard & Features	
	Important Information	01		Flip Key	19		Cockpit	27
	Safe Driving	01		Doors	21		Instrument Cluster - Analog	29
	Seat Belts	04		Windows	22		Driver Information Display	34
	Child Restraint System (CRS)	07		Bonnet	24		Driver Information Settings	39
	Supplementary Restraint System (SRS) (Airbags)	11		Trunk lid	25		Instrument Cluster - Digital	43
	ABS	18		Fuel lid	26		Warning Lamps	56
	EBD	18					Audio Reminders	63
							Combi Switches	64
							Fascia Switches	65
							Steering Wheel Switches	67
							Mic	67

CONTENTS

3	Dashboard & Features	4	Stowage Areas	5	Climate Control	
	Infotainment System	68	Storage Compartments	73	Air Vents & Distribution	77
	USB/AUX	68	Glove Box	74	HVAC Controls	78
	Power Socket	68	Driver side pocket	74	Functions & Settings	80
	Antenna	69	Center Console	75	Fully Automatic temperature Control	82
	Roof Lamp	69	Foldable arm rest	75	HVAC sensors	88
	Roof Grab Handles	70	Trunk lid Compartment	75		
	Boot Lamp	70	Card Holder	76		
	Tag Holder	71	Hooks	76		

CONTENTS

6 Starting & Driving

Pre-Driving Checks	89
Driving Tips	90
Seat Adjustments	93
Rear View Mirrors	94
Steering Wheel Adjustments	96
Starting the Engine	97
Gear Shifting & Driving	98
AMT Gearbox	100
Driving Mode	102
Parking brakes	107
Reverse Park Assist	108

7 Emergency & Break-down Assistance

Emergency Equipment	117
Hazard Warning Switch	118
In Case of Flat Tyre	119
Spare Wheel	119
Jump Lead Starting	124
Towing	125
Fuses	128
Bulb Replacement	135
24x7 Road Side Assistance	140
Vehicle Tracking System (VTS)	143

8 Maintenance

Maintenance & Service	147
Engine Compartment	148
Engine Oil Level	151
Battery	154
Spark Plug	155
Tyres	155
Key Battery Replacement	158
On Board Diagnostic (OBD)	159
Service Instructions	160
Service Schedule	161
Parking for Long Durations	167

CONTENTS

9 Technical Information

Fuel Specification 169

Lubricant Specification 171

Technical Specification 173

Vehicle Dimensions 177

Aggregate Identification Nos 178

10 Car Care and Value Added Services

Car Care 179

Washing 179

Waxing 180

Polishing 180

Interior Fabric Cleaning 180

Paint Care 181

Extended Warranty 182

Value Added Services 184

Vehicle Exterior Enrichment 186

Vehicle Interior Enrichment 187

11 Warranty – Terms and Conditions

Warranty 189

12 Environment Safety

Environmental Safety 191

Important Information

In this Owner's Manual, you will find the text under the heading "WARNING" and "NOTE" which highlights important information. Pay particular attention to these highlighted messages.

NOTE

Indicates additional information that will assist you in gaining the optimum benefit and care for your vehicle.

WARNING



Indicates procedures or information that must be followed precisely in order to avoid the possibility of severe personal injury and serious damage to the vehicle.

Safe Driving

Safety consciousness not only ensures your safety and the safety of other road users, but it also helps to reduce the wear and tear on your vehicle.

Safe driving depends on:

- How quickly you make decisions to avoid an accident.
- Your ability to concentrate.
- How well you can see and judge objects.
- How well familiar you are with your vehicle controls and its capabilities.

NOTE

Fatigue is a result of physical or mental exertion that impairs judgment. Driver fatigue may be due to inadequate sleep, extended work hours, strenuous work or non-work activities or combination of other factors. Take rest at regular intervals.

Safety Tips

- Always take into account the road conditions, weather conditions, vehicle speed in order to prevent accidents.
- Turn 'ON' the side indicators at least 30 meters before taking a turn or changing the lane.
- Decelerate to a safe speed before taking turn. Do not apply brakes during cornering.
- When overtaking other vehicles, watch out for the oncoming vehicle.
- Never drive under the influence of alcohol or drugs.
- If your vehicle is equipped with infotainment/navigation system, set and make changes to your travel route only when the vehicle is parked.
- Program radio presets with the vehicle parked, and use your programmed presets to make radio use quicker and simpler.

SAFETY

Driving through water

Do not drive through flooded areas. Judge the depth of water before driving through it. Otherwise, water may enter the vehicle interior or the engine compartment.

If at all the situation demands that you have to drive through water then;

- Keep engine in higher RPM and crawl the vehicle in low gear.
- Flowing or rushing water creates strong forces. Driving through flowing water could cause the vehicle to about trying to drive through flowing water.
- Lightly apply the brake pedal to dry the liners until the brakes work normally once you are out of water.

WARNING



Do not attempt to start the engine if vehicle gets flooded due to water. Tow the vehicle to a safe place. Contact a nearest TATA MOTORS Authorised Service Centre

Driving on a rainy day

- Check wiper blades, lights and brakes for proper functioning and condition.
- Check the tyre treads depth, the condition of the tread and tyre.
- Avoid harsh braking and sharp turns. It may cause loss of control and lead to a skid.
- For slowing down, shift to lower gears and brake gently.
- Keep lights 'ON' if visibility is poor.

Driving on wet roads

On wet road or during light showers, "Aquaplaning" can occur. "Aquaplaning" is the loss of direct contact between the road surface and the vehicle's tires due to a water film forming between them. Steering or braking the vehicle can be very difficult, and loss of control can occur.

There is no hard and fast rule about aquaplaning. The best advice is to slow down when the road is wet.

NOTE

If you have driven for a long time in heavy rain without braking, there may be a delayed reaction from the brakes when braking for the first time. You have to depress the brake pedal more firmly. Maintain a greater distance from the vehicle in front.

Night driving

- Ensure that all lights are working and windshield, window glasses are clean.
- Drive more slowly at night than in the daytime, as the visual range is restricted at night. Maintain a speed such that you can stop within illuminated distance of head lamps.
- Do not use the high beam unless inevitable. It may dazzle the driver of the oncoming vehicle, thus causing an accident.
- Use head lamp main/dip beam to alert other road users on turns/cross roads etc.
- Use side indicators for lane change or turning.

Driving on gradients

When climbing gradient, the vehicle may begin to slow down and show a lack of power. If this happens, shift to a lower gear and apply power smoothly so that there is no loss of traction.

When driving down a hill, the engine braking should be used by shifting into a lower gear. Do not drive in neutral gear or switch off the engine.

WARNING



On long and steep gradients you must reduce the load on the brakes by shifting early to a lower gear. This allows you to take advantage of the engine braking effect and helps avoid overheating of service brakes resulting in reduced braking efficiency.

Driving on highway

Stopping distance progressively increases with vehicle speed. Maintain a sufficient distance between your vehicle and the vehicle ahead.

For long distance driving, perform safety checks before starting a trip and take rest at certain intervals to prevent fatigue.

SAFETY

Seat Belts

This section of user manual describes your vehicle seat belt, airbag and Child restraints system. Please read and follow all these instructions carefully to minimise risk of severe injury or death.

- Seat belts are the primary restraints system in the vehicle. All occupants, including the driver, should always wear their seat belts to minimize the risk of injury.
- Sit back and adjust the front seat. Make sure that your seat is adjusted to a good driving position and the back of the seat is upright.

Buckling the Shoulder Seatbelt

- Grasp the tongue and slowly pull out the seat belt over the shoulder and across the chest. When the seat belt is long enough to fit, insert the tongue into the lock buckle until you hear a “CLICK” which indicates that the seat belt is securely locked.

- Position the lap portion of seat belt across your thighs, below your abdomen. To remove slack, pull up a bit on the shoulder seat belt. To loosen the lap portion seat belt if it is too tight, tilt the tongue and pull on the lap seat belt. A snug seat belt reduces the risk of sliding under the seat belt in a collision. Ensure that the seat belt running over the body (shoulder segment and lap segment) does not have any twist. Twisted seat belt may not offer effective protection when required.

Releasing the seat belt

To release the seat belt, push the red button on the lock buckle. The seat belt will automatically retract to its stowed position. If necessary, slide the tongue down the webbing to allow the seat belt to retract fully.

Fixed rear centre lap seat belt

- When buckling, make sure you hear a click confirming that the tab is latched into the seat belt lock. To tighten it, pull the loose end through the buckle until the seat belt is comfortably adjusted around the hips.



Seat belt height adjustments

If the height adjustment is provided in the seat belt, occupant can adjust it to their comfort, as may be applicable.

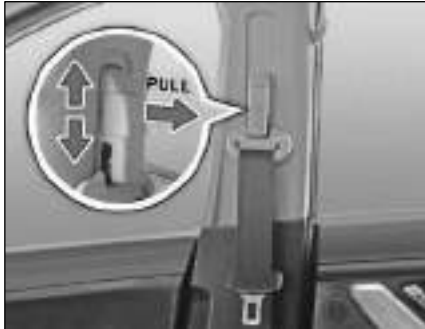

WARNING



- Each seat belt assembly must only be used by one occupant. It is not recommended to put a seat belt around a child, being carried on an occupant's lap.

- Be careful not to damage or tamper the seat belt webbing or hardware. Inspect the seat belt system periodically, checking for cuts, frays, or loose parts. A frayed or torn seat belt could rip apart in a collision and leave you with no protection.
- If the seat belt webbing or hardware is damaged, get it replaced immediately at TATA Motors Authorized service centre.
- Do not insert any items such as coins, clips, etc. into the seat belt buckles, and be careful not to spill liquids into these parts. If foreign materials get into a seat belt buckle, the seat belt will not work properly.
- Do not wear seat belts over hard, sharp or fragile items in clothing, such as pens, keys, spectacles etc.
- Do not use any accessories on seat belts or modify in any way the

seat belt system. Devices claiming to improve occupant comfort or reposition the seat belt can reduce the protection provided by the seat belt and increase the chance of serious injury in a collision.

Seat Belts with Pre – tensioner (if Equipped)

You can use the pre-tensioner seat belts in the same manner as ordinary seat belts .

The seat belt pre-tensioner system works in conjunction with the SUPPLEMENTARY RESTRAINTS SYSTEM (SRS-Air Bags).

In the event of a collision, as may be necessary, pre-tensioner tightens the seat belt so that it fits the occupant's body more snugly. When pre-tensioner activates, there could be some noise and release of smoke. This is normal and there are no health hazards or fire risk.

SAFETY

WARNING



- The pre-tensioner seat belt assembly mechanisms become hot during activation. Do not touch the pre-tensioner seat belt assemblies for several minutes after they have been activated.

If the vehicle has been involved in a collision, get it inspected immediately at authorised TATA MOTORS SERVICE Center.

Seat Belt with Load Limiter (if Equipped)

You can use the load limiter seat belts in the same manner as ordinary seat belts. The seat belt load limiter system works in conjunction with the SUPPLEMENTARY RESTRAINTS SYSTEM (SRS-Air Bags).

In the event of a collision, as may be necessary, load limiter reduces the load on the rib cage region of the occupant.

If the vehicle has been involved in a collision, get it inspected immediately at Authorised TATA MOTORS SERVICE Center.

Use of seat belts for pregnant woman

WARNING



- Pregnant woman must wear a correctly positioned seat belt. It is safer for mother as well as unborn child.
- Pregnant woman should wear the lap part of the seat belt across the thighs and as snug across the hips as possible. Keep the seat belt low so that it does not come across the abdomen. That way the strong bones of the hips will take the force if there is a collision.



Seat belt Warning Lamp (if equipped)

The seat belt warning lamp reminds to fasten the seat belt.



For Driver



For Front Passenger

- If the driver does not fasten seat belt, seat belt reminder lamp will blink and a buzzer will sound for pre-defined duration until the driver's seat belt is buckled.
- If front passenger seat is occupied by adult and does not fasten seat belt, seat belt reminder lamp will blink and a buzzer will sound for pre-defined duration until the front passenger seat belt is buckled.
- If this system is also provided for other than Front row seats, applicable above warning will appear until seat belts are buckled.
- If front passenger seat is occupied by child, system may detect occupancy

and warn with front passenger seat belt warning. It is not taken to mean child can occupy front passenger seat and use seat belt. Please refer CRS section for recommended seating position.

NOTE

Using unauthorized aftermarket seat cover may affect function of occupant sensor. TATA motors does not recommended any non-validated seat covers on seats.

Child Restraint System (CRS)

TATA MOTORS strongly recommends the use of Child Restraint Systems (CRS) for all children up to age of 12 years and to be placed at recommended positions only. Children travelling without recommended CRS and seated at other positions may face serious injuries in case of a collision.

CRS can be installed in the vehicle using seat belts and/or ISOFIX only (if

equipped) or ISOFIX with Top Tether (if equipped).

The harness system of CRS holds the child in place, and in a collision, acts to keep the child positioned in the seat and reduce the risk if injuries.

All children below age of one year must always ride in a rear-facing infant CRS.

Keep children in a forward-facing CRS with a harness until they reach the size or weight limit allowed by your CRS manufacturer.

Once your child outgrows the forward-facing CRS, your child is ready for a booster seat.

Selection and installation of CRS:

Always select the CRS that complies with latest safety standards (AIS072 / ECE R44). The CRS are classified according to the child's size, height and weight. Select the appropriate CRS for your child. Ensure that the child fits properly in the CRS and it is securely installed in

the vehicle. For installation, please refer CRS manufacturer's instruction manual.

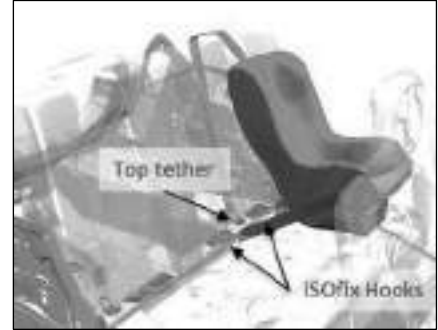

SAFETY

Recommended CRS position as per the vehicle matrix

The suitability of seat position for carriage of children and recommended category of CRS is shown in the table below as per the child group.

X - Seat Position not suitable for children in this age group.

U - Suitable for “universal” category restraints approved for use in this age group.

Universal is a category in the AIS072 / ECE R44 norm.

Group	Mass Group	Age Group	Front Passenger	Rear Out-board LH	Rear Out-board RH	Rear Center
0	Up to 10 kg	Up to 9 months	X	U	U	X
0+	Up to 13 kg	Up to 24 months	X	U	U	X
I	9 to 18 kg	9 months to 48 months	X	U	U	X
II	15 to 25 kg	Approx. 3 to 7 years	X	U	U	X
III	22 to 36 kg	Approx. 6 to 12 years	X	U	U	X

WARNING



- If a child is seated in the front seat it may cause serious injury or even death during any collision.

WARNING

- If your vehicle is equipped with a front passenger air bag (PAB) and do not have PAB deactivation switch, do not install a rear-facing CRS in the front passenger seat. If the PAB inflates, a child in a rear facing CRS could be seriously injured or killed.

If you install a CRS in the rear seat, slide the front seat far enough forward so that the child's feet do not touch the front seatback. This will help avoid injury to the child in the event of a collision.

NOTE

Children could be endangered in a collision if their CRS are not properly secured in the vehicle. Be sure to secure the child in the restraint system according to the manufacturer's instructions.

WARNING

Do not use an infant carrier or a child safety seat that "hooks" over a seatback, it will not provide adequate protection in a collision.

After a collision, we recommend to get seat belts, seats, ISOFIX and top-tether anchorages (as may be applicable) investigated at TATA MOTORS Authorised service centre.

NOTE

A CRS in a closed vehicle can become very hot. To prevent burns, check the seating surface and buckles before placing your child in CRS.

WARNING

- Do not leave unattended children in your vehicle.
- Do not modify CRS in any way.

NOTE

- *Do not install a booster seat or a booster cushion with only the lap strap of the seat belt.*
- *Do not install a booster seat or a booster cushion with a seat belt that is slack or twisted.*
- *Do not put the safety seat belt under your child's arm or behind its back.*
- *Do not use pillows, books or towels to boost your child's height.*
- *Make sure that your children sit in an upright position.*
- *Do not allow children to stand up or kneel on either the rear or the front seats. An unrestrained child could suffer serious or fatal injuries during a collision.*
- *Do not leave any toys or other objects loose in the CRS or on the seat while the vehicle is in motion.*

SAFETY

Each CRS should be used for one child only.

When PAB deactivation switch (if provided) is turned 'OFF', make sure 'PAB' operational status lamp illuminates with ignition 'ON', indicating that the passenger airbag is NOT operational. If the airbag SRS warning indicator in the instrument cluster illuminates continuously, it means that there is malfunction in the system. Remove the CRS from front passenger seat and contact your TATA MOTORS authorised service center.



Supplementary Restraint System (SRS) (air bags) (if equipped)

The airbag 'SRS' system comprises of the following components depending upon the provided safety features in vehicle.

- Seat belt Pre-tensioners
- Seat belt with load limiters
- Driver Airbag
- Front Passenger Airbag
- Knee Air Bag
- Side Airbags
- Curtain Air Bag
- Airbag 'SRS' ECU (Electronic Control Unit)
- Collision Sensors
- SRS wiring harness
- SRS Warning lamp
- Front Passenger airbag (PAB) Deactivation switch

The System is active when ignition switch is in the "ON" position or the

ignition mode is "ON". Air bags are designed to inflate in collisions when required. In the event of a collision, the collision sensors will detect signals, and if the Airbag ECU judges that the signals represent a severe collision, will trigger the airbags. The inflated air bags provide a cushion to the occupants. The air bag inflates and deflates so quickly that you may not even realize that it has activated. The air bag will neither hinder your view nor make it harder to exit the vehicle.

Airbag inflation is virtually instantaneous and occurs with considerable force, accompanied by loud noise and smoke, which is normal. The inflated airbag, together with seat belts, limit the movement of an occupant, thereby reducing the risk of injury.

When an airbag inflates, you may see some smoke-like particles. The particles are a normal by-product of the process that generates the non-toxic gas used for airbag inflation. These airborne particles may irritate the skin, eyes, nose, or

throat. If you have skin or eye irritation, rinse the area with water. For nose or throat irritation, move to fresh air. Also sometimes the smoke can cause breathing problems, in such cases get fresh air promptly.

After inflation, airbag provides a gradual cushioning effect for the occupant thereafter deflates. It is not advisable to drive your vehicle after the airbags have been deployed. If you are involved in another collision, the airbags will not be in place to protect you.



SAFETY

NOTE

- *Open your windows and doors as soon as possible after collision to reduce prolonged exposure to the smoke and powder released by the inflating air bag.*
- *Do not touch the air bag storage area's internal components immediately after an air bag has inflated. The parts that come into contact with an inflating air bag may be very hot.*
- *Always wash exposed skin areas thoroughly with lukewarm water and mild soap.*

The driver airbag is mounted in the centre of the steering wheel. The front passenger airbag is located inside the dashboard in front of the passenger seat. The vehicle fitted with the airbags have suitable indications on steering wheel and on dash board. The word 'SRS' is embossed on the airbag covers.

Side airbags are mounted in front row seats for outboard occupants only.



Curtain airbags are mounted above the doors along the roof on both sides.



Knee airbags are mounted in the dashboard around the knee region of the front row occupants.

Passenger airbag (PAB) deactivation switch and PAB operational status indicator (If equipped)

If it becomes necessary to fit a CRS on the front passenger seat, the passenger airbag must be de-activated. This switch can be accessed once front passenger side door is opened. On the contrary, when an adult is seated in the front passenger seat, ensure that PAB deactivation switch is turned to 'ON' position. This will ensure that the passenger airbag is operational in the event of a collision. This switch is operated using the ignition / remote key.

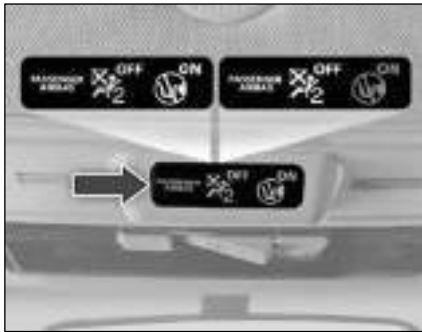

Operational status indicator



PAB deactivation switch

WARNING



- Even in vehicles with air bags, you and your passengers must always wear the seat belts provided. In order to minimize the risk and severity of injury in the event of a collision.
- ALWAYS use seat belts and CRS – during every trip and at all times. Even with air bags, you can be seriously injured or killed in a collision if you are improperly seat belted or not wearing your seat belt when the air bag inflates.
- You and your passengers should never sit or lean unnecessarily close to the air bags.
- Move your seat as far back as possible from front air bags, while still maintaining control of the vehicle.
- All occupants should sit upright with the seatback in an upright position, centred on the seat cushion with their seat belt on, legs

comfortably extended and their feet on the floor until the vehicle is parked and the engine is turned off.

- If an occupant is out of position during collision, the rapidly deploying air bag may forcefully contact the occupant causing serious or fatal injuries.
- Do not allow the front passenger to place their feet or legs on the dashboard.
- Do not allow the passenger to ride in the front seat when the front passenger air bag OFF indicator is illuminated.

SAFETY

Not recommended seating position



WARNING

- Never place your arm over the airbag as a deploying airbag can result in serious arm fractures or other injuries.
- Do not allow the passengers to lean their heads or bodies onto doors or place objects between the doors and passengers when they are seated on seats equipped with side and/or curtain air bags.
- Do not place or stick any item/s in the vehicle, except at designated locations (such as utility bins, cup/bottle holders, Boot space etc). Loose items may act as a projectile during a collision and cause severe to fatal injuries.
- Please be aware that any unsecured item in your vehicle, such as your pet, unsecured CRS or a laptop, can become a potential hazard in the event of a

collision or sudden stop, causing injuries to occupants in the vehicle.

- Coat hooks if provided, must be used only for that purpose. Never hang heavy items on to those hooks. This could affect deployment of the air bags, and may lead to severe to fatal injuries.
- ALWAYS contact your TATA MOTORS authorised service centre if the vehicle is damaged, even if airbag has not inflated.
- ALWAYS contact your TATA MOTORS authorised service centre if any part of an airbag module cover shows sign of cracking or damage.

If your SRS malfunctions, the air bag may not inflate properly during a collision thereby increasing risk of serious injury or death. If any of the following conditions occur, your SRS is malfunctioning:

WARNING

- The SRS warning lamp does not turn 'ON' when the ignition switch is placed in the 'ON' position for few seconds.
- The SRS warning lamp stays 'ON' after illuminating
- The SRS warning lamp comes 'ON'/stays 'ON' while the vehicle is in motion.
- The SRS warning lamp blinks when the engine is running.

SAFETY

We recommend the customer to immediately visit TATA MOTORS authorised service centre and get the SRS system inspected if any of the above conditions occur.

WARNING



- Never make any modifications to your vehicle. The modifications carried out, but not limited to the vehicle frame, bumpers, front fenders, ride height, suspension, seat belts, interior trims, steering wheel (especially holders), are not acceptable. This will affect the intended performance of SRS system.
- Fitment of bull bars, seat covers on seats with airbags etc, is strictly prohibited, unless authorised by TATA MOTORS. This will affect the intended performance of SRS system.
- If you need to make any modifications to accommodate

any disability you may have, please contact your Authorized TATA MOTORS Dealer for necessary guidance.

- Do not tamper with SRS in any way. This will lead to unexpected performance of system and may cause serious injury or death.

AIRBAGS Deployment Conditions (If equipped)**When front airbags (if equipped) should not deploy?**

Minor frontal collision: Seat belt offers adequate occupant protection in low severity collisions. The airbags are triggered only when there is a collision severe enough to trigger the airbags. Deployment of frontal airbags is not beneficial in low severity collisions.

Side collision: During a side collision, occupants tend to move sideways. Therefore, deploying frontal airbags in such situations will not benefit the occupants. Side airbags, side curtain airbags (if equipped) are specifically designed to reduce the injuries that can occur in side collision.

Rear collision: During a rear collision, occupants tend to move (rearwards) away from frontal airbags. Therefore, deploying frontal airbags in such situations will not benefit the occupant protection. Head restraints and seat belts provide

occupant protection during a rear collision.

Rollovers collision: During a rollover collision occupants may float inside the passenger compartment, if unbelted. This will increase the risk of injuries. Wearing seat belts provide highly effective occupant protection during rollover collision. If your vehicle is equipped with a rollover sensor, both, seat belt and side curtain airbag can provide highly effective occupant protection during rollover collision. Front airbags, however, are not designed to deploy in a rollover as frontal airbags cannot offer any protection in rollover collision.

When front airbags (if equipped) deploy with minor or no visible vehicle damage?

The airbags are triggered only when there is a collision severe enough to trigger the airbags. A severe collision to the vehicle underbody or suspension may cause airbags deployment. Examples include rough road driving, running into a curb or other low fixed object that

causes a sudden vehicle deceleration. Since the collision is underneath the vehicle, damage may not be readily visible.

When front airbags (if equipped) may not deploy, even with exterior visible vehicle damage?

The airbags are triggered only when there is a collision severe enough to trigger the airbags. The amount of visible vehicle damage is not always the correct indicator for airbag deployment. Some collisions can result in visible damage but no airbag deployment because the airbags would not have been needed or would not have provided protection even if they had deployed.

SAFETY

When a side airbag (if equipped) deploys with minor or no visible vehicle damage?

The airbags are triggered only when there is a collision severe enough to trigger the airbags. If the airbag system senses sudden deceleration, a strong collision to the side of the vehicle's frame can cause a side airbag to deploy. In such cases, there may be little

When a side airbag (if equipped) may not deploy, even with exterior visible vehicle damage?

It is possible that the side airbag does not deploy during a collision that results in visible severe damage. This can occur when the point of collision is toward the far front or far rear of the vehicle or when the vehicle's crushable body parts absorbed most of the collision energy. In either case, the side airbag would not have been needed nor provided protection even if it had deployed.

Anti-lock braking system (ABS) - (if equipped)

ABS regulates brake pressure in such a way that the wheels do not lock when you brake. This allows you to continue steering the vehicle when braking.

NOTE

When ABS is active, the driver will feel the brake pedal pulsating, which is normal.

WARNING



The stopping distance required for vehicles with ABS may be slightly more than conventional brake system but ABS will still offer the advantage of helping you maintain directional control.

However, remember that ABS will not compensate for bad road or weather conditions or poor driver judgment. Drive within safety margins, taking into consideration prevailing weather and traffic conditions.

NOTE

If the ABS warning lamp is ON while driving then there is a malfunction in the ABS system (the standard braking system will however function) and the vehicle should be driven cautiously to the nearest TATA MOTORS Authorized Service Centre.

Electronic brake force distribution (EBD) - (if equipped)

EBD monitors and controls the brake pressure on the wheels to improve driving stability while braking.

Flip Key

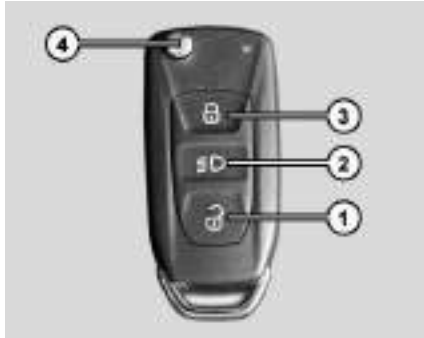

1. Unlock
2. Approach Light /follow me/trunk lid
3. Lock
4. Key blade in / out button

1. Unlocking all doors

To unlock all doors, press unlock push-button (1) once. Unlocking will be confirmed by single flash of turn indicators.

2. Approach light / Follow me

Press approach light button (2) once, low

beam, park and roof lamp will turn 'ON' for 60 seconds (default setting). This feature helps to find and reach the parked vehicle or to reach home in dark/ cloudy condition after parking. Red LED will be flashed on the remote. To switch 'OFF' the approach lights, press and release the same button or it automatically turns 'OFF' after 60 seconds.

Trunk lid opening (if equipped)

Electric trunk lid opening can be done through long press (4 sec) approach light button on remote key.

3. Locking all doors

To lock all doors, press lock push-button (3) once. Locking will be confirmed by two flashes of turn indicators.

If lock button is pressed on the remote key with the driver door open, locking-unlocking takes place with audible warning sound. If any other door is open, the vehicle gets locked but indicators do not flash.

4. Folding key blade in / out

Press button (4) to flip out the key blade. For folding, press the button (4) and fold the key blade inside.



NOTE

Key Blade should not be folded without pressing the button. Also, it should not be forced in any direction apart from folding direction to avoid damage to Flip Mechanism.

OPENING AND CLOSING

Manual operation of central door locking / unlocking

All doors can be locked / unlocked operating driver door using either key blade from outside or knob from inside.

E-Key Features

Vehicle search

In vehicle locked condition if lock button on remote key is pressed the turn indicators of vehicle flashes 4 times.

Automatic activation of immobilizer

If key is removed from ignition, the engine will be immobilized automatically even if you forget to lock the vehicle.

Auto locking / unlocking of doors / auto relock

Vehicle doors get automatically locked when all doors are closed and the vehicle speed crosses 10 kmph.

When ignition key is taken out all the doors get automatically unlocked.

Also, when unlocked with remote key and if no door is opened within 30 seconds, vehicle doors get automatically locked.

Anti-grab / anti-scan coding

The remote control set of this security system is protected against the use of devices called 'scanners' and 'grabbers' which can record and reproduce some types of remote codes.

Sleep Mode

If remote key is not used for more than a week then its functionalities will turn to sleep mode. In such a case, to activate the remote key functionalities, open the door mechanically with the key blade.

NOTE

In case any button of the key is accidentally pressed for more than 25 seconds, the remote stops functioning till the time the button is pressed. The LED on the Remote also stops

glowing. The function of the remote gets reinstated immediately when the user stops pressing the push button of remote.

Important

Don't operate Unlock push-button of remote while in the vicinity of your vehicle, as it could lead to an unintentional unlocking your vehicle.

Don't use discharged batteries in remote, as it could damage the remote.

For battery replacement procedure refer maintenance section.

Don't remove the battery connection of the vehicle while the vehicle has been locked by remote.

OPENING AND CLOSING

Doors

Door locking / unlocking with key

Driver door has separate locking facility. All doors can be locked or unlocked from outside using the key.



Insert the key and turn it clockwise to lock and counter clockwise to open the door.

Locking without a key from inside



All the doors can also be locked from inside by pressing knob (1) on driver door and independently on other doors respectively.

Opening the doors from inside

All doors can be opened from inside. To open, pull the door opening knob (1) and then lever (2).

OPENING AND CLOSING

Windows

Power windows (if equipped)

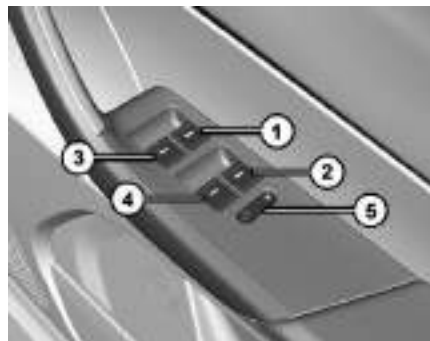

1. Front Window Winding Switch (Right)
2. Rear Window Winding Switch (Right)
3. Front Window Winding Switch (Left)
4. Rear Window Winding Switch (Left)
5. Inhibit Switch

Glasses on all four windows of your vehicle can be operated by switches provided on the main control panel located on the driver's arm rest. They work only when the key is in the 'IGN ON' position.

NOTE

Power windows can be operated for 3 minutes in 'IGN OFF' position and when key is taken out.

Individual switches

Individual window winding switches have been provided on the front passenger and rear doors.



Glasses are wound up by pulling the switch and are lowered by pressing.

WARNING



While raising the glass, take care to avoid fingers/hands getting trapped between glass and the frame.

Inhibit switch



Inhibit OFF (Released position)



When switch is released, the individual switches provided on rear passenger door can be operated. It can also be operated from the switches on driver's arm rest.

Inhibit ON (Pressed position)



When this switch is pressed the individual switches provided on rear passenger doors cannot be operated. It can only be operated by using the window switches on driver's arm rest.

WARNING



- If children operate the windows they could get trapped, particularly if they are left unsupervised. There is a risk of injury.
- Activate the window inhibit feature when children are travelling. When leaving the vehicle, always take the key with you and lock the vehicle. Never leave children unsupervised in the vehicle.

Manual Window Winding (if equipped)

Use window winder handle for lowering or raising up window glasses manually where power windows are not provided.



OPENING AND CLOSING

Bonnet

Opening

WARNING



Always switch off the windshield wipers and the ignition before opening the bonnet.

WARNING



Certain components in the engine compartment, such as the engine, radiator and parts of the exhaust system, can become very hot. Working in the engine compartment poses a risk of injury.

1. Ensure that the vehicle is in neutral gear with the parking brake applied.
2. Pull the bonnet release lever. The bonnet will pop up slightly.



3. Raise the bonnet slightly and with your finger slide the secondary lock lever located under the bonnet centre to the left side.

NOTE

Make sure that the wiper arms are not raised before you lift up the bonnet to avoid damaging the wiper arms and the bonnet.



4. Lift the bonnet up. Pull the bonnet stay rod from its clip and insert the free end into the slot.

WARNING



- The stay rod can be hot enough to burn your finger right after driving. Touch the rod after it becomes cool enough.
- Insert the stay rod into the hole securely. If the rod drops off, your body may be caught below the bonnet.

OPENING AND CLOSING

Closing

1. To close the bonnet, hold the bonnet by one hand, disengage the stay rod and clamp it back properly.
2. Lower the bonnet close to the bumper, and then let it drop down.

WARNING



Ensure that the bonnet is locked properly before driving or it can fly up unexpectedly during driving.

Trunk lid

Option I (If provided)



Trunk lid Opening Lever is located on the right hand side of the driver seat. Lift the lever to unlock trunk lid. Lift the trunk lid.

Option II

It can also be opened by using door key, The lock is located on the trunk lid. For closing, pull the trunk lid down and close it with a slight swing.



Option III (If provided)



To open the trunk lid, press the switch located on fascia switch.

NOTE

This option will work only in ignition ON condition.

OPENING AND CLOSING

Option IV (If provided)



trunk lid opening can be done through long press (4 sec) approach light button on remote key.

Fuel lid



Fuel lid opening Lever is located on the right hand side of the driver seat. Lift the lever to unlock fuel flap. Open the fuel cap by turning it in counter clockwise direction for fuel filling.



For closing, lock the fuel cap and gently push the fuel flap till it gets locked.

WARNING



- Fuel vapour is extremely hazardous. Always switch 'OFF' the engine before refueling and never refill near sparks or open flames.

- Do not use cell phone while refueling.
- Do not continue adding fuel after the automatic shut 'OFF' function operates. If it is equipped on the fuel station. Overfilling the fuel tank could damage the fuel system.

NOTE

Remove the fuel filler cap slowly, and wait for any hissing to stop. The fuel may be under pressure and may spray out.

If fuel cap needs replacement, ensure that it is replaced by a genuine cap at TATA MOTORS Authorized Service Centre only.

DASHBOARD AND FEATURES

Cockpit (MT)

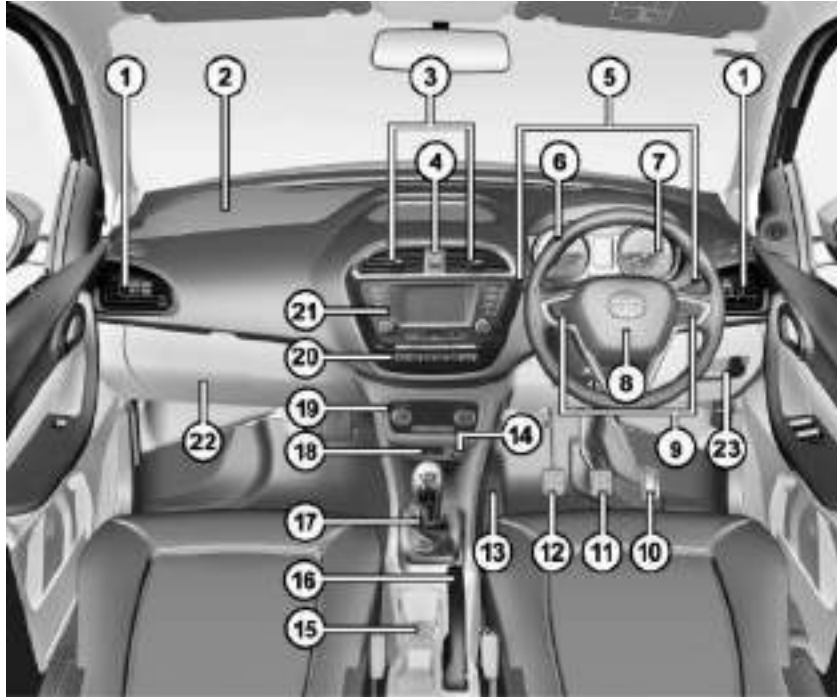

The above shown image is for reference purpose only.

1	A.C. Air vent (Side)
2	Air Bag (PAB) - if fitted
3	A.C. Air vent (Middle)
4	Hazard Warning Switch
5	Combi-Switch
6	Steering Wheel
7	Instrument Cluster
8	Horn pad / Air Bag (DAB) - if fitted
9	Steering Wheel Switches - if fitted
10	Accelerator Pedal
11	Brake Pedal
12	Clutch Pedal
13	Foot Rest
14	Power Socket
15	Cup Holder
16	Parking Brake Lever
17	Gear Shift Lever
18	USB/AUX Port - if fitted
19	HVAC /FATC Control panel(If fitted)
20	Fascia Switches
21	Infotainment System - if fitted
22	Glove Box
23	Driver Side Pocket

DASHBOARD AND FEATURES

Cockpit (AMT)

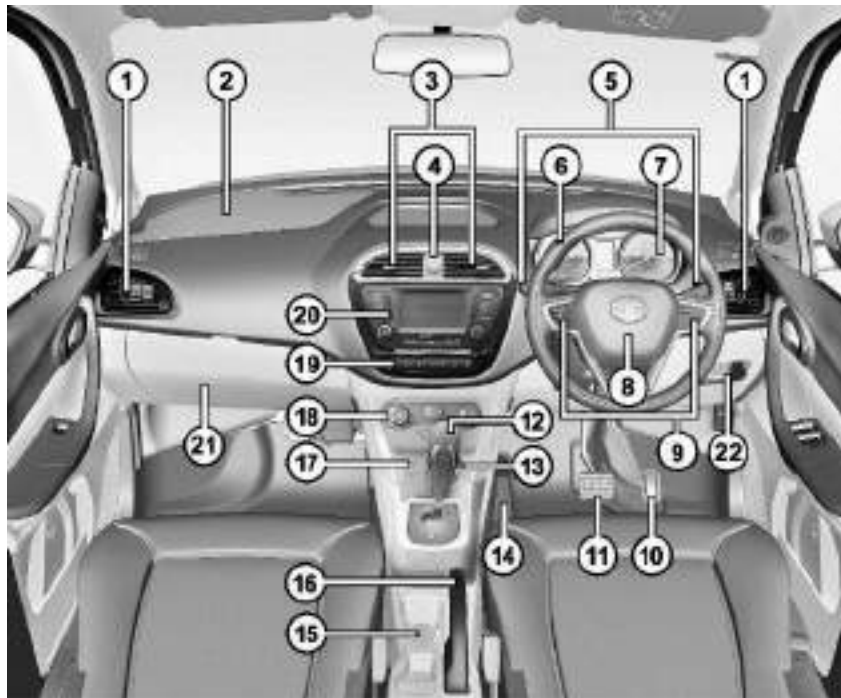

The above shown image is for reference purpose only.

1	A.C. Air vent (Side)
2	Air Bag (PAB) - if fitted
3	A.C. Air vent (Middle)
4	Hazard Warning Switch
5	Combi-Switch
6	Steering Wheel
7	Instrument Cluster
8	Horn pad / Air Bag (DAB) - if fitted
9	Steering Wheel Switches - if fitted
10	Accelerator Pedal
11	Brake Pedals
12	Gear Shift Lever
13	Power Socket
14	Foot Rest
15	Cup Holder
16	Parking Brake Lever
17	USB/AUX Port - if fitted
18	HVAC /FATC Control panel(If fitted)
19	Fascia Switches
20	Infotainment System - if fitted
21	Glove Box
22	Driver Side Pocket

Instrument Cluster – Version 1

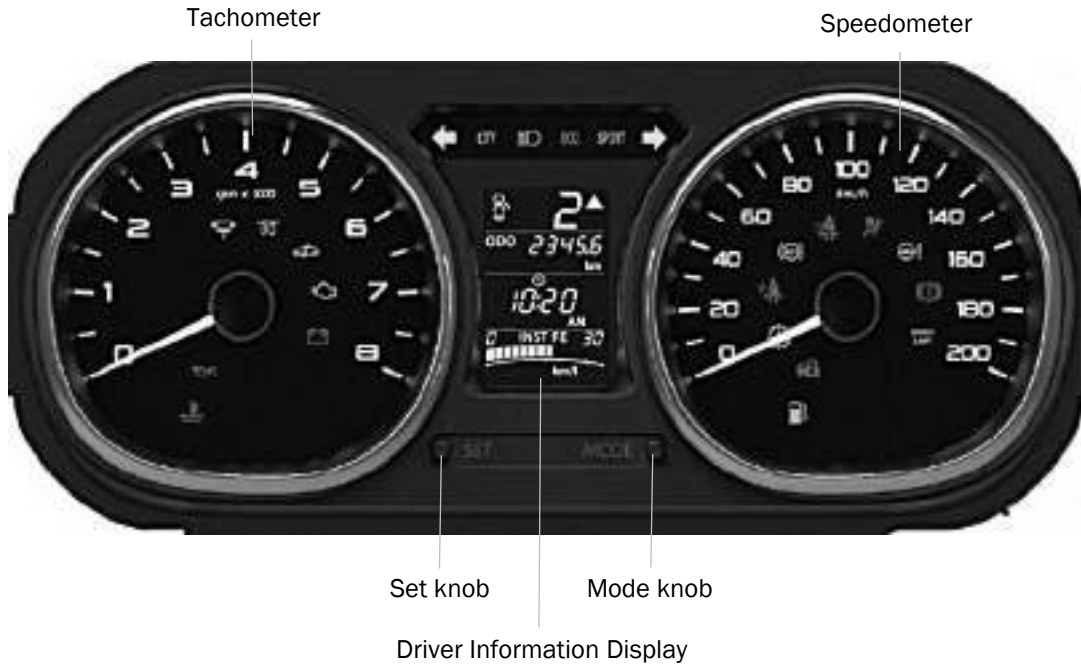

NOTE: All indicators shown may not be applicable to your vehicle.

DASHBOARD AND FEATURES

Instrument Cluster – Version 2

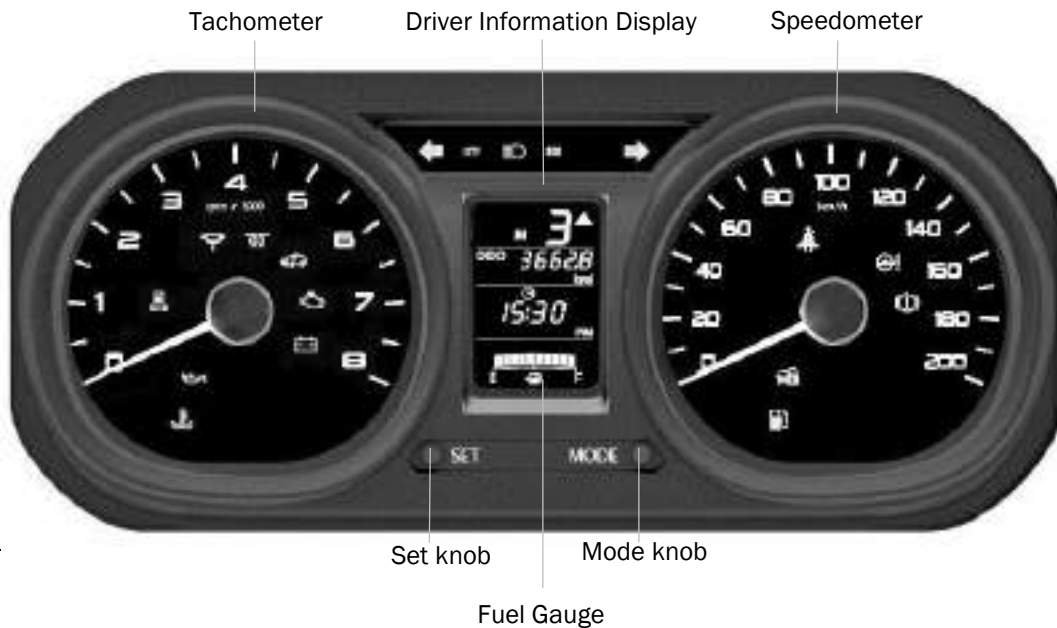

NOTE: All indicators shown may not be applicable to your vehicle.

DASHBOARD AND FEATURES

Speedometer



Version 1



Version 2

Speedometer indicates the vehicle speed in km/h.

NOTE

At every key IN and ignition ON, the Instrument Cluster needles and gauges moves to MAX. and returns to '0' position. This is a welcome strategy and a self-check feature.

Tachometer



Tachometer indicates engine speed in revolutions per min (rpm).

WARNING



- When engine is accelerated beyond safe 'rpm', the tachometer pointer turns RED. In such case, reduce the engine RPM immediately.

DASHBOARD AND FEATURES

- Never drive the vehicle with engine in high 'rpm'. This may cause severe engine damage.

Fuel Gauge

When the ignition switch is in "ON" position, fuel gauge gives an approximate indication of the amount of fuel in the fuel tank. "F" stands for full and "E" stands for empty.



When fuel in the tank is near to empty position, low fuel warning telltale turns 'ON'. Refill the tank as soon as possible.

If fuel is not filled even after Low fuel warning telltale 'ON', first bar in fuel gauge will start blinking to indicate more severe low fuel warning.

NOTE

- Check the fuel level when the vehicle is on level road.
- On inclines, curves, during braking and sudden acceleration due to the movement of fuel in the tank, the fuel level display may fluctuate or the low fuel warning lamp may illuminate earlier than usual.

WARNING



- Running the fuel tank too low or empty can cause engine to stall and could endanger User and passengers. User must stop and obtain additional fuel as soon as possible after low fuel warning telltale turns ON.
- Low fuel warning symbol will blink if there is any fault in the system. Take your vehicle to the nearest TATA MOTORS Authorised service

station if the symbol starts blinking.

- Do not continue adding fuel after the automatic shut off function is operated if it is equipped on the fuel pump. The sensor in the fuel tank may misjudge the amount of fuel remaining.

Temperature Gauge (if equipped)



When the ignition switch is in the “ON” position, this gauge indicates the engine coolant temperature. The indicator should stay within the normal, acceptable temperature range between “H” and “C”. If the indicator approaches “H”, overheating is indicated by red LED bar.

If the coolant temperature reading is very high, the warning telltale flashes with an audible buzzer. In this case, stop the vehicle, switch ‘OFF’ the engine and cool it down for some time. Contact a nearest TATA MOTORS Authorised Service Centre immediately for rectification.



High Coolant temperature warning may come when cooling fans in radiator sections are malfunctioning.

WARNING



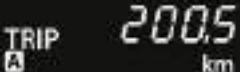

- High Coolant temp warning Telltale indicates overheating that may damage the engine. Continuing to drive the vehicle when engine overheating is indicated can result in severe engine damage or fire.
- Never remove the radiator pressure cap from the radiator when the engine is hot.





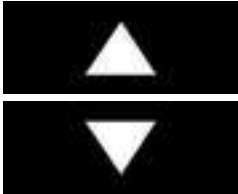



DASHBOARD AND FEATURES

Driver Information	System Image	Description
Odometer		<p>Indicates total distance travelled by a vehicle.</p> <p>The Odometer reading does not return to “0” when it reaches maximum value, the display will freeze to maximum value and resettable</p> <p>Note: You can change the Distance unit as Km using SET and MODE buttons.</p>
Trip meter A & B	 	<p>The trip meter is used to measure the distance travelled on short trips or between fuel stops. It can be reset to “0”</p> <p>Trip meter reading becomes “0.0” after it crosses 9999.9 km.</p> <p>Note: You can reset Trip meter using SET button by long press</p>
Clock		<p>When the ignition switch is in the “ON” position, it shows the time.</p>

DASHBOARD AND FEATURES

Driver Information	System Image	Description
Service reminder		<p>Indicates the number of days/kilometers in which service is due. If service is overdue, it will display “0” km or “0” days and spanner symbol will blink.</p> <p>Never reset the display between service intervals otherwise, this may result in to incorrect readings.</p> <p>Information is retained in the service interval display also after the vehicle battery is disconnected.</p> <p>NOTE: This option is for indicative purpose only. Keep track of your odometer reading and follow the maintenance schedule.</p>
Gear Recommendation		<p>Up or Down arrow shall be displayed on DIS whenever Gear should be put Up or Down.</p> <p>This feature is applicable to both AMT and Manual transmission variant.</p> <p>No arrow shall be displayed when the selected Gear is as per the Vehicle dynamics.</p>
Drive Mode (AMT)		<p>“M” indicates Manual Drive mode.</p> <p>“Auto” indicated Automatic Drive mode.</p>

DASHBOARD AND FEATURES

Driver Information	System Image	Description
Door Ajar (as applicable)		<p>All four door and trunk lid are indicated independently when respective door or trunk lid is open.</p> <p>Note: If any other door is open roof lamp will be 'ON' provided that roof lamp switch is in  position.</p>
		<p>This warning will be indicated when driver door is open.</p> <p>Note: If any other door is open roof lamp will be 'ON' provided that roof lamp switch is in  position.</p>
Outside Ambient Temperature		Displays outside ambient temperature in units °C.
Current Gear Indication	  - Neutral  - Reverse	<p>Current gear engaged by the transmission shall be displayed on DIS. This feature is applicable to both AMT and Manual transmission variant.</p> <p>In case of Manual transmission, the gear display is as per the User selection. IN case of AMT, the display is as per the Automatic selected gear.</p> <p>Note: If  is displayed, it means 'Fault' condition. In such case, take vehicle to authorized TATA MOTORS service station.</p>

DASHBOARD AND FEATURES

1. Instantaneous fuel economy (IFE)



IFE indicates fuel economy of current drive when Ignition is turned 'ON'.

Keep IFE bar graph 15 km/l to achieve better fuel economy.

NOTE

IFE will vary frequently as per driving pattern.

IFE display does not show Fuel Economy of last drive.

The display does not show actual value unless vehicle is moving.

NOTE

- At Every Ignition ON Fuel gauge will be displayed in place of "Instantaneous Fuel consumption" Bar Graph irrespective of user selection screen.
- You can Toggle between "Fuel Gauge" and "Instantaneous Fuel consumption" Bar Graph using SET and MODE Button.
- Selection to IFE screen will NOT be allowed if Fuel is below 1/4th tank level.
- During Vehicle Running if LCD Screen is in "Instantaneous Fuel consumption" Bar Graph mode & if fuel gauge reduces to 1/4th tank level then LCD Screen will automatically goes to Fuel Mode.
- The maximum value of IFE is 30 km/l. No more than 30 shall be indicated on the display even if the actual IFE is higher than 30 km/l.

2. Average fuel economy (AFE) for Trip and Trip B

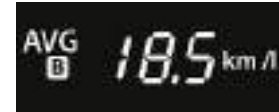

Average Fuel Economy A/B will reset to '0' whenever Trip meter A/B is reset.

Average Fuel Economy will be displayed as '---' for initial 0.5 km of respective trip. Once 0.5 km distance is covered, Average Fuel Economy will be displayed.

Even after 0.5 km distance covered for particular trip, if Average Fuel Economy is displayed as '---', then take your vehicle to TATA MOTORS Authorized Service Centre.

DASHBOARD AND FEATURES

NOTE

- AFE value is estimate of fuel economy. It may vary significantly based upon driving conditions, driving habits and condition of vehicle.
- Average Fuel Consumption will get Reset to '0' when Battery is removed and refitted.

3. Distance to empty (DTE)

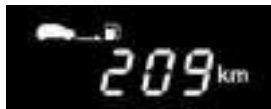

It indicates approximate distance in 'km' that your vehicle can travel with available fuel in tank with current average fuel consumption rate and it is displayed in "km".

DTE values may vary significantly based on driving conditions, driving habits, and condition of the vehicle. It is an estimate value of the available driving distance.

NOTE

- If DTE is displayed as '—', then take your vehicle to TATA MOTORS Authorized Service Centre.
- The DTE will update with new value when fuel is added more than 4 Litres at a time.

NOTE

- If low fuel warning light turns 'ON', fill the fuel tank immediately regardless the value of displayed DTE.
- If vehicle is not on level ground and negative of battery has been disturbed, the DTE function may not operate correctly.
- If low fuel warning light turns 'ON', fill the fuel tank immediately regardless the value of displayed DTE.
- Fill the fuel immediately in case of DTE shows rEFUEL.

Driver Information Settings (Version 1)

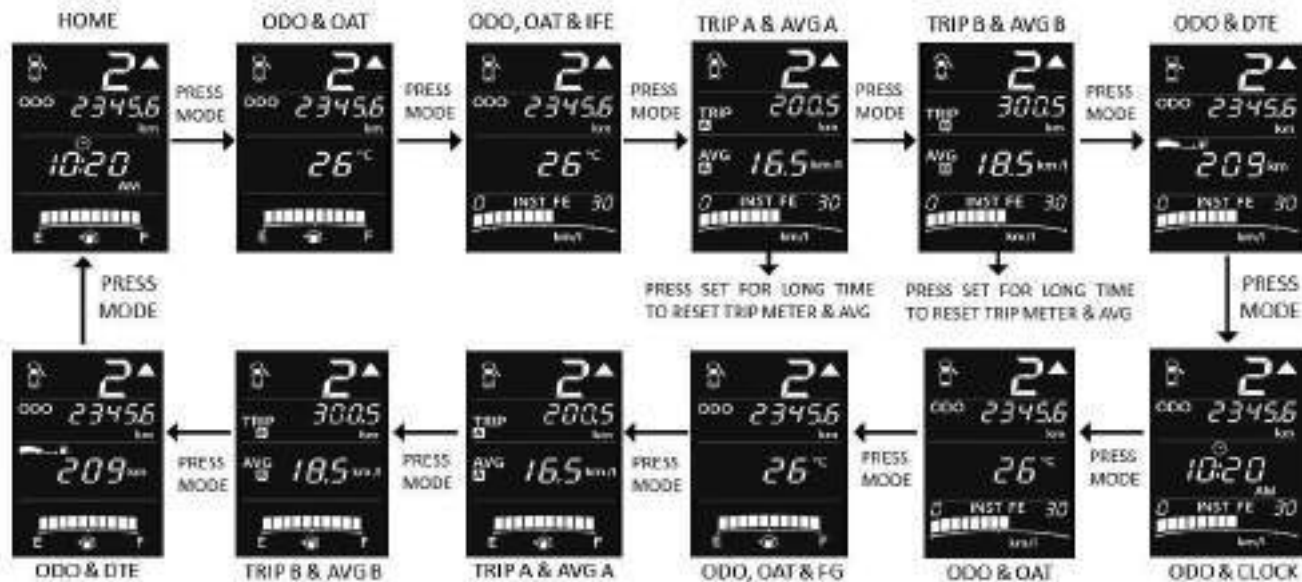

DASHBOARD AND FEATURES

Driver Information Settings (Version 2)

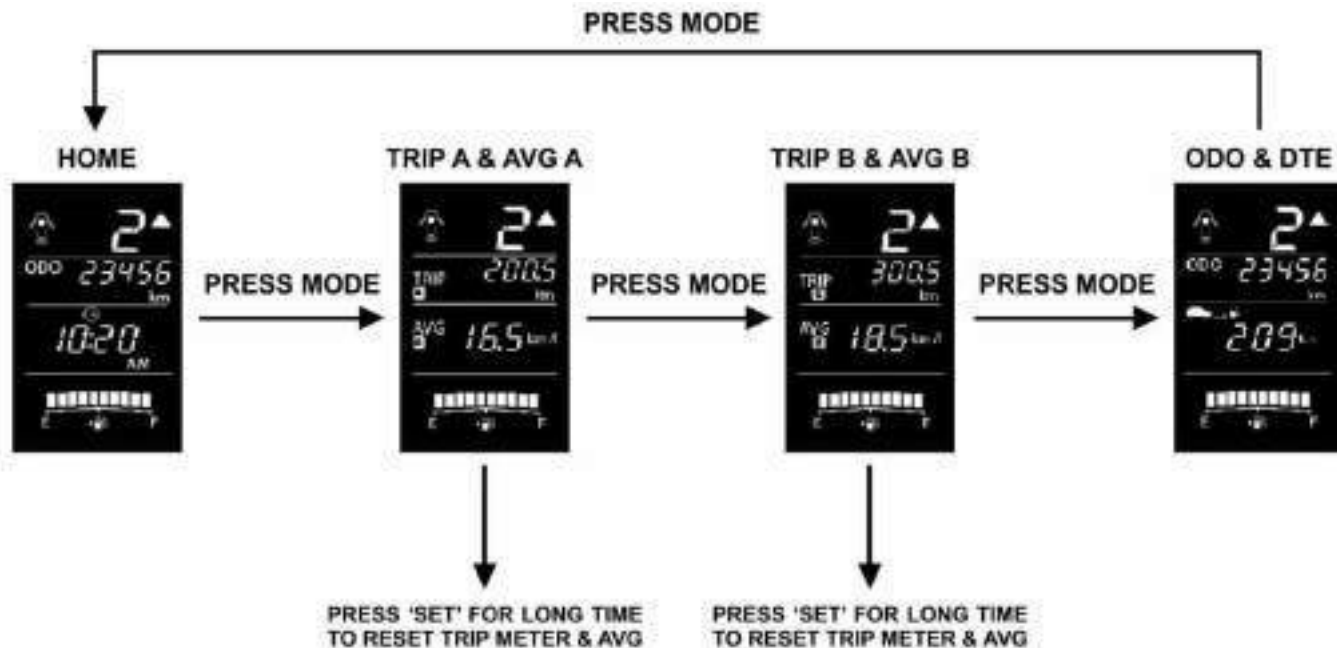

Digital Clock Setting

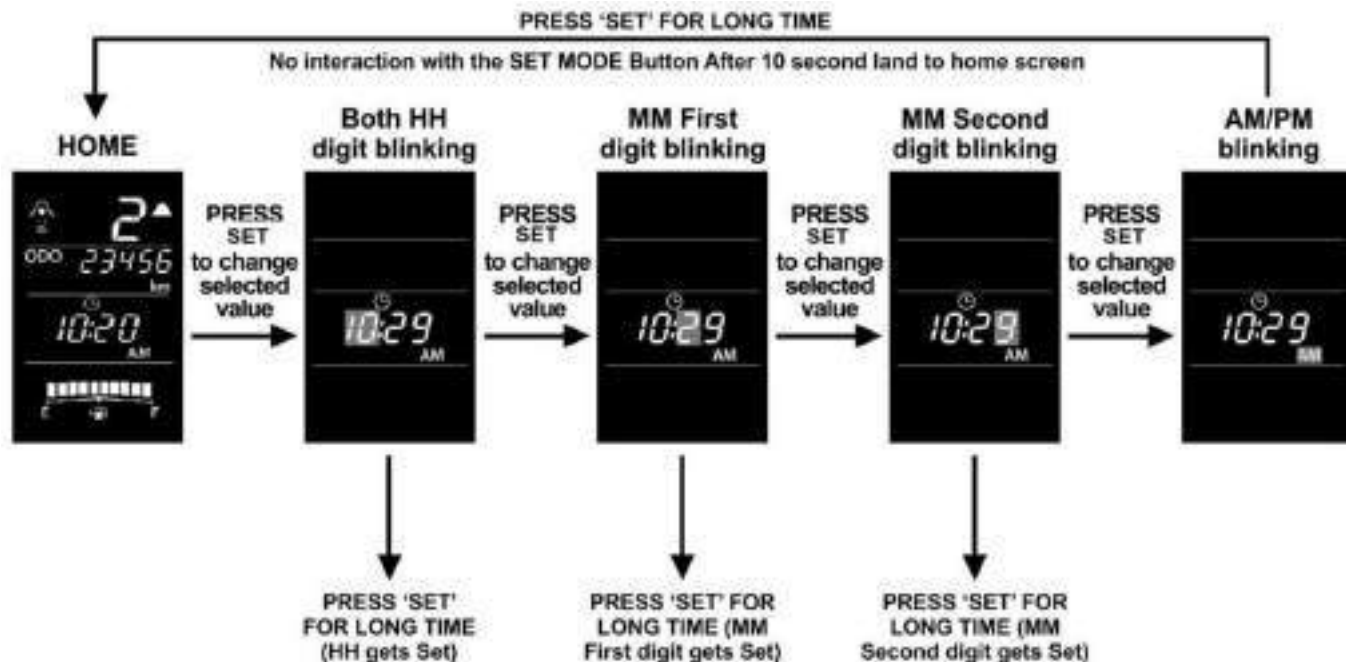

DASHBOARD AND FEATURES

Instrument Cluster Illumination



For Instrument Cluster illumination level settings, it is necessary to turn the Park Lamp 'ON' and then Press the 'SET' knob on Instrument Cluster.

Press 'SET' knob to change the illumination intensity level in 5 steps. A delayed press on the 'SET' knob for a selected intensity will confirm it.

WARNING



The Clock and Instrument Cluster Illumination settings should be done only when the vehicle is in stationary condition for safety purpose.

NOTE

- At Every Ignition ON Fuel gauge will be displayed in place of "Instantaneous Fuel consumption" Bar Graph irrespective of user selection screen.
- User can Toggle between "Fuel Gauge" and "Instantaneous Fuel consumption" Bar Graph using SET and MODE Button.
- User selection to IFE screen will NOT be allowed if Fuel is below 1/4th tank level.
- During Vehicle Running if LCD Screen is in "Instantaneous Fuel consumption" Bar Graph mode & if fuel gauge reduces to 1/4th tank level then LCD Screen will automatically goes to Fuel Mode.

Instrument Cluster – Digital Cluster (Version 3)

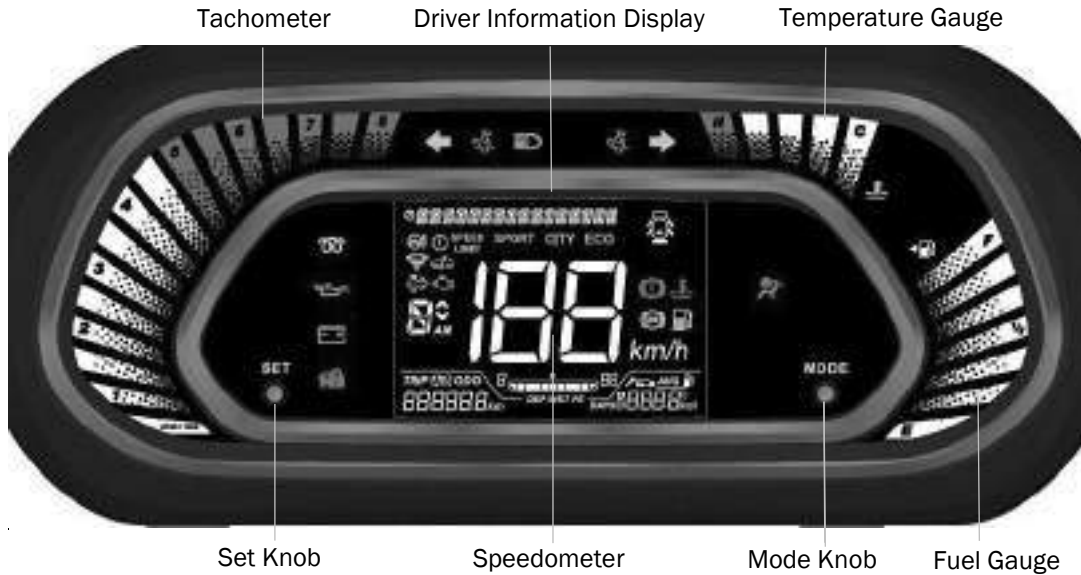

NOTE: All indicators shown may not be applicable to your vehicle.

DASHBOARD AND FEATURES

Instrument Cluster – Digital Cluster (Version 4)

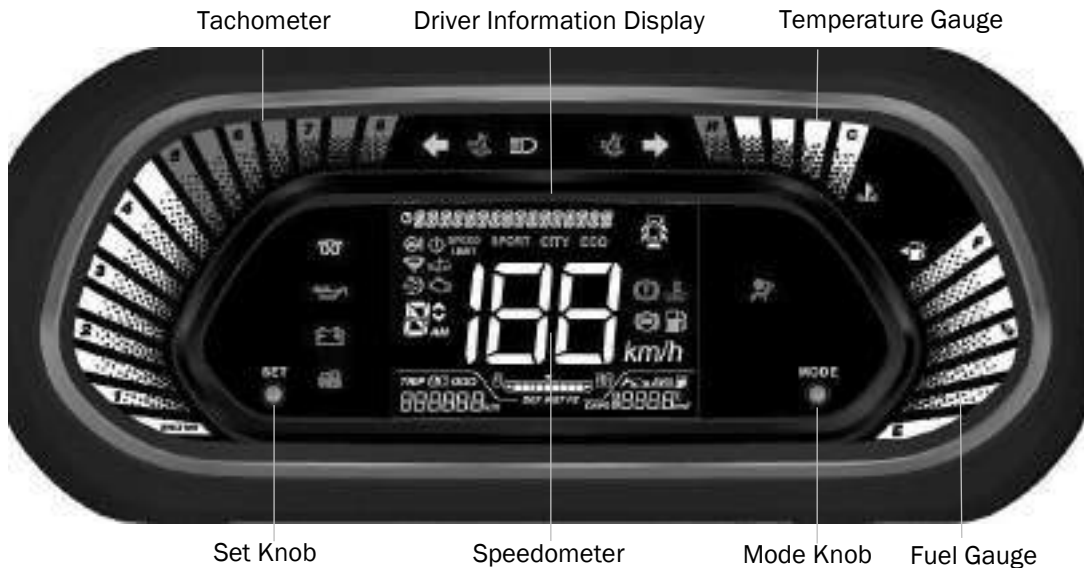

NOTE: All indicators shown may not be applicable to your vehicle.

DASHBOARD AND FEATURES

Speedometer



Speedometer indicates the vehicle speed in km/h.

NOTE

- At every key IN and ignition ON, the Instrument Cluster gauges moves to MAX. and returns to '0' position.

Tachometer



Tachometer indicates engine speed in revolutions per min (rpm).

WARNING



- When engine is accelerated beyond safe 'rpm', the tachometer pointer turns RED. In such case, reduce the engine RPM immediately.
- Never drive the vehicle with engine in high 'rpm'. This may cause severe engine damage.

DASHBOARD AND FEATURES

Fuel Gauge

When the ignition switch is in “ON” position, fuel gauge gives an approximate indication of the amount of fuel in the fuel tank. “F” stands for full and “E” stands for empty.



When fuel in the tank is near to empty position, low fuel warning telltale turns ‘ON’. Refill the tank as soon as possible.

If fuel is not filled even after Low fuel warning telltale ‘ON’, first bar in fuel

gauge will start blinking to indicate more severe low fuel warning.

NOTE

Check the fuel level when the vehicle is on level road.

On inclines, curves, during braking and sudden acceleration due to the movement of fuel in the tank, the fuel level display may fluctuate or the low fuel warning lamp may illuminate earlier than usual.

WARNING



Low fuel warning symbol will blink if there is any fault in the system. Take your vehicle to the nearest TATA MOTORS Authorised service station if the symbol starts blinking.

Temperature Gauge (if equipped)

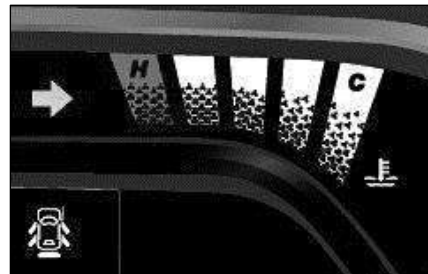

When the ignition switch is in the “ON” position, this gauge indicates the engine coolant temperature. The indicator should stay within the normal, acceptable temperature range between “H” and “C”. If the indicator approaches “H”, overheating is indicated by red LED bar.





If the coolant temperature reading is very high, the warning tell-tale flashes with an audible buzzer. In this case, stop the vehicle, switch ‘OFF’ the engine and cool it down for some time. Contact a nearest TATA MOTORS Authorised Service Centre immediately for rectification.

WARNING









The red LED bar and high coolant temperature warning tell-tale Indicates overheating that may damage the engine. Continuing to drive the vehicle when engine overheating is indicated can result in severe engine damage or fire.





DASHBOARD AND FEATURES

Driver Information	System Image	Description
Odometer		<p>Indicates total distance travelled by a vehicle.</p> <p>The Odometer reading does not return to “0” when it reaches maximum value, the display will freeze to maximum value.</p>
Trip meter A & B	 	<p>The trip meter is used to measure the distance travelled on short trips or between fuel stops. It can be reset to “0”</p> <p>Trip meter reading becomes “0.0” after it crosses 9999.9 km.</p>
Service reminder (Package Protected)	 	<p>Indicates the number of days/kilometers in which service is due. If service is overdue, it will display “0” km or “0” days and spanner symbol will blink.</p> <p>Never reset the display between service intervals otherwise, this may result in to incorrect readings.</p> <p>Information is retained in the service interval display also after the vehicle battery is disconnected.</p> <p>NOTE: This option is for indicative purpose only. Keep track of your odometer reading and follow the maintenance schedule.</p>

DASHBOARD AND FEATURES

Driver Information	System Image	Description
Gear Recommendation		<p>Up or Down arrow shall be displayed on DIS whenever Gear should be put Up or Down.</p> <p>This feature is applicable to both AMT and Manual transmission variant.</p> <p>No arrow shall be displayed when the selected Gear is as per the Vehicle dynamics.</p>
Outside Ambient Temperature		<p>Displays outside ambient temperature in °C.</p>
Door Ajar (as applicable)		<p>All four door and trunk lid are indicated independently when respective door or trunk lid is open.</p> <p>NOTE: If any other door is open roof lamp will be 'ON' provided that roof lamp switch is in  position.</p>
		<p>This warning will be indicated when driver door is open.</p> <p>NOTE: If any other door is open roof lamp will be 'ON' provided that roof lamp switch is in  position.</p>

DASHBOARD AND FEATURES

Driver Information	System Image	Description
Clock		<p>When the ignition switch is in the “ON” position, it shows the time.</p>
Drive Mode (AMT)		<p>“M” indicates Manual Drive mode. “A” indicated Automatic Drive mode.</p>
Current Gear Indication		<p>Current gear engaged by the transmission shall be displayed on DIS. This feature is applicable to both AMT and Manual transmission variant. In case of Manual transmission, the gear display is as per the User selection. IN case of AMT, the display is as per the Automatic selected gear.</p> <p>Note: If  is displayed, it means ‘Fault’ condition. In such case, take vehicle to authorized TATA MOTORS service station.</p>

1. Instantaneous fuel economy (IFE)



Monitor IFE bar graph to achieve better fuel economy.

NOTE

IFE will vary frequently as per driving pattern.

IFE display does not show Fuel Economy of last drive.

It indicates fuel economy of current Drive when Ignition is turned 'ON'.

The display does not show actual value unless vehicle is moving.

The indication on the display may be delayed if fuel consumption is affected by driving pattern.

2. Average fuel economy (AFE)



Average Fuel Economy A/B will reset to '0' whenever Trip meter A/B is reset.

Average Fuel Economy will be displayed as '---' for initial 0.5 km of respective trip. Once 0.5 km distance is covered, Average Fuel Economy will be displayed.

Even after 0.5 km distance covered for particular trip, if Average Fuel Economy is displayed as '---', then take your vehicle to TATA MOTORS Authorized Service Centre.

NOTE

AFE value is estimate of fuel economy. It may vary significantly based upon driving conditions, driving habits and condition of vehicle.

Average Fuel Consumption will get Reset to '0' when Battery is removed and refitted.

DASHBOARD AND FEATURES

3. Distance to empty (DTE)



It indicates approximate distance in 'km' that your vehicle can travel with available fuel in tank.

DTE values may vary significantly based on driving conditions, driving habits, and condition of the vehicle. It is an estimate value of the available driving distance.

NOTE

If DTE is displayed as '---', then take your vehicle to TATA MO-TORS Authorized Service Centre.

The DTE will update with new value when fuel is added more than 4 Litres at a time.

If low fuel warning light turns 'ON', fill the fuel tank immediately regardless the value of displayed DTE.

Driver Information Settings

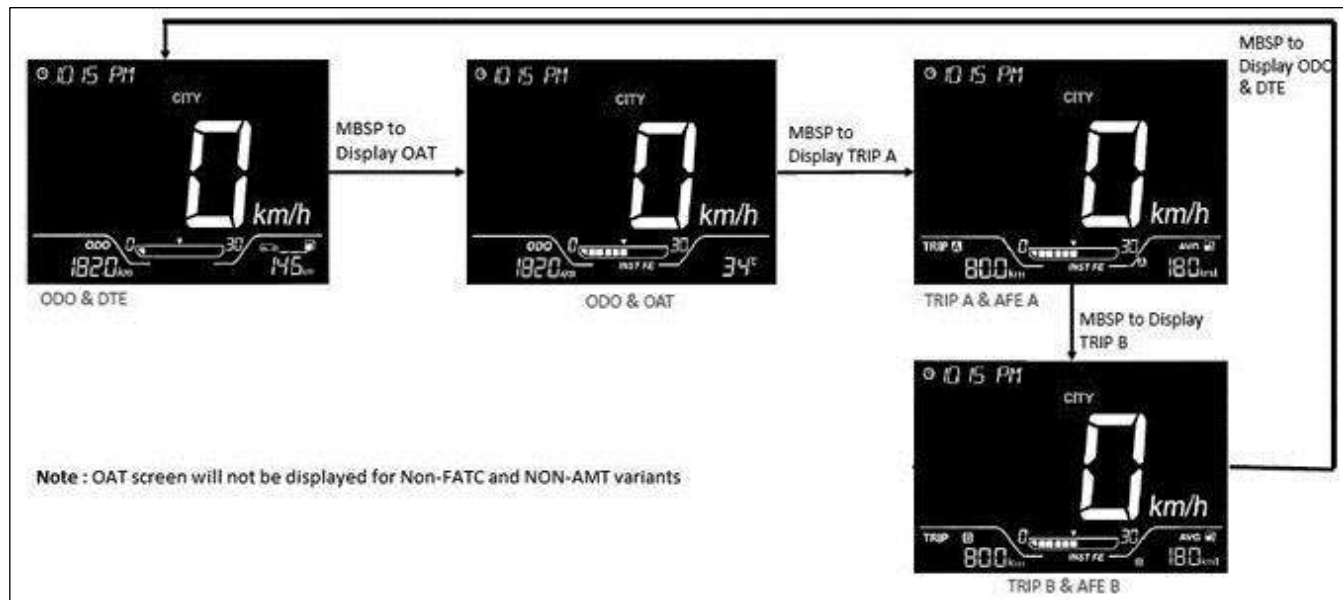

MBSP- Mode Button Short Press

DASHBOARD AND FEATURES

Driver Information Settings for Illumination and Clock setting

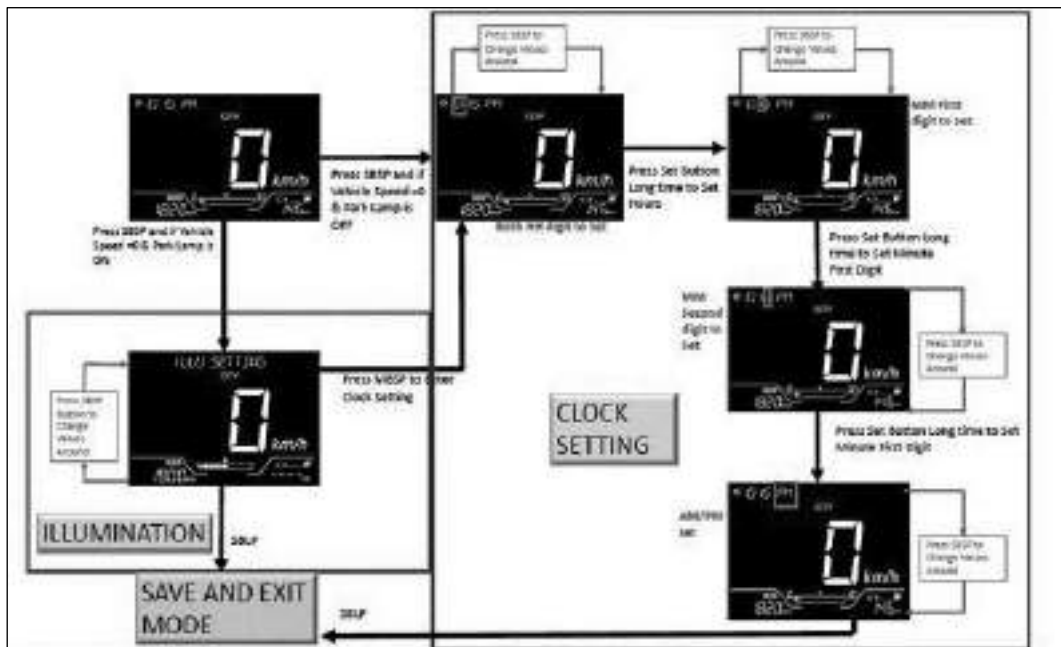

MBSP- Mode Button Short Press;

SBLP- Set Button Long Press;

SBSP- Set Button Short Press

Instrument Cluster Illumination



For Instrument Cluster illumination level settings, it is necessary to turn the Park Lamp 'ON' and then Press the 'SET' knob on Instrument Cluster.

Press 'SET' knob to change the illumination intensity level in 5 steps. A delayed press on the 'SET' knob for a selected intensity will confirm it.

NOTE





This is a welcome strategy and a self-check feature.

WARNING







The Clock and Instrument Cluster Illumination settings should be done only when the vehicle is in stationary condition for safety purpose.



DASHBOARD AND FEATURES

Warning Lamps	Color	Indicator	Remarks
Malfunction Indication Lamp (MIL)	Amber		<ol style="list-style-type: none"> 1. Illuminates when ignition is switched 'ON'. Once engine is started, it turns 'OFF'. 2. It remains 'ON' for any engine related fault that may increase emission levels of the vehicle beyond the regulatory norms. Contact a TATA MOTORS Authorised Service Centre for rectification.
Check Engine	Amber		<ol style="list-style-type: none"> 1. Illuminates when ignition is switched 'ON'. Once engine is started, it turns 'OFF'. 2. Illuminates continuously if a fault arises in Engine Management System. Contact a TATA MOTORS Authorised Service Centre.
Immobilizer	Red		<ol style="list-style-type: none"> 1. Illuminates when the system disables engine start if the original key is not used. 2. Lamp blinks: Vehicle is in immobilized condition when key is not inserted. 3. Lamp ON: Problem with key/system. Contact a TATA MOTORS Authorised Service Centre.
Water in fuel (Diesel)	Amber		<ol style="list-style-type: none"> 1. Illuminates when ignition is switched 'ON'. Once engine is started, it turns 'OFF'. 2. Illuminates continuously if excess water is accumulated in the fuel filter. Contact a TATA MOTORS Authorised Service Centre to drain the water immediately to avoid serious damage to the fuel injection system.





DASHBOARD AND FEATURES

Warning Lamps	Color	Indicator	Remarks
Glow Plug (Diesel)	Amber		Illuminates momentarily when ignition is switched 'ON' to indicate that the glow plugs are active. It will continuously illuminate when engine is getting preheated. Start the engine only after the indicator turns 'OFF'.
Turn Signal	Green		Indicates direction indicated by the turn signal. Blinks along with buzzer while operating left/right turn indicator only when ignition is switched 'ON'.
High Beam	Blue		Illuminates when the high beam headlamps are switched 'ON' or flashed.
Low Oil Pressure	Red		<ol style="list-style-type: none"> 1. Illuminates when ignition is switched 'ON'. Once engine is started, it turns 'OFF' once required oil pressure is achieved. 2. Illuminates continuously if there is insufficient oil pressure. Stop the vehicle as soon as safety permits and switch off the engine. Check engine oil level and top-up if required. Contact TATA MOTORS assistance before starting the engine.
Battery charging	Red		<p>Illuminates when ignition is switched 'ON'. Once engine is started, it turns 'OFF'.</p> <p>It will continuously illuminate when there is malfunction of charging system. Contact a TATA MOTORS Authorised Service Centre.</p>





DASHBOARD AND FEATURES

Warning Lamps	Color	Indicator	Remarks
Park Brake / Brake Fluid Low / EBD Fault	Red		<p>Illuminates momentarily when ignition is switched 'ON'. Once parking brake is released, it turns 'OFF'. If it remains 'ON', it indicates</p> <ol style="list-style-type: none"> 1. Brake fluid level is low. 2. Park brake is applied & turns 'OFF' when it is released. 3. ABS/EBD system has a fault.
Driver seat belt warning	Red		<p>Indicates that seat belt is not fastened when ignition is 'ON'. It will be continuously 'ON' if the seat belt is not fastened. When the vehicle speed goes above 15 kmph seat belt alarm will be audible. If seat belt is not fastened and vehicle speed goes above 15 Kmph, then final warning will start with telltale flashing and Audio chime for 90 seconds. After 90 seconds, telltale will be ON and Audio chime will be OFF.</p> <p>Note:</p> <ul style="list-style-type: none"> • Telltale will turn off either when seatbelt is buckled or Reverse gear is engaged when it is in initial warning stage. • When it is in final warning with Chime ON, the telltale will be OFF on fastening the seat belt or engaging the reverse gear.



DASHBOARD AND FEATURES

Warning Lamps	Color	Indicator	Remarks
Airbag status	Red		<p>Illuminates momentarily when ignition is switched 'ON'.</p> <p>It will continuously illuminate when there is malfunction of airbag (SRS) system. Contact a TATA MOTORS Authorised Service Centre immediately.</p>
EPAS (if applicable)	Amber		<p>Illuminates momentarily when ignition is switched 'ON'.</p> <p>Illuminates when there is a fault in the EPAS. Contact a TATA MOTORS Authorised Service Centre immediately.</p>
High Coolant Temperature	Red		<p>If the coolant temperature reading is very high, the warning Telltale flashes with an audible buzzer.</p> <p>In this case, stop the vehicle, switch 'OFF' the engine and cool it down for some time. Contact a nearest TATA MOTORS Authorized Service Centre immediately for rectification.</p> <p>High Coolant temperature warning may come when cooling fans in radiator sections are malfunctioning.</p>
ABS (if applicable)	Amber		<p>Illuminates momentarily when ignition is switched 'ON'. Illuminates continuously if there is any malfunction in ABS. Normal braking system will be operational without assistance of ABS. Contact a TATA MOTORS Authorised Service Centre immediately.</p>

DASHBOARD AND FEATURES

Warning Lamps	Color	Indicator	Remarks
Low Fuel	Amber		<p>Illuminates momentarily when ignition is switched 'ON'.</p> <p>Illuminates when fuel level is low. 1st bar on fuel gauge will start blinking when fuel level is low. Refill the fuel tank as soon as possible.</p> <p>IMPORTANT: The warning light will start flashing if there is any fault in the fuel system. Contact a TATA MOTORS Authorised Service Centre immediately.</p>
ECO (For MT) (If applicable)	Green		ECO indicates Economy drive. This mode is used to achieve better fuel economy.
CITY	Blue		CITY mode is default mode. This mode is used to achieve optimum torque.
SPORT (For AMT) (If applicable)	Amber		This indicates comes when vehicle is in a SPORT mode. It is applicable only in AMT. This mode is used to product more torque from engine.
AMT Fault (If applicable)	Amber		<p>Illuminates momentarily when ignition is switched 'ON'.</p> <p>Illuminates continuously when there is a fault in Automatic Manual Transmission system. Contact a TATA MOTORS authorized Service Centre immediately.</p>

DASHBOARD AND FEATURES

Warning Lamps	Color	Indicator	Remarks
Front passenger Seat Belt Indicator	Red		<p>Illuminates when ignition is switched 'ON' and goes 'OFF' after 4 Seconds.</p> <p>The warning lamp remains 'ON' if the front passenger seat is occupied and seat belt is not fastened.</p> <p>If seat belts remains unbuckled and vehicle speed goes above 15 kmph, then final warning will start illuminates with audio chime for 90 seconds continuously.</p>
Speed limit warning indicator	Amber		<p>Illuminates when ignition is switched 'ON' and goes 'OFF' after 4 Seconds.</p> <p>When the vehicle speed cross 80 km/hrs. then Speed limit Warning indicator turn 'ON' along with for every 2 minute chime shall be sounded (Audible warning).</p> <p>If vehicle speed crosses 120 km/hrs. then along with Speed limit Warning Indicator, Chime will start continuously ON till the vehicle speed is above 115 km/hrs.</p> <p>If vehicle speed reduced below 115 km/hrs, chime will be sounded one beam per two min. but speed limit warning indicator will remains 'ON' continuously.</p> <p>When the vehicle speed is reduce below 75 km/hrs. then Speed limit Warning Indicator along with chime will gets turns 'OFF'.</p>

DASHBOARD AND FEATURES

Warning Lamps	Color	Indicator	Remarks
DPF Lamp (Diesel)	Amber		<p>The warning light or symbol switches on constantly to indicate that the DPF needs to eliminate the trapped pollutants (particulate matter) through the regeneration process, it therefore does not indicate a malfunction. The warning light or symbol remain off during the entire DPF regeneration and light up only when driving conditions require the driver to be notified. To switch off the warning light or symbol, keep the car running until regeneration is complete (ideally at 3rd gear, 60 km/hr. with engine speed over 2000 rpm). The process normally takes about 20 minutes.</p> <p>Note: Failure to be observed the appropriate procedure for a long distance when the DPF warning light comes ON, can cause the warning light (MIL) to come ON. In that case, please contact nearest TATA authorized service center to restore correct DPF operation.</p>

DASHBOARD AND FEATURES

Audio Reminders

Key in reminder

While leaving your vehicle, if you forget the key inside the vehicle in Ignition 'OFF' position, buzzer will provide audio warning. Remove Key to stop the warning.

Park lamp 'ON' reminder

While leaving your vehicle, if you forget to turn 'OFF' the headlamps, buzzer will provide audio warning. Switch 'OFF' Park Lamps to stop the warning. Do not forget to turn 'OFF' your headlamps as it may drain your vehicle battery.

Park brake 'ON' reminder

If Park Brake is applied and vehicle is driven, Tell tale will turn 'ON' and buzzer will provide audio warning continuously. Disengage the park brake to stop audio warning.

Reverse gear reminder

When Reverse Gear is engaged, audio warning for 1 sec will alert you.

Driver seat Belt reminder

If seat belt remains unbuckled and vehicle speed goes above 15 km/ hrs, Final Warning will start. Audio Chime will continue for 90 seconds. Seat belt telltale will be flash when audio alarm is active.

Front passenger seat belt reminder

If Front passenger is present & its seat belt remains unbuckled and vehicle speed goes above 15 km/ hrs. Final Warning will start. Audio Chime will continue for 90 seconds. Seat belt telltale will be flash when audio alarm is active.

NOTE

Buckle the seat belt to stop Audible warning.

AMT fault Reminder

If Fault occur in AMT, 3 second audio warning will alert you.

Drive mode chime

Manual Transmission:

When drive mode changes from City to Eco mode or Eco to City mode, audio warning will be alert for one second.

Automatic Transmission:

When Drive mode changes from Manual to Auto or Auto to Manual, audio warning will be alert for one second.

DASHBOARD AND FEATURES

Combi-Switch (RH Stalk)



- 1. Left Turn signal** - Move the lever fully upward.
- 2. Right Turn signal** - Move the lever fully downward.

NOTE

When the turn is completed, the signal will cancel and the lever will return to its normal position.

3. High beam - Move the lever forward to select the High Beam function. Pull the lever back to normal for low beam.

4. High beam Flash (spring return)
To flash the high beam, pull the lever towards you from the normal position. It will return to its normal position when you release it.

5. Headlamp Rotary Switch

i) OFF Position



All lamps will remain 'OFF'.

ii) Parking Lamp



Rotate stalk to turn 'ON' the Parking lamps.

iii) Low Beam



Rotate stalk to turn 'ON' the Low Beam function.

6. Lane Change Signal

To signal a lane change, move the lever slightly up or down respective to the

point where the turn signal light begins to flash, but the lever does not latch. The turn signal will flash 3 times automatically.

7. Head lamp leveling rotary switch



Inner rotary switch on right hand stalk is provided for head lamp leveling. With the inner rotary switch, Head lamp leveling can be done with head lamp in Low Beam and in 'ON' position. Select correct position before start of trip and vehicle is stationary. Depending upon the number of passengers and luggage in the vehicle headlamp focus may change. This can be adjusted by rotating the knob to one of the 3 level positions.

Combi-Switch (LH Stalk)



0) 'OFF' Position

The wiper is switched 'OFF'.

1) Intermittent wipe

Push the stalk upwards to operate intermittent wipe.

Inner rotary switch on left hand stalk is provided for intermittent front wiper delay. The switch has 5 delay timers.



2) Slow Wipe

Push the stalk towards position (2) for continuous slow wipe.

3) Fast Wipe

Push the stalk towards position (3) for continuous fast wipe.

4) Flick wipe (spring return)

Pull the stalk downwards and hold it for continuous wipe, the wiper continuously wipes across the windshield at low speed till the stalk is released.



5) Front Windshield Washer

- Pull the lever little longer, washer fluid will be sprayed on the windshield.
- The windshield wipers operate for 3 cycles after the lever is released and 1 more cycle after 5 seconds.



NOTE

When you crank the engine, the supply to washer motor is momentarily cut off.

Fascia Switches –

Option I

Fascia switches are provided on the center console above HVAC control panel.



1. Front fog lamp switch
2. ECO mode switch
3. Electric trunk lid

DASHBOARD AND FEATURES

Option II



1. Rear window demister switch
2. Front fog lamp switch
3. Electric trunk lid

Option III



1. Electric trunk lid
2. Front fog lamp switch
3. ECO mode switch
4. Center locking switch

Front Fog Lamps

In conditions where visibility is poor due to fog, snow or rain, the fog lamps improve visibility as well as making it easier for other road users to see you.



It turns 'ON' when the front fog lamp switch is pushed in with ignition 'ON' and position and parking / head lamp is 'ON'. An indicator on the switch will be illuminated when the front fog light is 'ON'.

ECO mode Switch (if equipped)

Refer DRIVE MODES chapter in 'STARTING and DIVING' section.



Electric Trunk lid

To open the trunk lid, press the switch located on fascia switch.



Rear Window Demister (if equipped)

The switch turns the rear window demister ON/OFF. It operates when engine is running. The system will be deactivated after 15 min of continuous operation.



An indicator on the switch will be illuminate when the rear window demister is 'ON'

Center locking switch

All the doors can be lock and unlock from inside the vehicle by pressing this switch.



NOTE

All doors are closed while using the center locking switch.

Steering Wheel Switches (LHS) (if equipped)



Volume - To increase (+) / decrease (-) volume of music system / radio.

Mute / phone reject

To reject or hang up a phone call. It is also used to mute the volume of music system / radio.

Seek forward / backward

To change radio channels.

Source - To select the required source in the infotainment (USB, AUX, AM, FM).

Steering Wheel Switches (RHS) (if equipped)



Phone receive

This button is used to accept incoming call when a cell phone is connected via Bluetooth.

NOTE

For more information on steering wheel switches refer Infotainment manual.

Mic



A mic is provided on roof interior above driver seat position.

Speakers (if equipped)

Speakers and tweeters are provided on models with infotainment system. While provisions are given for music system and speakers on versions without infotainment system.

DASHBOARD AND FEATURES

Infotainment System (Option I)



(Option II)



NOTE

For more information on Infotainment system refer below link
<http://service.tatamotors.com/content/owners-manual>.

USB/AUX Port (if equipped)



Connect your portable digital music players, pen drives etc. to this socket for playing music tracks through the vehicle's music system.

Power Socket (if equipped)



Two power sockets are provided. The power socket will work when the ignition switch is in the "ACC" or "ON" position. This socket can be used to provide 12V (10A) power for electrical accessories.

NOTE

Use of inappropriate electrical accessories can cause damage to your vehicle's electrical system. Make sure that any electrical accessories you use are designed to plug into this type of socket.

DASHBOARD AND FEATURES

Antenna

(Option I)



Antenna is located on the roof. Turn antenna counter clockwise to remove from vehicle, if required.

(Option II)

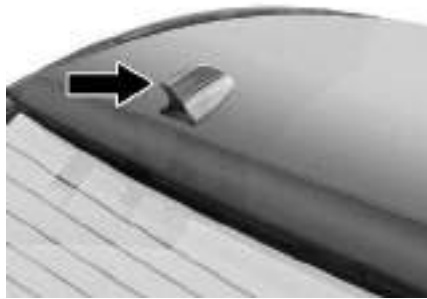

Shark FIN antenna is provided on the roof at rear end.

Roof Lamp



Interior roof lighting lamp is provided on the roof with inbuilt switch.

The switch has three positions:

ON - The lamp will turn 'ON' as long as the switch is in this position.



DOOR - In this position the lamp turns 'ON' with dimming when either of the doors are opened. When the last door is closed, the lamp will remain 'ON' for



DASHBOARD AND FEATURES

25 sec and turns 'OFF' with dimming. This helps settling in the seat and inserting the key in the ignition switch. When the key is turned to the 'IGN' position, the lamp goes 'OFF' immediately.

OFF - In this position the lamp will remain 'OFF'.



Roof Grab Handle



Roof grab handles are provided on all seats except driver's seat. This helps in comfortable positioning of passengers during a journey.

Boot Lamp (if equipped)



Boot lamp is provided in the luggage compartment to illuminate the luggage area.

Switch is provided on lamp to turn 'ON'/ 'OFF' boot lamp. If switch is retained in 'ON' position, Boot lamp will turn 'ON' automatically on opening the trunk lid.

Tag Holder



Tag holder is provided near the front windshield for ease of displaying toll, parking tickets, ID's, passes, labels etc.

DASHBOARD AND FEATURES

Storage Compartments

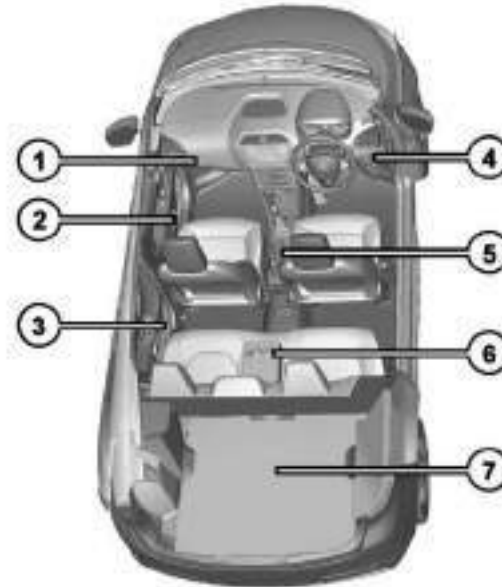

- 1) Glove box
- 2) Utility pockets on front doors
- 3) Utility pockets on rear doors

- 4) Driver side pocket
- 5) Center console
- 6) Foldable arm rest

- 7) Trunk lid compartment

STOWAGE AREAS

1) Glove box



To open - Press the knob and open the glove box flap.

To close - Fold glove box flap upwards until it engages.



1. Vent - Chiller glove box (If applicable)
2. Laptop holder
3. Pen / Visiting card holder

NOTE

On selected models, cooling facility is also provided. It cools the glove box only when the AC is 'ON'.

Chiller glove box (If applicable)

Upper Glove Box is provided with a cooling facility. It cools the glove box only when the front A/C is ON. Shut OFF the

vent by rotating the knob, whenever cooling is not required.

- 2) **Utility pockets on front doors**
- 3) **Utility pockets on rear doors**

Utility pockets are provided on front and rear doors and it can be used to keep magazines/books, water bottles etc.

4) **Driver side Pocket**



You can keep suitable items in the space provided.

STORAGE AREAS

NOTE

Use cups, containers, bottles of right size and which have lids. The drinks could otherwise spill.

5) Center console



a) Stowage compartment

Stowage compartment provided for keeping cell phones, iPod's, chargers etc.

b) Cup holder

c) Coin storage

d) Bottle holder

6) Foldable arm rest

A foldable arm rest has been provided in the rear seat. It also has two cup holders, which can be accessed by opening the cover. When not required, fold the arm-rest back into the seat.



NOTE

Remove all items and cups before folding the cup holders

7) Trunk lid Compartment



Store the luggage in trunk lid.

WARNING



Distribute the items of luggage as evenly as possible.

Position heavy loads as far forwards as possible and as low down in the trunk lid as possible.

The load must not protrude above the luggage cover. Never allow occupants to travel in the luggage compartment.

STOWAGE AREAS

Card holder (If applicable)

A pocket is provided on the back of the driver side sun visor to keep cards, papers etc.

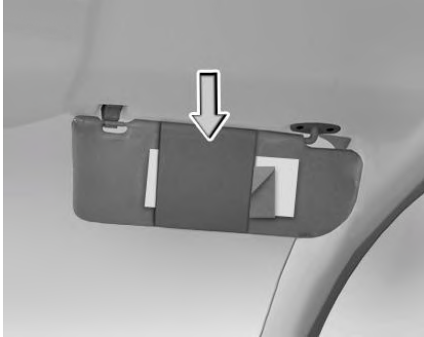

Coat hook

Coat hook is provided on rear passenger right side grab handle.



NOTE

Keep the sun visors in their original position when not in use or else, they may block driver's vision.

WARNING



The coat hook cannot restrain heavy objects or items of luggage.

Never hang hard, sharp-edged or fragile objects on the coat hook..

Collapsible hook

Collapsible hook is provided for hanging carry bags etc. Load up to 2 kg is permissible.



CLIMATE CONTROL

The HVAC is operational when engine is running and blower is 'ON'. The Climate control regulates the temperature in the vehicle interior and filters dust particles. You can manually set the desired temperature

Air Distribution- The air is distributed through the vents in the passenger compartment as shown below:



CLIMATE CONTROL

Air vents

Air vents are provided on dashboard. Air flow and its direction can be adjusted with the help of knob provided on respective vent.



HVAC Controls (if applicable)



- A. Air Distribution Control
- B. Blower Speed Control
- C. Temperature Control
- D. Air Intake Selector
- E. AC ON/OFF Switch

A. Air distribution control

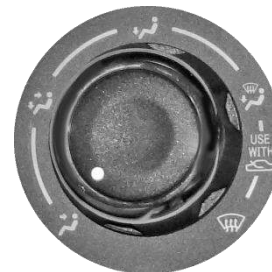

This is to select the air distribution pattern as described in the table.

	Directs air through the center and side air vents
	Directs air through the center, side and foot well vents
	Directs air through the foot well air vents
	Directs air through the defroster & foot well vents (Default fresh air mode)
	Directs air through the defroster vents (Default fresh air mode)

B. Blower Speed control



This is to turn 'ON' the blower and select desired blower speed.

C. Temperature control



The temperature control dial allows you to adjust the temperature. To lower the temperature, turn the dial to the left. To

NOTE

The AC can be switched 'ON' only if the blower is 'ON' and engine is running.

increase the temperature, turn the dial to the right.

D. Air intake selector

Press the switch to activate / deactivate recirculation mode.



Press to 'ON' or 'OFF'

Recirculation mode: (Indicator light 'ON')



Air in the passenger compartment recirculates. No fresh air enters the compartment.

Always use when:

- Driving on a dusty road or through tunnel.
- On signals or slow traffic to avoid traffic pollution.
- Maximum cooling is required.

Fresh Air mode: (Indicator light 'OFF')
Fresh air is drawn into the vehicle.

Always use when:

- Discomfort is felt or windows are fogging up.
- Using  or  air flow modes during demist / defrost.
- Using normal heating mode.

E. AC ON/OFF











Press the switch to activate / deactivate the climate control. The indicator lamp in the button will light up when climate control is activated.

When AC is switched 'ON', engine idling RPM increases marginally to adjust the AC compressor load.

When desired temperature is achieved AC trips 'OFF' automatically.

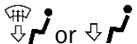
CLIMATE CONTROL

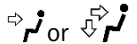
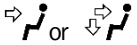
Recommended basic settings of the control elements of air conditioning system for the respective operating modes. These may vary depending on individual requirements and weather conditions.

Functions	Control Knob Position			Button Position	
	A. Air Flow Direction	B. Blower Speed	C. Air Temperature	D. Air Intake	E. AC ON / OFF
					
Normal heating		2 nd or 3 rd dot	Desired temp.	Fresh air mode.	Switched OFF
Quick heating		To MAX speed and then 2 nd or 3 rd dot	To the right up to the stop	Briefly switch ON to Fresh air mode then Recirculation	Switched OFF
Normal Cooling		1 st to 3 rd dot	Desired temperature	Recirculation mode	Switched ON
Quick Cooling		To MAX speed and then 2 nd or 3 rd dot	To the left up to the stop	Recirculation mode	Switched ON
Demisting		2 nd or 3 rd dot	Desired temperature	Fresh air mode (Default)	Switched ON (Optional)
Defrosting		To MAX speed	Desired temperature	Fresh air mode (Default)	Switched ON (Optional)

NOTE

- Condensation may drip from the underside of the vehicle when it is in cooling mode. Traces of water on the ground are normal and are not a sign that there is a malfunction.
 - Ventilate the vehicle for a brief period during warm weather. This will speed up the cooling process and the desired vehicle interior temperature will be reached quickly.
 - Never cover the air vents or air intake grilles in the vehicle interior.
 - If the AC is not used for a long period, such as during winter, it may not give the best performance when you start using it again. Operate the AC at least once a month to maintain optimum performance.
- While starting the vehicle itself after long duration (more than 15 days), following procedure needs to be followed to meet AC performance.
 - Start the vehicle with AC & Blower in OFF condition in idling for 2~3 minutes.
 - Then switch ON the AC & Blower and run it for another 2~3 minutes in idling for proper circulation of refrigerant & oil to lubricate the internal parts of AC system.

CLIMATE CONTROL

FULLY AUTOMATIC TEMPERATURE CONTROL (FATC) (if applicable)

(if applicable)



- | | |
|-----------------------------------|-------------------------------------|
| 1. AC compressor ON/OFF button | 2. Blower speed control knob |
| 3. Econ (economy mode) button | 4. Maximum defrost button |
| 5. Rear window demister button | 6. Fresh air / recirculation button |
| 7. Air distribution (mode) button | 8. OFF mode |
| 9. Auto on selection button | 10. Temperature control knob |

GENERAL DESCRIPTION

FATC system controls the in-cabin Temperature of the vehicle automatically and provides maximum passenger convenience regardless of outside weather conditions.

NOTE

If the display flashes 'ERR' in periodic pattern (Display will show 'ERR' for 5 sec. and set temperature for 30 sec.), It indicates FATC malfunctioning. Switch over to manual mode and contact a TATA MOTORS authorized service Centre.

CLIMATE CONTROL

DISPLAY UNIT



FATC display is shown on infotainment display screen.

FATC functions can be controlled using both the FATC control panel and the touch screen display.

Whenever the user presses any push button or turns the rotary knob, then the display unit will show the relevant Climate Information



Also, when the display is not in climate mode then climate information will be displayed on the all-time display provide on the bottom bar.

1. AC COMPRESSOR ON / OFF BUTTON:



Press the AC compressor ON/OFF button to turn the air conditioning ON or OFF. You will see AC text on the display, when AC is ON.

2. BLOWER SPEED CONTROL KNOB:



A. Rotate the knob clockwise to increase the blower speed up to MAX 7 speed, where as anti-clockwise would reduce the speed up to 'SPEED 1'.

CLIMATE CONTROL

B. In 'AUTO' mode, the FATC system will regulate the blower speed automatically.

3. ECON BUTTON:



During ECON AC operation, the system automatically cuts off compressor at a higher temperature than normal AC. The operation can be used during mild weather conditions for better fuel efficiency.

NOTE

The outside air intakes for the climate control systems are at the base of windscreen. Keep this area clear from leaves and other debris.

Comfort level may be compromised during this operation. By pressing ECON button text will be displayed on display.

4. MAX DEFROST BUTTON:

A. This button directs the main airflow towards windscreen for faster defrosting. (It also overrides any mode selection you may have made.)



B. When you turn off the button, the system returns to its former settings.

NOTE

For your safety make sure you have a clear view through all the windows before driving.

5. REAR WINDOW DEMISTER BUTTON:

A. This button turns the rear window demister ON or OFF. The system will be deactivated after 15 min of continuous operation.

6. FRESH AIR / RECIRCULATION BUTTON:

A. When the recirculation Button or LED is switched 'ON', air from the vehicle's interior is sent throughout the system.



B. When the recirculation button is switched off, air is brought in from outside of the vehicle (fresh mode). Whenever discomfort is felt, switch to fresh air mode.

The system should be used with recirculation air mode for faster heat up and cool down, however keeping the system in recirculation mode, particularly with AC OFF, can cause the windows fog up.





7. AIR DISTRIBUTION (MODE) BUTTON:

A. In AUTO mode, the FATC system will regulate the mode automatically. However, user override is



possible with the use of MODE button to select the desired airflow mode.

Each time you press the MODE button, the display shows the mode selected.

	Air flows from the center and side air vents
	Air flows from the center, side vents and foot well vents
	Air flows from mainly foot well vents
	Air flows from the defroster and foot well vents (always select fresh air mode)
	Air flows from the defroster vents (always select fresh air mode)

8. "OFF" BUTTON:



Press the OFF button to switch OFF The system. OFF will be displayed on the display.

9. AUTO ON SELECTION BUTTON



To put the automatic climate control in fully automatic mode:

- Press the 'AUTO' button.
- Set the desired temperature by turning temperature control knob. The display will show all the functions during 'AUTO' mode.
- The system automatically selects the proper mix of conditioned and / or

heated air that will, as quickly as possible, raise or lower the interior temperature to your preference.

- When you set the temperature to its lower limit (Lo) or its upper limit (Hi), the system runs at full cooling or heating only. It doesn't regulate the interior temperature.

Semi-automatic Operation

You can manually select various functions of the climate control system when it is in fully automatic mode. All other features remain automatically controlled. Making any manual selection causes the word 'AUTO' in the display to go OFF and overridden setting is displayed. System will remain in semiautomatic mode till 'AUTO' is re-pressed.

CLIMATE CONTROL

10. TEMPERATURE CONTROL









KNOB:



Turning the temperature control knob clockwise increases the temperature of the air. The desired temperature will be increased by steps of 0.5°C. User can select temperature range from 18°C to 30°C. Whereas the anticlockwise direction decreases the temperature.

When you set the temperature to its lower limit (Lo) or its upper limit (Hi), the system runs at full cooling or heating only. It doesn't regulate the interior temperature.

CLIMATE CONTROL

Functions	Control Knob Position			Button Position				
								
Normal heating	Desired Speed	Desired Temp.	Switched OFF	OFF	OFF	OFF	Switched OFF	ON
Quick heating	Max. speed	To the right up to the stop	Switched OFF	OFF	Switched OFF	Switched OFF	Switched OFF	ON
Normal Cooling	Desired speed	To the right up to the stop	Switched OFF	ON	Switched OFF	Switched OFF	Switched OFF	ON
Quick Cooling	Max speed	To the right up to the stop	Switched OFF	ON	Switched OFF	Switched OFF	Switched OFF	ON
Demisting	Max speed	To the right up to the stop	Switched OFF	OFF	Switched OFF	Switched OFF	Switched OFF	OFF
Demisting	Max speed	To the right up to the stop	Switched OFF	OFF	Switched OFF	Switched OFF	Switched OFF	OFF

CLIMATE CONTROL

HVAC Sensors

HVAC system is fitted with three sensors

1. A solar sensor on top of the dashboard at the right hand side of defroster grill



2. In-car sensor on control panel.



3. Outside Ambient Temperature (OAT) sensor located under the front bumper grill.

NOTE

- Do not cover or spill any liquid on sensors.
- Do not cover sensor, this may cause the sensor to malfunction. This may lead to FATC not functioning to desired level.

If your vehicle is parked under the sun, you can cool it down fast by following the steps given below:

- A. Start the engine.
- B. Turn on A/C by pressing the button. Make sure the temperature control is set to maximum cool. In case of FATC set temperature to 'Low' mode.
- C. Set the fan to maximum speed. (for ETC, manual HVAC variants)
- D. Open windows half, set air direction towards face and fresh air mode.
- E. When the interior has cooled down to a more comfortable level, close windows and set the controls as required in normal cooling, with recirculation mode ON.

Pre Driving Checks

Make sure that

- Windshield, windows, mirrors, lights, and reflectors are clean and unobstructed.
- Tools kit, jack & handle, warning triangle, owner's manual, first aid kit and vehicle documents are available and stored at their locations.

WARNING



Never put any mat on top of the floor carpet near pedal region.

- All doors, engine bonnet and trunk lid are securely closed and latched.
- All of your passengers are properly restrained. You and your passengers should always wear seat belts.
- Objects, luggage or loads are secured properly against slipping or tipping.
- Sufficient fuel for the trip.

Daily check

- Tyres for abnormal wear, cracks or damage and embedded foreign material such as nails, stones, etc.
- Traces of fluid and oil below vehicle.

NOTE

Water dripping from the air conditioning system after use is normal.

- All lamps, wipers, wiper blades and horn for proper operation.
- All switches, gauges and tell tales are working properly.

Adjust:

- Seats, head restraints (if equipped) and steering wheel position.
- All the mirrors properly.

Weekly check

- Engine oil level
- Coolant level
- Brake fluid level
- Windshield washer fluid level
- Fuel level

NOTE

Check the tyre pressure regularly including spare wheel.

STARTING AND DRIVING

Driving Tips

Fuel consumption, engine, transmission, brake and tyre wear are mainly affected by below factors:

- Operating conditions of your vehicle
- Your personal driving style

Operating conditions:

- Avoid frequent start and stop as these increase fuel consumptions.
- Always make sure that the tyre pressures are correct.
- Do not carry any unnecessary weight.
- Regularly service your vehicle and adhere to the recommended service maintenance schedule.

Personal driving style

- Do not depress the accelerator pedal when starting the engine.
- Do not warm up the engine when the vehicle is stationary.
- Always adapt your driving style to suit the prevailing road and weather conditions and maintain a safe distance from the vehicle in front. Drive carefully.
- Avoid frequent, sudden acceleration and braking.
- Select appropriate gear according to varying speeds and load conditions.

NOTE

Do not rest your foot on the clutch pedal while driving.

- Switch 'OFF' the engine in stationary traffic or at signals.
- Keep an eye on the vehicle's fuel consumption.

- Driving safety systems are merely aids designed to assist driving. You are responsible for the distance to the vehicle in front, for vehicle speed and anticipating braking in good time.

WARNING



You could lose control of your vehicle if you try to adjust the driver's seat, head restraint, mirror, steering wheel and fasten the seat belt while driving. There is a risk of an accident.

STARTING AND DRIVING

Recommended fuel economy speeds (For MT)

Gear	Speed (km/h)	
	Diesel	Petrol
1	15	15
2	25	30
3	45	45
4	65	65
5	80	80

Good driving practices

- Slow down before shifting to a lower gear. This will help avoiding revving of the engine causing damage.
- Avoid frequent brake application which can cause overheating of brakes.
- Slow down the vehicle speed while travelling in cross winds. This gives much better control over the vehicle.

- Avoid high speed when cornering or turning.
- Depress the clutch fully while shifting gears.
- Make sure that vehicle is completely stationary before you attempt to shift in reverse gear.
- Drive slowly on wet roads.
- You can get extra braking from the engine by shifting to a lower gear. This can help you to maintain a safe speed and prevent your brakes from overheating specially while going down a hill.

Tips for obtaining better fuel efficiency

- Always maintain the specified tyre pressure during fuel top-ups and also before a long trip. Vehicle running with low tyre pressure will consume more fuel than the one running with specified tyre pressure.

- Keep the vehicle clean. Get rid of the not in use luggage/stuff lying in the boot etc.
- Regularly inspect your vehicle for any leakages, worn out wires by rat bites etc.
- Always follow periodic & regular service schedule of the vehicle.
- In places with high dust content (e.g. Gurgaon, Jaisalmer etc.), Clean air filter element more frequently.
- Drive smart and smooth in an anticipatory manner. Select driving mode to suit your style.
- Do not accelerate excessively when you are in lower gears (1st or 2nd). Be gentle on the accelerator when you are in traffic. In lower gear, opening more throttle will shoot the engine RPM keeping the vehicle still at lower speeds which indirectly implies less distance with more fuel.

STARTING AND DRIVING

- Be in the maximum possible higher gear at a given speed. This reduces the engine operating speeds which means the engine is running at lower rpm (Revolutions per Minute) for the same vehicle speed. Lesser the number of engine revolution lesser the fuel burned.
- Avoid harsh braking.
- Maintain healthy driving habits & while decelerating, do coasting in gear and not in neutral or with clutch pedal depressed.
- Consider using the car AC when you really require. Consider using lower blower speeds rather than higher for cooling as at higher blower speeds it consumes more electric power which is ultimately drawn from engine by burning fuel.
- Avoid unnecessary extra electrical loading on the car.
- Stop the engine wisely at traffic signals. Switch 'OFF' the engine at the traffic signal only if the stoppage

time is high (typically more than 30 sec).

- While driving on highways, drive with windows closed. The more you open the windows the higher will be the resistance to the vehicle at higher speeds which will reduce the fuel efficiency.
- Do not over speed; follow the speed limits. More the speed, higher the external resistance on the vehicle which will finally result into unnecessary consumption of fuel.

Running-in period

The more you look after the engine when it is new, the more satisfied you will be with its performance in the future.

Avoid rapid acceleration and prolonged high speed running of the engine for the first 1,500 – 1,800 kms.

Do not exceed the following road speeds during running in period.

Gear	Diesel	Petrol
	Speed(km/h)	Speed(km/h)
1	20	20
2	30	40
3	50	60
4	70	80
5	90	100

Avoid heavy loads, e.g. driving at full throttle, during this period. Change gears judiciously.

NOTE

Avoid excessive revving up of engine rpm. Do not keep engine at idling for long duration.

Seat Adjustments

Front seat adjustments

Following seat adjustments can be carried out manually.



1. Backrest angle
2. Seat height (if equipped)
3. Seat forward / rearward adjustment lever

WARNING



Do not adjust the driver's seat while driving. Adjusting the seat while driving could cause the driver to lose control of the vehicle.

Seat backrest angle adjustment

To change the seat back rest angle, lean forward slightly and pull up the lever (1). Adjust seat backrest until it reaches desired comfortable position. Make sure that lever returns to its original position and seat is securely latched.

NOTE

Adjust the seat backrest until your arms are slightly angled when holding the steering wheel.

WARNING



Never travel in a moving vehicle with the seat backrest in an excessively

reclined position as this can be dangerous. You could slide under the seat belt in a collision.

Seat height adjustment (if equipped)

To raise the seat, pull and continue pumping the lever (2) in the upward direction until the seat is at the desired height.

To lower the seat, pump the lever downward until the seat is at desired height.

Seat forward / rearward adjustment

Lift lever (3) and slide the seat forwards or rearwards. Release lever and make sure that seat is securely latched.

NOTE

Adjust the driver seat position in such a way that the driver will be able to operate the controls pedals comfortably.

STARTING AND DRIVING

Adjustable head restraint

(If equipped)



Adjust the head restraint so that it is as close to the head as possible and the center of the head restraint supports the back of the head at eye level. This will reduce the potential for injury to the head and neck in the event of an accident or similar situation.

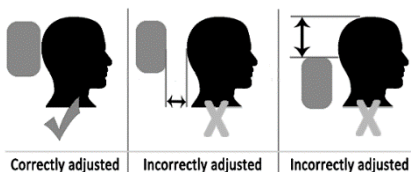

WARNING



Do not drive the vehicle without the seat head restraints. Head restraints are intended to help reduce injuries during an accident.

NOTE

Head restraint are not adjustable for seats with integrated head restraints.

Rear seats

Fixed rear seats are provided. Refer 'Stowage area' section for more details.

Rear View Mirrors

Inside Rear View Mirror (IRVM)

To adjust the mirror, set the selector knob to the normal position and then move the mirror up, down or sideways manually to obtain the best rear view.

When driving at night, set the selector tab to select anti-glare mode to reduce glare from the headlights of vehicles behind you.



NOTE

Use antiglare position only when necessary, as it reduces rear view clarity.

Outer Rear View Mirrors

You can adjust the outer rear view mirrors manually with the knob located on the driver's and front passenger's door panel. Adjust the outside rear view mirrors to desired position.

NOTE

Objects visible in mirror are actually closer than they appear. Always make sure of the actual distance from the road users traveling behind by glancing over your shoulder.

Motorized outer rear view mirrors (If equipped)



The switch to adjust the motorized mirrors is located on the driver's door. You can adjust the mirrors when the ignition switch is in the "ACC" or "ON" position.

Auto folding (If equipped)

To fold / unfold the ORVMs, keep the Selector switch in center position (i.e. neither 'L' nor 'R, position) and then toggle down.

To adjust the mirrors:

1. Move the selector switch to the left (L) or right (R) to select the mirror you wish to adjust.
2. Press the outer part of the switch that corresponds to the direction in which you wish to move the mirror.

Sun Visors

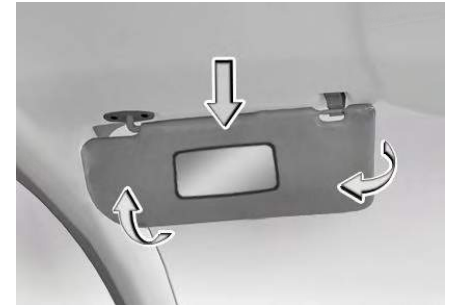

The sun visors can be pulled down to block glare coming through the windshield.

STARTING AND DRIVING

To block glare from side windows

Pull down the sun visor and release it from retainer. Swing the sun visor to the side.

Vanity mirror

Vanity mirror is provided on the back of the front passenger side sun visor.

Steering Wheel Adjustment



You can adjust the steering wheel position to suit your convenience.

The release lever is located under the steering column.

To adjust the steering wheel

1. Adjust the seat to a comfortable position.
2. Push release lever completely down to unlock the steering column.
3. Adjust the steering wheel to the desired position.
4. Pull release lever up completely to lock the steering column.
5. Make sure that steering wheel is securely locked by checking up and down direction.

NOTE

When adjusting the steering wheel, make sure that:

You can operate control pedals without any obstacles.

You can see all the displays in the instrument cluster clearly.

WARNING



Before starting off, make sure the steering wheel position is locked. Never unlock or adjust the steering wheel while the vehicle is in motion.

Steering lock cum ignition switch



The ignition switch has the following four positions:

LOCK - This is the normal parking position. Key from lock can be removed in this position only.

“LOCK” position prevents normal use of the steering wheel after the key is removed.

To release the steering lock, insert the key and turn it clockwise to one of the other positions.

ACC - Accessories such as the infotainment system can be operated, but the engine remains ‘OFF’. Steering gets unlocked.

ON - This is the normal operating position. All electrical systems are ‘ON’.

START - Turn the key further clockwise to the START position, (spring loaded) to start the engine. As soon as the engine starts, release the ignition key, which returns to ON position. While cranking, all accessories will be momentarily ‘OFF’.

Illuminated Key Ring (if equipped)

When the vehicle is unlocked, the illuminated key ring glows up. This helps to locate ignition switch in the dark.

Starting the Engine (Manual Transmission)

Make sure that parking brake is engaged and vehicle is in neutral gear.

Depress the clutch pedal fully and crank the engine. Do not press the accelerator pedal when starting the engine.

NOTE

The Starter protection system fitted in this vehicle does not allow you to crank the engine until you fully depress the clutch pedal.

Release the key as soon as the engine starts. Repeat if engine does not start.

NOTE

The Starter protection system switches off the starter when it is cranked for more than 10 secs. In such a case, get the key back to ‘OFF’ position & wait for 30 secs.

WARNING



The engine emits poisonous exhaust gases such as carbon monoxide. Inhaling these exhaust gases leads to poisoning. There is a risk of fatal injury. Therefore never leave the engine running in enclosed spaces without sufficient ventilation.

Starting off

To start off, depress the clutch pedal fully and shift into 1st gear.

After releasing the parking brake, gradually release the clutch and slowly press the accelerator.

NOTE

When shifting or starting off, do not race the engine. Racing the engine can shorten engine life and affect smooth shifting.

STARTING AND DRIVING

Gear Shifting and Driving (Manual Transmission)



The gearshift pattern is as shown on the gear lever knob. Gear shifting should always be done with clutch pedal pressed.

NOTE

- Depress the clutch fully when gear shifting. The reverse gear should be engaged only when the vehicle is stationary. Wait for 5 seconds after declutching to ensure smooth engagement of the reverse gear.

Do not de-press clutch pedal while driving the vehicle stationary on a slope.

- If clutch pedal lower/upper from brake pedal, in this condition customer should contact a Tata Motors authorized service center.

Current gear indication

The Driver Information display (DIS) in the Instrument Cluster indicates the current gear position engaged.

Gear recommendation

Up or down arrow will be displayed in DIS, recommending whenever gear should be shifted to up or down.

NOTE

- Gear recommendation is displayed when the clutch pedal is in fully released position.
- If "F" is displayed in DIS of instrument cluster it means 'Fault' condition. Contact a TA-TA MOTORS Authorized Service Centre.

Drive modes

'ECO' and 'CITY' drive modes are provided for Manual Transmission. These modes can be used to adjust engine characteristics and vehicle performance in line with desired requirement.

Drive mode selection switch is provided on dashboard fascia for activation

Drive Mode	Performance
ECO (for MT)	Optimum engine Torque and Power output for FUEL EFFICIENT performance
CITY	Increased engine Torque and Power output for BALANCED performance
SPORT (for AMT)	Produce more torque from engine.

WARNING



Do not switch off the ignition while driving.

If you switch off the ignition while driving, safety-relevant functions are only available with limitations, or not at all. This could affect the power steering and the brake boosting effect. You will require considerably more effort to steer and brake. There is a risk of an accident.

Braking

Your vehicle has power assisted brakes. The distance needed to bring the vehicle to a halt increases with the speed of the vehicle. Start applying brake anticipating the distance and slow down gradually.

WARNING



Never use the brake pedal as a footrest.

If you rest your foot on the brake pedal while driving, the braking system can overheat. This increases the stopping distance and can even cause the braking system to fail. There is a risk of an accident.

Never depress the brake pedal and the accelerator pedal at the same time.

If you have driven for a long time in heavy rain without braking, there may be a delayed reaction from the brakes when braking for the first time. This may also

occur after the vehicle has been washed.

Brake performance may become poor and unpredictable if brakes are wet.

After driving through water or washing the underside of the vehicle, test the brakes while driving at a slow speed to see if they have maintained their normal effectiveness. If the brakes are less effective than normal, dry them by repeatedly applying the brakes while driving slowly until the brakes have regained their normal effectiveness.

Braking on downhill gradients

On long and steep gradients, you must reduce the load on the brakes by shifting early to a lower gear. This allows you to take advantage of the engine braking effect and helps avoid overheating and excessive wear of the brakes.

STARTING AND DRIVING

WARNING



Do not shift to lower gear on a slippery road surface in an attempt to increase the engine's braking effect, the drive wheels could lose their grip. There is an increased danger of skidding and accidents.

Switch-off the engine

Turn the key to 'ACC' position to switch off the engine. Before switching off the engine, run the engine in idle condition for at least 30 seconds and then switch off. This will allow the engine oil to lubricate the turbocharger, till its speed is fully reduced and also allow the unit to cool down.

WARNING



A quick burst on the accelerator before turning off the engine serves absolutely no practical purpose; it wastes fuel and is damaging especially to turbocharged engine.

WARNING



Do not switch the engine off when it is running at high speed. This will lead to premature turbocharger bearing wear.

Automated Manual Transmission (AMT) Gearbox: (if fitted)



Gear Shift Lever (AMT)

The 5-speed Automated Manual Transmission (AMT) Gearbox offers a choice of two driving modes:

1. Automated mode with the gear lever in position 'A'
2. Manual mode with the gear lever in position 'M'.

Starting:

- Engage the parking brake firmly. Press Brake pedal.

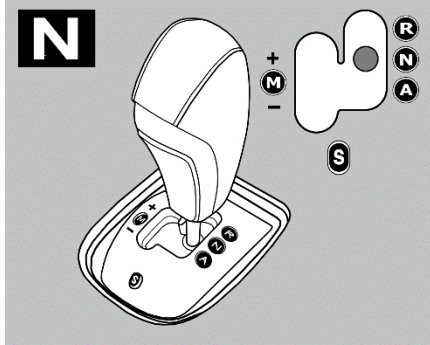

- Put the ignition 'ON'
- While the brake pedal is pressed, bring the shifter lever to Neutral - 'N'. Check 'N' on instrument cluster.
- Crank to start the engine with the brake pedal still pressed.

NOTE

The engine can only be started when the gearshift lever is in "N" position with the brake pedal firmly pressed.

Driving:

- With the engine running and brake pedal pressed, depending on your requirement shift the lever on R, A or M. Check the position engaged on the Instrument Cluster display.
- Release the parking brake.
- Release the brake pedal then because of creep feature, vehicle will move and if required press accelerator pedal.

NOTE

Use right foot only to operate brake or accelerator pedal.

Do not operate accelerator and brake pedal simultaneously.

Do not use your left leg to operate the pedals while driving AMT vehicle.

NOTE

If  displayed on the Instrument Cluster display, it means 'Fault condition. Contact a TATA MOTORS Authorized Service Centre immediately.

AMT Instruction sticker:

Follow the instructions provided on the sticker before driving the vehicle.



STARTING AND DRIVING

Driving Modes

Neutral:

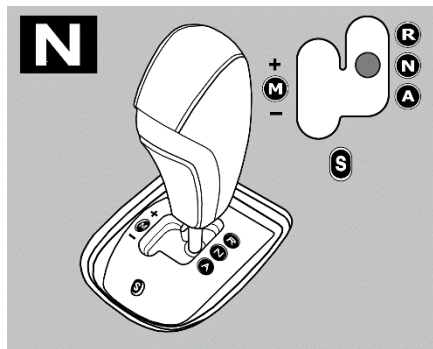

Vehicle is in neutral gear position. This will be indicated  on instrument cluster.

WARNING



Always make sure to keep the gear shift lever in the “N” position, when the engine is running and vehicle is stationary.

Do not shift the lever in “N” position, even momentarily, when the vehicle is in motion.

Reverse:

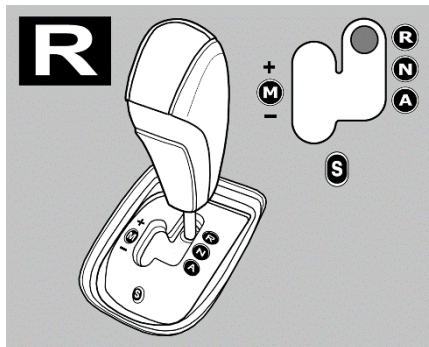

Reverse gear will be engaged only when vehicle is stationary and brake pedal pressed. An audio signal indicates when reverse gear is engaged.  will be indicated on instrument cluster.

Automatic Mode:

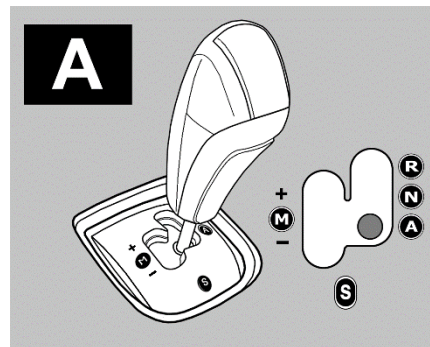

Automatic mode will be engaged only when vehicle is stationary and brake pedal pressed. An audio signal indicates when Automatic gear is engaged.  will be indicated in instrument cluster. Gear Upshift and Downshift will be done automatically while driving.

STARTING AND DRIVING

Manual Mode:

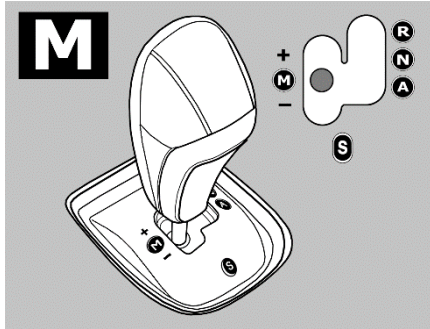

Shift gear lever to left for engaging manual mode. An audio signal indicates when manual mode is engaged. **M** will be indicated in instrument cluster.

In manual mode, driver should select the desired gear by shifting lever to,

- + Upshift the gears.
- Downshift the gears.

Push the gearshift lever to the '+' direction and release it. Every time the lever is operated, upshifting takes place 1

step in the order of 1st → 2nd → 3rd → 4th → 5th gear.

Pull the gearshift lever to the '-' direction and release it. Every time the lever is operated, downshifting takes place in the order 5th → 4th → 3rd → 2nd → 1st gear.

NOTE

Down shifting of gear occurs automatically while braking/engine rpm reduction.

In manual mode, gears are not shifted automatically unless the engine RPM threshold is reached.

Drive Mode:

Two drive modes 'CITY' and 'SPORT' are provided. These modes can be used to adjust engine characteristics and vehicle performance in line with desired requirement. **CITY mode is the default mode.** To activate SPORT mode, Press 'S' button situated on the gear shifter console.

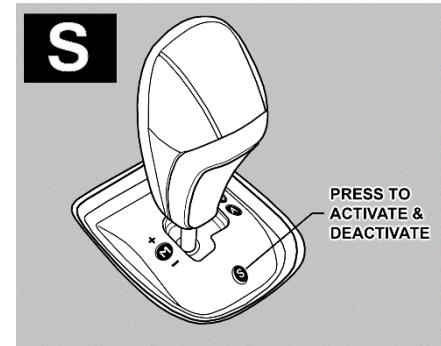

'SPORT' mode activation will be displayed on instrument cluster. It can be activated only in automatic mode. To deactivate press the 'S' button again.

STARTING AND DRIVING

Stopping:

The vehicle can be stopped by depressing the brake pedal regardless of the gear position. This is because the clutch is automatically disengaged to prevent the engine from stalling.

If the gearshift lever is in the 'A' position, the gear will be downshifted to '1st' when the vehicle stops. Also, if the gearshift lever is in the 'M' position, the gear will be downshifted to '1st' when the vehicle stops.

NOTE

'CITY' mode will give optimum engine Torque and Power output. Drive the vehicle in 'CITY' mode to get max fuel economy. If in case of AC discomfort switch to 'SPORT' mode.

NOTE

Exhaust fan in the engine compartment will remain 'ON' for a short while after IGN is switched 'OFF'.

Parking:

AMT does not have a parking position. The vehicle can be parked with the gearshift lever in any position.

1. Apply the parking brake firmly.
2. Depress the brake pedal and shift the gearshift lever to the 'R' position on a downhill slope, or to the drive 'A' mode or the 'M' position in the manual 'M' mode on an uphill slope or flat road and confirm the gear position by checking the gear position indicator on instrument cluster. Gear engagement (R or A) can be done with ignition ON/engine running condition only.
3. Turn the key to 'ACC' position to switch off the engine. Before switching off the engine, run the engine in

idle condition for at least 30 seconds and then switch off.

WARNING



Do not switch the engine off when it is running at high speed.

Creeping feature:

Creeping function allows the car movement without accelerator Pedal pressed when the brake pedal is released.

This functionality is generally used in parking maneuvers, with 1st or 'R' gear engaged, in this situations the driver enters and exits from creeping just by pressing the Acc. pedal.

- Creep feature is enabled for Manual as well as Auto Mode for first and reverse gear.
- After vehicle cranking and brake pedal released vehicle starts moving without pressing accelerator Pedal.

- Whenever accelerator pedal is pressed creep function will be disabled.
- Whenever driver door is opened and / or parking brake is engaged, creep function will be disabled.

Kick down feature:

In Automatic mode, while driving at a constant speed if the accelerator pedal is quickly pressed the AMT downshifts the gear (if required). It ensures optimum acceleration to complete overtaking in minimal time.

Driving in Adverse condition

Driving Through Water:

Never venture to drive through water when it flows over the guard stones on a bridge.

Your car's engine may get seriously damaged if attempted to cross through deep water. If at all the situation demands that you have to drive through water then;

- Keep engine in fast idling and crawl the car in low gear.
- After driving through water, apply brakes several times to dry the liners and to regain original braking.
- Do not attempt to start the engine if car gets flooded with water.
- Tow the car to a safe place.
- Take the car to nearest TATA MOTORS Authorised Service Centre to check entry of water in cylinders.
- If water has entered the engine, or transaxle or AMT kit, the lubricants will have to be replaced. Get the starter and alternator checked.

Driving on a Rainy Day:

Check brakes, steering, windows, and tyres for wear and tyre pressure. Check wiper blades for proper functioning. Avoid harsh braking and sharp turns. It may cause loss of control and lead to a skid. For slowing down, shift to lower gears and brake gently. Keep lights ON if visibility is poor.

Night Driving:

Use head lamp main/dip beam to alert other road users on turns/ cross roads etc.

Use side indicators for lane change or turning.

Switch on hazard warning switch in case of hazardous parking or if your vehicle is disabled to warn the passing traffic.

Maintain a speed such that you can stop within illuminated distance of head lamps.

STARTING AND DRIVING

Climbing Sharp Gradients on Loose Surfaces (MT)

Apply the parking brake firmly so that the vehicle does not roll backwards.

Shift the gearshift lever to the “M” position while depressing the brake pedal. Select suitable gear position.

Release the brake pedal and depress the accelerator pedal gradually, and when the vehicle starts to move, release the parking brake and depress the accelerator pedal to start off.

Choose as smooth a slope as possible and select the appropriate gear so that gear changing in the middle of the climb is not required.

Changing gears in the middle of the climb can cause loss of momentum and engine stalling. Shifting to lower gear has to be done cautiously to avoid loss of traction.

Under no conditions should the vehicle be moved diagonally across a hill. The danger is in loss of traction and sideways

slippage, possibly resulting in toppling over. If unavoidable, choose as mild an angle as possible and keep the vehicle moving.

If the vehicle stalls or losses headway while climbing a steep hill, make a quick shift to reverse and allow the vehicle to move back with the control of engine compression.

Climbing Sharp Gradients using AMT:

Apply the parking brake firmly so that the vehicle does not roll backwards.

Shift the gearshift lever to the “A” position while depressing the brake pedal. Make sure that the gear position indicator in the instrument cluster displays ‘1st’ gear.

Release the brake pedal and depress the accelerator pedal gradually, and when the vehicle starts to move, release the parking brake and depress the accelerator pedal to start off.

On climbing sharp gradients, never hold the vehicle at a stop using only the accelerator pedal or the creeping function. If you perform this operation for a certain period of time, this can also cause excessive damage to the clutch.

Descending Sharp Gradients (MT)

Depending on the severity of the gradient, shift into appropriate gear. Use engine braking judiciously without over revving the engine.

Brake application under such situations should be done very smoothly to avoid loss of control. Select appropriate gear so that gear changing or clutch disengagement is not involved while descending the gradient.

NOTE

Creeping function will not operate when vehicle is in standstill condition on inclined surface.

WARNING



Try not to hold the brake pedal down too long or too often while going down a steep or long hill.

This could cause the brakes to over-heat, resulting in reduced braking efficiency. Failure to take this precaution could result in loss of vehicle control.

WARNING



When descending on sharp gradients, NEVER turn the ignition key to the 'OFF' position. Emission control system damage may result.

Descending Sharp Gradients using AMT:

Depress the brake pedal and shift the gear shift lever to the 'A' position. Make sure that the gear position indicator in the instrumental cluster displays '1st' gear.

Release the brake pedal and depress the accelerator pedal slowly. Even if the accelerator pedal is not depressed, the clutch will be engaged when the vehicle speed increases.

Using Engine Braking

When driving on the downhill slope, down shifting is recommended. So you can use engine braking.

By placing the gearshift lever in "M" position, the manual (M) mode is selected, and you can shift to a lower gear manually.

Parking Brake

Mechanical parking brake acting only on the rear wheels is provided on the vehicle.



Parking brake applied

To apply the parking brake, pull the lever up fully (1). The parking brakes tell-tale illuminates on the instrument cluster.

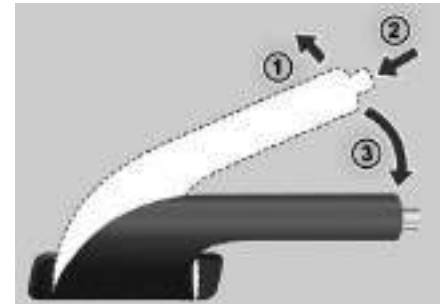

Parking brake released

STARTING AND DRIVING

To release it, pull the lever up slightly (1), press the release button (2) and push the lever down (3). Parking brakes tell-tale on the instrument cluster will turn 'OFF' when the lever is fully released.

NOTE

Apply the parking brake properly before leaving the vehicle and release it before moving.

Vehicle parking

Park the vehicle in a safe place. Switch on the indicator signal before turning to park.

- Apply the parking brake.
- Ensure that all window glasses are closed and all lamps are turned 'OFF'.
- At night, put on the parking lights if required.
- Remove the key from the ignition switch and lock the vehicle.
- Block the wheel if parked on a slope.

NOTE

- When parking on a downhill gradient, place the gear lever in 'Reverse' position. While parking on uphill gradient, place the gear lever in the '1st' position.
- Do not use parking brake for braking unless unavoidable circumstances like when service brake is not working properly. The braking distance is considerably longer and the wheels could lock. There is an increased danger of skidding and accidents.

WARNING



Never leave children unsupervised in the parked vehicle. They could also operate the vehicle's equipment. There is a risk of an accident and injury.

Reverse Park Assist (if equipped)

Reverse Park Assist system is an electronic parking aid that will assist you to park your vehicle safely when in reverse gear mode. It provides audio and visual information through the vehicles infotainment system.

Always look at surrounding before initiating reverse parking, for kids, pets and elderly people moving around the vehicle.



There are 4/3 ultrasonic sensors placed on the rear bumper of the vehicle. Once the system is activated, the sensors will

detect the proximity of an obstacle from the bumper, and this information would be displayed on the vehicles infotainment system. In Low variants, only audio warning shall be given through a buzzer.

WARNING



0 to 25 cm obstacle detection performance is not guaranteed due to ultrasonic sensor technology limitation.

Park assist indications

In case of Reverse park assist system malfunctions, the following screen may appear on the infotainment system.

Reason for this fault may be

- Park Assist Controller / Body Control Module Failure"
- Sensor Malfunction
- Partner components such as Infotainment music system, Instrument Cluster failure.



Reverse park assist limitations

Reverse Park Assist system is not a collision avoiding system. It is solely the driver's responsibility to park the vehicle safely.

Reverse Park Assist feature works on ultra sound echo technology, due to which performance is not guaranteed in following scenarios:

- If the object has a sharp edge surface, where surface may divert echoes from sensor reception.

- If object is mesh fence made up of thin wires, where echoes can't be given by the surface.
- Fast moving objects passes in the sensor field of detection, where echoes are not processed by the system.
- If object is made/covered by foam or sponge or snow where ultrasonic sound signals are absorbed.
- Objects close to the rear bumper can go undetected by the Reverse Park Assist field of detection. Driver should use extreme caution while parking the vehicle.
- If height of the bumper is changed due to alteration to the suspension or other causes
- If the sensor areas are extremely hot from direct sunlight or cold due to freezing weather.
- If Sensors are covered by a hand, sticker, accessory, etc.

STARTING AND DRIVING

- If ultrasonic noise is present around Vehicle due to other vehicle sensors, horn, engine, air braking system (large vehicles), Exhaust Fans, Wireless transmitters or mobile phones
- If the vehicle speed exceeds 10 km/h, the system will not warn you even though objects are detected, error message 'Vehicle Speed is high, drive slowly!' will appear.
- Driving on uneven road surfaces e.g. Gravel, unpaved roads, Artificial Speed Breakers, or gradient.

WARNING



Due to any reason, if the sensor gets misaligned or loses its intended fitment position, contact your dealer for refitment.

NOTE

Turning the ignition 'OFF' while the Park assist feature in running would disable the feature.

Reverse park assist system preventive maintenance

1. Regularly clean the Sensors and keep them free from dust, ice, mud, water, chewing gum etc. for proper working of the system. Use a smooth cloth for cleaning.
2. Do not use water at high pressure for cleaning the sensor.
3. Do not cover the Sensors. This will interrupt park assist performance.

Rear View Camera

Rear View Camera is a visual reverse guiding system. When reversing or parking, make sure that there are no persons, animals or objects in the area in which you are reversing.

NOTE

Turning the ignition 'OFF' while the Park assist feature in running would disable the feature.



Activation

- **Reverse gear**

This System will activate, if reverse gear is engaged, or park assist button (if equipped) is pressed.



Deactivation

System will deactivate, if reverse gear is disengaged, or park assist button (if equipped) is pressed

Understanding Guidelines Indication



Green Line

Indicates, if rear object is in this colored zone, you have to be cautious. Still you can go backward safely.

Yellow Line

Indicates, if rear objects are in this colored zone, you have to take utmost care. However, objects fall in this zone, may not hit vehicle

Red Line

Indicates, if rear objects are in this colored zone, you have to stop the vehicle and not allowed to go backward. If you still go backward, your vehicle will hit the object

Do's and don't

- Do not use camera when tailgate is open. If tailgate is open, visual information may not be the actual rear view of the vehicle & system will warn with message 'Tail Gate Open, Please close.'
- When the camera is operated under fluorescent lights, sodium light or mercury light etc., illuminated areas on the lens may appear to flicker in the display.
- Do not attach any advertisement or styling or any kind of stickers on top of camera. If this happens, camera cannot provide you the visual image and may damage camera.
- Do not add any accessory, which will obstruct camera field of view.

Cleaning camera

1. Due to environmental reasons, dust, mud or fog may accumulate on the camera lens. So regularly clean the camera lens.
2. Use water to clean the camera lens. Do not use extreme cold or hot water. Rapid changes in temperature may brittle the camera lens. Do not apply High Pressure water for cleaning.
3. Wipe the camera lens with soft cloth.
4. Do not use hard cloth or material to wipe the camera lens. This will cause scratches on the camera, and leads to deteriorated visual image on the display.
5. Do not apply organic solvent, car wax, window cleaner or glass coat to clean the camera. If this is applied, wipe it off as soon as possible.
6. Do not apply heavy force on lens, while cleaning.
7. Do not remove mud, snow on the camera lens using stick or hard material. Use normal water and soft cloth.

STARTING AND DRIVING

WARNING



- The camera uses fish eye lens. So the size of the objects or in the display may differ from the actual size and distances. In low light conditions, the screen may darken or image may appear faint.
- If the tire sizes are changed, the position of the fixed guidelines displayed on the screen may change.
- During rainy conditions, image may get obscured. In such conditions, do not depend on camera view. The camera used in the vehicle, may not reproduce the same color of the real object.
- In case of damage of the rear portion of the vehicle, camera position may change. Which causes wrong visual information on display. In case of damage, make

sure that, camera is fitted properly at the intended location.

- In case of uneven road conditions or up-hill or downhill conditions, do not depend on rear view camera park aid.
- Do not apply any kind of force on the camera.
- Always use rear View mirrors along with Rear View Camera for confirming the safety of the rear and the surrounding conditions.
- High humidity and variation in ambient temperature may result into condensation inside the camera lens, which may further result into degradation of camera video feed on the screen. It is recommended that not to rely on camera video feed for parking assistance in such scenario. This phenomenon is temporary and will be automatically recovered with reduction in humidity and

less variation in ambient temperature.

- The area displayed by the rear view camera is limited. The camera does not display objects that are close to or below the bumper, underneath the vehicle, or objects out of the camera's field of view. The area displayed on the screen may vary according to vehicle orientation or road conditions.

Rear view camera system precautions

1. Area displayed on screen

The rear view camera system displays an image of the view from the bumper of the rear area of the vehicle. To adjust the image on the rear view monitor system screen.

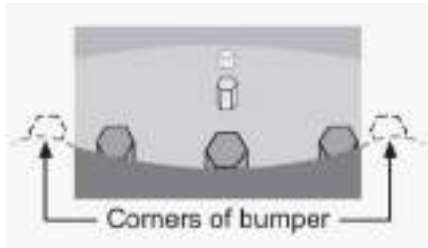
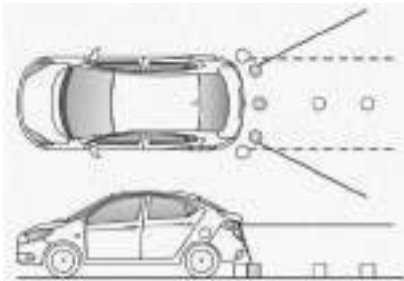

- The area displayed on the screen may vary according to vehicle orientation conditions.
- Objects, which are close to either corner of the bumper or under the bumper, cannot be seen on the screen.
- The camera uses a special lens. The distance of the image that appears on the screen differs from the actual distance. The monitor may not display items that are located higher than the camera field of view.

2. When the ground behind the vehicle slopes up sharply

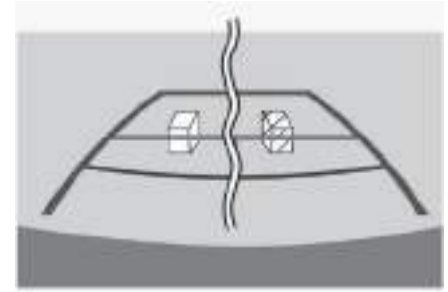
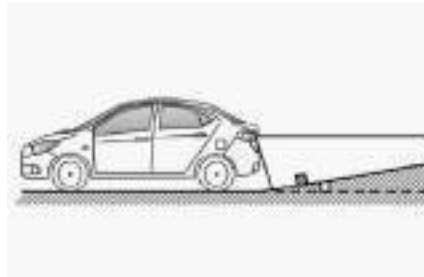

The distance guidelines will appear to be closer to the vehicle than the actual distance.

Because of this, objects will appear to be farther away than they actually are.

In the same way, there will be a margin of error between the guidelines and the actual distance/course on the road.

STARTING AND DRIVING

3. When the ground behind the vehicle slopes down sharply

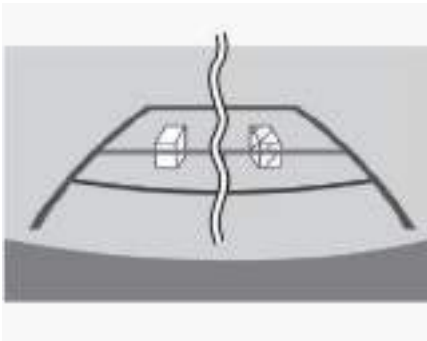
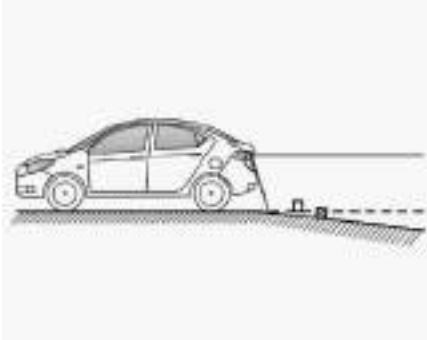

The distance guidelines will appear to be further from the vehicle than the actual distance.

Because of this, objects will appear to be closer than they actually are. In the same way, there will be a margin of error between the guidelines and the actual distance/course on the road.

4. When any part of the vehicle sags

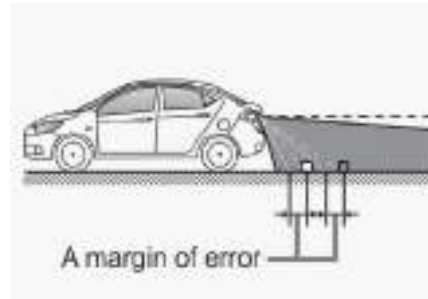

When any part of the vehicle sags due to the number of passengers or the distribution of the load, there is a margin of error between the fixed guide lines on

the screen and the actual distance/course on the road.

5. When approaching three-dimensional objects

The distance guidelines are displayed according to flat surfaced objects (such as the road). It is not possible to determine the position of three-dimensional objects (such as vehicles) using the distance guidelines. When approaching a three-dimensional object

a. Distance guidelines

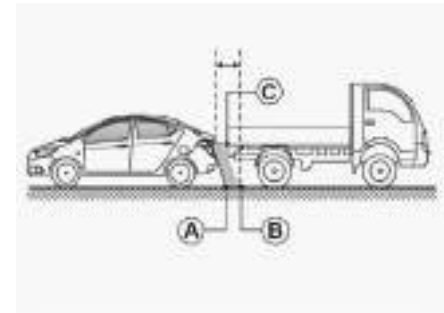

STARTING AND DRIVING

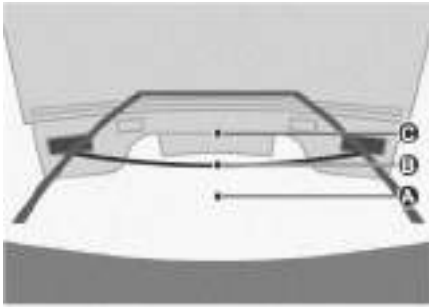

Visually check the surroundings and the area behind the vehicle. On the screen, it appears that a truck is parked at point B. However, in reality if you back up to point A, you will hit the truck. On the screen, it appears that A is closest and C is furthest away. However, in reality, the distance to A and C is the same, and B is farther than A and C.

b. Vehicle width guidelines

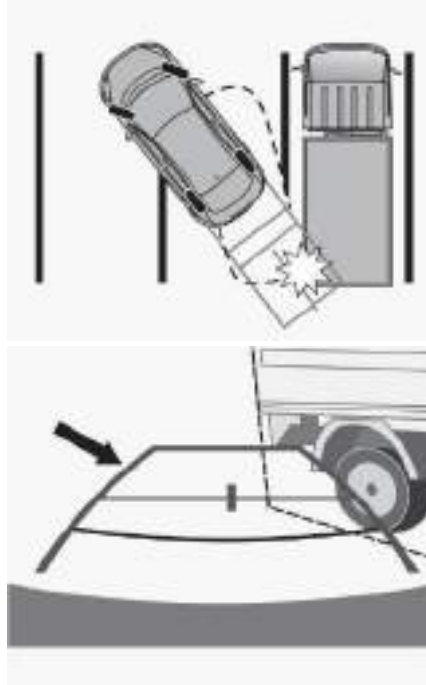

Visually check the surroundings and the area behind the vehicle. In the case shown below, the truck appears to be outside of the vehicle width guidelines and the vehicle does not look as if it hits the truck. However, the rear body of the truck may actually cross over the vehicle width guidelines. In reality if you back up as guided by the vehicle width guidelines, the vehicle may hit the truck.

EMERGENCY AND BREAKDOWN ASSISTANCE

Emergency Equipment

You should be familiar with the location of the emergency equipment provided in the vehicle and how to use it.

Check this equipment periodically and ensure that they are in proper working condition and stowed at their locations.

First aid kit

The first aid kit is kept inside the glove box compartment.

The kit contains items that can be used in case of minor injuries only.

NOTE

Check contents of the first aid kit periodically and replenish consumed or expired items.

Tool kit and tow hook



Tool kit & tow hook are kept inside luggage compartment near spare wheel.

NOTE

The tool kit should be properly stored when not in use.

Jack



A scissors jack is kept inside luggage compartment near the spare wheel.

NOTE

The jack should be used only to change wheels. It is important to read the jacking instructions in this section before attempting to use the jack.

EMERGENCY AND BREAKDOWN ASSISTANCE

Advance warning triangle

An advance warning triangle is kept in the luggage compartment.

Use advance warning triangle to warn the approaching traffic in case of vehicle break-down or during emergency, where your vehicle could become a potential traffic hazard.

Press hazard warning switch, all turn signal lamps will start blinking

Keep the warning triangle at suitable distance (depending on the situation) behind your vehicle in the same lane of traffic. The reflecting side of the triangle should face the oncoming traffic and it should be free from any obstacles.

Remove the advance warning triangle carefully from the bag and assemble. Refer instructions given on the bag.



NOTE

After using the warning triangle, tie it firmly and keep it inside the bag to avoid rattling noise.

Hazard Warning Switch



Press the hazard warning switch to activate the hazard warning. All the turn signal lamps will flash simultaneously. To turn OFF, press the switch again.

Use the hazard warning to warn the traffic during emergency parking or when your vehicle could otherwise become a traffic hazard.

The hazard warning lamps can operate even if the ignition is switched off.

EMERGENCY AND BREAKDOWN ASSISTANCE

In Case of Flat Tyre

- Reduce vehicle speed gradually, without making any sudden steering or braking maneuvers. Pay attention to the traffic conditions as you do so.
- Switch on the hazard warning lamps.
- Stop the vehicle on solid, non-slippery and level ground, as far away as possible from traffic.
- If possible, bring the front wheels into the straight-ahead position.
- Secure the vehicle against rolling away.
- Set the parking brake firmly and shift into “R” (Reverse) gear.
- Switch off the engine.
- Keep advance warning triangle at a suitable distance behind the vehicle as an indication of breakdown.
- Clear all passengers and luggage from the vehicle.
- Close all the doors.

WARNING



If you drive with a flat tyre, there is a risk of the following hazards:

- A flat tyre affects the ability to steer or brake the vehicle.
- You could lose control of the vehicle.
- Continued driving with a flat tyre will permanently damage the tyre and cause excessive heat buildup and possibly a fire. There is a risk of an accident.

Spare Wheel



Spare wheel is located in the luggage compartment.

To access the spare wheel, open the trunk lid, lift the carpet up and fold it.

To remove the spare wheel, unscrew and remove the retaining bolt. Take out the spare wheel.

EMERGENCY AND BREAKDOWN ASSISTANCE

Following precautions are to be taken when temporary spare wheel is fitted on the vehicle.

WARNING



- Drive the shortest possible distances. The temporary spare wheel should be exchanged for a normal wheel as soon as possible. The temporary spare wheel is designed for a short period of use only.
- “80 km/h” or “50 mph” is the maximum speed you are permitted to drive with this tyre. Never drive faster than 80 km/h (50 mph). Do not accelerate quickly, brake suddenly or drive at high speed through bends.
- After fitting the temporary spare wheel, the tyre pressure must be checked as soon as possible.
- Recommended tyre pressure is 36 psi (2.5 bar) for temporary spare wheel.

- Snow chains cannot be used on the temporary spare wheel.

WARNING



- Never use more than one temporary spare wheel.
- Do not drive through an automatic car wash.
- Never use a temporary spare tyre if it is damaged or worn down to the tread wear indicators.
- The ground clearance of your vehicle may be reduced. Take care when parking next to curb.
- The temporary spare should not be installed on the front axle if the vehicle must be driven in snow or on ice.
- Do not tow whilst the temporary spare wheel is installed.

NOTE

Your vehicle may exhibit some unusual driving characteristics when fitted with temporary spare wheel.

EMERGENCY AND BREAKDOWN ASSISTANCE

Wheel covers (if equipped)



Insert a piece of cloth between the spokes of the wheel cover and pull it outwards. Take out detached wheel cover from the wheel rim.

When installing the cover, make sure that it is positioned so that it does not cover the air filling valve. Apply equal pressure at the circumference of the wheel cover to fix it in the wheel rim.

NOTE

Do not use any sharp tools (such as screw driver etc.) to remove the wheel cover.

Changing flat tyre

Loosen the nuts of the flat tyre in diagonal sequence as indicated in figure. Do not remove the nuts completely before jacking the vehicle.



Wheel nut removal

Jacking point location on vehicle

Use the respective jacking points for jacking up the vehicle. Jacking point location are shown below:

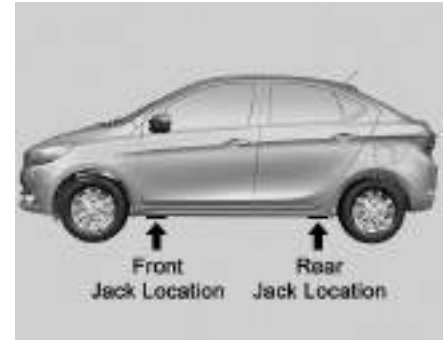

Jacking point location

EMERGENCY AND BREAKDOWN ASSISTANCE

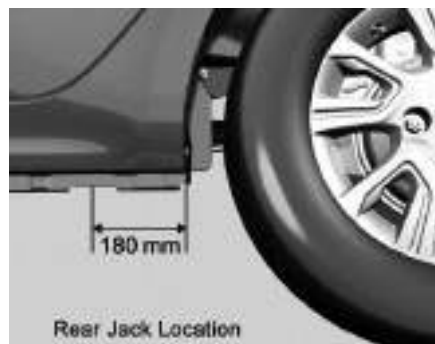
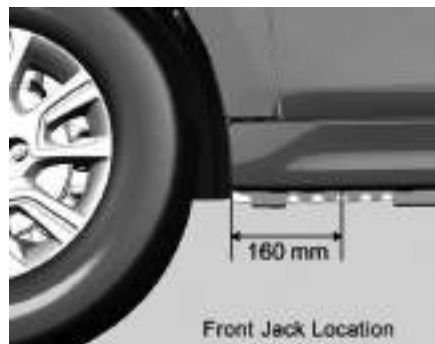

Jacking the vehicle

Position the jack vertically and align the “U” slot provided on jack with jacking point as shown below.



Front jacking Location

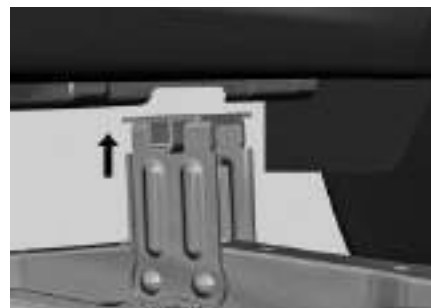

Rear jacking Location

Assemble the Jack handle and wheel spanner (as shown in jacking fig.)

Raise it by turning the jack handle clockwise until the jack sits completely on jacking point and the base of the jack lies evenly on the ground.

EMERGENCY AND BREAKDOWN ASSISTANCE



Jacking

WARNING



If you do not position the jack correctly at the appropriate jacking point of the vehicle, the jack could tip over with the vehicle raised. There is a risk of injury.

Continue to raise the jack slowly and smoothly until the tyre clears the ground. Do not raise the vehicle more than necessary.

Remove wheel mounting nuts with the help of wheel spanner and take out flat tyre.

NOTE

Do not place wheel nuts in sand or on a dirty surface. Do not apply oil or grease on it.

Roll the spare wheel into position and align the holes in the wheel studs.

Install wheel nuts with their cone shaped end facing the wheel. Tighten each nut by hand until the wheel is securely seated on the hub.

Lower the jack completely then tighten the wheel nuts one by one using wheel spanner.

Press fit the wheel cover back (if equipped).

Restore all the tools and jack at their respective location.

Place the flat tyre at spare wheel location.

NOTE

Check and correct the tyre pressure and wheel nuts tightness of the changed wheel at nearest authorised service station.

Get the flat tyre repaired at the earliest.

NOTE

- *The jack is designed only to raise and hold the vehicle for a short time while a wheel is being changed. It is not suited for performing maintenance work under the vehicle.*
- *Use the jack on level, hard ground. Avoid changing the wheel on uphill and downhill slopes. Apply wheel chokes if vehicle is parked on slope.*

EMERGENCY AND BREAKDOWN ASSISTANCE

- Before raising the vehicle, secure it from rolling away by applying the parking brake.
- Do not use wooden blocks or similar objects as a jack underlay.
- Never place your hands and feet or lie under the raised vehicle when it is supported by the jack.
- Never run the engine when the vehicle is supported by the jack and never allow passengers to remain in the vehicle.
- Never open or close a door or the trunk lid when the vehicle is raised.

Jump Lead Starting

Use only a battery of same rating & capacity to jump start your vehicle. Position the booster battery close to your vehicle so that the jump leads will reach both batteries.

When using a battery of another vehicle, do not let the vehicles touch. Apply the

parking brake firmly and keep the gear-shift lever in neutral. Turn off all vehicle accessories, except those necessary for safety like hazard warning lamps.

Make jump lead connections as follows:

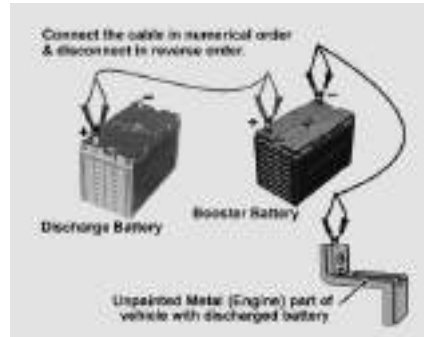

- Connect one end of the first jump lead to the positive (+) terminal of the discharged battery.
- Connect the other end to the positive (+) terminal of the booster battery.
- Connect one end of the second jump lead to the negative (-) terminal of the booster battery.

- Make the final connection (other end of the negative terminal) to an unpainted, heavy metal part (i.e. engine mounting stud/nut) of the vehicle of discharged battery.
- Start the engine of the vehicle with the discharged battery.
- Before disconnecting the jumper cables, let the engine run for several minutes.
- If the booster battery you are using is fitted to another vehicle, start the engine of the vehicle with the booster battery. Run the engine at moderate speed.
- Remove the jump leads in the exact reverse order in which you connected them.

NOTE

Do not disconnect the discharged battery from the vehicle.

EMERGENCY AND BREAKDOWN ASSISTANCE

WARNING



Never connect the jump lead directly to the negative (-) terminal of the discharged battery. This may lead to an explosion.

WARNING



- Do not allow battery electrolyte to come in contact with eyes, skin, fabrics or painted surfaces. The fluid contains acid which can cause injury and severe damage. Wear protective apparel. Do not inhale any battery gases. Keep children away from batteries. In case if battery acid comes in contact with the skin, wash it off immediately with water and seek medical attention.
- During charging and jump-starting, explosive gases can escape from the battery. There is a risk of an explosion. Particularly avoid

fire, open flames, creating sparks and smoking. Ensure there is sufficient ventilation while charging and jump-starting. Do not lean over the battery.

- Make sure that the positive terminal of a connected battery does not come into contact with vehicle parts. Never place metal objects or tools on a battery.
- It is important that you observe the described order of the battery terminals when connecting and disconnecting a battery. If you are in doubt, seek assistance from qualified specialist workshop.
- Never connect or disconnect the battery terminals while the engine is running.

Towing

When towing a break down vehicle, certain precautions and procedures must be taken to prevent damage to the vehicle and/or components. Failure to use standard towing precautionary measures when lifting or towing a break down vehicle could result in an unsafe operating condition.

To ensure proper towing and to prevent accidental damage to your vehicle, take help of a TATA MOTORS authorized dealer or a commercial tow-truck service.

NOTE

Make sure that the parking brake is released; vehicle in neutral gear position and steering wheel is unlocked. The power steering functions only when engine is running. Hence, during towing the steering efforts will be more

EMERGENCY AND BREAKDOWN ASSISTANCE

WARNING



- Never get under your vehicle after it has been lifted by a tow truck.
- For towing a vehicle, the best way is to use a wrecker. Alternatively use a rigid tow bar.
- Switch 'ON' the hazard warning indicators of both the vehicles to warn other road users.
- Limit the speed to 20-30 kmph.
- In case of brake failure, use the parking brake to control the vehicle.
- Fasten the tow rope or tow bar at the towing eyes. Otherwise, the vehicle could be damaged.
- When towing, pull away slowly and smoothly. If the tractive power is too high, the vehicles could be damaged.

Tow hook fitment

- Open the trunk lid and remove tow hook from the tool kit.
- Open the tow hook cover provided on the front bumper by pressing it at the bottom part and simultaneously pulling it at the top (as shown in fig). Screw in and tighten the tow hook in clockwise direction.
- After towing, remove the towing hook and press fit the cover properly.
- Place the towing hook in the vehicle tool kit.

Recommended towing



In case of break down we recommend that your vehicle be towed with the driving wheels off the ground or place the vehicle on a flatbed truck as shown.

WARNING



- Never tow your vehicle with the front wheels on the ground or four wheels on the ground (forward or backward), as this may cause serious damage to the transmission.
- When towing with the rear wheels on the ground or on towing dollies, place the ignition switch in the 'ACC' or 'ON' position, and secure the steering wheel in the straight-ahead position with a rope or similar device.

EMERGENCY AND BREAKDOWN ASSISTANCE



Towing instructions (AMT):

A) Where vehicle can be shifted in neutral condition:

- Shift the gear lever into neutral.
- Turn the ignition key to the “ACC” position to unlock the steering wheel.
- Release the parking brake.

NOTE

After shifting the AMT gearshift lever to the “N” position, always check the gear position indicator in the instrument cluster shows the “N” position to make sure that the transaxle is disengaged.

If the transaxle cannot be put in neutral, turn the key from the “OFF” to the “ON” position, and move the AMT gearshift lever from “N” to “A”, “M” or “R”, then back to “N” again. Then turn the key from the “ON” to the “OFF” position. These procedures may help to put the transaxle in neutral.

If the transaxle still cannot be put in neutral, you cannot tow the vehicle without lifting vehicle from rear side.

B) Where vehicle cannot be shifted in neutral condition:

- Secure the rear wheels on a towing lift and the front wheels on the towing trolley.
- Apply the parking brake.

WARNING



A safety chain/belt for tightening the wheels with lift should always be used when you tow your vehicle.



NOTE

Always unlock the steering wheel before towing.

EMERGENCY AND BREAKDOWN ASSISTANCE

Fuses

Your vehicle has fuse boxes at three locations.

The vehicle's electrical circuits have fuses to protect the wiring from short circuits or sustained overload.

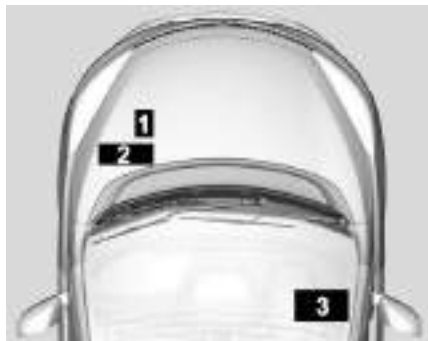

1. Battery Mounted Fuse Box.
2. Engine Compartment Fuse Box.
3. Cabin Compartment Fuse Box.

Checking and replacing fuses

If any electrical unit in your vehicle is not functioning, check the fuses first.

Please follow the steps below that will guide you to check and replace them.

- Apply parking brake
- Switch off all electrical consumers.
- Turn the ignition key to the 'LOCK' position.
- In the fuse box, identify the defective fuse from its melted wire.

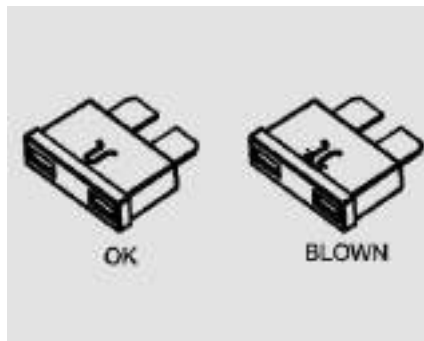

- Remove the blown fuse by “fuse puller”. The fuse puller and spare fuses are provided in the engine compartment fuse box.

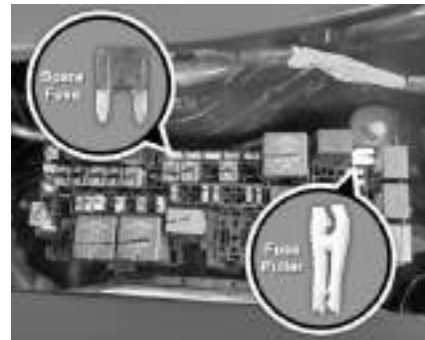

Engine compartment fuse box

- Blown fuses must be replaced with fuses of same rating, which you can recognize by color and value.

EMERGENCY AND BREAKDOWN ASSISTANCE

NOTE

Always ensure that the spare fuses are replenished.

- Ensure that all other fuses are pressed firmly in position.
- If a newly inserted fuse also blows, have the cause traced and rectified at nearest TATA MOTORS Authorized Service Centre immediately.

WARNING



If you manipulate or bridge a faulty fuse or if you replace it with a fuse with higher amperage, the electric cables could be overload-ed. This could result in a fire. There is a risk of an accident and injury.

Always replace faulty fuses with the specified new fuses having the correct amperage.

Battery mounted fuse box

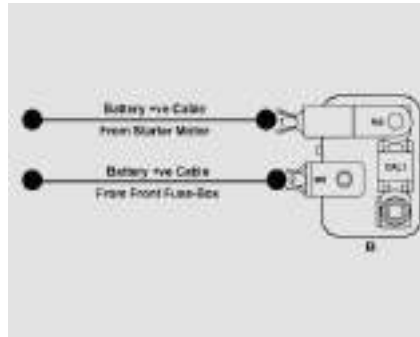
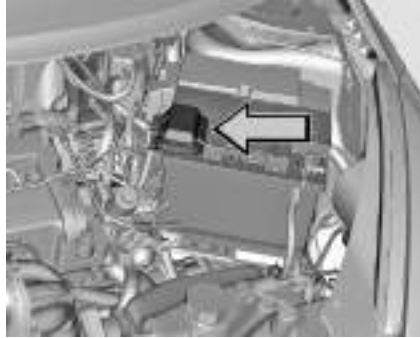

Fuse No.	Function	Fuse Rating
PF1	STARTER MOTOR	CAL 1

WARNING



If Fuse box cover is removed for any reason, it should be refitted properly at its original position.

EMERGENCY AND BREAKDOWN ASSISTANCE

Engine compartment fuse box



NOTE

The fuse box layout is for reference purpose only. Please refer the sticker provided inside the fuse box cover.

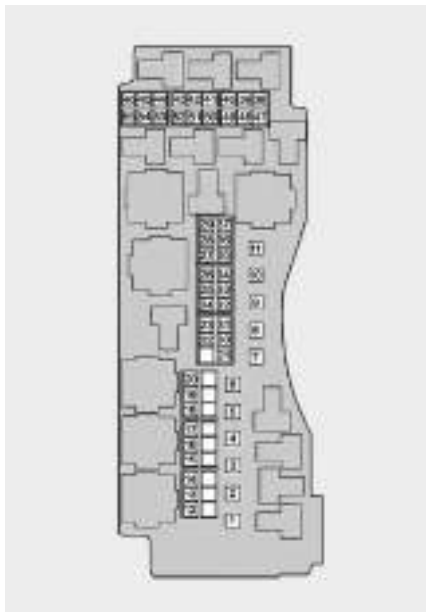

Fuses - Engine Compartment

Fuse No.	Function	Fuse Rating
1	INTERIOR F/B 2 IGNITION	60A
2	ABS	40A
3	GLOW PLUG (DIESEL)	60A
4	COOLING FAN HIGH SPEED	40A
5	EPAS	60A
6	-	-
7	INTERIOR F/B 1 BATTERY	60A
8	UNDER BONNET F/R BOX	60A
9	-	-
10	IGNITION LOAD	60A
11	-	-
12	COMPRESSOR	10A
13	STARTER SOLENOID	20A
14	ABS ECU	25A

EMERGENCY AND BREAKDOWN ASSISTANCE

15	-	-
16	HORN HIGH / LOW TONE	15A
17	FRONT FOG	10A
18	EMS BATTERY	10A
19	AMT HYD PUMP (If fitted)	30A
20	FUEL PUMP	20A
21	BRAKE LAMP	10A
22	RELAY COIL	5A
23	-	-
24	FRONT WIPER MOTOR	20A
25	ABS	5A
26	WASHER MOTOR	10A
27	-	-
28	REVERSE & BRAKE LAMP	10A
29	REAR WIPER	10A
38	EMS ECU	20A
39	EMS ECU	15A

40	INJECTORS (PETROL)	10A
41	H/L LOW LH	10A
42	HEAD LAMP LOW RH	10A
43	EMS IGN	10A
44	-	-
45	H/L LOW LH	10A
46	HEAD LAMP LOW	10A

Cabin compartment fuse box

Cover removal procedure

Fuse box is located inside the cover below steering column. To access the fuse box, remove cover as per procedure given below.

1. Fuse box cover is mounted on dashboard with the help of lugs at the top and bottom of the cover from inside.



EMERGENCY AND BREAKDOWN ASSISTANCE

2. To remove the cover, gently pull the cover from bottom side such that the lugs get disengaged.

Re-fitment procedure

Align and engage the top and bottom mounting lugs with respective slots on dash board and press the cover firmly.

Fuses

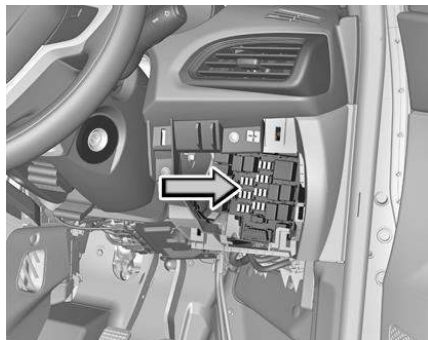

Cabin compartment fuse box

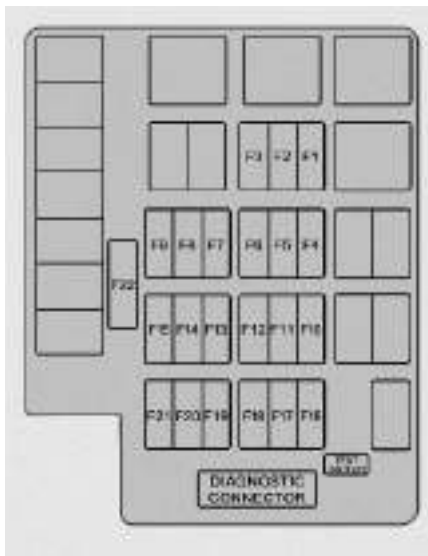

EMERGENCY AND BREAKDOWN ASSISTANCE

Fuses - Cabin Compartment

Fuse No.	Function	Fuse Rating
1	RESTRAINT RELAY	10A
2	ACC CON.2	15A
3	TRANSIT/INFO-TAINMENT	15A
4	BCM	15A
5	INT LAMP/ REV LAMP & BRK SW	5A/15A
6	MIRROR ADJUST MOTOR	5A
7	POS/PARK LAMP RH/BCM	5A/15A
8	CLUSTER / OBD	10A
9	BCM/POSITION LH	5A/15A
10	KEY IN	5A
11	IMMOBILIZER / EPAS	5A
12	ACC FUSE	5A
13	BLOWER MOTOR	30A

14	CDL / ACCESSORY CONN.1	15A
15	POWER SOCKET	15A
16	RELAY COILS	5A
17	TRUNK LID LATCH	10A
18	HVAC	10A
19	HEATED REAR SCREEN / FLASHER	25A/10A
20	MODULE KL.15 I/P	10A
21	POWER SOCKET CONSOLE	15A
22	TRANSIT/INFO-TAINMENT	15A

EMERGENCY AND BREAKDOWN ASSISTANCE

Bulb Specification

Sr. No.	Description	Rating	Type	Qty.
1	HIGH BEAM+LOW BEAM (Option I)	12V, 55W	H4	2
2	HIGH BEAM (Option II)	12V, 55W	H1	2
	LOW BEAM (Option II)	12V,55W	H11	2
3	TURN SIGNAL FRONT	12V, W21W	W21W	2
4	FOG LAMP FRONT	12V, 19W	H16	2
5	STOP + POSITION LAMP REAR	12V	LED	2
6	POSITION LAMP FRONT	12V, 5W	W5W	2
7	TURN SIGNAL REAR	12V, PY21W	PY21W	2
8	REVERSE LAMP	12V, P21W	P21W	1
9	REAR REGISTRATION PLATE LAMP	12V	LED	2
10	SIDE REPEATER LAMP	12V, WY5W	WY5W	2
11	ROOF LAMP	12V	LED	1
12	HIGH MOUNTED STOP LAMP	12V	LED	1
13	LOAD AREA LAMP	12V, W5W	W5W	1
14	TURN SIGNAL FRONT	12V, 21W	PY21W	2
15	POSITION LAMP REAR BSO	12V	LED	2
16	POSITION LAMP REAR TRUNK LID	12V	LED	2
17	REAR FOG LAMP	12V, P21W	P21W	1

EMERGENCY AND BREAKDOWN ASSISTANCE

Bulb Replacement: (Option I)

Open the bonnet to access the headlamps.



WARNING



The engine should not be running when changing bulbs.

If the engine has been running just prior to replacing bulbs in the headlight housing, please keep in mind that components in the engine compartment will be hot.

Replacing - High / Low beam bulb

1. Remove the rubber press fit cover by simply pulling it off.



2. Press the pin and pull the connector from the bulb.



3. To free the headlamp bulb from the socket, press and swing the retaining spring and pull it straight back.



4. Pull out the bulb from the socket.



EMERGENCY AND BREAKDOWN ASSISTANCE

5. Insert the new bulb (without touching the glass) into the socket.
6. Move the retaining spring up and push it slightly until it locks properly.
7. Refit the connector into the bulb and press the rubber cover on headlamp housing to fit it properly.

WARNING



It is dangerous if a halogen bulb breaks. These bulbs contain pressurized gas and if broken, will explode causing serious injury by the flying glass. Halogen bulbs can break if the glass portion is touched with bare hands, body oil could cause the bulb to heat unevenly and explode when lit. Never touch the glass portion of the bulb with your bare hands and always wear eye protection when handling or working around halogen bulbs. Always keep halogen bulbs out of the reach of children.

Replacing the position bulb

Unlock the position bulb by turning the socket in counter clockwise direction.



Replace with the new bulb (refer bulb specification table) and refit it by pressing and turning in clockwise direction firmly into the socket.

Replacing the turn indicator

Unlock the turn indicator bulb by turning the socket in counterclockwise direction.



Replace with the new bulb (refer bulb specification table) and refit it by pressing and turning it in clockwise direction firmly into the socket.



EMERGENCY AND BREAKDOWN ASSISTANCE

Option II

1. Open the bonnet to access the headlamps.
2. Remove the socket cover on the backside of the headlamp.



3. Disconnect lamp connection.



4. Unlock low beam bulb holder clip, by pushing it backward.



5. Remove low beam bulb.



6. Refit low beam bulb by locking high beam bulb holder clip.



EMERGENCY AND BREAKDOWN ASSISTANCE

7. Connect the connectors of low beam and refit low beam lamp cover.
8. Disconnect motor connection (if required) & high beam lamp connection.



9. Unlock position high beam bulb from its place



10. Remove position high beam bulb



11. Refit position high beam bulb.



EMERGENCY AND BREAKDOWN ASSISTANCE

12. Unlock position bulb from its place.



13. Remove position bulb.



14. Refit position bulb



15. Unlock side indicator lock in anti-clockwise direction & remove front direction indicator bulb.



16. Refit front direction indicator bulb by looking it in clockwise direction.



EMERGENCY AND BREAKDOWN ASSISTANCE

24 X 7 Road Assistance

Dear Customer,

It is our responsibility and our endeavor to ensure that you have our complete service backup if ever, wherever and whenever you need the same. When you have a road network that spans wide area, the probability of a breakdown happening within hailing distance of a TATA MOTORS Authorized Workshop is very low.

It is precisely for this reason, we have tied up with TVS AA, who will provide breakdown assistance including towing to the nearest TATA MOTORS Authorized Workshop through their Authorized Service Providers (ASP).

The 24X7 On Road Assistance Program shall be automatically available to your vehicle for the duration of Warranty period. The program shall also be available, if you avail the same post warranty.

Response Time ** for the On Road Assistance Program

Within City Limits	60 minutes
On State or National Highways	90 minutes
Ghat Roads and other places	120 minutes +/-

** (The response time will depend on the location, terrain, traffic density and the time of the day.)

Standard procedure when calling for On Road Assistance in case of a breakdown:

- Dial the toll free help line number – **1800 209 7979**
- Identify your vehicle with the Vehicle chassis number that is available in the Owner's Manual.
- Explain your exact location with landmarks and tell us about the problem you face with the vehicle.

- Park your vehicle on the edge of the road, open the bonnet and put on the hazard warning signal.
- Place the advance warning triangle supplied with the vehicle approx. 3 m from the vehicle in the direction of oncoming traffic.



Coverage under 24 X 7 On Road Assistance Program

I. The **24x7 On Road Assistance** Program Service covers the following services on your vehicle during warranty period.

EMERGENCY AND BREAKDOWN ASSISTANCE

- Wheel change through spare wheel.
- Arrangement of fuel. (Fuel cost will be chargeable at actual cost)
- Re-opening the vehicle in cases of key lock out.
- Rectification of electrical problems related to battery, fuses etc.
- On spot repairs for complaints repairable at site. ^
- Vehicle to vehicle towing or winching & towing for non-accident cases up to the nearest TATA MOTORS authorized workshop. Towing charges at actual cost beyond the same to be paid to the ASP in cash. (Any ferry or toll charges levied in relation to the vehicle being towed to be paid by the customers in actuals in cash).

For accident cases, towing charges to be borne by the customer.

II. The **24x7 On Road Assistance** Program coverage on availing the 24X7 policy, post warranty is up to maximum of 6 instance of assistance in one year for

both the plans- Basic and Premium. In the premium plan, this includes 2 instances of towing up to the nearest TATA MOTORS authorised workshop.

Exclusions

24 X 7 On Road Assistance Program does not apply to

- Cost of parts consumables and labour for such repairs not covered under warranty*. These charges are to be settled with ASP in cash.
- Toll or ferry charges paid by ASP in reaching to the breakdown site to be settled with ASP in actuals in cash.
- Cases involving accident, fire, theft, vandalism, riots, lightening, earth quake, windstorm, hail, tsunami, unusual weather conditions, other acts of God, flood, etc.
- Vehicles that are unattended, un-registered, impounded or abandoned.
- Breakdown/defects caused by misuse, abuse, negligence, alterations or modifications made to the vehicle.

- Lack of maintenance as per the maintenance schedule as detailed in the owner's manual.
- Cases involving racing, rallies, vehicle testing or practice for such events.

Disclaimer

- The Service is not available in Lakshadweep.
- **The reach time is indicative & the actual reach time will be conveyed by the call centre at the time of breakdown call.
- The reach time can vary depending on the traffic density & time of the day.
- The reach time indicated does not account for delays due to but not limited to acts of God, laws, rules & regulations for time being in force, orders of statutory or Govt. authorities, industrial disputes, inclement weather, heavy down pour, floods, storms, natural calamities, road blocks due to accidents, general

EMERGENCY AND BREAKDOWN ASSISTANCE

strife and law & order conditions viz. fire, arson, riots, strikes, terrorist attacks, war etc.

- ^ On spot repairs at breakdown site shall depend on nature of complaints & will be as per the discretion of the ASP.
- *The decision for free of charge repairs will be as per the warranty policy & procedures of TATA MOTORS LTD. and as per the interpretation of the same by ASP. You will be duly informed by the ASP & call centre for the change applicable if any.
- All charges wherever applicable need to be settled directly with the ASP.

Exclusion of Liabilities

- It is understood that TATA MOTORS shall be under no liability whatsoever in respect of any loss or damage arising directly or indirectly out of any delay in or non-delivery of, defect/deficiency in service/parts provided by ASP.

- In case vehicle cannot be repaired on-site, customers are advised to use the towing facility for taking their vehicle to the nearest TATA MOTORS authorized workshop only. In no condition will the vehicle be towed to any unauthorized workshop. TATA MOTORS will not be responsible for any repairs carried out in such unauthorized workshop.
- Customer are advised to take acknowledgment from the ASP for the list of accessories/extra fittings and other belongings in the vehicle as well as the current condition related to dents/scratches breakages of parts/fitments of the vehicle at the time of ASP taking possession of the vehicle & to verify these items when delivery is taken back by them, claim for loss of or damage to items, if any should be taken up with ASP directly. TATA MOTORS shall not be responsible for any such claims, damages/loss or any deficiency of service of the ASP.
- Vehicles will be handled, repaired & towed as per the customer's risk & TATA MOTORS shall not be liable for any damages / claims as a result of the same.
- Services entitled to the customers can be refused or cancelled on account of abusive behavior, fraudulent representation, malicious intent and refusal to pay the charges for any charges related services and spare parts during service or on previous occasion on part of the customer.
- On site repairs may be temporary in nature. The completion of repairs does not certify the road worthiness of the vehicle. The customer is advised to ensure temporary repairs carried out onsite is followed by permanent repairs at a TATA MOTORS Authorized Workshop at the earliest.
- Terms and conditions and service coverage, exclusions etc. are subject to change without notice.

EMERGENCY AND BREAKDOWN ASSISTANCE

Vehicle Tracking System (VTS)

Vehicle Tracking System (VTS) is an Electronic device fitted inside every Passenger vehicle (with Yellow plate registration used for commercial purpose), which operates as a Taxi / Fleet for carrying passengers. As per Govt. of India regulations (AIS: 140), it is mandatory to fit VTS in all above-mentioned vehicles registered on or after 1st Jan. 2019.

Purpose:

- a) Efficient management of Transport System in the country.
- b) To provide quick response & help in case of emergencies like accidents.
- c) Government servers may also monitor driver's rash / negligent driving behavior.

NOTE

- *Please ensure that the VTS system is functional in the vehicle at all times otherwise, it will lead to violation of regulation.*
- *Any tampering, disconnection or bypassing of VTS system will send the alerts to Government servers. Customers may be liable for legal action for any such incidents.*
- *Government servers may also monitor driver's rash / negligent driving behavior.*

Emergency (SOS) switch



The emergency switches are provided inside the vehicles. It shall be pressed by the driver or any occupant in emergency like accidents, medical emergencies & or Law & order situations. If the occupant feels threatened or unsafe, then also this can be used

NOTE

- *After pressing the Emergency Switch, Police or Law enforcing agencies may track and intercept the vehicle. The occupants should be able to justify the usage of Emergency Switch to them.*

EMERGENCY AND BREAKDOWN ASSISTANCE

NOTE

- After pressing switch, SOS (Safety Overflow Switch) symbol is not blinking; there is some fault in the system that needs to be rectified. Please contact your nearest Tata Motors Authorised Service Center for rectification

Operation:

a) Ignition ON & switch not pressed:

During normal Ignition ON, the 'SOS' symbol on switch will flash continuously as 0.1 Seconds ON ---4 Seconds OFF - 0.1 Seconds ON- 4 Seconds OFF - --When Ignition is turn OFF, it will switch OFF after some time.

b) Switch pressed

In emergency, lift the flap and gently press the SOS symbol on switch for 0.5 seconds. The 'SOS' symbol on switch will flash continuously as Seconds ON - 0.5 Seconds OFF - 0.5 Seconds ON - 0.5 Seconds OFF--

NOTE

- The flashing will continue until the authorized emergency services attend to the request and re-set the VTS system. If the Ignition is turn OFF, then also the SOS symbol will keep on Flashing.
- Please note that Emergency Switches also work when Ignition is Turned OFF. After pressing the switch, SOS symbol will start flashing in above frequency.
- If the SOS symbol inside Switch is not blinking even when Ignition is ON, please check if your data plan is expired. If data plan is active and still the SOS symbol is not blinking, contact your nearest Tata Motors Authorised Service Center immediately to get this fixed.

c) Un-intended Pressing of Emergency Switch:

To avoid un-intentional pressing of Emergency Switch, the flap is provide on switch. However, if any occupant presses the emergency switch by mistake, the emergency switch will keep on flashing until it is re-set by emergency response server. The Government agencies like Traffic Management & Police after verifying the incident with the owner/driver of the vehicle will re-set the switch.

Tata Motors or its dealers will not be able to re-set the system if Emergency Switch is press un-intentionally.

EMERGENCY AND BREAKDOWN ASSISTANCE

Location of Switches:



For driver and front passenger

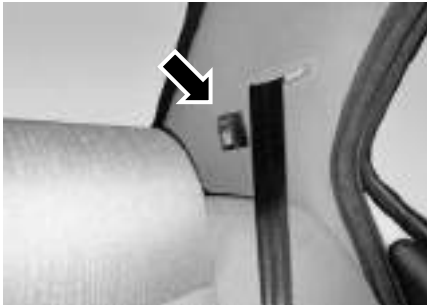

For rear Passenger (LHS)

Activation of VTS System:

Your dealer will help in activating the device when it is installed in the vehicle. If activation is not done, SOS symbol inside the switch will not flash.

If despite activation if SOS symbol inside emergency switch is not blinking, contact your nearest Tata Motors Authorised Service Center for rectification.

Re-charging of Data Plan:

The VTS system comes with pre-loaded data for 6 Months / 12 Months/24 months from the date of purchase of vehicle. After the data is consumed or after completion of bundled data period, the SIM needs to be re-charged. Your network operator will inform you about the data consumption & re-charging due dates. Re-charge can be done by:

- a) At Tata Motors Authorised Service Center.
- b) By logging onto the network provider portal.

For any support or further info, please contact your nearest Tata Motors Authorised Service Center.

NOTE

- The VTS consumes battery even when the Ignition is OFF. If the vehicle is parked or not used for more than 10 days, it is advisable to start the engine and keep the engine running at 3000 rpm for at least 30 minutes for re-charging the battery.
- Always keep the Ignition in OFF position when vehicle is parked or not being driven.

WARNING



Warranty may be void in case:

- Customer installs any other device/accessories, which are not authorised by Tata Motors. Additional accessories may lead to overloading of Electrical System inside vehicle and may reduce battery performance.
- Any tampering of the VTS device, Emergency Switches or its wiring harness.

Maintenance and Service

Periodic maintenance is essential for ensuring long trouble free performance.

Have your vehicle serviced regularly from TATA MOTORS Authorized Service Centre.

There is a large network of TATA MOTORS Authorized Service Centre's to help you with their professional servicing expertise. Scheduled maintenance information is provided which makes tracking routine service easy.

The following checks can be carried out between the recommended scheduled maintenance services. Take help of our authorized service centre for assistance.

- Engine oil level
- Engine coolant level
- Brake fluid level
- Washer fluid level checking & topping up
- Battery electrolyte level
- Tyre inflation pressure including spare wheel

NOTE

Refer "Opening and Closing" section for engine bonnet opening.

WARNING



- Be careful not to touch a hot engine, exhaust manifold and pipes, muffler, radiator and water hoses.
- Do not work on a vehicle with the engine running in an enclosed space, unless you are sure you have enough ventilation.
- Keep all open flames and other burning material (such as cigarettes) away from the battery and all fuel related parts.
- If you need to do any work inside the engine compartment,
- Switch off the ignition
- Never reach into the area where there is a risk of danger from moving components, such as the fan rotation area.
- Keep clothing away from moving parts.

MAINTENANCE

Engine Compartment – Diesel



1. Brake fluid reservoir
2. Dip Stick - Engine Oil
3. Engine oil filling cap

4. Windshield washer container
5. Air Filter
6. Fuse & relay box

7. Battery
8. Auxiliary tank

Engine Compartment – Petrol (MT)



- 1. Dip Stick - Engine Oil
- 2. Brake fluid reservoir
- 3. Engine oil filling cap

- 4. Windshield washer container
- 5. Air Filter
- 6. Fuse & relay box

- 7. Battery
- 8. Auxiliary tank

MAINTENANCE

Engine Compartment – Petrol (AMT)



- 1. Dip Stick - Engine Oil
- 2. Brake fluid reservoir
- 3. Engine oil filling cap

- 4. Windshield washer container
- 5. Air Filter
- 6. Fuse & relay box

- 7. Battery
- 8. AMT oil reservoir
- 9. Auxiliary tank

Engine Oil Level

Warm up the engine to normal operating temperature.

Turn it 'OFF' and wait for 5 minutes for the oil to return to the oil pan. Be sure the vehicle is on a level surface.

Take out the dipstick, wipe it clean, and reinsert it fully. Pull it out again and examine the oil level. It should be between 'MIN' and 'MAX' level. If not, top up with recommended engine oil.

NOTE

The oil consumption depends up-on the driving style and the conditions under which the vehicle is used.

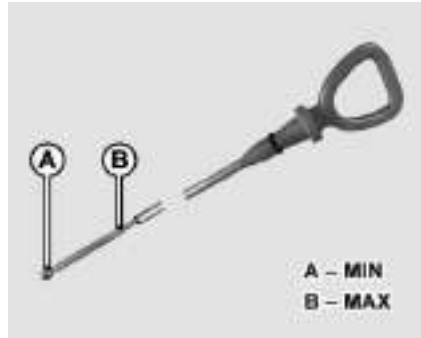

Diesel

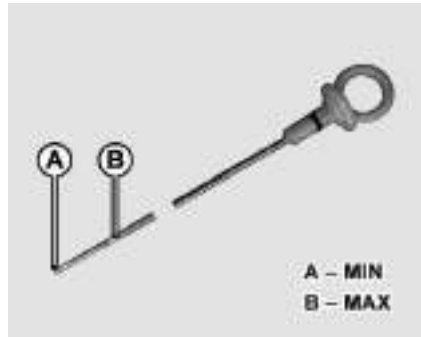

Petrol

NOTE

- Do not remove the filler cap when the engine is running.
- Do not add oil above than the MAX. mark. Oil level above the MAX. mark may cause engine damage.

For location of Engine oil filling cap and dip stick, please refer respective Engine Compartment pages.

MAINTENANCE

Brake Fluid Level



The level of the brake fluid should be between the 'MIN' and 'MAX' marks on the side of the brake fluid container. If the level falls below the 'MIN' mark, add recommended brake fluid.

NOTE

Do not allow brake fluid to make contact with the skin or eyes.

Do not allow brake fluid to splash or spill on the paint surface as it will

For location of Brake Fluid Container and filling cap, please refer respective Engine Compartment pages.

Engine Coolant Level



Check whether the coolant level is between the 'MIN' and 'MAX' marks on the coolant reservoir.

When the coolant level is low, top up with recommended coolant through filler of auxiliary tank until the level approaches the max level line. Refer 'Technical information' section.

NOTE

In case of emergency, a large amount of water without engine coolant may be added in order to reach a vehicle service location.

Whenever coolant has been added, the coolant level in the coolant reservoir should be checked the next few times you drive the vehicle to confirm correct level.

For location of Engine coolant container and filler cap, please refer respective Engine Compartment pages.

NOTE

Topping of the coolant should be done in the auxiliary tank only.

Make sure that only TATA MOTORS recommended coolant is used. Mixing of different coolants may harm your engine's cooling system and its components. Do not add extra inhibitors or additives to the coolant. These can be harmful and compromise the corrosion protection of the engine coolant.

WARNING



The engine cooling system is pressurized, particularly when the engine is warm. When opening the cap, you could be scalded by hot coolant spraying out. There is a risk of injury. Let the engine cool down before opening the cap. Wear eye and hand protection when opening the cap. Open the cap slowly half a turn to allow pressure to escape.

Checking AMT oil reservoir level



The level of the AMT oil reservoir level should be between the 'MIN' and 'MAX' marks on the side of the container. If the level falls below the 'MIN' mark, add recommended oil.

Windshield Washer Fluid Level

Check that there is washer fluid in the tank. Refill it if necessary. Use a good quality windshield washer fluid, diluted with water as necessary.

NOTE

- Do not use detergent or any other additive in the windshield washer reservoir. This can severely impair visibility when sprayed on the windshield, and can damage your vehicle's paint.
- Do not operate washer motor with no fluid in washer tank, washer motor will be damaged

For location of Windshield Washer Container and filling cap, please refer respective Engine Compartment pages.

MAINTENANCE

Battery

- Check the battery for electrolyte level against the marking on the battery outer case.
- Check the battery terminals for corrosion (a white or yellowish powder). To remove it, wash the terminals with a solution of baking soda. It will bubble up and turn brown.
- When this stops, wash it off with plain water. Dry off the battery with a cloth or paper towel.
- Coat the terminals with petroleum jelly to prevent future corrosion.
- Use a proper wrench to loosen and remove cables from the terminals.
- Always disconnect the negative (-ve) cable first and reconnect it last.
- Clean the battery terminals with a terminal cleaning tool or wire brush.
- Reconnect and tighten the cables, coat the terminals with petroleum jelly.

- Ensure that the battery is securely mounted.
- If you need to connect the battery to a charger, disconnect both cables to prevent damage to the vehicle's electrical system.

For location of battery, please refer respective Engine Compartment pages

NOTE

- *During normal operation, the battery generates gas, which is explosive in nature. A spark or open flame can cause the battery to explode causing very serious injuries.*
- *Keep all sparks, open flames and smoking materials away from the battery.*
- *The battery contains sulphuric acid (electrolyte) which is poisonous and highly corrosive in nature. Getting electrolyte in your eyes or on the skin can cause severe burns. Wear protective clothing and a face shield or have a skilled technician to do the battery maintenance.*

Spark Plug (Petrol)



Spark Plug	Number	Gap
BOSCH	YR7SES	0.7 to 0.8 mm
Federal Mogul (Champion)	RER8MC	0.8 to 0.9 mm

Tightening Torque - 25 Nm

NOTE

Use spark plug of recommended make & type for replacement.

Tyres

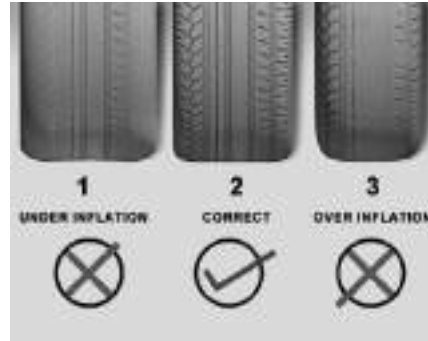

1	Under inflation	Excessive side tread wear
2	Correct tyre pressure	Uniform wear
3	Over inflation	Excessive center tread wear

Inflation

Check for inflation and condition of your vehicle tyres periodically.

Check the pressure in the tyres when they are cold.

Keeping the tyres properly inflated gives you the best combination of riding comfort, handling, tyre life and better fuel efficiency.

Over inflation of tyres makes the vehicle ride bumpy and harsh. Tyres are more prone to uneven wear and damage from road hazards.

Under inflated tyres reduce your comfort in vehicle handling and are prone to failures due to high temperature. They also cause uneven wear and more fuel consumption.

NOTE

Every time you check inflation pressure, you should also examine tyres for damage, trapping of foreign objects in the treads and wear.

MAINTENANCE

Recommended tyre pressures

Tyre size	Version	Wheel	Tyre pressure
175/65 R14 & 155/80 R13	Petrol	Front	33 psi (2.3 bar)
		Rear	30 psi (2.1 bar)
		Spare	36 psi (2.5 bar)
	Diesel	Front	33–36 psi (2.3 -2.5 bar)
		Rear	30 psi (2.1 bar)
		Spare	36 psi (2.5 bar)
175/60 R15	Petrol	Front	36 psi (2.5 bar)
		Rear	36 psi (2.5 bar)
		Spare	36 psi (2.5 bar)

Tyre pressure sticker location



NOTE

- *Maintain tyre inflation pressure as per the specific mentioned in tyre pressure sticker*
- *Regular tyre and spare tyre to be checked for correct tyre inflation pressure at least once a month*

Special care for tubeless tyres:

- While removing tyre from wheel rim and mounting it back on wheel rim, take precautions not to damage tyre bead. Use tyre removal and assembly machines. Damage or cut on tyre bead may cause gradual loss of air and deflation of tyre.
- Do not scratch inside of tubeless tyre with metallic or sharp object. Tubeless tyres are coated with impermeable layer of rubber from inside which holds the air inside the tyre. Removal of this layer due to scratching may cause gradual loss of air and deflation.
- If wheel rim gets damaged in service, get the wheel rim repaired/ replaced immediately. Running the vehicle with damaged rim may cause deflation of tyre and subsequent dislodging of tyre from rim.

- Maintain recommended inflation pressure. Over-inflation, in particular, may cause puncture or bursting of tyre.

NOTE

Life and wear pattern of tyres depends on various parameters like tyre pressure, wheel alignment, wheel balancing, tyre rotation, etc. It also largely depends on vehicle speed, load carried, usage, driving habits, road conditions, tyre quality, etc. In case fault is suspected to be due to poor quality of tyres, the same may be taken up with concerned tyre manufacturer.

Tyre rotation

To help increase tyre life and distribute wear more evenly you should have tyres rotated at specified intervals or earlier depending on the operation of vehicle.

The illustrations show how to rotate tyres when normal or temporary spare wheel is fitted.

For 155/80 R13 tyres

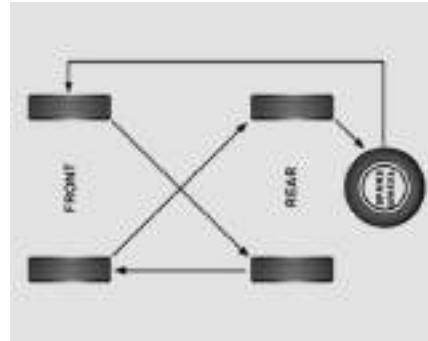

For 175/65 R14 and 175/60 R15 tyres with temporary spare wheel (if equipped)



NOTE

- Do not use spare wheel for tyre rotation, in case of temporary spare wheel used.
- Two or more temporary tyres should not be used on one vehicle.
- Tyre pressure of temporary wheel is to be checked at least once in a month.

MAINTENANCE

Wheel Alignment

Incorrect wheel alignment causes excessive and uneven tyre wear. Check wheel alignment at specified intervals. Wheel alignment values are given below:

	Front	Rear
Caster	$1^{\circ} 45' \pm 45'$	-
Camber	$30' \pm 30'$	$- 52' \pm 60'$
Toe in	-	$12' \pm 15'$
Toe Out	0 to 13'	-

Wheel Balancing

Wheels of your vehicle are balanced for better ride comfort and longer tyre life. Balancing needs to be done whenever tyre is removed from rim.

WARNING



If the vehicle vibrates abnormally on a smooth road, have the wheel balanced done immediately.

Remote Key Battery Replacement

Remote control key contains a battery which is housed under the cover.

If red LED remote flashes for 5 times after placing and releasing any button on remote. It is recommended to replace battery at a TATA MOTORS Authorised Service Centre.

You should, however, proceed as follows if you wish to replace the discharged battery yourself:

1. Open the key blade.
2. Press off the battery cover with your thumb or using a flat screw driver at the points of the arrows.
3. Remove the discharged battery from the key by pressing the battery downwards at the point of the arrow.



4. Insert the new battery.



5. Ensure that the “+” symbol on the battery is facing upwards. The correct polarity is shown on the battery cover.
6. Position the battery cover on the key and press on it until it is heard to lock in place.

NOTE

Use CR 2032 battery only.

On Board Diagnostic (OBD II) System

On board Diagnostics or OBD is an automotive term referring to a vehicle's self-diagnostic and reporting capability. The OBD system allows continuous diagnosis of the components of the vehicle correlated with emissions. This system warns the driver, by turning “ON” the Malfunction Indication lamp (MIL) on the instrument cluster, when a fault causes emission levels to increase.

The OBD system also has a diagnostic connector that can be interfaced with appropriate diagnostic tools, which makes it possible to read the fault codes stored in the Electronic Control Unit, together with a series of specific parameters for Engine operation and Diagnosis. This check can also be carried out by the traffic police.

To access the diagnostic connector, open the fuse box cover which is located on RH side below the steering wheel. Refer 'Emergency and Breakdown Assistance' section for removal of cover.



MAINTENANCE

Service Instructions

The **TATA TIGOR** has been manufactured to give you economical and trouble free performance. To achieve this, please follow the instructions as stated.

Your vehicle is entitled to three free services (labour only). The free service coupons are attached to the sales invoice. Please present these coupons to the servicing dealer while availing free services.

1st free service - At 1000-2000 kms. OR 2 months, whichever is earlier.

2nd free service - At 7000-8000 kms. OR 6 months, whichever is earlier.

3rd free service - At 14500-15500 kms. OR 12 months, whichever is earlier.

All services other than free services are chargeable.

Servicing of the vehicle can be done at any TATA MOTORS Authorised Dealer Workshop or TATA MOTORS Authorised Service Centre (TASC).

Warranty claims can be settled by any TATA MOTORS Authorised Dealer Workshop or TATA MOTORS Authorised Service Centre (TASC).

Service Schedule

Sr. No.	Operation	Kms	PDI	1.5K	7.5K	15K	22.5K	30K	37.5K	45K	52.5K	60K	67.5K	75K	82.5K	90K	97.5K	105K	112.5K	120K	127.5K	135K	142.5K	150K	
		Months	0	2	6	12	18	24	30	36	42	48	54	60	66	72	78	84	90	96	102	108	114	120	
	General																								
1	Wash the vehicle & Clean Condenser Fins	Every Service	•	•	•	•	•	•	•	•	•	•	•	•	•	•	•	•	•	•	•	•	•	•	•
2	Check & Top up Fluids (If required): Trans-axle Oil, Coolant, Brake Fluid, Battery Electrolyte, Wind Screen washer fluid.	Every Service	•	•	•	•	•	•	•	•	•	•	•	•	•	•	•	•	•	•	•	•	•	•	•
3	Check Fuel Lines for Leak-ages.	Every Service	•	•	•	•	•	•	•	•	•	•	•	•	•	•	•	•	•	•	•	•	•	•	•
4	Check and Cap-ture all DTC's Clear all faults and Erase the Codes.	Every Service	•	•	•	•	•	•	•	•	•	•	•	•	•	•	•	•	•	•	•	•	•	•	•
5	Check Rubber Boots for dam-age & replace if required (driveshaft)	15K / 12M				•		•		•		•		•		•		•		•		•		•	

- Kms or Months whichever occurs earlier

MAINTENANCE

Sr. No.	Operation	Kms	PDI	1.5K	7.5K	15K	22.5K	30K	37.5K	45K	52.5K	60K	67.5K	75K	82.5K	90K	97.5K	105K	112.5K	120K	127.5K	135K	142.5K	150K
		Months	0	2	6	12	18	24	30	36	42	48	54	60	66	72	78	84	90	96	102	108	114	120
6	Check Rubber Boots, Rubber seat, Dust cover & Bushes for damage & replace if required (Suspension) (First at 15K/12M then at every service)	7.5K / 6M			•	•	•	•	•	•	•	•	•	•	•	•	•	•	•	•	•	•	•	•
7	Check for all bolts & nuts (Tighten)	7.5K / 6M			•	•	•	•	•	•	•	•	•	•	•	•	•	•	•	•	•	•	•	•
	Engine (Diesel)																							
1	Clean air filter element (more frequently for vehicle operating as TAXI)	15K / 12M				•		•		•		•		•		•		•		•		•		•
2	Change engine oil and Oil filter	15K / 12M				•		•		•		•		•		•		•		•		•		•
3	Drain water from Fuel Filter Bowl	15K / 12M				•		•		•		•		•		•		•		•		•		•
4	Replace Fuel Pre filter assembly (WIF Sensor to be reused)	# 45K / 24M								•						•						•		
5	Replace Fuel Main fuel filter assembly	# 135K / 24M																				•		

- Kms or Months whichever occurs earlier

MAINTENANCE

Sr. No.	Operation	Kms	PDI	1.5K	7.5K	15K	22.5K	30K	37.5K	45K	52.5K	60K	67.5K	75K	82.5K	90K	97.5K	105K	112.5K	120K	127.5K	135K	142.5K	150K	
		Months	0	2	6	12	18	24	30	36	42	48	54	60	66	72	78	84	90	96	102	108	114	120	
6	Replace Diesel - Pressure Regulator	# 75K / 36M												•											•
7	Check accessory belt condition visually, replace if found damage	15K / 12M			•			•		•		•		•		•		•		•		•			•
8	Check timing belt visual condition, replace if found damage	# 105K / 24M																•							
9	Replace air filter element (more frequently for vehicle operating as TAXI)	45K / 36M								•						•							•		
10	Change coolant	# 60K / 36M										•								•					
11	Replace timing drive kit (Timing belt, Auto tensioner and Idler)	# 150K / 36M																							•

- Kms or Months whichever occurs earlier

MAINTENANCE

Sr. No.	Operation	Kms	PDI	1.5K	7.5K	15K	22.5K	30K	37.5K	45K	52.5K	60K	67.5K	75K	82.5K	90K	97.5K	105K	112.5K	120K	127.5K	135K	142.5K	150K
		Months	0	2	6	12	18	24	30	36	42	48	54	60	66	72	78	84	90	96	102	108	114	120
	Engine (Petrol)																							
1	Clean air filter element (more frequently for vehicle operating as TAXI)	15K / 12M				•		•		•		•		•		•		•		•		•		•
2	Change engine oil and Oil filter	15K / 12M				•		•		•		•		•		•		•		•		•		•
3	Gasoline - Replace Fuel Filter	75K / 60M												•										•
4	Change Spark plugs	45K / 36M								•						•						•		
5	Check accessory belt condition visually, replace if found damage	15K / 12M				•		•		•		•		•		•		•		•		•		•
6	Replace air filter element (more frequently for vehicle operating as TAXI)	45K / 36M								•						•						•		
7	Change coolant (60K /36M , whichever comes early)	# 60K / 36M										•								•				

- Kms or Months whichever occurs earlier

MAINTENANCE

Sr. No.	Operation	Kms	PDI	1.5K	7.5K	15K	22.5K	30K	37.5K	45K	52.5K	60K	67.5K	75K	82.5K	90K	97.5K	105K	112.5K	120K	127.5K	135K	142.5K	150K	
		Months	0	2	6	12	18	24	30	36	42	48	54	60	66	72	78	84	90	96	102	108	114	120	
	Transaxle																								
1	Replace trans-axle oil	75K / 60M												•											•
2	Check AMT Kit oil level, it should be in between min. & Max. level when the vehicle is in standstill and ignition ON condition. Top up AMT kit oil if necessary.	Every Service	•	•	•	•	•	•	•	•	•	•	•	•	•	•	•	•	•	•	•	•	•	•	•
	Brakes																								
1	Check front brake pads & rear brake linings. Replace if necessary	15K / 12M				•		•		•		•		•		•		•		•		•		•	•
2	Replace brake fluid Check brake system components for Leakages	# 45K / 24M								•						•							•		
3	Inspect & if necessary adjust handbrake setting	15K / 12M				•		•		•		•		•		•		•		•		•		•	•

- Kms or Months whichever occurs earlier

MAINTENANCE

Sr. No.	Operation	Kms	PDI	1.5K	7.5K	15K	22.5K	30K	37.5K	45K	52.5K	60K	67.5K	75K	82.5K	90K	97.5K	105K	112.5K	120K	127.5K	135K	142.5K	150K	
		Months	0	2	6	12	18	24	30	36	42	48	54	60	66	72	78	84	90	96	102	108	114	120	
	Wheels & Tyres																								
1	Check & Adjust Wheel alignment	# 15K / 18M				•		•		•		•		•		•		•		•		•		•	
2	Check for Tyre pressure, condition & rotate	# 7.5K / 12M			•	•	•	•	•	•	•	•	•	•	•	•	•	•	•	•	•	•	•	•	•
	Electrical																								
1	Check specific gravity of battery electrolyte (OR Every 6 Months)	Every Service	•	•	•	•	•	•	•	•	•	•	•	•	•	•	•	•	•	•	•	•	•	•	•
2	Check headlamp focussing	15K / 12M				•		•		•		•		•		•		•		•		•		•	
	A.C. System																								
1	Clean filter and check Air-conditioning / HVAC system for satisfactory performance	Every Service	•	•	•	•	•	•	•	•	•	•	•	•	•	•	•	•	•	•	•	•	•	•	•

- Kms or Months whichever occurs earlier

Vehicle Parking at One Place for Long Duration (Non - Use Maintenance)

If you want to park your vehicle at one place for long duration, following care is to be taken:

1. Park the vehicle in covered, dry and if possible well-ventilated premises. Engage a gear.
2. Remove the battery terminal cables (first remove the cable from the negative terminal).
3. Block the wheel or engage in the gear mode.
4. Clean and protect the painted parts using protective wax.
5. Clean and protect the shiny metal parts using commercially available special compounds.
6. Sprinkle talcum powder on the rubber windshield wiper and lift them off the glass.
7. Slightly open the windows.
8. Cover the vehicle with a cloth or perforated plastic sheet. Do not use sheets of imperforated plastic as they do not allow moisture on the vehicle body to evaporate.
9. Inflate the tyres to 0.5 bar above the normal specified pressure and check it at regular intervals.
10. Check the battery charge every six weeks.
11. Do not drain the engine cooling system.

TECHNICAL INFORMATION

Fuel Specification

Fuel (Diesel)

Normal grade BS IV compliant diesel conforming to IS1460 or EN 590 or equivalent is recommended to be used as fuel. Do not use premium diesel available in the market for example extra premium / Turbojet etc.

Recommended fuel specifications

Parameter	Unit	BS IV
Cetane Number (min)	CN	51
Sulphur content	mg/kg	50
Lubricity (HFRR)	micron	460

NOTE

Where oxidation catalytic converter is fitted, it is mandatory to use Diesel fuel with Sulphur contents as given above. Use of any other diesel fuel can increase the pollutants.

At very low temperature, fluidity of diesel may become insufficient due to paraffin separation. It is therefore necessary to mix supplementary fuel with summer or winter grade diesel.

The supplementary fuel to be used like kerosene. Ratio for mixing of supplementary fuel and diesel are shown in the table.

Ambient Temperature up to Deg C.	Percentage	
	Summer grade diesel	Supplementary fuel
Up to 0	100	0
0 to -10	70	30
-10 to -15	50	50

Care should be taken that diesel and supplementary fuel are thoroughly mixed before filling.

Ambient Temperature upto Deg C.	Percentage	
	Winter grade diesel	Supplementary fuel
Up to -15	100	0
-15 to -20	70	30
-20 and below	50	50

WARNING



Do not mix gasoline or alcohol with diesel. This mixture can cause an explosion.

TECHNICAL INFORMATION

Fuel (Petrol)

Unleaded regular grade petrol conforming to IS 2796:2008 and BS IV specification and RON not less than 91 is recommended. It is always recommended to use correct fuel to get optimum emission performance.

NOTE

Always use petrol of a correct specification in a vehicle fitted with catalytic converter. Even single fill of leaded petrol will seriously damage the catalytic converter.

Lubricant Specification

Use following genuine fluids, coolants and lubricants recommended for optimum performance of your vehicle.

Item	Specification	Company	Brand	Quantity
Engine Oil	5W30 ACEA A5/B5 TATA SS6576	CASTROL	Magnatec Professional T 5W30	Petrol - 3.5 L Diesel - 4.5 L
		EXXON MOBIL	Mobil super 3000 TMGO 5W 30 Tata motors genuine oil	
		PETRONAS	TATA MOTORS GENUINE OIL – Engine Oil synth 5W30	
Coolant (Pre-mixed) (Anti-freeze agent + Soft water 40 : 60 ratio)	Class II/JIS K2234 TATA SS7700S1	Sunstar CCI	Gloden Cruiser LLC2200NP	Petrol – 5.5 L Diesel – 6.5 L
		CASTROL	Castrol Radicoolant SFO Premix	
		IOCL	TATA MOTORS GENUINE COOLANT KOOL PLUS	
Transaxle Oil	EP80W LL (Next Gen) TATA SS6582	PETRONAS	TATA MOTORS Genuine Oil – Gear Oil New Gen 80 EP LL	1.8 Liters
		IOCL	TATA MOTORS GENUINE GEAR OIL 80WLL	
		CASTROL	Transmax Manual T 80W	

TECHNICAL INFORMATION

Item	Specification	Company	Brand	Quantity
Brake Fluid/Clutch fluid	SAE J1703, DOT4	PETRONAS	PETRONAS TATA MOTORS Genuine Brake Oil DOT 4S	As required
		Sunstar CCI	Golden Cruiser Tata Genuine Brake Fluid (DOT4)	
		CASTROL	CASTROL-Universal Brake Fluid DOT 4	
Refrigerant	R-134a	MAHLE	-	500 gms
Compressor Oil	ND-8	MAHLE	-	120 ml
AMT Kit oil	Hydraulic Oil	PETRONAS	TUTELA Cs – Speed	As required

NOTE

Check AMT Kit oil level at every service, it should be in between min. & max. level when the vehicle is in standstill and ignition ON condition. Top up AMT kit oil if necessary.”

TECHNICAL INFORMATION

Technical Specifications

Parameter	Diesel	Petrol
Engine		
Model/type	1.05 CRAIL Turbocharger Intercooled Diesel	1.2 REVOTRON
Capacity	1047 cc	1199 CC
Max. Engine output	51.5 kw (70 ps) @ 4500 rpm	62.5 kw (85 ps) @ 6000 rpm
Max. Torque	140 Nm @ 1800 to 3000 rpm	114.4 Nm @ 3500 +/-70 rpm
Clutch		
Type	Single plate dry friction diaphragm type	
Outside diameter of clutch	200 mm	
Transaxle		
Model	TA-65* 5/3.83 (5 speed) with overdrive manual	TA-65* 5/3.64 (5 speed) with overdrive manual
Type	Synchromesh on all forward gears and sliding mesh on reverse gear	
No. of gears	5-Forward, 1-Reverse	

TECHNICAL INFORMATION

Parameter	Diesel	Petrol
Steering		
Type	Electrical Power assist Steering, Rack & Pinion Gear, Collapsible Steering Column	
Brakes		
Brakes	Front (Disc); Rear (Drum)	
Parking brake	Cable Operated Mechanical (Variable Lever Ratio)	
Suspension		
Type	Independent	
Shock absorber	Hydraulic Shock absorber	
Wheels & tyre		
Tyres	1. 155/80 R13 79T Tubeless (XE, XE(O)) 2. 175/65 R14 82T Tubeless (XM, XM(O), XT, XT(O), XZ, XZ(O), XZ+)	1. 155/80 R13 79T Tubeless (XE, XE(O)) 2. 175/65 R14 82T Tubeless (XM, XM(O), XT, XT(O), XTA) 3. 175/60 R15 Tubeless (XZ, XZ(O), XZ+, XZA)
Wheel rims	1. 4.5JX13" Steel Wheel Rim (XE, XE(O)) 2. 5J X 14" Steel Wheel Rim (XM, XM(O), XT, XT(O), XTA) 3. 5J X 14" Alloy Wheel Rim (XZ, XZ(O), XZ+)	1. 4.5JX13" Steel Wheel Rim (XE, XE(O)) 2. 5J X 14" Steel Wheel Rim (XM, XM(O), XT, XT(O), XTA) 3. 5.5J X 15" Alloy Wheel Rim (XZ, XZ(O), XZ+, XZA)
Suspension		
Type	35 liters	

TECHNICAL INFORMATION

Parameter	Diesel	Petrol
Cab / body		
Type	Semi-mono volume, 4 doors sedan, steel monocoque body.	
Electrical system		
System voltage	12 Volts (-ve earth)	
Alternator capacity	14.5V,120 Amp	14.5 V, 110 Amp
Battery	12V, 50Ah	12V, 44Ah
Main chassis dimension (in mm)		
Wheel base	2450	
Track front	1400	
Track rear	1420	
Overall length	3992	
Overall height	1537	
Max. Width	1677	
Ground clearance	165	
Performance		
Max. Speed	150 Kmph	160 Kmph
Max. Recommended gradability	14 deg	
Minimum Turning Circle Dia.	10.1 m	

TECHNICAL INFORMATION

Parameter	Diesel	Petrol
Minimum Turning Clearance circle Dia.	11 m	
Weight (in kg)		
Gross vehicle weight	1485 XE, 1500 XE(O) 1490 XM, 1505 XM(O) 1510 XT, 1525 XT(O) 1525 XZ, 1530 XZ(O) 1510 BUZZ, 1530 XZ+	1420 XE, 1435 XE(O) 1422 XM, 1437 XM(O) 1442 XT, 1457 XT(O) 1457 XZ, 1462 XZ(O) 1442 BUZZ, 1462 XZ+ 1454 XTA, 1454 XMA 1469 XZA, 1469 XZA+
Kerb weight (Unladen)	1085 XE, 1100 XE(O) 1090 XM, 1105 XM(O) 1110 XT, 1125 XT(O) 1125 XZ, 1130 XZ(O) 1110 BUZZ, 1130 XZ+	1020 XE, 1035 XE(O) 1022 XM, 1037 XM(O) 1042 XT, 1057 XT(O) 1057 XZ, 1062 XZ(O) 1042 BUZZ, 1062 XZ+ 1054 XTA, 1054 XMA 1069 XZA, 1069 XZA+

Vehicle Dimensions

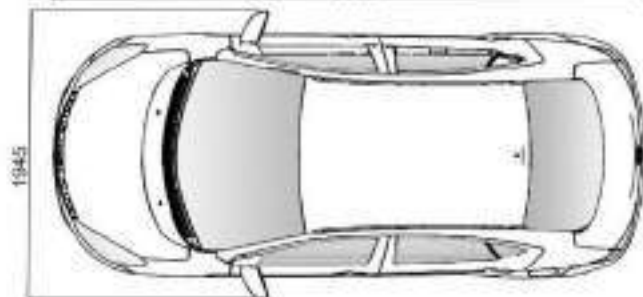
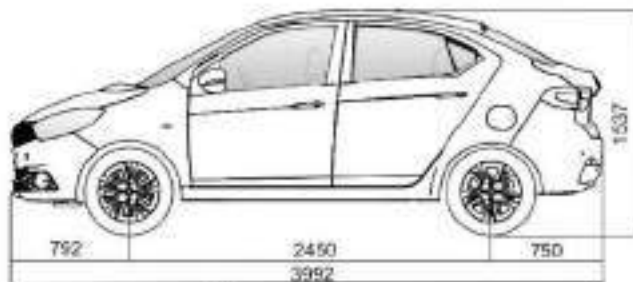
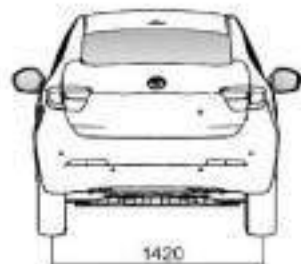

TECHNICAL INFORMATION

Aggregate Identification Numbers



Chassis No. punching near driver seat



Transaxle No. Punching



Engine No. Plate – Petrol



VIN plate near front passenger seat



Engine No. Plate – Diesel

CAR CARE AND VALUE ADDED SERVICES

Car Care

Your vehicle is subjected to many external influences such as climate, road conditions, industrial pollution and proximity to the sea. These conditions demand regular care of the vehicle body. Dirt, insects, bird droppings, oil, grease, fuel and stone chippings should be removed as soon as possible.

Washing

Following these tips while washing your vehicle.

Hand wash:

1. Always wash your vehicle in shade and the surface is at room temperature.
2. Wash with mild vehicle wash soap like 'Car Shampoo' and use a soft bristle brush, sponge or soft cloth and rinse it frequently while washing to avoid scratches.
3. To avoid scratches, please wear soft gloves. Remove finger rings, nails, wristwatch while washing.

4. To remove stubborn stains and contaminants like tar, use turpentine or cleaners like 'Stain remover', which are safe for, paint surfaces.
5. Avoid substances like petrol, diesel, kerosene, benzene, thinner or other solvents that cause damage to paint.
6. Dry your vehicle thoroughly to prevent any damp spots.
7. Rinse all surfaces thoroughly to prevent any traces of soap and other cleaners as this may lead to the formation of stains on the painted surface later.

WARNING



Do not direct high-pressure washer fluid/ water jets (Pressure above 0.5 Bar) at electrical devices and connector during washing. This is to prevent malfunction / failure of electrical system due to water ingress.

After drying the vehicle, inspect it for chips and scratches that could allow corrosion to start. Apply touch up paint where necessary.

Cleaning of Carpets

Vacuum clean the carpet regularly to remove dirt. Dirt will make the carpet wear out faster. Periodically shampoo the carpet to keep it looking new.

Use carpet cleaners (preferably foam type). Follow the instructions that come with the cleaner. Apply it with a sponge or soft brush. Keep the carpeting as dry as possible by not adding water to the foam.

NOTE

Avoid wiping of painted surface in dry condition as it may leave scratches on the painted surface.

CAR CARE AND VALUE ADDED SERVICES

Cleaning of Windows, Front and Rear Glasses

Clean the windows inside and outside with commercially available glass cleaners.

This will remove the haze that builds up on the inside of windows. Use a soft cloth or paper towels to clean all glass and plastic surfaces.

FAST TAG

FAST TAG is pasted on front windshield from the inside. It enables Electronic toll collection.



NOTE

Do not attempt to rip or tamper the tag. It will disable the functionality of the tag.

Waxing

Waxing and polishing is recommended to maintain the gloss and wet-look appearance of your paint finish.

1. Use good quality polish and wax for your vehicle.
2. Re-wax your vehicle when the water does not slip off the surface but collects over the surface in patches.

Polishing

Polishes and cleaners can restore shine to the painted surface that has oxidized and become dull. They normally contain mild abrasives and solvents that remove the top layer of the finish coat. Polish your vehicle, if the finish does not regain its original shine after using wax.

Interior fabric cleaning tips

1. Stains should be treated immediately. If left for a long time, they can leave a permanent mark.
2. Cleaning the stains immediately is important especially for stains which contain artificial colors in the stain creating liquid or semisolid substance. The colorant may leave a stain if kept for longer time.
3. Stain should not be removed by rubbing. As far as possible, try to blot or lift the stain with cloth or plastic spatula and then clean the remaining stain with cloth or sponge.
4. If the stain has dried, then gently brush off the material and then press with damp cloth or sponge till it disappears.
5. Do not use household detergents to clean the fabric.
6. Always use clean cotton cloth for cleaning.

Paint Care

Following guidelines will help you to protect your Vehicle from corrosion effectively.

Proper cleaning

In order to protect your vehicle from corrosion it is recommended that you wash your vehicle thoroughly and frequently in case:

- There is a heavy accumulation of dirt and mud especially on the underbody.
- It is driven in areas having high atmospheric pollution due to smoke, soot, dust, iron dust and other chemical pollutants.
- It is driven in coastal areas.
- The underbody must be thoroughly pressure washed after every three months.

In addition to regularly washing your car, the following precautions need to be taken.

Periodic Inspection

- Regularly inspect your vehicle for any damage in the paint film such as deep scratches and immediately get them repaired from an authorized service outlet, as these defects tend to accelerate corrosion.
- Inspect mud liners for damages.
- Keep all drain holes clear from clogging.

Proper Parking

- Always park your vehicle in shade to protect it from harsh sunlight or in a well-ventilated garage so that there is no dampness on any part of the vehicle.

Wiper care

- To prevent damage to the wipers or windshield, do not operate the wipers when the windshield is dry.
- To prevent damage to the wiper arms and other components, do not attempt to move the wipers manually.

CAR CARE AND VALUE ADDED SERVICES

Extended Warranty

TATA MOTORS recommends the purchase of its extended warranty program.

Coverage - Mechanical + Electrical

Benefits

- Insures you against unforeseen break down repair bills.
- Documentation is simple and hassle free.
- Near cashless & speedy claim

Term

24 + 12 months or 75,000 kms whichever occurs first

OR

24 + 24 months or 1,00,000 kms whichever occurs first

Extended Warranty is available in the dealership from where you have purchased your vehicle. We strongly recommend purchase of Extended Warranty at time of purchase of your vehicle. Extended Warranty can be availed till 421 days from date of purchase of vehicle. The Dealer Service Marketing Executive shall explain to you the Terms and conditions, Coverage and Owner's responsibility.

Extended Warranty Booklet & Cover Note

The Extended Warranty booklet and cover note is the basis of the contract between TATA MOTORS LIMITED and the Owner of the vehicle shown on the Extended Warranty booklet. The Customer is to retain this booklet and the same to be produced to the dealer while claiming benefits under Extended Warranty.



CAR CARE AND VALUE ADDED SERVICES

Note

- The 12 or 24 months extended warranty does not follow the 24 months Manufacturer's warranty.
- The extended warranty comes into force once the manufacturer's warranty expires e.g. after 24 Months.
- It is more restrictive as by the time it comes into force the vehicle is already 24 months old.

What is covered?

- Mechanical / Electrical break down as defined in this warranty and confirmed by the dealer within the stipulated terms and conditions.
- TATA MOTORS dealer shall either repair or replace any part found to be defective with a new part or an equivalent at no cost to the owner for parts or labour.
- Such defective parts which have been replaced will become property of TATA MOTORS LIMITED.
- Comprehensive list of parts covered is mentioned in the page 9-12 of the Extended Warranty Booklet.

What is not covered?

Please refer the Extended Warranty Booklet for details of the exclusion list.

Owner's Responsibility:

- Proper use, maintenance and care of the vehicle in accordance with the instructions contained in the Owner's Manual and Service Booklet. The records of the same to be ensured in Owner's Manual.
- Retention of maintenance service bills.

I / We have been explained the Terms and conditions, Coverage and Owner's responsibility by the Dealer Service Marketing Executive.

I wish to avail / Do not wish to avail extended warrant policy.

Customer's Signature

Dealer's Signature

CAR CARE AND VALUE ADDED SERVICES

Value Added Services

Why are Corrosion Protection Waxes necessary?

Corrosion is caused by:

Water / salt water acid rain & atmospheric fallouts.

Critical areas are:

Cavities: joints, crevices, spot welds, underbody

- Corrosion is the most important factor when we talk about the vehicle life. If you treat your car you can prolong the life.
- It is very dangerous to drive around in a corroded vehicle.
- The corrosion creeps onto the vehicle from the inside and from the outside. The most dangerous kind of corrosion is often not discovered until it is too late.

Benefits of Anti - Rust treatment:

- A professionally applied range of world class products offering real value to the new and used vehicle customer.
- The treatment has been developed to withstand the harshest environmental and climatic conditions (rust. Pollutants, stone and gravel impact, etc.)
- Insulate cabin space from external noises.
- Expensive tin work and Denting / Painting avoided.
- Higher resale value for the vehicle.
- Higher safety – uncorroded vehicle
- 10 free checkups available



CAR CARE AND VALUE ADDED SERVICES

TATA MOTORS has tied up with **M/s Wurth, M/s Autokrom, M/s 3M India Lt d & M/s Bardahl** for these world class treatment at affordable prices. These treatments are available in all authorized workshops. The Dealer Service Marketing Executive will explain to you the benefits and terms and conditions of this treatment.

I / We have been explained the Benefits, Terms and conditions and the prices of these treatments by the Dealer Service Marketing Executive.

I wish to avail / Do not wish to avail extended warrant policy.

Customer's Signature

Dealer's Signature

CAR CARE AND VALUE ADDED SERVICES

Vehicle Exterior Enrichment

Why vehicles are painted?

- For Corrosion protection of the metal surfaces.
- Ease of application from other corrosion protection treatments.
- Cheaper than other corrosion protection methods eg. Galvanizing, anodizing.
- For decoration and identification.



Various Environmental Hazards affecting paints

Environmental hazards: destroy your vehicle's finish.

Even as your new vehicle rolls off the assembly line, the paint is not protected.

The enemy

Ultraviolet Rays, Pollution, Tree Sap, Bird Droppings, Car Wash Chemicals, Road Salt, Acid Rain.

Benefits: Vehicle Exterior Enrichment

- Removal of medium scratches, orange peel, oxidation, dust nibs etc. & swirl marks from painted surface.
- Restoration of original gloss levels, UV protection after gloss is restored.
- Cleaning & dressing of tyres, Bumpers & all exterior plastic moldings/trims.

TATA MOTORS has tied up with **M/s Autokrom, M/s 3M & M/s Wurth** for this world class treatment at affordable prices. This treatment is available in all authorized workshops. The Dealer Service Marketing Executive will explain to you the benefits and terms and conditions of this treatment.

Vehicle Interior Enrichment

Why protect your new car's fabric interior?

- Someone will soil your vehicle's fabric carpet or seats.
- A significant detractor from your vehicle's resale value.
- A permanent stain on your vehicle's interior fabric.

The enemy:

Drink Spills - Food Stains - Mud - Ultraviolet Rays Pets - Traffic

Benefits: Vehicle Interior Enrichment

- Removal of medium stains and dirt from all interior parts of the car i.e., carpet, upholstery and roof lining.
- Cleaning of windshield and all windows (inside and outside)
- Dressing of all internal plastics (eg: door pad trims) and rubber parts.
- The treatment involves cleaning and dressing of all parts of the exposed interiors.
- Specialised protection for seat fabric from liquid spills.

TATA MOTORS has tied up with **M/s Wurth** and **M/s Autokrom** for this world class treatment at affordable prices. This treatment is available in all authorized workshops. The Dealer Service Marketing Executive will explain to you the benefits and terms and conditions of this treatment.

I / We have been explained the Terms and conditions, Coverage and Owner's responsibility by the Dealer Service Marketing Executive.

I wish to avail / Do not wish to avail extended warrant policy.

Customer's Signature

Dealer's Signature

WARRANTY - TERMS AND CONDITIONS

We WARRANT each **TATA TIGOR** vehicle and parts thereof manufactured by us to be free from defect in material and workmanship subject to the following terms and conditions:

1. This warranty shall be for a period of **24 months from the date of sale of the car or a mileage of 75,000 Kms which-ever occurs earlier.**
2. Our obligation under this warranty shall be limited to repairing or replacing, free of charge, such parts of the car which, in our opinion, are defective, on the car being brought to us or to our dealers within the period. The parts so repaired or replaced shall also be warranted for quality and workmanship but such warranty shall be co-terminus with this original warranty.
3. Any part which is found to be defective and is replaced by us under the warranty shall be our property.
4. As for such parts as Tyres, Batteries, Audio and / or Video equipment (if any), etc. not manufactured by us but supplied by other parties, this warranty shall not apply, but buyers of the car shall be entitled to, so far as permissible by law, all such rights as we may have against such parties under their warranties in respect of such parts.
5. This warranty shall not apply if the car or any part thereof is repaired or altered otherwise than in accordance with our standard repair procedure or by any person other than from our sales or service establishments, our authorized dealers, service centres or service points in any way so as, in our judgment which shall be final and binding, to affect its reliability, nor shall it apply if, in our opinion which shall be final and binding, the car is subjected to misuse, negligence, improper or inadequate maintenance or accident or loading in excess of such carrying capacity as certified by us, or such services as prescribed in our Owner's Manual are not carried out by the buyer through our sales or service establishments, our authorized dealers, service centres or service points.
6. **This warranty shall not apply to the replacement of normal wear parts, including without limitation, spark plugs, drive belts, hoses, wiper blades, fuses, clutch disc, brake shoes, brake pads, cables and all rubber parts (except oil seal and glass run).**
7. This warranty shall not cover any inherent normal deterioration of the car or any of its parts arising from the actual use of the car or any damage due to negligent or improper operation or storage of the car.
8. This warranty shall not apply to normal maintenance services like oils & fluid changes, head lamps focusing, fastener retightening, wheel balancing and alignment, tyre rotation, adjustment of valve clearance, fuel timing, ignition timing and consumables like bulbs, fuel, air & oil filters and gas leaks in case of air conditioned cars.
9. This warranty shall not apply to any damage or deterioration caused by environmental pollution or bird droppings. Slight irregularities not recognized as affecting the function

WARRANTY - TERMS AND CONDITIONS

- or quality of the vehicle or parts, such as slight noise or vibration, defects appearing only under particular or irregular operations are items considered characteristics of the vehicle.
10. This warranty shall be null and void if the car is subjected to abnormal use such as rallying, racing or participation in any other competitive sport. This warranty shall not apply to any repair or replacements as a result of accident or collision.
 11. This warranty is expressly in lieu of all warranties, whether by law or otherwise, expressed or implied, and all other obligations or liabilities on our part and we neither assume, nor authorize any person to assume on our behalf, any other liability arising from the sale of the car or any agreement in relation thereto.
 12. The buyer shall have no other rights except those set out above and have, in particular, no right to repudiate the sale, or any agreement or to claim any reduction in the purchase price of the car, or to demand any damages or compensation for losses, incidental or indirect, or inconvenience or consequential damages, loss of car, or loss of time, or otherwise, incurred or accrued.
 13. Any claim arising from this warranty shall be recognized only if it is notified in writing to us or to our authorized dealer without any delay soon after such defects as covered & ascertained under this warranty.
 14. **This warranty is fully transferable to subsequent vehicle owner. Only unexpired remaining period of warranty applies.**
 15. We reserve our rights to make any change or modification in design of the car or its parts or to introduce any improvement therein or to incorporate in the car any additional part or accessory at any time without incurring any obligation to incorporate the same in the cars previously sold.

TATA MOTORS LTD. is committed to produce vehicles using environmentally sustainable technology. A number of features have been incorporated in TATA MOTORS passenger vehicles which have been designed to ensure environmental compatibility throughout the life cycle of the vehicle. We would like to inform you that your vehicle meets emission norms and this is being regularly validated at the manufacturing stages.

As a user you too can protect the environment by operating your vehicle in a proactive manner. A lot depends on your driving style and the way you maintain your vehicle. We have given a few tips for your guidance.

Driving

- Avoid frequent and violent acceleration.
- Do not carry any unnecessary weight in the vehicle as it overloads the engine. Avoid using devices requiring high power consumption during slow city traffic condition.
- Monitor the vehicle's fuel consumption regularly and if showing rising trend get the car immediately attended at the Company's Authorised Service Outlets.
- Switch off the engine during long stops at traffic jams or signals. If you need to keep the engine running, avoid unnecessary revving it up or stopping and starting.
- It is not necessary to rev up the engine before turning it off as it unnecessarily burns the fuel.

- Shift to higher gears as soon as it is possible. Use each gear up to 2/3rd of its maximum engine speed.
- A chart indicating gear shifting speeds is given in this book.

Maintenance

- Ensure that recommended maintenance is carried out on the vehicle regularly at the Authorised Service Outlets.
- As soon as you see any leakages of oil or fuel in the vehicle we recommend to get it attended immediately.
- Use only recommended grades and specified quantity of lubricants.
- Get your vehicle checked for emission periodically by an authorised dealer.
- Ensure that fuel filter, oil filter and breather are checked periodically and replaced, if required, as recommended by TATA MOTORS.
- Do not pour used oils or coolants into the sewage drains, garden soil or open streams. Dispose the used filters and batteries in compliance with the current legislation.
- Do not allow unauthorized person to tamper with engine settings or to carry modifications on the vehicle.
- Never allow the vehicle to run out of fuel.
- Parts like brake liners, clutch discs should be vacuum cleaned. Do not use compressed air for cleaning these parts which may spread dust in the atmosphere.

ENVIRONMENT SAFETY

While carrying out servicing or repairs of your vehicle, you should pay keen attention to some of the important engine aggregates and wiring harness which greatly affect emission. These components are:

1. Fuel injection equipment's - pump, rail, injectors, nozzles and high pressure pipes.
2. Air Intake & Exhaust system, especially for leakages.
3. Cylinder head for valve leakage.
4. All filters such as air, oil and fuel filters (check periodically).
5. Turbocharger.
6. Electrical connections.
7. If the 'Service' lamp continuously glows, please take the vehicle to a TATA MOTORS authorized service outlet.
8. Catalytic Converter.
9. EMS wiring harness i.e. electrical connections to all sensors and actuators.

This Owner's manual contains further information on driving precautions and maintenance care leading to environment protection. Please familiarize yourself with these aspects before driving.