

TATA MOTORS



OWNER'S MANUAL



TIAGO
FROM **TATA MOTORS**

www.tatatiago.com



TIAGO

OWNER'S MANUAL



TATA MOTORS

CUSTOMER ASSISTANCE

In our constant endeavour to provide assistance and complete service backup, TATA MOTORS has established an all India customer assistance centre.

In case you have a query regarding any aspect of your vehicle, our Customer Assistance Centre will be glad to assist you on our Toll Free no. **1800 209 7979**

You can also approach nearest TATA MOTORS dealer. A separate Dealer network address booklet is provided with the Owner's manual.

TATA MOTORS 24X7 Roadside Assistance Program offers technical help in the event of a breakdown. Call to the toll-free Roadside Assistance.

For additional information, refer to "**24X7 Roadside Assistance**" section in the Owner's manual.



Dear Customer,

Welcome to the TATA MOTORS family.

We congratulate you on the purchase of your new vehicle and are privileged to have you as our valued customer.

We urge you to read this Owner's Manual carefully and familiarize yourself with the equipment descriptions and operating instructions before driving.

Always carry out prescribed service / maintenance work as well as any required repairs at an authorized TATA MOTORS Dealers or Authorized Service Centre's (TASCs). Use only genuine parts for continued reliability, safety and performance of your vehicle.

You are welcome to contact our dealer or Customer Assistance toll free no. **(1800 209 7979)** in case of any query or support required.

We wish you a safe and pleasant driving experience.

TATA MOTORS

Bombay House, 24, Homi Modi Street,
Hutatma Chowk, Fort, Mumbai – 400001

CUSTOMER ASSISTANCE

- Before driving, read this Owner's manual carefully and familiarize yourself with your vehicle. For your own safety and a longer vehicle life, follow the instructions, 'Warnings' and 'Notes' in this manual. Ignoring them could result in damage to the vehicle or personal injury to you or others.
- The Owner's manual and other booklets are important documents and should always be kept in the vehicle. If you sell the vehicle, always pass on the documents to the new owner.
- This Owner's Manual describes all variants of the model and all standard/optional equipment of your vehicle available at the time of printing. Please note that your vehicle may not be equipped with all features described.
- TATA MOTORS Limited reserves the right to introduce changes in the design, equipment and technical features without any obligation to install them on the vehicles previously sold. The equipment in your vehicle may therefore differ from that shown in the descriptions and illustrations.
- Do not carry out any modification including fitment of non-genuine accessories on your vehicle. Safety, handling, performance and durability, may otherwise be adversely affected and may violate government regulations. TATA MOTORS Limited accepts no liability for damage resulting from the modifications or use of non-genuine accessories.
- All rights reserved. The information in this manual shall not be copied, translated or otherwise reproduced, in whole or in part, without written permission from TATA MOTORS.

© Copyright 2016 TATA MOTORS

1 Safety

Important Information.....	9
Safe Driving.....	9
Seat Belts.....	10
Child Restraint System (CRS)...	13
Anti-theft Device: Immobilizer...	15
Child Lock.....	16
Air Bags.....	17
ABS.....	18
EBD.....	18

2 Opening & Closing

Flip Key.....	21
Doors.....	23
Windows.....	24
Bonnet.....	25
Tailgate and Fuel lid.....	26

3 Dashboard & Features

Cockpit.....	29
Instrument Cluster.....	30
Driver Information Display.....	34
Driver Information Settings.....	38
Warning Lamps.....	41
Audio Reminders.....	46
Combi Switches.....	47
Fascia Switches.....	49
Steering Wheel Switches.....	50
Mic.....	50
Infotainment System.....	51

CONTENTS

3 Dashboard & Features

USB/AUX.....51

Power Socket.....51

Antenna.....52

Roof Lamp.....52

Roof Grab Handles.....53

Boot Lamp.....53

Tag Holder.....53

4 Stowage Areas

Storage Compartments.....55

Glove Box.....56

Pocket on Dashboard.....56

Utility pockets on doors.....56

Center Console.....56

Tailgate Compartment.....57

Card Holder.....58

Hooks.....59

5 Climate Control

Air Vents & Distribution.....61

HVAC Controls.....62

Functions & Settings.....65

6 Starting & Driving

Pre-Driving Checks.....67

Driving Tips.....68

Seat Adjustments.....71

Rear View Mirrors.....72

Sun Visors.....73

Steering Wheel Adjustments.....74

Starting the Engine.....75

Gear Shifting & Driving.....76

Drive Modes.....76

Braking/Parking Brake.....77

Reverse Park Assist.....80

7 Emergency & Break-down Assistance

Emergency Equipment.....83

Hazard Warning Switch.....84

In Case of Flat Tyre.....85

Jump Lead Starting.....88

Towing.....90

Fuses.....91

Bulb Specification.....97

Bulb Replacement.....98

24x7 Road Side Assistance.....101

8 Maintenance

Maintenance & Service.....105

Engine Compartment.....106

Engine Oil/Coolant Level.....108

Battery.....110

Spark Plug.....111

Tyres.....112

Key Battery Replacement.....115

On Board Diagnostic (OBD).....116

Service Instructions.....117

Service Schedule.....118

Parking for Long Durations.....124

CONTENTS

9 Technical Information

Fuel Specification.....125

Lubricant Specification.....127

Technical Specification.....128

Vehicle Dimensions.....131

Aggregate Identification Nos.....132

10 Car Care and Value Added Services

Car Care.....133

Washing.....133

Waxing.....134

Polishing.....134

Interior Fabric Cleaning.....134

Paint Care.....135

Wiper Care.....135

Value Added Services.....136

11 Warranty – Terms and Conditions

12 Environment Safety

Important Information

In this Owner's Manual, you will find the text under the heading "WARNING" and "NOTE" which highlights important information. Pay particular attention to these highlighted messages.

NOTE

Indicates additional information that will assist you in gaining the optimum benefit and care for your vehicle.

WARNING

Indicates procedures or information that must be followed precisely in order to avoid the possibility of severe personal injury and serious damage to the vehicle.

Safe Driving

Safety consciousness not only ensures your safety and the safety of other road users, but it also helps to reduce the wear and tear on your vehicle.

Safe driving depends on:

- How quickly you make decisions to avoid an accident.
- Your ability to concentrate.
- How well you can see and judge objects.
- How well familiar you are with your vehicle controls and its capabilities.

NOTE

Fatigue is a result of physical or mental exertion that impairs judgment. Driver fatigue may be due to inadequate sleep, extended work hours, strenuous work or non-work activities or combination of other factors. Take rest at regular intervals.

Safety Tips

- Always take into account the road conditions, weather conditions, vehicle speed in order to prevent accidents.
- Turn 'ON' the side indicators at least 30 meters before taking a turn or changing the lane.
- Decelerate to a safe speed before taking turn. Do not apply brakes during cornering.
- When overtaking other vehicles, watch out for the oncoming vehicle.
- Never drive under the influence of alcohol or drugs.
- If your vehicle is equipped with infotainment/navigation system, set and make changes to your travel route only when the vehicle is parked.
- Program radio presets with the vehicle parked, and use your programmed presets to make radio use quicker and simpler.

SAFETY

Driving through water

Do not drive through flooded areas. Judge the depth of water before driving through it. Otherwise, water may enter the vehicle interior or the engine compartment.

If at all the situation demands that you have to drive through water then;

- Keep engine in higher RPM and crawl the vehicle in low gear.
- Flowing or rushing water creates strong forces. Driving through flowing water could cause the vehicle to be carried away. Be very cautious about trying to drive through flowing water.
- Lightly apply the brake pedal to dry the liners until the brakes work normally once you are out of water.

WARNING

Do not attempt to start the engine if vehicle gets flooded due to water. Tow the vehicle to a safe place. Contact a nearest TATA MOTORS Authorised Service Centre.

Driving on a rainy day

- Check wiper blades, lights and brakes for proper functioning and condition.
- Check the tyre treads depth, the condition of the tread and tyre.
- Avoid harsh braking and sharp turns. It may cause loss of control and lead to a skid.
- For slowing down, shift to lower gears and brake gently.
- Keep lights 'ON' if visibility is poor.

Driving through wet roads

On wet road or during light showers, "Aquaplaning" can occur. "Aquaplaning" is the loss of direct contact between the road surface and the vehicle's tires due to a water film forming between them. Steering or braking the vehicle can be very difficult, and loss of control can occur.

There is no hard and fast rule about aquaplaning. The best advice is to slow down when the road is wet.

NOTE

If you have driven for a long time in heavy rain without braking, there may be a delayed reaction from the brakes when braking for the first time. You have to depress the brake pedal more firmly. Maintain a greater distance from the vehicle in front.

Night driving

- Ensure that all light are working and windshield, window glasses are clean.
- Drive more slowly at night than in the daytime, as the visual range is restricted at night. Maintain a speed such that you can stop within illuminated distance of head lamps.
- Do not use the high beam unless inevitable. It may dazzle the driver of the oncoming vehicle, thus causing an accident.
- Use head lamp main/dip beam to alert other road users on turns/cross roads etc.
- Use side indicators for lane change or turning.

Driving on gradients

When climbing gradient, the vehicle may begin to slow down and show a lack of power. If this happens, shift to a lower gear and apply power smoothly so that there is no loss of traction.

When driving down a hill, the engine braking should be used by shifting into a lower gear. Do not drive in neutral gear or switch off the engine.

WARNING

On long and steep gradients you must reduce the load on the brakes by shifting early to a lower gear. This allows you to take advantage of the engine braking effect and helps avoid overheating of service brakes resulting in reduced braking efficiency.

Driving on highway

Stopping distance progressively increases with vehicle speed. Maintain a sufficient distance between your vehicle and the vehicle ahead.

For long distance driving, perform safety checks before starting a trip and take rest at certain intervals to prevent fatigue.

SAFETY

Seat Belts

Seat-belt is a safety device designed to secure the occupant travelling in the vehicle. TATA MOTORS strongly recommends that all the occupants should always wear seat belts while travelling, irrespective of journey duration.

In normal driving, the belt lets you move freely in your seat. In case of an accident or sudden braking, inertia reel automatically tightens the belt to help restrain your body.

Importance of wearing seat belt

- Reduces the risk of being thrown inside the vehicle in case of a collision/sudden braking.
- It will help to keep you in the proper position when the air bag inflates.
- Reduces the risk of harm in frontal/angular collisions that are not enough to activate the air bag.
- Reduces the risk of harm in rollover, side or rear impact collisions.

WARNING

Never wear seat belt over rigid or breakable objects, such as eyeglasses, pens, keys etc., as these might cause injuries.

Make sure the seat belt is always fitted comfortably.

Place the seat backrest in a position that is as upright as possible. Make sure that the seat belts are not twisted which can cause injury in a collision as the full width of the belt isn't available to absorb the impact. This could cause serious injury.

The maximum protection which seat belts can offer is only achieved if you are correctly seated.

NOTE

Do not bleach or dye seat belts as this may severely weaken them. In a crash they may not be able to provide adequate protection. Cleaning should be carried out using mild soap and water only.

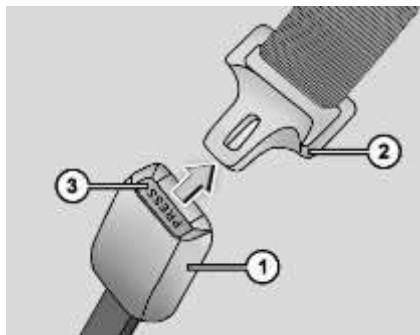
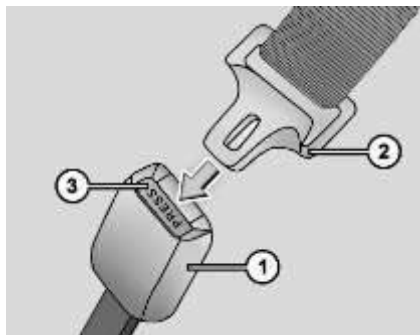
How to use seat belts

1. Buckle 2. Tongue 3. Press Button

1. Pull the belt tongue across your body and insert it into the buckle until click sound is heard.
2. Check and ensure that the belt is not twisted.
3. Position the lap portion of the belt as low as possible across your hip bone.
4. Pull up the shoulder part of the belt to remove the slack. Make sure that the belt goes over your collar bones and across chest.
5. The lap portion of the belt should be worn across the pelvis, not across the waist.



6. To unlatch the belt, press the red button on the buckle. Guide the belt to the pillar as it retracts.

WARNING

- The seat belts are intended for adults and each belt should be used by one occupant only.
- Use approved child restraint system for children.
- If the belt has withstood serious accident or shows signs of severe fraying/damage or cut, replace it with an approved belt kit.
- Do not make any modification that could change the effectiveness of the seat belts.
- If seat belt needs to be replaced, then it should be replaced, by TATA MOTORS Authorized Service Centre only.

SAFETY

Seat belt hanger (if equipped)



Insert the rear seat belt tongue (except middle seat) in the slit (shown in fig.) provided when not in use or during seat folding.

Make sure the belt webbing is not twisted.

Lap belt (for rear middle seat)

Pull the belt tongue to the desired length. Insert it into the buckle until you hear a click.

Adjust the belt length. To lengthen the belt, hold the tongue at a right angle to the webbing and pull. To shorten, pull the loose end of the webbing. To unfasten, press the button in the buckle.

WARNING

Position the lap belt as low as possible on your hip bone and not across the abdomen. If the lap belt is positioned across your abdomen, it could cause serious injuries in a crash.

Pregnant woman

Pregnant women should also always use a lap-shoulder belt. The lap belt portion should be positioned as low as possible on the hip bones to avoid any possible pressure on the abdomen.

Child Restraint System (CRS)

TATA MOTORS strongly recommends the use of Child Restraint Systems (CRS) for all children up to age of 12 years.

Children kept unrestrained while travelling, may face serious injuries in case of an accident.

Selection and installation of CRS

Always select the child restraint system that complies with latest safety standards (AIS072 / ECE R44). The CRS are classified according to the child's size, height and weight. Select the appropriate CRS for your child. Ensure that the child fits properly in the CRS and CRS is securely installed in the vehicle.

For installation, please refer CRS manufacturer's instruction manual.

Recommended CRS position

The suitability of seat position for carriage of children and recommended category of child restraint system is shown in the table below.

Group	Mass Group	Age Group	Front Passenger	Rear Out-board LH	Rear Out-board RH	Rear Center
0	Up to 10 kg	Up to 9 months	X	U	U	X
0+	Up to 13 kg	Up to 24 months	X	U	U	X
I	9 to 18 kg	9 months to 48 months	X	U	U	X
II	15 to 25 kg	Approx. 3 to 7 years	X	U	U	X
III	22 to 36 kg	Approx. 6 to 12 years	X	U	U	X

X - Seat Position not suitable for children in this age group.

U - Suitable for "universal" category restraints approved for use in this age group.

NOTE

Universal is a category in the AIS072 / ECE R44 norm.

SAFETY

NOTE

When installing CRS in rear seat, push the front seat fully forward so that child's feet do not touch the front seat back.

NOTE

If a child is to be seated in the front seat (if recommended only), push the vehicle seat fully rearward and keep the child in an approved forward facing CRS. Adjust the seat backrest to an upright position.

Storage for CRS

Always secure CRS safely in the vehicle or stow it in the luggage compartment if not being used.

While the vehicle is in motion an unrestrained CRS could flung through the vehicle interior in the event of a sudden braking, maneuver or an accident. This could cause injuries to the travelling occupants.

WARNING

Replace CRS that has withstood any force during an accident as it could have sustained damage which may not be visible.

Check list

1. Never carry children on somebody's lap when vehicle is in motion.
2. Always secure children in the vehicle in a CRS. The CRS must be suitable for the child's height, weight and build.
3. Observe the instructions from the manufacturer of the CRS and always keep the instruction manual in the vehicle.
4. Always make sure that the seat belt routing is correct for children and they are sitting in the correct position.
5. Do not leave any toys or other objects loose in the CRS or on the seat while the vehicle is in motion.

WARNING

Each CRS should be used for one child only.



Anti-Theft Device- Immobilizer

Immobilizer system is designed to prevent vehicle theft by electronically disabling the engine ignition system. The engine can be started only with vehicle's original Immobilizer ignition key which has an electronic identification programmed code.

NOTE

Use only E-key, the other should be kept in a safe location. Note down "key Tag no." information (and keep it safe) which is required while getting new/spare keys. Remember that it is not possible to prepare new/spare keys without the "key Tag number." Take precaution about E-key, as without E-key vehicle cannot be started.

Vehicle Condition	Immobilizer Lamp Status	Vehicle State	Meaning / Function of the state
Ignition OFF	Blinking	Locked	Vehicle Immobilized and awaiting electronic key
Ignition ON	OFF	Unlocked	Normal condition and ready to start the vehicle
Ignition ON	ON	Locked	<ul style="list-style-type: none"> - Problem with key (Wrong key used to start vehicle) - Problem with Immobilizer system. Contact a TATA MOTORS Authorized Service Centre
Ignition ON	Blinking	Unlocked	- Contact a TATA MOTORS Authorized Service Centre immediately

SAFETY

E- Key

An E-Key is an electronic access and authorization system which is provided as a standard feature on your vehicle.

Unlocking principle

The transponder which is built into the ignition E-Key carries a unique identification code. The vehicle unlocks when the code on the E-Key matches with the code on the Engine Management System (EMS).

Engine starting

When the key is inserted and the ignition is switched 'ON', all codes are communicated within E-Key, Immobilizer and EMS. The engine will start only if all the codes match.

Loss of keys

If one of the keys is lost, contact your nearest TATA MOTORS authorised dealer immediately.

WARNING

- Do not turn 'ON' ignition switch by using E-key with any type of metal wound around its grip or in contact with it. This may be detected as abnormal condition by immobilizer and prevent engine from starting.
- Do not leave the E-key in areas of high temperature. The transponder in it will behave abnormally when reused.
- Do not try to start the vehicle when the Immobilizer indicator lamp on the instrument cluster is glowing. In this condition the vehicle will not start and the vehicle's battery will also be drained due to frequent cranking.

Child Lock



Both the rear doors of the vehicle are provided with a child proof lock. Push the lock lever located on vertical face of the door downward before closing the door. The door which has been locked by activating the child lock cannot be opened from inside, it can be opened only from the outside.

NOTE

Lift the lock lever upward to deactivate the childproof lock when not required.

Air Bags - Supplemental Restraint System (if equipped)

The driver's front air bag is located behind the center pad of the steering wheel and the front passenger's front air bag is located on dashboard above glove box.

Front air bags are designed to inflate in severe frontal collisions when the ignition switch is in the 'ON' position.

Front air bags are not designed to inflate in rear impacts, side impacts, rollovers or minor frontal collisions, since they would offer no protection in those types of accidents.

Remember, since an air bag deploys only one time during an accident, seat belts are needed to restrain occupants from further movements during the accident.

Therefore, an air bag is NOT a substitute for seat belts. To maximize your protection, always wear your seat belts.

In a frontal collision, the crash sensors detect and trigger the inflators. The inflators inflate the air bags with nitrogen or argon gas. The movement of the driver and of the front passenger is cushioned when they make contact with the fully inflated airbag and the risk of injury to head and chest is reduced. You may hear a noise along with some smoke, dust and smell of burnt propellant immediately after the air bag has inflated. DO NOT PANIC as this is normal and is not an indication of fire in the vehicle.

NOTE

An air bag supplements, or adds to, the crash protection offered by seat belts. The driver and all passengers must be properly restrained by wearing seat belts at all times.

Drive with the seat belt fastened correctly and in a position that is as upright as possible with your back against the backrest.

Do not lean your head or chest close to the steering wheel or dashboard.

WARNING

Do not attach any objects to, or place any objects over, the steering wheel or dashboard. These objects may interfere with air bag operation or may be propelled by the air bag in the event of a crash. Either of these conditions may cause severe injury.

SAFETY

NOTE

If the Air bag warning tell-tale on the instrument cluster stays ON while driving, there may be a problem with the Air bag system. Contact TATA MOTORS Authorised Service Centre.

In case of any frontal damage to your vehicle or any maintenance required to be performed should be done by TATA MOTORS Authorised Service Centre only.

Do not permit anyone else to do any service, inspection, maintenance or repair on any SRS components or wiring.

Improper work on the SRS system will result in inadvertent deployment of the air bag or malfunctioning.

Anti-lock braking system (ABS) - (if equipped)

ABS regulates brake pressure in such a way that the wheels do not lock when you brake. This allows you to continue steering the vehicle when braking.

NOTE

When ABS is active, the driver will feel the brake pedal pulsating, which is normal.

WARNING

The stopping distance required for vehicles with ABS may be slightly more than conventional brake system but ABS will still offer the advantage of helping you maintain directional control.

However, remember that ABS will not compensate for bad road or weather conditions or poor driver judgment. Drive within safety margins, taking into consideration prevailing weather and traffic conditions.

NOTE

If the ABS warning lamp is ON while driving then there is a malfunction in the ABS system (the standard braking system will however function) and the vehicle should be driven cautiously to the nearest TATA MOTORS Authorized Service Centre.

Electronic brake force distribution (EBD) - (if equipped)

EBD monitors and controls the brake pressure on the wheels to improve driving stability while braking.

Flip Key

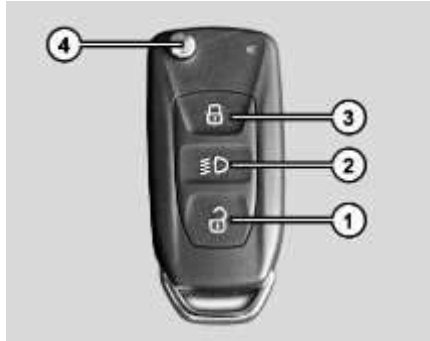

1. Unlock
2. Approach Light
3. Lock
4. Key blade in / out button

Unlocking all doors

To unlock all doors, press unlock push-button (1) once. Unlocking will be confirmed by single flash of turn indicators.

Approach light

Press approach light button (2) once, low beam, park and roof lamp will turn 'ON'

for 60 seconds (default setting). This feature helps to find and reach the parked vehicle or to reach home in dark/ cloudy condition after parking. Red LED will be flashed on the remote. To switch 'OFF' the approach lights, press and release the same button or it automatically turns 'OFF' after 60 seconds.

Locking all doors

To lock all doors, press lock push-button (3) once. Locking will be confirmed by two flashes of turn indicators.

If lock button is pressed on the remote key with the driver door open, locking-unlocking takes place with audible warning sound.

If any other door is open, the vehicle gets locked but indicators do not flash.

Folding key blade in / out

Press button (4) to flip out the key blade. For folding, press the button (4) and fold the key blade inside.



NOTE

Key Blade should not be folded without pressing the button. Also, it should not be forced in any direction apart from folding direction to avoid damage to Flip Mechanism.

Manual operation of central door locking / unlocking

All doors can be locked / unlocked operating driver door using either key blade from outside or knob from inside.

OPENING AND CLOSING

Features

Vehicle search

In vehicle locked condition if lock button on remote key is pressed the turn indicators of vehicle flashes 4 times.

Automatic activation of immobilizer

If key is removed from ignition, the engine will be immobilized automatically even if you forget to lock the vehicle.

Auto locking / unlocking of doors / auto relock

Vehicle doors get automatically locked when all doors are closed and the vehicle speed crosses 10 kmph.

When ignition key is taken out all the doors get automatically unlocked.

Also, when unlocked with remote key and if no door is opened within 30 seconds, vehicle doors get automatically locked.

Anti-grab / anti-scan coding

The remote control set of this security system is protected against the use of devices called 'scanners' and 'grabbers' which can record and reproduce some types of remote codes.

Sleep Mode

If remote key is not used for more than a week then its functionalities will turn to sleep mode. In such a case, to activate the remote key functionalities, open the door mechanically with the key blade.

NOTE

In case any button of the key is accidentally pressed for more than 25 seconds, the remote stops functioning till the time the button is pressed. The LED on the Remote also stops glowing. The function of the remote gets reinstated immediately when the user stops pressing the push button of remote.

Important

Don't operate Unlock push-button of remote while in the vicinity of your vehicle, as it could lead to an unintentional unlocking your vehicle.

Don't use discharged batteries in remote, as it could damage the remote.

For battery replacement procedure refer maintenance section.

Don't remove the battery connection of the vehicle while the vehicle has been locked by remote.

Doors

Door locking / unlocking with key

Driver door has separate locking facility. All doors can be locked or unlocked from outside using the key.



Insert the key and turn it clockwise to lock and counter clockwise to open the door.

Locking without a key from inside



All the doors can also be locked from inside by pressing knob (1) on driver door and independently on other doors respectively.

Opening the doors from inside

All doors can be opened from inside. To open, pull the door opening knob (1) and then lever (2).

OPENING AND CLOSING

Windows

Power windows (if equipped)

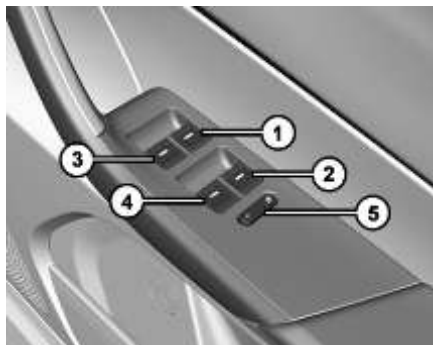

1. Front Window Winding Switch (Right)
2. Rear Window Winding Switch (Right)
3. Front Window Winding Switch (Left)
4. Rear Window Winding Switch (Left)
5. Inhibit Switch

Glasses on all four windows of your vehicle can be operated by switches provided on the main control panel located on the driver's arm rest. They work only when the key is in the 'IGN ON' position.

NOTE

Power windows can be operated for 3 minutes in 'IGN OFF' position and when key is taken out.

Individual switches

Individual window winding switches have been provided on the front passenger and rear doors.



Glasses are wound up by pulling the switch and are lowered by pressing.

WARNING

While raising the glass, take care to avoid fingers/hands getting trapped between glass and the frame.

Inhibit switch

Inhibit OFF - When switch is pressed, red light turns 'ON'. The individual switches provided on rear and front passenger door can be operated. It can also be operated from the switches on driver's arm rest.

Inhibit ON - When switch is released, red light turns 'OFF'. The individual switches provided on rear and front passenger door cannot be operated. Still it can be operated by using the switches on driver's arm rest.

Manual Window Winding (if equipped)

Use window winder handle for lowering or raising up window glasses manually where power windows are not provided.



Bonnet Opening

1. Ensure that the vehicle is in neutral gear with the parking brake applied.
2. Pull the bonnet release lever. The bonnet will pop up slightly.



3. Raise the bonnet slightly and with your finger slide the secondary lock lever located under the bonnet centre to the left side.

NOTE

Make sure that the wiper arms are not raised before you lift up the bonnet to avoid damaging the wiper arms and the bonnet.



4. Lift the bonnet up. Pull the bonnet stay rod from its clip and insert the free end into the slot.

OPENING AND CLOSING

WARNING

The stay rod can be hot enough to burn your finger right after driving. Touch the rod after it becomes cool enough.

Insert the stay rod into the hole securely. If the rod drops off, your body may be caught below the bonnet.

Closing

1. To close the bonnet, hold the bonnet by one hand, disengage the stay rod and clamp it back properly.
2. Lower the bonnet close to the bumper, then let it drop down.

WARNING

Ensure that the bonnet is properly locked before driving or it can fly up unexpectedly during driving.

Tail Gate and Fuel Lid

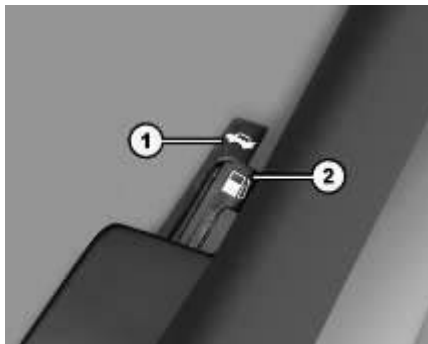

1. Tail Gate Opening Lever
2. Fuel Flap Opening Lever

Tail gate

To open the tail gate, pull the lever (1) located at the right hand side of the driver's side and lift the tail gate.

It can also be opened by using door key. The lock is located on the tail gate. For closing, pull the tail gate down and close it with a slight swing.



WARNING

Always make sure that the tailgate is closed and latched securely.

Fuel lid



To open the fuel flap, pull the lever (2) located at the right hand side of the driver on floor. Open the fuel cap by turning it in counter clockwise direction for fuel filling.

For closing, close the fuel cap and gently push the fuel flap till it gets locked.

WARNING

Fuel vapour is extremely hazardous. Always switch 'OFF' the engine before refueling and never refill near sparks or open flames. Do not use cell phone while refueling. Do not continue adding fuel after the automatic shut 'OFF' function is operated if it is equipped on the fuel station. Overfilling the fuel tank could damage the fuel system.

NOTE

Remove the fuel filler cap slowly, and wait for any hissing to stop. The fuel may be under pressure and may spray out.

If fuel cap needs replacement, ensure that it is replaced by a genuine cap at TATA MOTORS Authorized Service Centre only.

DASHBOARD AND FEATURES

Cockpit

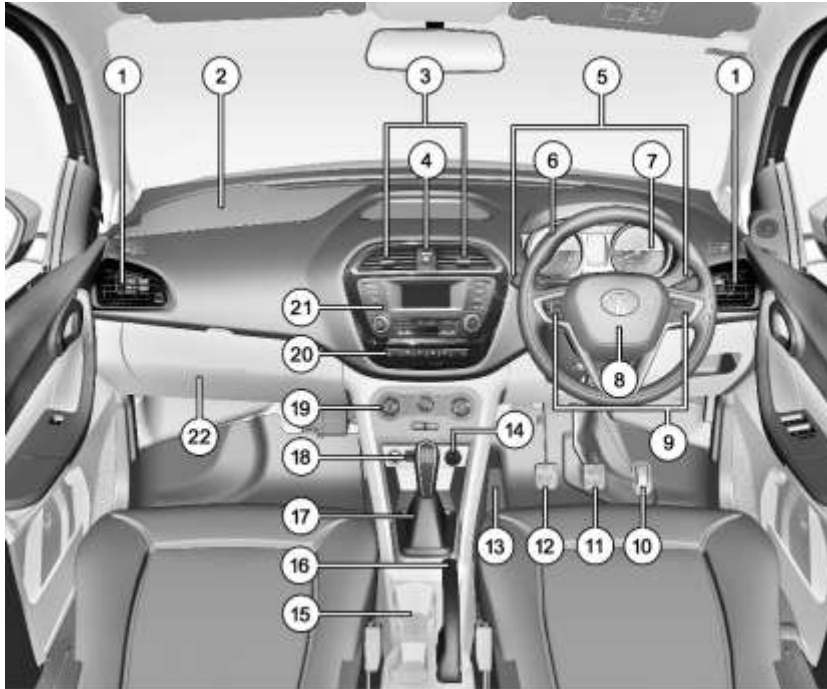

1	A.C. Air vent (Side)
2	Air Bag (PAB) - if fitted
3	A.C. Air vent (Middle)
4	Hazard Warning Switch
5	Combi-Switch
6	Steering Wheel
7	Instrument Cluster
8	Horn pad / Air Bag (DAB) - if fitted
9	Steering Wheel Switches - if fitted
10	Accelerator Pedal
11	Brake Pedal
12	Clutch Pedal
13	Foot Rest
14	Power Socket
15	Cup Holder
16	Parking Brake Lever
17	Gear Shift Lever
18	USB/AUX Port - if fitted
19	HVAC Control panel
20	Fascia Switches
21	Infotainment System - if fitted
22	Glove Box

DASHBOARD AND FEATURES

Instrument Cluster – Version 1

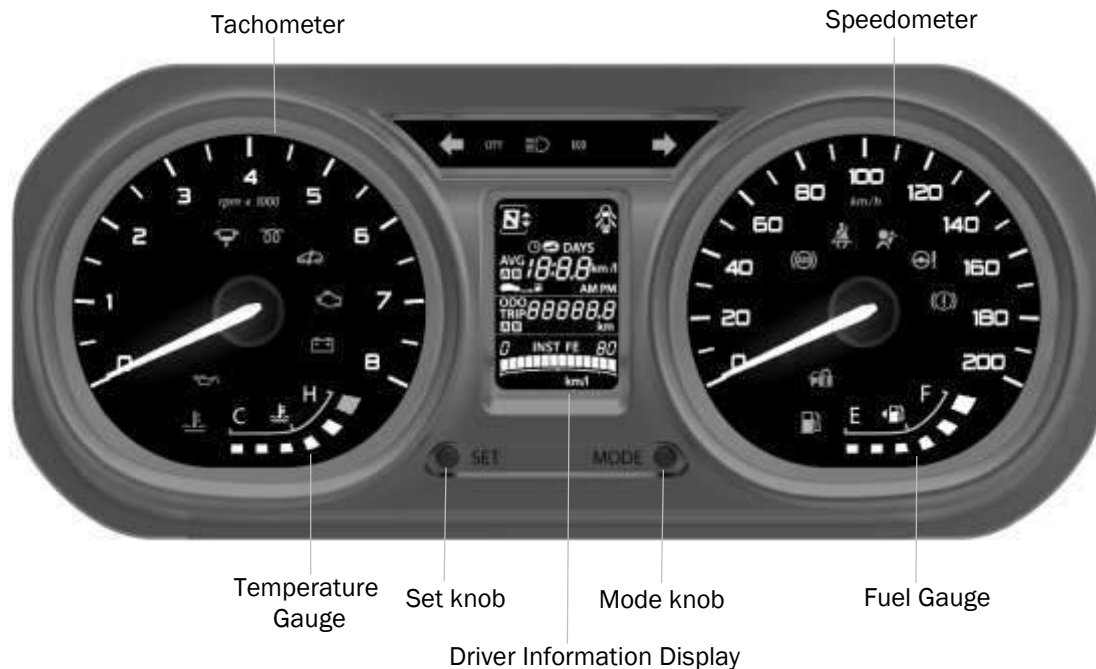

NOTE: All indicators shown may not be applicable to your vehicle.

Instrument Cluster – Version 2

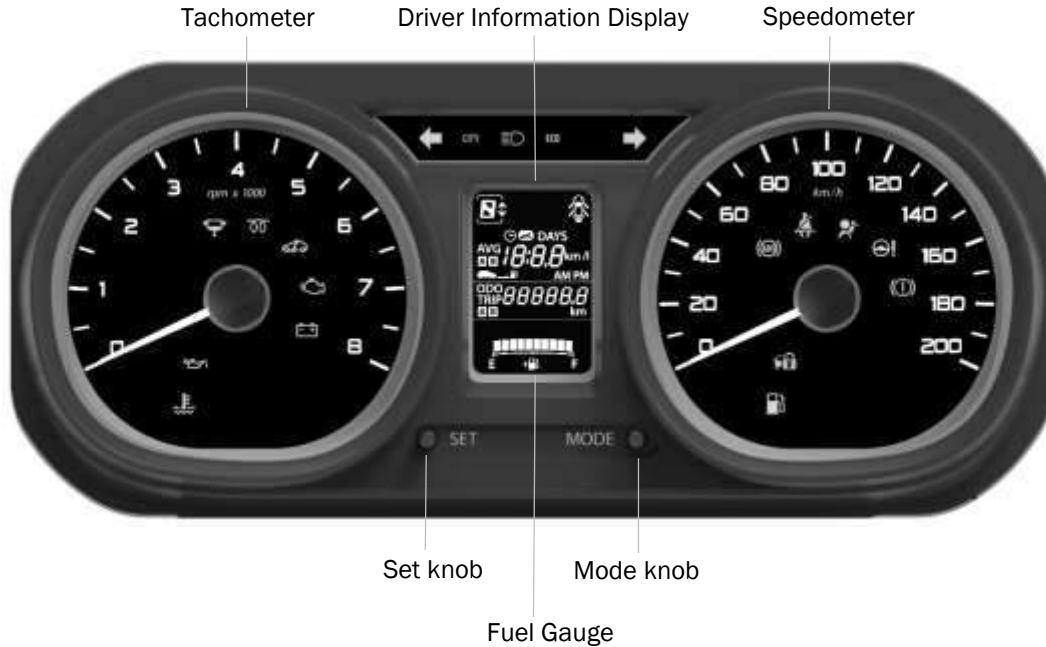

NOTE: All indicators shown may not be applicable to your vehicle.

DASHBOARD AND FEATURES

Speedometer

Speedometer indicates the vehicle speed in km/h.

NOTE

At every key IN and ignition ON, the Instrument Cluster needles and gauges moves to MAX. and returns to '0' position. This is a welcome strategy and a self-check feature.

Tachometer

Tachometer indicates engine speed in revolutions per min (rpm).

WARNING

When engine is accelerated beyond safe 'rpm', the tachometer pointer turns RED. In such case, reduce the engine RPM immediately. Never drive the vehicle with engine in high 'rpm'. This may cause severe engine damage.

Fuel Gauge

When the ignition switch is in "ON" position, fuel gauge gives an approximate indication of the amount of fuel in the fuel tank. "F" stands for full and "E" stands for empty.



Version - 1

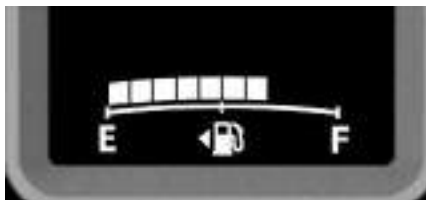

Version - 2

When fuel in the tank is near to empty position, low fuel warning telltale turns 'ON'. Refill the tank as soon as possible.

If fuel is not filled even after Low fuel warning telltale 'ON', first bar in fuel gauge will start blinking to indicate more severe low fuel warning.

NOTE

Check the fuel level when the vehicle is on level road.

On inclines, curves, during braking and sudden acceleration due to the movement of fuel in the tank, the fuel level display may fluctuate or the low fuel warning lamp may illuminate earlier than usual.

DASHBOARD AND FEATURES

WARNING

Low fuel warning symbol will blink if there is any fault in the system. Take your vehicle to the nearest TATA MOTORS Authorised service station if the symbol starts blinking.

Temperature Gauge (if equipped)

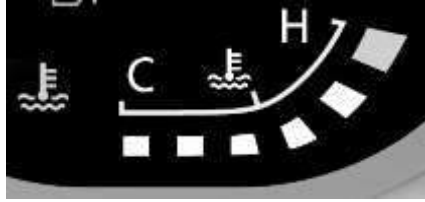





When the ignition switch is in the “ON” position, this gauge indicates the engine coolant temperature. The indicator should stay within the normal, acceptable temperature range between “H” and “C”. If the indicator approaches “H”, overheating is indicated by red LED bar.

If the coolant temperature reading is very high, the warning tell-tale flashes with an audible buzzer. In this case, stop the vehicle, switch ‘OFF’ the engine and cool it down for some time. Contact a nearest TATA MOTORS Authorised Service Centre immediately for rectification.





WARNING

The red LED bar and high coolant temperature warning tell-tale indicates overheating that may damage the engine. Continuing to drive the vehicle when engine overheating is indicated can result in severe engine damage or fire.



DASHBOARD AND FEATURES

Driver Information	System Image	Description
Odometer		<p>Indicates distance travelled by a vehicle.</p> <p>The Odometer reading does not return to “0” when maximum value is reached, the display will freeze to maximum value.</p>
Trip meter A & B		<p>The trip meter can be used to measure the distance travelled on short trips or between fuel stops. It can be reset to “0”</p> <p>Trip meter reading becomes “0.0” after it crosses 9999.9 kms.</p>
Average Fuel Economy for Trip A and Trip B		<p>Displays “Average Fuel Economy” since last reset.</p>
Distance To Empty		<p>Indicates approximate distance that your vehicle can travel with available fuel in tank under current average fuel consumption rate and it displays as ‘km’.</p> <p>NOTE: DTE will provide rolling text warning as ‘rFUEL’ below 25 km distance to empty.</p>

DASHBOARD AND FEATURES

Driver Information	System Image	Description
Instantaneous fuel Economy		<p>The display shows the value of instantaneous fuel consumption only when the vehicle is moving.</p>
Clock		<p>When the ignition switch is in the “ON” position, it shows the time.</p>
Service reminder		<p>Indicates the number of days/kilometers in which service is due. If service is overdue, it will display “0” km or “0” days and spanner symbol will blink.</p> <p>Never reset the display between service intervals otherwise this may results in to incorrect readings.</p> <p>Information is retained in the service interval display also after the vehicle battery is disconnected.</p> <p>NOTE: This option is for indicative purpose only. Keep track of your odometer reading and follow the maintenance schedule.</p>
Gear indicator		<p>Indicates the current gear engaged. Up or down arrow will be displayed, recommending whenever gear should be shifted to up or down.</p> <p>NOTE: If “F” is displayed it means ‘Fault’ condition. Contact a TATA MOTORS Authorised Service Centre.</p>

DASHBOARD AND FEATURES

Driver Information	System Image	Description
Door Ajar		<p>Applicable to XZ.</p> <p>All four door and tail gate are indicated independently when respective door or tail gate is open.</p>
		<p>Applicable to XT, XM, XE, XB.</p> <p>This warning will be indicated when driver door is open.</p> <p>NOTE: <i>If any other door is open roof lamp will be 'ON' provided that roof lamp switch is in  position.</i></p>

1. Instantaneous fuel economy (IFE)

Monitor IFE bar graph to achieve better fuel economy.

NOTE

IFE will vary frequently as per driving pattern.

IFE display does not show Fuel Economy of last drive.

It indicates fuel economy of current Drive when Ignition is turned 'ON'.

The display does not show actual value unless vehicle is moving.

The indication on the display may be delayed if fuel consumption is affected by driving pattern.

2. Average fuel economy (AFE)

Average Fuel Economy will reset to '0' when respective Trip meter is reset.

Average Fuel Economy will be displayed as '--.' for initial 0.5 km of respective trip. Once 0.5 km distance is covered, Average Fuel Economy will be displayed.

Even after 0.5 km distance covered for particular trip, if Average Fuel Economy is displayed as '--.', then take your vehicle to TATA MOTORS Authorized Service Centre.

NOTE

AFE value is estimate of fuel economy. It may vary significantly based upon driving conditions, driving habits and condition of vehicle.

Average Fuel Consumption will get Reset to '0' when Battery is removed and refitted.

3. Distance to empty (DTE)

It indicates approximate distance in 'km' that your vehicle can travel with available fuel in tank.

DTE values may vary significantly based on driving conditions, driving habits, and condition of the vehicle. It is an estimate value of the available driving distance.

NOTE

If DTE is displayed as '--', then take your vehicle to TATA MOTORS Authorized Service Centre.

The DTE will update with new value when fuel is added more than 4 Litres at a time.

If low fuel warning light turns 'ON', fill the fuel tank immediately regardless the value of displayed DTE.

DASHBOARD AND FEATURES

Driver Information Settings (Version 1)

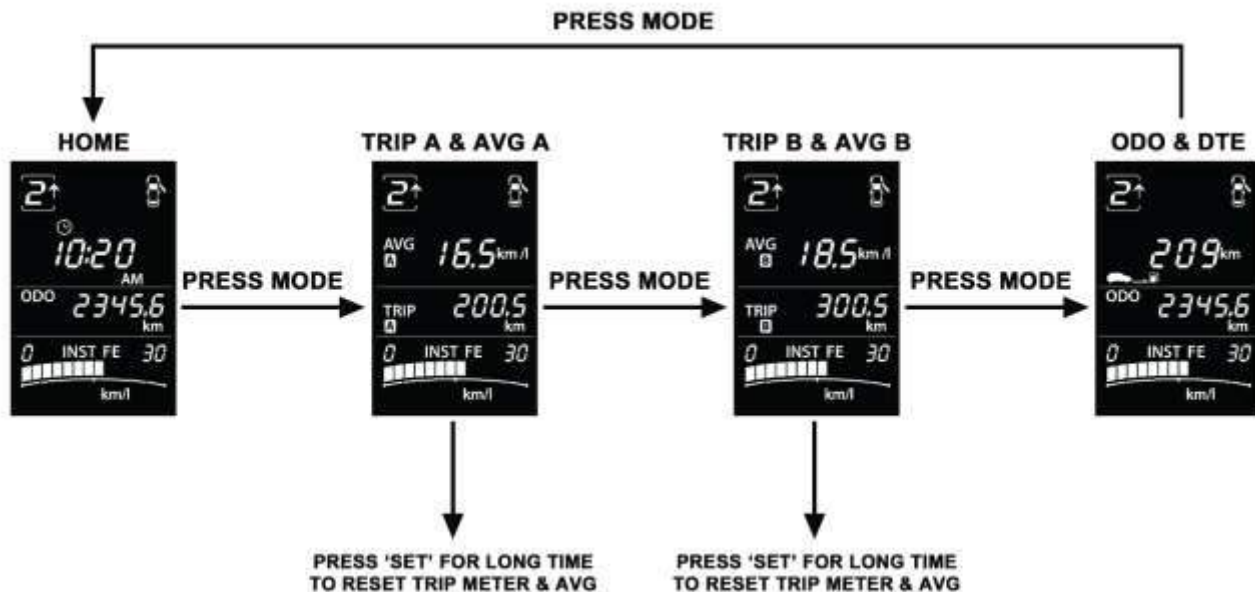

Driver Information Settings (Version 2)

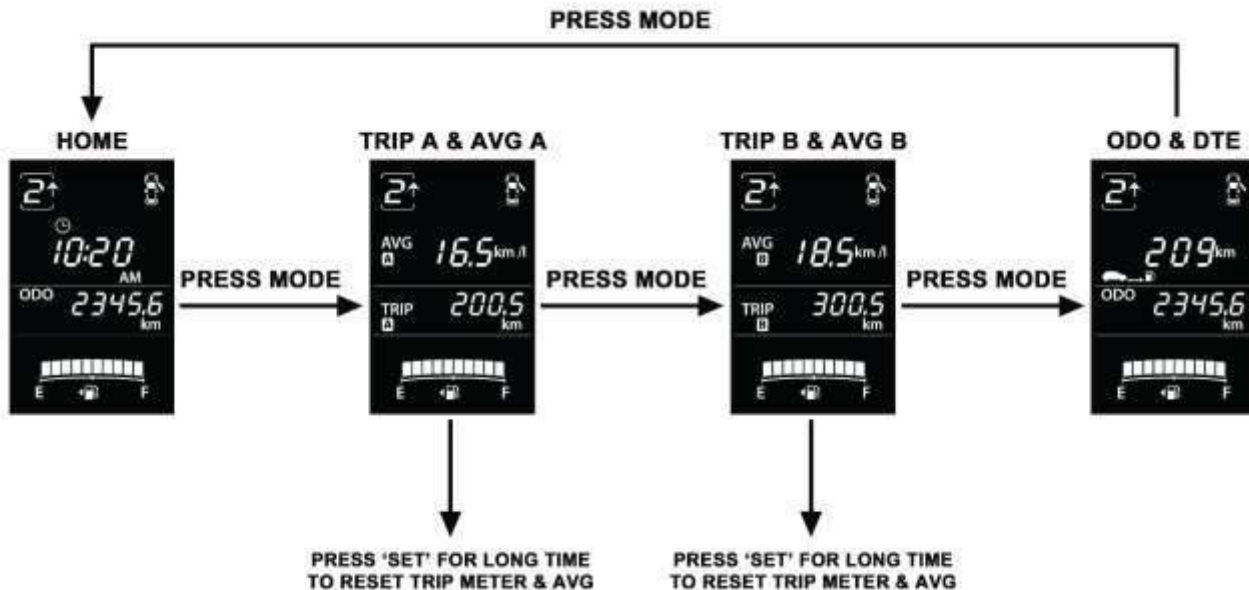

DASHBOARD AND FEATURES

Digital Clock Setting



Digital clock appears on the DIS screen. To adjust the values in Hrs. Min. and AM/PM mode, Press 'SET' knob on Instrument Cluster. A delayed press on the 'SET' knob for selected value will confirm it and move towards next respective value.

Instrument Cluster Illumination

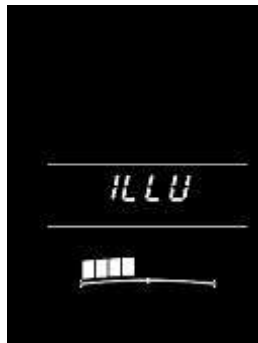





For Instrument Cluster illumination level settings, it is necessary to turn the Park Lamp 'ON' and then Press the 'SET' knob on Instrument Cluster.

Press 'SET' knob to change the illumination intensity level in 5 steps. A delayed press on the 'SET' knob for a selected intensity will confirm it.





WARNING

The Clock and Instrument Cluster Illumination settings should be done only when the vehicle is in stationary condition for safety purpose.





DASHBOARD AND FEATURES

Warning Lamps	Color	Indicator	Remarks
Malfunction Indication Lamp (MIL)	Amber		<ol style="list-style-type: none"> 1. Illuminates when ignition is switched 'ON'. Once engine is started, it turns 'OFF'. 2. It remains 'ON' for any engine related fault that may increase emission levels of the vehicle beyond the regulatory norms. Contact a TATA MOTORS Authorised Service Centre for rectification.
Check Engine	Amber		<ol style="list-style-type: none"> 1. Illuminates when ignition is switched 'ON'. Once engine is started, it turns 'OFF'. 2. Illuminates continuously if a fault arise in Engine Management System. Contact a TATA MOTORS Authorised Service Centre.
Immobilizer	Red		<ol style="list-style-type: none"> 1. Illuminates when the system disables engine start if the original key is not used. 2. Lamp blinks: Vehicle is in immobilized condition when key is not inserted. 3. Lamp ON: Problem with key/system. Contact a TATA MOTORS Authorised Service Centre.
Water in fuel (Diesel)	Amber		<ol style="list-style-type: none"> 1. Illuminates when ignition is switched 'ON'. Once engine is started, it turns 'OFF'. 2. Illuminates continuously if excess water is accumulated in the fuel filter. Contact a TATA MOTORS Authorised Service Centre to drain the water immediately to avoid serious damage to the fuel injection system.



DASHBOARD AND FEATURES

Warning Lamps	Color	Indicator	Remarks
Glow Plug (Diesel)	Amber		Illuminates momentarily when ignition is switched 'ON' to indicate that the glow plugs are active. It will continuously illuminate when engine is getting preheated. Start the engine only after the indicator turns 'OFF'.
Turn Signal	Green		Indicates direction indicated by the turn signal. Blinks along with buzzer while operating left/right turn indicator only when ignition is switched 'ON'.
High Beam	Blue		Illuminates when the high beam headlamps are switched 'ON' or flashed.
Low Oil Pressure	Red		<ol style="list-style-type: none"> 1. Illuminates when ignition is switched 'ON'. Once engine is started, it turns 'OFF' once required oil pressure is achieved. 2. Illuminates continuously if there is insufficient oil pressure. Stop the vehicle as soon as safety permits and switch off the engine. Check engine oil level and top-up if required. Contact TATA MOTORS assistance before starting the engine.
Battery charging	Red		<p>Illuminates when ignition is switched 'ON'. Once engine is started, it turns 'OFF'.</p> <p>It will continuously illuminate when there is malfunction of charging system. Contact a TATA MOTORS Authorised Service Centre.</p>



DASHBOARD AND FEATURES

Warning Lamps	Color	Indicator	Remarks
Park Brake / Brake Fluid Low / ABS Fault / EBD Fault	Red		<p>Illuminates momentarily when ignition is switched 'ON'. Once parking brake is released, it turns 'OFF'. If it remains 'ON', it indicates</p> <ol style="list-style-type: none"> 1. Brake fluid level is low. 2. Park brake is applied & turns 'OFF' when it is released. 3. ABS/EBD system has a fault.
Seat belt warning	Red		<p>Indicates that seat belt is not fastened when ignition is 'ON'. It will be continuously 'ON' if the seat belt is not fastened (above 4 kmph). When the vehicle speed goes above 25 kmph seat belt alarm will be audible.</p>
Airbag status (if applicable)	Red		<p>Illuminates momentarily when ignition is switched 'ON'. It will continuously illuminate when there is malfunction of airbag (SRS) system. Contact a TATA MOTORS Authorised Service Centre immediately.</p>
EPAS	Amber		<p>Illuminates momentarily when ignition is switched 'ON'. Illuminates when there is a fault in the EPAS. Contact a TATA MOTORS Authorised Service Centre immediately.</p>
Low Coolant Temperature (if applicable)	Blue		<p>Illuminates momentarily when ignition is switched 'ON'. Illuminates when engine coolant temperature is low, while it turns 'OFF' when engine coolant temperature is normal.</p>

DASHBOARD AND FEATURES

Warning Lamps	Color	Indicator	Remarks
High Coolant Temperature	Red		<p>Illuminates momentarily when ignition is switched 'ON'.</p> <p>Illuminates when engine coolant temperature is very high and continuously flashes along with buzzer if engine coolant temp. is extremely high. Switch off the engine and allow to cool.</p> <p>Contact a TATA MOTORS Authorised Service Centre immediately.</p>
ABS (if applicable)	Amber		<p>Illuminates momentarily when ignition is switched 'ON'. Illuminates continuously if there is any malfunction in ABS. Normal braking system will be operational without assistance of ABS. Contact a TATA MOTORS Authorised Service Centre immediately.</p>
Low Fuel	Amber		<p>Illuminates momentarily when ignition is switched 'ON'.</p> <p>Illuminates when fuel level is low. 1st bar on fuel gauge will start blinking when fuel level is low. Refill the fuel tank as soon as possible.</p> <p>IMPORTANT: The warning light will start flashing if there is any fault in the fuel system. Contact a TATA MOTORS Authorised Service Centre immediately.</p>

DASHBOARD AND FEATURES

Warning Lamps	Color	Indicator	Remarks
ECO	Green		ECO indicates Economy drive. This mode is used to achieve better fuel economy.
CITY	Blue		CITY mode is default mode. This mode is used to achieve optimum torque.

DASHBOARD AND FEATURES

Audio Reminders

Key in reminder

While leaving your vehicle, if you forget the key inside the vehicle in Ignition 'OFF' position, buzzer will provide audio warning. Remove Key to stop the warning.

Park lamp 'ON' reminder

While leaving your vehicle, if you forget to turn 'OFF' the head lamps, buzzer will provide audio warning. Switch 'OFF' Park Lamps to stop the warning. Do not forget to turn 'OFF' your head lamps as it may drain your vehicle battery.

Park brake 'ON' reminder

If Park Brake is applied and vehicle is driven, telltale will turn 'ON' and buzzer will provide audio warning continuously. Disengage the park brake to stop audio warning.

Reverse gear reminder

If Reverse Gear is engaged, audio warning for 1 sec will alert you.

Seat belt reminder

If driver seat belt is not fastened and vehicle speed goes above 25 kmph, audio alarm will start and continue for 90 seconds. If driver seat belt is still not fastened within 90 seconds, audio alarm will continue for next 90 seconds. Seat belt telltale will remain continuously 'ON' when audio alarm is active.

Combi-Switch (RH Stalk)

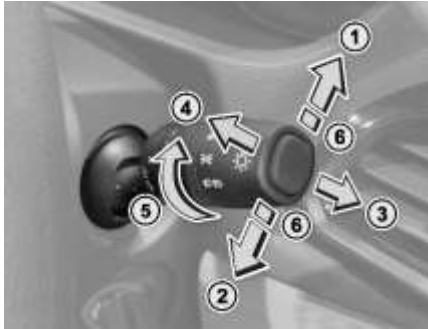

- 1. Left Turn signal** - Move the lever fully upward.
- 2. Right Turn signal** - Move the lever fully downward.

NOTE

When the turn is completed, the signal will cancel and the lever will return to its normal position.

- 3. High beam** - Move the lever forward to select the High Beam function. Pull the lever back to normal for low beam.
- 4. High beam Flash (spring return)** - To flash the high beams pull the lever towards you from the normal. It will return to its normal position when you release it.

5. Headlamp Rotary Switch

i) OFF Position



All lamps will remain 'OFF'.

ii) Parking Lamp



Rotate stalk to turn 'ON' the Parking lamps.

iii) Low Beam



Rotate stalk to turn 'ON' the Low Beam function.

6. Lane Change Signal

To signal a lane change, move the lever slightly up or down respective to the

point where the turn signal light begins to flash, but the lever does not latch. The turn signal will flash 3 times automatically.

7. Head lamp leveling rotary switch



Inner rotary switch on right hand stalk is provided for head lamp leveling. With the inner rotary switch, Head lamp leveling can be done with head lamp in Low Beam and in 'ON' position. Select correct position before start of trip and vehicle is stationary. Depending upon the number of passengers and luggage in the vehicle headlamp focus may change. This can be adjusted by rotating the knob to one of the 3 level positions.

DASHBOARD AND FEATURES

Combi-Switch (LH Stalk)

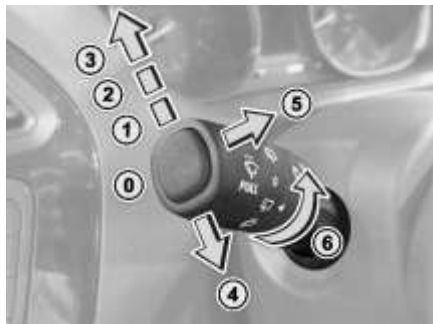

0) 'OFF' Position

The wiper is switched 'OFF'.

1) Intermittent wipe

Push the stalk upwards to operate intermittent wipe.

Inner rotary switch on left hand stalk is provided for intermittent front wiper delay. The switch has 5 delay timers.



2) Slow Wipe

Push the stalk towards position (2) for continuous slow wipe.

3) Fast Wipe

Push the stalk towards position (3) for continuous fast wipe.

4) Flick wipe (spring return)

Pull the stalk downwards and hold it for continuous wipe, the wiper continuously wipes across the windshield at low speed till the stalk is released.



5) Front Windshield Washer

- Pull the lever little longer, washer fluid will be sprayed on the windshield.
- The windshield wipers operate for 3 cycles after the lever is released and 1 more cycle after 5 seconds.



NOTE

When you crank the engine, the supply to washer motor is momentarily cut off.

6) Rear Wash and Wipe

(if equipped)



Rear Windshield / Wiper and Washer



Turn the rotary knob clockwise and release to operate rear windshield wash and wipe. The windshield wipers operate for 3 cycles.

Rear Wipe



Turn the rotary knob counter clockwise such that it aligns its positions with arrow mark to operate rear windshield wiper continuously.

DASHBOARD AND FEATURES

Rear Windshield / Wiper and Washer Switch

Turn the rotary knob counter clockwise such that it aligns its positions with arrow mark and hold it, to operate rear windshield wash and wipe. It will return to 'Rear wipe' position as soon as released and continue to wipe.



WARNING

If you operate wash and wipe function for more than 15 seconds the controller cuts off the supply to washer motors to avoid overheating.

Fascia Switches

Fascia switches are provided on the center console above HVAC control panel

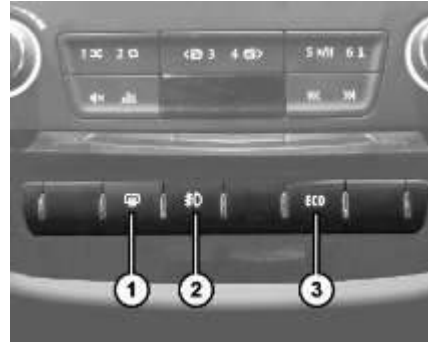

1. Rear Window demister Switch
2. Front fog lamp Switch
3. ECO mode Switch

Rear Window Demister

(if equipped)



The switch turns the rear window demister ON/OFF. It operates when engine is running. The system will

be deactivated after 15 min of continuous operation.

An indicator on the switch will be illuminate when the rear window demister is 'ON'

Front Fog Lamps

(if equipped)



In conditions where visibility is poor due to fog, snow or rain, the fog lamps improve visibility as well as making it easier for other road users to see you.

It turns 'ON' when the front fog lamp switch is pushed in with ignition 'ON' and position and parking / head lamp is 'ON'. An indicator on the switch will be illuminated when the front fog light is 'ON'.

ECO mode Switch

(if equipped)



Refer DRIVE MODES chapter in 'STARTING and DRIVING' section.

DASHBOARD AND FEATURES

Steering Wheel Switches (LHS)

(if equipped)



Volume - To increase (+) / decrease (-) volume of music system / radio.

Mute / phone reject

To reject or hang up a phone call. It is also used to mute the volume of music system / radio.

Seek forward / backward

To change radio channels.

Source - To select the required source in the infotainment (USB, AUX, AM, FM).

Steering Wheel Switches (RHS)

(if equipped)



Phone receive

This button is used to accept incoming call when a cell phone is connected via Bluetooth.

NOTE

For more information on steering wheel switches refer Infotainment manual.

Mic



A mic is provided on roof interior above driver seat position.

DASHBOARD AND FEATURES

Infotainment System (if equipped)



NOTE

For more information on Infotainment system refer infotainment manual.

Speakers (if equipped)

Speakers and tweeters are provided on models with infotainment system. While provisions are given for music system and speakers on versions without infotainment system.

USB/AUX Port (if equipped)



Connect your portable digital music players, pen drives etc. to this socket for playing music tracks through the vehicle's music system.

Power Socket



The power socket will work when the ignition switch is in the "ACC" or "ON" position. This socket can be used to provide 12V (10A) power for electrical accessories.

NOTE

Use of inappropriate electrical accessories can cause damage to your vehicle's electrical system. Make sure that any electrical accessories you use are designed to plug into this type of socket.

DASHBOARD AND FEATURES

Antenna (if equipped)

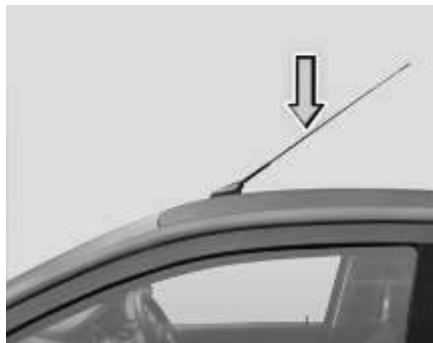

Antenna is located on the roof. Turn antenna counter clockwise to remove from vehicle, if required.

Roof Lamp



Interior roof lighting lamp is provided on the roof with inbuilt switch.

The switch has three positions:

ON - The lamp will turn 'ON' as long as the switch is in this position.



DOOR - In this position the lamp turns 'ON' with dimming when either of the doors are opened. When the last door



is closed, the lamp will remain 'ON' for 25 sec and turns 'OFF' with dimming. This helps settling in the seat and inserting the key in the ignition switch. When the key is turned to the 'IGN' position, the lamp goes 'OFF' immediately.

OFF - In this position the lamp will remain 'OFF'.



Roof Grab Handle

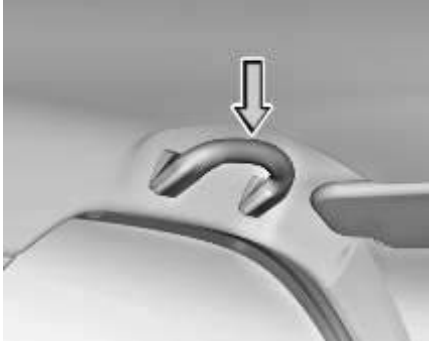

Roof grab handles are provided on all seats except driver's seat. This helps in comfortable positioning of passengers during a journey.

Boot Lamp (if equipped)



Boot lamp is provided in the luggage compartment to illuminate the luggage area.

Switch is provided on lamp to turn 'ON'/'OFF' boot lamp. If switch is retained in 'ON' position, Boot lamp will turn 'ON' automatically on opening the tailgate.

Tag Holder



Tag holder is provided near the front windshield for ease of displaying toll, parking tickets, ID's, passes, labels etc.

Storage Compartments



- 1) Glove box
- 2) Pocket on dashboard

- 3) Utility pockets on front doors
- 4) Utility pockets on rear doors

- 5) On center console
- 6) Tailgate (Trunk) Compartment

STOWAGE AREAS

1) Glove box



To open - Press the knob and open the glove box flap.

To close - Fold glove box flap upwards until it engages.

NOTE

On selected models, cooling facility is also provided. It cools the glove box only when the AC is 'ON'.

2) Pocket on dashboard



You can keep suitable items in the space provided.

3) Utility pockets on front doors

4) Utility pockets on rear doors

Utility pockets are provided on front and rear doors and it can be used to keep magazines/books, water bottles etc.

5) Center console

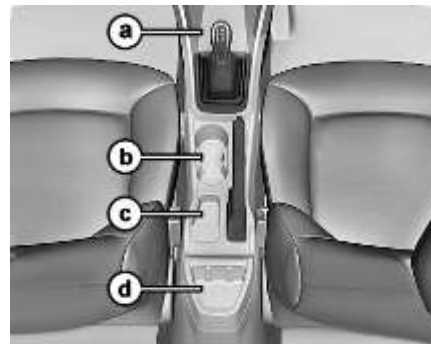

a) Stowage compartment

Stowage compartment provided for keeping cell phones, iPod's, chargers etc.

b) Cup holder

c) Coin storage

d) Bottle holder

NOTE

Use cups, containers, bottles of right size and which have lids. The drinks could otherwise spill.

6) Tailgate (Trunk) Compartment

Store the luggage in trunk.

WARNING

Distribute the items of luggage as evenly as possible.

Position heavy loads as far forwards as possible and as low down in the trunk as possible.

The load must not protrude above the luggage cover.

Never allow occupants to travel in the luggage compartment.

Rear bench seat folding

You can increase the trunk capacity by folding the rear seat. For folding:

- Slightly lift the seat cushion from front edge, and then lift it from rear and place it vertical.
- Pull the backrest release knobs and fold the seat backrest forwards. Move the driver and front passenger seat forward if necessary.



STOWAGE AREAS

WARNING

You should always engage the rear seat if you do not need the through loading feature.

If the rear bench seat and seat backrest are not engaged they could fold forwards, e.g. when braking suddenly or in the event of an accident.

The vehicle occupant would thereby be pushed into the seat belt by the rear bench seat or by the seat backrest. The seat belt can no longer offer the intended level of protection and could even cause injuries.

Objects or loads in the trunk cannot be restrained by the seat backrest. There is an increased risk of injury.

Before every trip, make sure that the seat backrests and the rear bench seat/rear seat are engaged.

Luggage cover

Luggage cover is designed only for hiding the luggage compartment.

WARNING

Do not place anything on luggage cover as it could obstruct driver's rear view. Also in case of an accident or sudden braking, it could cause an injury to occupants.

Card holder

A pocket is provided on the back of the driver side sun visor to keep cards, papers etc.

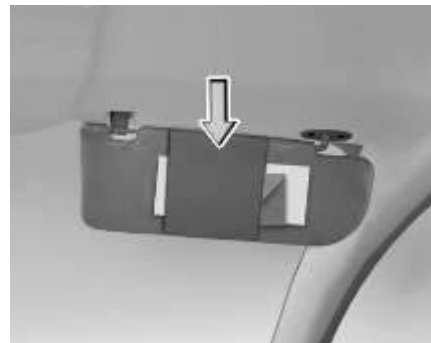

NOTE

Keep the sun visors in their original position when not in use or else, they may block driver's vision.

Hooks

Coat hook

Coat hook is provided on rear passenger right side grab handle.



WARNING

The coat hook cannot restrain heavy objects or items of luggage. Never hang hard, sharp-edged or fragile objects on the coat hook.

Collapsible hook

Collapsible hook is provided for hanging carry bags etc. Load up to 2 kg is permissible.



Carrier hooks

Carrier hooks are provided for hanging carry bags etc. Load up to 3 kg is permissible.



CLIMATE CONTROL

The HVAC is operational when engine is running and blower is 'ON'. The Climate control regulates the temperature in the vehicle interior and filters dust particles. You can manually set the desired temperature

Air Distribution- The air is distributed through the vents in the passenger compartment as shown below:



CLIMATE CONTROL

Air vents

Air vents are provided on dashboard. Air flow and its direction can be adjusted with the help of knob provided on respective vent.



HVAC Controls







- A. Air Distribution Control
- B. Blower Speed Control
- C. Temperature Control
- D. Air Intake Selector
- E. AC ON/OFF Switch

A. Air distribution control



This is to select the air distribution pattern as described in the table.

	Directs air through the center and side air vents
	Directs air through the center, side and foot well vents
	Directs air through the foot well air vents
	Directs air through the defroster & foot well vents (Default fresh air mode)
	Directs air through the defroster vents (Default fresh air mode)

B. Blower Speed control



This is to turn 'ON' the blower and select desired blower speed.

C. Temperature control



The temperature control dial allows you to adjust the temperature. To lower the temperature, turn the dial to the left. To increase the temperature, turn the dial to the right.

D. Air intake selector

Press the switch to activate / deactivate recirculation mode.



Press to 'ON' or 'OFF'

Recirculation mode: (Indicator light 'ON')

Air in the passenger compartment recirculates. No fresh air enters the compartment.

Always use when:



- Driving on a dusty road or through tunnel.
- On signals or slow traffic to avoid traffic pollution.
- Maximum cooling is required.

CLIMATE CONTROL

Fresh Air mode: (Indicator light 'OFF')

Fresh air is drawn into the vehicle.

Always use when:

- Discomfort is felt or windows are fogging up.
- Using  or  air flow modes during demist / defrost.
- Using normal heating mode.

E. AC ON/OFF



Press the switch to activate / deactivate the climate control. The indicator lamp in the button will light up when climate control is activated.

NOTE









The AC can be switched 'ON' only if the blower is 'ON' and engine is running.

When AC is switched 'ON', engine idling RPM increases marginally to adjust the AC compressor load.

When desired temperature is achieved AC trips 'OFF' automatically.

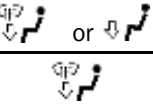
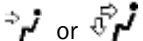
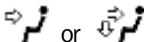
CLIMATE CONTROL

Recommended basic settings of the control elements of air conditioning system for the respective operating modes. These may vary depending on individual requirements and weather conditions.

Functions	Control Knob Position			Button Position	
	A. Air Flow Direction	B. Blower Speed	C. Air Temperature	D. Air Intake	E. AC ON / OFF
Normal heating					
Quick heating		2 nd or 3 rd dot	Desired temp.	Fresh air mode.	Switched OFF
Normal Cooling		To MAX speed and then 2 nd or 3 rd dot	To the right up to the stop	Briefly switch ON to Fresh air mode then Recirculation	Switched OFF
Quick Cooling		1 st to 3 rd dot	Desired temperature	Recirculation mode	Switched ON
Demisting		To MAX speed and then 2 nd or 3 rd dot	To the left up to the stop	Recirculation mode	Switched ON
Defrosting		2 nd or 3 rd dot	Desired temperature	Fresh air mode (Default)	Switched ON (Optional)
Defrosting		To MAX speed	Desired temperature	Fresh air mode (Default)	Switched ON (Optional)

CLIMATE CONTROL

NOTE

- *Condensation may drip from the underside of the vehicle when it is in cooling mode. Traces of water on the ground are normal and are not a sign that there is a malfunction.*
 - *Ventilate the vehicle for a brief period during warm weather. This will speed up the cooling process and the desired vehicle interior temperature will be reached quickly.*
 - *Never cover the air vents or air intake grilles in the vehicle interior.*
 - *If the AC is not used for a long period, such as during winter, it may not give the best performance when you start using it again. Operate the AC at least once a month to maintain optimum performance.*
- *While starting the vehicle itself after long duration (more than 15 days), following procedure needs to be followed to meet AC performance.*
 - *Start the vehicle with AC & Blower in OFF condition in idling for 2~3 minutes.*
 - *Then switch ON the AC & Blower and run it for another 2~3 minutes in idling for proper circulation of refrigerant & oil to lubricate the internal parts of AC system.*

Pre Driving Checks

Make sure that:

- Windshield, windows, mirrors, lights, and reflectors are clean and unobstructed.
- Tools kit, jack & handle, warning triangle, owner's manual, first aid kit and vehicle documents are available and stored at their locations.

WARNING

Never put any mat on top of the floor carpet near pedal region.

- All doors, engine bonnet and tail gate are securely closed and latched.
- All of your passengers are properly restrained. You and your passengers should always wear seat belts.
- Objects, luggage or loads are secured properly against slipping or tipping.
- Rear seat is securely latched.
- Sufficient fuel for the trip.

Daily check:

- Tyres for abnormal wear, cracks or damage and embedded foreign material such as nails, stones, etc.
- Traces of fluid and oil below vehicle.

NOTE

Water dripping from the air conditioning system after use is normal.

- All lamps, wipers, wiper blades and horn for proper operation.
- All switches, gauges and tell tales are working properly.

Adjust:

- Seats, head restraints (if equipped) and steering wheel position.
- All the mirrors properly.

Weekly check:

- Engine oil level
- Coolant level
- Brake fluid level
- Windshield washer fluid level
- Battery electrolyte level
- Fuel level

NOTE

Check the tyre pressure regularly including spare wheel.

STARTING AND DRIVING

Driving Tips

Fuel consumption, engine, transmission, brake and tyre wear are mainly affected by below factors:

- Operating conditions of your vehicle
- Your personal driving style

Operating conditions:

- Avoid frequent start and stop as these increase fuel consumption.
- Always make sure that the tyre pressures are correct.
- Do not carry any unnecessary weight.
- Regularly service your vehicle and adhere to the recommended service maintenance schedule.

Personal driving style

- Do not depress the accelerator pedal when starting the engine.
- Do not warm up the engine when the vehicle is stationary.
- Always adapt your driving style to suit the prevailing road and weather conditions and maintain a safe distance from the vehicle in front. Drive carefully.
- Avoid frequent, sudden acceleration and braking.
- Select appropriate gear according to varying speeds and load conditions.

NOTE

Do not rest your foot on the clutch pedal while driving.

- Switch 'OFF' the engine in stationary traffic or at signals.
- Keep an eye on the vehicle's fuel consumption.

- Driving safety systems are merely aids designed to assist driving. You are responsible for the distance to the vehicle in front, for vehicle speed and anticipating braking in good time.

WARNING

You could lose control of your vehicle if you try to adjust the driver's seat, head restraint, mirror, steering wheel and fasten the seat belt while driving. There is a risk of an accident.

Recommended fuel economy speeds

Gear	Speed (km/h)	
	Diesel	Petrol
1	15	15
2	25	30
3	45	45
4	65	65
5	80	80

Good driving practices

- Slow down before shifting to a lower gear. This will help avoiding revving of the engine causing damage.
- Avoid frequent brake application which can cause overheating of brakes.
- Slow down the vehicle speed while travelling in cross winds. This gives much better control over the vehicle.

- Avoid high speed when cornering or turning.
- Depress the clutch fully while shifting gears.
- Make sure that vehicle is completely stationary before you attempt to shift in reverse gear.
- Drive slowly on wet roads.
- You can get extra braking from the engine by shifting to a lower gear. This can help you to maintain a safe speed and prevent your brakes from overheating specially while going down a hill.

Tips for obtaining better fuel efficiency

- Always maintain the specified tyre pressure during fuel top-ups and also before a long trip. Vehicle running with low tyre pressure will consume more fuel than the one running with specified tyre pressure.

- Keep the vehicle clean. Get rid of the not in use luggage/stuff lying in the boot etc.
- Regularly inspect your vehicle for any leakages, worn out wires by rat bites etc.
- Always follow periodic & regular service schedule of the vehicle.
- In places with high dust content (e.g.: Gurgaon, Jaisalmer etc.), do get the air filter cleaned every 5000 kms.
- Drive smart and smooth in an anticipatory manner. Select driving mode to suit your style.
- Do not accelerate excessively when you are in lower gears (1st or 2nd). Be gentle on the accelerator when you are in traffic. In lower gear, opening more throttle will shoot the engine RPM keeping the vehicle still at lower speeds which indirectly implies less distance with more fuel.
- Be in the maximum possible higher gear at a given speed. This reduces

STARTING AND DRIVING

the engine operating speeds which means the engine is running at lower rpm (Revolutions per Minute) for the same vehicle speed. Lesser the number of engine revolution lesser the fuel burned.

- Avoid harsh braking.
- Maintain healthy driving habits & while decelerating, do coasting in gear and not in neutral or with clutch pedal depressed.
- Consider using the car AC when you really require. Consider using lower blower speeds rather than higher for cooling as at higher blower speeds it consumes more electric power which is ultimately drawn from engine by burning fuel.
- Avoid unnecessary extra electrical loading on the car.
- Stop the engine wisely at traffic signals. Switch 'OFF' the engine at the traffic signal only if the stoppage time is high (typically more than 30 sec).

- While driving on highways, drive with windows closed. The more you open the windows the higher will be the resistance to the vehicle at higher speeds which will reduce the fuel efficiency.
- Do not over speed; follow the speed limits. More the speed, higher the external resistance on the vehicle which will finally result into unnecessary consumption of fuel.

Running-in period

The more you look after the engine when it is new, the more satisfied you will be with its performance in the future.

Avoid rapid acceleration and prolonged high speed running of the engine for the first 1,500 – 1,800 kms.

Do not exceed the following road speeds during running in period.

Gear	Diesel	Petrol
	Speed(km/h)	Speed(km/h)
1	20	20
2	30	40
3	50	60
4	70	80
5	90	100

Avoid heavy loads, e.g. driving at full throttle, during this period. Change gears judiciously.

NOTE

Avoid excessive revving up of engine rpm. Do not keep engine at idling for long duration.

Seat Adjustments

Front seat adjustments

Following seat adjustments can be carried out manually.



1. Backrest angle
2. Seat height (if equipped)
3. Seat forward / rearward adjustment lever

WARNING

Do not adjust the driver's seat while driving. Adjusting the seat while driving could cause the driver to lose control of the vehicle.

Seat backrest angle adjustment

To change the seat back rest angle, lean forward slightly and pull up the lever (1). Adjust seat backrest until it reaches desired comfortable position. Make sure that lever returns to its original position and seat is securely latched.

NOTE

Adjust the seat backrest until your arms are slightly angled when holding the steering wheel.

WARNING

Never travel in a moving vehicle with the seat backrest in an excessively reclined position as this can

be dangerous. You could slide under the seat belt in a collision.

Seat height adjustment (if equipped)

To raise the seat, pull and continue pumping the lever (2) in the upward direction until the seat is at the desired height.

To lower the seat, pump the lever downward until the seat is at desired height.

Seat forward / rearward adjustment

Lift lever (3) and slide the seat forwards or rearwards. Release lever and make sure that seat is securely latched.

NOTE

Adjust the driver seat position in such a way that the driver will be able to operate the controls pedals comfortably.

STARTING AND DRIVING

Adjustable head restraint (if equipped)

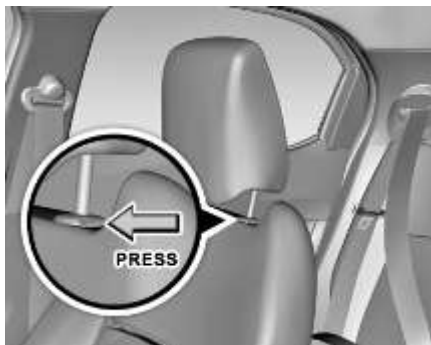

Adjust the head restraint so that it is as close to the head as possible and the center of the head restraint supports the back of the head at eye level. This will reduce the potential for injury to the head and neck in the event of an accident or similar situation.

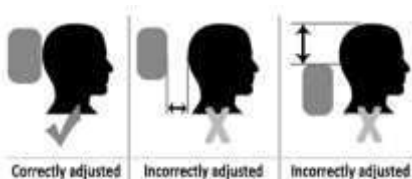

WARNING

Do not drive the vehicle without the seat head restraints. Head restraints are intended to help reduce injuries during an accident.

Rear seats

Foldable rear seats are provided. Refer 'Stowage area' section for more details.

Rear View Mirrors

Inside Rear View Mirror (IRVM)

To adjust the mirror, set the selector knob to the normal position and then move the mirror up, down or sideways manually to obtain the best rear view.

When driving at night, set the selector tab to select anti-glare mode to reduce glare from the headlights of vehicles behind you.



NOTE

Use antiglare position only when necessary, as it reduces rear view clarity.

Outer Rear View Mirrors

You can adjust the outer rear view mirrors manually with the knob located on the driver's and front passenger's door panel. Adjust the outside rear view mirrors to desired position.

NOTE

Objects visible in mirror are actually closer than they appear. Always make sure of the actual distance from the road users traveling behind by glancing over your shoulder.

Motorized outer rear view mirrors (if equipped)



The switch to adjust the motorized mirrors is located on the driver's door. You can adjust the mirrors when the ignition switch is in the "ACC" or "ON" position.

To adjust the mirrors:

1) Move the selector switch to the left (L) or right (R) to select the mirror you wish to adjust.

2) Press the outer part of the switch that corresponds to the direction in which you wish to move the mirror.

Sun Visors

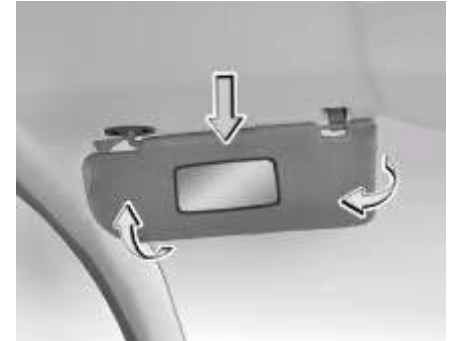

The sun visors can be pulled down to block glare coming through the windshield.

To block glare from side windows

Pull down the sun visor and release it from retainer. Swing the sun visor to the side.

STARTING AND DRIVING

Vanity mirror

Vanity mirror is provided on the back of the front passenger side sun visor.

Steering Wheel Adjustment



You can adjust the steering wheel position to suit your convenience.

The release lever is located under the steering column.

To adjust the steering wheel

1. Adjust the seat to a comfortable position.
2. Push release lever completely down to unlock the steering column.
3. Adjust the steering wheel to the desired position.
4. Pull release lever up completely to lock the steering column.
5. Make sure that steering wheel is securely locked by checking up and down direction.

NOTE

*When adjusting the steering wheel, make sure that:
You can operate control pedals without any obstacles.
You can see all the displays in the instrument cluster clearly.*

WARNING

Before starting off, make sure the steering wheel position is locked. Never unlock or adjust the steering wheel while the vehicle is in motion.

Steering lock cum ignition switch



The ignition switch has the following four positions:

LOCK - This is the normal parking position. Key from lock can be removed in this position only.

“LOCK” position prevents normal use of the steering wheel after the key is removed.

To release the steering lock, insert the key and turn it clockwise to one of the other positions.

ACC - Accessories such as the infotainment system can be operated, but the engine remains ‘OFF’. Steering gets unlocked.

ON - This is the normal operating position. All electrical systems are ‘ON’.

START - Turn the key further clockwise to the START position, (spring loaded) to start the engine. As soon as the engine starts, release the ignition key, which returns to ON position. While cranking, all accessories will be momentarily ‘OFF’.

Illuminated Key Ring (if equipped)

When the vehicle is unlocked, the illuminated key ring glows up. This helps to locate ignition switch in the dark.

Starting the Engine

Make sure that parking brake is engaged and vehicle is in neutral gear.

Depress the clutch pedal fully and crank the engine. Do not press the accelerator pedal when starting the engine.

NOTE

The Starter protection system fitted in this vehicle does not allow you to crank the engine until you fully depress the clutch pedal.

Release the key as soon as the engine starts. Repeat if engine does not start.

NOTE

The Starter protection system switches off the starter when it is cranked for more than 10 secs. In such a case, get the key back to ‘OFF’ position & wait for 30 secs.

WARNING

The engine emits poisonous exhaust gases such as carbon monoxide. Inhaling these exhaust gases leads to poisoning. There is a risk of fatal injury. Therefore never leave the engine running in enclosed spaces without sufficient ventilation.

Starting off

To start off, depress the clutch pedal fully and shift into 1st gear.

After releasing the parking brake, gradually release the clutch and slowly press the accelerator.

NOTE

When shifting or starting off, do not race the engine. Racing the engine can shorten engine life and affect smooth shifting.

STARTING AND DRIVING

Gear Shifting and Driving



The gearshift pattern is as shown on the gear lever knob. Gear shifting should always be done with clutch pedal pressed.

NOTE

Depress the clutch fully when gear shifting. The reverse gear should be engaged only when the vehicle is stationary. Wait for 5 seconds after declutching to ensure smooth engagement of the reverse gear. Do not depress clutch pedal while

driving the vehicle stationary on a slope.

Current gear indication

The Driver Information display (DIS) in the Instrument Cluster indicates the current gear position engaged.

Gear recommendation

Up or down arrow will be displayed in DIS, recommending whenever gear should be shifted to up or down.

NOTE

- Gear recommendation is displayed when the clutch pedal is in fully released position.
- If “F” is displayed in DIS of instrument cluster it means ‘Fault’ condition. Contact a TATA MOTORS Authorized Service Centre.

Drive modes

‘ECO’ and ‘CITY’ drive modes are provided. These modes can be used to adjust engine characteristics and vehicle performance in line with desired requirement.

Drive mode selection switch is provided on dashboard fascia for activation.

NOTE

Default mode is ‘CITY’ and tell-tale will be displayed on instrument cluster. Select the desired mode as per driving feasibility.

Drive Mode	Performance
CITY (default mode)	Increased engine Torque and Power output for BALANCED performance
ECO	Optimum engine Torque and Power output for FUEL EFFICIENT performance

WARNING

Do not switch off the ignition while driving. If you switch off the ignition while driving, safety-relevant functions are only available with limitations, or not at all. This could affect the power steering and the brake boosting effect. You will require considerably more effort to steer and brake. There is a risk of an accident.

Braking

Your vehicle has power assisted brakes.

The distance needed to bring the vehicle to a halt increases with the speed of the vehicle. Start applying brake anticipating the distance and slow down gradually.

WARNING

Never use the brake pedal as a footrest.

If you rest your foot on the brake pedal while driving, the braking system can overheat. This increases the stopping distance and can even cause the braking system to fail. There is a risk of an accident.

Never depress the brake pedal and the accelerator pedal at the same time.

If you have driven for a long time in heavy rain without braking, there may be a delayed reaction from the brakes when braking for the first time. This may also

occur after the vehicle has been washed.

Brake performance may become poor and unpredictable if brakes are wet.

After driving through water or washing the underside of the vehicle, test the brakes while driving at a slow speed to see if they have maintained their normal effectiveness. If the brakes are less effective than normal, dry them by repeatedly applying the brakes while driving slowly until the brakes have regained their normal effectiveness.

Braking on downhill gradients

On long and steep gradients, you must reduce the load on the brakes by shifting early to a lower gear. This allows you to take advantage of the engine braking effect and helps avoid overheating and excessive wear of the brakes.

STARTING AND DRIVING

WARNING

Do not shift to lower gear on a slippery road surface in an attempt to increase the engine's braking effect, the drive wheels could lose their grip.

There is an increased danger of skidding and accidents.

Switch-off the engine

Turn the key to 'ACC' position to switch off the engine. Before switching off the engine, run the engine in idle condition for at least 30 seconds and then switch off. This will allow the engine oil to lubricate the turbocharger, till its speed is fully reduced and also allow the unit to cool down.

WARNING

A quick burst on the accelerator before turning off the engine serves absolutely no practical purpose, it wastes fuel and is damaging especially to turbocharged engine.

WARNING

Do not switch the engine off when it is running at high speed. This will lead to premature turbocharger bearing wear.

Parking Brake



Mechanical parking brake acting only on the rear wheels is provided on the vehicle. To apply the parking brake, pull the lever up fully. The parking brakes tell-tale illuminates on the instrument cluster. To release it, pull the lever up slightly, press the release button and push the lever down. Parking brakes tell-tale on the instrument cluster will turn 'OFF' when the lever is fully released.

NOTE

Apply the parking brake properly before leaving the vehicle and release it before moving.

Vehicle parking

- Park the vehicle in a safe place. Switch on the indicator signal before turning to park.
- Apply the parking brake.
- Ensure that all window glasses are closed and all lamps are turned 'OFF'.
- At night, put on the parking lights if required.
- Remove the key from the ignition switch and lock the vehicle.
- Block the wheel if parked on a slope.

NOTE

When parking on a downhill gradient, place the gear lever in 'Reverse' position. While parking on uphill gradient, place the gear lever in the '1st' position.

WARNING

Never leave children unsupervised in the parked vehicle. They could also operate the vehicle's equipment. There is a risk of an accident and injury.

NOTE

Do not use parking brake for braking unless unavoidable circumstances like when service brake is not working properly. The braking distance is considerably longer and the wheels could lock. There is an increased danger of skidding and accidents.

STARTING AND DRIVING

Reverse Park Assist (if equipped)

Reverse Park Assist system is an electronic parking aid that will assist you to park your vehicle safely when in reverse gear mode. It provides audio and visual information through the vehicles infotainment system.



There are 4 ultrasonic sensors placed on the rear bumper of the vehicle. Once the system is activated, the sensors will detect the proximity of an obstacle from the bumper, and this information would be displayed on the vehicles infotainment system.

WARNING

0 to 25 cm obstacle detection performance is not guaranteed due to ultrasonic sensor technology limitation.

Operation

The reverse park assist will automatically start functioning once you engage reverse gear. Display will be seen on infotainment screen.

NOTE

Turning the ignition 'OFF' while the Park assist feature in running would disable the feature.

Park assist indications

In case of Reverse park assist system malfunctions, the following screen may appear on the infotainment system.

Reason for this fault may be

- Park assists control failure
- Sensor Malfunction
- Partner components such as Infotainment music system, Instrument Cluster or Body Control Module failure.

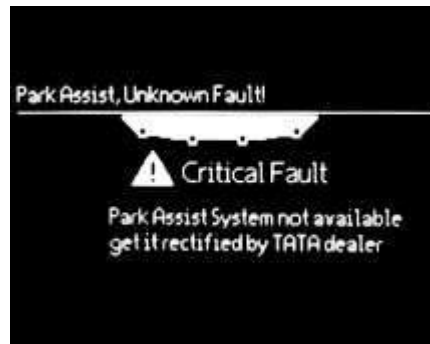

Reverse park assist limitations

Reverse Park Assist system is not a collision avoiding system. It is solely the driver's responsibility to park the vehicle safely.

Reverse Park Assist feature works on ultra sound echo technology, due to which performance is not guaranteed in following scenarios:

- If the object has a sharp edge surface, where surface may divert echoes from sensor reception.
- If object is mesh fence made up of thin wires, where echoes can't be given by the surface.
- Fast moving objects passes in the sensor field of detection, where echoes are not processed by the system.
- If object is made/covered by foam or sponge or snow where ultrasonic sound signals are absorbed.

- Objects close to the rear bumper can go undetected by the Reverse Park Assist field of detection. Driver should use extreme caution while parking the vehicle.

WARNING

Due to any reason, if the sensor gets misaligned or loses its intended fitment position, contact your dealer for refitment.

NOTE

Turning the ignition 'OFF' while the Park assist feature in running would disable the feature.

Reverse park assist system preventive maintenance

1. Regularly clean the sensors and keep them free from dust, ice, mud, water, chewing gum etc. for proper working of the system. Use a smooth cloth for cleaning.

2. Do not use water at high pressure for cleaning the sensor.
3. Do not cover the sensor surface with any additional fitment. This will interrupt park assist performance.



EMERGENCY AND BREAKDOWN ASSISTANCE

Emergency Equipment

You should be familiar with the location of the emergency equipment provided in the vehicle and how to use it.

Check this equipment periodically and ensure that they are in proper working condition and stowed at their locations.

First aid kit

The first aid kit is kept inside the glove box compartment.

The kit contains items that can be used in case of minor injuries only.

NOTE

Check contents of the first aid kit periodically and replenish consumed or expired items.

Tool kit and tow hook



Tool kit & tow hook are provided in bag. This bag is stowed inside LH side pocket of luggage compartment.

NOTE

The tool kit should be properly stored when not in use.

Jack

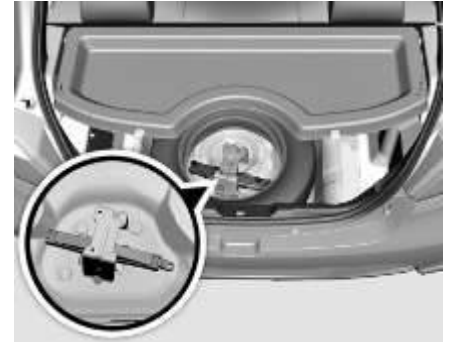

A scissors jack is kept inside luggage compartment below the spare wheel. Jack handle is kept in the tool kit bag.

NOTE

The jack should be used only to change wheels. It is important to read the jacking instructions in this section before attempting to use the jack.

EMERGENCY AND BREAKDOWN ASSISTANCE

Advance warning triangle

An advance warning triangle is kept in the luggage compartment.

Use advance warning triangle to warn the approaching traffic in case of vehicle break-down or during emergency, where your vehicle could become a potential traffic hazard.

Press hazard warning switch, all turn signal lamps will start blinking

Keep the warning triangle at an approximate distance of 50-150 m behind your vehicle in the same lane of traffic. The reflecting side of the triangle should face the oncoming traffic and it should be free from any obstacles.

Remove the advance warning triangle carefully from the bag and assemble. Refer instructions given on the bag.



NOTE

After using the warning triangle tie it firmly and keep it inside the bag to avoid rattling noise.

Hazard Warning Switch



Press the hazard warning switch to activate the hazard warning. All the turn signal lamps will flash simultaneously. To turn OFF, press the switch again.

Use the hazard warning to warn the traffic during emergency parking or when your vehicle could otherwise become a traffic hazard.

The hazard warning lamps can operate even if the ignition is switched off.

EMERGENCY AND BREAKDOWN ASSISTANCE

In Case of Flat Tyre

- Reduce vehicle speed gradually, without making any sudden steering or braking maneuvers. Pay attention to the traffic conditions as you do so.
- Switch on the hazard warning lamps.
- Stop the vehicle on solid, non-slippery and level ground, as far away as possible from traffic.
- If possible, bring the front wheels into the straight-ahead position.
- Secure the vehicle against rolling away.
- Set the parking brake firmly and shift into “R” (Reverse) gear.
- Switch off the engine.
- Keep advance warning triangle at a suitable distance behind the vehicle as an indication of breakdown.
- Close all the doors.

WARNING

If you drive with a flat tyre, there is a risk of the following hazards:

- A flat tyre affects the ability to steer or brake the vehicle.
- You could lose control of the vehicle.
- Continued driving with a flat tyre will permanently damage the tyre and cause excessive heat buildup and possibly a fire. There is a risk of an accident.

Spare Wheel

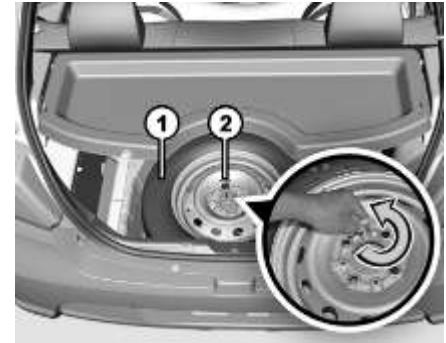

1. Spare Wheel 2. Retaining bolt

Spare wheel is located in the luggage compartment.

To access the spare wheel open the tail gate, lift the carpet up and fold it.

To remove the spare wheel, unscrew and remove the retaining bolt. Take out the spare wheel.

EMERGENCY AND BREAKDOWN ASSISTANCE

Wheel covers (if equipped)



Insert a piece of cloth between the spokes of the wheel cover and pull it outwards. Take out detached wheel cover from the wheel rim.

When installing the cover, make sure that it is positioned so that it does not cover the air filling valve. Apply equal pressure at the circumference of the wheel cover to fix it in the wheel rim.

NOTE

Do not use any sharp tools (such as screw driver etc.) to remove the wheel cover.

Changing flat tyre

Loosen the nuts (as indicated) on the wheel in diagonal sequence. Do not unscrew the nuts completely before jacking the vehicle.



Wheel nut removal

Assemble the Jack handle and wheel spanner (as shown in jacking fig.)

Position the jack vertically and raise it by turning the jack handle clockwise until the jack sits completely on jacking point and the base of the jack lies evenly on the ground.

The jacking points are indicated on the vehicle (Refer jacking point location).



Jacking point location

EMERGENCY AND BREAKDOWN ASSISTANCE

WARNING

If you do not position the jack correctly at the appropriate jacking point of the vehicle, the jack could tip over with the vehicle raised. There is a risk of injury.

Continue to raise the jack slowly and smoothly until the tyre clears the ground. Do not raise the vehicle more than necessary.



Jacking

Remove wheel mounting nuts with the help of wheel spanner and take out flat tyre.

NOTE

Do not place wheel nuts in sand or on a dirty surface. Do not apply oil or grease on it.

Roll the spare wheel into position and align the holes in the wheel studs.

Install wheel nuts with their cone shaped end facing the wheel. Tighten each nut by hand until the wheel is securely seated on the hub.

Lower the jack completely then tighten the wheel nuts one by one using wheel spanner.

Press fit the wheel cover back (if fitted). Restore all the tools and jack at their respective location.

Place the flat tyre at spare wheel location.

NOTE

Check and correct the tyre pressure and wheel nuts tightness of the changed wheel at nearest authorised service station.

Get the flat tyre repaired at the earliest.

EMERGENCY AND BREAKDOWN ASSISTANCE

NOTE

The jack is designed only to raise and hold the vehicle for a short time while a wheel is being changed. It is not suited for performing maintenance work under the vehicle.

Use the jack on level, hard ground. Avoid changing the wheel on uphill and downhill slopes. Apply wheel chokes if vehicle is parked on slope.

Before raising the vehicle, secure it from rolling away by applying the parking brake.

Do not use wooden blocks or similar objects as a jack underlay.

Never place your hands and feet or lie under the raised vehicle when it is supported by the jack.

Never run the engine when the vehicle is supported by the jack and never allow passengers to remain in the vehicle.

Never open or close a door or the trunk lid when the vehicle is raised.

Jump Lead Starting

Use only a battery of same rating & capacity to jump start your vehicle. Position the booster battery close to your vehicle so that the jump leads will reach both batteries.

When using a battery of another vehicle, do not let the vehicles touch.

Apply the parking brake firmly and keep the gearshift lever in neutral.

Turn off all vehicle accessories, except those necessary for safety like hazard warning lamps.

Make jump lead connections as follows:

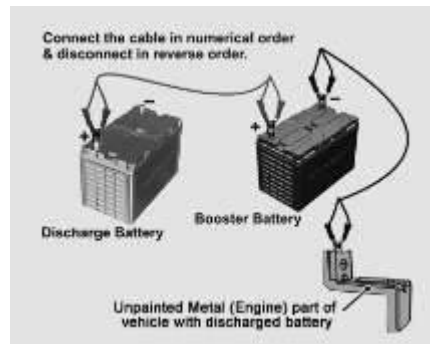

- Connect one end of the first jump lead to the positive (+) terminal of the discharged battery.
- Connect the other end to the positive (+) terminal of the booster battery.
- Connect one end of the second jump lead to the negative (-) terminal of the booster battery.
- Make the final connection (other end of the negative terminal) to an unpainted, heavy metal part (i.e. engine mounting stud/nut) of the vehicle of discharged battery.

EMERGENCY AND BREAKDOWN ASSISTANCE

- Start the engine of the vehicle with the discharged battery.
- Before disconnecting the jumper cables, let the engine run for several minutes.
- If the booster battery you are using is fitted to another vehicle, start the engine of the vehicle with the booster battery. Run the engine at moderate speed.
- Remove the jump leads in the exact reverse order in which you connected them.

NOTE

Do not disconnect the discharged battery from the vehicle.

WARNING

Never connect the jump lead directly to the negative (-) terminal of the discharged battery. This may lead to an explosion.

WARNING

Do not allow battery electrolyte to come in contact with eyes, skin, fabrics or painted surfaces. The fluid contains acid which can cause injury and severe damage. Wear protective apparel. Do not inhale any battery gases. Keep children away from batteries. In case if battery acid comes in contact with the skin, wash it off immediately with water and seek medical attention.

During charging and jump-starting, explosive gases can escape from the battery. There is a risk of an explosion. Particularly avoid fire, open flames, creating sparks and smoking. Ensure there is sufficient ventilation while charging and jump-starting. Do not lean over the battery.

Make sure that the positive terminal of a connected battery does not come into contact with vehicle

parts. Never place metal objects or tools on a battery.

It is important that you observe the described order of the battery terminals when connecting and disconnecting a battery. If you are in doubt, seek assistance from qualified specialist workshop.

Never connect or disconnect the battery terminals while the engine is running.

EMERGENCY AND BREAKDOWN ASSISTANCE

Towing

When towing a break down vehicle, certain precautions and procedures must be taken to prevent damage to the vehicle and/or components. Failure to use standard towing precautionary measures when lifting or towing a break down vehicle could result in an unsafe operating condition.

To ensure proper towing and to prevent accidental damage to your vehicle, take help of a TATA MOTORS authorized dealer or a commercial tow-truck service.

NOTE

Make sure that the parking brake is released; vehicle in neutral gear position and steering wheel is unlocked. The power steering functions only when engine is running. Hence, during towing the steering efforts will be more.

WARNING

- Never get under your vehicle after it has been lifted by a tow truck.
- For towing a vehicle, the best way is to use a wrecker. Alternatively use a rigid tow bar.
- Switch 'ON' the hazard warning indicators of both the vehicles to warn other road users.
- Limit the speed to 20-30 kmph.
- In case of brake failure, use the parking brake to control the vehicle.
- Fasten the tow rope or tow bar at the towing eyes. Otherwise, the vehicle could be damaged.
- When towing, pull away slowly and smoothly. If the tractive power is too high, the vehicles could be damaged.

Tow hook fitment

- Open the tailgate and remove tow hook from the tool kit.
- Open the tow hook cover provided on the front bumper by pressing it at the bottom part and simultaneously pulling it at the top (as shown in fig). Screw in and tighten the tow hook in clockwise direction.
- After towing, remove the towing hook and press fit the cover properly.
- Place the towing hook in the vehicle tool kit.



EMERGENCY AND BREAKDOWN ASSISTANCE

Recommended towing

In case of break down we recommend that your vehicle be towed with the driving wheels off the ground or place the vehicle on a flatbed truck as shown.

WARNING

- Never tow your vehicle with the front wheels on the ground or four wheels on the ground (forward or backward), as this may cause serious damage to the transmission.
- When towing with the rear wheels on the ground or on towing dollies, place the ignition switch in the 'ACC' or 'ON' position, and secure the steering wheel in the straight-ahead position with a rope or similar device.

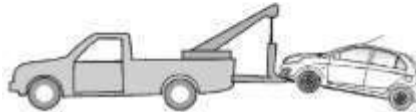
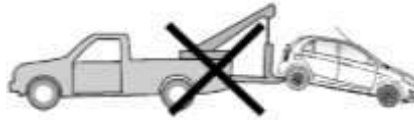

Fuses

Your vehicle has fuse boxes at three locations.

The vehicles electrical circuits have fuses to protect the wiring from short circuits or sustained overload.

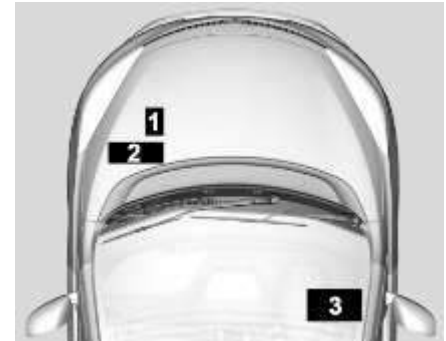

1. Battery Mounted Fuse Box.
2. Engine Compartment Fuse Box.
3. Cabin Compartment Fuse Box.

EMERGENCY AND BREAKDOWN ASSISTANCE

Checking and replacing fuses

If any electrical unit in your vehicle is not functioning, check the fuses first.

Please follow the steps below that will guide you to check and replace them.

- Apply parking brake
- Switch off all electrical consumers.
- Turn the ignition key to the 'LOCK' position.
- In the fuse box, identify the defective fuse from its melted wire.

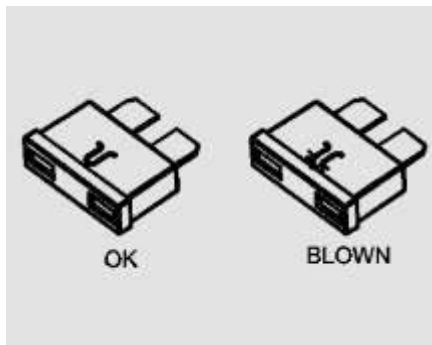

- Remove the blown fuse by “fuse puller”. The fuse puller and spare fuses are provided in the engine compartment fuse box.

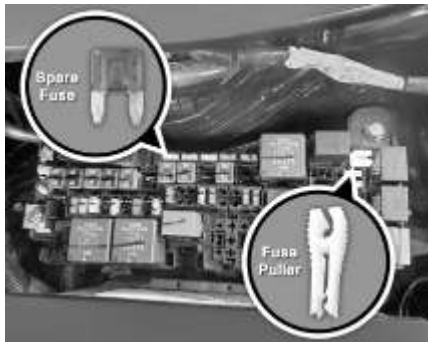

Engine compartment fuse box

- Blown fuses must be replaced with fuses of same rating, which you can recognize by color and value.

NOTE

Always ensure that the spare fuses are replenished.

- Ensure that all other fuses are pressed firmly in position.
- If a newly inserted fuse also blows, have the cause traced and rectified at nearest TATA MOTORS Authorized Service Centre immediately.

WARNING

If you manipulate or bridge a faulty fuse or if you replace it with a fuse with higher amperage, the electric cables could be overloaded. This could result in a fire. There is a risk of an accident and injury.

Always replace faulty fuses with the specified new fuses having the correct amperage.

EMERGENCY AND BREAKDOWN ASSISTANCE

Battery mounted fuse box

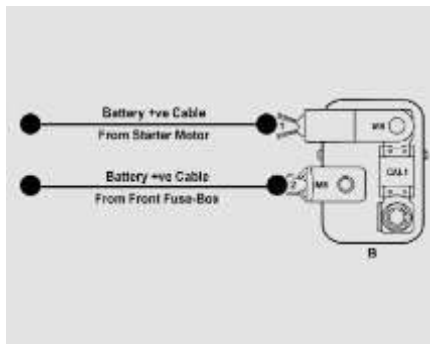
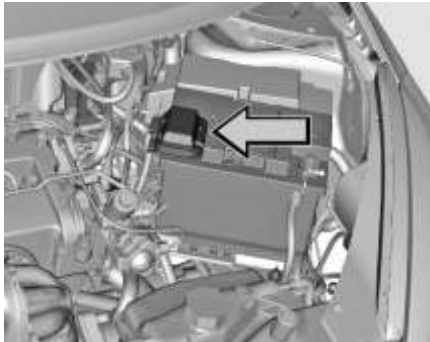

Fuse No.	Function	Fuse Rating
PF1	STARTER MOTOR	CAL 1

WARNING

If Fuse box cover is removed for any reason, it should be refitted properly at its original position.

Engine compartment fuse box



NOTE

The fuse box layout is for reference purpose only. Please refer the sticker provided inside the fuse box cover.

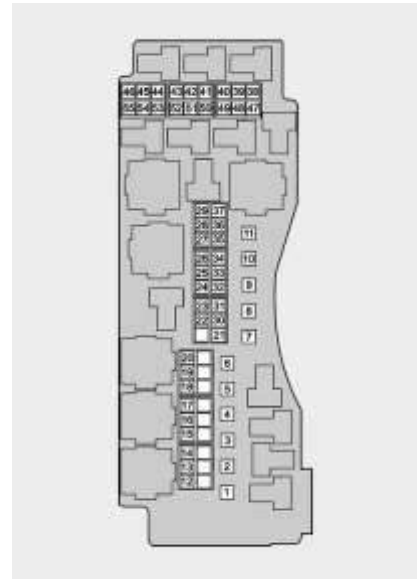

EMERGENCY AND BREAKDOWN ASSISTANCE

Fuses - Engine Compartment

Fuse No.	Function	Fuse Rating
1	INTERIOR F/B 2 IGNITION	60A
2	ABS	40A
3	GLOW PLUG (DIESEL)	60A
4	COOLING FAN HIGH SPEED	40A
5	EPAS	60A
6	-	-
7	INTERIOR F/B 1 BATTERY	60A
8	UNDER BON-NET F/R BOX	60A
9	-	-
10	IGNITION LOAD	60A
11	-	-
12	COMPRESSOR	10A
13	STARTER SOLENOID	20A
14	ABS ECU	25A

15	-	-
16	HORN HIGH / LOW TONE	15A
17	FRONT FOG	10A
18	EMS BATTERY	10A
19	-	-
20	FUEL PUMP	20A
21	BRAKE LAMP	10A
22	RELAY COIL	5A
23	-	-
24	FRONT WIPER MOTOR	20A
25	ABS	5A
26	WASHER MOTOR	10A
27	-	-
28	REVERSE & BRAKE LAMP	10A
29	REAR WIPER	10A
38	EMS ECU	20A
39	EMS ECU	15A

40	INJECTORS (PETROL)	20A
41	-	-
42	HEAD LAMP LOW	15A
43	EMS IGN	10A
44	-	-
45	-	-
46	HEAD LAMP HIGH	15A

EMERGENCY AND BREAKDOWN ASSISTANCE

Cabin compartment fuse box

Cover removal procedure

Fuse box is located inside the cover below steering column. To access the fuse box, remove cover as per procedure given below.

1. Fuse box cover is mounted on dash board with the help of lugs at the top and bottom of the cover from inside.



2. To remove the cover, gently pull the cover from bottom side such that the lugs get disengaged.

Re-fitment procedure

Align and engage the top and bottom mounting lugs with respective slots on dash board and press the cover firmly.

Fuses



Cabin compartment fuse box

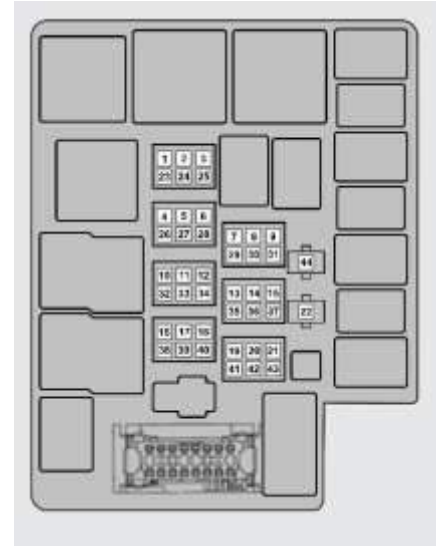

EMERGENCY AND BREAKDOWN ASSISTANCE

Fuses - Cabin Compartment

Fuse No.	Function	Fuse Rating
1	AIR BAG	10A
2	ACCESSORY	15A
3	-	-
4	BCM	15A
5	INTERIOR LAMP	5A
6	MIRROR ADJUST MOTOR	5A
7	BCM/POSITION RH	15A/5A
8	CLUSTER / OBD	10A
9	BCM/POSITION LH	15A/5A
10	KEY IN AFTER MARKET	5A
11	IMMOBILIZER / EPAS	5A
12	-	-
13	BLOWER MOTOR	30A
14	CDL / ACCESSORY	15A

15	POWER SOCKET	15A
16	RELAY COILS	5A
17	-	-
18	HVAC	10A
19	HRW / FLASHER	25A/10A
20	IGN SUPPLY	10A
21	POWER SOCKET	15A
22	TRANSIT/INFO-TAINMENT	15A

EMERGENCY AND BREAKDOWN ASSISTANCE

Bulb Specification

Sr. No.	Description	Rating	Type	Qty.
1	HIGH BEAM + LOW BEAM	12V, 55W	H4	2
2	TURN SIGNAL FRONT	12V, 21W	PY21W	2
3	FOG LAMP FRONT	12V, 19W	H16	2
4	STOP + POSITION LAMP REAR	12V, 21/5W	P21/5W	2
5	POSITION LAMP FRONT	12V, 5W	W5W	2
6	TURN SIGNAL REAR	12V, 21W	PY21W	2
7	REVERSE LAMP	12V, 16W	W16W	2
8	REAR REGISTRATION PLATE LAMP	12V, 5W	W5W	2
9	SIDE REPEATER LAMP	12V, 5W	WY5W	2
10	ROOF LAMP	LED	LED MODULE	1
11	HIGH MOUNTED STOP LAMP	12V, 5W	W5W	5
12	LOAD AREA LAMP	12V, 5W	W5W	1

EMERGENCY AND BREAKDOWN ASSISTANCE

Bulb Replacement

Open the bonnet to access the headlamps.

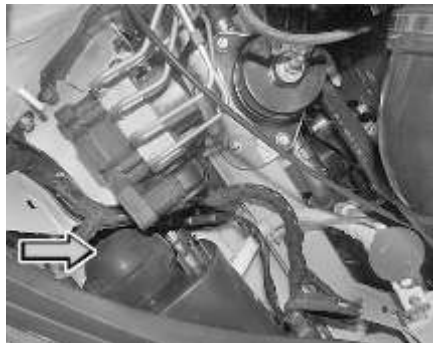

WARNING

The engine should not be running when changing bulbs.

If the engine has been running just prior to replacing bulbs in the headlight housing, please keep in mind that components in the engine compartment will be hot.

Replacing - High / Low beam bulb

1. Remove the rubber press fit cover by simply pulling it off.



2. Press the pin and pull the connector from the bulb.



3. To free the headlamp bulb from the socket, press and swing the retaining spring and pull it straight back.



4. Pull out the bulb from the socket.



EMERGENCY AND BREAKDOWN ASSISTANCE

5. Insert the new bulb (without touching the glass) into the socket.
6. Move the retaining spring up and push it slightly until it locks properly.



7. Refit the connector into the bulb and press the rubber cover on headlamp housing to fit it properly.

Replacing the position bulb

Unlock the position bulb by turning the socket in counter clockwise direction.



Replace with the new bulb (refer bulb specification table) and refit it by pressing and turning in clockwise direction firmly into the socket.

EMERGENCY AND BREAKDOWN ASSISTANCE

Replacing the turn indicator bulb

Unlock the turn indicator bulb by turning the socket in counterclockwise direction.



Replace with the new bulb (refer bulb specification table) and refit it by pressing and turning it in clockwise direction firmly into the socket.

EMERGENCY AND BREAKDOWN ASSISTANCE

24 X 7 Road Assistance

Dear Customer,

It is our responsibility and our endeavour to ensure that you have our complete service backup if ever, wherever and whenever you need the same. When you have a road network that spans wide area, the probability of a breakdown happening within hailing distance of a TATA MOTORS Authorized Workshop is very low.

It is precisely for this reason, we have tied up with TVS AA, who will provide breakdown assistance including towing to the nearest TATA MOTORS Authorized Workshop through their Authorized Service Providers (ASP).

The 24X7 On Road Assistance Program shall be automatically available to your vehicle for the duration of Warranty period. The program shall also be available, if you avail the same post warranty.

Response Time ** for the On Road Assistance Program

Within City Limits	60 minutes
On State or National Highways	90 minutes
Ghat Roads and other places	120 minutes +/-

** (The response time will depend on the location, terrain, traffic density and the time of the day.)

Standard procedure when calling for On Road Assistance in case of a breakdown:

- Dial the toll free help line number – **1 800 209 7979**
- Identify your vehicle with the Vehicle chassis number that is available in the Owner's Manual.

- Explain your exact location with landmarks and tell us about the problem you face with the vehicle.
- Park your vehicle on the edge of the road, open the bonnet and put on the hazard warning signal.
- Place the advance warning triangle supplied with the vehicle approx. 3 m from the vehicle in the direction of oncoming traffic.



EMERGENCY AND BREAKDOWN ASSISTANCE

Coverage under 24 X 7 On Road Assistance Program

I. The **24x7 On Road Assistance** Program Service covers the following services on your vehicle during warranty period.

- Wheel change through spare wheel.
- Arrangement of fuel. (Fuel cost will be chargeable at actual cost)
- Re-opening the vehicle in cases of key lock out.
- Rectification of electrical problems related to battery, fuses etc.
- On spot repairs for complaints repairable at site. ^
- Vehicle to vehicle towing or winching & towing for non-accident cases up to the nearest TATA MOTORS authorized workshop. Towing charges at actual cost beyond the same to be paid to the ASP in cash. (Any ferry or toll charges levied in relation to the vehicle being towed to be paid by the customers in actuals in cash).

For accident cases, towing charges to be borne by the customer.

II. The **24x7 On Road Assistance** Program coverage on availing the 24X7 policy, post warranty is upto maximum of 6 instance of assistance in one year for both the plans- Basic and Premium. In the premium plan, this includes 2 instances of towing upto the nearest TATA MOTORS authorised workshop.

Exclusions

24 X 7 On Road Assistance Program does not apply to

- Cost of parts consumables and labour for such repairs not covered under warranty*. These charges are to be settled with ASP in cash.
- Toll or ferry charges paid by ASP in reaching to the breakdown site to be settled with ASP in actuals in cash.
- Cases involving accident, fire, theft, vandalism, riots, lightning, earth-

quake, windstorm, hail, tsunami, unusual weather conditions, other acts of God, flood, etc.

- Vehicles that are unattended, un-registered, impounded or abandoned.
- Breakdown/defects caused by misuse, abuse, negligence, alterations or modifications made to the vehicle.
- Lack of maintenance as per the maintenance schedule as detailed in the owner's manual.
- Cases involving racing, rallies, vehicle testing or practice for such events.

EMERGENCY AND BREAKDOWN ASSISTANCE

Disclaimer

- The Service is not available in Lakshwadeep.
- **The reach time is indicative & the actual reach time will be conveyed by the call centre at the time of breakdown call.
- The reach time can vary depending on the traffic density & time of the day.
- The reach time indicated does not account for delays due to but not limited to acts of God, laws, rules & regulations for time being in force, orders of statutory or Govt. authorities, industrial disputes, inclement weather, heavy down pour, floods, storms, natural calamities, road blocks due to accidents, general strife and law & order conditions viz. fire, arson, riots, strikes, terrorist attacks, war etc.

- ^ On spot repairs at breakdown site shall depend on nature of complaints & will be as per the discretion of the ASP.
- *The decision for free of charge repairs will be as per the warranty policy & procedures of TATA MOTORS LTD. and as per the interpretation of the same by ASP. You will be duly informed by the ASP & call centre for the change applicable if any.
- All charges wherever applicable need to be settled directly with the ASP.

Exclusion of Liabilities

- It is understood that TATA MOTORS shall be under no liability whatsoever in respect of any loss or damage arising directly or indirectly out of any delay in or non-delivery of, defect/deficiency in service/parts provided by ASP.
- In case vehicle cannot be repaired on-site, customers are advised to use the towing facility for taking their

vehicle to the nearest TATA MOTORS authorized workshop only. In no condition will the vehicle be towed to any unauthorized workshop. TATA MOTORS will not be responsible for any repairs carried out in such unauthorized workshop.

- Customer are advised to take acknowledgment from the ASP for the list of accessories/extra fittings and other belongings in the vehicle as well as the current condition related to dents/scratches breakages of parts/fitments of the vehicle at the time of ASP taking possession of the vehicle & to verify these items when delivery is taken back by them, Claim for loss of or damage to items, if any should be taken up with ASP directly. TATA MOTORS shall not be responsible for any such claims, damages/loss or any deficiency of service of the ASP.
- Vehicles will be handled, repaired & towed as per the customer's risk & TATA MOTORS shall not be liable for

EMERGENCY AND BREAKDOWN ASSISTANCE

any damages / claims as a result of the same.

- Services entitled to the customers can be refused or cancelled on account of abusive behaviour, fraudulent representation, malicious intent and refusal to pay the charges for any charges related services and spare parts during service or on previous occasion on part of the customer.
- On site repairs may be temporary in nature. The completion of repairs does not certify the road worthiness of the vehicle. The customer is advised to ensure temporary repairs carried out onsite is followed by permanent repairs at a TATA MOTORS Authorized Workshop at the earliest.
- Terms and conditions and service coverage, exclusions etc. are subject to change without notice.

Maintenance and Service

Periodic maintenance is essential for ensuring long trouble free performance.

Have your vehicle serviced regularly from TATA MOTORS Authorized Service Centre.

There is a large network of TATA MOTORS Authorized Service Centre's to help you with their professional servicing expertise. Scheduled maintenance information is provided which makes tracking routine service easy.

The following checks can be carried out between the recommended scheduled maintenance services. Take help of our authorized service centre for assistance.

- Engine oil level
- Engine coolant level
- Brake fluid level
- Washer fluid level checking & topping up
- Battery electrolyte level
- Tyre inflation pressure including spare wheel

NOTE

Refer "Opening and Closing" section for engine bonnet opening.

WARNING

- Be careful not to touch a hot engine, exhaust manifold and pipes, muffler, radiator and water hoses.
- Do not work on a vehicle with the engine running in an enclosed space, unless you are sure you have enough ventilation.
- Keep all open flames and other burning material (such as cigarettes) away from the battery and all fuel related parts.

If you need to do any work inside the engine compartment,

- Switch off the ignition
- Never reach into the area where there is a risk of danger from moving components, such as the fan rotation area.
- Keep clothing away from moving parts.

MAINTENANCE

Engine Compartment - Diesel



1. Brake fluid reservoir
2. Dip Stick - Engine Oil
3. Engine oil filling cap

4. Windshield washer container
5. Air Filter
6. Fuse & relay box

7. Battery
8. Auxiliary tank

Engine Compartment – Petrol



- 1. Dip Stick - Engine Oil
- 2. Brake fluid reservoir
- 3. Engine oil filling cap

- 4. Windshield washer container
- 5. Air Filter
- 6. Fuse & relay box

- 7. Battery
- 8. Auxiliary tank

MAINTENANCE

Engine Oil Level

Warm up the engine to normal operating temperature.

Turn it 'OFF' and wait for 5 minutes for the oil to return to the oil pan. Be sure the vehicle is on a level surface.

Take out the dipstick, wipe it clean, and reinsert it fully. Pull it out again and examine the oil level. It should be between 'MIN' and 'MAX' level. If not, top up with recommended engine oil.

NOTE

The oil consumption depends upon the driving style and the conditions under which the vehicle is used.

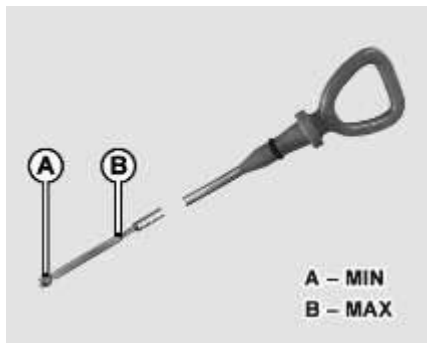

Diesel

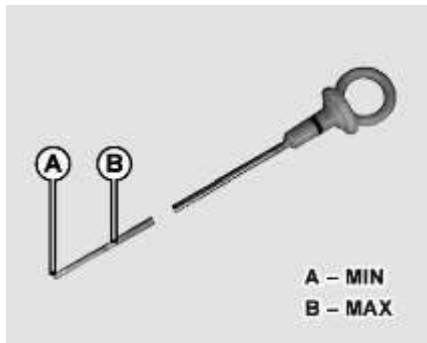

Petrol

NOTE

*Do not remove the filler cap when the engine is running.
Do not add oil above than the MAX. mark. Oil level above the MAX. mark may cause engine damage.*

For location of Engine oil filling cap and dip stick, please refer respective Engine Compartment pages.

Brake Fluid Level

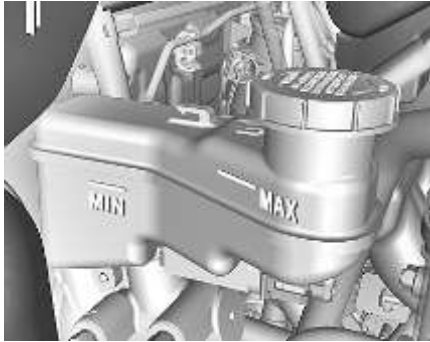

The level of the brake fluid should be between the 'MIN' and 'MAX' marks on the side of the brake fluid container. If the level falls below the 'MIN' mark, add recommended brake fluid.

NOTE

*Do not allow brake fluid to make contact with the skin or eyes.
Do not allow brake fluid to splash or spill on the paint surface as it*

will damage the paint. In case of spillage, wipe it off immediately.

For location of Brake Fluid Container and filling cap, please refer respective Engine Compartment pages.

Engine Coolant Level

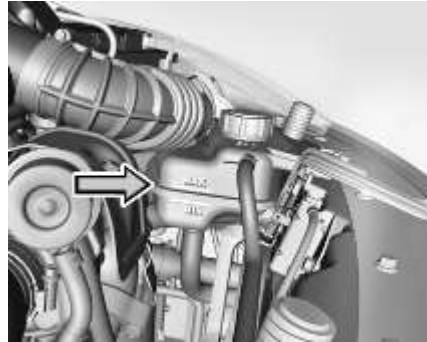

Check whether the coolant level is between the 'MIN' and 'MAX' marks on the coolant reservoir.

When the coolant levels is low, top up with recommended coolant through filler

of auxiliary tank until the level approaches the max level line. Refer 'Technical information' section.

NOTE

In case of emergency, a large amount of water without engine coolant may be added in order to reach a vehicle service location.

Whenever coolant has been added, the coolant level in the coolant reservoir should be checked the next few times you drive the vehicle to confirm correct level.

For location of Engine coolant container and filler cap, please refer respective Engine Compartment pages.

MAINTENANCE

NOTE

Topping of the coolant should be done in the auxiliary tank only.

Make sure that only TATA MOTORS recommended coolant is used. Mixing of different coolants may harm your engine's cooling system and its components. Do not add extra inhibitors or additives to the coolant. These can be harmful and compromise the corrosion protection of the engine coolant.

WARNING

The engine cooling system is pressurized, particularly when the engine is warm. When opening the cap, you could be scalded by hot coolant spraying out. There is a risk of injury.

Let the engine cool down before opening the cap. Wear eye and hand protection when opening the cap. Open the cap slowly half a turn to allow pressure to escape.

Windshield Washer Fluid Level

Check that there is washer fluid in the tank. Refill it if necessary. Use a good quality windshield washer fluid, diluted with water as necessary.

NOTE

Do not use detergent or any other additive in the windshield washer reservoir. This can severely impair visibility when sprayed on the windshield, and can also damage your vehicle's paint.

Do not operate washer motor with no fluid in washer tank, washer motor will be damaged

For location of Windshield Washer Container and filling cap, please refer respective Engine Compartment pages.

Battery

- Check the battery for electrolyte level against the marking on the battery outer case.
- Check the battery terminals for corrosion (a white or yellowish powder). To remove it, wash the terminals with a solution of baking soda. It will bubble up and turn brown.
- When this stops, wash it off with plain water. Dry off the battery with a cloth or paper towel.
- Coat the terminals with petroleum jelly to prevent future corrosion.
- Use a proper wrench to loosen and remove cables from the terminals.
- Always disconnect the negative (-ve) cable first and reconnect it last.
- Clean the battery terminals with a terminal cleaning tool or wire brush.
- Reconnect and tighten the cables, coat the terminals with petroleum jelly.

- Ensure that the battery is securely mounted.
- If you need to connect the battery to a charger, disconnect both cables to prevent damage to the vehicle's electrical system.

For location of battery, please refer respective Engine Compartment pages

NOTE

During normal operation, the battery generates gas which is explosive in nature. A spark or open flame can cause the battery to explode causing very serious injuries. Keep all sparks, open flames and smoking materials away from the battery.

The battery contains sulphuric acid (electrolyte) which is poisonous and highly corrosive in nature. Getting electrolyte in your eyes or on the skin can cause severe burns. Wear protective clothing and a face shield or have a skilled technician to do the battery maintenance.

Spark Plug (Petrol)



Spark Plug	Number	Gap
BOSCH	YR7SES	0.7 to 0.8 mm
Federal Mogul (Champion)	RER8MC	0.8 to 0.9 mm

Tightening Torque - 25 Nm

NOTE

Use spark plug of recommended make & type for replacement.

MAINTENANCE

Tyres



1	Under inflation	Excessive side tread wear
2	Correct tyre pressure	Uniform wear
3	Over inflation	Excessive center tread wear

Inflation

Check for inflation and condition of your vehicle tyres periodically.

Check the pressure in the tyres when they are cold.

Keeping the tyres properly inflated gives you the best combination of riding comfort, handling, tyre life and better fuel efficiency.

Over inflation of tyres makes the vehicle ride bumpy and harsh. Tyres are more prone to uneven wear and damage from road hazards.

Under inflated tyres reduce your comfort in vehicle handling and are prone to failures due to high temperature. They also cause uneven wear and more fuel consumption.

NOTE

Every time you check inflation pressure, you should also examine tyres for damage, trapping of foreign objects in the treads and wear.

Recommended tyre pressures

Tyre size	Version	Front	Rear
175/65 R14 Or 155/80 R13	Petrol	33 psi / 2.3 bar	30 psi / 2.1 bar
	Diesel	33 - 36 psi / 2.3 - 2.5 bar	30 psi / 2.1 bar

Tyre pressure sticker location



Special care for tubeless tyres:

- While removing tyre from wheel rim and mounting it back on wheel rim, take precautions not to damage tyre bead. Use tyre removal and assembly machines. Damage or cut on tyre bead may cause gradual loss of air and deflation of tyre.
- Do not scratch inside of tubeless tyre with metallic or sharp object. Tubeless tyres are coated with impermeable layer of rubber from inside which holds the air inside the tyre. Removal of this layer due to scratching may cause gradual loss of air and deflation.
- If wheel rim gets damaged in service, get the wheel rim repaired/ replaced immediately. Running the vehicle with damaged rim may cause deflation of tyre and subsequent dislodging of tyre from rim.

- Maintain recommended inflation pressure. Over-inflation, in particular, may cause puncture or bursting of tyre.

NOTE

Life and wear pattern of tyres depends on various parameters like tyre pressure, wheel alignment, wheel balancing, tyre rotation, etc. It also largely depends on vehicle speed, load carried, usage, driving habits, road conditions, tyre quality, etc. In case fault is suspected to be due to poor quality of tyres, the same may be taken up with concerned tyre manufacturer.

MAINTENANCE

Tyre rotation

For 175/65 R14 and 155/80 R13 tyres

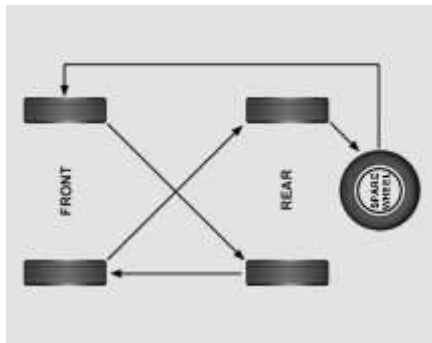

For 175/65 R14 alloy wheel rims
with spare wheel of steel wheel rim
(if equipped)

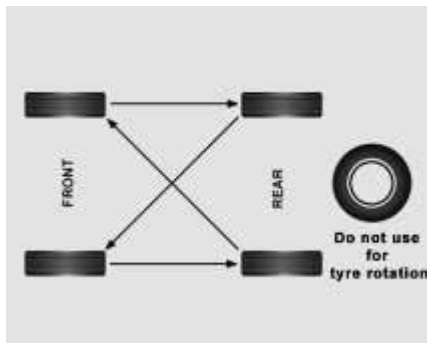

To help increase tyre life and distribute wear more evenly you should have tyres rotated at specified intervals or earlier depending on the operation of vehicle.

The illustrations shows how to rotate tyres when normal or temporary spare wheel is fitted.

Wheel Alignment

Incorrect wheel alignment causes excessive and uneven tyre wear. Check wheel alignment at specified intervals. Wheel alignment values are given below:

	Front	Rear
Caster	1° 45' ± 45'	-
Camber	30' ± 30'	- 52' ± 60'
Toe in	-	12' ± 15'
Toe Out	0 to 13'	-

Wheel Balancing

Wheels of your vehicle are balanced for better ride comfort and longer tyre life. Balancing needs to be done whenever tyre is removed from rim.

WARNING

If the vehicle vibrates abnormally on a smooth road, have the wheel balanced done immediately.

Remote Key Battery Replacement

Remote control key contains a battery which is housed under the cover.

If red LED remote flashes for 5 times after placing and releasing any button on remote. It is recommended to replace battery at a TATA MOTORS Authorised Service Centre.

You should, however, proceed as follows if you wish to replace the discharged battery yourself:

1. Open the key blade.
2. Press off the battery cover with your thumb or using a flat screw driver at the points of the arrows.
3. Remove the discharged battery from the key by pressing the battery downwards at the point of the arrow.



4. Insert the new battery.



MAINTENANCE

5. Ensure that the “+” symbol on the battery is facing upwards. The correct polarity is shown on the battery cover.
6. Position the battery cover on the key and press on it until it is heard to lock in place.

NOTE

Use CR 2032 battery only.

On Board Diagnostic (OBD II) System

On board Diagnostics or OBD is an automotive term referring to a vehicle’s self-diagnostic and reporting capability. The OBD system allows continuous diagnosis of the components of the vehicle correlated with emissions. This system warns the driver, by turning “ON” the Malfunction Indication lamp (MIL) on the instrument cluster, when a fault causes emission levels to increase.

The OBD system also has a diagnostic connector that can be interfaced with appropriate diagnostic tools, which makes it possible to read the fault codes stored in the Electronic Control Unit, together with a series of specific parameters for Engine operation and Diagnosis. This check can also be carried out by the traffic police.

To access the diagnostic connector, open the fuse box cover which is located

on RH side below the steering wheel. Refer ‘Emergency and Breakdown Assistance’ section for removal of cover.



Service Instructions

The **TATA TIAGO** has been manufactured to give you economical and trouble free performance. To achieve this, please follow the instructions as stated.

Your vehicle is entitled to three free services (labour only). The free service coupons are attached to the sales invoice. Please present these coupons to the servicing dealer while availing free services.

1st free service - At 1000-2000 kms. OR 2 months, whichever is earlier.

2nd free service - At 7000-8000 kms. OR 6 months, whichever is earlier.

3rd free service - At 14500-15500 kms. OR 12 months, whichever is earlier.

All services other than free services are chargeable.

Servicing of the vehicle can be done at any TATA MOTORS Authorised Dealer Workshop or TATA MOTORS Authorised Service Centre (TASC).

Warranty claims can be settled by any TATA MOTORS Authorised Dealer Workshop or TATA MOTORS Authorised Service Centre (TASC).

MAINTENANCE

Service Schedule

Sr. No.	Operation	Kms	PDI	1.5K	7.5K	15K	22.5K	30K	37.5K	45K	52.5K	60K	67.5K	75K	82.5K	90K	97.5K	105K	112.5K	120K	127.5K	135K	142.5K	150K	
		Months	0	2	6	12	18	24	30	36	42	48	54	60	66	72	78	84	90	96	102	108	114	120	
	General																								
1	Wash the vehicle & Clean Condenser Fins	Every Service	•	•	•	•	•	•	•	•	•	•	•	•	•	•	•	•	•	•	•	•	•	•	•
2	Check & Top up Fluids (if required): Transaxle Oil, Coolant, Brake Fluid, Battery Electrolyte, Wind Screen washer fluid.	Every Service	•	•	•	•	•	•	•	•	•	•	•	•	•	•	•	•	•	•	•	•	•	•	•
3	Check Fuel Lines for Leakages.	Every Service	•	•	•	•	•	•	•	•	•	•	•	•	•	•	•	•	•	•	•	•	•	•	•
4	Check and Capture all DTC's Clear all faults and Erase the Codes.	Every Service	•	•	•	•	•	•	•	•	•	•	•	•	•	•	•	•	•	•	•	•	•	•	•
5	Check Rubber Boots for damage & replace if required (driveshaft)	15K / 12M				•		•		•		•		•		•		•		•		•		•	

- Kms or Months whichever occurs earlier

MAINTENANCE

Sr. No.	Operation	Kms	PDI	1.5K	7.5K	15K	22.5K	30K	37.5K	45K	52.5K	60K	67.5K	75K	82.5K	90K	97.5K	105K	112.5K	120K	127.5K	135K	142.5K	150K
		Months	0	2	6	12	18	24	30	36	42	48	54	60	66	72	78	84	90	96	102	108	114	120
6	Check Rubber Boots, Rubber seat, Dust cover & Bushes for damage & replace if required (Suspension) (First at 15K/12M then at every service)	7.5K / 6M				•	•	•	•	•	•	•	•	•	•	•	•	•	•	•	•	•	•	•
7	Check for all bolts & nuts (Tighten)	7.5K / 6M			•	•	•	•	•	•	•	•	•	•	•	•	•	•	•	•	•	•	•	•
Engine (Diesel)																								
1	Clean air filter element (more frequently for vehicle operating as TAXI)	15K / 12M				•		•		•		•		•		•		•		•		•		•
2	Change engine oil and Oil filter	15K / 12M				•		•		•		•		•		•		•		•		•		•
3	Drain water from Fuel Filter Bowl	15K / 12M				•		•		•		•		•		•		•		•		•		•
4	Replace Fuel Pre filter assembly (WIF Sensor to be reused)	# 45K / 24M								•						•						•		
5	Replace Fuel Main fuel filter assembly	# 135K / 24M																					•	

- Kms or Months whichever occurs earlier

MAINTENANCE

Sr. No.	Operation	Kms	PDI	1.5K	7.5K	15K	22.5K	30K	37.5K	45K	52.5K	60K	67.5K	75K	82.5K	90K	97.5K	105K	112.5K	120K	127.5K	135K	142.5K	150K	
		Months	0	2	6	12	18	24	30	36	42	48	54	60	66	72	78	84	90	96	102	108	114	120	
6	Replace Diesel - Pressure Regulator	# 75K / 36M												•											•
7	Check accessory belt condition visually, replace if found damage	15K / 12M				•		•		•		•		•		•		•		•		•			•
8	Check timing belt visual condition, replace if found damage	# 105K / 24M																•							
9	Replace air filter element (more frequently for vehicle operating as TAXI)	45K / 36M								•						•							•		
10	Change coolant	# 60K / 36M										•									•				
11	Replace timing drive kit (Timing belt, Auto tensioner and Idler)	# 150K / 36M																							•

- Kms or Months whichever occurs earlier

MAINTENANCE

Sr. No.	Operation	Kms	PDI	1.5K	7.5K	15K	22.5K	30K	37.5K	45K	52.5K	60K	67.5K	75K	82.5K	90K	97.5K	105K	112.5K	120K	127.5K	135K	142.5K	150K
		Months	0	2	6	12	18	24	30	36	42	48	54	60	66	72	78	84	90	96	102	108	114	120
	Engine (Petrol)																							
1	Clean air filter element (more frequently for vehicle operating as TAXI)	15K / 12M				•		•		•		•		•		•		•		•		•		•
2	Change engine oil and Oil filter	15K / 12M				•		•		•		•		•		•		•		•		•		•
3	Gasoline - Replace Fuel Filter	30K / 24M						•				•				•				•				•
4	Change Spark plugs	45K / 36M								•						•						•		
5	Check accessory belt condition visually, replace if found damage	15K / 12M				•		•		•		•		•		•		•		•		•		•
6	Replace air filter element (more frequently for vehicle operating as TAXI)	45K / 36M								•						•						•		
7	Change coolant	# 60K / 36M										•								•				

- Kms or Months whichever occurs earlier

MAINTENANCE

Sr. No.	Operation	Kms	PDI	1.5K	7.5K	15K	22.5K	30K	37.5K	45K	52.5K	60K	67.5K	75K	82.5K	90K	97.5K	105K	112.5K	120K	127.5K	135K	142.5K	150K
		Months	0	2	6	12	18	24	30	36	42	48	54	60	66	72	78	84	90	96	102	108	114	120
	Transaxle																							
1	Replace transaxle oil	75K / 60M												•										•
	Brakes																							
1	Check front brake pads & rear brake linings. Replace if necessary	15K / 12M				•		•		•		•		•		•		•		•		•		•
2	Replace brake fluid. Check brake system components for Leakages	# 45K / 24M								•						•							•	
3	Inspect & if necessary adjust handbrake setting	15K / 12M				•		•		•		•		•		•		•		•		•		•
	Wheels & Tyres																							
1	Check & Adjust Wheel alignment	# 15K / 18M				•		•		•		•		•		•		•		•		•		•
2	Check for Tyre pressure, condition & rotate	# 7.5K / 12M			•	•	•	•	•	•	•	•	•	•	•	•	•	•	•	•	•	•	•	•

- Kms or Months whichever occurs earlier

MAINTENANCE

Sr. No.	Operation	Kms	PDI	1.5K	7.5K	15K	22.5K	30K	37.5K	45K	52.5K	60K	67.5K	75K	82.5K	90K	97.5K	105K	112.5K	120K	127.5K	135K	142.5K	150K	
		Months	0	2	6	12	18	24	30	36	42	48	54	60	66	72	78	84	90	96	102	108	114	120	
	Electrical																								
1	Check specific gravity of battery electrolyte (OR Every 6 Months)	Every Service	•	•	•	•	•	•	•	•	•	•	•	•	•	•	•	•	•	•	•	•	•	•	•
2	Check headlamp focussing	15K / 12M			•			•		•		•		•		•		•		•		•		•	•
	A.C. System																								
1	Clean filter and check Air-conditioning / HVAC system for satisfactory performance	Every Service	•	•	•	•	•	•	•	•	•	•	•	•	•	•	•	•	•	•	•	•	•	•	•

- Kms or Months whichever occurs earlier

MAINTENANCE

Vehicle Parking at One Place for Long Duration (Non - Use Maintenance)

If you want to park your vehicle at one place for long duration, following care is to be taken:

1. Park the vehicle in covered, dry and if possible well-ventilated premises. Engage a gear.
2. Remove the battery terminal cables (first remove the cable from the negative terminal).
3. Block the wheel or engage in the gear mode.
4. Clean and protect the painted parts using protective wax.
5. Clean and protect the shiny metal parts using commercially available special compounds.
6. Sprinkle talcum powder on the rubber windshield wiper and lift them off the glass.
7. Slightly open the windows.
8. Cover the vehicle with a cloth or perforated plastic sheet. Do not use sheets of imperforated plastic as they do not allow moisture on the vehicle body to evaporate.
9. Inflate the tyres to 0.5 bar above the normal specified pressure and check it at regular intervals.
10. Check the battery charge every six weeks.
11. Do not drain the engine cooling system.

TEHCNICAL INFORMATION

Fuel Specification

Fuel (Diesel)

Normal grade BS IV compliant diesel conforming to IS1460 or EN 590 or equivalent is recommended to be used as fuel.

Do not use premium diesel available in the market for example extra premium / Turbojet etc.

Recommended fuel specifications

Parameter	Unit	BS IV
Cetane Number (min)	CN	51
Sulphur content	mg/kg	50
Lubricity (HFRR)	micron	460

NOTE

Where oxidation catalytic converter is fitted, it is mandatory to use Diesel fuel with sulphur contents as given above. Use of any other diesel fuel can increase the pollutants.

At very low temperature, fluidity of diesel may become insufficient due to paraffin separation. It is therefore necessary to mix supplementary fuel with summer or winter grade diesel.

The supplementary fuel to be used like kerosene. Ratio for mixing of supplementary fuel and diesel are shown in the table.

Ambient Temperature up to Deg C.	Percentage	
	Summer grade diesel	Supplementary fuel
Up to 0	100	0
0 to -10	70	30
-10 to -15	50	50

Care should be taken that diesel and supplementary fuel are thoroughly mixed before filling.

Ambient Temperature upto Deg C.	Percentage	
	Winter grade diesel	Supplementary fuel
Up to -15	100	0
-15 to -20	70	30
-20 and below	50	50

WARNING

Do not mix gasoline or alcohol with diesel. This mixture can cause an explosion.

TECHNICAL INFORMATION

Fuel (Petrol)

Unleaded regular grade petrol conforming to IS 2796:2008 and BS IV specification and RON not less than 91 is recommended. It is always recommended to use correct fuel to get optimum emission performance.

NOTE

Always use petrol of a correct specification in a vehicle fitted with catalytic converter. Even single fill of leaded petrol will seriously damage the catalytic converter.

Lubricant Specification

Use following genuine fluids, coolants and lubricants recommended for optimum performance of your vehicle.

Item	Specification	Company and Brand	Qty.
Engine Oil	5W30 ACEA A5/B5 TATA SS6579	CASTROL - Magnatec Professional T 5W30 PETRONAS TATA MOTORS Genuine Oil – Engine Oil Synth 5W30	3.5 Litres (Petrol) 4 Litres (Diesel)
Coolant (Pre-mixed) (Antifreeze agent + Soft water 40 : 60 ratio)	Class II/JIS K2234 TATA SS7700S1	SUNSTAR CCI - Golden Cruiser LLC 2200NP IOCL TATA MOTORS GENUINE COOLANT KOOL PLUS	4 Litres (Petrol) 5 Litres (Diesel)
Transaxle Oil	EP80W LL (Next Gen) TATA SS6582	PETRONAS - TATA MOTORS Genuine Oil – Gear Oil New Gen 80 EP LL IOCL TATA MOTORS GENUINE GEAR OIL 80WLL	1.8 Litres
Brake Fluid	IS 8654 Type II DOT 4 TATA SS7711	PETRONAS - Tutela - TOP 45 DOT 4 CASTROL - UBF DOT 4 SUNSTAR CCI - Golden Cruiser Brake Fluid DOT 4	0.5 Litres

TECHNICAL INFORMATION

Technical Specifications

Parameter	Diesel	Petrol
Engine		
Model/type	1.05L REVOTORQ	1.2L REVOTRON
Capacity	1047 cc	1199 cc
Max. Engine output	70 PS @ 4000 +/-50 rpm	85 PS @ 6000 rpm
Max. Torque	140 Nm @ 1800 - 3000 rpm	114.4 Nm @ 3500 +/- 70 rpm
Clutch		
Type	Single plate dry friction diaphragm type	
Outside diameter of clutch	200 mm	
Transaxle		
Model	TA65*	
Type	Synchromesh with overdrive	
No. Of gears	5-Forward, 1-Reverse	
Steering		
Type	Electric Power Assisted Steering	
Brakes		
Brakes	Front (Disc); Rear (Drum)	
Parking brake	Lever type console mounted cable operated mechanical linkages acting on rear wheels	

TEHCNICAL INFORMATION

Suspension		
Type	Dual path McPherson strut (front) Twist beam Suspension at (rear)	
Shock absorber	Hydraulic Shock absorber	
Wheels & tyre		
Tyres	175/65R14 82T or 155/80R13 79T	175/65R14 82T or 155/80R13 79T
Wheel rims	5J x 14" or 4.5J x 13"	5J x 14" or 4.5J x 13"
Fuel tank		
Capacity	35 liters	35 liters
Cab / body		
Type	Hatch back, Five doors, Steel monocoque body, Passenger vehicle	
Electrical system		
System voltage	12 Volts (-ve earth)	12 Volts (-ve earth)
Alternator capacity	120 Amp	110 Amp
Battery	12V, 50 Ah	12V, 44Ah
Main chassis dimension (in mm)		
Wheel base	2400	2400
Track front	1400	1400
Track rear	1420	1420
Overall length	3746	3746
Overall height	1535	1535
Max. Width	1647	1647
Ground clearance	170	170

TECHNICAL INFORMATION

Performance		
Max. Speed	150 kmph	160 kmph
Max. Recommended gradability	28%	26.8%
Minimum Turning Circle Dia. in mm as per IS:12222	9800	9800
Minimum Turning Clearance circle dia. in mm as per IS:12222	10200	10200
Weight (in kg)		
Gross vehicle weight	1480 (XZ), 1465 (XT), 1445 (XM), 1440 (XE), 1430 (XB)	1412 (XZ), 1397 (XT), 1377 (XM), 1375 (XE), 1330 (XB)
Kerb weight (unladen)	1080 (XZ), 1065 (XT), 1045 (XM), 1040 (XE), 1030 (XB)	1012 (XZ), 997 (XT), 977 (XM), 975 (XE), 930 (XB)

Vehicle Dimensions

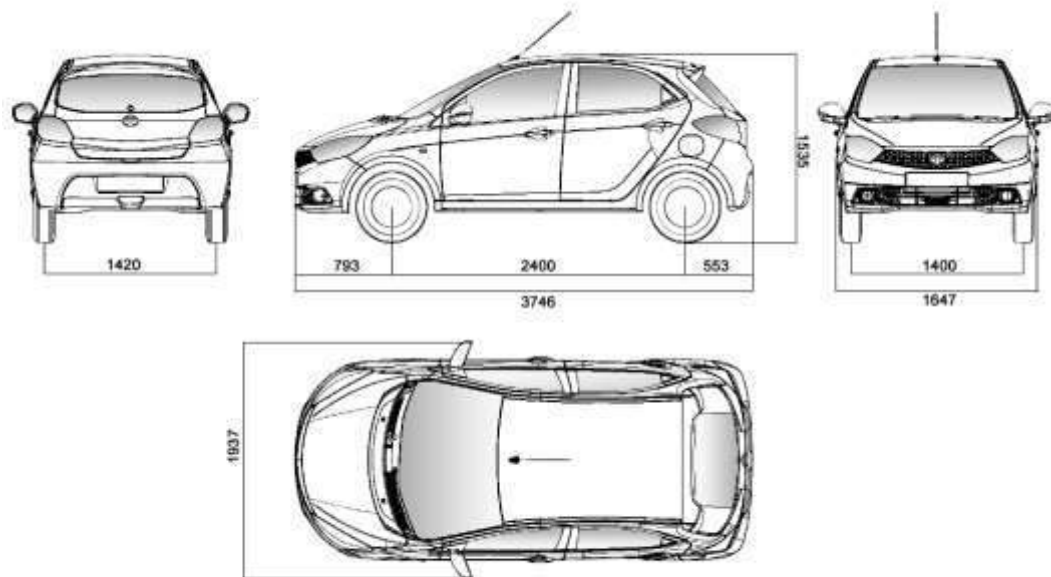

TECHNICAL INFORMATION

Aggregate Identification Numbers



Chassis No. punching near driver seat



VIN plate near front passenger seat



Transaxle No. Punching



Engine No. Plate - Diesel



Engine No. Plate - Petrol

CAR CARE AND VALUE ADDED SERVICES

Car Care

Your vehicle is subjected to many external influences such as climate, road conditions, industrial pollution and proximity to the sea. These conditions demand regular care of the vehicle body. Dirt, insects, bird droppings, oil, grease, fuel and stone chippings should be removed as soon as possible.

Washing

Following these tips while washing your vehicle.

Hand wash:

1. Always wash your vehicle in shade and the surface is at room temperature.
2. Wash with mild vehicle wash soap like 'Car Shampoo' and use a soft bristle brush, sponge or soft cloth and rinse it frequently while washing to avoid scratches.

3. To avoid scratches, please wear soft gloves. Remove finger rings, nails, wrist watch while washing.

4. To remove stubborn stains and contaminants like tar, use turpentine or cleaners like 'Stain remover' which are safe for paint surfaces.

5. Avoid substances like petrol, diesel, kerosene, benzene, thinner or other solvents that cause damage to paint.

6. Dry your vehicle thoroughly to prevent any damp spots.

7. Rinse all surfaces thoroughly to prevent any traces of soap and other cleaners as this may lead to the formation of stains on the painted surface later.

WARNING

Do not direct high pressure washer fluid/ water jets (Pressure above 0.5 Bar) at electrical devices and connector during washing. This is to prevent malfunction / failure of electrical system due to water ingress.

After drying the vehicle, inspect it for chips and scratches that could allow corrosion to start. Apply touch up paint where necessary.

Cleaning of Carpets

Vacuum clean the carpet regularly to remove dirt. Dirt will make the carpet wear out faster. Periodically shampoo the carpet to keep it looking new.

Use carpet cleaners (preferably foam type). Follow the instructions that come with the cleaner. Apply it with a sponge or soft brush. Keep the carpeting as dry as possible by not adding water to the foam.

NOTE

Avoid wiping of painted surface in dry condition as it may leave scratches on the painted surface.

CAR CARE AND VALUE ADDED SERVICES

Cleaning of Windows, Front and Rear Glasses

Clean the windows inside and outside with commercially available glass cleaners.

This will remove the haze that builds up on the inside of windows. Use a soft cloth or paper towels to clean all glass and plastic surfaces.

RFID TAG

RFID TAG is pasted on front windshield from the inside. It enables Electronic toll collection.



NOTE

Do not attempt to rip or tamper the tag. It will disable the functionality of the tag.

Waxing

Waxing and polishing is recommended to maintain the gloss and wet-look appearance of your paint finish.

1. Use good quality polish and wax for your vehicle.
2. Re-wax your vehicle when the water does not slip off the surface but collects over the surface in patches.

Polishing

Polishes and cleaners can restore shine to the painted surface that has oxidized and become dull. They normally contain mild abrasives and solvents that remove the top layer of the finish coat. Polish your vehicle, if the finish does not regain its original shine after using wax.

Interior fabric cleaning tips

1. Stains should be treated immediately. If left for a long time, they can leave a permanent mark.
2. Cleaning the stains immediately is important especially for stains which contain artificial colors in the stain creating liquid or semisolid substance. The colorant may leave a stain if kept for longer time.
3. Stain should not be removed by rubbing. As far as possible, try to blot or lift the stain with cloth or plastic spatula and then clean the remaining stain with cloth or sponge.
4. If the stain has dried, then gently brush off the material and then press with damp cloth or sponge till it disappears.
5. Do not use household detergents to clean the fabric.
6. Always use clean cotton cloth for cleaning.

Paint Care

Following guidelines will help you to protect your Vehicle from corrosion effectively.

Proper cleaning

In order to protect your vehicle from corrosion it is recommended that you wash your vehicle thoroughly and frequently in case:

- There is a heavy accumulation of dirt and mud especially on the underbody.
- It is driven in areas having high atmospheric pollution due to smoke, soot, dust, iron dust and other chemical pollutants.
- It is driven in coastal areas.
- The underbody must be thoroughly pressure washed after every three months.

In addition to regularly washing your car, the following precautions need to be taken.

Periodic Inspection

- Regularly inspect your vehicle for any damage in the paint film such as deep scratches and immediately get them repaired from an authorized service outlet, as these defects tend to accelerate corrosion.
- Inspect mud liners for damages.
- Keep all drain holes clear from clogging.

Proper Parking

- Always park your vehicle in shade to protect it from harsh sunlight or in a well-ventilated garage so that there is no dampness on any part of the vehicle.

Wiper care

- To prevent damage to the wipers or windshield, do not operate the wipers when the windshield is dry.
- To prevent damage to the wiper arms and other components, do not attempt to move the wipers manually.

CAR CARE AND VALUE ADDED SERVICES

Extended Warranty

TATA MOTORS recommends the purchase of its extended warranty program.

Coverage - Mechanical + Electrical

Benefits

- Insures you against unforeseen break down repair bills.
- Documentation is simple and hassle free.
- Near cashless & speedy claim

Term

24 + 12 months or 75,000 kms whichever occurs first

OR

24 + 24 months or 1,00,000 kms whichever occurs first

Extended Warranty is available in the dealership from where you have purchased your vehicle. We strongly recommend purchase of Extended Warranty at time of purchase of your vehicle. Extended Warranty can be availed till 421 days from date of purchase of vehicle. The Dealer Service Marketing Executive shall explain to you the Terms and conditions, Coverage and Owner's responsibility.

Extended Warranty Booklet & Cover Note

The Extended Warranty booklet and cover note is the basis of the contract between TATA MOTORS LIMITED and the Owner of the vehicle shown on the Extended Warranty booklet. The Customer is to retain this booklet and the same to be produced to the dealer while claiming benefits under Extended Warranty.



CAR CARE AND VALUE ADDED SERVICES

Note

- The 12 or 24 months extended warranty does not follow the 24 months Manufacturer's warranty.
- The extended warranty comes into force once the manufacturer's warranty expires e.g. after 24 Months.
- It is more restrictive as by the time it comes into force the vehicle is already 24 months old.

What is covered?

- Mechanical / Electrical break down as defined in this warranty and confirmed by the dealer within the stipulated terms and conditions.
- TATA MOTORS dealer shall either repair or replace any part found to be defective with a new part or an equivalent at no cost to the owner for parts or labour.
- Such defective parts which have been replaced will become property of TATA MOTORS LIMITED.
- Comprehensive list of parts covered is mentioned in the page 9-12 of the Extended Warranty Booklet.

What is not covered?

Please refer the Extended Warranty Booklet for details of the exclusion list.

Owner's Responsibility:

- Proper use, maintenance and care of the vehicle in accordance with the instructions contained in the Owner's Manual and Service Booklet. The records of the same to be ensured in Owner's Manual.
- Retention of maintenance service bills.

I / We have been explained the Terms and conditions, Coverage and Owner's responsibility by the Dealer Service Marketing Executive.

I wish to avail / Do not wish to avail extended warrant policy.

Customer's Signature

Dealer's Signature

CAR CARE AND VALUE ADDED SERVICES

Value Added Services

Why are Corrosion Protection Waxes necessary?

Corrosion is caused by:

Water / salt water acid rain & atmospheric fallouts.

Critical areas are:

Cavities: joints, crevices, spot welds, underbody

- Corrosion is the most important factor when we talk about the vehicle life. If you treat your car you can prolong the life.
- It is very dangerous to drive around in a corroded vehicle.
- The corrosion creeps onto the vehicle from the inside and from the outside. The most dangerous kind of corrosion is often not discovered until it is too late.

Benefits of Anti - Rust treatment:

- A professionally applied range of world class products offering real value to the new and used vehicle customer.
- The treatment has been developed to withstand the harshest environmental and climatic conditions (rust. Pollutants, stone and gravel impact, etc.)
- Insulate cabin space from external noises.
- Expensive tin work and Denting / Painting avoided.
- Higher resale value for the vehicle.
- Higher safety – uncorroded vehicle
- 10 free checkups available



Engine Wax Treatment

Engine Wax is a beige colored transparent lacquer coating on the engine compartment.

- Corrosion Prevention for the Engine compartment.
- Neat, clean and New Look to Engine compartment.
- No effect on MPFI vehicles.
- Engine wax can withstand upto 200 degrees temperature.
- No need of cleaning the engine compartment with diesel once engine wax is sprayed.
- Life of over a year.

Sound Deadening System

Door vibration deadeners - These pads when stuck on the insides of the sheet metal increase sheet metal rigidity, reduce vibrations and increase riding comfort.

- Used for reducing the sheet metal vibration in a vehicle.
- Product to be used once in the life of the vehicle - Life Time Warranty
- Effect is lifelong i.e. until & unless pads are physically removed.
- Negligible increase in Weight & hence no effect on fuel consumption.
- Areas covered - four doors, rear quarter panels & dickey. In case of diesel vehicles, can be used in the bonnet.

CAR CARE AND VALUE ADDED SERVICES

TATA MOTORS has tied up with **M/s Wuerth, M/s Autokrom, M/s 3M India Ltd & M/s Bardahl** for these world class treatment at affordable prices. These treatments are available in all authorized workshops. The Dealer Service Marketing Executive will explain to you the benefits and terms and conditions of this treatment.

I / We have been explained the Benefits, Terms and conditions and the prices of these treatments by the Dealer Service Marketing Executive.

I wish to avail / Do not wish to avail extended warrant policy.

Customer's Signature

Dealer's Signature

Vehicle Exterior Enrichment

Why vehicles are painted?

- For Corrosion protection of the metal surfaces.
- Ease of application from other corrosion protection treatments.
- Cheaper than other corrosion protection methods eg. Galvanizing, anodizing.
- For decoration and identification.



Various Environmental Hazards affecting paints

Environmental hazards: destroy your vehicle's finish.

Even as your new vehicle rolls off the assembly line, the paint is not protected.

The enemy

Ultraviolet Rays, Pollution, Tree Sap, Bird Droppings, Car Wash Chemicals, Road Salt, Acid Rain.

Benefits: Vehicle Exterior Enrichment

- Removal of medium scratches, orange peel, oxidation, dust nibs etc & swirl marks from painted surface.
- Restoration of original gloss levels, UV protection after gloss is restored.
- Cleaning & dressing of tyres, Bumpers & all exterior plastic moldings/trims.

TATA MOTORS has tied up with **M/s Autokrom, M/s 3M & M/s Wuerth** for this world class treatment at affordable prices. This treatment is available in all authorized workshops. The Dealer Service Marketing Executive will explain to you the benefits and terms and conditions of this treatment.

CAR CARE AND VALUE ADDED SERVICES

Vehicle Interior Enrichment

Why protect your new car's fabric interior?

- Someone will soil your vehicle's fabric carpet or seats.
- A significant detractor from your vehicle's resale value.
- A permanent stain on your vehicle's interior fabric.

The enemy:

Drink Spills - Food Stains - Mud - Ultraviolet Rays Pets - Traffic

Benefits: Vehicle Interior Enrichment

- Removal of medium stains and dirt from all interior parts of the car i.e carpet, upholstery and roof lining.
- Cleaning of windshield and all windows (inside and outside)
- Dressing of all internal plastics (eg: door pad trims) and rubber parts.
- The treatment involves cleaning and dressing of all parts of the exposed interiors.
- Specialised protection for seat fabric from liquid spills.

TATA MOTORS has tied up with M/s Wurth and M/s M/s Autokrom for this world class treatment at affordable prices. This treatment is available in all authorized workshops. The Dealer Service Marketing Executive will explain to you the benefits and terms and conditions of this treatment.

I / We have been explained the Terms and conditions, Coverage and Owner's responsibility by the Dealer Service Marketing Executive.

I wish to avail / Do not wish to avail extended warrant policy.

Customer's Signature

Dealer's Signature

Why de-carbonisation is required in Diesel engines?

Carbon deposits accumulate over time in injector pump, fuel injectors, combustion chambers & intake valves. This causes rough idle, vibration at idle, loss of power, hesitation, misfire, decreased mileage, increased smoke, slowed throttle response.

Decarbonisation process is designed to remove these deposits

- Clean fuel injectors
- Clean throttle body
- Clean plenum and air-intake
- Clean intake valves and ports
- Remove combustion chamber deposits
- In maintaining correct balance of fuel and air in system



Resulting in

- Comprehensive clean-up of combustion chamber, induction system & fuel injector deposits
- Better fuel economy
- Increased engine performance and response
- Smooth Starts, idles and quieter run
- Better combustion & increased power
- Faster starting & warm-up
- Reduced emissions
- Reduced injector & pump wear, thereby resulting in savings in maintenance costs

It is approved for low sulphur diesel fuel and EGR equipped diesel engines

CAR CARE AND VALUE ADDED SERVICES

Please note: These are symptomatic treatments to be availed beyond 20000 kms and only when you have problems in your car as mentioned in first paragraph and are to be done only after you give your consent for carrying out these treatments.

Engine Flush treatment helps in

- Safely and effectively cleaning and removing oxidized particles and fluid contamination left behind from previous oil changes
- Preventing further deposits
- Freeing sticky lifters and rings
- Chemically “tuning” the engine during driving
- Restoring pep and power
- Removing sludge from valve train
- Promoting fuel economy and improving overall engine operation

Special products used for improving compression

To fortify new oil and seal rings for optimum performance, special products from BG (RF7) and Bardhal (Special Duty) are added to new engine oil. This makes it suitable for petrol and diesel engine applications

Resulting in:

- Improved engine compression
- Increased power and increased fuel economy
- Reduced start-up wear
- Increased engine life, especially under severe service conditions
- Reduced emissions and oil consumption
- Improved power & performance of older engines
- Prevention of sludge, gum and varnish formation on engine parts both petrol & diesel engines

CAR CARE AND VALUE ADDED SERVICES

Please note: These are symptomatic treatments to be availed beyond 20000 kms and only when you have problems in your car as mentioned in first paragraph and are to be done only after you give your consent for carrying out these treatments.

TATA MOTORS has tied up with **M/s HOEC Bardahl India Ltd and M/s BG** for these world class treatment at affordable prices. These treatments are available in all authorized workshops. The Dealer Service Marketing Executive will explain to you the benefits and terms and conditions of this treatment.

I / We have been explained the Benefits, Terms and conditions and the prices of these treatments by the Dealer Service Marketing Executive.

I wish to avail / Do not wish to avail extended warrant policy.

Customer's Signature

Dealer's Signature

WARRANTY - TERMS AND CONDITIONS

We WARRANT each **TATA TIAGO** vehicle and parts thereof manufactured by us to be free from defect in material and workmanship subject to the following terms and conditions:

1. This warranty shall be for a period of **24 months from the date of sale of the car or a mileage of 75,000 Kms whichever occurs earlier.**
2. Our obligation under this warranty shall be limited to repairing or replacing, free of charge, such parts of the car which, in our opinion, are defective, on the car being brought to us or to our dealers within the period. The parts so repaired or replaced shall also be warranted for quality and workmanship but such warranty shall be co-terminus with this original warranty.
3. Any part which is found to be defective and is replaced by us under the warranty shall be our property.
4. As for such parts as Tyres, Batteries, Audio and / or Video equipment (if any), etc. not manufactured by us but supplied by other parties, this warranty shall not apply, but buyers of the car shall be entitled to, so far as permissible by law, all such rights as we may have against such parties under their warranties in respect of such parts.
5. This warranty shall not apply if the car or any part thereof is repaired or altered otherwise than in accordance with our standard repair procedure or by any person other than from our sales or service establishments, our authorized dealers, service centres or service points in any way so as, in our judgment which shall be final and binding, to affect its reliability, nor shall it apply if, in our opinion which shall be final and binding, the car is subjected to misuse, negligence, improper or inadequate maintenance or accident or loading in excess of such carrying capacity as certified by us, or such services as prescribed in our Owner's Manual are not carried out by the buyer through our sales or service establishments, our authorized dealers, service centres or service points.
6. **This warranty shall not apply to the replacement of normal wear parts, including without limitation, spark plugs, drive belts, hoses, wiper blades, fuses, clutch disc, brake shoes, brake pads, cables and all rubber parts (except oil seal and glass run).**
7. This warranty shall not cover any inherent normal deterioration of the car or any of its parts arising from the actual use of the car or any damage due to negligent or improper operation or storage of the car.
8. This warranty shall not apply to normal maintenance services like oils & fluid changes, head lamps focusing, fastener retightening, wheel balancing and alignment, tyre rotation, adjustment of valve clearance, fuel timing, ignition timing and consumables like bulbs, fuel, air & oil filters and gas leaks in case of air conditioned cars.
9. This warranty shall not apply to any damage or deterioration caused by environmental pollution or bird droppings.

WARRANTY - TERMS AND CONDITIONS

Slight irregularities not recognized as affecting the function or quality of the vehicle or parts, such as slight noise or vibration, defects appearing only under particular or irregular operations are items considered characteristics of the vehicle.

10. This warranty shall be null and void if the car is subjected to abnormal use such as rallying, racing or participation in any other competitive sport. This warranty shall not apply to any repair or replacements as a result of accident or collision.
11. This warranty is expressly in lieu of all warranties, whether by law or otherwise, expressed or implied, and all other obligations or liabilities on our part and we neither assume, nor authorize any person to assume on our behalf, any other liability arising from the sale of the car or any agreement in relation thereto.
12. The buyer shall have no other rights except those set out above and have, in particular, no right to repudiate the sale, or any agreement or to claim any reduction in the purchase price of the car, or to demand any damages or compensation for losses, incidental or indirect, or inconvenience or consequential damages, loss of car, or loss of time, or otherwise, incurred or accrued.
13. Any claim arising from this warranty shall be recognized only if it is notified in writing to us or to our authorized dealer without any delay soon after such defects as covered & ascertained under this warranty.
14. **This warranty is fully transferable to subsequent vehicle owner. Only unexpired remaining period of warranty applies.**
15. We reserve our rights to make any change or modification in design of the car or its parts or to introduce any improvement therein or to incorporate in the car any additional part or accessory at any time without incurring any obligation to incorporate the same in the cars previously sold.

TATA MOTORS LTD. is committed to produce vehicles using environmentally sustainable technology. A number of features have been incorporated in TATA MOTORS passenger vehicles which have been designed to ensure environmental compatibility throughout the life cycle of the vehicle. We would like to inform you that your vehicle meets emission norms and this is being regularly validated at the manufacturing stages.

As a user you too can protect the environment by operating your vehicle in a proactive manner. A lot depends on your driving style and the way you maintain your vehicle. We have given a few tips for your guidance.

Driving

- Avoid frequent and violent acceleration.
- Do not carry any unnecessary weight in the vehicle as it overloads the engine. Avoid using devices requiring high power consumption during slow city traffic condition.
- Monitor the vehicle's fuel consumption regularly and if showing rising trend get the car immediately attended at the Company's Authorised Service Outlets.
- Switch off the engine during long stops at traffic jams or signals. If you need to keep the engine running, avoid unnecessary revving it up or stopping and starting.
- It is not necessary to rev up the engine before turning it off as it unnecessarily burns the fuel.

- Shift to higher gears as soon as it is possible. Use each gear upto 2/3rd of its maximum engine speed.
- A chart indicating gear shifting speeds is given in this book.

Maintenance

- Ensure that recommended maintenance is carried out on the vehicle regularly at the Authorised Service Outlets.
- As soon as you see any leakages of oil or fuel in the vehicle we recommend to get it attended immediately.
- Use only recommended grades and specified quantity of lubricants.
- Get your vehicle checked for emission periodically by an authorised dealer.
- Ensure that fuel filter, oil filter and breather are checked periodically and replaced, if required, as recommended by TATA MOTORS.
- Do not pour used oils or coolants into the sewage drains, garden soil or open streams. Dispose the used filters and batteries in compliance with the current legislation.
- Do not allow unauthorized person to tamper with engine settings or to carry modifications on the vehicle.
- Never allow the vehicle to run out of fuel.
- Parts like brake liners, clutch discs should be vacuum cleaned. Do not use compressed air for cleaning these parts which may spread dust in the atmosphere.

ENVIRONMENT SAFETY

While carrying out servicing or repairs of your vehicle, you should pay keen attention to some of the important engine aggregates and wiring harness which greatly affect emission. These components are:

1. Fuel injection equipment's - pump, rail, injectors, nozzles and high pressure pipes.
2. Air Intake & Exhaust system, especially for leakages.
3. Cylinder head for valve leakage.
4. All filters such as air, oil and fuel filters (check periodically).
5. Turbocharger.
6. Electrical connections.
7. If the 'Service' lamp continuously glows, please take the vehicle to a TATA MOTORS authorized service outlet.
8. Catalytic Converter.
9. EMS wiring harness i.e. electrical connections to all sensors and actuators.

This Owner's manual contains further information on driving precautions and maintenance care leading to environment protection. Please familiarize yourself with these aspects before driving.



TATA MOTORS | SERVICE

RESPONSIVE • RELIABLE • BEST VALUE

TATA MOTORS | SERVICE
RESPONSIVE

24x7
ON-ROAD ASSISTANCE
1800 209 7979

TATA MOTORS | SERVICE
RESPONSIVE

DOORSTEP SERVICE
MOBILE SERVICE

TATA MOTORS | SERVICE
RESPONSIVE

ONLINE SERVICE
APPOINTMENT
AT A CLICK

TATA MOTORS | SERVICE
RESPONSIVE

QUICK REPAIR
REPAIR IN MINUTES

TATA MOTORS | SERVICE
RESPONSIVE

SPEED-O-SERVICE
FASTER SERVICE
DELIVERY

TATA MOTORS | SERVICE
RELIABLE

REFINISHING SOLUTIONS
BODY & PAINT

TATA MOTORS | SERVICE
RELIABLE

DIAGNOSTIC EXPERT
HIGH SKILLED TECHNICIAN

TATA MOTORS | SERVICE
RELIABLE

QUALITY SERVICE
SERVICE QUALITY
ASSURANCE

TATA MOTORS | SERVICE
RELIABLE

**ASSESSMENT TRAINING
AND CERTIFICATION**
BUILDING COMPETENCY

TATA MOTORS | SERVICE
BEST VALUE

EXTENDED WARRANTY
UP TO 4 YEARS

TATA MOTORS | SERVICE
BEST VALUE

RAPID REPAIR
MINOR BODY REPAIRS

TATA MOTORS | SERVICE
BEST VALUE

TOP
ORIGINAL PARTS
UNMATCHED QUALITY

TATA MOTORS | SERVICE
BEST VALUE

VALUE CARE
MAINTENANCE PLANS

Call us: 1-800-209-7979
Mail us: customercare@tatamotors.com
Visit us: service.tatamotors.com

5424 5840 99 01

TIAGO
FROM **TATA** MOTORS



Developed by: Technical Literature Cell, ERC.