



TATA MOTORS



Indica eV2

(NA / CR-4 / MPFI)

OWNER'S MANUAL & SERVICE BOOK

CAR IDENTIFICATION AND RECORD :

OWNER'S NAME : _____

ADDRESS : _____

SELLING DEALER CODE : _____

DATE OF DELIVERY : _____

DATE OF REGISTRATION : _____

REGISTRATION NO. : _____

CHASSIS NO. : _____

ENGINE NO. : _____

TRANSAXLE NO. : _____

BATTERY MAKE : _____

BATTERY SR. NO. : _____

BATTERY CODE : _____

THE WARRANTY ON THIS CAR IS VALID ONLY IF THE DETAILS ARE FILLED, SIGNED AND STAMPED BY THE SELLING DEALER

**DEALER'S SIGNATURE
AND STAMP**



**Following items are provided with your
TATA Indica eV2 :**

1. Owner's Manual & Service Book
2. Battery Warranty Card
3. First Aid Kit
4. Advance Warning Triangle
5. Jack and Handle
6. Spare Headlamp bulbs - 2 Nos.
7. Spare Fuses - (Provided in fuse box)
8. Tool Kit
 - a. Wheel Spanner
 - b. Screw Driver
 - c. Open end spanner (8-10)
 - d. Adjustable Plier
 - e. Tubular Spanner (10-11)
9. Manufacturer's Manual for Music System (if fitted)



INDICA e-V2 & INDICA XETA

NA (BS-III) / CR-4 (BS-IV) / MPFI (BS-IV)

Owner's Manual & Service Book

TATA MOTORS

Passenger Vehicle Business Unit

• Mumbai • Pune •

The contents given in this book are not binding, subject to change without notice and are for illustration purpose only.

-
- Should any question or query exist regarding any aspect of your car, please contact the nearest **TATA MOTORS** dealer, who will be pleased to assist wherever possible.
 - The recommended routine maintenance servicing along with any running repairs that may be required, should be entrusted to **TATA MOTORS** dealership or to **TATA MOTORS Authorised Service centres (TASCS)** or **TATA MOTORS Authorised Service Points (TASPS)** to ensure that only latest methods and genuine **TATA MOTORS** replacement parts are used for the continued reliability, safety and performance of the vehicle.
 - Copyright 2013 **TATA MOTORS**
 - All rights reserved. The material in this manual may not be reproduced or copied, in whole or in part, in any form without written permission from **TATA MOTORS**.
 - In the event of the Vehicle being sold, please ensure that this manual is left in the vehicle for the reference of the new owner.

This owner's manual & service book includes information on the operation and maintenance of various equipment installed on the different versions of **Tata Indica e-V2**. Please note that this manual applies to all the models and explains all equipment including options not installed on your car.

Dear Indica Customer,

We are privileged to have you choose the **Tata Indica e-V2**. The car comes backed by the trusted Tata brand and is part of the stable of offerings from **TATA MOTORS** in the passenger car range.

We would want you to be acquainted with the details in this user's manual, which will enable you to derive optimum performance from your Indica. We look forward to having you as a satisfied customer and hope to have you retain us as your first choice for any of your motoring needs.

TATA MOTORS



Contents

INTRODUCTION	3
24 X 7 ON ROAD ASSISTANCE	9
VALUE ADDED SERVICE	13
TAKING CARE OF THE ENVIRONMENT	23
WARRANTY	25
INFORMATION AT A GLANCE	27
BEFORE DRIVING	29
STARTING & DRIVING	81
MAINTENANCE & CAR CARE	99
EMERGENCY SERVICE TIPS	133
IMPORTANT INFORMATION	143
CUSTOMER SUPPORT NETWORK	161

TATA MOTORS

Rely on us... always.

Call Us : 1 800 209 7979

Mail Us : [customercare @tatamotors.com](mailto:customercare@tatamotors.com)

Visit Us : [www. customercare.tatamotors.com](http://www.customercare.tatamotors.com)

IMPORTANT INFORMATION ABOUT THIS MANUAL

SAFETY AND VEHICLE DAMAGE WARNINGS

In this manual, you will see **CAUTION**, **NOTICE** and **WARNING**.

CAUTION

This is a warning. May cause injury to people if the warning is ignored. You are informed what you must or must not do in order to avoid or reduce the risk to yourself and other people.

NOTICE

This is a warning. May cause damage to the vehicle or its equipment if the warning is ignored. You are informed what you must or must not do in order to avoid or reduce the risk of damage to your vehicle and its equipment.

WARNING

Indicates a strong possibility of severe personal injury or death if the instructions are not followed.

SAFETY SYMBOL

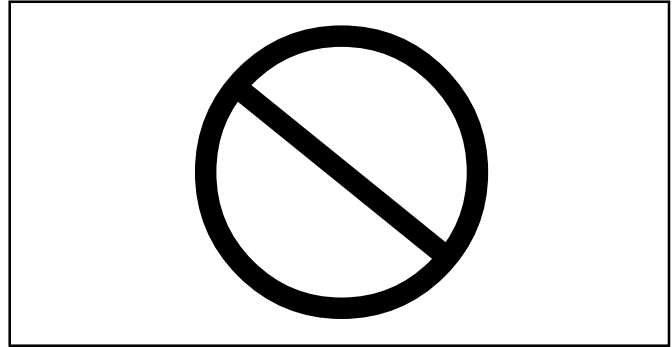

In this manual, you will also see a circle with a slash. This means "Do not", "Do not do this", or "Do not let this happen".

IMPORTANT INFORMATION FOR OWNERS

The information and specifications given in this book are valid as on the date of printing. **TATA MOTORS** reserves the right to make changes in design and specifications and/or to make additions to or improvements in this product without obligation to install them on products previously sold.



Dear Customer,

It is our responsibility and our endeavour to ensure that you have our complete service backup if ever, wherever and whenever you need the same. When you have a road network that spans 33.80 kms, the probability of a breakdown happening within hailing distance of a **TATA MOTORS** Authorized Workshop is very low. It is Precisely for this reason, we have tied up with MyTVS, who will provide breakdown assistance including towing to the nearest **TATA MOTORS** Authorized Workshop through their Authorized Service Providers (ASP)

The **24X7 On Road Assistance** Program shall be automatically available to your vehicle for the duration of Warranty period. The program shall also be available for Extended Warranty period if you avail the same at the time of buying of your vehicle.

Response Time ** for the On Road Assistance Program

Within City Limits	60 minutes
On State or National Highways	90 minutes
Ghat Roads and other places	120 minutes +/-

(The response time will depend on the location, terrain, traffic density and the time of the day.)

Standard procedure when calling for On Road Assistance in case of a breakdown :

- Dial the toll free help line number – **1 800 209 7979**
- Identify your vehicle with the Vehicle chassis number that is available in the Owners Service manual or on the Helpline sticker on the dashboard, near the steering wheel.
- Explain your exact location with landmarks and tell us about the problem you face with the vehicle.
- Park your vehicle on the edge of the road, open the bonnet and put on the hazard warning signal.
- Place the caution sign supplied with the vehicle approx. 3 m from the vehicle in the direction of on coming traffic.

24 X 7 ON ROAD ASSISTANCE

Coverage under the 24 X 7 On road Assistance Program

- I. The **24x7 On Road Assistance** Program Service covers the following services on your vehicle during warranty period.
 - Wheel change through spare wheel.
 - Arrangement of fuel. (Fuel cost will be chargeable at actual cost)
 - Re-opening the vehicle in cases of key lock out.
 - Rectification of electrical problems related to battery, fuses etc.
 - On spot repairs for complaints repairable at site. ^
 - Car to car towing or winching & towing for non accident cases up to a maximum of 15 kms to the nearest Tata Motors authorized workshop. Towing charges at actual cost beyond the same to be paid to the ASP in cash. (Any ferry or toll charges levied in relation to the vehicle being towed to be paid by the customers in actuals in cash).
- II. The **24x7 On Road Assistance** Program coverage as indicated above during the extended warranty period of your vehicle is up to a maximum of 3 events for 18/12 months extended warranty period & 4 events for 30/24 months extended warranty period.

- III. The **24x7 On Road Assistance** Program as indicated above covers Tata Motors Assured vehicles during the extended warranty period up to a maximum of 3 events.

Exclusions

24x7 On Road Assistance Program does not apply to

- Cost of parts consumables and labour for such repairs not covered under warranty*. These charges are to be settled with ASP in cash.
- Toll or ferry charges paid by ASP in reaching to the breakdown site to be settled with ASP in actuals in cash.
- Cases involving accident, fire, theft, vandalism, riots, lightening, earthquake, windstorm, hail, tsunami, unusual weather conditions, other acts of God, flood, etc.
- Vehicles that are unattended, un-registered, impounded or abandoned.
- Breakdown/defects caused by misuse, abuse, negligence, alterations or modifications made to the vehicle.
- Lack of maintenance as per the maintenance schedule as detailed in the owner's manual.

- Cases involving racing, rallies, vehicle testing or practice for such events.

Disclaimer

- The service is not available in the states of Arunachal Pradesh, Assam (Except Guwahati City), Meghalaya, Manipur, Mizoram, Nagaland, Sikkim, Tripura, J&K and in Union Territories of Andaman & Nicobar Islands and Lakshwadeep.
- **The reach time is indicative & the actual reach time will be conveyed by the call centre at the time of breakdown call.
- The reach time can vary depending on the traffic density & time of the day.
- The reach time indicated does not account for delays due to but not limited to acts of God, laws, rules & regulations for time being in force, orders of statutory or Govt. authorities, industrial disputes, inclement weather, heavy down pour, floods, storms, natural calamities, road blocks due to accidents, general strife and law & order conditions viz. fire, arson, riots, strikes, terrorist attacks, war etc.
- ^ On spot repairs at breakdown site shall depend on nature of complaints & will be as per the discretion of the ASP.

- *The decision for free of charge repairs will be as per the warranty policy & procedures of **TATA MOTORS LTD.** and as per the interpretation of the same by ASP. You will be duly informed by the ASP & call centre for the change applicable if any.
- All charges wherever applicable need to be settled directly with the ASP.

24 X 7 ON ROAD ASSISTANCE

EXCLUSION OF LIABILITIES :

- It is understood that **TATA MOTORS** shall be under no liability whatsoever in respect of any loss or damage arising directly or indirectly out of any delay in or non delivery of, defect/deficiency in service/parts provided by ASP.
- In case vehicle cannot be repaired on-site, customers are advised to use the towing facility for taking their vehicle to the nearest **TATA** authorized workshop only. In no condition will the vehicle be towed to any unauthorized workshop. **TATA MOTORS** will not be responsible for any repairs carried out in such unauthorized workshop.
- Customer are advised to take acknowledgment from the ASP for the list of accessories/extra fittings and other belongings in the vehicle as well as the current condition related to dents/scratches breakages of parts/fitments of the vehicle at the time of ASP taking possession of the vehicle & to verify these items when delivery is taken back by them, Claim for loss of or damage to items, if any should be taken up with ASP directly. **TATA MOTORS** shall not be responsible for any such claims, damages/loss or any deficiency of service of the ASP.
- Vehicles will be handled, repaired & towed as per the customer's risk & **TATA MOTORS** shall not be liable for any damages / claims as a result of the same.
- Services entitled to the customers can be refused or cancelled on account of abusive behaviour, fraudulent representation, malicious intent and refusal to pay the charges for any charges related services and spare parts during service or on previous occasion on part of the customer.
- On site repairs may be temporary in nature. The completion of repairs does not certify the road worthiness of the vehicle. The customer is advised to ensure temporary repairs carried out onsite is followed by permanent repairs at **TATA MOTORS** Authorized Workshop at the earliest.
- Terms and conditions and service coverage, exclusions etc. are subject to change without notice.

Dear Customer,

It is our never ending responsibility and endeavor to ensure that our customer's expectations are fulfilled comprehensively. To fulfill your vehicle service needs, we recommend the following :

- 1) *Extended Warranty*
- 2) *Anti Rust / Sound Deadening / Engine waxing treatment*
- 3) *Iftex Fuel Additive : System D (For diesel) and System G (For Petrol)*
- 4) *Car detailing programming : Exterior Enrichment and Interior Enrichment Program*

These products shall help maintain optimum vehicle performance and shall enhance vehicle life.

We have tied up with best in the Class companies, who would bring you the above world class products at affordable prices. The above products are available with all our Dealers, TASCs and TASP.

Our Dealer Service marketing executive shall explain to you the benefits of the above mentioned products.



VALUE ADDED SERVICE

Tata Motors recommends the purchase of Extended Warranty, a product of **M/s Global Administration Services and United India Insurance.**

Coverage : Mechanical + Electrical + Emission

Benifits :

- Insures you against unforeseen break down repair bills.
- Documentation is simple and hassle free.
- Near cashless & speedy claim settlement.



Term :

- **24 + 12 or 150000 kms** whichever occurs first
- **24 + 24 or 150000 kms** whichever occurs first
- **50000 kms + 100000 kms or 36 months** whichever occurs first **(For Taxis).**

EMISSION WARRANTY : Emission warranty is limited to the period of the **Extended Warranty** or **80,000 kms** whichever is earlier.

Extended Warranty available in the dealership from where you have purchased your vehicle. We strongly recommend purchase of Extended Warranty at time of purchase of your vehicle. Surcharge applicable on purchase of Extended Warranty after 30 days of purchase of vehicle. **Extended Warranty can be availed till 421 days from date of purchase of vehicle.** The Dealer Service Marketing Executive shall explain to you the Terms and conditions, Coverage and Owner's responsibility.

Extended Warranty Booklet & Cover Note :

The Extended Warranty booklet and cover note is the basis of the contract between United India Insurance Co. and the Owner of the vehicle shown on the Extended Warranty Cover note. The Customer to retain this booklet and the same to be produced to the dealer while claiming benefits under Extended Warranty.

Note :

- The 12 / 24 month extended warranty does not follow the 24 month Manufacturer's warranty.
- The extended warranty comes into force once the manufacturer's warranty expires e.g. after 24 Months.
- It is more restrictive as by the time it comes into force the vehicle is already 24 months old.

What is covered ?

- Mechanical / Emission / Electrical break down as defined in this warranty and confirmed by the dealer within the stipulated terms and conditions.
- Tata Motors dealer shall either repair or replace any part found to be defective with a new part or an equivalent at no cost to the owner for parts or labour.
- Such defective parts which have been replaced will become property of United India Insurance Company.
- Comprehensive list of parts covered is mentioned in the page 9-12 of the Extended Warranty Booklet.

What is not covered ?

Pages 6 – 7 of the Extended Warranty Booklet provided details of the exclusion list.

Owner's Responsibility :

- Proper use, maintenance and care of the vehicle in accordance with the instructions contained in the Owner's Manual and Service Booklet. The records of the same to be ensured in Owner's Manual.
- Retention of maintenance service bills.

I / We have been explained the Terms and conditions, Coverage and Owner's responsibility by the Dealer Service Marketing Executive.

I wish to avail / Do not wish to avail extended warranty policy.

Customer's Sign

Dealer's Sign

VALUE ADDED SERVICE

IFTEX / BG / BARDAHL Fuel Additive :

Fuel Additive with multiple benefits

- For diesel cars: Iftex System D
- For Petrol cars: Iftex System G

Benefits:

- Cleans injector and fuel system.
- Maintains peak engine performance.
- Saves diesel / petrol and maintenance cost.
- Reduces smoke and harmful emission.
- Helps Smooth running of the engine
- Reduces deposit on intake manifold and combustion chamber.
- Reduces deposit on injector tips.

Approved for use in TATA VEHICLES. NOT RECOMMENDED FOR ON QUADRAJET.

TREAT YOUR CAR TO EXPERIENCE, THE ULTIMATE PERFORMANCE

Directions of use :

- a) For Iftex, Use every 7000 kms for System G Extra / System D Extra. b) For System D / System G - Remove cap, squeeze lightly till dispenser fills to 10 ml mark. Add before filling up the tank. Use at the rate of 1 ml per litre of fuel. For best results, regular use is recommended.
- For BG, add one bottle to full fuel tank every 10000 kms. For Bardahl, add one bottle to full fuel tank every 3000 kms



I / We have been explained the Benefits of the Iftex Fuel additive by the Dealer Service Marketing Executive

I wish to buy / Do not wish to buy the Iftex Fuel Aditive

Customer Signature

Dealer Signature

Why are Corrosion Protection Waxes necessary?

Corrosion is caused by:

Water / salt water acid rain & atmospheric fallouts.

Critical areas are:

Cavities: joints, crevices, spot welds, underbody

- Corrosion is the most important factor when we talk about the vehicle life. If you treat your car you can prolong the life.
- It is very dangerous to drive around in a corroded car.
- The corrosion creeps onto the car from the inside and from the outside. The most dangerous kind of corrosion is often not discovered until it is too late.

Benefits of Anti-Rust treatment :

- A professionally applied range of world class products offering real value to the new and used car customer.
- The treatment has been developed to withstand the harshest environmental and climatic conditions (rst. Pollutants, stone and gravel impact, etc)
- Insulate cabin space from external noises.
- Expensive tin work and Denting / Painting avoided.
- Higher resale value for the car.
- Higher safety – uncorroded vehicle
- Upto 60 months warranty & 10 free checkups available



VALUE ADDED SERVICE

Engine Wax Treatment :

Engine Wax is a beige coloured transparent lacquer coating on the engine compartment.

- Corrosion Prevention for the Engine compartment
- Neat, clean and New Look to Engine compartment
- No effect on MPFI vehicles
- Engine wax can withstand upto 200 degrees temp
- No need of cleaning the engine compartment with diesel once engine wax is sprayed
- Life of over a year

Sound Deadening System :

Door vibration deadeners - These pads when stuck on the insides of the sheet metal increase sheet metal rigidity, reduce vibrations and increase riding comfort.

- Used for reducing the sheet metal vibration in a vehicle.
- Product to be used once in the life of the vehicle - Life Time Warranty
- Effect is Life long i.e. until & unless pads are physically removed.
- Negligible increase in Weight & hence no effect on fuel consumption.
- Areas covered - four doors, rear quarter panels & dicky. In case of diesel vehicles, can be used in the bonnet.

Tata Motors has tied up with **M/s Wuerth** , **M/s STS Chemicals (Dinitrol)**, **M/s 3M India Ltd & M/s Opuient (Waxoyl Brand)** for these world class treatment at affordable prices. These treatments are available in all authorized workshops. The Dealer Service Marketing Executive will explain to you the benefits and terms and conditions of this treatment.

I / We have been explained the Benefits, Terms and conditions and the prices of these treatments by the Dealer Service Marketing Executive

I wish to avail / Do not wish to avail these treatment

Customer Signature

Dealer Signature

Vehicle Exterior Enrichment :

Why vehicles are painted?

- For Corrosion protection of the metal surfaces.
- Ease of application from other corrosion protection treatments.
- Cheaper than other corrosion protection methods eg.galvanizing, anodizing.
- For decoration and identification.



Various Environmental Hazards affecting paints :

- Environmental hazards: destroy your vehicle's finish.
- Even as your new vehicle rolls off the assembly line, the paint is not protected.

The enemy :

Ultraviolet Rays, Pollution, Tree Sap, Bird Droppings, Car Wash Chemicals, Road Salt, Acid Rain.

Benefits: Vehicle Exterior Enrichment

- Removal of medium scratches, orange peel, oxidation , dust nibs etc & swirl marks from painted surface.
- Restoration of original gloss levels UV protection after gloss is restored.
- Cleaning & dressing of tyres, Bumpers & all exterior plastic moldings/trims.

Tata Motors has tied up with **M/s Opulent (Waxoyl brand) M/s 3M & M/s Wuerth** for this world class treatment at affordable prices. This treatment is available in all authorized workshops. The Dealer Service Marketing Executive will explain to you the benefits and terms and conditions of this treatment.

VALUE ADDED SERVICE

Vehicle Interior Enrichment

Why protect your new car's fabric interior ?

- Someone will soil your vehicle's fabric carpet or seats.
- A significant detractor from your vehicle's resale value.
- A permanent stain on your vehicle's interior fabric.

The enemy :

Drink Spills - Food Stains - Mud - Ultraviolet Rays Pets - Traffic

Benefits: Vehicle Interior Enrichment

- Removal of medium stains and dirt from all interior parts of the car i.e carpet, upholstery and roof lining.
- Cleaning of windshield and all windows (inside and outside)
- Dressing of all internal plastics (eg: door pad trims)and rubber parts.
- The treatment involves cleaning and dressing of All parts of the exposed interiors.
- Specialised protection for seat fabric from liquid spills.

Tata Motors has tied up with **M/s Oplulent (Waxoyl brand and M/s 3M** for this world class treatment at affordable prices. This treatment is available in all authorized workshops. The Dealer Service Marketing Executive will explain to you the benefits and terms and conditions of this treatment.

I / We have been explained the Terms and conditions, Coverage and Owner's responsibility by the Dealer Service Marketing Executive.

I wish to avail / Do not wish to avail extended warranty

Customer's Sign

Dealer's Sign

Why de-carbonisation is required?

Carbon deposits accumulate over time in the entire fuel system, including the fuel lines, injector pump, fuel injectors, combustion chambers & intake valves. This causes rough idle, vibration at idle, loss of power, hesitation, misfire, decreased mileage, increased smoke, slowed throttle response.

Decarbonisation process is designed to remove these deposits

- Clean fuel injectors
- Clean throttle body
- Clean plenum and air-intake
- Clean intake valves and ports
- Remove combustion chamber deposits
- In maintaining correct balance of fuel and air in system



Resulting in

- Comprehensive clean-up of combustion chamber, induction system & fuel injector deposits
- Better fuel economy
- Increased engine performance and response
- Smooth Starts, idles and quieter run
- Better combustion & increased power
- Faster starting & warm-up
- Reduced emissions
- Reduced injector & pump wear, thereby resulting in savings in maintenance costs

It is approved for low sulphur diesel fuel and EGR equipped diesel engines

Please note: These are symptomatic treatments to be availed beyond 20000 kms and only when you have problems in your car as mentioned in first paragraph and are to be done only after **you give your consent** for carrying out these treatments

VALUE ADDED SERVICE

Engine Flush treatment helps in

- Safely and effectively cleaning and removing oxidised particles and fluid contamination left behind from previous oil changes
- Preventing further deposits
- Freeing sticky lifters and rings
- Chemically “tuning” the engine during driving
- Restoring pep and power
- Removing sludge from valve train
- Promoting fuel economy and improving overall engine operation

Special Products used for improving Compression

To fortify new oil and seal rings for optimum performance, special products from BG (RF7) and Bardhal (Special Duty) are added to new engine oil. This makes it suitable for petrol and diesel engine applications

Resulting in:

- Improved engine compression
- Increased power and increased fuel economy
- Reduced start-up wear
- Increased engine life, especially under severe service conditions
- Reduced emissions and oil consumption
- Improved power & performance of older engines
- Prevention of sludge, gum and varnish formation on engine parts both petrol & diesel engines

Please note: These are symptomatic treatments to be availed beyond 20000 kms and only when you have problems in your car as mentioned in first paragraph and are to be done only after you give your consent for carrying out these treatments

Tata Motors has tied up with **M/s HOEC Bardahl India Ltd and BG** for these world class treatment at affordable prices. These treatments are available in all authorized workshops. The Dealer Service Marketing Executive will explain to you the benefits and terms and conditions of this treatment.

I / We have been explained the Benefits, Terms and conditions and the prices of these treatments by the Dealer Service Marketing Executive

I wish to avail / Do not wish to avail these treatment

Customer's Sign

Dealer's Sign

Taking care of the Environment

Tata Motors is committed to producing cars using environmental friendly technology. A number of features have been incorporated in our passenger cars which are specifically designed to ensure environmental compatibility throughout the life cycle of the car. We would like to inform you that your car meets emission norms and is being regularly validated at the manufacturing stages to keep up with the stringent emission norms.

As a user you too can protect the environment by operating your car in a proactive manner. A lot depends on your driving style and the way you maintain your car. Listed below are few tips that will help you do so.

WHILE DRIVING :

- Avoid frequent and violent acceleration.
- Do not carry any unnecessary weight on the vehicle as it overloads the engine.
- Avoid using devices requiring high power consumption during slow traffic condition.
- Monitor the car's fuel consumption regularly. If it shows

a rising trend get the car immediately attended to at the Company's Authorised Service Centre.

- Switch off the engine during long stops at traffic jams or signals. If you need to keep the engine running, avoid unnecessary revving or stopping and starting.
- It is not necessary to rev up the engine before turning it off as it unnecessarily burns the fuel.
- Shift to higher gears as soon as it is possible. Use each gear upto $2/3^{\text{rd}}$ of it's maximum engine speed. A chart indicating gear shifting speeds is given in this book.

MAINTENANCE OF THE CAR :

- Ensure that recommended maintenance is carried out on the car regularly at the Tata Motors Authorised Service Outlets.
- As soon as you notice any leakage of oil or fuel in the car we recommend that you get it attended immediately.
- Use only recommended brands and grades of lubricants & coolants and clean/uncontaminated fuels.

ENVIRONMENTAL PROTECTION

- Get your vehicle checked for emission periodically by our authorised dealer and regularly renew the P.U.C. Certificate.
- Ensure that fuel filter, oil filter, breathers are periodically checked and if required, replace the same using only genuine recommended brands.
- Do not pour used oils or coolants into sewage drains, garden soil or open streams. Dispose of the used filters and batteries in compliance with the current legislation.
- Do not allow any unauthorised person to tamper with the engine settings or to carry out modifications on the car.
- Never allow the vehicle to run out of fuel. This will result in misfiring of the engine and could cause harm to the catalytic converter.
- Parts like brake liners and clutch disc should be vacuum cleaned. Do not use compressed air for cleaning these parts which may spread the dust in the atmosphere.

While carrying out the servicing or repairs of your car, you should pay keen attention to some of the important engine aggregates which greatly affect emission. These components are :

- 1. Fuel injection pump , Injectors / Nozzles**
- 2. Air intake & Exhaust system especially for leakage**
- 3. Cylinder head for valve leakage**
- 4. All filters such as air, oil & fuel filters (check periodically)**
- 5. Catalytic converter**
- 6. E.G.R. system (Diesel)**
- 7. Turbocharger & Intercooler (Diesel)**
- 8. Ignition System - Spark plug gap (Petrol)**

This Owner's Manual & Service Book contains further information on driving precautions and maintenance care leading to environment protection. Please familiarise yourself with these aspects before driving.

We **WARRANT** each **Tata Indica** car and parts thereof manufactured by us to be free from defect in material and workmanship subject to the following terms and conditions -

1. This warranty shall be for **24 months from the date of sale of the car or 75,000 kms**, whichever occurs earlier.
2. Our obligation under this warranty shall be limited to repairing or replacing, free of charge, such parts of the car which, in our opinion, are defective, on the car being brought to us or to our dealers within the period. The parts so repaired or replaced shall also be warranted for quality and workmanship but such warranty shall be co-terminus with this original warranty.
3. Any part which is found to be defective and is replaced by us under the warranty shall be our property.
4. As for such parts as tyres, batteries, electrical equipment, fuel injection equipment, etc. not manufactured by us but supplied by other parties, this warranty shall not apply, but buyers of the car shall be entitled to, so far as permissible by law, all such rights as we may have against such parties under their warranties in respect of such parts.
5. This warranty shall not apply if the car or any part thereof is repaired or altered otherwise than in accordance with our standard repair procedure or by any person other than from our sales or service establishments, our authorised dealers, service centres or service points in any way so as, in our judgement which shall be final and binding, to affect its reliability, nor shall it apply if, in our opinion which shall be final and binding, the car is subjected to misuse, negligence, improper or inadequate maintenance or accident or loading in excess of such carrying capacity as certified by us, or such services as prescribed in our Owner's Manual and Service Book are not carried out by the buyer through our sales or service establishments, our authorised dealers, service centres or service points.
6. This warranty shall not cover normal wear and tear or any inherent normal deterioration of the car or any of its parts arising from the actual use of the car or any damage due to negligent or improper operation or storage of the car. This warranty shall not apply to normal maintenance services like oils & fluid changes, head lamps focussing, fastener retightening, wheel balancing, tyre rotation, adjustment of valve clearance, fuel timing, ignition timing and consumables like bulbs, fuel filters & oil filters, etc. This warranty shall not apply to any damage or deterioration

- caused by environmental pollution or bird droppings. This warranty shall not apply to V-belts, hoses and gas leaks in case of air conditioned cars. Slight irregularities not recognised as affecting the function or quality of the vehicle or parts, such as slight noise or vibration, defects appearing only under particular or irregular operations are items considered characteristics of the vehicle.
7. This warranty shall be null and void if the car is subjected to abnormal use such as rallying, racing or participation in any other competitive sport. This warranty shall not apply to any repair or replacements as a result of accident or collision.
 8. This warranty is expressly in lieu of all warranties, whether by law or otherwise, expressed or implied, and all other obligations or liabilities on our part and we neither assume, nor authorise any person to assume on our behalf, any other liability arising from the sale of the car or any agreement in relation thereto.
 9. The buyer shall have no other rights except those set out above and have, in particular, no right to repudiate the sale, or any agreement or to claim any reduction in the purchase price of the car, or to demand any damages or compensation for losses, incidental or indirect, or inconvenience or consequential damages, loss of car, or loss of time, or otherwise, incurred or accrued.
 10. Any claim arising from this warranty shall be recognised only if it is notified in writing to us or to our authorised dealer without any delay soon after such defects as covered & ascertained under this warranty.
 11. This warranty shall stand terminated if the car is transferred or otherwise alienated by the buyer without our prior written consent.
 12. We reserve our rights to make any change or modification in design of the car or its parts or to introduce any improvement therein or to incorporate in the car any additional part or accessory at any time without incurring any obligation to incorporate the same in the cars previously sold.

TATA MOTORS

FILLING STATION INFORMATION

INFORMATION AT A GLANCE

ENGINE OIL UPTO DIPSTICK MAX.MARK ~ 5.5 Litres (DIESEL)
ENGINE OIL UPTO DIPSTICK MAX.MARK ~ 4.0 Litres (PETROL)

FUEL TANK CAPACITY 42 Litres

* Premixed ready to
use Engine Coolant
= 6 Litres

Windshield Washer
reservoir
= 3.5 Litres (With Rear Wiper)
= 1.5 Litres (For rest models)

Brake fluid = 0.270 Litres

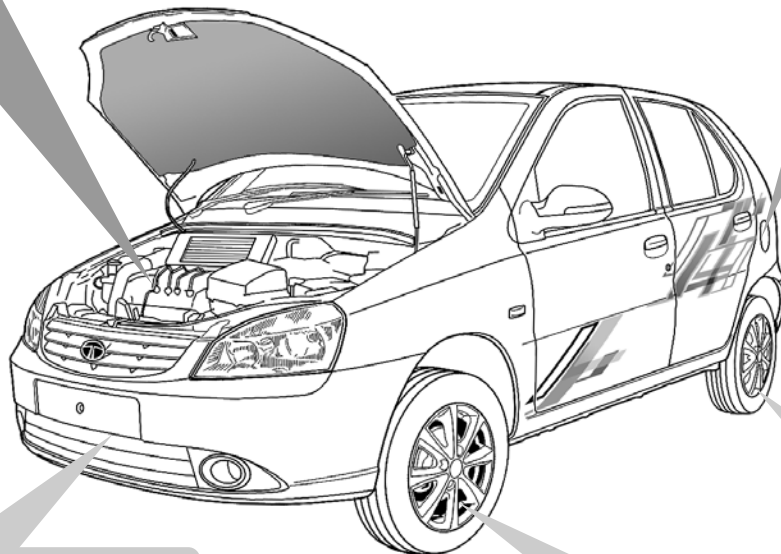

TRANSAXLE OIL 3.3 Litres

IMPORTANT : For fuel specification, please refer 'IMPORTANT INFORMATION - Fuel, Lubricants & Coolants' group

TYRE PRESSURE

TYRE SIZE	FRONT	REAR
165/65 R14 (CR-4)	30 - 36 psi	30 psi
155/80 R13 (NA/MPFI)	32 psi	30 psi

For recommended oil grades and change intervals, refer lubricants chart and Service Schedule.

* If concentrated antifreeze agent is used, mix it with soft water in the ratio of 50:50.

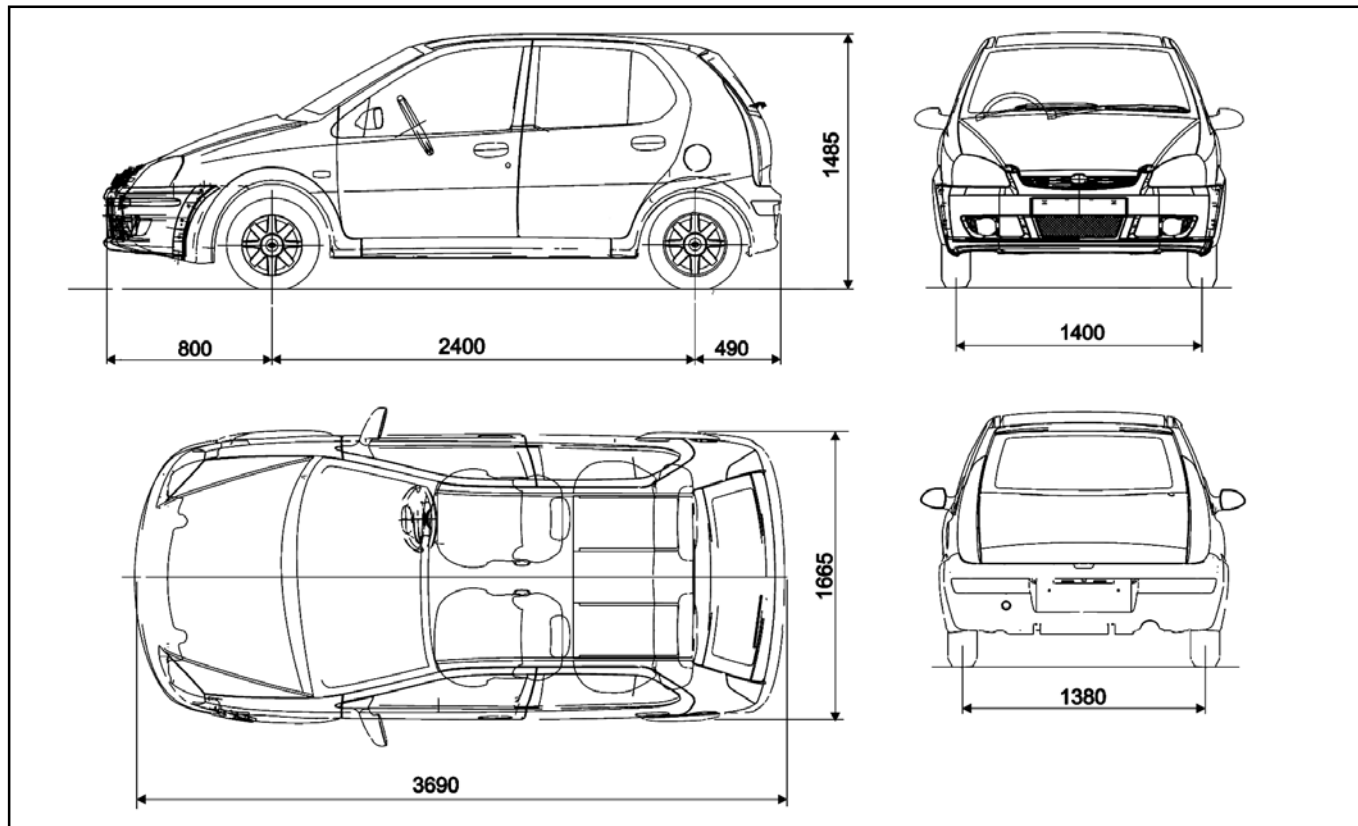

DRIVING CONTROLS

- Driving Controls
- Keys
- Door Locks
- Child Lock
- Remote Keyless Entry
- Steering cum Ignition Switch
- Combi-switch
- Accessory Switches
- Fog Lamps
- Gearshift Lever & Shifting Pattern
- Parking Brake

INSTRUMENT PANEL

- Instrument Panel
- Turn Signals & Hazard Warning
- Indicators
- OBD Diagnostic System
- Gauges
- Audio Warning

LAMPS

- Headamp & Headlamp Leveling Switch
- Fog Lamps
- Tail Lamp
- Registration Plate Lamp
- High Mounted Stop Lamp

HEATING, VENTILATION & AIR-CONDITIONING

- Air Flow Pattern
- Control Knobs

INTERIORS & ACCESSORIES

- Rear View Mirrors
- Inner Rear View Mirror
- Sunvisors
- Window Winding
- Power Windows
- Digital Clock
- Front Seat & Seat Adjustment
- Head Restraint
- Rear Seat & Rear Seat Folding
- Seat-Belt and Seat-Belt Adjustment
- Glove Box
- Power Socket
- Music system
- Trunk lid Opening
- Fuel Flap Opening
- Utility Pocket
- Roof Grab Handle
- Toolkit
- Jack

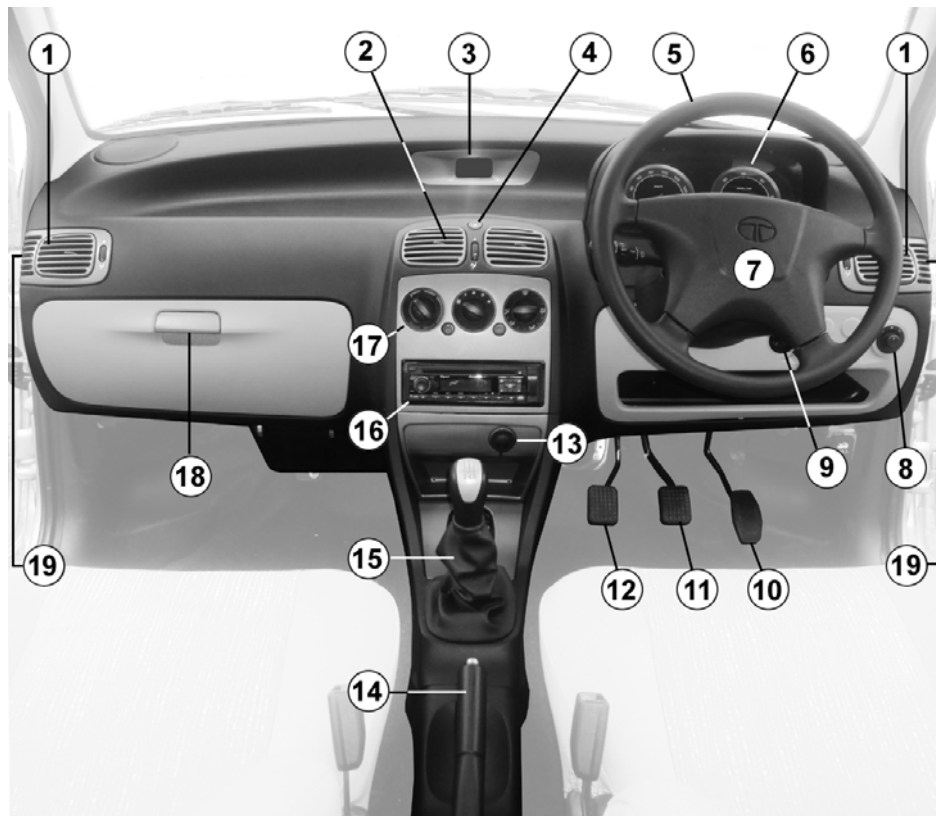

1.	A.C. Side Vents
2.	A.C. Vents at centre
3.	Digital Clock
4.	Hazard Warning Switch
5.	Steering Wheel
6.	Instrument Cluster
7.	Horn Pad
8.	Motorised ORVM Switch
9.	Headlamp leveling Switch
10.	Accelerator Pedal
11.	Brake Pedal
12.	Clutch Pedal
13.	Power Socket
14.	Parking Brake
15.	Gear Shifting Lever
16.	Music System (if fitted)
17.	A.C. Controls
18.	Glove Box
19.	Side Window Demist Grill

Keys :

Your car comes with three identical keys. With this key, you can operate -

1. Door Locks
2. Steering Lock cum ignition switch
3. Trunk lid Lock
4. Glove box

It is advisable to keep one of the keys in a safe place for use in case of an emergency.

NOTICE

- Do not use a locally made key, but obtain a duplicate through your Tata Motors dealer.
- Do not leave the key inside the car.

Door Locks :

The front doors can be locked and unlocked from outside with the key or from inside using the door lock lever. In your car, the driver's door & co-driver's door have separate locking facilities. To lock from inside turn the lever towards the inner hinged handle.

Where the central locking system is provided, if you lock/unlock the driver door with the key, the remaining three doors get locked/unlocked at the same time. The trunk lid is not a part of the central locking provision.

To open the door from outside use the swing handle. After unlocking the door with the key, pull the swing handle upward. The swing handles are provided on each door.

To open the door from inside pull the hinged handle outward.

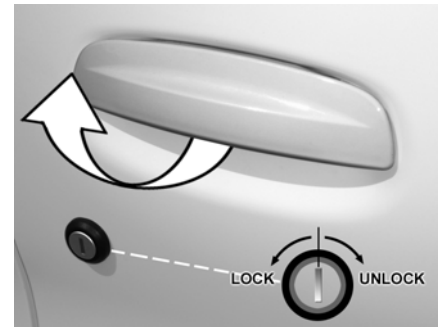
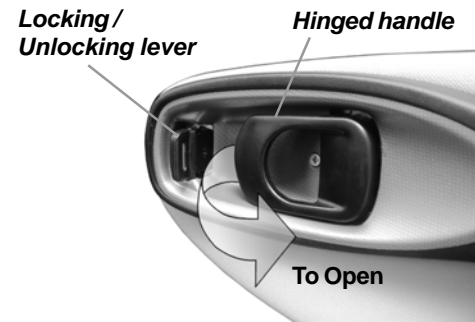
**Outside swing handle****Inside door handle**

IN CASE OF EMERGENCY

- 1) The electrically operated devices (like central locking, power windows) may malfunction in the event of flood / fire, because of temporary or permanent damage to the device. Exercise appropriate precautions for safety of yourself and other occupants.
- 2) If the central locking system malfunctions and is unable to unlock doors electrically, the door can still be opened by manually unlocking knob '1' and opening the door using lever '2'. The mechanical system overrides the electrically operated locking system.

Child Lock :

Both the rear doors of the car are provided with child locks. Push the lock lever located on the vertical face near the rear lock downward before closing the door. The door which has been locked can no longer be opened from inside.

It can be opened only from the outside.

When child lock on rear door is 'LOCKED' the door can only be opened from outside. Use front doors to exit or take help of front occupants.

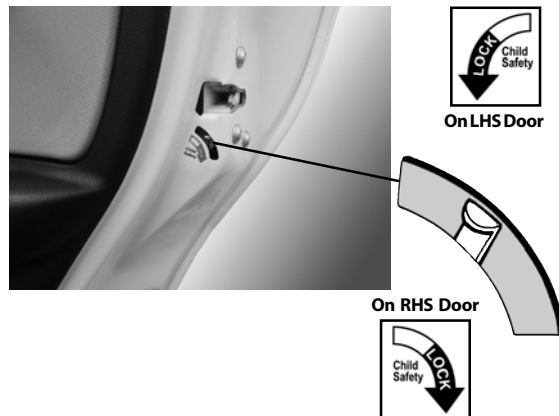

CAUTION

Deactivate the childproof lock when not required.

ELECTRICAL SECURITY SYSTEM :**FEATURES :****1. Remote Operated Central Door Locking**

Pressing the Lock push - button of remote once locks all the doors of the vehicle.

2. Unlocking through Remote

Pressing the unlock push-button of remote will unlock all the Doors.

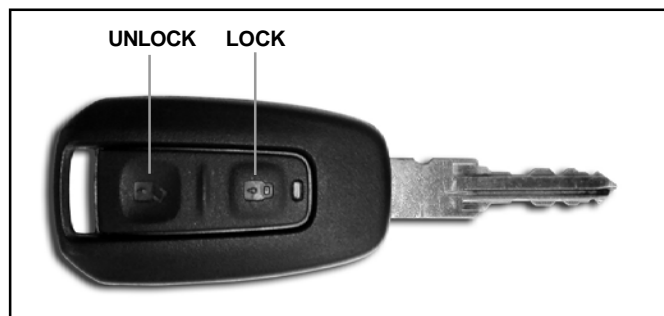
**3. Manual Operation of Central Door Locking / Unlocking:**

All doors can be locked/unlocked from driver door using a key from outside or driver's door knob from inside.

4. Activation of Immobiliser through Remote

Pressing the Lock push-button of remote once will immediately activate the engine Immobiliser and lock all doors also i.e. the vehicle can not be started using a mechanical key (without first pressing the Unlock push-button on remote unit).

6. Automatic activation of Immobiliser

The engine of your vehicle will be immobilised automatically even if you forget to arm the system via the remote unit.

7 Theft Detection & Panic Alarm

Once the system is armed, the alarm is triggered when any of the door is opened or when the key is inserted into the ignition lock.

8. Visual Indication by flashing of Turn Indicators during Locking / Unlocking**9. Auto Locking / Unlocking of Doors**

Approx. 5 seconds after the ignition key returns from Crank position to ignition ON position, all doors get locked (no immobilization takes place in this case).

Immediately after Ignition is Switched OFF, all doors get unlocked automatically.

10. Anti-grab/Anti-scan coding

The remote control set of this security system is protected against the use of devices called 'scanners' and grabbers' which can record and reproduce some types of remote codes.

OPERATING INSTRUCTIONS :**1. Locking, Unlocking & Vehicle Search through Remote Unit****1.1. Arming + Locking all doors**

To activate the immobiliser, alarm and lock all doors, press Lock - push button of the remote. Arming will be confirmed by two flash of turn indicators

The instrument cluster LED will also start flashing.

A safety circuit, makes arming impossible while the engine is running (i.e. either the key is inside the Ignition lock or Ignition in ON).

1.2. Disarming + Unlocking all doors

To disarm the immobiliser, alarm and unlock all Doors, press Unlock push-button of the remote. Disarming will be confirmed by

- A one flash of turn indicators.
- The instrument cluster LED will also turn off.

1.3 Vehicle Search

In Vehicle lock condition if Lock button on remote key is pressed the turn indicators of vehicle flashes 3 times.

2. Manual Operation of Central Door Locking / Unlocking

All doors can be locked / unlocked from driver door lock without using remote.

3. Emergency Disarming Procedure (In case of loss or failure of Remote Unit)

With every vehicle fitted with an immobiliser, the owner is supplied with a card giving a secret code number, and instructions for emergency disarming of the security system.

This is to be used in case the remote is lost, or malfunctions, while the vehicle is in armed or auto-armed condition. It will help the owner disarm the security system and start the vehicle.

The Confidential Code Card is supplied to the vehicle owner in a sealed plastic cover. This plastic cover is to be opened only by the vehicle owner.

Note : Emergency disarming of the vehicle will disarm the vehicle once only. When

Ignition is switched OFF and key removed subsequently, vehicle can auto immobilise again.

a) If the complete system is armed by remote, enter the vehicle using the mechanical key and turn the Ignition ON and then to OFF.

i) The turn indicators start flashing and audio alarm starts sounding. In the meantime the instrument cluster LED stops flashing for about 5 seconds and then starts flashing very slowly.

ii) Count the number of these slow flashes.

iii) When the number of flashes are equal to the first digit of your secret code, turn the ignition ON (for example, if the first digit of your code is 3, wait for the LED to flash 3 times before turning the ignition ON). The instrument cluster LED gives some quick flashes indicating that the first digit entered is correct. Turn the Ignition OFF.

iv) After the quick flashes the instrument cluster LED stops flashing for about 2 seconds and then starts flashing slowly.

v) Count the number of flashes. When the numbers of flashes are equal to the second digit of your secret code, turn the Ignition ON (for example, if the second digit of your code is 2 wait for the LED to flash twice before turning the ignition ON).

The instrument cluster LED gives some quick flashes indicating that the second digit entered is correct. Turn the Ignition OFF.

In the same manner you can enter the remaining digits of your secret code, following the above procedure from step no. (iv) above. In case of error take out the key and insert it again into the Ignition switch, turn the ignition switch ON and OFF and repeat the procedure from step no. i above.

ONCE ALL THE DIGITS HAVE BEEN ENTERED PROPERLY THE SYSTEM WILL DISARM ITSELF. THIS WILL BE CONFIRMED BY THE SHORT FLASHING OF TURN INDICATORS. THEREAFTER, THE VEHICLE CAN BE STARTED.

b) If only Immobiliser is armed due to automatic activation then enter the vehicle and insert the key into the Ignition switch. No audio alarm sounding and flashing of turn indicators will take place. Switching the ignition to ON and then OFF will stop blinking of instrument cluster LED. Wait for the instrument cluster LED to start flashing slowly. Starts from step no. ii above to disarm the system.

Learning of New Remotes : To Learn new remote following procedure to be followed.

- i) Put the vehicle key into the steering lock and turn the Ignition key to ON and OFF position 3 times then turn the ignition back on within 5 seconds.
- ii) After step (i) above the Control Unit enters the Remote Learning mode indicated by flashing of turn indicators (4 times) within 8 seconds follow step (iii) below or Learn routine would be exited.
- iii) Press Lock and Unlock buttons together. Learning of remote would be confirmed by actuators moving to Lock position and then to unlock position and fast blinking of dashboard LED for 2 to 3 seconds. To learn second remote repeat step (iii) within 8 seconds. To erase old lost remote: Learning a new remote would erase the previously learnt remotes.

Important :

For security reasons, every system can accept a maximum of only two remotes.

Every learning procedure disables the remotes which the system had previously 'learnt'.

In case of any error in performing the above sequences the whole procedure has to be repeated from step no. i above.

Battery changing procedure for Indica/Indigo Remote Key :

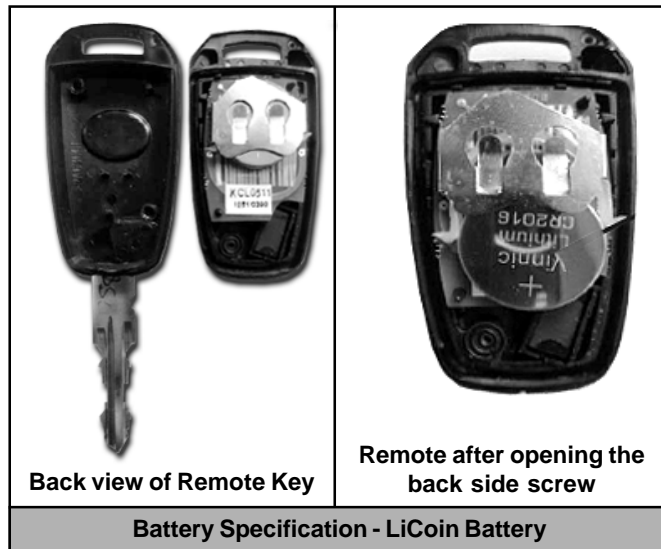

SPECIAL FEATURE :**1. Theft detection & Panic Alarm**

Once the system is armed, the system can sense/detect irregularity by the following conditions:

- Through key in sensor (any unauthorized insertion of key in the Ignition Lock)
- Through opening of door

Once an irregularity is sensed, the system triggers and audible and visual alarm of about 30 seconds.

To stop the alarm press Unlock push-button of remote unit, the audio alarm will stop, all doors will unlock and system will disarm.

2. Limited Alarm Cycle

This facility is designed to minimize any environmental disturbance in conformity with the regulations in force in many countries. The system is equipped with a software that limits the number of repeated alarm cycles generated by any detectors to a maximum of 10 per arming period. This means the alarm will trigger for 30 seconds in case any theft attempt is made on the vehicle and after that the audio alarm will automatically stop. If further theft attempt is detected (i.e. the alarm will again

trigger for 30 seconds. After 10 such cycles of 30 seconds each, no alarm triggering will take place. It will be reinstated the next time the system is armed.

3. Status Memory

In the event that the vehicle battery supply is disconnected and then reconnected, the internal memory of the system remembers the armed/disarmed state it was previously in.

4. Automatic Activation of the Engine Immobiliser

The function of engine immobilisation is vital to the security of a vehicle. Therefore, its activation has been made automatic ("passive"). That is : the engine of your vehicle will be immobilised automatically even if you forget to arm the system via the remote control in the following cases :

- a) If the key is removed from ignition switch, then if any door is opened but not closed the immobiliser will auto arm after approx 5 minutes from the door opening.
- b) If the key is removed from the Ignition switch, any door is opened and all doors are then closed, then the immobiliser will auto arm after approx. 2 minutes of last door closing.

c) If no door is opened, immobilizer will automatically arm within 5 mins.

d) After receiving unlock command, if door open /key in/ ignition on is not sensed by ECU, immobilizer will automatically arm within 5 mins. of unlock button press.

In any of the above cases (a) and (b), only the engine immobiliser will auto arm. The instrument cluster LED will start blinking. And there will be no automatic locking of doors or automatic of alarm in these cases.

To start the vehicle press Unlock push-button of remote unit from outside the vehicle or after switching ON the Ignition.

5. Auto Locking / Unlocking of doors

When the vehicle is started, every time the Ignition key returns from “Crank Position” to the “Ignition ON Position”, all doors get locked after approx. 5 seconds (only doors get locked, no immobilization takes place). As soon as the Ignition is switched OFF, all doors unlock automatically.

6. Open Door Sensing

i. When door is locked manually from driver door, if any door is open, then the driver door knob will spring back

to unlock position immediately and rest of doors will not lock.

ii. When locking is done through remote, if any door is open, the system will go into panic state (alarm mode). In this condition to stop the alarm, the user has to press Unlock push-button of the remote once. The audio alarm will stop, all doors will unlock and system will disarm. Now close all the doors properly and press Lock push-button of remote to lock the vehicle and arm the system.

7. Prevention of Remote Battery Discharge

In case any push push-button of the remote is accidentally pressed for more than 25 seconds, the Remote stops functioning till the time the push-button is pressed. The LED on the Remote also stops glowing.

The function of the remote gets reinstated immediately when the user stops pressing the push-button of remote.

Note : In case of Learning of new remotes, wherein the push-button has to be pressed for a longer duration than 25 seconds (till the instrument cluster LED goes OFF), stop pressing the push-button as soon as the LED on the remote stops glowing and immediately press again till the instrument cluster LED goes OFF.

TIPS ON USE

DO		DON'TS	
1.	Do always keep your vehicle's battery properly charged.	1.	Don't play with Lock/Unlock push-button of remote while in the vicinity of your vehicle, as it could lead to an unintentional unlocking your vehicle.
2.	Do always press the Lock push-button of the remote only after coming out from the vehicle.	2.	Don't lock the vehicle by remote while sitting inside the vehicle.
3.	Do keep the remote in safe and secure place.	3.	Don't use discharged batteries in remote, as it could damage the remote.
4.	Do keep in a safe place your confidential disarming code card, which is supplied in a blue plastic cover with the vehicle. Should you lose or damage your remote control key, using this number and following the procedure of "emergency disarming" will enable you to disarm the system and continue to use your vehicle until you can replace your remote control key.	4.	Don't remove the battery connection of the vehicle while the vehicle has been locked by remote. First unlock the vehicle by remote, and then remove the battery connection.
5.	In case of any problem, always consult only a TATA MOTORS dealer or an authorised service centre.		

CHECK POINTS FOR TROUBLE SHOOTING

This list below details of some possible problems that the owner could face. In case of such problem try using the suggestions given below. If the problem still persist, consult the nearest dealer or authorised service centre of **TATA MOTORS**.

PROBLEM	POSSIBLE REASON	SUGGESTED SOLUTION
Significant change in range of remote	Remote battery is low (even in an open space)	Change the remote battery and try again
No locking / unlocking by space	1. Remote battery is discharged / low 2. Vehicle battery is discharged / low 3. Central door locking fuse has blown	1. Change the remote battery. 2. Charge / Change the vehicle battery as required 3. Fit fuse properly. Change fuse (if it has blown)
No locking by remote	Key is in ignition switch	Remove the key from ignition switch and then try
After turning the ignition switch the vehicle still does not start	The system is in the automatic arming mode of engine immobilizer.	Press the Unlock push-button of remote once Check the LED status
Audio alarm and turn indicators are not been able to stop even after pressing Unlock push-button	Remote is not working	1. Check for the remote batteries, if required change it 2. Try disarming the system through emergency disarming procedure.

Steering lock cum ignition switch :

The steering column lock cum ignition switch has the following four positions and is operated with the key.

- 1. LOCK POSITION** - The key can be inserted or taken out only in this position. When the key is removed from the switch, the steering is locked. To unlock the steering, insert the key and turn it to the 'OFF' (Steering unlock) position.
- 2. 'OFF' POSITION** - In this position, the steering lock opens and the music system is powered.

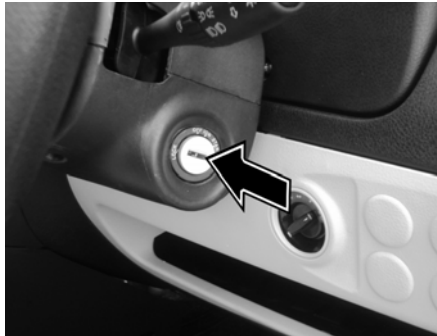

Steering Lock cum Ignition Switch

- 3. 'IGN' POSITION** - This is for switching on the power supply to the following items :

- Blower & A/C
 - Engine cooling fan
 - Horn
 - Power Socket
 - Power window
 - Head lamp leveling switch
 - Head lamps
 - Music system (if fitted)
 - Digital clock / Analog clock
- } Accessories supply
- Engine ignition, fuel supply and glow plug.
 - Turn signal lamps
 - Wash and wiper system
 - Reverse light
 - Instruments and gauges and tell tale warning lamps
 - Audio warning unit
 - Fog Lamps

- 4. 'START' POSITION (Spring return to "IGN")** - In this position, which is momentary, the switch cranks the engine. When the switch is in this position the devices listed under "Accessories supply" above, are switched 'OFF'.

The following items are operated/powerd without the key in the ignition switch :

Hazard warning system, Stop lamps, Position lamps, Registration lamps, Illumination of A.C. control panel and Instrument cluster, Switch symbol lamps, Roof lamp, Reading lamps, Engine lamp, Central door locking, Audio warning unit, Memory of digital clock and Music system.

NOTICE

When the key is returned from 'OFF' position to LOCK position, the music system and the digital clock display continue to be powered until the key is removed from the switch. This also helps to remind the driver if the key is inadvertently left in the vehicle when alighting from the vehicle, where this is provided.

Instrument Panel Light Brightness Control (if installed)

The brightness of instrument panel lights/A.C. Control panel back lights can be controlled by the thumb operated rotary knob which is located on the dashboard near the accessory switches.

⚠ CAUTION

- I) Do not remove the key, while the car is in motion, as the steering will get locked and the car cannot be steered.
- II) While turning the key from 'LOCK' position to 'OFF' position slightly rotate steering wheel to relieve pressure on steering spindle for easy operation of the key. Also ensure the key is inserted fully before turning the key.

COMBI-SWITCH

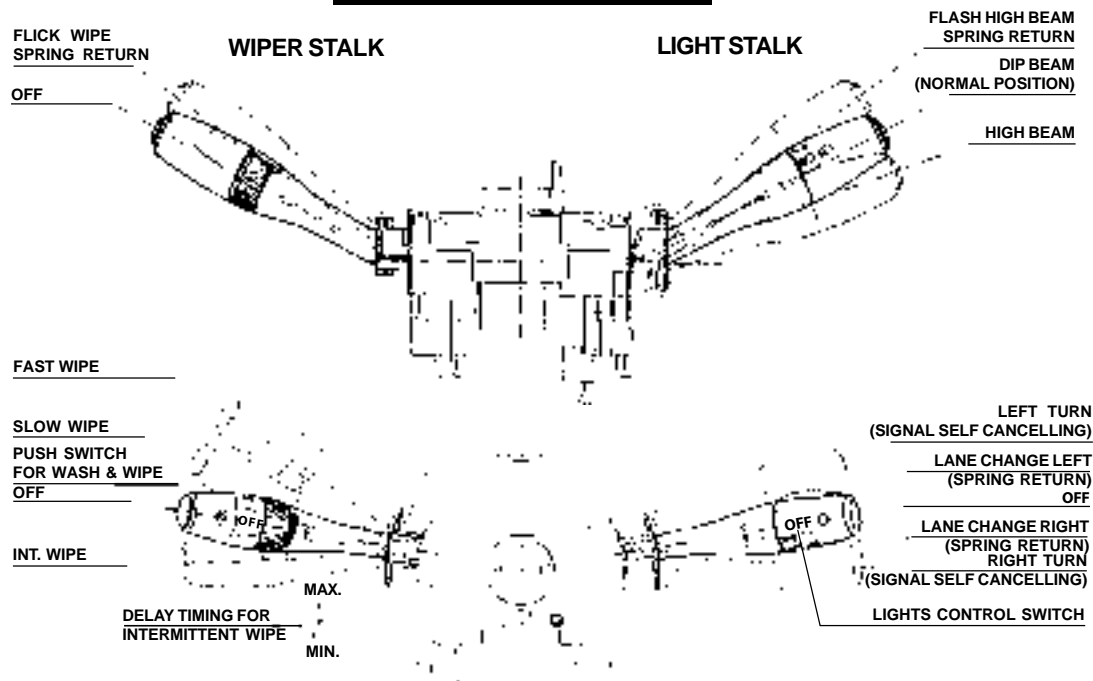

WIPER CONTROL SWITCH LEVER - LEFT

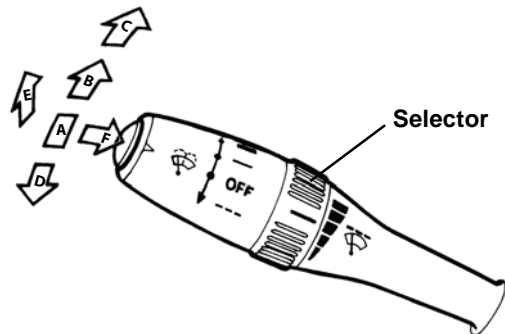
**Wiper Control Switch Lever - Left**

- A. Wiper 'OFF' position
- B. Slow Wipe
- C. Fast Wipe
- D. Intermittent wipe *
- E. Pull up for windshield wipe
(Flick Wipe Spring Return)
- F. Press side knob for wash and wipe

* Rotate selector to set delay timing for intermittent wipe

LIGHTS CONTROL SWITCH LEVER - RIGHT

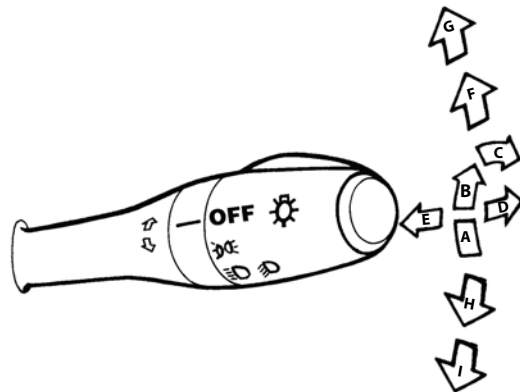
**Lights Control Switch Lever - Right**

- A. Head lamp 'OFF' position
- B. Position lamp 'ON'
- C. Position lamp & head lamp 'ON'
- D. Push down the lever for high beam
- E. Pull up the lever (spring return) for high beam flash
- F. Lane change left (spring return)
- G. Side Indicator - LH (self cancelling)
- H. Lane change right (spring return)
- I. Side Indicator - RH (self cancelling)

Accessory Switches : (if installed)

Accessory switches have been provided on the dash board near the steering column on the right hand side.

1. Rear windshield demister (unlatched switch)

The switch is pushed and released to switch 'ON' and the knob returns to the normal position. The function indicator lights up in amber indicating that the demister heater is 'ON'. The function is controlled through a timer and operates for 15 minutes (approximately) and goes 'OFF' automatically at the end of the duration. The heater can be switched 'OFF' anytime by once again pushing and releasing the switch knob.

NOTICE

Switching 'ON' and 'OFF' can be done only with key in 'IGN' position. The demister heater remains 'ON' even after removal of ignition switch key and goes 'OFF' at the end of 15 minutes period.

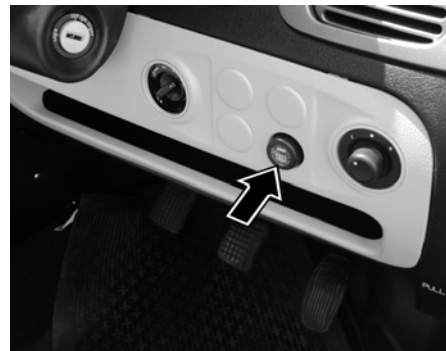

Rear Window Winding Switch

Fog lamps : (If fitted)

Front and Rear fog lamps can be switched ON/OFF by rotating the switch on Combi-Switch.

For front fog lamp: Rotate the switch clockwise to switch 'ON' the front fog lamp. Front fog lamps are operative only when the position lamps are switched 'ON'. Rotate the switch to same direction to switch 'OFF' the front fog lamp.

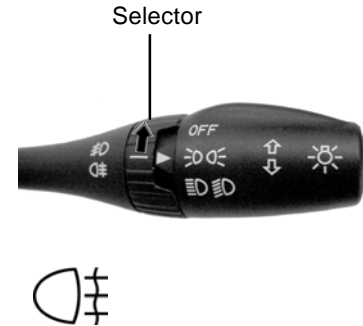

For rear fog lamp: Rotate the switch anticlockwise to switch 'ON' rear fog lamp. Rear fog lamps are operative only when the head lights are switched 'ON' or front fog lamps are switched 'ON'. Rotate the switch to same direction to switch 'OFF' the rear fog lamp.

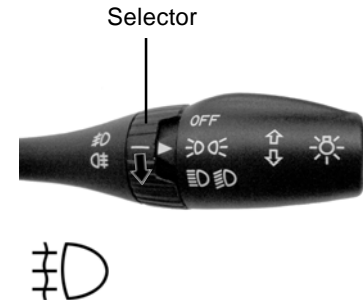

Gearshift lever & Shifting pattern :

The gearshift lever is mounted on the central console between the two front seats. The gearshift pattern is shown on the gear lever knob.

NOTICE

The reverse gear should be engaged only when the car is stationary. Wait for 5 seconds after declutching to ensure smooth engagement of the reverse gear.

Parking brake :

A mechanical parking brake acting only on the rear wheels is provided on your car. The parking brake lever is located behind the gearshift lever. To apply the parking brake, pull the lever up fully. The indicator light (Ⓜ)(Ⓟ) on the instrument panel will become 'ON'. To release it, **pull the lever up slightly**, press the release button and push the lever down. The parking brake indicator (Ⓜ)(Ⓟ) on the instrument panel will go 'OFF' when the parking brake lever is fully released.

NOTICE

Apply the parking brake properly before leaving the car & release it before moving. Use the parking brake for holding the car on a gradient.

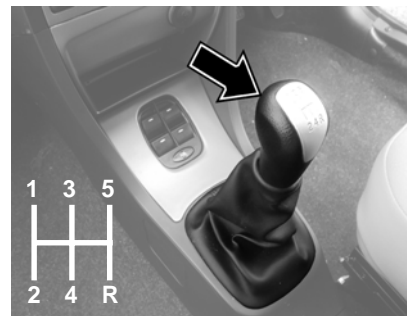

Gear Shift Lever & Shifting Pattern

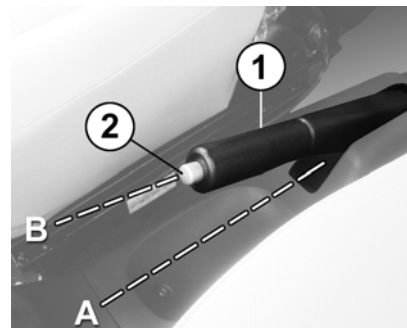

1. Parking Brake Lever
2. Release Button
- A. Parking Brake (Released Condition)
- B. Parking Brake (Applied Condition)

INSTRUMENT PANEL (DIESEL)

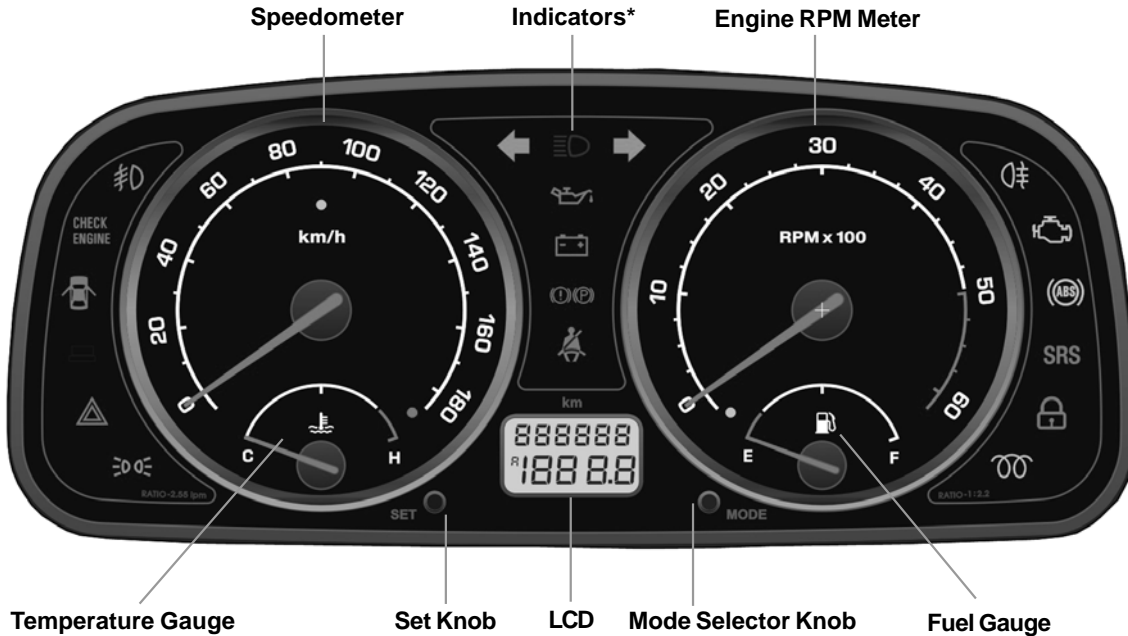

*All indicators and Chrome ring may not be provided on some clusters.

INSTRUMENT PANEL (PETROL)

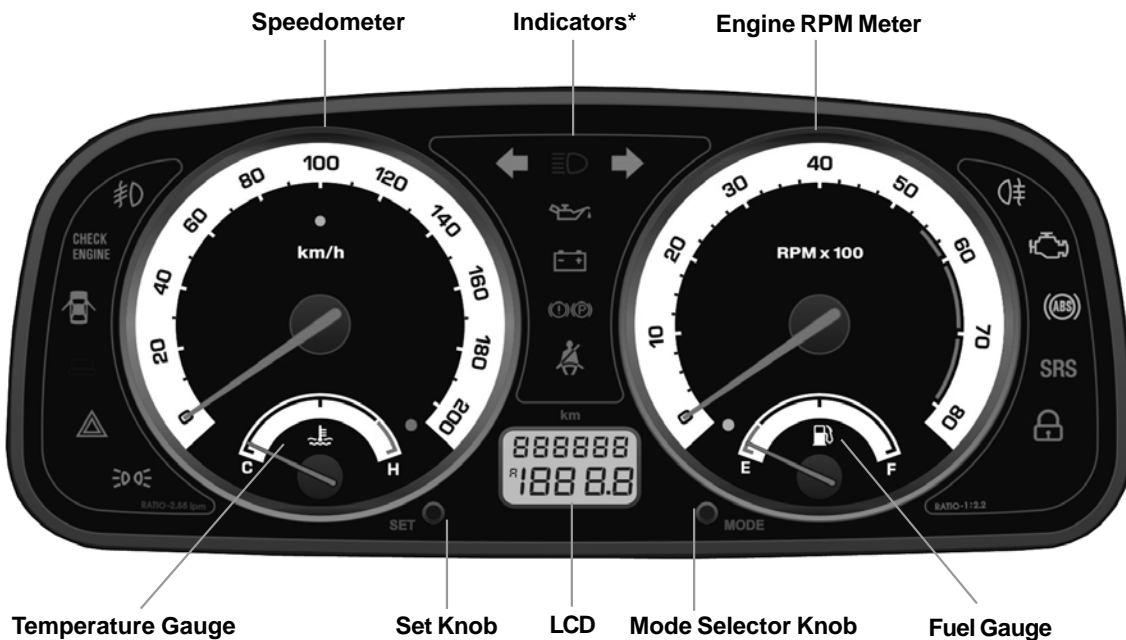

Turn Signal and Hazard Warning :

I) Turn Signal :

Turn signal lamps can be operated only when the ignition supply is 'ON' and by using the turn indicator switch on the combiswitch.

The direction indicator arrow ◀ (LHS) and ▶ (RHS) on the instrument cluster flashes alongwith external indicator lights as selected.



II) Hazard Warning :

This can be operated without ignition 'ON'. Press the hazard warning switch (red knob) on the centre of the dash board, all side indicator lights and indicator ▲ if provided on cluster will flash simultaneously to warn the other road users about any hazardous condition of the car. Depress the knob again to switch 'OFF' the hazard function.

CAUTION

If lights do not blink or blink rapidly, it is an indication of problem in the blinker electrical system or the indicator bulb at front or rear has fused. Get it rectified immediately.



Hazard Warning Switch

Parking Brake Indicator cum Low Brake Fluid Warning Light



When the ignition key is turned to the 'IGN' position, It comes 'ON' for 3 seconds and goes 'OFF' (self check). The symbols light up bright contineously for the following conditions :

- i) when the parking brake is applied, and/or
- ii) when the brake fluid level in the container is low with parking brake released and with brake fluid level in the container is normal, the symbol lights up with low intensity to indicate the warning to check for the lamp bulb. The lamp in this condition goes off automatically along with battery charge indicator when the engine is started. If the lamp glows bright while engine is running, then check the parking brake or brake fluid oil level.
- iii) When ABS/EBD system has some fault (For ABS)

CAUTION

Do not drive the car if this indicator remains 'ON'. Get the problem attended to immediately at an Authorised Service outlet.

High Beam Indicator :

Symbol lights up when the headlamp high beam is 'ON'.



Position Lamp Indicator :



Symbol lights up when the position lamps are switched 'ON'. (Instrument cluster illumination lamps, illumination lamps for AC, HVAC or ventilation panel are 'ON', when the position lamps are 'ON'). The intensity of digital clock display reduces. Position lamps can be used as parking lamps.

NOTICE

Position lamps also remain 'ON' while head lamps are 'ON' and in this condition, instrument cluster illumination lamps will not be 'ON'.

Low Oil Pressure Indicator :



When the ignition key is turned to the 'IGN' position, symbol lights up and goes off as soon as the required engine oil pressure is developed after starting the engine.

NOTICE

If the low oil pressure indicator does not glow or remains 'ON' with the 'IGN' on and engine is running, it indicates a fault in the electrical circuit/lubrication system. Check & get the problem attended to at an Authorised Service outlet.

Water in fuel sedimenter indicator lamp:(If fitted)- CR-4

This light comes 'ON' when there is excess water in the Water sedimenter. In the event of this lamp glowing continuously, it is recommended to take your vehicle to nearest service outlet or drain the water from the sedimenter yourself. Please refer to fuel filter and fuel system in maintenance section for steps to be followed for draining the Water.

Battery Charging Indicator :

Symbol lights up when the 'IGN' is turned 'ON' and should go 'OFF' after the engine starts.

NOTICE

If it remains 'ON' while the engine is running, it indicates that the battery is not being charged. Switch off all unnecessary electrical equipment and get the problem attended to at an Authorised Service outlet.

Glow Plug Indicator (Diesel)

Symbol lights up when the 'IGN' is switched 'ON' and goes 'OFF' after a few moments automatically depending on the engine temperature, indicating readiness to start the engine.

Do not start the engine until this light goes off. The duration of 'ON' time varies with engine block temperature and it glows for a longer duration with a cold engine.

NOTICE

If this indicator blinks instead of glowing steadily, it indicates that the temperature sensor connection to the glow plug regulator is either open or the sensor is faulty. In this condition, the engine can be started, and the car can be driven. However, the fault should be attended to at the earliest, at an Authorised Service outlet, as it affects the engine starting performance initially before the engine warms up.

ABS Indicator:

When ignition is turned 'ON', this symbol comes 'ON' for three seconds and goes 'OFF'.

This symbol will continue to remain 'ON' or will come 'ON' after Ignition On precheck if there is a problem in the ABS system.

Service Indicator Lamp :

This symbol indicates the car's engine condition.

1. It comes "ON" when ignition is switched "ON" and once engine is cranked, it goes "OFF".

- It remains “ON” if there is a problem in any of the EMS related / engine components.

NOTICE

If the Service indicator lamp remains “ON” when the engine is running, the engine’s performance deteriorates marginally & sometimes significantly. Take your car to a TATA Motors Authorized Service Centre.

Malfunction Indication Lamp (MIL) :

This symbol comes 'ON' when the ignition is turned “ON” and goes “OFF” once the engine is cranked.

**NOTICE**

This symbol will remain “ON” for any engine related fault, which may cause increase in emission levels of the car beyond the regulatory limit. Take your car to a TATA Authorized service centre.

On Board Diagnostic (OBD) System:

On board Diagnostics or OBD is an automotive term referring to a vehicle’s self Diagnostic and reporting capability. The OBD system allows continuous diagnosis of the components of the vehicle correlated with emissions. This system warns the driver, by turning “ON” the Malfunction Indication lamp (MIL) on the instrument cluster, when a fault causes emission levels to increase.

The OBD system also has a diagnostic connector that can be interfaced with appropriate diagnostic tools, which makes it possible to read the fault codes stored in the Electronic Control Unit, together with a series of specific parameters for Engine operation and Diagnosis. This check can also be carried out by the traffic police. The diagnostic connector is located below co-driver seat as shown in the figure.

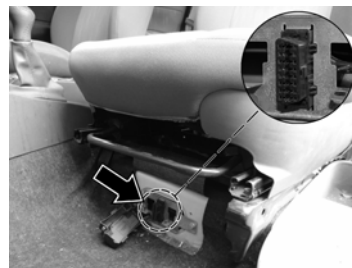

OBD connector below co-driver seat

NOTICE

In case the fault occurs and MIL on the instrument cluster comes ON, contact nearest **TATA MOTORS** authorized service center. After eliminating the inconvenience, to check the system completely, **TATA MOTORS** authorized service centers are obliged to run a bench test and if necessary, road tests which may also call for a long journey. The functioning of MIL lamp may also be checked by the traffic police using specific devices.

Speedometer, Odometer and Tripmeter (on LCD) :

The speedometer indicates the car speed in km/hr. The odometer records the total distance the car has been driven. The tripmeter can be used to measure the distance travelled on each trip or between fuel fillings. The tripmeter can be reset to zero by pushing the reset knob.

NOTICE

Keep track of the odometer reading and follow the maintenance schedule regularly for meeting service requirements.

Odometer, Tripmeter and Intensity control on instrument panel (LCD) :

The Instrument panel has a LCD to display the following :

- Main Odometer (Non-resettable) - Counts upto 999999 kms
- Tripmeter A (Resettable) - Counts upto 1999.9 kms
- Tripmeter B (Resettable) - Counts upto 1999.9 kms

Intensity level of instrument panel illumination - selection among preset levels.

LCD has two line display. The first line displays the Odometer count. The second line displays either of Tripmeter A, Trip meter B, Intensity level of panel illumination.

The selection and control of functions are done through 'MODE' and 'SET' pushbuttons (knobs) provided on either side of the LCD.



Speedometer (Diesel)



Speedometer (Petrol)

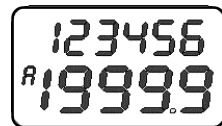

Display for Trip - A

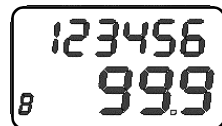

Display for Trip - B

Odometer

Tripmeter
or
Intensity
level of
panel
illumination

Set
Knob

Mode
Selector
Knob

The 'MODE' knob is used to select one of Tripmeter A, Tripmeter B or Intensity level of panel illumination. Switching among the above three function scan be done by pressing the knob.

RPM meter : (if installed)

The meter indicates engine speed in revolutions per minute (rpm). Change gears at appropriate engine rpm and car speed to get optimum fuel economy.

The red mark provided on the dial is the permitted engine rpm upper limit. (5000 RPM for Diesel vehicles)

If RPM meter doesnot indicate during cold starting, gently raise the engine RPM till the battery charge lamp goes off.

Temperature gauge :

The gauge indicates the temperature level of the engine coolant. The red zone at 'H' indicates temperatures higher than normal.

Avoid driving, when the pointer is in the red zone. It indicates engine overheating, which may be due to insufficient coolant in the radiator or due to any other defect. Take the car to the nearest Authorised Service outlet for necessary attention.

⚠ CAUTION

Never remove the cap from the coolant reservoir when the engine is hot. Do not restart the engine until the problem has been duly attended.

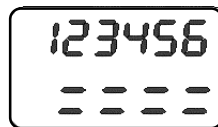

Intensity Level Indicator



RPM meter (Diesel)



RPM meter (Petrol)



Temp Gauge (Diesel)



Temp Gauge (Petrol)

Fuel Gauge :

The fuel gauge indicates the approximate fuel level in the tank. Refill the fuel tank at the earliest, when the needle touches the red band at this time amber light comes 'ON' (indicating reserve level has been reached.) When key is turned to 'IGN' amber light will come 'ON' and go 'OFF' as a self-check, even if needle not touches the red band.

NOTICE

As the gauge is a high damped type, observe the reading only 60 seconds after the ignition being 'ON'.

Over speed warning indicator: (if provided)

The over speed warning indicator will come 'ON' if vehicle speed is reaching more than 120 kmph.

Audio Warning Unit**Seat-belt Reminder (Beeper) : (If installed)**

When the key is in the 'IGN' position and the driver's seat-belt has not been fastened, you get an audio warning. The beeper will go off automatically after a few seconds.

'Key in 'Warning Beeper : (if installed)

When the ignition is turned to 'OFF' position and the key is not removed from the switch, an audio beep comes on if driver door is open. The beeper will go off after a few seconds automatically or if warning is ignored or if the key is removed/ door is closed.

*Fuel Gauge (Diesel)**Fuel Gauge (Petrol)***Over Speed Warning Indicator***Speedometer (Diesel)**Speedometer (Petrol)*

Head Lamp:

Head lamps are clear lens type having multi focal reflector and are provided with two H7 halogen lamps for straight ahead illumination of the road over a long distance or dip beam for short distance visibility. It also contains side indicator lamp and a parking lamp.

Headlamp leveling switch: (If fitted)

A motorised headlamp leveling arrangement with the setting knob at the dash board is provided on the LH side of steering column.

As and when required, head lamp leveling, setting is done by rotating the knob to select one of the 3 levels marked in the switch depending upon the loading of the vehicle.

Head lamp leveling can be done with the head lamp in Low beam and in 'ON' position.

NOTICE

- Setting should be done only when the car is stationary.
- Since the leveling switch alters the headlamp focus pattern under varying load conditions, it is advisable to select the correct position before starting a trip depending on load.



Headlamp Leveling Switch

Fog Lamps (if fitted):

Front and rear fog lamps are provided for your convenience and they can be operated via the right control switch lever of combi-switch (Right stalk).

Front fog lamps are provided on front bumper and rear fog lamps are provided in tail lamp assembly.



Front Fog Lamps

Lamps 'ON' Reminder (if installed)

When the parking lamps are 'ON', with the ignition key removed from the switch and driver's door is opened then an audio warning is heard to remind you that the lamps are left 'ON'. Please switch off the lamps before leaving the car. However the lamps can be kept 'ON' despite the warning, if desired.

Tail Lamp : The tail lamp assembly incorporates the following-

1. Stop cum position lamp
2. Turn indicator
3. Reverse lamp
4. Fog lamp (provided in some version only)
5. Reflex reflector

Registration Plate Lamps :

Two concealed lamps are provided for illumination of the rear registration number plate.

High Mounted Stop Lamp :

High mounted stop lamp is provided at the rear and it glows whenever service brake is applied.

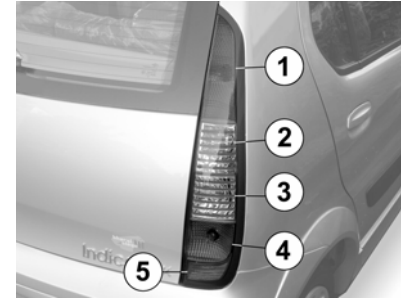

Tail Lamp

*High mounted
stop lamp*



Registration Plate Lamps

Roof Lamps :

Front interior light with reading lamps :

Interior roof lighting and reading lamps with inbuilt switches are provided on the roof near the rear view mirror.

The central rectangular switch has three positions :

- **ON** - The lamp will come 'ON' as long as switch is in this position.
-  **DOOR** - In this position the lamp comes 'ON' when either of the four doors (if door switch provided to all four doors) are opened. When the door is closed, the lamp will not go 'OFF' immediately, but remain 'ON' for 5-8 sec. This helps you to settle in your seat and also insert the key into the Ignition switch.

When the key is turned to the 'IGN' position, the lamp goes 'OFF' immediately, before the delay period.

- **OFF** - In this position the lamp will remain 'OFF' in all conditions.

Two triangular shaped push type 'ON / OFF' switches are provided separately for the right and left reading lamps.

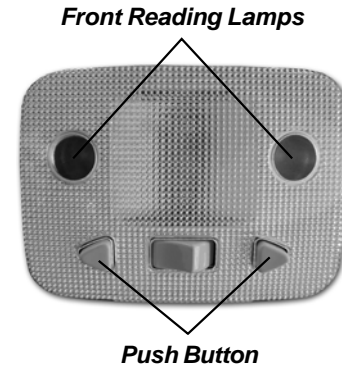

Luggage Compartment Lamp : (if fitted)

A lamp is fitted in the luggage compartment centrally below the parcel shelf to illuminate the luggage area, ON/OFF switch is provided on the lamp and it should be in 'ON' position for lamp to come on automatically with the opening of the trunk lid.

This control is through a switch provided underneath the LH hinge of the trunk lid.

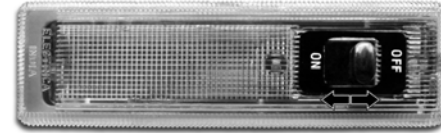

Luggage Compartment Lamp

AIR FLOW PATTERN

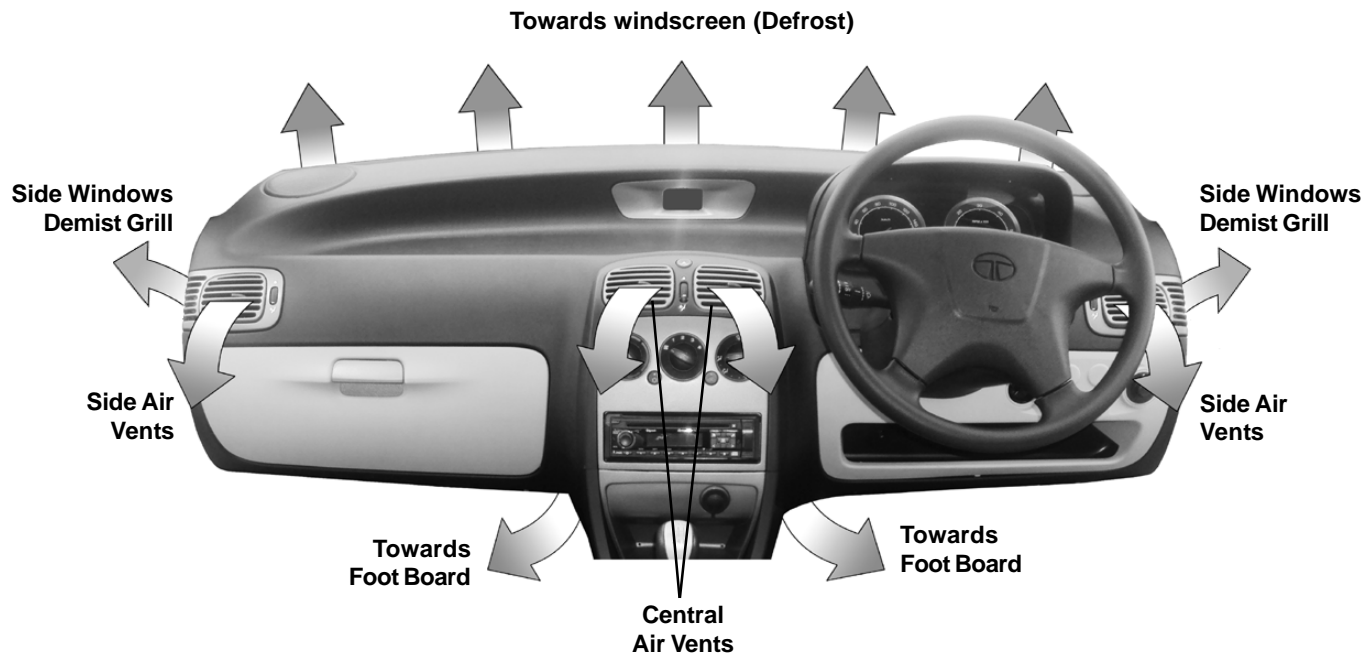

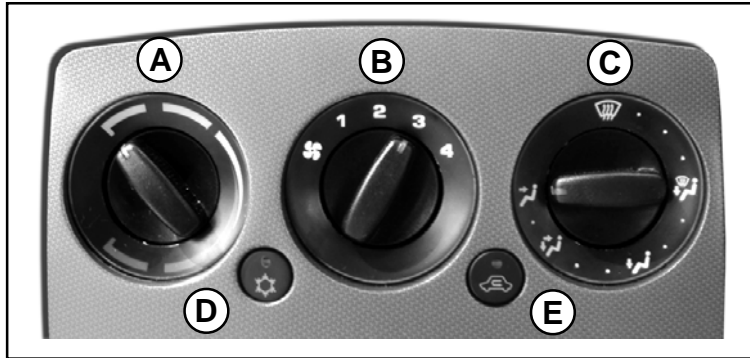
HEATING, VENTILATION & AIR CONDITIONING : (if installed)**A. Temperature Control Knob :**

The air temperature in the car can be controlled by operating the temperature control knob (A) at the left hand side of the control panel. The temperature can be increased by rotating the knob towards the red segment and decreased by rotating it towards the blue segment.

B. Blower Speed Regulation Knob :

The ventilation system has a three/four speed blower. The blower speeds can be regulated to any one of the following speeds by operating the knob (B) at the centre of the control panel.

LOW • MEDIUM • HIGH • VERY HIGH



Temperature Control Knob



Blower Speed Control Knob

C. Air Direction Control Knob :

The air flow can be changed by turning the switch **(C)** to the desired direction.

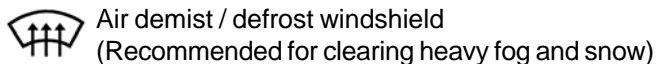
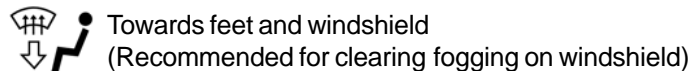
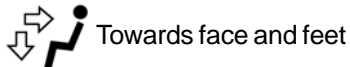
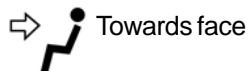

D. A.C. ON/OFF Switch :

The A.C. can be switched 'ON' by pressing the switch **(D)** on the A.C. control panel provided the blower is 'ON' and the engine is running. The indicator lamp will show that the A.C. is 'ON'.



Blower Speed Control Knob

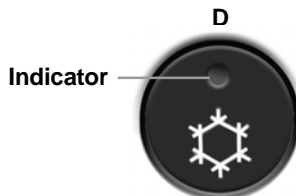

A.C. ON / OFF Switch

E. Air Circulation Switch :

- In HVAC version to put air circulation mode in recirculation, press switch 'E'. The indicator lamp will show air circulation is in recirculation.

To put vehicle in Fresh mode release switch 'E'. Indicator lamp will be 'OFF'.

- In A.C. version, air circulation mode can be selected by pressing knob 'E'.
- In recirculation mode, air inside the vehicle is circulated again and again. In Fresh mode, air is taken from atmosphere and circulated in the vehicle.

Recirculation mode can be used

- While driving in dusty condition
- To avoid traffic pollution
- To get quick cooling/heating as required.

Whenever discomfort is felt switch air circulation mode to fresh.

NOTICE

The A.C. can be switched 'ON' only if the blower is 'ON' and engine is running. When A.C. is switched 'ON' engine idling RPM increases marginally, to adjust to the A.C. compressor load. When desired temperature is achieved A.C. trips 'OFF' automatically.

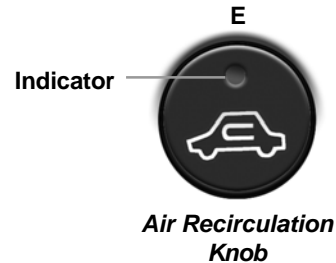

NOTICE

The A.C. compressor gets switched 'OFF' automatically when engine gets overheated. The A.C. is automatically switched 'ON' when the engine cools down.

Normal Cooling :

- A.C. - ON
- Knob 'B' - Desired speed position
- Knob 'C' - Towards face 
- Switch 'E' - Suitably as explained

Quick Cooling :

If your car is left in the sun with window closed, inside temperature increases.

To achieve quick cooling effect, open the windows briefly while you operate the air conditioner, with air circulation switch is in Fresh mode, fan at higher speed and air direction towards 'FACE'. All vents to be opened completely.

Once temperature inside has come down sufficiently, close the windows and change air circulation suitably to fresh/ recirculation.

Demisting :

In rainy season or in areas of high humidity, mist formation inside windshield glass is observed. To clear mist dehumidified air is passed on the windshield glass.

The position of control knobs should be adjusted as follows :

- A.C. - ON
- Knob 'B' - desired speed position
- Knob 'C' - Towards windshield 
- Knob 'A' (Vehicles fitted - at suitable temperature with HVAC)
- Air circulation - at suitable position

NOTICE

When mist gets cleared switch the knob "C" position to Face mode. In high humidity areas, if cold air continues to flow over windshield, it may cause sudden fogging on outside surface of windshield.

Defrosting :(For vehicles fitted with HVAC unit)

In low temperature areas, to clear frost formation outside the windshield glass, this setting is used.

First start the engine and accelerate to warm up.

- Knob 'A' - Maximum hot position
- Knob 'B' - Very High
- Knob 'C' - Towards windshield 
- Switch 'E' - Fresh air mode condition

Once the windscreen has become clear, move the fan switch to desired speed.

NOTICE

Electric heater coil is provided for demisting of tail gate glass for deluxe versions.

Normal Heating : (For vehicles fitted with HVAC)

- Knob 'A' - Suitable temperature position
- Knob 'B' - Suitable blower speed
- Knob 'C' - Towards face & feet 
- A.C. - OFF

Air Circulation- Fresh switch

Quick Heating :

All settings as explained before except air circulation switch to recirculation.

Once vehicle is heated, switch back to fresh mode.

Ventilator :

The air flow can be adjusted continuously with the rotary control knob at the vents on the dash board. The air vents can be adjusted upward and downward. This is common for HVAC, AC and ventilation.

NOTICE

Refrigerant charged in the air conditioning circuit has been identified on the label over front body member. Use only refrigerant as given in the label for topping up or recharge, i.e. do not charge R12 (CFC) in the vehicle earlier charged with R134a (Non CFC) or vice versa.

NOTICE

Fresh air is taken from the grill opening provided at base of windshield glass outside the vehicle. Keep these openings clear and free from fallen leaves etc.

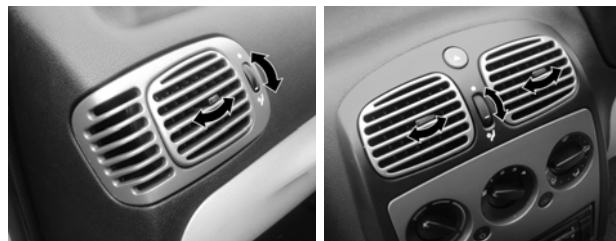

Air Flow Direction Control Knob

REAR VIEW MIRRORS

Outer rear view mirrors :

The rear view mirror is fitted on the door from the outside. In some versions, it can be adjusted manually by the lever provided inside the door and in some versions, motorised outer rear view mirrors are provided.

Motorised Outer Rear View Mirrors: (if fitted)

Your car is equipped with motorised outer rear view mirrors fitted on both front doors and can be adjusted to the desired position with the help of a switch / knob mounted on the driver's side along with the window winding switches.

Using this switch / knob, the driver can adjust the car's outer rear view mirrors without lowering the glasses and shifting from his / her position.

Steps to operate the Rear View Mirrors :

1. Move the main switch to the left "**dot**" to adjust the left side rear view mirror and to the right "**dot**" to adjust the right side rear view mirror.
2. Use the 4 positions of the knob (marked by a triangle) to adjust the rear view mirrors to correct angles.



Rear view mirror adjustment lever



Rear view mirror adjustment switch

Inner Rear View Mirror :

Antiglare mirror has been fitted inside the cab. Provision has been made for two positions :

1. Normal position
2. Antiglare position

Use antiglare position only when necessary, as it reduces rear view clarity.

Sunvisors :

Two adjustable sunvisors are provided inside the cab above the windshield to prevent sun glare.

Lower the sunvisors to protect the eyes from bright sunlight. The sunvisor also moves sideways towards the door.

A vanity mirror has been provided on the back of the co-driver's sunvisor.

⚠ CAUTION

When not in use keep the sunvisors in their original position otherwise they may block the driver's vision.



1. Inside Rear View Mirror
2. Mirror Adjustment Lever

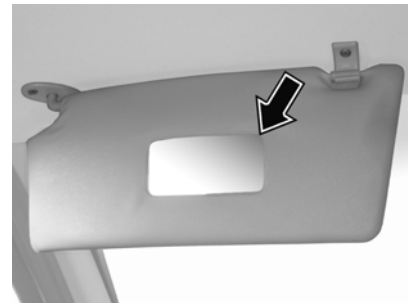

Sunvisor with Vanity Mirror

Window Winding :

Manually Operated Window Winding :

Window winding in the standard version is manually operated. Rotate the handle on the door pad to raise or lower the window glass.



Window Winding Lever

Power Windows : (if installed)

All the window glasses can be operated by means of switches, provided on the central console near the gear shift lever for all the four windows. These can be operated only when the key is in the 'IGN' position.

Pull up the switch to raise the glass.

Press down the switch to lower the glass

In the same switch, a safety locking arrangement has also been provided by means of a push type switch. This switch has two positions:

LOCK - When the key is in depressed position.

UNLOCK – When the switch is in normal position.



Window Winding Switch

In the 'LOCK' position, the rear window switches become inoperative. However the rear windows can be operated by the switches on the console. Illumination on rear window switches goes off in locked position. Press down the lock button to unlock. Individual window winding switches have been provided only on the rear doors.

WARNING

While raising the glass take care to avoid fingers/hands getting trapped between the glass and the frame.

Digital Clock : (if installed)

A digital clock is provided in the middle of the dash board. It displays the time when the steering lock cum ignition switch is in 'IGN' position. Three push knobs 'H', 'M' and 'Z' are provided for setting the time and for resetting the display to zero - 'H' for hours setting, 'M' for minute setting and 'Z' for accurate setting of the clock.

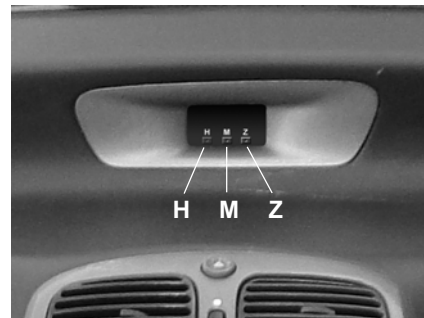
Window Winding Switch On Rear Door*Digital Clock*

Front Seats and Seat Adjustments :

Front Seats : Both the driver and co-driver seats are of bucket type to provide maximum riding comfort.

Moving the seats forward and backward :

To adjust the seat position, lift the lever (1) under the seat cushion front, then move the seat to the desired position and release the lever.

Make sure the seat is locked in position.

Adjusting the angle of the seat back :

To adjust the angle of the seat back, a lever (3) has been provided on the sides of the front seats. By lifting the lever, you can adjust the angle of the backrest.

⚠ CAUTION

Do not adjust the seat when the car is in motion.

Always adjust the seat back to an upright position and sit well back in the seat.

Seat height adjustment lever: (if provided)

Front Seats height can be adjusted for better drivability. The lever (2) provided on the side of the seats has to be manually opened as per need.

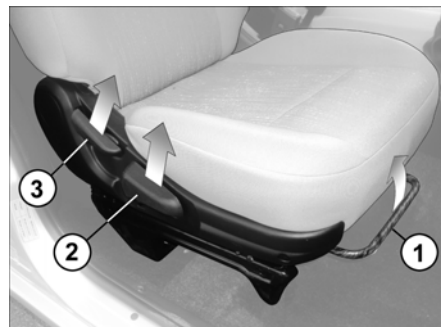

1. **Lever for seat backward/forward movement**
2. **Lever for seat height adjustment**
3. **Lever for seat back angle adjustment**

Head-restraint :

Head-rests are designed to help reduce the risk of neck injuries in case of accidents. For best protection, adjust the top of the headrest, so that it is in level with one's ears. To adjust the head-rest pull /push it to the desired position until it clicks. The head-rest can be adjusted up to 64 mm in steps of 16 mm. If headrest is required to be removed (for cleaning fabric etc.) pull the headrest fully up, then push notch button with a thin punch while pulling the headrest up. To install follow the reverse order of removal.

Avoid driving the car with the head-rest removed as it is a safety item. Do not attempt to adjust the head-rest while driving the car.

Rear Seat :

A cushion bench 60 : 40 split seat has been provided for the rear passengers. Any one of the split seat back can be folded by releasing the latch, on both the 'C' pillars simultaneously. For making more luggage space, the folded rear seat can be somersaulted further. Before summersaulting ensure that the front seats are at 3/4 the full travel towards rear.

For fixing the seat back upright, just push back the seat in position. It will get locked by itself.

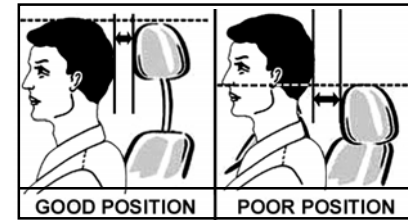

Seat Release Latch on 'C' pillar



SOMERSAULT POSITION

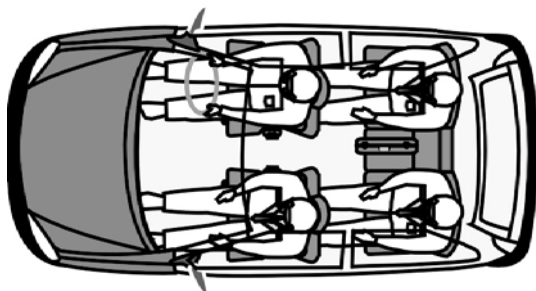

Luggage space before summersault operation

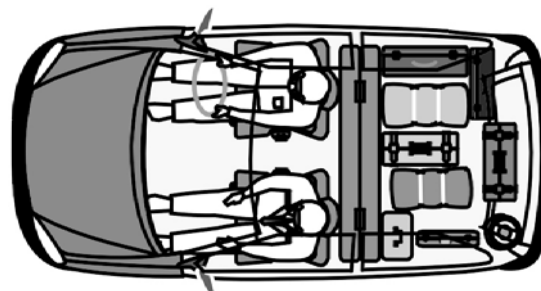

Luggage space after summersault operation

Seat-Belt :

Seat-belts have been provided on the front and rear seats (with micro switch on driver's side for the deluxe model)

WARNING

Always wear seat belts, while driving.

Seat-belt adjustment :

1. Pull the latch plate across your body and insert it into the buckle.
2. Check and ensure that the belt is not twisted.
3. Position the lap portion of the belt as low as possible across your hip bone.
4. Pull up the shoulder part of the belt to remove the slack.
5. Make sure that the belt goes over your collar bone and across the chest.
6. Belt gets locked automatically in case of sudden deceleration or roll.
7. To unlatch the belt, press the red button on the buckle. Guide the belt to the pillar as it retracts.

WARNING

Do not wear your seat-belt over hard or breakable objects in pockets or on your clothing. If an accident occurs, objects such as glasses, pens, etc. under the seat-belt can cause injury.

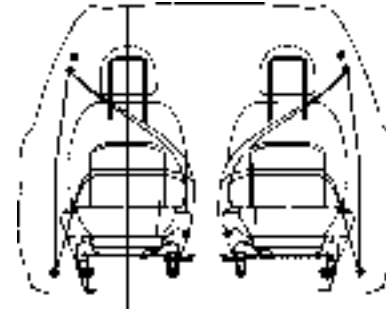

Front seat seat-belts arrangement

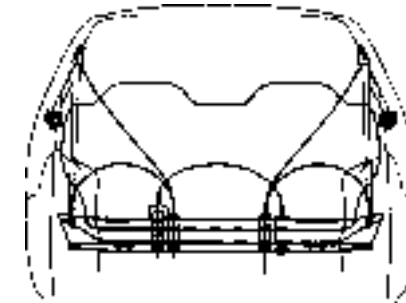

*Rear seat seat-belts arrangement
viewed from rear*

Glove Box :

The glove box is located on the dash board in front of the co-driver's seat. The glove box can be locked with the ignition key.

Cup holders are provided on the inner face of glove box flap.

CAUTION

Do not use the cup holders while the car is in motion.



Glove Box

Power Socket :

A power sockets is provided on central console.

This can be used for connecting loads upto 10 A maximum like mobile charger. To use this socket, remove the cap first.

Always keep these sockets covered with the cap when not in use.



Power Socket

Music System (if provided) :

A music system is provided on the centre console below AC controls.

To operate this system, please refer operator's handbook, which is provided along with the Owner's Manual.



Music System

Trunk Lid opening and closing :

A trunk lid opening lever is provided on the floor between the driver's seat and door.

Pull the lever up to unlock the trunk lid.

Lift the trunk lid by hand using the recess in the centre, near the bumper. The two telescopic balancers will open the door automatically.

To close and lock the trunk lid push it down.

The trunk lid can also be opened with the key.

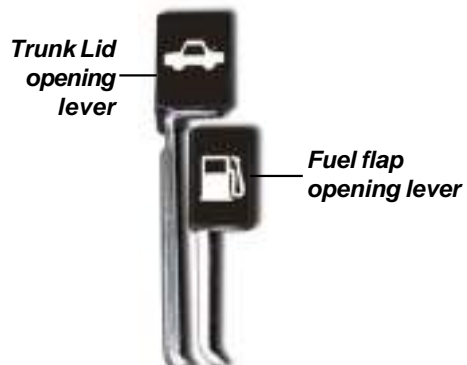

Fuel flap opening and closing :

The fuel flap is located on the left rear side of the car. The fuel flap can be opened by pulling the opening lever located near the trunk lid opening lever and can be locked by simply closing the flap.

WARNING

Fuel vapour is extremely hazardous. Always stop the engine before refueling and never fuel near sparks or open flames.

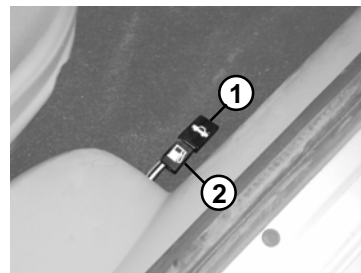

1. Trunk Lid Opening Lever
2. Fuel Flap Opening Lever

Utility pocket :

Utility pocket is provided on front doors to keep magazines / books/ paper/drinking water bottle etc.



Utility Pocket on Front Door Trim

Roof Grab Handle :

These are provided on all seats except driver seat. This helps in comfortable positioning of passengers.



Grab Handle

Spare Wheel :

It is located in the luggage compartment.

- To take out the spare wheel, first fold in and lift up the floor cover.
- Unscrew and remove retaining bolt, at the centre.
- Lift and take out the spare wheel.

Jack :

The jack is provided with your car and is located in the luggage area. The handle jack is provided in the tool kit.

Tool Kit :

A tool kit is provided with your car and is located on the left side of the luggage area.

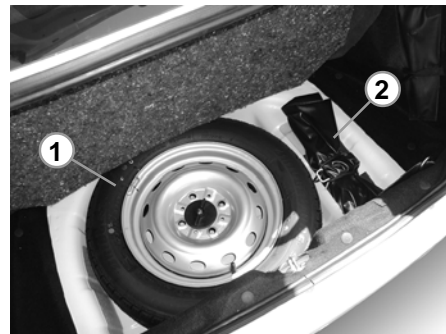

1. Spare Wheel 2. Jack Location

NOTICE

The tool kit should be properly secured after usage.

STARTING & DRIVING

- Opening & Closing the Bonnet
- Check List
- Fuel Level
- Engine Oil Level
- Engine Coolant Level
- Brake Fluid Level

STARTING & STOPPING

- Starting the Engine
- Stopping the Engine

PREPARING TO DRIVE

- Preparing to drive
- Running in Instructions
- Gear Shifting

FUEL ECONOMY

- Instructions to Improve Fuel Economy

DRIVING IN ADVERSE CONDITIONS

- Driving through Water
- Driving on a Rainy Day
- Night Driving
- Climbing Sharp Gradients
- Descending Sharp Gradients
- Towing the Vehicle

DRIVING SAFETY

CAR SAFETY CHECKS

OPENING & CLOSING THE BONNET

Opening :

1. Ensure that the car is in neutral gear with the parking brake applied.
2. Pull the bonnet release lever located under the right hand corner of the dash board. The bonnet will pop up slightly.
3. Raise the bonnet slightly and with your finger lift the secondary lock lever located under the bonnet centre.
4. Lift the bonnet up. Pull the bonnet stay rod from its clip and insert the free end into the slot in the bonnet, slide stay rod outward to secure.

Closing :

1. To close the bonnet disengage the stay rod & clamp it properly.
2. Lower the bonnet and drop it from a short height to shut.

CAUTION

Ensure that the bonnet is properly locked before driving.
Do not press the bonnet onto the bonnet lock.

CAUTION

Do not leave the engine running in a closed garage.



Bonnet release lever



CHECK	ADJUST	ENSURE
<ol style="list-style-type: none">1. Tyre pressure2. Coolant level3. Engine oil level4. Brake fluid level5. Water in windshield washer reservoir6. Power steering oil level (if installed)7. Battery electrolyte level8. Fuel level	<ol style="list-style-type: none">1. Front seat2. Rear view mirrors	<ol style="list-style-type: none">1. Bonnet is fully closed2. All doors are properly closed3. Seat belts are fastened4. All switches & lamps are working5. Gear shift lever is in neutral position6. Parking brake is released

Fuel Level :

Check fuel level on the gauge in the instrument panel. If the pointer is in the red zone and/or visual low fuel warning indicator glows, please ensure fuel filling at the earliest. Avoid driving with fuel at minimum level.

Engine Oil Level :

1. Open the bonnet. Pull out the dipstick and wipe it with a clean cloth or a paper napkin.
2. Insert it again to its original position.
3. Pull out the dipstick again and observe the oil level on the dipstick.
4. Top up oil if the oil level is below the mid point of min. and max. marks.

NOTICE

Oil level should not exceed the max. mark. Always check the oil level when the car is on level ground and the engine is cold.

Check the engine oil level if low oil pressure warning comes 'ON' while driving.

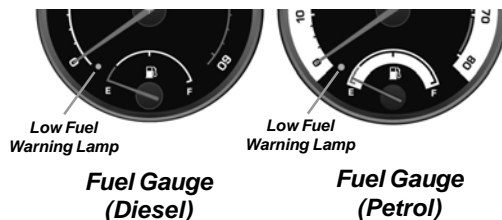

Engine Coolant Level :

The coolant level is visible through the translucent reservoir. It should be between max. & min. marks. If it seems less, add premixed coolant into the auxiliary tank upto the max. mark. Put the cap back properly.

⚠ CAUTION

Never remove the filler cap when the engine is hot. Use only branded premixed ready to use coolant.

In case of an emergency, normal water can be used, but the system should be flushed & filled with proper coolant mixture at the earliest.

Brake Fluid Level :

The level of the brake fluid must be between the min. & max. marks on the side of the brake fluid container. If the level falls below the min. mark, add recommended brake fluid. **(Refer chapter - Fuels, coolants & lubricants) In case of spongy or hard pedal or low brake efficiency, please contact the nearest Authorised Service outlet.**

⚠ CAUTION

1. Do not allow brake fluid to make contact with the skin or eyes.
2. Do not allow brake fluid to splash or spill on the paint surface as it will damage the paint. In case of spillage, wipe it off immediately.

STARTING THE ENGINE

Before starting the engine :

- Apply the parking brake fully.
- Ensure that the gear lever is in neutral position.

Starting the engine (Diesel)

- Press the clutch pedal fully and turn the ignition key to 'IGN' position. Ensure the **“CHECK ENGINE” (BS-III)“MIL” (BS-IV)** lamp turns **“ON”**.

NOTICE

The Starter Protection System fitted in this car does not allow you to crank the engine until you fully press the clutch pedal.

- **The glow plug indicator on the instrument panel will glow.**
- **Wait till the glow plug indicator goes off.**
- Do not press the accelerator pedal.
- Keep the clutch pedal fully pressed and crank the engine, if the engine cranks but fails to start then repeat the above procedure. Release the key as soon as the engine starts. Ensure that the **“MIL”** lamp is **“OFF”**.

- **After starting the engine, keep the engine in idling for at least 30 seconds. Do not accelerate the engine immediately after starting to avoid damage to turbocharger. (Diesel)**

NOTICE

The Starter Protection System switches off the starter when it is cranked for more than 10 secs. In such a case, get the key back to OFF position and wait for 30 secs before cranking again. This safeguards the starter motor as cranking continuously for more than 10 secs can damage the starter motor. Also immediately release the key after the engine has started, otherwise the flywheel ring/ starter motor may get damaged.

NOTICE

Tata Indigo diesel cars use Electronic Micro Processor Controller to control critical engine parameters like pre/post glow and cold advance. The glow plug and cold advance function will remain on even after starting of the engine depending on the engine coolant temperature at the start.

It is quite likely that at higher altitude (above 2000 meters) one may experience exhaust smoke being white in colour or engine hesitations in cold driving condition. The above

observations are for few seconds only, and in order to contain the happening, it is suggested that after idle run of 30 seconds on a cold engine start, the car can be driven off.

The above white smoke at altitude in cold condition from diesel engine is a normal happening, and due to temporary effect of atmospheric pressure. This in no way will affect the engine performance or the ecology.

Starting the engine with a malfunction (Petrol):

- Press the clutch pedal and turn the ignition key to 'IGN' position.
- Press the accelerator pedal by 1/4th of full travel. Do not depress the accelerator pedal fully down.
- Crank the engine. If the engine starts, car may be driven to nearest authorised service outlet, even though **“CHECK ENGINE” (BS-III) “MIL” (BS-IV)** lamp is indicating a malfunction.
- In the above condition engine may stall if the accelerator pedal is released back to idle position.
- If engine stalls, repeat the above procedure from beginning & drive the car without releasing the accelerator pedal to 'Idle' position.

Stopping the Engine :

- Let the car come to a stop and engine to idle.
- Turn the key to “OFF” position

Parking :

- Park the car in a safe place. Switch on the indicator signal before turning to park.
- Apply the parking brake.
- Ensure that all window glasses are closed & all lamps are turned 'OFF'.
- At night, put on the parking lights if required.
- Remove the key from the ignition switch.
- Place wheel chokes at the wheels if parked on a slope.

Read the Parking Brake section in “BEFORE DRIVING” for precautions on how to park the vehicle on a slope.

WARNING

Do not leave the key inside the car.

Do not leave children unattended in the car.

Avoid parking the car over inflammable materials, such as dry leaves, grass etc., as the exhaust system is hot enough to initiate 'FIRE'.

Preparing to Drive :

The following checks and adjustments should be carried out before you start driving the car.

- Ensure that the windshield, all mirrors, windows and outside lights are clean. Check & adjust rear view mirrors.
- Ensure that the windshield washer reservoir is full.
- Ensure that the bonnet is properly closed.

NOTICE

Do not put excessive pressure on top of bonnet to avoid damage.

- Check that any items that you may be carrying inside, are fully secured.
- Check & adjust seat.
- Ensure that all doors are locked properly.
- Fasten seat belt properly.
- Ensure that all gauges and indicator lights are working.
- Check for blind areas being unobstructed in front and rear of the car.
- Release the parking brake.
- Before driving off check in the rear view mirror, for oncoming traffic. Switch on side indicator signal when getting into main stream of traffic.

Running-in instructions :

During running-in period i.e. first 1000 km. follow the running-in instructions given below :

1. After starting the engine do not rev it up. Warm up gradually at idling speed.
2. Avoid sudden acceleration and full throttle.
3. It is always preferred not to rev up a cold engine lest engine bearings get affected.

Recommended car speeds during running-in period for diesel and petrol versions :

	DIESEL		PETROL
	NA / TC / TCIC	CR-4	MPFI
Gear	Speed (kmph)	Speed (kmph)	Speed (kmph)
1st	20	20	20
2nd	40	40	30
3rd	60	60	40
4th	80	80	60
5th	90	90	80

Gear Shifting :

All forward gears being synchronised, provide for easy and effortless gear shifting. Always remember to press the clutch pedal fully while shifting the gears and also to release the clutch pedal gently.

Avoid sudden clutching i.e. abrupt release of depressed clutch pedal.

Do not shift into reverse gear when the car is moving forward or when the engine is not at idling r.p.m. A 5 second pause after declutching will ensure smooth engagement of the reverse gear. Change gears at appropriate gear change speeds.

NOTICE

There is an interlock provided between fifth and reverse gear to prevent accidental shift from 5th gear to reverse gear. (Shifting from reverse gear to 5th gear is possible)

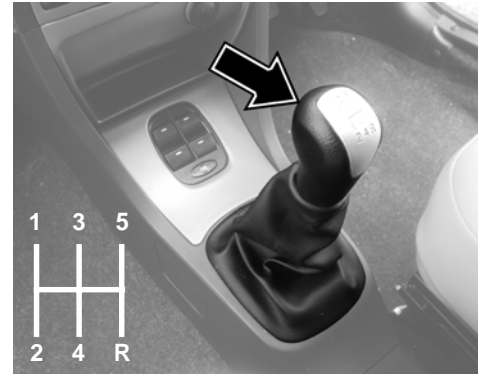

Gear Shift Lever & Shifting Pattern

Gear Shifting

Appropriate gear change speeds for good pick-up :

NA / TC / TCIC	CR-4	MPFI
Speed (kmph) Upshift	Speed (Kmph) Upshift	Speed (Kmph) Upshift
1st to 2nd-25-30	1st to 2nd-30	1st to 2nd - 25-30
2nd to 3rd-50-60	2nd to 3rd-60	2nd to 3rd - 50-60
3rd to 4th-80-90	3rd to 4th-90	3rd to 4th - 80-90
4th to 5th-100-110	4th to 5th-130	4th to 5th - 100-110

Recommended maximum speed, during normal operation.

Gear	NA / TC / TCIC	CR-4	MPFI
	Speed (kmph)	Speed (Kmph)	Speed (Kmph)
1	30	30	30
2	60	60	60
3	90	90	90
4	110	130	110
5	150	155	150

INSTRUCTIONS TO IMPROVE FUEL ECONOMY :

Your car's fuel economy is mainly dependent on your style of driving.

To operate your car as economically as possible, use the following driving suggestions.

Avoid Excessive Idling :

Switch OFF the engine if you have to stop for more than a minute.

Avoid fast starts & unnecessary stops :

Start off slowly from traffic lights or stop signs to prevent excessive fuel consumption and reduced engine life. Avoid unnecessary deceleration (stopping or slowing down) and then acceleration which uses more fuel.

Always maintain clean air-cleaner :

The amount of air supplied will reduce due to clogged air-cleaner, resulting in waste of fuel due to incomplete combustion.

Avoid incorrect tyre pressures :

Under-inflated tyres result in increased running resistance of the tyres, leading to wastage of fuel.

Always have the engine tuned correctly through recommended maintenance at an Authorised Service outlet.

Proper Driving Practices :

Keep a safe distance from other vehicles to avoid braking suddenly.

Do not rest your foot on the clutch pedal. It does not allow full engine power to be transmitted to the vehicle and reduces clutch life.

Fuel economy speeds :

Gear	DIESEL		PETROL
	NA / TC / TCIC	CR-4	MPFI
	Speed (kmph)	Speed (kmph)	Speed (kmph)
1st	15	15	10
2nd	25	30	20
3rd	45	45	40
4th	65	60	60
5th	70	80	80

MPFI System :

NOTICE

The multi point fuel injection system has been designed to meet various load and speed conditions of the engine and doesn't require any regular maintenance. MPFI system should be serviced by Authorised Service personnel only, if required.

TIPS RELATED TO FUEL SYSTEM MAINTENANCE (MPFI) :

Basically, the fuel system of the vehicle consists of the following main components :

1. Fuel tank
2. Fuel Filter
3. Fuel Pump
4. Fuel Rail
5. Fuel pressure regulator and
6. Fuel injector.

The following instructions are to be followed for reducing problems related to the fuel system.

- a) Avoid keeping the fuel tank empty and preferably keep it topped up as frequently as possible.

NOTICE

Empty fuel tank may lead to inner corrosion of the tank. The rust particles thus formed may result in frequent clogging of fuel filters. If the rust particles enter the system, it may result in malfunctioning of the MPFI system.

- b) Replace clogged fuel filters to prevent inconsistent fuel delivery from the fuel pump.

Driving Through Water :

- Never venture to drive through water when it flows above the stone guard or above the tyre centre line.
- The engine may get seriously damaged if attempts are made to cross through deep water.
- If at all the situation demands that you have to drive through water even at great risk then, keep the engine in fast idling and 'crawl' in low gear.
- After driving through water apply the brakes several times to dry the liners and to regain original braking.
- Check the engine and transaxle for any water entry.

Do not attempt to start the engine if the car gets flooded due to water.

- Tow the car to a safe place.
- Take the car to the nearest Authorised Service outlet to check for entry of water in the engine.
- Lubricants in the engine and transaxle need to be changed in case of water entry.



Driving on a Rainy Day :

- Check wiper blades for proper functioning.
- Check brakes, steering and windows.
- Check tyres for wear and tyre pressure. Worn out tyres are unsafe on wet roads.
- Avoid harsh braking and sharp turns. It may cause loss of steering control and lead to the car skidding.
- For slowing down, shift to lower gears and apply brakes gently.
- Keep lights on if visibility is poor.
- Use heater and demister if required to clear off mist on the windshield.

Night Driving :

- Dip the head lamp for oncoming traffic during night driving.
- Maintain a speed such that you can stop within illuminated distance of the head lamps.
- Use head lamp main/dip beam to alert other users on turns/cross roads, etc.
- Use side indicators to indicate lane change or turning.
- Put on the hazard warning switch in case of hazardous parking or if your car is disabled to warn passing traffic. Put on the fog lamps (for Deluxe version) if required.



Climbing Sharp Gradients on Loose Surfaces:

- Start off smoothly in any suitable gear. Apply power smoothly so that there is no loss of traction by over-revving of the engine.
- Choose as smooth a slope as possible and select the appropriate gear so that gear changing in the middle of the climb is not required.
- Changing gears in the middle of the climb can cause loss of momentum and engine stalling. Shifting to a lower gear has to be done cautiously to avoid loss of traction.
- Never move the car diagonally across a hill. The danger is in loss of traction and sideways slippage, possibly resulting in tipping over. If unavoidable, choose as mild an angle as possible and keep the car moving.
- If the wheels start to slip within few feet of the end of the climb, motion can be maintained by swinging the steered wheels left and right, thereby providing increased grip.
- If the car stalls or losses headway while climbing a steep hill, make a quick shift to reverse and allow the car to move back with the control of engine compression.



Descending Sharp Gradients :

- Depending on the severity of the gradient, shift into appropriate gear. Use engine braking judiciously without over-revving the engine.
- Brake application under such situations should be done very smoothly to avoid loss of control. Select appropriate gear so that gear changing or clutch disengagement is not involved while descending the gradient.



Towing the Vehicle :

- For towing a car, the best way is to use a wrecker.
- Alternatively use a rigid tow bar.
- Avoid using a flexible cable or rope as your car may crash into the car towing your car when it stops suddenly.
- Switch 'ON' the hazard warning signals of both the cars to warn other road users.
- Where possible, keep the engine idling so that power steering assistance and brake vacuum are available.
- Limit the speed to 20-30 kmph.
- In case of brake failure, use the parking brake to control the car.

DRIVING SAFETY**Seat-Belt :**

Seat-belts are life saving equipment and their use reduces the chance of injury and severity of injury in case of an accident. It is strongly recommended that all the car occupants should always wear seat-belt, while car is in motion.

Mobile phones :

Avoid using mobile phones while driving. This could divert your attention from the road and result an accident.

Influence of Alcohol :

Avoid driving under the influence of alcohol or drugs. Alcohol and drugs will severely impair your control on the vehicle and increase the risk of injury to yourself and others.

Fatigue 'Rest Revive Survive':

Do not attempt driving when you feel tired or sleepy. Long distance driving can tire you very much and fatigue can dull your reflexes and judgment. Take a break and get refreshed at intervals.

CAR SAFETY CHECKS :**Windshield/wiper/windshield Washer :**

Always keep windshield glass clean to avoid any distraction in visibility. Ensure proper working of wipers and condition of wiper blade. Ensure that windshield washer reservoir is full. Do not operate wiper when the windshield glass is dry, This could damage the windshield.

Headlights :

Keep headlight lenses clean. Check for operation of headlamp in both high/low beam conditions. Check for correct focusing of headlamps. Use only recommended type of bulbs. Do not use the high beam unless it is inevitable. Its dazzle may glare the driver of the oncoming car, thus causing an accident.

Side indicators / Hazard warning

Ensure that all side indicators/hazard warning lights are always in working condition and they are used when required.

Horn

Ensure the horn is working properly. Horn provides safety to other road users by alerting your presence.

Brakes

Ensure brakes are in working condition. Check brake fluid level in reservoir. Do not drive the car when brake warning lamp is 'ON'.

Tyres

Check the condition of tyres for any abnormalities. Maintain correct tyre pressure, it is very important particularly when subjected to extreme conditions, such as high speed, high load and high outside temperature. Do not use worn or bald tyres on the front wheels.

First Aid Kit :

First aid kit is provided in your car. This is for use in case of minor injuries. It is to be regularly checked for any disintegration and should be updated regularly.

Advance Warning Triangle :

There is an advance warning triangle provided along with your vehicle. In case there is a breakdown and the vehicle is parked at the side of road, then the triangle is to be kept as per instructions given below :

Remove advance warning triangle from case and assemble.

Place the triangle on the road behind the vehicle when it stranded on the road. The triangle must be at least 50 meters behind the vehicle in the same lane of traffic.

Increase the distance to 150 meters on a highway or if a bad/hill top obscures the view.

MAINTENANCE POINTS

- Engine Compartment
- Windshield Washer
- Air Filter
- Engine Cooling System
- Fuel System
- Transaxle Oil
- Clutch & Clutch Adjustment
- Brake & Brake Adjustment
- Power Steering
- Battery
- Starting the Engine with Jump Leads
- Catalytic Converter
- Turbocharger
- Intercooler
- EGR System
- Spark Plug
- Carbon Canister

WHEELS & TYRES

- Wheel Change
- Wheel Alignment
- Wheel Balancing
- Tyres & Tyre Rotation
- Spare Wheel
- Repairing a Tyre/Tube

ELECTRICAL MAINTENANCE

- Fuses & Relays
- Head Lamps & Head Lamp Adjustment

CAR CARE

- Washing
- Polishing
- Cleaning of Carpets
- Cleaning of Glass
- Wiper Care
- Paint Care

ENGINE COMPARTMENT-NA

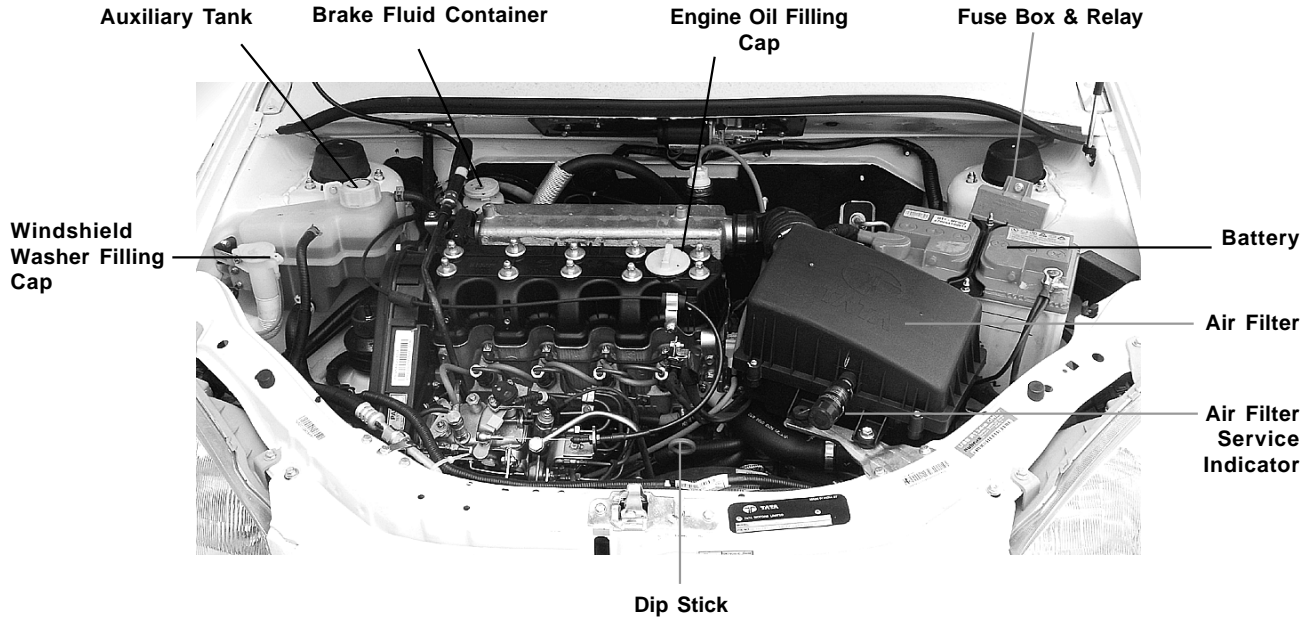

ENGINE COMPARTMENT-CR-4

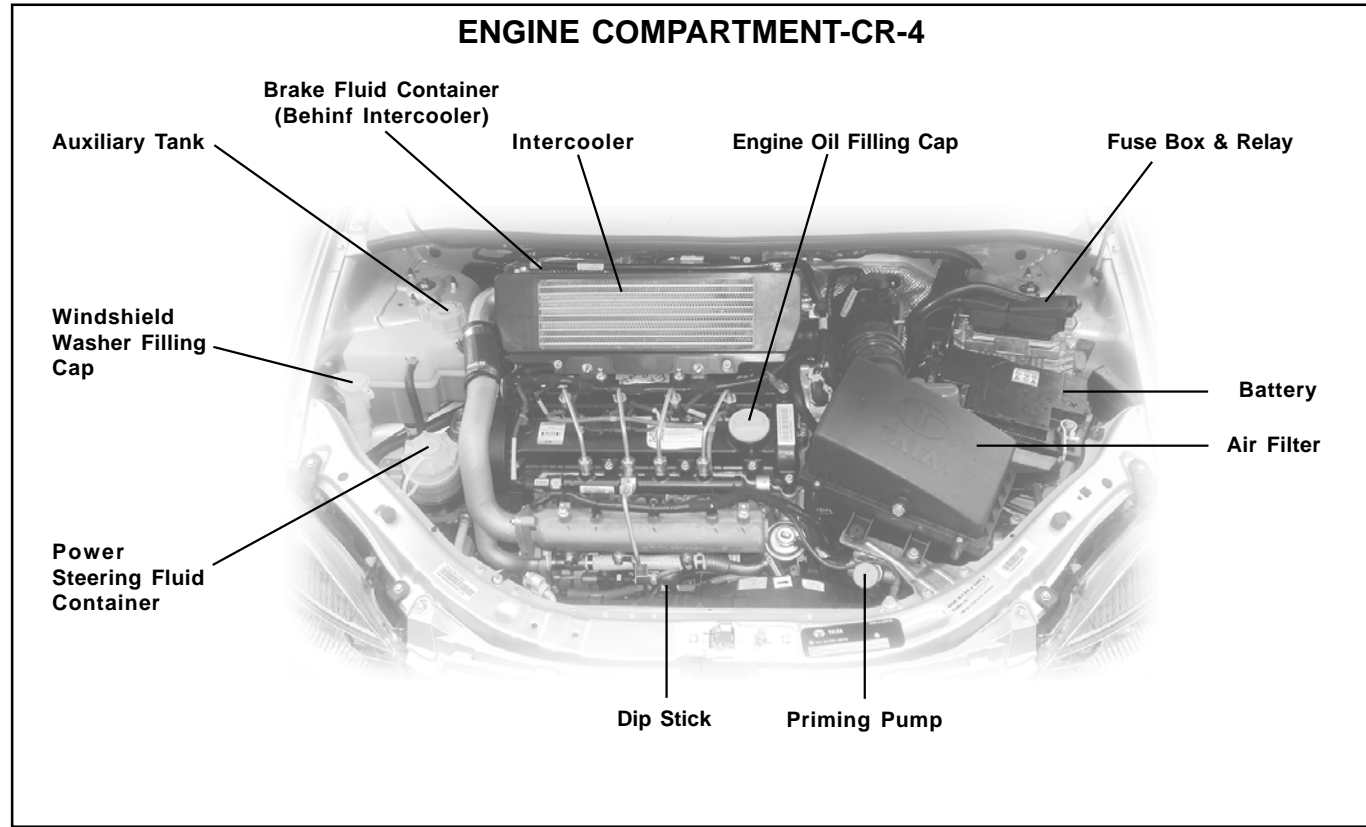

ENGINE COMPARTMENT- 475 SI MPFI

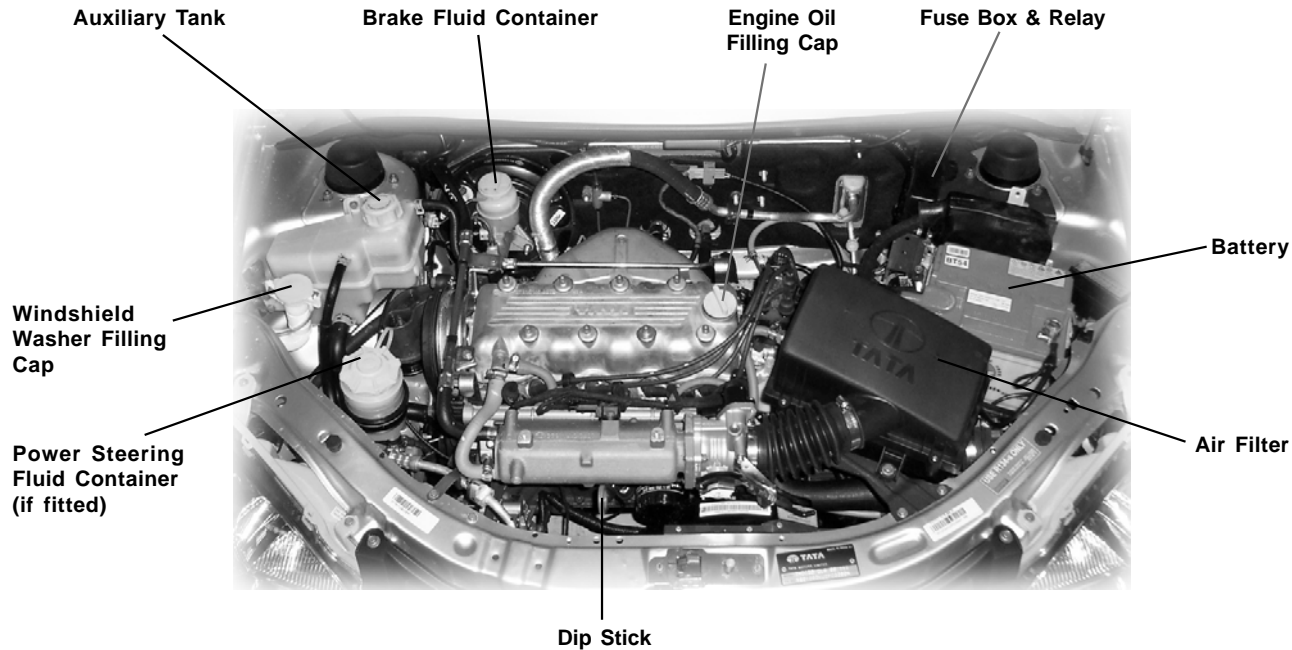

Windshield Washer :

Windshield washer fluid container is located behind the front right hand side panel and its filler neck is provided near auxiliary tank in the engine compartment.

NOTICE

Do not add detergent or any solvent in the windshield washing water.

AIR FILTER :

The air filter element should be periodically cleaned. Replace the air filter element with a new one, when air cleaner service indicator shows red band, even after cleaning.

Always use a genuine air filter element. The air filter is located on the LH side of the engine compartment.

Replacement of Air Filter Element :

- Remove the cover of the air filter, by removing the screws.
- Remove the air filter element.
- Clean it gently by tapping. Clean air filter cover and air ducting.
- Check the element for puncture or pin holes by holding against a bright light source.

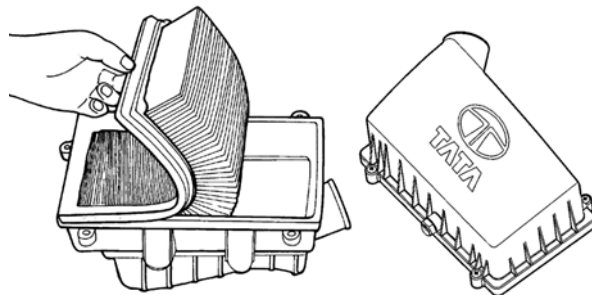

- If found to be OK, reinstall the filter element. Fit the cover and plug on the clips.
- After cleaning, if the service indicator shows 'RED', replace air filter element.

NOTICE

- When a car is driven under dusty conditions, frequent replacement of the air-cleaner element may be required.
- Clogged air-cleaners lead to greater intake resistance and result in increased fuel consumption. Using low pressure compressed air, blow off dust on the air cleaner element. If the air cleaner element appears to be choked, replace it with a new one.

Engine Cooling System :

Check coolant level and top up if necessary.

If engine overheating occurs, there could be a fault in the cooling system which may be due to :

1. Insufficient coolant in the cooling system or dirt/scales having accumulated inside the cooling water passages especially in the radiator core.
2. Choking or damage of radiator passages.
3. Defective thermostat.
4. Non operation of electrically operated fan. (40 Amp. fuse blown)
5. Coolant leakage.
6. Auxiliary tank cap not sealing properly.
7. A.C. condenser fan not working.
8. Excessive refrigerant charging in the A.C. system.
9. Improper bleeding of the cooling system.

Prevention of Rust Formation :

To prevent rust formation, use the branded premixed engine coolant in the radiator.

This is sufficient to operate the car upto -40°C.

Fuel Sedimenter (CR-4): (if fitted)

The water accumulated should be drained if the water in fuel sedimenter Indicator in the cluster glows during engine running.

Fuel sedimenter (If fitted) is the equipment fitted in fuel system to separate Water contents from diesel and to prevent the water from entering the Fuel System.

CAUTION

Water ingress in fuel system can result in system failure. A water sensor is fitted in the sedimenter to indicate to the driver that the sedimenter has to be drained. Check if water in fuel sedimenter indicator lamp in instrument cluster is 'ON' (if fitted).

NOTICE

If the water in fuel indicator comes ON, immediately take the vehicle to an Authorised service station.

Limp - home mode operation :

When water gets accumulated in water sedimenter, "water in fuel indicator lamp" on instrument cluster remains ON continuously.



This causes the vehicle to run on “Limp Home Mode”; there is a drastic reduction in performance of the vehicle in Limp Home Mode.

NOTICE

At initial “Key-ON”, the water in fuel lamp indication on the dashboard glows for 2 seconds and goes 'OFF' automatically. If this lamp does not glow, vehicle has to be taken to the service station for verification and necessary attention.

Fuel filling cap :

The fuel filler cap is located on the left rear side of the car. The fuel filler lid can be unlocked by pulling the opening lever located on the out-board side of the driver's seat and locked by simply closing the lid.

CAUTION

Remove the fuel filler cap slowly. The fuel may be under pressure & may spray out, causing injury if the cap is opened suddenly.

- Switch OFF the Engine when refueling.
- Do not use your mobile phone when you are at a Filling station.

NOTICE

The fuel cap for petrol and diesel versions are of the vented type. For petrol ,it is black in colour & for diesel it is in grey in colour. Use genuine and correct cap for replacement.

- To remove the fuel filler cap turn the cap anti-clockwise. Turn the cap slowly to allow any residual pressure to escape.
- To install turn the cap clockwise till a click sound is heard.

WARNING

Fuel vapour are extremely hazardous. Always stop the engine before refueling and never fuel near sparks or open flames.

If you need to replace the fuel cap, use only specified for your car. Using an improper fuel cap can cause a serious malfunctioning of the fuel system. You can get the correct replacement from an authorised service outlet.

Transaxle Oil :

Checking of Oil Level :

1. Clean the oil level plug and the surrounding area.
2. Remove the oil level plug and check whether oil is dripping out. The oil level must not be below the filler plug.

Add oil to bring it to the required level.

3. Tighten the oil level plug to 3 - 4 mkg. torque.

Changing Oil in Transaxle :

1. Let the engine idle for about 5 min. in neutral gear, so that the Transaxle is warmed up.
2. Clean the oil level plug, drain plug and surrounding area.
3. Place a container under the transaxle to collect the oil.
4. Remove the oil level plug.
5. Remove the drain plug and let the oil drain out fully.
6. Refit the drain plug with a new sealing washer. Tighten the oil drain plug and fill new recommended oil through the oil level plug. Tighten both the oil drain plug and oil level plug (with new sealing washer) to 3 - 4 mkg. torque.

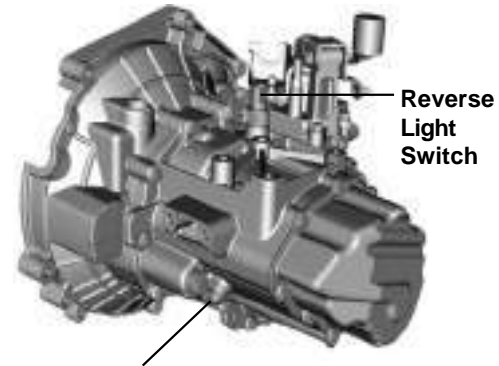

Oil Filler / Level Plug



Drain Plug

CLUTCH :

Your car is provided with a single plate dry friction diaphragm type, pre-loaded release bearing clutch which is mechanically actuated by a cable connecting the clutch pedal & the clutch release lever.

There is no free play in the system and hence no clutch pedal free play adjustment is required although the clutch pedal height from the floor has to be adjusted as clutch lining wears and operate pedal 4-5 time and confirm no change in pedal height. The clutch pedal height from the floor keeps on increasing as the clutch lining wears. However, ensure that clutch pedal has free movement when lifted upward.

NOTICE

- Do not ride the clutch. It will cause premature clutch wear.
- Do not release the clutch suddenly.

BRAKES :

Dual circuit, diagonal split hydraulic brakes through tandem master cylinder have been provided. The front brakes are disc brakes with floating type calipers while the rear brakes are drum brakes with automatic adjustment. No adjustments are required for front & rear brakes. The parking brake is a

mechanical lever type, console mounted, cable operated, acting on rear wheels. To operate, pull up. To release, pull the parking brake lever slightly up, press the release button and push down the lever. Pressure reducing valves are provided on both circuits for the rear brakes to avoid locking of wheels & skidding of the car. If parking brake lever travel is observed to be more than 6th notch, tighten the adjustment screw so that the parking brake lever stroke is between 3 to 6 notches. Jack up the rear wheels and ensure that the wheels are free to rotate in 6th notch.

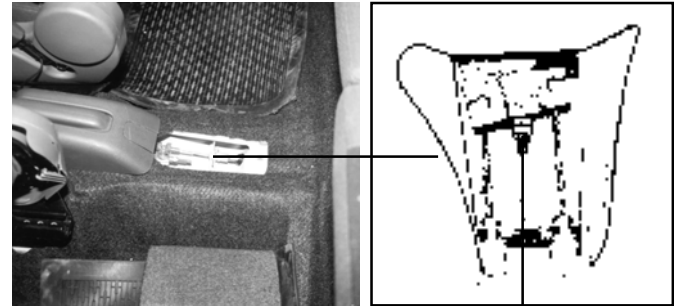

***Parking Brake
Adjustment Screw***

BRAKES (Vacuum Assisted) :

The hydraulic brake system of your car is assisted by a vacuum booster which reduced the effort of driver during braking. In the unlikely event of disruption in supply of vacuum to the booster (e.g. stoppage of engine, or failure of vacuum hose) this assistance will still be available but only for one or two brake applications to bring the vehicle to a stop. Beyond this, vacuum assistance will not be felt by the driver and brakes will appear to be hard/ineffective. In order to stop the vehicle effectively the driver will have to apply a much higher force on the brake pedal (roughly 5 times the normal effort).

CAUTION

Never drive the vehicle in engine switched 'OFF' condition.

Brake Fluid :

Check the level of brake fluid in the brake fluid container. It should be between the **MIN.** and **MAX.** marks.

If not, then add brake fluid. Clean the area surrounding the cap before opening the cap. Always use fresh brake fluid and tighten the cap fully, otherwise moisture from the atmosphere will be absorbed by the brake fluid, making it unserviceable.

In case of spongy or hard pedal or low brake efficiency, please contact the nearest **TATA MOTORS** Authorised Service outlet and get the defect rectified.

POWER STEERING (if installed)

Power steering is fitted for lighter steering effort and easy manoeuvrability, during driving and also help absorb the road shocks. The system consists of steering gear box, hydraulic pump and hydraulic tank. Pump drive is through the poly 'V' belt from the engine. Power assistance is available during normal operating conditions. In case of failure in the hydraulic system, the steering can be operated mechanically to bring the car to an Authorised Service outlet.

 CAUTION

Report any external leakage to the nearest Authorised Service outlet.

WARNING

Do not allow fluid level to drop significantly or run out of the reservoir during the above operation. This may induce air into the system.

Severe damage could occur to the power steering pump due to dry running (Running without sufficient oil and due to severe cavitation on account of air entry due to low oil level). This could lead to loss of power assistance, damage and failure of the power steering system.

Do not start the engine without oil in the power steering system. This will result in serious damage to the pump. In case of an emergency, disconnect the pump drive belt and then start the engine or drive slowly as vacuum assistance for brake would not be available (as vacuum pump is also being driven by same belt).

Always use recommended oil from sealed containers. Any contaminated oil poured in the system will result in damage to the pump and gear box.

Avoid mixing of different brands of oils.

BATTERY :

Check the battery for proper electrolyte level and corrosion on the terminals.

WARNING

During normal operation, the battery generates gas which is explosive in nature, a spark or open flame can cause the battery to explode causing very serious injuries.

Keep all sparks & open flames and smoking materials away from the battery.

Getting electrolyte in your eyes or on the skin can cause severe burns. Wear protective clothing and a face shield or have a skilled technician to do the battery maintenance.

The battery contains sulphuric acid (electrolyte) which is poisonous and highly corrosive in nature.

1. Check the battery for electrolyte level against the marking on the battery outer case.
2. Check the battery terminals for corrosion (a white or yellowish powder). To remove it, cover the terminals with a solution of baking soda. It will bubble up and turn brown.

When this stops wash it off with plain water. Dry off the

battery with a cloth or paper towel. **Coat the terminal with petroleum jelly to prevent future corrosion.**

Use a proper wrench to loosen and remove cables from the terminals. **Always disconnect the negative (-ve) cable first and reconnect it last.**

Clean the battery terminals with a terminal cleaning tool or wire brush.

Reconnect and tighten the cables, coat the terminals with petroleum jelly.

If you need to connect the battery to a charger, disconnect both cables to prevent damage to the vehicle's electrical system.

NOTICE

Charging the battery with the cables connected can seriously damage your vehicle's electrical/electronic equipment.

Detach the battery cables before connecting the battery to a charger.

CAUTION

Swallowing electrolyte can cause fatal injury if immediate action is not taken. Do not reverse the battery connection on the vehicle as it may damage the vehicle electricals.

NOTICE

Negative terminal is connected to the body/cab.

Starting the Engine with Jump Leads :

The engine with a discharged battery may be started by transferring electrical power from a battery in another car.

This may be dangerous as any deviation from the following instructions could lead to personal injury resulting from any battery explosion, as well as damage to the electrical systems in both cars.

⚠ CAUTION

Do not allow battery electrolyte to come in contact with eyes, skin, fabrics or painted surfaces. The fluid contains sulphuric acid which can cause injury and severe damage. Wear rubber gloves, to avoid risk of contact.

- To lessen the risk of injury, wear eye protection when working near any battery.
- Make sure that the battery providing the jump start has the same voltage as the battery in your car (12 V). Its capacity must be approximately the same as the original battery capacity. The voltage and capacity are given on the batteries.
- Do not disconnect the discharged battery from the car.
- Switch off all unnecessary electrical loads.

- Do not lean over the battery during jump starting.
- Do not allow the terminals of one lead to touch those of the other lead.
- Apply the hand brake. Keep the gearshift lever in neutral.

Connect leads in the order as shown in the sketch :

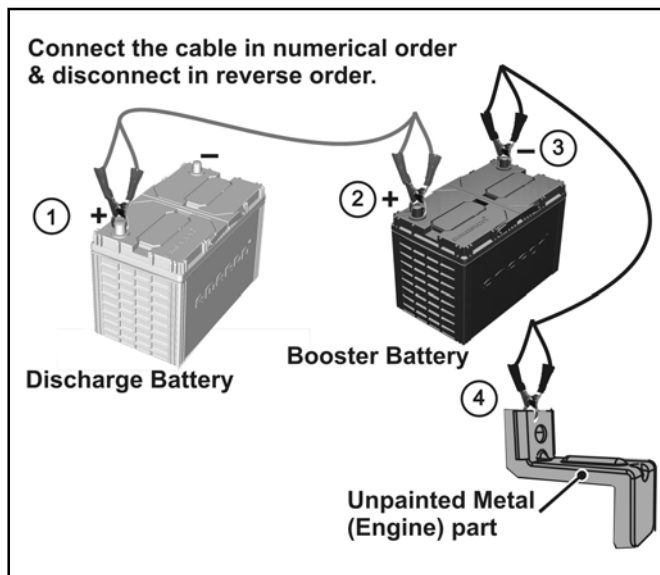

- Do not connect the lead to the negative terminal of the discharged battery.
- The connection of the -ve lead point should be as far away from the discharged battery as possible and close to the starter motor on engine/transaxle.
- Route the leads so that they cannot get caught by the rotating parts in the engine compartment.
- The engine of the car providing the jump start can be allowed to run during starting.

Attempts to start the engine of the car with the discharged battery should be made at intervals of one minute and should not last more than 15 seconds. After starting, allow both engines to idle for approximately 3 minutes with the leads still connected.

Catalytic Converter (DIESEL):

To reduce exhaust pollution, the vehicle is fitted with Diesel Oxidation Catalytic Converter. The two way Catalytic Converter has coating of precious metals which enables conversion of pollutants.

Oxidation Catalytic Converter (Diesel) CR-4 :

Two numbers of Oxidation catalytic converters are fitted on your car to reduce exhaust pollution. The two way catalytic converters are having coating of precious metals which enables conversion of pollution. The Oxidation catalytic converters will quickly heat up after starting to ensure that it operates correctly during the warm up phase of the engine.

Care of the Catalytic Converter :

The catalytic Converter does not require any special maintenance however, following precaution should be taken for the effective functioning of the converter and to avoid damage to the Converter.

- Always use fuel of recommended specifications. Use of any other diesel fuel can increase the pollutants.

⚠ CAUTION

Avoid parking the vehicle over inflammable materials, such as dry leaves, grass etc., as the exhaust system is hot enough to initiate 'FIRE'.

Catalytic Converter (PETROL):

The catalytic converter is fitted on your car to reduce exhaust pollution. The catalytic converter will quickly heat up after starting to ensure that it operates correctly during the warm up phase of the engine. **On a car with a catalytic converter, the fuel tank filler neck is of reduced diameter compatible with standard unleaded petrol supply nozzle.**

NOTICE

Even one time use of leaded petrol may cause permanent damage to the catalytic converter. Hence use unleaded petrol of recommended specifications only.

Care & Maintenance :**Avoid**

- Use Unleaded Petrol only, since use of Leaded Petrol will damage (poison) the Catalytic Converter permanently.
- Consult an Authorised Service Outlet at the earliest when,
 - Engine misfires or runs irregularly, following a cold start,
 - A significant loss of Power is noticed.

- In the event of above symptoms, drive the car at slow speed without rapid acceleration. If the vehicle is continuously run with misfiring, it may cause overheating of shell, carpet etc. resulting into fire.

Turbocharger (If fitted) :

Your car is fitted with a turbocharger. Turbocharger is an efficient supercharging device used in our engine. It makes use of thermal energy of engine exhaust gases to run a turbine which in turn drives a compressor to force air under pressure into the inlet manifold.

Lubrication of Turbocharger :

The turbocharger rotor assembly is supported by two fully floating bearing bushes in the bearing housing. These bearing bushes are lubricated with finely filtered engine oil from the lubrication system of the engine.

Idle the engine for a while (one minute) after starting the engine and before stopping the engine to ensure adequate lubricating oil supply to the turbocharger.

Turbocharger Connections :

All turbocharger connections must be leak-proof. Check air inlet, air outlet, exhaust gas inlet and exhaust outlet connections as well as oil inlet and outlet connections to the turbocharger and tighten the connections where required.

Proper maintenance of air filter, oil filter as well as use of correct grade of oil and adherence to oil change intervals is essential for proper functioning of the turbocharger.

If you suspect any malfunctioning of the turbocharger, take the vehicle to the nearest dealer. Do not remove the turbocharger yourself.

Intercooler (If fitted):

Hot air coming out of turbocharger flows the inter cooler and gets cooled before entering the intake manifold. The inter cooler is mounted on top of cylinder head cover.

As such it does not require any maintenance however it can be cleaned externally (when it is not hot) by blowing compressed air through its fins.

Maintenance recommendations:

- a) Check the boost pressure pipe for its proper fitment, damage etc.
- b) Specified engine and the oil filter should be used and should be changed regularly in accordance with Service Schedule.
- c) Check oil feed pipes, return pipes, air intake and exhaust piping for leakages and restrictions.
- d) Check the engine breathing system and oil separator.
- e) Fill the oil inlet hole of the turbo charger with clean engine oil, when the engine is started after long storage.

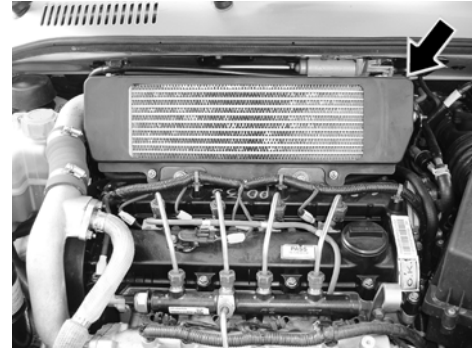

Intercooler (CR-4)

EGR System : (CR- 4) (if fitted)

To reduce exhaust pollution from your car, the engine is provided with exhaust gas recirculation (EGR) system.

The EGR system consists of an EGR valve, EGR cooler and EGR pipe. The continuously variable EGR valve is controlled by ECU. A controlled amount of exhaust gas is mixed with intake air, in part load and part throttle conditions. This helps in reducing harmful emissions.

In addition to EGR System your car is also fitted with diesel oxydation catalytic convertor to reduce exhaust pollution.

NOTICE

Use diesel fuel of recommended specifications. Use of any other diesel fuel can increase the pollutants.

WARNING

Avoid breathing exhaust gases. This contain carbon monoxide which is harmful.

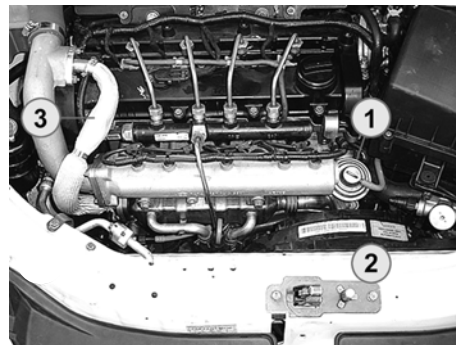

1. EGR Valve 2. EGR Cooler 3. EGR Tube
4. Electronic Vacuum Regulator (EVRV)

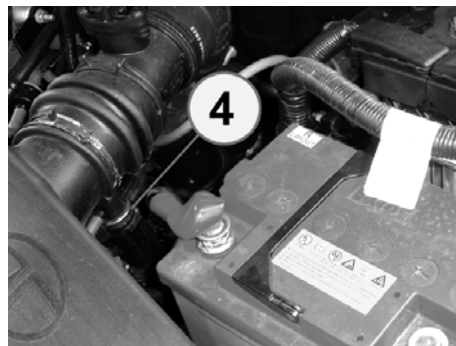

SPARK PLUG (MPFI) :

Spark Plug	-	BOSCH
Spark Plug No.	-	FR6 DC4
Spark Plug Gap	-	0.7 mm to 0.8 mm

You should inspect the spark plugs periodically for carbon deposits. When carbon accumulates on the spark plug, a strong spark will not be produced. Remove carbon deposits using a spark plug cleaner.

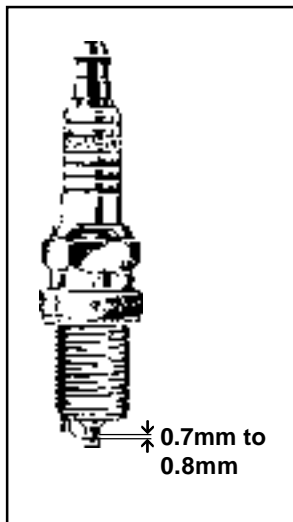
**Spark Plug Replacement :**

1. Clean up any dirt or oil that is collected around the spark plug caps.
2. Pull out the spark plug cables by gripping at the connector.
3. Remove the spark plug with the help of a special socket.
4. Check and adjust the gap, it should be 0.7 mm to 0.8 mm.
5. Replace the spark plug if the gap is more than 1.2 mm.

6. Fix the spark plug and tighten it to the torque of 25 Nm (dry).
7. Fit the spark plug cable, until a 'click' sound is heard. Repeat the procedure for the other spark plugs.

NOTICE

Tighten the spark plug carefully. Overtightening can damage the threads in the cylinder head. A loose spark plug or loose spark plug cable can affect combustion and cause damage to engine and catalytic converter.

CARBON CANISTER (MPFI) :

As petrol evaporates in the fuel tank, hydrocarbons are discharged into the atmosphere. The carbon canister stores these hydrocarbons from the fuel tank.

Air drawn through the carbon canister into the engine should be controlled to maintain exhaust emissions within desired limits as well as to ensure good driveability.

The carbon canister should be replaced at an Authorised Service outlet.

WHEELS & TYRES :

Always use only the recommended size of wheel rims & tyres. Use of non-recommended rims and tyres may have an adverse effect on car safety and furthermore could infringe on car regulations.

Wheel Change :

When changing wheels, use the jack provided with the car. The jack with handle is located on tailgate inner sill.

- Park the car on a safe level ground. Engage 1st gear and also apply the parking brake. Place wheel chocks behind the rear wheels and in front of the front wheels.
- Remove the wheel rim cover (if fitted) which is snap fitted.
- Loosen the wheel pins of the wheel to be changed slightly. Keep the spare wheel to be fitted nearby.
- Jack up the car by placing the jack at the appropriate location.
- Remove the wheel pins and the wheel.
- Fit the new wheel and tighten the wheel pins.
- Lower the jack and tighten the wheel pins to 8 mkg. torque. Fit the wheel rim cover.

NOTICE

The jack should never be supported on any of the body sheet metal components. This can cause damage to the body. Do not apply oil on the wheel pins. Wipe off the oil if present.

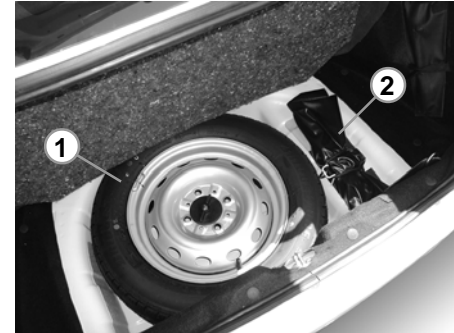

1. Spare Wheel 2. Jack Location

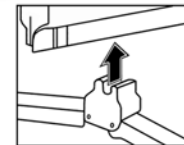

Jacking Point

- The jack should be placed below the body sill behind the front wheel tyre for front wheel changing and before the rear wheel tyre for rear wheel changing. Please refer to the sticker (Jack location) fixed on the jack.
- Do not work under the jacked up car without proper support.

Wheel Alignment :

Correct wheel alignment helps to ensure uniform tyre wear. You should get your car's wheel alignment checked regularly as per recommendation.

In case uneven tyre wear is observed, the vehicle's wheel alignment should be checked as soon as possible.

Wheel Balancing :

Wheels are balanced at the factory. They have to be rebalanced as per recommendations.

The wheels should be checked for balance if a tyre or tube is repaired.

Whenever a tyre or wheel rim is changed, the tyre needs to be balanced.

1. Permissible imbalance for tyre with rim = 95 gm. cm. (max.)
2. Total balance weight should be within 140 gm on each side.
3. Relocate the tyre on the wheel rim if the weight required to balance is more than 140 gm.

4. Balance weights are available from 5 gm to 140 gm, in steps of 5 gm.
5. Do not use more than one balance weight on one side.

TYRES :

Check for inflation and condition of your car tyres periodically.

Inflation :

Check the pressure in the tyres when they are cold.

Refer to the tyre information label fitted on the driver side doorpost for correct cold tyre pressure.

Recommended Tyre Pressures : (with cold tyres)

For tyre pressure (Refer page 'Filling Station Information')

You should have your own tyre pressure gauge and use it at all times. This makes it easier for you to tell if pressure loss is caused by a tyre problem and not by variation between gauges.

Keeping the tyres properly inflated gives you the best combination of riding comfort, handling and tyre life.

Over inflation of tyres makes the car ride bumpy and harsh. Tyres are more prone to uneven wear and damage from road hazards.

Under inflated tyres reduce your comfort in car handling and are prone to failures due to high temperature. They also cause uneven wear and more fuel consumption.



1. **Underinflation** - Excessive Side Tread Wear
2. **Correct Tyre Pressure** - Uniform Tyre Wear
3. **Overinflation** - Excessive Centre Tread Wear

Inspection :**⚠ CAUTION**

Every time you check inflation pressure, you should also examine tyres for leakage, damage, foreign objects & wear.

You should look for :**⚠ CAUTION**

- Bumps or bulges in the tread or the side of the tyre. Replace the tyre if you find either of these conditions.
- Cuts, splits or cracks in the side of the tyre. Replace the tyre if you notice this on the fabric or cord.
- Excessive tread wear or non uniform tyre wear.

Tyre Rotation :

To help increase tyre life and distribute wear more evenly you should have tyres rotated at specified intervals or earlier depending on the operation of car and tyre wear pattern.

The illustration shows how to rotate tyres when a normal spare wheel is included in tyre rotation.

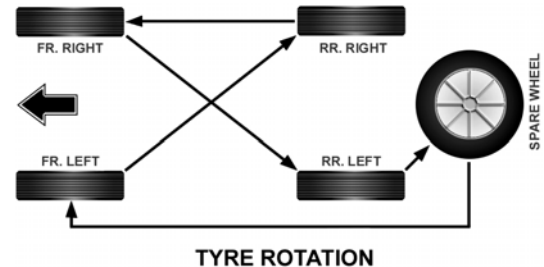

Spare Wheel :

It is located in the luggage compartment.

- To take out the spare wheel, first fold in and lift up the floor cover.
- Unscrew and remove retaining bolt, at the centre.
- Lift and take out the spare wheel.

Repairing a Tyre/Tube :

Mark the tyre position suitably (if original colour dot mark is not visible) with respect to valve stem hole to ensure that the tyre is refitted in the original location on the wheel rim.

Check the balance weight prior to the removal of the tyre. If found loose, mark its location on the rim & refit properly.

Balance the wheel after every dismantling and assembly of tyre on the wheel rim.

While fitting wheels on the car ensure that wheel pins are free from dust, scratches, dirt, dents, etc.

Ensure the tube being replaced has the correct valve.

NOTICE

Do not apply any oil on the wheel pins. Wipe off the oil if present.

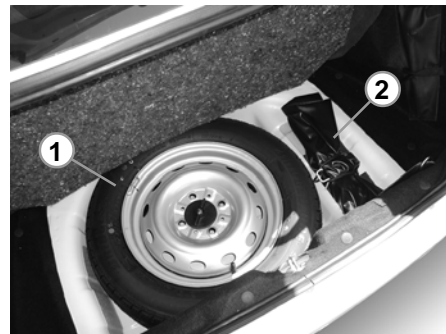

1. Spare Wheel 2. Jack Location

Fuses & Relays :

The electrical circuits in your car have fuses to protect the wiring from accidental short circuit or sustained overload. Fuses and relays are located at 3 locations in your car as shown in the sketch.

Circuit connected through fuses and relays and the amperage of the fuse is printed on the fuse box covers.

Checking and replacing fuses :

If any electrical unit in your car has stopped functioning, the fuses should be checked first.

- Turn the ignition key to 'LOCK' position.
- Remove the fuse box cover, locate the fuse for the function.
- Remove the fuse & look for the fuse element inside the fuse. If it is damaged replace it with a fuse of same rating and type. Push the fuse firmly into the holder.
- Check that all other fuses are firmly in position & fix the cover back in position. Spare fuses are provided in the fuse box in the cabin.

If the replaced fuse of the correct rating burns out in short time, there is probably a serious electrical problem in your car. Get the car attended to at the nearest Authorised Service outlet.

If any of the function relays is found defective, replace it by a genuine relay.

⚠ CAUTION

The electrical system is protected by fuses that are designed to foil and prevent damage to wiring harness. Always replace blown fuse with the same rating as specified to prevent wiring damage that can result in a possible fire.

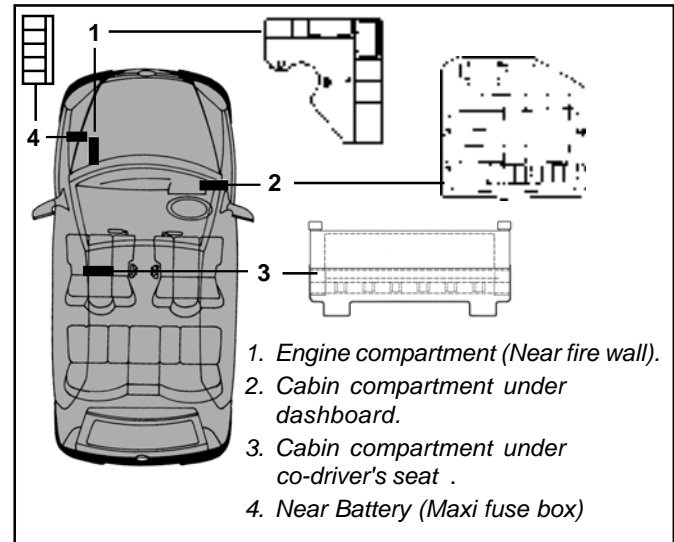

1. FUSE BOX - CABIN COMPARTMENT UNDER DASH BOARD

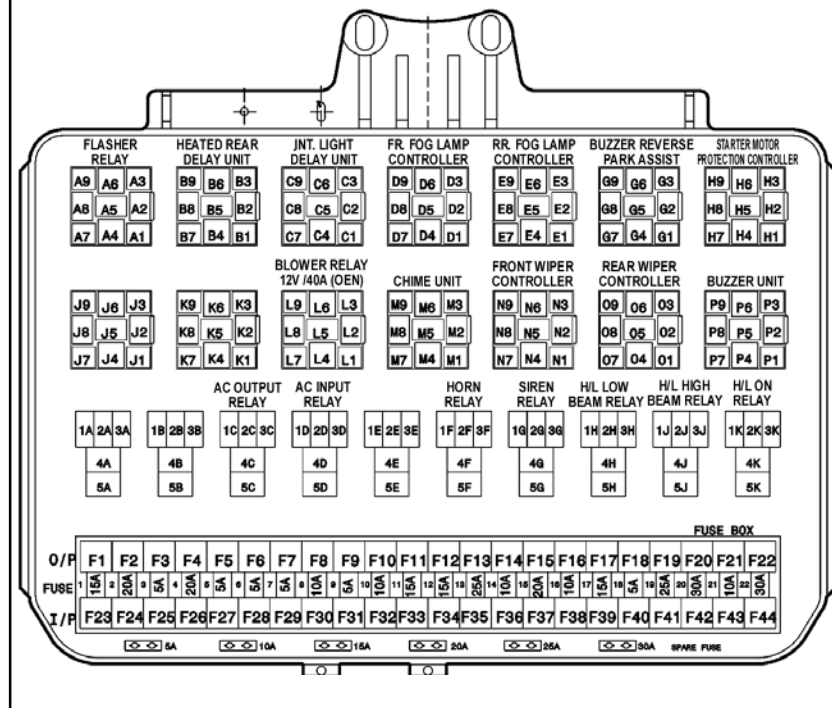

NO.	FUNCTION	FUSE
1	HORN	15A
2	FRONT & REAR FOG LAMP	20A
3	STARTER PROTECTION CIRCUIT	5A
4	STARTER RELAY	20A
5	POSITION LAMP RH	5A
6	POSITION LAMP LH	5A
7	BLOWER + WW + HORN RELAY COIL	5A
8	INDICATOR LAMPS	10A
9	MUSIC SYSTEM & CHIME KEY IN	5A
10	A/C CONTROLS	10A
11	HEAD LAMP LOW BEAM RELAY	15A
12	HEAD LAMP HIGH BEAM RELAY	15A
13	WASH & WIPERS	25A
14	INSTRUMENT CLUSTER, FUEL CUT OFF	10A
15	REVERSE LAMP, CLOCK & CIG. LIGHTER	20A
16	POWER PLUG	10A
17	MUSIC SYSTEM, CLOCK	15A
18	ROOF, ENGINE & LOAD AREA LAMP	5A
19	HEATED REAR WINDOW	25A
20	C.D.L. & IMMOBILIZER	30A
21	STOP LAMP	10A
22	VENTILATION MOTOR	30A

2. FUSE BOX - NEAR FIRE WALL- CR-4

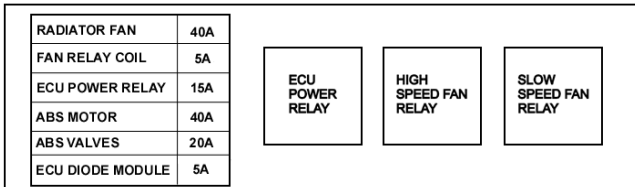

2. FUSE BOX - NEAR FIRE WALL- NA

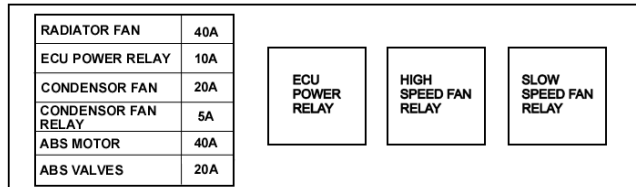

2. FUSE BOX - NEAR FIRE WALL- MPFI

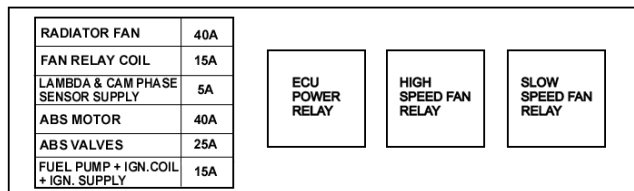

3. MAXI FUSE BOX - NEAR BATTERY

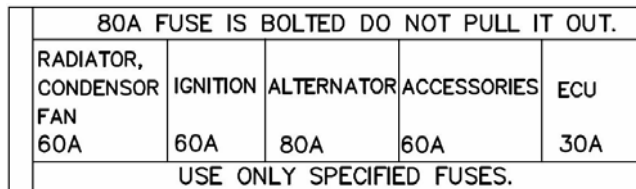

4. FUSE BOX - UNDER CO-DRIVER SEAT

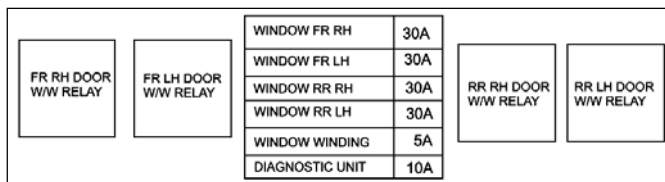

Head Lamps :

The head lamps are provided with two halogen lamps of H1 (High beam) / H7 (Low beam) type with single filament for providing straight ahead illumination of the road for long distance or a dip beam which illuminates the road immediately ahead for short distance visibility. Use dip beam to avoid inconvenience / blinding the drivers of oncoming vehicles.

The head lamps must be properly aligned in order to obtain maximum road illumination and reduced glare for oncoming traffic. It is recommended to check alignment of head lamp beams periodically at authorised service outlets

Head lamp focus adjustment should be always carried out at the authorised service outlets with the help of screen

Head Lamp Bulb Replacement :

- Switch 'OFF' the head lamps & ensure that the bulb is not hot.
- Open the bonnet and remove the lamp connector from the head lamp bulb.
- Remove rubber cap. Unlock the locking clip and take out the bulb from the holder. This should be done carefully, otherwise it may lead to breakage of the bulb holder / holding clip.
- Note the instructions on the bulb carton.

Replace the bulb with a new one of the same type with right orientation in the holder.

- Lock the clip, fit the rubber cap and fix the connector.
- Switch 'ON' the head lamps and check the lighting.

⚠ CAUTION

Do not clean or touch the head lamp reflector as it will damage the mirror finish of the surface.

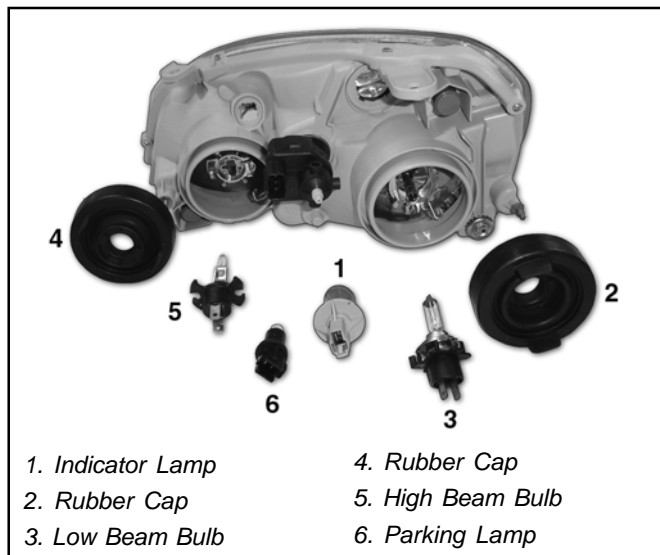

Headlamp Alignment :

The horizontal and vertical adjustment screws are located on the back of the reflector.

Precise adjustment can be carried out only in the authorised workshops.

When replacing the head lamp bulb, handle it by gripping the cap. Protect the glass from contact with your skin or hard object. If you touch the glass, clean it with spirit & a clean cloth. After replacement of the bulb in any emergency get the head lamp adjustment done at an **TATA MOTORS** Authorised Service outlet at the earliest.

 **CAUTION**

Halogen head lamp bulbs get very hot when illuminated. Oil, perspiration or a scratch on the glass can cause the bulb to break due to the heat.

CAR CARE :

The car is subjected to many external influences such as climate, road conditions, industrial pollution and proximity to the sea. These conditions demand regular care of the car body. Dirt, insects, bird droppings, oil, grease, fuel and stone chippings should be removed as soon as possible.

Washing :

Do not wash the car in direct sunlight, wash in shade. Spray the car thoroughly with a cold water jet (car on a washing pit or hoist). Mix car shampoo in the wash water. No solvent (fuel, thinners) need be used.

NOTICE

Avoid wiping of painted surface in dry condition as it may leave scratches on the painted surface.

Use a soft bristle brush, sponge or soft cloth and rinse it frequently while washing. When you have washed the whole exterior, dry it with a chamois or soft cloth. After drying the car, inspect it for chips and scratches that could allow corrosion to start. Apply touch up paint where necessary.

Polishes :

Polishes and cleaners can restore shine to the painted surface that has oxidised and become dull. They normally contain mild abrasives and solvents that remove the top

layer of the finish coat. Polish your car if the finish does not regain its original shine after using wax.

Cleaning of Carpets :

Vacuum clean the carpet regularly to remove dirt. Dirt will make the carpet wear out faster. Periodically shampoo the carpet to keep it looking new.

Use carpet cleaners (preferably foam type). Follow the instructions that come with the cleaner, applying it with a sponge or soft brush. Keep the carpeting as dry as possible by not adding water to the foam.

Cleaning of Windows, Front & Rear Glass :

RFID TAG is pasted on front windshield from inside. It enables Electronic toll collection.



DO NOT TRY TO PEEL OFF RFID TAG

TML PART NO. 2816 5420 99 05
VENUS WINDSHIELD MOUNT AVI TAG

NOTICE

Do not attempt to rip or tamper the tag. It will disable the functionality of the tag.

Clean the windows inside and outside with commercially available glass cleaners.

This will remove the haze that builds up on the inside of windows. Use a soft cloth or paper towels to clean all glass and plastic surfaces.

Maintaining the car when not in extended use :

Park the car in covered, dry and if possible well-ventilated premises.

Engage a gear.

Remove the cables from the battery terminals (first remove the cable from the negative terminal).

Make sure the handbrake is not engaged.

Clean and protect the painted parts using protective wax.

Clean and protect the shiny metal parts using commercially available special compounds.

Sprinkle talcum powder on the rubber windscreen wiper and rear window wiper blades and lift them off the glass.

Slightly open the windows.

Cover the car with a cloth or perforated plastic sheet. Do not use sheets of imperforated plastic as they do not allow moisture on the car body to evaporate.

Inflate the tyres to 0.5 bar above the normal specified pressure and check it at regular intervals.

Check the battery charge every six weeks.

Do not drain the engine cooling system.

Wiper Care :

Wiper blade attack angle on windshield glass should be 90° i.e. perpendicular.

Remove wiper blade and root wiper arm on windshield glass in the centre position. Check the gap between arm strip and glass.

Adjust by twisting wiper arm as shown in the figure.

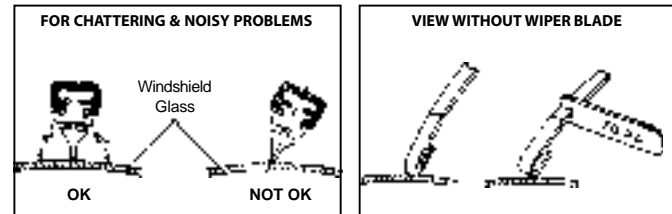

FOLLOWING GUIDELINES WILL HELP YOU TO BETTER PROTECT YOUR CAR FROM CORROSION

PROPER CLEANING :

In order to protect your car from corrosion it is recommended that you wash your car thoroughly and frequently in case :

1. There is an heavy accumulation of dirt and mud especially on the underbody.
2. It is driven in areas having high atmosphere pollution due to smoke, soot, dust, iron dust & other chemical pollutants.
3. It is driven in coastal areas.
4. The underbody must be thoroughly pressure washed after every three months.

In addition to regularly washing your car, the following precautions need to be taken.

PERIODIC INSPECTION :

1. Regularly inspect your car for any damage in the paint film such as deep scratches and immediately get them repaired from an Authorised Service Centre, as these defects tend to accelerate corrosion.
2. Inspect mud liners for damages.
3. Keep all drain holes clear from clogging.

PROPER PARKING :

Always park your car in shade to protect it from harsh sunlight or in a well-ventilated garage so that there is no dampness on any part of the car.

WASHING YOUR CAR :

Follow these tips while washing your car.

HAND WASH :

1. Always wash your car in shade and when the surface is at room temperature.
2. Wash with mild car wash soap like "Car Shampoo" and use a soft 100% cotton cloth to avoid scratches. Please take help of your dealer to buy the right products.
3. Please be sure that you remove your wristwatch and wear soft gloves to avoid scratches due to finger rings or nails.
4. To remove stubborn stains and contaminants like tar, use turpentine or cleaners like "Stain Remover" which is safe for painted surfaces. Again your dealer can help you in selecting the right product.
5. Avoid substances like petrol, diesel, kerosene, benzene or other solvents that cause damage to paint.
6. Dry your vehicle thoroughly to prevent any damp spots.

7. Rinse all surfaces thoroughly to prevent any traces of soap and other cleaners as this may lead to the formation of stains on the painted surface later.

WAXING :

Waxing and polishing is recommended to maintain the gloss and wet-look appearance of your paint finish.

1. Use a good quality polish and wax for your car.
2. Re-wax your car when the water does not slip off the surface and collects over the surface in patches.

Further tips for the care of your new CAR finish :

We recommend that you do not use an automatic car wash as the stiff brushes or sponges could mar the finish and damage the surface of your car. Wash the vehicle by hand with cool and clean water using a soft cloth or sponge. Please do not use soap but a car shampoo recommended by your dealer.

Please take the following precautions :

1. Always wash your car in shade, avoiding direct exposure to sunlight during washing.
2. Dry wiping your car may lead to the formation of scratches and hence always use a soft cloth and clean water while wiping your car.

3. Always keep your car parked in a well ventilated shade. Exposure to heat with entrapped moisture promotes corrosion.

4. Avoid driving on gravel roads, as the possibility of paint chip off due to the impact of stones is high. If you are driving on freshly tarred road, check immediately afterwards for any stains & clean them.

5. External contamination in the form of sap or industrial fall-out may mar or develop spots on a new finish. Hence avoid parking your car near trees, which are known to drop sap, or near factories, which give out heavy smoke.

6. The acid content in bird droppings may damage the newly painted finish and hence any bird dropping must be immediately washed off.

7. The paint finish is susceptible to damage in case petrol, brake fluid, liquid from car battery, oil, antifreeze, transmission fluid or windshield solvent spills onto the painted surface. In case of such a spillage immediately rinse the affected area with water. Avoid wiping the area as far as possible, however if wiping is required, ensure that you wipe the area gently with soft cotton cloth.

8. Avoid using sharp objects to scrap off tar or mud from a painted surface as it may develop scratches or may peel off the paint.

EMERGENCY SERVICE TIPS

EMERGENCY SERVICE TIPS

- Engine
- Clutch
- Transaxle
- Brakes
- Steering System
- Electrical
- Suspension

EMERGENCT SERVICE TIPS

These tips are given for your guidance. These preliminary jobs are to be carried out in an emergency. In normal cases the problems should be attended to in an Authorised Service outlet by following the repair procedures given in the Workshop Manual.

SR. NO.	PROBLEM OBSERVED	PROBABLE CAUSE	ACTION TO BE TAKEN
ENGINE (DIESEL)			
1.	Engine not cranking	Dead battery, loose or improper battery/electrical connections	<ul style="list-style-type: none"> • Get battery checked and / or changed.
			<ul style="list-style-type: none"> • Jump start using another battery
			<ul style="list-style-type: none"> • Clean & tighten connections
2.	Engine cranks but does not start	Air in the fuel system	<ul style="list-style-type: none"> • Get the air removed by bleeding • Check leakages & correct.
		Engine stop solenoid fuse blown	<ul style="list-style-type: none"> • Replace the fuse
3.	Check Engine/MIL lamp continue to glow, even after start	Some fault are detected by the ECU controlled system	<ul style="list-style-type: none"> • Get the vehicle checked and rectified at Authorised w/shop
4.	Engine overheats	Coolant level low, coolant leakages	<ul style="list-style-type: none"> • Check and correct leakages • Top up coolant
		Hose collapsed/torn	<ul style="list-style-type: none"> • Get the hose replaced
		Low engine oil level	<ul style="list-style-type: none"> • Add oil
		Cap not sealing properly	<ul style="list-style-type: none"> • Fit the auxiliary water tank cap correctly
		A.C. condenser fan not working	<ul style="list-style-type: none"> • Get defect rectified
		Brakes binding	<ul style="list-style-type: none"> • Get defect rectified
		Electric fan not working	<ul style="list-style-type: none"> • Get defect rectified
		High delivery pressure in A.C. refrigerant circuit	<ul style="list-style-type: none"> • Get defect rectified

EMERGENCY SERVICE TIPS

SR. NO.	PROBLEM OBSERVED	PROBABLE CAUSE	ACTION TO BE TAKEN
		Radiator fins clogged	<ul style="list-style-type: none"> • Clean it
		Radiator water passage clogged	<ul style="list-style-type: none"> • Get it rectified
		Thermostat defective	<ul style="list-style-type: none"> • Get it rectified
5.	Charging indicator continuously remains ON	Battery not getting charged due to loose belt	<ul style="list-style-type: none"> • Get the belt tension adjusted • Replace if broken
6.	Poor pickup	Accelerator cable loose	<ul style="list-style-type: none"> • Get it adjusted correctly
		Air in the fuel system	<ul style="list-style-type: none"> • Remove the air
		Clogged fuel filter	<ul style="list-style-type: none"> • Clean / Replace the element
		Clogged air filter	<ul style="list-style-type: none"> • Clean / Replace the element
		Clutch slipping/out of adjustment	<ul style="list-style-type: none"> • Get it rectified
		Brakes grabbing	<ul style="list-style-type: none"> • Get it rectified
7.	Does not accelerate	Accelerator cable broken	<ul style="list-style-type: none"> • Get cable replaced
		Fuel filter choked	<ul style="list-style-type: none"> • Replace
8.	Belt squeal	Loose belt	<ul style="list-style-type: none"> • Get belt tension adjusted
		Belt glazed	<ul style="list-style-type: none"> • Get belt replaced
9.	Low engine oil pressure indicator 'ON' when engine is running eventhough engine oil level is within MAX/MIN marking	Pressure transducer faulty, and/or oil pump faulty	<ul style="list-style-type: none"> • Do not run the engine extensively . Take the car to the nearest Authorised Service outlet & get the fault rectified

EMERGENCT SERVICE TIPS

SR. NO.	PROBLEM OBSERVED	PROBABLE CAUSE	ACTION TO BE TAKEN
ENGINE (PETROL)			
1.	Engine not cranking	Dead battery, loose or improper battery/electrical connections	• Get battery checked and/or changed
			• Jump start using another battery
			• Clean & tighten connections
2.	Engine cranks but does not start	No fuel	• Get the unleaded fuel filled
		Fuel filter chocked	• Get the fuel filter replaced
		Engine stop solenoid fuse blown	• Check fuse for fuel pump & EMS
		Inertia Switch tripped off	• Replace the fuse
3.	Engine overheats	Coolant level low, coolant leakages	• Reset Inertia switch
		Hose collapsed/torn	• Check and correct leakages Top up coolant
		Low engine oil level	• Get the hose replaced
		Cap not sealing properly	• Add oil
		A.C. condenser fan not working	• Fit the auxiliary water tank cap correctly
		Brakes binding	• Get defect rectified
		Electric fan not working	• Get defect rectified
		High delivery pressure in A.C. refrigerant circuit	• Get defect rectified
		Radiator fins clogged	• Clean it
		Radiator water passage clogged	• Get it rectified
Thermostat defective	• Get it rectified		

EMERGENCY SERVICE TIPS

SR. NO.	PROBLEM OBSERVED	PROBABLE CAUSE	ACTION TO BE TAKEN
4.	Charging indicator continuously remains ON	Battery not getting charged due to loose belt	<ul style="list-style-type: none"> • Get the belt tension adjusted • Replace if broken
5.	Check engine/MIL lamp continues to glow, even after start	Some faults are detected by the fuel injection & ignition system	<ul style="list-style-type: none"> • Get the vehicle checked and rectified at Authorised Workshop
6.	Poor pickup	Accelerator cable loose	<ul style="list-style-type: none"> • Get it adjusted correctly
		Air in the fuel system	<ul style="list-style-type: none"> • Remove the air
		Clogged fuel filter	<ul style="list-style-type: none"> • Clean / Replace the element
		Clogged air filter	<ul style="list-style-type: none"> • Clean / Replace the element
		Clutch slipping/out of adjustment	<ul style="list-style-type: none"> • Get it rectified
		Brakes grabbing	<ul style="list-style-type: none"> • Get it rectified
7.	Does not accelerate	Accelerator cable broken	<ul style="list-style-type: none"> • Get cable replaced
		Fuel filter choked	<ul style="list-style-type: none"> • Replace
8.	Belt squeal	Loose belt	<ul style="list-style-type: none"> • Get belt tension adjusted
		Belt glazed	<ul style="list-style-type: none"> • Get belt replaced
9.	Low engine oil pressure indicator 'ON' when engine is running even though engine oil level is within MAX / MIN marking	Pressure transducer faulty, and/or oil pump faulty	<ul style="list-style-type: none"> • Do not run the engine extensively. Take the car to the nearest Authorised Service outlet & get the fault rectified.
CLUTCH			
1.	Clutch slipping	Improper pedal travel	<ul style="list-style-type: none"> • Adjust pedal travel
		Rusted clutch cable	<ul style="list-style-type: none"> • Replace cable
		Oil on clutch disc	<ul style="list-style-type: none"> • Clean or replace disc at Authorised Service outlet

EMERGENCT SERVICE TIPS

SR. NO.	PROBLEM OBSERVED	PROBABLE CAUSE	ACTION TO BE TAKEN
2.	Noisy clutch	Pressure plate & diaphragm spring rattling	• Get car attended to by Authorised Service outlet
		Release bearing broken/worn out	• Replace
		Broken damper spring of clutch disc	• Replace
TRANSAXLE			
1.	Gears slipping out of mesh	Worn/damaged grooves on shifter shaft	• Replace
		Worn shift fork or synchroniser sleeve	• Replace
		Weak or damaged detent springs	• Replace
		Worn bearings on input shaft or layshaft	• Replace
		Worn dog teeth on sleeve and gear	• Replace sleeve and gear
2.	Hard shifting	Inadequate lubricant	• Replenish
		Inadequate clutch pedal travel	• Adjust
		Distorted or broken clutch disc	• Replace
		Damaged clutch pressure plate	• Replace clutch cover/disc
		Worn synchrocones	• Replace
		Worn dog teeth on sleeve or gear	• Replace sleeve or gear
		Distorted shift shaft/linkages	• Replace
3.	Noise	Inadequate or insufficient lubricant	• Replenish
		Damaged or worn bearing(s)	• Replace
		Damaged or worn gear(s)	• Replace
		Damaged or worn synchroniser parts	• Replace

EMERGENCY SERVICE TIPS

SR. NO.	PROBLEM OBSERVED	PROBABLE CAUSE	ACTION TO BE TAKEN
BRAKES			
1.	Poor brakes	Insufficient brake fluid	• Get the brake fluid filled
		Air in the system	• Get the air removed
		Pedal travel excessive due to excessive shoe gap	• Rectify automatic adjuster
		Vacuum leakage	• Rectify the leakage
		Brake oil (line) leaking	• Replace the leaking line
		Oil on the drum/liners	• Get the liners cleaned/ replace seals if leaking
		Worn brake lining	• Get the liners replaced
		Defective/worn parts	• Get them replaced
2.	Brake pulling to one side	Oil on the brake lining	• Clean the brake lining
		One side shoe/pad worn	• Get the shoe/pad replaced
		Loose brake anchor plate	• Tighten the bolts
		One side brake pipe clogged	• Get the brake line cleaned
		Defective tandem master cylinder	• Rectify/Replace tandem master cylinder
3.	Brake Squeal	Defective brake lining	• Replace
		Glazed lining	• Clean or replace lining
		Loose rivets.	• Install rivets properly
		Wrong lining	• Install correct lining
		Shoe return spring broken	• Replace
		Front pads rubbing on the disc	• Get it corrected

EMERGENCT SERVICE TIPS

SR. NO.	PROBLEM OBSERVED	PROBABLE CAUSE	ACTION TO BE TAKEN
STEERING SYSTEM			
1.	Hard steering (For power steering)	Less fluid in the power steering tank	• Get the fluid topped up to the correct level
		Air in the system	• Get the air removed by bleeding the system
		Loose pump belt	• Get the belt correctly adjusted
		Low tyre pressure	• Adjust to correct value
2.	Poor Returnability	Grabbing of linkages	• Check & rectify
		Steering gear disturbed	• Check & adjust
3.	Excessive play on steering	Rack & pinion attachment loose	• Get it tightened
ELECTRICAL			
1.	Battery charge & engine oil pressure lamp in cluster not operating when key is in 'IGN' position	Battery terminal loose or disconnected	• Check connections
		Battery completely dead	• Get the battery properly connected
		Bulb fused	• Get the battery charged
		Fuse blown	• Get the alternator & charging circuit checked
		Loose/open connections	• Get the bulb checked
2.	Non functioning Electrical accessories such as power windows, head lamps, fuel & temp. gauge, RPM meter, wiper & washer unit and all lamps etc.	Fuse blown in the circuit	• Replace the fuse if blown
		Loose connectors.	• Get the connection properly tightened/fixed
		Circuit relay/controllers loose in the base	• Fix the relay firmly

EMERGENCY SERVICE TIPS

SR. NO.	PROBLEM OBSERVED	PROBABLE CAUSE	ACTION TO BE TAKEN
		Defective components	<ul style="list-style-type: none"> • Get the defective components replaced at an Authorise Service outlet
SUSPENSION			
1.	Abnormal or excessive tyre wear	Tyre out of balance	<ul style="list-style-type: none"> • Check balance and/or adjust if required
		Steering geometry disturbed	<ul style="list-style-type: none"> • Adjust steering geometry
		Tyres not adequately inflated	<ul style="list-style-type: none"> • Adjust tyre pressure
		Wobbly wheel or tyre	<ul style="list-style-type: none"> • Replace wheel or tyre
		Defective tyre	<ul style="list-style-type: none"> • Replace tyre
		Hub play not proper	<ul style="list-style-type: none"> • Adjust hub play
		Brake grabbing	<ul style="list-style-type: none"> • Check and rectify
		Excessive braking	<ul style="list-style-type: none"> • Modify driving habit
2.	Abnormal noise from front end	Worn, sticky or loose tie rod ends, lower ball joints, tie rod in side ball joints or drive shaft joints.	<ul style="list-style-type: none"> • Replace tie rod end, suspension arm, tie rod or drive shaft joints
		Warning noise for pad wear	<ul style="list-style-type: none"> • Replace pad
		Damaged struts or mounting	<ul style="list-style-type: none"> • Repair mounting or replace struts
		Worn suspension arm bushings	<ul style="list-style-type: none"> • Replace
		Loose wheel nuts	<ul style="list-style-type: none"> • Tighten wheel nuts
		Loose suspension bolts or nuts	<ul style="list-style-type: none"> • Tighten suspension bolts or nuts
		Broken or damaged wheel bearing	<ul style="list-style-type: none"> • Replace

EMERGENCT SERVICE TIPS

SR. NO.	PROBLEM OBSERVED	PROBABLE CAUSE	ACTION TO BE TAKEN
		Poorly lubricated or worn strut bearings	• Lubricate or replace strut bearings
		Excessive hub play	• Adjust
		Loose caliper housing bolts	• Check & tighten
3.	Ride too soft / bumpy	Faulty struts	• Replace strut
4.	Suspension bottoms	Over loaded	• Check loading
		Faulty struts	• Replace struts

IMPORTANT INFORMATION

IMPORTANT INFORMATION

- Chassis & Aggregate Numbers
- Fuel, Lubricants & Coolants
- Co-branded Lubricants & Coolants
- Technical Specifications
- Service Instructions
- Service Schedule
- Car Record Sheet



Chassis Number Plate



Chassis Number on 'B' pillar

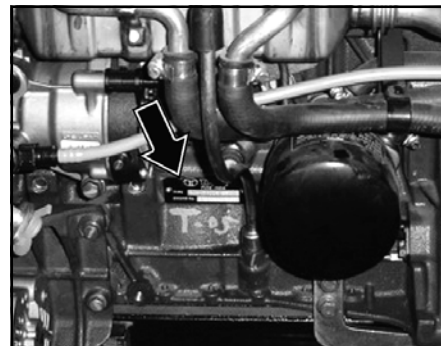

Engine Number (CR-4)



Engine Number (NA)



Engine Number (MPFI)

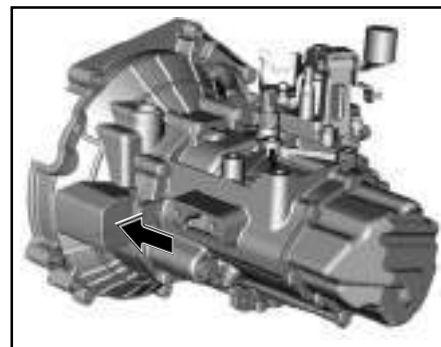

Transaxle Number

FUEL (DIESEL) :

Fuel BS-III : High speed diesel conforming to IS 1460 or DIN 51601 or equivalent is recommended to be used as fuel.

Fuel BS-IV : Normal grade BS IV compliant diesel conforming to IS1460 or EN 590 or equivalent is recommended to be used as fuel. It is always recommended to use BS IV Compliant fuel to get optimum emission performance.

Do not use premium diesels available in the market for **example extra premium / Turbojet etc.**

Recommended Fuel Specification.

	Parameter	Unit	BS III	BS IV
1	Cetane Number (min)	CN	51	51
2	Sulphur content	mg/kg	350	50
3	Lubricity (HFRR)	micon	460	460

NOTICE

Where oxidation catalytic converter is fitted, it is mandatory to use Diesel fuel with sulphur contents as given above. Use of any other diesel fuel can increase the pollutants.

At very low temperature, fluidity of diesel may become insufficient due to paraffin separation. It is therefore necessary to mix supplementary fuel with summer or winter grade diesel. The supplementary fuel to be used is kerosene or aviation turbine fuel. Ratio for mixing of supplementary fuel and diesel are shown in the table.

Ambient Temperature upto Deg. C	Percentage	
	Summer grade diesel	Supplementary fuel
Upto 0	100	0
0 to -10	70	30
-10 to -15	50	50

Care should be taken that diesel and supplementary fuel are thoroughly mixed before filling.

Ambient temperature upto Deg. C	Percentage	
	Winter grade diesel	Supplementary fuel
Upto -15	100	0
-15 to -20	70	30
-20 and below	50	50

WARNING: Do not mix gasoline or alcohol with diesel. This mixture can cause explosion.

FUEL (PETROL) :

Fuel BS-III : Unleaded regular grade petrol conforming to IS 2796 DIN 51607 (or equivalent) and octane rating not less than 87 RON (RON stands for Research Octane Number) is recommended to be used as fuel.

Fuel BS-IV : Unleaded regular grade BS IV compliant petrol conforming to IS2796-1994/DIN 51607 (or equivalent) and RON not less than 91 is recommended to be used as fuel. It is always recommended to use BS IV Compliant petrol to get optimum emission performance.

CAUTION

Always use proper fuel of recommended specifications

Lubricants : (Diesel)

Engine Oil : Recommended grade of engine oil conforming to API CF4+ specification and range of ambient temperature at which these can be used are given in the table below.

Ambient temp. in deg. C	Engine oil grade
-10 deg. & above	SAE 15W/40 or SAE 15W/50
Below -10 deg.	SAE 5W/20 or SAE 5W/30

Lubricants : (Petrol)

Engine oil : Recommended grade of engine oil conforming to API-SL/CH4 specification and range of ambient temperature at which these can be used are given in the table below.

Ambient temp. in deg. C	Engine oil grade
-10 deg. & above	SAE 15W/40 or SAE 20W/50
-15 deg. to 40 deg.	SAE 15W/40 or SAE 15W/50
-20 deg. to 40 deg.	SAE 10W/40 or SAE 10W/50
-35 deg. to 40 deg.	SAE 5W/30

Transaxle :

Use recommended brand of EP 80 gear oil.

Grease for axle bearings :

Lithium base complex grease

Brake fluid :

IS 8654/DOT 4

Power Steering :

ATF A DEXRON III

Coolants :

Presence of dirt in the coolant chokes up passages in the radiator, cylinder head and cylinder block, thereby causing insufficient cooling of engine.

To prevent rust formation and freezing of coolant inside the passages of radiator, cylinder block and cylinder head, use only branded premixed engine coolant.

PLEASE USE ONLY GENUINE ENGINE OILS, COOLANTS, LUBRICANTS, BRANDED BY TATA MOTORS FOR OPTIMUM PERFORMANCE OF YOUR TATA INDICA e-V2....

ITEM	COMPANY	BRAND	QTY
ENGINE OIL (DIESEL)	CASTROL HPCL	Castrol GTD 15 W/40 HP Milcy 15 W/40	5.5 Litres
ENGINE OIL (PETROL)	CASTROL HPCL	Castrol GTX 20 W/40 HP ESMO 20 W/40	4.0 Litres
COOLANT	SUNSTAR ANCHEMCO HPCL	Golden Cruiser 1400 M Frostox SFD 12 HP Thanda Raja P	6 Litres
TRANSMISSION OIL	HPCL CASTROL	Gear Oil EP 80 Castrol Extreme Pressure 80 EP	3.3 Litres
STEERING OIL	HPCL CASTROL EXXON	HP ATF DEX III CASTROL-TQ DEX III EXXON- Multipurpose ATF	1.2 Litres
BRAKE FLUID	HPCL CASTROL	Super Duty Brake Fluid DOT-4 Castrol Universal Brake Fluid DOT-4	0.270 Litres
HUB GREASE	CASTROL	Castrol Grease AP2	

1. ENGINE (DIESEL) :

Model	: Tata 475 IDI (NA) : Tata 1.4L (CR-4)
Type	: Water cooled, Diesel Engine with Turbo-charger, EGR system & oxydation catalyst with Turbo Charger & Intercooler
No of cylinders	: 4 inline
Bore/Stroke	: 75 mm x 79.5 mm (NA) : 75 mm x 79 mm (CR-4)
Capacity	: 1405 cc (NA) : 1396 cc (CR-4)
Max. engine output	: 53.5 Ps @ 5000 rpm (NA) 70 Ps @ 4000 rpm (CR-4)
Max. Torque	: 85 Nm @ 2500 rpm (NA) 140 Nm @ 1800-3000 rpm (CR-4)
Compression ratio	: 22:1 (NA) : 17.5:1 (CR-4)
Firing order	: 1-3-4-2

1. ENGINE (PETROL)

Model	: Tata 475 SI 56 (MPFI)- (1.2L) BS- IV
Type	: Water cooled, (Multi Point Fuel Injection) Petrol Engine
No of cylinders	: 4 inline
Bore/Stroke	: 75mm x 67.5mm (1.2L)-BS-III/IV
Capacity	: 1193 cc (1.2L)-BS-III/IV
Max. engine output	: 65 PS at 5000 rpm (1.2L)-BS-IV as per ISO-1585
Max. Torque	: 100 Nm at 2700 rpm (1.2L)-BS-IV as per ISO-1585
Compression ratio	: 10 : 1
Firing order	: 1-3-4-2

2. CLUTCH

Type	: Single plate dry friction diaphragm type
Outside dia. of of clutch lining	: 200 mm (CR-4) / 190 mm (NA / MPFI)
Friction area	: 346 sq.cm. (CR-4) / 285 sq.cm. (NA / MPFI)

- 3. TRANSAXLE** : Front wheel drive through constant velocity joints.
- Model** : TA65-STAR / 3.64 with overdrive
- Type** : Synchromesh on all forward gears. Sliding mesh for reverse gear.
- No. of gears** : 5 Forward, 1 Reverse
- | | NA | CR-4 | MPFI |
|---------------------------|-------|-------|------|
| Gear ratios : 1st- | 3.64 | 3.64 | 3.42 |
| 2nd- | 1.95 | 1.95 | 1.95 |
| 3rd- | 1.27 | 1.27 | 1.36 |
| 4th- | 0.88 | 0.88 | 0.95 |
| 5th- | 0.636 | 0.636 | 0.71 |
| Rev.- | 3.58 | 3.58 | 3.58 |
| Final driveratio : | 4.4 | 3.765 | 4.64 |
- Gear Shift** : Floor mounted with International "H" pattern, with Fifth and Reverse inline. with interlock to prevent accidental engagement from 5th to reverse
- 4. REAR AXLE** : Non driven axle Independently suspended

- 5. SUSPENSION**
- Front** : Independent, Lower wishbone, McPherson Strut type.
- Rear** : Independent 3 link & Mc Pherson strut type
- Antiroll bar** : At front & rear
- 6. STEERING**
- Standard** : Mechanical rack and pinion steering gear with collapsible steering column (**LE / GLE**)
- : Hydraulic Power assisted Rack & Pinion Steering Gear with collapsible steering column (**LX/LS/ LX ABS/GLX/GLS**)
- Steering Wheel** : 380 mm dia
- 7. BRAKES**
- Service brakes** : Dual circuit, diagonal split hydraulic brakes through tandem master cylinder.
- Front** : 231 mm dia disc brake
- Rear** : 200 mm dia drum brake
- Parking brake** : Lever type, Console mounted, Cable operated mechanical linkages acting on rear wheels

8. WHEELS & TYRES

Tyres : 165/65 R 14 **(CR-4)**
 155/80 R 13 **(NA & MPFI)**

Wheel rims : 4.5 J x 13" Stylised steel rims **(NA)**
 : 5J X 14" Stylised Alloy rims **(CR-4 & MPFI)**

No. of wheels : Front - 2 , Rear - 2, Spare - 1

9. FUEL TANK : Capacity :37 litres

10. BODY : 3 Box steel monocoque body

11. ELECTRICAL SYSTEM

System Voltage : 12 Volts -ve earth

Battery : 12V, DIN 55 **(NA/CR-4)**
 12V, DIN 44 **(MPFI)**

Alternator : 13.5 V 90A **(CR-4)**
 12 V 90A **(NA & MPFI)**

12. PERFORMANCE (kmph)

Max. speed at : 150 **(CR-4 / NA)** /
 rated GVW 140 **(MPFI)**

13. MAIN CHASSIS DIMENSIONS AS PER ISO:612 IN MM

Wheel base : 2400

Track front : 1400

Track rear : 1380

Front Overhang : 800

Rear Overhang : 490

Overall length : 3690

Max. Width :

Over body : 1665

Overall height - unladen : 1485 (NA & MPFI)
 1500 (CR-4)

Min. turning circle dia : 9.8 m

Min. turning clearance : 10.2 m
 circle dia

Ground clearance - unladen : 165 (NA)
 178 (CR-4 & MPFI)

14. WEIGHT (kg) (TOLERANCE AS PER EEC 92/21)

		NA	TCIC	CR-4	MPFI
Complete car kerb weight as Per ISO:1176 (with spare wheel & tools)	GLS / LS	1000	-	1035	1000
	GLE / LE	995	-	-	995
	GLX / LX	1005	-	1105	1005
	DLS / GLS	-	1000	-	-
Gross Vehicle Weight	GLS / LS	1400	-	1435	1400
	GLE / LE	1395	-	-	1395
	GLX / LX	1405	-	1505	1405
	DLS / GLS	-	1400	-	-
Pay load	ALL	400	400	400	400

15. PASSENGER CAPACITY : 2 front + 3 rear

16. LUGGAGE SPACE

Net inside loading space : 0.22 cubic metre upto rear seat backrest
0.61 cubic metre upto front seat backrest when rear seat is folded

SERVICE INSTRUCTIONS :

To achieve economical and trouble free performance, please follow the instructions as stated.

YOUR CAR IS ENTITLED TO FOUR FREE SERVICES (LABOUR ONLY). THE FREE SERVICE COUPONS ARE ATTACHED TO THE SALES INVOICE. PLEASE PRESENT THESE COUPONS TO THE SERVICING DEALER WHILE AVAILING FREE SERVICES.

- 1st free service** - At 1000-1500 km. OR 1 month whichever is earlier
- 2nd free service** - At 5000-5500 km. OR 6 months whichever is earlier
- 3rd free service** - At 10000-10500 km. OR 12 months whichever is earlier
- 4th free service** - At 20000-20500 km. OR 24 months whichever is earlier

All services other than free services are chargeable.

Servicing of the car can be done at any **TATA MOTORS** Authorised Dealer Workshop, **TATA MOTORS** Authorised Service Centre (TASC) or **TATA MOTORS** Authorised Service Point (TASP). The details of their locations are given in this manual.

Warranty claims can be settled by any Tata Motors Authorised Dealer for all failures, while all warranty claims excluding the consideration on the replacement of major aggregates, can be settled by any TASC which is authorised for handling warranty claims. TASPs will not handle warranty repairs.

IMPORTANT INFORMATION

SERVICE SCHEDULE

	OPERATION	FREQUENCY (IN KM)	PDI	1,000 - 1,500	5,000 - 5,500	10,000 - 10,500	20,000 - 20,500	30,000 - 30,500	40,000 - 40,500	50,000 - 50,500	60,000 - 60,500	70,000 - 70,500	80,000 - 80,500	90,000 - 90,500	100,000 - 100,500
1	Wash the vehicle & Clean Condenser Fins	Every Service	•	•	•	•	•	•	•	•	•	•	•	•	•
2	Drain water accumulated in Sedimenter / when warning lamp glows (CR-4)	Every Service	•	•	•	•	•	•	•	•	•	•	•	•	•
	Drain water from Fuel Filter Bowl (DIESEL)														
3	Check & Top up Fluids (If required): Transaxle Oil, Coolant, Brake Fluid, Battery Electrolyte, Wind Screen washer fluid, Power Steering Oil (If fitted).	Every Service	•	•	•	•	•	•	•	•	•	•	•	•	•
4	Check Fuel Lines for Leakages.	10,000				•	•	•	•	•	•	•	•	•	•
5	Check Rubber Boots & Bushes for damage.	30,000						•			•			•	
	DIESEL / MPFI / CR-4 ENGINE														
1	Clean air filter element (more frequently for vehicle operating as TAXI)	10,000			•	•	•	•	•	•	•	•	•	•	•
2	Change engine oil and Oil filter Or 12 Months whichever is earlier	10,000				•	•	•	•	•	•	•	•	•	•
3	Change fuel filter (MPFI)	10,000				•	•	•	•	•	•	•	•	•	•
	Clean the bowl & replace the fuel tank side fuel filter element (DIESEL)	10,000				•	•	•	•	•	•	•	•	•	•
	Clean the bowl & replace the FIP side fuel filter element (DIESEL)	20,000					•		•		•		•		•
	Change pre filter cartridge (CR-4)	20,000					•		•		•		•		•
	Replace main fuel filter (CR-4)	40,000							•				•		
4	Check all Drive belts for tension, adjust if necessary	10,000				•	•	•	•	•	•	•	•	•	•
5	Replace air filter element (more frequently for vehicle operating as TAXI)	40,000							•				•		
6	Change coolant (or two years whichever is earlier)	40,000							•				•		

	OPERATION	FREQUENCY (IN KM)	PDI	1,000 - 1,500	5,000 - 5,500	10,000 - 10,500	20,000 - 20,500	30,000 - 30,500	40,000 - 40,500	50,000 - 50,500	60,000 - 60,500	70,000 - 70,500	80,000 - 80,500	90,000 - 90,500	100,000 - 100,500	
7	Replace timing belt	100,000													•	
8	Replace Spark Plugs (MPFI)	30,000						•			•				•	
	TRANSAXLE															
1	Change Transaxle oil	20,000					•		•		•		•			•
	BRAKES															
1	Check front brake pads & rear brake linings. Replace if necessary	20,000					•		•		•		•			•
2	Repalce brake fluid (or 2 years whichever is earlier) & Check brake system components for Leakages	40,000							•				•			
	WHEELS & TYRES															
1	Rotate tyres	20,000					•		•		•		•			•
	FRONT & REAR SUSPENSION															
1	Check & Adjust Wheel alignment	20,000					•		•		•		•			•
	STEERING															
1	Replace power steering oil	80,000												•		
	ELECTRICAL															
1	Check specific gravity of battery electrolyte (OR Every 6 Months)	10,000				•	•	•	•	•	•	•	•	•	•	•
2	Check headlamp focussing	30,000						•			•			•		
	A.C. SYSTEM															
1	Check Airconditioning / HVAC System for satisfactory performance	Every Service	•	•	•	•	•	•	•	•	•	•	•	•	•	•

IMPORTANT INFORMATION

ABBREVIATIONS

AC	Air Conditioning
ACC	Accessories
Amp	Ampere
Br	Branch
Brg	Bearing
cc	Cubic Centimeters
Cm	Centimeter
Dia	Diagonal
EGR	Exhaust Gas Recirculation
FAW	Front Axle Weight
Fig	Figure
FIP	Fuel Injection Pump
gm	Gram
GVW	Gross Vehicle Weight
IGN	Ignition
Kg	Kilogram
Km	Kilometer
Km/h	Kilometer per hour
LH	Left Hand
Max	Maximum
MD	Main Dealer
Min	Minimum

mkg	Meter per Kilogram
mm	Millimeter
Mtg	Mounting
No	Number
PCBU	Passenger Car Business Unit
PDI	Pre-delivery Inspection
PSI	Pounds per Square Inch
PUC	Pollution Under Control
RAW	Rear Axle Weight
RCSM	Regional Customer Support Manager
RH	Right Hand
RM	Regional Manager
RPM	Revolution Per Minute
Sec	Seconds
Sq.cm.	Square Centimeter
TASC	Tata Motors Authorised Service Centre
TASP	Tata Motors Authorised Service Point
V	Volts
W	Watts
Wt	Weight

Date	km reading	Fuel filled	Fuel consumption	Remarks / Complaints

IMPORTANT INFORMATION

RECORD OF SERVICE PERFORMED

Recommended Service	Date	Odometer reading km.	Repair Order No.	Servicing Dealer's Signature & Stamp
At km.				
PDI Free Labour				
1,000 *				
10,000 *				
20,000 *				
30,000 #				
40,000 #				
50,000 #				
60,000 #				
70,000 #				
80,000 #				
90,000 #				
1,00,000 #				
1,10,000 #				

* Labour free, material chargeable

Recommended Service	Date	Odometer reading km.	Repair Order No.	Servicing Dealer's Signature & Stamp
At km.				
1,20,000 #				
1,30,000 #				
1,40,000 #				
1,50,000 #				
1,60,000 #				
1,70,000 #				
1,80,000 #				
1,90,000 #				
2,00,000 #				

Change engine oil and oil filter

RECORD OF WARRANTY REPAIR PERFORMED**IMPORTANT INFORMATION**

Date	Odometer reading (km)	Repair Order No.	Particulars of Repair	Servicing Dealer's Signature & Stamp

IMPORTANT INFORMATION

RECORD OF WARRANTY REPAIR PERFORMED

Date	Odometer reading (km)	Repair Order No.	Particulars of Repair	Servicing Dealer's Signature & Stamp



TATA MOTORS ORIGINAL PARTS





TATA MOTORS

Rely on us... always.

Call Us : **1 800 209 7979**

Mail Us : customercare@tatamotors.com

Visit Us: www.customercare.tatamotors.com

5402 5840 99 03

TATA MOTORS

Designed & Developed by : Content Creation & Publication, Customer Support - PVBU, Pune