



**HARRIER**  
**OWNER'S MANUAL**



**TATA MOTORS**

## CUSTOMER ASSISTANCE

In our constant endeavour to provide assistance and complete service backup, TATA MOTORS has established an all India customer assistance centre.

In case you have a query regarding any aspect of your vehicle, our Customer Assistance Centre will be glad to assist you on our Toll Free no. **1800 209 7979**

You can also approach nearest TATA MOTORS dealer. A separate Dealer network address booklet is provided with the Owner's manual.

TATA MOTORS 24X7 Roadside Assistance Program offers technical help in the event of a breakdown. Call the toll-free Roadside Assistance.

For additional information, refer to "**24X7 Roadside Assistance**" section in the Owner's manual.



## **Dear Customer,**

Welcome to the TATA MOTORS family.

We congratulate you on the purchase of your new vehicle and are privileged to have you as our valued customer.

We urge you to read this Owner's Manual carefully and familiarize yourself with the equipment descriptions and operating instructions before driving.

Always carry out prescribed service / maintenance work as well as any required repairs at an authorized TATA MOTORS Dealers or Authorized Service Centre's (TASCs). Use only genuine parts for continued reliability, safety and performance of your vehicle.

You are welcome to contact our dealer or Customer Assistance toll free no. **(1800 209 7979)** in case of any query or support required.

We wish you a safe and pleasant driving experience.

**TATA MOTORS**

Bombay House, 24, Homi Modi Street,  
Hutatma Chowk, Fort, Mumbai – 400001

## **IMPORTANT INFORMATION**

---

- Before driving, read this Owner's manual carefully and familiarize yourself with your vehicle. For your own safety and a longer vehicle life, follow the instructions, 'Warnings' and 'Notes' in this manual. Ignoring them could result in damage to the vehicle or personal injury to you or others.
- The Owner's manual and other booklets are important documents and should always be kept in the vehicle. If you sell the vehicle, always pass on the documents to the new owner.
- This Owner's Manual describes all variants of the model and all standard/optional equipment of your vehicle available at the time of printing. Please note that your vehicle may not be equipped with all features described.
- TATA MOTORS Limited reserves the right to introduce changes in the design, equipment and technical features without any obligation to install them on the vehicles previously sold. The equipment in your vehicle may therefore differ from that shown in the descriptions and illustrations.
- Do not carry out any modification including fitment of non-genuine accessories on your vehicle. Safety, handling, performance and durability, may otherwise be adversely affected and may violate government regulations. TATA MOTORS Limited accepts no liability for damage resulting from the modifications or use of non-genuine accessories.
- All rights reserved. The information in this manual shall not be copied, translated or otherwise reproduced, in whole or in part, without written permission from TATA MOTORS.

**© Copyright 2019 TATA MOTORS**

## CONTENTS

<b>1</b>	<b>Safety</b>	<b>2</b>	<b>Opening &amp; Closing</b>	<b>3</b>	<b>Dashboard &amp; Features</b>
Important Information	01	Keys	23	Cockpit	39
Safe Driving	01	Doors	31	Instrument Cluster (for TFT)	40
Seat Belts	03	Windows	32	Driver Information System	43
Child Restraint System (CRS)	06	Bonnet Opening	34	Display Messages	49
Air Bags	10	Tailgate Opening	36	Instrument Cluster (for LCD)	56
Child Lock	17	Fuel Lid	37	Driver Information System	59
Anti-theft Device: Immobilizer	18			Display Messages	63
ABS	19			Tell Tales	65
EBD	20			Audio Reminders	74
Additional safety features	20			Combi Switches	75
				Fascia Switches	78

## CONTENTS

---

<b>3</b>	<b>Dashboard &amp; Features</b>	<b>3</b>	<b>Dashboard &amp; Features</b>	<b>4</b>	<b>Stowage Areas</b>
Steering Wheel Switches	79	Puddle / Ajar Lamp	85	Storage Compartments	89
Mic	81	Roof Lamp	86	Glove Box	90
Infotainment System Display	81	Boot Lamp	87	Goggle Holder	91
Speakers & Tweeter	82	Outer Mirror with Logo projection	87	Utility Pockets on Front Doors	91
USB/AUX	82	Side Indicator Lamp on ORVM	87	Utility Pockets on Rear Doors	92
Smart charger	83	Front Lamp	88	Mobile / Wallet Stowage	92
Power Socket	83	Tail Lamp	88	Cup Holder	92
Antenna	84			Stowage for Rear Passenger	93
Roof Grab Handles	84			Stowage below Arm Rest	93
Front Fog Lamp	85			Foldable Arm Rest	93
Rear Fog Lamp	85			Tailgate Compartment	94

## CONTENTS

<b>4</b>	<b>Stowage Areas</b>	<b>5</b>	<b>Climate Control</b>	<b>6</b>	<b>Starting &amp; Driving</b>
Hooks	95	Air Distribution	97	Pre-Driving Checks	109
Front seat back pockets	95	Air Vents	98	Driving Tips	110
		Side vent for rear passenger	98	Seat Adjustments	113
		HVAC Controls	99	Rear Seat folding	115
		Fully Automatic Temperature Control (FATC)	103	Rear View Mirrors	117
		Quick Cooling	108	Sun Visors	119
		HVAC Sensors	108	Steering Wheel Adjustments	120
				Steering Lock Cum Ignition Switch	121
				Starting and Stopping	121
				Gear Shifting & Driving	126

## CONTENTS

<b>6</b>	<b>Starting &amp; Driving</b>		
	Reverse Gear	126	
	Braking	128	
	Driving	129	
	Drive Mode	130	
	Terrain Response Mode	130	
	Parking Brake	132	
	Vehicle Parking	134	
	Reverse Park Assist	134	
	Reverse Park Assist with Sensor	137	
	Reverse Park Assist with Camera	137	
<b>7</b>	<b>Emergency &amp; Break-down Assistance</b>		
	Emergency Equipment	145	
	Hazard Warning Switch	148	
	In Case of Flat Tyre	148	
	Jump Lead Starting	151	
	Towing	153	
	Fuses	155	
	Bulb Specification	163	
	24x7 Road Side Assistance	165	
<b>8</b>	<b>Maintenance</b>		
	Maintenance & Service	169	
	Engine Compartment	170	
	Oil / Fluid Level	171	
	Battery	175	
	Tyres	176	
	Remote Key Battery Replacement	178	
	On Board Diagnostic (OBD)	180	
	Diesel Particulate Filter (DPF) warning Indicator	180	
	Service Schedule	183	
	Parking for Long Durations	188	



**9 Technical Information**

Fuel Specification	189
Lubricant Specification	190
Technical Specification	191
Vehicle Dimensions	195
Aggregate Identification Nos	196

**10 Car Care and Value Added Services**

Car Care	197
Washing	197
Waxing	198
Polishing	198
Interior Fabric Cleaning	198
Paint Care	199
Wiper Care	199
Value Care AMC	200
Extended Warranty	204
Value Added Services	206

**11 Warranty – Terms and Conditions**

Warranty – Terms & Conditions	211
----------------------------------	-----

## CONTENTS

---

12

Environment Safety

Environment Safety

213

## Important Information

In this Owner's Manual, you will find the text under the heading "WARNING" and "NOTE" which highlights important information. Pay particular attention to these highlighted messages.

### NOTE

*Indicates additional information that will assist you in gaining the optimum benefit and care for your vehicle.*

### WARNING

Indicates procedures or information that must be followed precisely in order to avoid the possibility of severe personal injury and serious damage to the vehicle.

## Safe Driving

Safety consciousness not only ensures your safety and the safety of other road users, but it also helps to reduce the wear and tear on your vehicle.

### Safe driving depends on:

- How quickly you make decisions to avoid an accident.
- Your ability to concentrate.
- How well you can see and judge objects.
- How well familiar you are with your vehicle controls and its capabilities.

### NOTE

*Fatigue is a result of physical or mental exertion that impairs judgment. Driver fatigue may be due to inadequate sleep, extended work hours, strenuous work or non-work activities or combination of other factors. Take rest at regular intervals.*

## Safety Tips

- Always take into account the road conditions, weather conditions, vehicle speed in order to prevent accidents.
- Turn 'ON' the side indicators at least 30 meters before taking a turn or changing the lane.
- Reduce to a safe speed before taking turn. Do not apply brakes during cornering.
- When overtaking other vehicles, watch out for the oncoming vehicle.
- Never drive under the influence of alcohol or drugs.
- If your vehicle is equipped with infotainment/navigation system, set and make changes to your travel route only when the vehicle is parked.
- Program radio presets with the vehicle parked, and use your programmed presets to make radio use quicker and simpler.

## SAFETY

---

### Driving through water

Do not drive through flooded areas. Judge the depth of water before driving through it. Otherwise, water may enter the vehicle interior or the engine compartment.

If in case you have to drive through water then:

- Keep engine in higher RPM and crawl the vehicle in low gear.
- Flowing or rushing water creates strong forces. Driving through flowing water could cause the vehicle to drive away through flowing water.
- Lightly apply the brake pedal to dry the liners until the brakes work normally once you are out of water.

#### WARNING

Do not attempt to start the engine if vehicle gets flooded due to water. Tow the vehicle to a safe place. Contact a nearest TATA MOTORS Authorised Service Centre

### Driving on a rainy day

- Check wiper blades, lights and brakes for proper functioning and condition.
- Check the tyre treads depth, the condition of the tread and tyre.
- Avoid harsh braking and sharp turns. It may cause loss of control and lead to a skid.
- For slowing down, shift to lower gears and brake gently.
- Keep lights 'ON' if visibility is poor.

#### NOTE

*If you have driven for a long time in heavy rain without braking, there may be a delayed reaction from the brakes when braking for the first time. You have to depress the brake pedal more firmly. Maintain a greater distance from the vehicle in front.*

### Night driving

- Ensure that all lights are working and windshield, window glasses are clean.
- Drive more slowly at night than in the daytime, as the visual range is restricted at night. Maintain a speed such that you can stop within illuminated distance of headlamps.
- Do not use the high beam unless required. It may dazzle the driver of the oncoming vehicle, thus causing an accident.
- Use headlamp main/dip beam to alert other road users on turns/cross roads etc.
- Use side indicators for lane change or turning.

## Driving on gradients

When climbing gradient, the vehicle may begin to slow down and show a lack of power. If this happens, shift to a lower gear and apply power smoothly so that there is no loss of traction.

### **WARNING**

On long and steep gradients you must reduce the load on the brakes by shifting early to a lower gear. This allows you to take advantage of the engine braking effect and helps avoid overheating of service brakes resulting in reduced braking efficiency.

## Seat Belts

This section describes your vehicle seat belt, airbag and child restraints system. Please read and follow all these instructions carefully to minimise risk of severe injury or death.

- Seat belts are the primary restraints system in the vehicle. All occupants, including the driver, should always wear their seat belts to minimize the risk of injury.
- Sit back and adjust the front seat. Make sure that your seat is adjusted to a good driving position and the back of the seat is upright.

## Buckling the shoulder seat belt

- Grasp the tongue and slowly pull out the seat belt over the shoulder and across the chest. When the seat belt is long enough to fit, insert the tongue into the lock buckle until you hear a “CLICK” which indicates that the seat belt is securely locked.

- Position the lap portion of seat belt across your thighs, below your abdomen. To remove slack, pull up a bit on the shoulder seat belt. To loosen the lap portion seat belt if it is too tight, tilt the tongue and pull on the lap seat belt. A snug seat belt reduces the risk of sliding under the seat belt in a collision. Ensure that the seat belt running over the body (shoulder segment and lap segment) does not have any twist. Twisted seat belt may not offer effective protection when required.

## Releasing the seat belt

To release the seat belt, push the red button on the lock buckle. The seat belt will automatically retract to its stowed position. If necessary, slide the tongue down the webbing to allow the seat belt to retract fully.

## SAFETY

### Fixed rear centre lap seat belt

- When buckling, make sure you hear a click confirming that the tab is latched into the seat belt lock. To tighten it, pull the loose end through the buckle until the seat belt is comfortably adjusted around the hips.



### Seat Belts with Pre – tensioner (If equipped)

You can use pre-tensioner seat belts in the same manner as ordinary seat belts.

The seat belt pre-tensioner system works in conjunction with the SUPPLEMENTARY RESTRAINTS SYSTEM (SRS-Air Bags).

In the event of a collision, as may be necessary, pre-tensioner tightens the seat belt so that it fits the occupant's body more snugly. When pre-tensioner activates, there could be some noise and release of smoke. This is normal and there are no health hazards or fire risk.

#### WARNING

The pre-tensioner seat belt assembly mechanisms become hot during activation. Do not touch the pre-tensioner seat belt assemblies for several minutes after they have been activated.

If the vehicle has been involved in a collision, get it inspected immediately at authorised TATA MOTORS SERVICE Center.

### Seat Belt with Load Limiter (If equipped)

You can use the load limiter seat belts in the same manner as ordinary seat belts. The seat belt load limiter system works in conjunction with the SUPPLEMENTARY RESTRAINTS SYSTEM (SRS-Air Bags).

In the event of a collision, as may be necessary, load limiter reduces the load on the rib cage region of the occupant.

If the vehicle has been involved in a collision, get it inspected immediately at Authorised TATA MOTORS SERVICE Center.

## Use of seat belts for pregnant woman

### WARNING

- Pregnant woman must wear a correctly positioned seat belt. It is safer for mother as well as unborn child.
- Pregnant woman should wear the lap part of the seat belt across the thighs and as snug across the hips as possible. Keep the seat belt low so that it does not come across the abdomen. That way the strong bones of the hips will take the force if there is a collision.

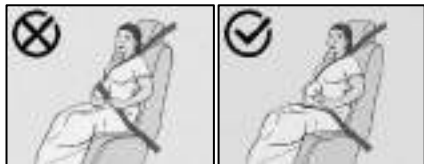

## Seat belt warning lamp (If equipped)

The seat belt warning lamp reminds you to fasten the seat belt.



For Driver



For Front Passenger

- If the driver does not fasten seat belt, seat belt reminder lamp will blink and a buzzer will sound for pre-defined duration until the driver's seat belt is buckled.
- If front passenger seat is occupied by adult and does not fasten seat belt, seat belt reminder lamp will blink and a buzzer will sound for pre-defined duration until the front passenger seat belt is buckled.
- If this system is also provided for other than Front row seats, applicable above warning will appear until seat belts are buckled.

- If front passenger seat is occupied by child, system may detect occupancy and warn with front passenger seat belt warning. It is not taken to mean child can occupy front passenger seat and use seat belt. Please refer CRS section for recommended seating position.

### NOTE

*Using unauthorized aftermarket seat cover may affect function of occupant sensor. TATA motors does not recommended any non-validated seat covers on seats.*

## SAFETY

### Child Restraint System (CRS)

(if applicable)

TATA MOTORS strongly recommends the use of Child Restraint Systems (CRS) for all children up to age of 12 years and to be placed at recommended positions only. Children travelling without recommended CRS and seated at other positions may face serious injuries in case of a collision.

CRS can be installed in the vehicle using seat belts and/or ISOFIX only (if equipped) or ISOFIX with Top Tether (if equipped).

The harness system of CRS holds the child in place, and in a collision, acts to keep the child positioned in the seat and reduce the risk if injuries.

All children below age of one year must always ride in a rear-facing infant CRS.

Keep children in a forward-facing CRS with a harness until they reach the size

or weight limit allowed by your CRS manufacturer.

Once your child outgrows the forward-facing CRS, your child is ready for a booster seat.

#### Selection and installation of CRS:

Always select the CRS that complies with latest safety standards (AIS072 / ECE R44). The CRS are classified according to the child's size, height and weight. Select the appropriate CRS for your child. Ensure that the child fits properly in the CRS and it is securely installed in the vehicle. For installation, please refer

CRS manufacturer's instruction manual.

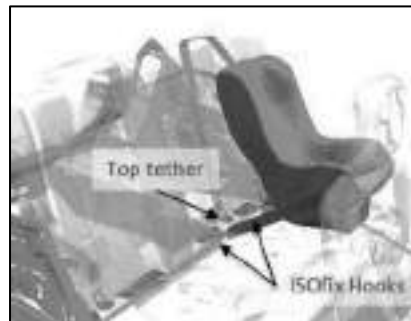



### Recommended CRS position as per the vehicle matrix

The suitability of seat position for carriage of children and recommended category of CRS is shown in the table below as per the child group.

**X** - Seat Position not suitable for children in this age group.

**U** - Suitable for “universal” category restraints approved for use in this age group.

Universal is a category in the AIS072 / ECE R44 norm.

#### WARNING

If a child is seated in the front seat it may cause serious injury or even death during any collision.

Group	Mass Group	Age Group	Front Passenger	Rear Outboard LH	Rear Outboard RH	Rear Center	Intermediate Outboard	Intermediate Centre
0	Up to 10 kg	Up to 9 months	X	U	U	X	X	X
0+	Up to 13 kg	Up to 24 months	X	U	U	X	X	X
I	9 to 18 kg	9 months to 48 months	X	U	U	X	X	X
II	15 to 25 kg	Approx. 3 to 7 years	X	U	U	X	X	X
III	22 to 36 kg	Approx. 6 to 12 years	X	U	U	X	X	X

## SAFETY

### WARNING

If your vehicle is equipped with a front passenger air bag (PAB) and do not have PAB deactivation switch, do not install a rear-facing CRS in the front passenger seat. If the PAB inflates, a child in a rear facing CRS could be seriously injured or killed.

If you install a CRS in the rear seat, slide the front seat far enough forward so that the child's feet do not touch the front seatback. This will help avoid injury to the child in the event of a collision.

### NOTE

*Children could be endangered in a collision if their CRS are not properly secured in the vehicle. Be sure to secure the child in the restraint system according to the manufacturer's instructions.*

### WARNING

Do not use an infant carrier or a child safety seat that "hooks" over a seatback, it will not provide adequate protection in a collision.

After a collision, we recommend to get seat belts, seats, ISOFIX and top-tether anchorages (as may be applicable) investigated at TATA MOTORS Authorised service centre.

### NOTE

*A CRS in a closed vehicle can become very hot. To prevent burns, check the seating surface and buckles before placing your child in CRS.*

### WARNING

- Do not leave unattended children in your vehicle.
- Do not modify CRS in any way.

### NOTE

- *Do not install a booster seat or a booster cushion with only the lap strap of the seat belt.*
- *Do not install a booster seat or a booster cushion with a seat belt that is slack or twisted.*
- *Do not put the safety seat belt under your child's arm or behind its back.*
- *Do not use pillows, books or towels to boost your child's height.*
- *Make sure that your children sit in an upright position.*
- *Do not allow children to stand up or kneel on either the rear or the front seats. An unrestrained child could suffer serious or fatal injuries during a collision.*
- *Do not leave any toys or other objects loose in the CRS or on the seat while the vehicle is in motion.*



## SAFETY

### Supplementary Restraint System (SRS - Air bags)



The airbag 'SRS' system comprises of the following components depending upon the provided safety features in vehicle.

- Seat belt Pre-tensioners
- Seat belt with load limiters
- Driver Airbag
- Front Passenger Airbag
- Side Airbags (if equipped)
- Curtain Air Bag (if equipped)
- Airbag 'SRS' ECU (Electronic Control Unit)

- Collision Sensors
- SRS wiring harness
- SRS Warning lamp

The System is active when ignition switch is in the "ON" position or the ignition mode is "ON". Air bags are designed to inflate in collisions. In the event of a collision, the collision sensors will detect signals, and if the Airbag ECU judges that the signals represent a severe collision, will trigger the airbags. The inflated air bags provide a cushion to the occupants. The air bag inflates and deflates so quickly that you may not even realize that it has activated. The air bag will neither hinder your view nor make it hurdle to exit the vehicle.

Airbag inflation is virtually instantaneous and occurs with considerable force, accompanied by loud noise and smoke, which is normal. The inflated airbag, together with seat belts, limit the movement of an occupant, thereby reducing the risk of injury.

When an airbag inflates, you may see some smoke-like particles. The particles are a normal by-product of the process that generates the non-toxic gas used for airbag inflation. These airborne particles may irritate the skin, eyes, nose, or throat. If you have skin or eye irritation, rinse the area with water. For nose or throat irritation, move to fresh air. Also sometimes the smoke can cause breathing problems, in such cases get fresh air promptly.

After inflation, airbag provides a gradual cushioning effect for the occupant thereafter deflates. It is not advisable to drive your vehicle after the airbags have been deployed. If you are involved in another collision, the airbags will not be in place to protect you.

**NOTE**

- *Open your windows and doors as soon as possible after collision to reduce prolonged exposure to the smoke and powder released by the inflating air bag.*
- *Do not touch the air bag storage area's internal components immediately after an air bag has inflated. The parts that come into contact with an inflating air bag may be very hot.*
- *Always wash exposed skin areas thoroughly with lukewarm water and mild soap.*

The driver airbag is mounted in the centre of the steering wheel. The front passenger airbag is located inside the dashboard in front of the passenger seat. The vehicle fitted with the airbags have suitable indications on steering wheel and on dash board. The word 'SRS' is embossed on the airbag covers.

Side airbags are mounted in front row seats for outboard occupants only.

**NOTE**

*Seat has side airbag, which is a safety device, hence aftermarket seat covers may impact to deployment of seat side airbag.*

Curtain airbags are mounted above the doors along the roof on both sides.

**NOTE**

*Do not hang objects on coat hooks which can obstruct the curtain airbag deployment during impact.*

## SAFETY

---

### WARNING

- Even in vehicles with air bags, you and your passengers must always wear the seat belts provided. In order to minimize the risk and severity of injury in the event of a collision.
- ALWAYS use seat belts and CRS – during every trip and at all times. Even with air bags, you can be seriously injured or killed in a collision if you are improperly seat belted or not wearing your seat belt when the air bag inflates.
- You and your passengers should never sit or lean unnecessarily close to the air bags.
- Move your seat as far back as possible from front air bags, while still maintaining control of the vehicle.
- All occupants should sit upright with the seatback in an upright position, centred on the seat cushion with their seat belt on,

legs comfortably extended and their feet on the floor until the vehicle is parked and the engine is turned off.

- If an occupant is out of position during collision, the rapidly deploying air bag may forcefully contact the occupant causing serious or fatal injuries.
- Do not allow the front passenger to place their feet or legs on the dashboard.
- Do not allow the passenger to ride in the front seat when the front passenger air bag OFF indicator is illuminated.

## Not recommended seating position



## SAFETY

### WARNING

- Never place your arm over the airbag as a deploying airbag can result in serious arm fractures or other injuries.
- Do not allow the passengers to lean their heads or bodies onto doors or place objects between the doors and passengers when they are seated on seats equipped with side and/or curtain air bags.
- Do not place or stick any item/s in the vehicle, except at designated locations (such as utility bins, cup/bottle holders, boot space etc). Loose items may act as a projectile during a collision and cause severe to fatal injuries.
- Please be aware that any unsecured item in your vehicle, such as your pet, unsecured CRS or a laptop, can become a potential hazard in the event of a

collision or sudden stop, causing injuries to occupants in the vehicle.

- Coat hooks if provided, must be used only for that purpose. Never hang heavy items on to those hooks. This could affect deployment of the air bags, and may lead to severe to fatal injuries.
- ALWAYS contact your TATA MOTORS authorised service centre if the vehicle is damaged, even if airbag has not inflated.
- ALWAYS contact your TATA MOTORS authorised service centre if any part of an airbag module cover shows sign of cracking or damage.

If your SRS malfunctions, the air bag may not inflate properly during a collision thereby increasing risk of serious injury or death. If any of the following conditions occur, your SRS is malfunctioning:

### WARNING

- The SRS warning lamp does not turn 'ON' when the ignition switch is placed in the 'ON' position for few seconds.
- The SRS warning lamp stays 'ON' after illuminating
- The SRS warning lamp comes 'ON'/stays 'ON' while the vehicle is in motion.
- The SRS warning lamp blinks when the engine is running.



We recommend the customer to immediately visit TATA MOTORS authorised service centre and get the SRS system inspected if any of the above conditions occur.

**WARNING**

- Never make any modifications to your vehicle. The modifications carried out, but not limited to the vehicle frame, bumpers, front fenders, ride height, suspension, seat belts, interior trims, steering wheel (especially holders), are not acceptable. This will affect the intended performance of SRS system.
- Fitment of bull bars, seat covers on seats with airbags etc, is strictly prohibited, unless authorised by TATA MOTORS. This will affect the intended performance of SRS system.
- If you need to make any modifications to accommodate any disability you may have,

please contact your Authorized TATA MOTORS Dealer for necessary guidance.

- Do not tamper with SRS in any way. This will lead to unexpected performance of system and may cause serious injury or death.

**Airbag Warning sticker on front passenger Sun visor**

The Airbag Warning Symbol on sun visor reminds extreme hazards associated with the use of rearward-facing child restraint on front passenger seat during airbag deployment

**WARNING**

Never use a rearward facing child restraint on a seat protected by an active Airbag in front of it, Death or serious injury to the child can occur.

## SAFETY

---

### Air Bag Deployment Conditions

#### When front airbags should not deploy?

**Minor frontal collision:** Seat belt offers adequate occupant protection in low severity collisions. The airbags are triggered only when there is a collision severe enough to trigger the airbags. Deployment of frontal airbags is not beneficial in low severity collisions.

**Side collision:** During a side collision, occupants tend to move sideways. Therefore, deploying frontal airbags in such situations will not benefit the occupants. Side airbags, side curtain airbags (if equipped) are specifically designed to reduce the injuries that can occur in side collision.

**Rear collision:** During a rear collision, occupants tend to move (rearwards) away from frontal airbags. Therefore, deploying frontal airbags in such situations will not benefit the occupant protection. Head restraints and seat belts provide

occupant protection during a rear collision.

**Rollovers collision:** During a rollover collision occupants may float inside the passenger compartment, if unbelted. This will increase the risk of injuries. Wearing seat belts provide highly effective occupant protection during rollover collision. If your vehicle is equipped with a rollover sensor, both, seat belt and side curtain airbag can provide highly effective occupant protection during rollover collision. Front airbags, however, are not designed to deploy in a rollover as frontal airbags cannot offer any protection in rollover collision.

#### When front airbags deploy with minor or no visible vehicle damage?

The airbags are triggered only when there is a collision severe enough to trigger the airbags. A severe collision to the vehicle underbody or suspension may cause airbags deployment. Examples include rough road driving, running into a curb or other low fixed object that

causes a sudden vehicle deceleration. Since the collision is underneath the vehicle, damage may not be readily visible.

#### When front airbags may not deploy, even with exterior visible vehicle damage?

The airbags are triggered only when there is a collision severe enough to trigger the airbags. The amount of visible vehicle damage is not always the correct indicator for airbag deployment. Some collisions can result in visible damage but no airbag deployment because the airbags would not have been needed or would not have provided protection even if they had deployed.

#### When a side airbag deploys with minor or no visible vehicle damage?

The airbags are triggered only when there is a collision severe enough to trigger the airbags. If the airbag system senses sudden deceleration, a strong collision to the side of the vehicle's frame can cause a side airbag to deploy. In such cases, there may be little

**When a side airbag may not deploy, even with exterior visible vehicle damage?**

It is possible that the side airbag does not deploy during a collision that results in visible severe damage. This can occur when the point of collision is toward the far front or far rear of the vehicle or when the vehicle's crushable body parts absorbed most of the collision energy. In either case, the side airbag would not have been needed nor provided protection even if it had deployed.

**Child Lock (if equipped)**

Both the rear doors of the vehicle are provided with a child proof lock. Push the lock lever located on vertical face of the door downward before closing the door. The door which has been closed by activating the child lock cannot be opened from inside, it can be opened only from the outside.

**NOTE**

- *Lift the lock lever upward to deactivate the childproof lock when not required.*
- *Child safety lever to be used for safety of child for preventing them to open rear door while seating in passenger seat to avoid accident while vehicle is running.*

## SAFETY

---

### Anti-Theft Device-Immobilizer/ PEPS

(If equipped)

Immobilizer system is designed to prevent vehicle theft by electronically disabling the engine ignition system. The engine can be started only with vehicle's original Immobilizer ignition key which has an electronic identification programmed code.

Vehicle Condition	Immobilizer Lamp Status	Vehicle State	Meaning / Function of the state
Ignition OFF	Blinking	Locked	Vehicle Immobilized and awaiting electronic key
Ignition ON	OFF	Unlocked	Normal condition and ready to start the vehicle
Ignition ON	ON	Locked	<ul style="list-style-type: none"><li>- Problem with key (Wrong key used to start vehicle)</li><li>- Problem with Immobilizer system. Contact a TATA MOTORS Authorized Service Centre</li></ul>
Ignition ON	Blinking	Unlocked	<ul style="list-style-type: none"><li>- Contact a TATA MOTORS Authorized Service Centre immediately</li></ul>

## Anti-lock braking system (ABS)



ABS regulates brake pressure in such a way that the wheels do not lock when you brake. This allows you to continue steering the vehicle when braking.

The ABS warning lamp in the instrument cluster lights up when the ignition is switched on. It goes off after 2-3 seconds if system is healthy.

### WARNING

- If ABS is faulty, the wheels could lock when braking. The steer ability and braking characteristics may be severely impaired. There is an increased danger of skidding and accidents.
- Drive on carefully. Have ABS checked immediately at the TATA MOTORS Authorized Service Centre as soon as possible.

## While Braking

- If ABS intervenes: continue to depress the brake pedal vigorously until the braking situation is over.
- To make a full brake application: depress the brake pedal with full force.

If ABS intervenes when braking, you will feel a pulsing in the brake pedal. The pulsating brake pedal can be an indication of hazardous road conditions, and functions as a reminder to take extra care while driving.

### WARNING

- The stopping distance required for vehicles with ABS may be slightly more than conventional brake system but ABS will still offer the advantage of helping you maintain directional control.
- However, remember that ABS will not compensate for bad road or weather conditions or poor driver

judgment. Drive within safety margin taking into consideration prevailing weather and traffic conditions.

## SAFETY

### Electronic brake force distribution (EBD)

EBD monitors and controls the brake pressure on the rear wheels to improve driving stability while braking.



EBD provides optimal braking pressure distribution between front and rear wheels to optimize braking distance and to ensure vehicle stability by means of lowering braking pressure at rear wheels.

#### WARNING

- If EBD is malfunctioning, the rear wheels can lock, e.g. under full braking. This increases the risk of skidding and an accident.
- You should therefore adapt your driving style to the different handling characteristics. Have the brake system checked immediately at a TATA MOTORS Authorized Service Centre as soon as possible.

### Additional safety features

#### Cornering Stability Control (CSC)

Corner stability Control supports / stabilizes vehicle during partial braking on curves by reducing pressure at required inner wheel of the vehicle.

This helps to reduce probability of vehicle over steering during cornering.

#### OFF Road ABS

Based on wheel speed information off road ABS helps to avoid wheel lock on uneven surfaces like loose gravel, pot holes by reducing the stopping distance compared to standard ABS.

#### Electronic Traction Control (ETC)

The Electronic Traction Control system function (ETC) is designed as a slip control system to prevent the driven wheels of a vehicle from excessive wheel slip.

#### Roll over Mitigation (ROM)

The main feature of the Roll over Mitigation function is the detection of a rollover

critical situation and to prevent the vehicle rollover. This is done by active brake interventions on selected wheels, thereby reducing the forces that cause a roll-over situation.

#### Brake Disc Wiping (BDW)

Water on the brake disc leads to a delay in brake response time. The purpose of the function Brake Disc wiping is to remove moisture when driving in wet conditions automatically. To get quick response from Brake and better deceleration.

#### Electronic Brake Pre-fill (EBP)

The Electronic Brake Prefill (EBP) function reduces the air gap of the brake pad and the brake disc. The function is triggered after a sudden release of the accelerator pedal due to an unexpected emergency brake situation. By actively pre-filling the brake-system the brake response time is reduced and results in a shorter stopping distance.

---

**Hydraulic Brake Assist (HBA)**

In a dangerous emergency situation, most drivers don't use the full available performance of the brake system, because they brake too soft. The HBA function detects the critical situation and builds up additional brake pressure to reduce the braking distance.

**Hydraulic Fading compensation (HFC)**

In dangerous fading situations most drivers operate the brake pedal with a small or regular braking force and they never reach to the maximum possible vehicle deceleration. The HFC function improve the stopping distance by eliminating required pressure build-up lag by the driver.

**Dynamic Wheel Torque by Brake (DWT-B)**

The main goal of the function is to improve the agility of a vehicle and to enable a more direct steering. This is mainly achieved by braking interventions at the

inner wheels during turning. DWT-B reduces understeer tendency of the car and a higher curve speed can be achieved.

**Engine Drag Torque Control (EDTC)**



On slippery road conditions during in-gear Braking or Shift down of gear or sudden throttle release on a curve road. This causes high Engine drag on the driven wheel resulting into brake slip situations without any brake application. This makes vehicle highly under steerable. EDTC controls such brake slip on the driven wheels by increasing the engine torque to makes the vehicle stable and steerable.





## OPENING AND CLOSING

Keys (as applicable)

SN	Name	Remote key	Description
1.	Flip key with remote	 A black flip key with a remote control. The key is shown in its closed position. Four numbered callouts point to specific features: 1. The top button (lock), 2. The middle button (unlock), 3. The bottom button (tail gate), and 4. The key blade on the left side.	<ol style="list-style-type: none"><li>1. Unlocking all doors</li><li>2. Approach light/Tail gate opening</li><li>3. Locking all doors</li><li>4. Folding key blade in/out</li></ol>
2.	Mechanical key	 A silver mechanical key with a black plastic head. The head has a circular logo with a stylized 'T' inside.	<ol style="list-style-type: none"><li>1. Locking all doors</li><li>2. Unlocking all doors</li></ol>
3.	Smart Key (PEPS)	 A black smart key (PEPS) with a remote control. The key is shown in its closed position. Four numbered callouts point to specific features: 1. The top button (lock), 2. The middle button (unlock), 3. The bottom button (tail gate), and 4. The key blade on the left side.	<ol style="list-style-type: none"><li>1. Locking all doors</li><li>2. Approach light</li><li>3. Tail gate opening</li><li>4. Unlocking all doors</li></ol>

## OPENING AND CLOSING

### KEYS

A key is an electronic access and authorization system which is provided as a standard feature on your vehicle.

#### Unlocking principle

The transponder which is built into the ignition key carries a unique identification code. The vehicle unlocks when the code on the key matches with the code on the Engine Management System (EMS). In case of PEPS variant, Immobilizer function is provided by PEPS.

#### Engine starting

When the key is inserted and the ignition is switched 'ON', all codes are communicated within key, Immobilizer and EMS. The engine will start only if all the codes match.

#### Loss of keys

If one of the key is lost, contact your nearest TATA MOTORS authorised dealer immediately.

### WARNING

- Do not turn 'ON' ignition switch by using key with any type of metal wound around its grip or in contact with it. This may be detected as abnormal condition by immobilizer and prevent engine from starting.
- Do not leave the key in areas of high temperature. The transponder in it will behave abnormally when reused.
- Do not try to start the vehicle when the Immobilizer indicator lamp on the  instrument cluster is glowing. In this condition the vehicle will not start and the vehicle's battery will also be drained due to frequent cranking.

### Flip Key with Remote

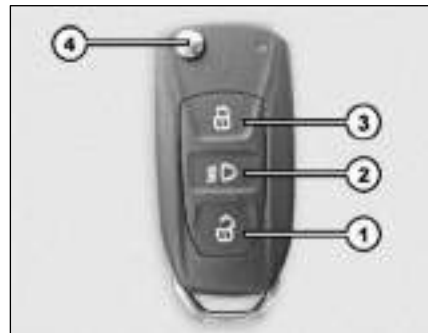

1. Unlocking all doors
2. Approach Light/Tail gate unlatch
3. Locking all doors
4. Folding key blade IN/OUT

#### 1. Unlocking all doors

Pressing the unlock button (1) of remote will unlock all the Doors. One flash is coming on side indicators.

### 2. Approach light

Press approach light button (2) once, low beam and position lamp will turn 'ON'. This feature helps to find and reach the parked vehicle or to reach home in dark/ cloudy condition after parking. Red LED will be flash on the remote. To switch 'OFF' the approach lights, press and release the same button or it automatically turns 'OFF' after certain time.

### Tail gate Unlatch

To unlatch the Tail gate, long press the approach light button (2) on remote for more than 2 sec.

#### NOTE

*Tail gate once unlatched will not get lock automatically with doors. It will locked by slamming.*

### 3. Locking all doors

Pressing the Lock button (3) once. Remote locks all the doors of the vehicle.

### 4. Folding key blade IN / OUT

Press button (4) to flip out the key blade. For folding, press the button (4) and fold the key blade inside.



#### NOTE

*Do not fold the key blade without pressing the button. Also, it should not be forced in any direction apart from folding direction to avoid damage to flip mechanism.*

### Flip key Features

#### Vehicle search

In vehicle, locked condition if lock button on remote key is pressed the turn indicators of vehicle flashes for 4 times.

#### Automatic activation of immobilizer

If key is removed from ignition switch, the engine will be immobilized automatically even if you forget to lock the vehicle.

For few variant, Ignition off is required to immobilize the vehicle.

#### Auto locking / unlocking of doors / auto relock

- Vehicle doors are automatically locked when all doors are closed and the vehicle speed crosses 10 kmph.
- When key is taken out all the doors get automatically unlocked.
- For few variant, when ignition is turned off all the doors get automatically unlocked.

## OPENING AND CLOSING

Also, when unlocked with remote key and if no door is opened within 30 seconds, vehicle doors get automatically locked.

### Anti-grab / anti-scan coding

The remote control set of this security system is protected against the use of devices called 'scanners' and 'grabbers' which can record and reproduce some types of remote codes.

#### NOTE

*In case any button of the key is accidentally pressed for more than 20 seconds, the remote stops functioning till the time the button is pressed. The LED on the Remote also stops glowing. The function of the remote gets reinstated immediately when the user stops pressing the push button of remote.*

### Smart Key (PEPS)



Keep the smart key with user to perform the passive access. It is used for locking, unlocking and starting the vehicle.

1. Locking all doors
2. Approach Light
3. Tail gate opening
4. Unlocking all doors

### 1. Locking all door

Pressing the Lock button (1) once. Remote locks all the doors of the vehicle. Please refer section starting and driving for more information.

### 2. Approach light

Press approach light button (2) once, low beam and position lamp will turn 'ON'. This feature helps to find and reach the parked vehicle or to reach home in dark/cloudy condition. To switch 'OFF' the approach lights, press and release the same button or it automatically turns 'OFF' after certain time.

### 3. Tail gate opening

To open the Tail gate press the button (3) once on the smart key, Tail gate will unlatch. Please refer section starting and driving for more information.

### 4. Unlocking all doors

Pressing the unlock button (4) once. Remote will unlock all the Doors. Please refer section starting and driving for more information.

## OPENING AND CLOSING

### NOTE

If smart key battery is low/drained or vehicle battery is low/drained, user can unlock and enter into vehicle by using Emergency key blade. Provision is given on driver door handle only.

### Emergency Key blade in / out



Slide the knob (1) to unlatch the key. Pull the key blade (2) out.

### Unlocking Door with Emergency Key

- Slot is provided below driver door handle.

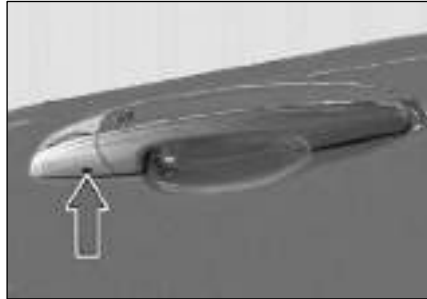

- Insert the key blade in slot and press.



- Outer cover of door handle will be unlock first.
- Remove the cover to access the door lock slot.

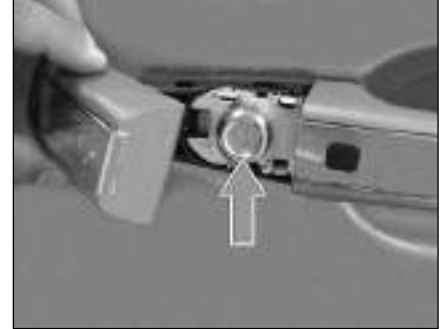

- Insert the key blade in slot and turn clockwise to unlock the door.

## OPENING AND CLOSING

---

### Smart Key Features

#### Force Panic ON operation

When vehicle is in OFF condition, if we press lock button and unlock button simultaneously, Force panic operation gets activated. In this case, turn indicators of vehicle start flashing and horn will blow automatically.

#### Force Panic OFF operation

By pressing any button of smart key, Force panic operation gets deactivated

#### Vehicle search

In vehicle locked condition, if lock button on smart key is pressed, the turn indicators of vehicle flashes 4 times.

#### Automatic activation of immobilizer

If smart key is not found within the passenger compartment, engine will be immobilized and vehicle cannot start.

### Auto locking / unlocking of doors / auto relock

In PEPS variants, door will get unlocked when ignition is OFF by pressing Start Stop switch.

### Anti-grab / anti-scan coding

The remote control set of this security system is protected against the use of devices called 'scanners' and 'grabbers' which can record and reproduce some types of remote codes.

### Important

- Don't operate Unlock button of remote in the vicinity of your vehicle, as it could lead to an unintentional unlocking your vehicle.
- For battery, replacement procedure refer 'MAINTENANCE' section.
- Do not remove the battery connection of the vehicle while the vehicle has been locked by remote.

### Smart key Precautions

1. If smart key is close to radio transmitter such as radio station or an airport which can interfere with normal operation of the transmitter.
2. If smart key is near a mobile two way radio system or a cellular phone, then it will not work properly.
3. If another vehicle's smart key is being operated close to your vehicle, signal will fluctuate.

### WARNING

Keep smart key away from electromagnetic materials that blocks electromagnetic waves to the key surface.

**Two Smart Keys Scenarios**

SN	Scenarios	Precondition	Action	PEPS behavior
1	One smart key is inside the vehicle (away from Immobilizer antenna) and other smart key is outside the vehicle within authentication range.	Vehicle is in OFF mode and all door closed	Lock the vehicle with outside smart key (passive lock / RKE lock) and keep outside smart key away from authentication range.	When user tries to start the vehicle with inside smart key, vehicle doesn't start.
2	One smart key is inside the vehicle (near Immobilizer antenna) and other smart key is outside the vehicle within authentication range.	Vehicle is in OFF mode and all door closed.	Lock the vehicle with outside smart key and keep outside smart key away from authentication range.	When user tries to start the vehicle with inside smart key, vehicle would start with back up start. User presses start/stop button twice with the interval of 2.5 sec between two presses within 5 seconds. <b>Note:</b> The vehicle doesn't start if inside smart key is kept away from Immobilizer antenna until vehicle is unlocked by outside smart key via outside door handle OR RKE unlock command from inside/outside smart key is received.

## OPENING AND CLOSING

SN	Scenarios	Precondition	Action	PEPS behavior
3	One smart key is inside the vehicle (near Immobilizer antenna) and other smart key is outside the vehicle within authentication range.	Vehicle is in OFF mode and all door closed.	Lock the vehicle with outside smart key and keep outside smart key away from authentication range.	When user tries to unlock/lock the vehicle ((RKE lock / unlock) with inside smart key, RKE lock/ unlock operation takes place normally.
4	One smart key is inside the vehicle (away from Immobilizer antenna) and other smart key is outside the vehicle within authentication range.	Vehicle is in OFF mode and all door closed	Lock the vehicle with outside smart key (passive lock / RKE lock) and then unlock the vehicle with mechanical key.	When user tries to start the vehicle with inside smart key, vehicle doesn't start. However, RKE operations (lock/unlock) take place normally.
5	One smart key is inside the vehicle (away from Immobilizer antenna) and other smart key is outside the vehicle within authentication range.	Vehicle is in ACC/IGN mode and all door closed.	Lock the vehicle with internal knob.	When user tries to unlock the vehicle passively with outside Smart key (from drive), vehicle doesn't get unlocked in ACC/IGN mode. Also, when user tries to unlock the Tail gate passively, Tail gate doesn't get unlocked.
6	One smart key is inside the vehicle (away from Immobilizer antenna) and other. Smart key is outside the vehicle within authentication range.	Vehicle is in ACC/IGN mode, all door closed, and vehicle is in unlock state.	Keep the outside smart key within driver door vicinity and try to lock vehicle with driver door handle switch from driver side.	Vehicle doesn't get locked in ACC / IGN mode.



### Doors

#### Option 1

##### Door locking / unlocking with key

Driver / front passenger doors can be locked or unlocked from outside using the key blade.



Insert the key and turn it clockwise to lock and anticlockwise to unlock the door.

#### Option 2

##### Door locking / unlocking using door handle switch (DHS)

To lock/unlock all the doors without operating smart key button/ key blade. Press the door handle switch (DHS) provided on the driver door to lock/unlock all the four doors except tailgate.

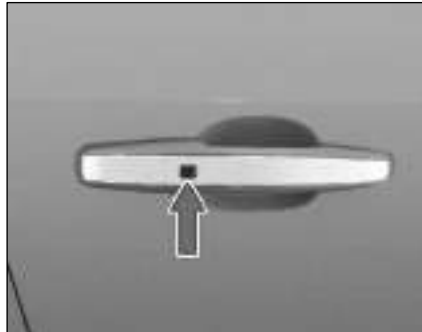

##### Horn honking when Door locking using door handle switch (DHS)

If vehicle is in unlock condition and smart key is not available, (i.e. Smart Key is present away from authentication range) and if you try to lock the vehicle through door handle switch then vehicle horn honking gets activated for 9 sec.

If vehicle is in unlock condition and Smart key is present inside the vehicle. If you try to press the door handle switch then vehicle horn honking gets activated for 9 sec.

#### NOTE

- Authentication range for smart key shall be 1 to 1.5 meter from outside the respective door or Tail gate.
- Passive entry only works during ignition off.

## OPENING AND CLOSING

### Locking without a key from inside



All the doors can also be locked from inside by pressing knob on driver door and independently on other doors respectively.

### Unlocking the doors from inside



1. Door opening knob
2. Door opening Lever

All doors can be opened from inside. To open, pull the door opening knob (1) and then opening lever (2).

#### NOTE

*There is a single pull override feature on driver door. All door can be unlocked by inner handle without operating lock knob of inner handle.*

### Windows

#### Power windows (if equipped)

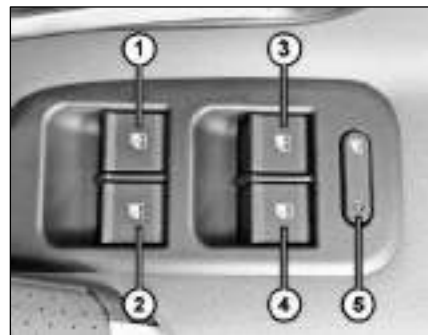

1. Front Window Winding Switch (Right)
2. Front Window Winding Switch (Left)
3. Rear Window Winding Switch (Right)
4. Rear Window Winding Switch (Left)
5. Inhibit Switch

Window glasses on all four doors can be operated by switches provided on the main control panel located on the driver's arm rest. They work only when the key is in the 'IGN ON' position.

## OPENING AND CLOSING

### NOTE

Power windows can be operated for 30 sec. in 'IGN OFF' and 'KEY OUT' position, provided doors are not open.

### Express down (if equipped)

Window glasses can be opened by a single long press of the switch. Express down feature is provided for driver door only.

### Anti-pinch function (if equipped)



The Anti-pinch module is provided. It will stop window upward movement if any obstruction or resistance detected.

Thus, it gives full and reliable protection for hand, neck and any obstacles as well. Anti-pinch function is provided for driver door only.

### Individual switches

Individual window winding switches have been provided for front passenger and rear passengers.



Glasses are wound up by pulling the switch and are lowered by pressing.

### WARNING

While raising the glass, take care to avoid fingers/hands getting trapped between glass and the door frame.

## OPENING AND CLOSING

### Inhibit switch (if equipped)

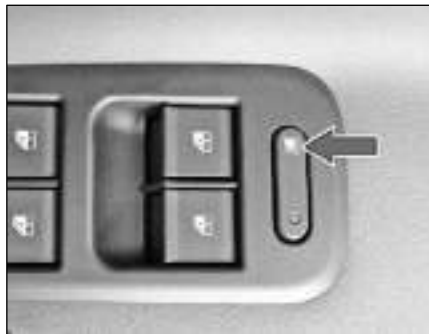

### Inhibit switch ON

When switch is pressed, red light turns 'OFF'. The individual switches provided on rear and front passenger door cannot be operated. Still it can be operated from the switches on driver's arm rest.



### Inhibit switch OFF

When switch is pressed, red light turns 'ON'. The individual switches provided on rear and front passenger door can be operated. It can also be operated from the switches on driver's arm rest.



### WARNING

- If children operate the windows they could get trapped, particularly if they are left unsupervised. There is a risk of injury.
- Activate the window inhibit feature when children are travelling. While leaving the vehicle, always take the key with you and lock the vehicle. Never leave children unsupervised in the vehicle.

### Bonnet Opening

1. Ensure that the vehicle is in neutral gear with the parking brake applied.
2. Pull the bonnet release lever. The bonnet will pop up slightly.



3. Raise the bonnet slightly and with your finger lift (up) the secondary lock lever located under the bonnet center.

## OPENING AND CLOSING

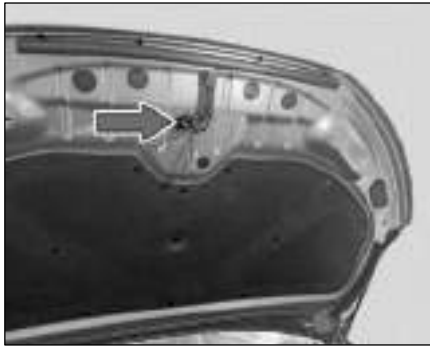

### NOTE

*Make sure that the wiper arms are not raised before you lift up the bonnet to avoid damaging the wiper arms and the bonnet.*

4. Lift the bonnet up. Pull the bonnet stay rod from its clip and insert the free end into the slot provided on frame.

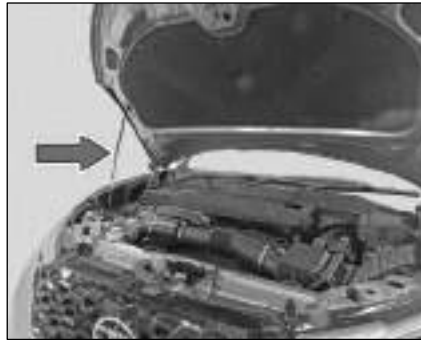

### WARNING

- The stay rod can be hot enough to burn your finger right after driving. To avoid this, use rubber packing given on stay rod.
- Touch the rod after it becomes cool enough.
- Insert the stay rod into the hole securely. If the rod drops off, your body may be caught below the bonnet.

### Closing

1. To close the bonnet, hold the bonnet by one hand, disengage the stay rod and clamp it back properly.
2. Lower the bonnet close to the bumper, then let it drop down.

### WARNING

Ensure that the bonnet is properly locked before driving or it can fly up unexpectedly during driving.

## OPENING AND CLOSING

### Tail gate opening (as applicable)

#### NOTE

Some variants may have multiple options.

#### Option I



Remote operated Tail gate unlatching can be done through long press (2 sec) approach light button on remote key.

#### Option II



When user press the Tail gate button on remote, Tail gate gets unlatched.

#### Option III



If vehicle is locked and tail gate is closed. Tail gate switch is pressed with valid smart key in the authentication range, Tail gate gets unlatched.

On closing the tail gate door, Tail gates gets locked.

## OPENING AND CLOSING

### NOTE

- During closing Tail gate if doors are in locked condition and valid smart key is inside the trunk, then Tail gate can be unlocked by pressing tailgate switch.
- For Tail gate unlatch remote operation, vehicle shall be in OFF mode.
- Tail gate once unlatch it will not get locked automatically with other doors.
- If doors are in unlocked condition, Tail gate can be unlocked via Tail gate handle switch independent of smart key.
- Avoid keeping smart key inside the boot space area while closing Tail gate.

### WARNING

Tail gate can't be locked using mechanical key/ flip key/ smart key. It can be locked by slamming it.

### Fuel lid

1. To open the fuel flap, gently press on fuel flap. Make sure the smart key should be in authentication range and the vehicle is in unlock condition.

### NOTE

*For mechanical/flip key (without smart key), to open the fuel flap. Make sure that vehicle is in unlock condition. Then gently press the fuel flap.*

2. Open the fuel flap by gently pressing flap.



3. To open the fuel cap by turning it in counter clockwise for fuel filling.
4. For closing, close the fuel cap and gently push the fuel flap till it gets locked.

### WARNING

- Fuel vapour is extremely hazardous. Always switch 'OFF' the engine before refueling and never refill near sparks or open flames. Do not use cell phone while refueling.
- Do not continue adding fuel after the automatic shut 'OFF' function is operated if it is equipped on the fuel station. Overfilling the fuel tank could damage the fuel system.

## OPENING AND CLOSING

---

### **NOTE**

- *Remove the fuel filler cap slowly, and wait for any hissing to stop. The fuel may be under pressure and may spray out.*
- *When smart key is inside the car, fuel flap can be open by pressing the flap.*

If fuel cap needs replacement, ensure that it is replaced by a genuine cap at the TATA MOTORS Authorized Service Centre only.



## DASHBOARD AND FEATURES

### Cockpit

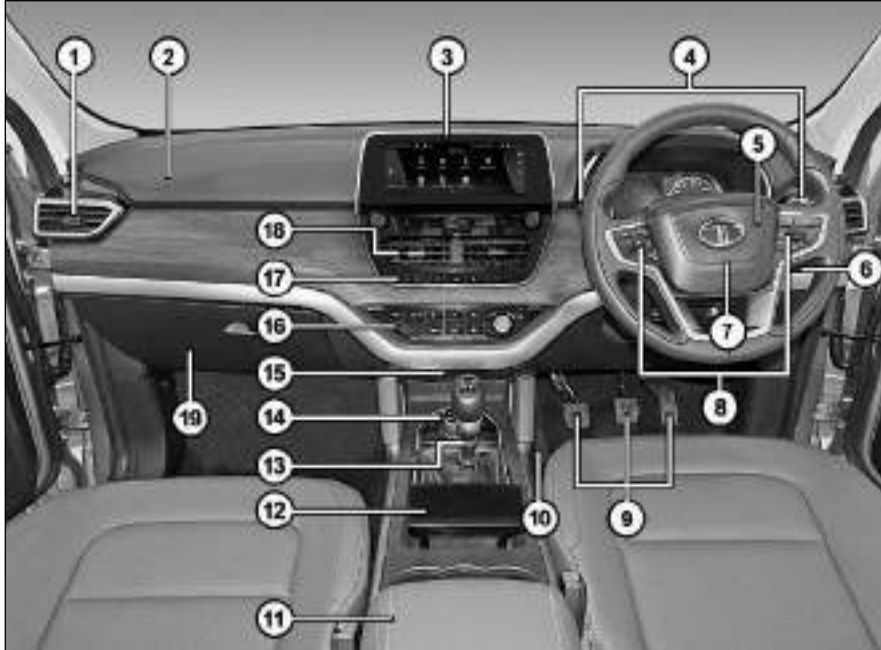

1	A.C. Air vent
2	Air Bag (PAB)
3	Infotainment Display (if fitted)
4	Combi-Switch
5	Horn pad
6	Start/Stop switch (if fitted)
7	Air Bag (DAB)
8	Steering Wheel Switches (if fitted)
9	Controls
10	Foot Rest
11	Foldable Arm-Rest
12	Parking Brake Lever
13	Gear Shift Lever
14	Terrain Response Knob (if fitted)
15	USB/AUX Port
16	HVAC Control panel
17	Fascia switches
18	Centre Air Vent
19	Glove Box

**NOTE:** All location shown may not be applicable to your vehicle / Variants.

## DASHBOARD AND FEATURES

### Instrument Cluster ( TFT Screen )

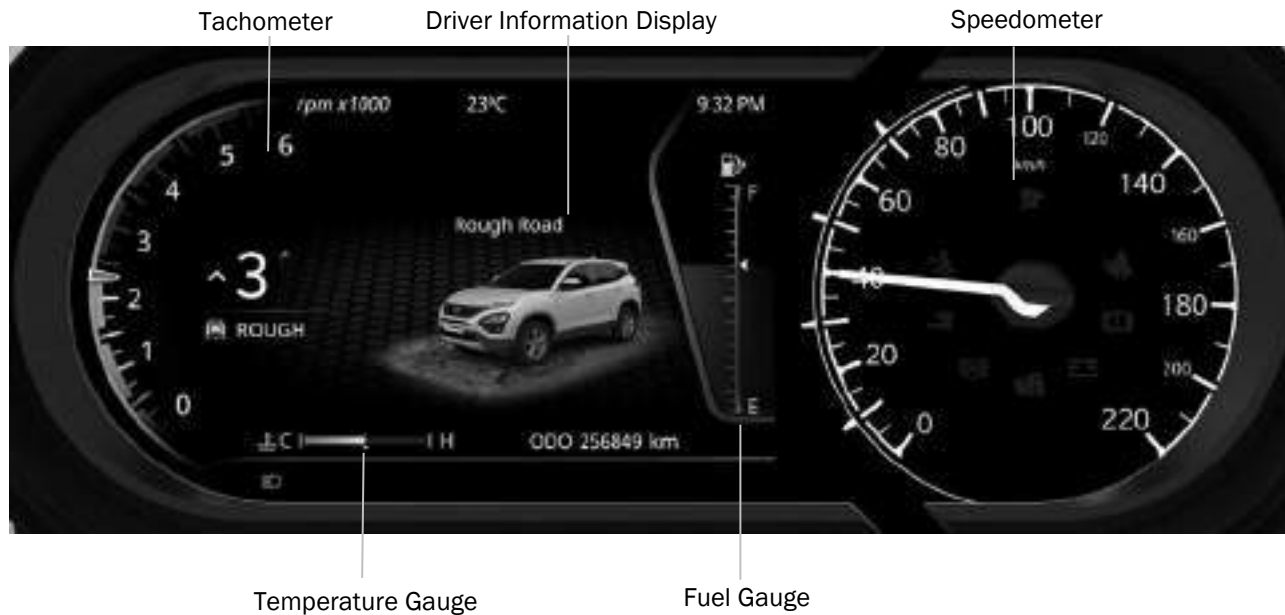

***NOTE: All indicators shown may not be applicable to your vehicle.***

## DASHBOARD AND FEATURES

### Speedometer



Speedometer indicates the vehicle speed in km/h.

#### NOTE

*At every key IN and ignition ON, the Instrument Cluster needles and gauges moves to MAX. and returns to '0' position. This is a welcome strategy and a self-check feature.*

### Tachometer



Tachometer indicates engine speed in revolutions per min (rpm).

#### WARNING

Never drive the vehicle with engine in high 'rpm'. This may cause severe engine damage.

### Fuel Gauge

When the ignition switch is in "ON" position, fuel gauge gives an approximate indication of the amount of fuel in the fuel tank. In indication window, "F" stands for full and "E" stands for empty.



When fuel in the tank is near to empty position, low fuel warning Tell tale turns Amber. Refill the tank as soon as possible.

## DASHBOARD AND FEATURES

### NOTE

- Check the fuel level when the vehicle is stationary and on plain level road.
- On inclines, curves, during braking and sudden acceleration due to the movement of fuel in the tank, the fuel level display may fluctuate or the low fuel warning lamp may turn ON/OFF earlier or delayed than usual.

### WARNING

If there is any fault in the system, Low fuel warning symbol will blink. Take your vehicle to the nearest TATA MOTORS Authorised service station.

### Temperature Gauge

When the ignition switch is in the “ON” position, this gauge indicates the engine coolant temperature.





The indicator should be within the normal, acceptable temperature range i.e. between “H” and “C”. If the indicator approaches “H”, overheating is indicated by RED progress bar.

If the coolant temperature reading is very high, The Engine coolant temperature telltale flashes with an audible buzzer. In this case, stop the vehicle, switch ‘OFF’ the engine and cool it down for some time. Contact the nearest TATA MOTORS Authorised Service centre immediately for rectification.



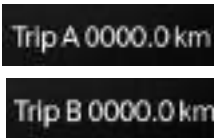
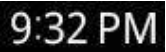

### WARNING

The RED progress bar on high coolant temperature indicates overheating that may damage the engine. Continuing to drive the vehicle when engine overheating is indicated can result in severe engine damage or fire.

### Driver Information System

Driver Information	System Image	Description
Odometer		Indicates distance travelled by a vehicle. The Odometer reading does not return to “0” when maximum value is reached, the display will freeze to maximum value.
Trip meter A & B		The trip meter can be used to measure the distance travelled on short trips or between fuel stops. It can be reset to “0”. The Trip meter reading becomes “0.0” after it crosses 9999.9 km.
Clock		Indicates current time in AM/PM mode. Clock time can be changed using ‘SET’ & ‘MODE’ knob. Whenever the battery terminals or related fuses are connected, you must reset the clock time. This feature is available when ignition switch is in ‘ON’ position. <b>NOTE:</b> Clock settings can also be changed through infotainment system. For more information, refer infotainment manual.
Power and Torque		Indicates the value of Power and Torque delivered by engine in the particular driving condition.

## DASHBOARD AND FEATURES



Driver Information	System Image	Description
Service reminder		<p>Indicates the number of days/kilometers in which service is due. If service is overdue, it will display “0” km or “0” days and spanner symbol will blink at every ignition ON for few seconds. Never reset the display between service intervals otherwise this may result in to incorrect readings. Information is retained in the service interval display even after the vehicle battery is disconnected.</p> <p><b>NOTE:</b> This option is for indicative purpose only. Keep track of your odometer reading and follow the maintenance schedule.</p>
Door Ajar		<p>All four door and Tail gate are indicated independently when respective door or tail gate is open.</p>
Current gear position (indicator)		<p>Current gear engaged by the transmission shall be displayed on DIS.</p> <p><b>NOTE:</b> If “F” is displayed it means ‘Fault’ condition. Contact the TATA MOTORS Authorised Service Centre.</p> <p><i>In case of Manual Transmission, the Gear number shall be displayed when the clutch is fully released.</i></p>
Gear Recommendation		<p>Up or Down arrow shall be displayed on DIS whenever Gear should be put Up or Down.</p> <p>No arrow shall be displayed when the selected Gear is as per the Vehicle dynamics.</p>

## DASHBOARD AND FEATURES

### 1. Instantaneous fuel economy (IFE)



It indicates fuel economy of current drive when Ignition is turned 'ON'.

To reach the Instant Fuel Economy in the Instrument cluster. Press the   switch, which is on the RHS steering switch.

IFE display does not show Fuel Economy of last drive.

The display does not show actual value unless vehicle is moving.

The indication on the display screen may be delayed if fuel consumption is affected by driving pattern.

#### NOTE

- IFE will vary frequently as per driving pattern.
- IFE display does not show Fuel Economy of last drive.

### 2. Power and Torque



Indicates the value of Power and Torque delivered by engine in the particular driving condition.

### 3. Average fuel economy (AFE)





Trip A



Trip B

## DASHBOARD AND FEATURES

AFE value is estimate of fuel economy it may vary significantly based upon driving conditions, driving habits and condition of vehicle.

To reach the Average fuel economy in the Instrument cluster. Press the   switch, which is on the RHS steering switch.

Trip time, Average speed and Trip distance will reset to '0' when respective Trip meter is reset.

### NOTE



- Average Fuel Economy, Trip time and Average speed will get reset to '0' when Battery is removed and refitted.
- Average Fuel Economy will be displayed as '---' for initial 0.5 km of respective trip. Once 0.5 km distance is covered, Average Fuel Economy will be displayed.
- Even after 0.5 km distance covered for particular trip, if Average Fuel Economy is displayed as '---', then take your vehicle to

TATA MOTORS Authorized Service Centre.

### 4. Distance to empty (DTE)



The above image indicates approximate distance in 'km' that your vehicle can travel with available fuel in tank.

To reach the Distance to empty in the Instrument cluster. Press the   switch, which is on RHS steering switch.

DTE values may vary significantly based on driving conditions, driving habits, and

condition of the vehicle. It is an estimate value of the available driving distance.

If low fuel warning light turns 'ON', fill the fuel tank immediately regardless the value of displayed DTE.

### NOTE

- If DTE is displayed as '---', then take your vehicle to the TATA MOTORS Authorized Service Centre.
- The DTE will update with new value when fuel is added more than 7 Litres at a time.

### 5. Infotainment information on Instrument Cluster display unit.

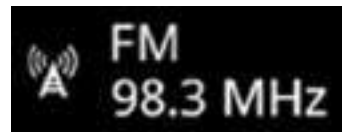

The Instrument Cluster will display the Infotainment information like Media, Navigation and FM.





## DASHBOARD AND FEATURES

### 6. Setting Screen







Screen can be seen in DIS by long pressing  switch for more than 1.5 seconds in vehicle static condition in the instrument cluster.

To change the option from unit to service reminder reset by pressing   RHS steering switch.

### 7. Illumination Screen



You can select illumination setting by scroll down and press   RHS steering switch.

Increase the Illumination from (20% to 100%) in 5 steps by pressing   on RHS steering switch.

### 8. Outside Ambient temperature



This displays outside ambient temperature in units of °C with the resolution of 1 °C.

The temperature sensor shows the front bumper of the vehicle, therefore the temperature reading can be affected by heat reflection from the road surface, engine heat and the exhaust from surrounding traffic.

#### NOTE

*This can cause an incorrect temperature reading when your speed is under low speed less than 30 km/hrs. or when stopped.*

## DASHBOARD AND FEATURES

---

At outside temperature falls below  $-1^{\circ}\text{C}$  “snowflake symbol along with Ice Possible” warning appears in addition to the outside temperature.

### WARNING

If display shows OAT temp as “- - “, take your car to a TATA authorized service Centre.

### Display Messages on Instrument Cluster

Below messages can be displayed in the screen for 4 sec based on the priority and some of the warnings shall be minimized in the screen.

#### 1. **Warning Messages** (messages displayed within the Red border)



**NOTE:** All messages may not be applicable to your vehicle

SN	Warning / Information Title	Warning Message Title	Warning Messages on Instrument Cluster (Displayed after Warning Message Title)
1	Fasten Seat Belt - Driver	Seat Belt Reminder	Fasten Driver Seat Belt
2	Engine Is Locked	Immobilizer Malfunction	Engine Is Locked Contact Service Center

## DASHBOARD AND FEATURES

SN	Warning / Information Title	Warning Message Title	Warning Messages on Instrument Cluster (Displayed after Warning Message Title)
3	Low Brake Fluid	Brake Warning	Low Brake Fluid Check and Refill
4	Electronic Brake Distribution Fault	EBD Malfunction	Drive Cautiously Contact Service Center
5	Electronic Stability Fault	Electronic Stability System	Malfunction Detected Contact Service Center
6	Traction Control Fault	Traction Control System	Malfunction Detected Contact Service Center
7	Transmission Oil Temperature High	Transmission Warning	Transmission Oil Temperature High
8	Transmission Failure Drive Cautiously Visit Service Center	Transmission Malfunction	Drive Cautiously Contact Service Center
9	Drive Control Shift Denied	Drive Mode Warning	Drive Control Shift Denied
10	Drive Control Shift Fault	Drive Mode Malfunction	Drive Control System Fault
11	Torque On Demand Fault	Torque On Demand	Malfunction Detected Contact Service Center
12	Hill Hold Control Failure	Hill Hold Control	Malfunction Detected Contact Service Center
13	Hill Decent Control Failure	Hill Decent Control	Malfunction Detected Contact Service Center
14	Parking Lamp Failed	Lamp Warning	Parking Lamp Failure
15	Brake Lamp Failed	Lamp Warning	Brake Lamp Failure
16	Reverse Lamp Failed	Lamp Warning	Reverse Lamp Failure

## DASHBOARD AND FEATURES

SN	Warning / Information Title	Warning Message Title	Warning Messages on Instrument Cluster (Displayed after Warning Message Title)
17	Low Beam Lamp Failed	Lamp Warning	Low Beam Lamp Failure
18	Low SoC Indication	Battery Warning	Low Battery Charge
19	Forward Collision Warning Indication	Collision Alert	Object Ahead Apply Brake
20	Battery Charging State	Battery Warning	Battery not charging
21	Fuel filter clogging	Fuel Filter Warning	Fuel Filter Choked Contact Service Center
22	Water in Fuel	Water in Fuel Warning	Water detected in Fuel Contact Service Center
23	Engine Oil Pressure Low State	Oil Pressure Warning	Low Engine Oil Pressure Contact Service Center
24	Fuel Level Low State	Fuel Level Warning	Fuel Level Low
25	Fasten seat belt front passenger	Seat Belt Reminder	Fasten Front passenger Seat Belt
26	High Security Integrated Audio System	Security Alert	Audio system Theft Detected
27	Transmission Failure Limp home Activated Visit Service Center	Transmission System	Malfunction Detected Contact Service Center
28	Refuel Alert	Fuel Level Warning	Fill Fuel
29	Jet Pump Failure	Fuel System	Malfunction Detected Contact Service Center

## DASHBOARD AND FEATURES

### 2. Alert Messages (messages displayed within Grey border)



**NOTE: All messages may not be applicable to your vehicle.**

SN	Alert / Information Title	Alert Message Title	Action to be taken
1	Speed Limit Warning	Speed Limit Warning	Over Speeding Detected Slow Down
2	HDC Deactivation Due To Speed Above Set Value	Hill Decent Control	System Deactivated Speed Crossed Set Limit
3	Park Brake Engaged	Brake Alert	Park Brake Engaged
4	Low washer fluid	Washer Fluid Alert	Low Washer Fluid Check and Refill
5	Electronic Stability Off	Electronic Stability System	ESP Turned Off

## DASHBOARD AND FEATURES

SN	Alert / Information Title	Alert Message Title	Action to be taken
6	Traction Control Off	Traction Control System	TCS Turned Off
7	Hill Hold Control Active	Hill Hold Control	HDC Activated
8	Ice Possible	Weather Alert	Ice Formation Possible Drive Cautiously
9	Auto Headlamp	Lamp Alert	Auto Headlamp Activated
10	Service Reminder Days	Service Reminder	Service Due in/Service Overdue 80 Days
11	Service Reminder Km	Service Reminder	Service Due in/Service Overdue 50 Km
12	Cruise ON/Ready to Cruise/Enabled/Armed	Cruise Control	Cruise ON
13	Cruise Enabled & Activated	Cruise Control	Cruise Activated
14	Resume to Target Speed Not Possible in Current Gear	Cruise Control	Shift to higher gear to resume Cruise Speed
15	Cruise deactivated/cancel	Cruise Control	Cruise Cancelled
16	Cruise Override	Cruise Control	Cruise Override
17	Cruise is resuming to set speed	Cruise Control	Cruise is Resuming to set speed
18	ESS disabled	Auto Start-Stop	Auto Start-Stop Disabled
19	ESS Enabled	Auto Start-Stop	Auto Start-Stop Enabled
20	ESS System Error	Auto Start-Stop	Auto Start-Stop System Error
21	Please Crank"	Auto Start-Stop	Start the Engine
22	Autonomous Start Enabled - Battery SOC Low	Auto Start-Stop	Auto Start Enabled Low Battery Charge

## DASHBOARD AND FEATURES

SN	Alert / Information Title	Alert Message Title	Action to be taken
23	Autonomous Start Enabled - Brake Vacuum Low	Auto Start-Stop	Auto Start Enabled Low Brake Assist Vacuum
24	Autonomous Start Enabled – Cabin Temp high	Auto Start-Stop	Auto Start Enabled High Cabin Temperature
25	Autonomous Start Enabled – Coolant Temp Low	Auto Start-Stop	Auto Start Enabled. Low High Coolant Temperature
26	Auto Stop Inhibited – Safety Not Met Door/Hood Open	Auto Start-Stop	Auto Stop Disabled Hood Open
27	Auto Stop Inhibited – Safety Not Met Seat Belt Unfasten	Auto Start-Stop	Auto Stop Disabled Seat Belt Not Fastened
28	Auto Stop Inhibited – Steep Gradient	Auto Start-Stop	Auto Stop Disabled Due to Steep Gradient
29	Auto Stop Inhibited – High Steering Wheel Angle	Auto Start-Stop	Auto Stop Disabled Due to Sharp Turn Angle
30	Auto Stop Inhibited – Smart Key Out Of Range	Auto Start-Stop	Auto Stop Disabled Smart Key Out of Range
31	Auto Stop Inhibited – Coolant Temp low	Auto Start-Stop	Auto Stop Disabled. Low Coolant Temperature
32	Auto Stop Inhibited – Battery SOC low	Auto Start-Stop	Auto Stop Disabled Low Battery Charge



## DASHBOARD AND FEATURES

SN	Alert / Information Title	Alert Message Title	Action to be taken
33	Auto Start Disabled Engine Error	Auto Start-Stop	Auto Start Disabled Due to Engine Error
34	Auto Start Disabled Engine Limp Home	Auto Start-Stop	Auto Start Disabled Engine Limp Home
35	Auto Start Disabled Hood/Door	Auto Start-Stop	Auto Start Disabled Door/Hood Open
36	Auto Start Disabled Transmission Limp Home	Auto Start-Stop	Auto Start Disabled Transmission Limp Home
37	Auto Start Disabled Seat Belt Not Fasten	Auto Start-Stop	Auto Start Disabled Seat Belt Not Fastened
38	Auto Start Disabled Crash Active	Auto Start-Stop	Auto Start Disabled Due to Crash System Active
39	Auto Start Disabled Park Brake Active	Auto Start-Stop	Auto Start Disabled Park Brake Engaged
40	Auto Start Disabled Seat Belt Not Fasten	Auto Start-Stop	Auto Start Disabled Seat Belt Not Fastened
41	Hill Decent Control Switched ON	Hill Decent Control	HDC Turned ON
42	Hill Decent Control Active	Hill Decent Control	HDC Activated
43	Autonomous Start Enabled – Start due to TCU requirement	Auto Start-Stop	Auto Start Enabled High Steering Angle
44	Autonomous Start Enabled – Start due to TCU requirement	Auto Start-Stop	Auto Start Enabled Vehicle Rolling
45	Cruise OFF	Cruise Control	Cruise OFF

## DASHBOARD AND FEATURES

### Instrument Cluster (LCD Screen)

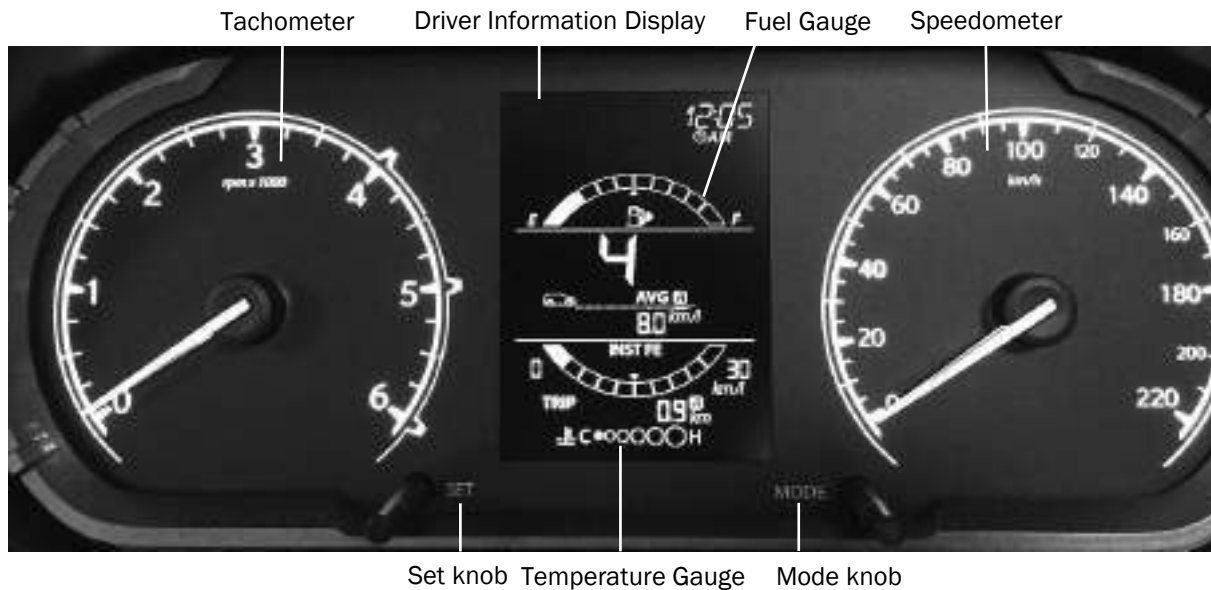

**NOTE: All indicators shown may not be applicable to your vehicle**

## DASHBOARD AND FEATURES

### Speedometer



Speedometer indicates the vehicle speed in km/h.

#### NOTE

*At every key IN and ignition ON, the Instrument Cluster needles and gauges moves to maximum value and returns to '0' position. This is a welcome strategy and a self-check feature.*

### Tachometer



Tachometer indicates engine speed in revolutions per min (rpm).

#### WARNING

Never drive the vehicle with engine in high 'rpm'. This may cause severe engine damage.

### Fuel Gauge

When the ignition switch is in "ON" position, fuel gauge gives an approximate indication of the amount of fuel in the fuel tank. "F" stands for full and "E" stands for empty.



When fuel in the tank is near to empty position, low fuel warning Tell tale turns Amber. Refill the tank as soon as possible.

## DASHBOARD AND FEATURES

### NOTE

- Check the fuel level when the vehicle is on plain surface.
- On inclines, curves, during braking and sudden acceleration due to the movement of fuel in the tank, the fuel level display may fluctuate or the low fuel warning lamp may turn ON/OFF earlier or delayed than usual.

### WARNING

If there is any fault in the system, Low fuel warning symbol will start blinking. Take your vehicle to the nearest TATA MOTORS Authorised service station.

### NOTE

- At every ignition ON Fuel gauge will be displayed in place of “Instantaneous Fuel consumption” bar graph irrespective of user selection screen.

- User can toggle between “Fuel Gauge” and “Instantaneous Fuel consumption” bar graph using SET and MODE button.
- User selection to IFE screen will NOT be allowed if fuel is below  $\frac{1}{4}$  tank level.
- During vehicle running if LCD screen is in “Instantaneous Fuel consumption” bar graph mode & if fuel gauge reduces to  $\frac{1}{4}$  the tank level then LCD screen will automatically go to Fuel Mode.

### Temperature Gauge

When the ignition switch is in the “ON” position, this gauge indicates the engine coolant temperature.







The indicator should stay within the normal, acceptable temperature range between “H” and “C”. If the indicator approaches “H”, overheating is indicated by red bar.

If the coolant temperature reading is very high, the engine coolant temperature tell-tale flashes with an audible buzzer. In this case, stop the vehicle, switch ‘OFF’ the engine and cool it down for some time. Contact the nearest TATA MOTORS Authorised Service Centre immediately for rectification.



### WARNING

The Red bar on high coolant temperature warning indicates overheating that may damage the engine. Continuing to drive the vehicle when engine overheating is indicated can result in severe engine damage or fire.

### Driver Information System

Driver Information	System Image	Description
Odometer		Indicates distance travelled by a vehicle. The Odometer reading does not return to “0” when maximum value is reached, the display will freeze to maximum value.
Trip meter A & B		The trip meter can be used to measure the distance travelled on short trips or between fuel stops. It can be reset to “0”. The Trip meter reading becomes “0.0” after it crosses 9999.9 km.
Clock		Indicates current time in AM/PM mode. Clock time can be changed using ‘SET’ & ‘MODE’ knob.  Whenever the battery terminals or related fuses are connected, you must reset the clock time. This feature is available when ignition switch is in ON position.  <b>NOTE:</b> Clock settings can also be changed through infotainment system. For more information, refer infotainment manual.
Door Ajar		This warning will be indicated when driver door is open.  <b>NOTE:</b> If any other door is open roof lamp will be ‘ON’.

## DASHBOARD AND FEATURES

Driver Information	System Image	Description
Service reminder		<p>Indicates the number of days/kilometers in which service is due. If service is overdue, it will display “0” km or “0” days and spanner symbol will blink at every ignition ON for few seconds. Never reset the display between service intervals otherwise this may result in to incorrect readings. Information is retained in the service interval display even after the vehicle battery is disconnected.</p> <p><b>NOTE:</b> This option is for indicative purpose only. Keep track of your odometer reading and follow the maintenance schedule.</p>
Current gear position indicator		<p>Current gear engaged by the transmission shall be displayed on Driver Information System.</p> <p><b>NOTE:</b> If “F” is displayed it means ‘Fault’ condition. Contact the TATA MOTORS Authorised Service Centre.</p> <p>In case of Manual Transmission, the Gear number shall be displayed when the clutch is fully released.</p>
Gear Recommendation		<p>Up or Down arrow shall be displayed on DIS whenever Gear should be put Up or Down.</p> <p>No arrow shall be displayed when the selected Gear is as per the Vehicle dynamics.</p>

## DASHBOARD AND FEATURES

### 1. Instantaneous fuel economy (IFE)



Monitor IFE bar graph to achieve better fuel economy.

IFE display does not show Fuel Economy of last drive.

The above image indicates fuel economy of current drive when ignition is turned 'ON'.

The display does not show actual value unless vehicle is moving.

The indication on the display may be delayed if fuel consumption is affected by driving pattern.

### NOTE

- IFE will vary frequently as per driving pattern.
- IFE display does not show Fuel Economy of last drive.
- At every ignition ON fuel gauge will be displayed in place of "Instantaneous fuel consumption" bar graph irrespective of user selection screen.
- User can toggle between "Fuel Gauge" and "Instantaneous Fuel consumption" bar graph using SET and MODE Button.
- User selection to IFE screen will NOT be allowed if fuel is below 1/4<sup>th</sup> tank level.
- During vehicle running if LCD screen is in "Instantaneous Fuel consumption" bar graph mode & if fuel gauge reduces to 1/4<sup>th</sup> tank level then LCD screen will automatically goes to fuel mode.

### 2. Average fuel economy (AFE)



Trip time, Average speed and Trip distance will reset to '0' when respective Trip meter is reset.

Average Fuel Economy will be displayed as '---' for initial 0.5 km of respective trip. Once 0.5 km distance is covered, Average Fuel Economy will be displayed.

Even after 0.5 km distance covered for particular trip, if Average fuel economy is displayed as '---', then take your vehicle to TATA MOTORS Authorized Service Centre.

## DASHBOARD AND FEATURES

### NOTE

- AFE value is estimate of fuel economy. It may vary significantly based upon driving conditions, driving habits and condition of vehicle.
- Average Fuel Consumption will get Reset to '0' when Battery is removed and refitted.

### 3. Distance to empty (DTE)



The above image indicates approximate distance in 'km' that your vehicle can travel with available fuel in tank.

DTE values may vary significantly based on driving conditions, driving habits, and condition of the vehicle. It is an estimate value of the available driving distance.

The DTE will update with new value when fuel is added more than 7 Litres at a time.

If low fuel warning light turns 'ON', fill the fuel tank immediately regardless the value of displayed DTE.

### NOTE

If DTE is displayed as '---', then take your vehicle to the TATA MOTORS Authorized Service Centre.

### 4. Instrument Cluster Illumination



Instrument cluster illumination & backlight illumination will turn on after Park lamp is ON.

Illumination can be changed by SET button short press (less than 1.5 seconds).

### WARNING

The Clock and Instrument Cluster Illumination settings should be done only when the vehicle is in stationary condition for safety purpose.

### 5. Outside Ambient temperature



This displays outside ambient temperature in units of °C with the resolution of 1 °C.

The temperature sensor shows the front bumper of the vehicle, therefore the temperature reading can be affected by heat reflection from the road surface, engine heat and the exhaust from surrounding traffic.



## DASHBOARD AND FEATURES

### Display Messages on Instrument Cluster

Below messages can be displayed in the screen for 4 sec based on the priority.



SN	Warning Title/ Title	Warning Messages on Instrument Cluster
1	Speed Limit Warning	Over speed

SN	Warning Title/ Title	Warning Messages on Instrument Cluster
2	HDC Deactivation Due To Speed Above Set Value	HDC Deactive
3	Engine Is Locked	Engine locked
4	Low Brake Fluid	Low Brake Fluid
5	Electronic Stability Off	ESP Off
6	Transmission Oil Temperature High	At Temp High
7	Drive Control Swift Denied	Shift denied
8	Hill Hold Control Active	HHC active
9	Brake Lamp Failed	Brake lamp failed
10	Reverse Lamp Failed	Reverse lamp fail
11	Service Reminder Days	Service Due
12	Service Reminder Kms	Service Due
13	Fuel Level Low State	Low fuel
14	Drive Alert1 - Tea Break	Take a Break
15	Key Fob battery Low	Key batt low
16	Smart key out of range	Key out of Range
17	Rotate steering wheel (In ESCL jam condition)	Rotate Steering



**NOTE: All messages may not be applicable to your vehicle.**

## DASHBOARD AND FEATURES





SN	Warning Title/ Title	Warning Messages on Instrument Cluster
18	Resume to Target Speed Not Possible in Current Gear	Unable to resume
19	Cruise off	Cruise Off
20	Cruise deactivated/cancel	Cruise Cancelled
21	Cruise is Resuming to set speed	Cruise Resumed
22	Press Clutch for MT	Press Clutch
25	Transmission Failure Limp home Activated Visit Service Center	At fault
26	ESS OFF	ESS Off
27	Please Crank	Please crank
28	Autonomous Start Enabled - Battery SOC Low	Auto start

SN	Warning Title/ Title	Warning Messages on Instrument Cluster
30	Autonomous Start Enabled - Brake Vacuum Low	Auto start
31	Autonomous Start Enabled – Cabin Temp high	Auto start
32	Autonomous Start Enabled – Coolant Temp Low	Auto start
34	Autonomous Start Enabled – High Steering Angle	Auto start
35	Autonomous Start Enabled – Vehicle Rolling	Auto start
36	Auto/NORMAL Mode	Normal
37	Rough Road Mode	Mud / Ruts
38	Wet/Rain Mode	Wet / Rain
39	Mud / Ruts	Mud / Ruts
40	Sand	Sand
41	Grass/Snow	Snow
42	Jet Pump Fault	Fuel Sys Fault



### Tell Tales

Warning Lamps	Color	Indicator	Remarks
Malfunction Indication Lamp (MIL)	Amber		<ol style="list-style-type: none"> <li>1. Illuminates when ignition is switched 'ON'. Once engine is started, it turns 'OFF'.</li> <li>2. It remains 'ON' for any engine related fault that may increase emission levels of the vehicle beyond the regulatory norms. Contact the TATA MOTORS Authorised Service Centre for rectification.</li> </ol>
Check Engine Lamp	Amber		<ol style="list-style-type: none"> <li>1. Illuminates when ignition is switched 'ON'. Once engine is started, it turns 'OFF'.</li> <li>2. Illuminates continuously if a fault arises in Engine Management System. Contact the TATA MOTORS Authorised Service Centre.</li> </ol>
Immobilizer	Red		<ol style="list-style-type: none"> <li>1. Illuminates when the system disables engine start if the original key is not used.</li> <li>2. Lamp blinks: Vehicle is in immobilized condition when key is not inserted.</li> <li>3. Lamp ON: Problem with key/system. Contact a TATA MOTORS Authorised Service Centre.</li> <li>4. Lamp OFF: Normal condition (Authenticated user) and engine will start.</li> </ol>





## DASHBOARD AND FEATURES

Warning Lamps	Color	Indicator	Remarks
Pre-Heat indicator / Glow Plug indicator (Diesel)	Amber		<ol style="list-style-type: none"> <li>1. Illuminates when ignition key is in 'ON' position.</li> <li>2. Engine shall be started only after this indicator goes 'OFF'.</li> </ol>
Turn Signal	Green		<p>Indicates direction indicated by the turn signal.</p> <p>Blinks along with buzzer while operating left/right turn indicator only when ignition is switched 'ON'. The direction indicator arrow on Instrument Cluster flashes along with external indicator lights as selected. Both Tell tales shall blink simultaneously when Hazard switch is pressed irrespective of Ignition ON and the Tick-Tock sound shall be given when any one or both the Tell tales are ON.</p>
High Beam	Blue		<p>Illuminates when the high beam headlamps are switched 'ON' or flashed.</p>
Low Oil Pressure indicator	Red		<ol style="list-style-type: none"> <li>1. Illuminates when ignition is switched 'ON' and goes 'OFF' once required engine oil pressure is developed after starting the engine.</li> <li>2. If the low oil pressure indicator does not glow or remains 'ON' with the 'IGN' 'ON' and engine is running, it indicates a fault in the electrical circuit / lubrication system. Contact the TATA MOTORS Authorised Service Centre.</li> </ol>





## DASHBOARD AND FEATURES

Warning Lamps	Color	Indicator	Remarks
Battery charging	Red		<p>Illuminates when ignition is switched 'ON'. Once engine is started, it turns 'OFF'.</p> <p>If it remains 'ON' while the engine is running, it indicates that the battery is not getting charged. Switch off all unnecessary electrical equipment and contact the TATA MOTORS Authorised Service Centre.</p>
Driver seat belt warning	Red		<p>Seat belt warning indicator comes 'ON' for 4 seconds, when ignition is turned 'ON'.</p> <p>If seat belt is not fastened and speed is less than 15 Kmph, then seat belt telltale will turn ON as initial warning.</p> <p>If seat belt is not fastened and vehicle speed goes above 15 Kmph, then final warning will start with telltale flashing and Audio chime for 90 seconds. After 90 seconds, telltale will be ON and Audio chime will be OFF.</p> <p><b>Note:</b></p> <ul style="list-style-type: none"> <li>Telltale will turn off either when seatbelt is buckled or Reverse gear is engaged when it is in initial warning stage.</li> <li>When it is in final warning with Chime ON, the telltale will be OFF on fastening the seat belt or engaging the reverse gear.</li> </ul>
HHC Warning lamp (If applicable)	Amber		<p>Illuminates if Hill Hold System is activated. If continuously ON then HHC system is at fault condition, please take your vehicle to nearest TATA authorized service centre at the earliest</p>





## DASHBOARD AND FEATURES

Warning Lamps	Color	Indicator	Remarks
Airbag status (if applicable)	Red		Illuminates when ignition is switched 'ON' and goes 'OFF' in approx. 4 seconds. If it continuously illuminates or blinks then contact the TATA MOTORS Authorised Service Centre immediately.
Park Brake / Brake Fluid Low / EBD malfunction	Red		Illuminates momentarily when ignition is switched 'ON'. Once parking brake is released, it turns 'OFF'. If it remains 'ON', it indicates 1. Brake fluid level is low. 2. Park brake is applied & turns 'OFF' when it is released. 3. EBD malfunctioning
High Coolant Temperature	Red		Illuminates when ignition is switched 'ON' and goes 'OFF' in approx. 4 seconds. If the engine is overheating, this indicator blinks along with an audible buzzer at his stage Contact the TATA MOTORS Authorised Service Centre immediately. This symbol blinks along with audible buzzer when engine coolant temperature is more than normal. When engine coolant temp increases to hazardous level, Tell tale shall blink with RED color and it is accompanied by audio warning. <b>Note:</b> Never remove the radiator pressure cap from the radiator when the engine is hot. Do not restart the engine until the problem has been duly attended.
Cruise Control lamp (if applicable)	Green		This symbol lights up when the 'IGN' is turned 'ON' and shall go 'OFF' after 4 sec. The Cruise Control is used to indicate the status of cruise control system to the driver. Lamp ON indicates cruise control feature is present and it is activated.

## DASHBOARD AND FEATURES



Warning Lamps	Color	Indicator	Remarks
ABS	Amber		Illuminates when ignition is switched 'ON' and goes 'OFF' in 3 seconds. Illuminates continuously if there is any malfunction in ABS. Normal braking system will be operational without assistance of ABS. Contact the TATA MOTORS Authorised Service Centre immediately.
Low Fuel indicator	Amber		Illuminates momentarily when ignition is switched 'ON'. The symbol lights up continuously if fuel level in the tank is low. Fuel needs to be filled immediately. <b>IMPORTANT:</b> The warning light will start flashing if there is any fault in the fuel system. Contact the TATA MOTORS Authorised Service Centre immediately
Key Not Detected (If applicable)	Amber		This symbol lights up when the Valid Smart key is not detected inside the vehicle.
Press Clutch Pedal to Start Engine (If applicable)	Amber		Press Clutch: This turns ON with IGN ON till user press the clutch pedal to start the engine.
Water in fuel indicator (Diesel)	Amber		Illuminates continuously if excess water is accumulated in the fuel filter. Contact the TATA MOTORS Authorised Service Centre to drain the water immediately to avoid serious damage to the fuel injection system.

## DASHBOARD AND FEATURES



Warning Lamps	Color	Indicator	Remarks
Daytime running lamps DRL (if applicable)	Amber		This symbol illuminates when the Day Time Running lamp is 'ON'.
Door Ajar lamp	Red		All four door and Tail gate are indicated independently when respective door or tail gate is open.
HDC Warning lamp (If applicable)	Red		Illuminates if Hill Decent Control System is activated. If continuously ON then HDC system is at fault condition, Please take your vehicle to nearest TATA authorized service centre at the earliest
Rear Fog Lamp (if applicable)	Amber		Illuminates when the rear fog lamp is 'ON'.
Front Fog Lamp (If applicable)	Green		Illuminates when the front fog lamp is 'ON'.





## DASHBOARD AND FEATURES

Warning Lamps	Color	Indicator	Remarks
Electronic Stability Program (ESP) (if applicable)	Amber		If continuously ON then ESP system is at fault condition, Please take your vehicle to nearest TATA authorized service center at the earliest.
Front passenger Seat Belt Indicator	Red		<p>Illuminates when ignition is switched 'ON' and goes 'OFF' after 4 Seconds.</p> <p>The warning lamp remains 'ON' for 30 seconds if the front passenger seat belt is not fastened.</p> <p>The warning lamp remains 'ON' continuously if the vehicle goes above 4 kmph</p> <p>If seat belts remains unbuckled and vehicle speed goes above 15 kmph, then final warning will start illuminates with audio chime for 90 seconds continuously.</p> <p><b>Note:</b></p> <ul style="list-style-type: none"> <li>• The warning lamp turns 'OFF' when vehicle speed goes below 2 kmph when it is in initial warning.</li> <li>• Once the seat belt is fastened, the buzzer and warning indicator will go 'OFF'.</li> <li>• Seat belt audio alarm remains OFF when reverse gear is engaged.</li> </ul>

## DASHBOARD AND FEATURES

Warning Lamps	Color	Indicator	Remarks
Speed limit warning indicator	Amber		<p>Illuminates when ignition is switched 'ON' and goes 'OFF' after 4 Seconds.</p> <p>When the vehicle speed cross 80 km/hrs. then Speed limit Warning indicator turn 'ON' along with for every 2 minute chime shall be sounded (Audible warning).</p> <p>If vehicle speed crosses 120 km/hrs. then along with Speed limit Warning Indicator, Chime will start continuously ON till the vehicle speed is above 120 km/hr.</p> <p>If vehicle speed is between 80 km/hrs. to 120 km/hrs. then chime will become less frequent but Speed Limit warning Indicator will remains 'ON' continuously. When the vehicle speed is reduce below 80 km/hrs. then Speed limit Warning Indicator along with chime will gets turns 'OFF'.</p>
DPF Lamp	Amber		<p>The warning light or symbol switches on constantly to indicate that the DPF needs to eliminate the trapped pollutants (particulate matter) through the regeneration process, it therefore does not indicate a malfunction. The warning light or symbol remain off during the entire DPF regeneration and light up only when driving conditions require the driver to be notified. To switch off the warning light or symbol, keep the car running until regeneration is complete (ideally at 3<sup>rd</sup> gear, 60 km/hr. with engine speed over 2000 rpm). The process normally takes about 20 minutes.</p> <p><b>Note:</b> Failure to be observed the appropriate procedure for a long distance when the DPF warning light comes ON, can cause the warning light (MIL) to come ON. In that case, please contact nearest TATA authorized service center to restore correct DPF operation.</p>

## DASHBOARD AND FEATURES

Warning Lamps	Color	Indicator	Remarks
ECO (If applicable)	Green		ECO lamp ON indicates Economy drive. This mode is used to achieve better fuel economy.
SPORT (If applicable)	Amber		This symbol comes ON when SPORT driving mode is activated when more torque is required.
CITY (If applicable)	White		CITY lamp ON indicates City drive mode. This mode is used to achieve optimum torque with fuel economy.

## DASHBOARD AND FEATURES

---

### Audio Reminders (as applicable)

#### 1. Key in reminder / audio warning

While leaving your vehicle, if you forget the key inside the vehicle in Ignition 'OFF' position, audio warning will be started. Remove key to stop the warning.

#### 2. Park lamp 'ON' reminder

While leaving your vehicle, if you forget to turn 'OFF' the headlamps, buzzer sound will come. Switch 'OFF' Park Lamps to stop the warning indication. Do not forget to turn 'OFF' your headlamps as it may drain your vehicle battery.

#### 3. Park brake 'ON' reminder

If Park Brake is applied and vehicle is driven, Tell tale will turn 'ON' and buzzer will provide audio warning continuously. Disengage the park brake to stop audio warning.

#### 4. Reverse Gear reminder

If reverse Gear engaged Buzzer shall sound to alert you.

#### 5. Driver Seat Belt reminder

If seat belt remains unbuckled and vehicle speed goes above 15 km/ hrs. Final Warning will start. Audio Chime will continue for 90 seconds. Seat belt telltale will remain continuously ON when audio alarm is active

#### NOTE

Buckle the seat belt to stop Audible warning.

#### 6. Front passenger Seat Belt reminder

If Front passenger is present & its seat belt remains unbuckled and vehicle speed goes above 15 km/ hr. Final Warning will start. Audio Chime will continue for 90 seconds. Seat belt telltale will remain continuously ON when audio alarm is active.

#### NOTE

Buckle the seat belt to stop Audible warning.

#### 7. Door open reminder

If any door is open and try to lock the vehicle, one flash with beep will indicate that door is open.

### Combi-Switch (RH Stalk)

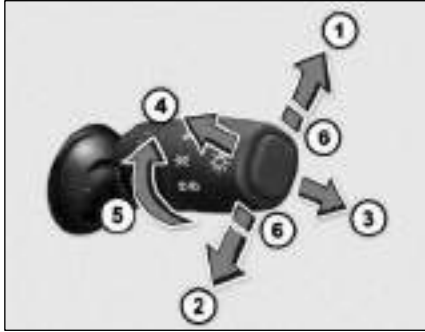

1. **Left Turn signal** - Move the lever fully upward.
2. **Right Turn signal** - Move the lever fully downward.

#### NOTE

*When the turn is completed, the signal will cancel and the lever will return to its normal position.*

3. **High beam** - Move the lever forward to select the high beam function.

Pull the lever back to normal for low beam.

#### 4. High beam Flash (spring return)

To flash the high beam, pull the lever towards you from the normal position. It will return to its normal position when you release it.

#### 5. Headlamp Rotary Switch

##### i. OFF Position



All lamps will remain 'OFF'.

##### ii. Parking Lamp



Rotate stalk to turn 'ON' the Parking lamps.

#### NOTE

*DRL (if equipped) will turn 'ON' as long as parking lamp input is 'OFF' and engine is running.*

*To temporary deactivate DRL turn 'ON' and 'OFF' the park lamp switch two times within 3 seconds.*

*The lamp can be activated again by performing the same action.*

#### iii. Low Beam



Rotate stalk to turn 'ON' the Low Beam function.

#### iv. Auto Light



The headlights will be automatically switched ON depending on ambient light conditions (while entering a tunnel or when it is twilight).

#### 6. Lane Change Signal

To signal a lane change, move the lever slightly up or down to the point where the turn signal light begins to flash, but the lever does not latch. The turn signal will flash 6 times automatically.

## DASHBOARD AND FEATURES

### 7. Head lamp leveling rotary switch

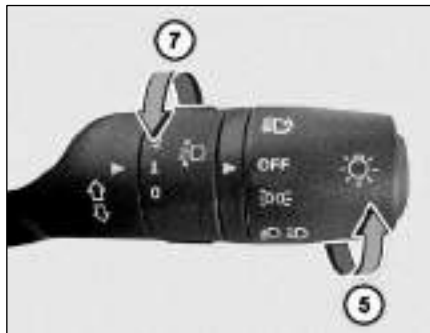

Inner rotary switch on right hand stalk is provided for head lamp leveling. With the inner rotary switch, Head lamp leveling can be done with head lamp in Low Beam and in 'ON' position. Select correct position before start of trip and vehicle is stationary. Depending upon the number of passengers and luggage in the vehicle headlamp focus may change. This can be adjusted by rotating the knob to one of the 3 level positions.

### Combi-Switch (LH Stalk)

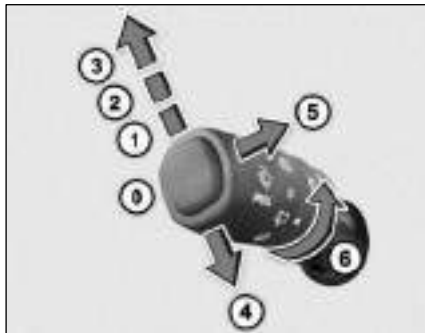

#### 0) 'OFF' Position

The wiper is switched 'OFF'.

#### 1) Intermittent wipe

Push the stalk upwards to operate intermittent wipe.

Inner rotary switch on left hand stalk is provided for intermittent front wiper delay. The switch has 5 delay timers.



#### 2) Slow Wipe

Push the stalk towards position (2) for continuous slow wipe.

#### 3) Fast Wipe

Push the stalk towards position (3) for continuous fast wipe.

#### 4) Flick wipe (spring return)



Pull the stalk downwards and hold it for continuous wipe, the wiper continuously wipes across the windshield at low speed till the stalk is released.

#### 5) Front Windshield Washer

- Pull the lever little longer, washer fluid will be sprayed on the windshield.
- The windshield wipers operate for 3 cycles after the lever is released and 1 more cycle after 5 seconds.



## DASHBOARD AND FEATURES

### Auto front wiper (if equipped)

If your vehicle is fitted with a Rain and Light Sensor, Auto Front Wipe is activated only when the wiper stalk is in the 'Auto' position. The wipe sensitivity can be altered with the help of intermittent wipe rotary switch.

#### NOTE

*When you crank the engine, the supply to washer motor is momentarily cut off.*

### 6) Rear Wash and Wipe (If equipped)



### Rear Windshield / Wiper and Washer

Turn the rotary knob clockwise and release to operate rear windshield wash and wipe. The windshield wipers operate for 3 cycles.



### Rear Wipe

Turn the rotary knob counter clockwise such that it aligns its positions with arrow mark to operate rear windshield wiper continuously.



#### NOTE

*Rear wiper stop working as long as tailgate is found open.*

### Rear Windshield / Wiper and Washer Switch

Turn the rotary knob counter clockwise such that it aligns its positions with arrow mark and hold it, to operate rear windshield wash and wipe. It will return to 'Rear wipe' position as soon as released and continue to wipe.



## DASHBOARD AND FEATURES

---

### WARNING

If you operate wash and wipe function for more than 15 seconds the controller cuts off the supply to Washer motors to avoid overheating.

### Rain / Light Sensor (if equipped)

Rain & light sensor is integrated sensor & mounted on front windshield glass to detect rain & light.

According to input from sensor, wipe & light function will be work automatically.

### Fascia Switches

Fascia switches are provided on the center console below HVAC control panel.

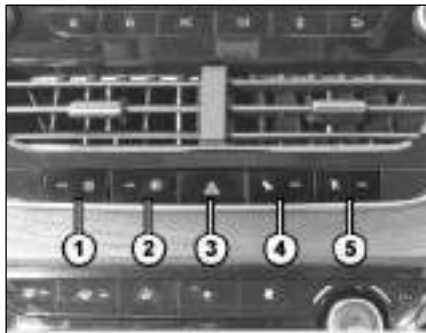

1. Rear fog lamp switch (If applicable)
2. Front fog lamp switch (If applicable)
3. Hazard warning switch
4. Economy mode switch (If applicable)
5. Sports mode switch (If applicable)



### Steering Wheel Switches (LHS)

(If equipped)

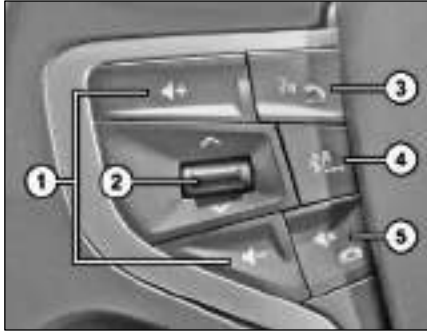

#### 1. Volume



Press above switch to increase or decrease volume of music system / radio.

#### 2. Seek forward/backward



Press above switch to change radio channels.

#### 3. Phone receive / PTT (Push to Talk)



Press above switch to accept incoming call when a cell phone is connected via Bluetooth.

#### Voice Recognition

To activate, long press the voice activation button provided on the steering wheel. The system mutes/ pauses the currently played audio and you will hear a beep sound to indicate the activation of the voice recognition feature. The system also display the icon on the right top corner of the screen to indicate activation of voice recognition.

#### NOTE

*The system will start recognizing your voice command only after the beep. So, speak your command only after you hear the voice activation beep.*

#### 4. Source



Press above switch to select the required source in the infotainment system i.e. USB, AUX, AM, FM.

#### 5. Mute / phone reject



Press above switch to reject or hang up a phone call. It is also used to mute the volume of music system / radio.

#### NOTE

*For more information of steering wheel switches refer infotainment manual.*

*((Refer link -<http://service.tatamotors.com/content/owners-manual>) if applicable)*

## DASHBOARD AND FEATURES

### Steering Wheel Switches (RHS)

(If equipped)

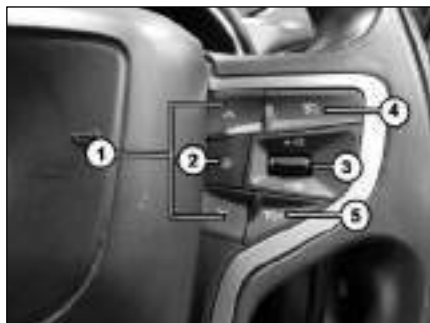

#### 1. Instrumentation controls(IC)

##### i. Instrumentation controls scroll up

Press above switch to scroll up on Instrument Cluster display.

##### ii. Instrumentation controls scroll down

Press above switch to scroll down on Instrument Cluster display.

#### 2. OK / Select & long press for setting

Press above switch to select the option and also press long (approx. 3) to go directly to Instrument cluster settings.

#### 3. Cruise resetting/setting speed increasing/decreasing switch

- Press the cruise control master switch on steering wheel.
- Accelerate the vehicle to the desired speed.
- Press the 'SET' button on steering wheel switch to set the desired cruise speed. The cruise control indicator on instrument cluster will turn 'ON'.
- Remove your foot from the accelerator pedal.

Once Cruise control is activated the vehicle automatically maintains the stored speed.

#### Changing the set cruise speed

The set cruise speed can be adjusted (i.e. increased or decreased) using '+' (to increase) or '-' (to decrease) switches on steering wheel. The speed increases and decreases on a single press. The changed speed will be shown on the speedometer. Keeping the switch pressed increases or decreases the speed continuously till the switch is released. The set speed can also be increased by pressing the accelerator pedal till the desired speed is achieved and then pressing the 'SET' button. The set speed can also be decreased by pressing the brake pedal (The cruise indicator will turn OFF) and slowing down to desired speed and then pressing the 'SET' button (The cruise control indicator will turn 'ON' again).

### 4. Cruise control master switch



Cruise speed can be resumed only if cruise control is deactivated by depressing Brake Pedal. To resume the previously set cruise speed, accelerate the vehicle to a speed above approx. 32 kmph and press reset ('RES') switch.

### 5. Cruise control deactivating switch



There are several ways to deactivate cruise control:

- Applying brake / clutch.
- Press deactivation switch on Steering Wheel
- Activation of ESP/ TCS system.

#### **NOTE**

*For more information on cruise switches on steering wheel refer cruise control section.*

### Mic (If applicable)



Mics are provided on roof near roof lamp.

### Infotainment System Display

(If applicable)



#### **NOTE**

*For more information, refer infotainment manual.  
(Refer link -<http://service.tatamotors.com/content/owners-manual> if applicable)*

## DASHBOARD AND FEATURES

### Speakers & Tweeter (if equipped)



Speaker

4 Speakers and 4 tweeters are provided on models with infotainment system. Provisions are given for music system and speakers on versions without infotainment system.

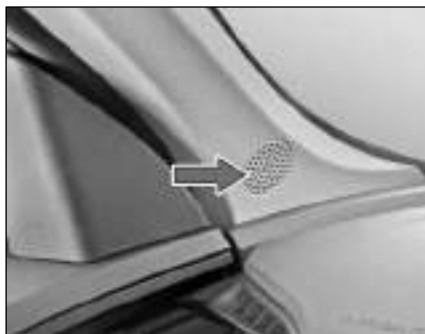

Tweeter

### USB/AUX Port (if equipped)



Connect your portable digital music players, pen drives etc. to this socket for playing music tracks through the vehicle's music system.

### Smart Charger (if equipped)



It's provided between the front passenger seats below the rear stowage area. It's used to charge the mobile phone, Power Bank etc.

### Power Socket



Power socket are provided inside the Foldable arm rest on center console.

The power socket will work when the ignition switch is in the "ACC" or "ON" position. This socket can be used to provide 12V (10A) power for electrical accessories.

### NOTE

*Use of inappropriate electrical accessories can cause damage to your vehicle's electrical system. Make sure that any electrical accessories you use are designed to plug into this type of socket and rating.*

## DASHBOARD AND FEATURES

---

### Antenna

#### Option I



Antenna is located on the roof. Turn antenna anticlockwise to remove from vehicle, if required.

#### Option II



Shark FIN antenna is provided on the roof at rear end.

### Roof Grab Handle (If applicable)

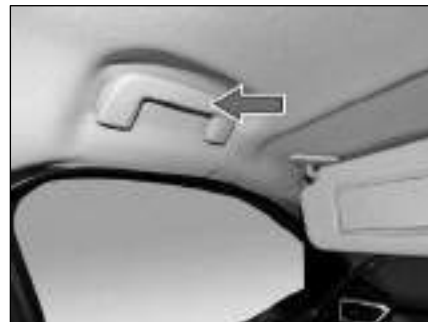

Roof grab handles are provided on all seats except driver's seat. This helps in comfortable positioning of passengers during the journey.

## DASHBOARD AND FEATURES

### Front Fog Lamps

(If applicable)

Front fog lamp is located on front bumper. When visibility is poor due to fog, snow or rain, use the fog lamps which improves visibility as well as making it easier for other road users to see you.



An indicator on the switch will be illuminated when the front fog light is 'ON'.

### Cornering feature:

For front fog lamp cornering feature the Head Lamp must be 'ON'.

As you turn steering wheel to left or right, the corresponding fog lamp will automatically get 'ON'.

**Rear Fog Lamps** (If applicable)



Rear Fog Lamp is provided on rear bumper to improved visibility in adverse weather conditions to vehicles behind you.



For switching 'ON' the Fog lamps, either the Head Lamp or Parking lamp must be 'ON'.

Operate the front fog lamp switch provided on fascia to 'ON' or 'OFF' the fog lamp.



For switching 'ON' the rear fog lamps, front fog lamp must be 'ON'.

Operate the rear fog lamp switch provided on fascia to 'ON' or 'OFF' the fog lamp.

An indicator on the switch will be illuminated when the rear fog light is 'ON'.

### Puddle / Ajar Lamp



Puddle / Ajar Lamp is provided on driver, front passenger & rear doors trim. It will be ON only when particular door is in open condition.

## DASHBOARD AND FEATURES

### Roof Lamp

Interior roof lighting lamp is provided on the roof with inbuilt switch.



Front Roof lamp

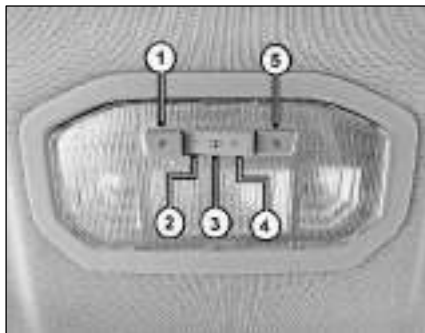

Rear Roof lamp

The switch has three positions:

#### 1. Spot / reading lamp for Front passenger side

The front row interior lamp has separate switches to operate the spot / reading lamp for Front passenger side.



#### 2. OFF - In this position, the lamp will remain 'OFF'.



3. **DOOR** - In this position, the lamp turns 'ON' with dimming when either of the doors are opened. When the last door is closed, the lamp will turn 'OFF' with dimming. This helps settling in the seat and inserting the key in the ignition switch. When the key is turned to the 'IGN' position, the lamp goes 'OFF' immediately.



4. **ON** - The lamp will turn 'ON' as long as the switch is in this position.



#### 5. Spot / reading lamp for Driver side



The front row interior lamp has separate switches to operate the spot / reading lamp for Driver side.



### Boot Lamp (if equipped)



Boot lamp is provided in the rear luggage compartment to illuminate the luggage area.

Boot lamp is without switch type. It will be ON only when tailgate is open.

### Outer Mirror with Logo projection (if equipped)



Outer mirror with logo projection is located on both ORVM (Outside Rear View Mirror).

It is used to guide the user to see the area near the Driver and Front passenger door. These lamps will come ON whenever the Unlock/Lock switch is pressed on Remote.

### Side indicator lamp on ORVM



It is provided on outer part of ORVM.

It will turn ON when the turn signal indicator switch is ON and Hazard Warning indicator switch is ON.

## DASHBOARD AND FEATURES

### Front Lamp

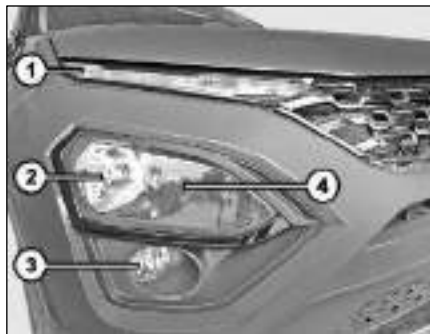

1. Position / DRL /Turn indicator lamp  
(If applicable)
2. High beam lamp
3. Front fog lamp (If applicable)
4. Low beam lamp

### Lamp Condensation / Fogging Condition

Condensation is a natural phenomenon in Lamp. This occurs mainly because of atmospheric condition/weather change. During normal condensation, thin film of mist is visible on the inside surface of the exterior lens. Generally, this condition is considered normal and can be eliminated by turning on the headlamp with engine running or during normal driving conditions.

#### NOTE

- *Headlamp fogging / condensation is natural occurrence and headlamp assembly replacement will not be necessary to resolve the issue.*
- *High-pressure washer jet direct on vent system of lamp are not recommended, there might be possibility of water ingress causing heavy fogging.*

### Tail Lamp

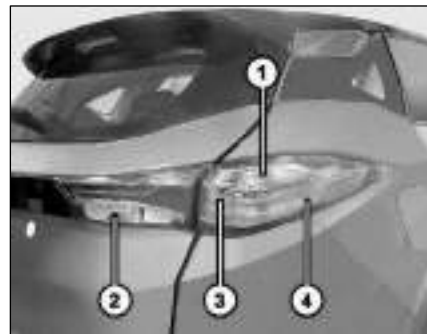

1. Turn indicator
2. Reverse lamp
3. Stop lamp (If applicable)
4. Parking lamp (If applicable)

### Storage Compartment

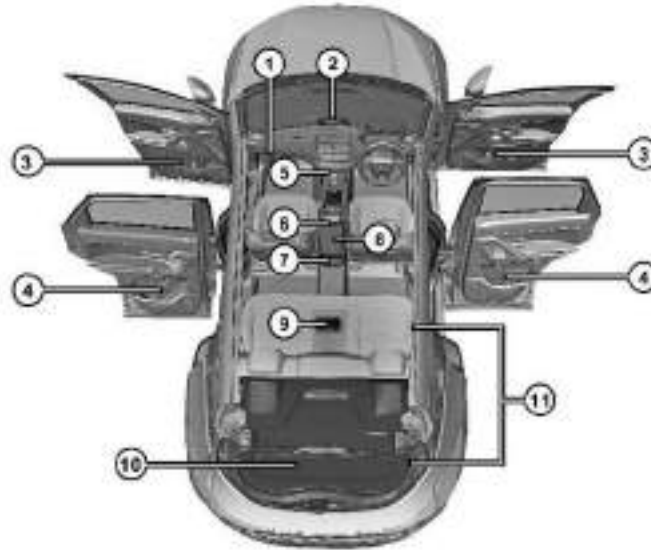

1. Glove box
2. Goggle holder
3. Utility pockets on front doors
4. Utility pockets on rear doors

5. Mobile / Wallet stowage(near gear shifter lever)
6. Cup holder for front passenger
7. Stowage for rear passenger

8. Stowage below arm rest
9. Foldable arm rest
10. Tailgate Compartment
11. Hooks

## STOWAGE AREAS

### 1) Glove box

#### i) Opening and closing

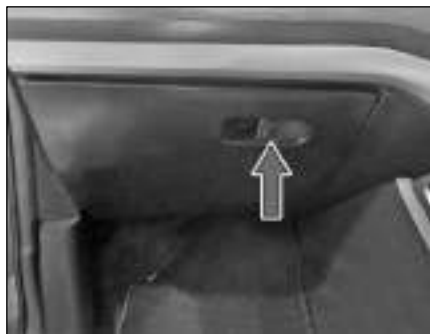

**To open** - Pull the lever to open the glove box flap.

**To close** - Lift glove box flap until it engages.

#### ii) Glove box illumination



The glove box lamp illuminates when the glove box is opened.

#### **NOTE**

*Make sure that glove box flap is closed while driving.*

#### iii) Stowage detail

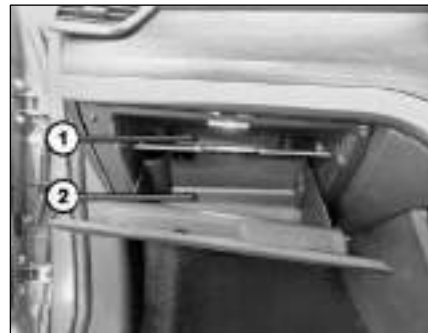

Following items can be stowage in glove box.

1. Owner's manual and other vehicle document,
2. First aid kit, Visiting card, Pen, Receipts etc.

## STORAGE AREAS

### iv) Cooling facility (If applicable)

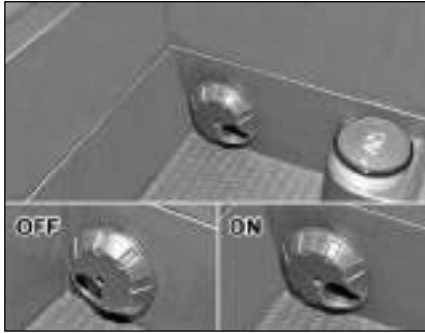

On selected models cooling facility is provided below driver foldable arm rest. It cools only when the A/C is ON. Close the vent by rotating the knob, whenever cooling is not required.

### 2) Goggle holder (If applicable)



Goggle holder is provided near the roof lamp.

### 3) Utility pockets on front doors



Utility pockets are provided on front doors and it can be used to keep following items.

1. Magazine/ paper
2. Umbrella holder
3. Water bottle

#### **NOTE**

*Remove the water from umbrella and fold it properly before storing it in umbrella holder.*

## STOWAGE AREAS

### 4) Utility pockets on rear doors

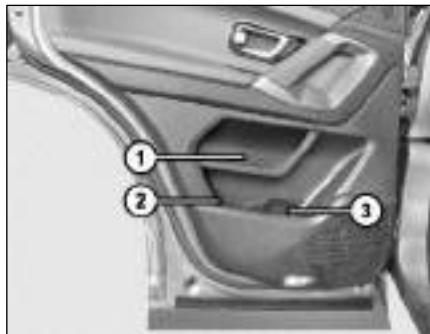

Utility pockets are provided on rear doors and it can be used to keep following items.

1. Mobile holder
2. Magazines/books
3. Water bottles etc.

### 5) Mobile / Wallet stowage



Place for keeping wallet / mobile is provided in front of Gear shifter lever.

### 6) Cup holder for front passenger



Space for cup holder are provided in centre console.

## STORAGE AREAS

### 7) Storage for rear passenger (If applicable)

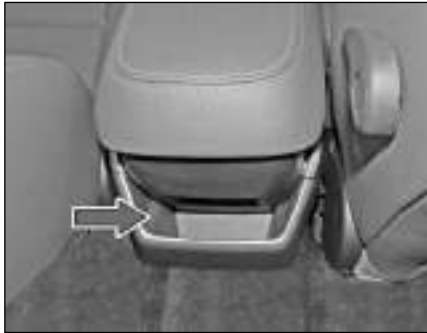

Storage for rear passenger is provided on rear side of floor console between the front passenger seats. It can be used to keep mobile charger, mobile and small items like wallet, Power bank etc.

### 8) Storage below arm rest



Storage below front arm rest with chiller is provided on center console between the front passenger seats. It can be used to keep small items.

### 9) Foldable arm rest (If applicable)



A foldable arm rest has been provided in the rear seat. It also has two cup holders, which can be accessed by opening the cover. When not required, fold the arm-rest back into the seat.

#### NOTE

- Remove all items and cups before folding the cup holders.
- Use cups, containers, bottles of right size and which have lids. The content could otherwise spill.

## STOWAGE AREAS

### 10) Tailgate Compartment



Store the luggage in tailgate compartment. You can keep suitcase bag etc.

### WARNING

- Distribute the items of luggage as evenly as possible.
- Position heavy loads as far forwards as possible and as low down in the trunk as possible.
- Never allow occupants to travel in the luggage compartment.
- Do not place anything on luggage cover as it could obstruct driver's rear view. Also in case of an accident or sudden braking, it could cause an injury to occupants.
- The luggage cover can be lift.

### Stowage below load floor



Luggage cover is designed only for hiding the luggage compartment.



## STORAGE AREAS

### 11) Hooks

#### i) Coat Hanger (If applicable)

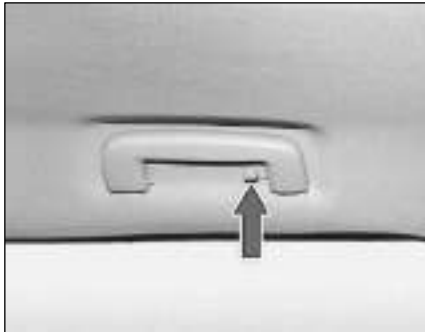

Coat hanger is provided for rear passenger near grab handle.

#### WARNING

- The coat hook cannot restrain heavy objects or items.
- *Do not hang objects on coat hooks which can obstruct the curtain airbag deployment during impact.*
- Never hang hard, sharp-edged or fragile objects on the coat hook.

#### ii) Hooks in luggage compartment (if applicable)



These hooks are provided on both sides in luggage compartment for hanging small carry bags carrying up to 3 kg weight only.

#### NOTE

*Do not use these hooks for securing luggage like using nets etc.*

#### Front seat back pockets (If applicable)



Rear pockets are provided behind the front seats for keeping small magazines /Notebook etc.

#### NOTE

*Do not hang objects on coat hooks which can obstruct the curtain airbag deployment during impact.*



## CLIMATE CONTROL

The Climate Control regulates the temperature inside the vehicle and filter the dust particles in cabin based on the user set temperature settings.

**Air Distribution-** The air is distributed through the vents in the passenger compartment as shown below:



## CLIMATE CONTROL

### Air vents

#### Centre Vent

Centre air vents are provided on dashboard. Air flow and its direction can be adjusted with the help of knob provided on respective vent.



Centre Air Vents (Front)



Side Air Vents (Front)

#### Side Vent for Rear passenger (if applicable)

Side air vents are provided on both side of B pillar for rear passenger.

Air flow and its direction can be adjusted with the help of knob provided on respective vent.



Side Air Vents (Rear)

## CLIMATE CONTROL

### 1. HVAC Controls (if applicable)



- A. Temperature Control
- B. Fresh / Recirculation air mode
- C. Blower Speed Control
- D. AC ON/OFF Switch
- E. Air Distribution Control

### A. Temperature control



The temperature control knob allows you to adjust the temperature. The temperature can be increased by rotating the knob towards the red segment (clockwise) and decreased by rotating it towards the blue segment (anti-clockwise).

### B. Fresh / Recirculation air mode

Press the switch to activate / deactivate air recirculation mode.



Press to 'ON' or 'OFF'

**Recirculation mode:** (Indicator light 'ON')

Air in the passenger compartment recirculates. No fresh air enters the compartment.

Always use when:



- Driving on a dusty road or through tunnel.
- On signals or slow traffic to avoid traffic pollution.
- Maximum cooling is required.

## CLIMATE CONTROL

**Fresh Air mode:** (Indicator light 'OFF')

Fresh air is drawn into the vehicle.

Always use when:

- Discomfort is felt or windows are fogging up.
- Using  or  air flow modes during demist / defrost.
- Using normal heating mode.

### C. Blower Speed control



This is to turn 'ON' the blower and select desired blower speed.

### D. AC ON/OFF

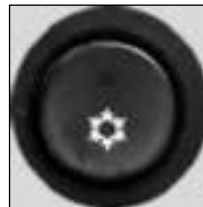

Press the switch to activate / deactivate the AC. The indicator lamp in the button will light up when climate control is activated.

#### **NOTE**

*The AC can be switched 'ON' only if the blower is 'ON' and engine is running.*

When AC is switched 'ON', engine idling RPM increases marginally to adjust the AC compressor load.

When desired temperature is achieved AC trips 'OFF' automatically.

### NOTE

- Condensation may drip from the underside of the vehicle when it is in cooling mode. Traces of water on the ground are normal and are not a sign of leakage or malfunction.
- Ventilate the vehicle for a brief period during warm weather. This will speed up the cooling process and the desired vehicle interior temperature will be reached quickly.
- Never cover the air vents or air intake grilles in the vehicle interior.
- If the AC is not used for a long period, such as during winter, it may not give the best performance when you start using it again. Operate the AC at least once a month to maintain optimum performance.

- While starting the vehicle itself after long duration (more than 15 days), following procedure needs to be followed to meet AC performance.
  - Start the vehicle with AC & Blower in OFF condition in idling for 2~3 minutes.
  - Then switch ON the AC & Blower and run it for another 2~3 minutes in idling for proper circulation of refrigerant & oil to lubricate the internal parts of AC system.
- Rear blower will be effective after 5-10 min of front HVAC running (after cabin cooling).

### E. Air distribution control











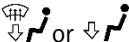

This is to select the air distribution pattern as described in the table.

	Directs air through the center and side air vents
	Directs air through the center, side and foot well vents
	Directs air through the foot well air vents
	Directs air through the defroster & foot well vents (Default fresh air mode)
	Directs air through the defroster vents (Default fresh air mode)
	Directs fresh air enters in the compartment.

## CLIMATE CONTROL

Recommended basic settings of the control elements of air conditioning system for the respective operating modes. These may vary depending on individual requirements and weather conditions.

Functions	Control Knob Position			Button Position	
	Air Flow Direction 	Blower Speed 	Air Temperature 	Fresh / Recirculation air mode 	AC ON/OFF 
<b>Normal heating</b>		2 <sup>nd</sup> or 3 <sup>rd</sup>	Desired temp.	Fresh air mode.	Switched OFF
<b>Quick heating</b>		To MAX speed and then 2 <sup>nd</sup> or 3 <sup>rd</sup>	To the extreme right up to the stop	Briefly switch ON to Fresh air mode then Recirculation	Switched OFF
<b>Normal Cooling</b>		1 <sup>st</sup> to 3 <sup>rd</sup>	Desired temperature	Recirculation mode	Switched ON
<b>Quick Cooling</b>		To MAX speed and then 2 <sup>nd</sup> or 3 <sup>rd</sup>	To the extreme left up to the stop	Recirculation mode	Switched ON
<b>Demisting</b>		2 <sup>nd</sup> or 3 <sup>rd</sup>	Desired temperature	Fresh air mode (Default)	Switched ON (Optional)
<b>Defrosting</b>		To MAX speed	Desired temperature	Fresh air mode (Default)	Switched ON (Optional)



### 2. Fully Automatic Temperature Control (FATC) (if applicable)

FATC system controls the inside temperature of the vehicle automatically and provides maximum passenger convenience regardless of outside weather conditions.

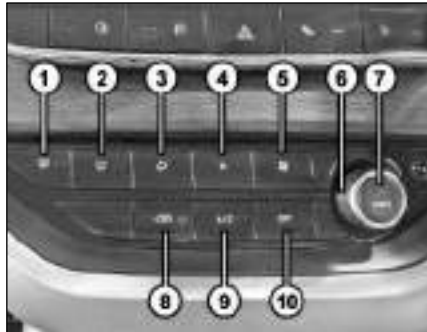

1. Rear window demister switch
2. Maximum defrost switch
3. Air distribution (mode) switch
4. Blower speed control down switch

5. Blower speed control up switch
6. Temperature control knob
7. Auto 'ON' selection switch
8. Fresh air / recirculation switch
9. AC compressor 'ON / OFF' switch
10. OFF mode switch

### Display unit



FATC display is shown on infotainment display screen.

FATC functions can be controlled using both the FATC control panel and the touch screen display.

Whenever the user presses any switch or turns the rotary knob, then the display unit will show the relevant Climate Information.

Also, when the display is not in climate mode then climate information will be displayed on the all-time display provide on the bottom bar.

### 1. Rear Window Demister switch

This switch operates rear window demister. The system will be deactivated after 15 min of continuous operation.



### 2. Maximum Defrost switch

- A. This switch directs the main airflow towards windscreen for faster defrosting. (It also overrides any mode selection you may have made.)
- B. When you turn off the button, the system returns to its default setting.



### NOTE

*For your safety make sure you have a clear view through all the windows before driving.*

## CLIMATE CONTROL

### 3. Air Distribution (Mode) switch

In AUTO mode, the FATC system will regulate the mode automatically. However, user override is possible with the use of MODE button to select the desired airflow mode.



Each time you press the MODE button, the display shows the mode selected.

	Directs air through the center and side air vents
	Directs air through the center, side and foot well vents
	Directs air through the foot well air vents
	Directs air through the defroster & foot well vents (Default fresh air mode)
	Directs air through the defroster vents (Default fresh air mode)

### 4. Blower Speed Control down switch (Low)

Press the Blower Speed control down button to decrease the blower speed.



### 5. Blower Speed Control up switch (High)

Press the Blower Speed control up button to increase the blower speed.



#### NOTE

*In 'AUTO' mode, the FATC system will regulate the blower speed automatically.*

### 6. Temperature control knob



Turning the temperature control knob clockwise increases the temperature of the air. The desired temperature will be

increased by steps of 0.5°C. User can select temperature range from 18°C to 30°C. Whereas the anticlockwise direction decreases the temperature.

When you set the temperature to its lower limit (Lo) or its upper limit (Hi), the system runs at full cooling or heating only. It doesn't regulate the interior temperature.

### 7. Auto ON selection switch



To put the automatic climate control in fully automatic mode:

- Press the 'AUTO' button.
- Set the desired temperature by turning temperature control knob. The display will show all the functions during 'AUTO' mode.
- The system automatically selects the proper mix of conditioned and / or

heated air that will, as quickly as possible, raise or lower the interior temperature to your preference.

- D. When you set the temperature to its lower limit (Lo) or its upper limit (Hi), the system runs at full cooling or heating only. It does not regulate the interior temperature.

### Semi-automatic Operation

You can manually select various functions of the climate control system when it is in fully automatic mode. All other features remain automatically controlled. Making any manual selection causes the word 'AUTO' in the display to go OFF and overridden setting is displayed. System will remain in semiautomatic mode till 'AUTO' is re-pressed.

### 8. Fresh Air / Recirculation switch

- A. When the recirculation switch or LED is switched 'ON', air from the vehicle's interior is sent throughout the system.



- B. When the recirculation switch is switched 'OFF', air is brought in from outside of the vehicle (fresh mode). Whenever discomfort is felt, switch to fresh air mode.

#### NOTNOTE

*The outside air intakes for the climate control systems are at the base of windscreen. Keep this area clear from leaves and other debris.*

The system should be used with recirculation air mode for faster heat up and cool down, however keeping the system

in recirculation mode, particularly with AC OFF, can cause the windows fog up.

#### NOTE

*When Reverse gear is selected, air intake may switch to recirculation mode if previously in fresh mode to prevent exhaust fumes from entering in the vehicle.*

### 9. AC ON/OFF button

Press the AC compressor ON/OFF button to turn the air conditioning ON or OFF. The AC icon will be activated on the display when the AC will be ON.















### 10. "OFF" switch











Press the OFF button to switch OFF The system. OFF will be displayed on the infotainment screen



## CLIMATE CONTROL

Functions	Control Knob Position		Button Position							
	(6)	(7)	(1)	(2)	(3)	(4)	(5)	(8)	(9)	(10)
	Temperature 	Auto 	Rear demister 	Maximum defrost 	Air Distribution 	Blower Down 	Blower Up 	Fresh/air Recirculation 	A/C 	OFF Button 
<b>Normal heating</b>	Desired Temperature	No change	No change	No change	No change	Desired Speed	Desired Speed	No change	No change	OFF
<b>Quick heating</b>	To the extreme right till temp 'HI'	OFF	No change	OFF		NA	Max speed	Fresh	ON	OFF
<b>Normal Cooling</b>	Desired Temperature	No change	No change	No change	No change	Desired Speed	Desired Speed	No change	No change	OFF
<b>Quick Cooling</b>	To the extreme left till temp 'LO'	OFF	No change	OFF		NA	Max Speed	Recirculation	ON	OFF
<b>Demisting</b>	To the right up to the desired temperature	No change	ON	No change	No change	No change	No change	No change	No change	No change

## CLIMATE CONTROL

Functions	Control Knob Position		Button Position							
	(6)	(7)	(1)	(2)	(3)	(4)	(5)	(8)	(9)	(10)
	Temperature 	Auto 	Rear demister 	Maximum defrost 	Air Distribution 	Blower Down 	Blower Up 	Fresh/air Recirculation 	A/C 	OFF Button 
<b>Defrosting</b> To the right up to the desired temperature	OFF	No change	ON		NA	Max Speed	Fresh	ON	OFF	
<b>Panel OFF</b>	OFF	OFF	No change	OFF	OFF	OFF	OFF	No change	OFF	ON

## CLIMATE CONTROL

### Quick Cooling

If your vehicle is parked under the sun, you can cool it down fast by following the steps given below:

1. Start the engine.
2. Turn on A/C by pressing the button. Make sure the temperature control is set to maximum cool. In case of FATC set temperature to 'Low' mode.
3. Set the blower to maximum speed
4. Open windows half, set air direction towards face and fresh air mode.
5. When the interior has cooled down to a more comfortable level, close windows and set the controls as required in normal cooling, with recirculation mode ON.

### HVAC Sensors:

HVAC system is fitted with three sensors

#### 1. Solar sensor

A solar sensor is on top of the dashboard at the middle of defroster grill.

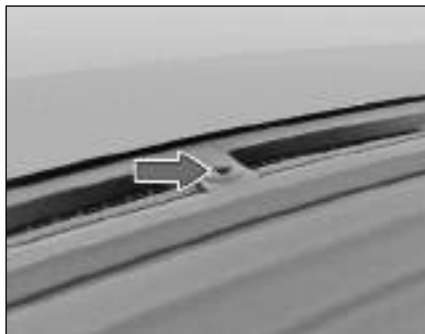

#### 2. Outside Ambient Temperature (OAT) sensor

It is located under the front bumper grill.

#### NOTE

- Do not cover or spill any liquid on sensors.
- Do not cover sensor, this may cause the sensor to malfunction. This may lead to FATC not functioning to desired level.

#### 3. In-car sensor on control panel



### Pre Driving Checks

#### Make sure that

- Windshield, windows, mirrors, lights, and reflectors are clean and unobstructed.
- Tools kit, jack & handle, warning triangle, owner's manual, first aid kit and vehicle documents are available and stored at their locations.

#### WARNING

Never put any mat on top of the floor carpet near pedal region.

- All doors, engine bonnet and tail gate are securely closed and latched.
- All passengers are properly restrained. All occupants travelling should always wear seat belts or suitable CRS as applicable.
- Objects/luggage are secure properly against slipping or tipping.
- Rear seat is securely latched.
- Sufficient fuel for the trip.

### Daily check

- Tyres for abnormal wear, cracks or damage and embedded foreign material such as nails, stones, etc.
- Traces of fluid and oil below vehicle.

#### NOTE

*Water dripping from the air conditioning system after use is normal.*

- All lamps, wipers, wiper blades and horn for proper operation.
- All switches, gauges and tell tales are working properly.

### Adjust

- Seats, head restraints (if equipped) and steering wheel position.
- All the mirrors properly adjusted.

### Weekly check

- Engine oil level
- Coolant level
- Brake fluid level
- Windshield washer fluid level
- Battery electrolyte level
- Fuel level

#### NOTE

- *Tyre pressure to be measured at cold condition.*
- *Check tyre pressure and condition after every 15 days including spare wheel.*

## STARTING AND DRIVING

---

### Driving Tips

Fuel consumption, engine, transmission, brake and tyre wear are mainly affected by below factors:

- Operating conditions of your vehicle
- Your personal driving style

### Operating conditions

- Avoid frequent start and stop as these increase fuel consumptions.
- Always make sure that the tyre pressures are correct.
- Do not carry any unnecessary weight.
- Regularly, service your vehicle and adhere to the recommended service maintenance schedule.

### Personal driving style

- Do not press the accelerator pedal while starting the engine.
- Do not warm up the engine when the vehicle is stationary.
- Always adapt your driving style to suit the prevailing road, weather conditions, and maintain a safe distance from the vehicle in front. Drive carefully.
- Avoid frequent, sudden acceleration and braking.
- Select appropriate gear according to varying speeds and load conditions.

### NOTE

*Do not rest your foot on the clutch pedal while driving.*

- Switch 'OFF' the engine in stationary traffic or at signals.
- Keep an eye on the vehicle's fuel consumption.

- Driving safety systems are merely aids designed to assist driving. You are responsible for the distance to the vehicle in front, for vehicle speed and anticipating braking in good time.

### WARNING

You could lose control of your vehicle if you try to adjust the driver's seat, head restraint, mirror, steering wheel and fasten the seat belt while driving. There is a risk of an accident.



## STARTING AND DRIVING

### Recommended fuel economy speeds

Gear	Speed (km/h)
1	15
2	30
3	50
4	70
5	90
6	105

### Good driving practices

- Slow down before shifting to a lower gear. This will help avoiding revving of the engine causing damage.
- Avoid frequent brake application which can cause overheating of brakes.
- Slow down the vehicle speed while travelling in cross winds. This gives much better control over the vehicle.

- Avoid high speed when cornering or turning.
- Press the clutch fully while shifting gears.
- Make sure that vehicle is completely stationary before you attempt to shift in reverse gear.
- Drive slowly on wet roads.
- You can get extra braking from the engine by shifting to a lower gear. This can help you to maintain a safe speed and prevent your brakes from overheating specially while going down a hill.

### Tips for obtaining better fuel efficiency

- Always maintain the specified tyre pressure during fuel top-ups and also before a long trip. Vehicle running with low tyre pressure will consume more fuel than the one running with specified tyre pressure.

- Keep the vehicle clean. Get rid of the not in use luggage/stuff lying in the boot etc.
- Regularly inspect your vehicle for any leakages, worn out wires, rat bites etc.
- Always follow periodic & regular service schedule of the vehicle.
- Drive smart and smooth in an anticipatory manner. Select driving mode to suit your style.
- Do not accelerate excessively when you are in lower gears (1<sup>st</sup> or 2<sup>nd</sup>). Be gentle on the accelerator when you are in traffic. In lower gear, opening more throttle will shoot the engine RPM keeping the vehicle still at lower speeds which indirectly implies less distance with more fuel.
- Be in the maximum possible higher gear at a given speed. This reduces the engine operating speeds which means the engine is running at lower rpm (Revolutions per Minute) for the

## STARTING AND DRIVING

same vehicle speed. Lesser the number of engine revolution lesser the fuel burned.

- Avoid harsh braking.
- Maintain healthy driving habits & while decelerating, do coasting in gear and not in neutral or with clutch pedal pressed.
- Consider using the car AC when you really require. Consider using lower blower speeds rather than higher for cooling as at higher blower speeds it consumes more electric power which is ultimately drawn from engine by burning fuel.
- Avoid unnecessary extra electrical loading on the car.
- Stop the engine wisely at traffic signals. Switch 'OFF' the engine at the traffic signal only if the stoppage time is high (typically more than 30 sec).
- While driving on highways, drive with windows closed. The more you open

the windows the higher will be the resistance to the vehicle at higher speeds which will reduce the fuel efficiency.

- Do not over speed; follow the speed limits. More the speed, higher the external resistance on the vehicle which will finally result into unnecessary consumption of fuel.

### Running-in period

The more you look after the engine when it is new, the more satisfied you will be with its performance in the future.

Avoid rapid acceleration and prolonged high speed running of the engine for the first 2,000 km.

Do not exceed the following road speeds during running in period.

Gear	Speed(km/h)
1	15
2	30
3	45
4	60
5	80
6	100

Avoid heavy loads, e.g. driving at full throttle, during this period. Change gears judiciously.

While cruising, brief full-throttle acceleration within the limits of local traffic laws contributes to a good break-in. Wide-open throttle acceleration in low gear can be detrimental and should be avoided.

### NOTE

*Avoid excessive revving up of engine rpm. Do not keep engine at idling for long duration.*

### Seat Adjustments

#### Front seat adjustments

Following seat adjustments can be carried out manually.

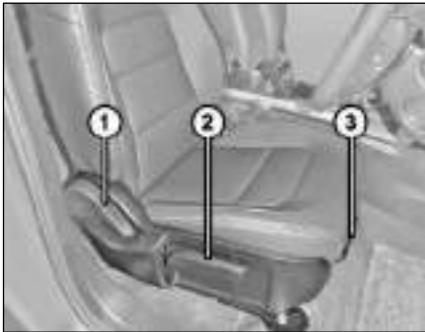

1. Backrest angle
2. Seat height (if equipped)
3. Seat forward / rearward adjustment lever

#### WARNING

Do not adjust the driver's seat while driving. Adjusting the seat while driving could cause the driver to lose control of the vehicle.

#### 1. Seat backrest angle adjustment

To change the seat back rest angle, lean forward slightly and pull up the lever (1). Adjust seat backrest until it reaches desired comfortable position. Make sure that lever returns to its original position and seat is securely latched.

#### NOTE

*Adjust the seat backrest until your arms are slightly angled when holding the steering wheel.*

#### WARNING

Never travel in a moving vehicle with the seat backrest in an excessively reclined position as this can be dangerous. You could slide under the seat belt in a collision.

#### 2. Seat height adjustment (If equipped)

To raise the seat, pull and continue pumping the lever (2) in the upward direction until the seat is at the desired height.

To lower the seat, pump the lever downward until the seat is at desired height.

#### 3. Seat forward / rearward adjustment

Lift lever (3) and slide the seat forwards or rearwards. Release lever and make sure that seat is securely latched.

#### NOTE

*Adjust the driver seat position in such a way that the driver will be able to operate the control pedals conformably.*

## STARTING AND DRIVING

### Lumbar Support (if equipped)



Continuous (Multiple adjusting position) lumbar support is provided on driver and front passenger seat to give you comfort while driving. It is adjusted by the lever provided on the side of the seat backrest.

### Adjustable head restraint

#### Front seat



Adjust the head restraint so that it is as close to the head as possible and the center of the head restraint supports the back of the head at eye level. This will reduce the potential for injury to the head and neck in the event of an accident or similar situation.

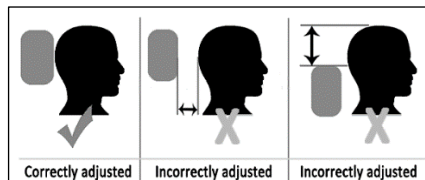

### WARNING

Do not drive the vehicle without the seat head restraints. Head restraints are intended to help reduce injuries during an accident.

## STARTING AND DRIVING

### Rear seat folding

#### Option 1

#### 60:40 % Split Seat

You can increase the luggage capacity by folding the respective rear seats as required.

To fold the seat:



- Press the backrest release knob to fold the backrest seat forward.



- Fold the backrest seat forward. Move the driver and front passenger seat forward if necessary.



- Follow the same procedure for other rear seat.

## STARTING AND DRIVING

- Press the backrest release knob to fold the backrest seat forward.
- Fold the backrest seat forward. Move the driver and front passenger seat forward if necessary.



### NOTE

- *Ensure that 'foldable arm rest' is close before seat folding.*
- *Fold both seats if required.*

### Option 2

#### Rear seat folding (Complete Seat 100%)

To fold the seat:

- Simultaneously, press the backrest release knobs provided on both side.



## STARTING AND DRIVING



- Fold the backrest seat forward. Move the driver and front passenger seat forward if necessary.



### WARNING

- You should always engage the rear seat back rest if you do not need the through loading feature.
- If the rear bench seat and seat backrest are not engaged they could fold forwards, e.g. when braking suddenly or in the event of an accident.
- The vehicle occupant would thereby be pushed into the seat belt by the rear bench seat or by the seat backrest. The seat belt can no longer offer the intended level of protection and could even cause injuries.
- Objects or loads in the trunk cannot be restrained by the seat backrest. There is an increased risk of injury.
- Before every trip, make sure that the seat backrests and the rear bench seat/rear seat are engaged and securely latched.

### Rear View Mirrors

#### Inside Rear View Mirror (IRVM)

To adjust the mirror move the mirror up, move down or sideways to obtain the best rear view.

When driving at night, set the selector tab to select anti-glare mode (if equipped) to reduce glare from the headlights of vehicles behind you.



## STARTING AND DRIVING

### NOTE

Use *antiglare* position only when necessary, as it reduces rear view clarity.

### Outer Rear View Mirrors (ORVM)

You can adjust the outer rear view mirrors manually by joy stick or remotely by knob. Adjust the outside rear view mirrors to desired position.

### NOTE

Objects visible in mirror are actually closer than they appear. Always make sure of the actual distance from the road users traveling behind by glancing over your shoulder.

### Motorized outer rear view mirrors

(If equipped)

The switch to adjust the motorized mirrors is located on the driver's door. You can adjust the mirrors when the ignition switch is in the "ACC" or "ON" position.

### Mirror folding

To fold / unfold the ORVMs, keep the Selector switch in center position (i.e. neither 'L' nor 'R, position) and then toggle down.



### NOTE

When vehicle is locked, mirrors will be folded automatically. When it unlock mirrors will be unfolded automatically.

### To adjust the mirrors

1. Move the mirror selection switch to L (for left side) and R (for right side) to select the mirror you wish to adjust.
2. Use the 4 positions of the knob to adjust the rear view mirrors to required position.





### Rear view mirrors with joy stick knob (If applicable)



You can adjust the outer rear view mirrors manually by joy stick knob located in the driver and front passenger door panel.

If required mirrors are folded manually.

### Sun Visors

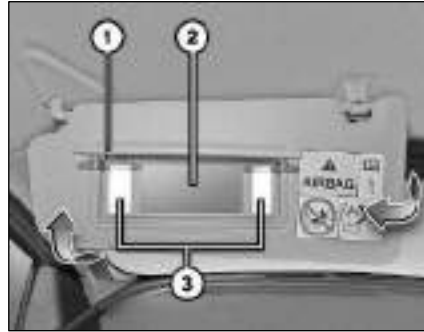

1. Mirror Flap
2. Vanity Mirror
3. Light for Vanity Mirror

#### 1. **Mirror Flap** (if equipped)

The sun visors can be pulled down to block the glare coming through the windshield.

To block the glare from side windows:

Pull down the sun visor and release it from retainer. Swing the sun visor to the side.

#### 2. **Vanity mirror** (If equipped)

Vanity mirror is provided on the back of the front passenger side sun visor.

#### 3. **Light for Vanity mirror** (If equipped)

It is provided beside the vanity mirror. Light glows 'ON' as soon as flap of vanity mirror is open.

## STARTING AND DRIVING

### Steering wheel adjustment

(If applicable)



You can adjust the steering wheel position to suit your convenience.

The release lever is located under the steering column.

#### To adjust the steering wheel

1. Adjust the seat to a comfortable position.
2. Pull down release lever completely to unlock the steering column.

3. Adjust the steering wheel to the desired position by moving steering wheel in axial and radial direction (telescopic & tilt).



4. Push release lever up completely to lock the steering column.
5. Make sure that steering wheel is securely lock by checking up and down direction.

#### NOTE

*When adjusting the steering wheel, make sure that:*

- You can operate control pedals without any obstacles.
- You can see all the displays in the instrument cluster clearly.

#### WARNING

- Before starting off, make sure that the steering wheel position is locked.
- Never unlock or adjust the steering wheel while the vehicle is in motion.

### Steering lock cum ignition switch (If applicable)



The ignition switch has the following four positions:

**LOCK** - This is the normal parking position. Key from lock can be removed in this position only.

“LOCK” position prevents normal use of the steering wheel after the key is removed.

To release the steering lock, insert the key and turn it clockwise to one of the other positions.

**ACC** - Accessories such as the infotainment system can be operated, but the engine remains ‘OFF’. Steering gets unlocked.

**ON** - This is the normal operating position. All electrical systems are ‘ON’.

**START** - Turn the key further clockwise to the START position, (spring loaded) to start the engine. As soon as the engine starts, release the ignition key, which returns to ON position. While cranking, all accessories will be momentarily ‘OFF’.

#### **Illuminated Key Ring** (if equipped)

When the vehicle is unlocked, the illuminated key ring glows up. This helps to locate ignition switch in the dark.

#### **NOTE**

*The engine can only be started when the gearshift lever is in “N” position with the clutch pedal firmly pressed.*

### Starting and stopping (without PEPS)

#### Starting the Engine

Make sure that parking brake is engaged and vehicle is in neutral gear.

Press the clutch pedal fully and crank the engine. Do not press the accelerator pedal while starting the engine.

#### **NOTE**

*The Starter protection system fitted in this vehicle does not allow you to crank the engine until you fully press the clutch pedal.*



Release the key as soon as the engine starts. Repeat if engine does not start.

#### **NOTE**

*The Starter protection system switches off the starter when it is continuously cranked for more than 10 secs. In such a case, get the key back to ‘OFF’ position & wait for 30 secs.*

## STARTING AND DRIVING

### WARNING

The engine emits poisonous exhaust gases such as carbon monoxide. Inhaling these exhaust gases leads to poisoning. There is a risk of fatal injury. Therefore, never leave the engine running in enclosed spaces without sufficient ventilation.

### NOTE

*After starting, run the engine in idle speed for at least 30 seconds. Do not press accelerated pedal while starting the engine to avoid damage to turbocharger.*

### Stopping the Engine

Turn the key to 'ACC' position to switch off the engine. Before switching off the engine, run the engine in idle condition for at least 30 seconds and then switch off. This will allow the engine oil to lubricate the turbocharger, till its speed is fully reduced and also allow the unit to cool down.

### WARNING

- A quick burst on the accelerator before turning off the engine serves no practical purpose, it wastes fuel and can damage turbocharger.
- Do not switch off the engine when it is running at high speed. This will lead to premature turbocharger bearing wear.

### Starting and stopping (PEPS) (If equipped)

#### Engine Passive Start/Stop



Start/Stop switch is provided on the dashboard towards the right side of steering wheel.

#### Start / Stop Switch

A Start Stop Switch (SSSW) or Push to Start Button is a main component of Passive (Engine) Start and Stop system. It is used to control ACC, IGN outputs as well as to start and stop the engine.

## STARTING AND DRIVING

### NOTE

- If Smart key is inside the vehicle and on pressing start stop switch, if start stop switch green LED blink for 10 sec. duration then rotate steering wheel and simultaneously press start stop switch again.
- If smart key is inside the vehicle and on pressing start stop switch, if start stop switch green LED blinks more than 10 sec. duration then contact authorized TATA MOTORS dealer.
- If ESCL (Electronic Column Steering Lock) is not unlocked properly, then vehicle doesn't go into ACC mode

### Backup start

If smart key battery voltage is low or empty and vehicle is in OFF mode then to start the engine user needs to press start/stop button two times with interval of 2.5 sec. between two switch press after pressing the clutch pedal OR brake

with valid smart key near Immobilizer antenna (located below front cup holder).



### Emergency start

If vehicle engine is switched from ON to OFF and Start Stop button is pressed with clutch press within 5 sec, Engine gets crank.

### NOTE

*If ESCL (Electronic Column Steering Lock) is not unlocked properly, then Engine will not get cranked.*

### • Single Press Start:

1. Bring the smart key with you and sit in the driver seat.
2. Press the clutch pedal and then press the start-stop switch.
3. Green colour LED on start-stop switch turn ON.
4. Once engine started successfully, green colour LED on start-stop switch remains ON.

### • Two Step Start:

#### a) Step 1

1. Bring the smart key with you and sit in the driver seat.
2. Press the start-stop switch without pressing clutch pedal.
3. Amber colour LED on start-stop switch turns ON.
4. Engine will remain OFF and all electrical equipment and infotainment

## STARTING AND DRIVING

---

system can be used. Steering is unlocked.

### b) Step 2

1. Press the clutch pedal and then press start-stop switch to start the engine.
2. Green colour LED on start-stop switch turn ON.
3. Once engine start successfully, green colour LED on start-stop switch will remain ON.

- **Three Step Start:**

### a) Step 1

1. Bring the smart key with you and sit in the driver seat.
2. Press the start-stop switch without pressing clutch pedal.
3. Amber colour LED on start-stop switch turn ON.

4. Limited display on instrument cluster will be ON and steering will be unlocked. Engine remain OFF.

### b) Step 2

1. Press the start-stop switch without pressing clutch pedal again.
2. Green colour LED on start-stop switch turn ON.
3. Engine will remain OFF and all electrical equipment and infotainment system can be used.

### c) Step 3

1. Press the clutch pedal and then press start-stop switch to start the engine.
2. Green colour LED on start-stop switch turn ON.
3. Once engine started successfully, green colour LED on start-stop switch will remain ON.

### Option I

#### Passive Stop / OFF -Single Press Stop:

- IGN is ON and engine is running.
- Customer presses start-stop switch with clutch pedal
- ACC and IGN relay turns OFF.
- LED on start-stop switch turns OFF.

### Option II

#### Emergency stop / OFF -Single Long Press Stop:

- IGN is ON and engine is running
- Vehicle is in running condition i.e. wheel rpm >10 RPM or wheel sensor faulty.
- Customer does long press of start-stop switch i.e. pressed for more than 3 seconds

- IGN relay turns OFF, ACC relay remains ON.
- Amber colour LED on start-stop switch turns ON.

### WARNING

When vehicle is in OFF mode (ACC, IGN and Crank OFF) and user tries to lock the vehicle from outside by pressing any door handle switch and if PEPS detect smart key left inside the vehicle, then audio warning / chime comes ON.

### Starting the Engine

Make sure that parking brake is engaged and vehicle is in neutral gear.

Press the clutch pedal fully and crank the engine. Do not press the accelerator pedal when starting the engine.

### NOTE

*The Starter protection system fitted in this vehicle does not allow you to crank the engine until you fully press the clutch pedal.*



Release the key as soon as the engine starts. Repeat if engine does not start.

### NOTE

*The Starter protection system switches off the starter when it is continuously cranked for more than 10 secs. In such a case, get the key back to 'OFF' position & wait for 30 secs.*

### WARNING

The engine emits poisonous exhaust gases such as carbon monoxide. Inhaling these exhaust gases leads to poisoning. There is a risk of fatal injury. Therefore, never leave the engine running in enclosed spaces without sufficient ventilation.

### NOTE

- After starting, run the engine in idle speed for at least 30 seconds. Do not press accelerated pedal while starting the engine to avoid damage to turbocharger.
- When vehicle is in ACC/IGN/RUN mode and user does any door state transition including tailgate and if PEPS does not detect smart key inside the vehicle when last door including tailgate is closed, then audio warning chime comes ON.

## STARTING AND DRIVING

### Stopping the Engine

Press the start stop switch to switch off the engine. Before switching off the engine, run the engine in idle condition for at least 30 seconds and then switch off. This will allow the engine oil to lubricate the turbocharger, till its speed is fully reduced and also allow the unit to cool down.

#### WARNING

- A quick burst on the accelerator before turning off the engine serves no practical purpose, it wastes fuel and can damage turbocharger.
- Do not switch off the engine when it is running at high speed. This will lead to premature turbocharger bearing wear.

### Starting off

To start off, press the clutch pedal fully and shift into first gear.

After releasing the parking brake, gradually release the clutch and slowly press the accelerator.

#### NOTE

*When shifting or starting off, do not race the engine. Racing the engine can shorten engine life and affect smooth shifting.*

### Gear Shifting and Driving



The gearshift pattern is as shown on the gear lever knob. Gear shifting should always be done with clutch pedal pressed.

### Reverse gear



For engaging reverse gear, lift the latch and by keeping latch lifted, shift to reverse position.



### NOTE

- Gear recommendation is displayed when the clutch pedal is in fully released position.
- If "F" is displayed in DIS of instrument cluster, it means 'Fault' condition. Contact the TATA MOTORS Authorized Service Centre.
- Press the clutch fully while shifting the gear. The reverse gear should be engaged only when the vehicle is stationary. Wait for 5 seconds after declutching to ensure smooth engagement of the reverse gear.
- Do not press clutch pedal while driving the vehicle or when stationary on a slope

### WARNING

- Do not switch off the ignition while driving.
- If you switch off the ignition while driving, safety-relevant functions are only available with limitations, or not at all. This could affect the power steering and the brake boosting effect. You will require considerably more effort to steer and brake. There is a risk of an accident.

### NOTE

You may notice a noise from transmission under certain circumstances. This noise is normal and is not an indication of a problem with your clutch or transmission. This noise may be noticed when vehicle is idling in NEUTRAL condition with the clutch engaged (clutch pedal released) or when the transmission is warm. It may also be heard while driving.

### NOTE

- Your vehicle is equipped with Dual Mass Flywheel (DMF), which plays important role in providing refined powertrain / driveline experience.
- Driving at very low engine speed is likely to stall the engine, especially when driven without any accelerator pedal inputs.

#### Recommended driving precautions:

- Shift to lower gear as per gear-shift indicator (GSI) on cluster.
- To start-off (marching/ drive away), always engage in first gear.
- While down shifting (from 3<sup>rd</sup> to 2<sup>nd</sup> gear) at low engine RPM's (below 1000 rpm) press accelerator pedal to provide required rpm.

## STARTING AND DRIVING

---

### Braking

Your vehicle has power assisted brakes.

The distance needed to bring the vehicle to a halt increases with the speed of the vehicle. Start applying brake anticipating the distance and slow down gradually.

#### WARNING

- Never use the brake pedal as a footrest.
- If you rest your foot on the brake pedal while driving, the braking system can overheat. This increases the stopping distance and can even cause the braking system to fail. There is a risk of an accident.
- Never press the brake pedal and the accelerator pedal at the same time.

If you have driven for a long time in heavy rain without braking, there may be a delayed reaction from the brakes when braking for the first time. This may also

occur after the vehicle has been washed.

Brake performance may become poor and unpredictable if brakes are wet.

After driving through water or washing the underside of the vehicle, test the brakes while driving at a slow speed to see if they have maintained their normal effectiveness. If the brakes are less effective than normal, dry them by repeatedly applying the brakes while driving slowly until the brakes have regained their normal effectiveness.

### Braking on downhill gradients

On long and steep gradients, you must reduce the load on the brakes by shifting early to a lower gear. This allows you to take advantage of the engine braking effect and helps avoid overheating and excessive wear of the brakes.

#### WARNING

- Do not shift to lower gear on a slippery road surface in an attempt to increase the engine's braking effect, the drive wheels could lose their grip.
- There is an increased danger of skidding and accidents.

### Driving

#### Climbing Sharp Gradients on Loose Surfaces

Start off smoothly in a suitable gear. Accelerate smoothly so that there is no loss of traction by over-revving of the engine.

Choose a slope as smooth as possible and select the appropriate gear so that gear changing in the middle of the climb is not required.

Changing gears in the middle of the climb can cause loss of momentum and engine stalling. Shifting to lower gear has to be done cautiously to avoid loss of traction.

Under no conditions should the vehicle be moved diagonally across a hill. The danger is in loss of traction and sideways slippage, possibly resulting in toppling over. If unavoidable, choose as mild an angle as possible and keep the vehicle moving.

If the wheels start to slip within few feet of the end of the climb, motion can be maintained by swinging the steered wheels left and right, thereby providing increased grip.

If the vehicle stalls or losses headway while climbing a steep hill, make a quick shift to reverse and allow the vehicle to move back with the control of engine compression.

#### Descending Sharp Gradients

Depending on the severity of the gradient, shift into appropriate gear. Use engine braking judiciously without over-revving the engine.

Brake application under such situations should be done very.

#### WARNING

When descending on sharp gradients, NEVER turn the ignition key to the 'OFF' position. Emission control system damage may result.

### Stopping the vehicle

Turn the key to 'ACC' position to switch off the engine. Before switching off the engine, run the engine in idle condition for at least 30 seconds and then switch off. This will allow the engine oil to lubricate the turbocharger, till its speed is fully reduced and also allow the unit to cool down.

#### WARNING

A quick burst on the accelerator before turning off the engine serves absolutely no practical purpose, it wastes fuel and can damage turbocharger.

#### WARNING

Do not switch the engine off when it is running at high speed. This will lead to premature turbocharger bearing wear.



## STARTING AND DRIVING

### Drive Mode (If applicable)



'ECO', 'CITY' and 'SPORT' drive modes are provided. These modes can be used to adjust engine characteristics and vehicle performance in line with desired requirement.

Drive mode selection switches are provided on center console for activation.

Drive Mode	Performance
CITY 	Increased engine Torque and Power output for BALANCED performance. It is default mode.
ECO 	Optimum engine Torque and Power output for FUEL EFFICIENT performance.
SPORT 	Produce more torque from engine.

#### NOTE

When vehicle is in ECO or SPORT mode, by pressing current mode switch again, mode will switch to CITY mode.

### Terrain Response Mode (If applicable)



#### 1. Normal road mode

In this mode vehicle performance optimized to support, all surface condition. Stopping distance progressively, increases with vehicle speed. Maintain a sufficient distance between your vehicle and the vehicle ahead.

For long distance driving, perform safety checks before starting a trip and take rest at certain intervals to prevent fatigue.

### 2. Wet Mode

On wet road or during light showers, “Aquaplaning” can occur. “Aquaplaning” is the loss of direct contact between the road surface and the vehicle’s tires due to a water film forming between them. Steering or braking the vehicle can be very difficult, and loss of control can occur.

The best advice is to slow down when the road is wet.

The wet mode is designed for driving in the rain. It is characterized by having better traction and handling so you can effectively and safely drive during these conditions.

#### NOTE

*If you have driven for a long time in wet road without braking, there may be a delayed reaction from the brakes when braking for the first time. You have to depress the brake pedal more firmly. Maintain a greater distance from the vehicle in front.*

### 3. Rough Road Mode

Rough Road Mode optimizes the vehicle behavior for driving over rough road or other unyielding obstacles.

Braking performance is also tuned to support Rough road surfaces as compared to other drive modes.

System allows improved rough road performance to be more easily accessible to all customers specially novice or inexperienced user.

#### NOTE

Cautiously drive the vehicle on a rough road or off the road. Otherwise, the tires and wheels may be damaged. After driving those areas, inspect the tires and wheels.

### 4. Electronic Stability Program (ESP) (if equipped)

ESP monitors driving stability and traction.



If ESP detects that the vehicle is deviating from the direction desired by the driver, one or more wheels are braked to stabilize the vehicle. The engine output is also modified to keep the vehicle on the desired course within physical limits. ESP assists the driver when pulling away on wet or slippery roads. ESP can also stabilize the vehicle during braking and acceleration.

### 5. Hill Descent Control (HDC) (If equipped)

While driving down on a hill slope, activate the HDC feature by pressing on the center console.



HDC provides a smooth and controlled hill descent by enabling the vehicle to control the speed of each wheel. The system will automatically apply the

## STARTING AND DRIVING

brakes to slow down to the desired vehicle speed. Cruise control +/-buttons or Brake and accelerator pedal can be adjust the speed to a comfortable level.

HDC interventions will be automatically disabled once the descent is complete and vehicle is on levelled road. Non-zero speed less than 35 kmph would be required to turn ON HDC. A speed greater than 40 kmph will end all active HDC control and switch HDC to standby mode. Once the vehicle speed is lower than the specified threshold of 40 kmph HDC becomes activated again whenever required (No press of HDC button is required).HDC is permanently switched off if the vehicle speed exceeds 60 kmph and Active state on HDC switch will go off automatically. HDC works in both Neutral and in Gear forward and reverse position.

While driving down a hill, the engine braking should be used by shifting into a lower gear. Do not drive in neutral gear or switch off the engine.

### WARNING

HDC cannot take account of road, weather, traffic and tyre conditions. You are always responsible for keeping control of the vehicle and for assessing whether the downhill gradient can be managed.

### Parking Brake

Mechanical parking brake acting on the rear wheels is provided on the vehicle.



Parking Brake

### Parking brake applied



To apply the parking brake, hold the lever as shown in above figure with knuckle facing towards vehicle front and pull the lever.

#### **WARNING**

Do not press the button, while applying parking brake.

### Parking brake released

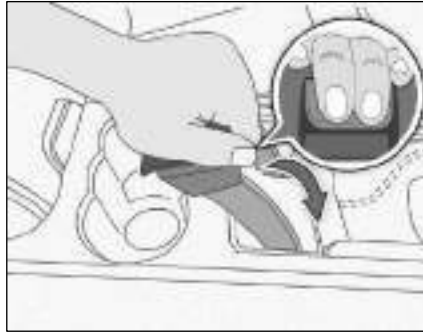

To release parking brake, hold the lever and pull the lever up slightly, press the knob with the help of middle and ring finger as shown in figure and release the parking brake.

#### **NOTE**

*Apply the parking brake properly before leaving the vehicle and release it before moving the vehicle.*

Mechanical parking brake acting only on the rear wheels is provided on the vehicle. To apply the parking brake, pull the lever up fully. The parking brakes tell-tale illuminates on the instrument cluster. To release it, pull the lever up slightly, press the release knob and push the lever down. Parking brakes tell-tale on the instrument cluster will turn 'OFF' when the lever is fully released.

## STARTING AND DRIVING

### Vehicle parking

- Park the vehicle in a safe place. Switch on the indicator signal before turning to park.
- Apply the parking brake.
- Ensure that all window glasses are closed and all lamps are turned 'OFF'.
- At night, put on the parking lights if required.
- Remove the key from the vehicle and lock the vehicle.
- Block the wheels and engaged in gear if parked on a slope.

#### NOTE

*When parking on a downhill gradient, place the gear lever in 'Reverse' position. While parking on uphill gradient, place the gear lever in the '1st' position.*

#### WARNING

Never leave children unsupervised in the parked vehicle. They could also operate the vehicle's equipment. There is a risk of an accident and injury.

#### NOTE

*Do not use parking brake for braking unless unavoidable circumstances like when service brake is not working properly. The braking distance is considerably longer and the wheels could lock. There is an increased danger of skidding and accidents.*

### Reverse Park Assist

(If applicable)

The system can display the Park assist screen by selecting this feature in Infotainment display to see any obstacle behind the vehicle while parking.



The system also displays the Park assist screen when the reverse gear is engaged.

It provides audio and visual information through the vehicles infotainment system / Buzzer. Always look at surrounding before initiating reverse parking for kids, pets and elderly people moving around the vehicle.



### Reverse Park Assist with sensor

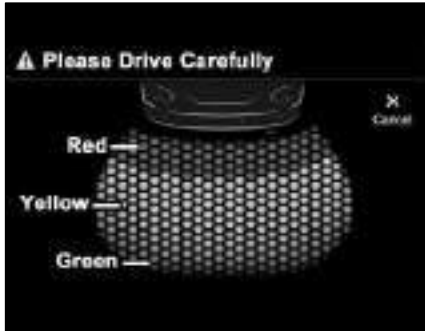

#### Operation

The reverse park assist system can also be activated manually through infotainment screen. Display will be seen on infotainment screen.

#### NOTE

*Turning the ignition 'OFF' while the Park assist feature in running would disable the feature.*

### Reverse park assist limitations

Reverse Park Assist system is not a collision avoiding system. It is solely the driver's responsibility to park the vehicle safely.

Reverse Park Assist feature works on ultra sound echo technology, due to which performance is not guaranteed in following scenarios:

- If the object has a sharp edge surface, where surface may divert echoes from sensor reception.
- If object is mesh fence made up of thin wires, where echoes can't be given by the surface.
- Fast moving objects passes in the sensor field of detection, where echoes are not processed by the system.
- If object is made/covered by foam or sponge or snow where ultrasonic sound signals are absorbed.
- Objects close to the rear bumper can go undetected by the Reverse Park Assist field of detection. Driver

should use extreme caution while parking the vehicle.

- If height of the bumper is changed due to alteration to the suspension or other causes.
- If the sensor areas are extremely hot from direct sunlight or cold due to freezing weather.
- If Sensors are covered by a hand, sticker, accessory, etc.
- If ultrasonic noise is present around Vehicle due to other vehicle sensors, horn, engine, air braking system (large vehicles), Exhaust Fans, Wireless transmitters or mobile phones.
- If the vehicle speed exceeds 10 km/h, the system will not warn you even though objects are detected, error message 'Vehicle Speed is high, drive slowly!' will appear.
- Driving on uneven road surfaces e.g. Gravel, unpaved roads, Artificial Speed Breakers, or gradient.

## STARTING AND DRIVING

### WARNING

Due to any reason, if the sensor gets misaligned or loses its intended fitment position, contact your dealer for refitment.

### NOTE

*Turning the ignition 'OFF' while the Park assist feature in running would disable the feature.*

### WARNING

0 to 25 cm obstacle detection performance is not guaranteed due to ultrasonic sensor technology limitation.

### Reverse park assist system preventive maintenance/ cleaning

1. Regularly clean the Sensors and keep them free from dust, ice, mud, water, chewing gum etc. for proper working of the system. Use a smooth cloth for cleaning.
2. Do not use water at high pressure for cleaning the sensor.
3. Do not cover the sensors. This will interrupt park assist performance.
4. Do not remove mud, snow on the sensors using stick or hard material. Use normal water and soft cloth.

### WARNING

- In low light conditions, the screen may darken or image may appear faint.
- If the tire sizes are changed, the position of the fixed guidelines displayed on the screen may change.

- In case of damage of the rear portion of the vehicle, Reverse Park Assist sensors position may change which causes wrong visual information on display. In case of damage, make sure that, Reverse Park Assist sensors are fitted properly at the intended location.
- In case of uneven road conditions or up-hill or downhill conditions, do not depend on Reverse Park Assist aid.
- Do not apply any kind of force on the reverse park assist sensors.

### Park assist Malfunction indications

In case of Reverse park assist system malfunctions, the following screen may appear on the infotainment system.

Reason for this fault may be

- Body Control Module Failure
- Sensor Malfunction
- Partner components such as Infotainment music system, Instrument Cluster failure.



### Rear Park Assist with Camera (If applicable)



Rear View Camera is a visual reverse guiding system. When reversing or parking, make sure that there are no persons, animals or objects in the area in which you are reversing.



Display screen

Three colour moving grid lines guide the user to understand the rear object distance exactly. The grid lines are updated by the motion of the vehicle as well as by the steering input.

Guidelines will help you to rightly find the sufficient parking place, helps you to keep the vehicle straight, rear object proximity indication etc.

### NOTE

*Turning the ignition 'OFF' while the Park assist feature in running would disable the feature.*

## STARTING AND DRIVING

---

### Audio Warning

Audio warning may come from Infotainment system speaker or through Buzzer, depending on vehicle model and configuration.

Distance range from Bumper (in cm)	Visual Information	Audible Information
25 – 50	All six zones are highlighted (Red, Green and Yellow zones)	Continuous Beep
51 – 100	Bottom four zones are highlighted (Yellow and Green zones)	Fast Beep
101 – 150	Bottom two zones are highlighted (Green zones)	Slow Beep



### Activation

#### Reverse gear

This System will activate, if reverse gear is engaged.

### Deactivation

System will deactivate, if reverse gear is disengaged, or park assist button (if equipped) is pressed

### Understanding Guidelines Indication

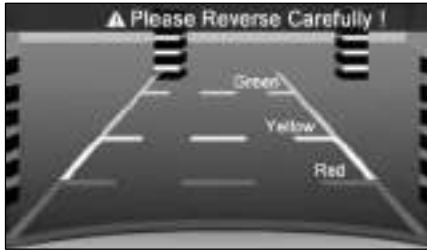

Static guidelines

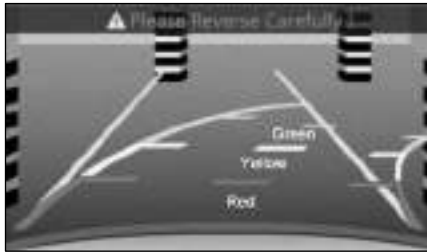

Dynamic guidelines

### Green Line

Indicates, if rear object is in this colored zone, you have to be cautious. Still you can go backward safely.

### Yellow Line

Indicates, if rear objects are in this colored zone, you have to take utmost care. However, objects fall in this zone, may not hit vehicle.

### Red Line

Indicates, if rear objects are in this colored zone, you have to stop the vehicle and not allowed to go backward. If you still go backward, your vehicle will hit the object.

### Do's and don't

- As the camera is, IP protected, do not detach, disassemble or modify in any manner from the actual position. This will show required visual information in display.
- Do not use camera when tailgate is open. If tailgate is open, visual information may not be the actual rear view of the vehicle & system will warn with message 'Tail Gate Open, Please close.'
- When the camera is operated under fluorescent lights, sodium light or mercury light etc., illuminated areas on the lens may appear to flicker in the display.
- Do not attach any advertisement or styling or any kind of stickers on top of camera. If this happens, camera cannot provide you the visual image and may damage camera.
- Do not add any accessory, which will obstruct camera field of view.

## STARTING AND DRIVING

### Cleaning camera

1. Due to environmental reasons, dust, mud or fog may accumulate on the camera lens. So regularly clean the camera lens.
2. Use water to clean the camera lens. Do not use extreme cold or hot water. Rapid changes in temperature may brittle the camera lens. Do not apply High Pressure water for cleaning.
3. Wipe the camera lens with soft cloth.
4. Do not use hard cloth or material to wipe the camera lens. This will cause scratches on the camera, and leads to deteriorated visual image on the display.
5. Do not apply organic solvent, car wax, window cleaner or glass coat to clean the camera. If this is applied, wipe it off as soon as possible.
6. Do not apply heavy force on lens, while cleaning.
7. Do not remove mud, snow on the camera lens using stick or hard material. Use normal water and soft cloth.

### WARNING

- The camera uses fish eye lens. So the size of the objects or in the display may differ from the actual size and distances in low light conditions, the screen may darken or image may appear faint.
- If the tire sizes are changed, the position of the fixed guidelines displayed on the screen may change.
- During rainy conditions, image may get obscured. In such conditions, do not depend on camera view. The camera used in the vehicle, may not reproduce the same color of the real object.
- The camera used in the vehicle, may not reproduce the same color of the real object.
- In case of damage of the rear portion of the vehicle, camera position may change. Which

causes wrong visual information on display. In case of damage, make sure that, camera is fitted properly at the intended location.

- In case of uneven road conditions or up-hill or downhill conditions, do not depend on rear view camera park aid.
- Do not apply any kind of force on the camera.
- Always use rear View mirrors along with Rear View Camera for confirming the safety of the rear and the surrounding conditions.
- High humidity and variation in ambient temperature may result into condensation inside the camera lens, which may further result into degradation of camera video feed on the screen. It is recommended that not to rely on camera video feed for parking assistance in such scenario. This phenomenon is temporary and will be automatically recovered

with reduction in humidity and less variation in ambient temperature.

- The area displayed by the rear view camera is limited. The camera does not display objects that are close to or below the bumper, underneath the vehicle, or objects out of the camera's field of view. The area displayed on the screen may vary according to vehicle orientation or road conditions.

## STARTING AND DRIVING

### Rear view camera system precautions

#### 1. Area displayed on screen

The rear view camera system displays an image of the view from the bumper of the rear area of the vehicle. To adjust the image on the rear view monitor system screen.

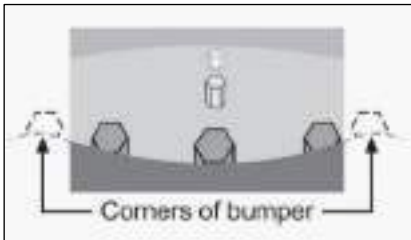
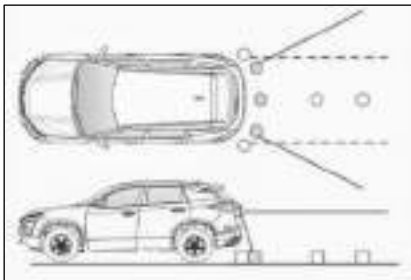

- The area displayed on the screen may vary according to vehicle orientation conditions.
- Objects, which are close to either corner of the bumper or under the bumper, cannot be seen on the screen.
- The camera uses a special lens. The distance of the image that appears on the screen differs from the actual distance. The monitor may not display items that are located higher than the camera field of view.

#### 2. When the ground behind the vehicle slopes up sharply

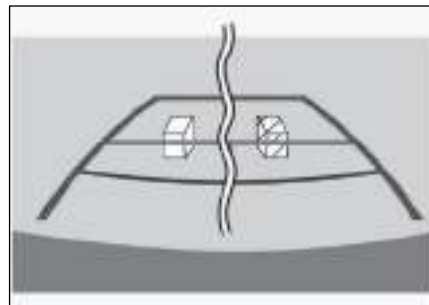
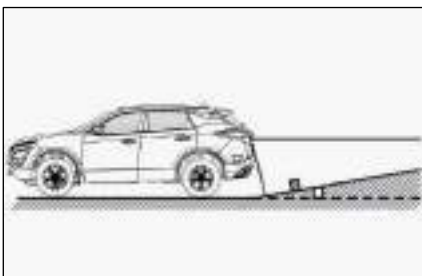

The distance guidelines will appear to be closer to the vehicle than the actual distance.

Because of this, objects will appear to be farther away than they actually are.

In the same way, there will be a margin of error between the guidelines and the actual distance/course on the road.



## STARTING AND DRIVING

### 3. When the ground behind the vehicle slopes down sharply

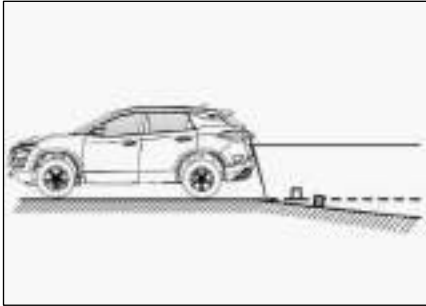

The distance guidelines will appear to be further from the vehicle than the actual distance.

Because of this, objects will appear to be closer than they actually are. In the same way, there will be a margin of error between the guidelines and the actual distance/course on the road.

### 4. When any part of the vehicle sags

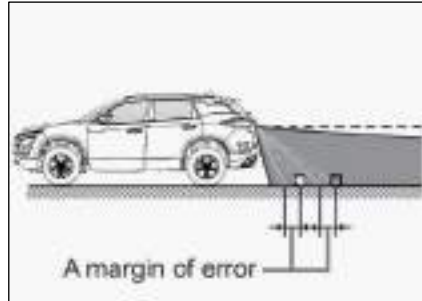

When any part of the vehicle sags due to the number of passengers or the distribution of the load, there is a margin of error between the fixed guide lines on

the screen and the actual distance/course on the road.

### 5. When approaching three-dimensional objects

The distance guidelines are displayed according to flat surfaced objects (such as the road). It is not possible to determine the position of three-dimensional objects (such as vehicles) using the distance guidelines. When approaching a three-dimensional object.

#### a. Distance guidelines

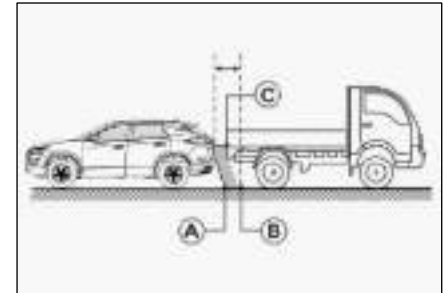

## STARTING AND DRIVING

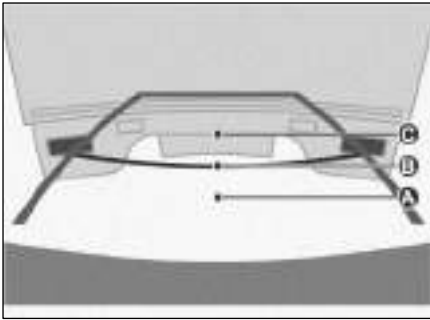

Visually check the surroundings and the area behind the vehicle. On the screen, it appears that a truck is parked at point B. However, in reality if you back up to point A, you will hit the truck. On the screen, it appears that A is closest and C is furthest away. However, in reality, the distance to A and C is the same, and B is farther than A and C.

### b. Vehicle width guidelines

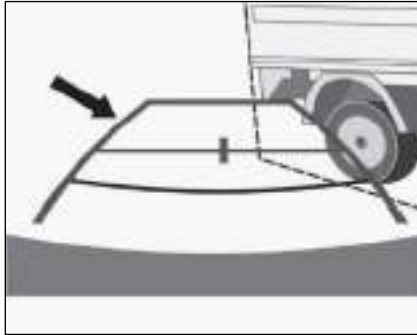
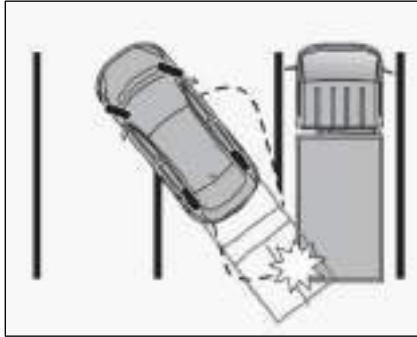

Visually check the surroundings and the area behind the vehicle. In the case shown below, the truck appears to be outside of the vehicle width guidelines and the vehicle does not look as if it hits the truck. However, the rear body of the truck may actually cross over the vehicle width guidelines. In reality if you back up as guided by the vehicle width guidelines, the vehicle may hit the truck.

## EMERGENCY AND BREAKDOWN ASSISTANCE

### Emergency Equipment

You should be familiar with the location of the emergency equipment provided in the vehicle and how to use it.

Check this equipment periodically and ensure that they are in proper working condition and stowed at their locations.

### First aid kit

The first aid kit is kept inside the glove box compartment.

The kit contains items that can be used in case of minor injuries only.

#### **NOTE**

*Check contents of the first aid kit periodically and replenish consumed or expired items.*

### Tool kit, Jack and Spare wheel

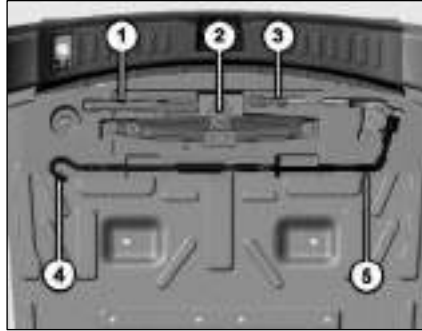

Tool kit, Jack are provided in rear boot.

1. Spare wheel removal spanner
2. Jack
3. Reversible screw driver
4. Jack Handle
5. Wheel Spanner

### Spare Wheel

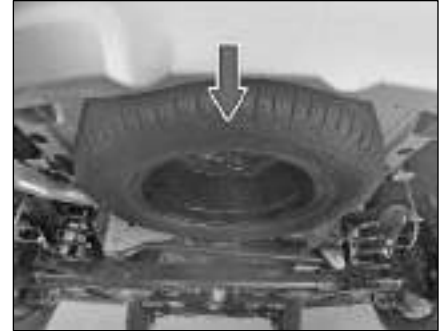

## EMERGENCY AND BREAKDOWN ASSISTANCE

### Advance Warning Triangle

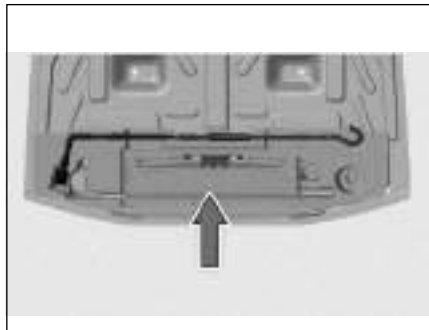

An advance warning triangle is kept on the tool tray in the luggage compartment.

Use advance warning triangle to warn the approaching traffic in case of vehicle breakdown or during emergency, where your vehicle could become a potential traffic hazard.

Press hazard warning switch, all turn signal lamps will start blinking.



Keep the warning triangle at an approximate distance of 50-150 m behind your vehicle in the same lane of traffic. The reflecting side of the triangle should face the oncoming traffic and it should be free from any obstacles.

#### NOTE

*After using the warning triangle tie it firmly and keep it inside the bag to avoid rattling noise.*

### Spare Wheel removal process

- To remove the spare wheel, open the tail gate.
- Open the cover and take out the advance warning triangle.



- Open the flap with the help of screw driver provided in tool kit for accessing to spare wheel removal retaining bolt.

## EMERGENCY AND BREAKDOWN ASSISTANCE



- Insert the spare wheel removal spanner and rotate anticlockwise to unscrew the retaining bolt.



- As the retaining bolt gets loosened, the spare wheel lowers down as shown.



- Remove the holding bracket from the spare wheel and get the spare wheel separated.



### Spare Wheel fitment process

- Engage the holding brackets in spare wheel.

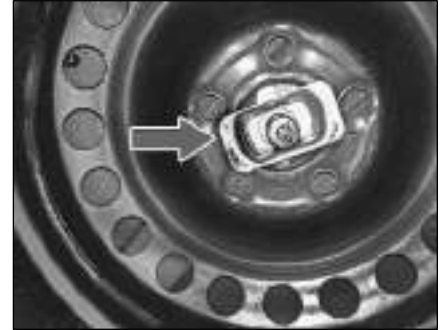

- Insert the spare wheel removal spanner and rotate clockwise to lift the spare wheel.
- Tighten the bolt until you heard the 'Tak' noise. Do not overtight.

### NOTE

*While stowing the spare wheel, ensure that winch bracket is properly engaged in wheel slot.*

## EMERGENCY AND BREAKDOWN ASSISTANCE

### Hazard Warning Switch



Press the hazard warning switch to activate the hazard warning. All the turn signal lamps will flash simultaneously. To turn OFF, press the switch again.

Use the hazard warning to warn the traffic during emergency parking or when your vehicle could become a traffic hazard.

#### NOTE

*The hazard warning lamps can operate even if the ignition is switched off.*

### In Case of Flat Tyre

- Reduce vehicle speed gradually, without making any sudden steering or braking maneuvers. Pay attention to the traffic conditions as you do so.
- Switch on the hazard warning lamps.
- Stop the vehicle on solid, non-slippery and level ground, as far away as possible from traffic.
- If possible, bring the front wheels into the straight-ahead position.
- Secure the vehicle against rolling away.
- Set the parking brake firmly and shift into “R” (Reverse) gear.
- Switch off the engine.
- Keep advance warning triangle at a suitable distance behind the vehicle as an indication of breakdown.
- Close all the doors.

#### WARNING

If you drive with a flat tyre, there is a risk of the following hazards:

- A flat tyre affects the ability to steer or brake the vehicle.
- You could lose control of the vehicle.
- Continued driving with a flat tyre will permanently damage the tyre and cause excessive heat buildup and possibly a fire. There is a risk of an accident.

#### NOTE

*The jack should be used only to change wheels. It is important to read the jacking instructions in this section before attempting to use the jack.*

## EMERGENCY AND BREAKDOWN ASSISTANCE

### Changing flat tyre

Loosen the nuts (as indicated) on the wheel in diagonal sequence. Do not unscrew the nuts completely before jacking the vehicle.



Wheel nut removal

#### NOTE

- The jack is designed only to raise and hold the vehicle for a short time while a wheel is being changed. It is not suited for performing maintenance work under the vehicle.

- Use the jack on level, hard ground. Avoid changing the wheel on uphill and downhill slopes. Apply wheel chokes if vehicle is parked on slope.
- Engage the jack at the correct jacking location.
- Before raising the vehicle, secure it from rolling away by applying the parking brake and wheel chock. Gear shift knob to be engaged in first / reverse gear.
- Do not use wooden blocks or similar objects as a jack underlay.
- Never place your hands and feet or lie under the raised vehicle when it is supported by the jack.
- Never run the engine when the vehicle is supported by the jack and never allow passengers to remain in the vehicle.
- Never open or close a door or the tailgate when the vehicle is raised.

Assemble the Jack handle and wheel spanner (as shown in jacking fig).

Position the jack vertically and raise it by turning the jack handle clockwise until the jack sits completely on jacking point and the base of the jack lies evenly on the ground.

### Jacking point location on vehicle

The jacking points  are indicated the door of the vehicle (Refer jacking point location).

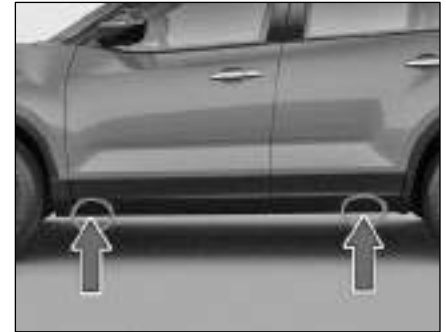

Jacking point location

## EMERGENCY AND BREAKDOWN ASSISTANCE

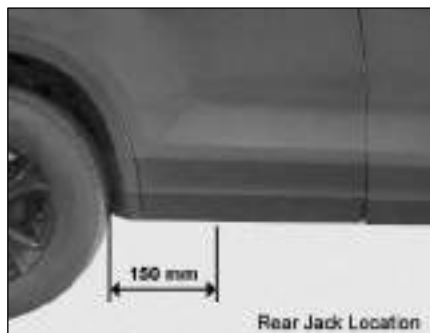
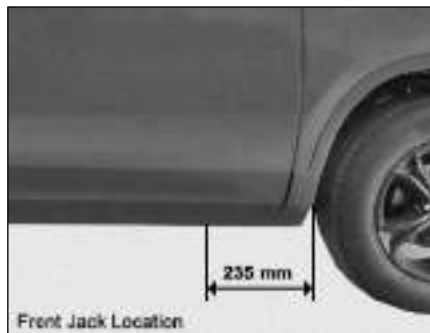

### WARNING

If you do not position the jack correctly at the appropriate jacking point of the vehicle, the jack could tip over with the vehicle raised. There is a risk of injury. Jack may get damage.

Continue to raise the jack slowly and smoothly until the tyre clears the ground. Do not raise the vehicle more than necessary.



Jacking front wheel



Jacking rear wheel

Remove wheel mounting nuts with the help of wheel spanner and take out flat tyre.

### NOTE

*Do not place wheel nuts in sand or on a dirty surface. Do not apply oil or grease on it.*

Roll the spare wheel into position and align the holes in the wheel studs.



## EMERGENCY AND BREAKDOWN ASSISTANCE

Install wheel nuts with their cone shaped end facing the wheel. Tighten each nut by hand until the wheel is securely seated on the hub.

Lower the jack completely then tighten the wheel nuts one by one using wheel spanner.

Press fit the wheel cover back (if fitted).

Restore all the tools and jack at their respective location.

Place the flat tyre at spare wheel location.

### NOTE

*Check and correct the tyre pressure and wheel nuts tightness of the changed wheel at nearest authorised service station.*

*Get the flat tyre repaired at the earliest.*

### WARNING

Do not jack the vehicle under rear axle.

### Jump Lead Starting

Use only a battery of same rating & capacity to jump start your vehicle. Position the booster battery close to your vehicle so that the jump leads will reach both batteries.

When using a battery of another vehicle, do not let the vehicles touch.

Apply the parking brake firmly and keep the gearshift lever in neutral.

Turn off all vehicle accessories, except those necessary for safety like hazard warning lamps.

Make jump lead connections as follows:

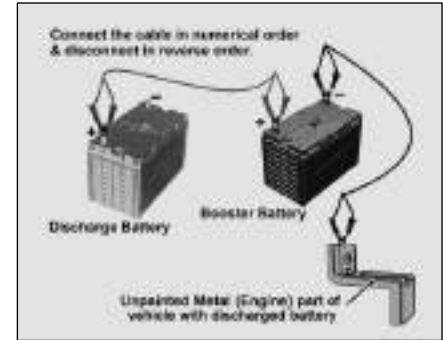

- Connect one end of the first jump lead to the positive (+) terminal of the discharged battery.
- Connect the other end to the positive (+) terminal of the booster battery.
- Connect one end of the second jump lead to the negative (-) terminal of the booster battery.
- Make the final connection (other end of the negative terminal) to an unpainted, heavy metal part (i.e. engine

## EMERGENCY AND BREAKDOWN ASSISTANCE

mounting stud/nut) of the vehicle of discharged battery.

- Start the engine of the vehicle with the discharged battery.
- Before disconnecting the jumper cables, let the engine run for several minutes.
- If the booster battery you are using is fitted to another vehicle, start the engine of the vehicle with the booster battery. Run the engine at moderate speed.
- Remove the jump leads in the exact reverse order in which you connected them.

### NOTE

*Do not disconnect the discharged battery from the vehicle.*

### WARNING

Never connect the jump lead directly to the negative (-) terminal of the discharged battery. This may lead to an explosion.

### WARNING

- Do not allow battery electrolyte to come in contact with eyes, skin, fabrics or painted surfaces. The fluid contains acid which can cause injury and severe damage. Wear protective apparel. Do not inhale any battery gases. Keep children away from batteries. In case if battery acid comes in contact with the skin, wash it off immediately with water and seek medical attention.
- During charging and jump-starting, explosive gases can escape from the battery. There is a risk of an explosion. Particularly avoid fire, open flames, creating sparks and smoking. Ensure

there is sufficient ventilation while charging and jump-starting. Do not lean over the battery.

- Make sure that the positive terminal of a connected battery does not come into contact with vehicle parts. Never place metal objects or tools on a battery.
- It is important that you observe the described order of the battery terminals when connecting and disconnecting a battery. If you are in doubt, seek assistance from qualified specialist workshop.
- Never connect or disconnect the battery terminals while the engine is running.

## EMERGENCY AND BREAKDOWN ASSISTANCE

### Towing

When towing a break down vehicle, certain precautions and procedures must be taken to prevent damage to the vehicle and/or components. Failure to use standard towing precautionary measures when lifting or towing a break down vehicle could result in an unsafe operating condition.

To ensure proper towing and to prevent accidental damage to your vehicle, take help of a TATA MOTORS authorized dealer or a commercial tow-truck service.

#### NOTE

*Make sure that the parking brake is released; vehicle in neutral gear position and steering wheel is unlocked. The power steering functions only when engine is running. Hence, during towing the steering efforts will be more.*

#### WARNING

- Never get under your vehicle after it has been lifted by a tow truck.
- For towing a vehicle, the best way is to use a wrecker. Alternatively use a rigid tow bar.
- Switch 'ON' the hazard warning indicators of both the vehicles to warn other road users.
- Limit the speed to 20-30 kmph.
- In case of brake failure, use the parking brake to control the vehicle.
- Fasten the tow rope or tow bar at the towing eyes. Otherwise, the vehicle could be damaged.
- When towing, pull away slowly and smoothly. If the tractive power is too high, the vehicles could be damaged.

### Access to Tow hook

- Unscrew the screws (1) & (2) with the help of screw driver which is provided in Tool kit.

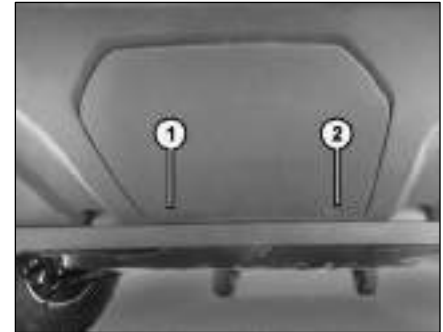

## EMERGENCY AND BREAKDOWN ASSISTANCE

- For removal of cover, pull the rear side down.



- Slide the cover in rear direction to disengage front lugs.
- Then carefully disengage the side lugs.



For fitment of cover,

- Engage the front lugs first.
- Slowly press from both side to engage side lugs.
- Engage rear lugs and then tighten the screws.

### Recommended towing

In case of break down, we recommend that your vehicle be towed with the driving wheels off the ground or place the vehicle on a flatbed truck as shown.

#### WARNING

- Never tow your vehicle with the front wheels on the ground or four wheels on the ground (forward or backward), as this may cause serious damage to the transmission.
- When towing with the rear wheels on the ground or on towing dollies, place the ignition switch in the 'ACC' or 'ON' position, and secure the steering wheel in the straight-ahead position with a rope or similar device.

## EMERGENCY AND BREAKDOWN ASSISTANCE

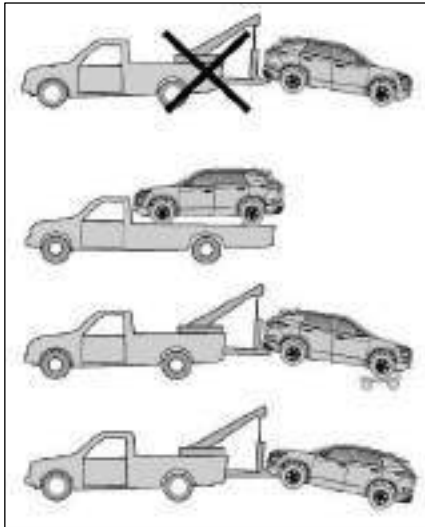

### Fuses

Your vehicle has fuse boxes at two locations.

The vehicle's electrical circuits have fuses to protect the wiring from short circuits or sustained overload.



1. Engine Compartment Fuse Box.
2. Cabin Compartment Fuse Box.

### Checking and replacing fuses

If any electrical unit in your vehicle is not functioning, check the fuses first.

Please follow the steps below that will guide you to check and replace them.

- Apply parking brake
- Switch off all electrical accessories.
- Turn the ignition key to the 'LOCK' position.
- In the fuse box, identify the defective fuse from its melted wire.

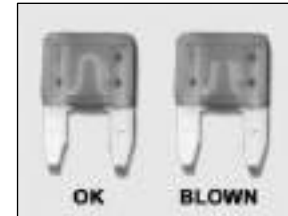

- Remove the blown fuse by "fuse puller". The fuse puller and spare fuses are provided in the engine compartment fuse box.

## EMERGENCY AND BREAKDOWN ASSISTANCE

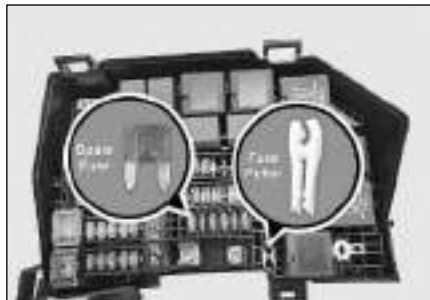

Engine compartment fuse box

- Blown fuses must be replaced with fuses of same rating, which you can recognize by color and value.

### NOTE

*Always ensure that the spare fuses are replenished.*

- Ensure that all other fuses are pressed firmly in position.
- If a newly inserted fuse also blows, have the cause traced and rectified at nearest TATA MOTORS Authorized Service Centre immediately.

### WARNING

- If you manipulate or bridge a faulty fuse or if you replace it with a fuse of higher amperage, the electric cables could be overloaded. This could result in a fire. There is a risk of an accident and injury.
- Always replace faulty fuses with the specified new fuses having the correct amperage.

### Battery mounted fuse

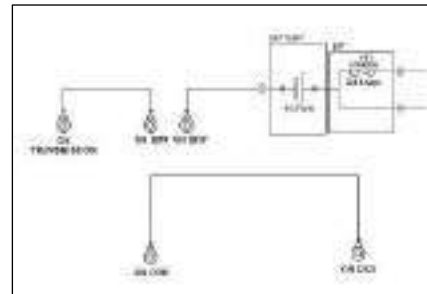
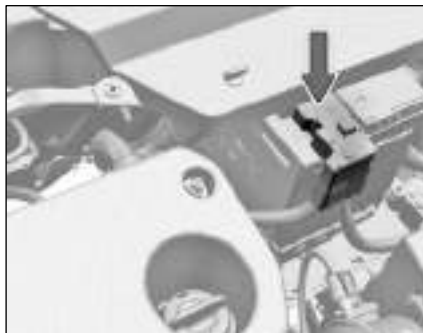

Fuse No.	Function	Fuse Rating
PF1	STARTER MOTOR	250 A

### WARNING

If Fuse box cover is removed for any reason, it should be refitted properly at its original position.

## EMERGENCY AND BREAKDOWN ASSISTANCE

### 1. Engine compartment fuse box

Fuse box located in Engine compartment near battery.



#### NOTE

*The fuse box layout is for reference purpose only. Please refer the sticker provided inside the fuse box cover.*

To access the fuse box, follow the procedure as given below:

- Open the Engine compartment.
- Remove the 2 screws of air intake cover (snorkel) with the help of screw driver provided in tool kit



- Remove the snap fitted cover of fuse box.



## EMERGENCY AND BREAKDOWN ASSISTANCE

### Fuses - Engine Compartment (Diesel)

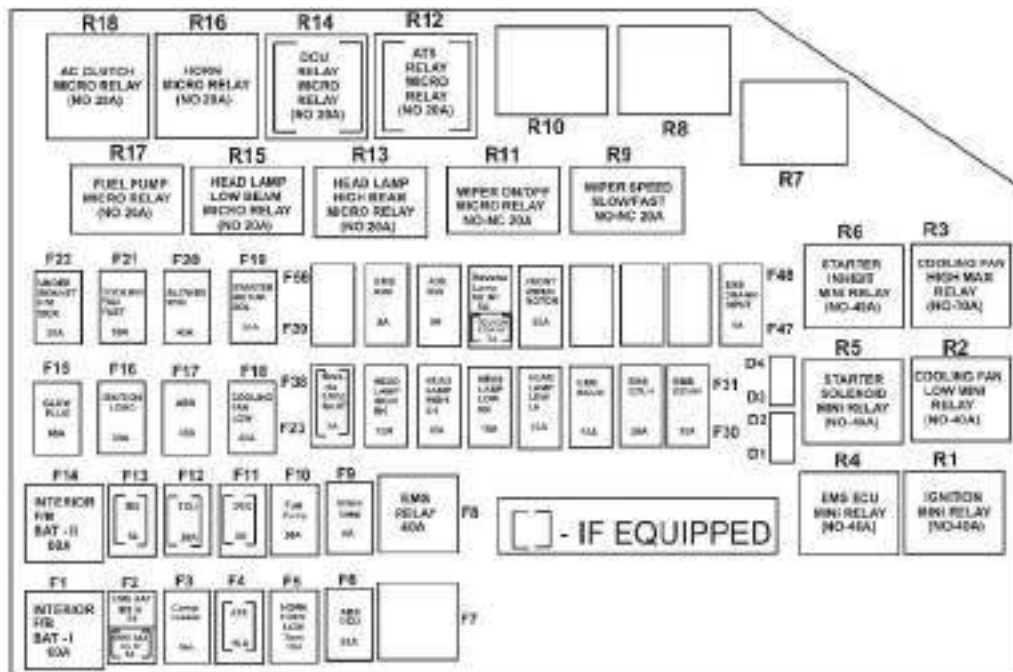



## EMERGENCY AND BREAKDOWN ASSISTANCE

Fuse No.	Function	Fuse Rating
1	INTERIOR F/B BAT - I	60 A
2	EMS BATT	5 A
3	COMPRESSOR	10 A
4	SPARE	---
5	HORN HIGH/LOW TONE	15 A
6	ABS ECU	25 A
7	SPARE	---
8	EMS RELAY	40 A
9	BRAKE LAMP	5 A
10	FUEL PUMP	20 A
11	SPARE	---
12	SPARE	---
13	SPARE	---
14	INTERIOR F/B BAT - II	60 A
15	GLOW PLUG	60 A
16	IGNITION LOAD	30 A
17	ABS ECU	40 A
18	COOLING FAN LOW	40 A
19	STARTER MOTOR SOL	30 A

20	BLOWER MOTOR	40 A
21	COOLING FAN FAST	60 A
22	UNDERBONNET F/R BOX	30 A
23	SPARE	---
24	HEAD LAMP HIGH BEAM RH	10 A
25	HEAD LAMP HIGH BEAM LH	10 A
26	HEAD LAMP LOW BEAM RH	10 A
27	HEAD LAMP LOW BEAM LH	10 A
28	EMS ECU - II	15 A
29	EMS ECU - I	20 A
30	EMS ECU - III	10 A
39	SPARE	---
40	EMS IGN	5 A
41	ABS IGN	5 A
42	REVERSE LAMP	5 A
43	FRONT WIPER MOTOR	30 A
44	SPARE	---
45	SPARE	---
46	SPARE	---
47	EMS-CRANK INPUT	5 A

## EMERGENCY AND BREAKDOWN ASSISTANCE

### 2. Cabin compartment fuse box Cover removal procedure

Fuse box is located behind glove box. To access the fuse box, remove cover as per procedure given below:

1. Remove snap fitted end-cover first.



2. To remove the cover, gently pull the cover from bottom side such that the lugs get disengaged.



3. Open glove box and remove complete assembly by removing high-lighted 4 screws.



4. Disconnect glove box lamp connection.

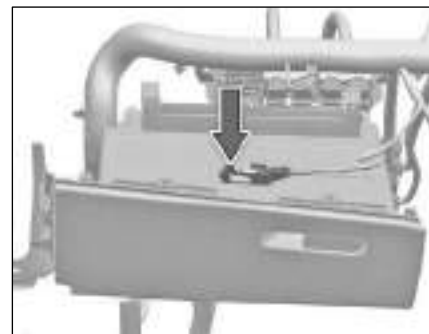

## EMERGENCY AND BREAKDOWN ASSISTANCE

5. Disconnect glove box switch connection.



6. Pull out the fuse from fuse box modules from available cutout as shown below.

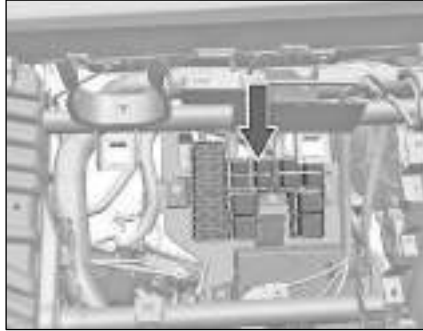

7. Check the fuse of required function with help of fuse box sticker present at shown location.

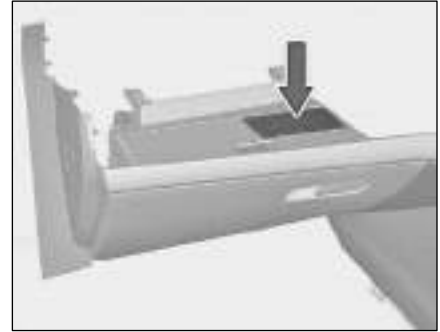

8. If fuse is blown, replace with same rating fuse from spare fuses in engine compartment fuse box.
9. Fit back the glove box by following reverse procedure.

### NOTE

It is recommended to replace fuse at TATA Authorised service centre.

## EMERGENCY AND BREAKDOWN ASSISTANCE

### Fuses - Cabin Compartment

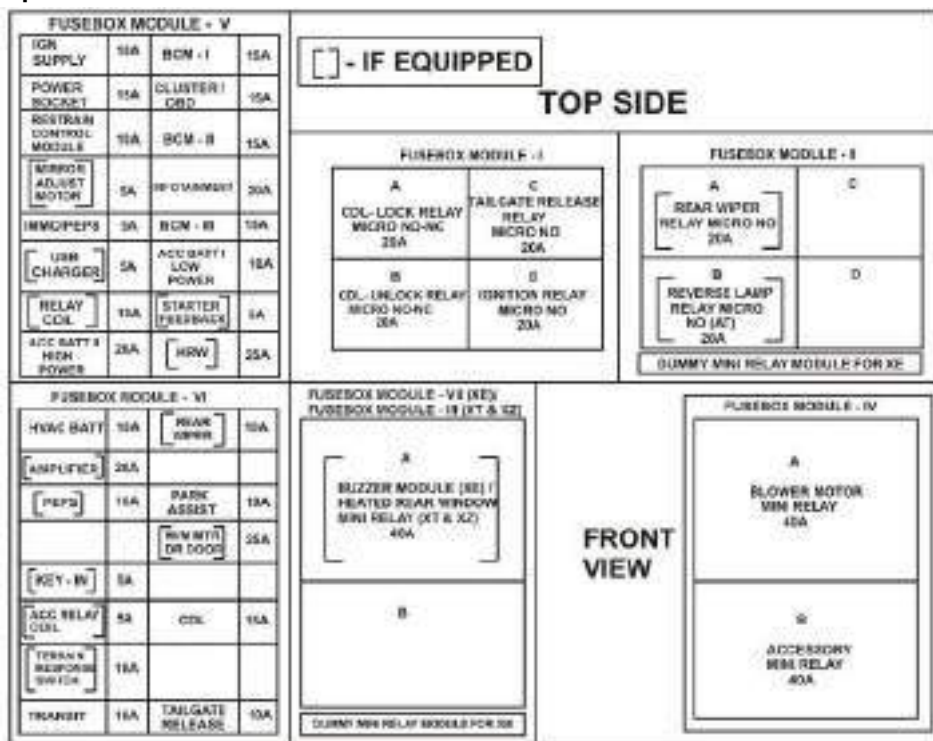

## EMERGENCY AND BREAKDOWN ASSISTANCE

### Bulb Specification

Sr. No.	Description	Rating	Type	Qty.
1	High beam + Low beam (Option I)	12V, 55W	H7	4
2	High beam + Low beam (Option II)	High Beam : 12V, 55W Low Beam : 12V, 25W	High Beam : H7 Low Beam : D5S	4
3	Turn Signal Front (Option I)	12V, 21W	PY21W	2
4	Turn Signal Front (Option II)	LED	LED Module	2
5	Turn Signal Rear	12V, 21W	PY21W	2
6	Fog Lamp Front (Option I)	12V, 19W	H16	2
7	Fog Lamp Rear (Option II)	12V, 21W	P21W	2
8	Stop Lamp	LED	LED Module	2
9	Position Lamp Front (Option I)	12V, 5W	W5W	6
10	Position Lamp Front (Option II)	LED	LED Module	2
11	Position Lamp Rear	LED	LED Module	4
12	Reverse Lamp	12V, 16W	W16W	2
13	Rear Registration Plate Lamp	LED	LED Module	2
14	Side Repeater Lamp on ORVM	LED	LED Module	2
15	High Mounted Stop Lamp (Option I)	12V, 5W	W5W	5
16	High Mounted Stop Lamp (Option II)	LED	LED Module	1

## **EMERGENCY AND BREAKDOWN ASSISTANCE**

<b>Sr. No.</b>	<b>Description</b>	<b>Rating</b>	<b>Type</b>	<b>Qty.</b>
17	Boot Lamp	12V, 5W	W5W	1
18	Glove Box Lamp	12V, 5W	W5W	1
19	DRL (If applicable)	LED	LED Module	2
20	Roof Lamp 1st Row	LED	LED Module	1
21	Roof Lamp 2nd Row	LED	LED Module	1
22	Door Ajar / Puddle Lamp	12V, 5W	W5W	4

## EMERGENCY AND BREAKDOWN ASSISTANCE

### 24 X 7 Road Assistance

Dear Customer,

It is our responsibility and our endeavor to ensure that you have our complete service backup, wherever and whenever you need the same. When you have a road network that spans wide area, the probability of a breakdown happening within hailing distance of a TATA MOTORS Authorized Workshop is very low.

It is precisely for this reason, we have tied up with TVS AA, who will provide breakdown assistance including towing to the nearest TATA MOTORS Authorized Workshop through their Authorized Service Providers (ASP).

The 24X7 On Road Assistance Program shall be automatically available to your vehicle for the duration of Warranty period. The program shall also be available, if you avail the same post warranty.

### Response Time \*\* for the On Road Assistance Program

<b>Within City Limits</b>	<b>60 minutes</b>
<b>On State or National Highways</b>	<b>90 minutes</b>
<b>Ghat Roads and other places</b>	<b>120 minutes</b>

\*\* (The response time will depend on the location, terrain, traffic density and the time of the day.)

### Standard procedure when calling for On Road Assistance in case of a breakdown:

- Dial the toll free help line number – **1800 209 7979**
- Identify your vehicle with the Vehicle chassis number that is available in the Owner's Manual.

- Explain your exact location with landmarks and tell us about the problem you face with the vehicle.
- Park your vehicle on the edge of the road, open the bonnet and put on the hazard warning signal.
- Place the advance warning triangle supplied with the vehicle approx. 3 m from the vehicle in the direction of oncoming traffic.



## EMERGENCY AND BREAKDOWN ASSISTANCE

---

### Coverage under 24 X 7 on Road Assistance Program

I. The **24x7 On Road Assistance** Program Service covers the following services on your vehicle during warranty period.

- Wheel change through spare wheel.
- Arrangement of fuel. (Fuel cost will be chargeable at actual cost)
- Re-opening the vehicle in cases of key lock out.
- Rectification of electrical problems related to battery, fuses etc.
- On spot repairs for complaints repairable at site.
- Vehicle to vehicle towing or winching & towing for non-accident cases up to the nearest TATA MOTORS authorized workshop. Towing charges at actual cost beyond the same to be paid to the ASP in cash. (Any ferry or toll

charges levied in relation to the vehicle being towed to be paid by the customers in actuals in cash).

For accident cases, towing charges to be borne by the customer.

II. The **24x7 On Road Assistance** Program coverage on availing the 24X7 policy, post warranty is up to maximum of 6 instance of assistance in one year for both the plans- Basic and Premium. In the premium plan, this includes 2 instances of towing up to the nearest TATA MOTORS authorised workshop.

### Exclusions

#### **24 X 7 On Road Assistance Program does not apply to**

- Cost of parts consumables and labour for such repairs not covered under warranty\*. These charges are to be settled with ASP in cash.
- Toll or ferry charges paid by ASP in reaching to the breakdown site to be settled with ASP in actuals in cash.

- Cases involving accident, fire, theft, vandalism, riots, lightening, earthquake, windstorm, hail, tsunami, unusual weather conditions, other acts of God, flood, etc.
- Vehicles that are unattended, un-registered, impounded or abandoned.
- Breakdown/defects caused by misuse, abuse, negligence, alterations or modifications made to the vehicle.
- Lack of maintenance as per the maintenance schedule as detailed in the owner's manual.
- Cases involving racing, rallies, vehicle testing or practice for such events.



## EMERGENCY AND BREAKDOWN ASSISTANCE

### Disclaimer

- The Service is not available in Lakshadweep.
- \*\*The reach time is indicative & the actual reach time will be conveyed by the call centre at the time of breakdown call.
- The reach time can vary depending on the traffic density & time of the day.
- The reach time indicated does not account for delays due to but not limited to acts of God, laws, rules & regulations for time being in force, orders of statutory or Govt. authorities, industrial disputes, inclement weather, heavy down pour, floods, storms, natural calamities, road blocks due to accidents, general strife and law & order conditions viz. fire, arson, riots, strikes, terrorist attacks, war etc.

- ^ On spot repairs at breakdown site shall depend on nature of complaints & will be as per the discretion of the ASP.
- \*The decision for free of charge repairs will be as per the warranty policy & procedures of TATA MOTORS LTD. and as per the interpretation of the same by ASP. You will be duly informed by the ASP & call centre for the change applicable if any.
- All charges wherever applicable need to be settled directly with the ASP.

### Exclusion of Liabilities

- It is understood that TATA MOTORS shall be under no liability whatsoever in respect of any loss or damage arising directly or indirectly out of any delay in or non-delivery of, defect/deficiency in service/parts provided by ASP.
- In case vehicle cannot be repaired on-site, customers are advised to use the towing facility for taking their vehicle to the nearest TATA MOTORS authorized workshop only. In no condition will the vehicle be towed to any unauthorized workshop. TATA MOTORS will not be responsible for any repairs carried out in such unauthorized workshop.
- Customer are advised to take acknowledgment from the ASP for the list of accessories/extra fittings and other belongings in the vehicle as well as the current condition related to dents/scratches breakages of parts/fitments of the vehicle at the

## **EMERGENCY AND BREAKDOWN ASSISTANCE**

---

time of ASP taking possession of the vehicle & to verify these items when delivery is taken back by them, Claim for loss of or damage to items, if any should be taken up with ASP directly. TATA MOTORS shall not be responsible for any such claims, damages/loss or any deficiency of service of the ASP.

- Vehicles will be handled, repaired & towed as per the customer's risk & TATA MOTORS shall not be liable for any damages / claims as a result of the same.
- Services entitled to the customers can be refused or cancelled on account of abusive behavior, fraudulent representation, malicious intent and refusal to pay the charges for any charges related services and spare parts during service or on previous occasion on part of the customer.
- On site repairs may be temporary in nature. The completion of repairs does not certify the road worthiness of the vehicle. The customer is advised to ensure temporary repairs carried out onsite is followed by permanent repairs at a TATA MOTORS Authorized Workshop at the earliest. Terms and conditions and service coverage, exclusions etc. are subject to change without notice.

**Maintenance and Service**

Periodic maintenance is essential for ensuring long trouble free performance.

Have your vehicle serviced regularly from TATA MOTORS Authorized Service Centre.

There is a large network of TATA MOTORS Authorized Service Centre to help you with their professional servicing expertise. Scheduled maintenance information is provided which makes tracking routine service easy.

The following checks can be carried out between the recommended scheduled maintenance services. Take help of our authorized service centre for assistance.

- Engine oil level
- Engine coolant level
- Brake/Clutch fluid level
- Washer fluid level checking & topping up
- Power steering fluid level
- Battery electrolyte level
- Tyre inflation pressure including spare wheel

**NOTE**

*Refer "Opening and Closing" section for engine bonnet opening.*

**WARNING**

- Be careful not to touch a hot engine, exhaust manifold and pipes, muffler, radiator and water hoses.
- Do not work on a vehicle with the engine running in an enclosed space, unless you are sure of enough ventilation.
- Keep all open flames and other burning material (such as cigarettes) away from the battery and all fuel related parts.

If you need to do any work inside the engine compartment,

- Switch off the ignition
- Never reach into the area where there is a risk of danger from moving components, such as the fan rotation area.
- Keep clothing away from moving parts.

## MAINTENANCE

---

### Engine Compartment



1. Brake fluid reservoir

2. Fuel Filter

3. Coolant auxiliary tank

4. Windshield washer container

5. Power Steering Oil reservoir

6. Battery

7. Fuse and relay box (Below Air intake)

8. Engine oil filling cap

9. Dip stick engine oil

### Oil / Fluid Level

#### Engine Oil Level checking

Warm up the engine to normal operating temperature.

Turn it 'OFF' and wait for 5 minutes for the oil to return to the oil pan. Be sure the vehicle is on a level surface.

Take out the dipstick, wipe it clean, and reinsert it fully. Pull it out again and examine the oil level. It should be between 'MIN' and 'MAX' level. If not, top up with recommended engine oil.

#### NOTE

*The oil consumption depends upon the driving style and the conditions under which the vehicle is used.*

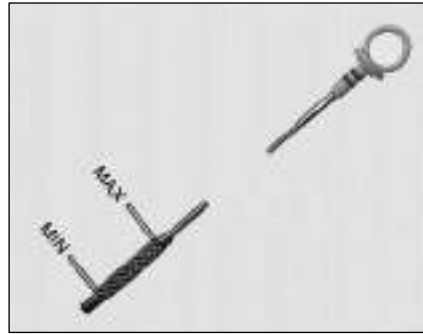

Engine oil dipstick

#### NOTE

- *Do not remove the filler cap when the engine is running.*
- *Do not add oil above the MAX. mark. Oil level above the MAX. mark may cause engine damage.*

***For location of Engine oil filling cap and dip stick, please refer Engine Compartment.***

#### Engine oil quality Monitoring Indicator

Your vehicle is equipped with a feature in the engine management system which will monitor the engine oil quality through out the lifetime of the oil in the engine. This will ensure that an oil change is requested only when really necessary. Once the oil quality reaches a threshold, the engine management system will ask for oil change by lighting the above lamp. This lamp will be blinking for oil change request.



Depending on your driving conditions, the oil quality may get deteriorated sooner. For example, if you are driving predominantly in highway conditions without straining the engine excessively, the oil lamp indicating oil change may appear later than expected. Similarly, if you drive continuously and for a long time in city at low speeds with frequent cold starts and short journeys, the engine management system may prompt

## MAINTENANCE

you to change the oil sooner than had the car been used mainly in highways.

### NOTE

- *Under no circumstances oil change intervals should exceed 15,000 km or 12 Months, whichever occurs earlier.*

This behaviour is absolutely normal, the oil change is intended to keep your engine at peak efficiency, and replacing used oil with fresh oil is normal maintenance and not a malfunction.

As soon as this lamp is blinking, the oil should be changed as per oil change / servicing procedure. Please contact nearest TATA authorized service center immediately.

Once the oil is changed as per the normal oil change / servicing procedure, the oil quality should be reset using



TML diagnostic tool. The vehicle should never be run again after an oil change without resetting oil quality using TML diagnostic tool.

172

If the vehicle is continuously driven ignoring this lamp, MIL, in addition to the above lamp, will be turned ON. Depending on the distance driven without oil change and oil quality reset, the engine will go into a soft or strong performance reduction mode.

### NOTE

- *The appearance of this blinking warning light or symbol is not related to the amount of oil in the engine, so if the light or symbol comes ON and blinking, never add / top up engine oil but contact the nearest TATA authorized service center to have oil change and reset.*

## Brake/Clutch Fluid Level



Pull the notch and release the top cover. Remove the cap and check the level. Top up if required.

### NOTE

- *Do not allow brake fluid to make contact with the skin or eyes.*
- *Do not allow brake fluid to splash or spill on the painted surface as it will damage the paint. In case of spillage, wipe it off immediately.*

**For location of Brake/Clutch Fluid Container and filling cap, please refer Engine Compartment.**

### Engine Coolant Level



Check whether the coolant level is between the 'MIN' and 'MAX' marks provided on the coolant reservoir.

When the coolant levels is low, top up with recommended coolant up to 'MAX' level.

#### NOTE

*In case of emergency, a large amount of water without engine coolant may be added in order to reach a vehicle service location.*

Whenever coolant has been added, the coolant level in the coolant reservoir should be checked few times after driving the vehicle to confirm correct level.

***For location of Engine coolant container and filler cap, please refer Engine Compartment.***

#### NOTE

*Topping of the coolant should be done in the auxiliary tank only.*

Make sure that only TATA MOTORS recommended coolant is used. Mixing of different coolants may harm your engine's cooling system and its components. Do not add extra inhibitors or additives to the coolant. These can be harmful and compromise the corrosion protection of the engine coolant.

#### WARNING

- The engine cooling system is pressurized, particularly when the engine is warm. When opening the cap, you could be scalded by hot coolant spraying out. There is a risk of injury.
- Let the engine cool down before opening the cap. Wear eye and hand protection when opening the cap. Open the cap slowly half a turn to allow pressure to escape.

## MAINTENANCE

### Power Steering Fluid Level



The level of the power steering fluid should be between the MIN. and MAX. mark on the side of the power steering fluid container. If the level falls below the MIN. mark, add recommended fluid.

In case of leakage or hard steering, please contact the nearest Authorised Service outlet.

#### WARNING

- Do not start the engine without oil in the power steering system.
- Do not allow dirt into power steering fluid reservoir during refilling or top up.

#### NOTE

*Turning the steering wheel to full left or right lock and holding it there can damage the power steering pump.*

#### NOTE

*For Oil/fluid specification and Quantity, please refer 'Maintenance' section.*

***For location of Power steering fluid container, please refer Engine Compartment section.***

### Windshield Washer Fluid Level

Check that there is washer fluid in the tank. Refill it if necessary. Use a good quality windshield washer fluid, diluted with water as necessary.

#### NOTE

- *Do not use detergent or any other additive in the windshield washer reservoir. This can severely impair visibility when sprayed on the windshield, and can also damage your vehicle's paint.*
- *Do not operate washer motor with no fluid in washer tank, washer motor will be damaged.*

***For location of Windshield Washer Container and filling cap, please refer respective Engine Compartment.***



### Battery



- To access battery terminals, remove the cover by removing the 5 knobs.
- Check the battery for electrolyte level against the marking on the battery outer case.
- Check the battery terminals for corrosion (a white or yellowish powder). To remove it, wash the terminals with a solution of baking soda. It will bubble up and turn brown.

- When this stops, wash it off with plain water. Dry off the battery with a cloth or paper towel.
- Coat the terminals with petroleum jelly to prevent future corrosion.
- Use a proper wrench to loosen and remove cables from the terminals.
- Always disconnect the negative (-ve) cable first and reconnect it last.
- Clean the battery terminals with a terminal cleaning tool or wire brush.
- Reconnect and tighten the cables, coat the terminals with petroleum jelly.
- Ensure that the battery is securely mounted.
- If you need to connect the battery to a charger, disconnect both cables to prevent damage to the vehicle's electrical system.

**For location of battery, please refer Engine Compartment.**

#### NOTE

- *During normal operation, the battery generates gas which is explosive in nature. A spark or open flame can cause the battery to explode causing very serious injuries.*
- *Keep all sparks, open flames and smoking materials away from the battery.*
- *The battery contains sulphuric acid (electrolyte) which is poisonous and highly corrosive in nature. Getting electrolyte in your eyes or on the skin can cause severe burns. Wear protective clothing and a face shield or have a skilled technician to do the battery maintenance.*

## MAINTENANCE

### Tyres



1	Under inflation	Excessive side tread wear
2	Correct tyre pressure	Uniform wear
3	Over inflation	Excessive center tread wear

### Inflation

Check for inflation and condition of your vehicle tyres periodically.

Check the pressure in the tyres when they are cold.

Keeping the tyres properly inflated gives you the best combination of riding comfort, handling, tyre life and better fuel efficiency.

Over inflation of tyres makes the vehicle ride bumpy and harsh. Tyres are more prone to uneven wear and damage from road hazards.

Under inflated tyres reduce your comfort in vehicle handling and are prone to failures due to high temperature. They also cause uneven wear and more fuel consumption.

#### NOTE

*Every time you check inflation pressure, you should also examine tyres for uneven wear, damage and trapping of foreign objects in the treads and wear.*

### Recommended tyre pressure in Cold condition (Laden / Unladen)

Tyre size	Front	Rear
235/70 R16	33 psi / 2.27 bar	33 psi / 2.27 bar
235/65 R17	33 psi / 2.27 bar	33 psi / 2.27bar

#### NOTE

*In case of Air filling in hot tyre condition, increase tyre pressure by 3 psi over specified cold pressures.*

### Tyre pressure sticker location



On B Pillar near driver seat.

### Tyre rotation

To increase tyre life rotate the tyre at specified intervals or earlier depending on the operation of vehicle.

The illustrations shows how to rotate tyres when normal or temporary spare wheel is fitted.

#### For steel wheel rims with spare steel wheel rim

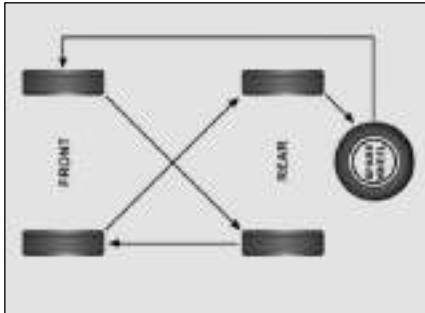

#### For alloy wheel rims with spare wheel of steel wheel rim (if equipped)

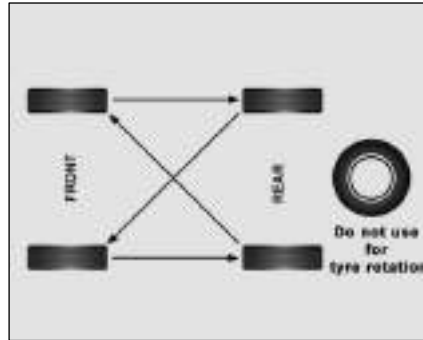

### Wheel Alignment

Incorrect wheel alignment causes excessive and uneven tyre wear. Check wheel alignment at specified intervals.

### Wheel Balancing

Wheels of your vehicle are balanced for better ride comfort and longer tyre life. Balancing needs to be done whenever tyre is removed from rim.

#### WARNING

If the vehicle vibrates abnormally on a smooth road, have the wheel balanced done immediately.

## MAINTENANCE

---

### Special care for tubeless tyres

- While removing tyre from wheel rim and mounting it back on wheel rim, take precautions not to damage tyre bead. Use tyre removal and assembly machines. Damage or cut on tyre bead may cause gradual loss of air and deflation of tyre.
- Do not scratch inside of tubeless tyre with metallic or sharp object. Tubeless tyres are coated with impermeable layer of rubber from inside which holds the air inside the tyre. Removal of this layer due to scratching may cause gradual loss of air and deflation.
- If wheel rim gets damaged in service, get the wheel rim repaired/ replaced immediately. Running the vehicle with damaged rim may cause deflation of tyre and subsequent dislodging of tyre from rim.

- Maintain recommended inflation pressure. Over-inflation, in particular, may cause puncture or bursting of tyre.

#### NOTE

- *Life and wear pattern of tyres depends on various parameters like tyre pressure, wheel alignment, wheel balancing, tyre rotation, etc. It also largely depends on vehicle speed, load carried, usage, driving habits, road conditions, tyre quality, etc. In case fault is suspected to be due to poor quality of tyres, the same may be taken up with concerned tyre manufacturer.*
- *For steel rim, Red dot of tyre to be matched with blue dot of rim while re-fitment.*
- *For alloy rim, Yellow dot of tyre to be matched with valve of rim while re-fitment.*

### Remote Key Battery Replacement (For Flip key)

Remote control key contains a battery, which is housed under the cover.

If red LED on remote flashes for 5 times after operating any button on remote. It is recommended to replace battery at a TATA MOTORS Authorised Service Centre.

You should, however, proceed as follows if you wish to replace the discharged battery yourself:

1. Open the key blade.
2. Press off the battery cover with your thumb or using a flat screwdriver at the points of the arrows.
3. Remove the discharged battery from the key by pressing the battery downwards at the point of the arrow.



4. Insert the new battery.



5. Ensure that the “+” symbol on the battery is facing upwards. The correct polarity is shown on the battery cover.
6. Position the battery cover on the key and press on it until it is heard to lock in place.

### NOTE

Use CR 2032 battery only.

### NOTE

*An inappropriately disposed battery can be harmful to the environment and human health. Dispose the battery according to your local law(s) and regulation.*

### Smart Key Battery Replacement (For PEPS variant)

#### Procedure:

1. Open rear side of key (battery cover).



2. Replace with new battery in the smart key battery slot.
3. Close the battery cover.
4. Ensure that the key cover is intact properly.

## MAINTENANCE

---

### On Board Diagnostic (OBD II) System

Diagnostic connector is located on RH side below the steering wheel.



On board Diagnostics or OBD, is an automotive term referring to a vehicle's self-diagnostic and reporting capability. The OBD system allows continuous diagnosis of the components of the vehicle correlated with emissions. This system warns the driver, by turning "ON" the Malfunction Indication lamp (MIL) on the

instrument cluster, when a fault causes emission levels to increase.

The OBD system also has a diagnostic connector that can be interfaced with appropriate diagnostic tools, which makes it possible to read the fault codes stored in the Electronic Control Unit, together with a series of specific parameters for Engine operation and Diagnosis. This check can also be carried out by the traffic police.

### Diesel Particulate Filter (DPF) warning Indicator

Your vehicle is equipped with a Diesel Particulate Filter (DPF). DPF is a mechanical filter that physically traps particulate matter from diesel engine exhaust gas.

DPF traps the particulate matter in the following way:

- **Filtration** – Particulates / soot are collected in the inlet channel of the filter.
- **Regeneration** – When the filter channels are filled up with soot, they are cleaned automatically by the engine management system. This process is known as DPF Regeneration and this will happen during normal running of the vehicle.

DPF equipped in vehicle normally regenerates automatically which is controlled by engine management system.

In certain specific driving conditions, DPF regeneration may not happen automatically as the desired temperatures required to regenerate soot may not be achievable due to specific driving conditions. This includes prolonged driving at low vehicle speeds for considerable amount of time (driving in heavy city traffic), prolonged running of the engine in idle conditions etc. In such cases, a warning lamp as indicated above will be illuminated in the instrument cluster indicating that soot regeneration is insufficient.



This warning lamp switches ON constantly to indicate that the DPF needs to be regenerated. This lamp does not indicate any malfunction.

The warning lamp remains OFF during normal vehicle behavior and lights up only when driving condition requires the driver to be notified. When this lamp is ON, keep the car running ideally at 3<sup>rd</sup> gear, 60km/hr with engine speed over

2000 rpm until regeneration is completed and warning lamp goes OFF. The process normally takes about 20 minutes.

### NOTE

*Do not shut down engine till the warning lamp goes OFF.*

If DPF regeneration process requested above is not followed for a long distance and the vehicle is driven with warning lamp ON, it can cause MIL to be turned ON.



Once MIL is ON, please contact nearest TATA authorized service center.

Service should connect the TML diagnostic tool and conduct DPF service regeneration as indicated in the diagnostic tool.

Insufficient DPF regeneration resulting in the above lamps can also happen if the vehicle is driven with adulterated diesel.

## MAINTENANCE

---

### Service Instructions

The **TATA HARRIER** has been manufactured to give you economical and trouble free performance. To achieve this, please follow the instructions as stated.

Your vehicle is entitled to three free services (labour only). The free service coupons are attached to the sales invoice. Please present these coupons to the servicing dealer while availing free services.

**1st free service** - At 1,000 - 2,000 kms. OR 2 months, whichever is earlier.

**2nd free service** - At 7,000 - 8,000 kms. OR 6 months, whichever is earlier.

**3rd free service** - At 14,500 - 15,500 kms. OR 12 months, whichever is earlier.

All services other than free services are chargeable.

Servicing of the vehicle can be done at any TATA MOTORS Authorised Dealer Workshop or TATA MOTORS Authorised Service Centre (TASC).

Warranty claims can be settled by any TATA MOTORS Authorised Dealer Workshop or TATA MOTORS Authorised Service Centre (TASC).



**Service Schedule**

SN	Operation	Kms	PDI	1.5K	7.5K	15K	22.5K	30K	37.5K	45K	52.5K	60K	67.5K	75K	82.5K	90K	97.5K	105K	112.5K	120K	127.5K	135K	142.5K	150K	
		Months	0	2	6	12	18	24	30	36	42	48	54	60	66	72	78	84	90	96	102	108	114	120	
	<b>General</b>																								
1	Wash the vehicle & Clean Condenser Fins.	Every Service	•	•	•	•	•	•	•	•	•	•	•	•	•	•	•	•	•	•	•	•	•	•	•
2	Check & Top up Fluids (If required): Transaxle Oil, Coolant, Brake Fluid, Battery Electrolyte, Wind Screen washer fluid.	Every Service	•	•	•	•	•	•	•	•	•	•	•	•	•	•	•	•	•	•	•	•	•	•	•
3	Check Fuel Lines for Leakages.	Every Service	•	•	•	•	•	•	•	•	•	•	•	•	•	•	•	•	•	•	•	•	•	•	•
4	Check and Capture all DTC's Clear all faults and Erase the Codes.	Every Service	•	•	•	•	•	•	•	•	•	•	•	•	•	•	•	•	•	•	•	•	•	•	•
5	Check & Replace if found damaged -- Exhaust hanger, Suspension bushes.	30K/ 24M						•				•				•				•				•	
6	Check all door latch & striker operations, Adjust If required.	15K/ 12M				•		•		•		•		•		•		•		•		•		•	

# - Kms or Months whichever occurs earlier

## MAINTENANCE

SN	Operation	Kms	PDI	1.5K	7.5K	15K	22.5K	30K	37.5K	45K	52.5K	60K	67.5K	75K	82.5K	90K	97.5K	105K	112.5K	120K	127.5K	135K	142.5K	150K
		Months	0	2	6	12	18	24	30	36	42	48	54	60	66	72	78	84	90	96	102	108	114	120
7	Check Rubber Boots, Rubber seat, Dust cover & Bushes for damage & replace if required (Suspension) (First at 15K/12M then at every service).	7.5K / 6M			•	•	•	•	•	•	•	•	•	•	•	•	•	•	•	•	•	•	•	•
8	Check for all bolts & nuts (Tighten).	7.5K / 6M			•	•	•	•	•	•	•	•	•	•	•	•	•	•	•	•	•	•	•	•
<b>Engine (Diesel)</b>																								
1	Change engine oil and Oil filter.	15K / 12M or Whenever oil quality lamp glows - whichever occurs earlier				•		•		•		•		•		•		•		•		•		•
2	Drain water from Fuel Filter Bowl.	7.5K / 6M			•	•	•	•	•	•	•	•	•	•	•	•	•	•	•	•	•	•	•	•
3	Replace fuel filter cartridge.	15K/ 24M				•		•		•		•		•		•		•		•		•		•
4	Check AC & alternator belt condition visually, replace if found damage.	15K / 12M				•		•		•		•		•		•		•		•		•		•
5	Change coolant.	# 60K / 36M										•								•				

# - Kms or Months whichever occurs earlier

## MAINTENANCE

SN	Operation	Kms	PDI	1.5K	7.5K	15K	22.5K	30K	37.5K	45K	52.5K	60K	67.5K	75K	82.5K	90K	97.5K	105K	112.5K	120K	127.5K	135K	142.5K	150K			
		Months	0	2	6	12	18	24	30	36	42	48	54	60	66	72	78	84	90	96	102	108	114	120			
6	Replace air filter element (more frequently for vehicle operating in severe condition) <b>Do not clean the Air Filter element at any time.</b>	# 30K / 36M						•				•				•				•					•		
7	Replace timing drive kit (Timing belt, Auto tensioner and Idler).	# 150K / 60M																							•		
8	Replace FEAD kit (Belt, idler 1&2, Auto tensioner)	90K / 48M																	•								
<b>Transaxle</b>																											
1	Check oil level and top up if necessary.	15K / 12M				•		•		•		•		•		•		•		•		•		•		•	
<b>Steering</b>																											
1	Check oil level and top up if necessary.	15K / 12M				•		•		•		•		•		•		•		•		•		•		•	
2	Replace Power steering Oil & filter element.	# 105K / 36M																	•								
<b>Brakes</b>																											
1	Check front brake pads & rear brake linings. Replace if necessary.	15K / 12M				•		•		•		•		•		•		•		•		•		•		•	
2	Replace brake fluid. Check brake system components for Leakages.	# 45K / 24M								•						•								•			

# - Kms or Months whichever occurs earlier

## MAINTENANCE

SN	Operation	Kms	PDI	1.5K	7.5K	15K	22.5K	30K	37.5K	45K	52.5K	60K	67.5K	75K	82.5K	90K	97.5K	105K	112.5K	120K	127.5K	135K	142.5K	150K
		Months	0	2	6	12	18	24	30	36	42	48	54	60	66	72	78	84	90	96	102	108	114	120
3	Inspect & if necessary adjust handbrake setting.	15K / 12M				•		•		•		•		•		•		•		•		•		•
	<b>Wheels &amp; Tyres</b>																							
1	Check & Adjust Wheel alignment.	# 15K / 12M				•		•		•		•		•		•		•		•		•		•
2	Check for Tyre pressure, condition & rotate.	# 7.5K / 12M			•	•	•	•	•	•	•	•	•	•	•	•	•	•	•	•	•	•	•	•
	<b>Electrical</b>																							
1	Check specific gravity of battery electrolyte.	7.5K/ 6M			•	•	•	•	•	•	•	•	•	•	•	•	•	•	•	•	•	•	•	•
2	Check headlamp focussing.	15K / 12M				•		•		•		•		•		•		•		•		•		•
	<b>A.C. System</b>																							
1	Clean filter and check Air-conditioning / HVAC system for satisfactory performance.	Every Service	•	•	•	•	•	•	•	•	•	•	•	•	•	•	•	•	•	•	•	•	•	•
2	Replace Pollen Filter.	15K/ 12M				•		•		•		•		•		•		•		•		•		•

# - Kms or Months whichever occurs earlier

\*\*-- For severe off-road usage, above checks to be done at every 5,000 km or after every severe usage event.

**Additional Maintenance Schedule under Severe Driving Conditions**

Sr. No.	Operation	Frequency	Condition			
			A	B	C	D
1	Engine oil and oil filter	Change every 7500 km or 6 months or whenever oil quantity lamp glows.	•	•	•	•
2	Air filter element	Change at every 15,000 km or 18 months whichever is earlier.		•	•	

**A - Driving in conditions such as Patrolling, Pickup Van, Vehicle Towing, with Trailer Towing**

**B - Driving on Dusty / Sandy roads**

**C - More than 50% (in terms of km) driving in heavy city traffic**

**D - Frequently operating in mountainous area**

**NOTE**

*In case of emergency, a large amount of water without engine coolant may be added in order to reach a vehicle service location.*

## MAINTENANCE

---

### Vehicle Parking for Long Duration (Non - Use Maintenance)

If you want to park your vehicle at one place for long duration, following care is to be taken:

1. Park the vehicle in covered, dry and if possible well-ventilated premises. Engage a gear.
2. Remove the battery terminal cables (first remove the cable from the negative terminal). Ensure that battery is fully charged.
3. Block the wheel or engage in the gear mode.
4. Clean and protect the painted parts using protective wax.
5. Clean and protect the shiny metal parts using commercially available special compounds.
6. Sprinkle talcum powder on the rubber windscreen wiper and lift them off the glass.
7. Wiper blade lifting sequence during cleaning / replacing, first lift front passenger side wiper blade, then driver side blade.
8. Slightly open the windows.
9. Cover the vehicle with a cloth or perforated plastic sheet. Do not use sheets of imperforated plastic as they do not allow moisture on the vehicle body to evaporate.
10. Inflate the tyres to 0.5 bar above the normal specified pressure and check it at regular intervals.
11. Check the battery charge every six weeks.
12. Do not drain the engine cooling system.

## TECHNICAL INFORMATION

### Fuel Specification

#### Fuel (Diesel)

Normal grade BS IV compliant diesel conforming to IS1460 or EN 590 or equivalent is recommended to be used as fuel.

Do not use premium diesel available in the market for example extra premium / Turbojet etc.

#### Recommended fuel specifications

Parameter	Unit	BS IV
Cetane Number (min)	CN	51
Sulphur content	mg/kg	50
Lubricity (HFRR)	micron	460

#### NOTE

Where oxidation catalytic converter is fitted, it is mandatory to use Diesel fuel with recommended Sulphur contents as given above. Use of any other diesel fuel can increase the pollutants.

At very low temperature, fluidity of diesel may become insufficient due to paraffin separation. It is therefore necessary to mix supplementary fuel with summer or winter grade diesel.

The supplementary fuel to be used like kerosene. Ratio for mixing of supplementary fuel and diesel are shown in the table.

Ambient Temperature up to Deg C.	Percentage	
	Summer grade diesel	Supplementary fuel
Up to 0	100	0
0 to -10	70	30
-10 to -15	50	50

Care should be taken that diesel and supplementary fuel are thoroughly mixed before filling.

Ambient Temperature upto Deg C.	Percentage	
	Winter grade diesel	Supplementary fuel
Up to -15	100	0
-15 to -20	70	30
-20 and below	50	50

#### WARNING

Do not mix gasoline or alcohol with diesel. This mixture can cause an explosion.

## TECHNICAL INFORMATION

### Lubricant Specification

Use following genuine fluids, coolants and lubricants recommended for optimum performance of your vehicle.

Item	Specification	Company	Qty.
Engine Oil (Diesel)	5W30 ACEA C2	<b>CASTROL</b> Magnatec Professional S1 5W-30	5 L
		<b>PETRONAS</b> TATA Motors Genuine Oil Synth HARRIER UV 5W30 ACEAC2	
Coolant (Pre-mixed) (Anti-freeze agent +Soft water 40:60 ratio)	Class II/JIS K2234 TATA SS7700S1	<b>SUNSTAR CCI</b> TATA Motors Genuine Coolant 2200	7 L
		<b>ANSYESCO</b> TATA Motors Genuine Coolant Purocool++ Anchemo Anand	
Transaxle Oil	PETRONAS ZC 601 FF	<b>PETRONAS</b> TATA Motors Genuine Transaxle oil HARRIER	1.9 L
Brake / Clutch fluid	SAE J 1703, DOT 4	<b>GOLDEN CRUISER</b> TATA Genuine Brake Fluid	0.71 L
		<b>CASTROL</b> Universal Brake fluid DOT 4	
		<b>PETRONAS</b> Tutela Brake Fluid DOT 4	
Power Steering oil	ATF-DEXRON IID	<b>CASTROL</b> ATF DEX III	1L
		<b>EXXON MOBIL</b> Mobil ATF 220	



**Technical Specifications**

<b>Parameter</b>	<b>Specifications</b>
<b>Engine</b>	
Model/type	2.0L KryoTec 140 PS
Capacity	1956 cc
Max. Engine output	103 kW (140 PS) at 3750 rpm
Max. Torque	350 Nm at 1750-2500 rpm
<b>Clutch</b>	
Type	Dry, Single Plate diaphragm type
Outside diameter of clutch	240 mm
<b>Transaxle</b>	
Model	C635
Type	Manual, 6-speed, Synchromesh
No. Of gears	6 Forward, 1 Reverse
<b>Steering</b>	
Type	Power assisted-Hydraulic with Tilt & Telescopic mechanism and collapse feature
<b>Brakes</b>	
Brakes	Front (Disc); Rear (Drum)
Parking Brakes	Cable Operated mechanical

## TECHNICAL INFORMATION

Parameter	Specifications
<b>Suspension</b>	
Type	Front: Independent lower wishbone MacPherson strut with coil spring Rear: Semi-independent Twist blade suspension with Panhard rod & coil spring
Shock absorber	Front: MacPherson strut Damper twin tube with gas filled Rear: Damper twin tube with gas filled
<b>Wheels &amp; tyres</b>	
Tyres	For Front & Rear, Option 1 : 235 / 70 R16 106S (Radial-Tubeless) Option 2: 235 / 65 R17 104H (Radial-Tubeless) For Spare wheel, (16 Inch) : 235/70 R16 106S (Radial, Tubeless)
Wheel rims	Option 1: 6.5J X 16 steel wheel Option 2 : 7.5J X 17 alloy wheel
<b>Fuel tank</b>	
Capacity	50 liters
<b>Cab / body</b>	
Type	Monocoque

## TECHNICAL INFORMATION

Parameter	Specifications
<b>Electrical system</b>	
System voltage	12 Volts
Alternator capacity	110 Amp
Battery	12V, 74 Ah
<b>Main chassis dimension (in mm)</b>	
Wheel base	2741
Track front	1616
Track rear	1630
Overall length	4598
Overall height	1706
Max. Width	1894 over body
Ground clearance	176 mm (Laden)

## TECHNICAL INFORMATION

Parameter	Specifications	
<b>Performance</b>		
Max. Speed	170	
Max. Recommended gradability	35%	
Minimum Turning Circle Dia. in meters	11.6 m	
Minimum Turning Clearance circle dia. in meters	12.2 m	
<b>Weight (in kg)</b>		
Kerb weight (unladen)	1650 (XE)	1658 (XM)
	1663 (XT)	1675 (XZ)
Gross vehicle weight	2125 (XE)	2133 (XM)
	2138 (XT)	2150 (XZ)

### Vehicle Dimensions

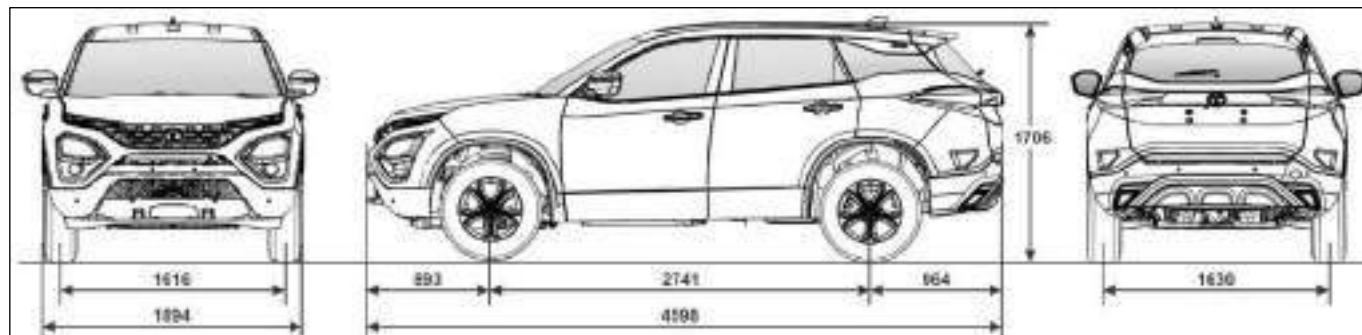

**NOTE:** Dimensions are in mm Unladen condition

## TECHNICAL INFORMATION

### Aggregate Identification Numbers



Engine No. Plate – Diesel



Chassis No. punching near driver seat



VIN plate near Front passenger seat

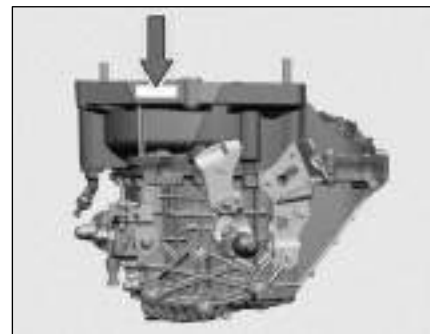

Transaxle No. Punching

## CAR CARE AND VALUE ADDED SERVICES

### Car Care

Your vehicle is subjected to many external influences such as climate, road conditions, industrial pollution and proximity to the sea. These conditions demand regular care of the vehicle body. Dirt, insects, bird droppings, oil, grease, fuel and stone chippings should be removed as soon as possible.

### Washing

Following these tips while washing your vehicle.

1. Always wash your vehicle in shade and the surface is at room temperature.
2. Wash with mild vehicle wash soap like 'Car Shampoo' and use a soft bristle brush, sponge or soft cloth and rinse it frequently while washing to avoid scratches.
3. To avoid scratches, please wear soft gloves. Remove finger rings, nails, wrist watch while washing.

4. To remove stubborn stains and contaminants like tar, use turpentine or cleaners like 'Stain remover' which are safe for paint surfaces.
5. Avoid substances like petrol, diesel, kerosene, benzene, thinner or other solvents that cause damage to paint.
6. Dry your vehicle thoroughly to prevent any damp spots.
7. Rinse all surfaces thoroughly to prevent any traces of soap and other cleaners as this may lead to the formation of stains on the painted surface later.

#### WARNING

Do not direct high pressure washer fluid/ water jets (Pressure above 0.5 bar) at electrical devices and connector during washing. This is to prevent malfunction / failure of electrical system due to water ingress.

After drying the vehicle, inspect it for chips and scratches that could allow corrosion to start. Apply touch up paint where necessary.

### Cleaning of Carpets

Vacuum clean the carpet regularly to remove dirt. Dirt will make the carpet wear out faster. Periodically, shampoo the carpet to keep it looking new.

Use carpet cleaners (preferably foam type). Follow the instructions that come with the cleaner. Apply it with a sponge or soft brush. Keep the carpeting as dry as possible by not adding water to the foam.

#### NOTE

*Avoid wiping of painted surface in dry condition as it may leave scratches on the painted surface.*

## CAR CARE AND VALUE ADDED SERVICES

---

### Cleaning of Windows, Front and Rear Glasses

Clean the windows inside and outside with commercially available glass cleaners.

This will remove the haze that builds up on the inside of windows. Use a soft cloth or paper towels to clean all glass and plastic surfaces.

### FAST TAG

FAST TAG is pasted on front windshield from the inside. It enables Electronic toll collection.



#### NOTE

Do not attempt to rip or tamper the tag. It will disable the functionality of the tag.

### Waxing

Waxing and polishing is recommended to maintain the gloss and wet-look appearance of your paint finish.

1. Use good quality polish and wax for your vehicle.
2. Re-wax your vehicle when the water does not slip off the surface but collects over the surface in patches.

### Polishing

Polishes and cleaners can restore shine to the painted surface that has oxidized and become dull. They normally contain mild abrasives and solvents that remove the top layer of the finish coat. Polish your vehicle, if the finish does not regain its original shine after using wax.

### Interior fabric cleaning tips

1. Stains should be treated immediately. If left for a long time, they can leave a permanent mark.
2. Cleaning the stains immediately is important especially for stains which

contain artificial colors in the stain creating liquid or semisolid substance. The colorant may leave a stain if kept for longer time.

3. Stain should not be removed by rubbing. As far as possible, try to blot or lift the stain with cloth or plastic spatula and then clean the remaining stain with cloth or sponge.
4. If the stain has dried, then gently brush off the material and then press with damp cloth or sponge till it disappears.
5. Do not use household detergents to clean the fabric.
6. Always use clean cotton cloth for cleaning.



## CAR CARE AND VALUE ADDED SERVICES

### Paint Care

Following guidelines will help you to protect your Vehicle from corrosion effectively.

### Proper cleaning

In order to protect your vehicle from corrosion it is recommended that you wash your vehicle thoroughly and frequently in case:

- There is a heavy accumulation of dirt and mud especially on the underbody.
- It is driven in areas having high atmospheric pollution due to smoke, soot, dust, iron dust and other chemical pollutants.
- It is driven in coastal areas.
- The underbody must be thoroughly pressure washed after every three months.

In addition to regularly washing your car, the following precautions need to be taken.

### Periodic Inspection

- Regularly inspect your vehicle for any damage in the paint film such as deep scratches and immediately get them repaired from an authorized service outlet, as these defects tend to accelerate corrosion.
- Inspect mud liners for damages.
- Keep all drain holes clear from clogging.

### Proper Parking

- Always park your vehicle in shade to protect it from harsh sunlight or in a well-ventilated garage so that there is no dampness on any part of the vehicle.

### Wiper care

- To prevent damage to the wipers or windshield, do not operate the wipers when the windshield is dry.
- To prevent damage to the wiper arms and other components, do not attempt to move the wipers manually.
- Wiper blade lifting sequence during cleaning / replacing, first lift front passenger side wiper blade, then driver side blade.

## CAR CARE AND VALUE ADDED SERVICES

---

### Value Care – AMC

Value Care (AMC) is a fixed cost maintenance plan that guarantees protection against unexpected repairs & provides substantial savings through protection against inflation & price volatility of consumables during the running of the vehicle.

Our customers can choose from **Value Care Gold, Value Care Silver, Promise to Protect (P2P) and Protect plus** plan as per the requirement & usage to ensure hassle free, reliable & economic maintenance of the vehicle.

Coverage – **Schedule Service and Wear & tear.**

#### **Advantage** (Customer Benefits)

- Price protection against rising prices of lubes and parts.
- A higher resale value for your vehicle.
- Peace of mind with Cashless repairs & services.
- Vehicle servicing at a workshop of your choice pan India.
- Covers Repairs including Wear & Tear parts viz. Brakes, Suspension, Wiper, Clutch, Brake Pads, Brake Liners etc.
- Covers Scheduled maintenance services including Lubricants, Parts, Wheel Alignment and Balancing Labour.
- Available at unmatched value.... Huge Savings!!!
- Savings on Goods & Services Tax whenever vehicle attend under AMC.



### **Available offers** (Types of AMC)

1. Gold AMC
2. Silver AMC
3. Promise to Protect (P2P)
4. Protect Plus

### **Gold AMC**

The value care Gold Plan extends your scheduled maintenance cover to include any normal wear and tear items identified during the scheduled service and other vehicle parts that need to replace during the period of cover arising from proper and uniform usage.

Scheduled maintenance services at periodic interval of Km for Labor, Parts & Consumables.

### **Silver AMC**

Value Care Silver Plan covers the following:

Scheduled maintenance services at periodic interval of Km for Labor, Parts & Consumables.

- a. Change of Oil Filter, Fuel Filter, Air Filter & Sedimenter.
- b. Change of Engine Oil, Transmission Oil, and Power steering Oil\*.
- c. Change of Coolant, Brake Oil & Clutch Fluid\*.
- d. General Checkup, Wheel Alignment / Balancing (Excluding Balancing Weight).
- e. Washing of Vehicle, Wheel greasing as applicable.

## **CAR CARE AND VALUE ADDED SERVICES**

---

In addition to coverage mentioned under Silver AMC, the Gold AMC also covers Repairs or Replacement of Wear & Tear Items for both Parts & Labour.

- a. Brake Pads, Brake Liners, Wheel Cylinders.
- b. Clutch Disc, Clutch Cover, Cables, Mountings.
- c. Suspension Bush, Wiper Blades, Auxiliary Belt & other Wear & Tear Items.
- d. Washing of Vehicle, Wheel greasing as applicable.

### **Promise to Protect (P2P)**

Value Care – Promise to protect (P2P) is a maintenance plan that guarantees protection against unexpected wear & tear repairs to provide substantial saving through protection against inflation & price volatility during the running of the vehicle.

New Vehicle (under warranty vehicles) are eligible to avail this offer – Identified 13 wear & tear parts listed below Including Labour is covered in this AMC with the price range of 11 to 14 paisa per Km.

#### **\*applicable to selected models\***

**List of covered Parts-** Clutch, Brake Pad, Brake Linings, Brake Disc, Wiper, Wheel Cylinder, Suspension Bushes, Engine Mountings, Ball Joints, Hoses, Auxiliary Belt, (Alternator & A/C Belt), Window Winder.

### **Protect Plus**

The value care Protect plus Plan extends your scheduled maintenance cover to include coverage of P2P. It covers scheduled maintenance services – labour, parts & consumables + Identified 13 wear & tear parts of P2P plan Including Labour.

New Vehicle (under warranty vehicles) are eligible to avail this offer.

#### **\*Applicable to selected models\***

## CAR CARE AND VALUE ADDED SERVICES

### NOTE

- *AMC is available in the dealership from where you have purchased your vehicle.*
- *We strongly recommend purchase of AMC at time of purchase of your vehicle to get benefit for coverage of Scheduled Services and Wear & Tear parts.*
- *The Dealer Service Marketing Executive shall explain to you the Terms and conditions, Coverage and Owner's responsibility.*
- *One Time payment is to be made to avail AMC offer.*
- *P2P & Protect plus offer valid on selected models & may vary from Model to Model, Variant to Variant.*
- *Please read the offer eBooklet for further details about coverage and exclusions of various AMCs.*

### Owner's Responsibility:

- Proper use, maintenance and care of the vehicle in accordance with the instructions contained in the Owner's Manual and Service Booklet. The records of the same to be ensured in Owner's Manual.
- Retention of maintenance service bills.

I / We have been explained the Terms and conditions, Coverage and Owner's responsibility by the Dealer Service Marketing Executive.

I wish to avail /  Do not wish to avail extended warrant policy.

**Customer's Signature**

**Dealer's Signature**

## CAR CARE AND VALUE ADDED SERVICES

---

### Extended Warranty

TATA MOTORS recommends the purchase of its extended warranty program.

**Coverage** - Mechanical + Electrical

### Benefits

- Insures you against unforeseen break down repair bills.
- Documentation is simple and hassle free.
- Near cashless & speedy claim

### Term

2+1 Year or 1,15,000 Km whichever occurs first

OR

2+2 Year or 1,30,000 Km whichever occurs first

Extended Warranty is available in the dealership from where you have purchased your vehicle. We strongly recommend purchase of Extended Warranty at time of purchase of your vehicle. Extended Warranty can be availed till 421 days from date of purchase of vehicle. The Dealer Service Marketing Executive shall explain to you the Terms and conditions, Coverage and Owner's responsibility.

### Extended Warranty Booklet & Cover Note

The Extended Warranty booklet and cover note is the basis of the contract between TATA MOTORS LIMITED and the Owner of the vehicle shown on the Extended Warranty booklet. The Customer is to retain this booklet and the same to be produced to the dealer while claiming benefits under Extended Warranty.



## **CAR CARE AND VALUE ADDED SERVICES**

---

### **Note**

- The 12 or 24 months extended warranty does not follow the 24 months Manufacturer's warranty.
- The extended warranty comes into force once the manufacturer's warranty expires e.g. after 24 Months.
- It is more restrictive as by the time it comes into force the vehicle is already 24 months old.

### **What is covered?**

- Mechanical / Electrical break down as defined in this warranty and confirmed by the dealer within the stipulated terms and conditions.
- TATA MOTORS dealer shall either repair or replace any part found to be defective with a new part or an equivalent at no cost to the owner for parts or labour.
- Such defective parts which have been replaced will become property of TATA MOTORS LIMITED.
- Comprehensive list of parts covered is mentioned in the page 9-12 of the Extended Warranty Booklet.

### **What is not covered?**

Please refer the Extended Warranty Booklet for details of the exclusion list.

### **Owner's Responsibility:**

- Proper use, maintenance and care of the vehicle in accordance with the instructions contained in the Owner's Manual and Service Booklet. The records of the same to be ensured in Owner's Manual.
- Retention of maintenance service bills.

---

I / We have been explained the Terms and conditions, Coverage and Owner's responsibility by the Dealer Service Marketing Executive.

I wish to avail /  Do not wish to avail extended warrant policy.

**Customer's Signature**

**Dealer's Signature**

## CAR CARE AND VALUE ADDED SERVICES

---

### Value Added Services

**Why are Corrosion Protection Waxes necessary?**

**Corrosion is caused by:**

Water / salt water acid rain & atmospheric fallouts.

**Critical areas are:**

Cavities: joints, crevices, spot welds, underbody

- Corrosion is the most important factor when we talk about the vehicle life. If you treat your car you can prolong the life.
- It is very dangerous to drive around in a corroded vehicle.
- The corrosion creeps onto the vehicle from the inside and from the outside. The most dangerous kind of corrosion is often not discovered until it is too late.

**Benefits of Anti - Rust treatment:**

- A professionally applied range of world class products offering real value to the new and used vehicle customer.
- The treatment has been developed to withstand the harshest environmental and climatic conditions (rust. Pollutants, stone and gravel impact, etc.)
- Insulate cabin space from external noises.
- Expensive tin work and Denting / Painting avoided.
- Higher resale value for the vehicle.
- Higher safety – uncorroded vehicle
- 10 free checkups available





## **CAR CARE AND VALUE ADDED SERVICES**

TATA MOTORS has tied up with **M/s Würth, M/s Autokrom, M/s 3M India Lt d & M/s Bardahl** for these world class treatment at affordable prices. These treatments are available in all authorized workshops. The Dealer Service Marketing Executive will explain to you the benefits and terms and conditions of this treatment.

---

I / We have been explained the Benefits, Terms and conditions and the prices of these treatments by the Dealer Service Marketing Executive.

I wish to avail /  Do not wish to avail extended warrant policy.

**Customer's Signature**

**Dealer's Signature**

## CAR CARE AND VALUE ADDED SERVICES

---

### Vehicle Exterior Enrichment

#### Why vehicles are painted?

- For Corrosion protection of the metal surfaces.
- Ease of application from other corrosion protection treatments.
- Cheaper than other corrosion protection methods eg. Galvanizing, anodizing.
- For decoration and identification.



#### Various Environmental Hazards affecting paints

Environmental hazards: destroy your vehicle's finish.

Even as your new vehicle rolls off the assembly line, the paint is not protected.

#### The enemy

Ultraviolet Rays, Pollution, Tree Sap, Bird Droppings, Car Wash Chemicals, Road Salt, Acid Rain.

#### Benefits: Vehicle Exterior Enrichment

- Removal of medium scratches, orange peel, oxidation, dust nibs etc. & swirl marks from painted surface.
- Restoration of original gloss levels, UV protection after gloss is restored.
- Cleaning & dressing of tyres, Bumpers & all exterior plastic moldings/trims.

TATA MOTORS has tied up with **M/s Autokrom, M/s 3M & M/s Wurth** for this world class treatment at affordable prices. This treatment is available in all authorized workshops. The Dealer Service Marketing Executive will explain to you the benefits and terms and conditions of this treatment.

### Vehicle Interior Enrichment

#### Why protect your new car's fabric interior?

- Someone will spoil your vehicle's fabric carpet or seats.
- A significant detractor from your vehicle's resale value.
- A permanent stain on your vehicle's interior fabric.

#### The enemy:

Drink Spills - Food Stains - Mud - Ultraviolet Rays Pets - Traffic

Benefits: Vehicle Interior Enrichment

- Removal of medium stains and dirt from all interior parts of the car i.e., carpet, upholstery and roof lining.
- Cleaning of windshield and all windows (inside and outside).
- Dressing of all internal plastics (e.g.: door pad trims) and rubber parts.
- The treatment involves cleaning and dressing of all parts of the exposed interiors.
- Specialised protection for seat fabric from liquid spills.

TATA MOTORS has tied up with **M/s Wurth** and **M/s Autokrom** for this world class treatment at affordable prices. This treatment is available in all authorized workshops. The Dealer Service Marketing Executive will explain to you the benefits and terms and conditions of this treatment.

---

I / We have been explained the Terms and conditions, Coverage and Owner's responsibility by the Dealer Service Marketing Executive.

I wish to avail /  Do not wish to avail extended warrant policy.

**Customer's Signature**

**Dealer's Signature**



## WARRANTY - TERMS AND CONDITIONS

### Vehicle Warranty: Terms and conditions

We WARRANT each **TATA HARRIER** vehicle and parts thereof manufactured by us to be free from defect in material and workmanship subject to the following terms and conditions:

1. This warranty shall be for a period of **2 years from the date of sale of the car or a mileage of 1, 00,000 Kms whichever occurs earlier.**
2. Our obligation under this warranty shall be limited to repairing or replacing, free of charge, such parts of the car which, in our opinion, are defective, on the car being brought to us or to our dealers within the period. The parts so repaired or replaced shall also be warranted for quality and workmanship but such warranty shall be co-terminus with this original warranty.
3. Any part which is found to be defective and is replaced by us under the warranty shall be our property.
4. As for such parts as Tyres, Batteries, Audio and / or Video equipment (if any), etc. not manufactured by us but supplied by other parties, this warranty shall not apply, but buyers of the car shall be entitled to, so far as permissible by law, all such rights as we may have against such parties under their warranties in respect of such parts.
5. This warranty shall not apply if the car or any part thereof is repaired or altered otherwise than in accordance with our standard repair procedure or by any person other than from our sales or service establishments, our authorized dealers, service centres or service points in any way so as, in our judgment which shall be final and binding, to affect its reliability, nor shall it apply if, in our opinion which shall be final and binding, the car is subjected to misuse, negligence, improper or inadequate maintenance or accident or loading in excess of such carrying capacity as certified by us, or such services as prescribed in our Owner's Manual are not carried out by the buyer through our sales or service establishments, our authorized dealers, service centres or service points.
6. **This warranty shall not apply to the replacement of normal wear parts, including without limitation, drive belts, hoses, wiper blades, fuses, clutch disc, brake shoes, brake pads, cables and all rubber parts (except oil seal and glass run).**
7. This warranty shall not cover any inherent normal deterioration of the car or any of its parts arising from the actual use of the car or any damage due to negligent or improper operation or storage of the car.

## WARRANTY - TERMS AND CONDITIONS

---

8. This warranty shall not apply to normal maintenance services like oils & fluid changes, head lamps focusing, fastener retightening, wheel balancing and alignment, tyre rotation, adjustment of valve clearance, fuel timing, ignition timing and consumables like bulbs, fuel, air & oil filters and gas leaks in case of air conditioned cars.
9. This warranty shall not apply to any damage or deterioration caused by environmental pollution or bird droppings. Slight irregularities not recognized as affecting the function or quality of the vehicle or parts, such as slight noise or vibration, defects appearing only under particular or irregular operations are items considered characteristics of the vehicle.
10. This warranty shall be null and void if the car is subjected to abnormal use such as rallying, racing or participation in any other competitive sport. This warranty shall not apply to any repair or replacements as a result of accident or collision.
11. This warranty is expressly in lieu of all warranties, whether by law or otherwise, expressed or implied, and all other obligations or liabilities on our part and we neither assume, nor authorize any person to assume on our behalf, any other liability arising from the sale of the car or any agreement in relation thereto.
12. The buyer shall have no other rights except those set out above and have, in particular, no right to repudiate the sale, or any agreement or to claim any reduction in the purchase price of the car, or to demand any damages or compensation for losses, incidental or indirect, or inconvenience or consequential damages, loss of car, or loss of time, or otherwise, incurred or accrued.
13. Any claim arising from this warranty shall be recognized only if it is notified in writing to us or to our authorized dealer without any delay soon after such defects as covered & ascertained under this warranty.
14. **This warranty is fully transferable to subsequent vehicle owner. Only unexpired remaining period of warranty applies.**
15. We reserve our rights to make any change or modification in design of the car or its parts or to introduce any improvement therein or to incorporate in the car any additional part or accessory at any time without incurring any obligation to incorporate the same in the cars previously sold.

TATA MOTORS LTD. is committed to produce vehicles using environmentally sustainable technology. A number of features have been incorporated in TATA MOTORS passenger vehicles which have been designed to ensure environmental compatibility throughout the life cycle of the vehicle. We would like to inform you that your vehicle meets emission norms and this is being regularly validated at the manufacturing stages.

As a user you too can protect the environment by operating your vehicle in a proactive manner. A lot depends on your driving style and the way you maintain your vehicle. We have given a few tips for your guidance.

### Driving

- Avoid frequent and violent acceleration.
- Do not carry any unnecessary weight in the vehicle as it overloads the engine. Avoid using devices requiring high power consumption during slow city traffic condition.
- Monitor the vehicle's fuel consumption regularly and if showing rising trend get the car immediately attended at the Company's Authorised Service Outlets.
- Switch off the engine during long stops at traffic jams or signals. If you need to keep the engine running, avoid unnecessary revving it up or stopping and starting.

- It is not necessary to rev up the engine before turning it off as it unnecessarily burns the fuel.
- Shift to higher gears as soon as possible. Use each gear upto 2/3rd of maximum engine speed.
- A chart indicating gear shifting speeds is given in this book.

### Maintenance

- Ensure that recommended maintenance is carried out on the vehicle regularly at the Authorised Service Outlets.
- As soon as you see any leakages of oil or fuel in the vehicle we recommend to get it attended immediately.
- Use only recommended grades and specified quantity of lubricants.
- Get your vehicle checked for emission periodically by an authorised dealer.
- Ensure that fuel filter, oil filter and breather are checked periodically and replaced, if required, as recommended by TATA MOTORS.
- Do not pour used oils or coolants into the sewage drains, garden soil or open streams. Dispose the used filters and batteries in compliance with the current legislation.

## ENVIRONMENT SAFETY

---

- Do not allow unauthorized person to tamper with engine settings or to carry modifications on the vehicle.
- Never allow the vehicle to run out of fuel.
- Parts like brake liners, clutch discs should be vacuum cleaned. Do not use compressed air for cleaning these parts which may spread dust in the atmosphere.

**While carrying out servicing or repairs of your vehicle, you should pay keen attention to some of the important engine aggregates and wiring harness which greatly affect emission. These components are:**

1. Fuel injection equipment's - pump, rail, injectors, nozzles and high pressure pipes.
2. Air Intake & Exhaust system, especially for leakages.
3. Cylinder head for valve leakage.
4. All filters such as air, oil and fuel filters (check periodically).
5. Turbocharger.
6. Electrical connections.
7. If the 'Service' lamp continuously glows, please take the vehicle to a TATA MOTORS authorized service outlet.
8. Catalytic Converter.

9. EMS wiring harness i.e. electrical connections to all sensors and actuators.

This Owner's manual contains further information on driving precautions and maintenance care leading to environment protection. Please familiarize yourself with these aspects before driving.