



Service Division
MARUTI SUZUKI INDIA LIMITED
Palam Gurgaon Road, Gurgaon - 122 015 (Haryana)
www.marutisuzuki.com

CODED01/10/14/10000

SWIFT

99011M74L10-74E



SWIFT

OWNER'S MANUAL & SERVICE BOOKLET

Keep With Vehicle At All Times.
Contains Important Information
On Safety, Operation & maintenance.



This Owners Manual & Service Booklet applies to the SWIFT series
produced by MARUTI SUZUKI INDIA LIMITED.

SWIFT

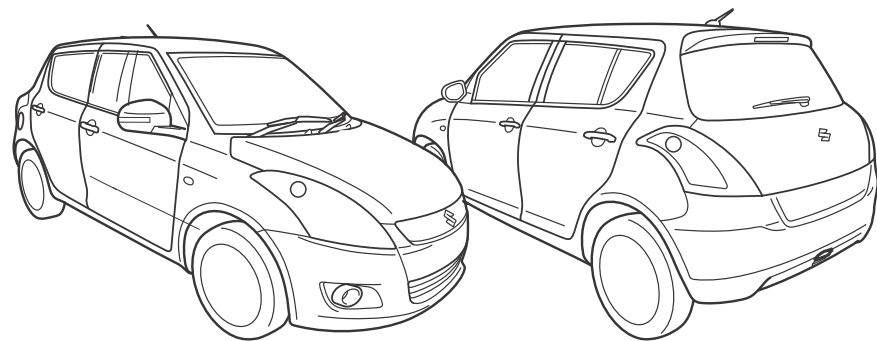

SWIFT DZIRE

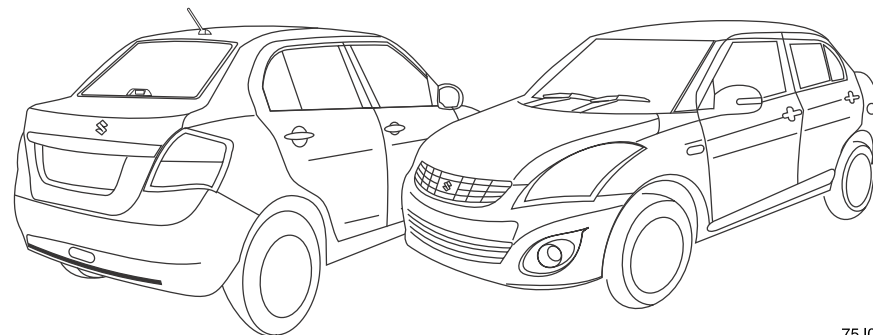

75J024

© COPYRIGHT MARUTI SUZUKI INDIA LIMITED 2014

NOTE: The illustrated models are one of the SWIFT series.

Prepared by
MARUTI SUZUKI INDIA LIMITED

Service Division
October, 2014

Part No. 99011M74L10-74E
Printed in India

For round-the-clock on-road assistance, call Maruti On-road Service at 1800 102 1800#

No STD code to be prefixed.

“WARNING”



Vehicle may **break-down**, meet with an **accident** or **catch fire** due to

1. Installation of
 - High wattage bulbs
 - Non genuine lamps / horns
 - Modified suspension / wheels
 - Non genuine parts / accessories etc.
2. Retrofitment of LPG / CNG fuel systems/kits.
3. Usage of domestic LPG.
4. Short circuiting due to tampering of wiring harness.

CAUTION: DO NOT STORE OR CARRY INFLAMMABLE MATERIALS IN THE VEHICLE.

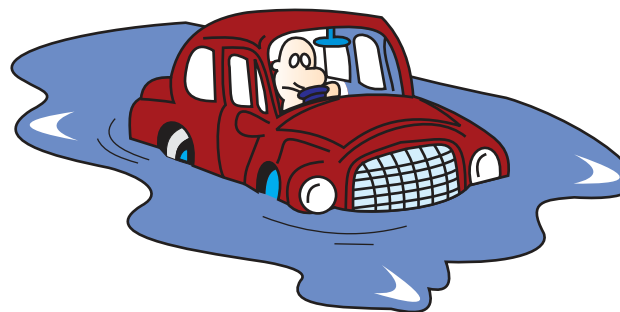

Avoid driving into or starting the vehicle in a heavily water logged area. Vehicle may break-down or engine may fail due to

1. Water entry into the engine.
2. Short circuiting of the electrical systems.

If the vehicle is stuck in deep water, do not start / crank the vehicle until the level of water drops below the level of exhaust pipe.

NOTE:
IF THE VEHICLE IS SUBMERGED IN WATER, REPORT TO THE NEAREST AUTHORIZED WORKSHOP.

“CAUTION”

1. Retro-fitment of LPG/CNG kit may deteriorate vehicle performance, reduce engine & engine related component's life and also warranty will be null and void for such vehicles.
2. Do not use domestic LPG/LPG cylinder for your factory fitted LPG vehicles.
3. Usage of domestic LPG for running vehicles is prohibited as per law.
4. Do not remove company fitted LPG/CNG kit to install some other kit. It may affect vehicle performance and may cause fire.
5. Drive slowly on wet roads. Tires may slip while braking at higher speeds due to aquaplaning. (reduced contact area between tire and road due to presence of water)
6. Do not leave engine running in garages or confined areas, with passengers inside. This may result in accumulation of carbon-mono-oxide in cabin and may lead to suffocation or breathing problems.
7. Do not park vehicle on dry leaves or grass. This may lead to fire due to hot catalytic converter, igniting the dry leaves/grass.
8. If the vehicle is equipped with CNG/LPG, ensure availability of fire extinguisher in the vehicle all the time.
9. Always wear seat belt at all the times.
10. Do not use mobile phone while driving.
11. Avoid Smoking in the car, live bud thrown in car may cause fire.
12. Do not put any body part under the vehicle when it is supported on a Jack.
13. Do not use non-genuine accessories in your vehicle.
14. Do not fit accessories from unauthorized workshops/sources.
15. Usage of non-approved electrical accessories in your vehicle may result in spark, fire or personal injury.

Stamp of Selling dealer (Code & Full Address)

For Servicing Dealer/Mass

- 1.0 : Please fill up Model codes correctly.
- 2.0 : Please fill up Complete chasis No.
- 3.0 : Please fill up customer details i.e. Address and Telephone No. legibly and correctly of the latest owner.

For Selling Dealer

- 1.0 : Please send all Free Service Coupon to us once in a month after settlement of free service charges.

Service Division
Maruti Suzuki India Limited

Model Code*																				
Chassis No. :																				
Engine No. :																				
Mileage																				
Date of Delivery																				
Date of Inspection																				
Registration No.																				
Service Dealer/Mass Code																				
Customer Name																				
Address (Please write complete address)																				
Telephone No.																				

<i>Mechanic's Signature</i>
<i>Service Manager's Signature</i>
<i>Customer's Signature</i>

2ND. FREE INSPECTION COUPON (CUSTOMER'S COPY) (5,000 KM or 6 MONTHS)

WHICHEVER COMES FIRST

JOB MARK: : Checked OK, A: Adjust, C: Clean, R: Replace or Change, L: Lubricate, T: Tighten,
O: Rotate, I: Inspect, clean, adjust, lubricate or replace as necessary

1. ENGINE

- Engine Coolant (Level, Leakage)
- Engine Oil (Level, Leakage)
- Cooling System hoses & connections (Leakage, Damage)
- Exhaust System (Noise, Leakage)
- PCV System (Hoses, Connections, Valve)

JOB

2. FUEL

- Air cleaner (Clean) (Petrol)
- Fuel filter, Fuel tank cap, Fuel lines and connections (Leakage)
- Fuel filter water draining (Diesel)

3. CLUTCH AND TRANSMISSION

- Clutch pedal (Play) (Petrol)
- Clutch slipping (Dragging, Damage) Transmission Oil/Differential/Transfer oil (Level Leakage)

*4. Automatic Transmission Fluid (Level, Leakage)

- Hose A/T fluid (Inspect)
- Gear Shifter Cables (Operation)
- Drive shaft boots (Damage)
- Clutch Fluid (Level, Leakage)

4. BRAKE

- Brake fluid (Level, Leakage)
- Brake pedal (Pedal to wall clearance)
- Parking brake lever (Play)
- Brake Disc & Pads (Inspect)
- Brake hoses & pipes (Leakage, Damage)

5. WHEEL

- Tyres (Air pressure, Abnormal wear, Rotation)
- Wheels (Inspect)
- Front/Rear Wheel Bearings (Loose, Damage)

*APPLICABLE FOR AUTOMATIC TRANSMISSION ONLY

COST OF MATERIALS AND CONSUMABLES TO BE BORNE BY CUSTOMER

6. FRONT AND REAR SUSPENSION

- Suspension strut/shock absorber (Oil Leakage)
- Suspension arms, Knuckle, Rear spring (Damage, Loose)
- All Nuts & Bolts (Tighten)

JOB

7. STEERING

- Steering wheel (Play)
- All Rods & Arms (Loose, Damage, Wear)
- Power Steering System (Operation)
- Steering gear box (Inspect)
- Tilt steering (Operation) (if equipped)

8. ELECTRICAL

- Battery electrolyte (Level, Leakage)
- Lighting system/Horn (Operation)
- Wiring Harness Connections (Looseness)
- Wiper (Operation)

9. BODY

- All Latches, Hinges & Locks/Central Locking (Operation/Lubrication)
- All Chassis nuts & bolts (Inspect)
- Seat belt (Operation)
- Seat latch, lever & knob (Operation)

10. FOR MARUTI AIR-CONDITIONED VEHICLES

- Drive belt (Tension, Damage)
- Check functioning of Recirc flap
- Check all Hose Joints
- Tighten Compressor Mounting Bolts
- Clean Condenser with low pressure water

11. ROAD TEST

- Operation of Brakes, clutch Gear shifting and Speedometer
- Body & Chassis noise

2ND. FREE INSPECTION COUPON

(DEALER'S COPY)

(5,000 KM or 6 MONTHS)

Model Code*									
Chassis No. :									
Engine No. :									
Mileage									
Date of Delivery									
Date of Inspection									
Registration No.									
Service Dealer/Mass Code									

Mechanic's Signature
Service Manager's Signature
Customer's Signature

*MODEL CODES: ALTO-MRF308/310/410/308C, BALENO-MY416, MARUTI 800-MB308, ESTEEM-MF413/MF415D, GYPSY KING-MG413W, OMNI-MT308, VERSA-MGA413, WAGONR-MRD410, ZEN-MH410/MH415D, SWIFT-RS412/RS413/RS413D, SK4-RW416/416C, GRAND VITARA XL7-JA62Z, ZEN ESTILO-RK410/310/310C, SWIFT DZIRE-RN412/RN413/RN413D, A-STAR-AMF310, RITZ-ASE412/A5E413D, EECO-MGA412/412C, NEW WAGONR-A1J310/310C, ALTO800-AOD308/308C, ERTIGA-AVI414/413D, CELERIO-AVH310/310C, NEW SWIFT-AZI412/413D, NEW SWIFT DZIRE - AZI412PN/413DN, CIAZ-AVB414/AVB413D.

Stamp of Selling dealer (Code & Full Address)

For Servicing Dealer/Mass

- 1.0 : Please fill up Model codes correctly.
- 2.0 : Please fill up Complete chasis No.
- 3.0 : Please fill up customer details i.e. Address and Telephone No. legibly and correctly of the latest owner.

For Selling Dealer

- 1.0 : Please send all Free Service Coupon to us once in a month after settlement of free service charges.

Service Division
Maruti Suzuki India Limited

Model Code									
Chassis No. :									
Engine No. :									
Mileage									
Date of Delivery									
Date of Inspection									
Registration No.									
Service Dealer/Mass Code									

<i>Mechanic's Signature</i>
<i>Service Manager's Signature</i>
<i>Customer's Signature</i>

Stamp of Selling dealer (Code & Full Address)

For Servicing Dealer/Mass

- 1.0 : Please fill up Model codes correctly.
- 2.0 : Please fill up Complete chasis No.
- 3.0 : Please fill up customer details i.e. Address and Telephone No. legibly and correctly of the latest owner.

For Selling Dealer

- 1.0 : Please send all Free Service Coupon to us once in a month after settlement of free service charges.

Service Division
Maruti Suzuki India Limited

Model Code									
Chassis No. :									
Engine No. :									
Mileage									
Date of Delivery									
Date of Inspection									
Registration No.									
Service Dealer/Mass Code									

<i>Mechanic's Signature</i>
<i>Service Manager's Signature</i>
<i>Customer's Signature</i>

TABLE OF CONTENTS

FUEL RECOMMENDATION	1
BEFORE DRIVING	2
OPERATING YOUR VEHICLE	3
DRIVING TIPS	4
OTHER CONTROL AND EQUIPMENT	5
VEHICLE LOADING AND TOWING	6
INSPECTION AND MAINTENANCE	7
EMERGENCY SERVICE	8
APPEARANCE CARE	9
GENERAL INFORMATION	10
SPECIFICATIONS	11
SERVICE NETWORK	12

FOREWORD

This manual is an essential part of your vehicle and should remain with the vehicle when resold or otherwise transferred to a new owner or operator. Please read this manual carefully before operating your new MARUTI SUZUKI and review the manual from time to time. It contains important information on safety, operation and maintenance. You are invited to avail the three Free Inspection Services as described in the manual. Three free inspection coupons are attached to this manual. Please show this manual to your dealer while you take your MARUTI SUZUKI for any Service.

To prolong the life of your vehicle and reduce maintenance cost, the periodic maintenance must be carried out according to "PERIODIC MAINTENANCE SCHEDULE" described in "INSPECTION AND MAINTENANCE" section of this manual. It is essential for preventing trouble and accidents to ensure your satisfaction and safety.

Daily inspection and care as per "DAILY INSPECTION CHECKLIST" described in the "INSPECTION AND MAINTENANCE" section of this manual is essential for prolonging the life of the vehicle and for safe driving.

MARUTI SUZUKI INDIA LIMITED believes in conservation and protection of Earth's natural resources.

To that end, we encourage every vehicle owner to recycle, trade-in or properly dispose of, as appropriate, used Engine Oil, coolant and other fluids, batteries and tyres etc.

MARUTI SUZUKI INDIA LIMITED

All information in this manual is based on the latest product information available at the time of publication. Due to improvements or other changes, there may be discrepancies between information in this manual and your vehicle. MARUTI SUZUKI INDIA LIMITED reserves the right to make production changes at any time, without notice and without incurring any obligation to make the same or similar changes to vehicles previously built or sold.

This vehicle may not comply with standards or regulations of other countries. Before attempting to register this vehicle in any other country, check all applicable regulations and make any necessary modifications.

IMPORTANT

▲ WARNING/ ▲ CAUTION/NOTICE/ NOTE

Please read this manual and follow its instructions carefully. To emphasize special information, the symbol  and the words **WARNING**, **CAUTION**, **NOTICE** and **NOTE** have special meanings. Pay particular attention to messages highlighted by these signal words:

▲ WARNING

Indicates a potential hazard that could result in death or serious injury.

▲ CAUTION

Indicates a potential hazard that could result in minor or moderate injury.

NOTICE

Indicates a potential hazard that could result in vehicle damage.

NOTE:

Indicates special information to make maintenance easier or instructions clearer.

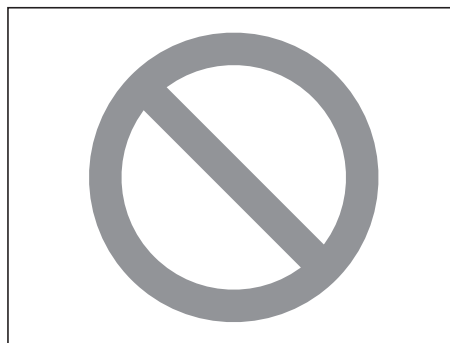

75F135

The circle with a slash in this manual means "Don't do this" or "Don't let this happen".

MODIFICATION WARNING

▲ WARNING

Do not modify your vehicle. Modification could adversely affect safety, handling, performance, or durability and may violate governmental regulations. In addition, damage or performance problems resulting from modification may not be covered under warranty.

NOTICE

Improper installation of mobile communication equipment such as cellular telephones or CB (Citizen's Band) radios may cause electronic interference with your vehicle's ignition system, resulting in vehicle performance problems. Consult your MARUTI SUZUKI dealer for advice on installing such mobile communication equipment.

▲ WARNING

Severe damage may be caused by the use of either poor quality fuel and/or lubricants not recommended by MARUTI SUZUKI.

VEHICLE DETAILS

MODEL	CHASSIS NO.	ENGINE NO.	KEY NO.	DATE OF DELIVERY	ODOMETER READING (KM)	BATTERY	
						MAKE	SR.NO. BATCH CODE

OWNER'S NAME & ADDRESS _____ _____ _____ _____ TEL.NO. _____
--

ADRESS/STAMP OF SELLING DEALER	SELLING DEALER CODE
SHOWROOM	
WORKSHOP	IMPORTANT INFORMATION TO CUSTOMER Dear Customer, For any assistance with regard to our product, please contact General Manager/Works Manager at any of our Dealer or Authorised Service Station. For additional enquiry you may contact our Regional Office or Service Department. The Addresses and Phone nos. are given in Service Network section of this Manual.

WARRANTY POLICY

Maruti Suzuki India Limited (hereinafter called "Maruti Suzuki"), warrants that each new Maruti Suzuki vehicle distributed in India by Maruti Suzuki and sold by an authorised Maruti Suzuki dealer will be free, under normal use and service, from any defects in material and workmanship at the time of manufacture SUBJECT TO THE FOLLOWING TERMS AND CONDITIONS:

(1) Qualification:

To qualify for this warranty:

- (a) The Maruti Suzuki vehicle must be delivered by Maruti Suzuki authorised dealer and set-up, serviced by Maruti Suzuki authorised dealer / service station.
- (b) The warranty registration card in respect of each vehicle must be completed by the dealer at the time of delivery of the vehicle and dealer should retain the same.

(2) Term:

The term of the warranty shall be twenty-four (24) months or 40,000 kilometers (whichever occurs first) from the date of delivery to the first owner.

(3) Maruti Suzuki Warranty Obligation:

If any defect(s) should be found in a Maruti Suzuki vehicle within the term stipulated above, Maruti Suzuki's only obligation is to repair or replace at its sole discretion any part shown to be defective, with a new part or the equivalent at no cost to the owner for parts or labour, when Maruti Suzuki acknowledges that such a defect is attributable to faulty material or workmanship at the time of manufacture. The owner is responsible for any repair or replacements which are not covered by this warranty.

(4) Limitation:

This warranty shall not apply to:

- 1) Normal maintenance service required other than the three free services, including without limitation, oil and fluid changes, headlight aiming, fastener retightening, wheel balancing, wheel alignment and tyre rotation, cleaning of injectors, adjustments of carburettor, ignition timing, clutch and valve clearance.
- 2) The replacement of normal wear parts including without limitation, bulbs, tyres and tubes, spark plugs, belts, hoses, filters, wiper blades, brushes, contact points, fuses, clutch disc, brake shoes, brake pads, cable and all rubber parts (except oil seal and glass run).
- 3) Any vehicle which has been used for competition or racing.
- 4) Any repairs or replacement required as a result of accidents or collision.
- 5) Any defects caused by misuse, negligence, abnormal use or insufficient care.
- 6) Any vehicle which has been modified or altered, including without limitation, the installation of performance accessories.
- 7) Any vehicle on which parts or accessories not approved by Maruti Suzuki have been used.
- 8) Any vehicle which has not been operated in accordance with the operating instructions in the Maruti Suzuki Owner's Manual.
- 9) Any vehicle which has not received, during the warranty term, the service inspections prescribed in the Maruti Suzuki Owner's Manual.
- 10) Any vehicle which has been assembled, disassembled, adjusted or repaired by other than an Maruti Suzuki authorised dealer/service station.

- 11) Any vehicle which has been used for purposes other than what it was designed for.
- 12) Any damage or deterioration caused by industrial pollution and bird droppings.
- 13) Insignificant defects which do not affect the function of the vehicle including without limitation, sound, vibration and fluid seep.
- 14) Any natural wear and tear including without limitation, aging etc.
- 15) Installation and usage of domestic LPG gas/LPG Cylinder.
- 16) V-belts, hoses and gas leaks (For Maruti Suzuki AC vehicle).
- 17) Any vehicle retrofitted with LPG/CNG kits.

(5) Extent of Warranty:

This warranty is the entire written warranty given by Maruti Suzuki for Maruti Suzuki vehicles and no dealer or its or his agent or employee is authorised to extend or enlarge this warranty and no dealer or its or his agent or employee is authorised to make any oral warranty on Maruti Suzuki's behalf.

Maruti Suzuki reserves the right to add any improvements or change the design of any model at any time with no obligation to make the same changes on units previously sold.

(6) Warranty Service:

To obtain warranty service, the complete vehicle must be presented at the owner's expenses to any authorised Maruti Suzuki dealer.

(7) Owner's Warranty Responsibilities:

It is responsibility of each owner to:

- Make certain that the warranty registration/PDI card was completed at the time of delivery of the vehicle;

- Have performed, at his own expenses, by an Maruti Suzuki authorised dealer/service station all the service inspections specified in the Maruti Suzuki "Owner's Manual and Service Booklet and maintain adequate proof that such service inspections have been performed.
- Make certain that the Maruti Suzuki authorised dealer/service station performing the service inspection has certified the work on the "Maintenance Service Record" page in the "Owner's Manual and Service Booklet and
- Present the Maruti Suzuki "Owner's Manual and Service Booklet to the authorised Maruti Suzuki dealer whenever requesting service inspections or warranty service.

If the "Owner's Manual and Service Booklet should be lost or destroyed the owner should consult the authorised Maruti Suzuki dealer from whom the vehicle was purchased for instructions concerning replacement of the "Owner's Manual and Service Booklet.

(8) Disclaimer of Consequential Damage:

Maruti Suzuki assumes no responsibility for loss of vehicle, loss of time, inconvenience or any other indirect incidental or consequential damage resulting from the vehicle not being available to the owner because of any defect covered by this warranty.

(9) Change of Owner

Even if ownership of the vehicle changes, the remaining warranty period is effective for the new owner.

EMISSION WARRANTY POLICY

Maruti Suzuki offers the Emission Warranty on all Maruti Suzuki vehicles (apart from the Regular Warranty and will run parallel to the regular product warranty) only in four metropolitan cities (New Delhi, Kolkata, Mumbai and Chennai) with effect from July 1st, 2001.

Terms:

The Emission Warranty will be applicable for 80,000 kms or 3 years (Whichever comes earlier) from the date of delivery to the first owner. The remaining warranty terms will be valid in case of any change in ownership provided the production of all valid documents.

Conditions:

1. Under Emission Warranty, Warranty claims will be admitted for a prima facie examination, in case vehicle fails to meet the Emission Standard as specified in sub rule (2) of rule no. 115 of Central Motor Vehicles Rules (CMVR), 1989.
2. The warranty claims will only be accepted after examination carried out by Maruti Suzuki or its dealer which leads to firm conclusions that the
 - a) Original settings have not been tempered in any case.
 - b) Part (as given in Annexure - A) has a manufacturing defect.
 - c) Vehicle is unable to meet the Emission Standards (as given in 1.), in spite of the vehicle having been maintained and used in accordance with the instructions as specified in Owner's Manual and Service Booklet and the used fuel and different oils (Engine oil, Transmission oil, Brake oil etc.) are also as per specification.
3. The method of examination for deciding the warranty of the parts will be at the sole discretion of Maruti Suzuki and its dealer and results of the examination will be final and binding. If after examination, the warrantable condition is not established, Maruti Suzuki and its dealer has the right to charge all, or part of the cost of such examination.
4. Under Emission Warranty, the parts (as given in Annexure - A) will be changed free of cost, but the consumables will be charged as per actual.
5. If the part covered under Emission Warranty or the associated parts, are not independently replaceable, on account of these being integral parts of a complete assembly, Maruti Suzuki and its dealer will have the sole discretion to replace either the entire assembly or by using some of the parts of the system through suitable repairs or modifications.
6. Any consequential repairs or replacement of parts which may be found necessary to establish compliance of Emission Warranty, will not be considered under warranty, unless the same is under product warranty. The consumable will be charged as per actual under such repair or replacement.
7. Maruti Suzuki will not be responsible for the cost of transportation of the vehicle to the nearest Maruti Suzuki dealer workshop or any loss due to non-availability of the vehicle during the period of lodging of a warranty claim and examination and/or repair by Maruti Suzuki dealer.
8. Maruti Suzuki will not be responsible for any penalty that may be charged by statutory authorities on account of failure to comply with the EMISSION STANDARDS.
9. Emission Warranty will not be affected on the change of owner, provided all the documents are available.

10. All maintenance actions (as specified in the Owner's Manual and Service Booklet) need to be followed and recorded in the manual for emission warranty.

11. The customer needs to produce the PUC (Pollution Under Control) certificate valid for the period preceeding the test during which the failure is discovered. The receipts (for the maintenance of the vehicle as per specification in Owner's Manual and Service Booklet from the date of original purchase of the vehicle) will also be required.

Conditions under which the Emission Warranty is not APPLICABLE

1. In the absence of valid PUC certificate.
2. Vehicle not serviced from Maruti Suzuki authorised workshop as per the schedule specified in the Owner's Manual.
3. Vehicle subjected to abnormal use (accident, motor race, rallies or for the purpose of establishing the records etc).
4. Use of non MGP (Maruti Genuine Part).
5. Vehicle tampered in an unauthorised manner.
6. Tampering with odometer so that the actual kilometer reading can not be read.
7. Use of adulterated fuel and/or unspecified oils (Engine oil, Transmission oil and Brake oil etc).

Annexure - A

List of parts covered under Emission Warranty

1. Fuel Injection Assembly, Pressure Regulator, Throttle Body Assembly.
2. Electronic Control Module (ECM).
3. Intake Manifold.
4. EGR valve.
5. Distributor and internal parts.
6. Ignition Coil.
7. Canister Assembly.
8. Vapour Liquid Separator.
9. Fuel Tank and Filler Cap.
10. PCV (Positive Crankcase Ventilation) Valve.
11. Oil Filler Cap.
12. Catalytic Converter.
13. Exhaust Manifold.
14. All Fuel Injection System related SENSORS.
15. High Pressure Fuel Pump.
16. Glow Plug.
17. Glow Plug Controller.

FUEL RECOMMENDATION

FUEL RECOMMENDATION

Petrol Engine

You must use unleaded Petrol with an octane number (RON) of 91 or higher.

Petrol/Ethanol blends

Blends of unleaded petrol and ethanol (grain alcohol), also known as gasohol, are commercially available in some areas. Blends of this type may be used in your vehicle if they are no more than 10% ethanol. Make sure this petrol-ethanol blend has octane ratings no lower than those recommended for petrol.

Petrol/Methanol blends

Blends of unleaded Petrol and methanol (wood alcohol) are also commercially available in some areas. DO NOT USE fuels containing more than 5% methanol under any circumstances. Fuel system damage or vehicle performance problems resulting from the use of such fuels are not the responsibility of MARUTI SUZUKI and may not be covered under the New Vehicle Warranty. Fuels containing 5% or less methanol may be suitable for use in your vehicle if they contain cosolvents and corrosion inhibitors.

NOTE:

If you are not satisfied with the driveability or fuel economy of your vehicle when you are using a Petrol/alcohol blend, you should switch back to unleaded Petrol containing no alcohol.

NOTICE

The fuel tank has an air space to allow for fuel expansion in hot weather. If you continue to add fuel after the filler nozzle has automatically shut off or an initial blowback occurs, the air chamber will become full. Exposure to heat when fully fuelled in this manner will result in leakage due to fuel expansion. To prevent such fuel leakage, stop filling after the filler nozzle has automatically shut off, or when using an alternative non-automatic system, initial vent blowback occurs.

NOTICE

Be careful not to spill fuel containing alcohol while refueling. If fuel is spilled on the vehicle body, wipe it up immediately. Fuels containing alcohol can cause paint damage, which is not covered under the New Vehicle Limited Warranty.

Diesel Engine

The diesel fuel should be with Cetane Number (CN) higher than 51 and sulfur content less than 350 ppm (parts per million). MARUTI SUZUKI recommends to use the diesel fuel conformable to EN590. Do not use marine diesel fuel, heating oils and so forth.

NOTICE

The fuel tank has an air space to allow for fuel expansion in hot weather. If you continue to add fuel after the filler nozzle has automatically shut off or an initial blowback occurs, the air chamber will become full. Exposure to heat when fully fuelled in this manner will result in leakage due to fuel expansion. To prevent such fuel leakage, stop filling after the filler nozzle has automatically shut off, or when using an alternative non-automatic system, initial vent blowback occurs.

NOTICE

Be careful not to spill fuel containing alcohol while refueling. If fuel is spilled on the vehicle body, wipe it up immediately. Fuels containing alcohol can cause paint damage, which is not covered under the New Vehicle Limited Warranty.

BEFORE DRIVING

BEFORE DRIVING

Keys 2-1
Door Locks 2-2
Central Door Locking System (if equipped) 2-2
Keyless Push Start System Remote Controller/Keyless
Entry System Transmitter 2-5
Alarm System (If equipped)..... 2-12
Security System (If equipped)..... 2-20
Windows 2-23
Mirrors 2-25
Heated Rear Window Switch (if equipped) 2-26
Front Seats 2-26
Rear Seats 2-28
Folding Rear Seat 2-29
Seat Belts and Child Restraint Systems 2-30
Driver’s Seat Belt Reminder (if equipped) 2-34
Supplemental Restraint System (air bags)
(if equipped) 2-39
Instrument Cluster 2-44
Warning and Indicator Lights 2-46
Speedometer 2-51
Tachometer (if equipped) 2-51
Fuel Gauge 2-51
Temperature Gauge 2-52
Brightness Control 2-52
Information Display 2-53
Lighting Control Lever 2-60
Headlight Leveling Switch 2-61
Turn Signal Control Lever 2-61
Hazard Warning Switch 2-62
Windshield Wiper and Washer Lever 2-62
Tilt Steering Lock Lever 2-64
Horn 2-64

BEFORE DRIVING

Keys

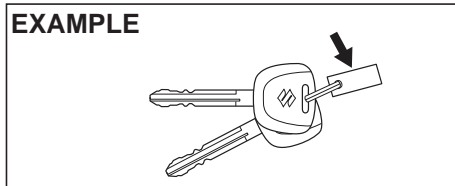

Your vehicle comes with a pair of identical keys. Keep the spare key in a safe place. One key can open all of the locks on the vehicle.

The key identification number is stamped on a metal tag provided with the keys or on the keys. Keep the tag (if equipped) in a safe place. If you lose your keys, you will need this number to have new keys made. Write the number below for your future reference.

KEY NUMBER:

Immobilizer System

This system is designed to help prevent vehicle theft by electronically disabling the engine starting system.

The engine can be started only with your vehicle's original immobilizer ignition key or keyless push start system remote controller which has an electronic identification code programmed into it. The key or remote controller communicates the identi-

fication code to the vehicle when the ignition switch is turned to the "ON" position or the engine switch is pressed to change the ignition mode to "ON". If you need to make spare keys or remote controllers, see your MARUTI SUZUKI dealer. The vehicle must be programmed with the correct identification code for the spare. A key made by an ordinary locksmith will not work.



If the immobilizer/keyless push start system warning light blinks when the ignition switch is in the "ON" position or the ignition mode is "ON", the engine will not start.

For vehicles without keyless push start system

If this light blinks, turn the ignition switch to the "LOCK" position, then turn it back to the "ON" position.

If the light still blinks after the ignition switch is turned back to the "ON" position, there may be something wrong with your key or with the immobilizer system. Ask your MARUTI SUZUKI dealer to have the system inspected.

For vehicles with keyless push start system

If this light blinks, change the ignition mode

to "LOCK" (OFF), then change back to "ON". Also refer to "If the master warning indicator light blinks and the engine cannot be started" in "Starting the Engine (Vehicle with Keyless Push Start System)" in the "OPERATING YOUR VEHICLE" section.

If the light still blinks after the ignition mode is changed back to "ON", there may be something wrong with your key or with the immobilizer system. Ask your MARUTI SUZUKI dealer to have the system inspected.

The immobilizer/keyless push start system warning light may also blink if the remote controller is not in the vehicle when you close the door or attempt to start the engine.

NOTE:

- If you lose your immobilizer ignition key or remote controller, see your MARUTI SUZUKI dealer as soon as possible to have the lost one deactivated, then have the new key or remote controller made by them.
- If you own other vehicles with immobilizer keys, keep those keys away from the ignition switch or the engine switch when using your Vehicle, or the engine may not be started because they may interfere with your Vehicle immobilizer system.
- If you attach any metal objects to the immobilizer key or remote controller, it may not start the engine.

BEFORE DRIVING

NOTICE
<p>The immobilizer key and remote controller are sensitive electronic instruments. To avoid damaging them:</p> <ul style="list-style-type: none"> • Do not expose them to impacts, moisture or high temperature such as on the dashboard under direct sunlight. • Keep them away from magnetic objects..

Ignition Key Reminder (if equipped)
 A buzzer sounds intermittently to remind you to remove the ignition key if it is in the ignition switch when the driver's door is opened.

Door Locks

Side Door Locks

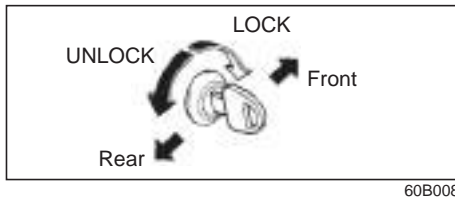

To lock a front door from outside the vehicle:

- Insert the key and turn the top of the key towards the front of the vehicle, or

- Turn the lock knob forward, then pull and hold the door handle as you close the door.

To unlock a front door from outside the vehicle, insert the key and turn the top of the key toward the rear of the vehicle.

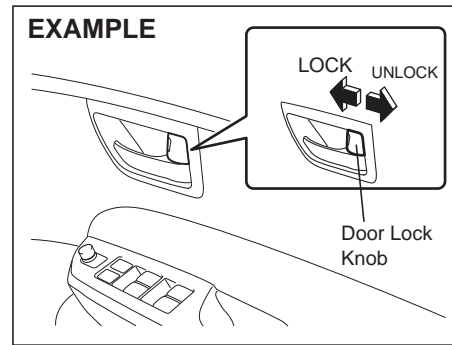

To lock a door from inside the vehicle, turn the lock knob forward. Turn the lock knob backward to unlock the door.

To lock a rear door from outside the vehicle, turn the lock knob forward and close the door.

NOTE:
Be sure to hold the door handle when you close a locked front door, or the door will not remain locked.

Central Door Locking System (if equipped)

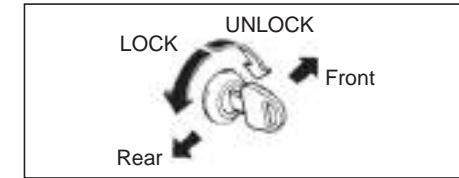

You can lock and unlock all 5 doors (Front, Rear and Back door) or 4 doors (Front and Rear only) (Depending upon the specification of the vehicle) simultaneously by using the key in the driver's door lock.

To lock all (4 or 5) doors simultaneously, insert the key in the driver's door lock and turn the top of the key anticlockwise.

To unlock all (4 or 5) doors simultaneously, insert the key in the driver's door lock and turn the top of the key clockwise.

BEFORE DRIVING

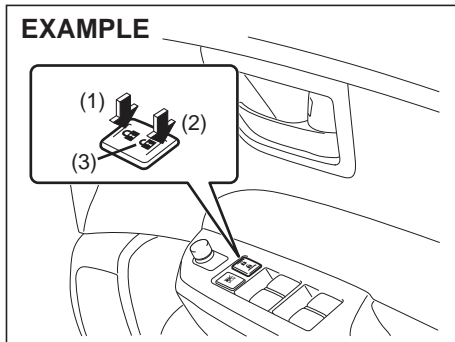

- (1) LOCK
- (2) UNLOCK

You can also lock or unlock all doors by depressing the front or rear of the switch, (3) respectively.

Note:

- Individual doors can also be UNLOCKED anytime by using their respective "Door Lock Knob" inside the vehicle.
- If child proof locks are in locked position, rear doors cannot be opened from inside.

NOTE:

- You can also lock or unlock all doors by operating the transmitter or remote controller. Refer to "Keyless Push Start System Remote Controller/Keyless Entry System Transmitter" in this section.
- If your vehicle is equipped with the keyless push start system, you can also lock or unlock all doors by pushing the request switch. Refer to "Keyless Push Start System Remote Controller/Keyless Entry System Transmitter" in this section.

NOTE:

- All doors are automatically unlocked when you change the ignition mode to "LOCK" (OFF) or turn the ignition switch to the "LOCK" position and pull out the key.
- All doors are automatically locked for safety when the vehicle speed reaches 15 km/h.

You can change the automatic locking or unlocking function mentioned above via the setting mode of the information display. For details on how to use the information display, refer to "Information Display" in this section.

Child-Proof Locks (rear door)

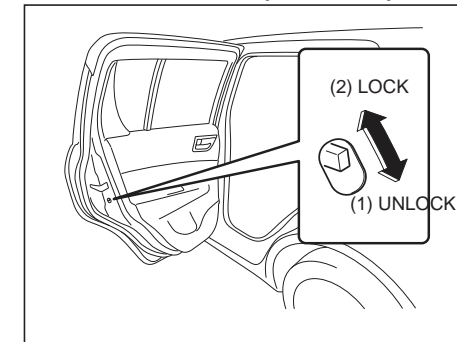

As illustrated, a child-proof lock is provided for both rear doors. When the lock lever is in position (1), the child-proof lock is locked, and when in position (2), the child-proof lock is unlocked. When the childproof lock is in the locked position, the rear door cannot be opened from the inside even if the inside door lock is unlocked but can be opened from the outside.

⚠ WARNING

Be sure to place the child-proof lock in the locked position whenever children are seated in the rear.

BEFORE DRIVING

Tailgate

Type 1

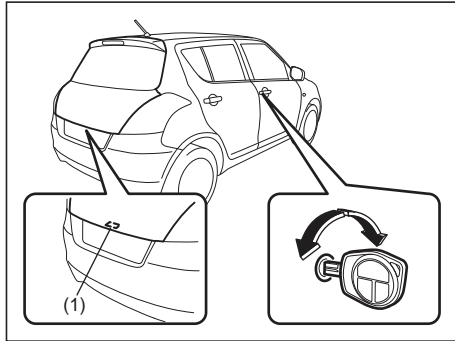

74LHT0203

(1) Tailgate unlatch switch

(Vehicle with keyless entry system)

You can lock and unlock the tailgate by using the key in the driver's door lock.

To open the tailgate, push and hold the tailgate unlatch switch (1) and lift the tailgate.

(Vehicle with keyless push start system)

You can lock or unlock the tailgate by pushing the request switch, when the keyless push start system remote controller is within the switch's operating range. For details refer to "Keyless Push Start System Remote Controller/Keyless Entry System Transmitter"

To open the tailgate push the tail gate unlatch switch (1) and lift the tail gate to open the trunk lid.

The tail gate unlatch switch (1) operates only to open the tail gate.

If you close the trunk lid with the keyless push start system remote controller left in the trunk with all the doors locked, the tail gate will be automatically unlatched.

NOTE:

When the tailgate is closed incompletely, follow the procedure below:

- 1) Push the tailgate unlatch switch (1) and open the tailgate a little.
- 2) After a few seconds, close the tailgate.
- 3) Make sure that the tailgate is closed completely.

Type 2

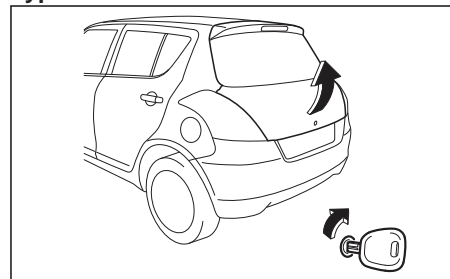

68LM245

To open the tailgate, insert the key and turn it clockwise to unlatch and lift the tailgate.

⚠ WARNING

Always make sure that the tailgate is closed and latched securely. Completely closing the tailgate helps prevent occupants from being thrown from the vehicle in the event of an accident. Completely closing it also helps keep exhaust gases from entering the vehicle.

If you cannot unlatch the tailgate by pushing the unlatch switch (1) due to a discharged battery or malfunction, follow the procedures below to unlatch the tailgate from inside the vehicle.

- 1) Fold the rear seat forward for easier access. Refer to "Folding Rear Seat" section for details on how to fold the rear seat forward.

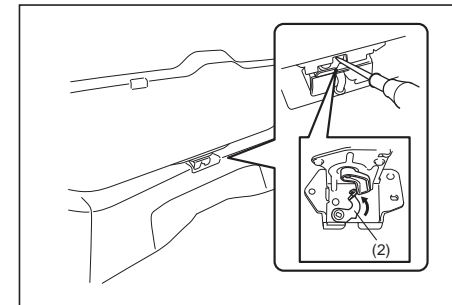

68LM246

BEFORE DRIVING

- 2) Push open the tailgate from inside by pushing up on the emergency lever (2) using a flat blade screwdriver or the jack handle. The tailgate will be latched again by closing the tailgate simply.

If the tailgate cannot be unlatched by pushing the unlatch switch (1), have the vehicle inspected by your MARUTI SUZUKI dealer.

⚠ CAUTION

- To avoid injury, do not use your finger to push the emergency lever.
- Make sure there is no one near the tailgate when pushing open the tailgate from inside the vehicle.

Trunk Lid (if equipped)

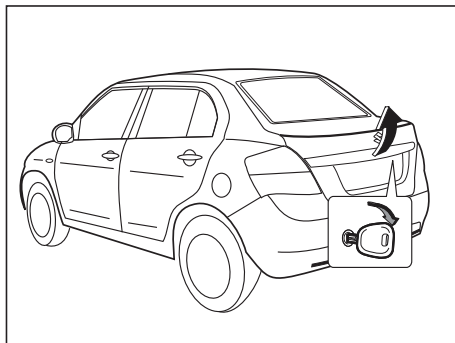

68LM246

If the vehicle is equipped with a trunk lid keylock. You can open the trunk lid by using the key in the trunk lid lock. To open the trunk lid, insert the key and turn it clockwise to unlatch and lift the trunk lid

⚠ WARNING

Always make sure that the trunk lid is fully opened before using the luggage compartment.

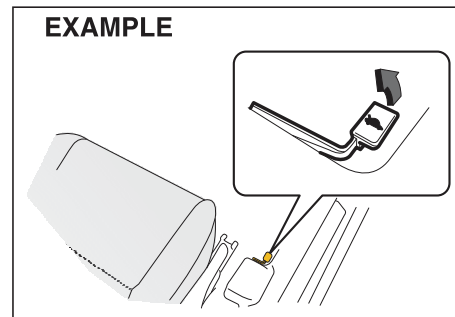

63J054

You can also unlatch the tailgate-trunklid by pulling the release lever (if equipped) located on the outboard side of the driver's seat.

⚠ WARNING

Always make sure that the trunk lid is fully opened before using the luggage compartment.

Keyless Push Start System Remote Controller/Keyless Entry System Transmitter)

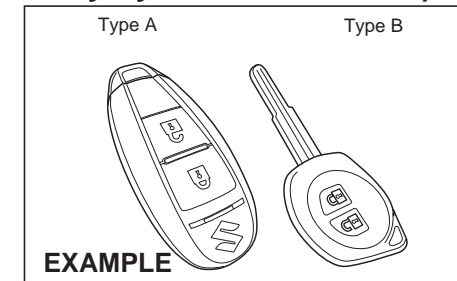

79MH0205

Your vehicle is equipped with either a keyless push start system remote controller (Type A) or a keyless entry system transmitter (Type B). The remote controller has a keyless entry system and a keyless push start system. The transmitter has only a keyless entry system. For details, refer to the following explanations.

BEFORE DRIVING

▲ WARNING

Radio waves from the keyless push start system antenna(s) may interfere with operation of electrical medical equipment such as pacemakers. Failure to take the precautions listed below can increase the risk of severe injury or death due to radio wave interference.

- Anyone who uses electrical medical equipment such as a pacemaker should consult the medical equipment supplier or their medical advisor about whether radio waves from the antenna(s) can interfere with the medical equipment.
- If radio wave interference is a concern, have the function of the antenna(s) disabled by your MARUTI SUZUKI dealer.

Keyless Push Start System Remote Controller (Type A)

The remote controller enables the following operations:

- You can lock or unlock the doors by operating the LOCK/UNLOCK buttons on the remote controller. Refer to the explanation in this section.
- You can lock or unlock the doors by pushing the request switch. For details, refer to the explanation in this section.
- You can start the engine without using an ignition key. For details, refer to "Engine Switch" in the "OPERATING YOUR VEHICLE" section.

2-6

EXAMPLE

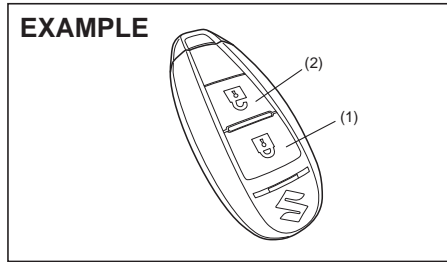

79MH0206

- (1) "LOCK" button
- (2) "UNLOCK" button

You can lock or unlock all doors simultaneously by operating the remote controller near the vehicle.

Central door locking system

- To lock all doors, push the "LOCK" button (1) once.
- To unlock all door, push the "UNLOCK" button (2).

The turn signal lights will flash once and the siren will sound once when the doors are locked.

When the doors are unlocked:

- The turn signal lights will flash twice and the siren will sound twice.
- If the interior light switch is in the "DOOR" position, the interior light will turn on for about 15 seconds and then fade out. If you press the engine switch during this time, the light will start to fade out immediately.

Be sure the doors are locked after you operate the "LOCK" button (1).

If no door is opened within about 30 seconds after the "UNLOCK" button (2) is operated, the doors will automatically lock again.

Panic alarm function

This function is to get the attention of others. Push both of the "LOCK" button (1) and "UNLOCK" button (2) for more than 3 seconds.

The turn signal lights will blink for about 27.5 seconds. Also, the siren will sound for about 27.5 seconds at the same time.

To cancel the panic alarm, press any button (LOCK or UNLOCK). You can also press the engine switch to change the ignition mode to "ON" to cancel the panic alarm.

NOTE:

The panic alarm function will not activate when the ignition mode is "ACC" or "ON".

NOTE:

- If you lock the doors using the remote controller when the tail gate or engine hood are open, the siren will sound 3 times to remind you.
- If the security system was triggered due to an unauthorized entry into the vehicle and then you unlock the doors using the remote controller, the siren will sound 4 times to remind you. If this happens, check whether your vehicle has been broken into while you were away from it.
- Once you push both of the "LOCK" button (1) and "UNLOCK" button (2), then you

BEFORE DRIVING

push one of the buttons within 5 seconds, the siren will not sound. However, if you push one of the buttons twice within 5 seconds, or push one of the buttons 5 seconds later, the siren will sound.

- You can set whether the siren sounds when locking or unlocking the door(s) via the setting mode of the information display. For details on how to use the information display, refer to "Information Display" in this section.

NOTE:

- The maximum operating distance of the remote controller is about 5 m (16 ft.), but this can vary depending on the surroundings, especially near other transmitting devices such as radio towers or CB (Citizen's Band) radios.
- The door locks cannot be operated with the remote controller if the ignition mode is other than the "LOCK" (OFF).
- If any door is open, you cannot lock the door by operating the remote controller, however unlock the door.
- If you lose one of the remote controllers, ask your MARUTI SUZUKI dealer as soon as possible for a replacement. Be sure to have your dealer program the new remote controller code in your vehicle's memory so that the old code is erased.

Keyless unlocking/locking using the request switches

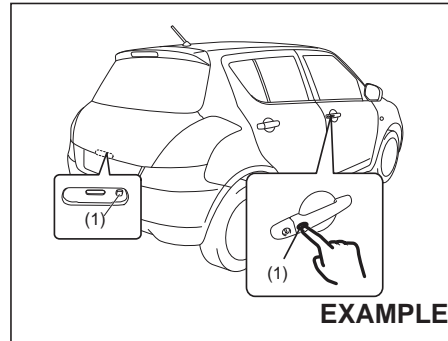

79MH0207

When the remote controller is within the operating range described in this section, you can lock or unlock the doors by pushing the request switch (1) on the driver's door handle, front passenger's door handle or tailgate.

To lock all doors when all doors are unlocked:

- push one of the request switches once.

The turn signal lights will flash once and the exterior siren will sound once when the doors are locked.

To unlock doors:

- Push one of the request switches to unlock all door.

When the doors are unlocked:

- The turn signal lights will flash twice and the exterior siren will sound twice.
- If the interior light switch is in the "DOOR" position, the interior light will turn on for about 15 seconds and then fade out. If you press the engine switch during this time, the light will start to fade out immediately.

Be sure the doors are locked after you operate the request switch to lock the doors.

NOTE:

- The door locks cannot be operated by the request switch under the following conditions:
 - If any door is open or is not completely closed.
 - If the ignition mode is other than "LOCK" (OFF).
- If no doors are opened within about 30 seconds after unlocking the doors by pushing the request switch, the doors will be locked again automatically.

BEFORE DRIVING

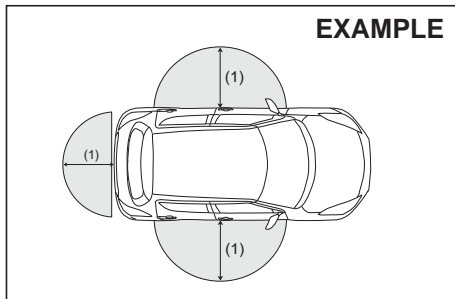

79MH0208

(1) 80 cm (2 1/2 feet)

When the remote controller is within approximately 80 cm (2 1/2 feet) from a front door handle, you can lock or unlock the doors by pushing the request switch.

NOTE:

- If the remote controller is outside the request switch operating range described above, you will not be able to operate the request switch.
- If the battery of the remote controller runs down or there are strong radio waves or noise, the request switch operating range may be reduced or the remote controller may be inoperative.
- If the remote controller is too close to the door glass, the request switches may not operate.
- If a spare remote controller is in the vehicle, the request switches may not operate normally.
- The remote controller will only operate a request switch if it is within the switch's operating range. For example, if the remote controller is within the operating range of the driver's door request switch but not the front passenger's door request switch, the driver's door switch can be operated but the front passenger's door switch cannot be operated.
- Avoid operations of switch with sharp objects or long nails.

NOTICE

The remote controller is a sensitive electronic instrument. To avoid damaging the remote controller:

- Do not expose it to impacts, moisture or high temperature such as by leaving it on the dashboard under direct sunlight.
- Keep the remote controller away from magnetic objects such as a television.

NOTE:

The keyless push start system may not function correctly in certain environments or under certain operating conditions such as the following:

- When there are strong signals coming from a television, power station or a cellular phone.
- When the remote controller is in contact with or covered by a metal object.
- When a radio wave type remote keyless entry is used nearby.
- When the remote controller is placed near an electronic device such as personal computer.

Some additional precautions you should take and information you should be aware of are:

- Make sure the key is stowed in the remote controller. If the remote controller becomes unreliable, you will not be able to lock or unlock the doors.

BEFORE DRIVING

- Be sure that the driver always carries the remote controller.
- If you lose one of the remote controllers, ask your MARUTI SUZUKI dealer as soon as possible for a replacement. Be sure to have your dealer program the new remote controller code in your vehicle's memory so that the old code is erased.
- You can use up to four remote controllers and the keys for your vehicle. Ask your MARUTI SUZUKI dealer for details.
- The battery life of the remote controller is about two years, but it can vary depending on usage conditions.

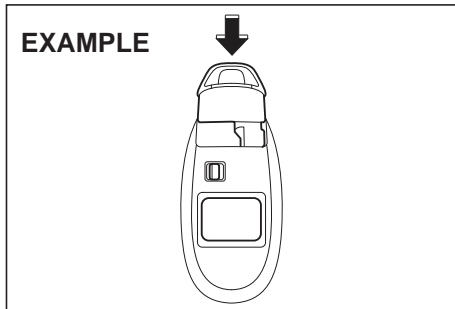

57L21016

To stow the key into the remote controller, push the key in the remote controller until you hear a click.

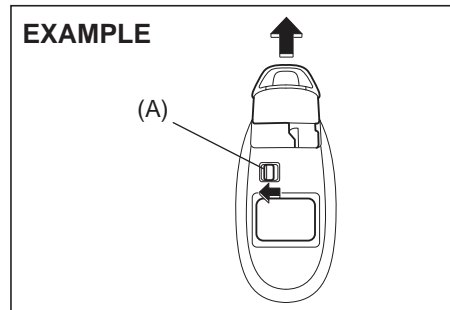

68LM247

To remove the key from the remote controller, push the button (A) in the direction of the arrow and pull the key out from the remote controller.

Request switch warning buzzer

This exterior buzzer beeps for about 2 seconds in the following conditions to warn you that the request switch is not working:

- The request switch is pressed after all doors are closed with the ignition mode changed to "ACC" or "ON" by pressing the engine switch.
- The request switch is pressed in any of the following conditions after changing the ignition mode to "LOCK" (OFF) by pressing the engine switch.
 - The remote controller is left inside the vehicle.
 - Any door is open.

Press the request switch again after doing the following:

With the ignition mode changed to "LOCK" (OFF) by pressing the engine switch, bring out the remote controller if it is inside the vehicle and check that all doors are completely closed.

Reminder function

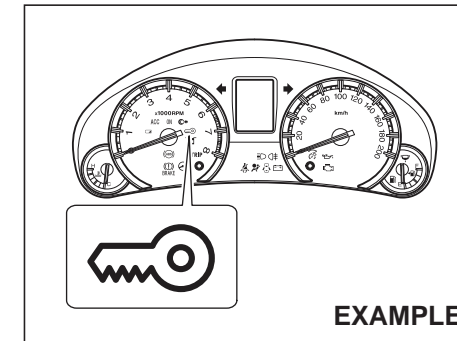

79MH0209

If the remote controller is not in the vehicle under the following conditions, the buzzer sounds intermittently for about 2 seconds and the immobilizer/keyless push start system warning light on the instrument cluster blinks:

When one or more doors are opened and all of the doors are later closed with the ignition mode is other than "LOCK".

BEFORE DRIVING

The indicator light will turn off within several seconds after the remote controller is returned to an area of the vehicle other than the luggage compartment.

If the remote controller is left in the vehicle and you lock the driver's door or front passenger's door or tailgate as described below, the door will be automatically unlocked.

- If you open the driver's door and lock the door by turning the lock knob forward or pushing the power door locking switch, the driver's door will be automatically unlocked.
- If you open the front passenger's door and lock the door by turning the lock knob forward or pushing the power door locking switch, the front passenger's door will be automatically unlocked.

If you close the trunk lid with the remote controller left in the trunk with all the doors locked, the trunk will be automatically unlatched.

NOTE:

- *The reminder will not operate when the remote controller is on the instrument panel, in the glove box, in a storage compartment, in the sun visor or on the floor etc.*
- *Be sure that the driver always carries the remote controller.*
- *Do not leave the remote controller in the vehicle when leaving the vehicle.*

Replacement of the battery

If the remote controller becomes unreliable, replace the battery.

To replace the battery of the remote controller:

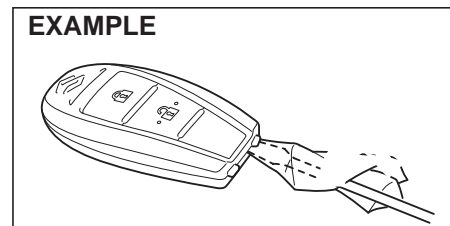

57L20201

- 1) Pull the key out from the remote controller.
- 2) Insert a flat blade screwdriver covered with a soft cloth in the slot of the remote controller and pry it open.

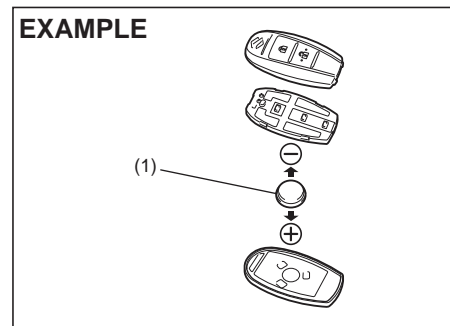

- (1) Lithium disc type battery: CR2032 or equivalent

- 3) Replace the battery (1) so its + terminal faces the bottom of the case as shown in the illustration.
- 4) Close the remote controller firmly.
- 5) Make sure the door locks can be operated with the remote controller.
- 6) Dispose of the used battery properly according to applicable rules or regulations. Do not dispose of lithium batteries with ordinary household trash.

⚠ WARNING
Swallowing a lithium battery may cause serious internal injury. Do not allow anyone to swallow a lithium battery. Keep lithium batteries away from children and pets. If swallowed, contact a physician immediately.

NOTICE
The remote controller is a sensitive electronic instrument. To avoid damaging it, do not expose it to dust or moisture or tamper with internal parts.

NOTE:
Used batteries must be disposed properly according to applicable rules or regulations and must not be disposed with ordinary household trash.

BEFORE DRIVING

Keyless Entry System Transmitter (Type B)

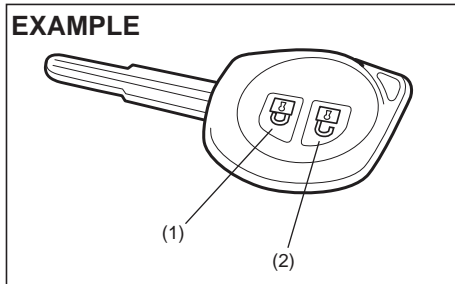

79MH0237

- (1) "LOCK" button
- (2) "UNLOCK" button

You can lock or unlock all doors simultaneously by operating the transmitter near the vehicle.

Central door locking system

- To lock all doors, push the "LOCK" button (1) once.
- To unlock all door, push the "UNLOCK" button (2) once.

The turn signal lights will flash once and the siren will sound once when the doors are locked.

When the doors are unlocked:

- The turn signal lights will flash twice and the siren will sound twice.

- If the interior light switch is in the "DOOR" position, the interior light will turn on for about 15 seconds and then fade out. If you insert the key into the ignition switch during this time, the light will start to fade out immediately.

Be sure the doors are locked after you operate the "LOCK" button (1). If no door is opened within about 30 seconds after the "UNLOCK" button (2) is operated, the doors will automatically lock again.

NOTE:

- The maximum operating distance of the keyless entry system transmitter is about 5 m (16 ft.), but this can vary depending on the surroundings, especially near other transmitting devices such as radio towers or CB (Citizen's Band) radios.
- The door locks cannot be operated with the transmitter, if the ignition key is inserted in the ignition switch.
- If any door is open, you cannot lock the door by operating the transmitter, however unlock the door.
- If you lose one of the transmitters, ask your MARUTI SUZUKI dealer as soon as possible for a replacement. Be sure to have your dealer program the new transmitter code in your vehicle's memory so that the old code is erased.

NOTICE

The transmitter is a sensitive electronic instrument. To avoid damaging the transmitter:

- Do not expose it to impacts, moisture or high temperature such as by leaving it on the dashboard under direct sunlight.
- Keep the transmitter away from magnetic objects such as a television.

BEFORE DRIVING

Security System (Vehicle with Keyless entry system)

The Alarm System has two basic modes of operation.

Valet Mode

In Valet Mode all the Security Alarm features of the system like arm/disarm, trigger are deactivated. In this mode, system will work as a Keyless Entry only. When the vehicle is given for servicing or valet parking, turn the system into Valet Mode.

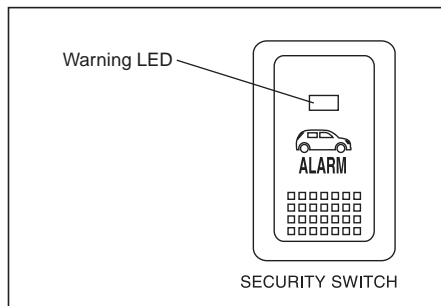

68LM24

ALARM MODE

The Alarm mode is designed to protect your vehicle from unauthorised entry. It operates in three stage :

First : Arm Stage
Second : Trigger Stage
Third : Disarm Stage

2-12

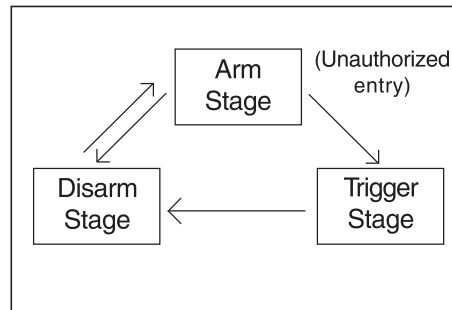

68LM2

Arm Stage

In Arm Stage, your vehicle is monitored for any unauthorized entry. In order to arm, press the key LOCK button once.

As response to locking/arming:

- 1) Doors will get locked & vehicle will get armed. This is indicated by one siren chirp & one light flash of all indicator lights.
- 2) Visible theft warning LED on security switch will flash slowly.

NOTE:

- 1) Three siren chirps and one light flash of all indicator lights will indicate that hood is open. However locking & arming of all doors take place.

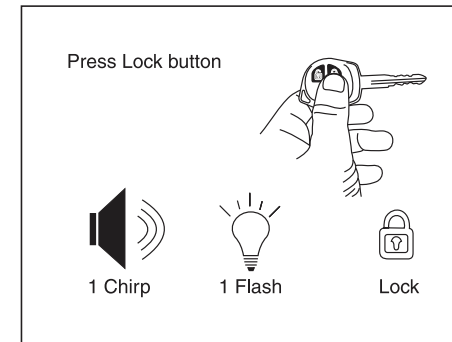

68LM2

- 2) Be sure to close the doors and windows before locking/arming the vehicle.
- 3) System will not Lock/Arm in following conditions
 - a) If any of door is open (except Hood)
 - b) If key is in key cylinder.

Trigger Stage

In the event of any unauthorized entry (without unlocking/disarming) into the vehicle, the alarm triggers and all indicator lights flash. The triggering of the alarm is in two stages. First acting as a warning to the intruder and then full blast drawing the surrounding attention. In order to bring the system to disarm stage, press UNLOCK button on the key or enter the Emergency Pin. (Described in Emergency disarm section).

BEFORE DRIVING

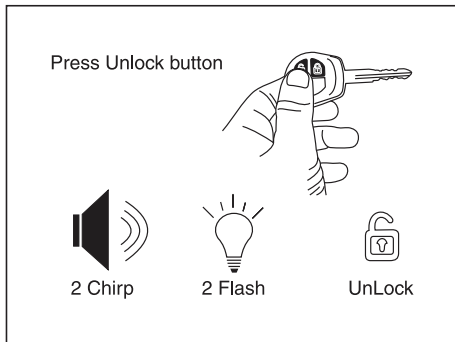

68LM2

Disarm Stage

System should be brought in Disarm Mode while you are entering the vehicle. In order to disarm: Press the key UNLOCK button once.

As response to unlocking/disarming:

- 1) Doors will unlock and vehicle will disarm. This is indicated by two siren chirps and two light flashes of all indicator lights.
- 2) Visible theft warning LED on security switch will flash faster than in arm stage indicating Auto rearm (described in auto rearm section).

Trigger Type	Alarm Cycle
Door Trigger (By Driver Door, Passenger Door, Hood & Back Door)	3 Cycle of 30 Sec each
Ignition Trigger	3 Cycle of 30 Sec each
Impact Trigger (Built in sensor Trigger)	1 Cycle of 30 sec

GENERAL FEATURES

Illuminated Entry

When vehicle is unlocked, the room lamp will turn ON to facilitate illuminated entry into the vehicle. If no door is opened in about 15 seconds of above operation, room lamp will fade out.

If any door is opened after 15 seconds, the room lamp turns ON again and after 15 seconds of closing all doors room lamp will fade out.

If within 15 seconds after closing all the doors the driver inserts the key into the key cylinder, then the room lamp will fade out.

Illuminated Exit

When key is removed from the key cylinder, the room lamp will turn ON to facilitate illuminated exit. If no door is opened in about 15 seconds of key removal from key cylinder, the room lamp will fade out.

When door is opened to exit the vehicle, the room lamp will turn ON again (if it has turned OFF after 15 seconds of key removal from key cylinder) and will turn OFF after 15 seconds of closing all the doors.

If within 15 seconds of all doors closure, vehicle is locked by pressing the LOCK button, the room lamp will fade out.

NOTE: Room lamp will fade out gradually approximately in 2 seconds.

Mute Lock/Unlock

To Arm/Disarm the vehicle without siren chirps use this function.

- a) Press and release the Key LOCK & UNLOCK buttons simultaneously.
- b) Press and release Key LOCK or UNLOCK button for desired function.

Example: To Lock/arm the system without the Siren chirp sound, press and release the Key LOCK & UNLOCK button simultaneously, then press and release the Key LOCK button once.

Auto Rearm

In case of accidental Unlock/Disarm of vehicle by Key, vehicle will automatically Lock & Arm within 30 sec. without any indication. Auto rearm cycle gets cancelled if user does any of the following operation within 30sec :

1. Open any door (including back door).
2. Open Hood.
3. Key On.

BEFORE DRIVING

NOTE: If the vehicle is in Valet mode, system will only lock the vehicle.

Radio Frequency Lock Out

Key Lock/Unlock/Panic will cease to function when Key is inside Key cylinder.

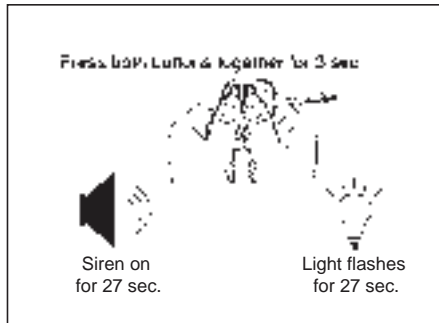

68LM2

Panic Alarm (Car Locator)

Panic Alarm feature can be used to bring the surrounding attention to the vehicle or to locate the vehicle in congested parking area.

- a) Press and hold the Key LOCK & UNLOCK button simultaneously for 3 seconds or more.
- b) Panic alarm will be activated and siren will sound and indicator lights will flash for 27 seconds.

- c) Press and release the Key LOCK & UNLOCK button simultaneously to cancel the Panic alarm.

Flashing LED Status

The flashing LED always reflects the status of the system as following.

SYSTEM CONDITION	LED STATUS
Disarmed condition	LED does not glow
Armed condition	Slow Flashes of LED
Auto Arming Condition	Fast Flashes

Intrusion Alert

The system gives a report if it has been intruded in your absence. Four chirps are given when UNLOCK button is pressed after an intrusion.

Diagnostic report	Visual-LED	Sound
Built in Shock Sensor Trigger	2 Flashes	Four Chirps
Door/Trunk/Hood Intrusion	3 Flashes	Four Chirps
Ignition	5 Flashes	Four Chirps

PROGRAMMABLE FEATURES

System has some features which can be programmed by user according to their choice.

Drive Lock Mode

Drive lock mode can be programmed by SPEED LOCK or can be turned OFF. If drive lock mode is programmed to SPEED LOCK, all the vehicle doors will lock when vehicle attains the speed of 15 Km/hr. If Drive Lock is programmed to OFF, no door will lock by speed.

NOTE:

In case of SPEED LOCK Mode, if any door is open while driving, it will get cancelled.

Once vehicle Speed crosses 15 Km/hr, the LED on Security Switch will blink for 5 seconds as indication of door open.

Drive Unlock Mode

Drive unlock can be programmed to KEY or can be turned OFF. When programmed to KEY, turning Ignition ON to OFF then removing the key from the key cylinder will unlock all the doors. If drive unlock is programmed to OFF then no door will unlock by removing key from key cylinder.

Siren Chirp ON/OFF feature

Siren Chirps can be programmed to ON or OFF. When siren chirp feature disabled, siren will not chirp after Arm/Disarm by LOCK/UNLOCK button.

BEFORE DRIVING

Shock Sensor feature

This is a very important feature of security system. It enables protection of your vehicle against any major impact. If anybody tries to intrude into the vehicle, the alarm triggers. The triggering of the alarm is in two stages, first acting as a warning to the intruder and then at full blast. The sensitivity of shock sensor can be adjusted as desired by the user.

PROCEDURE TO PROGRAM FEATURE

No.	Feature	1 Chirp	2 Chirps	Default
1.	Drive Lock Mode	Speed	OFF	Speed
2.	Drive Unlock Mode	Key	OFF	Key
3.	Siren chirp ON/OFF	ON	OFF	ON
4.	Shock Sensor ON/OFF	ON	OFF	ON

Programming Drive Lock Mode

- a) Open the Driver Door of your vehicle.
- b) With your vehicle key in the Key cylinder, turn Ignition ON and then switch it OFF.
- c) Press and release the Security switch One time.
- d) Press and hold the Security switch.
- e) One chirp sound confirms entry into Drive Lock programming mode.

- f) Press the Key "Lock" button (while holding the Security switch), a single chirp sound confirms mode changed to speed lock.
- g) Two-Siren chirp sound confirms Drive lock mode OFF.
- h) Release the Security switch.
- i) Turn the Ignition ON.

Programming Drive Unlock Mode

- a) Open the Driver Door of your vehicle.
- b) With your vehicle key in the Key cylinder, turn Ignition ON and then switch it OFF.
- c) Press and release the Security switch two times.
- d) Press and hold the Security switch.
- e) Two-chirp sound confirms entry into Drive unlock programming mode.
- f) Press the Key Lock button (while holding the Security switch), a single chirp sound confirms the mode changed to key Unlock.
- g) Two-siren chirp sound confirms the mode changed to Drive Unlock mode OFF.
- h) Release the Security switch.
- i) Turn the Ignition ON.

Programming Siren Chirp ON/OFF

- a) Open the Driver Door of your vehicle.
- b) With your vehicle key in the Key cylinder, turn Ignition ON and then switch it OFF.

- c) Press and release the Security switch Three times.
- d) Press and hold the Security switch.
- e) Three-chirp sound confirms entry into Siren Chirp ON/OFF programming mode.
- f) Press the Key Lock button (while holding the Security switch), a single chirp sound confirms the mode changed to Siren Chirp ON.
- g) Two-Siren chirp sound confirms the mode changed to Siren Chirp OFF.
- h) Release the Security switch.
- i) Turn the Ignition ON.

Programming Shock Sensor ON/OFF

- a) Open the Driver Door of your vehicle.
- b) With your vehicle key in the Key cylinder, turn Ignition ON and then switch it OFF.
- c) Press and release the Security switch Four times.
- d) Press and hold the Security switch.
- e) Four-chirp sound confirms entry into Shock Sensor ON/OFF programming mode.
- f) Press the Key Lock button (while holding the Security switch), a single chirp sound confirms the mode changed to shock sensor ON.
- g) Two-Siren chirp sound confirms the mode changed to shock sensor OFF.
- h) Release the Security switch.
- i) Turn the Ignition ON.

BEFORE DRIVING

Shock Sensor Sensitivity Adjustment via Key

Full Blast adjustment

Full Blast can be adjusted in 16 levels as mentioned below.

- a) Press Unlock button on Key to Unlock/Disarm the System.
- b) Press Lock button (within 2 seconds of key UNLOCK) on Key to Lock/Arm the System.
- c) Within 2 sec press Lock & Unlock button simultaneously for at least 3 sec. Siren will give Long chirp to confirm entry into sensitivity adjustment mode
 - i) Press Lock button to adjust the sensitivity one step lower. Siren will give one chirp every time lock button is pressed till at level 1 where it will give a long chirp. When adjusted to level 1, Full Blast will turn OFF
 - ii) Press unlock button to adjust the sensitivity one step higher. Siren will give two chirp every time unlock button is pressed till at level 16 where it will give a long chirp.

Pre-warn Adjustment

Pre-warn can be adjusted in 16 levels as mentioned below:

- a) Press Lock button on Key to Lock/Arm the System
- b) Press Unlock button (within 2 seconds of key LOCK) on Key to Unlock/Disarm the System
- c) Within 2 sec press Lock & Unlock button simultaneously for at least 3 sec. Siren will give Long chirp to confirm entry into Sensitivity Adjustment Mode.
 - i) Press Lock button to adjust the sensitivity one step lower. Siren will give one chirp every time lock button is pressed till at level 1 where it will give a long chirp. When adjusted to level 1, prewarn will turn OFF.
 - ii) Press Unlock button to adjust the sensitivity one step higher. Siren will give two Chirp every time Unlock button is pressed till at level 16 where it will give a long chirp.

Mode Programming (Valet/Alarm)

The valet mode can be programmed as follows:

- a) Close the driver door.
- b) Turn Ignition ON-OFF quickly.
- c) Press and hold Security switch for 3 sec minimum.
- d) Change to valet mode is confirmed by LED ON for 1 minute.

The alarm mode can be programmed as follows:

Repeat step (i)-(iii) to program the system to alarm mode.

Change to alarm mode will be confirmed by one long siren chirp and LED OFF.

Program Customer Pincode (Personalised Pincode)

If transmitter is not working properly, then it is possible to disarm the system by personalised pin code.

The Personalised 4-digit number can be changed from the factory default to ensure Personalised Security.

Pin code entry

- a) Disarm the system.
- b) Open the Driver Door.
- c) Turn Ignition ON then OFF.
- d) Within 5 seconds press and release Valet switch 5 times. A short chirp followed by long chirps confirms entry into Pin Code programming mode.
- e) Press Lock button on Key, after a single chirp enter the First digit (within 1-9) by pressing Valet switch (for e.g. to enter 2 press and release Valet switch two times).
- f) Press Lock button on Key, after two chirp enter the Second digit (within 1-9) by pressing Valet switch.

- g) Press Lock button on Key, after 3-chirps enter the Third digit (within 1-9) by pressing Valet switch.
- h) Press Lock button on Key, after 4-chirps enter the Fourth digit (within 1-9) by pressing Valet switch.

Emergency Disarm by personalised pin code

The Personalised 4- Digit Pin Code acts as a secret Key, to Emergency Disarm the vehicle.

- a) Turn the Ignition ON, OFF and then ON.
- b) Enter the First digit (for e. g. to enter 2 press and release Valet switch twice)
- c) Turn the Ignition OFF then ON.
- d) Enter the Second digit.
- e) Turn the Ignition OFF and then ON.
- f) Enter the Third Digit.
- g) Turn the Ignition OFF and then ON
- h) Enter the Last Digit.
- i) Turn the Ignition OFF and then ON.
- j) The vehicle will get disarmed.

NOTE: The default pin will be provided by the dealer at the time of delivery. It is recommended to personalize the pin for increased security. The pin must be remembered as it is not possible to Retrieve a lost pin.

Transmitter battery Replacement of the Battery

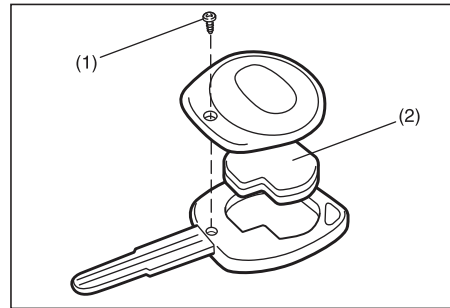

If the transmitter battery gets discharged, replace the battery with a new one.

To replace the battery of the transmitter:

- 1) Remove the screw (1), and open the transmitter cover.
- 2) Remove the transmitter (2).
- 3) Put the edge of a flat blade screw driver in the slot of the transmitter (2) and pry it open.
- 4) Replace the battery (3) (Lithium disc type CR1620) so that its +ve terminal faces the bottom cover of the transmitter (5).

BEFORE DRIVING

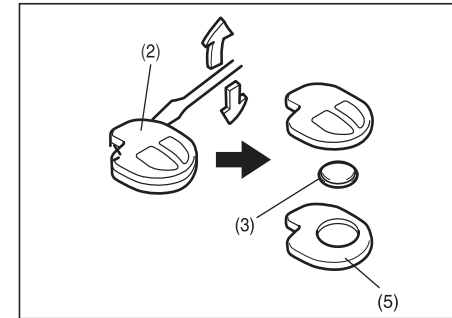

- 5) Close the transmitter and install it into the transmitter holder.
- 6) Close the transmitter cover, install and tighten the screw (1).
- 7) Make sure the door locks can be operated with the transmitter.

Note: Normal battery life is approximately 2 years, but varies depending on usage. It is advisable to get battery replaced from MARUTI SUZUKI Authorized workshop.

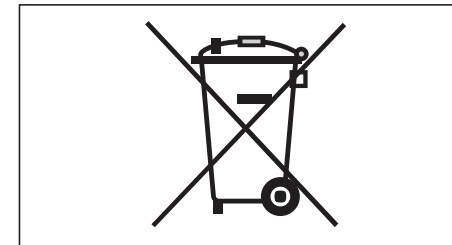

BEFORE DRIVING

▲ CAUTION

Do not remove the screw from the key Unnecessarily as it damages the screw head. Kindly replace the screw once the transmitter battery is changed.

▲ CAUTION

Dispose off the used battery properly according to applicable rules or regulations. Do not dispose off lithium batteries with ordinary household trash.

▲ WARNING

Swallowing a lithium battery may cause serious internal injury. Do not allow anyone to swallow a lithium battery. Keep lithium batteries away from children and pets. If swallowed, contact a physician immediately.

BEFORE DRIVING

TROUBLESHOOTING

SYMPTOMS	PROBABLE CAUSES	REMEDIES
Transmitter function (Unlock/Lock/Panic)not working	<ol style="list-style-type: none"> 1. Battery of the transmitter is weak. 2. Transmitter is exposed to water or it is wet. 3. D/L or Dome fuse for controller is blown in the vehicle. 4. In case if any door is open or door sensor is shorted with the body ground, remote will not activate the central locking/ alarm system. 	<ol style="list-style-type: none"> 1. Check the battery. 2. Dry the transmitter and check it. 3. Check and replace the D/L or Dome fuse. 4. Check if all doors are properly closed and door switch functioning is O.K.
Operation distance of the transmitter is less than 20m but still transmitter (Unlock/Lock/Panic) is not working	<ol style="list-style-type: none"> 1. Battery of the transmitter is weak. 2. Strong RF interference. (e.g. Radio Towers, High Voltage Transmission line near by) 	<ol style="list-style-type: none"> 1. Check the battery. 2. Drive the vehicle away from the particular spot and re-test the control distance.
It is difficult to activate or deactivate the system in certain area using the transmitter.	<ol style="list-style-type: none"> 1. The strong interference caused by excessive RF activity in a particular area 	<ol style="list-style-type: none"> 1. The interference is temporary and only while the vehicle is in that area.
Alarm is not triggered even if any door(s)/hood/trunk opened in arm stage.	<ol style="list-style-type: none"> 1. The contact point of the door(s), front bonnet or rear boot switch is faulty. 2. The connection of the door(s), front bonnet or rear boot switch is loose. 	<ol style="list-style-type: none"> 1. Replace the defective Switch. 2. Make proper connection.
Siren does not sound when alarm is triggered.	<ol style="list-style-type: none"> 1. The connection of the siren wire is loose. 2. Siren is faulty. 	<ol style="list-style-type: none"> 1. Make proper connection. 2. Change the siren.

BEFORE DRIVING

Security System (Vehicle with Keyless push start system)

The security system is armed in about 5 seconds after you lock all doors by using the keyless push start system remote controller or request switch.

Once the system is armed, any attempt to open a door by using any other means (*) than the keyless push start system remote controller or open the engine hood, will cause the alarm to be triggered.

* These means include the following:

- The key
- The lock knob on a door
- The central door locking switch
- The tailgate unlatch button
- The trunk lid emergency lever

Also, in case that you have set the shock sensor to enabled state and set sensitivity of the pre-warning function and full blast warning function to a level other than 0, the alarm will be triggered if any attempt to tamper with the vehicle. The shock sensor can be selected enabled or disabled state, and sensitivity of each warning can be adjusted as desired. To set the shock sensor, ask your MARUTI SUZUKI dealer or use the setting mode of the information display.

NOTE:

- The default setting of the shock sensor is in the disabled state. Set to the enabled state and adjust sensitivity of each warning according to your preference. For details on how to use the information display, refer to "Information Display" in this section.
- Your dealer may have already set the shock sensor of the vehicle to the enabled state before you purchase it. Consult your dealer for further information.

NOTE:

- The security system generates alarms when any of the predetermined conditions is met. However, the system does not have any function of blocking unauthorized entry into the vehicle.
- Always use the keyless push start system remote controller to unlock the doors when the security system has been armed. Using a key instead will trigger the alarm.
- If a person who does not know the security system is going to drive the vehicle, we recommend you explain the system and its operation to the person, or disable the system beforehand. Mistakenly triggering the alarm may cause a nuisance to others.
- Even if the security system is armed, you should still be careful to guard against theft. Do not leave money or things of value in the vehicle.

How to arm the security system (when enabled)

Lock all doors (including tailgate) using the keyless push start system remote controller. The security system indicator (1) will start blinking rapidly, and the security system will be armed in about 5 seconds. While the system is being armed, the indicator continues to blink at intervals of approximately 2 seconds.

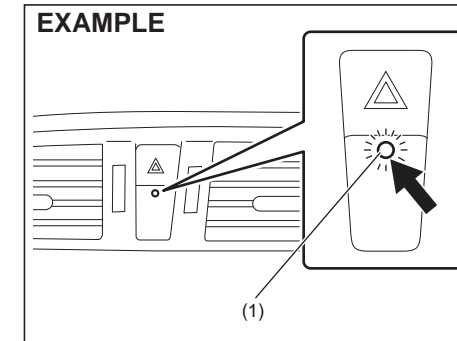

79MH0210

BEFORE DRIVING

NOTE:

- To prevent the alarm from being accidentally triggered, avoid arming it while anyone remains inside the vehicle. The alarm will be triggered if any person inside opens the door, luggage compartment engine hood, or swings the vehicle (if the shock sensor is in the enabled state).
- The security system is not armed when all doors are locked using the key from outside, using the door lock knobs or the central door locking switch from inside.
- If any door is not operated within approximately 30 seconds after the doors have been unlocked using the keyless push start system remote controller, the doors are automatically locked again. When the doors are locked, the security system will be armed in about 5 seconds if the system is in the enabled state.
- If the security system indicator (1) blinks when the ignition mode is "ON", there may be something wrong with the security system. Ask your MARUTI SUZUKI dealer to inspect the system.

How to disarm the security system

Simply unlock the doors using the keyless push start system remote controller. The security system indicator will go out, indicating that the security system is disarmed.

How to stop the alarm

Should the alarm be triggered accidentally, the alarm will stop by the following operations.

- Press the engine switch to change the ignition mode to "ON".
- Unlock the doors using the keyless push start system remote controller, the request switch.

NOTE:

- Even after the alarm has stopped, if you lock the doors using the keyless push start system remote controller, the security system will be rearmed with a delay of about 5 seconds.
- If you disconnect the battery while the security system is in the armed condition or the alarm is actually in operation, the alarm will be re-triggered when the battery is then reconnected.
- Even after the alarm has stopped at the end of the predetermined operation time, it will be triggered again if any of the doors, luggage compartment or engine hood is opened, or the vehicle feels a shock (if the shock sensor is in the enabled state), without disarming the security system.

Checking whether the alarm has been triggered during parking

If the alarm was triggered and you then turn the ignition mode is "ON", the security system indicator will blink rapidly for about 8 seconds and a buzzer will beep 4 times during this period. If this happens, check whether the vehicle has been broken into while you were away from it.

Enabling and disabling the security system

The security system can be either enabled or disabled.

When enabled

- If any of the doors or trunk are opened without unlocking by the keyless push start system remote controller, all turn signal lights start to blink and the interior buzzer beeps intermittently. After 5 seconds, the siren will sound for about 27.5 seconds. The security system indicator continues to blink during this time.
- If the engine hood is opened, all turn signal lights blink, and the siren sounds for about 27.5 seconds. The security system indicator continues to blink during this time.

BEFORE DRIVING

(If the shock sensor is in the enabled state)

- If the vehicle feels a shock higher than the pre-warning sensitivity, the siren sounds for about 2 seconds (pre-warning). If the vehicle feel a shock higher than the full blast warning sensitivity, all turn signal lights start to blink and the interior buzzer beeps intermittently. After 5 seconds, the siren will sound for about 27.5 seconds (full blast warning). The security system indicator continues to blink during this time.

NOTE:

If you set the full blast warning sensitivity higher than the pre-warning sensitivity in the setting mode of the information display, or the vehicle feels such shock as to be able to trigger the full blast warning, the full blast warning will be triggered preferentially. In this case, the pre-warning will not be triggered.

When disabled

When the system is disabled, it stays disarmed even if you perform any system arming operation.

How to switch the state of the security system

When the security system has been already disarmed, you can switch the system from the enabled state to the disabled state, and vice versa, using the following method.

- 1) Sit in the driver's seat and make sure that all doors, luggage compartment and engine hood are closed.
 - If any door is open, the open door warning light comes on.

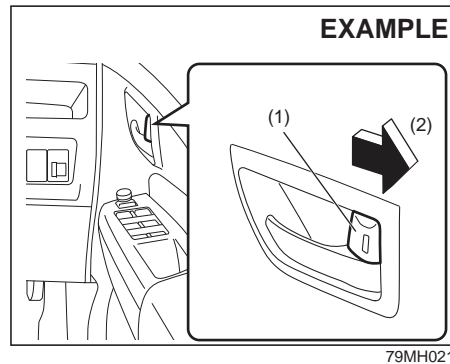

- 2) **(Vehicle with keyless push start system only)**
Turn the lock knob (1) on the driver's door rearward (2).

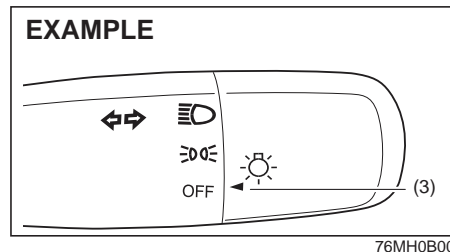

- 3) Turn the knob on the lighting control lever to the OFF position (3). Then, turn the ignition switch to "ON" position or the ignition mode is "ON".

NOTE:

The following steps 4) and 5) must be completed within 15 seconds.

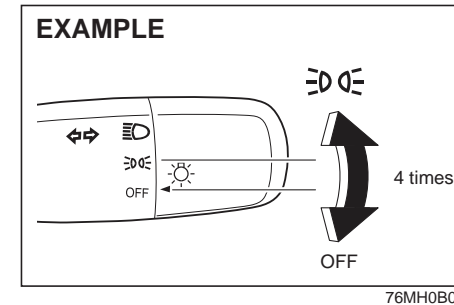

- 4) Turn the knob on the lighting control lever to the ON position and then turn back to the OFF position. Repeat this operation 4 times.

BEFORE DRIVING

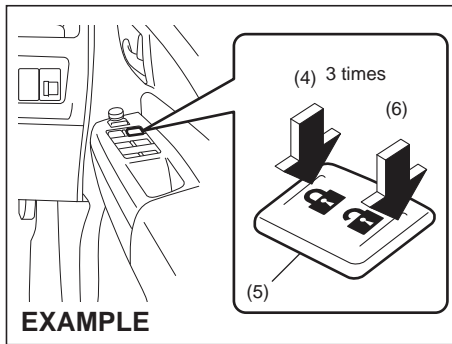

79MH0212

- 5) Push the lock end (4) (forward end) of the central door locking switch (5), and then push the unlock end (6) (backward end). Repeat this operation 3 times.

Every time you perform the series of the above steps, the state of the security system changes from the currently selected one to the other. You can check whether the system is enabled or disabled by the number of interior buzzer beeps at the end of the procedure as follows.

System state	Number of beeps
Disabled	Once
	↕
Enabled	4 times

- If you cannot complete the operations in step 4) and 5) within 15 seconds correctly, the state of the security system will not change and the interior buzzer does not beep. Perform the procedure again from the beginning.

NOTE:

You can also switch the security system from the enabled state to the disabled state, and vice versa, via the setting mode of the information display. For details on how to use the information display, refer to "Information Display" in this section.

Windows

Manual Window Control (if equipped)

EXAMPLE

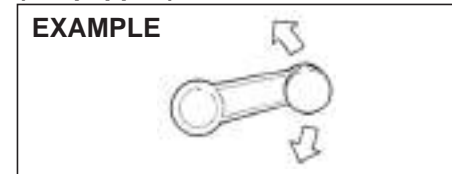

60G010

Raise or lower the door windows by turning the handle located on the door panel.

Electric Window Controls (if equipped)

The electric windows can only be operated when the ignition switch is in the "ON" position.

Driver's door

EXAMPLE

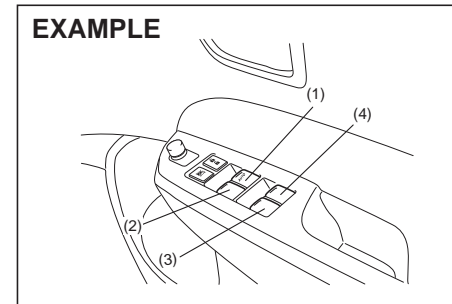

74LHT0204

BEFORE DRIVING

The driver's door has a switch (1) to operate the driver's window, and a switch (2) to operate the front passenger's window or there are switches (3), (4), to operate the rear left and right passenger windows, respectively.

Passenger's door (if equipped)

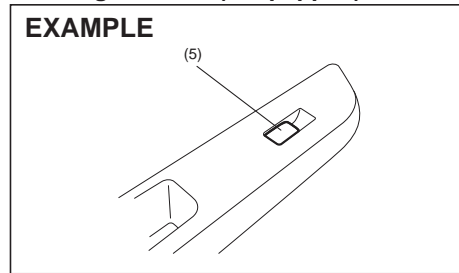

74LHT0205

The passenger's door has a switch (5) to operate the passenger's window.

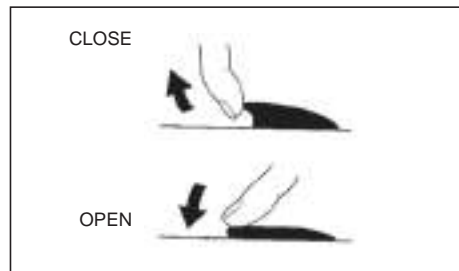

81A009

To open a window, push the top part of the switch and to close the window lift up the top part of the switch.

The driver's window has an "auto-down" feature for added convenience (at toll booths or drive-through restaurants, for example). This means you can open the window without holding the window switch in the "Down" position. Press the driver's window switch completely down and release it. To stop the window before it reaches the bottom, pull the switch up briefly.

Lock switch

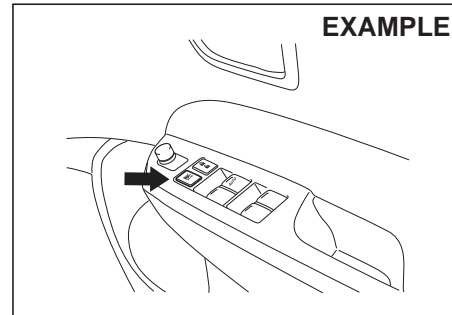

74LHT0206

The driver's door also has a lock switch for the passenger's windows. When you push in the lock switch, the passenger's windows cannot be raised or lowered by operating any of the switches (2), (3), (4) or (5). To restore normal operation, release the lock switch by pushing again.

⚠ WARNING

- You should always lock the passenger's window operation when there are children in the vehicle. Children can be seriously injured if they get part of their body caught by the window during operation.
- To avoid injuring an occupant by window entrapment, be sure no part of the occupant's body such as hands or head is in the path of the electric windows when closing them.
- Always remove the ignition key when leaving the vehicle even if only for a short time. Also do not leave children alone in a parked vehicle. Unattended children could use the electric window switches and get trapped by the window.

NOTE:
If you drive with one of the rear windows open, you may hear a loud sound caused by air vibration. To reduce the sound, open the driver's or front passenger's window, or narrow the rear window opening.

BEFORE DRIVING

Mirrors

Inside Rearview Mirror

You can adjust the inside rearview mirror by hand so as to see the rear of your vehicle in the mirror. To adjust the mirror, move the mirror up, down or side ways by hand to obtain the best view.

Type1

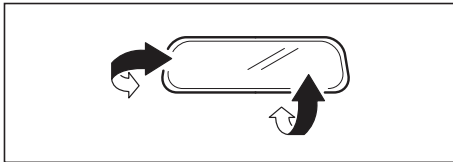

74LHT0235

Type2

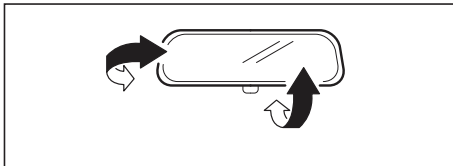

68LMT0205

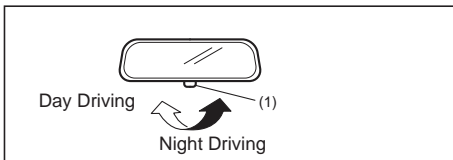

68LMT0206

To adjust the mirror, set the selector tab (1) to the day position, then move the mirror up, down or sideways by hand to obtain the best view.

When driving at night, you can move the selector tab to the night position to reduce glare from the headlights of vehicles behind you.

⚠ WARNING

- Always adjust the mirror with the selector set to the day position.
- Only use the night position if it is necessary to reduce glare from the headlights of vehicles behind you. Be aware that in this position you may not be able to see some objects that could be seen in the day position.

Outside Rearview Mirrors

Adjust the outside rearview mirrors so you can just see the side of your vehicle in the mirrors.

⚠ WARNING

Be careful when judging the size or distance of a vehicle or other object seen in the side convex mirror. Be aware that objects look smaller and appear farther away than when seen in a flat mirror.

Type1

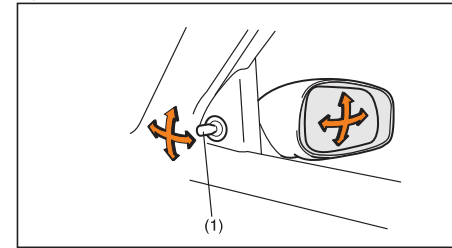

75J003

You can adjust the outside rearview mirrors by hand with the knob (1) located on the driver's or front passenger's door panel.

Type2

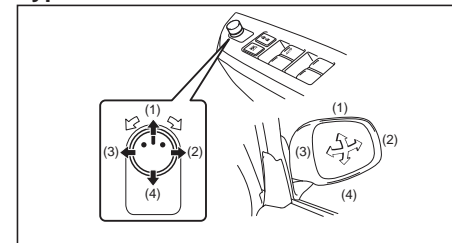

74LHT0207

The switch to control the electric mirrors is located on the driver's door panel. You can adjust the mirrors when the ignition switch is in the "ACC" or "ON" position, or the ignition mode is "ACC" or "ON". To adjust the mirrors:

BEFORE DRIVING

- 1) Move the selector switch to the left or right to select the mirror you wish to adjust.
- 2) Press the outer part of the switch that corresponds to the direction in which you wish to move the mirror.
- 3) Return the selector switch to the center position to help prevent unintended adjustment.

Outside Rearview Mirrors Folding Switch (if equipped)

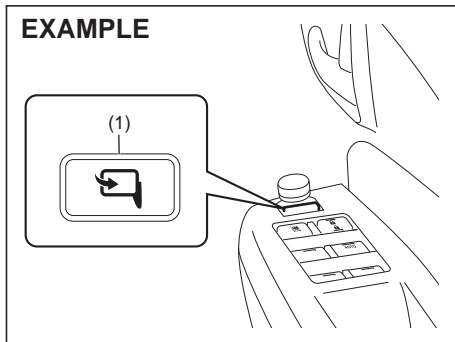

79MH0218

You can fold the mirrors when you park the vehicle in a narrow space. When the ignition switch is in the "ACC" or "ON" position, or the ignition mode is "ACC" or "ON", push the folding switch (1) to fold and unfold the mirrors. Make sure the mirrors are completely unfolded before you start driving.

CAUTION
Moving mirrors can pinch and injure a hand. Do not allow any one's hand to get near the mirrors when folding and unfolding the mirrors.

Heated Rear Window Switch (if equipped)

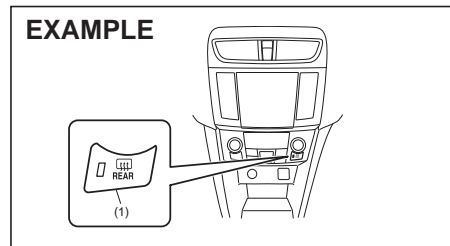

74LHT0234

When the rear window is misted, push this switch (1) to clear the window. An indicator light will be lit when the defogger is on. The defogger will work only when the engine is running. To turn off the defogger, push the switch (1) again.

NOTICE
The heated rear window uses a large amount of electricity. Be sure to turn off after the window has become clear.

NOTE:

- The defogger will work only when the engine is running.
- The defogger will automatically turn off after the defogger remains on for 15 minutes to prevent discharging of the battery.

Front Seats

Seat Adjustment

WARNING
Never attempt to adjust the driver's seat or seatback while driving. The seat or seatback could move unexpectedly, causing loss of control. Make sure that the driver's seat and seatback are properly adjusted before you start driving.

WARNING
To avoid excessive seat belt slack, which reduces the effectiveness of the seat belts as a safety device, make sure that the seats are adjusted before the seat belts are fastened.

NOTICE
Do not rest your feet on the seat adjustment lever or push it down. This may affect the performance of the seat adjusters.

BEFORE DRIVING

Adjusting Seat Position



74LHT0208

The adjustment lever for each front seat is located under the front of the seat. To adjust the seat position, pull up on the adjustment lever and slide the seat forward or rearward.

After adjustment, try to move the seat forward and rearward to ensure that it is securely latched.

Seat Height Adjuster (if equipped)

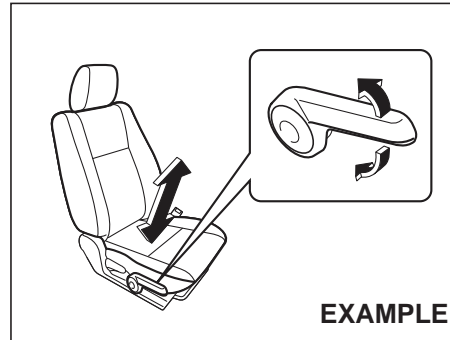

74LHT0209

If the driver's seat is equipped with a seat height adjuster lever on the outboard side of the seat, raise or lower the seat by pulling up or down the adjuster lever.

Adjusting Seatbacks

⚠ WARNING
All seatbacks should always be in an upright position when driving, or seat belt effectiveness may be reduced. Seat belts are designed to offer maximum protection when seatbacks are in the upright position.

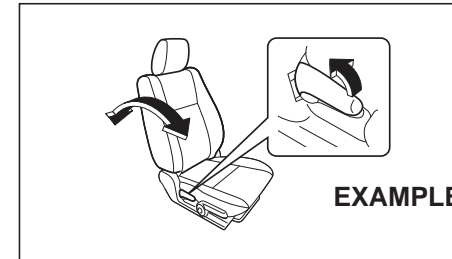

74LHT0210

To adjust the seatback angle of front seats, pull up the lever on the outboard side of the seat, move the seatback to the desired position, and release the lever to lock the seatback in place.

Adjustable Head Restraints

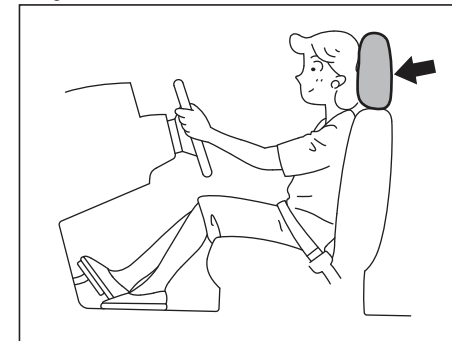

63J246

Head restraints are designed to help reduce the risk of neck injuries in the case of an accident. Adjust the head restraint to

BEFORE DRIVING

the position which places the center of the head restraint closest to the top of your ears. If this is not possible for very tall passengers, adjust the head restraint as high as possible.

⚠ WARNING

- Never drive the vehicle with the head restraints removed.
- Do not attempt to adjust the head restraint while driving.

NOTE:
It may be necessary to recline the seatback to provide enough overhead clearance to remove the head restraint.

Front

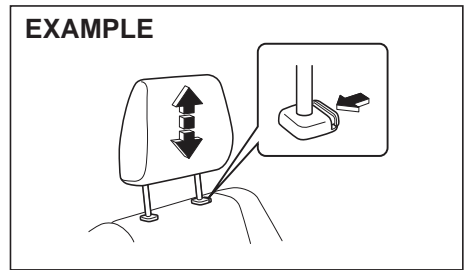

80JS082

To raise the front head restraint, pull upward on the restraint until it clicks. To lower the restraint, push down on the restraint while holding in the lock lever. If a head restraint must be removed (for clean-

ing, replacement, etc.), push in the lock lever and pull the head restraint all the way out.

Rear Seats

Adjustable Head Restraints (if equipped)

Head restraints are designed to help reduce the risk of neck injuries in the case of an accident.

⚠ WARNING

- Never drive the vehicle with the head restraints removed.
- Do not attempt to adjust the head restraint while driving.

NOTE:
It may be necessary to fold forward the seatback to provide enough overhead clearance to remove the head restraint.

Adjust the head restraint to the position which places the center of the head restraint closest to the top of your ears. If this is not possible for very tall passengers, adjust the head restraint as high as possible.

Rear (If equipped)

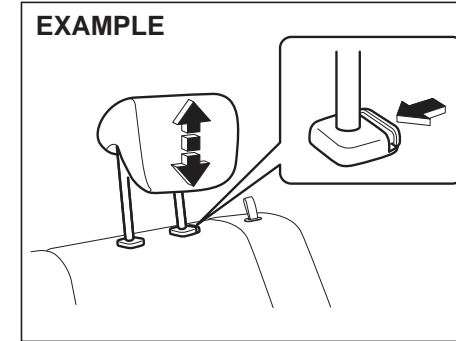

74LHT0211

To raise the rear head restraint, pull upward on the restraint until it clicks. To lower the restraint, push down on the restraint while holding in the lock lever. If a head restraint must be removed (for cleaning, replacement, etc.), push in the lock lever and pull the head restraint all the way out.

When installing a child restraint system, raise the head restraint to the most upper position.

BEFORE DRIVING

Folding Rear Seat (If equipped)

The rear seat(s) of your vehicle can be folded forward to provide additional cargo space.

To fold the rear seat (s) forward:

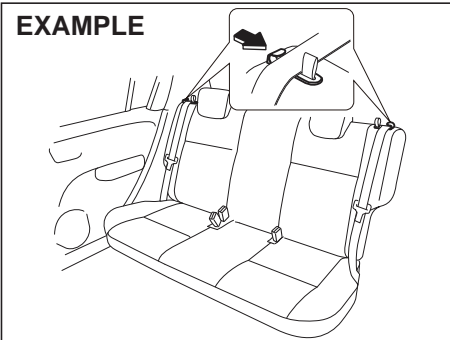

74LHT0212

- 1) Hook the webbing of the outboard lap-shoulder belts in the belt hangers.

NOTICE

- When you move a seatback(s), make sure the belt webbing is hooked in the seat belt hangers so the seat belts are not caught by the seatback (s), seat inge, or seat latch. This helps prevent damage to the belt system.
- Make sure the belt webbing is not twisted.

- 2) Lower the adjustable head restraint fully.

- 3) Store the center buckle in the seat(s) back slit.

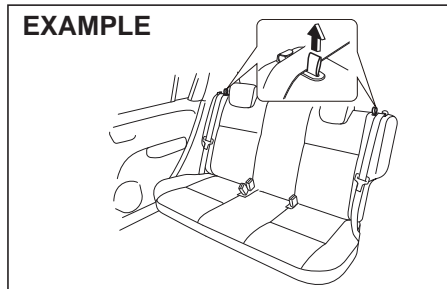

74LHT0239

- 4) Pull up the both release straps on the top of seat(s), and fold the seatback(s) forward.

NOTICE

After folding the rear seatback(s) forward, do not allow any foreign material to enter the lock opening. This may cause damage to the inside of the lock and prevent the seatback(s) from being locked securely.

WARNING

If you need to carry cargo in the passenger compartment with the rear seatback(s) folded forward, be sure to secure the cargo or it may be thrown about, causing injury. Never pile cargo higher than the seatback(s).

To return the seat to the normal position, follow the procedure below.

CAUTION

- When returning the rear seatback(s) to the normal position, do not allow any foreign material to enter the lock opening. This may prevent the seatback(s) from being locked securely.

NOTICE

- When returning the rear seatback(s) to the normal position, make sure that there is nothing around the striker. Any foreign materials prevent the seatback(s) from being locked securely.
- When you move a seatback(s), make sure the belt webbing is hooked in the seat belt hangers so the seat belts are not caught by the seatback(s), seat hinge, or seat latch. This helps prevent damage to the belt system.

BEFORE DRIVING

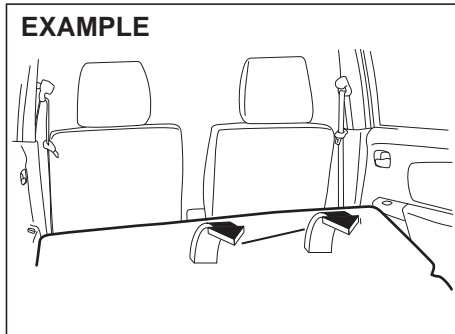

74LHT0213

Raise the seatback(s) until it locks into place.

After returning the seat(s), try moving the seatback(s) to make sure they are securely latched.

⚠ CAUTION
Do not put your hand into the rear seatback(s) lock opening, or your finger may get caught and be injured.

NOTICE

- When returning the rear seatback(s) to the normal position, do not allow any foreign material to enter the lock opening. This may prevent the seatback(s) from being locked securely.
- When returning the rear seatback(s) to the normal position, be sure to handle it carefully by hand to avoid any damage to the lock itself. Do not push it by using some material or by applying excessive force.
- As the lock is designed exclusively for securing the rear seatback(s), do not use it for any other purpose. Incorrect use of it may cause damage to the inside of the lock and prevent the seatback(s) from being locked securely.

Seat Belts and Child Restraint Systems

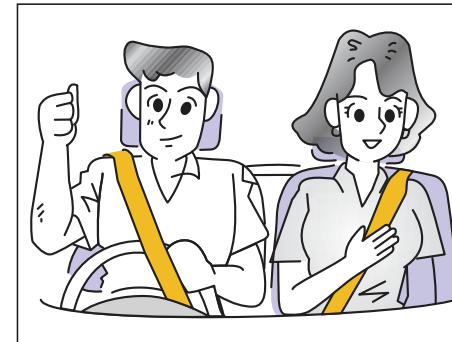

65D231S

⚠ WARNING
Wear Your Seat Belts at All Times.

⚠ WARNING
An air bag supplements, or adds to, the frontal crash protection offered by seat belts. The driver and all passengers must be properly restrained by wearing seat belts at all times, whether or not an air bag is mounted at their seating position, to minimize the risk of severe injury or death in the event of a crash.

BEFORE DRIVING

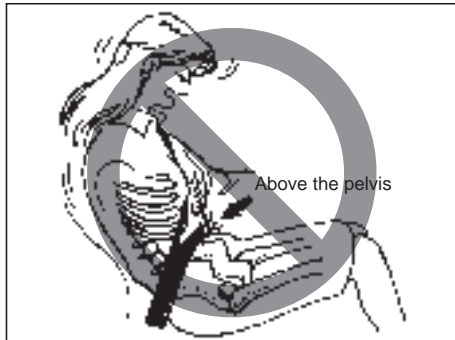

65D606

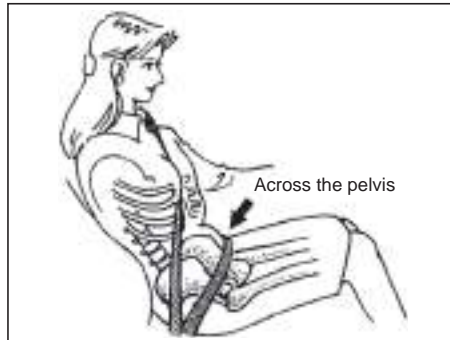

65D201

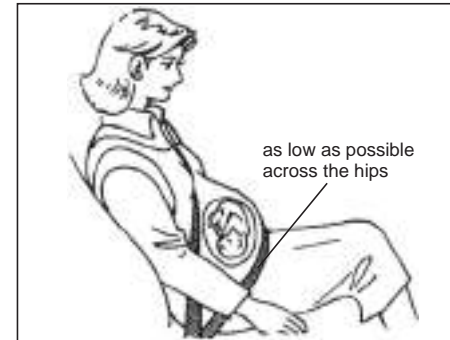

65D199

⚠ WARNING

- Never allow persons to ride in the cargo area of a vehicle. In the event of an accident, there is a much greater risk of injury for persons who are not riding in a seat with their seat belt securely fastened.
- Seat belts should always be adjusted as follows:
 - the lap portion of the belt should be worn low across the pelvis, not across the waist.
 - the shoulder straps should be worn on the outside shoulder only, and never under the arm.
 - the shoulder straps should be away from your face and neck, but not falling off your shoulder.

(Continued)

⚠ WARNING

(Continued)

- Seat belts should never be worn with the straps twisted and should be adjusted as tightly as is comfortable to provide the protection for which they have been designed. A slack belt will provide less protection than one which is snug.
- Make sure that each seat belt buckle is inserted into the proper buckle catch. It is possible to cross the buckles in the rear seat.

(Continued)

⚠ WARNING

(Continued)

- Pregnant women should use seat belts, although specific recommendations about driving should be made by the woman's medical advisor. Remember that the lap portion of the belt should be worn as low as possible across the hips, as shown in the diagram.
- Do not wear your seat belt over hard or breakable objects in your pockets or on your clothing. If an accident occurs, objects such as glasses, pens, etc. under the seat belt can cause injury.

(Continued)

BEFORE DRIVING

⚠ WARNING

(Continued)

- **Never use the same seat belt on more than one occupant and never attach a seat belt over an infant or child being held on an occupant's lap. Such seat belt use could cause serious injury in the event of an accident.**
- **Periodically inspect seat belt assemblies for excessive wear and damage. Seat belts should be replaced if webbing becomes frayed, contaminated, or damaged in any way. It is essential to replace the entire seat belt assembly after it has been worn in a severe impact, even if damage to the assembly is not obvious.**
- **Children age 12 and under should ride properly restrained in the rear seat.**
- **Infants and small children should never be transported unless they are properly restrained. Restraint systems for infants and small children can be purchased locally and should be used. Make sure that the system you purchase meets applicable safety standards. Read and follow all the directions provided by the manufacturer.**

(Continued)

⚠ WARNING

(Continued)

- **For children, if the shoulder belt irritates the neck or face, move the child closer to the center of the vehicle.**
- **Avoid contamination of seat belt webbing by polishes, oils, chemicals, and particularly battery acid. Cleaning may safely be carried out using mild soap and water.**
- **Do not insert any items such as coins, clips, etc. into the seat belt buckles, and be careful not to spill liquids into these parts. If foreign materials get into a seat belt buckle, the seat belt may not work properly.**
- **All seatbacks should always be in an upright position when driving, or seat belt effectiveness may be reduced. Seat belts are designed to offer maximum protection when seatbacks are in the upright position.**

Lap-Shoulder Belt

Emergency Locking Retractor (ELR) (if equipped)

The seat belt has an emergency locking retractor (ELR), which is designed to lock the seat belt only during a sudden stop or impact. It also may lock if you pull the belt across your body very quickly. If this hap-

pens, let the belt go back to unlock it, then pull the belt across your body more slowly.

Safety reminder

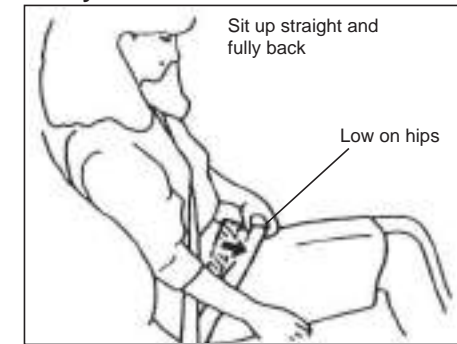

60A038



60A040

To reduce the risk of sliding under the belt during a collision, position the lap portion of the belt across your lap as low on your hips as possible and adjust it to a snug fit by pulling the shoulder portion of the belt upward through the latch plate. The length

BEFORE DRIVING

of the diagonal shoulder strap adjusts itself to allow freedom of movement.

All Seat Belts Except Rear Center



60A036

To fasten the seat belt, sit up straight and well back in the seat, pull the latch plate attached to the seat belt across your body and press it straight into the buckle until you hear a "click".

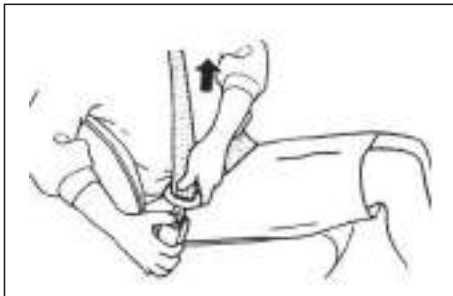

60A039

2-33

To unfasten the seat belt, push the red "PRESS" button on the buckle and retract the belt slowly while attaching a hand to the belt or/and the latch plate.

Rear Center Seat Belt Lap belt

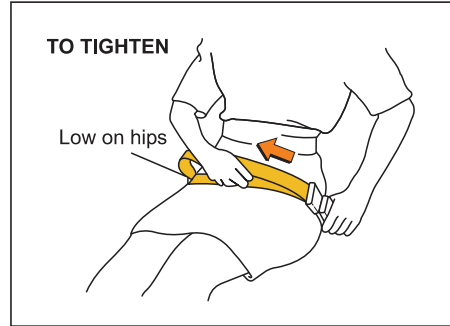

80JS028

Sit up straight and well back in the seat. To fasten the belt, pull the latch plate attached to the seat belt across your hips and press it straight into the buckle until you hear a "click". To reduce the risk of sliding under the belt during a collision, position the belt across your lap as low on your hips as possible and adjust it to a snug fit. To tighten the belt, pull the free end of the belt across alongside the lap strap.

TO LOOSEN

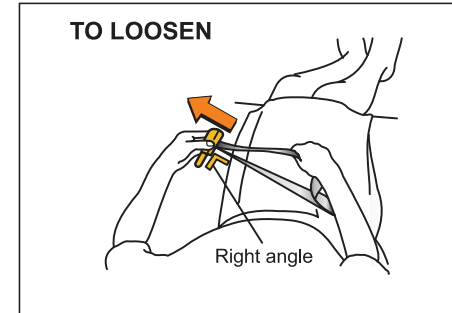

60A046

To lengthen, release the latch plate from the buckle, pull the latch plate (adjuster) in the direction of the arrow, at right angles to the belt. The latch plate should then be refitted into the buckle and the belt tightened as previously described.

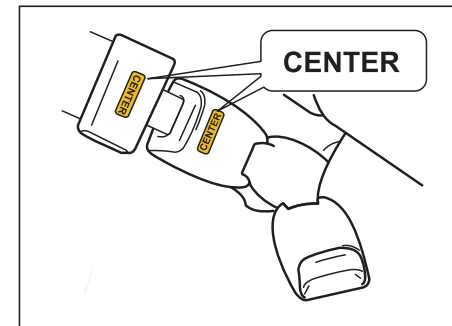

63J017

BEFORE DRIVING

NOTE:

The word "CENTER" is molded on the buckle and latch plate of the centre lap belt. The buckles are designed so a latch plate can not be inserted into the wrong buckle.

Driver's Seat Belt Reminder (if equipped)

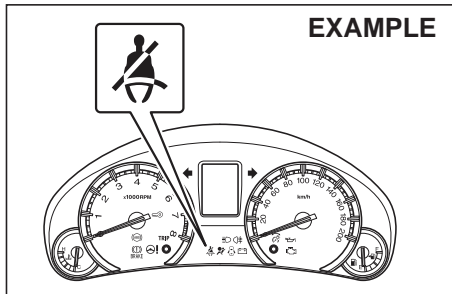

74LHT0214

When the driver does not buckle his or her seat belt with the ignition switch in the "ON" position, or the ignition mode is "ON" the driver's seat belt reminder light in the instrument cluster will blink until the driver's seat belt is buckled.

The reminder will be automatically canceled when the driver's seat belt is buckled or the ignition switch is turned off.

⚠ WARNING

It is absolutely essential that the driver and passengers wear their seat belts at all times. Persons who are not wearing seat belts have a much greater risk of injury if an accident occurs. Make a regular habit of buckling your seat belt before putting the key in the ignition.

Shoulder Anchor Height Adjuster (if equipped)

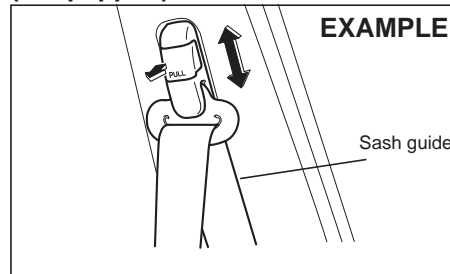

64J198

Adjust the shoulder anchor height so that the shoulder belt rides on the center of the outboard shoulder. To upward, slide the anchor up by pushing through the Sash guide. To downward, slide the anchor down while pulling the lock knob out. After adjustment, make sure that the anchor is securely locked.

⚠ WARNING

Be sure that the shoulder belt is positioned on the center of the outside shoulder. The belt should be away from your face and neck, but not falling off your shoulder. Misadjustment of the belt could reduce the effectiveness of the safety belt in a crash.

Seat Belt Hanger (if equipped)

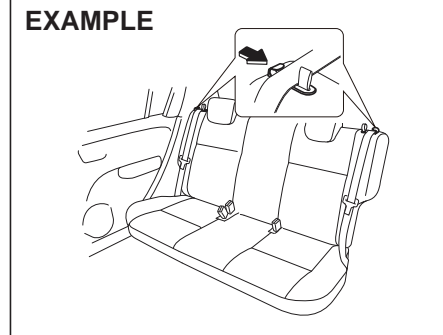

74LHT0212

NOTICE

When you move a seatback, make sure the belt webbing is hooked in the seat belt hangers so the seat belts are not caught by the seatback, seat hinge, or seat latch. This helps prevent damage to the belt system.

BEFORE DRIVING

Seat Belt Inspection

EXAMPLE



65D209S

Periodically inspect the seat belts to make sure they work properly and are not damaged. Check the webbing, buckles, latch plates, retractors, anchorages, and guide loops. Replace any seat belts which do not work properly or are damaged.

▲ WARNING

Be sure to inspect all seat belt assemblies after any collision. Any seat belt assembly which was in use during a collision (other than a very minor one) should be replaced, even if damage to the assembly is not obvious. Any seat belt assembly which was not in use during a collision should be replaced if it does not function properly, it is damaged in any way or the seat belt pretensioners were activated (that is, if the front air bags were activated).

Child Restraint Systems



60G332S

Infant restraint - rear seat only

EXAMPLE

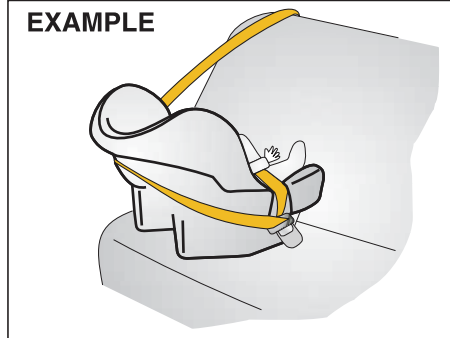

80JC007

Child restraint

EXAMPLE

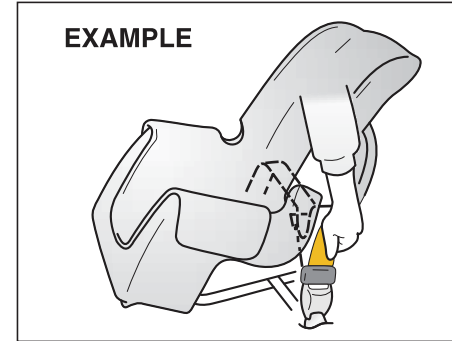

80JC016

Booster seat

EXAMPLE

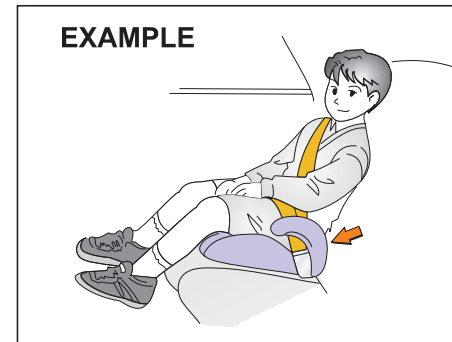

80JC008

BEFORE DRIVING

MARUTI SUZUKI highly recommends that you use a child restraint system to restrain infants and small children. Many different types of child restraint systems are available; make sure that the restraint system you select meets applicable safety standards.

All child restraint systems are designed to be secured in vehicle seats by either seat belts (lap belts or the lap portion of lap-shoulder belts). Whenever possible, MARUTI SUZUKI recommends that child restraint systems be installed on the rear seat. According to accident statistics, children are safer when properly restrained in rear seating positions than in front seating positions.

If you must use a front-facing child restraint in the front passenger's seat, adjust the passenger's seat as far back as possible.

NOTE:
Observe any statutory regulation about child restraints.



65D607

⚠ WARNING

If your vehicle is equipped with a front passenger air bag, do not install a rear-facing child restraint in the front passenger's seat. If the passenger's air bag inflates, a child in a rear-facing child restraint could be killed or seriously injured. The back of a rear-facing child restraint would be too close to the inflating air bag.



65D609

⚠ WARNING

If you install a child restraint system in the rear seat, slide the front seat for enough forward so that the child's feet do not contact the front seat-back. This will help avoid injury to the child in the event of an accident.



65D608

⚠ WARNING

Children could be endangered in a crash if their child restraint systems are not properly secured in the vehicle. Be sure to secure the child in the restraint system according to the manufacturer's instructions.

Installation with Lap-Shoulder Seat Belts

NOTICE

Before installing a child restraint system in the rear seat, raise the head restraint (if equipped) to the most upper position.

BEFORE DRIVING

ELR type belt

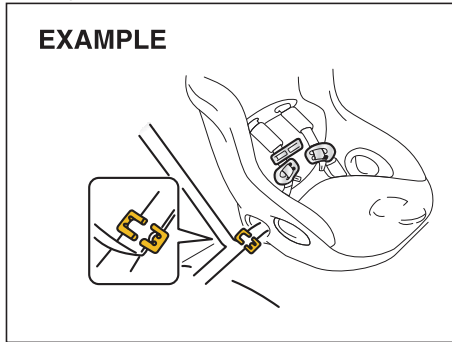

Install your child restraint system according to the instructions provided by the child restraint system manufacturer.

Make sure that the seat belt is securely latched.

Try to move the child restraint system in all directions to make sure it is securely installed.

Seat Belt Pretensioner System (if equipped)

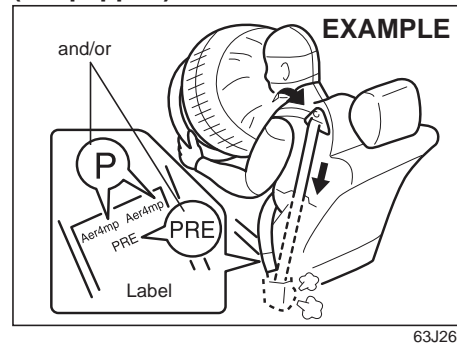

! WARNING

This section of the owner's manual describes your MARUTI SUZUKI's SEAT BELT PRETENSIONER SYSTEM. Please read and follow ALL these instructions carefully to minimize your risk of severe injury or death.

To determine if your vehicle is equipped with a seat belt pretensioner system at the front seating positions, check the label on the front seat belt at the bottom part. If the letters "p" and/or "PRE" appear as illustrated, your vehicle is equipped with the seat belt pretensioner system. You can use the pretensioner seat belts in the same manner as ordinary seat belts.

Read this section and the "Supplemental Restraint System (air bags)" section to learn more about the pretensioner system.

The seat belt pretensioner system works with the SUPPLEMENTAL RESTRAINT SYSTEM (Air Bags). The crash sensors and the electronic controller of the air bag system also control the seat belt pretensioners. When the air bags are triggered, the pretensioners are also triggered. For precautions and general information including servicing the pretensioner system, refer to the "Supplemental Restraint System (air bags)" section in addition to this "Seat Belt Pretensioner System" section, and follow all those precautions.

The pretensioner is located in each front seat belt retractor. The pretensioner tightens the seat belt so the belt fits the occupant's body more snugly in the event of a frontal crash. The retractors will remain locked after the pretensioners are activated. Upon activation, some noise will occur and some smoke may be released. These conditions are not harmful and do not indicate a fire in the vehicle.

The driver and all passengers must be properly restrained by wearing seat belts at all times, whether or not a pretensioner is equipped at their seating position, to minimize the risk of severe injury or death in the event of a crash.

BEFORE DRIVING

Sit fully back in the seat; sit up straight; do not lean forward or sideways. Adjust the belt so the lap portion of the belt is worn low across the pelvis, not across the waist. Please refer to the "Seat Adjustment" section and the instructions and precautions about the seat belts in this "Seat Belts and Child Restraint Systems" section for details on proper seat and seat belt adjustments.

Please note that the pretensioners along with the air bags will activate in severe frontal collisions. They are not designed to activate in rear impacts, side impacts, roll-overs, or minor frontal collisions. The pretensioners can be activated only once. If the pretensioners are activated (that is, if the air bags are activated), have the pretensioner system serviced by an authorized MARUTI SUZUKI dealer as soon as possible.

If the "AIR BAG" light on the instrument cluster does not blink or come on briefly when the ignition switch is turned to the "ON" position, stays on for more than 10 seconds, or comes on while driving, the pretensioner system or the air bag system may not work properly. Have both systems inspected by an authorized MARUTI SUZUKI dealer as soon as possible.

Service on or around the pretensioner system components or wiring must be performed only by an authorized MARUTI SUZUKI dealer who is specially trained.

Improper service could result in unintended activation of pretensioners or could render the pretensioner inoperative. Either of these two conditions may result in personal injury.

To prevent damage or unintended activation of the pretensioners, be sure the battery is disconnected and the ignition switch has been in the "LOCK" position or the ignition mode has been "LOCK" (OFF) for at least 90 seconds before performing any electrical service work on your MARUTI SUZUKI.

Do not touch pretensioner system components or wiring. The wires are wrapped with yellow tape or yellow tubing, and the couplers are yellow. When scrapping your MARUTI SUZUKI, ask your MARUTI SUZUKI dealer, body repair shop, or scrap yard for assistance.

Supplemental Restraint System (air bags) (if equipped)

▲ WARNING

This section of the owner's manual describes the protection provided by your MARUTI SUZUKI's SUPPLEMENTAL RESTRAINT SYSTEM (air bags). Please read and follow ALL these instructions carefully to minimize your risk of severe injury or death in the event of a collision.

Your vehicle is equipped with a Supplemental Restraint System consisting of the following components in addition to a lap-shoulder belt at each front seating position.

1. Driver's front air bag module (if equipped)
2. Front passenger's front air bag module (if equipped)
3. Seat belt pretensioners (if equipped)
4. Air bag controller (if equipped)
5. Forward crash sensor (if equipped)

EXAMPLE

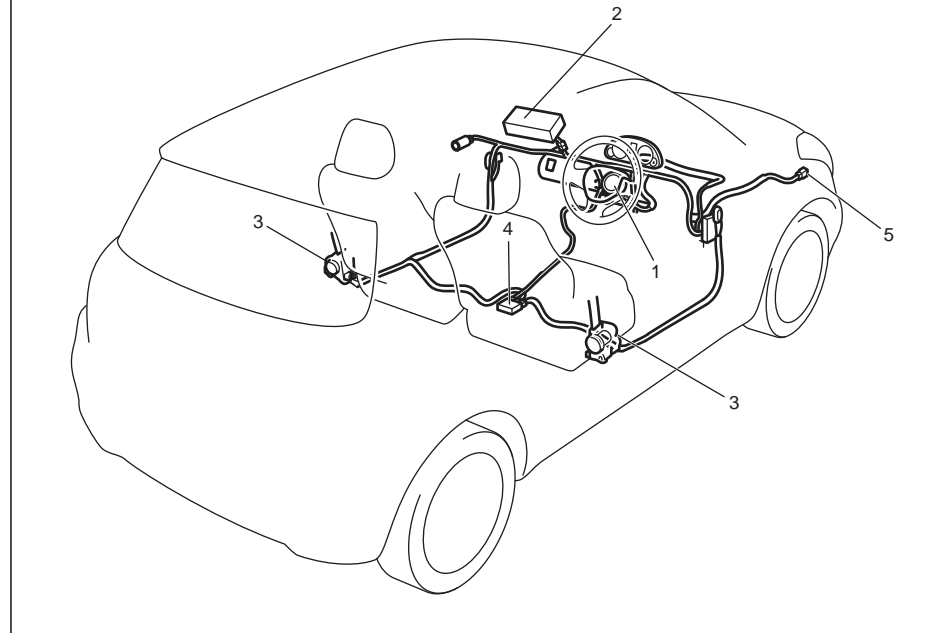

74LHT0215

"AIR BAG" light (If equipped)



63J030

If the "AIR BAG" light on the instrument cluster does not blink or come on when the ignition switch is first turned to the "ON" position, or the ignition mode is first changed to "ON" or the "AIR BAG" light stays on, or comes on while driving, the air bag system (or the seat belt pretensioner system) may not work properly. Have the air bag system inspected by an authorized MARUTI SUZUKI dealer as soon as possible.

Front Air Bags

EXAMPLE

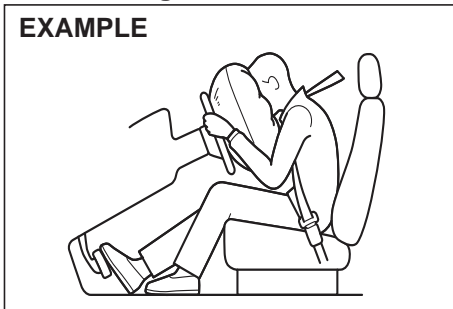

63J113

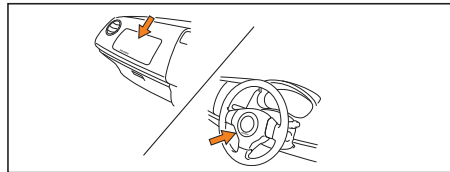

74LHT0237

The driver's front air bag is located behind the center pad of the steering wheel and the front passenger's front air bag is located behind the passenger's side of the dashboard. The words "SRS AIRBAG" are molded into the air bag covers to identify the location of the air bags.

Conditions of front air bags deployment (inflation)

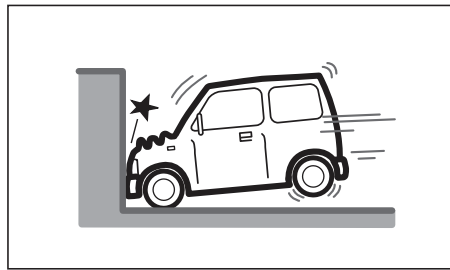

80J097

- In frontal collisions with a fixed wall that does not move or deform in more than about 25 km/h (15 mph)

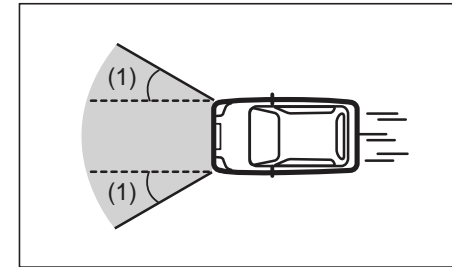

80J098E

- In collisions such as above at an angle of about 30 degrees (1) or less from the front

Conditions of front air bags may inflate

Receiving a strong impact to the lower body of your vehicle, the front air bags will inflate in many cases.

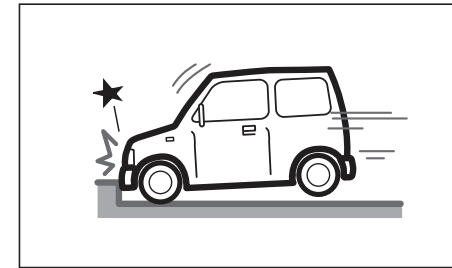

80J099

- Hitting a curb or medial strip

BEFORE DRIVING

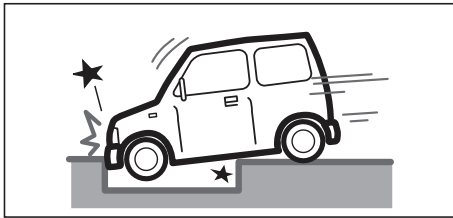

80J100E

- Falling into a deep hole or ditch

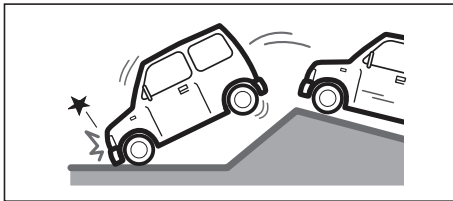

80J101

- Landing hard or falling

Front air bags may inflate in a strong impact

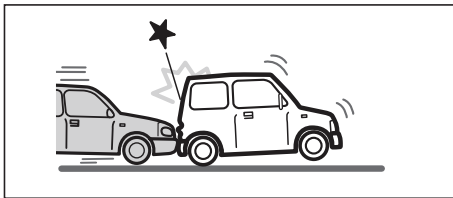

80J120

- Collision from the rear

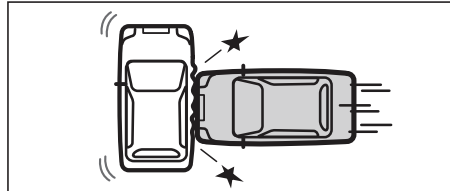

80J119

- Collision from the side



80J110

- Vehicle rollover

Front air bags may not inflate
The front air bags may not inflate when the impact is absorbed since the collision object moved, vehicle body deformed, or collision angle was greater than about 30 degrees from the front.

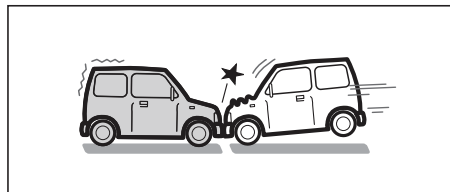

80J102

- Approximately 50 km/h (30 mph) or lower speed frontal collision to a stopped vehicle

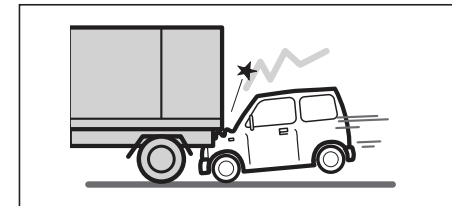

80J103

- Collision that the front of your vehicle goes under the bed of a truck etc.

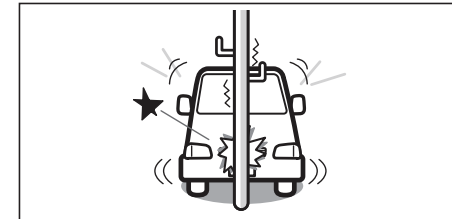

80J104

- Collision with a utility pole or stumpage

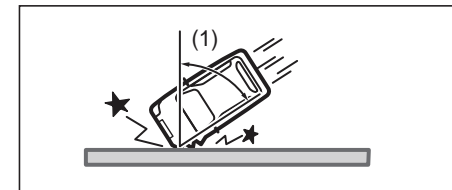

80J105E

- Collision with a fixed wall or guardrail at an angle of greater than about 30 degrees (1) from the front

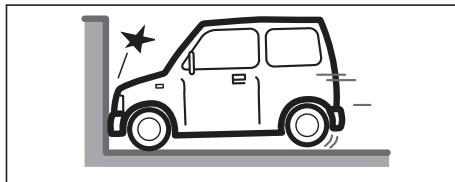

80J106

- In frontal collisions with a fixed wall that does not move or deform in less than about 25 km/h (15 mph)

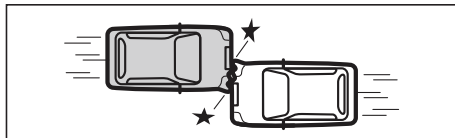

80J107

Collision angle is offset from the vehicle angle (offset collision)

Air bag symbol (if equipped) meaning

EXAMPLE

	<p>⚠ WARNING</p> <ul style="list-style-type: none"> • DO NOT place rear-facing child seat on this seat with airbag. • DEATH OR SERIOUS INJURY can occur. • The BACK SEAT is the SAFEST place for children aged 12 and under. • ALWAYS use SEAT BELTS and CHILD RESTRAINTS. • See the owner's manual for further information and explanation.
	<p>⚠ चेतावनी</p> <p>.....</p> <p>.....</p> <p>.....</p> <p>.....</p>

67LH029

You may find this label on the sun visor.

⚠ WARNING

Do not use a rearward facing child restraint on a seat protected by an active airbag in front of it.

⚠ WARNING

If the AIR BAG light in the instrument cluster ever comes on and stays on, it means that something may be wrong with the air bag system. If this ever happens, have the vehicle serviced immediately, because the air bags may not offer the protection for which they were designed.

How the System Works

In a frontal collision, the crash sensors will detect rapid deceleration, and if the controller judges that the deceleration represents a severe frontal crash, the controller will trigger the inflators. The inflators inflate the appropriate air bags with nitrogen or argon gas. The inflated air bags provide a cushion for your head and upper body. The air bag inflates and deflates so quickly that you may not even realize that it has activated. The air bag will neither hinder your view nor make it harder to exit the vehicle.

Air bags must inflate quickly and forcefully in order to reduce the chance of serious or fatal injuries. However, an unavoidable consequence of the quick inflation is that the air bag may irritate bare skin, such as the facial area against a front air bag. Also, upon inflation, a loud noise will occur and some powder and smoke will be released. These conditions are not harmful and do not indicate a fire in the vehicle. Be aware, however, that some air bag components may be hot for a while after inflation.

A seat belt helps keep you in the proper position for maximum protection when an air bag inflates. Adjust your seat as far back as possible while still maintaining control of the vehicle. Sit fully back in your seat; sit up straight; do not lean over the steering wheel or dashboard. Front occupants should not lean on or sleep against the door. Please refer to the "Seat Adjustment" section and the "Seat Belts and Child Restraint Systems" in this section for details on proper seat and seat belt adjustments.

BEFORE DRIVING



▲ WARNING

- **The driver should not lean over the steering wheel. The front passenger should not rest his or her body against the dashboard, or otherwise get too close to the dashboard. In these situations, the out-of-position occupant would be too close to an inflating air bag, and may suffer severe injury.**
- **Do not attach any objects to, or place any objects over, the steering wheel or dashboard. Do not place any objects between the air bag and the driver or front passenger. These objects may interfere with air bag operation or may be propelled by the air bag in the event of a crash. Either of these conditions may cause severe injury.**

Note that even though your vehicle may be moderately damaged in a collision, the collision may not have been severe enough to trigger the air bags to inflate. If your vehicle sustains ANY front-end or side damage, have the air bag system inspected by an authorized MARUTI SUZUKI dealer to ensure it is in proper working order.

Your vehicle is equipped with a diagnostic module which records information about the air bag system if the air bags deploy in a crash. The module records information about overall system status, which sensors activated the deployment.

Servicing the air bag system

If the air bags inflate, have the air bags and related components replaced by an authorized MARUTI SUZUKI dealer as soon as possible.

If your vehicle ever gets in deep water and the driver's floor is submerged, the air bag controller could be damaged. If it does, have the air bag system inspected by the MARUTI SUZUKI dealer as soon as possible.

Special procedures are required for servicing or replacing an air bag. For that reason, only an authorized MARUTI SUZUKI dealer should be allowed to service or replace your air bags. Please remind anyone who services your MARUTI SUZUKI that it has air bags.

Service on or around air bag components or wiring must be performed only by an authorized MARUTI SUZUKI dealer. Improper service could result in unintended air bag deployment or could render the air bag inoperative. Either of these two conditions may result in severe injury.

To prevent damage or unintended inflation of the air bag system, be sure the battery is disconnected and the ignition switch has been in the "LOCK" position or the ignition mode has been "LOCK" (OFF) for at least 90 seconds before performing any electrical service work on your MARUTI SUZUKI. Do not touch air bag system components or wires. The wires are wrapped with yellow tape or yellow tubing, and the couplers are yellow for easy identification.

Scrapping a vehicle that has an uninflated air bag can be hazardous. Ask your dealer, body repair shop or scrap yard for help with disposal.

According to accident statistics, children are safer when properly restrained on rear seats than front passenger's seat whenever possible, MARUTI SUZUKI recommends that child restraint systems be installed the rear seat.

Instrument Cluster (without Tachometer)

1. Speedometer
2. Fuel gauge
3. Temperature gauge
4. Information display
5. Trip meter selector knob
6. Indicator selector knob
7. Warning and indicator lights

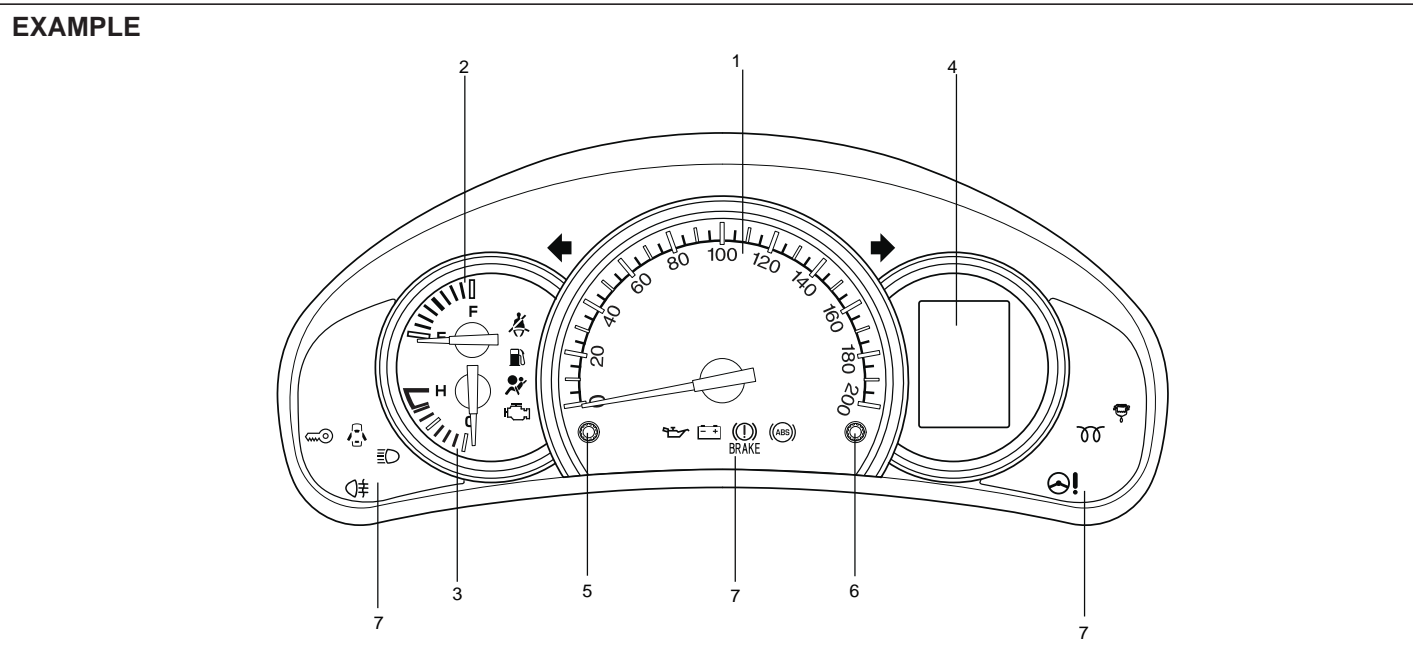

BEFORE DRIVING

Instrument Cluster (with Tachometer)

1. Speedometer
2. Tachometer
3. Fuel gauge
4. Temperature gauge
5. Information display
6. Trip meter selector knob
7. Indicator selector knob
8. Warning and indicator lights

EXAMPLE

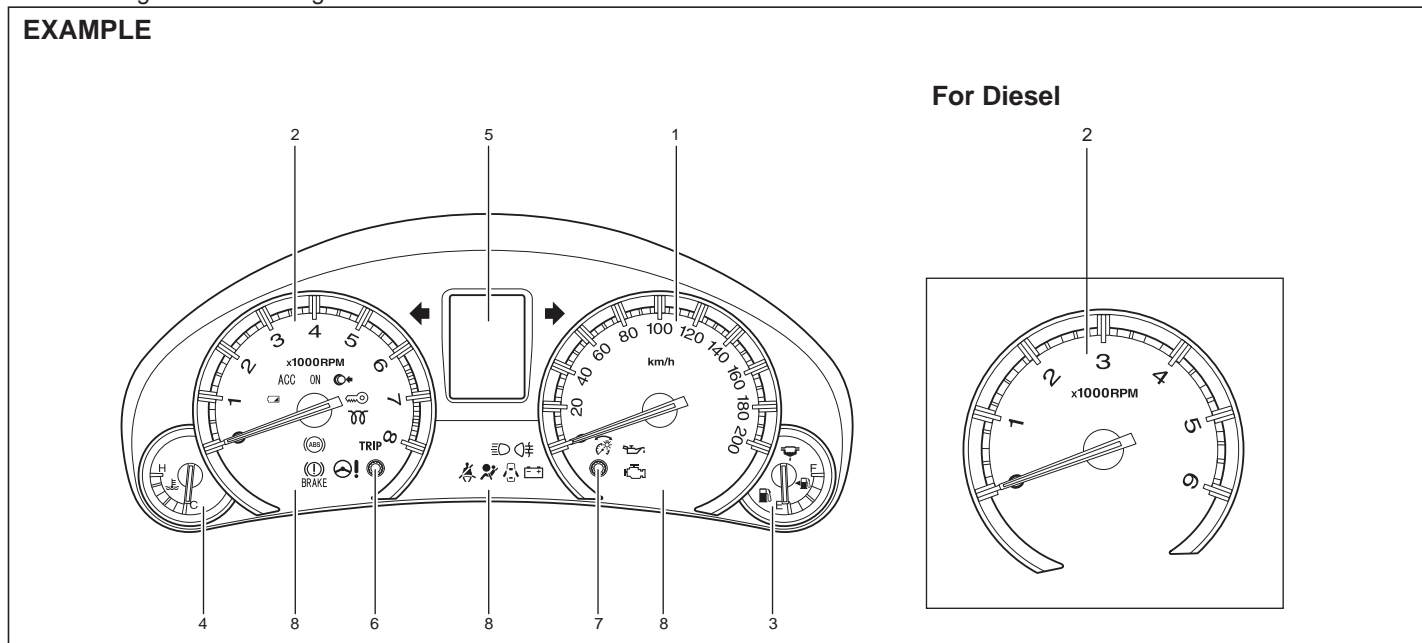

74LHT0236

Warning and Indicator Lights

Brake System Warning Light



65D477

For working check of this light, there are following three different type of operations depending on the vehicle's specification.

- 1) The light comes on briefly when the ignition switch is turned to the "ON" position or the engine switch is pressed to change the ignition mode to "ON".
- 2) The light comes on when the parking brake is engaged with the ignition switch in the "ON" position or the ignition mode "ON".
- 3) The light comes on when under either or both of above two conditions.

The light also comes on when the fluid in the brake fluid reservoir falls below the specified level.

The light should go out after starting the engine and fully releasing the parking brake, if the fluid level in the brake fluid reservoir is adequate.

The light also comes on together with the ABS warning light when the rear brake force control function (proportioning valve function) of the ABS system fails.

If the brake system warning light comes on while you are driving the vehicle, it may mean that there is something wrong with the vehicle's brake system. If this happens, you should:

- 1) Pull off the road and stop carefully.

⚠ WARNING

Remember that stopping distance may be longer, you may have to push harder on the pedal, and the pedal may go down farther than normal.

- 2) Test the brakes by carefully starting and stopping on the shoulder of the road.
- 3) If you determine that it is safe, drive cautiously at low speed to the nearest dealer for repairs, or
- 4) Have the vehicle towed to the nearest MARUTI SUZUKI dealer for repairs.

⚠ WARNING

If any of the following conditions occur, you should immediately ask your MARUTI SUZUKI dealer to inspect the brake system.

- If the brake system warning light does not go out after the engine has been started and the parking brake has been fully released.
- If the brake system warning light does not come on when the ignition switch is turned to the "ON" position or the engine switch is pressed to change the ignition mode to "ON".
- If the brake system warning light comes on at any time during vehicle operation.

NOTE:

Because the brake system is self-adjusting, the fluid level will drop as the brake pads become worn. Replenishing the brake fluid reservoir is considered normal periodic maintenance.

NOTE:

*(Parking Brake Reminder Buzzer)
A buzzer sounds intermittently to remind you to release the parking brake if you start the vehicle without releasing the parking brake. Make sure that the parking brake is fully released and the brake system warning light turns off.*

BEFORE DRIVING

Anti-Lock Brake System (ABS) Warning Light (if equipped)

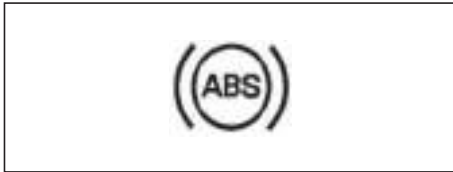

When the ignition switch is turned to the "ON" position or the engine switch is pressed to change the ignition mode to "ON", the light comes on briefly so you can check that the light is working.

If the light stays on, or comes on when driving, there may be something wrong with the ABS.

If this happens:

- 1) Pull off the road and stop carefully.
- 2) Turn the ignition switch to "LOCK" or change the ignition mode to "LOCK" (OFF) by pressing the engine switch and then start the engine again.

If the warning light comes on briefly then turns off, the system is normal. If the warning light still stays on, there is something wrong in the system.

If the light and the brake system warning light stay on, or come on simultaneously when driving, your ABS system is equipped with the rear brake force control function (proportioning valve function) and there may be something wrong with both the rear brake force control function and anti-lock function of the ABS system.

If one of these happens, have the system inspected by your MARUTI SUZUKI dealer.

If the ABS becomes inoperative, the brake system will function as an ordinary brake system that does not have this ABS system.

Oil Pressure Light



This light comes on when the ignition switch is turned to the "ON" position or the engine switch is pressed to change the ignition mode to "ON", and goes out when the engine is started. The light will come on and remain on if there is insufficient oil pressure. If the light comes on when driving, pull off the road as soon as you can and stop the engine.

Check the oil level and add oil if necessary. If there is enough oil, the lubrication system should be inspected by your MARUTI SUZUKI dealer before you drive the vehicle again.

NOTICE

- If you operate the engine with this light on, severe engine damage can result.
- Do not rely on the oil pressure light to indicate the need to add oil. Be sure to periodically check the engine oil level.

Charging Light

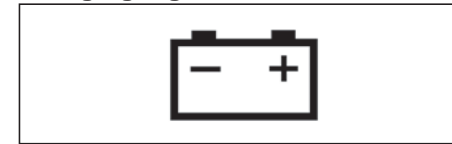

This light comes on when the ignition switch is turned to the "ON" position or the engine switch is pressed to change the ignition mode to "ON", and goes out when the engine is started. The light will come on and remain on if there is something wrong with the battery charging system. If the light comes on when the engine is running, the charging system should be inspected immediately by your MARUTI SUZUKI dealer.

BEFORE DRIVING

Driver's Seat Belt Reminder Light



60G049

When the driver doesn't buckle his or her seat belt, this light will come on and/or blink.

For details about the seat belt reminder, refer to "Seat Belts and Child Restraint Systems" in this section.

"AIR BAG" Light (if equipped)



63J030

This light blinks or comes on for several seconds when the ignition switch is turned to the "ON" position or the engine switch is pressed to change the ignition mode to "ON" so you can check if the light is working.

The light will come on and stay on if there is a problem in the air bag system or the seat belt pretensioner system (if equipped).

⚠ WARNING

If the "AIR BAG" light does not blink or come on briefly when the ignition switch is turned to the "ON" position or the engine switch is pressed to change the ignition mode to "ON", stays on for more than 10 seconds, or comes on while driving, the air bag system or the seat belt pretensioner system (if equipped) may not work properly. Have both systems inspected by an authorized MARUTI SUZUKI dealer.

Malfunction Indicator Light



65D530

Your vehicle has a computer-controlled emission control system. A malfunction indicator light is provided on the instrument panel to indicate when it is necessary to have the emission control system serviced. The malfunction indicator light comes on when the ignition switch is turned to the "ON" position or the engine switch is pressed to change the ignition mode to "ON" to let you know the light is working and goes out when the engine is started.

If the malfunction indicator light comes on or blinks when the engine is running, there is a damage in the emission control system.

Take the vehicle to your MARUTI SUZUKI dealer to have the damage fixed.

NOTICE

Continuing to drive the vehicle when the malfunction indicator light is on or blinking can cause permanent damage to the vehicle's emission control system, and can affect fuel economy and driveability.

Transaxle Warning Light (if equipped)



80J219

This light comes on for several seconds when the ignition switch is turned to the "ON" position or the engine switch is pressed to change the ignition mode to "ON" so you can check the light is working. If this light comes on when the engine is running, there is a problem with the transaxle system. Ask your MARUTI SUZUKI dealer to have the system inspected.

BEFORE DRIVING

Immobilizer/Keyless Push Start System Warning Light

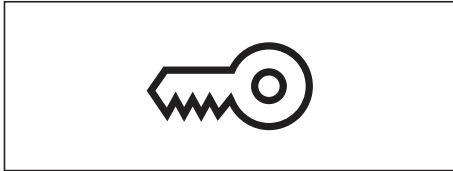

80JM122

When the ignition switch is turned to the "ON" position or the engine switch is pressed to change the ignition mode to "ON", the light comes on briefly so you can check that the light is working. If this light stays on, there is a problem with the system. Ask your MARUTI SUZUKI dealer to have the system inspected.

Open Door Warning Light

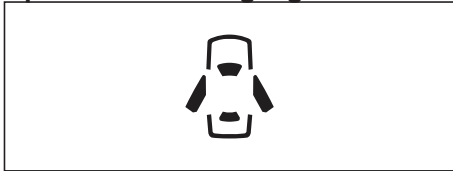

54G391

This light remains on until all doors (including the tail gate for some model) are completely closed.

If any door is open when the vehicle is moving, a ding sounds to remind you to close all doors completely.

Low Fuel Warning Light



54G343

If this light comes on, fill the fuel tank immediately.

When this light comes on, a ding sounds once to remind you to fill the fuel.

If you do not fill the fuel, a ding sounds every time when the ignition switch is turned to the "ON" position or the engine switch is pressed to change the ignition mode to "ON".

NOTE:

The activation point of this light varies depending on road conditions (for example, slope or curve) and driving conditions because of fuel moving in the tank.

Electric Power Steering Light



79J039

This light comes on when the ignition switch is turned to the "ON" position or the engine switch is pressed to change the ignition mode to "ON", and goes out when the engine is started.

If this light comes on while driving, the power steering system may not work properly. Have the system inspected by your MARUTI SUZUKI dealer.

NOTE:

Following operations of the steering wheel while parking or driving at a very low-speed may have steering effort bigger gradually. This is not a malfunction of the steering system, but the power steering control system limits the power assist in order to prevent them from overheating.

- *The steering wheel is operated very often.*
- *The steering wheel is kept in a fully turned position for a long while.*

When the power steering control system cool down, the power steering system back to the original condition.

However, repeating these operations could cause the power steering system damaged.

NOTE:

If the power steering system does not work properly, you will feel heavier to steer but you still will be able to steer.

NOTE:

If the steering is operated, you may hear a rubbing noise. This is normal and indicates that the power steering system works properly.

BEFORE DRIVING

Turn Signal Indicators

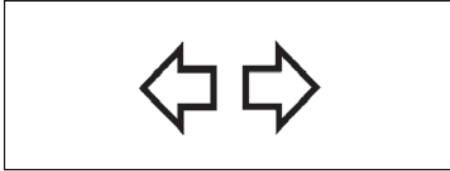

50G055

When you turn on the left or right turn signals, the corresponding green arrow on the instrument panel will flash along with the respective turn signal lights. When you turn on the hazard warning switch, both arrows will flash along with all of the turn signal lights.

Main Beam (high beam) Indicator Light



50G056

This indicator comes on when headlight main beams (high beams) are turned on.

Glow Plug Indicator Light (For Diesel Engine Model)

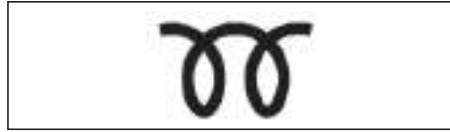

60A543

If the coolant temperature is cool enough, this light comes on when the ignition switch is turned to the "ON" position or the engine switch is pressed to change the ignition mode to "ON" and goes out when the glow plug is heated enough for engine starting.

Fuel Filter Warning Light (For Diesel Engine Model)



60A541

This light comes on for several seconds when the ignition switch is turned to the "ON" position or the engine switch is pressed to change the ignition mode to "ON" so you can check that light is working.

If the light comes on when driving, there is a possibility to have water in the fuel filter. Drain water as soon as possible. Have your vehicle inspected by an authorized MARUTI SUZUKI dealer.

Keyless Push Start System Remote Controller Battery Consumption Warning Light (if equipped)



70K122

If the remote controller becomes unreliable, this light comes on for several seconds when the engine switch is pressed to change the ignition mode to "ON".

"PUSH" Indicator Light



82K174

If this light comes on when depressing the clutch pedal for manual transaxle vehicles, you can start the engine.

"ACC" Indicator Light (if equipped)



82K097

This light comes on when the ignition mode is "ACC".

BEFORE DRIVING

Ignition "ON" Indicator Light (if equipped)



82K098

This light comes on when the ignition mode is "ON" with the engine off.

Speedometer

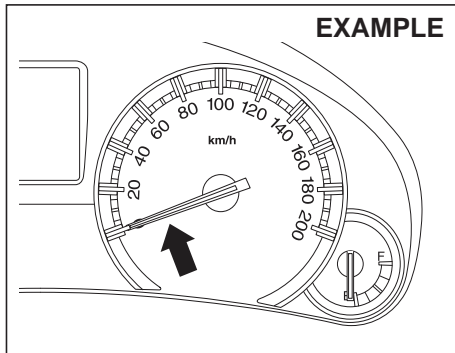

68LM223

The speedometer indicates vehicle speed in km/h.

Tachometer (if equipped)

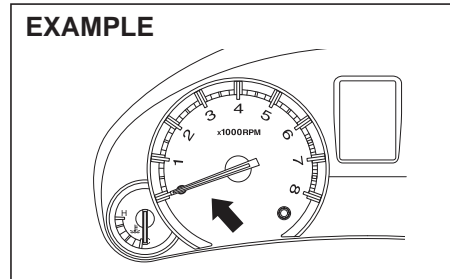

68LM224

The tachometer indicates engine speed in revolutions per minute.

NOTICE

Never drive the vehicle with the engine revving in the red zone or severe engine damage can result. Keep the engine speed below the red zone even when downshifting to a lower gear position. Refer to "Downshifting maximum allowable speeds" in the "OPERATING YOUR VEHICLE" section.

NOTE:

Maximum engine speed is limited at approximately 5000 revolutions per minute by the fuel cut control when you press the accelerator pedal while the gearshift is in "N" (Neutral).

Fuel Gauge

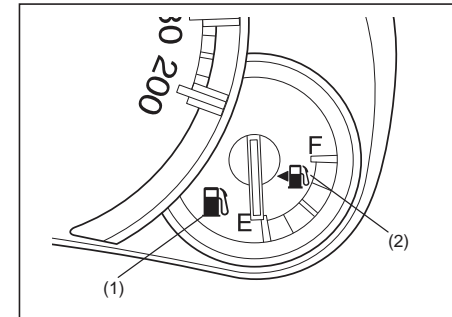

74LHT0220

When the ignition switch is in the "ON" position or the ignition mode is "ON", this gauge gives an approximate indication of the amount of fuel in the fuel tank. "F" stands for full and "E" stands for empty.

If the indicator gets off the graduation of "E" (not character "E"), refill the tank as soon as possible.

NOTE:

The indicator moves a little depending on road conditions (for example, slope or curve) and driving conditions because of fuel moving in the tank.

If the low fuel warning light (1) comes on, fill the fuel tank immediately.

BEFORE DRIVING

When the low fuel warning light (1) comes on, a ding sounds once to remind you to fill the fuel.

If you do not fill the fuel, a ding sounds every time when the ignition switch is turned to "ON" position.

NOTE:

The activation point of the low fuel warning light (1) varies depending on road conditions (for example, slope or curve) and driving conditions because of fuel moving in the tank.

The mark (2) indicates that the fuel filler door is located on the left side of the vehicle.

Temperature Gauge

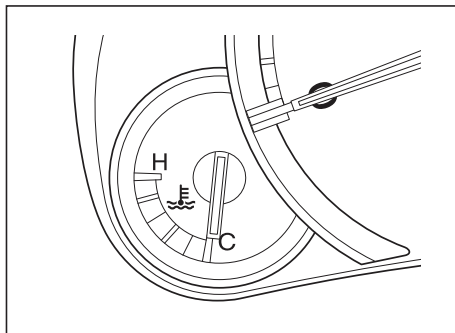

74LHT0221

When the ignition switch is in the "ON" position or the ignition mode is "ON", this gauge indicates the engine coolant tem-

perature. Under normal driving conditions, the indicator should stay within the normal, acceptable temperature range between "H" and "C". If the indicator approaches "H", overheating is indicated. Follow the instructions for engine overheating in the "EMERGENCY SERVICE" section.

NOTICE

Continuing to drive the vehicle when engine overheating is indicated can result in severe engine damage.

Brightness Control

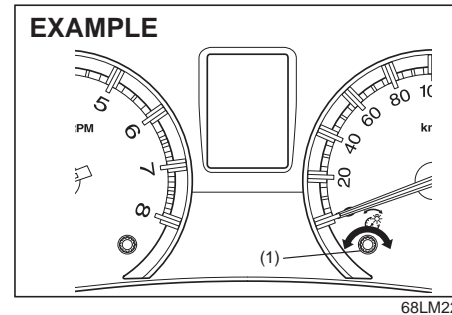

68LM227

When the ignition switch is turned to the "ON" position or the engine switch is pressed to change the ignition mode is "ON", the pointer lights come on.

Your vehicle has a system to automatically dim the brightness of the instrument panel

lights when the position lights or headlights are on.

When the position lights and/or headlights are ON, you can control the meter illumination intensity.

To increase the brightness of the instrument panel lights, turn the brightness control knob (1) clockwise.

To reduce the brightness of the instrument panel lights, turn the brightness control knob (1) counterclockwise.

NOTE:

- *If you do not turn the brightness control knob within about 5 seconds of activating the brightness control display, the brightness control display will be canceled automatically.*
- *When you reconnect the battery, the brightness of the instrument panel lights will be reinitialized. Readjust the brightness according to your preference.*

BEFORE DRIVING

Information Display

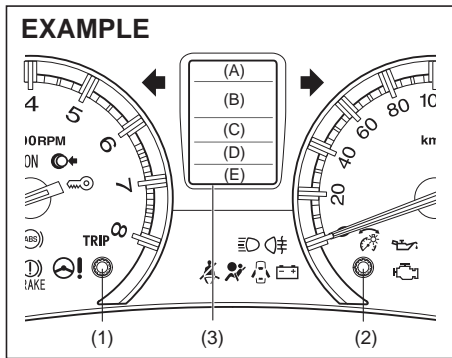

- (1) Trip meter selector knob
- (2) Indicator selector knob
- (3) Information display

When the ignition switch is in the "ON" position or the ignition mode is "ON", the information display shows the following information.

Display (A)
Thermometer

Display (B) (For automatic transmission)

Transmission selector Position Indicator

Display (C)

Trip meter / Instantaneous fuel consumption / Average fuel consumption / Driving range.

Display (D)
Odometer

Display (E)
Clock

Thermometer (if equipped)

When the ignition switch is in the "ON" position or the ignition mode is "ON", the display (A) shows the thermometer.

The thermometer indicates the outside temperature.



68LM258

If the outside temperature nears freezing, the mark (a) will appear on the display.

NOTE:

- The outside temperature indication is not the actual outside temperature when driving at low speed, or when stopped.
- If there is something wrong with the thermometer, or just after the ignition switch is turned to the "ON" position or the engine switch is pressed to change the ignition mode is "ON", the display may not indicate the outside temperature.

When the display (B) shows the driving range, you can change the unit of temperature.

To change the unit of temperature, while pushing and holding the trip meter selector knob (1), turn the indicator selector knob (2).

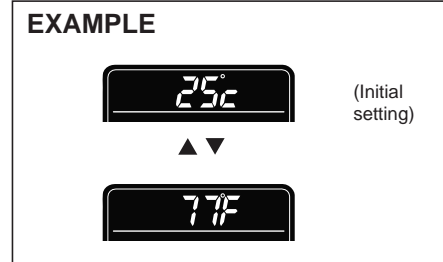

68LM259

NOTE:

When you reconnect the negative (-) terminal to the battery, the unit of temperature will be reinitialized. Change the unit again to your preference.

Transmission selector position indicator (for automatic transmission vehicles)

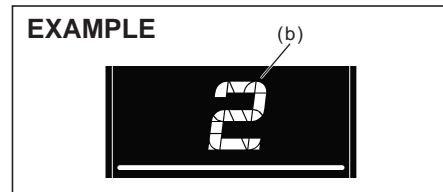

68LM258

When the ignition switch is in the "ON" position or the ignition mode is "ON" the

BEFORE DRIVING

display (B) indicates the gear position (b). For details on how to use the transmission refer to “Using the transmission in the “OPERATING YOUR VEHICLE” section.

Trip meter / Instantaneous fuel consumption / Average fuel consumption / Driving range

When the ignition switch is in the “ON” position or the ignition mode is “ON”, the display (B) shows one of the following five indications, trip meter A, trip meter B, Instantaneous fuel consumption, Average fuel consumption or Driving range.

To switch the display indication (B), push the trip meter selector knob (1) or the indicator selector knob (2) quickly.

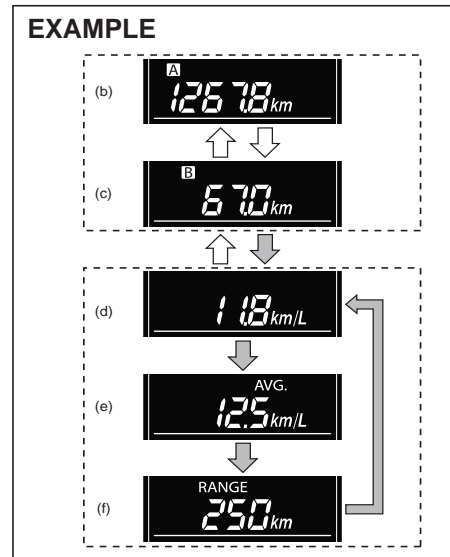

↑ ↓	Push the trip meter selector knob (1).
↑ ↓	Push the indicator selector knob (2).

- (b) Trip meter A
- (c) Trip meter B
- (d) Instantaneous Fuel Consumption
- (e) Average fuel consumption
- (f) Driving range

⚠ WARNING

If you attempt to adjust the display while driving, you could lose control of the vehicle.

Do not attempt to adjust the display while driving.

NOTE:

- Indications will change when you push and release a knob.
- The display shows estimated values. Indications may not be the same as actual values.

Trip meter

The trip meter can be used to measure the distance traveled on short trips or between fuel stops.

You can use the trip meter A or trip meter B independently.

To reset the trip meter to zero, push and hold the trip meter selector knob (1) for a while when the display shows the trip meter.

NOTE:

The indicated maximum value of the trip meter is 9999.9. When you run past the maximum value, the indicated value will return to 0.0.

Instantaneous Fuel Consumption

If you selected instantaneous fuel consumption the last time you drove the vehicle, the display does not show the last

BEFORE DRIVING

value of instantaneous fuel consumption from previous driving when the ignition switch is turned to the "ON" position or the engine switch is pressed to change the ignition mode is "ON". The display shows the value only when the vehicle is moving.

NOTE:

- The display does not show the value unless the vehicle is moving.
- Depending on the vehicle's specification, the initial setting for the fuel consumption unit is indicated as L/100km, km/L or MPG.
- For "L/100km" or "km/L" setting, the indicated maximum value of instantaneous fuel consumption is 30. No more than 30 will be indicated on the display even if the actual instantaneous fuel consumption is higher.
- For "MPG" setting, the indicated maximum value of instantaneous fuel consumption is 99.9. No more than 99.9 will be indicated on the display even if the actual instantaneous fuel consumption is higher.
- The indication on the display may be delayed if fuel consumption is greatly affected by driving conditions.
- The display shows estimated values. Indications may not be the same as actual values.
- For "L/100km" or "km/L" setting, you can change the units that instantaneous fuel consumption is displayed in. Refer to

"Average fuel consumption" in this section.

⚠ WARNING

If you attempt to adjust the display while driving, you could lose control of the vehicle.

Do not attempt to adjust the display while driving.

NOTE:

When you reconnect the negative (-) terminal to the battery, the indication of the instantaneous fuel consumption will be reinitialized. Change the indication again to your preference.

Average fuel consumption

If you selected average fuel consumption the last time you drove the vehicle, the display shows the last value of average fuel consumption from previous driving when the ignition switch is turned to the "ON" position or the engine switch is pressed to change the ignition mode is "ON". Unless you reset the value of average fuel consumption, the display indicates the value of average fuel consumption which includes average fuel consumption during previous driving.

To reset the average fuel consumption to zero, push and hold the indicator selector knob (2) for a while when the display shows the average fuel consumption.

NOTE:

When you reset the indication or reconnect the negative (-) terminal to the battery, the value of average fuel consumption will be shown after driving for a while.

For "L/100 KM" or "KM/L" setting

To change the unit of average fuel consumption, while pushing and holding the trip meter selector knob (1), turn the indicator selector knob (2).

EXAMPLE



68LM262

NOTE:

Depending on the vehicle's specification, the fuel consumption units of initial setting are indicated as km/L or L/100km.

NOTE:

- When you change the units that average fuel consumption is displayed in, the instantaneous fuel consumption units will be changed automatically.

BEFORE DRIVING

- When you reconnect the negative (-) terminal to the battery, the unit of the average fuel consumption will be reinitialized. Change the unit again to your preference.

Driving range

If you selected driving range the last time you drove the vehicle, the display indicates "---" for a few seconds and then indicates the current driving range when the ignition switch is turned to the "ON" position or the engine switch is pressed to change the ignition mode is "ON".

The driving range shown in the display is the approximate distance you can drive until the fuel gauge indicates "E", based on current driving conditions.

When the low fuel warning light comes on, the display "---" will appear.

If the low fuel warning light comes on, fill the fuel tank immediately regardless of the value of driving range shown in the display.

As the driving range after refueling is calculated based on the most recent driving condition, the value is different each time you refuel.

NOTE:

- If you refuel when the ignition switch is in the "ON" position or the ignition mode is "ON", the driving range may not indicate the correct value.
- When you reconnect the negative (-) terminal to the battery, the value of driv-

ing range will be shown after driving for a while.

Odometer

When the ignition switch is in the "ON" position or the ignition mode is "ON", the display (C) shows the odometer. The odometer records the total distance the vehicle has been driven.

NOTICE

Keep track of your odometer reading and check the maintenance schedule regularly for required services. Increased wear or damage to certain parts can result from failure to perform required services at the proper mileage intervals.

Clock

When the ignition switch is in the "ON" position or the ignition mode is "ON", the display (D) shows the time.

To change the time indication:

- 1) Push the trip meter selector knob (1) and the indicator selector knob (2) together.
- 2) To change the hour indication, turn the indicator selector knob (2) left or right repeatedly when the hour indication blinks. To change the hour indication quickly, turn and hold the indicator selector knob (2). To set the hour indication, push the indicator selector knob (2) and the minute indication will blink.

- 3) To change the minute indication, turn the indicator selector knob (2) left or right repeatedly when the minute indication blinks. To change the minute indication quickly, turn and hold the indicator selector knob (2). To set the minute indication, push the indicator selector knob (2).

⚠ WARNING

If you attempt to adjust the display while driving, you could lose control of the vehicle.

Do not attempt to adjust the display while driving.

NOTE:

When you reconnect the negative (-) terminal to the battery, the clock indication will be reinitialized. Change the indication again to your preference.

BEFORE DRIVING

Setting Mode (If equipped)

In the setting mode, you can set up the following functions.

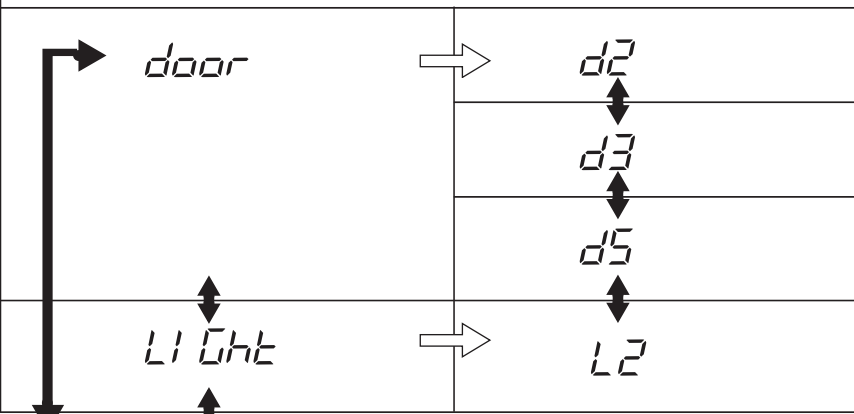
Indication		Functions
 <p><i>door</i></p>	<p><i>d2</i></p>	Automatic door locking function “ <i>d2</i> ”
	<p><i>d3</i></p>	Automatic door unlocking function “ <i>d3</i> ”
	<p><i>d5</i></p>	Door locking and unlocking siren “ <i>d5</i> ”
<p><i>LIGHT</i></p>	<p><i>L2</i></p>	Additional flashes of the turn signal “ <i>L2</i> ”

BEFORE DRIVING

Indication		Functions
	SECURITY	Security system "51"
	51	Shock sensor "52"
	52	Pre-warning sensitivity of the shock sensor "53"
	53	Full blast warning sensitivity of the shock sensor "54"
	54	Initialization setting "dE-on"
	default	Exit the setting mode "End"
	End	

	Turn the indicator selector knob (3).
	Push the indicator selector knob (3).

NOTE:
Depending on vehicle's specifications, some items may not be displayed.

How to operate the setting mode:

- 1) When the ignition switch is in the "ON" position or press the engine switch to change the ignition mode to "ON" and the vehicle is stationary, push the trip meter selector knob (2) to switch the information display indication (D) to the odometer.
- 2) Push and hold the indicator selector knob (3) until the display shows "door".
- 3) Turn and/or push the indicator selector knob (3) to select a function that you want to set up according to the above chart.
- 4) Turn and/or push the indicator selector knob (3) to register settings of the following functions.

BEFORE DRIVING

Automatic door locking function “d2”

- *d2-SL1*: Disable the automatic door locking function
- *d2-SL2*: Lock all doors when the vehicle speed reaches 15 km/h (default setting)
- *d2-SL3*: (For automatic transaxle vehicle)
Lock all door when the gearshift lever is in other than “P”

Security system “51”

- *51-SL1*: Enable the security system (default setting)
- *51-SL2*: Disable the security system

Shock sensor “52”

- *52-SL1*: Enable the shock sensor
- *52-SL2*: Disable the shock sensor (default setting)

Pre-warning sensitivity of the shock sensor “53”

- *53-L00*: Disable the pre-warning
53-L01 to *L15*:

Adjust the pre-warning sensitivity of shock sensor (Lowest sensitivity level is L01 and highest is L15, and default setting is L14)

Automatic door unlocking function “d3”

- *d3-SL1*: Disable the automatic door unlocking function (default setting of vehicle with keyless push start system)
- *d3-SL2*: (For automatic transaxle vehicle)
Unlock all doors when the gearshift lever is moved to the “P” from other position
- *d3-SL3*: (Vehicle with keyless entry system)
Unlock all doors when the key is pulled out from the ignition switch (default setting of vehicle with keyless entry)
(Vehicle with keyless push start system)
Unlock all doors when the ignition mode is “LOCK” (OFF)

Full blast warning sensitivity of the shock sensor “54”

- *54-L00*: Disable the full blast warning
54-L01 to *L15*:
Adjust the full blast warning sensitivity of shock sensor (Lowest sensitivity level is L01 and highest is L15, and default setting is L09)

Door locking and unlocking siren “d5”

- *d5-SL1*: Siren sounds when the door(s) is(are) locked or unlocked by using the keyless entry system transmitter, keyless push start system remote controller or request switch (default setting)
- *d5-SL2*: Siren does not sound when the door(s) is(are) locked or unlocked by using the keyless entry system transmitter, keyless push start system remote controller or request switch

Additional flashes of the turn signal “L2”

- *L2-SL1*: Turn signal flashes three times after the turn signal lever is returned (default setting)
- *L2-SL2*: Disable the additional flashes of turn signal

Initialization setting “dE-on”

- *dE-on*: Initialize all settings

BEFORE DRIVING

EXAMPLE

76MH0017

NOTE:

- As shown in the above illustration, “**AB**” indicates on the display of currently setting item.
- To go back to the higher level display during operation, turn the indicator selector knob (3) to display “**BRCH**” or “**-BR**” and then push the indicator selector knob (3).
- If the security system “**51**” is in the disabled state, the shock sensor “**52**”, pre-warning sensitivity “**53**” and full blast warning sensitivity “**54**” cannot be set up.

To exit the setting mode, switch the display to show “**End**” and then push the indicator selector knob (3).

Lighting Control Lever

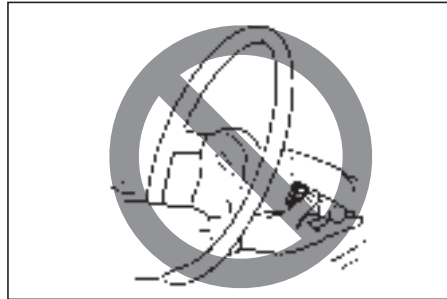

65D611

⚠ WARNING

To avoid possible injury, do not operate controls by reaching through the steering wheel.

Lighting Operation

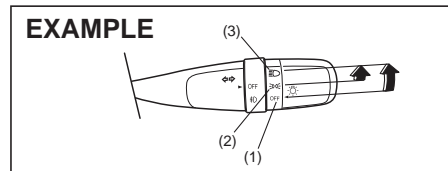

74LHT0224

To turn the lights on or off, twist the knob on the end of the lever. There are three positions:

OFF (1)

All lights are off.

☞ (2)

Front position lights, tail lights, license plate light and instrument lights are on, but headlights are off.

☞ (3)

Front position lights, tail lights, license plate light, instrument lights and headlights are on.

EXAMPLE

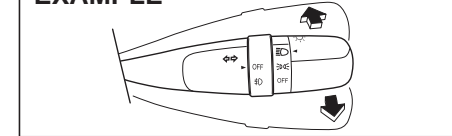

74LHT0225

With the headlights on, push the lever forward to switch to the high beams (main beams) or pull the lever toward you to switch to the low beams. When the high beams (main beams) are on, a light on the instrument panel will come on. To momentarily activate the high beams (main beams) as a passing signal, pull the lever slightly toward you and release it when you have completed the signal.

Light Reminder Buzzer (if equipped)

A buzzer sounds to remind you to turn off the lights if they are left on when the igni-

BEFORE DRIVING

tion key is removed and the driver's door is opened.

Rear Fog Light Switch (if equipped)

EXAMPLE

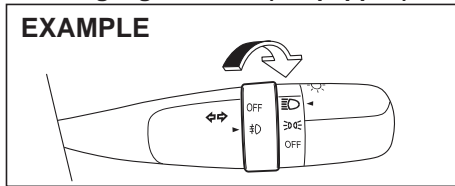

74LHT0226

To turn the rear fog light on, twist the knob as shown in the illustration with the headlights are on. When the rear fog light is on, an indicator light on the instrument cluster will come on.

Front Fog Light Switch (if equipped)

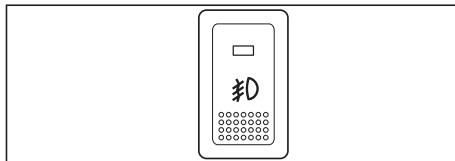

64J058

The front fog light comes on when the fog light switch is pushed in with the position lights, tail lights and/or the headlights are on. An indicator light above the switch will be lit when the front fog light is on.

Headlight Leveling Switch

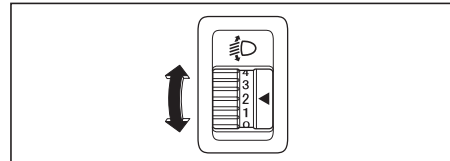

80JM040

Level the headlight beam according to the load condition of your vehicle by turning this switch. The chart below shows the appropriate switch position for different vehicle-load conditions.

Vehicle Load Condition	Switch Position
Driver only	0
Driver + 1 passenger (in front seat)	1
Driver + 4 passengers, no cargo	2
Driver + 4 passengers, cargo added	2
Driver + full cargo	3

Turn Signal Control Lever



65D611

WARNING

To avoid possible injury, do not operate controls by reaching through the steering wheel.

Turn Signal Operation

With the ignition switch in the "ON" position or the ignition mode is "ON", move the lever up or down to activate the left or right turn signals.

Normal turn signal

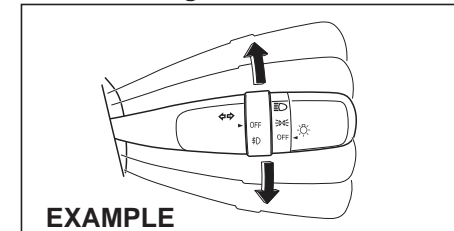

EXAMPLE

74LHT0227

Move the lever all the way upward or downward to signal. When the turn is com-

BEFORE DRIVING

pleted, the signal will cancel and the lever will return to its normal position.

Lane change signal

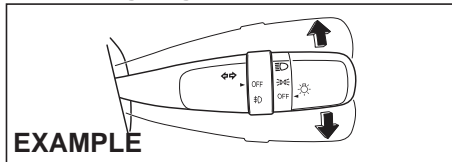

74LHT0228

Some times, such as when changing lanes, the steering wheel is not turned far enough to cancel the turn signal. For convenience, you can flash the turn signal by moving the lever part way and holding it there. The lever will return to its normal position when you release it.

Hazard Warning Switch

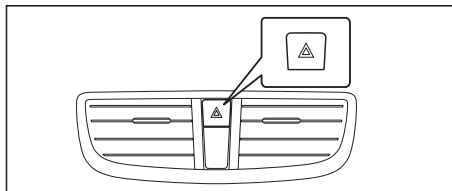

74LHT0229

Push in the hazard warning switch to activate the hazard warning lights. All turn signal lights and both turn signal indicators will flash simultaneously. To turn off the lights, push the switch again.

Use the hazard warning lights to warn other traffic during emergency parking or

when your vehicle could otherwise become a traffic hazard.

Windshield Wiper and Washer Lever



57L21128

WARNING

To avoid possible injury, do not operate controls by reaching through the steering wheel.

Windshield Wipers

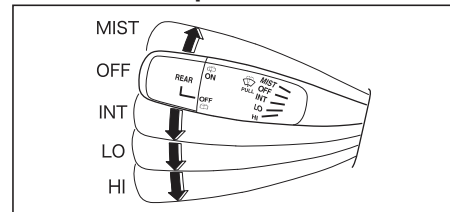

74LHT0230

To turn the windshield wipers on, move the lever down to one of the three operating positions. In the "INT" position, the wipers

operate with "LO" speed & with a gap between two wipes/wipe cycle. The "INT" position is very convenient for driving in mist or light rain. In the "LO" position, the wipers operate at a steady low speed. In the "HI" position, the wipers operate at a steady high speed. To turn off the wipers, move the lever back to the "OFF" position.

Move the lever up and hold it to the "MIST" position, the windshield wipers will turn on continuously at low speed.

Windshield Washer

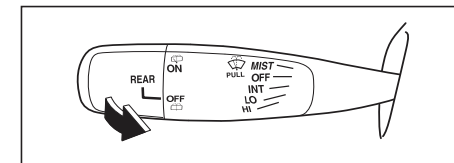

74LHT0231

To spray windshield washer fluid, pull the lever toward you. The windshield wipers will automatically turn on at low speed if they are not already on and the "INT" position is equipped.

BEFORE DRIVING

WARNING

- To prevent windshield icing in cold weather, turn on the defroster to heat the windshield before and during windshield washer use.
- Do not use radiator antifreeze in the windshield washer reservoir. It can severely impair visibility when sprayed on the windshield, and can also damage your vehicle's paint.

NOTICE

To help prevent damage to the windshield wiper and washer system components, you should take the following precautions:

- Do not continue to hold in the lever when there is no windshield washer fluid being sprayed or the washer motor can be damaged.
- Do not attempt to remove dirt from a dry windshield with the wipers or you can damage the windshield and the wiper blades. Always wet the windshield with washer fluid before operating the wipers.
- Clear ice or packed snow from the wiper blades before using the wipers.
- Check the washer fluid level regularly. Check it often when the weather is bad.
- Only fill the washer fluid reservoir 3/4 full during cold weather to allow room for expansion if the temperature falls low enough to freeze the solution.

Rear Window Wiper/Washer Switch (if equipped)

EXAMPLE

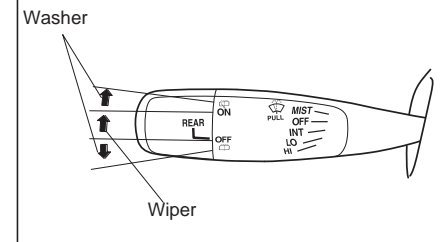

To turn the rear wiper on, twist the rear wiper switch on the end of the lever forward to the "ON" position. To turn the rear wiper off, twist the switch rearward to the "OFF" position.

To spray window washer fluid, twist the switch rearward from the "OFF" position, or twist the switch forward from the "ON" position. The rear wiper will turn on automatically while spraying the window washer fluid.

NOTICE

Clear ice or snow from the rear window and rear wiper blade before using the rear wiper. Accumulated ice or snow could prevent the wiper blade from moving, causing damage to the wiper motor.

Tilt Steering Lock Lever

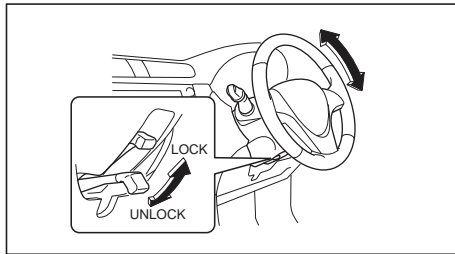

74LHT0333

The lock lever is located under the steering column. To adjust the steering wheel height:

- 1) Push down the lock lever to unlock the steering column.
- 2) Adjust the steering wheel to the desired height and lock the steering column by pulling up the lock lever.
- 3) Try moving the steering wheel up and down to make sure it is securely locked in position.

⚠ WARNING

Never attempt to adjust the steering wheel while the vehicle is moving or you could lose control of the vehicle.

Horn

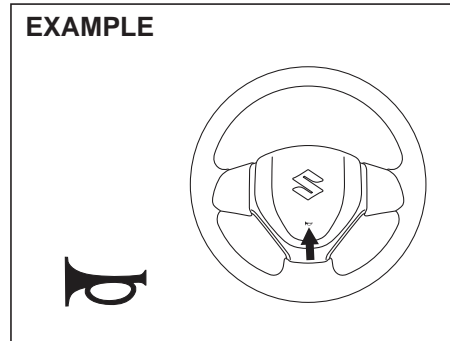

68LM240

Press the horn button of the steering wheel to sound the horn. The horn will sound with the ignition switch in any position.

OPERATING YOUR VEHICLE

OPERATING YOUR VEHICLE

Exhaust Gas Warning 3-1
Daily Inspection Checklist 3-1
Engine Oil Consumption 3-2
Ignition Switch
(Vehicle Without Keyless Push Start System) 3-3
Engine Switch
(Vehicle with Keyless Push Start system) 3-4
Parking Brake Lever 3-8
Pedal 3-9
Starting the Engine
(Vehicle Without Keyless Push Start System) 3-10
Starting the Engine
(Vehicle With Keyless Push Start System) 3-11
Using the Transmission 3-15
Parking Sensors (If equipped) 3-18
Braking 3-21
Anti-Lock Brake System 3-22

OPERATING YOUR VEHICLE

Exhaust Gas Warning

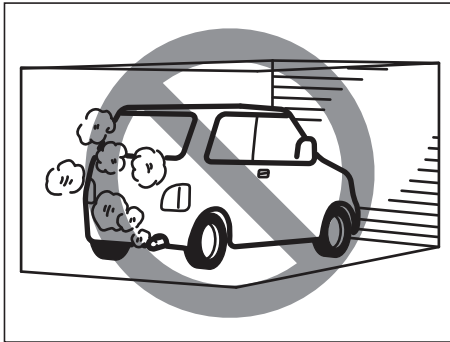

52D334

⚠ WARNING

Avoid breathing exhaust gases. Exhaust gases contain carbon monoxide, a potentially lethal gas that is colorless and odorless. Since carbon monoxide is difficult to detect by itself, be sure to take the following precautions to help prevent carbon monoxide from entering your vehicle.

- Do not leave the engine running in garages or other confined areas.

(Continued)

⚠ WARNING

(Continued)

- Do not park with the engine running for a long period of time, even in an open area. If it is necessary to sit for a short time in a parked vehicle with the engine running, make sure the air intake selector is set to "FRESH AIR" and the blower is at high speed.
- Avoid operating the vehicle with the tailgate or trunk open. If it is necessary to operate the vehicle with the tailgate or trunk open, make sure all windows are closed, and the blower is at high speed with the air intake selector set to "FRESH AIR".
- To allow proper operation of your vehicle's ventilation system, keep the air inlet grille in front of the windshield clear of snow, leaves or other obstructions at all times.
- Keep the exhaust tailpipe area clear of snow and other material to help reduce the buildup of exhaust gases under the vehicle. This is particularly important when parked in blizzard conditions.
- Have the exhaust system inspected periodically for damage and leaks. Any damage or leaks should be repaired immediately.

Daily Inspection Checklist

Before Driving



60A187S

- 1) Make sure that windows, mirrors, lights and reflectors are clean and unobstructed.
- 2) Visually check the tyres for the following points:
 - the depth of the tread groove
 - abnormal wear, cracks and damage
 - loose wheel bolts
 - existence of foreign material such as nails, stones, etc.Refer to "Tyres" in "INSPECTION AND MAINTENANCE" section for details.
- 3) Look for fluid and oil leaks.

NOTE:

It is normal for water to drip from the air conditioning system after use.

- 4) Make sure the bonnet is fully closed and latched.

**Daily Inspection Checklist: NO
Engine Oil Consumption:**

OPERATING YOUR VEHICLE

- 5) Check the headlights, turn signal lights, brake lights and horn for proper operation.
- 6) Adjust the seat and adjustable head restraint (if equipped).
- 7) Check the brake pedal and the parking brake lever.
- 8) Adjust the mirrors.
- 9) Make sure that you and all passengers have properly fastened your seat belts.
- 10) Make sure that all warning lights come on as the key is turned to the "ON" position.
- 11) Check all gauges.
- 12) Make sure that the BRAKE SYSTEM WARNING light turns off when the parking brake is released.

Once a week, or each time you fill your fuel tank, perform the following under-hood checks:

- 1) Engine oil level
- 2) Coolant level
- 3) Brake fluid level
- 4) Battery solution level
- 5) Windshield washer fluid level
- 6) Bonnet latch operation
Pull the bonnet release handle inside the vehicle. Make sure that you cannot open the bonnet all the way without releasing the secondary latch. Be sure to close the bonnet securely after checking for proper latch operation. See "All latches, hinges and locks" of "CHASSIS AND BODY" in the "Periodic

Maintenance Schedule" in the "INSPECTION AND MAINTENANCE" section for lubrication schedule.

⚠ WARNING

Make sure the hood is fully closed and latched before driving. If it is not, it can fly up unexpectedly during driving, obstructing your view and resulting in an accident.

Once a month, or each time you fill your fuel tank, check the tyre pressure using a tyre pressure gauge. Also check the tyre pressure of the spare tyre.

Engine Oil Consumption

It is normal for the engine to consume some engine oil during normal vehicle operation.

The amount of engine oil consumed depends on the viscosity of the oil, the quality of the oil and the conditions the vehicle is driven under.

More oil is consumed during high-speed driving and when there is frequent acceleration and deceleration. Under high loads, your engine also will consume more oil.

A new engine also consumes more oil, since its pistons, piston rings and cylinder walls have not yet become conditioned. New engines reach the normal level of oil consumption only after approximately 5000 km (3000 miles) driving.

**Oil consumption:
Max. 1.0 L per 1000 km
(1 Qt. per 600 miles)**

When judging the amount of oil consumption, note that the oil may become diluted and make it difficult to accurately judge the true oil level.

As an example, if a vehicle is used for repeated short trips, and consumes a normal amount of oil, the dipstick may not show any drop in the oil level at all, even after 1000 km (600 miles) or more of driving. This is because the oil is gradually becoming diluted with fuel or moisture, making it appear that the oil level has not changed.

You should also be aware that the diluting ingredients evaporate out when the vehicle is subsequently driven at high speeds, such as on an expressway, making it appear that oil is excessively consumed after high-speed driving.

Ignition Switch (Vehicle without Keyless Push Start System)

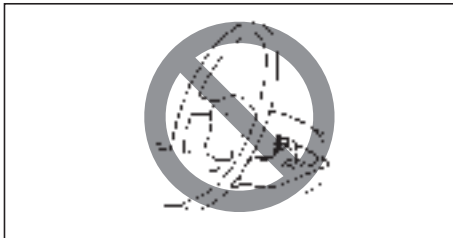

65D611

⚠ WARNING
To avoid possible injury, do not operate controls by reaching through the steering wheel.

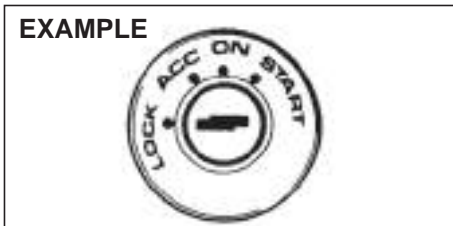

60B041

The ignition switch has the following four positions:

LOCK

This is the normal parking position. It is the only position in which the key can be removed.

Manual transaxle

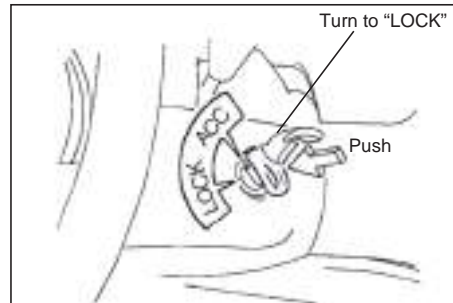

60G033

- **Manual transaxle vehicles**

You must push in the key to turn it to the "LOCK" position. It locks the ignition, and prevents normal use of the steering wheel after the key is removed.

- **Automatic transaxle vehicles**

The gearshift lever must be in the "P" (Park) position to turn the key to the "LOCK" position. It locks the ignition and prevents normal use of the steering wheel and gearshift lever.

To release the steering lock, insert the key and turn it clockwise to one of the other positions. If you have trouble turning the key to unlock the steering, try turning the steering wheel slightly to the right or left while turning the key.

ACC

Accessories such as the radio can operate, but the engine is off.

ON

This is the normal operating position. All electrical systems are on.

START

This is the position for starting the engine using the starter motor. The key should be released from this position as soon as the engine starts.

Ignition key reminder (if equipped)

A buzzer sounds intermittently to remind you to remove the ignition key if it is in the ignition switch when the driver's door is opened.



81A297S

⚠ WARNING

- **Never return the ignition switch to the "LOCK" position and remove the ignition key while the vehicle is moving. The steering wheel will lock and you will not be able to steer the vehicle.**
(Continued)

OPERATING YOUR VEHICLE

⚠ WARNING

(Continued)

- Always return the ignition switch to the "LOCK" position and remove the ignition key when leaving the vehicle even if only for a short time. Also do not leave children alone in a parked vehicle. Unattended children could cause accidental movement of the vehicle or could tamper with power windows or power sunroof. They also could suffer from heat stroke in warm or hot weather. These could result in severe injury or even death.

NOTICE

- Do not use the starter motor for more than 12 seconds at a time. If the engine does not start, wait 15 seconds before trying again. If the engine does not start after several attempts, check the fuel and ignition systems or consult your MARUTI SUZUKI dealer.
- Do not leave the ignition switch in the "ON" position if the engine is not running as the battery will discharge.

**Engine Switch
(Vehicle with Keyless Push
Start System)**

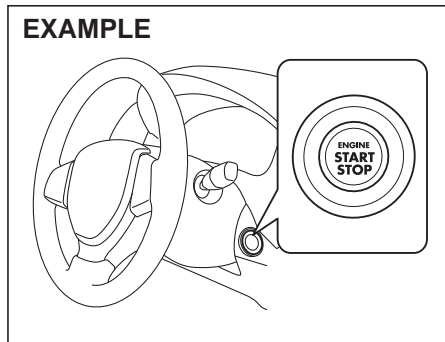

61MM0B001

LOCK (OFF)

This mode is for parking the vehicle. When this mode is selected by pressing the engine switch and then any door is opened or closed, the steering will be locked automatically.

ACC

Press the engine switch to select this ignition mode to use such electric equipment as the audio system, outside rearview mirrors and accessory socket with the engine off. When this position is selected, the information display in the instrument cluster come on. Refer to "Warning and Indicator Lights" in the "BEFORE DRIVING" section for details.

ON

- **With the engine off**
You can use such electric equipment as the power windows and wipers with the engine off. When this ignition mode is selected by pressing the engine switch, the information display in the instrument cluster will come on.
- **With the engine on**
All electric equipment is operational. The vehicle can be driven when you have selected this ignition mode by pressing the engine switch.

START

Provided you have the keyless push start system remote controller with you, the engine automatically starts when you press the engine switch to select this ignition mode after shifting to "N" (Neutral) and depressing the brake and clutch pedals.

NOTE:

You do not need to keep the engine switch pressed to start the engine.

NOTICE

Do not leave the engine switch in the "ACC" or "ON" mode when the engine is not running. Avoid using the radio or other electric accessories for a long time when the engine switch is in the "ACC" or "ON" mode when the engine is not running, otherwise the battery may discharge.

NOTE:

- *The steering lock may not be released if some load is acting on the steering wheel. If this happens, turn the steering wheel to the right or left to relieve it from the load before you press the engine switch again to change to the desired ignition mode.*
- *In the presence of strong radio signals or noise, you may not be able to change the ignition mode to "ACC" or "ON" or to start the engine using the engine switch.*

Keyless Push Start System (if equipped)

Provided the keyless push start system remote controller is within the "interior workable area" (refer to the related explanation in this section), you can use the engine switch for starting the engine and selecting an ignition mode ("ACC" or "ON"). In addition, the following functions can be used:

- Keyless entry function. Refer to "Keyless Push Start System Remote Controller" in the "BEFORE DRIVING" section for details.
- Locking and unlocking doors using a request switch. Refer to "Keyless Push Start System Remote Controller" in the "BEFORE DRIVING" section for details.
- Immobilizer (anti-theft) function. Refer to "Immobilizer System" in the "BEFORE DRIVING" section for details.

Engine Switch Illumination

The engine switch is illuminated (lit) in the following situations:

- When the engine is off and the driver's door is open, or for 15 seconds after the driver's door is closed. The illumination will fade out after the 15 seconds past.
- When the engine is off and the position lights are on. The illumination will go out when the position lights are turned off.
- When the engine is on and the position lights and/or the headlights are on. The illumination will go out when the headlights are turned off.

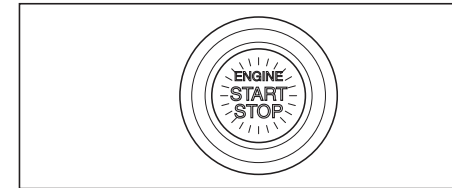

82K253

NOTE:

To save the battery, the illumination will be automatically turned off when both of the following conditions are simultaneously met:

- *The headlights and position lights are turned off.*
- *A period of 15 minutes has elapsed after opening the driver's door.*

Selection of Ignition Modes

Press the engine switch to select the "ACC" or "ON" mode as follows when you use an electric accessory or check the operation of instruments without running the engine.

- 1) Bring the keyless push start system remote controller with you and sit in the driver's seat.
- 2) Without depressing the clutch pedal, press the engine switch (1).

OPERATING YOUR VEHICLE

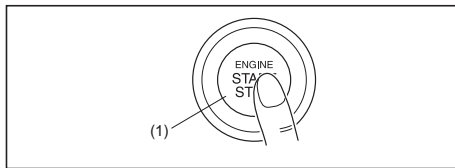

Every time you press the engine switch, the ignition mode changes as follows.

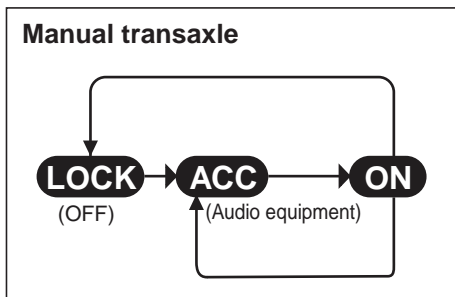

If the “PUSH” indicator light blinks and the ignition modes cannot be selected

Your keyless push start system remote controller may not be sensed as being within the “interior workable area” (refer to the related explanation in this section). Try again after making sure you have the remote controller with you. If the ignition modes still cannot be selected, the battery of the remote controller may be discharged. To be able to select an ignition mode, you must then use the following method:

3-6

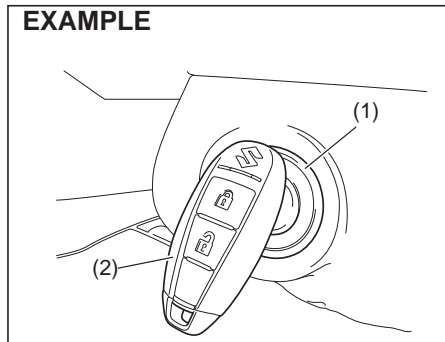

- 1) Without depressing the brake pedal and the clutch pedal, push the engine switch (1).
- 2) Within about 10 seconds during which the “PUSH” indicator light in the instrument cluster is blinking, touch the engine switch with the lock switch end of the remote controller (2) for about 2 seconds.

NOTE:

- If you still cannot select the ignition modes, there may be some problem with the keyless push start system. Contact an authorized MARUTI SUZUKI dealer for an inspection of the system.
- The immobilizer/keyless push start system warning light come on for about 5 seconds while the “PUSH” indicator light is blinking. Refer to “Warning and Indicator Lights” in the “BEFORE DRIVING” section for details.
- You may customize the system to cause the interior buzzer to sound once for the “remote controller out of sensing range” warning. To incorporate this customization, please contact an authorized MARUTI SUZUKI dealer.
- If the battery of the remote controller is about to become completely discharged, the keyless push start system remote controller battery consumption warning light in the instrument cluster will come on for a few seconds when you press the engine switch to change the ignition mode to “ON”. Refer to “Warning and Indicator Lights” in the “BEFORE DRIVING” section for details. For details on replacing the battery, refer to the “Keyless Push Start System Remote Controller” in the “BEFORE DRIVING” section.

OPERATING YOUR VEHICLE

“Remote Controller Outside” Warning

When the conditions described below are met, the system gives a “remote controller outside” warning by sounding the interior and exterior buzzers and blinking the immobilizer/keyless push start system warning light.

- Any door is opened and then closed while the remote controller is not inside the vehicle and the engine is running or the ignition mode has been changed to “ACC” or “ON” by pressing the engine switch.
- The remote controller is not inside the vehicle when you attempt to start the engine after changing the ignition mode to “ACC” or “ON” by pressing the engine switch.

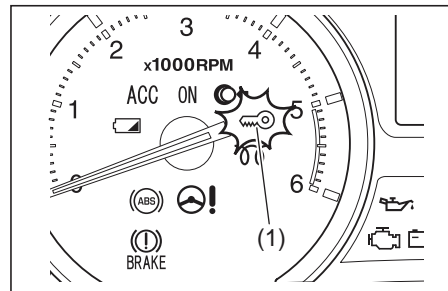

79MH0315

(1) Immobilizer/keyless push start system warning light (blinks)

NOTE:

- If the warning is given, locate the remote controller as soon as possible.
- Any attempt to start the engine will fail while the warning is active. Blinking of the immobilizer/keyless push start system warning light in the instrument cluster will indicate this condition. Refer to “Warning and Indicator Lights” in the “BEFORE DRIVING” section for details.
- Blinking of the immobilizer/keyless push start system warning light should stop shortly after the remote controller is brought back inside the vehicle. If they do not stop blinking, change the ignition mode to “LOCK” (OFF) by pressing the engine switch and then perform the engine starting operation.
- Always keep the remote controller with you as the driver.

Interior Workable Area for Engine Starting, Ignition Mode Selection and “Remote Controller Outside” Warning

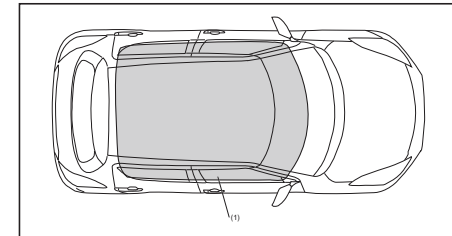

57L31004

(1) Interior workable area

The “interior workable area” for these functions is defined as all the interior spaces except for the space above the instrument panel.

NOTE:

- Even when the remote controller is in the “interior workable area”, if it is in any of the following conditions, you may not be able to start the engine or select the ignition modes, and the “remote controller outside” warning may be given.
 - The remote controller’s battery is low.
 - The remote controller is affected by strong radio signals or noise.
 - The remote controller is in contact with or covered by a metallic object.
 - The remote controller is in stowage like the glove box or a door pocket.
 - The remote controller is in the sun visor pocket or on the floor.

OPERATING YOUR VEHICLE

- Even when the remote controller is outside the “interior workable area”, if it is in any of the following conditions, you may be able to start the engine or select the ignition mode. The “remote controller outside” warning may not be given at that time.
 - The remote controller is outside the vehicle but very close to a door.
 - The remote controller is on the instrument panel.

Parking Brake Lever

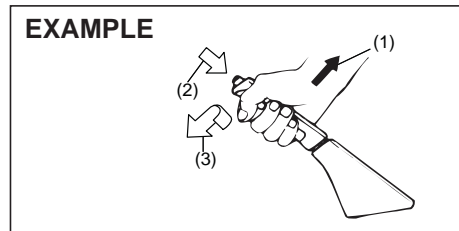

- (1) To set
- (2) To release
- (3) To release

The parking brake lever is located between the seats. To set the parking brake, hold the brake pedal down and pull the parking brake lever all the way up. To release the parking brake, hold the brake pedal down, pull up slightly on the parking brake lever, push the button on the end of the lever with your thumb, and lower the lever to its original position.

3-8

For automatic transaxle vehicles, always set the parking brake before moving the gearshift lever to the “P” (PARK) position. If you park on an incline and shift into “P” before setting the parking brake, the weight of the vehicle may make it difficult to shift out of “P” when you are ready to drive the vehicle.

When preparing to drive the vehicle, move the gearshift lever out of the “P” position before releasing the parking brake.

⚠ WARNING

- Never drive your vehicle with the parking brake on: rear brake effectiveness can be reduced from overheating, brake life may be shortened, or permanent brake damage may result.
- If the parking brake does not hold the vehicle securely or does not fully release, have your vehicle inspected immediately by an authorized MARUTI SUZUKI dealer.

⚠ WARNING

Always set the parking brake fully before leaving your vehicle or it may move, causing injury or damage. When parking, make sure the gearshift lever for manual transaxle vehicles is in reverse or first gear and the gearshift lever for automatic transaxle vehicles is in “P” (Park). Remember, even though the transaxle is in gear or in Park, you must set the parking brake fully.

⚠ WARNING

When parking the vehicle in extremely cold weather, the following procedure should be used:

- 1) Set the parking brake.
- 2) Manual transaxle - turn off the engine, then shift into reverse or first gear.
Automatic transaxle - shift into “P” (Park) and turn off the engine.
- 3) Get out of the vehicle and put chocks under the wheels.
- 4) Release the parking brake.

When you return to your vehicle, you must remember to first set the parking brake, then remove the wheel chocks.

OPERATING YOUR VEHICLE

Parking Brake Reminder Buzzer

A buzzer sounds intermittently to remind you to release the parking brake if you start the vehicle without releasing the parking brake. Make sure that the parking brake is fully released and the brake system warning light turns off.

Pedal

Manual transaxle

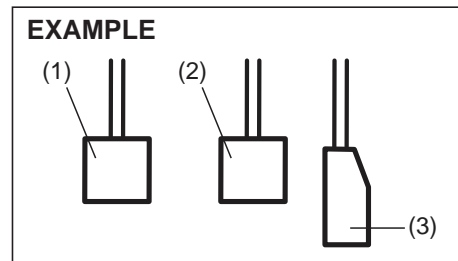

80J2121

Automatic transaxle

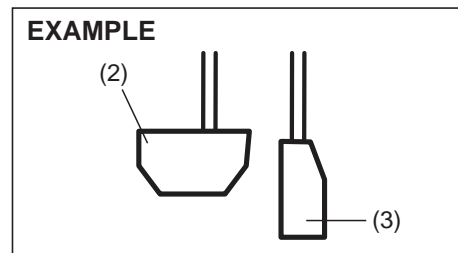

80J2122

Clutch Pedal (1) (For manual transaxle)

The clutch pedal is used to disengage the drive to the wheels when starting the engine, stopping, or shifting the gearshift lever. Depressing the pedal disengages the clutch.

⚠ WARNING

Do not drive with your foot resting on the clutch pedal. It could result in excessive clutch wear, clutch damage, or unexpected loss of engine braking.

NOTICE

Do not pump the clutch pedal repeatedly. It may result in pressure built up in the clutch circuit and damage to the clutch system.

Brake Pedal (2)

Your MARUTI SUZUKI vehicle is equipped with front and rear drum brakes. Depressing the brake pedal applies both sets of brakes.

You may hear occasional brake squeal when you apply the brakes. This is a normal condition caused by environmental factors such as cold, wet, snow, etc.

⚠ WARNING

If brake squeal is excessive and occurs each time the brakes are applied, you should have the brakes checked by your MARUTI SUZUKI dealer.

⚠ WARNING

Do not "ride" the brakes by applying them continuously or resting your foot on the pedal. This will result in overheating of the brakes which could cause unpredictable braking action, longer stopping distances, or permanent brake damage.

Accelerator Pedal (3)

This pedal controls the speed of the engine. Depressing the accelerator pedal increases power output and speed.

OPERATING YOUR VEHICLE

Starting the Engine (Vehicle without Keyless Push Start System)

Before Starting the Engine

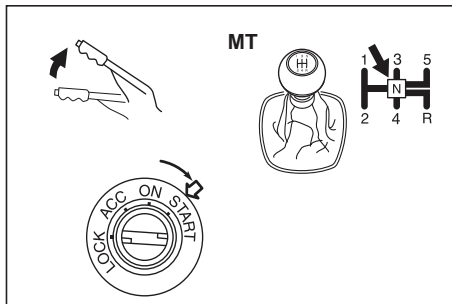

- 1) Make sure the parking brake is set fully.
- 2) Manual transaxle – Shift into “N” (Neutral) and depress the clutch pedal all the way to the floor. Hold the clutch pedal while starting the engine.
Automatic transaxle – If the gearshift lever is not in “P” (Park) position, shift into “P” (Park). (If you need to re-start the engine while the vehicle is moving, shift into “N”.)

NOTE:

Automatic transaxle vehicles have a starter interlock device which is designed to keep the starter from operating if the transaxle is in any of the drive positions.

3-10

⚠ WARNING

Make sure that the parking brake is set fully and the transaxle is in Neutral (or Park for vehicles with an automatic transaxle) before attempting to start the engine.

Starting a Cold and Warm Engine

(For Petrol Engine Model)

With your foot off the accelerator pedal, crank the engine by turning the ignition key to “START”. Release the key when the engine starts.

NOTICE

- Stop turning the starter immediately after the engine has started or the starter system can be damaged.
- Do not crank the engine for more than 12 seconds at a time. If the engine doesn't start on the first try, wait about 15 seconds before trying again.

If the engine does not start after 12 seconds of cranking, wait about 15 seconds, then press down the accelerator pedal to 1/3 of its travel and try cranking the engine again. Release the key and accelerator pedal when the engine starts.

If the engine still does not start, try holding the accelerator pedal all the way to the floor while cranking. This should clear the engine if it is flooded.

(For Diesel Engine Model)

Cold engine

Turn the ignition switch to the “ON” position and wait until the glow plug indicator goes out if it comes on. Crank the engine by turning the ignition key to “START”. Release the key when the engine starts.

NOTICE

- Stop turning the starter immediately after the engine has started or the starter system can be damaged.
- Do not crank the engine for more than 30 seconds at a time. If the engine doesn't start on the first try, wait about 15 seconds before trying again.

Warm engine

Crank the engine by turning the ignition key to “START”. Release the key when the engine starts.

Caution when stopping the engine with turbocharger

When stopping the engine after climbing or high speed driving, let the engine idle for about one minute or more (if it is not prohibited) to cool down the turbocharger and engine oil. This is to prevent the engine oil from over-deteriorating. Deteriorated

engine oil will damage the bearings of the turbocharger.

Restarting diesel engine after fuel-empty stop

If the engine stops and the low fuel warning light and the malfunction indicator light come on, use the following procedure:

- 1) Fill the fuel tank.
- 2) Hold the ignition key in "ON" position for 5-10 seconds to feed fuel.
- 3) Perform above engine starting procedure to start the engine.

If the malfunction indicator light still comes on after the engine started, there may be some problem with the engine. Ask your MARUTI SUZUKI dealer to have the engine inspected.

Starting the Engine (Vehicle with Keyless Push Start System) Before Starting the Engine

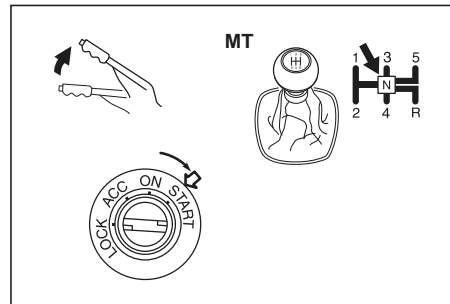

79MH0302

- 1) Make sure the parking brake is set fully.
- 2) Shift to "N" (Neutral) and fully depress the clutch pedal. Hold the clutch and brake pedals fully depressed.

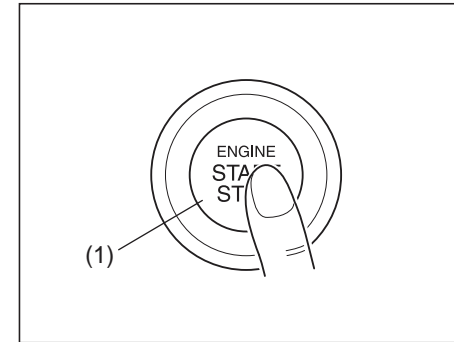

82K254

- 3) The "PUSH" indicator light in the instrument cluster will come on. Push the engine switch (1). When the engine is started, the starter motor will automatically stop.

⚠ WARNING
Make sure that the parking brake is set fully and the transaxle is in Neutral before attempting to start the engine.

OPERATING YOUR VEHICLE

NOTICE

- Do not depress the accelerator during the engine starting procedure.
- If the engine does not respond when you try to start it with the engine switch or if the engine switch repeats cycling through the "LOCK"(OFF) - "ACC" - "ON" mode, the vehicle battery may be discharged. Check the voltage of the vehicle battery before trying again.

NOTE:

- You do not need to keep the engine switch pressed to start the engine.
- The engine of a manual transaxle vehicle will not start unless the clutch pedal is depressed.
- You should turn off such loads as the headlights and air conditioning system to facilitate starting of the engine.
- Even if you fail to start the engine, the starter motor will stop turning automatically after a short time. After the starter motor has stopped or if there is some problem with the system, the starter motor will rotate only while the engine switch is being pressed.

Stopping the engine

- Depress the engine switch to stop the engine after the vehicle stopped completely.
- In case of emergency, you can stop the engine by quickly pushing the engine

switch more than 3 times, or pushing and holding the engine switch more than 2 seconds while the vehicle in motion.

NOTE:

Except in emergency, do not stop the engine while the vehicle in motion. The steering and braking operation will require more efforts when the engine stopped.

Refer to "Braking" in this section.

NOTICE

Avoid stopping the engine while driving.

- If the engine has been stopped and stayed as it as for while after the engine was stopped unexpectedly or was raced before stopped, a clicking sound may be heard from around the engine when engine restarted. This is not a malfunction. In this case, always let the engine idle before stop it.

Starting a Cold and Warm Engine (For Petrol Engine Model)

With your foot off the accelerator pedal, crank the engine by pressing the engine switch to change the ignition mode to "START".

NOTICE

Do not crank the engine for more than 12 seconds at a time. If the engine doesn't start on the first try, wait about 15 seconds before trying again.

After pressing the engine switch to change the ignition mode to "START", the starter cranks the engine for about 12 seconds before it can start the engine. If the engine fails to start at the first attempt, wait about 15 seconds, then try again while keeping the engine switch pressed while pressing down the accelerator pedal to 1/3 of its travel. Release the accelerator pedal when the engine starts.

If the engine still does not start, try holding the accelerator pedal all the way to the floor while cranking. This should clear the engine if it is flooded.

If you are unable to start the engine using this procedure, consult your MARUTI SUZUKI dealer.

(For Diesel Engine Model)

Cold engine

Depress the clutch and brake pedals fully and press the engine switch to crank the engine. If the glow plug indicator light comes on, the engine will start automatically after the glow plug indicator light goes off or 10 seconds past.

NOTICE

Do not crank the engine for more than 30 seconds at a time. If the engine doesn't start on the first try, wait about 15 seconds before trying again.

Warm engine

Crank the engine by pressing the engine switch to change the ignition mode to "START".

Caution when stopping the engine with turbocharger

When stopping the engine after climbing or high speed driving, let the engine idle for about one minute or more (if it is not prohibited) to cool down the turbocharger and engine oil. This is to prevent the engine oil from over-deteriorating. Deteriorated engine oil will damage the bearings of the turbocharger.

Restarting diesel engine after fuel-empty stop

If the engine stops and the low fuel warning light and the malfunction indicator light come on, use the following procedure:

- 1) Fill the fuel tank.
- 2) Press the engine switch to change the ignition mode to "ON" for 5-10 seconds to feed fuel.
- 3) Perform above engine starting procedure to start the engine.

If the malfunction indicator light still comes on after the engine started, there may be some problem with the engine. Ask your MARUTI SUZUKI dealer to have the engine inspected.

If the "PUSH" indicator light blinks and the engine cannot be started

Your keyless push start system remote controller may not be sensed as being within the "interior workable area". Try again after making sure that you have the remote controller with you. If the engine still cannot be started, the battery of the remote controller may be discharged. You must then use the following method to be able to start the engine.

EXAMPLE

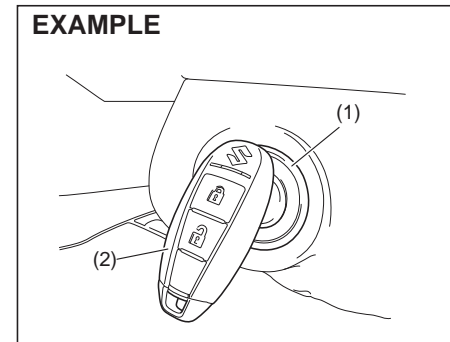

57L21131

- 1) Make sure the parking brake is set fully.
- 2) Shift to "N" (Neutral) and fully depress the clutch pedal. Hold the clutch and brake pedals fully depressed.
- 3) The "PUSH" indicator light in the instrument cluster will come on. Press the engine switch (1).
- 4) Within about 10 seconds of blinking of the "PUSH" indicator light in the instrument cluster, touch the engine switch with the lock switch end of the remote controller (2) for about 2 seconds.

OPERATING YOUR VEHICLE

NOTE:

- If you still cannot start the engine after several attempts using the above method, there may be a problem elsewhere, such as a low battery. Contact your MARUTI SUZUKI dealer for inspection.
- The immobilizer/keyless push start system warning light come on for about 5 seconds while the "PUSH" indicator light is blinking.
- You may customize the system to cause the interior buzzer to sound once for the "remote controller out of sensing range" warning. Please contact an authorized MARUTI SUZUKI dealer for the customization.
- If the battery of the remote controller is about to be completely discharged, the keyless push start system remote controller battery consumption warning light in the instrument cluster will come on for a few seconds when the ignition mode is changed to "ON" by pressing the engine switch. For details on replacing the battery, refer to the "Keyless Push Start System Remote Controller" in the "BEFORE DRIVING" section.

Returning the ignition mode to "LOCK" (OFF)

NOTE:

Certain problems like a fault in engine system may prevent the engine switch from going back to the "LOCK" (OFF) mode. If this happens, have the vehicle inspected by an authorized MARUTI SUZUKI dealer after doing the following:

- Lock the doors using the key to prevent theft. (The request switches and the keyless push start system remote controller cannot be used to lock them.)
- Disconnect the negative cable from the battery to prevent discharge.

"LOCK" (OFF) mode reminder buzzer

If the driver's door is opened without returning the ignition mode to "LOCK" (OFF) by pressing the engine switch, a buzzer sounds to warn you of this state.

- If you open the driver's door after pressing the engine switch to change the ignition mode to "ACC", the interior buzzer beeps intermittently.
- The buzzer will stop sounding if you then push the engine switch twice, thus bringing it back the ignition mode to "LOCK" (OFF).

NOTE:

Whenever you leave the vehicle, make sure you have returned the ignition mode to "LOCK" (OFF) using the engine switch and then lock the doors. Without returning the ignition mode to "LOCK" (OFF), you cannot use a request switch or keyless push start system remote controller to lock the doors.

Steering lock warning buzzer

If the steering lock fails to engage due to a fault in the system when the ignition mode is turned to "LOCK" (OFF) by pressing the engine switch and then any door is opened or closed, the interior buzzer will warn you of this condition with repeated short beeps. If this happens, have the vehicle inspected by an authorized MARUTI SUZUKI dealer.

Using the Transmission Manual Transmission

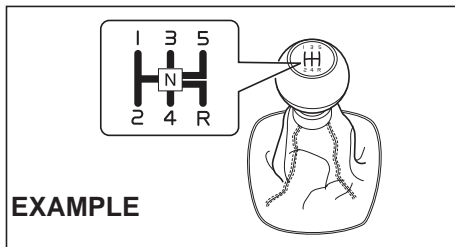

EXAMPLE

68LM324

Starting off

To start off, push the clutch pedal all the way to the floor and shift into 1st gear. After releasing the parking brake, gradually release the clutch. When you hear a change in the engine's sound, slowly press the accelerator while continuing to gradually release the clutch.

Gear changing

All forward gears are synchronized, which provides for quiet, and easy changing. Always depress the clutch pedal all the way to the floor before shifting gears. Maintain the engine speed, so it does not get into the red zone of tachometer.

Downshifting maximum allowable speeds

For Petrol engine

Downshifting	Km/h
2nd to 1st	20
3rd to 2nd	54
4th to 3rd	80
5th to 4th	112*

For Diesel engine

Downshifting	Km/h
2nd to 1st	24
3rd to 2nd	60
4th to 3rd	92
5th to 4th	125*

***NOTE:**

You may not accelerate to the maximum allowable speed because of the driving situation and/or the vehicle condition.

NOTICE

When downshifting to a lower gear, make sure not to downshift at the speed faster than the maximum allowable speeds for the next lower speed, or severe engine damage can result.

⚠ WARNING

- Reduce your speed and downshift to a lower gear before going down a long or steep hill. A lower gear will allow the engine to provide braking. Avoid riding the brakes or they may overheat, resulting in brake failure.
- When driving on slippery roads, be sure to slow down before downshifting. Excessive and/or sudden changes in engine speed may cause loss of traction, which could cause you to lose control.

NOTICE

- Make sure that the vehicle is completely stationary before you shift into reverse.

OPERATING YOUR VEHICLE

NOTICE

- To help avoid clutch damage, do not use the clutch pedal as a foot-rest while driving or use the clutch to keep the vehicle stationary on a slope. Depress the clutch fully when shifting.
- When shifting or starting off, do not race the engine. Racing the engine can shorten engine life and affect to smooth shifting.

4-Speed Automatic Transmission

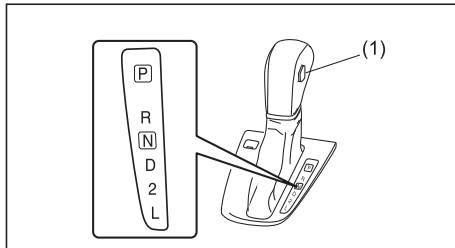

68LM324

(1) Overdrive off switch

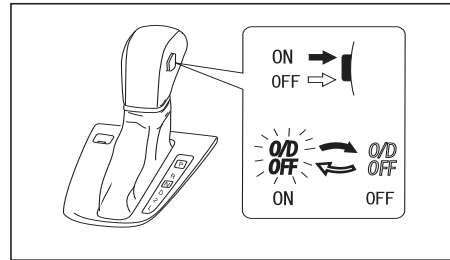

68LM324

Overdrive off switch

The transmission is a 4-speed (3-speed plus overdrive) automatic transmission. By operating the overdrive off switch, the transmission can be converted to a 3-speed automatic transmission that will not move to the overdrive position. To convert the transmission to the 3-speed mode, push in the overdrive off switch and release it.

To return the transmission to the 4-speed mode, push in the overdrive off switch again.

When the ignition switch is turned to the "ACC" position or the engine switch is pressed to change the ignition mode to "ACC", the transmission in the 3-speed mode is converted to the 4-speed mode automatically.]

The 3-speed mode is suitable for the following driving conditions:

- Driving on hilly, winding roads

- You can drive more smoothly with less frequent gear changing
- Going down a steep hill
 - Some engine braking is provided

Gearshift lever

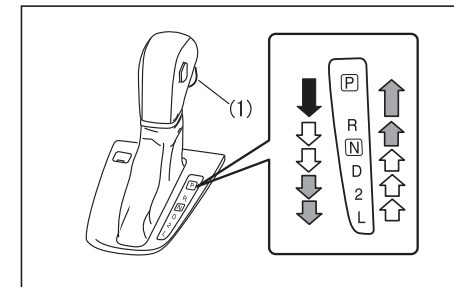

68LM324

(1) Knob button



The gearshift lever is designed so that it cannot be shifted out of the "P" position unless the ignition switch is in the "ON" position or the ignition mode is "ON" and the brake pedal is depressed.

⚠ WARNING

Always depress the brake pedal before shifting from "P" (Park) or "N" (Neutral) if the vehicle is stationary) to a forward or reverse gear, to help prevent the vehicle from moving unexpectedly when you shift.

OPERATING YOUR VEHICLE

The gearshift lever has a lock mechanism to help prevent accidental shifting. To shift the gearshift lever.

	Shift with the knob button (1) pushed in and the brake pedal depressed.
	Shift with the knob button (1) pushed in.
	Shift without the knob button (1) pushed in.

NOTE:

- Always shift the gearshift lever without pushing in the knob button (1) except when you shift from “P” to “R”, from “D” to “2”, from “2” to “L”, from “N” to “R” or from “R” to “P”. If you always push in the knob button (1) when shifting the gearshift lever, you could shift into “P”, “R”, “2”, or “L” by mistake.
- If driver’s or passenger’s knee hits the gearshift lever while driving, the lever could move and the gear could be changed unexpectedly.

Use the gearshift lever positions as described below:

P (Park)

Use this position to lock the transmission when the vehicle is parked or when start-

ing the engine. Shift into Park only when the vehicle is completely stationary.

R (Reverse)

Use this position to reverse the vehicle from stop. Make sure that vehicle is completely stationary before shifting into Reverse.

N (Neutral)

Use this position for starting the engine if the engine stalls and you need to restart it while the vehicle is moving. You may also shift into Neutral and depress the brake pedal to hold the vehicle stationary during idling.

D (Drive)

Use this position for all normal driving. With the gearshift lever in “D” range you can get an automatic downshift by pressing the accelerator pedal. The higher the vehicle speed is, the more you need to press the accelerator pedal to get a downshift.

2 (Low 2)

Use this position to provide extra power when climbing hills, or to provide engine braking when going down hills.

L (Low 1)

Use this position to provide maximum power when climbing steep hills or driving through deep snow or mud, or to provide maximum engine braking when going down steep hills.

NOTE:

If you move the gearshift lever to a lower gear while driving faster than the maximum allowable speed for the lower gear, the transaxle will not actually downshift until your speed drops below the maximum speed for the lower gear.

NOTICE

Be sure to take the following precautions to help avoid damage to the automatic transmission :

- Make sure that the vehicle is completely stationary before shifting into “P” or “R”.
- Do not shift from “P” or “N” to “R”, “D”, “2”, or “L” when the engine is running above idle speed.
- Do not rev the engine with the transmission in a drive position (“R”, “D”, “2”, or “L”) and the front wheels not moving.

NOTICE

- Do not use the accelerator to hold the vehicle on a hill. Use the vehicle’s brakes.

OPERATING YOUR VEHICLE

If You Cannot Shift Automatic transmission Gearshift Lever Out of “P” (PARK)

Automatic transmission

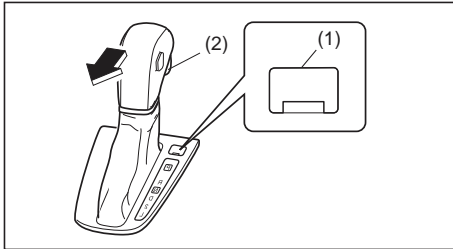

Vehicles with an automatic transmission have an electrically operated parklock feature. If the vehicle's battery is discharged, or there is some other electrical failure, the automatic transmission cannot be shifted out of Park in the normal way. Jump starting may correct the condition. If not, follow the procedure described below. This procedure will permit shifting the transmission out of Park.

- 1) Be sure the parking brake is firmly applied.
- 2) If the engine is running, stop the engine.
- 3) Make sure the key is in the “ON” or “ACC” position, or the ignition mode is “ON” or “ACC”.
- 4) Remove the cover (1) over the button.
- 5) With the release button (1) pushed by the key or the flat end rod, push the

knob button (2) and shift the gearshift lever to the desired position.

This procedure is for emergency use only. If repeated use of this procedure is necessary, or the procedure does not work as described, take the vehicle to your dealer for repair.

Parking Sensors (if equipped)

- The parking sensor system uses ultrasonic sensors to detect obstacles near the rear bumpers. If obstacles are sensed while you are parking or moving the vehicle slowly, the system warns you by sounding a buzzer.
- The system emits an ultrasonic wave and the relevant sensor detects the return of the wave reflected by an obstacle. The system measures the time taken by the ultrasonic wave to reach the obstacle and return from it, from which it determines the obstacle's position.
- The parking sensor function can be used when the ignition switch is turned to the “ON” or the engine switch is pressed to change the ignition mode to “ON”, the gearshift lever is in the “R” position and the parking sensor switch is in the “ON” position. This function is helpful in the following cases: pulling over to the curb; parallel-parking the vehicle; steering the vehicle into a garage; driving along an alley; and moving slowly in a place with obstacles.

WARNING

- The parking sensor warns you of obstacles with buzzers. However, you must still pay full attention yourself while driving.
- The sensors can detect obstacles only within a limited area and only when the vehicle is moving within a limited speed range. So, in tricky areas, you must move the vehicle slowly while checking around it using your direct vision or rearview mirrors. There is increased risk of an accident if you control the vehicle relying only on the parking sensor.

NOTICE

Parking sensors are only for driver's assistance.

Sensor Locations

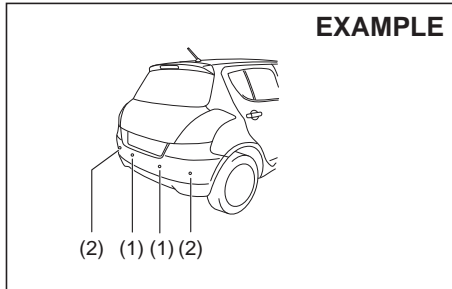

79MH0307

- (1) Rear center sensors (2 places)
- (2) Rear corner sensors (2 places)

NOTICE

- Avoid hitting the sensor areas or directing the nozzle of a high-pressure car washer onto the sensor areas. Otherwise, the sensors may be damaged.
- If the bumper hits a hard object, the sensors on it may not work properly. If this occurs, have the sensors inspected by an authorized MARUTI SUZUKI dealer.

Working sensors

The sensors that work depends on the position of the gearshift lever as follows:

Gearshift lever position		Manual trans-axle	
		R	N, 1st – 5th
Rear sensors	Center	On	Off
	Corner	On	Off

Approximate areas where obstacles can be detected

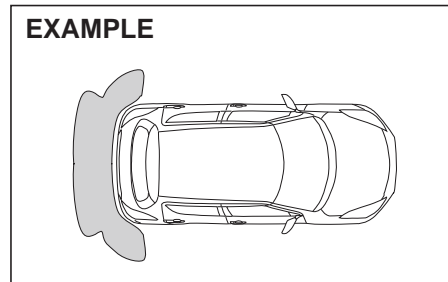

79MH0308

- An obstacle within about 20 cm (8 in) from a sensor or just below a sensor is not detectable.
- The sensors can detect an obstacle up to about 1.5 m (5 ft) from the rear of vehicle.

⚠ WARNING

- Under the following conditions, the parking sensor system may not work normally because the sensors cannot detect obstacles correctly.
 - Sensors are covered with mud, ice or other materials. (Such materials must be removed for normal operation.)
 - Sensors are wet from water splashes or heavy rain.
 - Sensors are covered by a hand, sticker, accessory, etc.
 - There is an accessory or other object attached within the sensor's sensing area.
 - Items such as tow hooks, commercially available corner poles, radio antenna, etc. are installed on the bumper.
 - The height of the bumper is changed due to alteration to the suspension or other causes.
 - The sensor areas are extremely hot from direct sunlight or cold due to freezing weather.
 - The vehicle is on a rough surface, slope, gravel road or grass field.
 - The vehicle is at a steep angle.

(Continued)

OPERATING YOUR VEHICLE

WARNING

(Continued)

- Sensors have intercepted ultrasonic noise from another vehicle's horn, engine, air braking system (large vehicles), or parking sensor.
- Obstacles are too close to the sensors.
- Sensors are at an angle to a highly reflective object such as glass. (Ultrasonic waves are not reflected back from the obstacle.)
- Sensors may not be able to correctly detect the following types of obstacles:
 - Objects made of a thin material like wire netting and ropes
 - Square-shaped curbstones or other objects with sharp edges
 - Tall objects with a large upper part like a road sign
 - Low-profile objects such as curbstones
 - Sound-absorbing objects such as cotton and snow

NOTE:

- Thin poles or obstacles lower than the sensors may become undetectable as the vehicle moves closer to them even if they have been detected from longer distances.
- The system may calculate the distance to a road sign or similar obstacle to be shorter than the actual distance.

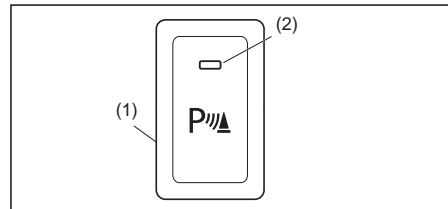

How to Use the Parking Sensor

Parking sensor switch



79MH0309

- (1) Parking sensor switch
(2) Indicator
- Turn the ignition switch to the "ON" position or press the engine switch to change the ignition mode to "ON" with the parking sensor switch in the "ON" position.
 - Push the switch again and it stays in; this is the OFF position. The indicator in the switch goes out and the parking sensor is deactivated.

Switch position	State
EXAMPLE  	ON <ul style="list-style-type: none"> • When the indicator light is on and all necessary conditions are met, system becomes ready for operation.

EXAMPLE



OFF

- The system does not operate. Push the switch to turn off the indicator if you do not wish to use the parking sensor.

NOTE:

- If you push the parking sensor switch from the "OFF" to "ON" position when the ignition switch is turned to "ON" position or the engine switch is pressed to change the ignition mode to "ON", the inside buzzer sounds.
- When the gearshift lever is shifted to the "R" (Reverse) position with the system ON, a buzzer will sound once.

Obstacle Indication by Parking Sensor

Upon detecting an obstacle, the parking sensor causes an interior buzzer to sound.

- A buzzer located behind the rear seat sounds when a sensor at the rear detects an obstacle.
- Warnings when obstacles are detected by corner sensors

OPERATING YOUR VEHICLE

Distance (approx.)	Buzzer
45 – 60 cm (18 – 24 in.)	Short beeps at short intervals
35 – 45 cm (14 – 18 in.)	Short beeps at very short intervals
Less than 35 cm (14 in.)	Continuous beep

- Warnings when obstacles are detected by center sensors

Distance (approx.)	Buzzer
60 – 150 cm (24 – 59 in.)	Short beeps at long intervals
45 – 60 cm (18 – 24 in.)	Short beeps at short intervals
35 – 45 cm (14 – 18 in.)	Short beeps at very short intervals
Less than 35 cm (14 in.)	Continuous beep

Warning and Indicator Messages

If there is a problem or warning regarding the parking sensor system, a buzzer and the status of the indicator on the parking sensor inform it. Follow its instruction.

- The buzzer sounds intermittently. The indicated sensor is contaminated. Wipe it clean with a soft cloth. If the buzzer does not stop after wiping, there may be problem with the parking sensor system. Have your vehicle inspected by an authorized MARUTI SUZUKI dealer.

The indicator does not come on when the parking sensor switch is pressed. The indicator goes off while operating. There may be a problem with the parking sensor system. Have your vehicle inspected by an authorized MARUTI SUZUKI dealer.

Braking

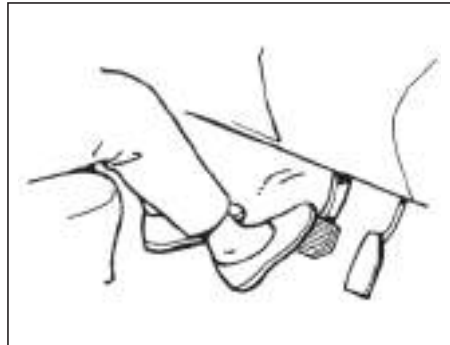

60G165S

The distance needed to bring any vehicle to a halt increases with the speed of the vehicle. The braking distance needed, for example, at 60 km/h (37 mph) will be approximately 4 times greater than the braking distance needed at 30 km/h (19 mph). Start to brake the vehicle when there is plenty of distance between your vehicle and the stopping point, and slow down gradually.

WARNING

If water gets into the brake drums, brake performance may become poor and unpredictable. After driving through water or washing the underside of the vehicle, test the brakes while driving at a slow speed to see if they have maintained their normal effectiveness. If the brakes are less effective than normal, dry them by repeatedly applying the brakes while driving slowly until the brakes have regained their normal effectiveness.

Power-Assisted Brakes (if equipped)

Your vehicle has power-assisted brakes. If power assistance is lost due to a stalled engine or other failures, the system is still fully operational on reserve power and you can bring the vehicle to a complete stop by pressing the brake pedal once and holding it down. The reserve power is partly used up when you depress the brake pedal and

OPERATING YOUR VEHICLE

reduces each time the pedal is pressed. Apply smooth and even pressure to the pedal. Do not pump the pedal.

WARNING

Even without reserve power in the brake system, you can still stop the vehicle by pressing the brake pedal harder than normally required. However, the stopping distance may be longer.

Brake Assist System (if equipped)

When you slam the brakes on, the brake assist system judges as an emergency stop and provides more powerful braking for a driver who cannot hold down the brake pedal firmly.

NOTE:

If you quickly and forcefully depress the brakes, you may hear a clicking sound in the brake pedal. This is normal and indicates that the brake assist system is activated properly.

Anti-Lock Brake System (ABS) (if equipped)

ABS will help you avoid skidding by electronically controlling braking pressure. It will also help you maintain steering control when braking on slippery surfaces or when braking hard.

The ABS works automatically, so you do not need any special braking technique. Just push the brake pedal down without pumping. The ABS will operate whenever it senses that the wheels are locking up. You may feel the brake pedal moves a little while the ABS is operating.

NOTE:

The ABS will not work if vehicle speed is under about 10 km/h (6mph).

WARNING

- On some types of loose surfaces (such as gravel, snow-covered roads, etc.) the stopping distance required for an ABS-equipped vehicle may be slightly greater than for a comparable vehicle with a conventional brake system. With a conventional brake system, skidding tyres are able to “plow” the gravel or snow layer, shortening the stopping distance. ABS minimizes this resistance effect. Allow for extra stopping distance when driving on loose surfaces.
- On regular paved roads, some drivers may be able to obtain slightly shorter stopping distances with conventional brake systems than with ABS.

(Continued)

▲ WARNING

(Continued)

- In both of the above conditions, ABS will still offer the advantage of helping you maintain directional control. However, remember that ABS will not compensate for bad road or weather conditions or poor driver judgment. Use good judgment and do not drive faster than conditions will safely allow.



(1)



(2)

63J081

- (1) ABS warning light
- (2) Brake system warning light

▲ WARNING

- If the ABS warning light (1) on the instrument panel comes on and stays on while driving, there may be a problem with the ABS system. Contact your MARUTI SUZUKI dealer to inspect the ABS system immediately. If the ABS system becomes inoperative, the brake system will function as an ordinary brake system that has no ABS.
- If the ABS warning light (1) and the Brake system warning light (2) on the instrument panel simultaneously stays on or comes on when driving, both anti-lock function and rear brake force control function (proportioning valve function) of the ABS system may have failed. If so, the rear wheels may easily skid or the vehicle can even spin in the worst case when braking on a slippery road or when hard braking even on a dry paved road. Contact your MARUTI SUZUKI dealer to inspect the ABS system immediately. Drive carefully, avoiding hard braking as much as possible.

How the ABS Works

A computer continuously monitors wheel speed. The computer compares the changes in wheel speed when braking. If the wheels slow suddenly, indicating a skidding situation, the computer will change braking pressure several times each second to prevent the wheels from locking. When you start your vehicle after a stop, you may hear a momentary motor or clicking noise as the system resets or checks itself.

▲ WARNING

The ABS may not work properly if tyres or wheels other than those specified in the owner's manual are used. This is because the ABS works by comparing changes in wheel speed. When replacing tyres or wheels, use only the size and type specified in this owner's manual.

DRIVING TIPS

Running-in4-1
Catalytic Converter4-1
Improving Fuel Economy4-2
Highway Driving4-3
Driving on Hills4-3
Driving on Slippery Roads4-3
Driving on Wet Roads4-4
Do's and Dont's for Safe Driving4-5

DRIVING TIPS



52D078S

⚠ WARNING

- **Wear Your Seat Belts at All Times.** Even though air bags are equipped at the front seating positions, the driver and all passengers should be properly restrained at all times, using the seat belts provided. Refer to the “Seat Belts and Child Restraint Systems” section for instructions on proper use of the seat belts.
- **Never drive while under the influence of alcohol or other drugs.** Alcohol and drugs can seriously impair your ability to drive safely, greatly increasing the risk of injury to yourself and others. You should also avoid driving when you are tired, sick, irritated, or under stress.

Running-in

NOTICE

The future performance and reliability of the engine depends on the care and restraint exercised during its early life. It is especially important to observe the following precautions during the initial 960 km (600 miles) of vehicle operation.

- After starting, do not race the engine. Warm it up gradually.
- Avoid prolonged vehicle operation at a constant speed. Moving parts will break in better if you vary your speed.
- Start off from a stop slowly. Avoid full throttle starts.
- Avoid hard braking, especially during the first 320 km (200 miles) of driving.
- Do not drive slowly with the trans-axle in a high gear.
- Drive the vehicle at moderate engine speeds.

Catalytic Converter

EXAMPLE

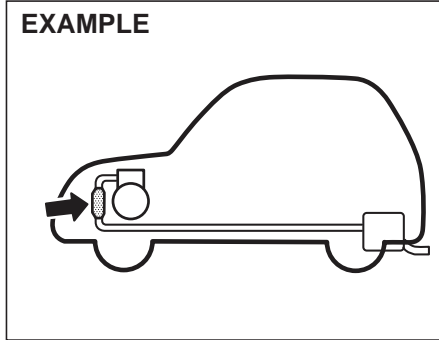

80G106

The purpose of the catalytic converter is to minimize the amount of harmful pollutants in your vehicle's exhaust. Use of leaded fuel in vehicles equipped with catalytic converters is prohibited, because lead deactivates the pollutant-reducing components of the catalyst system.

The converter is designed to last the life of the vehicle under normal usage and when unleaded fuel is used. No special maintenance is required on the converter. However, it is very important to keep the engine properly tuned. Engine misfiring, which can result from an improperly tuned engine, may cause overheating of the catalyst. This may result in permanent heat damage to the catalyst and other vehicle components.

DRIVING TIPS

NOTICE

To minimize the possibility of catalyst or other vehicle damage:

- Maintain the engine in the proper operating condition.
- In the event of an engine malfunction, particularly one involving engine misfire or other apparent loss of performance, have the vehicle serviced promptly.
- Do not turn off the engine or interrupt the ignition when the transmission is in gear and the vehicle is in motion.
- Do not try to start the engine by pushing or towing the vehicle, or coasting down a hill.
- Do not idle the engine with any spark plug wires disconnected or removed, such as during diagnostic testing.
- Do not idle the vehicle for prolonged periods if idling seems rough or there are other malfunctions.
- Do not allow the fuel tank to get near the empty level.



54G584S

WARNING

Be careful where you park and drive; the catalytic converter and other exhaust components can get very hot. As with any vehicle, do not park or operate this vehicle in areas where combustible materials such as dry grass or leaves can come in contact with a hot exhaust system.

Improving Fuel Economy

The following instructions will help you improve fuel economy.

Avoid excessive idling

If you are to wait for more than a minute while you are parked, stop the engine and start it again later. When warming up a cold engine, allow the engine to idle until the temperature gauge pointer comes up to the "C" position (if the idling is not prohibited). In this position, the engine is sufficiently warm for starting off.

Avoid "fast" starts

Fast starts away from lights or stop signs will consume fuel unnecessarily and shorten engine life. Start off slowly.

Avoid unnecessary stops

Avoid unnecessary deceleration and stopping. Try to maintain a slow, steady speed whenever possible. Slowing down and then accelerating again uses more fuel.

Keep a steady cruising speed

Keep as constant a speed as road and traffic conditions will permit.

Keep the air cleaner clean

EXAMPLE



60A183S

A dirty air cleaner will cause the fuel supply system to supply too much fuel to the engine for the amount of air being supplied. The result is waste of fuel due to incomplete combustion.

(Diesel Engine)

No cleaning is required. Replace as per periodic maintenance schedule.

Keep weight to a minimum

The heavier the load, the more fuel the vehicle consumes. Take out any luggage or cargo when it is not necessary.

DRIVING TIPS

Keep tyre pressures correct

Underinflation of the tyres can waste fuel due to increased running resistance of the tyres. Keep your tyres inflated to the correct pressure shown on the label on the driver's side door or the driver's door lock pillar.

Highway Driving

When driving at highway speeds, pay attention to the following:

- Stopping distance progressively increases with vehicle speed. Apply the brakes far enough ahead of the stopping point to allow for the extra stopping distance.
- On rainy days, "Aquaplaning" can occur. "Aquaplaning" is the loss of direct contact between the road surface and the vehicle's tyres due to a water film forming between them. Steering or braking the vehicle while "Aquaplaning" can be very difficult, and loss of control can occur. Keep speed down when the road surface is wet.
- At high speeds, the vehicle may be affected by side winds. Therefore, reduce speed and be prepared for unexpected buffeting, which can occur at the exits of tunnels, when passing by a cut of a hill, or when being overtaken by large vehicles, etc.

Driving on Hills

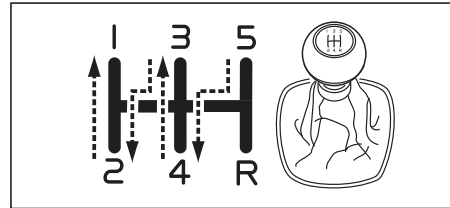

71LMT0401

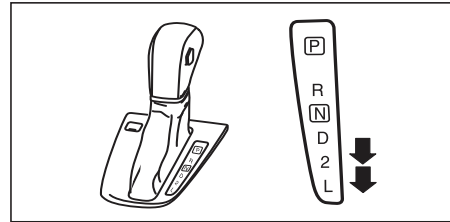

71LMT0401

- When climbing steep hills, the vehicle may begin to slow down and show a lack of power. If this happens, you should shift to a lower gear so that the engine will again be operating in its normal power range. Shift rapidly to prevent the vehicle from losing momentum.
- When driving down a hill, the engine should be used for braking by shifting to next lower gear.

⚠ WARNING

Try not to hold the brake pedal down too long or too often while going down a steep or long hill. This could cause the brakes to overheat, resulting in reduced braking efficiency. Failure to take this precaution could result in loss of vehicle control.

NOTICE

When descending a down hill, NEVER turn the ignition key to the "OFF" position. Emission control system and automatic transmission damage may result.

Driving on Slippery Roads



60G089S

Under wet road conditions you should drive at a lower speed than on dry roads due to possible slippage of tyres during braking. When driving on icy, snow-cov-

DRIVING TIPS

ered, or muddy roads, reduce your speed and avoid sudden acceleration, abrupt braking, or sharp steering movements.

Tire Chains

Tire chains should only be used if they are needed to increase traction or are required by law. Make sure that the chains you use are the correct size for your vehicle's tires. Also make sure that there is enough clearance between the fenders and the chains as installed on the tires.

Install the chains on the front tires tightly, according to the chain manufacturer's instructions. Retighten the chains after driving about 1.0 km (1/2 mile) if necessary. With the chains installed, drive slowly.

NOTICE

- If you hear the chains hitting against the vehicle body while driving, stop and tighten them.
- If your vehicle is equipped with full wheel caps, remove the wheel caps before installing the chains or the wheel caps can be damaged by the chain bands.

If Your Vehicle Gets Stuck

If your vehicle gets stuck in snow, mud, or sand, follow the directions below:

- 1) Change back and forth between first gear and reverse. This will create a rocking motion which may give you enough momentum to free the vehicle.

Press gently on the accelerator to keep wheel spinning to a minimum wheel rpm. Remove your foot from the accelerator while changing gear.

Do not race the engine. Excessive wheel spin will cause the tyres to dig deeper, making it more difficult to free the vehicle.

- 2) If your vehicle remains stuck after a few minutes of rocking, get another vehicle to pull your vehicle out.

⚠ WARNING

Do not allow anyone to stand near the vehicle when you are rocking it, and do not spin the wheels faster than an indicated 40 km/h (25 mph) on the speedometer. Personal injury and/or vehicle damage may result from spinning the wheels too fast.

NOTICE

Do not continue rocking the vehicle for more than a few minutes. Prolonged rocking can cause engine overheating or transaxle damage.

DRIVING ON WET ROADS

NOTICE

- When driving on wet roads, avoid driving through large amount of standing water on the road. Large amount of water entering the engine compartment may cause damage to the engine and or electrical components.
- If stuck in deep water, do not start till water level drops.
- Water is incompressible substance, water inside engine is harmful to the engine.

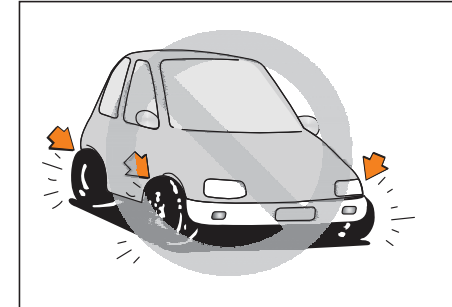

54G074S

DRIVING TIPS

⚠ WARNING

In addition to following the driving tips in this section, it is important to observe the following precautions.

- Make sure your tyres are in good condition and always maintain the specified tyre pressure. Refer to "Tyres" in the "INSPECTION AND MAINTENANCE" section for details.
- Do not use tyres other than those specified by MARUTI SUZUKI. Never use different sizes or types of tyres on the front and rear wheels. For information regarding the specified tyres, refer to the Tyre Inflation Pressure Label located on the driver's side door pillar.

(Continued)

⚠ WARNING

(Continued)

- Never use oversized tyres or special shock absorbers and springs to raise (jack up) your vehicle. This will change the handling characteristics. Oversized tyres may also rub against the fender over bumps, causing vehicle damage or tyre failure.
- After driving through water, test the brakes while driving at a slow speed to see if they have maintained their normal effectiveness. If the brakes are less effective than normal, dry them by repeatedly applying the brakes while driving slowly until the brakes have regained their normal effectiveness.

Do's and Dont's for Safe Driving

Exercise care in handling your vehicle. Be conscious of not only your own safety but also the safety of others on the road, and thus enjoy the best and most comfortable driving experience.

This section contains basic rules for safe driving. Read it carefully for good understanding of the content so that you can enjoy safe and pleasant driving in your Maruti Suzuki vehicle.

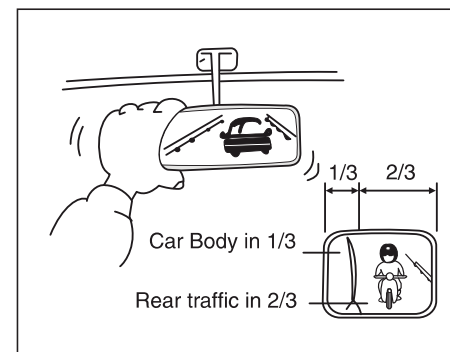

72F-08-002

Starting

- 1) Adjust the driver's seat for the proper driving posture.
- 2) Adjust the rear view mirror so as to obtain the best possible rear view.
- 3) Before moving off, look forward and back to confirm safety.

DRIVING TIPS

- 4) Don't start quickly, since it is dangerous and wastes fuel.

General driving

- 1) Be sure to stop before the stop light and stop sign. When moving into the inter-section without any traffic lights or signs, drive slowly to confirm safety.

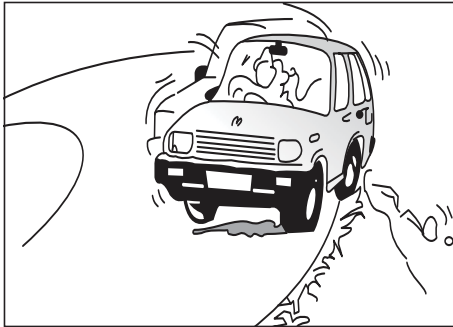

72F-08-002

- 2) Always follow other vehicles at a safe distance in order to prevent a rear-end collision, in case the vehicle ahead make a sudden stop.
- 3) Turn ON the turn signal at least 30 meters before making a turn or changing the lane so as not to be hit from behind.
- 4) Before entering a corner, decelerate to a safe speed. Don't apply brakes during cornering, or a cornering skid may occur.

- 5) When overtaking other vehicles, watch out for the oncoming vehicle and care-fully confirm the safety.
- 6) Don't attempt zigzag driving which will hinder your control over the vehicle and cause an accident.

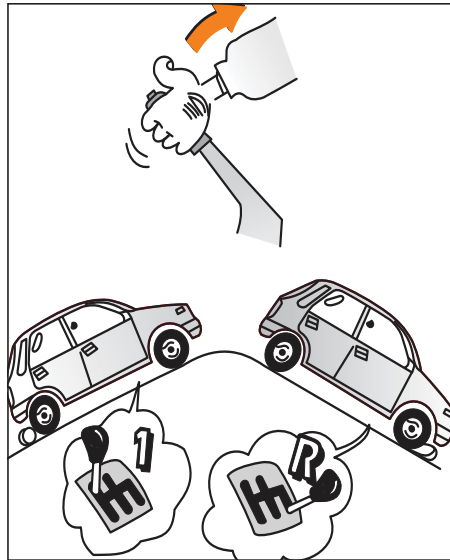

72F-08-011

Braking

- 1) Use the parking brake when parking your vehicle and shift the gear shift lever into the first gear or reverse gear position for the sake of safety.

- 2) Don't use handbraking unless unavoidable. It causes the vehicle to skid and a rearend collision occur. It is especially dangerous when the tyres are worn, for they allow a larger skid.



72F-08-012

Use foot brake in three stages

1. Warn the vehicle behind you
 2. Gradually apply the brake.
 3. Bring the vehicle to a halt.
- 3) When driving on a downhill, try not to apply the brake but use the engine brake effectively. Overuse of the foot-brake may result in total brake failure.
 - 4) Avoid reckless high speed driving and try to drive at a safe speed suitable for the road conditions while maintaining a constant speed.

DRIVING TIPS

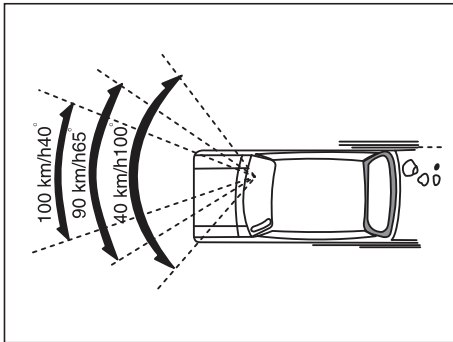

72F-08-015

- 5) The higher the speed, the narrower the driver's visual range becomes. In such a state, it is difficult to anticipate any hazard and the driver feels much fatigued.
- 6) Never do sharp handling during high speed driving. You will lose your control over your vehicle.
- 7) When overtaking or changing the lane while driving at a high speed, keep an ample vehicle-to-vehicle distance.

Long distance driving

- 1) Be sure to perform safety checks before starting a trip.
- 2) Take rest at certain intervals to prevent an accident which may occur when you are sleepy or tired.



72F-08-020

Night time driving

- 1) Drive more slowly at night than in the daytime, for the visual range is restricted at night.
- 2) Don't overtake other vehicles at night. Darkness bothers your sense of speed and hinders your judgement on the vehicle-to-vehicle distance.
- 3) Don't use the high headlight beam unless its use is inevitable. Its dazzle may blitz the driver of the oncoming vehicle, thus causing an accident.
- 4) Always keep the window glasses clean. Don't operate the windshield wiper

when the windshield glass is dry or the wiper blade and glass may get damaged.



72F-08-021

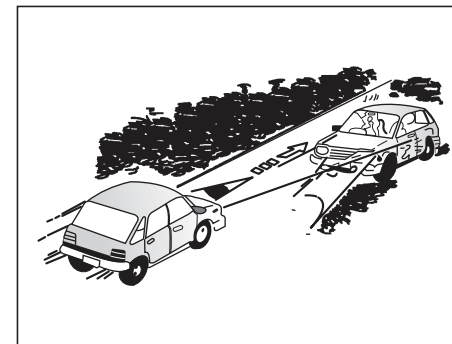

72F-08-022

Margin For Safety

It is important to allow yourself a margin for safety during driving so that you can cope with erroneous or unexpected driving of other drivers. For that, observe the following.

- Drive at a safe speed.
- Maintain a sufficient distance between your vehicle and the vehicle ahead.
- Don't force yourself to overtake other vehicles.
- Don't make quick start, hard steering or sudden stops.
- Allow an ample time in the driving schedule.
- Observe traffic rules and regulations.

Conclusion

A perfect driver does not exist. The endeavour of every motorist should be to strive for perfection. Safety consciousness not only ensures your safety and the safety of other road users, it also helps reduce the wear and tear on your vehicle, prolongs its life, gives more mileage and ensures a comfortable driving experience.

Follow the do's and don'ts listed, and driving will never be the same again.

OTHER CONTROLS AND EQUIPMENT

OTHER CONTROLS AND EQUIPMENT

Heating and Air Conditioning System (if equipped)	5-1
Manual Heating and Air Conditioning System (if equipped)	5-2
Automatic Heating and Air Conditioning System (Climate Control) (if equipped)	5-5
Radio Antenna	5-9
Installation of Radio Frequency Transmitters	5-9
Audio System (if equipped)	5-10
Audio System With Bluetooth (if equipped)	5-49
Fuel Filler Cap	5-86
Engine Bonnet	5-87
Sun Visor	5-87
Interior Light Switch	5-88
Luggage Compartment Light (if equipped)	5-89
Accessory Socket (if equipped)	5-90
Assist Grips	5-90
Glove Box	5-90
Cup Holder and Storage Area	5-90
Front Seat Back Pocket (if equipped)	5-91
Floor Mats (if equipped)	5-92
Shopping Hook (if equipped)	5-92
Luggage Compartment Cover (if equipped)	5-92
Frame Hooks	5-93
Luggage Carpet Hook (if equipped)	5-94

OTHER CONTROLS AND EQUIPMENT

Heating and Air Conditioning System (if equipped)

There are two types of heating and air conditioning systems as follows:

- Manual Heating and Air Conditioning System (if equipped)
- Automatic Heating and Air Conditioning System (Climate Control) (if equipped)

Air Outlet

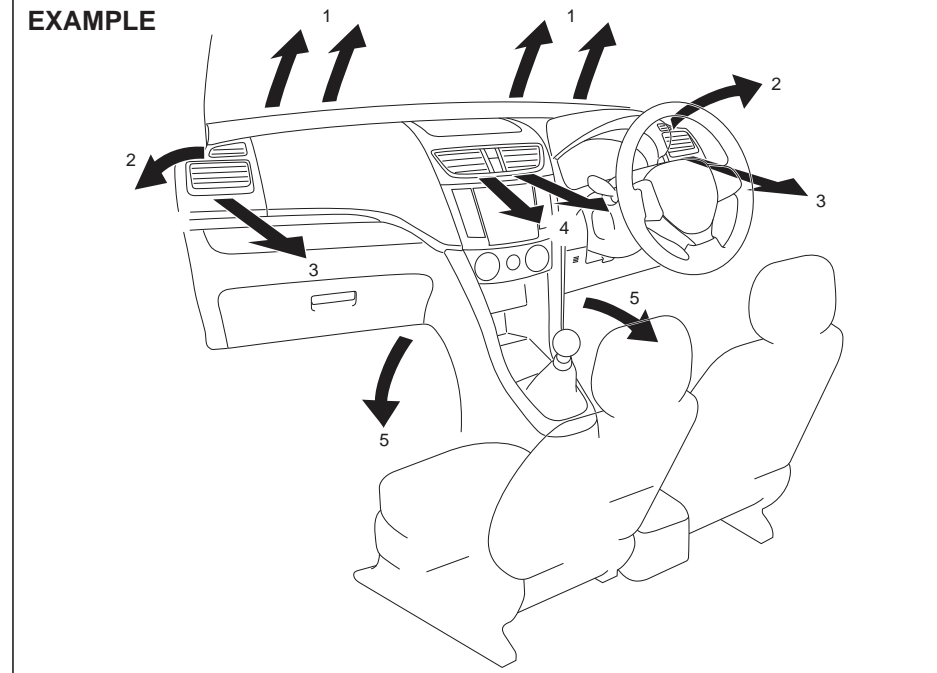

74LHT0501

1. Windshield defroster outlet
2. Side defroster outlet
3. Side outlet
4. Center outlet
5. Floor outlet

OTHER CONTROLS AND EQUIPMENT

Side outlet

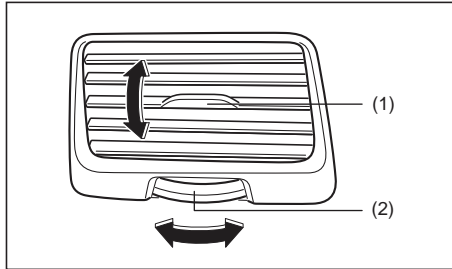

68LM502

Move the knob (1) vertically and the dial (2) horizontally, to adjust the direction of air-flow as desired. When "Open", air comes out from the side outlets regardless of the airflow selector position.

Center outlet

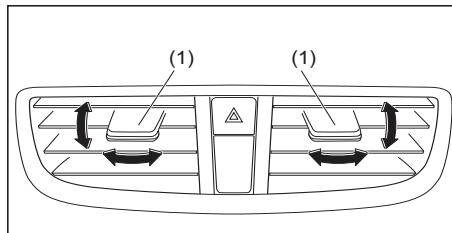

74LHT0502

Move the knob (1) vertically or horizontally to adjust the direction of airflow as desired.

Manual Heating and Air Conditioning System (if equipped)

Description of Controls

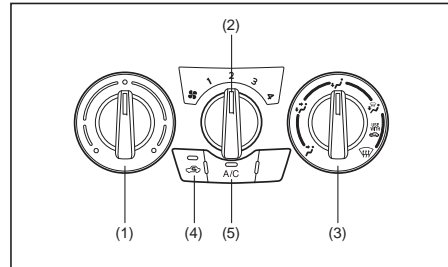

74LHT0503

Temperature selector (1)

This is used to select the temperature by turning the selector.

Blower speed selector (2)

This is used to turn on the blower and to select blower speed by turning the selector.

Air flow selector (3)

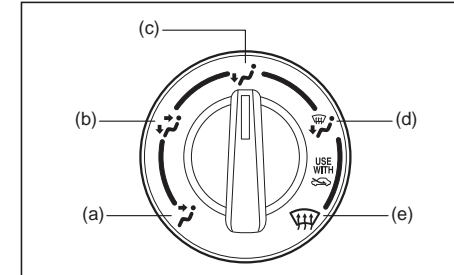

63J048

This is used to select one of the functions described below.

Ventilation (a)

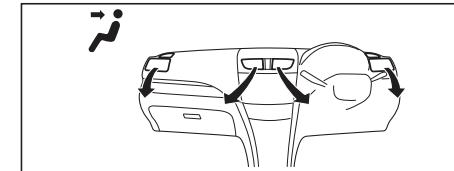

74LHT0504

Temperature-controlled air comes out of the center and side air outlets.

Bi-level (b)

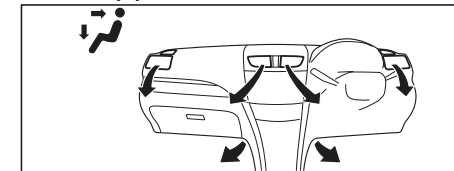

74LHT0505

OTHER CONTROLS AND EQUIPMENT

Temperature-controlled air comes out of the floor outlets and cooler air comes out of the center and side outlets. When the temperature selector (1) is in the fully COLD position or fully HOT position, however, the air from the floor outlets and the air from the center and side outlets will be the same temperature.

Heat (c)

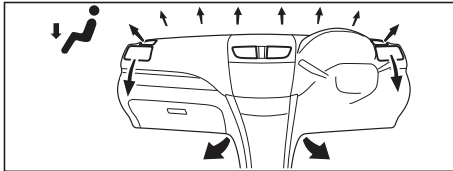

74LHT0506

Temperature-controlled air comes out of the floor outlets and the side outlets, also comes out of the windshield defroster outlets and the side demister outlets slightly.

Heat & defrost (d)

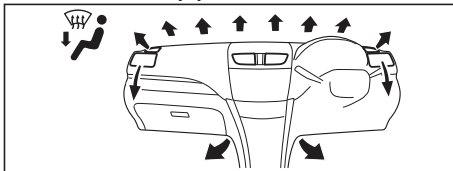

74LHT0507

Temperature-controlled air comes out of the floor outlets, the windshield defroster outlets, the side demister outlets and the side outlets.

Defrost (e)

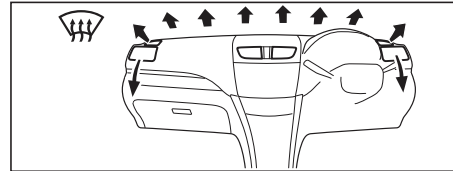

74LHT0508

Temperature-controlled air comes out of the windshield defroster outlets, the side demister outlets and the side outlets.

Air intake selector (4)

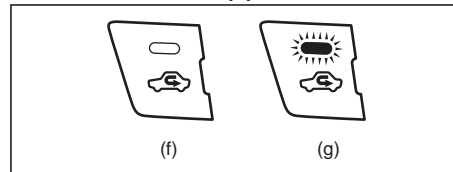

68LM511

This selector is used to select the following modes.

Fresh Air (f)

When this mode is selected, the indicator light will go off and outside air is used.

Recirculated Air (g)

When this mode is selected, the indicator light will come on, outside air is shut out and inside air is recirculated. This mode is suitable when driving through dusty or polluted air such as in a tunnel, or when attempting to quickly cool down the interior.

“FRESH AIR” and “RECIRCULATED AIR” are switched alternately each time the air intake selector is pushed.

NOTE:

If you select “RECIRCULATED AIR” for an extended period of time, the air in the vehicle can become contaminated. Therefore, you should occasionally select “FRESH AIR”.

Air conditioning switch (5)

To turn on the air conditioning system, push in the “A/C” switch and set the blower speed selector to a position other than “OFF”. With this “A/C” switch operation, a indicator light will come on when the air conditioning system is on. To turn off the air conditioning system, push the “A/C” switch again.

During operation of the air conditioner, you may notice slight changes in engine speed. These changes are normal, the system is designed so that the compressor turns on or off to maintain the desired temperature.

Less operation of the compressor results in better fuel economy.

System Operating Instructions

Natural ventilation

Select “VENTILATION” and “FRESH AIR”, the temperature selector to the desired temperature position, and the blower

OTHER CONTROLS AND EQUIPMENT

speed selector to "OFF". Fresh air will flow through the vehicle during driving.

Forced ventilation

The control settings are the same as for natural ventilation except you set the blower speed selector to a position other than "OFF".

Normal heating (using outside air)

Select "HEAT" and "FRESH AIR", the temperature selector to the desired temperature position and the blower speed selector to the desired blower speed position. Setting the blower speed selector to a higher blower speed position increases heating efficiency.

Quick heating (using recirculated air)

The control settings are the same as for normal heating except you select "RECIRCULATED AIR". If you use this heating method for an extended period of time, the air in the vehicle can become contaminated and the windows can become misty. Therefore, use this method only for quick heating and change to the normal heating method as soon as possible.

Cool face/warm feet

Select "BI-LEVEL" and "FRESH AIR", the temperature selector to the desired temperature position, and the blower speed selector to the desired blower speed position. Unless the temperature selector is in the fully COLD position or fully HOT position, the air that comes out of the center

and side outlets will be cooler than the air that comes out of the floor outlets.

Normal cooling

Turn on the "A/C" switch, set the air flow selector to "VENTILATION", the temperature selector to the desired temperature position and the blower speed selector to the desired blower speed position. Setting the blower speed selector to a higher blower speed position increases cooling efficiency.

You can switch the air intake selector to either "FRESH AIR" or "RECIRCULATED AIR" as you desire. Choosing "RECIRCULATED AIR" increases cooling efficiency.

Quick cooling (using recirculated air)

The control settings are the same as for normal cooling except you select "RECIRCULATED AIR" and the highest blower speed.

NOTE:

- If you select "RECIRCULATED AIR" for an extended period of time, the air in the vehicle can become contaminated. Therefore, you should occasionally select "FRESH AIR".
- If your vehicle has been left in the sun with the windows closed, it will cool faster if you open the windows briefly while you operate the air conditioner with the air intake selector at "FRESH AIR" and the blower at high speed.

Dehumidifying

Turn on the "A/C" switch, set the air flow selector to a desired air flow selector position, and select "FRESH AIR", the temperature selector to the desired temperature position, and the blower speed selector to the desired blower speed position.

NOTE:

Because the air conditioner dehumidifies the air, turning it on will help keep the windows clear, even when blowing heated air using the "DEMIST" or "HEAT & DEMIST" functions.

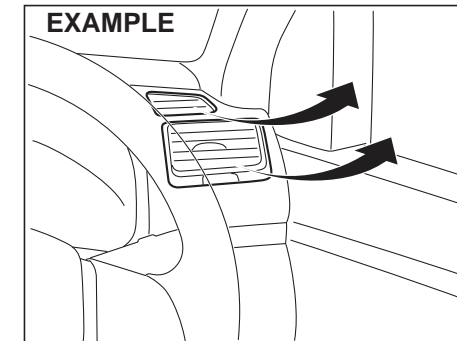

74LHT0509

NOTE:

If you need maximum defrosting:

- select "DEFROST" and "FRESH AIR",
- turn on the "A/C" switch,
- set the blower speed selector to HIGH,
- adjust the temperature selector to the HOT end, and

OTHER CONTROLS AND EQUIPMENT

- adjust the side outlets so the air blows on the side windows.

Maintenance

If you do not use the air conditioner for a long period, such as during winter, it may not give the best performance when you start using it again. To help maintain optimum performance and durability of your air conditioner, it needs to be run periodically. Operate the air conditioner at least once a month for one minute with the engine idling. This circulates the refrigerant and oil and helps protect the internal components.

NOTE:

Your vehicle uses the air conditioning refrigerant HFC-134a, commonly called "R-134a". Only R-134a should be used in your vehicle.

NOTICE

Using the wrong refrigerant may damage your air conditioning system. Use R-134a only. Do not mix or replace the R-134a with other refrigerants.

Automatic Heating and Air Conditioning System (Climate Control) (if equipped)

Description of Controls

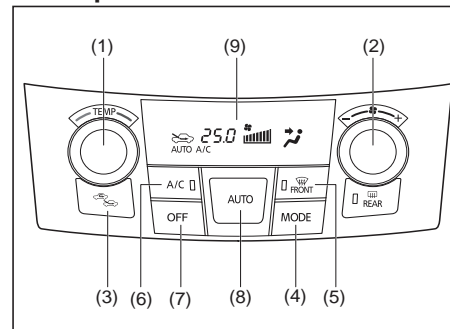

71LST0504

- (1) Temperature selector
- (2) Blower speed selector
- (3) Air intake selector
- (4) Air flow selector
- (5) Defrost switch
- (6) Air conditioning switch
- (7) "OFF" switch
- (8) "AUTO" switch
- (9) Display

Temperature selector (1)

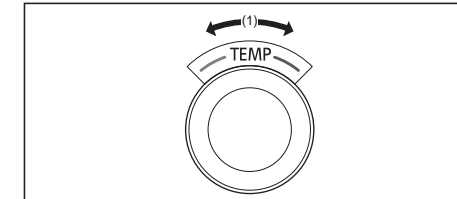

68LM514

Turn the temperature selector (1) to adjust the temperature.

You can set the temperature between 18°C and 32°C. The selected temperature is shown in the display.

Blower speed selector (2)

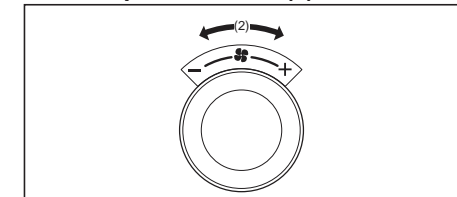

68LM515

The blower speed selector (2) is used to turn on the blower and to select blower speed. The selected blower speed is shown in the display.

If the "AUTO" switch (8) is pushed, the blower speed will vary automatically as the climate control system maintains the selected temperature.

OTHER CONTROLS AND EQUIPMENT

Air intake selector (3)

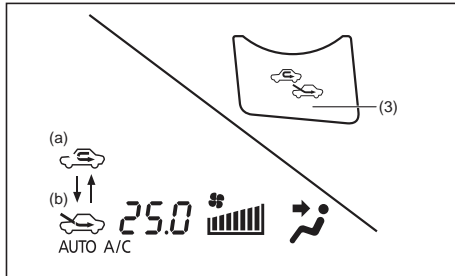

71LST0505

Push the air intake selector (3) to change between the FRESH AIR or RECIRCULATED AIR mode.

If the "AUTO" switch (8) is pushed, the air intake will vary automatically as the climate control system maintains the selected temperature.

NOTE:

When you select the recirculated air mode, the automatic operation system is deactivated if you push the "AUTO" switch (8).

RECIRCULATED AIR (a)

When this mode is selected, outside air is shut off and inside air is recirculated. This mode is suitable when driving through an area with polluted air such as a tunnel, or when attempting to quickly cool down the vehicle.

FRESH AIR (b)

When this mode is selected, outside air is introduced.

"FRESH AIR" and "RECIRCULATED AIR" are selected alternately each time the air intake selector is pushed.

NOTE:

If you select "RECIRCULATED AIR" for an extended period of time, the air in the vehicle can become contaminated. Therefore, you should occasionally select "FRESH AIR".

Air flow selector (4)

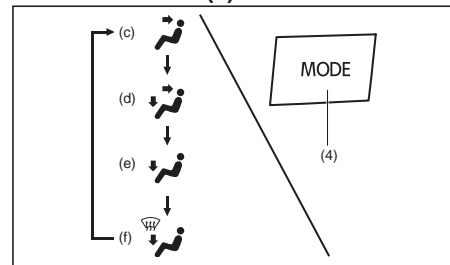

68LM517

Push the air flow selector (4) to change among the following functions. The indication of the selected mode appears on the display.

If the "AUTO" switch (8) is pushed, the air flow will vary automatically as the climate control system maintains the selected temperature.

Ventilation (c)

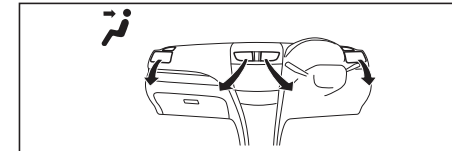

74LHT0504

Temperature-controlled air comes out of the center and side air outlets.

Bi-level (d)

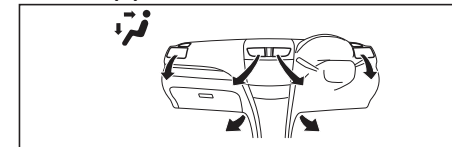

74LHT0505

Temperature-controlled air comes out of the floor outlets and cooler air comes out of the center and side outlets. When the temperature selector (1) is in the fully COLD position or fully HOT position, however, the air from the floor outlets and the air from the center and side outlets will be the same temperature.

Heat (e)

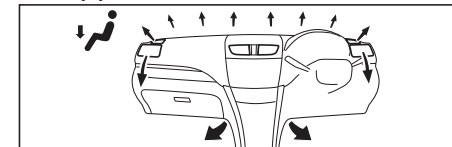

74LHT0506

OTHER CONTROLS AND EQUIPMENT

Temperature-controlled air comes out of the floor outlets and the side outlets, a small amount of air comes out of the windshield defroster outlets and also comes slightly out of the side demister outlets.

Heat & defrost (f)

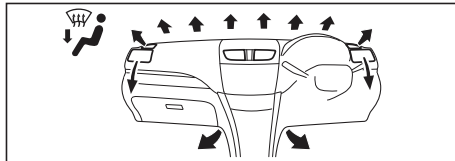

74LHT0507

Temperature-controlled air comes out of the floor outlets, the windshield defroster outlets, the side demister outlets and the side outlets.

Defrost switch (5)

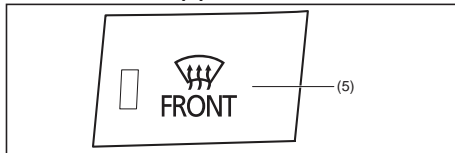

68LM518

Push the defrost switch (5) to turn on the defroster. This is used to clear the windscreen and side windows by Pushing the switch when the defroster switch is ON, the indicator light above the defroster switch will come ON and the defroster display is shown in the display.

5-7

Defrost

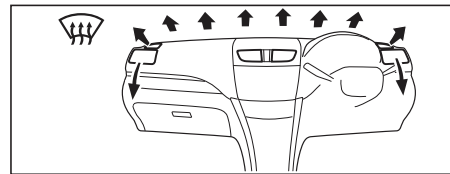

74LHT0508

Temperature-controlled air comes out of the windshield defroster outlets, the side defroster outlets and the side outlets.

NOTE:

When the defrost switch (5) is pushed to turn on the defroster, the air conditioning system will come on and the "FRESH AIR" mode will be selected automatically. In very cold weather, however, the air conditioning system will not turn on.

Air conditioning switch (6)

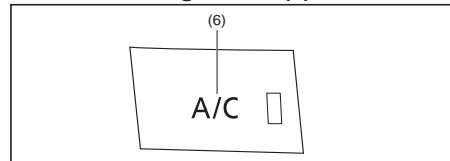

68LM555

The air conditioning switch (6) is used to turn on and off the air conditioning system only when the blower is on. To turn on the air conditioning system, push in the switch and "A/C" will appear on the display. To turn off the air conditioning system, push in the switch again and "A/C" will go off.

System Operating Instructions

Automatic operation

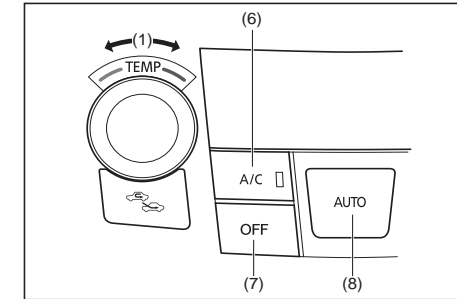

68LM520

You can let the climate control system work automatically. To set the system for fully-automatic operation, follow the procedure below.

- 1) Start the engine.
- 2) Push the "AUTO" switch (8).
- 3) Set the desired temperature by turning the temperature selector (1).

The blower speed, air intake and air flow are controlled automatically to maintain the set temperature.

NOTE:

When you select the recirculated air mode, the automatic operation system is deactivated if you push the "AUTO" switch (8).

OTHER CONTROLS AND EQUIPMENT

You can use the air conditioning switch (6) to manually turn the air conditioner on or off according to your preference. When you turn the air conditioning switch off, the climate control system cannot lower the inside temperature below outside temperature.

To turn the climate control system off, push the "OFF" switch (7).

NOTE:

If the "AUTO" on the display blinks, there is a problem in the heating system and/or air conditioning system. You should have the system inspected by an authorized MARUTI SUZUKI dealer.

NOTE:

- To find the temperature at which you are most comfortable, start with the 25°C (75°F) setting.
- If you turn the temperature selector (1) until "HI" or "LO" appears on the display, the climate control system will operate at maximum heating or cooling and the blower will run at full speed.
- To avoid blowing cold air in cold weather or hot air in hot weather, the system will delay turning on the blower until warmed or chilled air is available.
- If your vehicle has been left in the sun with the windows closed, it will cool faster if you open the windows briefly.

- Even under the automatic operation, you can set individual selectors to the manual mode. The manually selected functions are maintained, and the other functions remain under automatic operation.
- To return the blower speed selector (2), air intake selector (3), and air flow selector (4) to automatic operation, push the "AUTO" switch (8).

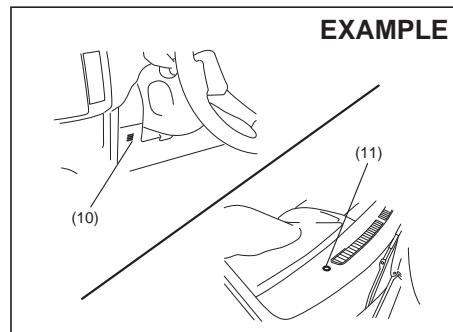

74LHT0510

Be careful not to cover the interior temperature sensor (10) located between the steering wheel and the climate control panel, or the solar sensor (11) located at the top of the driver's side dashboard. These sensors are used by the automatic system to regulate temperature. Even if the engine is turned OFF, the temperature Setting remains in the memory.

Manual operation

You can manually control the climate control system. Set the selectors to the desired positions.

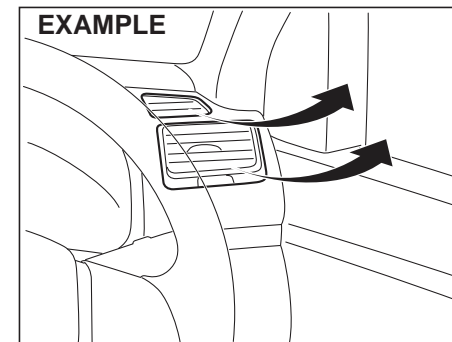

74LHT0509

NOTE:

If you need maximum defrosting:

- push the defrost switch (5) to turn on the defroster (the air conditioning system will come on and the "FRESH AIR" mode will be selected automatically),
- set the blower speed selector to HIGH,
- adjust the temperature selector to the "HI" indication on the display, and
- adjust the side outlets so the air blows on the side windows.

Maintenance

If you do not use the air conditioner for a long period, such as during winter, it may not give the best performance when you start using it again. To help maintain opti-

OTHER CONTROLS AND EQUIPMENT

mum performance and durability of your air conditioner, it needs to be run periodically. Operate the air conditioner at least once a month for one minute with the engine idling. This circulates the refrigerant and oil and helps protect the internal components.

NOTE:

Your vehicle uses the air conditioning refrigerant HFC-134a, commonly called "R-134a". Only R-134a should be used in your vehicle.

NOTICE

Using the wrong refrigerant may damage your air conditioning system. Use R-134a only. Do not mix or replace the R-134a with other refrigerants.

Radio Antenna

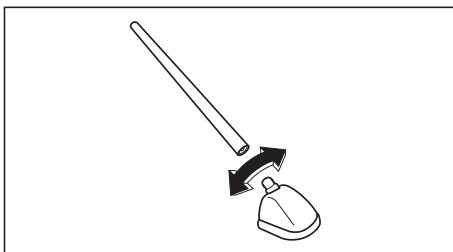

63J055

The radio antenna on the roof is removable. To remove the antenna, turn it counterclockwise. To reinstall the antenna, turn it clockwise firmly by hand.

NOTICE

To avoid damage to the radio antenna:

- Remove the antenna when using an automatic car wash.
- Remove the antenna when the antenna hits anything such as a low ceiling in a parking garage or putting a car cover over your vehicle.

Installation of Radio Frequency Transmitters

We recommend that you always ask a MARUTI SUZUKI dealer about frequency band, max output power, antenna position at vehicle and specific conditions for installation and/or use before installing a radio transmitter in your vehicle. Such equipments may cause the electronic control system to malfunction if they are incorrectly installed or they are not suited for the vehicle.

Folding Rear Seats: 3
Seat Armrest: 3

OTHER CONTROLS AND EQUIPMENT

Audio System (If equipped)

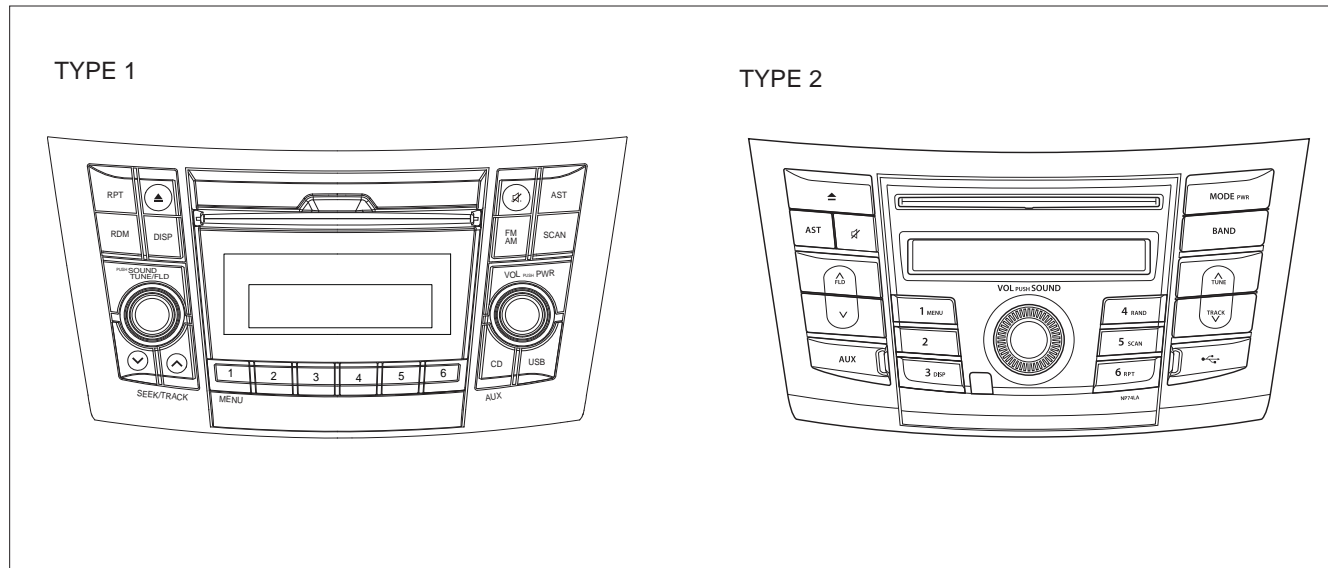

AM/FM CD PLAYER

OTHER CONTROLS AND EQUIPMENT

Safety Information

⚠ WARNING

If you pay extended attention to operating the audio system or viewing the audio system display while driving, an accident can occur. If you set the sound volume too loud, it could prevent you from being aware of road and traffic conditions.

- Keep your eyes on the road and your mind on the drive. Avoid paying extended attention to operating the audio system or viewing the audio system display.
- Familiarize yourself with the audio system controls and operation of the audio system before driving.
- Preset your favorite radio stations before driving so that you can quickly tune to them using the presets.

Set the sound volume to a level that will allow you to continue to be aware of road and traffic conditions while driving.

Notes on Discs

Precautions

- When the inside of the vehicle is very cold and the player is used soon after switching on the heater, condensation

may form on the disc or the optical parts of the player and proper playback may not be possible. If condensation forms on the disc, wipe it off with a soft cloth. If condensation forms on the optical parts of the player, do not use the player for about one hour. This will allow the condensation to disappear normally.

- Driving on extremely bumpy roads which cause severe vibrations may cause sound to skip.
- This unit uses a precision mechanism. Even in the event that trouble arises, never open the case, disassemble the unit, or lubricate the rotating parts. Please bring the unit to an authorized MARUTI SUZUKI dealer.

Cautions on Handling



60M-05-016

This unit has been designed specifically for playback of compact discs bearing mark (A) shown above.

No other discs can be played.

Removing the disc Proper way to hold the compact disc

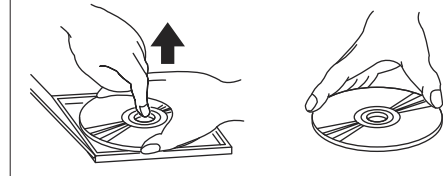

60M-05-017

To remove the compact disc from its storage case, press down on the center of the case and lift the disc out, holding it carefully by the edges.

Always handle the compact disc by the edges.

Never touch the surface.

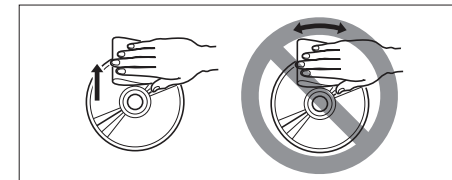

60M-05-018

To remove fingerprints and dust, use a soft cloth, and wipe in a straight line from the center of the compact disc to the circumference.

OTHER CONTROLS AND EQUIPMENT

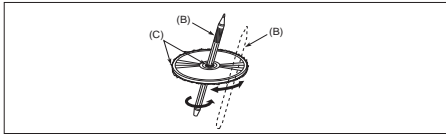

60M-05-019

New discs may have some roughness around the edges. The unit may not work or the sound may skip if such discs are used. Use a ball-point pen (B), etc. to remove the roughness (C) from the edges of the disc before inserting it into the unit. ic spray, or thinner to clean compact discs.

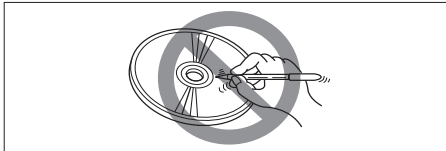

60M-05-020

Never stick labels on the surface of the compact disc or write on the surface with a pencil or pen.

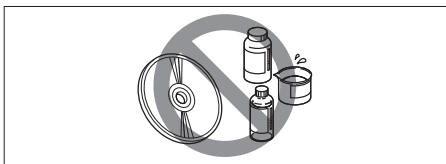

60M-05-021

Do not use any solvents such as commercially available cleaners, anti-stat

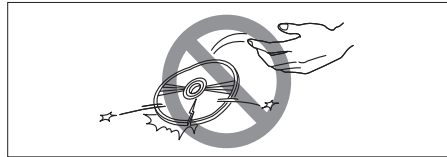

60M-05-022

Do not use compact discs that have large scratches, are misshaped, or cracked, etc. Use of such discs will cause damage or prevent the system from operating properly.

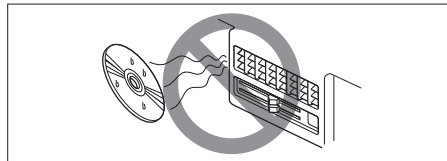

60M-05-023

Do not expose compact discs to direct sunlight or any heat source.

NOTE:

- Do not use commercially available CD protection sheets or discs equipped with stabilizers, etc.

These may get caught in the internal mechanism and damage the disc.

- It may be impossible to play CD-R discs with this unit due to the recording conditions.
- CD-RW discs cannot be played with this unit.

⚠ WARNING

This is a class I laser product. Use of controls or adjustments or performance of procedures other than those specified herein may result in hazardous radiation exposure.

Do not open covers and do not attempt to repair this unit by yourself. Refer servicing to qualified personnel.

Basic Operations

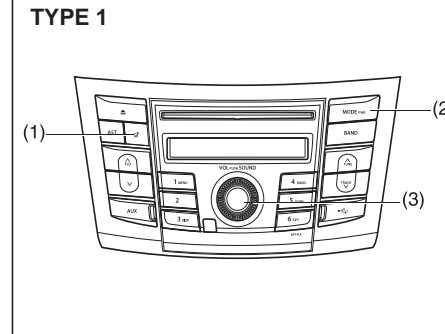

60M-05-024

- TYPE 1
- (1) VOL PUSH POWER knob
 - (2) TUNE FOLDER PUSH SOUND knob
 - (3) MUTE button

OTHER CONTROLS AND EQUIPMENT

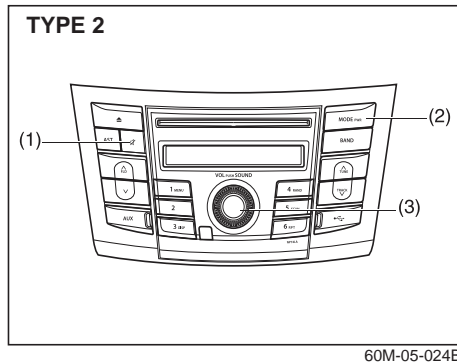

- (1) MUTE button
- (2) MODE PWR button
- (3) VOL PUSH SOUND knob

Turning power on/off

TYPE 1:

Press the VOL PUSH POWER knob (1).
The unit starts in the function mode it was in when the power was turned off last.

TYPE 2:

Press the MODE PWR button (2).
The unit starts in the function mode it was in when the power was turned off last.
When the power is ON, holding down the MODE PWR button for 2 seconds or longer turns the power OFF.

Adjusting the volume

TYPE1:

Turn the VOL PUSH POWER knob (1).

TYPE 2

Turn the VOL PUSH SOUND knob (3):

Turning it clockwise increases the volume; turning it counterclockwise decreases the volume.

NOTE:

While driving, adjust the volume to an extent that sound and/or noise coming from outside the vehicle can be heard.

Mute

Press the MUTE button (3) to mute the sound. To cancel the mute, press the MUTE button (3) again.

Adjusting bass/treble/balance /fader

TYPE 1:

1) Press the TUNE FOLDER PUSH SOUND knob (2).

Each time the knob is pressed, sound adjustment will change as follows:

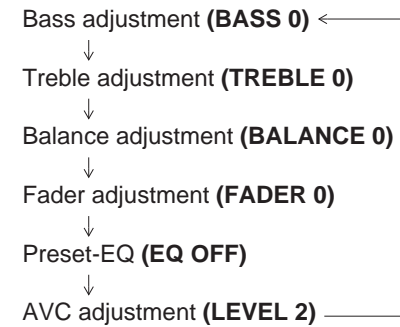

2) Turn the TUNE FOLDER PUSH SOUND knob (2) to adjust the sound.

TYPE 2:

1) Press the VOL PUSH SOUND knob (3).
Each time the knob is pressed, sound adjustment will change as follows:

OTHER CONTROLS AND EQUIPMENT

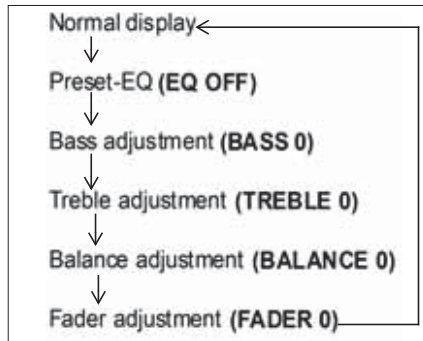

2) Turn the VOL PUSH SOUND knob (3) to adjust the sound.

Adjusting the AVC (if equipped)

The Auto Volume Control (AVC) function automatically adjusts (increases/decreases) the sound volume in accordance with vehicle speed. The AVC control is provided with three selectable levels (LEVEL OFF, 1, 2, 3). The range of volume adjustment increases together with the LEVEL number.

- 1) Press the TUNE FOLDER PUSH SOUND knob (2) until the AVC adjustment mode is selected.
- 2) Turn the TUNE FOLDER PUSH SOUND knob (2) to select the desired AVC adjustment level. (Initial setting: LEVEL 2)

Preset-EQ

TYPE 1:

Preset-EQ calls up various sound types in accordance with the listening music type.

- 1) Press the TUNE FOLDER PUSH SOUND knob (2) several times until "PRESET-EQ" appears.
- 2) Turn the TUNE FOLDER PUSH SOUND knob (2).

Each time the knob is turned, preset EQ mode will change as follows:

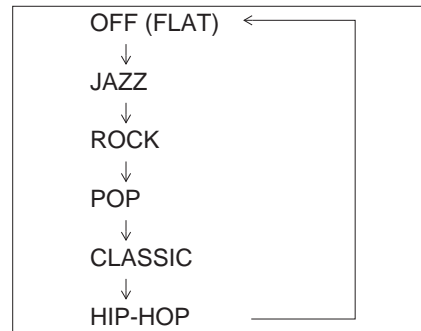

TYPE 2:

Preset-EQ calls up various sound types in accordance with the listening music type.

- 1) Press the VOL PUSH SOUND knob (3) several times until "PRESET-EQ" appears.
 - 2) Turn the VOL PUSH SOUND knob (3).
- Each time the knob is turned, preset EQ mode will change as follows:

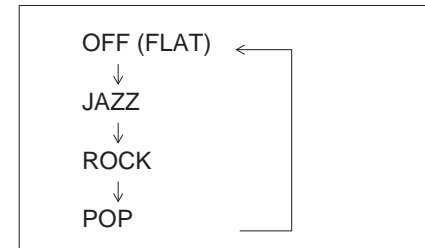

Listening to the Radio

TYPE 1

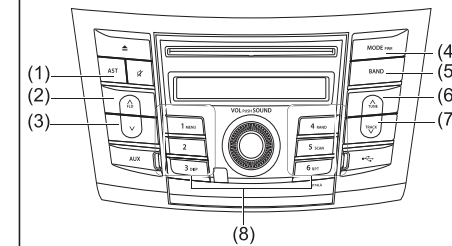

60M-05-027

Display

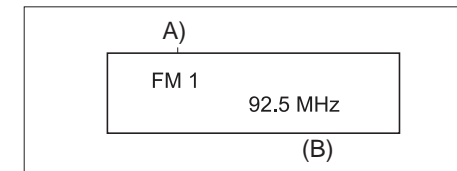

OTHER CONTROLS AND EQUIPMENT

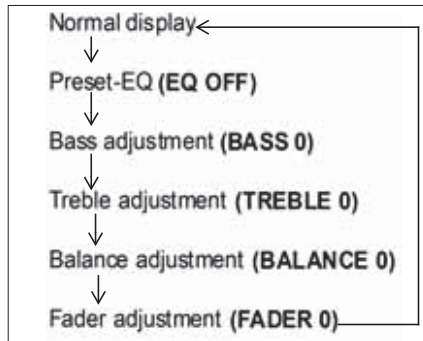

2) Turn the VOL PUSH SOUND knob (3) to adjust the sound.

Adjusting the AVC (if equipped)

The Auto Volume Control (AVC) function automatically adjusts (increases/decreases) the sound volume in accordance with vehicle speed. The AVC control is provided with three selectable levels (LEVEL OFF, 1, 2, 3). The range of volume adjustment increases together with the LEVEL number.

- 1) Press the TUNE FOLDER PUSH SOUND knob (2) until the AVC adjustment mode is selected.
- 2) Turn the TUNE FOLDER PUSH SOUND knob (2) to select the desired AVC adjustment level. (Initial setting: LEVEL 2)

Preset-EQ

TYPE 1:

Preset-EQ calls up various sound types in accordance with the listening music type.

- 1) Press the TUNE FOLDER PUSH SOUND knob (2) several times until "PRESET-EQ" appears.
- 2) Turn the TUNE FOLDER PUSH SOUND knob (2).

Each time the knob is turned, preset EQ mode will change as follows:

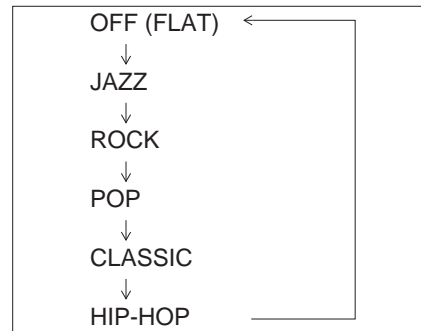

TYPE 2:

Preset-EQ calls up various sound types in accordance with the listening music type.

- 1) Press the VOL PUSH SOUND knob (3) several times until "PRESET-EQ" appears.
 - 2) Turn the VOL PUSH SOUND knob (3).
- Each time the knob is turned, preset EQ mode will change as follows:

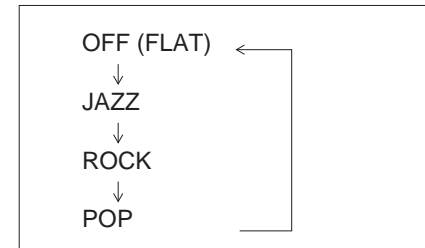

Listening to the Radio

TYPE 1

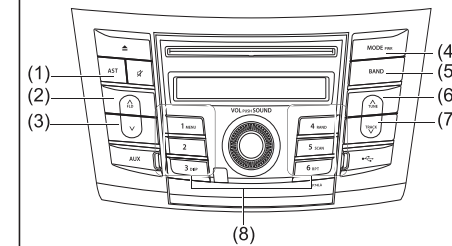

60M-05-027

Display

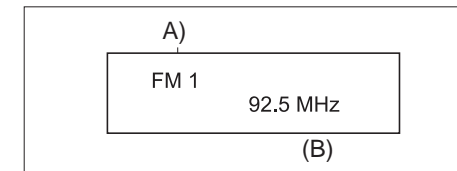

OTHER CONTROLS AND EQUIPMENT

- (1) FM/AM button
- (2) SCAN button
- (3) Up button
- (4) Down button
- (5) TUNE FOLDER PUSH SOUND knob
- (6) Preset buttons ([1] to [6])
- (7) AST button

- (A) Band
(B) Frequency

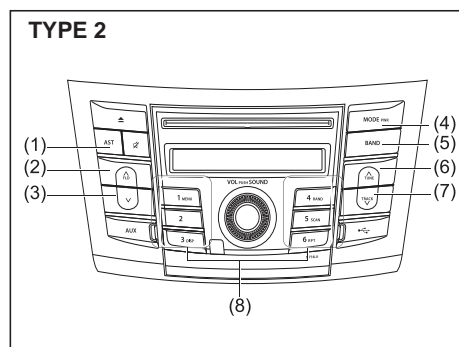

60M-05-027B

Display

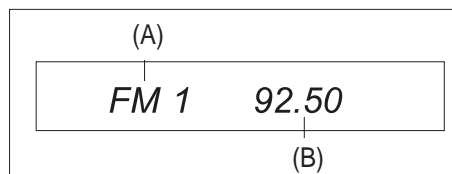

- (1) AST button
- (2) SCAN Up button
- (3) SCAN Down button
- (4) MODE PWR button
- (5) BAND button
- (6) TUNE Up button
- (7) TUNE Down button
- (8) Preset buttons ([1] to [6])

- (A) Band
(B) Frequency

Selecting the reception band

TYPE 1:

Press the FM/AM button (1).

Each time the button is pressed, the reception band will change as follows:



TYPE 2:

Press the MODE PWR button (4).

Each time the button is pressed, the mode will change as follows:

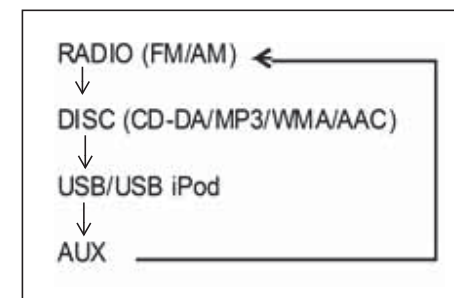

When you switch to RADIO (FM/AM) mode, the radio automatically enters the same radio mode you used last time.

Each time the BAND button (5) is pressed, the reception band will change as follows.

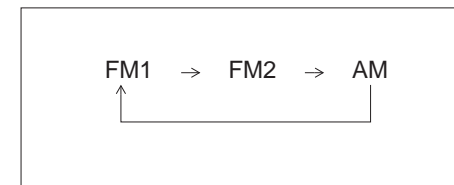

Seek tuning

TYPE 1:

Press the seek Up button (3) or the seek Down button (4).

OTHER CONTROLS AND EQUIPMENT

TYPE 2:

Hold down the TUNE Up button (6) or the TUNE Down button (7) for 1 second or longer.

The unit stops searching for a station at a frequency where a broadcast station is available.

Manual tuning

TYPE 1:

Turn the TUNE FOLDER PUSH SOUND knob (5).

TYPE 2:

Press the TUNE Up button (6) or the TUNE Down button (7).

The frequency being received is displayed.

Scan

TYPE 1:

Press the SCAN button (2).

It starts seeking upward (higher frequency), and pauses for 5 seconds to receive the band, and sequentially repeats seeking and play.

NOTE:

- When the SCAN button (2) is pressed while pausing for receiving, it cancels the scan operation and continuously receives the station.
- When the SCAN button (2) is pressed while searching, it cancels the scan operation and stops at next receivable station.

TYPE 2:

Press the SCAN Up button (2) or the SCAN Down button (3)

It starts seeking, and pauses for 5 seconds to receive the band, and sequentially repeats seeking and play.

NOTE:

- When the radio detects a station and pauses during a Scan Up search, if you press the SCAN Up button (2), Scan Up search mode is released and the radio stays on that station.
- When the radio detects a station and pauses during a Scan Down search, if you press the SCAN Down button (3), Scan Down search mode is released and the radio stays on that station.
- If you press the SCAN Up button (2) during a Scan Up search, Scan Up search mode is released and the radio tunes in the next receivable station.

If you press the SCAN Down button (3) during a Scan Down search, Scan Down search mode is released and the radio tunes in the next receivable station.

Preset memory

- 1) Select the desired station.
- 2) Hold down a desired button ([1] to [6]) of the Preset buttons (6) to which you want to store the station for 2 seconds or longer.

Auto store

Hold down the AST button (7) for 2 seconds or longer.

Six stations in good reception will automatically be stored to the Preset buttons (5) in order, starting from a station whose frequency is the lowest.

NOTE:

- Auto store can be released by pressing AST button (7) while auto store is under way.
- When the auto store is performed, the station previously stored in the memory at the position is overwritten.
- When there are fewer than 6 stations that can be stored even if 1 round of auto store operation is performed, no station will be stored at the remaining Preset buttons (6).
- 6 stations can be preset for FM1 and FM2 in common, and 6 stations for AM in auto store mode.

Auto store mode on/off

Press the AST button (7).

Each time the button is pressed, the mode is switched as follows:

OTHER CONTROLS AND EQUIPMENT

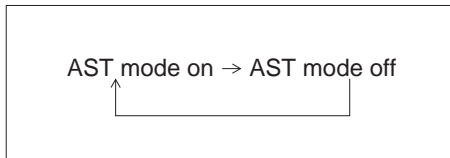

Radio Reception

Radio reception can be affected by environment, atmospheric conditions, or radio signal's power and distance from the station. Nearby mountains and buildings may interfere or deflect radio reception, causing poor reception. Poor reception or radio static can also be caused by electric current from overhead wires or high voltage power lines.

Listening to a CD

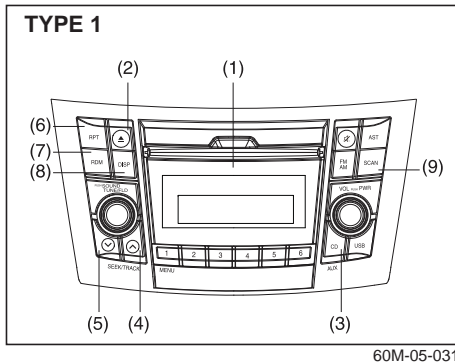

60M-05-031

Display

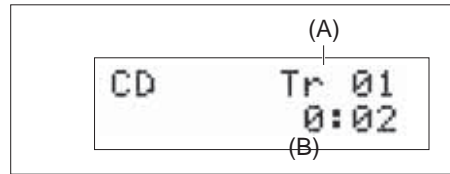

- (1) Insertion slot
- (2) Eject button
- (3) CD button
- (4) Up button
- (5) Down button
- (6) RPT button
- (7) RDM button
- (8) DISP button
- (9) SCAN button

- (A) Track number
- (B) Play time

NOTE:

This product does not support 8 cm CD (sometimes called as "mini single CD", "3-inch CD", "CD3", etc.).

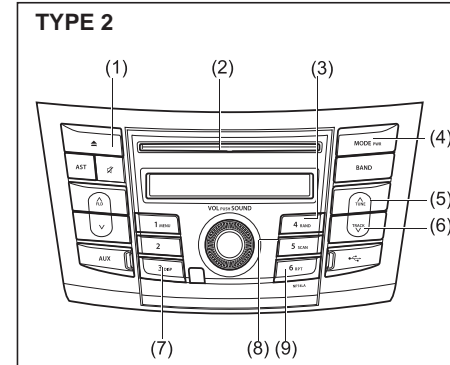

60M-05-032B

Display

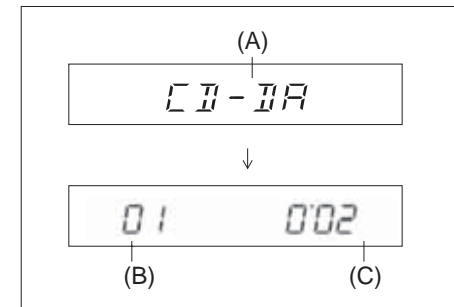

- (1) Eject button
- (2) Insertion slot
- (3) RAND button
- (4) MODE PWR button
- (5) TRACK Up button

OTHER CONTROLS AND EQUIPMENT

- (6) TRACK Down button
- (7) DISP button
- (8) SCAN button
- (9) RPT button
- (A) Disc type
- (B) Track number
- (C) Play time

NOTE:

This product does not support 8 cm CD (sometimes called as "mini single CD", "3-inch CD", "CD3", etc.).



- CDs or CD-ROMs carrying no mark (A) cannot be used.
- Some discs recorded in CD-R/CD-RW format may sometimes be impossible to use.

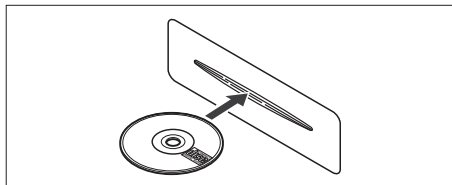

- A CD is to be inserted with its label side up.
- When there is a CD already in the unit, it is impossible to insert another CD without ejecting the CD in the unit. Do not use force to insert a CD into the CD insertion slot.

NOTICE

• Never insert your finger or hand into the CD insertion slot. Never insert foreign objects.
Never insert a CD with glue coming out from adhesive tape or a rental CD label or with a trace indicating that adhesive tape or a rental CD label has been removed. This may cause the CD not to eject or result in a malfunction.

Selecting a CD mode

TYPE 1:

Press the CD button (3).
 Each time the button is pressed, the mode will change as follows:

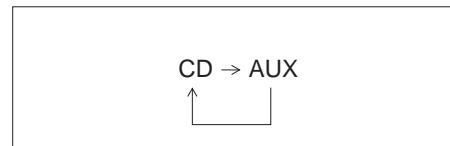

TYPE 2:

Press the MODE PWR button (4).
 Each time the button is pressed, the mode will change as follows:

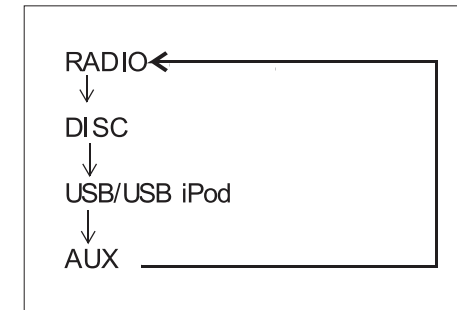

When the system enters DISC mode, the disc starts playing automatically.

Loading a CD

Insert a CD in the Insertion slot (1).
 When a CD is loaded, play starts.

Ejecting a CD

Press the Eject button (2).
 When the ignition mode is "LOCK", the CD remained ejected for around 15 seconds or longer will automatically be drawn inside the unit. (Auto reload function)
 The backup eject function:

OTHER CONTROLS AND EQUIPMENT

This function allows you to eject a CD by pressing the Eject button (2) even when the ignition mode is off.

NOTICE

If you forcefully try to push an ejected CD inside the unit before auto reloading, the disc surface might be scratched. When reloading a CD, remove it from the unit completely before reloading.

Listening to a CD

TYPE 1:

When a CD is inserted, playback will automatically start.

When a CD is already inside the unit, press the CD button (3) to start playback.

TYPE 2:

When a CD is inserted, playback will automatically start.

To start playing the disc, press the MODE PWR button (4) and switch the unit into DISC mode when a CD is already inside the unit.

Selecting a track

Press the Up button (4) to listen to the next track.

Press the Down button (5) twice to listen to the previous track.

When the Down button (5) is pressed once, the track currently being played will

start from the beginning again.

Fast forwarding/Rewinding a track

Hold down the Up button (4) to fast forward the track.

Hold down the Down button (5) to fast rewind the track.

Track scan play

Press the SCAN button (9).

The first 10 seconds of each track in the disc is played in sequence.

NOTE:

When the scan play is done for one round, the normal playback starts.

To cancel the scan play, press the SCAN button (9) again.

Random playback

TYPE 1:

Press the RDM button (7).

Each time the button is pressed, the mode will change as follows:

OFF → TRACK RANDOM



- TRACK RANDOM
The random indicator "RDM" will light.
The tracks in the loaded disc will be played in random order.

TYPE 2:

Press the RAND button (3).

Each time the button is pressed, the mode will change as follows:

OFF → TRACK RANDOM



- TRACK RANDOM
The random indicator "RAND" will light.
The tracks in the loaded disc will be played in random order.

Repeat playback

TYPE 1:

Press the RPT button (6).

Each time the button is pressed, the mode will change as follows:

OFF → TRACK REPEAT



TRACK REPEAT

The repeat indicator "RPT" will light.
The track currently being played will be played repeatedly.

OTHER CONTROLS AND EQUIPMENT

TYPE 2:

Press the RPT button (9).
Each time the button is pressed, the mode will change as follows:

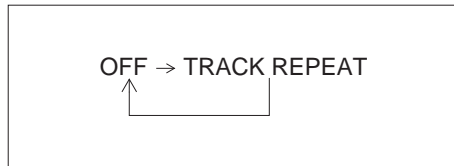

- **TRACK REPEAT**
The repeat indicator "RPT" will light.
The track currently being played will be played repeatedly.

Display change

Press the DISP button
Each time the button is pressed, display will change as follows:

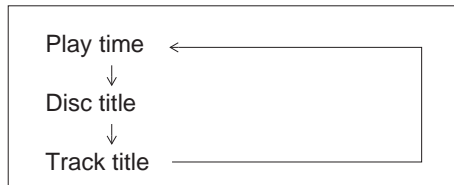

NOTE:

"NO TITLE" will be displayed when there is no text information in the disc currently being played.

TYPE 1:

If text data contains more than 12 characters, the ">" mark will appear at the right end. Holding down the DISP button (8) for 1 second or longer can display the next page.

TYPE 2:

If text data contains more than 10 characters, holding down the DISP button (7) for 2 second or longer can display the next page.

Listening to an MP3/WMA/AAC(if equipped) Disc

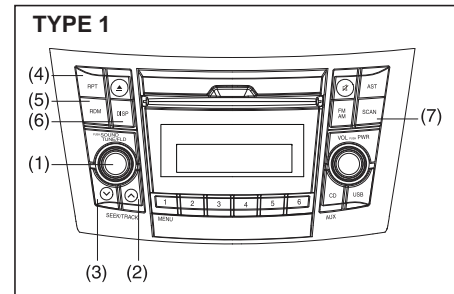

60M-05-039

Display

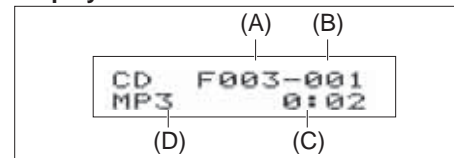

- (1) TUNE FOLDER PUSH SOUND knob
- (2) Up button
- (3) Down button
- (4) RPT button
- (5) RDM button
- (6) DISP button
- (7) SCAN button

- (A) Folder number
- (B) Track number
- (C) Play time
- (D) MP3/WMA indicator

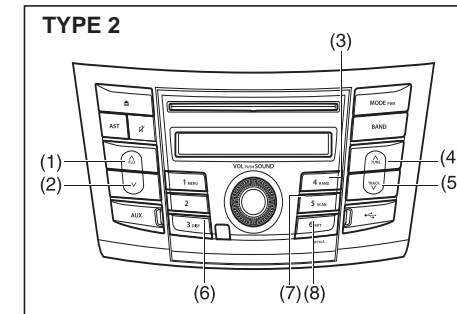

60M-05-039B

OTHER CONTROLS AND EQUIPMENT

Display

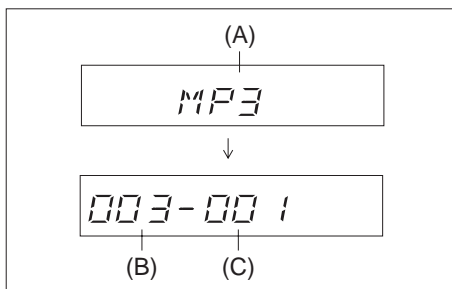

- (1) FOLDER Up button
- (2) FOLDER Down button
- (3) RAND button
- (4) TRACK Up button
- (5) TRACK Down button
- (6) DISP button
- (7) SCAN button
- (8) RPT button

- (A) DISC type
(B) Folder number
(C) File number

Selecting a folder

TYPE 1

Turn the TUNE FOLDER PUSH SOUND knob (1) to select a folder.

TYPE 2

Press the FOLDER Up button (1) to jump to the next folder.

Press the FOLDER Down button (2) to jump to the previous folder.

Selecting a track

Press the Up button to listen to the next track.

Press the Down button twice to listen to the previous track. When the Down button is pressed once, the track currently being played will start from the beginning again.

Fast forwarding/Rewinding a track

Hold down the Up button to fast forward the track.

Hold down the Down button to fast rewind the track.

Scan play

FILE SCAN

Press the SCAN button (7).

The first 10 seconds of each file in the currently playing folder is played in sequence.

FOLDER SCAN

TYPE 1:

Press the SCAN button (7) for 1 second or longer.

TYPE 2:

Press the SCAN button (7) for 2 seconds or longer. The first 10 seconds of the first file in each folder stored in the disc is played in sequence.

NOTE:

When the scan play is done for one round, the normal playback starts. To cancel the scan play, press the SCAN button (7) again.

Random playback

TYPE 1:

Press the RDM button (5).

Each time the button is pressed, the mode will change as follows:

FOLDER RANDOM

The random indicator "RDM.F" will light. The tracks in the current folder will be played in random order.

ALL RANDOM

The random indicator "RDM" will light. The tracks in the loaded disc will be played in random order.

TYPE 2:

FOLDER RANDOM

Each time you press the RAND button (3) for less than 2 seconds, the mode will change as follows.



The random indicator "FLD RAND" will light. The files in the current folder will be played in random order.

OTHER CONTROLS AND EQUIPMENT

- **ALL RANDOM**
Each time you hold down the RAND button (3) for 2 seconds or longer, the mode will change as follows.

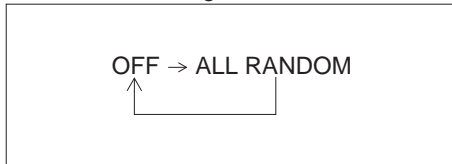

The random indicator "RAND" will light. The files in the loaded disc will be played in random order.

Repeat playback

TYPE 1:

Press the RPT button (4). Each time the button is pressed, the mode will change as follows:



- **FILE REPEAT**
The repeat indicator "RPT" will light. The track currently being played will be played repeatedly.

- **FOLDER REPEAT**
The repeat indicator "RPT.F" will light. All tracks in the currently selected folder will be played repeatedly.

TYPE 2:

- **FILE REPEAT**
Each time you press the RPT button (8) for less than 2 seconds, the mode will change as follows.

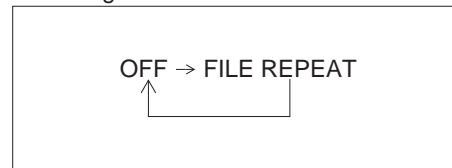

The repeat indicator "RPT" will light. The file currently being played will be played repeatedly.

- **FOLDER REPEAT**
Each time you hold down the RPT button (8) for 2 seconds or longer, the mode will change as follows.



The repeat indicator "FLD RPT" will light. All files in the currently selected folder will be played repeatedly.

Display change

TYPE 1:

Press the DISP button (6). Each time the button is pressed, display will change as follows:

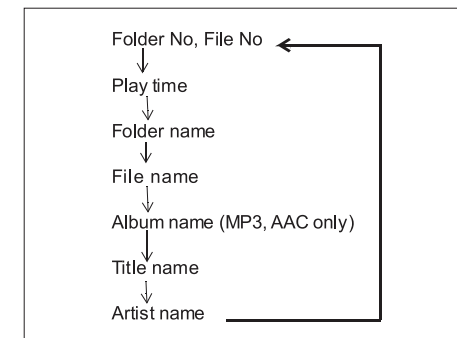

NOTE:

"NO TITLE" will be displayed when there is no text information in the disc currently being played. If text data contains more than 12 characters, the ">" mark will appear at the right end. Holding down the DISP button (6) for 1 second or longer can display the next-page.

TYPE 2

Press the DISP button (6). Each time the button is pressed, display will change as follows:

OTHER CONTROLS AND EQUIPMENT

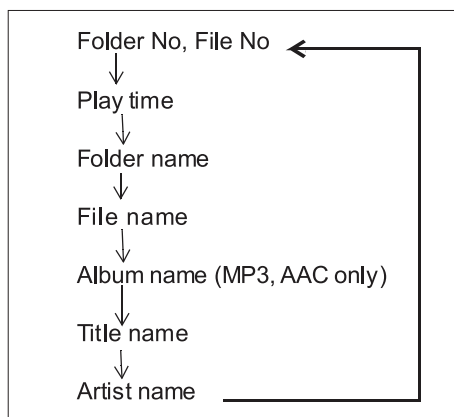

NOTE:
"NO TITLE" will be displayed when there is no text information in the disc currently being played.

TYPE 2:

If text data contains more than 10 characters, holding down the DISP button (6) for 2 second or longer can display the next page.

Notes on MP3/WMA/AAC (if equipped)

What is MP3?

MP3 (MPEG audio layer3) is an audio compression format that has become the standard format among PC users. Its merit is that the original audio data is compressed to approximately 1/10 and high sound quality is maintained. This means

that it is possible to store the data of approximately 10 music CDs on a single CD-R/RW disc, which in turn makes it possible to play music for a long time without having to change the disc.

What is WMA?

An abbreviation of "Windows Media Audio," WMA is an audio compression format developed by Microsoft. WMA files for which the DRM (Digital Rights Management) function is ON cannot be played. Windows Media™ and the Windows® logo are trademarks or registered trademarks of Microsoft Corporation in the United States and other countries.

What is AAC?

An abbreviation of "Advanced Audio Coding," AAC is an audio compression format used by MPEG2 and MPEG4.

Points to remember when making MP3/WMA/AAC files

Common

High bit rate and high sampling frequency are recommended for high quality sounds. Selecting VBR (Variable Bit Rate) is not recommended. Selecting VBR may cause display of incorrect playing time and jumpiness of playback.

Playback sound quality varies depending on the encoding environment. For details, refer to the user manual of the encoding software and the writing software in use.

NOTICE

Never assign the ".mp3", ".wma", or ".m4a" file name extension to a file if it is not in the MP3/WMA/AAC format file. Failure to observe this may result in damage to the speaker due to noise production..

Recording MP3/WMA/AAC files on a CD media

It is recommended not to write both CD-DA files and MP3/WMA/AAC files on a disc.

If both CD-DA files and MP3/WMA/AAC files are on the same disc, tracks may not be played in the correct order or some tracks may not be played at all.

When storing both MP3 data and WMA data on the same disc, sort and place them in different folders. Do not write files other than MP3/WMA/AAC files and unnecessary folders on a disc.

MP3/WMA/AAC files should be named to meet the standards and the file system specifications as shown below.

The file extension ".mp3", ".wma" or ".m4a" should be assigned to files based on their format independently.

You may encounter a trouble in playing MP3/WMA/AAC files or displaying information of MP3/WMA/AAC files depending on the writing software or CD recorder in use.

OTHER CONTROLS AND EQUIPMENT

This unit does not have a play list function. It is recommended to write discs in Disc at-Once mode even though Multi-session mode is supported.

Compression formats

TYPE 1

MP3

- Bit rate:
 - MPEG1 Audio Layer III: 64 k - 320 kbps
 - MPEG2 Audio Layer III: 64 k - 160 kbps
- Sampling frequency:
 - MPEG1 Audio Layer III: 32 k/44.1 k/48 kHz
 - MPEG2 Audio Layer III: 16 k/22.05 k/24 kHz
- WMA (Ver.7, Ver.8)
- Bit rate: CBR 48 k - 192 kbps
- Sampling frequency: 32 k/44.1 k/48 kHz
- WMA (Ver. 9*)
- Bit rate: CBR 48 k - 320 kbps
- Sampling frequency: 32 k/44.1 k/48 kHz
- *WMA 9 Professional/LossLess/Voice are not supported

TYPE 2

MP3

- Bit rate:
 - MPEG1 : 32 k - 384 kbps
 - MPEG2 : 8 k - 160 kbps
 - MPEG2.5 : 8 k - 160 kbps
- Sampling frequency:
 - MPEG1 : 32 k/44.1 k/48 kHz
 - MPEG2 : 16 k/22.05 k/24 kHz
 - MPEG2.5 : 8 k/11.025 k/12 kHz

WMA (Ver. 7, Ver. 8, Ver. 9*)

- Bit rate: 5 k - 384 kbps
- Sampling frequency: 8 k/11.025 k/16 k/22.05 k/32 k/44.1 k/48 kHz
- *Compliant with WMA Ver.9 Standard AAC
- Bit rate
 - monoral : 8 k - 160 kbps
 - stereo : 16 k - 320 kbps
- Sampling frequency: 8 k/11.025 k/12 k/16 k/22.05 k/24 k/32 k/44.1 k/48 kHz

Supported file systems

ISO 9660 Level 1/Level 2, Joliet, Romeo

Maximum number of files/folders

- Maximum number of files: 512 (files + folders)
- Maximum number of files in a folder: 512
- Maximum depth of tree structure: 8
- Maximum number of folders: 255 (Root folder is included.)

Listening to files stored in a USB device

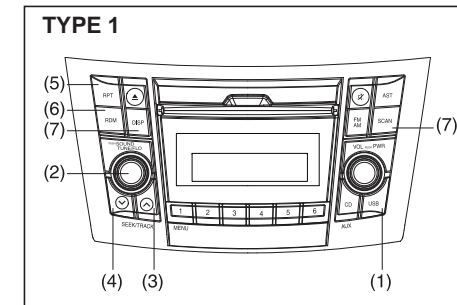

60M-05-044

Display

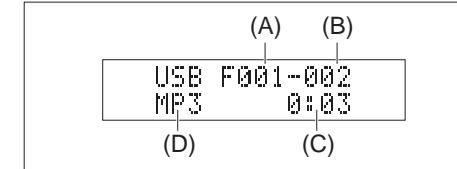

- (1) USB button
- (2) TUNE FOLDER PUSH SOUND knob
- (3) Up button
- (4) Down button
- (5) RPT button
- (6) RDM button
- (7) DISP button
- (8) SCAN button

OTHER CONTROLS AND EQUIPMENT

- (A) Folder number
- (B) Track number
- (C) Play time
- (D) MP3/WMA indicator

- (7) DISP button
- (8) SCAN button
- (9) RPT button
- (10) USB connector

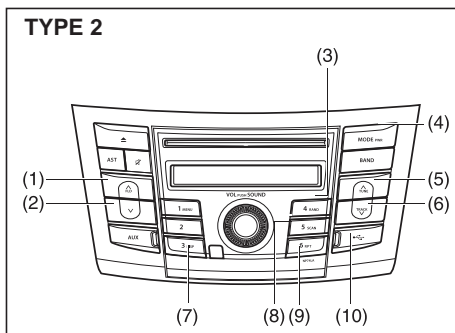

60M-05-044B

Display

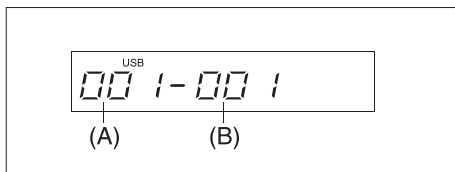

- (1) FOLDER Up button
- (2) FOLDER Down button
- (3) RAND button
- (4) MODE PWR button
- (5) TRACK Up button
- (6) TRACK Down button

- (A) Folder number
- (B) File number

NOTICE

Do not connect any USB device other than a USB memory or a USB audio player. Do not connect multiple USB devices to the USB connector using a USB hub, etc. Supplying power to multiple USB devices from the connector could cause overheating and smoking.

Selecting a USB device mode

TYPE 1:

Press the USB button (1).

TYPE 2:

Press the MODE PWR button (4).

Each time the button is pressed, the mode will change as follows:

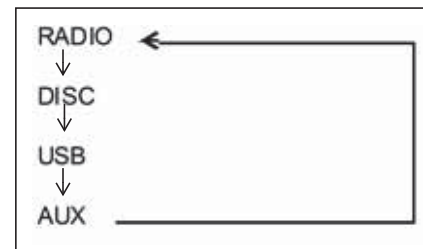

When the system enters USB mode, playback starts automatically.

Selecting a folder

TYPE1:

Turn the TUNE FOLDER PUSH SOUND knob (2) to select the desired folder.

TYPE 2:

Press the FOLDER Up button (1) to jump to the next folder.

Press the FOLDER Down button (2) to jump to the previous folder.

Selecting a track

Press the Up button to listen to the next track.

Press the Down button twice to listen to the previous track.

When the Down button is pressed once, the track currently being played will start from the beginning again.

OTHER CONTROLS AND EQUIPMENT

Fast forwarding/Rewinding a track

Hold down the Up button to fast forward the track.

Hold down the Down button to fast rewind the track.

Scan play

FILE SCAN

Press the SCAN button (8).

The first 10 seconds of each file in the currently playing folder is played in sequence

FOLDER SCAN

TYPE 1:

Press the SCAN button (8) for 1 second or longer.

TYPE 2:

Press the SCAN button (8) for 2 second or longer.

The first 10 seconds of the first file in each folder stored in the USB is played in sequence.

NOTE:

When the scan play is done for one round, the normal playback starts.

To cancel the scan play, press the SCAN button (8) again.

Random playback

TYPE 1:

Press the RDM button (6).

Each time the button is pressed, the mode will change as follows:

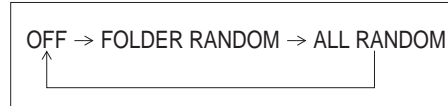

- **FOLDER RANDOM**
The random indicator "RDM.F" will light. The tracks in the currently selected folder will be played in random order.
- **ALL RANDOM**
The random indicator "RDM" will light. The tracks in the connected USB device will be played in random order.

TYPE 2:

- **FOLDER RANDOM**
Each time you press the RAND button (3) for less than 2 seconds, the mode will change as follows.



- The random indicator "FLD RAND" will light. The files in the currently selected folder will be played in random order.
- **ALL RANDOM**
Each time you hold down the RAND button (3) for 2 seconds or longer, the mode will change as follows.

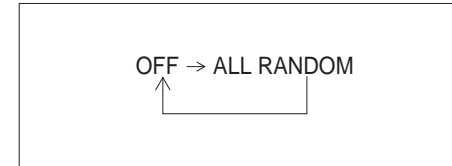

- The random indicator "RDM" will light. The files in the connected USB device will be played in random order.

Repeat playback

TYPE 1:

Press the RPT button (5).

Each time the button is pressed, the mode will change as follows:



- **FILE REPEAT**
The repeat indicator "RPT" will light. The track currently being played will be played repeatedly.
- **FOLDER REPEAT**
The repeat indicator "RPT.F" will light. All the tracks in the folder currently selected will be played repeatedly.

OTHER CONTROLS AND EQUIPMENT

TYPE 2:

- **FILE REPEAT**

Each time you press the RPT button (9) for less than 2 seconds, the mode will change as follows.

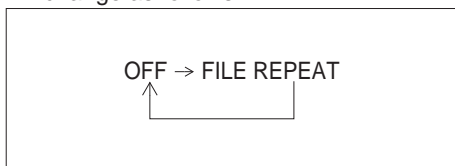

- The repeat indicator “RPT” will light. The file currently being played will be played repeatedly.
- **FOLDER REPEAT**
Each time you hold down the RPT button (9) for 2 seconds or longer, the mode will change as follows.

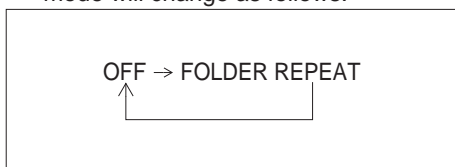

The repeat indicator “FLD RPT” will light. All the files in the folder currently selected will be played repeatedly.

Display change

TYPE 1:

Press the DISP button (7). Each time the button is pressed, display will change as follows:

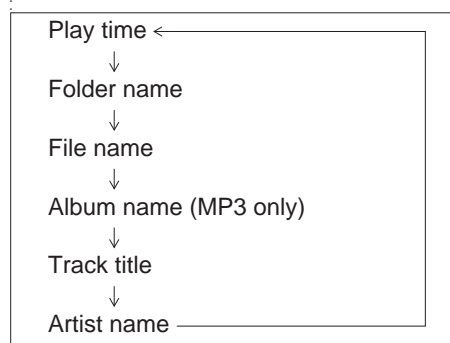

NOTE:

“NO TITLE” will be displayed when there is no text information in the disc currently being played.

If text data contains more than 12 characters, the “>” mark will appear at the right end. Holding down the DISP button (7) for 1 second or longer can display the next page.

TYPE 2:

Press the DISP button (7). Each time the button is pressed, display will change as follows:

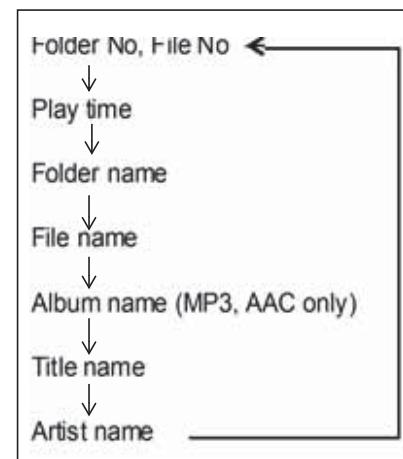

NOTE:

“NO TITLE” will be displayed when there is no text information in the disc currently being played.

If text data contains more than 10 characters, holding down the DISP button (7) for 2 second or longer can display the next page.

OTHER CONTROLS AND EQUIPMENT

Notes on USB device

TYPE 1:

Compatible USB devices

- USB Mass Storage Class
For details as to whether your USB memory/USB Audio is compatible with USB Mass Storage Class, please contact the USB memory/USB Audio manufacturer.
- USB Standard Compatibility 1.1/2.0 Full Speed
- File System FAT16/32
- Maximum current less than 500 mA
- Capacity less than 4 GB (1 partition)

TYPE 2:

- USB Mass Storage Class
For details as to whether your USB memory/USB Audio is compatible with USB Mass Storage Class, please contact the USB memory/USB Audio manufacturer.
- USB Standard Compatibility 1.1/2.0 Full Speed
- File System FAT12/16/32, VFAT
- Maximum current less than 1 A

USB device connection

- When connecting a USB device, make sure that the connector is pushed all the way into the port.

- Do not leave the USB device for long periods of time in places inside the vehicle where the temperature can rise too high.
- Back up any important data beforehand. We cannot accept responsibility for any lost data.
- It is recommended not to connect a USB device that contains data files other than MP3/WMA format.

Recording MP3/WMA/AAC files on a USB device

- Playback or display may not be possible depending on the type of USB device in use or the condition of the recording.
- Depending on the connected USB memory, the files may be played in different order from the order that the files were stored.

Compression formats

TYPE 1

MP3

- Bit rate:
MPEG1 Audio Layer III: 64 k - 320 kbps
MPEG2 Audio Layer III: 64 k - 160 kbps
- Sampling frequency:
MPEG1 Audio Layer III: 32 k/44.1 k/48 kHz
MPEG2 Audio Layer III: 16 k/22.05 k/24 kHz

WMA (Ver.7, Ver.8)

- Bit rate: CBR 48 k - 192 kbps
- Sampling frequency: 32 k/44.1 k/48 kHz

WMA (Ver.9*)

- Bit rate: CBR 48 k - 320 kbps
- Sampling frequency: 32 k/44.1 k/48 kHz
- * WMA 9 Professional/LossLess/Voice are not supported.

TYPE 2:

MP3

- Bit rate:
MPEG1 : 32 k - 384 kbps
MPEG2 : 8 k - 160 kbps
MPEG2.5 : 8 k - 160 kbps
- Sampling frequency:
MPEG1 : 32 k/44.1 k/48 kHz
MPEG2 : 16 k/22.05 k/24 kHz
MPEG2.5 : 8 k/11.025 k/12 kHz

WMA (Ver. 7, Ver. 8, Ver. 9*)

- Bit rate: 5 k - 384 kbps
- Sampling frequency: 8 k/11.025 k/16 k/22.05 k/32 k/44.1 k/48 kHz
- Compliant with WMA Ver.9 Standard

AAC

- Bit rate
monoral: 8 k - 160 kbps
stereo : 16 k - 320 kbps

Sampling frequency: 8 k/11.025 k/12 k/16 k/22.05 k/24 k/32 k/44.1 k/48 kHz

Maximum number of files/folders

- Maximum number of files: 2500 (files + folders)
- Maximum number of files in a folder: 255
- Maximum depth of tree structure: 8
- Maximum number of folders: 255 (Root folder is included.)

OTHER CONTROLS AND EQUIPMENT

Listening to an iPod®

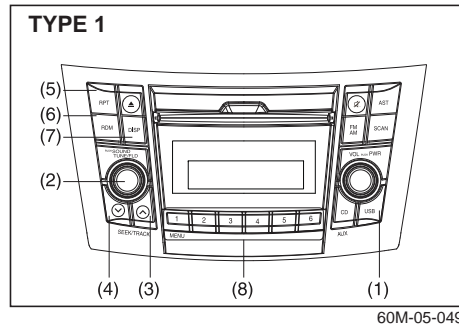

Display

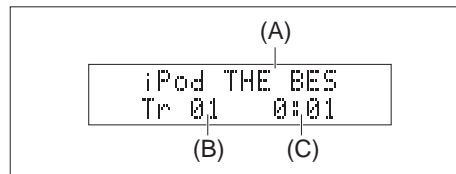

- (1) USB button
- (2) TUNE FOLDER PUSH SOUND knob
- (3) Up button
- (4) Down button
- (5) RPT button
- (6) RDM button
- (7) DISP button
- (8) Preset buttons ([1] to [6])

- (A) Track title
- (B) Track number
- (C) Play time

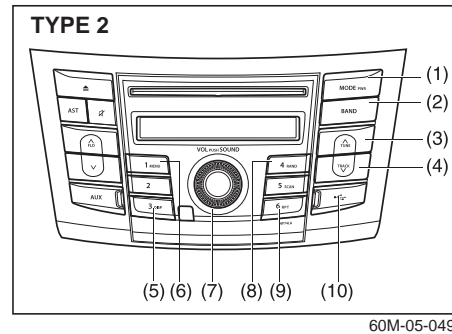

Display

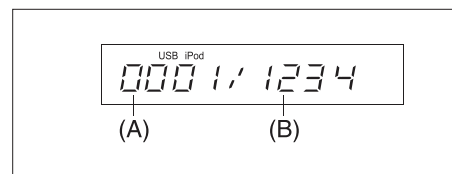

- (1) MODE PWR button
- (2) BAND button
- (3) TRACK Up button
- (4) TRACK Down button
- (5) DISP button
- (6) MENU button
- (7) VOL PUSH SOUND knob
- (8) RAND button

- (9) RPT button
- (10) USB connector

- (A) Song number
- (B) Number of song in title

Selecting an iPod® mode

TYPE 1:

Press the USB button (1).

TYPE 2:

Press the MODE PWR button (1).

Each time the button is pressed, the mode will change as follows:

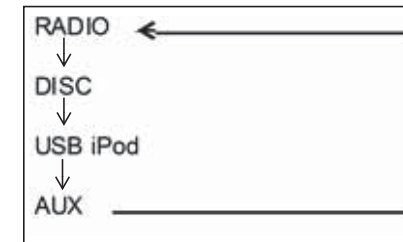

When the system enters USB iPod mode, playback starts automatically

Selecting a track

Press the Up button (3) to listen to the next track.

Press the Down button (4) twice to listen to the previous track.

When the Down button (4) is pressed once, the track currently being played will start from the beginning again.

OTHER CONTROLS AND EQUIPMENT

Fast forwarding/Rewinding a track

Hold down the Up button (3) to fast forward the track.

Hold down the Down button (4) to fast-rewind the track.

Random playback

TYPE 1:

Press the RDM button (6).

Each time the button is pressed, the mode will change as follows:

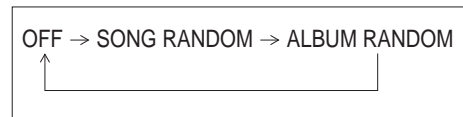

- **SONG RANDOM**
The random indicator "RDM" will light. The tracks in the iPod® will be played in random order.
- **ALBUM RANDOM**
The random indicator "D.RDM" will light. The albums in the iPod® will be played in random order.

TYPE 2:

- **SONG RANDOM**
Each time you press the RAND button (8) for less than 2 seconds, the mode will change as follows:

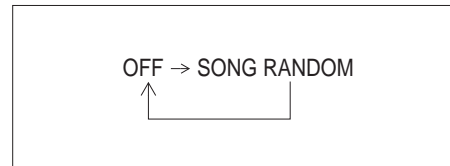

- The random indicator "RAND" will light. The files in the iPod® will be played in random order.
- **ALBUM RANDOM**
Each time you hold down the RAND button (8) for 2 seconds or longer, the mode will change as follows:



The random indicator "RAND" starts flashing. The albums in the iPod® will be played in random order.

Repeat playback

TYPE 1:

Press the RPT button (5).

Each time the button is pressed, the mode will change as follows:

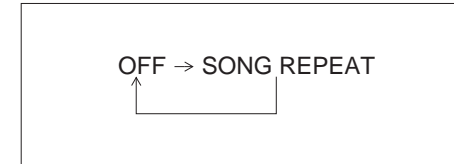

- **SONG REPEAT**
The repeat indicator "RPT" will light. The track currently being played will be played repeatedly.

TYPE 2:

Press the RPT button (9).

Each time the button is pressed, the mode will change as follows:

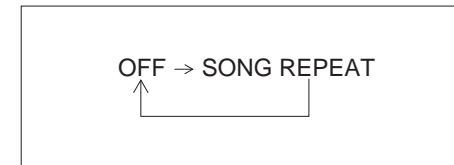

- **SONG REPEAT**
The repeat indicator "RPT" will light. The track currently being played will be played repeatedly.

Display change

TYPE 1:

Press the DISP button (7).

Each time the button is pressed, display will change as follows:

OTHER CONTROLS AND EQUIPMENT

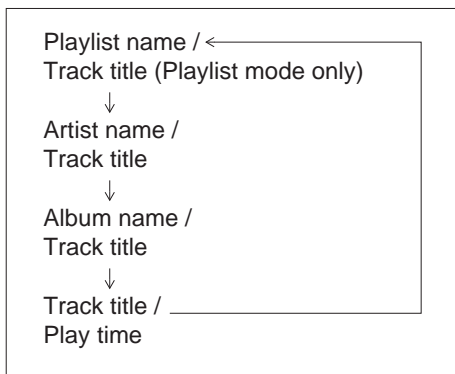

NOTE:
If text data contains more than 12 characters, the ">" mark will appear at the right end. Holding down the DISP button (7) for 1 second or longer can display the next page.

TYPE 2:
Press the DISP button (5). Each time the button is pressed, display will change as follows:

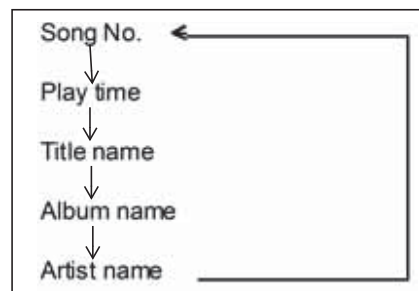

NOTE:
If text data contains more than 10 characters, holding down the DISP button (5) for 2 second or longer can display the next page.

Playing Mode selection

TYPE 1:

- 1) Press the button numbered [6] of the Preset buttons (8) for 1 second or longer.
- 2) Turn the TUNE FOLDER PUSH SOUND knob (2). Each time the knob is turned, the mode will change as follows:

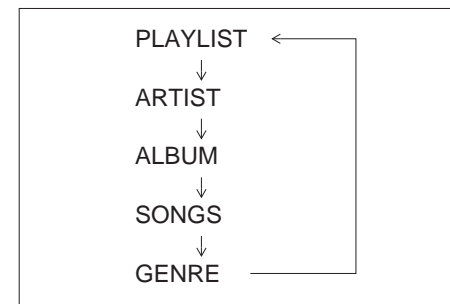

- 3) Press the TUNE FOLDER PUSH SOUND knob (2) to select the desired mode.

NOTE:
When the button numbered [6] of the Preset buttons (8) is pressed, the previous mode will be displayed.

TYPE 2:

- 1) Press the MENU button (6).
- 2) Turn the VOL PUSH SOUND knob (7). Each time the knob is turned, the mode will change as follows:

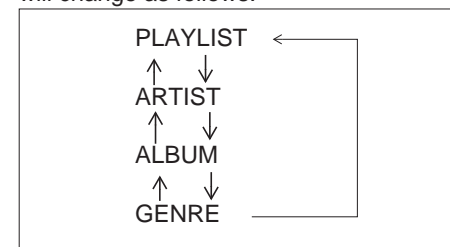

OTHER CONTROLS AND EQUIPMENT

Notes on iPod®

Supported iPod

TYPE 1:

- iPod® touch
- iPod® classic
- iPod® nano (4th generation)
- iPod® nano (3rd generation)
- iPod® nano (2nd generation)
- iPod® nano (1st generation)
- iPod® (5th generation)
- iPhone®
- iPhone® 3G

TYPE 2:

- iPod® touch (4th generation)
- iPod® touch (3rd generation)
- iPod® touch (2nd generation)
- iPod® touch (1st generation)
- iPod® classic
- iPod® nano (6th generation)
- iPod® nano (5th generation)
- iPod® nano (4th generation)
- iPod® nano (3rd generation)
- iPod® nano (2nd generation)
- iPod® nano (1st generation)
- iPod® (5th generation)
- iPhone® 6 Plus
- iPhone® 6
- iPhone® 5S
- iPhone® 5
- iPhone® 4S
- iPhone® 4
- iPhone® 3GS
- iPhone® 3G
- iPhone®

Some functions may not be available depending on the model of iPod®. iPod® is a trademark of Apple Inc., registered in the U.S. and other countries. iPhone® is a trademark of Apple Inc., registered in the U.S. and other countries. Apple is not responsible for the operation of this device or its compliance with safety and regulatory standards.

iPod® connection

Make sure to detach the iPod® after pressing the engine switch to change the ignition mode to LOCK. The iPod® may not be shut down when it is being connected and may result in battery depletion. Please do not connect iPod® accessories such as an iPod® remote control or headphones while connecting the iPod® with the unit. The unit may not operate correctly.

AUX Function

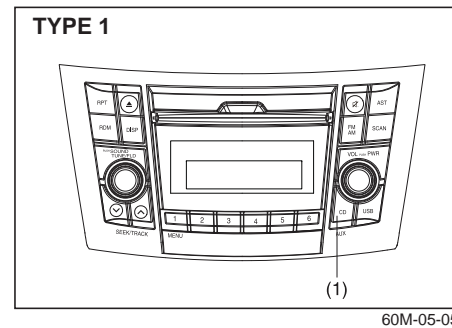

(1) AUX (CD) button

AUX connection

To listen to auxiliary audio sources (sold separately) through the unit, follow the instruction below.

- 1) Press the AUX (CD) button (1).
- 2) Connect the auxiliary audio source to the AUX/USB socket (separately attached) with an AUX cable.

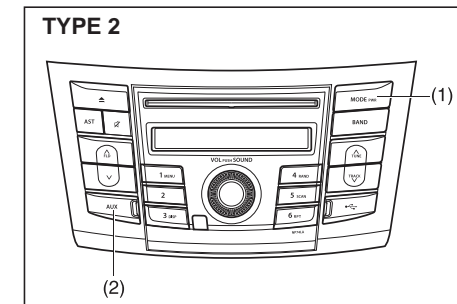

60M-05-055B

(1) MODE PWR button

(2) AUX socket

AUX connection

To listen to auxiliary audio sources through the unit, follow the instruction below.

- 1) Press the MODE PWR button (1).
- 2) Connect the auxiliary audio source to the AUX socket (2).

OTHER CONTROLS AND EQUIPMENT

CAUTION:

- Before connection, mute the unit, and also keep the volume of the auxiliary audio source within a range that will not cause distortion.
- When the audio source is turned off, noise may be emitted. Be sure to turn off the unit or switch to another mode before turning off the audio source.

NOTE:

- The volume and tone controls of the auxiliary audio source can be adjusted on the unit.
- In AUX mode, the volume setting is different from another mode.

Remote Audio Controls (if equipped)

Controlling of basic functions of the audio system is available using the switches on the steering wheel.

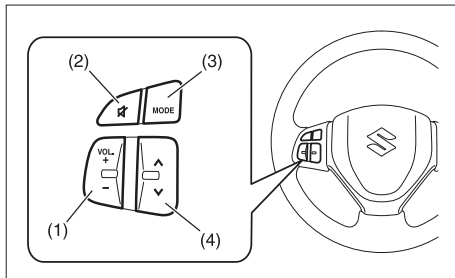

60M-05-056

Adjusting the volume

To increase the volume, hold down “+” of the VOL switch (1). The volume will keep on being increased until the switch is released.

To decrease the volume, hold down “-” of the VOL switch (1). The volume will keep on being decreased until the switch is released. To mute the sound, press the switch (2).

Selecting the mode

Press the switch (3). Each time the button is pressed, the mode will change as follows:

```
FM1 (Radio) ←
↓
FM2 (Radio)
↓
CD
↓
AUX
↓
USB (iPod®)
↓
AM (Radio) →
```

Selecting the radio station (FM1, FM2, AM mode)

To select the next preset station, press “^” of the switch (4) only for a moment. To select the previous preset station, press “v” of the switch (4) only for a moment. To scan a higher frequency radio station, press “^” of the switch (4) for 1 second or longer. To scan a lower frequency radio station, press “v” of the switch (4) for 1 second or longer.

Selecting the track (CD, USB (iPod®) mode)

To skip to the next track, press “^” of the switch (4) only for a moment. To skip to the previous track, press “v” of the switch (4) twice only for a moment. When the switch (4) is pushed down once only for a moment, the track currently being played will start from the beginning again.

Fast forwarding/Rewinding a track

To fast forward, press “^” of the switch (4) for 1 second or longer. To fast rewind, press “v” of the switch (4) for 1 second or longer.

OTHER CONTROLS AND EQUIPMENT

Remote Controller

Common operations

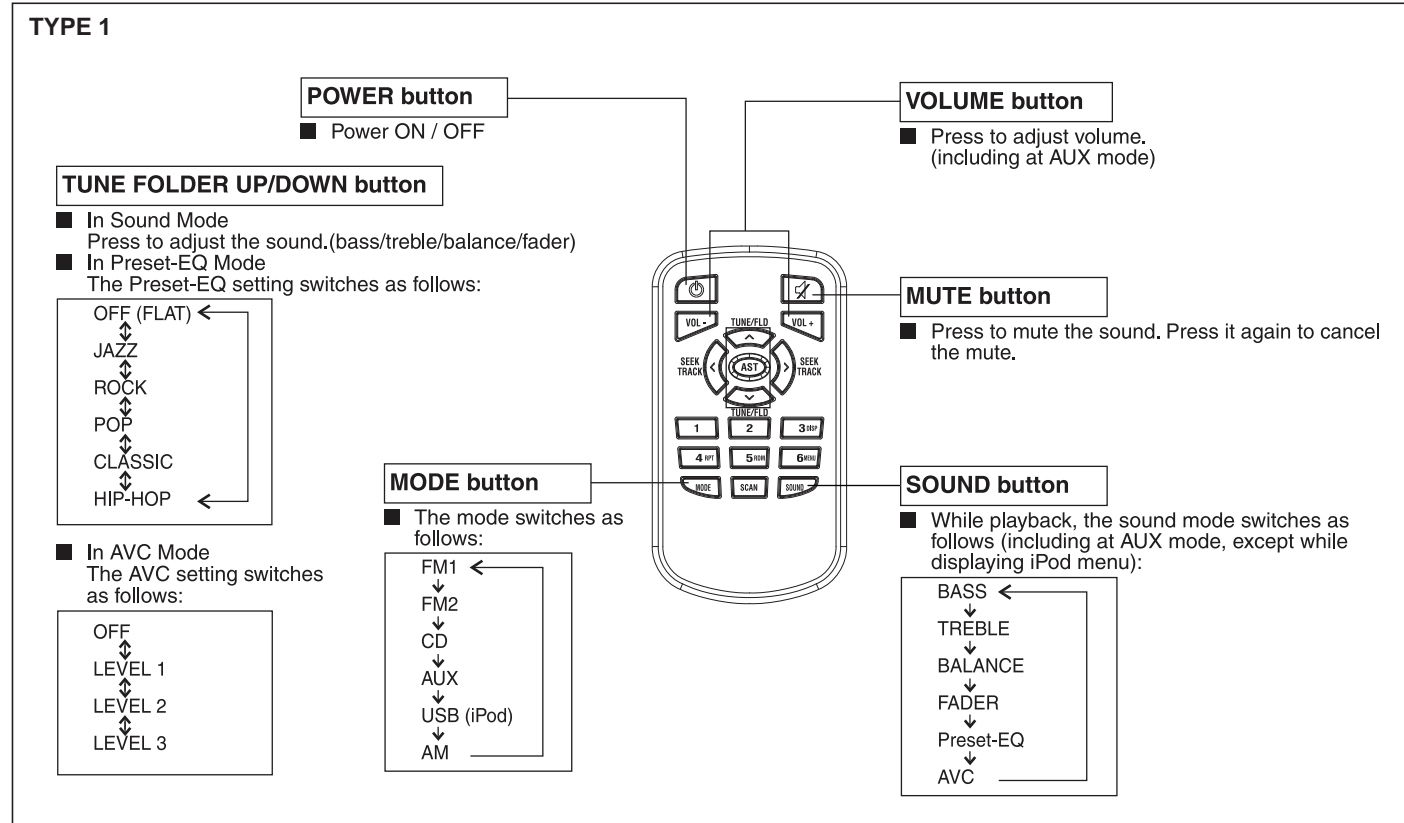

60M-05-060

OTHER CONTROLS AND EQUIPMENT

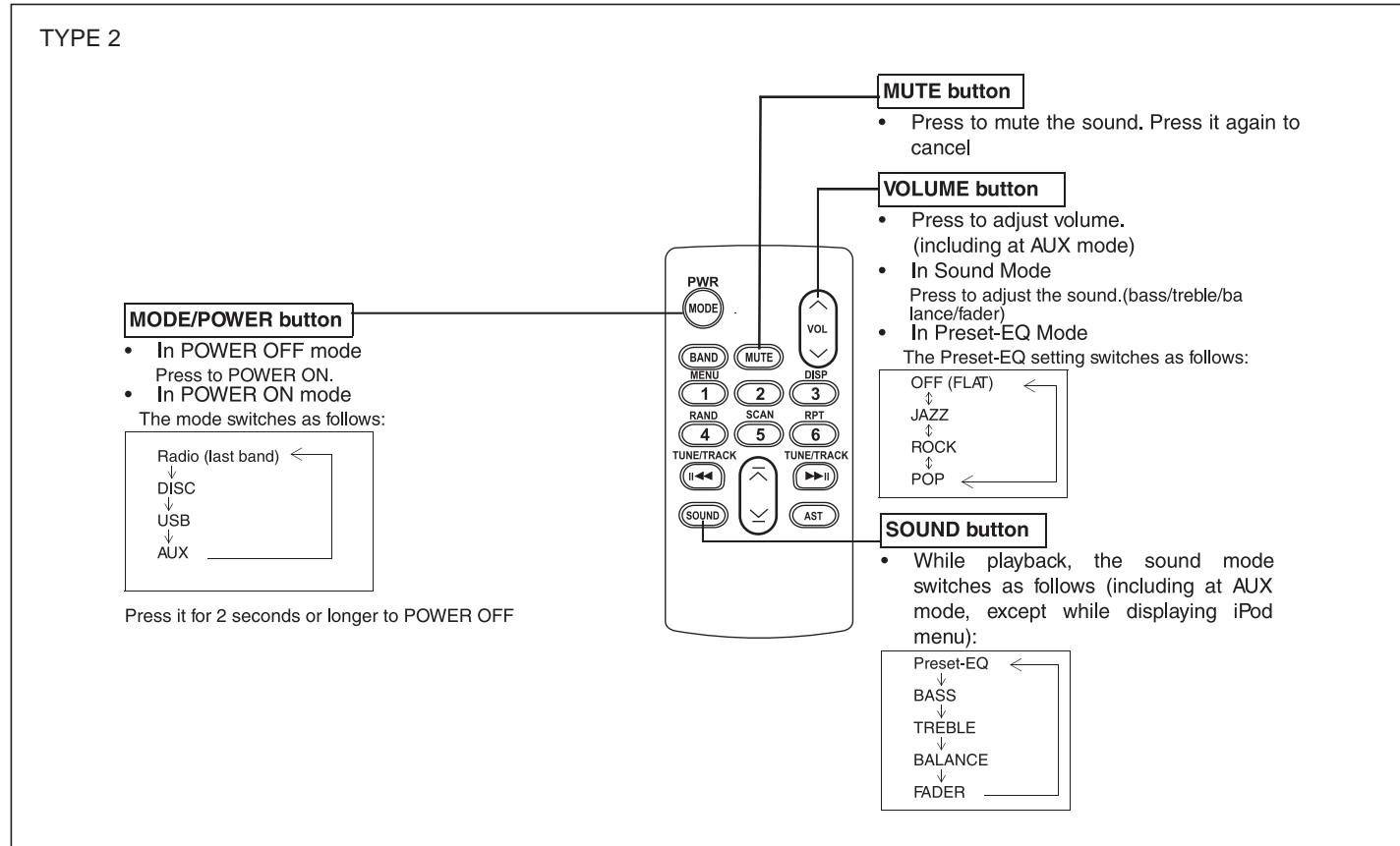

OTHER CONTROLS AND EQUIPMENT

Radio operations

TYPE 1

SCAN button

- Press to start the scan play. It starts seeking upward (higher frequency), and pauses for 5 seconds to receive the band, and sequentially repeats seeking and play.

AST button

- Press to return to the last received frequency in the previous auto store mode.
- Press it for 2 seconds or longer. It selects the stations with the stronger signals and stores them in order.

SEEK TRACK UP/DOWN button

- Press to select the radio station.

PRESET buttons (1-6)

- Press to select the desired preset station.

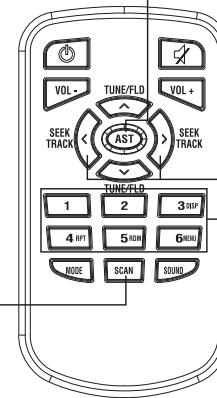

NOTE:

- When the SCAN button is pressed while pausing for receiving, it cancels the scan operation and continuously receives the station.
- When the SCAN button is pressed while searching, it cancels the scan operation and stops at next receivable station.
- When there are fewer than 6 stations that can be stored even if 1 round of auto store operation is performed, no station will be stored at the remaining preset buttons.

OTHER CONTROLS AND EQUIPMENT

TYPE 2

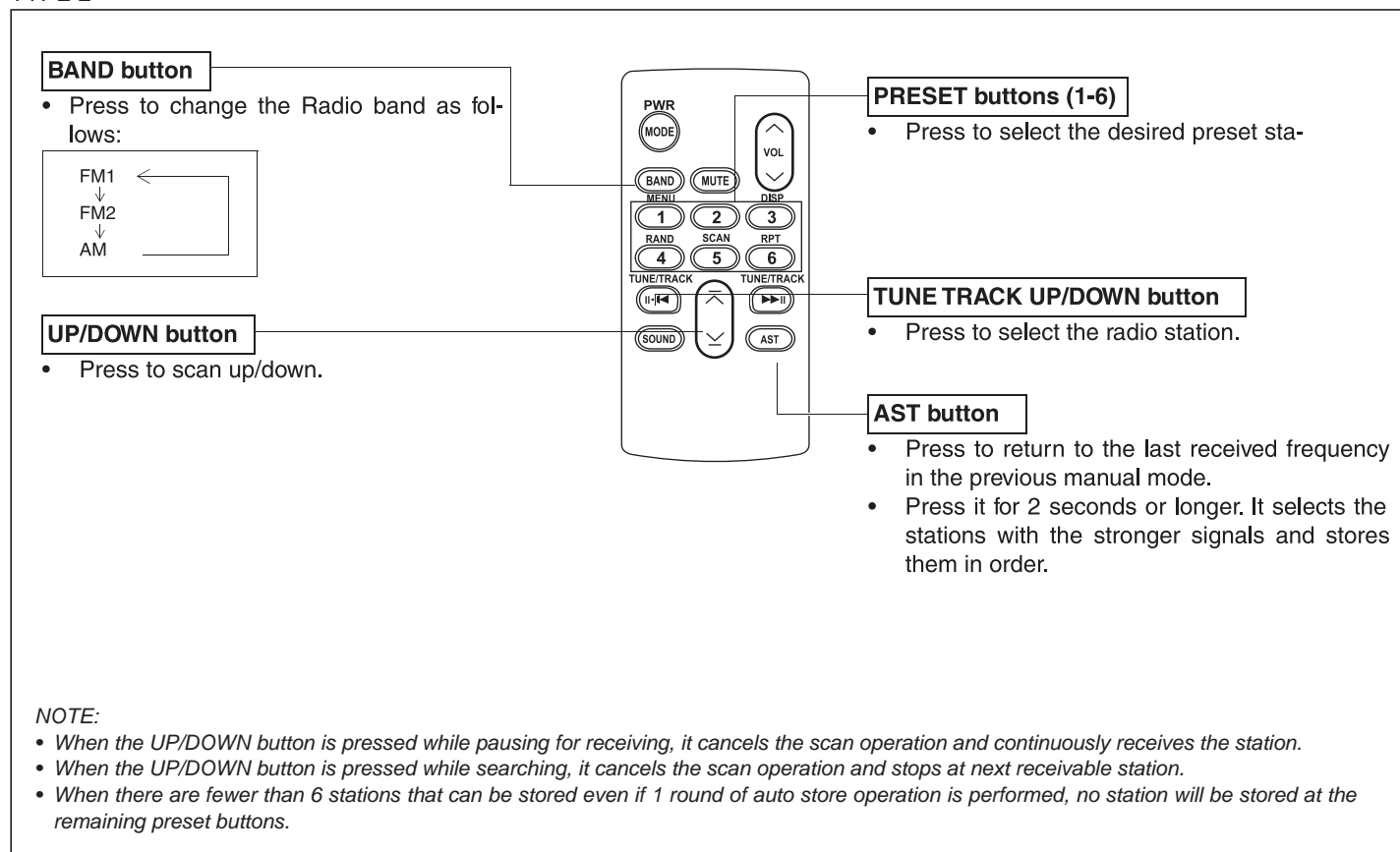

OTHER CONTROLS AND EQUIPMENT

CD operations

TYPE 1

RDM (5) button

- Press to play the current track randomly. Press it again to cancel.

RPT (4) button

- Press to play the current track repeatedly. Press it again to cancel.

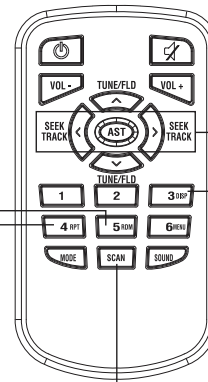

SEEK TRACK UP/DOWN button

- Press to skip to the next/previous track.
- Press it for 1 second or longer to fast-forward/fast-rewind the track.

DISP (3) button

- The display switches as follows:

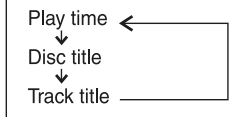

- Press it for 1 second or longer to display the next page.

SCAN button

- Press to play the first 10 seconds of each track in the disc sequentially.

NOTE:

- When the scan play is done for one round, the normal playback starts.
- To cancel the scan play, press the SCAN button again.

OTHER CONTROLS AND EQUIPMENT

TYPE 2

SCAN (5) button

- Press to play the first 10 seconds of each track in the disc sequentially.

RAND (4) button

- Press to play the current track randomly.
Press it again to cancel.

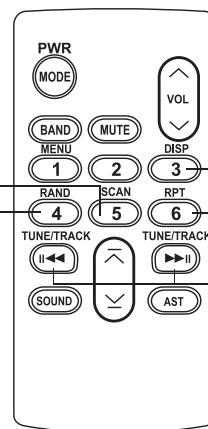

DISP (3) button

- The display switches as follows:

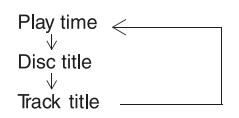

- Press it for 1 second or longer to display the next page.

RPT (6) button

- Press to plays the current track repeatedly.
- Press it again to cancel.

TUNE TRACK UP/DOWN button

- Press to skip to the next/previous track.
- Press it for 1 second or longer to fast-forward/fast-rewind the track.

NOTE:

- When the scan play is done for one round, the normal playback starts.
- To cancel the scan play, press the SCAN button again.

OTHER CONTROLS AND EQUIPMENT

MP3/WMA/AAC Disc operations (If equipped)

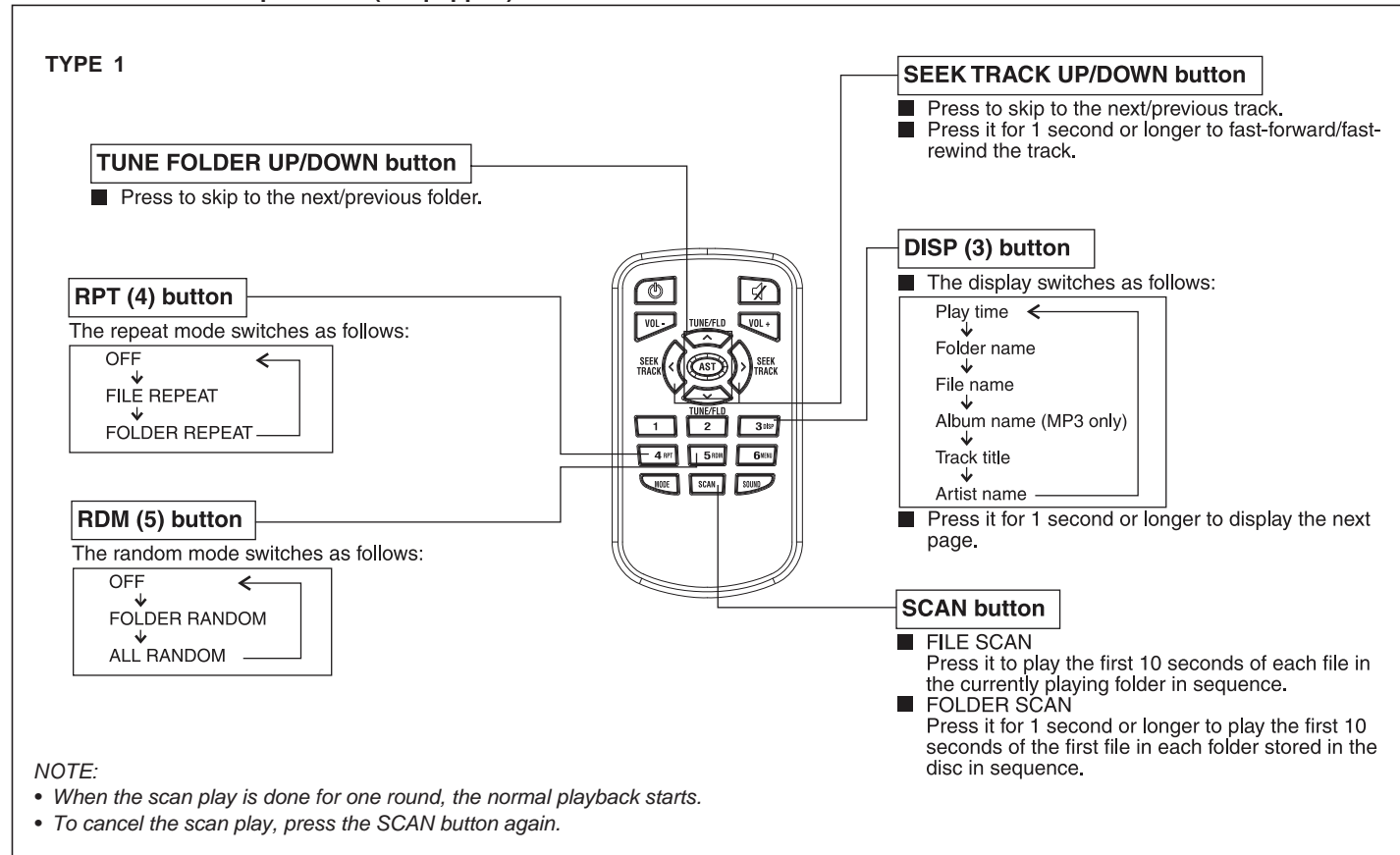

OTHER CONTROLS AND EQUIPMENT

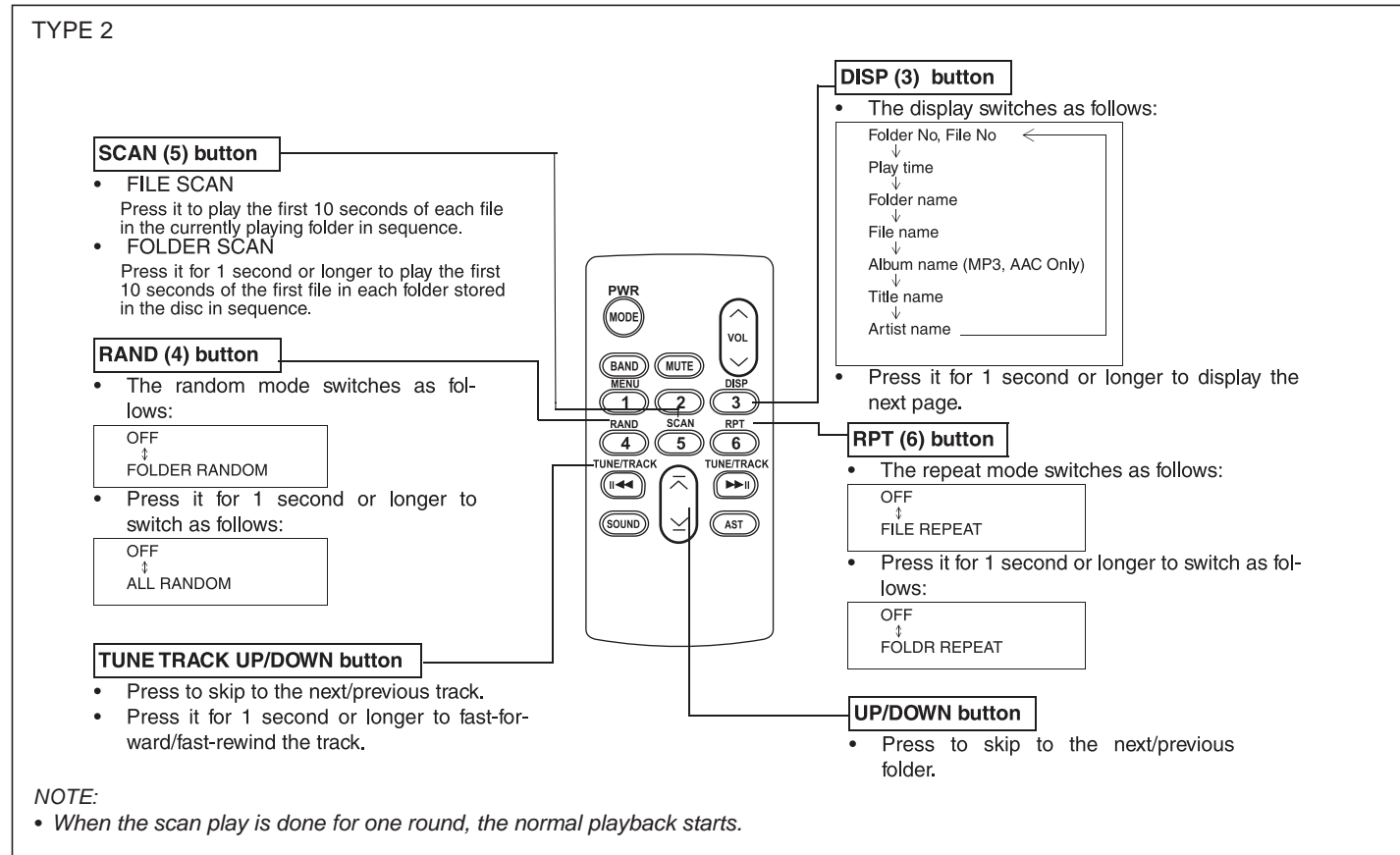

OTHER CONTROLS AND EQUIPMENT

USB operations

TYPE 1

TUNE FOLDER UP/DOWN button

- Press to skip to the next/previous folder.

RPT (4) button

The repeat mode switches as follows:

OFF
↓
FILE REPEAT
↓
FOLDER REPEAT

RDM (5) button

The random mode switches as follows:

OFF
↓
FOLDER RANDOM
↓
ALL RANDOM

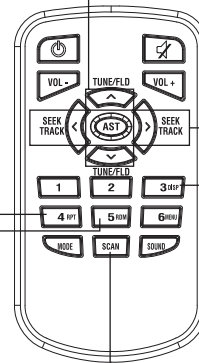

SEEK TRACK UP/DOWN button

- Press to skip to the next/previous file.
- Press it for 1 second or longer to fast-forward/fast-rewind the track.

DISP (3) button

- The display switches as follows:

Play time
↓
Folder name
↓
File name
↓
Album name (MP3 only)
↓
Track title
↓
Artist name

- Press it for 1 second or longer to display the next page.

SCAN button

- FILE SCAN
Press it to play the first 10 seconds of each file in the currently playing folder in sequence.
- FOLDER SCAN
Press it for 1 second or longer to play the first 10 seconds of the first file in each folder stored in the disc in sequence.

NOTE:

- When the scan play is done for one round, the normal playback starts.
- To cancel the scan play, press the SCAN button again.

OTHER CONTROLS AND EQUIPMENT

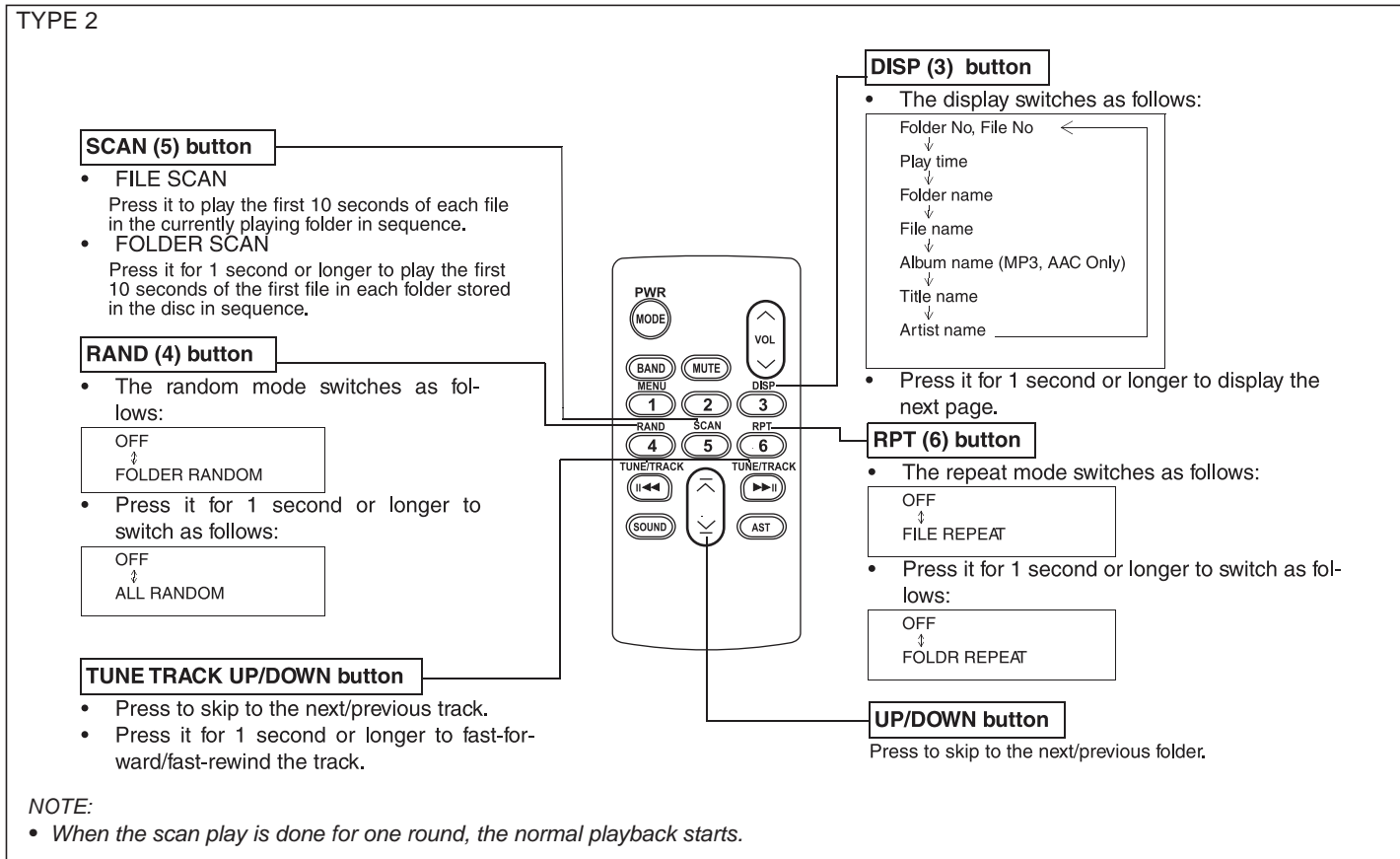

OTHER CONTROLS AND EQUIPMENT

iPod operations

TYPE 1

AST button

- While displaying iPod menu, press to select the desired item and display the list. When a track is selected from the list, the playback starts.

TUNE FOLDER UP/DOWN button

- While displaying iPod menu, press to display the next/previous list in the same layer.

RPT (4) button

- Press to play the current track repeatedly. Press it again to cancel.

RDM (5) button

The random mode switches as follows:

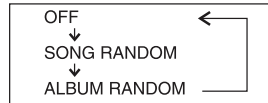

SEEK TRACK UP/DOWN button

- Press to skip to the next/previous file.
- Press it for 1 second or longer to fast-forward/fast-rewind the track.

DISP (3) button

- The display switches as follows:

```

    Playlist name / Track title (Playlist mode only)
    ↓
    Artist name / Track title
    ↓
    Album name / Track title
    ↓
    Track title / Play time
  
```

- Press it for 1 second or longer to display the next page.

MENU button

- During playback
 - Press to display iPod menu.
 - Press it for 1 second or longer to display the top menu.
- While iPod menu is displayed
 - Press to display the folder in one layer upper.
 - Press it for 1 second or longer to display the top menu.

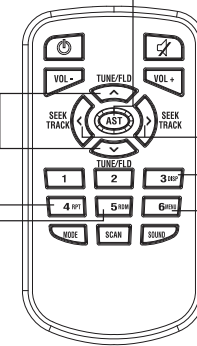

NOTE:

- When the scan play is done for one round, the normal playback starts.
- To cancel the scan play, press the SCAN button again.

OTHER CONTROLS AND EQUIPMENT

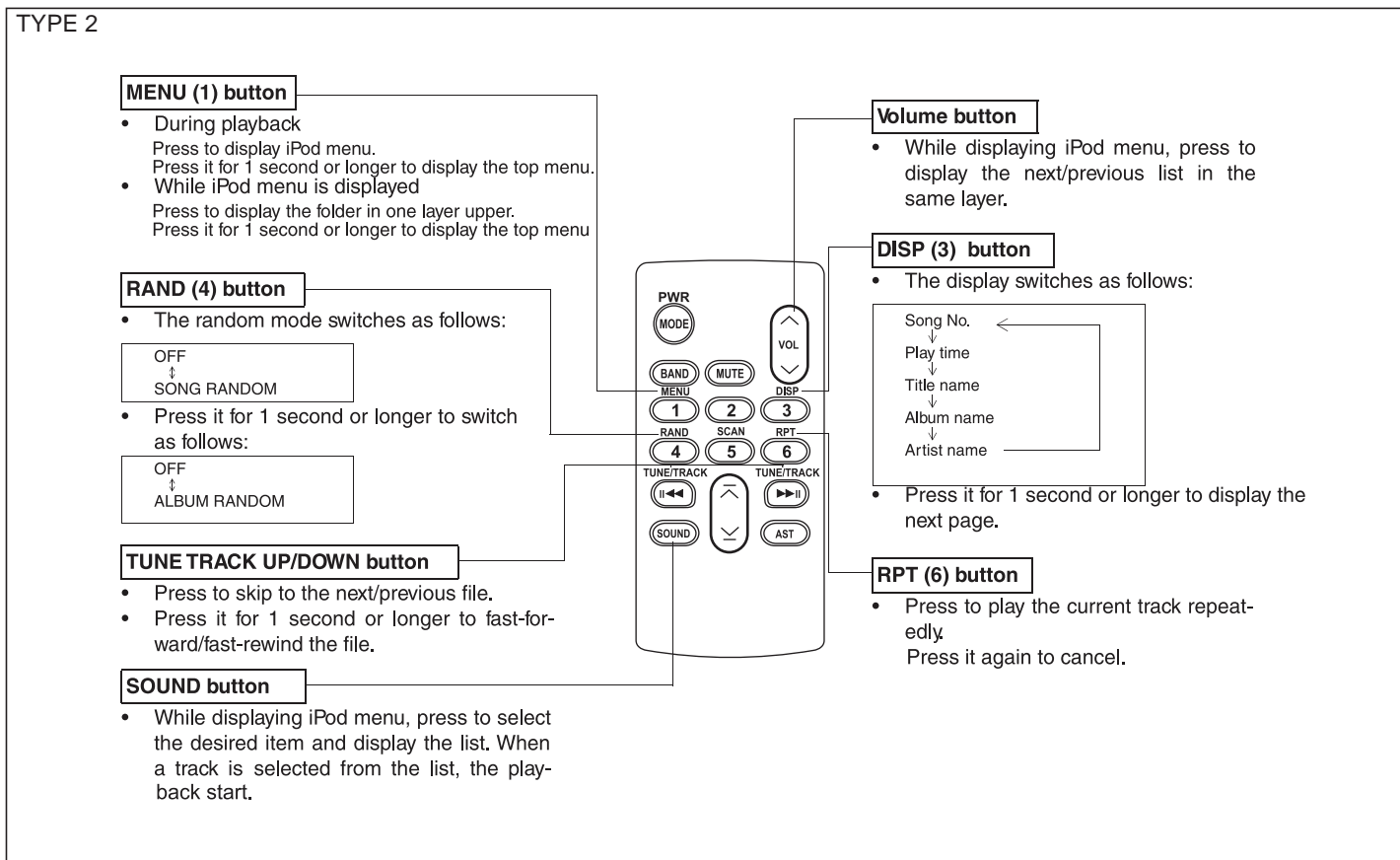

OTHER CONTROLS AND EQUIPMENT

Troubleshooting

When encountered a problem, check and follow the instructions as described below.

If the described suggestions do not solve the problem, it is recommended to take the unit to your authorized MARUTI SUZUKI dealer.

Problem	Possible cause	Possible solution
---------	----------------	-------------------

Common

Unable to turn on the power (no sound). (No sound is produced)	Fuse is blown.	Contact your authorized MARUTI SUZUKI dealer.
---	----------------	---

Radio

Much noise	It may not be exactly tuned in to the station.	Tune it in exactly to the station.
Unable to receive by auto tuning	There may be no station emitting signals powerful enough.	Pick up a station by manual tuning.

CD

Sound skips or noise produced	The disc is dirty.	Wipe the disc with a soft cloth.
	The disc has a major scratch or is warped.	Replace the disc with the one with no scratch and also not warped.

OTHER CONTROLS AND EQUIPMENT

Problem	Possible cause	Possible solution
---------	----------------	-------------------

MP3/WMA

No playback	The disc contains unsupported formatted data.	Check the file format.
Sound skips or noise produced	Sound skipping may occur when playing VBR (Variable Bit Rate) files.	It is not recommended to play VBR files.

USB

Playback does not start when the USB device is connected.	There is no supported format file to play on this unit.	Check the file format.
	The current consumption of the USB device exceeds 500 mA.	Use an USB device with a current consumption lower than 500 mA.

Error Display Messages

Display	Possible cause	Possible solution
---------	----------------	-------------------

CD

E 1, E 2	The disc cannot be read.	Insert the disc with its label side up. Check the disc if it is not warped or is free of flaws. When E 1, E 2 does not disappear even when a normal disc is inserted, contact your dealer.
E 3	The player developed an error of an unidentified cause.	When the CD is in the unit, press the CD eject button to remove the disc. When the disc cannot be ejected, contact your dealer.

OTHER CONTROLS AND EQUIPMENT

Display	Possible cause	Possible solution
---------	----------------	-------------------

USB/iPod®

ERROR 1	Inoperable due to an unidentified cause.	Unplug the USB device and plug it again. When ERROR 1 does not disappear, contact your dealer.
ERROR 3	The USB device is disconnected.	Check the connection of the USB device.
ERROR 4	The current consumption of the USB device exceeds 500 mA.	Check the USB device.

Display	Possible cause	Possible solution
---------	----------------	-------------------

E 1, E 6	Inoperable due to an unidentified cause.	Unplug the USB device and plug it again. When E 1, E 6 does not disappear, connect your dealer.
E 2	The Current consumption of the USB device exceeds 1 A.	check the USB device.
E3	The USB device is disconnected	Check the connection of the USB device.

OTHER CONTROLS AND EQUIPMENT

Audio System With Bluetooth (if equipped)

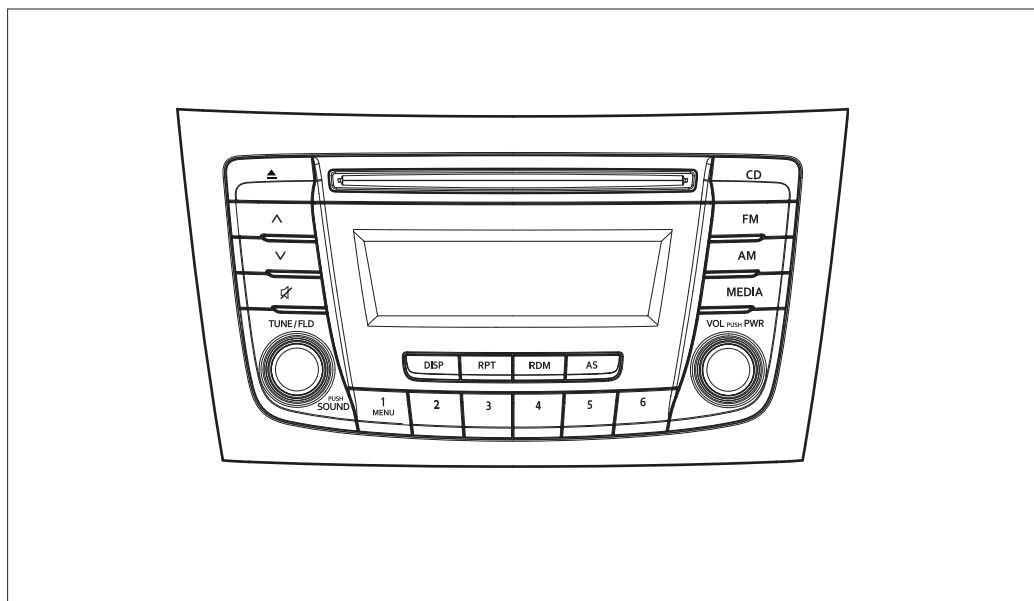

AM/FM CD PLAYER

OTHER CONTROLS AND EQUIPMENT

Safety Information

WARNING

If you pay extended attention to operating the audio system or viewing the audio system display while driving, an accident can occur. If you set the sound volume too loud, it could prevent you from being aware of road and traffic conditions.

- Keep your eyes on the road and your mind on the drive. Avoid paying extended attention to operating the audio system or viewing the audio system display.
- Familiarize yourself with the audio system controls and operation of the audio system before driving.
- Preset your favorite radio stations before driving so that you can quickly tune to them using the pre-sets.
- Set the sound volume to a level that will allow you to continue to be aware of road and traffic conditions while driving.

Notes on Discs

Precautions

- When the inside of the vehicle is very cold and the player is used soon after switching on the heater, condensation may form on the disc or the optical parts of the player and proper playback may not be possible. If condensation forms on the disc, wipe it off with a soft cloth. If condensation forms on the optical parts of the player, do not use the player for about one hour. This will allow the condensation to disappear normally.
- Driving on extremely bumpy roads which cause severe vibrations may cause sound to skip.
- This unit uses a precision mechanism. Even in the event that trouble arises, never open the case, disassemble the unit, or lubricate the rotating parts. Please bring the unit to an authorized MARUTI SUZUKI dealer.

Cautions on Handling



This unit has been designed specifically for playback of compact discs bearing mark (A) shown above.

No other discs can be played.

Removing the disc Proper way to hold

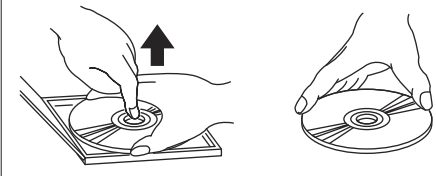

To remove the compact disc from its storage case, press down on the center of the case and lift the disc out, holding it carefully by the edges.

Always handle the compact disc by the edges. Never touch the surface.

OTHER CONTROLS AND EQUIPMENT

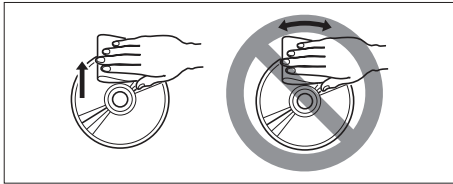

To remove fingermarks and dust, use a soft cloth, and wipe in a straight line from the center of the compact disc to the circumference.

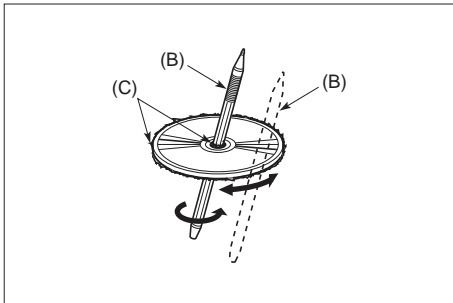

New discs may have some roughness around the edges. The unit may not work or the sound may skip if such discs are used. Use a ball-point pen (B), etc. to remove the roughness (C) from the edges of the disc before inserting it into the unit.

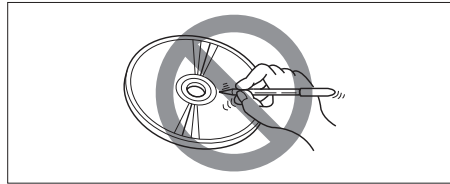

Never stick labels on the surface of the compact disc or write on the surface with a pencil or pen.

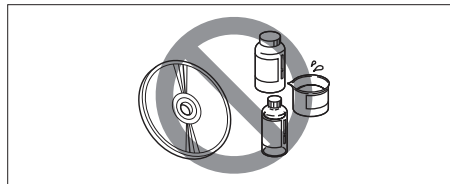

Do not use any solvents such as commercially available cleaners, anti-static spray, or thinner to clean compact discs.

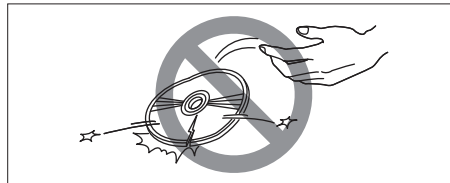

Do not use compact discs that have large scratches, are misshaped, or cracked, etc. Use of such discs will cause damage or prevent the system from operating properly.

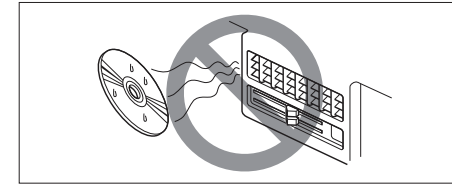

Do not expose compact discs to direct sunlight or any heat source.

NOTE:

- Do not use commercially available CD protection sheets or discs equipped with stabilizers, etc. These may get caught in the internal mechanism and damage the disc.
- It may be impossible to play CD-R discs with this unit due to the recording conditions.
- CD-RW discs cannot be played with this unit.

⚠ WARNING

This is a class I laser product. Use of controls or adjustments or performance of procedures other than those specified herein may result in hazardous radiation exposure. Do not open covers and do not attempt to repair this unit by yourself. Refer servicing to qualified personnel.

OTHER CONTROLS AND EQUIPMENT

Bluetooth® (if equipped)

The Bluetooth® word mark and logo are registered trademarks and are owned by the Bluetooth SIG, Inc.

Stop using this unit and a Bluetooth® ready device whenever requested.

This unit shares the communication frequency with other private or public wireless communication equipment such as a wireless LAN and other wireless communication radios.

You should stop using this unit whenever you are notified that your unit disturbs other wireless communication immediately.

Basic Operations

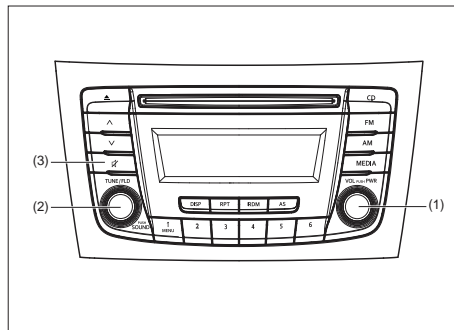

- (1) VOL PUSH POWER knob
- (2) TUNE FOLDER PUSH SOUND knob
- (3) MUTE button

Turning power on/off

Press the VOL PUSH POWER knob (1). The unit starts in the function mode it was in when the power was turned off last.

Adjusting the volume

Turn the VOL PUSH POWER knob (1). Turning it clockwise increases the volume; turning it counterclockwise decreases the volume.

NOTE:

While driving, adjust the volume to an extent that sound and/or noise coming from outside the vehicle can be heard.

Mute

Press the MUTE button (3) to mute the sound. To cancel the mute, press the MUTE button (3) again.

Bluetooth® Mic (1) (if equipped)

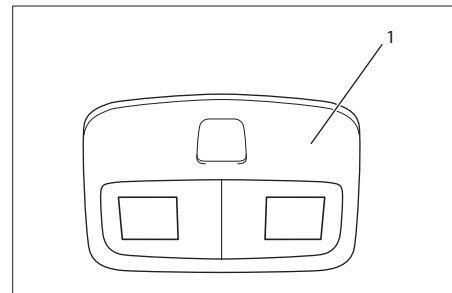

Adjusting bass/treble/balance /fader

- 1) Press the TUNE FOLDER PUSH SOUND knob (2).

Each time the knob is pressed, sound adjustment will change as follows:

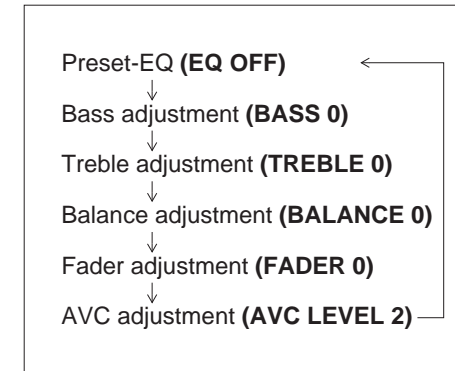

- 2) Turn the TUNE FOLDER PUSH SOUND knob (2) to adjust the sound.

OTHER CONTROLS AND EQUIPMENT

Adjusting the AVC (Auto volume control)

The Auto Volume Control (AVC) function automatically adjusts (increases/decreases) the sound volume in accordance with vehicle speed. The AVC control is provided with three selectable levels (LEVEL OFF, 1, 2, 3). The range of volume adjustment increases together with the LEVEL number.

- 1) Press the TUNE FOLDER PUSH SOUND knob (2) until the AVC adjustment mode is selected.
- 2) Turn the TUNE FOLDER PUSH SOUND knob (2) to select the desired AVC adjustment level. (Initial setting: LEVEL 2)

Preset-EQ

Preset-EQ calls up various sound types in accordance with the listening music type.

- 1) Press the TUNE FOLDER PUSH SOUND knob (2) several times until "PRESET-EQ" appears.
- 2) Turn the TUNE FOLDER PUSH SOUND knob (2). Each time the knob is turned, preset EQ mode will change as follows:

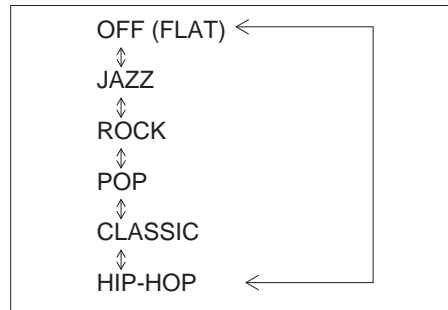

Listening to the Radio

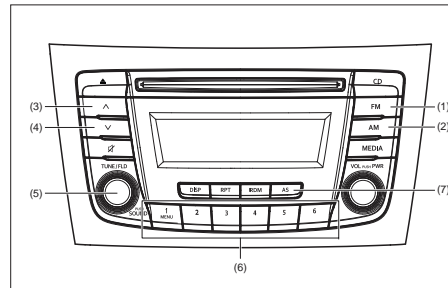

Display

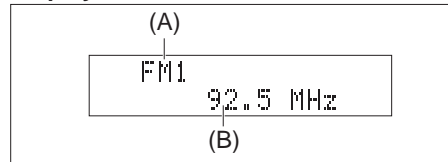

- (1) FM button
 - (2) AM button
 - (3) Up button
 - (4) Down button
 - (5) TUNE FOLDER PUSH SOUND knob
 - (6) Preset buttons ([1] to [6])
 - (7) AS button
- (A) Band
(B) Frequency

Selecting the FM band

Press the FM button (1). Each time the button is pressed, the reception band will change as follows:

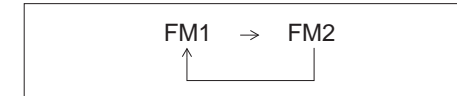

Selecting the AM band

Press the AM button (2).

Seek tuning

Press the seek Up button (3) or the seek Down button (4).

The unit stops searching for a station at a frequency where a broadcast station is available.

Manual tuning

Turn the TUNE FOLDER PUSH SOUND knob (5).

The frequency being received is displayed.

Preset memory

- 1) Select the desired station.

OTHER CONTROLS AND EQUIPMENT

- 2) Hold down a desired button ([1] to [6]) of the Preset buttons (6) to which you want to store the station for 2 seconds or longer.

Auto store

Hold down the AS button (7) for 2 seconds or longer.

Six stations in good reception will automatically be stored to the Preset buttons (6) in order, starting from a station whose frequency is the lowest.

NOTE:

- Auto store can be released by pressing AS button (7) while auto store is under way.
- When the auto store is performed, the station previously stored in the memory at the position is overwritten.
- When there are fewer than 6 stations that can be stored even if 1 round of auto store operation is performed, no station will be stored at the remaining Preset buttons (6).
- 6 stations can be preset for FM1 and FM2 in common, and 6 stations for AM in auto store mode.

Auto store mode on/off

Press the AS button (7). Each time the button is pressed, the mode is switched as follows:

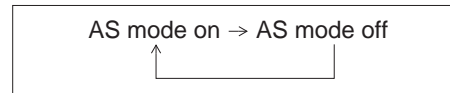

Radio Reception

Radio reception can be affected by environment, atmospheric conditions, or radio signal's power and distance from the station. Nearby mountains and buildings may interfere or deflect radio reception, causing poor reception. Poor reception or radio static can also be caused by electric current from overhead wires or high voltage power lines.

Listening to a CD

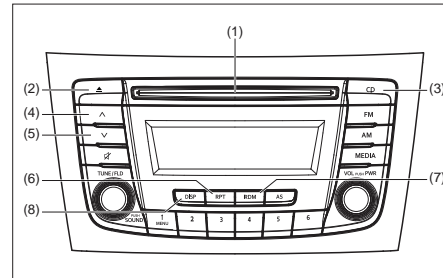

Display

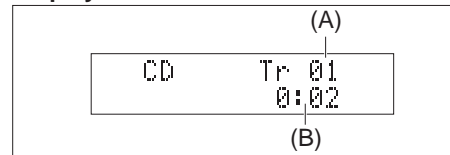

- (1) Insertion slot
- (2) Eject button
- (3) CD button
- (4) Up button
- (5) Down button
- (6) RPT button
- (7) RDM button
- (8) DISP button

- (A) Track number
- (B) Play time

NOTE:

This product does not support 8 cm CD (sometimes called as "mini single CD", "3-inch CD", "CD3", etc.).



- CDs or CD-ROMs carrying no mark (A) cannot be used.
- Some discs recorded in CD-R/CD-RW format may sometimes be impossible to use.

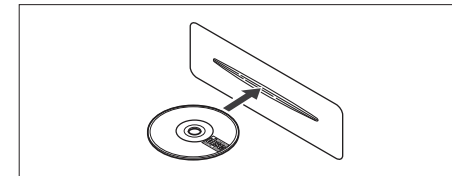

OTHER CONTROLS AND EQUIPMENT

- A CD is to be inserted with its label side up.
- When there is a CD already in the unit, it is impossible to insert another CD without ejecting the CD in the unit. Do not use force to insert a CD into the CD insertion slot.

NOTICE

- **Never insert your finger or hand into the CD insertion slot. Never insert foreign objects.**
- **Never insert a CD with glue coming out from adhesive tape or a rental CD label or with a trace indicating that adhesive tape or a rental CD label has been removed. This may cause the CD not to eject or result in a malfunction.**

Loading a CD

Insert a CD in the Insertion slot (1).
When a CD is loaded, play starts.

Ejecting a CD

Press the Eject button (2).
When the ignition mode is "LOCK", the CD remained ejected for around 15 seconds or longer will automatically be drawn inside the unit. (Auto reload function)
The backup eject function:
This function allows you to eject a CD by pressing the Eject button (2) even when the ignition mode is off.

NOTICE

If you forcefully try to push an ejected CD inside the unit before auto reloading, the disc surface might be scratched.
When reloading a CD, remove it from the unit completely before reloading.

Listening to a CD

When a CD is inserted, playback will automatically start.

When a CD is already inside the unit, press the CD button (3) to start playback.

Selecting a track

- Press the Up button (4) to listen to the next track.
- Press the Down button (5) twice to listen to the previous track.

When the Down button (5) is pressed once, the track currently being played will start from the beginning again.

Fast forwarding/Rewinding a track

- Hold down the Up button (4) to fast forward the track.
- Hold down the Down button (5) to fast rewind the track.

Random playback

Press the RDM button (7).

Each time the button is pressed, the mode will change as follows:

OFF → TRACK RANDOM



- **TRACK RANDOM**

The random indicator "RDM" will light.
The tracks in the loaded disc will be played in random order.

Repeat playback

Press the RPT button (6).

Each time the button is pressed, the mode will change as follows:

OFF → TRACK REPEAT



- **TRACK REPEAT**

The repeat indicator "RPT" will light.
The track currently being played will be played repeatedly.

OTHER CONTROLS AND EQUIPMENT

Display change

Press the DISP button (8). Each time the button is pressed, display will change as follows:

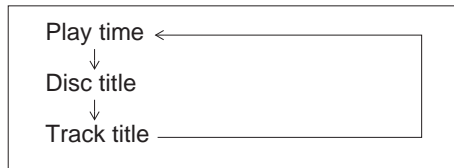

NOTE:

- "NO TITLE" will be displayed when there is no text information in the disc currently being played.
- If text data contains more than 12 characters, the ">" mark will appear at the right end. Holding down the DISP button (8) for 1 second or longer can display the next page.

Listening to an MP3/WMA/AAC Disc

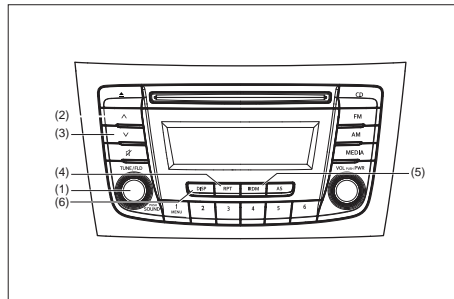

Display

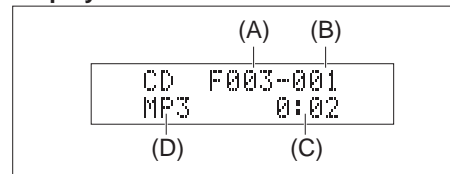

- (1) TUNE FOLDER PUSH SOUND knob
- (2) Up button
- (3) Down button
- (4) RPT button
- (5) RDM button
- (6) DISP button

- (A) Folder number
- (B) Track number
- (C) Play time
- (D) DISC type

Selecting a folder

Turn the TUNE FOLDER PUSH SOUND knob (1) to select a folder.

Selecting a track

- Press the Up button (2) to listen to the next track.
 - Press the Down button (3) twice to listen to the previous track.
- When the Down button (3) is pressed once, the track currently being played will start from the beginning again.

Fast forwarding/Rewinding a track

- Hold down the Up button (2) to fast forward the track.
- Hold down the Down button (3) to fast rewind the track.

Random playback

Press the RDM button (5). Each time the button is pressed, the mode will change as follows:

OFF → FOLDER RANDOM → ALL RANDOM

- FOLDER RANDOM
The random indicator "RDM.F" will light. The tracks in the current folder will be played in random order.
- ALL RANDOM
The random indicator "RDM" will light. The tracks in the loaded disc will be played in random order.

Repeat playback

Press the RPT button (4). Each time the button is pressed, the mode will change as follows:

OFF → FILE REPEAT → FOLDER REPEAT

- FILE REPEAT
The repeat indicator "RPT" will light.

OTHER CONTROLS AND EQUIPMENT

The track currently being played will be played repeatedly.

- **FOLDER REPEAT**

The repeat indicator "RPT.F" will light. All tracks in the currently selected folder will be played repeatedly.

Display change

Press the DISP button (6). Each time the button is pressed, display will change as follows:

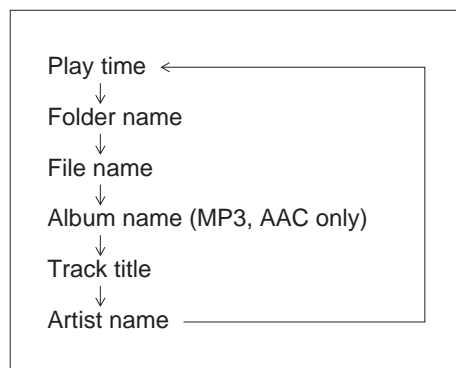

NOTE:

- "NO TITLE" will be displayed when there is no text information in the disc currently being played.
- If text data contains more than 12 characters, the ">" mark will appear at the right end. Holding down the DISP button (6) for 1 second or longer can display the next page.

Notes on MP3/WMA/AAC

What is MP3?

- MP3 (MPEG audio layer3) is an audio compression format that has become the standard format among PC users. Its merit is that the original audio data is compressed to approximately 1/10 and high sound quality is maintained. This means that it is possible to store the data of approximately 10 music CDs on a single CD-R/RW disc, which in turn makes it possible to play music for a long time without having to change the disc.

What is WMA?

- An abbreviation of "Windows Media Audio," WMA is an audio compression format developed by Microsoft.
- WMA files for which the DRM (Digital Rights Management) function is ON cannot be played.
- Windows Media™ and the Windows® logo are trademarks or registered trademarks of Microsoft Corporation in the United States and other countries.

What is AAC?

- An abbreviation of "Advanced Audio Coding," AAC is an audio compression format used by MPEG2 and MPEG4.

Points to remember when making MP3/WMA/AAC files

Common

- High bit rate and high sampling frequency are recommended for high quality sounds.
- Selecting VBR (Variable Bit Rate) is not recommended. Selecting VBR may cause display of incorrect playing time and jumpiness of playback.
- Playback sound quality varies depending on the encoding environment. For details, refer to the user manual of the encoding software and the writing software in use.

NOTICE

Never assign the ".mp3", ".wma", or ".m4a" file name extension to a file if it is not in the MP3/WMA/AAC format file. Failure to observe this may result in damage to the speaker due to noise production.

Recording MP3/WMA/AAC files on a CD media

- It is recommended not to write both CD-DA files and MP3/WMA/AAC files on a disc.
- If both CD-DA files and MP3/WMA/AAC files are on the same disc, tracks may not be played in the correct order or some tracks may not be played at all.

OTHER CONTROLS AND EQUIPMENT

- When storing both MP3 data and WMA data on the same disc, sort and place them in different folders.
- Do not write files other than MP3/WMA/AAC files and unnecessary folders on a disc.
- MP3/WMA/AAC files should be named to meet the standards and the file system specifications as shown below.
- The file extension “.mp3”, “.wma” or “.m4a” should be assigned to files based on their format independently.
- You may encounter a trouble in playing MP3/WMA/AAC files or displaying information of MP3/WMA/AAC files depending on the writing software or CD recorder in use.
- This unit does not have a play list function.
- It is recommended to write discs in Disc-at-Once mode even though Multi-session mode is supported.

Compression formats

MP3

- Bit rate:
 - MPEG1 Audio Layer III: 32 k - 320 kbps
 - MPEG2 Audio Layer III: 8 k - 160 kbps
 - MPEG2.5 Audio Layer III: 8 k - 160 kbps
- Sampling frequency:
 - MPEG1 Audio Layer III: 32 k/44.1 k/48 kHz
 - MPEG2 Audio Layer III: 16 k/22.05 k/24 kHz
 - MPEG2.5 Audio Layer III: 8 k/11.025 k/12 kHz

WMA (Ver. 7, Ver. 8, Ver. 9*)

- Bit rate: CBR 32 k - 320 kbps
- Sampling frequency: 32 k/44.1 k/48 kHz
- * WMA 9 Professional/LossLess/Voice are not supported.

AAC*

- Bit rate: ABR 16k - 320 kbbs
- Sampling frequency: 32 k/44.1 k/48 kHz
- * Apple Lossless is not supported.

Supported file systems

ISO 9660 Level 1/Level 2, Joliet, Romeo

Maximum number of files/folders

- Maximum number of files: 512
- Maximum number of files in a folder: 255
- Maximum depth of tree structure: 8
- Maximum number of folders: 255 (Root folder is included.)

Listening to files stored in a USB device

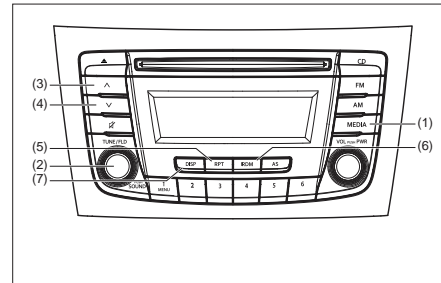

Display

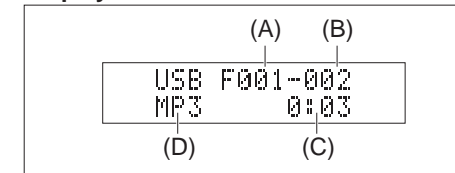

- (1) MEDIA button
- (2) TUNE FOLDER PUSH SOUND knob
- (3) Up button
- (4) Down button
- (5) RPT button
- (6) RDM button
- (7) DISP button

- (A) Folder number
 (B) Track number
 (C) Play time
 (D) File type

NOTICE

Do not connect any USB device other than a USB memory or a USB audio player. Do not connect multiple USB devices to the USB connector using a USB hub, etc. Supplying power to multiple USB devices from the connector could cause overheating and smoking.

OTHER CONTROLS AND EQUIPMENT

Selecting a USB device mode

Press the MEDIA button (1).
Each time the button is pressed, the mode will change as follows:

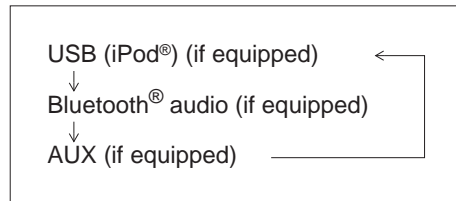

Selecting a folder

Turn the TUNE FOLDER PUSH SOUND knob (2) to select the desired folder.

Selecting a track

- Press the Up button (3) to listen to the next track.
- Press the Down button (4) twice to listen to the previous track.
When the Down button (4) is pressed once, the track currently being played will start from the beginning again.

Fast forwarding/Rewinding a track

- Hold down the Up button (3) to fast forward the track.
- Hold down the Down button (4) to fast rewind the track.

Random playback

Press the RDM button (6).
Each time the button is pressed, the mode will change as follows:

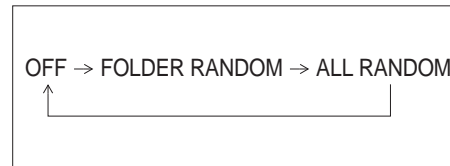

- FOLDER RANDOM
The random indicator “RDM.F” will light.
The tracks in the currently selected folder will be played in random order.
- ALL RANDOM
The random indicator “RDM” will light.
The tracks in the connected USB device will be played in random order.

Repeat playback

Press the RPT button (5).
Each time the button is pressed, the mode will change as follows:



- FILE REPEAT
The repeat indicator “RPT” will light.
The track currently being played will be played repeatedly.

- FOLDER REPEAT

The repeat indicator “RPT.F” will light.
All the tracks in the folder currently selected will be played repeatedly.

Display change

Press the DISP button (7).
Each time the button is pressed, display will change as follows:

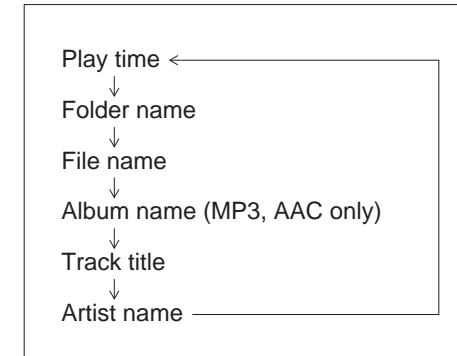

NOTE:

- “NO TITLE” will be displayed when there is no text information in the disc currently being played.
- If text data contains more than 12 characters, the “>” mark will appear at the right end. Holding down the DISP button (7) for 1 second or longer can display the next page.

OTHER CONTROLS AND EQUIPMENT

Notes on USB device

Compatible USB devices

- USB Mass Storage Class
For details as to whether your USB memory/USB Audio is compatible with USB Mass Storage Class, please contact the USB memory/USB Audio manufacturer.
- USB Standard Compatibility 1.1/2.0 Full Speed
- File System FAT12/16/32, VFAT
- Maximum current less than 1.0 A
- If devices such as USB hub, extension cable are connected to the audio system, it may not be recognized. In such case connect the USB device directly to the audio system.
- Devices such as MP3 player/Mobile phone/digital camera may not be recognized by the audio system for playing music.

USB device connection

- When connecting a USB device, make sure that the connector is pushed all the way into the port.
- Do not leave the USB device for long periods of time in places inside the vehicle where the temperature can rise too high.
- Back up any important data beforehand. We cannot accept responsibility for any lost data.
- It is recommended not to connect a USB device that contains data files other than MP3/WMA/AAC format.

Recording MP3/WMA/AAC files on a USB device

- Playback or display may not be possible depending on the type of USB device in use or the condition of the recording.
- Depending on the connected USB memory, the files may be played in different order from the order that the files were stored.

Compression formats

MP3

- Bit rate:
MPEG1 Audio Layer III: 32 k - 320 kbps
MPEG2 Audio Layer III: 8 k - 160 kbps
MPEG2.5 Audio Layer III: 8 k - 160 kbps
- Sampling frequency:
MPEG1 Audio Layer III: 32 k/44.1 k/48 kHz
MPEG2 Audio Layer III: 16 k/22.05 k/24 kHz
MPEG2.5 Audio Layer III: 8 k/11.025 k/12 kHz

WMA (Ver. 7, Ver. 8, Ver. 9*)

- Bit rate: CBR 32 k - 320 kbps
- Sampling frequency: 32 k/44.1 k/48 kHz
- * WMA 9 Professional/LossLess/Voice are not supported.

AAC*

- Bit rate: ABR 16k - 320 kbps
- Sampling frequency: 32 k/44.1 k/48 kHz
- * Apple Lossless is not supported.

Maximum number of files/folders

- Maximum number of files: 2500
- Maximum number of files in a folder: 255
- Maximum depth of tree structure: 8
- Maximum number of folders: 255 (Root folder is included.)

Listening to an iPod®

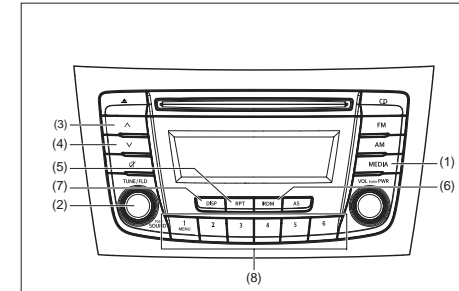

Display

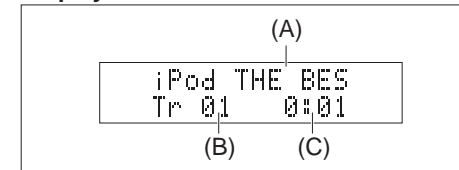

- (1) MEDIA button
- (2) TUNE FOLDER PUSH SOUND knob
- (3) Up button
- (4) Down button
- (5) RPT button
- (6) RDM button
- (7) DISP button
- (8) Preset buttons ([1] to [6])

- (A) Track title
- (B) Track number
- (C) Play time

OTHER CONTROLS AND EQUIPMENT

Selecting an iPod® mode

Press the MEDIA button (1).
Each time the button is pressed, the mode will change as follows:

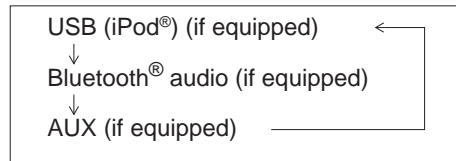

Selecting a track

- Press the Up button (3) to listen to the next track.
- Press the Down button (4) twice to listen to the previous track.
When the Down button (4) is pressed once, the track currently being played will start from the beginning again.

Fast forwarding/Rewinding a track

- Hold down the Up button (3) to fast forward the track.
- Hold down the Down button (4) to fast rewind the track.

Random playback

Press the RDM button (6).
Each time the button is pressed, the mode will change as follows:



- SONG RANDOM
The random indicator “RDM” will light.
The tracks in the iPod® will be played in random order.
- ALBUM RANDOM
The random indicator “D.RDM” will light.
The albums in the iPod® will be played in random order.

Repeat playback

Press the RPT button (5).
Each time the button is pressed, the mode will change as follows:

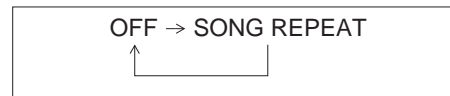

- SONG REPEAT
The repeat indicator “RPT” will light.
The track currently being played will be played repeatedly.

Display change

Press the DISP button (7).
Each time the button is pressed, display will change as follows:

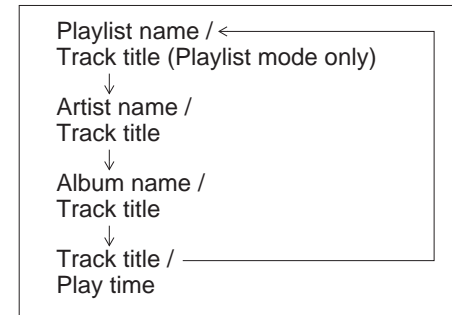

NOTE:

If text data contains more than 12 characters, the “>” mark will appear at the right end. Holding down the DISP button (7) for 1 second or longer can display the next page.

Playing Mode selection

- 1) Press the button numbered [6] of the Pre-set buttons (8) for 1 second or longer.
- 2) Turn the TUNE FOLDER PUSH SOUND knob (2).
Each time the knob is turned, the mode will change as follows:

OTHER CONTROLS AND EQUIPMENT

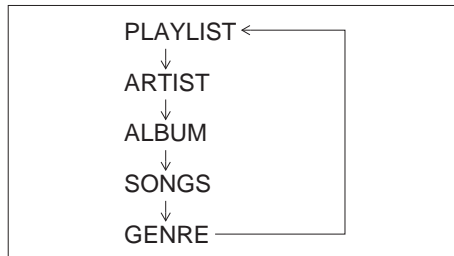

3) Press the TUNE FOLDER PUSH SOUND knob (2) to select the desired mode.

NOTE:

- When the button numbered [6] of the Preset buttons (8) is pressed, the previous mode will be displayed.

Notes on iPod® Supported iPod®

- iPod® touch (5th generation)
- iPod® touch (4th generation)
- iPod® touch (3rd generation)
- iPod® touch (2nd generation)
- iPod® touch (1st generation)
- iPod® classic
- iPod® nano (7th generation)
- iPod® nano (6th generation)
- iPod® nano (5th generation)
- iPod® nano (4th generation)
- iPod® nano (3rd generation)
- iPod® nano (2nd generation)
- iPod® nano (1st generation)
- iPod® (5th generation)
- iPhone® 6 Plus

- iPhone® 6
- iPhone® 5S
- iPhone® 5
- iPhone® 4S
- iPhone® 4
- iPhone® 3GS
- iPhone® 3G
- iPhone®

* Some functions may not be available depending on the model of iPod®.

* iPod® is a trademark of Apple Inc., registered in the U.S. and other countries.

* iPhone® is a trademark of Apple Inc., registered in the U.S. and other countries.

* Apple is not responsible for the operation of this device or its compliance with safety and regulatory standards.

iPod® connection

- Make sure to detach the iPod® after pressing the engine switch to change the ignition mode to LOCK. The iPod® may not be shut down when it is being connected and may result in battery depletion.
- Please do not connect iPod® accessories such as an iPod® remote control or headphones while connecting the iPod® with the unit. The unit may not operate correctly.

AUX Function

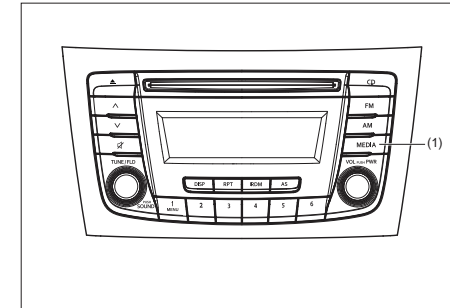

(1) MEDIA button

AUX connection

To listen to auxiliary audio sources (sold separately) through the unit, follow the instruction below.

- 1) Connect the auxiliary audio source to the AUX/USB socket (separately attached) with an AUX cable.
- 2) Press the MEDIA button (1). Each time the button is pressed, the mode will change as follows:

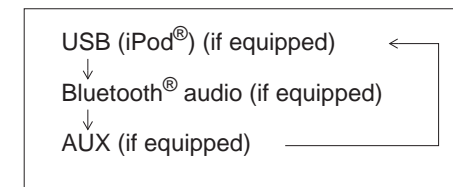

OTHER CONTROLS AND EQUIPMENT

⚠ CAUTION

- Before connection, mute the unit, and also keep the volume of the auxiliary audio source within a range that will not cause distortion.
- When the audio source is turned off, noise may be emitted. Be sure to turn off the unit or switch to another mode before turning off the audio source.

NOTE:

- Please consult your place of purchase for details about whether a given auxiliary audio source can be connected and the proper auxiliary cord to use.
- The volume and tone controls of the auxiliary audio source can be adjusted on the unit.
- In AUX mode, the volume setting is different from another mode.

Bluetooth® Hands-Free (if equipped)

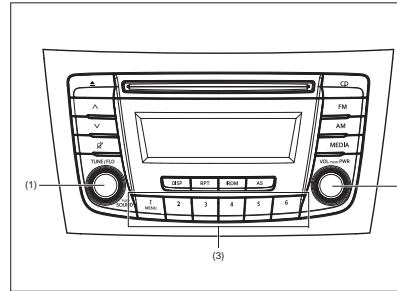

- (1) TUNE FOLDER PUSH SOUND knob
- (2) VOL PUSH POWER knob
- (3) Preset buttons

Steering switch

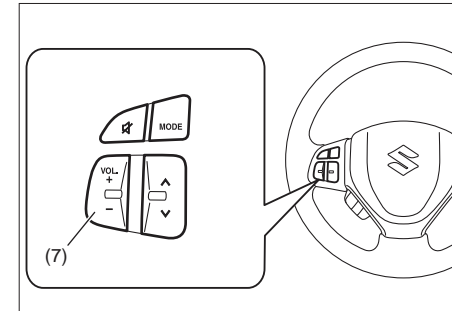
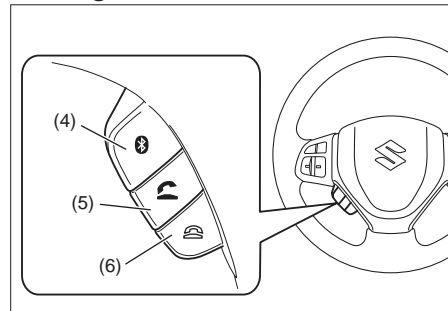

- (4) Bluetooth® setup button
- (5) Off Hook button
- (6) On Hook button
- (7) VOL switch

Phone registration

To use the hands-free function with this unit, it is required to register the phone in advance.

NOTE:

- Up to 5 phones can be registered.
- To set up a new phone, disconnect the audio player from the unit. Connect the audio player again after phone setup is completed if necessary.
- When failed to establish the pairing within 120 seconds, the connecting operation will be canceled. Please try again or refer to the manual of the phone in use for how to establish the pairing with the phone.

OTHER CONTROLS AND EQUIPMENT

- *Bluetooth/Telephone setup mode can be entered only during vehicle is stationary (or speed less than ~ 8 kmph)*

- 1) Press the Bluetooth® setup button (4). The Bluetooth® setup menu will be displayed.
- 2) Turn the TUNE FOLDER PUSH SOUND knob (1) to select “Setup Bluetooth”, and press the knob (1) to determine the selection.
- 3) Turn the TUNE FOLDER PUSH SOUND knob (1) to select “Pairing”, and press the knob (1) to determine the selection.
- 4) Select “CAR AUDIO” from the Bluetooth® menu of the phone and establish the pairing.
Refer to the manual of the phone in use for further information.
- 5) Enter the Passkey displayed on the unit to the phone.
- 6) Press the On Hook button (6).

NOTE:

- *When selecting “Go Back”, the previous menu will be displayed.*
- *When additionally registering a phone, operate the same step from 1).*

Receiving a call

Press the Off Hook button (5) to receive a call.

Ending a call

Press the On Hook button (6) to end a call.

Rejecting a call (only for supported models)

Press the On Hook button (6) to reject a incoming call.

Adjusting the listening volume

- Turn the VOL PUSH POWER knob (2) during a call.
Turning it clockwise increases the volume; turning it counterclockwise decreases the volume.
- Press the VOL switch (7) during a call. Pressing “+” of the switch increases the volume, pressing “-” of the switch decreases the volume.

Adjusting the ring volume

- Turn the VOL PUSH POWER knob (2) while a call coming in.
Turning it clockwise increases the volume; turning it counterclockwise decreases the volume.
- Press the VOL switch (7) during a call. Pressing “+” of the switch increases the volume, pressing “-” of the switch decreases the volume.

Adjusting the call or ringtone volume

Follow the instructions below to adjust the call or ringtone volume.

- 1) Press the Bluetooth® setup button (4). The Bluetooth® setup menu will be displayed.
- 2) Turn the TUNE FOLDER PUSH SOUND knob (1) to select “Setup Telephone”, and press the knob (1) to determine the selection.

- 3) Turn the TUNE FOLDER PUSH SOUND knob (1) to select “Sound Setting”, and press the knob (1) to determine the selection.
- 4) Turn the TUNE FOLDER PUSH SOUND knob (1) to select “Call Volume” or “Ringtone Volume”, and press the knob (1) to determine the selection. The current call or ringtone volume will be displayed.
- 5) Turn the TUNE FOLDER PUSH SOUND knob (1) to select desired call or ringtone volume, and press the knob (1) to determine the selection.

NOTE:

When selecting “Go Back”, the previous menu will be displayed.

Selecting the Ringtone

Follow the instructions below to select a ringtone.

- 1) Press the Bluetooth® setup button (4). The Bluetooth® setup menu will be displayed.
- 2) Turn the TUNE FOLDER PUSH SOUND knob (1) to select “Setup Telephone”, and press the knob (1) to determine the selection.
- 3) Turn the TUNE FOLDER PUSH SOUND knob (1) to select “Sound Setting”, and press the knob (1) to determine the selection.
- 4) Turn the TUNE FOLDER PUSH SOUND knob (1) to select “Ringtone”, and press the knob (1) to determine the selection. The current ringtone will be sounded.

OTHER CONTROLS AND EQUIPMENT

- 5) Turn the TUNE FOLDER PUSH SOUND knob (1) to select desired ringtone, and press the knob (1) to determine the selection.

NOTE:

When selecting "Go Back", the previous menu will be displayed.

Dialing using Missed/Incoming/Outgoing Calls

Follow the instructions below to dial to the last dialed number again.

NOTE:

Up to 10 phone numbers of the latest calls can be stored. (10 each for dialed, received and missed call)

- 1) Press the Off Hook button (5). The Bluetooth® phonebook menu will be displayed.
- 2) Turn the TUNE FOLDER PUSH SOUND knob (1) to select "Missed Calls", "Incoming Calls" or "Outgoing Calls", and press the knob (1) to determine the selection.
To dial from the dialed history or the received history, select "Missed Calls", "Incoming Calls" or "Outgoing Calls" respectively.
- 3) Turn the TUNE FOLDER PUSH SOUND knob (1) to select the desired number, and press the knob (1) to determine the selection.
- 4) Turn the TUNE FOLDER PUSH SOUND knob (1) to select "Dial", and press the

knob (1) or the Off Hook button (5) to dial to the selected number.

NOTE:

- When selecting "Go Back", the previous menu will be displayed.
- Pressing "Confirm" after selecting "Add Speed Dial" can register the selected number in the speed dial.
- Pressing "Confirm" after selecting "Delete" can delete the selected number from the call history.

Deletion of call history

Follow the instructions below to delete a missed/incoming/outgoing call history.

- 1) Press the Off Hook button (5). The Bluetooth® phonebook menu will be displayed.
- 2) Turn the TUNE FOLDER PUSH SOUND knob (1) to select "Setup Phonebook", and press the knob (1) to determine the selection.
- 3) Turn the TUNE FOLDER PUSH SOUND knob (1) to select "Delete History", and press the knob (1) to determine the selection.
- 4) Turn the TUNE FOLDER PUSH SOUND knob (1) to select "Missed Calls", "Incoming Calls", or "Outgoing Calls", and press the knob (1) to determine the selection.
- 5) Turn the TUNE FOLDER PUSH SOUND knob (1) to select a number to be deleted or "ALL", and press the knob (1) to determine the selection.

- 6) Turn the TUNE FOLDER PUSH SOUND knob (1) to select "Delete?" or "Delete All?", and press the knob (1) to determine the selection.

- 7) Turn the TUNE FOLDER PUSH SOUND knob (1) to select "Confirm", and press the knob (1) to complete the deletion.

NOTE:

When selecting "Go Back", the previous menu will be displayed.

Registration in Phonebook

Registration of numbers in the phonebook. Follow the instructions below to register phone numbers in the Phonebook of the unit.

- 1) Press the Bluetooth® setup button (4). The Bluetooth® setup menu will be displayed.
- 2) Turn the TUNE FOLDER PUSH SOUND knob (1) to select "Setup Telephone", and press the knob (1) to determine the selection.
- 3) Turn the TUNE FOLDER PUSH SOUND knob (1) to select "Setup Phonebook", and press the knob (1) to determine the selection.
- 4) Turn the TUNE FOLDER PUSH SOUND knob (1) to select "Add Contacts", and press the knob (1) to determine the selection.
- 5) Turn the TUNE FOLDER PUSH SOUND knob (1) to select "Overwrite All" or "Add One Contact", and press the knob (1) to determine the selection.

OTHER CONTROLS AND EQUIPMENT

The “Rest of Memory XXXX: Ok?” will be displayed.

- 6) Press or turn the TUNE FOLDER PUSH SOUND knob (1) to select “Confirm”, and press the knob (1) to determine the selection.
- 7) Transfer contacts from the phone. When the registration is completed, the “Setup Phonebook” will be displayed.

NOTE:

- *When selecting “Go Back” the previous menu will be displayed.*
- *Up to 1000 numbers can be registered in Phonebook.*

Transfer of call history (Call History)

Follow the instructions below to transfer call history of the registered phone.

- 1) Press the Bluetooth® setup button (4). The Bluetooth® setup menu will be displayed.
- 2) Turn the TUNE FOLDER PUSH SOUND knob (1) to select “Setup Telephone”, and press the knob (1) to determine the selection.
- 3) Turn the TUNE FOLDER PUSH SOUND knob (1) to select “Call History”, and press the knob (1) to determine the selection.
- 4) Turn the TUNE FOLDER PUSH SOUND knob (1) to select “Call History?”, and press the knob (1) to determine the selection.
- 5) Turn the TUNE FOLDER PUSH SOUND knob (1) to select “Confirm”,

and press the knob (1) to transfer the call history from the phone.

NOTE:

When selecting “Go Back”, the previous menu will be displayed.

Making a call by Phonebook

Follow the instructions below to dial a number registered in Phonebook.

- 1) Press the Off Hook button (5). The Bluetooth® phonebook menu will be displayed.
- 2) Turn the TUNE FOLDER PUSH SOUND knob (1) to select “Phonebook”, and press the knob (1) to determine the selection.
- 3) Turn the TUNE FOLDER PUSH SOUND knob (1) to select the initial of the name you would like to make a call, and press the knob (1) to determine the selection. The registered numbers will be displayed in sequence. If names have been registered together with numbers, the names will be displayed.
- 4) Turn the TUNE FOLDER PUSH SOUND knob (1) to select “Dial”, and press the knob (1) to determine the selection.
- 5) Press the Off Hook button (5). The displayed number or the number registered with the displayed name will be dialed.

Deletion of registered data (Delete Entry)

Follow the instructions below to delete a number registered in Phonebook.

- 1) Press the Bluetooth® setup button (4). The Bluetooth® setup menu will be displayed.
- 2) Turn the TUNE FOLDER PUSH SOUND knob (1) to select “Setup Telephone”, and press the knob (1) to determine the selection.
- 3) Turn the TUNE FOLDER PUSH SOUND knob (1) to select “Setup Phonebook”, and press the knob (1) to determine the selection.
- 4) Turn the TUNE FOLDER PUSH SOUND knob (1) to select “Delete Contacts”, and press the knob (1) to determine the selection.
- 5) Turn the TUNE FOLDER PUSH SOUND knob (1) to select a number to be deleted, and press the knob (1) to determine the selection.
- 6) Turn the TUNE FOLDER PUSH SOUND knob (1) to select “Delete?”, and press the knob (1) to determine the selection.
- 7) Turn the TUNE FOLDER PUSH SOUND knob (1) to select “Confirm”, and press the knob (1) to complete the deletion.

NOTE:

When selecting “Go Back”, the previous menu will be displayed.

OTHER CONTROLS AND EQUIPMENT

Registration in speed dial

Follow the instructions below to assign a number to one of the Preset buttons to use as the speed dial.

- 1) Press the Bluetooth® setup button (4). The Bluetooth® setup menu will be displayed.
- 2) Turn the TUNE FOLDER PUSH SOUND knob (1) to select “Setup Telephone”, and press the knob (1) to determine the selection.
- 3) Turn the TUNE FOLDER PUSH SOUND knob (1) to select “Setup Phonebook”, and press the knob (1) to determine the selection.
- 4) Turn the TUNE FOLDER PUSH SOUND knob (1) to select “Add Speed Dial”, and press the knob (1) to determine the selection.
- 5) Turn the TUNE FOLDER PUSH SOUND knob (1) to select a number to be assigned, and press the knob (1) to determine the selection.
- 6) Turn the TUNE FOLDER PUSH SOUND knob (1) to select “Choose Preset”, and press the knob (1) to determine the selection.
- 7) Press one of the Preset buttons (3) to which the selected number is to be assigned. If a number is already assigned to the selected button, a confirmation message will be displayed. Turn the TUNE FOLDER PUSH SOUND knob (1) to select “Confirm”, and press the knob (1) to complete the assignment.

When the assignment is completed, the “Setup Phonebook” will be displayed.

NOTE:

When selecting “Go Back”, the previous menu will be displayed.

One-touch call (Speed dial)

Follow the instructions below to dial the number assigned to each of the Preset buttons (3).

- 1) Press the Off Hook button (5). The Bluetooth® phonebook menu will be displayed.
- 2) Turn the TUNE FOLDER PUSH SOUND knob (1) to select “Speed Dials”, and press the knob (1) to determine the selection.
- 3) Press one of the Preset buttons (3). When no number is assigned, “No Entry” is displayed.
- 4) Press the Off Hook button (5). The selected number will be dialed.

Deletion of speed dial (Del Speed Dial)

To delete a number assigned for the speed dial, follow the instructions below.

- 1) Press the Off Hook button (5). The Bluetooth® phonebook menu will be displayed.
- 2) Turn the TUNE FOLDER PUSH SOUND knob (1) to select “Speed Dials”, and press the knob (1) to determine the selection.
- 3) Press one of the Preset buttons (3) to which the number to be deleted is

assigned.

“No Entry” appears if the number is not registered.

- 4) Turn the TUNE FOLDER PUSH SOUND knob (1) to select “Delete”, and press the knob (1) to determine the selection.
- 5) Turn the TUNE FOLDER PUSH SOUND knob (1) to select “Del Speed Dial”, and press the knob (1) to determine the selection.
- 6) Turn the TUNE FOLDER PUSH SOUND knob (1) to select “Confirm”, and press the knob (1) to complete the deletion.

NOTE:

When selecting “Go Back”, the previous menu will be displayed.

Display of device data (Device Name)

Follow the instructions below to display the BD (Bluetooth® Device) address and device name.

- 1) Press the Bluetooth® setup button (4). The Bluetooth® setup menu will be displayed.
- 2) Turn the TUNE FOLDER PUSH SOUND knob (1) to select “Setup Bluetooth”, and press the knob (1) to determine the selection.
- 3) Turn the TUNE FOLDER PUSH SOUND knob (1) to select “Bluetooth Info”, and press the knob (1) to determine the selection.

OTHER CONTROLS AND EQUIPMENT

- 4) Turn the TUNE FOLDER PUSH SOUND knob (1) to select "Device Name" or "Device Address", and press the knob (1) to display the device name or the BD (Bluetooth® Device) address.

NOTE:

When selecting "Go Back", the previous menu will be displayed.

Reset to the factory defaults

Follow the instructions below to reset all the settings to the factory defaults.

- 1) Press the Bluetooth® setup button (4).
The Bluetooth® setup menu will be displayed.
- 2) Turn the TUNE FOLDER PUSH SOUND knob (1) to select "Setup Bluetooth", and press the knob (1) to determine the selection.
- 3) Turn the TUNE FOLDER PUSH SOUND knob (1) to select "Initialize", and press the knob (1) to determine the selection.
- 4) Turn the TUNE FOLDER PUSH SOUND knob (1) to select "All Initialize", and press the knob (1) to determine the selection.
- 5) Turn the TUNE FOLDER PUSH SOUND knob (1) to select "Confirm", and press the knob (1) to start the reset.

NOTE:

When selecting "Go Back", the previous menu will be displayed.

Selection of phone (Select Phone)

Follow the instructions below to select a phone to be paired with from the registered phones.

- 1) Press the Bluetooth® setup button (4).
The Bluetooth® setup menu will be displayed.
- 2) Turn the TUNE FOLDER PUSH SOUND knob (1) to select "Setup Bluetooth", and press the knob (1) to determine the selection.
- 3) Turn the TUNE FOLDER PUSH SOUND knob (1) to select "List Phone", and press the knob (1) to determine the selection.
- 4) Turn the TUNE FOLDER PUSH SOUND knob (1) to select a phone to be paired with, and press the knob (1) to determine the selection.
- 5) Turn the TUNE FOLDER PUSH SOUND knob (1) to select "Select", and press the knob (1) to determine the selection.

NOTE:

- *When selecting "Go Back", the previous menu will be displayed.*
- *The Bluetooth® ready audio device will be disconnected when the phone is selected.*

List of phones (List Phones)

Follow the instructions below to display the names of the registered phones in sequence.

- 1) Press the Bluetooth® setup button (4).
The Bluetooth® setup menu will be displayed.
- 2) Turn the TUNE FOLDER PUSH SOUND knob (1) to select "Setup Bluetooth", and press the knob (1) to determine the selection.
- 3) Turn the TUNE FOLDER PUSH SOUND knob (1) to select "List Phone", and press the knob (1) to determine the selection.
The names of the registered phones are displayed in sequence.

NOTE:

When selecting "Go Back", the previous menu will be displayed.

Passkey setting (Set Passkey)

Follow the instructions below to set the security number (Passkey).

- 1) Press the Bluetooth® setup button (4).
The Bluetooth® setup menu will be displayed.
- 2) Turn the TUNE FOLDER PUSH SOUND knob (1) to select "Setup Bluetooth", and press the knob (1) to determine the selection.
- 3) Turn the TUNE FOLDER PUSH SOUND knob (1) to select "Passkey", and press the knob (1) to determine the selection.

OTHER CONTROLS AND EQUIPMENT

- 4) Turn the TUNE FOLDER PUSH SOUND knob (1) to select "New Passkey", and press the knob (1) to determine the selection.
- 5) Press or turn the TUNE FOLDER PUSH SOUND knob (1) to select "Confirm".
- 6) Turn the TUNE FOLDER PUSH SOUND knob (1) to select a number for the first digit, and press the knob (1) to determine the selection. Select and determine numbers for the second, third and fourth digits in order in the same manner. When not entering up to the eighth digit, enter blanks for the successive digits.
- 7) Turn the TUNE FOLDER PUSH SOUND knob (1) to determine the passkey setting.

NOTE:

When selecting "Go Back", the previous menu will be displayed.

Deletion of phone information (Delete Phone)

Follow the instructions below to delete the registered information of the phone.

- 1) Press the Bluetooth® setup button (4). The Bluetooth® setup menu will be displayed.
- 2) Turn the TUNE FOLDER PUSH SOUND knob (1) to select "Setup Bluetooth", and press the knob (1) to determine the selection.
- 3) Turn the TUNE FOLDER PUSH SOUND knob (1) to select "List Phone",

and press the knob (1) to determine the selection.

- 4) Turn the TUNE FOLDER PUSH SOUND knob (1) to select a phone to be deleted, and press the knob (1) to determine the selection.
- 5) Turn the TUNE FOLDER PUSH SOUND knob (1) to select "Delete Phone", and press the knob (1) to determine the selection.
- 6) Turn the TUNE FOLDER PUSH SOUND knob (1) to select "Delete?", and press the knob (1) to determine the selection.
- 7) Turn the TUNE FOLDER PUSH SOUND knob (1) to select "Confirm", and press the knob (1) to determine the selection.

NOTE:

When selecting "Go Back", the previous menu will be displayed.

BT function on/off (BT Power)

Follow the instructions below to turn on/off the Bluetooth® function.

- 1) Press the Bluetooth® setup button (4). The Bluetooth® setup menu will be displayed.
- 2) Turn the TUNE FOLDER PUSH SOUND knob (1) to select "Setup Bluetooth", and press the knob (1) to determine the selection.
- 3) Turn the TUNE FOLDER PUSH SOUND knob (1) to select "BT Power", and press the knob (1) to determine the selection.

- 4) Press the TUNE FOLDER PUSH SOUND knob (1) to select "BT Power On" or "BT Power Off".

NOTE:

- When the BT function is turned off, the connection between this unit and the registered phone in use will be disconnected.
- When selecting "Go Back", the previous menu will be displayed.

Bluetooth® audio (if equipped)

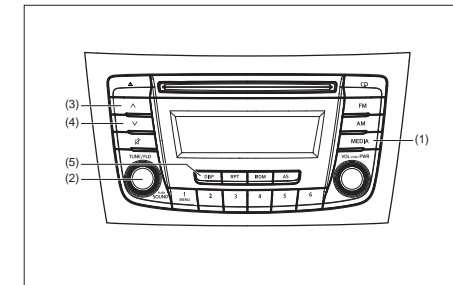

NOTE:

Applicable for Bluetooth® audio version 2.1 and above

OTHER CONTROLS AND EQUIPMENT

Steering switch

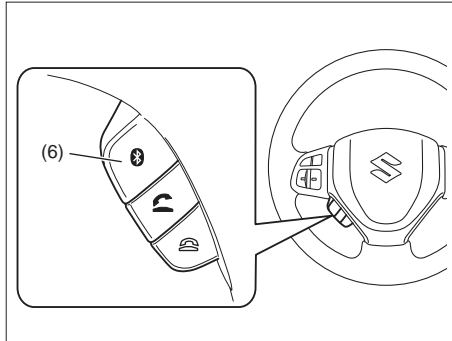

Display

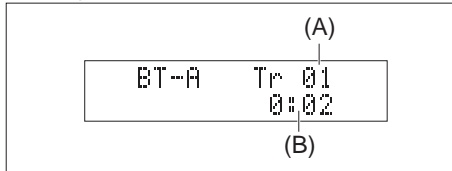

- (1) MEDIA button
- (2) TUNE FOLDER PUSH SOUND knob
- (3) Up button
- (4) Down button
- (5) DISP button
- (6) Bluetooth® setup button

- (A) Track number
- (B) Play time

Registration of audio devices

To use Bluetooth® ready audio devices with this unit, it is required to register the devices.

NOTE:

- To set up a new audio player, disconnect the phone from the unit. Connect the phone after audio player setup is completed if necessary.
- When failed to establish the connection within 120 seconds, the connecting operation will be canceled. Please try again or refer to the audio player manual for assistance with the pairing process.
- A separate audio mobile device can be selected for Bluetooth audio, even if a phone is already connected to the hands free profile.

- 1) Press the Bluetooth® setup button (6). The Bluetooth® setup menu will be displayed.
- 2) Turn the TUNE FOLDER PUSH SOUND knob (2) to select "Setup Bluetooth", and press the knob (2) to determine the selection.
- 3) Turn the TUNE FOLDER PUSH SOUND knob (2) to select "Pairing", and press the knob (2) to determine the selection.
- 4) Select "CAR AUDIO" from the Bluetooth® menu of the audio player and establish the pairing. Refer to the manual of the audio player in use for further information.

- 5) Enter the Passkey displayed on the unit to the audio player. (For phones with Bluetooth version 2.1 or above passkey input is not required)

NOTE:

- When selecting "Go Back", the previous menu will be displayed.
- When additionally registering audio devices, operate the same step from 1).

OTHER CONTROLS AND EQUIPMENT

Selecting the Bluetooth® audio mode

Press the MEDIA button (1).
Each time the button is pressed, the mode will change as follows:

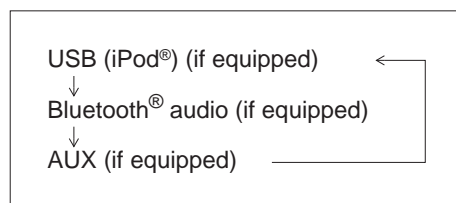

Selecting a group (only for supported models)

Turn the TUNE FOLDER PUSH SOUND knob (2) to select a group.

Selecting a track

- Press the Up button (3) to listen to the next track.
- Press the Down button (4) twice to listen to the previous track.

When the Down button (4) is pressed once, the track currently being played will start from the beginning again.

Fast forwarding/Rewinding a track

- Hold down the Up button (3) to fast forward the track.
- Hold down the Down button (4) to fast rewind the track.

NOTE:

Some functions may not be available depending on Bluetooth® audio.

Display change

Press the DISP button (5).
Each time the button is pressed, display will change as follows:

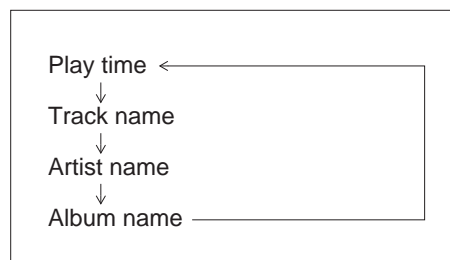

NOTE:

If text data contains more than 12 characters, the “>” mark will appear at the right end. Holding down the DISP button (5) for 1 second or longer can display the next page.

Selection of audio device (Select Audio)

Follow the instructions below to select an audio device to be paired with from the registered audio devices.

- 1) Press the Bluetooth® setup button (6).
The Bluetooth® setup menu will be displayed.
- 2) Turn the TUNE FOLDER PUSH SOUND knob (2) to select “Setup Bluetooth”, and press the knob (2) to determine the selection.
- 3) Turn the TUNE FOLDER PUSH SOUND knob (2) to select “List Audio”, and press the knob (2) to determine the selection.
- 4) Turn the TUNE FOLDER PUSH SOUND knob (2) to select an audio device to be used, and press the knob (2) to determine the selection.
- 5) Turn the TUNE FOLDER PUSH SOUND knob (2) to select “Select”, and press the knob (2) to determine the selection.
- 6) Turn the TUNE FOLDER PUSH SOUND knob (2) to select “Confirm”, and press the knob (2) to complete the pairing.

NOTE:

- When selecting “Go Back”, the previous menu will be displayed.
- The phone will be disconnected when the Bluetooth® ready audio device is selected.

OTHER CONTROLS AND EQUIPMENT

List of audio devices (List Audio)

Follow the instructions below to display the names of the registered audio devices in sequence.

- 1) Press the Bluetooth® setup button (6). The Bluetooth® setup menu will be displayed.
- 2) Turn the TUNE FOLDER PUSH SOUND knob (2) to select “Setup Bluetooth”, and press the knob (2) to determine the selection.
- 3) Turn the TUNE FOLDER PUSH SOUND knob (2) to select “List Audio”, and press the knob (2) to determine the selection. The names of registered audio devices will be displayed in sequence.

NOTE:

When selecting “Go Back”, the previous menu will be displayed.

Passkey setting (Set Passkey)

Follow the instructions below to set the security number (Passkey).

- 1) Press the Bluetooth® setup button (6). The Bluetooth® setup menu will be displayed.
- 2) Turn the TUNE FOLDER PUSH SOUND knob (2) to select “Setup Bluetooth”, and press the knob (2) to determine the selection.
- 3) Turn the TUNE FOLDER PUSH SOUND knob (2) to select “Passkey”, and press the knob (2) to determine the selection.

- 4) Turn the TUNE FOLDER PUSH SOUND knob (2) to select “New Passkey”, and press the knob (2) to determine the selection.
- 5) Press or turn the TUNE FOLDER PUSH SOUND knob (2) to select “Confirm”.
- 6) Turn the TUNE FOLDER PUSH SOUND knob (2) to select a number for the first digit, and press the knob (2) to determine the selection. Select and determine numbers for the second, third and fourth digits in order in the same manner. When not entering up to the eighth digit, enter blanks for the successive digits.
- 7) Turn the TUNE FOLDER PUSH SOUND knob (2) to determine the passkey setting.

NOTE:

When selecting “Go Back”, the previous menu will be displayed.

Deletion of audio device information (Delete Audio)

Follow the instructions below to delete the registered information of audio device.

- 1) Press the Bluetooth® setup button (6). The Bluetooth® setup menu will be displayed.
- 2) Turn the TUNE FOLDER PUSH SOUND knob (2) to select “Setup Bluetooth”, and press the knob (2) to determine the selection.

- 3) Turn the TUNE FOLDER PUSH SOUND knob (2) to select “List Audio”, and press the knob (2) to determine the selection.
- 4) Turn the TUNE FOLDER PUSH SOUND knob (2) to select an audio device to be deleted, and press the knob (2) to determine the selection.
- 5) Turn the TUNE FOLDER PUSH SOUND knob (2) to select “Delete”, and press the knob (2) to determine the selection.
- 6) Turn the TUNE FOLDER PUSH SOUND knob (2) to select “Delete?”, and press the knob (2) to determine the selection.
- 7) Turn the TUNE FOLDER PUSH SOUND knob (2) to select “Confirm”, and press the knob (2) to complete the deletion.

NOTE:

When selecting “Go Back”, the previous menu will be displayed.

Disclaimer for Bluetooth® function

- Depending on the mobile phone models, some phones may not be compatible fully or partially (some function may be restricted).
- Connectivity or voice quality may get affected depending on circumstances.
- After the ignition switch is turned to the “ON” position, the audio system takes few seconds to detect and connect to the Bluetooth® device (if already paired).

OTHER CONTROLS AND EQUIPMENT

- Make sure that you are aware of all applicable local laws and accordingly use Bluetooth device.

Remote Audio Controls (if equipped)

Controlling of basic functions of the audio system is available using the switches on the steering wheel.

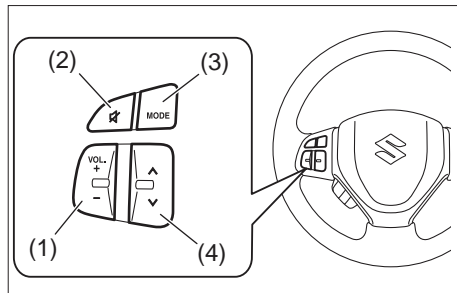

Adjusting the volume

- To increase the volume, hold down “+” of the VOL switch (1). The volume will keep on being increased until the switch is released.
- To decrease the volume, hold down “-” of the VOL switch (1). The volume will keep on being decreased until the switch is released.
- To mute the sound, press the switch (2).

Selecting the mode

Press the switch (3).

Each time the button is pressed, the mode will change as follows:

```

FM1 (Radio) ←
↓
FM2 (Radio)
↓
CD
↓
Bluetooth® audio (if equipped)
↓
AUX (if equipped)
↓
USB (iPod®) (if equipped)
↓
AM (Radio)
    
```

It is possible to turn on the audio system by pressing the switch (3).

Selecting the radio station (FM1, FM2, AM mode)

- To select the next preset station, press “^” of the switch (4) only for a moment.
- To select the previous preset station, press “v” of the switch (4) only for a moment.
- To scan a higher frequency radio station, press “^” of the switch (4) for 1 second or longer.
- To scan a lower frequency radio station, press “v” of the switch (4) for 1 second or longer.

Selecting the track (CD, USB (iPod®), Bluetooth® audio mode)

- To skip to the next track, press “^” of the switch (4) only for a moment.
- To skip to the previous track, press “v” of the switch (4) twice only for a moment. When the switch (4) is pushed down once only for a moment, the track currently being played will start from the beginning again.

Fast forwarding/Rewinding a track

- To fast forward, press “^” of the switch (4) for 1 second or longer.
- To fast rewind, press “v” of the switch (4) for 1 second or longer.

Anti-Theft Feature

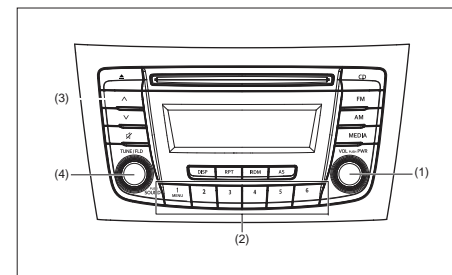

- (1) VOL PUSH POWER knob
- (2) Preset buttons ([1] to [6])
- (3) Up button
- (4) TUNE FOLDER PUSH SOUND knob

OTHER CONTROLS AND EQUIPMENT

The anti-theft function is intended to discourage thefts, such as that the audio system becomes inoperable when it is installed on other vehicles.

This function works by entering a Personal Identification Number (PIN).

When the unit is disconnected from its power source, such as when the audio system is removed or the battery is disconnected, the unit will become inoperable until the PIN is reentered.

Setting the Anti-Theft Function

- 1) Press the VOL PUSH POWER knob (1) to power off.
- 2) Hold down the buttons numbered [1] and [6] of the Preset buttons (2) and press the VOL PUSH POWER knob (1).
“SECURITY” will be displayed.
- 3) Press the Up button (3) and the button numbered [1] of the Preset buttons (2) simultaneously.
- 4) Enter a 4-digit number to be registered as PIN using the buttons numbered [1] - [4] of the Preset buttons (2).
- 5) Hold down the TUNE FOLDER PUSH SOUND knob (4) for 1 second or longer to set the anti-theft function.

NOTE:

Take a note of the registered PIN and keep it for the future use.

Canceling the anti-theft feature

To cancel the anti-theft function, delete the registered PIN.

- 1) Press the VOL PUSH POWER knob (1) to power off.
- 2) Hold down the buttons numbered [1] and [6] of the Preset buttons (2) and press the VOL PUSH POWER knob (1).
“PIN ENTRY” will be displayed.
- 3) Press the Up button (3) and the button numbered [1] of the Preset buttons (2) simultaneously.
- 4) Enter a 4-digit number to be registered as PIN using the buttons numbered [1] - [4] of the Preset buttons (2).
- 5) Hold down the TUNE FOLDER PUSH SOUND knob (4) for 1 second or longer to delete the registered PIN. The indication “----” will be displayed and the anti-theft function will be canceled.

NOTE:

To change your PIN, first delete your current PIN, then set a new one.

Confirming the Personal Identification Number (PIN)

When the main power source is disconnected such as when the battery is replaced, etc, it is required to enter the PIN to make the unit operable again.

- 1) Set the ignition switch to the “ACC” position.
“SECURITY” will be displayed.
- 2) Press the Up button (3) and the button numbered [1] of the Preset buttons (2) simultaneously.
- 3) Enter a 4-digit number to be registered as PIN using the buttons numbered [1] - [4] of the Preset buttons (2).
- 4) Hold down TUNE FOLDER PUSH SOUND knob (4) for 1 second or longer.

When the PIN same as registered is entered, the power of the audio system will be turned off automatically and it will become operable again.

NOTE:

If an incorrect PIN is entered, “ERROR” and the total number of incorrect entry attempts will be displayed.

If an incorrect PIN is entered 10 times, “HELP” will be displayed and the audio system will become inoperable.

OTHER CONTROLS AND EQUIPMENT

Battery Installation

Install a lithium battery (CR2025) with the poles facing the correct direction.

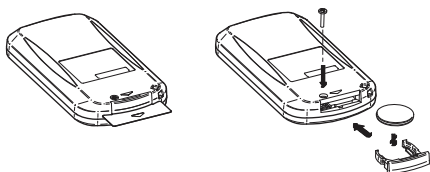

Battery replacement timing

- When battery power is depleted, the button may not be operable. If the remote controller does not operate, replace the battery and check the operation.

Caution on battery

- Be sure to follow the instructions to prevent battery leakage, over-heating, ignition or explosion.

⚠ WARNING

- Do not expose the battery to flame. Do not short circuit, disassemble, or heat the battery.
 - Do not charge the battery.
 - Use the specified type battery.
 - Keep the button-shaped battery away from children to prevent accidental swallowing.
- If the battery is swallowed, contact a doctor immediately.

⚠ CAUTION

- Install the battery with the poles facing the correct direction.
- When not in use for a long period of time, or if the battery is dead, remove the battery from the remote controller.

If battery leakage has occurred, wipe the container first then install a new battery. If the battery solution contacts the skin, wash off with water completely.

Caution on Remote Controller

- Do not leave the remote controller in an area exposed to direct sunlight, such as on the dashboard or steering wheel. The remote controller may deform because of the heat, (Be especially careful of the dashboard exposed to direct sunlight in the summer, as it will become extremely hot).
- When the vehicle is parked in an area exposed to direct sunlight, Ensure the remote controller is placed in an area not exposed to direct sunlight. For example: Glove box. Under direct sunlight, signal reception from the remote controller weakens. If this happens, hold the remote controller close to the signal receptor on the front panel.

OTHER CONTROLS AND EQUIPMENT

Remote Controller Common operations

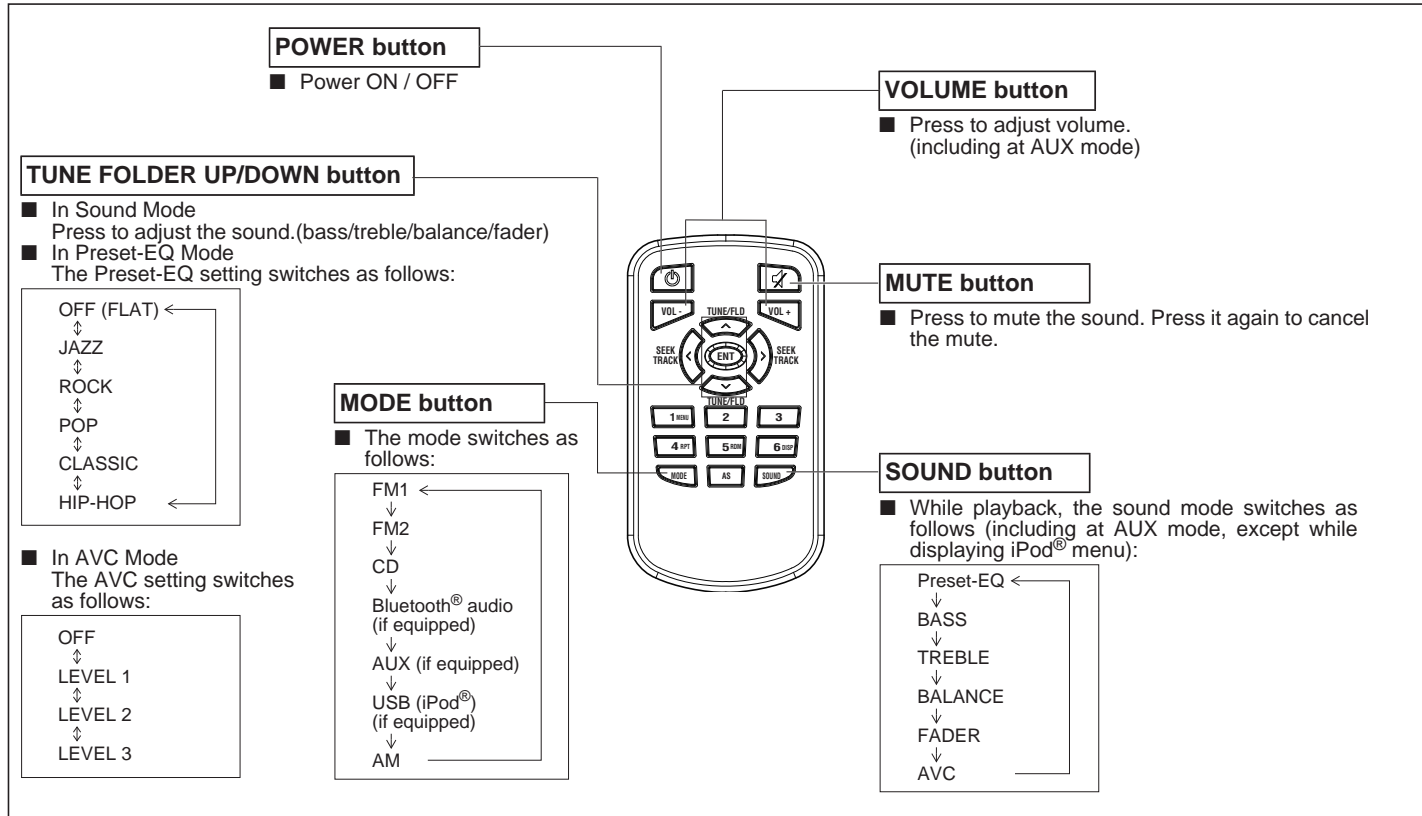

OTHER CONTROLS AND EQUIPMENT

Radio operations

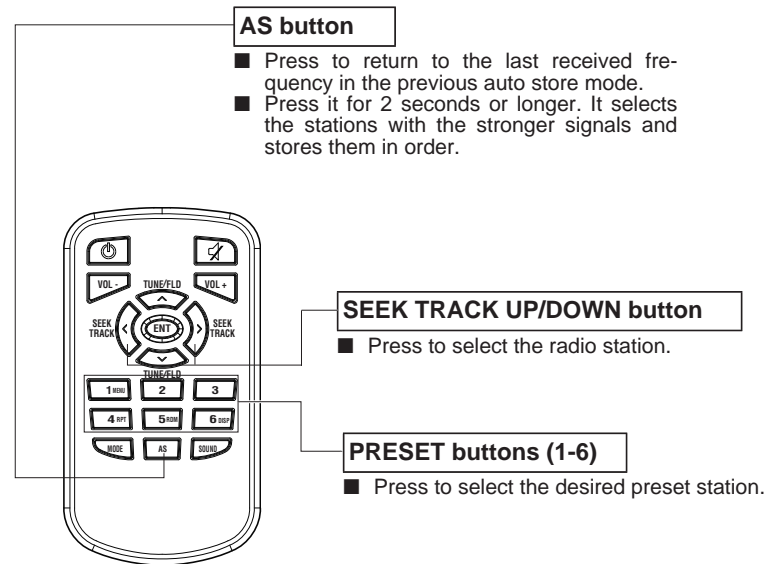

NOTE:

When there are fewer than 6 stations that can be stored even if 1 round of auto store operation is performed, no station will be stored at the remaining preset buttons.

OTHER CONTROLS AND EQUIPMENT

CD operations

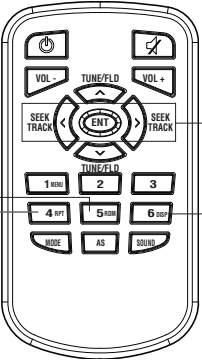

The diagram shows a car stereo remote control with several buttons. Callouts point to the RDM (5) button, RPT (4) button, SEEK TRACK UP/DOWN button, and DISP (6) button. The RDM (5) button is located on the left side of the remote. The RPT (4) button is located on the right side of the remote. The SEEK TRACK UP/DOWN button is located in the center of the remote. The DISP (6) button is located on the right side of the remote. The remote also features a power button, volume controls, and a central navigation pad.

RDM (5) button

- Press to play the current track randomly. Press it again to cancel.

RPT (4) button

- Press to plays the current track repeatedly. Press it again to cancel.

SEEK TRACK UP/DOWN button

- Press to skip to the next/previous track.
- Press it for 1 second or longer to fast-forward/ fast-rewind the track.

DISP (6) button

- The display switches as follows:

Play time ←
↓
Disc title
↓
Track title

- Press it for 1 second or longer to display the next page.

OTHER CONTROLS AND EQUIPMENT

MP3/WMA/AAC Disc operations

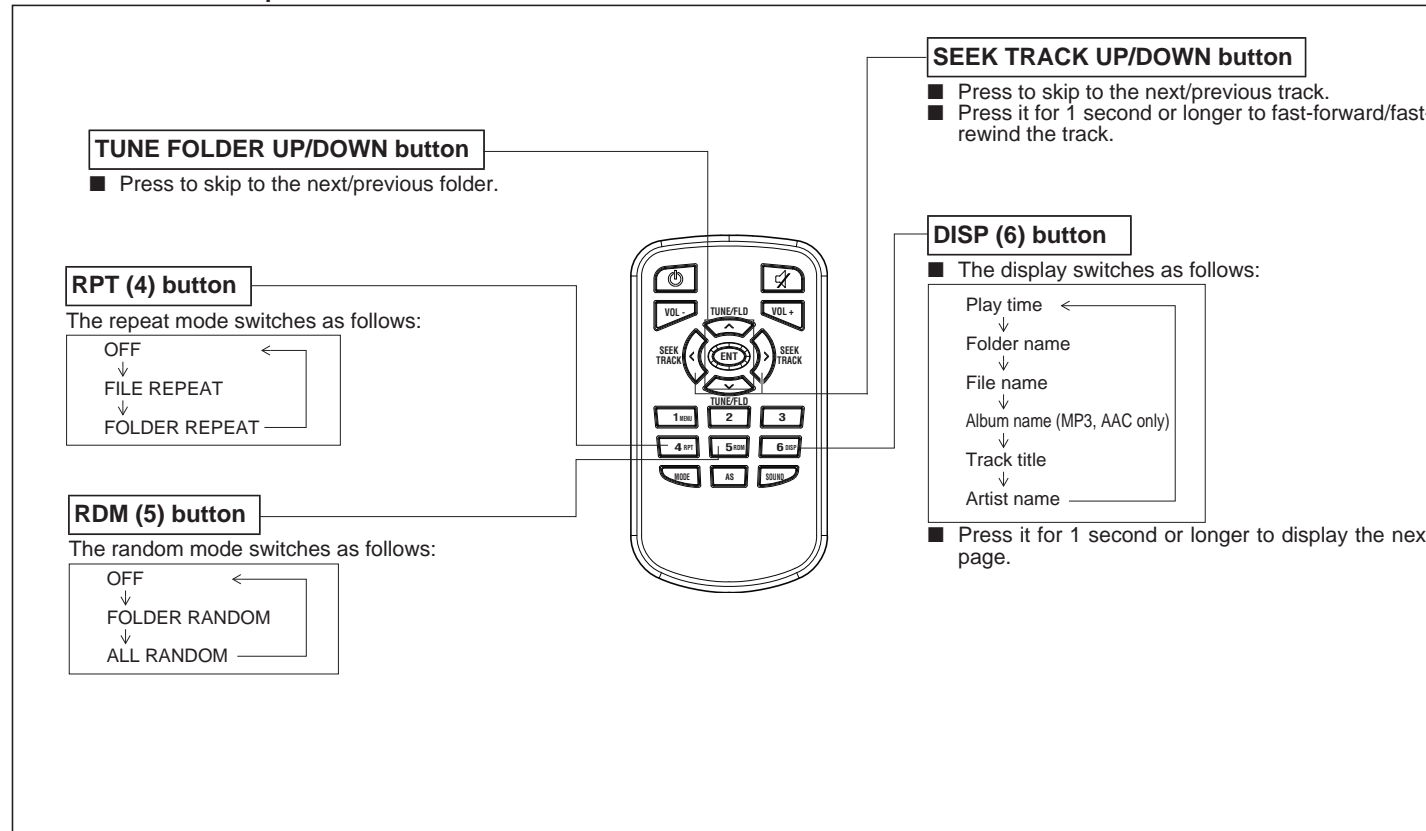

OTHER CONTROLS AND EQUIPMENT

USB operations

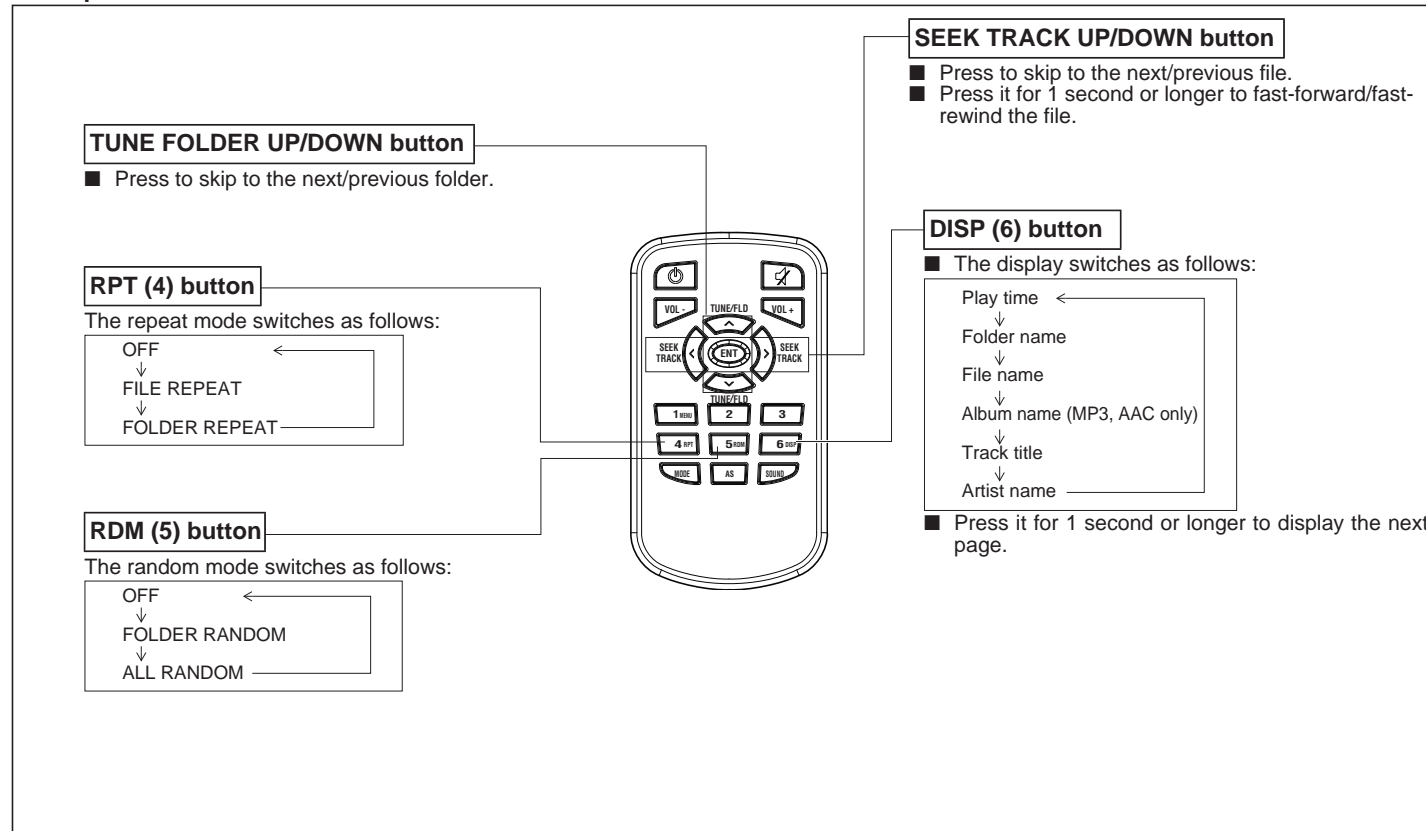

OTHER CONTROLS AND EQUIPMENT

iPod® operations

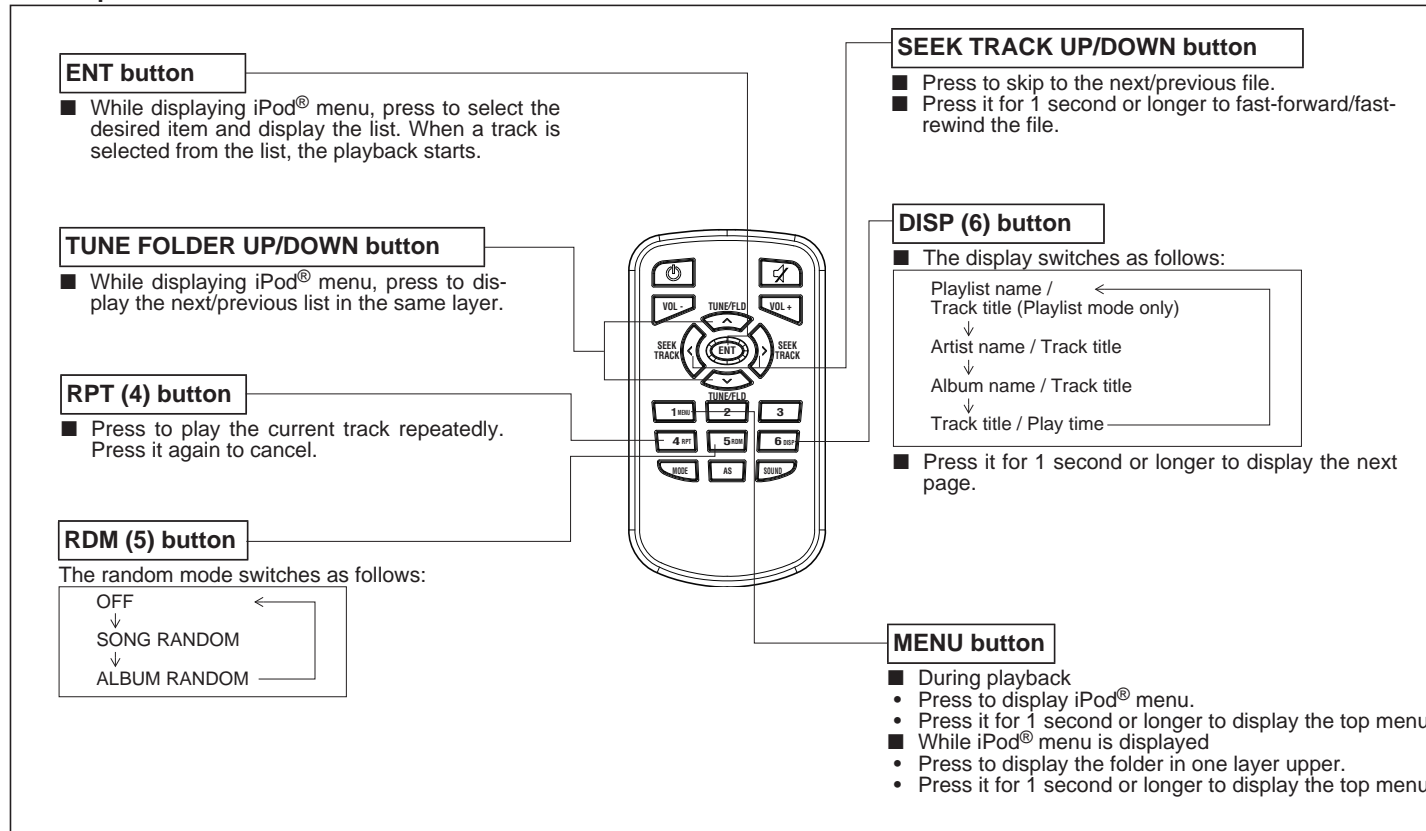

OTHER CONTROLS AND EQUIPMENT

Troubleshooting

When encountered a problem, check and follow the instructions as described below.

If the described suggestions do not solve the problem, it is recommended to take the unit to your authorized MARUTI SUZUKI dealer.

Problem	Possible cause	Possible solution
---------	----------------	-------------------

Common

Unable to operate	The security function is on.	When "SECURITY" is displayed, enter the ID. When "HELP" is displayed, contact your authorized MARUTI SUZUKI dealer.
Unable to turn on the power (no sound). (No sound is produced)	Fuse is blown.	Contact your authorized MARUTI SUZUKI dealer.

Radio

Much noise	It may not be exactly tuned in to the station.	Tune it in exactly to the station.
Unable to receive by auto tuning	There may be no station emitting signals powerful enough.	Pick up a station by manual tuning.

CD

Sound skips or noise produced	The disc is dirty.	Wipe the disc with a soft cloth.
	The disc has a major scratch or is warped.	Replace the disc with the one with no scratch and also not warped.

OTHER CONTROLS AND EQUIPMENT

Problem	Possible cause	Possible solution
---------	----------------	-------------------

MP3/WMA/AAC

No playback	The disc contains unsupported formatted data.	Check the file format.
Sound skips or noise produced	Sound skipping may occur when playing VBR (Variable Bit Rate) files.	It is not recommended to play VBR files.

USB

Playback does not start when the USB device is connected.	There is no supported format file to play on this unit.	Check the file format.
	The current consumption of the USB device exceeds 1.0 A.	Use an USB device with a current consumption lower than 1.0 A.

Bluetooth®

Pairing failed	The distance between this unit and the Bluetooth® ready device is too far, or a metallic object may be located between the Bluetooth® ready device and this unit.	Change the location of the Bluetooth® ready device.
	The Bluetooth® function of the Bluetooth® ready device is off.	Refer to the manual of the Bluetooth® ready device. (Some devices have the power saving function that automatically activates after a certain time.)
Unable to receive a call.	Your current location may be out of service area.	Drive your vehicle to the service area of the phone.
The voice quality of hands-free is low (Distortion, noise etc.).	Another wireless device may be located near the unit.	Switch off the wireless device or keep it away from the unit.

OTHER CONTROLS AND EQUIPMENT

Error Display Messages

Display	Possible cause	Possible solution
---------	----------------	-------------------

CD

ERROR 1	The disc cannot be read.	Insert the disc with its label side up. Check the disc if it is not warped or is free of flaws. When ERROR 1 does not disappear even when a normal disc is inserted, contact your dealer.
ERROR 3	The player developed an error of an unidentified cause.	When the CD is in the unit, press the CD eject button to remove the disc. When the disc cannot be ejected, contact your dealer.

USB/iPod®

ERROR 1	The USB device is disconnected.	Check the connection of the USB device.
ERROR 2	Impossible to communicate correctly with the USB device.	Unplug the USB device and plug it again. Check the USB device.
ERROR 3	Inoperable due to an unidentified cause.	Unplug the USB device and plug it again. When ERROR 3 does not disappear, contact your dealer.
ERROR 4	The current consumption of the USB device exceeds 1.0 A.	Check the USB device.

OTHER CONTROLS AND EQUIPMENT

Display	Possible cause	Possible solution
---------	----------------	-------------------

Bluetooth®

ERROR 1	The player developed an error of an unidentified cause.	Disconnect the Bluetooth® ready device and connect it again. When ERROR 1 does not disappear, contact your dealer.
Failed	Failed to establish pairing	Try to establish the pairing again.
Memory Full	Reached the limit for the number of connected device information	Delete information of unnecessary devices and try to establish the pairing again.
Not Avail.	Inoperable during driving	Operate the system after pulling over your vehicle.
Not Linked	Phone is disconnected	Try to establish the pairing again.

OTHER CONTROLS AND EQUIPMENT

Fuel Filler Cap

Swift

EXAMPLE

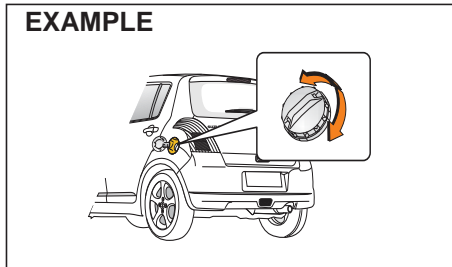

68LM522

Dzire

EXAMPLE

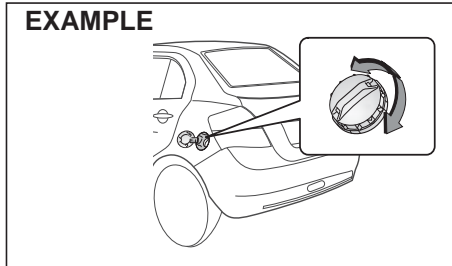

EXAMPLE

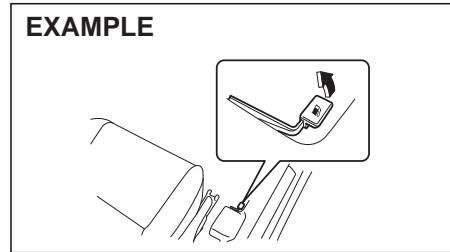

74LHT0511

The fuel filler cap is located on the left rear side of the vehicle. The fuel filler door can be unlocked by pulling up the opener lever located on the outboard side of the driver's seat and locked by simply closing the door.

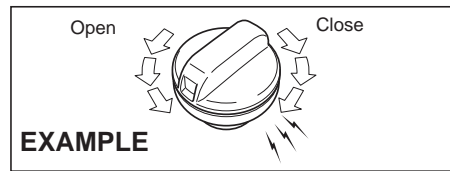

57I51093

To remove the fuel filler cap:
1) Open the fuel filler door.
2) Remove the cap by turning it counter clockwise.

⚠ CAUTION

Remove the fuel filler cap slowly. The fuel may be under pressure and may spray out, causing injury.

EXAMPLE

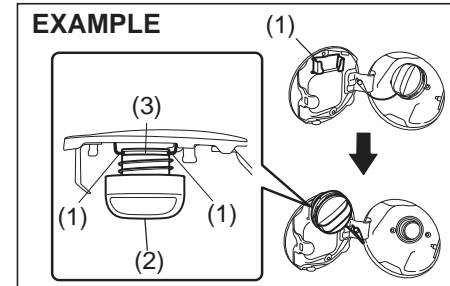

68MLT0503

NOTE:

The cap holder (1) holds the fuel filler cap (2) by hooking the groove (3) when refueling.

To reinstall the fuel filler cap:

- 1) Turn the cap clockwise until you hear several clicks.
- 2) Close the fuel filler door.

⚠ WARNING

Fuel is extremely flammable. Do not smoke when refueling, and make sure there are no open flames or sparks in the area.

⚠ WARNING

If you need to replace the fuel cap, use a genuine MARUTI SUZUKI cap. Use of an improper cap can result in a malfunction of the fuel system or emission control system. It may also result in fuel leakage in the event of an accident.

OTHER CONTROLS AND EQUIPMENT

Engine Bonnet

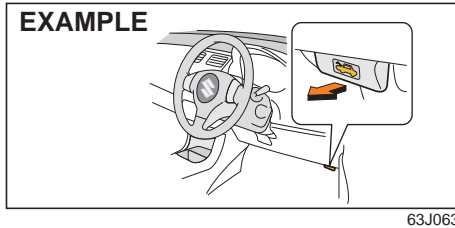

To open the engine hood:

- 1) Pull the hood release handle located on the outboard side of the driver's side of the instrument panel. This will disengage the engine hood lock halfway.

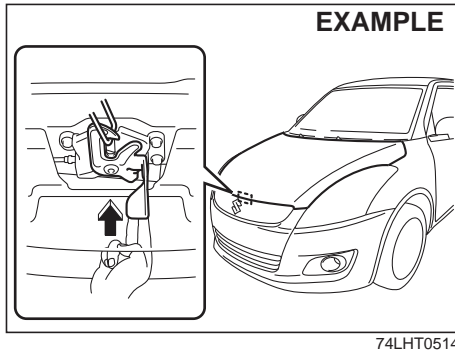

- 2) Push the under-hood release lever up with your finger, as shown in the illustration. While pushing the lever, lift up the engine hood.

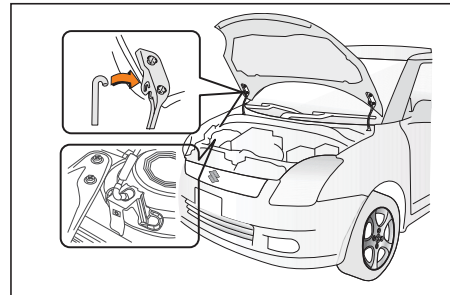

- 3) Continue to lift up the hood until it is high enough to support with the prop rod.

To close the engine hood:

- 1) Lift the hood up slightly and remove the prop rod from the hole. Put the prop rod back to the holding clip.
- 2) Lower the hood close to the bumper, then let it drop down. Make sure the hood is securely latched after closing.

⚠ WARNING

Make sure the hood is fully closed and latched before driving. If it is not, it can fly up unexpectedly during driving, obstructing your view and resulting in an accident.

Sun Visor

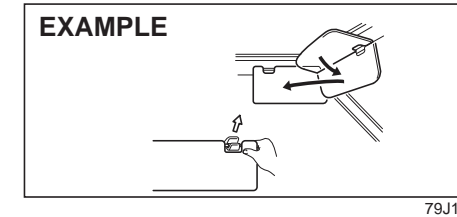

The sun visors can be pulled down to block glare coming through the windshield, or they can be unhooked and turned to the side to block glare coming through the side window.

NOTICE

When unhooking and hooking a sun visor, be sure to handle it by the hard plastic parts or the sun visor can be damaged.

Card holder (if equipped)

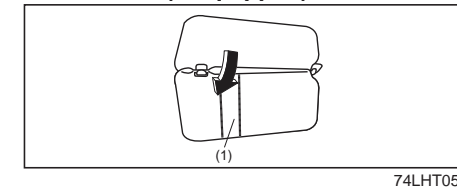

- (1) Card holder

You can put a card in the card holder (1) on the back of the sun visor.

OTHER CONTROLS AND EQUIPMENT

NOTICE

When you park your vehicle outdoors in direct sunlight or in hot weather, do not leave plastic cards in the holder. The heat may distort them.

Vanity mirror (if equipped)

EXAMPLE

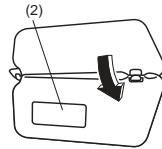

74LHT0532

(2) Vanity mirror

⚠ WARNING

- Do not use the mirror while driving your vehicle or could lose control of the vehicle.
- When using the vanity mirror, do not move too close to a front air bag location or lean against it. If the front air bag is accidentally inflated, it could hit you hard.

Interior Light

Front Overhead Light (if equipped)

EXAMPLE

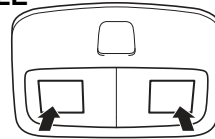

64J104

Push the switch to turn on the light and push it again to turn off the light.

Center Overhead Light (if equipped)

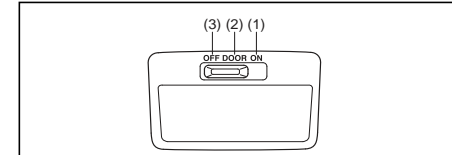

64J104

These light switch has three positions which function as described below:

ON (1)

The light comes on and stays on regardless of whether the door is open or closed.

DOOR (2)

The light comes on when the door is opened. After closing all doors, the light will remain on for about 15 seconds and then fade out. If you insert the key into the ignition switch during this time, the light will start to fade out immediately. After removing the key from the ignition switch, the light will turn on for about 15 seconds and then fade out.

OFF (3)

The light remains off even when the door is opened.

OTHER CONTROLS AND EQUIPMENT

EXAMPLE

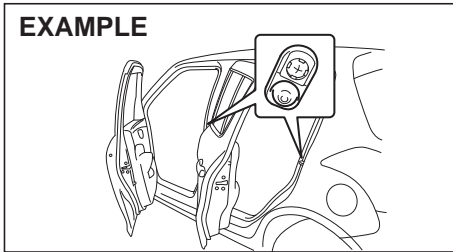

68LM529

NOTE:

The number of doors involved in the lighting operation of the interior light depends on the vehicle specification. If there is a switch (rubber projection) at the door opening as shown, the door is involved in the lighting operation. The tailgate is also involved in this operation even without the rubber projection.

Trim Partition (if equipped)

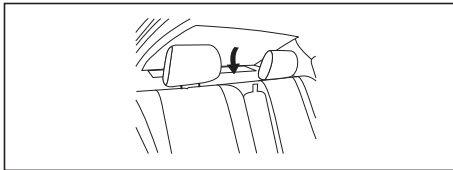

⚠ WARNING

Do not carry items on top of the Trim partition cover, even if they are small and light. Objects on top of the cover could be thrown about in an accident, causing injury, or could obstruct the driver's rear view.

Luggage Compartment Light (if equipped)

EXAMPLE

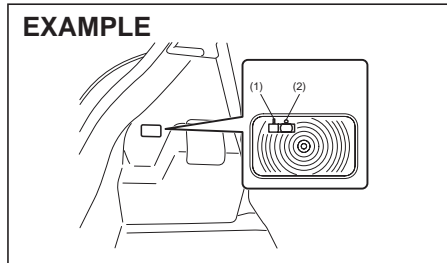

71LMT0505

When you open the tailgate with the luggage compartment light switch in the "ON" position (1), the light comes on and remains on as long as you keep the tailgate open.

When the luggage compartment light switch is in the "OFF" position (2), the light remains off regardless of whether the tailgate is opened or closed.

⚠ CAUTION

Do not leave the tailgate open with the luggage compartment light switch in the "ON" position for a long time, or the battery will discharge.

Trunk Light (if equipped)

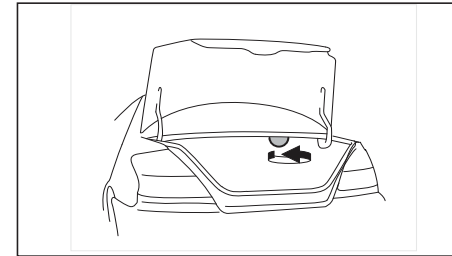

74LHT0517

When you open the trunk lid, the trunk light comes on and remains on as long as you keep the lid open.

NOTICE

Do not leave the trunk lid open for a long time, or the battery will discharge.

OTHER CONTROLS AND EQUIPMENT

Accessory Socket (if equipped)

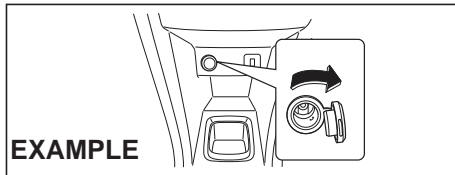

74LHT0517

This socket can be used to provide 12 volt/120 watt power for electrical accessories.

NOTICE

Use of inappropriate electrical accessories can cause damage to your vehicle's electrical system. Make sure that any electrical accessories you use are designed to plug into this type of socket.

AUX/USB Socket (if equipped)

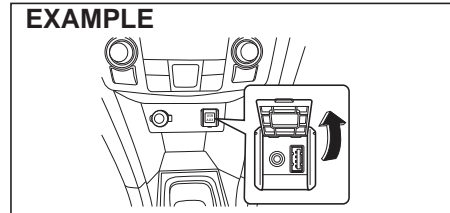

74LHT0518

Connect your portable digital music player, etc. to this socket to enjoy music through the vehicle's audio system using it as a source. Refer to "Audio System" in the "OTHER CONTROL AND EQUIPMENT" section.

Assist Grips

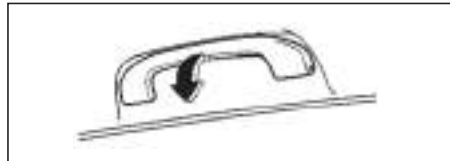

54G249

Assist grips are provided for passenger convenience.

NOTICE

To avoid damaging the assist grip and the molded headlining, do not hang down the assist grip.

Assist grips is not provided on driver seat.

Glove Box

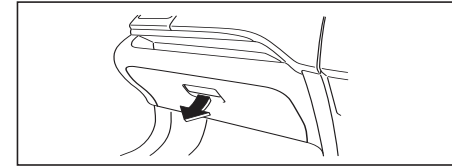

74LHT0519

To open the glove box, pull the latch lever. To close it, push the lid until it latches securely.

WARNING

Never drive with the glove box lid open. It could cause injury if an accident occurs.

Cup Holder and Storage Area (if equipped) Front

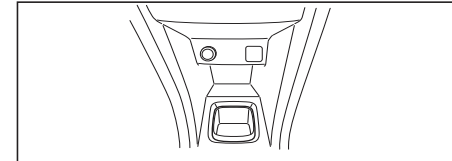

74LHT0520

OTHER CONTROLS AND EQUIPMENT

Passenger side

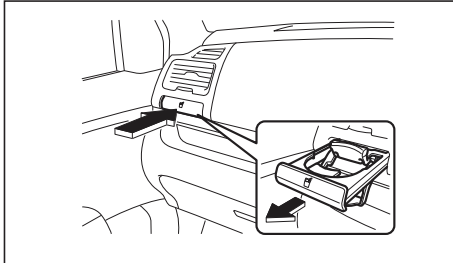

74LHT0529

To use the cup holder, push it. The cup holder slides out automatically. After using the holder, push it back to return it.

Rear

EXAMPLE

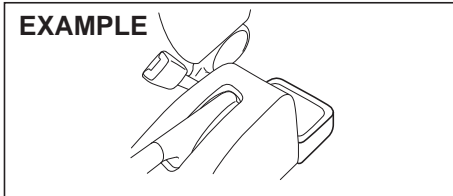

74LHT0527

The storage area is provided in the center console.

⚠ CAUTION

Do not use the cup holder to hold cups containing hot liquids, or sharp-edged, hard or breakable objects. Objects in the cup holder may be thrown about during a sudden stop or impact, and could cause personal injury.

Bottle holder

Front

EXAMPLE

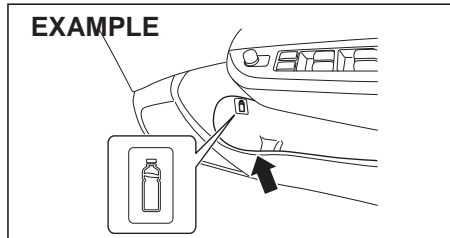

74LHT0522

Rear

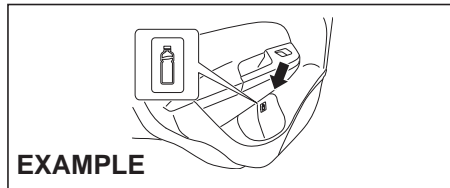

68LM542

You should hold a bottle with a cap in the holder.

Front Seat Back Pocket (if equipped)

EXAMPLE

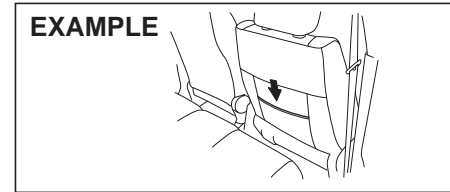

74LHT0535

This pocket is provided for holding light and soft things such as gloves, newspapers or magazines.

⚠ CAUTION

Do not put hard or breakable objects in the pocket. If an accident occurs, objects such as bottles, cans, etc. can injure the occupants in the rear seat.

OTHER CONTROLS AND EQUIPMENT

Floor Mats (if equipped)

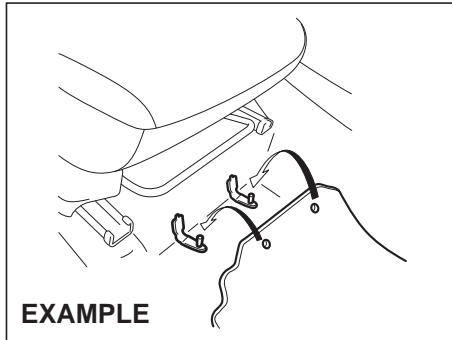

74LHT0534

To prevent the driver's side floor mat from sliding forward and possibly interfering with the operation of the pedals, genuine MARUTI SUZUKI floor mats are recommended.

Whenever you put the driver's side floor mat back in the vehicle after it has been removed, be sure to hook the floor mat grommets to the fasteners and position the floor mat properly in the footwell.

When you replace the floor mats in your vehicle with a different type such as all-weather floor mats, we highly recommend using genuine MARUTI SUZUKI floor mats for proper fitting.

⚠ WARNING

Failure to take the following precautions may result in the driver's side floor mat interfering with the pedals and causing a loss of vehicle control or an accident.

- Make sure that the floor mat grommets are hooked to the fasteners.
- Never place additional floor mats on top of the existing floor mats.

Shopping Hook (if equipped)

The shopping hooks are located on the both sides of the luggage compartment. You can hang the shopping bag or other suitable objects on the hook.

This hook is not designed for large or heavy items.

NOTICE

To avoid breaking the hook, do not hang items heavier than following weight.

- Shopping hook: 2 kg (4.4 lbs)

Rear

EXAMPLE

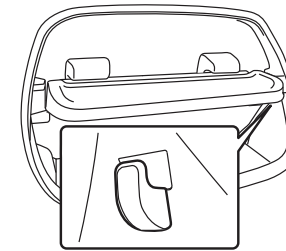

Luggage Area Cover (if equipped)

EXAMPLE

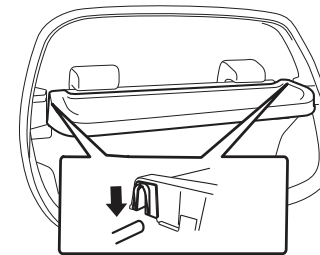

Luggage or other cargo placed in the luggage area is hidden from view by a luggage area cover.

OTHER CONTROLS AND EQUIPMENT

▲ WARNING

Do not carry items on top of the luggage area cover, even if they are small and light. Objects on top of the cover could be thrown about in an accident, causing injury, or could obstruct the driver's rear view.

NOTICE

To avoid damaging the luggage area cover:

- Do not push down on it or lean on it
- Handle it carefully when installing or removing.

Frame Hooks

Front

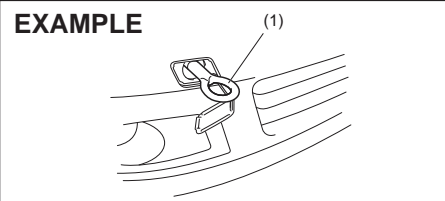

The towing hook (1) is provided on the front of the vehicle for use in emergency situations only.

To install the hook (1), follow the procedure below.

5-93

(with spare tyre)

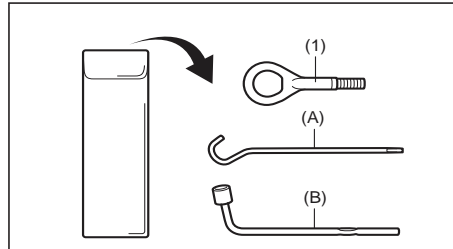

- 1) Pick up the towing hook (1), jack handle (A) and wheel brace (B) kept in the storage bag under the spare tyre in the luggage compartment

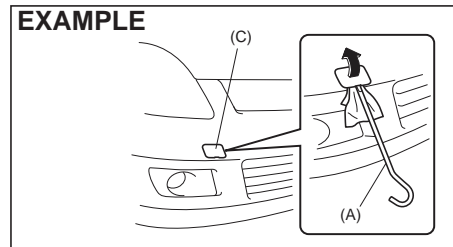

- 2) Remove the cover (C) by using a jack handle (A) covered with a soft cloth as shown in the illustration.

EXAMPLE

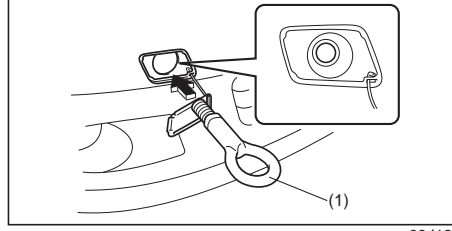

- 3) Install the towing hook (1) by hand.

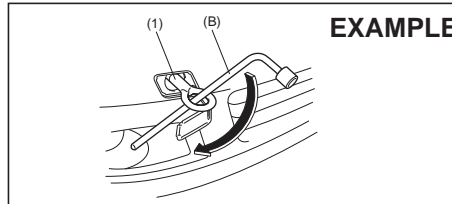

- 4) To tighten the towing hook (1), turn it clockwise by using a wheel brace (B) until the hook (1) is securely installed.

NOTICE

When you use the towing hook (1), avoid the driving that gives significant physical shock on hook. Such operation can damage the hook, or the vehicle body.

Do not sudden accelerate.

OTHER CONTROLS AND EQUIPMENT

To remove the towing hook (1), reverse the procedure used to install the towing hook.

Rear

EXAMPLE

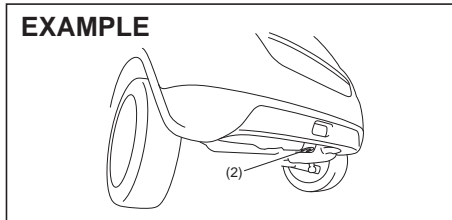

68LM547

The frame hook (2) is provided on the rear of the vehicle for use in emergency situations and trailer/train shipping purposes only.

NOTICE

When you use the frame hook (2), avoid the driving that gives significant physical shock on hook. Such operation can damage the hook, the vehicle body or the drive system.

- Do not sudden accelerate.
- Do not tow the vehicle heavier than your vehicle.

To tow your vehicle on the road or highway, follow the instruction of "Towing" in "EMERGENCY SERVICE" section.

Other Hooks

EXAMPLE

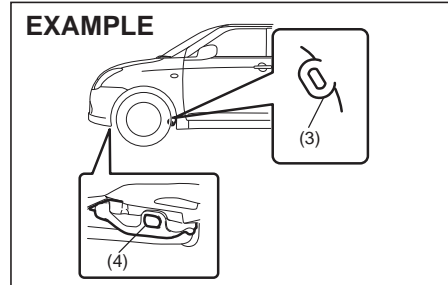

74LHT0536

The hooks (3) (if equipped) is provided for trailer/train shipping purposes only. The hooks (4) are provided for sea shipping-purposes only.

⚠ WARNING

Do not use the frame hooks to tow another vehicle or to have your vehicle towed on the road or highway. The hook (1) is designed for use in emergency situations only, such as if your vehicle or another vehicle gets stuck in deep mud or snow. The hook (2) is designed for use in emergency situations and trailer/train shipping only.

The hooks (3) (if equipped) is provided for trailer/train shipping purposes only. The hooks (4) are provided for sea shipping purpose only.

NOTICE

Never use the hooks (1) for trailer/train shipping and sea shipping purposes to prevent damage to the vehicle.

Luggage Carpet Hook (if equipped)

EXAMPLE

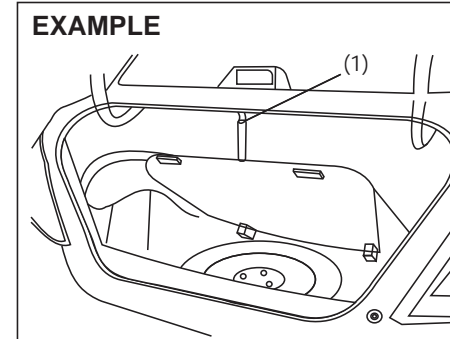

The hook (1) is provided in the luggage compartment area to hang the luggage carpet.

VEHICLE LOADING AND TOWING

VEHICLE LOADING AND TOWING

Vehicle Loading	6-1
Trailer Towing	6-1
Vehicle/Trailer Loading	6-2
Additional Trailer Towing Warnings	6-3
Towing Your Vehicle	6-4
Towing Instruction Table	6-4
Towing Method A	6-5
Towing Method B	6-5

VEHICLE LOADING AND TOWING

Vehicle Loading

Your vehicle was designed for specific weight capacities. The weight capacities of your vehicle are indicated by the Gross Vehicle Weight Rating (GVWR) and the Gross Axle Weight Rating (GAWR, front and rear). The GVWR and GAWR (front and rear) are listed in the "SPECIFICATIONS" section.

GVWR – Maximum permissible overall weight of the fully loaded vehicle (including all the occupants, accessories and cargo plus the trailer nose weight if towing a trailer).

GAWR – (Front and Rear) Maximum permissible weight on an individual axle.

Actual weight of the loaded vehicle and actual loads at the front and rear axles can only be determined by weighing the vehicle. Compare these weights to the GVWR and GAWR (front and rear). If the gross vehicle weight or the load on either axle exceeds these ratings, you must remove enough weight to bring the load down to the rated capacity.

WARNING

Never overload your vehicle. The gross vehicle weight (sum of the weights of the vehicle, all the occupants, accessories, cargo plus trailer nose weight if towing a trailer) must never exceed the Gross Vehicle Weight Rating (GVWR). In addition, never distribute a load so that the weight on either the front or rear axle exceeds the Gross Axle Weight Rating (GAWR).

WARNING

Always distribute cargo evenly. To avoid personal injury or damage to your vehicle, always secure cargo to prevent it from shifting if the vehicle moves suddenly. Place heavier objects on the floor and as far forward in the cargo area as possible. Never pile cargo higher than the top of the seat backs.

Trailer Towing

Your MARUTI SUZUKI was originally designed to carry people and a normal amount of cargo, not to tow a trailer. MARUTI SUZUKI does not recommend you use your vehicle to tow a trailer. Towing a trailer can adversely affect handling, durability,

Some countries have regulations which specifically allow trailer towing up to a specified maximum trailer weight (registered or statutory towing capacity, whichever is smaller); vehicles sold in these countries can be used to tow a light trailer, provided the trailer does not exceed the maximum trailer weight specified in the country's regulations.

If you use your MARUTI SUZUKI to tow a trailer, you should always observe the requirements and recommendations in this section. If you intend to tow a trailer, it is essential to select a trailer and trailer towing equipment which are compatible. A reputable towing specialist can help you. and fuel economy.

NOTICE

Trailer towing puts additional stress on the engine, drive train, and brakes of your vehicle. Never tow a trailer during the first 960 km (600 miles) of vehicle operation.

VEHICLE LOADING AND TOWING

Brakes

WARNING

If trailer brakes are used, you should follow all instructions provided by the manufacturer. Never connect to the brake system of your vehicle and never take an electrical supply directly from the wiring harness.

Tyres

WARNING

When towing a trailer, it is very important for your vehicle and trailer to have properly inflated tyres. Your vehicle's tyres should be inflated to the pressures listed on your vehicles Tyre Information label. If laden pressures are listed on the label, the tyres should be inflated to the laden pressures. Inflate trailer tyres according to the specifications provided by the trailer manufacturer.

Mirrors

Check to see if your vehicle's mirrors meet local requirements for mirrors used on towing vehicles. If they do not, you must install the required mirrors before you tow.

Vehicle/Trailer Loading

To load your vehicle and trailer properly, you must know how to measure gross trailer weight and trailer nose weight.

Gross Trailer Weight is the weight of the trailer plus all the cargo in it. You can measure gross trailer weight by putting the fully loaded trailer on a vehicle scale.

Nose Weight is the downward force exerted on the tow bar by the trailer coupler, with the trailer fully loaded and the coupler at its normal towing height. This weight can be measured using a bathroom scales.

The weight of your loaded trailer (Gross Trailer Weight) should never exceed the "Towing capacity".

Distribute cargo in your trailer so that nose weight is about 10% of gross trailer weight, but does not exceed "Maximum vertical load on trailer hitch point". You should measure gross trailer weight and nose weight before towing to make sure that your load is properly distributed.

WARNING

Improper weight distribution of your trailer may result in poor vehicle handling and swaying of the trailer. Always make sure that trailer nose weight is about 10% of gross trailer weight, but does not exceed "Maximum vertical load on trailer hitch point". Also make sure that the cargo is properly secured. Failure to observe this requirement may result in an accident.

WARNING

Never overload your trailer or your vehicle. Gross trailer weight must never exceed the "Towing capacity". Gross vehicle weight (sum of the weights of the vehicle, all the occupants, accessories including tow bars and a trailer hitch, cargo and trailer nose weight) must never exceed the Gross Vehicle Weight Rating (GVWR) listed in the "SPECIFICATIONS" section.

VEHICLE LOADING AND TOWING

Additional Trailer Towing Warnings

WARNING

Connect trailer lights and hook up safety chains every time you tow.

NOTICE

Because towing a trailer puts additional stress on your vehicle, more frequent maintenance will be required than under normal driving conditions.

WARNING

Your vehicle will handle differently when towing a trailer. For your safety and the safety of others, you should observe the following precautions:

- Practice turning, stopping, and reversing before you begin towing in traffic. Do not tow in traffic until you are confident that you can handle the vehicle and trailer safely.
- Never exceed towing speed limits or 80 km/h (50 mph), whichever is lower.
- Never drive at a speed that causes shaking or swaying of the trailer. If you notice even the slightest sign of shaking or swaying, slow down.
- When roads are wet, slippery or rough, drive at a slower speed than you would on dry, smooth roads. Failure to slow down when road conditions are bad can result in loss of control.
- Always have someone guide you when reversing.
- Allow adequate stopping distance. Stopping distance is increased when you tow a trailer. For each 16

(Continued)

WARNING

(Continued)

km/h (10 mph) of speed, allow at least one vehicle and trailer length between you and the vehicle ahead. Follow at a greater distance if roads are wet or slippery.

- If the trailer has over-run brakes, apply the brakes gradually to avoid snatching caused by the trailer wheels locking.
- Slow down before corners and maintain a steady speed while cornering. Deceleration or acceleration while cornering can result in loss of control. Remember that a larger than normal turning radius is needed because the trailer wheels will be closer than vehicle wheels to the inside of the turn.
- Avoid sudden acceleration and stopping of the vehicle. Do not make quick maneuvers unless they are necessary.
- Slow down in cross winds and be prepared for gusts of wind from large passing vehicles.

(Continued)

VEHICLE LOADING AND TOWING

⚠ WARNING

- Be careful when overtaking other vehicles. Be sure to allow enough room for your trailer before you change lanes, and signal well in advance.
- Slow down and change into a lower gear before you reach long or steep downhill grades. It is hazardous to attempt changing down while you are descending a hill.
- Avoid “riding” the brakes. This could cause the brakes to overheat resulting in reduced braking efficiency. Use engine braking as much as possible.
- Because of the added trailer weight, your engine may overheat on hot days when going up long or steep hills. Pay attention to your engine temperature gauge. If it indicates overheating, pull off the road and stop in a safe place. Refer to “If the Engine Overheats” in “EMERGENCY SERVICE” section.

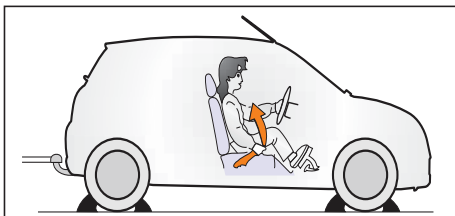

60A186

6-4

⚠ WARNING

When parking your vehicle and connected trailer, always use the following procedure:

- 1) Apply the vehicle’s brakes firmly.
- 2) Have another person place wheel chocks under the wheels of the vehicle and the trailer while you are holding the brakes.
- 3) Slowly release the brakes until the wheel chocks absorb the load.
- 4) Fully engage the parking brake.
- 5) Change the manual transmission into reverse or first gear and turn off the engine.

When starting out after parking:

- 1) Depress the clutch and start the engine.
- 2) Change into gear, release the parking brake, and slowly pull away from the chocks.
- 3) Stop, apply the brakes firmly and hold them.
- 4) Have another person remove the chocks.

Towing Your Vehicle

Your vehicle may be towed behind another vehicle (such as a motorhome), provided your vehicle is 2 wheel drive (2WD) and you use the proper towing method specified for your vehicle.

Use the towing instruction table to select the proper towing method for your vehicle, and carefully follow the corresponding instructions. Be sure to use proper towing equipment designed for recreational towing and make sure that towing speed does not exceed 90 km/h (55 mph)

⚠ WARNING

When you tow your vehicle, follow the instructions below to avoid accidents and damage to your vehicle. In addition, be sure to observe government and local requirements regarding vehicle lighting and trailer hitches or tow bars.

TOWING INSTRUCTION TABLE

DRIVE TRAIN	TRANSMISSION	TOWING METHOD
2WD	M/T (MANUAL)	A/B
2WD	A/T (AUTOMATIC)	A

VEHICLE LOADING AND TOWING

A: 2WD VEHICLES WITH MANUAL TRANSAXLE OR AUTOMATIC TRANSAXLE

- 1) Secure the front wheels on a towing dolly according to the instructions provided by the dolly manufacturer.
- 2) Release the parking brake.

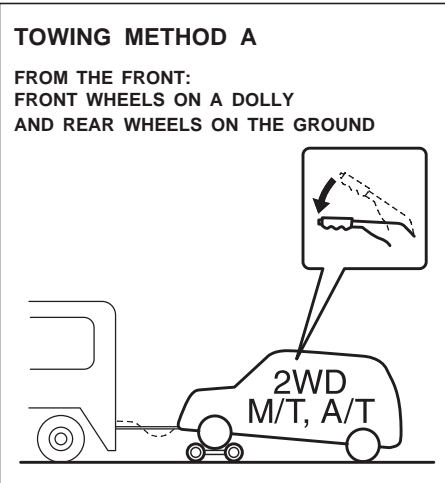

NOTICE

The steering column is not strong enough to withstand shocks transmitted from the front wheels during towing. Always unlock the steering wheel before towing.

B: 2WD VEHICLES WITH MANUAL TRANSAXLE

- 1) Shift the manual transaxle lever into neutral.
- 2) Turn the ignition key to the "ACC" position to unlock the steering wheel.
- 3) Release the parking brake.

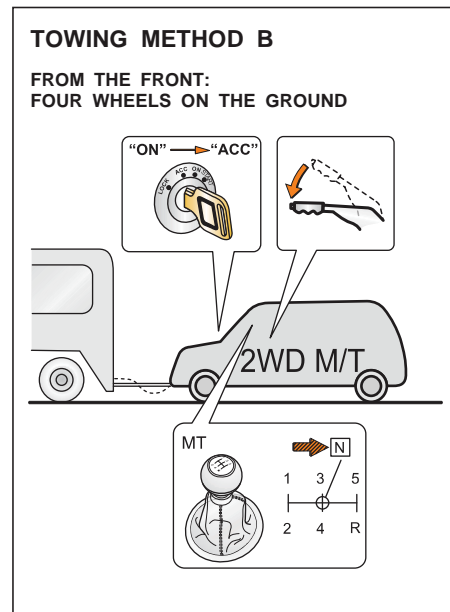

INSPECTION AND MAINTENANCE

INSPECTION AND MAINTENANCE

Maintenance Schedule	7-2
Periodic Maintenance Schedule	7-2
Drive Belt	7-6
Engine Oil and Filter	7-6
Engine Coolant	7-10
Air Cleaner	7-11
Spark Plugs	7-11
Gear Oil	7-13
Clutch Pedal	7-14
Fuel Filter (Diesel engine)	7-15
Brakes	7-15
Steering	7-17
Tyres	7-17
Battery	7-20
Fuses	7-21
Bulb Replacement	7-25
Wiper Blades	7-29
Windshield Washer Fluid	7-31
Air Conditioning System	7-31

INSPECTION AND MAINTENANCE



60B128S

⚠ WARNING

You should take extreme care when working on your vehicle to prevent accidental injury. Here are a few precautions that you should be especially careful to observe:

- To prevent damage or unintended activation of the air bag system or seat belt pretensioner system, be sure the battery is disconnected and the ignition switch has been in the "LOCK" position for at least 90 seconds before performing any electrical service work on your vehicle. Do not touch air bag system components, seat belt pretensioner system components or wires. The wires are wrapped with yellow tape or yellow tubing, and the couplers are yellow for easy identification.
- Do not leave the engine running in garages or other confined areas.

(Continued)

⚠ WARNING

(Continued)

- When the engine is running, keep hands, clothing, tools, and other objects away from the fan and drive belt. Even though the fan may not be moving, it can automatically turn on without warning.
- When it is necessary to do service work with the engine running, make sure that the parking brake is set fully and the transmission is in Neutral.
- Do not touch ignition wires or other ignition system parts when starting the engine or when the engine is running, or you could receive an electric shock.
- Be careful not to touch a hot engine, exhaust manifold and pipes, muffler, radiator and water hoses.
- Do not allow smoking, sparks, or flames around fuel or the battery. Flammable fumes are present.
- Do not get under your vehicle if it is supported only with the portable jack provided in your vehicle.
- Be careful not to cause accidental short circuits between the positive and negative battery terminals.

(Continued)

⚠ WARNING

(Continued)

- Keep used oil, coolant, and other fluids away from children and pets. Dispose of used fluids properly; never pour them on the ground, into sewers, etc.

INSPECTION AND MAINTENANCE

Maintenance Schedule

The following table shows the times when you should perform regular maintenance on your vehicle. This table shows in miles, kilometers and months when you should perform inspections, adjustments, lubrication and other services.

WARNING

MARUTI SUZUKI recommends that maintenance on your Maruti Suzuki vehicle should be performed by MARUTI SUZUKI authorised workshop/Service station.

NOTICE

Whenever it becomes necessary to replace parts on your vehicle, it is recommended that you use MARUTI genuine replacement parts or their equivalent.

Periodic Maintenance Schedule

“A” :Adjust
“C” : Clean
“R” : Replace or Change
“I” : Inspect, clear, adjust, lubricate or replace as necessary
“L” : Lubricate
“T” : Tighten to Specified Torque
“O” : Rotate

NOTE:

This table includes services as scheduled up to 80,000 km mileage. Beyond 80,000 km, carry out the same services at the same intervals respectively.

INSPECTION AND MAINTENANCE

Interval: This interval should be judged by odometer reading or months, whichever comes first.			FREE INSPECTION			PERIODIC MAINTENANCE AT COST							
			km (x1000)	1	5	10	20	30	40	50	60	70	80
			months	1	6	12	24	36	48	60	72	84	96
Engine													
1-1.	Water pump drive (Tension, Wear)	Petrol	-	-	-	-	-	I	-	-	-	R	
1-2.	Engine Coolant (Level, Leakage)		I	I	I	R	I	R	I	R	I	R	
1-3.	Engine oil and engine oil filter		-	-	R	R	R	R	R	R	R	R	
1-4.	Cooling system hoses and connections (Leakage and Damage)		I	I	I	I	I	I	I	I	I	I	
1-5.	Engine bolts (All cylinder head and manifold fixings)		-	-	T	-	T	-	T	-	T	-	
1-6.	Engine Mounting (All Cylinder head and manifold fixings)		-	-	T	-	T	-	T	-	T	-	
1-7.	Valve Clearance	Petrol	-	-	-	-	I	-	-	I	-	-	
1-8.	Exhaust System (Noise, Leakage etc.)		-	I	-	I	-	-	-	-	-	I	
1-9.	Positive Crank Case Ventilation System (Hoses, Connections and Valve)		-	I	-	I	-	-	-	-	-	I	
1-10.	Exhaust Gas Recirculation Valve	Diesel	-	-	-	-	C	-	-	C	-	-	
Ignition													
2-1.	Ignition wiring (Damage, Deterioration)		-	-	-	I	-	I	-	I	-	I	
2-2.	Spark Plug (Clean and adjust the gap)	Petrol	-	-	-	-	-	R	-	-	-	R	
Fuel													
3-1.	Air cleaner filter element	Paved-road	Petrol	Clean after every 5,000 KM. Replace after every 40,000 KM.									
			Diesel	Replace after every 20,000 KM. Cleaning not required.									
		Dusty Condition	Petrol	Clean after every 2,500 KM or as required. Replace after every 40,000 KM.									
			Diesel	Replace after every 20,000 KM. Cleaning not required. More frequent replacement if dust condition is severe.									
3-2.	Fuel tank cap, fuel lines and connections (Leakage and Damage)		-	I	-	-	-	I	-	-	-	I	
3-3.	Fuel Filter (Leakage)	Petrol	-	-	-	-	-	R	-	-	-	R	
3-4.	Fuel Filter and Water Draining	Diesel	I	I	I	R	I	R	I	R	I	R	
Clutch and Transmission													
4-1.	Clutch Pedal (Play)	Petrol	I	I	I	I	I	I	I	I	I	I	
4-2.	Clutch fluid (level, leakage)	Diesel	I	I	I	R	I	R	I	R	I	R	
4-3.	Clutch slipping (Dragging or Excess Damage)		I	I	I	I	I	I	I	I	I	I	

Drive Belt: 1, 2
 Engine Oil and Filter: 1, 2

INSPECTION AND MAINTENANCE

Interval: This interval should be judged by odometer reading or months, whichever comes first.		FREE INSPECTION			PERIODIC MAINTENANCE AT COST							
		km (x1000)	1	5	10	20	30	40	50	60	70	80
		months	1	6	12	24	36	48	60	72	84	96
4-4.	Manual Transmission/Transfer or Differential Oil (Level, Leakage)	Swift Type 2	Replace at 1,60,000 km or 10 years whichever comes first									
		Swift Dzire/Swift Type 1						R				R
4-5.	Automatic Transmission Fluid (Level, Leakage)	Replace at 1,65,000 km or 11years whichever comes first										
4-6.	Hose, Automatic Transmission Fluid											
Drive shaft												
5-1.	Drive shaft boot (boot damage)	-										
BRAKE												
6-1.	Brake Fluid (Level, Leakage)				R		R		R		R	
6-2.	Brake pedal (pedal - wall clearance)											
6-3.	Parking brake lever and cable (Play, damage)											
6-4.	Brake disc and pad (Wear)	-										
6-5.	Brake drum and shoes (Wear)	-	-									
6-6.	Master cylinder and wheel cylinder or caliper, brake hoses and pipes (Fluid leakage, damage)											
WHEEL												
7-1.	Tyres (air pressure, abnormal wear, crack and rotation)		I&O	I&O	I&O	I&O	I&O	I&O	I&O	I&O	I&O	
7-2.	Wheels (Damage)											
7-3.	Front/Rear wheel bearing (Loose, damage)											
FRONT / REAR SUSPENSION												
8-1.	Suspension strut (Oil leakage, damage)											
8-2.	Suspension arms / Knuckle support (Loose, damager)	-										
8-3.	Rear spring (Damage)											
8-4.	Shock absorbers (Oil leakage, damage)											
8-5.	All bolts and nuts (Loose)	-	T	T	T	T	T	T	T	T	T	
8-6.	Suspension arms and torsion rods	-										
STEERING												
9-1.	Steering wheel (Play, loose)											

7-4

INSPECTION AND MAINTENANCE

Interval: This interval should be judged by odometer reading or months, whichever comes first.		FREE INSPECTION			PERIODIC MAINTENANCE AT COST							
		km (x1000)	1	5	10	20	30	40	50	60	70	80
		months	1	6	12	24	36	48	60	72	84	96
9-2.	All rods and arms (Loose, damage, wear)											
ELECTRICAL												
10-1.	Battery electrolyte (Level, leakage)											
10-2.	Wiring harness connection (Loose, damage)	-										
10-3.	Lightening system (Operation, stains, damage)											
10-4.	Horn (Operation)											
10-5.	System Voltage											
BODY												
11-1.	All chassis bolts and nuts (Tighten)	-		T	T	T	T	T	T	T	T	T
11-2.	All latches, hinges and locks (Function))		I&L	I&L	I&L	I&L	I&L	I&L	I&L	I&L	I&L	I&L
ROAD TEST												
12-1.	Operation of Brakes, gear shifting and speedometer											
12-2.	Body and chassis noise											
AIR CONDITIONER (If equipped)												
13-1.	Check belt tension											
13-2.	Tighten compressor mounting bolt	-	T	T	T	T	T	T	T	T	T	T
13-3.	All hose joint (Check, tighten)											
13-4.	Check functioning of Recirc flap											
13-5.	Clean condensor with low pressure water	-	C	C	C	C	C	C	C	C	C	C
13-6.	Check belt for frayed edges											
13-7.	Check all mounting bolts											

INSPECTION AND MAINTENANCE

Drive Belt

⚠ WARNING

When the engine is running, keep hands, hair, clothing, tools, etc. away from the moving fan and drive belts.

(For Petrol Engine Model)

Make sure the drive belt tension is correct. If the belt is too loose, insufficient battery charging, engine overheating, poor power steering, poor air conditioning, or excessive belt wear can result. When you press the belt with your thumb midway between the pulleys, there should be a deflection according to the following chart.

The belts should also be examined to ensure that they are not damaged.

If you need to replace or adjust the belt have it done by your MARUTI SUZUKI dealer.

(For Petrol Engine Model)

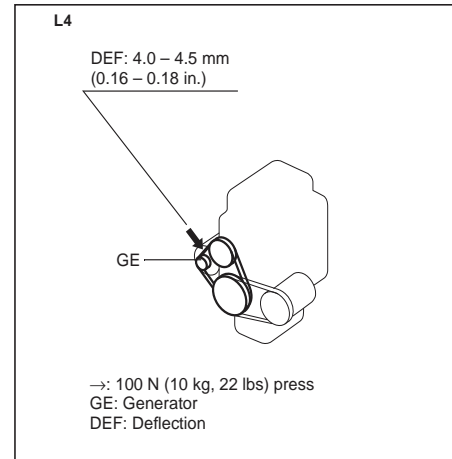

68LM70703

(For Diesel Engine Model)

The drive belts tension adjusted automatically.

Engine Oil and Filter

Specified Oil

(For Petrol Engine Model)

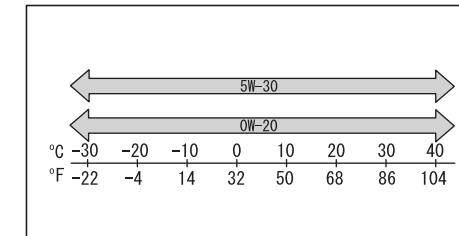

74LHT0718

The recommended Engine oil:

Swift Type 2 : SL 0W/20

Swift Dzire/Swift Type 1 : SG+ 5W/30

Specified Oil (For Diesel Engine)

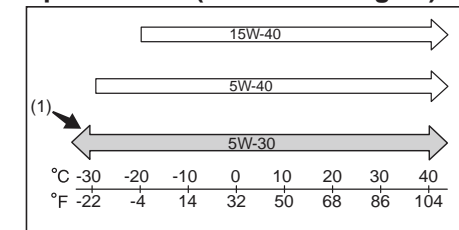

84E010

(1) Preferred

INSPECTION AND MAINTENANCE

Be sure that the engine oil you use comes under the quality classification of ACEA A5/B5. The recommended Engine oil is 5W30 A5/B5.

**Oil Level Check
(For Petrol Engine Model)**

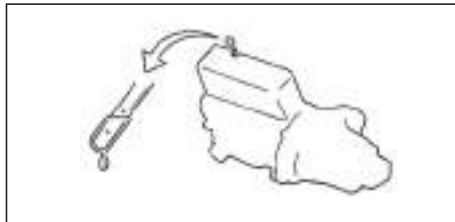

80G064

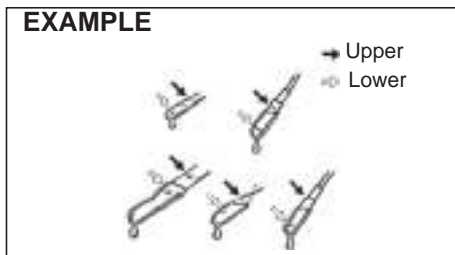

52D084

(For Diesel Engine Model)

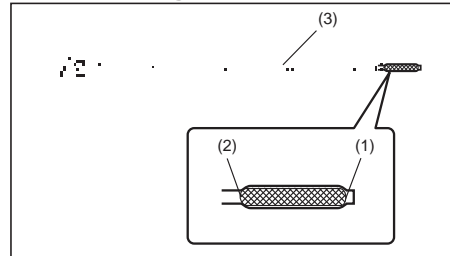

84E012

- (1) MIN
- (2) MAX
- (3) Engine oil dipstick

It is important to keep the engine oil at the correct level for proper lubrication of your vehicle's engine. Check the oil level with the vehicle on a level surface. The oil level indication may be inaccurate if the vehicle is on a slope. The oil level should be checked either before starting the engine or at least 5 minutes after stopping the engine.

Pull out the oil dipstick, wipe oil off with a clean cloth, insert the dipstick all the way into the engine, then remove it again. The oil on the stick should be between the upper and lower limits shown on the stick. If the oil level indication is near the lower limit, add enough oil to raise the level to the upper limit.

NOTICE

Failure to check the oil level regularly could lead to serious engine trouble due to insufficient oil.

NOTICE

(For Diesel Engine Model)
Do not top up the oil over the MAX limit. Too much oil causes serious engine trouble.

Refilling

EXAMPLE

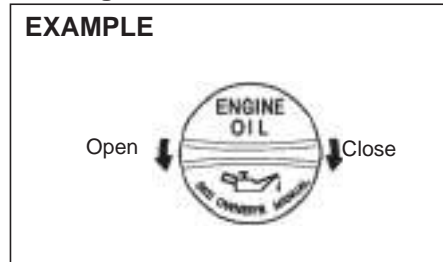

81A147

Remove the oil filler cap and pour oil slowly through the filler hole to bring the oil level to the upper limit on the dipstick. Be careful not to overfill. Too much oil is almost as bad as too little oil. After refilling, start the engine and allow it to idle for about a minute. Stop the engine, wait about 5 minutes and check the oil level again.

INSPECTION AND MAINTENANCE

Changing Engine Oil and Filter

Drain the engine oil while the engine is still warm.

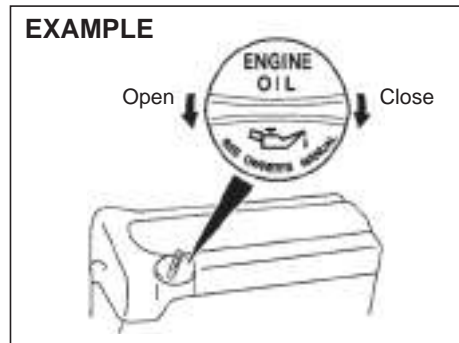

- 1) Remove the oil filler cap.
- 2) Place a drain pan under the drain plug.
- 3) Using a wrench, remove the drain plug and drain out the engine oil.

CAUTION

The engine oil temperature may be high enough to burn your fingers when the drain plug is loosened. Wait until the drain plug is cool enough to touch with your bare hands.

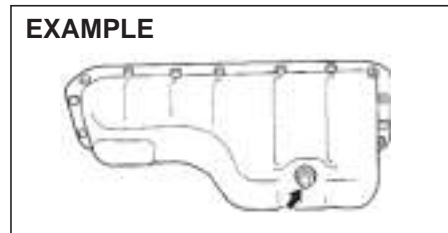

Tightening torque for drain plug
Petrol engine:
 35 Nm (3.5 kg-m, 25.3 lb-ft)

For Diesel Engine

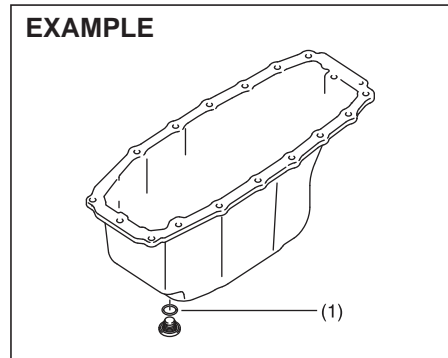

For Diesel Engine
 20 Nm (2.0 kg-m, 14.5 lb-ft)

Note: Washer (1) should be replaced every time when opened.

WARNING

New and used oil can be hazardous. Children and pets may be harmed by swallowing new or used oil. Keep new and used oil and used oil filters away from children and pets.

Continuous contact with used engine oil may cause skin cancer laboratory animals

Brief contact with used oil may irritate skin.

To minimize your exposure to used oil, wear a long-sleeve shirt and moisture-proof gloves (such as dish-washing gloves) when changing oil. If oil contacts your skin, wash thoroughly with soap and water.

Launder any clothing or rags if wet with oil.

Recycle or properly dispose of used oil and filters.

- 4) Reinstall the drain plug and gasket. Tighten the plug with a wrench to the specified torque.

INSPECTION AND MAINTENANCE

Replace the Oil Filter

- 1) Using an oil filter wrench, turn the oil filter counterclockwise and remove it.
- 2) Using a clean rag, wipe off the mounting surface on the engine where the new filter will be seated.
- 3) Smear a little engine oil around the rubber gasket of the new oil filter.
- 4) Screw on the new filter by hand until the filter gasket contacts the mounting surface.

(For Petrol Engine Model)

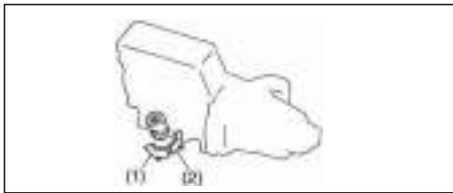

54G092

- (1) Loosen
- (2) Tighten

Tightening (viewed from filter top)

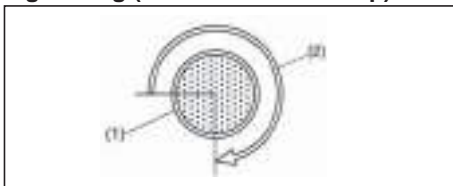

54G093

- (1) Oil filter
- (2) 3/4 turn

(For Diesel Engine Model)

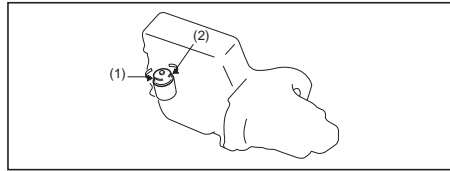

84E016

- (1) Loosen
- (2) Tighten

NOTICE

To tighten the oil filter properly, it is important to accurately identify the position at which the filter gasket first contacts the mounting surface.

- 5) Tighten the filter specified turn from the point of contact with the mounting surface (or to the specified torque) using an oil filter wrench.

Tightening torque for oil filter 3/4 turn or

Petrol engine:
14 Nm (1.4 kg-m, 10.1 lb-ft)

Diesel engine:
25 Nm (2.5 kg-m, 18.5 lb-ft)

NOTICE

To prevent oil leakage, make sure that the oil filter is tight, but do not over-tighten it.

NOTE:

- Replace ring along with the new filter
- Never use the old ring in the new filter.

Refill with Oil and Check for Leaks

- 1) Pour oil through the filler hole and install the filler cap.
For the approximate capacity of the oil, refer to the "Capacities" item in the "SPECIFICATIONS" section.
- 2) Start the engine and look carefully for leaks at the oil filter and drain plug. Run the engine at various speeds for at least 5 minutes.
- 3) Stop the engine and wait about 5 minutes. Check the oil level again and add oil if necessary. Check for leaks again.

NOTICE

- When replacing the oil filter, it is recommended that you use a **MARUTI** genuine replacement filter.
- Oil leaks from around the oil filter or drain plug indicate incorrect installation or gasket damage. If you find any leaks or are not sure that the filter has been properly tightened, have the vehicle inspected by your **MARUTI SUZUKI** dealer.

INSPECTION AND MAINTENANCE

Engine Coolant

Selection of Coolant

To maintain optimum performance and durability of your engine, use MARUTI SUZUKI Genuine Coolant or equivalent.

This type of coolant is best for your cooling system as it:

- Helps maintain proper engine temperature.
- Gives proper protection against freezing and boiling.
- Gives proper protection against corrosion and rust.

Failure to use the proper coolant can damage your cooling system. Your authorized MARUTI SUZUKI dealer can help you select the proper coolant.

NOTICE

To avoid damaging your cooling system:

- Always use a high quality ethylene glycol base non-silicate type coolant diluted with distilled water at the correct mixture concentration.
- Make sure that the proper mix is 50/50 coolant to distilled water (Diesel) and 30/70 (Petrol). Concentrations greater than this may cause overheating conditions.
- Neither use 100% coolant nor 100% Plain water.

NOTICE

- Do not add extra inhibitors or additives. They may not be compatible with your cooling system.
- Do not mix different types of base coolants. Doing so may result in accelerated seal wear and/or the possibility of severe overheating and extensive engine/automatic transaxle damage.

Coolant Level Check

Check the coolant level at the reservoir tank, not at the radiator. With the engine cool, the coolant level should be between the "FULL" and "LOW" marks.

Adding Coolant

⚠ WARNING

Engine coolant is harmful or fatal if swallowed or inhaled. Do not drink antifreeze or coolant solution. If swallowed, do not induce vomiting. Immediately contact a poison control center or a physician. Avoid inhaling mist or hot vapors; if inhaled, remove to fresh air. If coolant gets in eyes, flush eyes with water and seek medical attention. Wash thoroughly after handling. Solution can be poisonous to animals. Keep out of the reach of children and animals.

NOTICE

- The mixture you use should contain 50% concentration of antifreeze.
- If the lowest ambient temperature in your area is expected to be -35°C (-31°F) or below, use higher concentrations up to 60% following the instructions on the antifreeze container.

(For Petrol Engine Model)

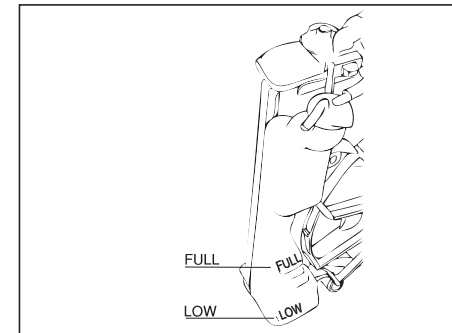

68LMT0701

Coolant level is to be maintained between "LOW" and "FULL" mark. When the engine is cool, remove the reservoir tank cap. Add coolant until the reservoir tank level reaches the "FULL" mark. Never fill the reservoir tank above the "FULL" mark.

Automatic Transaxle (AT) Fluid: 10
Engine Coolant: 1, 2

INSPECTION AND MAINTENANCE

NOTICE

When putting the cap on the reservoir tank, line up the mark on the cap and the mark on the tank. Failure to follow this can result in coolant leakage.

(For Diesel Engine Model)

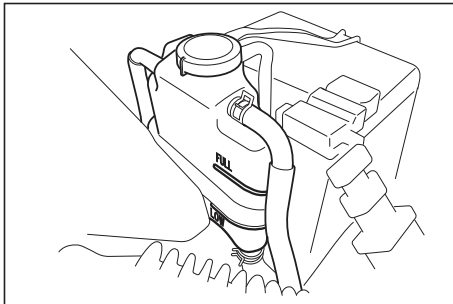

74LHT0705

WARNING

It is hazardous to remove the reservoir tank cap (degassing tank cap) for a diesel engine when the water temperature is high, because scalding fluid and steam may be blown out under pressure. Wait until the coolant temperature has lowered before removing the cap.

If the coolant level is below the "LOW" mark, more coolant should be added. When the engine is cool, remove the degassing tank cap by turning it anticlockwise slowly to release any pressure. And add coolant until the degassing tank level reaches the "FULL" mark. Never fill the degassing tank above the "FULL" mark.

Coolant Replacement

Coolant replacement work requires technical skill. Do not replace the coolant by yourself. Trust this job to Maruti Suzuki Authorised Dealer workshop or service station.

Air Cleaner

(For Petrol Engine Model)

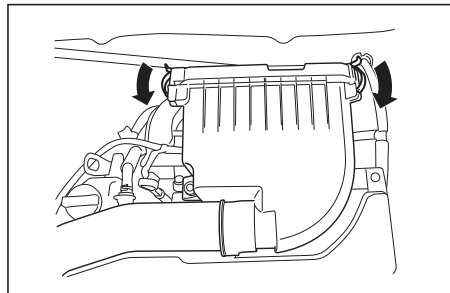

74LHT0713

(For Diesel Engine Model)

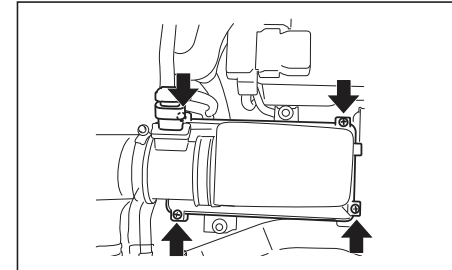

74LHT0702

If the air cleaner is clogged with dust, there will be greater intake resistance, resulting in decreased power output and increased fuel consumption.

Unclamp/unscrew the side clamps/screws, and remove the element from the air cleaner case. If it appears to be dirty, replace it with a new one.

Spark Plugs (Petrol Engine)

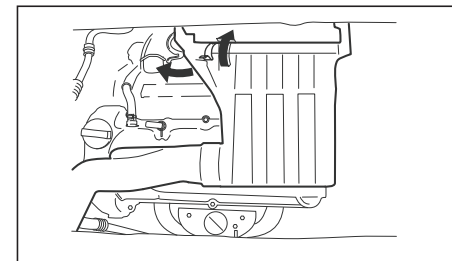

52KM121

INSPECTION AND MAINTENANCE

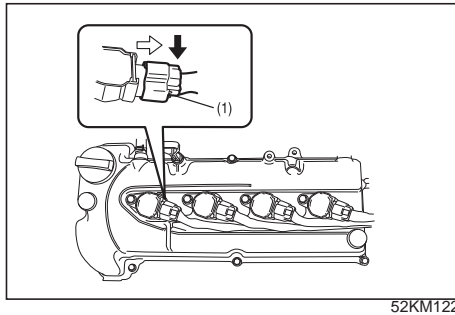

52KM122

For nickel spark plugs (traditional type):

You should inspect spark plugs periodically for carbon deposits. When carbon accumulates on a spark plug, a strong spark may not be produced. Remove carbon deposits with a wire or pin and adjust the spark plug gap.

To access the spark plugs:

- 1) Unclamp the air cleaner cover.
- 2) Remove the engine top cover.
- 3) If necessary, disconnect the coupler (1) while pushing the release lever.
- 4) Remove the ignitor bolts.5) Pull the spark plug boots out.

NOTE:
When installation, make sure the wires, couplers, sealing rubber of top cover and washers, are correctly returned in place.

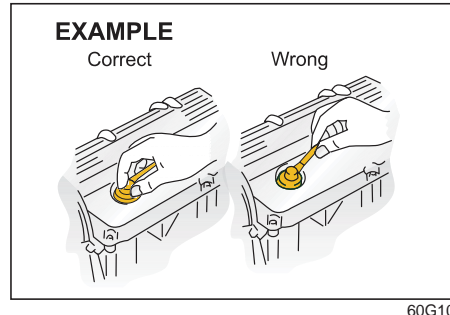

60G102

NOTICE

- When disconnecting the spark plug cables, pull on the boot, not on the cable itself. Pulling on the cable can damage it.
- When servicing the iridium/platinum spark plugs (slender center electrode type plugs), do not touch the center electrode, as it is easy to damage.

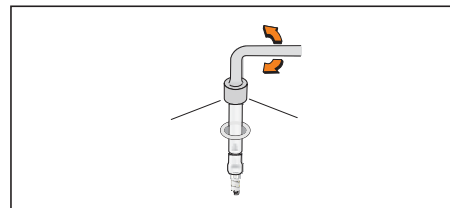

60G160S

NOTICE

- When installing the spark plugs, screw them in with your fingers to avoid stripping the threads. Tighten with a torque wrench to 25 Nm (2.5 kg-m, 18.0 lb-ft). Do not allow contaminants to enter the engine through the spark plug holes when the plugs are removed.
- Never use spark plugs with the wrong thread size.

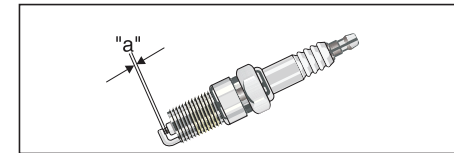

54G106

Spark plug gap "a"
1.0 mm +/- 0.05 mm

NOTICE

When replacing spark plugs, you should use the brand and type specified for your vehicle. For the specified spark plugs, refer to the "SPECIFICATIONS" section at the end of this book. If you wish to use a brand of spark plug other than the specified plugs, consult your MARUTI SUZUKI dealer.

INSPECTION AND MAINTENANCE

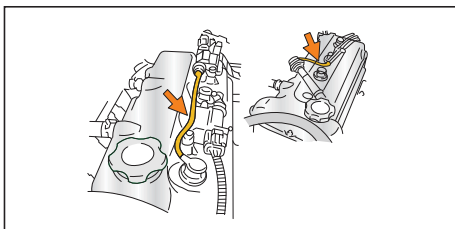

60D204

NOTE:

If your engine is equipped with the high tension cord type ignition wiring and you experience some firing problem of spark plugs, such as, hard engine-starting, mis-fire etc., the cause may be located not only on spark plugs but also on deteriorated ignition wirings (generally, used for more than 80,000 km or five years). If spark plug replacement does not solve the problem, have the ignition wiring and other ignition system inspected by your MARUTI SUZUKI dealer.

Gear Oil

Transmission Oil

When adding gear oil, use gear oil with the appropriate viscosity and grade.

We highly recommend you use:

Swift Type 2

"75W-80" for manual transmission gear oil.

Swift Dzire/Swift Type 1

API GL-4 SAE 75W-90 for manual transmission gear oil.

Gear Oil Level Check

Manual transmission

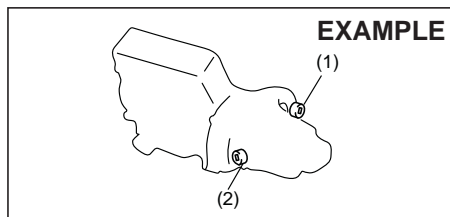

74LHT0714

- (1) Oil filler and level plug (for Petrol engine model)
- (2) Oil filler and level plug (for diesel engine model)

To check the gear oil level, use the following procedure:

- 1) Park the vehicle on a level surface with the parking brake applied. Then, stop the engine.
- 2) Remove the oil filler plug (1) or (2) .
- 3) Check the inside of the hole with your finger. If the oil level comes up to the bottom of the plug hole, the oil level is correct. If so, reinstall the plug.
- 4) If the oil level is low, add gear oil through the oil filler plug hole (1) or (2) until the oil level reaches the bottom of the filler hole, then reinstall the plug.

Tightening torque for oil filler plug (1) or (2)
 21 Nm (2.1 kg-m, 15.2 lb-ft)

CAUTION

After driving the vehicle, the transmission oil temperature may be high enough to burn you. Wait until the oil filler plug is cool enough to touch with your bare hands before inspecting transmission oil level.

NOTICE

When tightening the plug, apply the following sealing compound or equivalent to the plug threads to prevent oil leakage.

SUZUKI Bond No. "1216E" or "1217G"

Gear Oil Change

Since special procedures, materials and tools are required, it is recommended that you trust this job to your MARUTI SUZUKI authorised dealer.

INSPECTION AND MAINTENANCE

Clutch Pedal

Cable Control Clutch (For Petrol Engine Model)

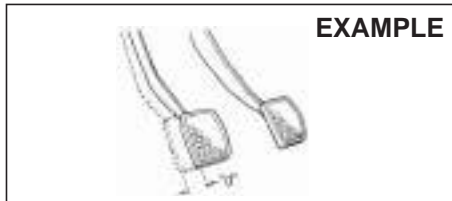

54G274

**Clutch pedal play "d":
10 - 15 mm (0.4 - 0.6 in.)**

Measure the clutch pedal play by moving the clutch pedal with your hand and measuring the distance it moves until you feel slight resistance. The play in the clutch pedal should be between the specified values. If the play is more or less than the above, or clutch dragging is felt with the pedal fully depressed, have the clutch inspected by your MARUTI SUZUKI authorised dealer.

Fluid Control Clutch (For Diesel Engine Model)

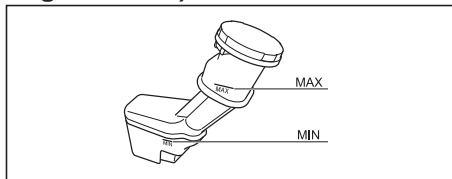

68LM703

7-14

Check the clutch pedal for smooth operation and clutch fluid level from time to time. If clutch dragging is felt with the pedal fully depressed, have the clutch inspected by your MARUTI SUZUKI dealer. If the clutch fluid level is near the "MIN" line, fill it up to the "MAX" line with MARUTI GENUINE brake fluid.

Automatic Transaxle (AT) Fluid

Specified Fluid

Use an automatic transaxle fluid SUZUKI ATF 3317 or Mobil ATF 3309.

Fluid Level Check

NOTICE

Driving with too much or too little fluid can damage the transaxle.

You must check the fluid level with the automatic transaxle fluid at normal operating temperature.

To check the fluid level:

- 1) To warm up the transaxle fluid, drive the vehicle or idle the engine until the temperature gauge indicates normal operating temperature.
- 2) Then drive for ten more minutes.

NOTICE

Be sure to use the specified automatic transaxle fluid. Using automatic transaxle fluid other than SUZUKI ATF 3317 or Mobil ATF 3309 may damage the automatic transaxle of your vehicle.

NOTE:

Do not check the fluid level if you have just driven the vehicle for a long time at high speed, if you have driven in city traffic in hot weather, or if the vehicle has been pulling a trailer. Wait until the fluid cools down (about 30 minutes), or the fluid level indication will not be correct.

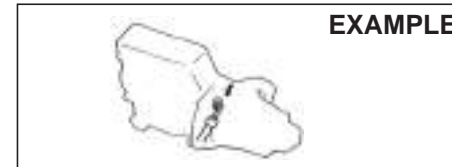

- 3) Park your vehicle on level ground.
- 4) Apply the parking brake and then start the engine in "P" (Park). Let it idle for two minutes and keep it running during the fluid level check.
- 5) With your foot on the brake pedal, move the gearshift lever through each range, pausing for about three seconds in each range. Then move it back to the "P" (Park) position.

INSPECTION AND MAINTENANCE

⚠ WARNING

Be sure to depress the brake pedal when moving the gearshift lever, or the vehicle can move suddenly.

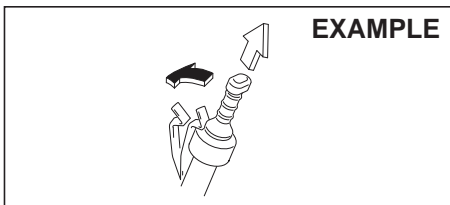

- 6) The handle of the A/T fluid dipstick is colored red for easy identification. Remove the dipstick, clean it and push it back in until the cap seats. Then pull out the dipstick.
- 7) Check both sides of the dipstick, and read the lowest level. The fluid level should be between the two marks in the "HOT" range on the dipstick.

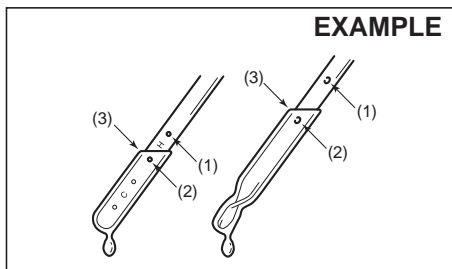

- (1) FULL HOT
- (2) LOW HOT
- (3) The lowest point = Fluid level

- 8) Add just enough specified fluid through the dipstick hole to fill the transaxle oil to the proper level.

NOTICE

After checking or adding oil, be sure to insert the dipstick securely.

Changing Oil

Since special procedures, materials, and tools are required to change the automatic transaxle oil, it is recommended that you trust this job to your authorized MARUTI SUZUKI dealer.

Fuel Filter (Diesel engine)

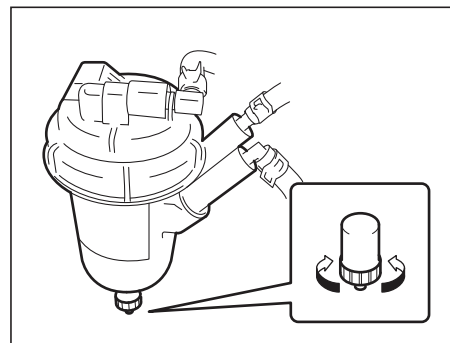

The fuel filter works as a water sedimentor as well.

Drain water according to the Periodic Maintenance Schedule. To drain water:

- 1) Remove the battery. (Refer to "Battery" in this section.)
- 2) Place a pan or ample rag under the fuel filter drain nozzle.
- 3) Loosen the drain knob. The water will be drained.
- 4) Tighten the drain knob when the water changes to the diesel fuel.
- 5) Tighten the drain knob.

Tightening torque for drain knob
1.5 Nm (0.15 kg-m, 1.1 lb-ft)

NOTE:

Trust this job to be carried out at Maruti Suzuki authorised dealer.

Brakes

Brake Fluid

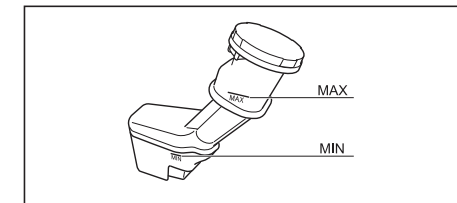

Check the brake fluid level by looking at the reservoir in the engine compartment. Check that the fluid level is between the "MAX" and "MIN" lines. If the brake fluid

INSPECTION AND MAINTENANCE

level is near the "MIN" line, fill it up to the "MAX" line with MARUTI GENUINE brake fluid.

⚠ WARNING

Failure to follow the guidelines below can result in personal injury or serious damage to the brake system.

- If the brake fluid in the reservoir drops below a certain level, the brake warning light on the instrument panel will come on (the engine must be running with the parking brake fully disengaged). Should the light come on, immediately ask your MARUTI SUZUKI dealer to inspect the brake system.
- A rapid fluid loss indicates a leak in the brake system which should be inspected by your MARUTI SUZUKI dealer immediately.
- Do not use any fluid other than specified brake fluid. Do not use reclaimed fluid or fluid that has been stored in old or open containers. It is essential that foreign particles and other liquids are kept out of the brake fluid reservoir.

⚠ CAUTION

Brake fluid can harm your eyes and damage painted surfaces. Use caution when refilling the reservoir.

⚠ WARNING

Brake fluid is harmful or fatal if swallowed, and harmful if it comes in contact with skin or eyes. If swallowed, do not induce vomiting. Immediately contact a poison control center or a physician. If brake fluid gets in eyes, flush eyes with water and seek medical attention. Wash thoroughly after handling. Solution can be poisonous to animals. Keep out of the reach of children and animals.

NOTE:

With disc brakes, the fluid level can be expected to gradually fall as the brake pads wear.

Brake Pedal

Check if the brake pedal stops at the regular height without "spongy" feeling when you depress it. If not, have the brake system inspected by your MARUTI SUZUKI dealer. If you doubt the brake pedal for the regular height, check it as follows:

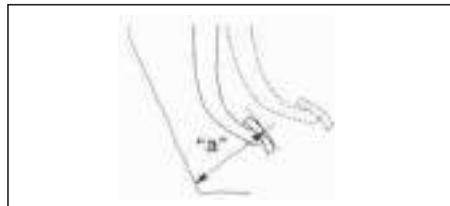

54G108

Pedal to floor carpet minimum distance "a": 68 mm (2.7 in.)

With the engine running, measure the distance between the brake pedal and floor carpet when the pedal is depressed with approximately 30 kg (66 lbs) of force. The minimum distance required is as specified. Since your vehicle's brake system is self-adjusting, there is no need for pedal adjustment.

If the pedal to floor carpet distance as measured above is less than the minimum distance required, have your vehicle inspected by your MARUTI SUZUKI dealer.

NOTE:

When measuring the distance between the brake pedal and floor wall, be sure not to include the floor mat or rubber on the floor wall in your measurement.

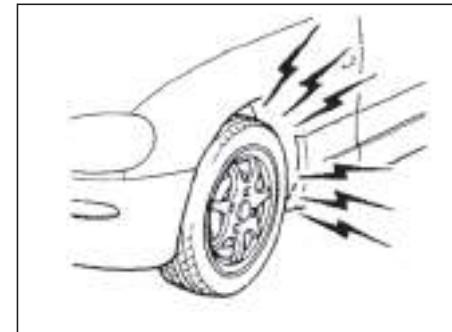

60G104S

Fuel Filter (diesel engine):

Brakes: 6

INSPECTION AND MAINTENANCE

⚠ WARNING

If you experience any of the following problems with your vehicle's brake system, have the vehicle inspected immediately by your MARUTI SUZUKI dealer.

- Poor braking performance
- Uneven braking (brakes not working uniformly on all wheels.)
- Excessive pedal travel
- Brake dragging
- Excessive noise
- Pedal Pulsation (Pedal Pulsates when depressed)

Parking Brake

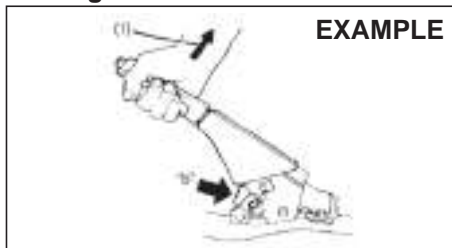

54G109

Ratchet tooth specification "b":
4th – 9th
Lever pull force (1):
200 N (20 kg, 44 lbs)

Check the parking brake for proper adjustment by counting the number of clicks

made by the ratchet teeth as you slowly pull up on the parking brake lever to the point of full engagement. The parking brake lever should stop between the specified ratchet teeth and the rear wheels should be securely locked. If the parking brake is not properly adjusted or the brakes drag after the lever has been fully released, have the parking brake inspected and/or adjusted by your MARUTI SUZUKI dealer.

Steering

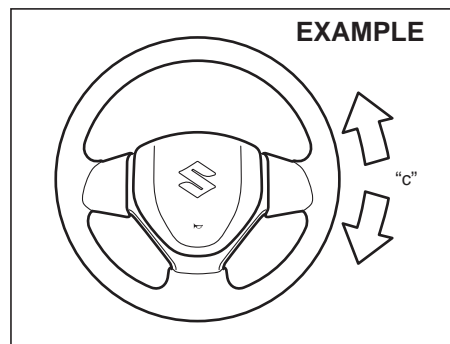

68LM708

Steering wheel play "c":
0 – 30 mm (0.0 – 1.2 in.)

Check the play of the steering wheel by gently turning it from left to right and measuring the distance that it moves before

you feel slight resistance. The play should be between the specified values.

Check that the steering wheel turns easily and smoothly without rattling by turning it all the way to the right and to the left while driving very slowly in an open area. If the amount of free play is outside the specification or you find anything else to be wrong, an inspection must be performed by your MARUTI SUZUKI dealer.

Tyres

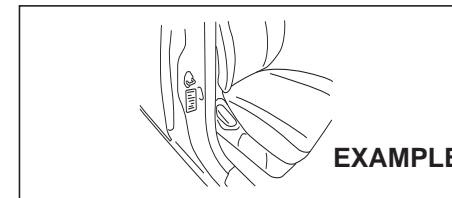

74LHT0704

The front and rear tyre pressure specifications for your vehicle are listed on the Tyre Information Label. Both the front and rear tyres should have the specified tyre pressure.

Tyre Inspection

Inspect your vehicle's tyres at least once a month by performing the following checks:

- 1) Measure the air pressure with a tyre gauge. Adjust the pressure if necessary. Remember to check the spare tyre, too.

INSPECTION AND MAINTENANCE

▲ WARNING

- Air pressures should be checked when the tyres are cold or you may get inaccurate readings.
- Check the inflation pressure from time to time while inflating the tyre gradually, until the specified pressure is obtained.
- Never underinflate or overinflate the tyres.
Underinflation can cause unusual handling characteristics or can cause the rim to slip on the tyre bead, resulting in an accident or damage to the tyre or rim.
Overinflation can cause the tyre to burst, resulting in personal injury. Overinflation can also cause unusual handling characteristics which may result in an accident.

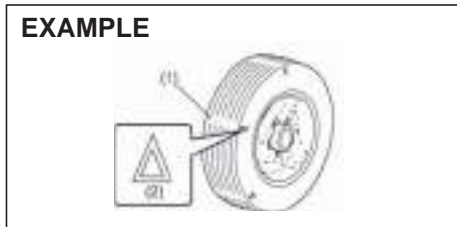

54G136

- (1) Tread wear indicator
- (2) Indicator location mark

- 2) Check that the depth of the tread groove is more than 1.6 mm (0.06 in.). To help you check this, the tyres have molded-in tread wear indicators in the grooves. When the indicators appear on the tread surface, the remaining depth of the tread is 1.6 mm (0.06 in.) or less and the tyre should be replaced.
- 3) Check for abnormal wear, cracks and damage. Any tyres with cracks or other damage should be replaced. If any tyres show abnormal wear, have them inspected by your MARUTI SUZUKI dealer.

▲ CAUTION

Hitting curbs and running over rocks can damage tyres and affect wheel alignment. Be sure to have tyres and wheel alignment checked periodically by your MARUTI SUZUKI dealer.

- 4) Check for loose wheel nuts.
- 5) Check that there are no nails, stones or other objects sticking into the tyres.

▲ WARNING

- Your MARUTI SUZUKI is equipped with tyres which are all the same type and size. This is important to ensure proper steering and handling of the vehicle. Never mix tyres of different size or type on the four wheels of your vehicle. The size and type of tyres used should be only those approved by MARUTI SUZUKI as standard or optional equipment for your vehicle.
- Replacing the wheels and tyres equipped on your vehicle with certain combinations of aftermarket wheels and tyres can significantly change the steering and handling characteristics of your vehicle.
- Therefore, use only those wheel and tyre combinations approved by MARUTI SUZUKI as standard or optional equipment for your vehicle.

NOTICE

Replacing the original tyres with tyres of a different size may result in false speedometer or odometer readings.

INSPECTION AND MAINTENANCE

Tyre Rotation

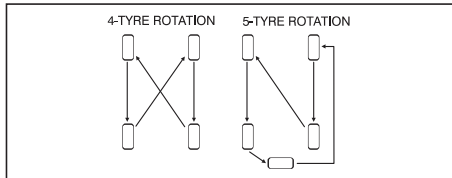

60G-09-019E

To avoid uneven wear of your tyres and to prolong their life, rotate the tyres as illustrated. Tyres should be rotated as mentioned in periodic maintenance schedule. After rotation, adjust front and rear tyre pressures to the specification listed on your vehicle's Tyre Inflation Pressure Label.

Wheel Balancing

If the vehicle vibrates abnormally on smooth road, have the wheel balanced at Maruti Suzuki Authorized Workshop.

Wheel Alignment

In case of abnormal tyre wear or pulling towards one side, have the wheel aligned at Maruti Suzuki Authorized Workshop.

Tubeless Tyres (If equipped)

The vehicle is equipped with Tubeless Tyres. In tubeless tyre, a thin layer of butyl rubber is used for lining the inside of the tubeless tyre. This layer is to prevent air loss and fulfilling the purpose of tube. The air pressure is maintained by the sealing

between tyre bead and wheel rim. Tubeless tyres are having advantage of slow air loss and preventing sudden deflation while driving.

Care and maintenance tips for tubeless tyres

- 1) Always maintain recommended inflation pressure. Driving continuously at low inflation pressure can lead to tyre damage.
- 2) In case any leakage is found, check for any nail penetration/valve core damage or rim bent. Damaged wheel must not be used.
- 3) In case tyre has run at low pressure, it must be inspected for any defect.
- 4) Whenever new tyre is fitted, replace the valve.
- 5) If continuous high speed driving is required, increase tyre pressure by 5 psi over recommended inflation pressure.
- 6) Never run the tyre beyond TWI (Tread wear indicator). The tyre is recommended to be replaced when the remaining tread has worn to this point. The indicators are spaced across the tread around the tyre marked by a triangular symbol (TWI).
- 7) Always prefer tubeless tyre mounting machine. In case of manual mounting-tyre/wheel rim damage may occur.
- 8) In case of any problem, please get in touch with MARUTI SUZUKI Authorized workshop.

Temporary Spare Tire (if equipped)

Your vehicle comes equipped with the temporary spare tire. It is only intended for temporary emergency use, until the conventional tire can be repaired or replaced. The inflation pressure of the temporary spare tire should be checked at least monthly. At the same time, check that the tire is stored securely. If it is not, tighten it.

Note that two or more temporary spare tires should not be used on one vehicle simultaneously.

INSPECTION AND MAINTENANCE

⚠ WARNING

The temporary spare tire and wheel are intended for temporary emergency use only. Continuous use of this spare can result in tire failure and loss of control. Always observe these precautions when using this spare:

- Your vehicle will handle differently with this temporary spare.
- Do not exceed 80 km/h speed (only vehicle with 185/65R15 tire).
- Replace this spare with a standard tire and wheel as soon as possible.
- Use of this spare will reduce ground clearance.
- Set the specified tire pressure indicated on the tire information label located on the driver's door lock pillar.
- Do not use tire chains on the temporary spare. If you must use tire chains, rearrange the wheels so standard tires and wheels are fitted to the front axle.
- The temporary spare tire has a much shorter tread life than the conventional tires on your vehicle. Replace the tire as soon as the tread wear indicator appears.
- When replacing the temporary spare tire, use a replacement tire with the exact same size and construction.

Battery

⚠ WARNING

- Batteries produce flammable hydrogen gas. Keep flames and sparks away from the battery or an explosion may occur. Never smoke when working in the vicinity of the battery.
- When checking or servicing the battery, disconnect the negative cable. Be careful not to cause a short circuit by allowing metal objects to contact the battery posts and the vehicle at the same time.
- To avoid harm to yourself or damage to your vehicle or battery, follow the jump starting instructions in the "EMERGENCY SERVICE" section of this manual if it is necessary to jump start your vehicle.

Petrol

EXAMPLE-1

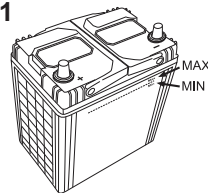

54G118

EXAMPLE-2

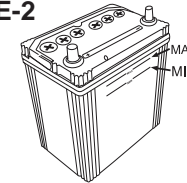

Diesel

EXAMPLE

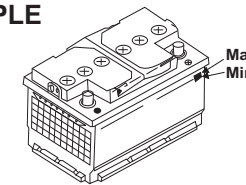

The level of the battery solution must be kept between the "Max" and the "Min" level lines at all times. If the level is found to be below the "Min" level line, add distilled water to bring level between "Max" and "Min". You should, however, periodically check the battery, battery terminals and battery holddown bracket for corrosion. Remove corrosion using a stiff brush and ammonia mixed with water, or baking soda mixed with water. After removing corrosion, rinse with clean water.

If your vehicle is not going to be driven for a month or longer, disconnect the cable from the negative terminal of the battery to help prevent discharge..

INSPECTION AND MAINTENANCE

Replacement of the battery

TYPE 1

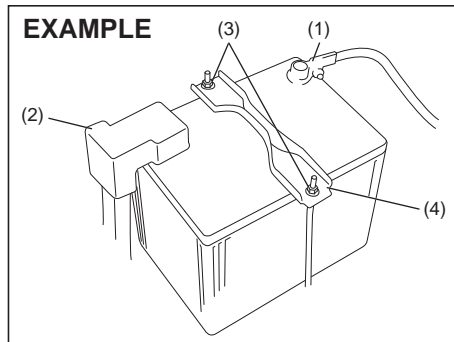

51KM038

TYPE 2

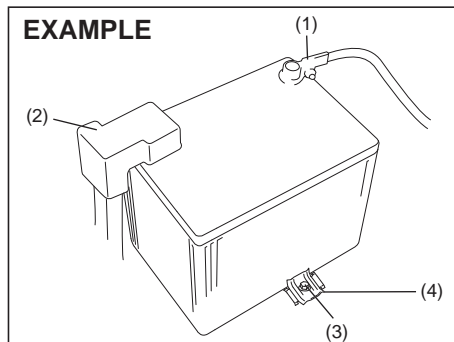

51KM039

To remove the battery:

- 1) Disconnect the negative cable (1).
- 2) Disconnect the positive cable (2).

For Type 1

- 3) Remove the retainer nuts (3) and remove the retainer (4).

For Type 2

- 3) Remove the bracket bolt (3) and remove the bracket (4).
- 4) Remove the battery.

NOTICE

- Ensure that battery should not be removed without cover assembly.
- When the battery is reassembled into the vehicle, kindly ensure that battery cover is also installed along with battery.

To install the battery:

- 1) Install the battery in the reverse order of removal.
- 2) Tighten the retainer nuts and battery cables securely.

NOTE:

When the battery is disconnected, some of the vehicle's function will be initialized and/or deactivated.

These function are required to reset after the battery is reconnected.

Fuses

Your vehicle has three types of fuses, as described below:

Main fuse

The main fuse takes current directly from the battery.

Primary fuses

These fuses are between the main fuse and individual fuses, and are for electrical load groups.

Individual fuses

These fuses are for individual electrical circuits.

Fuses in the Engine Compartment

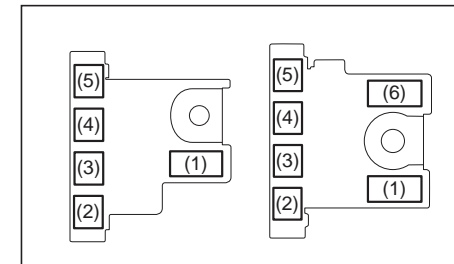

74LHT0715

INSPECTION AND MAINTENANCE

(Swift)

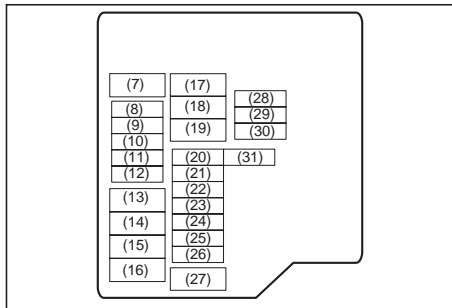

MAIN FUSE / PRIMARY FUSE		
(1)	100 A	FL1 (GAS)
	120 A	FL1 (DIESEL)
(2)	100 A	FL2
(3)	100 A	FL3
(4)	50 A	FL4
(5)	80 A	FL5
(6)	100 A	FL6
(7)	50 A	Ignition switch -2
(8)	7.5 A	ECM
(9)	–	Blank
(10)	20 A	F/P (DIESEL)

(11)	10 A	Air compressor
(12)	15 A	FI (PETROL)
(13)	30 A	FI (DIESEL)
(14)	60 A	Power steering
(15)	30 A	Radiator fan
(16)	40 A	ABS motor
(17)	30 A	Blower fan
(18)	30 A	Starting motor
(19)	–	Blank
(20)	30 A	Accessory
(21)	–	Blank
(22)	15 A	Head light (Left)
(23)	25 A	ABS control module
(24)	15 A	Head light (Right)
(25)	20 A	Front fog light
(26)	–	Blank
(27)	40 A	Ignition switch
(28)	20 A	INJ DRV (DIESEL)
(29)	10 A	FI 2 (DIESEL)
(30)	–	Blank
(31)	7.5 A	Starting signal

Swift Deziire

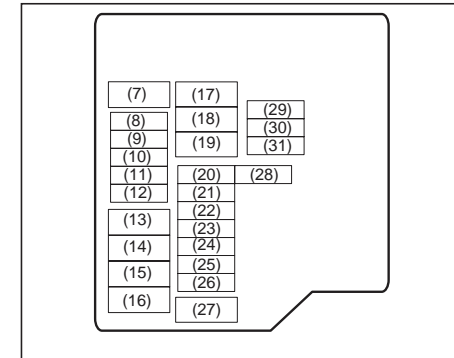

74LHT0716

MAIN FUSE / PRIMARY FUSE		
(1)	100 A	FL1 (GAS)
	120 A	FL1 (DIESEL)
(2)	100 A	FL2
(3)	100 A	FL3
(4)	50 A	FL4
(5)	80 A	FL5
(6)	100 A	FL6
(7)	50 A	Ignition switch -2
(8)	7.5 A	ECM
(9)	15 A	Automatic Transmission Relay

INSPECTION AND MAINTENANCE

(10)	–	Blank
(11)	10 A	Air compressor
(12)	15 A	FI (GAS)
(13)	30 A	FI (DIESEL)
(14)	60 A	Power steering
(15)	30 A	Radiator fan
(16)	40 A	ABS motor
(17)	30 A	Blower fan
(18)	30 A	Starting motor
(19)	–	Blank
(20)	30 A	Accessory
(21)	–	Blank
(22)	15 A	Head light (Left)
(23)	25 A	ABS control module
(24)	15 A	Head light (Right)
(25)	20 A	Front fog light
(26)	–	Blank
(27)	40 A	Ignition switch
(28)	7.5 A	Starting Signal
(29)	20 A	INJ DRV (DIESEL)
(30)	10 A	FL 2 (DIESEL)
(31)	15 A	F/P (DIESEL)

The main fuse, primary fuses and some of the individual fuses are located in the engine compartment. If the main fuse blows, no electrical component will function. If a primary fuse blows, no electrical component in the corresponding load group will function. When replacing the main fuse, a primary fuse or an individual fuse, use a MARUTI genuine replacement.

To remove a fuse, use the fuse puller provided in the fuse box. The amperage of each fuse is shown in the back of the fuse box cover.

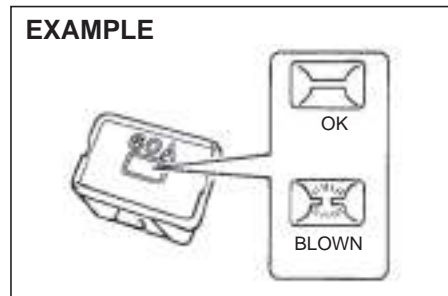

60G111

⚠ WARNING

If the main fuse or a primary fuse blows, be sure to have your vehicle inspected by an authorized MARUTI SUZUKI dealer. Always use a genuine MARUTI replacement. Never use a substitute such as a wire even for a temporary repair, or extensive electrical damage and a fire can result.

NOTE:

Make sure that the fuse box always carries spare fuses.

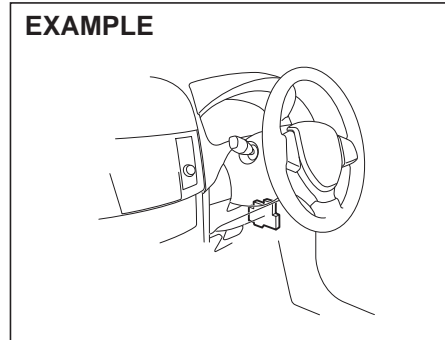
Fuses under the Dash Board**EXAMPLE**

74LHT0711

Battery: 9
Fuses: 7

INSPECTION AND MAINTENANCE

(Vehicle with keyless push start system)

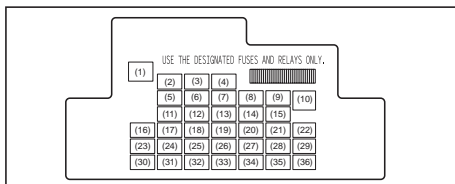

PRIMARY FUSE		
(1)	30 A	Belt
(2)	20 A	Power window
(3)	20 A	Steering Lock
(4)	20 A	Rear defogger
(5)	–	Blank
(6)	–	Blank
(7)	–	Blank
(8)	7.5 A	Starting Signal
(9)	15 A	ACC-2
(10)	30 A	Power window
(11)	10 A	Hazard
(12)	7.5 A	BLANK
(13)	15 A	Ignition coil
(14)	10 A	ABS control module

(15)	15 A	ACC
(16)	–	Blank
(17)	15 A	Horn
(18)	10 A	Stop light
(19)	10 A	Air bag
(20)	10 A	Back-up light
(21)	15 A	Rear wiper / Washer
(22)	25 A	Front wiper
(23)	7.5 A	Dome light
(24)	–	Blank
(25)	7.5 A	RR fog lamp
(26)	–	Blank
(27)	7.5 A	Ignition-1 signal
(28)	15 A	Radio 2
(29)	10 A	ACC 3
(30)	15 A	Radio
(31)	10 A	Tail lamp
(32)	20 A	D/L
(33)	7.5 A	CRUISE
(34)	10 A	Meter
(35)	7.5 A	Ignition-2 signal
(36)	–	Blank

(Vehicle without keyless push start system)

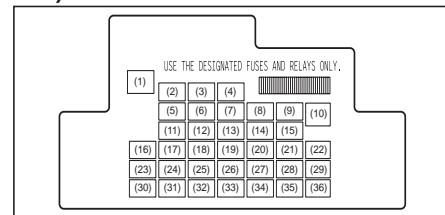

68LM701

PRIMARY FUSE		
(1)	30 A	Belt
(2)	–	Blank
(3)	–	Blank
(4)	20 A	Rear defogger
(5)	–	Blank
(6)	–	Blank
(7)	–	Blank
(8)	7.5 A	Starting Signal
(9)	15 A	ACC-2
(10)	30 A	Power window
(11)	10 A	Hazard
(12)	–	BLANK
(13)	15 A	Ignition coil
(14)	10 A	ABS control module

INSPECTION AND MAINTENANCE

(14)	10 A	ABS control module
(15)	15 A	ACC
(16)	–	Blank
(17)	15 A	Horn
(18)	10 A	Stop light
(19)	10 A	Air bag
(20)	10 A	Back-up light
(21)	15 A	Rear wiper / Washer
(22)	25 A	Front wiper
(23)	7.5 A	Dome light
(24)	–	Blank
(25)	7.5 A	RR fog lamp
(26)	–	Blank
(27)	7.5 A	Ignition-1 signal
(28)	–	Blank
(29)	–	Blank
(30)	15 A	Radio
(31)	10 A	Tail lamp
(32)	20 A	D/L
(33)	7.5 A	Stop lamp sw / Clutch sw
(34)	10 A	Meter
(35)	7.5 A	Ignition-2 signal

(36)	–	Blank
------	---	-------

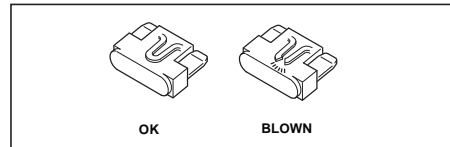

⚠ WARNING

Always be sure to replace a blown fuse with a fuse of the correct amperage. Never use a substitute such as aluminum foil or wire to replace a blown fuse. If you replace a fuse and the new one blows in a short period of time, you may have a major electrical problem. Have your vehicle inspected immediately by your **MARUTI SUZUKI** dealer.

Bulb Replacement

⚠ WARNING

- Light bulbs can be hot enough to burn your finger right after being turned off. This is true especially for halogen headlight bulbs. Replace the bulbs after they become cool enough.
- The headlight bulbs are filled with pressurized halogen gas. They can burst and injure you if they are hit or dropped. Handle them carefully.

NOTICE

The oils from your skin may cause a halogen bulb to overheat and burst when the lights are on. Grasp a new bulb with a clean cloth.

NOTICE

Frequent replacement of a bulb indicates the need for an inspection of the electrical system. This should be carried out by your **MARUTI SUZUKI** dealer.

INSPECTION AND MAINTENANCE

Front Interior Light

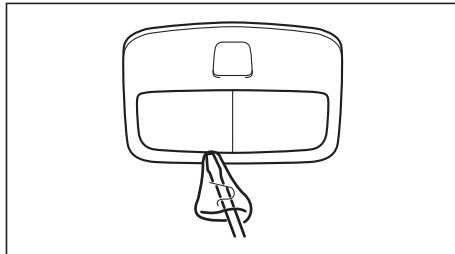

60G114

Center Interior Light

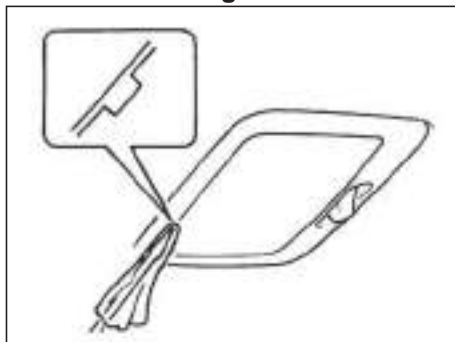

60G115

Pull down the lens by using a Plane screwdriver covered with a soft cloth as shown. To install it, simply push it back in. The bulb can be removed by simply pulling it out. When replacing the bulb, make sure that the contact springs are holding the bulb securely.

Headlight

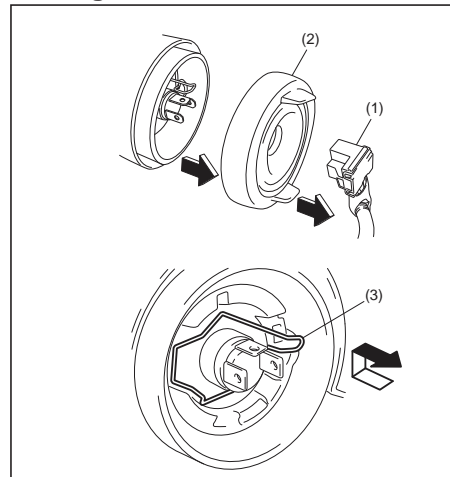

80JM069

Open the engine hood. Disconnect the coupler (1). Remove the sealing rubber (2). Push the retaining spring (3) forward and unhook it. Then remove the bulb. Install a new bulb in the reverse order of removal.

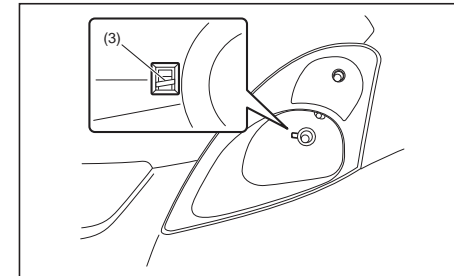

68LM713

NOTE:

You can see the position of retaining spring (3) from the hole of headlight.

Side Turn Signal Light (if equipped)

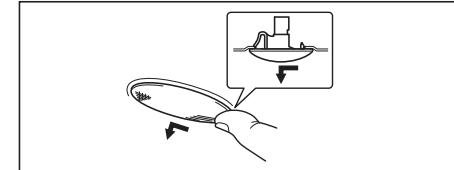

64J195

If the bulb is fused then only bulb can be replaced by taking out the side Turn lamp. Remove the light assembly by sliding the light housing leftward with your finger. For LED type, if LED's are not working then outside Rear view mirror needs to be replaced.

Other General Lights

Bulb holder

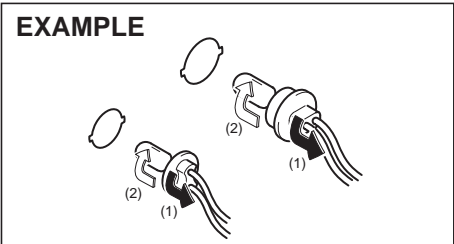

54G123

- (1) Removal
- (2) Installation

To remove a bulb holder from a light housing, turn the holder counterclockwise and pull it out. To install the holder, push the holder in and turn it clockwise.

Bulb

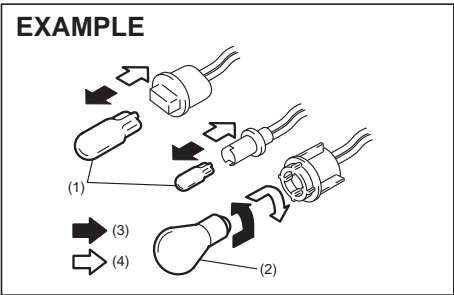

54G124

- (3) Removal
- (4) Installation

There are two types of bulb, "Full glass type" (1) and "Glass/metal type" (2).

To remove and install a full glass type bulb (1), simply pull out or push in the bulb.

To remove a glass metal type bulb (2) from a bulb holder, push in the bulb and turn it counterclockwise. To install a new bulb, push it in and turn it clockwise.

You can access the individual bulb or bulb holders as follows.

**Front turn signal light (1)
Front position light (2)**

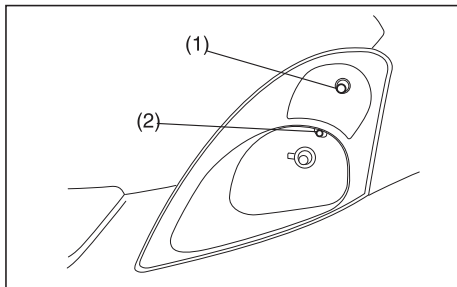

68LM714

Front fog light (if equipped)

1) Start the engine. Turn the steering wheel to the opposite side of the replacing fog light to replace the bulb easily. Then turn off the engine.

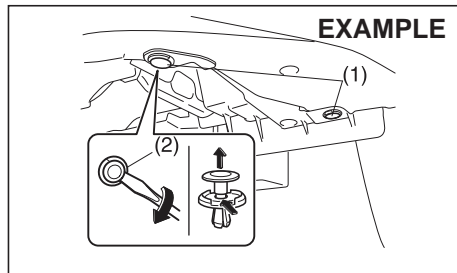

68LM715

2) Insert a flat blade screwdriver into the hole (2) and remove the clips (1) by twist the driver as shown in the illustration.

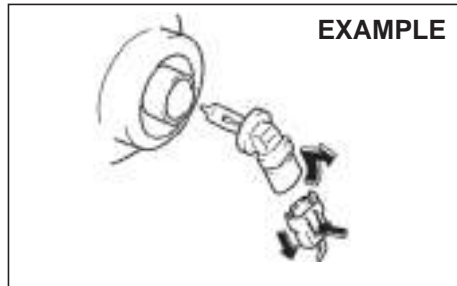

80JM071

3) Open the fender cover. Disconnect the coupler with pushing the lock release. Turn the bulb holder counterclockwise and remove it.

INSPECTION AND MAINTENANCE

Rear combination light (tail, stop, turn signal, etc.)

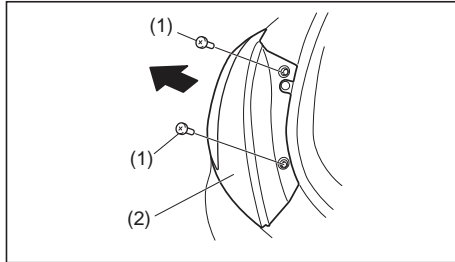

68LM704

Remove the screw (1). Remove the combination light (2) by pulling it outside.

License plate light

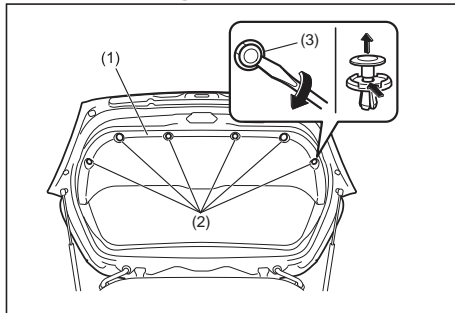

68LM705

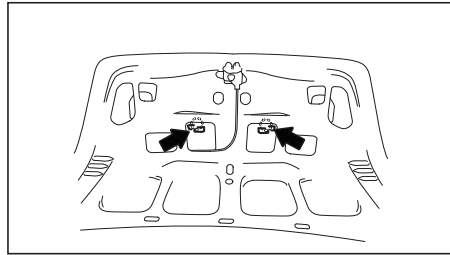

To remove licence plate light, cover trim on the license lamp needs to be removed. To open the trim (1), insert a flat blade screw driver into the hole (3) and remove the clips (2) by twisting the driver as shown in the figure. Then after pushing the license lamp it can be taken out.

Luggage compartment light (if equipped)

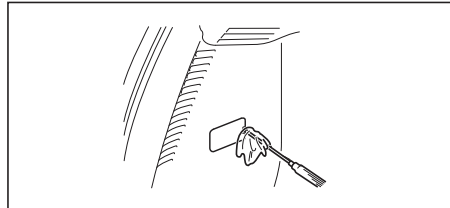

68LM717

Trunk Room Light (if equipped)

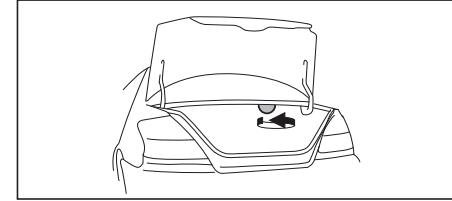

High-mount stop light

Swift

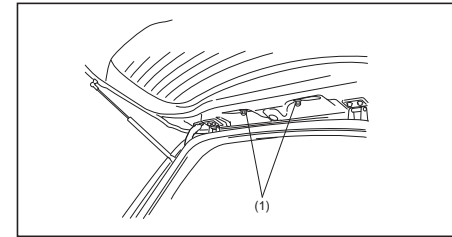

80J100

To remove a high-mount stop light housing the following procedure:

- 1) Open the tailgate, and remove the nuts (1) as shown in the illustration.

INSPECTION AND MAINTENANCE

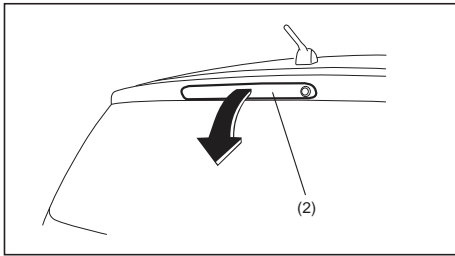

63J127

- 2) Close the tailgate. Remove a high-mounted stop light housing (2) from the tailgate.

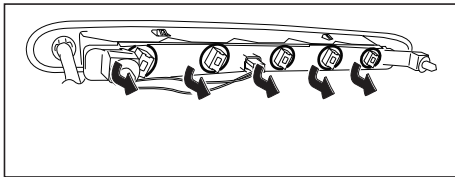

74LHT0712

- 3) Remove the each bulb.
- 4) Replace the bulbs.
To install a high-mounted stop light housing in the reverse order of removal.

Swift Dzire

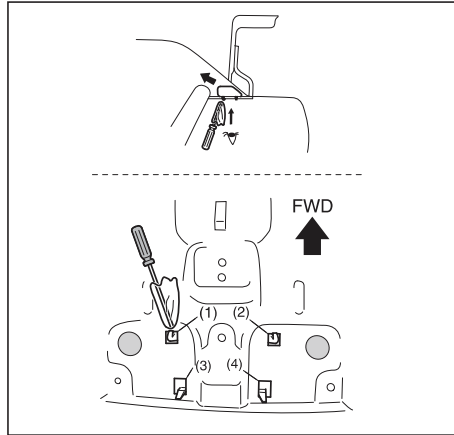

Wiper Blades



54G129

If the wiper blades become brittle or damaged, or make streaks when wiping, replace the wiper blades.

To install new wiper blades, follow the procedures below.

NOTICE

To avoid scratching or breaking the window, do not let the wiper arm strike the window while replacing the wiper blade.

NOTE:

Some wiper blades may be different from the ones described here depending on vehicle specifications. If so, consult your MARUTI SUZUKI dealer for proper replacement method.

For windshield wipers:



70G119

- 1) Hold the wiper arm away from the window.

NOTE:

When raising both of the front wiper arms, pull the driver's side wiper arm up first. When returning the wiper arms, lower the passenger's side wiper arm first. Otherwise, the wiper arms may interfere with each other.

INSPECTION AND MAINTENANCE

EXAMPLE

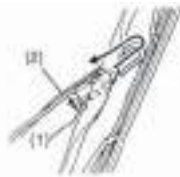

EXAMPLE



54G130

- 2) Squeeze lock (1) towards wiper arm (2) and remove the wiper frame from the arm as shown.
- 3) Unlock the lock end of the wiper blade and slide the blade out as shown.

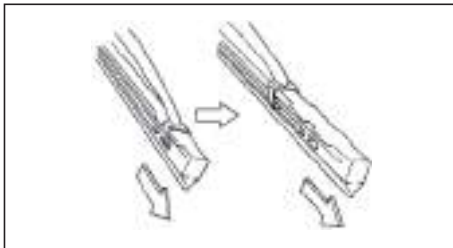

60A260

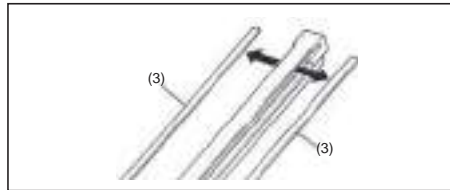

71LMT0708

- (3) Retainer
- 4) If the new blade is provided without the two metal retainers, move them from the old blade to the new one.

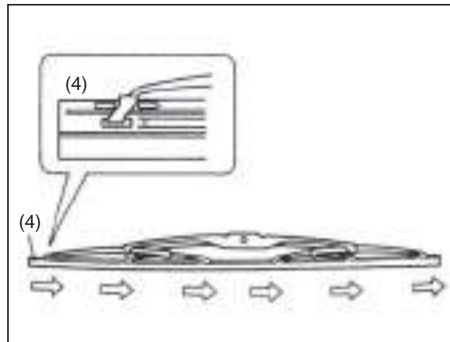

71LMT0707

- (4) Locked end
- 5) Install the new blade in the reverse order of removal, with the locked end positioned toward the wiper arm. Make sure the blade is properly

retained by all the hooks. Lock the blade end into place.

- 6) Reinstall wiper frame to arm, making sure that the lock lever is snapped securely into the arm.

For rear wipers:

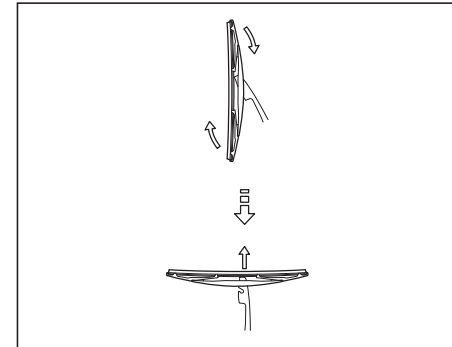

80G146

- 1) Hold the wiper arm away from the window.
- 2) Remove the wiper frame from the arm as shown.
- 3) Slide the blade out as shown.

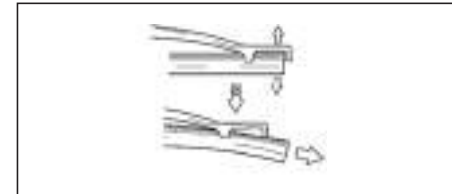

65D151

NOTE:
Do not flex the wiper blade frame end more than necessary. If you do, it can break off.

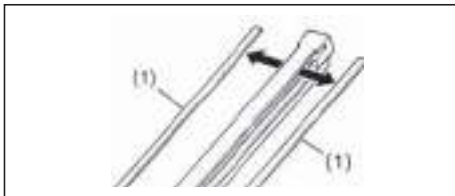

54G135

(1) Retainer

- 4) If the new blade is provided without the two metal retainers, move them from the old blade to the new one.
- 5) Install the new blade in the reverse order of removal.
Make sure the blade is properly retained by all the hooks.
- 6) Reinstall wiper frame to arm in the reverse order of removal.

Windshield Washer Fluid

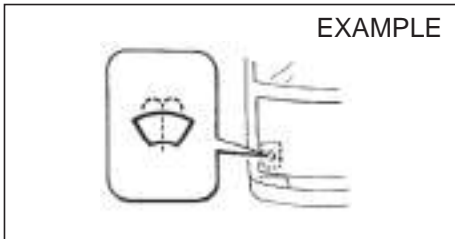

80JM078

Check that there is washer fluid in the tank. Refill it if necessary. Use a good quality windshield washer fluid, diluted with water as necessary.

⚠ WARNING

Do not use “anti-freeze” solution in the windshield washer reservoir. This can severely impair visibility when sprayed on the windshield, and also damage your vehicle’s paint.

NOTICE

Damage may result if the washer motor is operated with no fluid in the washer tank.

Air Conditioning System

If you do not use the air conditioner for a long period, such as during winter, it may not give the best performance when you start using it again. To help maintain optimum performance and durability of your air conditioner, it needs to be run periodically. Operate the air conditioner at least once a month for one minute with the engine idling. This circulates the refrigerant and oil and helps protect the internal components.

EMERGENCY SERVICE

Tire Changing Tool 8-1
Jacking Instructions 8-2
Jump Starting Instructions 8-5
Towing 8-6
If the Starter Does Not Operate 8-7
If the Engine is Flooded 8-7
If the Engine Overheats 8-8

EMERGENCY SERVICE

Tyre Changing Tool

Spare tyre and tyre changing tool

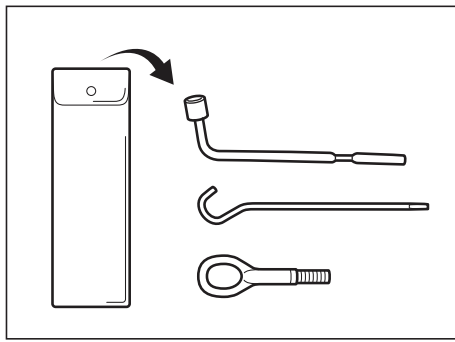
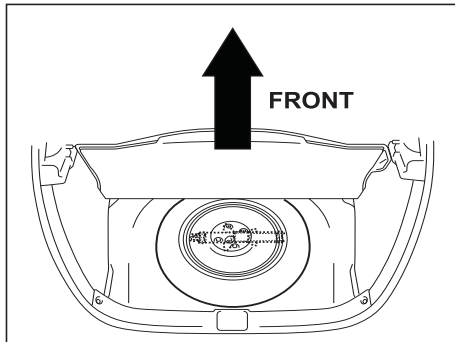

The jack, is stowed just under the spare tyre in the luggage compartment.

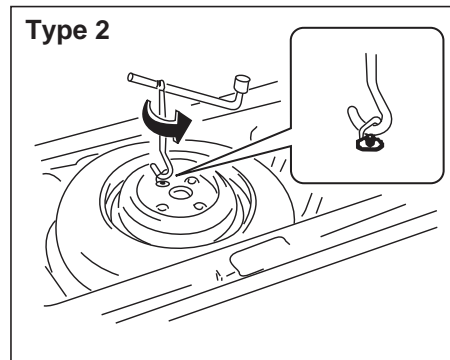
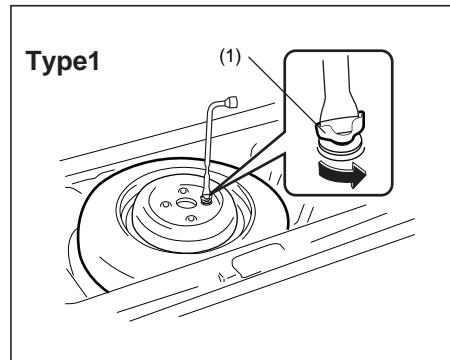

To remove the spare tyre, turn its bolt (1) counterclockwise by using the tools as shown in the figure and remove it.

NOTICE

When stowing the jack, place the shaft facing to the left as shown in the illustration. Otherwise the jack cannot be held securely in place in the storage bracket.

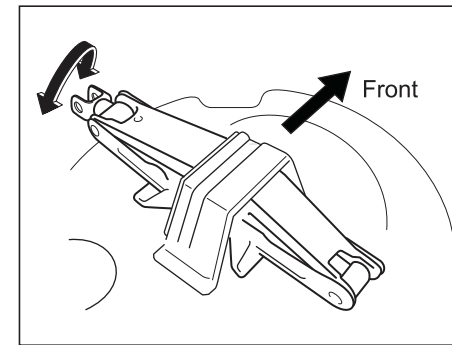

To remove the jack, turn its shaft counterclockwise and pull the jack out of the storage bracket.

To stow the jack, place it in the storage bracket and turn the shaft clockwise until the jack is securely held in place.

⚠ WARNING

After using the tyre changing tools, be sure to stow them securely or they can cause injury if an accident occurs.

⚠ CAUTION

The jack should be used only to change wheels. It is important to read the jacking instructions in this section before attempting to use the jack.

Jacking Instructions

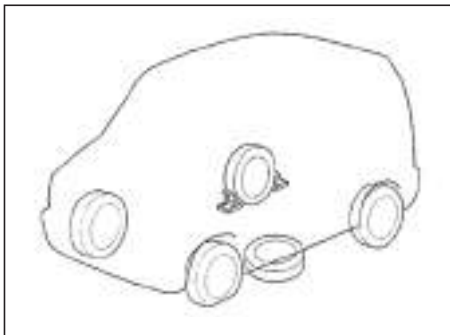

75F062

- 1) Place the vehicle on level, hard ground.
- 2) Set the parking brake firmly and shift into "R" (Reverse).

⚠ WARNING

- Be sure to shift into "R" (Reverse) when you jack up the vehicle.
- Never jack up the vehicle with the transmission in "N" (Neutral). Otherwise, unstable jack may cause an accident.

- 3) Turn on the hazard warning flasher if your vehicle is near traffic.
- 4) Block the front and rear of the wheel diagonally opposite of the wheel being lifted.
- 5) Place the spare wheel near the wheel being lifted as shown in the illustration in case that the jack slips.

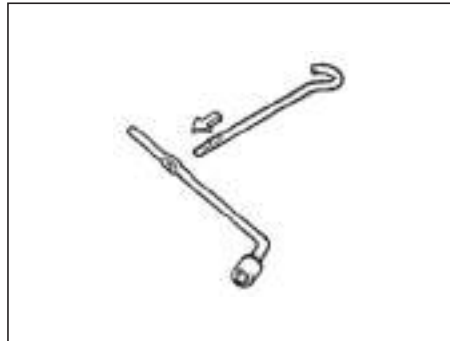

54G253

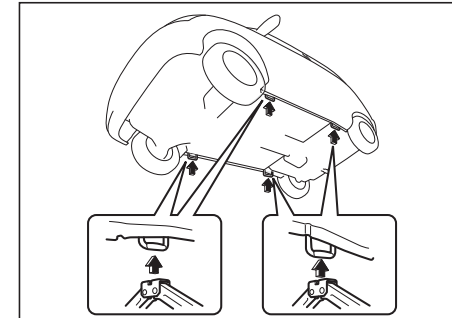

63J100

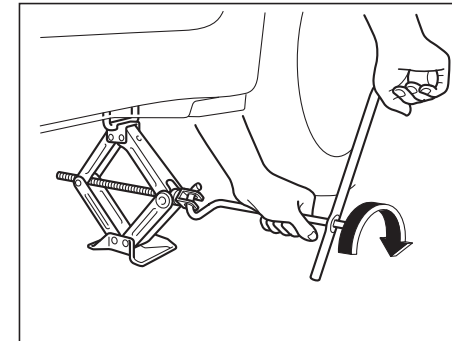

63J101

- 6) Position the jack vertically as shown in the illustration and raise the jack by turning the jack handle clockwise until the jack-head groove fits around the jacking bar beneath the vehicle body.

Jacking Instructions: 5

EMERGENCY SERVICE

- 7) Continue to raise the jack slowly and smoothly until the tyre clears the ground. Do not raise the vehicle more than necessary.

⚠ CAUTION

Never jack up the vehicle with passengers inside the vehicle.

To Raise the Vehicle with a Garage Jack

- Apply the garage jack to one of the points indicated below.
- Always support the raised vehicle with jack stands (commercially available) at the points indicated below.

- 1) Front
- 2) Jack stand
- 3) Jacking point for onboard jack
- 4) Rear
- 5) Front suspension frame
- 6) Frame hook
- 7) Jacking point for garage jack
- 8) Application point for two-column lift and jack stand

NOTICE

Never apply a garage jack to the exhaust pipe or engine undercover and rear torsion beam.

NOTE:

For more details, please contact an authorized MARUTI SUZUKI dealer.

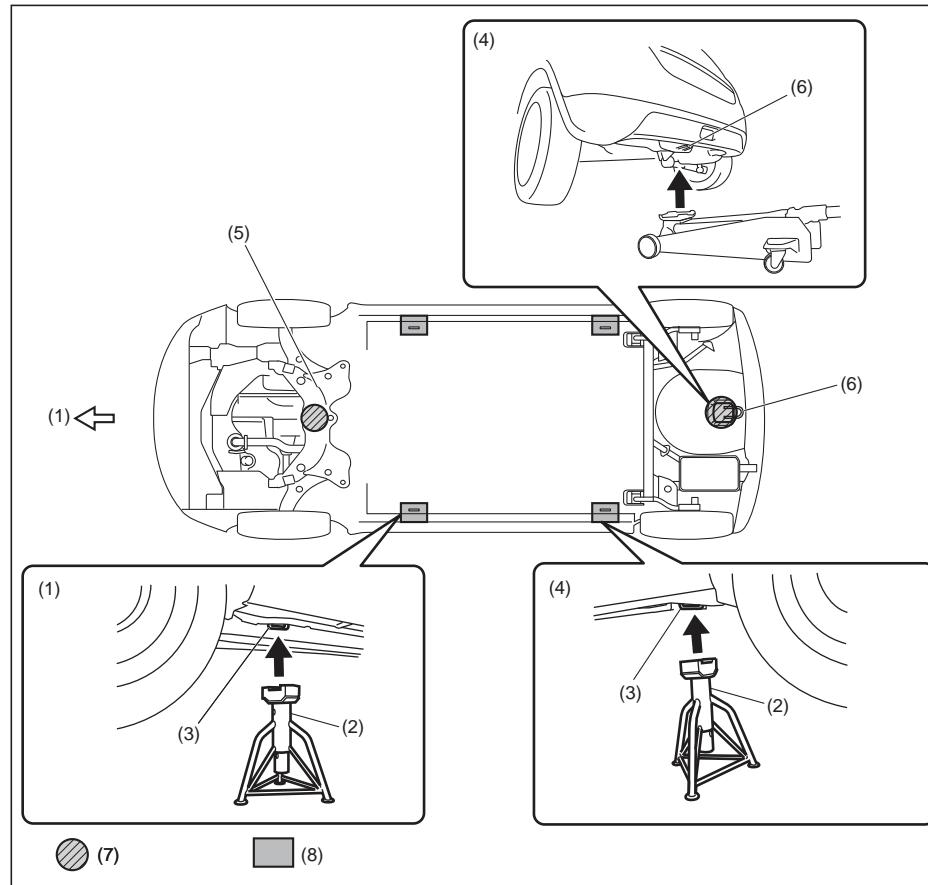

⚠ WARNING

- Use the jack only to change wheels on level, hard ground.
- Never jack up the vehicle on an inclined surface.
- Never raise the vehicle with the jack in a location other than the specified jacking point (shown in the illustration) near the wheel to be changed.
- Especially, do not raise the vehicle with a jack at a part of the torsion beam which is located under the vehicle body, between rear wheels.
- Make sure that the jack is raised at least 51 mm (2 inches) before it contacts the suspension arm boss. Use of the jack when it is within 51 mm (2 inches) of being fully collapsed may result in failure of the jack.
- Never get under the vehicle when it is supported by the jack.
- Never run the engine when the vehicle is supported by the jack and never allow passengers to remain in the vehicle.

Changing Wheels

To change a wheel, use the following procedure:

- 1) Clear all passengers and luggage from the vehicle.

NOTE:

The Jack and tools are located under the spare wheel.

- 2) Remove the jack, tools and spare wheel from the vehicle.
- 3) Loosen, but do not remove the wheel nuts.
- 4) Jack up the vehicle (follow the jacking instructions in this section).

⚠ WARNING

- Be sure to shift into "R" (Reverse) when you jack up the vehicle.
- Never jack up the vehicle with the Transmission in "N" (Neutral). Otherwise, unstable jack may cause an accident.

- 5) Remove the wheel nuts and wheel.
- 6) Before installing the new wheel, clean any mud or dirt off from the surface of the wheel and hub with a clean cloth. Clean the hub carefully; it may be hot from driving.
- 7) Install the new wheel and replace the wheel nuts with their cone shaped end facing the wheel. Tighten each nuts snugly by hand until the wheel is securely seated on the hub.

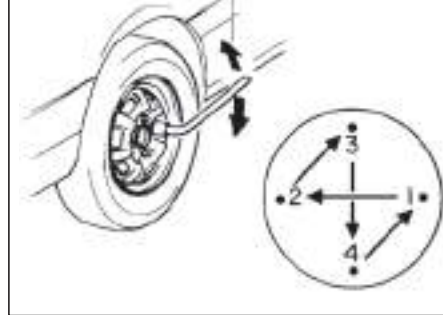
EXAMPLE

54G116

Tightening torque for wheel nuts
85 Nm (8.5 kg-m, 61.5 lb-ft)

- 8) Lower the jack and fully tighten the nuts in a crisscross fashion with a wrench as shown in the illustration.

⚠ WARNING

Use MARUTI genuine wheel nuts and tighten them to the specified torque as soon as possible after changing wheels. Incorrect wheel nuts or improperly tightened wheel nuts may come loose or fall off, which can result in an accident. If you do not have a torque wrench, have the wheel nuts torque checked by an authorized MARUTI SUZUKI dealer.

EMERGENCY SERVICE

Full Wheel Cover (if equipped)

EXAMPLE

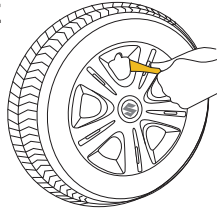

60G309

Insert a piece of cloth between the spokes of the wheel cover and try to pull the cover outward (as shown in figure). Take out the detached wheel cover from the wheel rim. For installation first match the slot at the wheel cover with the air filling nozzle of the wheel. Apply equal pressure at the circumference of the wheel cover to fix it in the wheel rim.

EXAMPLE

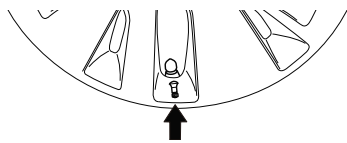

74LHT0860

When installing the cover, make sure that it is positioned so that it does not cover or foul the air valve.

Jump Starting Instructions

⚠ WARNING

- Never attempt to jump start your vehicle if the battery appears to be frozen. Batteries in this condition may explode or rupture if jump starting is attempted.
- When making jump lead connections, be certain that your hands and the jump leads remain clear from pulleys, belts, or fans.
- Batteries produce flammable hydrogen gas. Keep flames and sparks away from the battery or an explosion may occur. Never smoke when working in the vicinity of the battery.
- If the booster battery you use for jump starting is installed in another vehicle, make sure the two vehicles are not touching each other.
- If your battery discharges repeatedly, for no apparent reason, have your vehicle inspected by an authorized MARUTI SUZUKI dealer.
- To avoid harm to yourself or damage to your vehicle or battery, follow the jump starting instructions below precisely and in order. If you are in doubt, contact your nearest MARUTI SUZUKI authorised workshop.

NOTICE

Your vehicle should not be started by pushing or towing. This starting method could result in permanent damage to the catalytic converter and high pressure fuel pump (diesel) Use jump leads to start a vehicle with a weak or flat battery.

When Jump Starting Your Vehicle, Use the Following Procedure:

- 1) Use only a 12-volt battery to jump start your vehicle. Position the good 12-volt battery close to your vehicle so that the jump leads will reach both batteries. When using a battery installed on another vehicle, DO NOT LET THE VEHICLES TOUCH. Set the parking brakes fully on both vehicles.
- 2) Turn off all vehicle accessories, except those necessary for safety reasons (for example, headlights or hazard lights).

EMERGENCY SERVICE

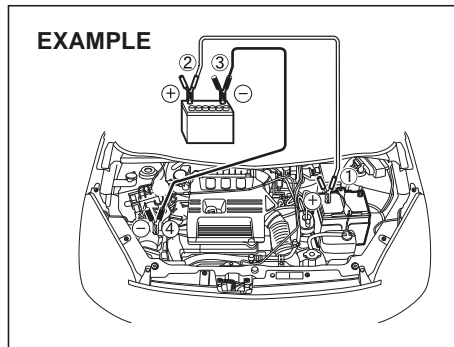

3) Make jump lead connections as follows:

1. Connect one end of the first jump lead to the positive (+) terminal of the flat battery (1).
2. Connect the other end to the positive (+) terminal of the booster battery (2).
3. Connect one end of the second jump lead to the negative (-) terminal of the booster battery (3).
4. Make the final connection to an unpainted, heavy metal part (i.e. engine mounting stud/nut (4)) of the engine of the vehicle with the flat battery (1).

⚠ WARNING

Never connect the jump lead directly to the negative (-) terminal of the discharged battery, or an explosion may occur.

- 4) If the booster battery you are using is fitted to another vehicle, start the engine of the vehicle with the booster battery. Run the engine at moderate speed.
- 5) Start the engine of the vehicle with the flat battery.
- 6) Remove the jump leads in the exact reverse order in which you connected them.

Towing

If you need to have your vehicle towed, contact a Maruti Suzuki authorised dealer/ service stations.

NOTICE

To help avoid damage to your vehicle during towing, proper equipment and towing procedures must be used.

2 Wheel Drive (2WD) Automatic Transmission

Automatic Transmission vehicles may be towed using either of the following methods

- 1) From the front, with the front wheels lifted and the rear wheels on the ground. Before towing, make sure that the parking brake is released.
- 2) From the rear, with the rear wheels lifted and a dolly under the front wheels.

NOTICE

Towing your vehicle with the front wheels on the ground can result in damage to the automatic transmission.

2-Wheel Drive (2WD) Automatic Transaxle

Automatic transaxle vehicles may be towed using either of the following methods.

- 1) From the front, with the front wheels lifted and the rear wheels on the ground. Before towing, make sure that the parking brake is released.
- 2) From the rear, with the rear wheels lifted and a dolly under the front wheels.

NOTICE

Towing the 2WD vehicle with the front wheels on the ground can result in damage to the Automatic trans-axle.

EMERGENCY SERVICE

2-Wheel Drive (2WD) Manual Trans-axle

Manual transaxle vehicles may be towed using either of the following methods.

- 1) From the front, with the front wheels lifted and the rear wheels on the ground. Before towing, make sure that the parking brake is released.
- 2) From the rear, with the rear wheels lifted and the front wheels on the ground, provided the steering and drivetrain are in operational condition. Before towing, make sure that transaxle is in neutral, the steering wheel is unlocked (vehicle without keyless push start system - the ignition key should be in the "ACC" position) (vehicle with keyless push start system - the ignition mode is "ACC"), and the steering wheel is secured with a clamping device designed for towing service.

NOTICE

The steering column is not strong enough to withstand shocks transmitted from the front wheels during towing. Always unlock the steering wheel before towing.

If the Starter Does Not Operate

- 1) Try turning the ignition switch to the "START" position or try pressing the engine switch to change the ignition mode to "START" with the headlights turned on to determine the battery condition. If the headlights go excessively dim or go off, it usually means that either the battery is flat or the battery terminal contact is poor. Recharge the battery or correct battery terminal contact as necessary.
- 2) If the headlights remain bright, check the fuses. If the reason for failure of the starter is not obvious, there may be a major electrical problem. Have the vehicle inspected by your authorized MARUTI SUZUKI dealer.

If the Engine is Flooded (Vehicle without Keyless Push Start System)

If the engine is flooded with Petrol, it may be hard to start. If this happens, press the accelerator pedal all the way to the floor and hold it there while cranking the engine.

- For Petrol engine model, do not operate the starter motor for more than 12 seconds.
- For diesel engine model, do not operate the starter motor for more than 30 seconds.

(Vehicle with Keyless Push Start System)

If the engine is flooded with Petrol, it may be hard to start. If this happens, press the accelerator pedal all the way to the floor and hold it there while cranking the engine.

- For Petrol engine model, do not operate the starter motor for more than 12 seconds.
- For diesel engine model, do not operate the starter motor for more than 30 seconds.

NOTE:

If the engine refuses to start, the starter motor automatically stops after a certain period of time. After the starter motor has automatically stopped or there is anything abnormal in the engine starting system, the starter motor runs only while the engine switch is held pressed.

EMERGENCY SERVICE

If the Engine Overheats

The engine could overheat temporarily under severe driving conditions. If the engine coolant temperature gauge indicates overheating during driving:

- 1) Turn off the air conditioner, if equipped.
- 2) Take the vehicle to a safe place and park.
- 3) Let the engine run at the normal idle speed for a few minutes until the indicator is within the normal, acceptable temperature range between "H" and "C".

⚠ WARNING

If you see or hear escaping steam, stop the vehicle in a safe place and immediately turn off the engine to let it cool. Do not open the hood when steam is present. When the steam can no longer be seen or heard, open the hood to see if the coolant is still boiling. If it is, you must wait until it stops boiling before you proceed.

If the temperature indication does not come down to within the normal, acceptable range:

- 1) Turn off the engine and check that the water pump belt and pulleys are not damaged or slipping. If any abnormality is found, correct it.
- 2) Check the coolant level in the reservoir. If it is found to be lower than the "LOW" line, look for leaks at the radiator, water pump, and radiator and heater hoses. If you locate any leaks that may have caused the overheating, do not run the engine until these problems have been corrected.
- 3) If you do not find a leak, carefully add coolant to the reservoir and then the radiator, if necessary. (Refer to "Engine Coolant" in the "INSPECTION AND MAINTENANCE" section.)

NOTE:

If your engine overheats and you are unsure what to do, contact your MARUTI SUZUKI dealer.

For Petrol



65D350

For Diesel

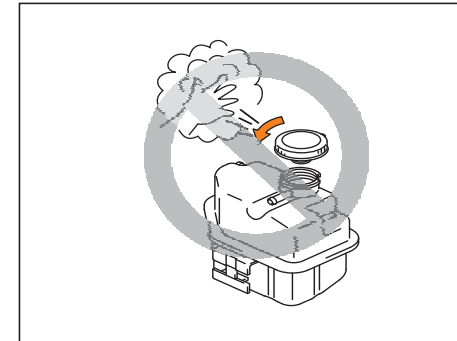

65D350D

EMERGENCY SERVICE

WARNING

- It is hazardous to remove the radiator cap (or degassing tank cap for a diesel engine) when the water temperature is high, because scalding fluid and steam may be blown out under pressure. The cap should only be taken off when the coolant temperature has lowered.
- To help prevent personal injury, keep hands, tools and clothing away from the engine cooling fan and air-conditioner fan (if equipped). These electric fans can automatically turn on without warning.

Warning Triangle

EXAMPLE

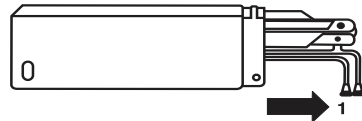

MHO-07-001

In case of vehicle break-down or during emergency stopping, where, your vehicle could become a potential traffic hazard, keep the warning triangle, provided with your vehicle, on the road free from any obstacles behind your vehicle so as to warn the approaching traffic, at an approximate distance of 50-100 m. The reflecting side of the triangle should face the on coming traffic. Please activate the hazard warning lamps before alighting the vehicle to keep the warning triangle.

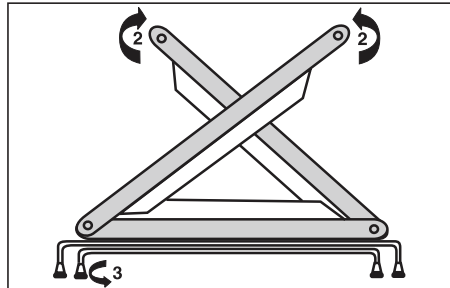

MHO-07-014

- Remove the warning triangle carefully from the cover as shown by arrow 1.
- Open both the reflector arms as shown by arrow and lock the arms with each other with the clip provided in the right arm. Open the bottom stand in counter clock-wise direction as shown by arrow 3. Position the warning triangle behind the vehicle on a plain surface.
- Reverse the removal procedure for keeping inside the cover.

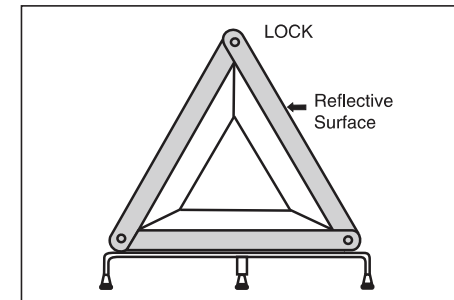

MHO-07-014

APPEARANCE CARE

APPEARANCE CARE

Corrosion Prevention9-1
Vehicle Cleaning9-2

APPEARANCE CARE

APPEARANCE CARE

Corrosion Prevention

It is important to take good care of your vehicle to protect it from corrosion. Listed below are instructions for how to maintain your vehicle to prevent corrosion. Please read and follow these instructions carefully.

Important Information About Corrosion

Common causes of corrosion

- 1) Accumulation of road salt, dirt, moisture, or chemicals in hard-to-reach areas of the vehicle underbody or frame.
- 2) Chipping, scratches and any damage to treated or painted metal surfaces resulting from minor accidents or abrasion by stones and gravel.

Environmental conditions which accelerate corrosion

- 1) Road salt, dust control chemicals, sea air or industrial pollution will all accelerate the corrosion of metal.
- 2) High humidity will increase the rate of corrosion particularly when the temperature range is just above the freezing point.
- 3) Moisture in certain areas of a vehicle for an extended period of time may promote corrosion even though other body sections may be completely dry.

- 4) High temperatures will cause an accelerated rate of corrosion to parts of the vehicle which are not well ventilated to permit quick drying.

This information illustrates the necessity of keeping your vehicle (particularly the underbody) as clean and dry as possible. It is equally important to repair any damage to the paint or protective coatings as soon as possible.

How to Help Prevent Corrosion

Wash your vehicle frequently

The best way to preserve the finish on your vehicle and to help avoid corrosion is to keep it clean with frequent washing. Wash your vehicle at least once during the winter and once immediately after the winter. Keep your vehicle, particularly the underside, as clean and dry as possible. If you frequently drive on salted roads, your vehicle should be washed at least once a month during the winter. If you live near the ocean, your vehicle should be washed at least once a month throughout the year.

For washing instructions, refer to the "Vehicle Cleaning" section.

Remove foreign material deposits

Foreign material such as salts, chemicals, road oil or tar, tree sap, bird droppings and industrial fall-out may damage the finish of your vehicle if it is left on painted surfaces. Remove these types of deposits as quickly as possible. If these deposits are difficult to wash off, an additional cleaner may be required. Be sure that any cleaner you use is not harmful to painted surfaces and is specifically intended for your purposes. Follow the manufacturer's directions when using these special cleaners.

Repair finish damage

Carefully examine your vehicle for damage to the painted surfaces. Should you find any chips or scratches in the paint, touch them up immediately to prevent corrosion from starting. If the chips or scratches have gone through to the bare metal, contact your Maruti Suzuki Authorised Dealer.

Keep passenger and luggage compartments clean

Moisture, dirt or mud can accumulate under the floor mats and may cause corrosion. Occasionally, check under these mats to ensure that this area is clean and dry. More frequent checks are necessary if the vehicle is used off road or in wet weather. Certain cargos such as chemicals, fertilizers, cleaners, salts, etc. are extremely corrosive by nature. These products should be transported in sealed containers. If a spill or leak does occur, clean and dry the area immediately.

APPEARANCE CARE

Store your vehicle in a dry, well-ventilated area

Do not park your vehicle in a damp, poorly ventilated area. If you often wash your vehicle in the garage or if you frequently drive it in when wet, your garage may be damp. The high humidity in the garage may cause or accelerate corrosion. A wet vehicle may corrode even in a heated garage if the ventilation is poor.

⚠ WARNING

Do not apply additional undercoating or rust preventive coating on or around exhaust system components such as the catalytic converter, exhaust pipes, etc. A fire could be started if the undercoating substance becomes overheated.

Vehicle Cleaning



76G044S

⚠ WARNING

When cleaning the interior or exterior of the vehicle, NEVER USE flammable solvents such as lacquer thinners, gasoline, benzene or cleaning materials such as bleaches or strong household detergents. The materials could cause personal injury or damage to the vehicle.

Cleaning the Interior

Vinyl upholstery

Prepare a solution of soap or mild detergent mixed with warm water. Apply the solution to the vinyl with a sponge or soft cloth and let it soak for a few minutes to loosen dirt.

Rub the surface with a clean, damp cloth to remove dirt and the soap solution. If some dirt still remains on the surface, repeat this procedure.

Fabric upholstery

Remove loose dirt with a vacuum cleaner. Using a mild soap solution, rub stained areas with a clean damp cloth. To remove soap, rub the areas again with a cloth dampened with water. Repeat this until the stain is removed, or use a commercial fabric cleaner for tougher stains. If you use a fabric cleaner, carefully follow the manufacturer's instructions and precautions.

Seat belts

Clean seat belts with a mild soap and water. Do not use bleach or dye on the belts. They may weaken the fabric in the belts.

Vinyl floor mats

Ordinary dirt can be removed from vinyl with water or mild soap. Use a brush to help loosen dirt. After the dirt is loosened, rinse the mat thoroughly with water and dry it in the shade.

Carpets

Remove dirt and soil as much as possible with a vacuum cleaner. Using a mild soap solution, rub stained areas with a clean damp cloth. To remove soap, rub the areas again with a cloth dampened with water. Repeat this until the stain is removed, or use a commercial carpet cleaner for tougher stains. If you use a carpet cleaner, carefully follow the manufacturer's instructions and precautions.

Instrument panel and console

NOTE:

Wipe up spills containing chemicals, alcohol, etc., immediately with a soft, damp cloth. Use a mild soap solution if necessary. Do not use cleaners or polishes containing strong solvents or acidic solutions. These chemicals may stain and discolor the instrument panel and console.

APPEARANCE CARE

Cleaning the Exterior

NOTICE

It is important that your vehicle be kept clean and free from dirt. Failure to keep your vehicle clean may result in fading of the paint or corrosion to various parts of the vehicle body.

Caring for Aluminum Wheels

NOTE:

- Do not use an acidic or alkaline detergent to wash aluminum wheels. These types of detergent will cause permanent spots, discoloration and cracks on finished surfaces.
- Do not use a bristle brush and soap containing an abrasive material. These will damage finished surfaces.

Washing



60B212S

⚠ WARNING

- Never attempt to wash and wax your vehicle with the engine running.
- When cleaning the underside of the body and fender, where there may be sharp-edged parts, you should wear gloves and a long-sleeved shirt to protect your hands and arms from being cut.
- After washing your vehicle, carefully test the brakes before driving to make sure they have maintained their normal effectiveness.

When washing the vehicle, park it where direct sunlight does not fall on it and follow the instructions below:

- 1) Flush the underside of body and wheel housings with pressurized water to remove mud and debris. Use plenty of water.

NOTICE

When washing the vehicle Avoid directing steam or hot water of more than 80°C (176°F) on plastic parts.

- To avoid damaging engine components, do not use pressurized water in the engine compartment.
- 2) Rinse the body to loosen the dirt. Remove dirt and mud from the body

exterior with running water. You may use a soft sponge or brush. Do not use hard materials which can scratch the paint or plastic. Remember that the headlight covers or lenses are made of plastic in many cases.

NOTICE

To avoid damage to the paint or plastic surface, do not wipe the dirt off without ample water. Be sure to follow above procedure.

- 3) Wash the entire exterior with a mild detergent or car wash soap using a sponge or soft cloth. The sponge or cloth should be frequently soaked in the soap solution.

NOTICE

When using a commercial car wash product, observe the cautions specified by the manufacturer. Never use strong household detergents or soaps.

- 4) Once the dirt has been completely removed, rinse off the detergent with running water.
- 5) After rinsing, wipe off the vehicle body with a wet chamois or cloth and allow it to dry in the shade.
- 6) Check carefully for damage to painted surfaces. If there is any damage,

“touch-up” the damage following the procedure below:

1. Clean all damaged spots and allow them to dry.
2. Stir the paint and “touch-up” the damaged spots lightly using a small brush.
3. Allow the paint to dry completely.

- Only use waxes and polishes of good quality.
- When using waxes and polishes, observe the precautions specified by the manufacturers.

NOTICE

If you use an automatic car wash, make sure that your vehicle’s body parts, such as spoilers, cannot be damaged. If you are in doubt, consult the car wash operator for advice.

Waxing



60B211S

After washing the vehicle, waxing and polishing are recommended to further protect and beautify the paint.

GENERAL INFORMATION

GENERAL INFORMATION

Vehicle Identification

Chassis Serial Number

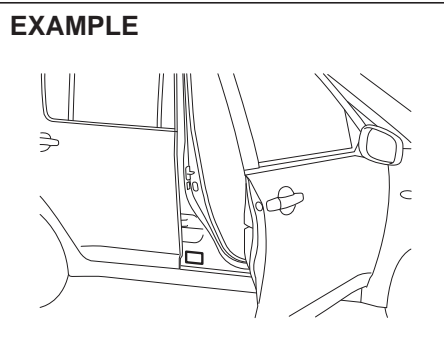

EXAMPLE

74LHT1001

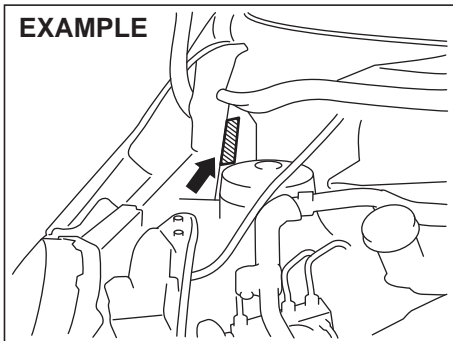

EXAMPLE

74LHT1002

The chassis and/or engine serial numbers are used to register the vehicle. They are also used to assist your dealer when ordering or referring to special service information. Whenever you have occasion to consult your MARUTI SUZUKI dealer, remember to identify your vehicle with this number. Should you find the number difficult to read, you will also find it on the identification plate.

Engine Serial Number

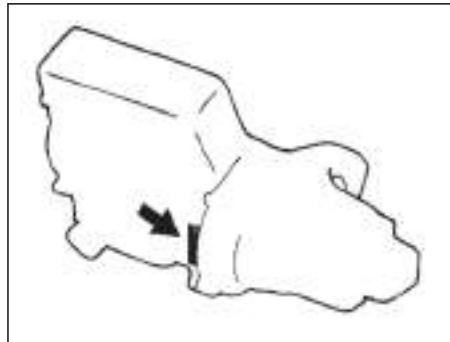

60G128

The engine serial number is stamped on the cylinder block as shown in the illustration.

SPECIFICATIONS

SPECIFICATIONS

NOTE: Specifications are subject to change without notice. Petrol: Petrol engine model
 Diesel: Diesel engine model

ITEM: Dimensions			UNIT: mm	
			SWIFT	SWIFT DZIRE
Overall length			3850	3995
Overall width			1695	1695
Overall height			1530	1555
Wheelbase			2430	2430
Track	Front	165 tyre	1485	1485
		185 tyre	1475	1475
	Rear	165 tyre	1495	1495
		185 tyre	1485	1485
Ground clearance			170	170

ITEM: Mass (weight)				UNIT: kg		
		SWIFT TYPE 1	SWIFT TYPE 2	SWIFT DZIRE		
Curb mass (weight)	Petrol	960 - 990	935-965	960 - 990		
	Diesel	1050 - 1080	1035 - 1060	1050 - 1080		
Gross vehicle mass (weight) rating	Petrol	1415	1415	M/T 1415, A/T 1435		
	Diesel	1505	1505	1505		
Gross axle mass (weight) rating	Front	Petrol	800	800	800	
		Diesel	850	850	850	
	Rear	Petrol	800	800	800	
		Diesel	830	830	830	

SPECIFICATIONS

ITEM: Engine		
Type	K12M (DOHC)	D13A (DOHC)
Number of cylinders	4	4
Bore	73.0 mm	69.6 mm
Stroke	71.5 mm	82.0 mm
Piston displacement	1197 cm ³	1248 cm ³
Compression ratio	10.0 : 1	17.6 : 1

ITEM: Electrical		SWIFT TYPE 2	SWIFT DZIRE/SWIFT TYPE 1
Standard spark plug	Petrol	NGK LKR6F-10	NGK KR6F-10
Battery	Petrol	12V 34B20L	
	Diesel	12V DIN50L	12V-DIN65L
Fuses	See "INSPECTION AND MAINTENANCE" section.		

SPECIFICATIONS

ITEM: Lights		WATTAGE	BULB No.
Headlight		12V 60/55W	H4
Turn signal light	Front	12V 21W	PY21W
	Rear	12V 21W	PY21W
Side turn signal light (on fender)		12V 5W	WY5W
Side turn signal light (on outside rearview mirror)		LED	-
Position light		12V 5W	W5W
Tail/brake light		12V 5/21W	P21/5W
License plate light		12V 5W	W5W
Reversing light		12V 16W	W16W
Interior light		12V 10W	-
Luggage compartment light		12V 5W	-
Front fog light		12V 35W	H8
Rear fog light		12V 21W	P21W
High mount stop light		12V 16W	W16W

SPECIFICATIONS

ITEM: Wheel and Suspension	
Tyre size, front and rear	185/65R 15 ^{*1} 165/80R 14 ^{*1}
Rim size	185 tyre: 15X5 1/2J ^{*2} 165 tyre: 14X5J
Tyre pressures	For the specified tyre pressure, see the Tyre Information Label located on the driver's door lock pillar.

*1: When tire replacement is necessary and if the specified load index and speed rated tire is not available, then use a tire of higher load index and speed rating.

*2: The spare wheel provided with alloy wheel variant is steel wheel rim, hence follow 4 tire rotation only. (Refer: under section "Inspection and maintenance")

Petrol	Front (Kg per cm ²)	Rear (Kg per cm ²)
185/65 R15	2.0	2.0
165/80 R14	2.3	2.3

Diesel	Front (Kg per cm ²)	Rear (Kg per cm ²)
185/65 R15	2.2	2.0
165/80 R14	2.5	2.3

Temporary Spare tire	2.8 Kg per cm ²
----------------------	----------------------------

SPECIFICATIONS

ITEM: Steering	
Toe-in	1.0 mm
Camber angle	0° 13'
Caster angle	5 °

ITEM: Capacities (approx.)			
Coolant (including reservoir tank)	M/T	Petrol	4.5 L
		Diesel	5.9 L
	A/T	Petrol	4.5 L
Fuel tank			42 L
Engine oil	Petrol/Diesel		3.1 L (With filter)
Transmission oil	M/T	Petrol	2.2 L
		Diesel	2.6 L
	A/T	Petrol	3.05 L