

Suzuki Aftermarket Application

ECM (OBD II)

ECM (OBD I)

BCM

ABS/Airbag

Operator's Manual

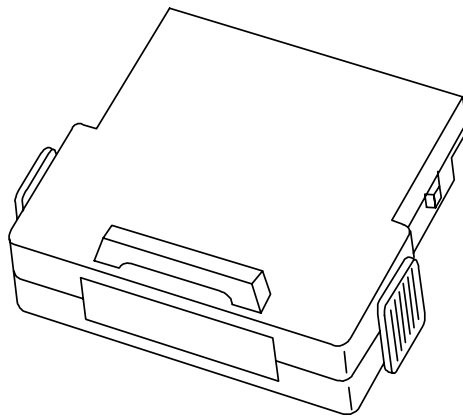

Vetronix Corporation

Copyright © 2002

Manual P/N 08002589 Ver. B

Tech 1[®], Tech 1A[®], Mastertech[®] is a registered trademark of Vetronix Corp.

Printed in USA 11/02

This entire document and all information contained herein are proprietary, confidential, and exclusive trade secret property of Vetronix Corporation, and shall not be reproduced, duplicated, or copied in whole or in part, or made available to any person, firm, or corporation without the prior written permission of Vetronix Corporation.

Some Things You Should Know

CAUTION!



When performing any checks with the engine running in an enclosed space such as a garage, be sure there is proper ventilation. Never inhale exhaust gases; they contain carbon monoxide, a colorless, odorless, extremely dangerous gas which can cause unconsciousness or death.

CAUTION!



Always set the parking brake securely and block the drive wheels before performing any checks or repairs on the vehicle.

Disclaimer

The Tech 1, Tech 1A, and MTS 3100 testers are designed for use by trained service personnel only. The testers have been developed for the sole purpose of diagnosing and repairing automotive electronic systems. Every attempt has been made to provide complete and accurate technical information based on factory service information available at the time of publication. However, the right is reserved to make changes at any time without notice.

FCC Compliance

This equipment has been tested and found to comply with the limits for a Class A digital device, pursuant to Part 15 of the FCC Rules. These limits are designed to provide reasonable protection against harmful interference when the equipment is operated in a commercial environment. This equipment generates, uses, and can radiate radio frequency energy and, if not installed and used in accordance with the instruction manual, may cause harmful interference to radio communications. Operation of this equipment in a residential area is likely to cause harmful interference in which case the user will be required to correct the interference at his own expense.

Using This Cartridge With A Tech 1 Or Tech 1A Tester

The TECH 1A tester is an updated version of the TECH 1 tester. In addition to already proven TECH 1 diagnostic power, the TECH 1A has on-board RS232, Instrumentation Port, and DC Power Jack capabilities. You can identify a TECH 1A by the phone-style jacks on both sides of the tester.

Note that the TECH 1 and TECH 1A require a different DLC cable, DC Power cable, and vehicle adapters. When using this manual to diagnose a vehicle, take the time to determine the type of tester that you have, and be sure you are using the correct cables and adapters. Doing so may prevent misuse of application cartridges and incorrect vehicle diagnosis.

The hardware required to connect a Tech 1A tester is described in Chapter 2 of the application manuals that follow.

On some vehicles power to the cigarette lighter is controlled by the ignition switch. When testing these vehicles with a TECH 1 or TECH 1A, it is best to connect the tester directly to the battery with the optional Battery Adapter Cable (P/N 02001636), which is available from your TECH 1A distributor.

Using This Cartridge With The MTS 3100 Tester

In addition to the TECH 1/TECH 1A, this cartridge can also be used with the MTS 3100 tester.

The operation of the cartridge and the vehicle identification screens, test menus and data screens are as described in this manual. The cartridge can be used with the MTS 3100 tester in conjunction with a program card, which allows viewing of data list screens in full-screen Enhanced Mode displays. Refer to the Enhanced Mode operating instructions in the Multi-Function Tester Program Card Operator's Manual for further details and examples of Enhanced Mode displays.

How to connect the MTS 3100 tester to a Suzuki vehicle is described in Chapter 2 of the application manuals that follow.

Introduction

The Suzuki application cartridge is compatible with the TECH 1, TECH 1A, and MTS 3100 testers. Applications described in this Operator's Manual include:

- Engine Control Module ECM (OBD II)
- Engine Control Module ECM (OBD I)
- Body Control Module BCM
- Anti Lock Brake/Airbag ABS/AIRBAG

When diagnosing a specific Suzuki system, be sure to reference the correct system application section in this manual.

Overall Vehicle Coverage

YEAR	MODEL	ENGINE
1995-99	Esteem	1.6L I4 MFI
1991-94	Sidekick	1.6L I4 TBI
1992-98	Sidekick	1.6L I4 MFI
1996-98	Sidekick	1.8L I4 MFI
1992-94	Swift	1.0L I3 TBI
1996-99	Swift	1.0L I3 MFI
1995-99	Swift	1.3L I4 MFI
1999	Vitara	1.6L I4 2.0L I4 2.5L V6
1996-98	X-90	1.6L I4 MFI

Table of Contents

SUZUKI AFTERMARKET APPLICATION

ECM (OBD II) APPLICATION

1. SUZUKI ECM (OBD II) APPLICATION DESCRIPTION	1
VEHICLE COVERAGE	2
DIAGNOSTIC MODES AVAILABLE	3
<i>Carb Mode</i>	3
<i>Suzuki Mode</i>	3
<i>Diagnosis of the SQ Series, SY418, and JA627</i>	3
2. GETTING STARTED	4
SETTING UP THE TESTER	4
3. OPERATING PRECAUTIONS	9
REMOVING THE CARTRIDGE WHILE POWER IS APPLIED	9
REMOVING OR CHANGING MASS STORAGE CARTRIDGES CONTAINING SNAPSHOT DATA	9
4. SELECTING THE MODEL YEAR, COMMUNICATIONS MODE & TEST MODE	10
SELECTING THE MODEL YEAR	10
SELECTING A MODEL	11
SELECTING A COMMUNICATIONS MODE	11
F0: CARB MODE - INITIALIZATION OF COMMUNICATIONS	12
COMMUNICATION FAILURE	12
SELECTING THE TEST MODES	12
SELECT MODE FUNCTIONS MENU FOR CARB MODE	13
SELECT MODE FUNCTIONS MENU FOR F1: SUZUKI MODE	14
MISCELLANEOUS TESTS (FOR SUZUKI MODE)	14
<i>Select Mode Menu</i>	14
<i>Select Transmission Type</i>	15
<i>Select Mode Menu for SQ Series, SY418, and JA627</i>	15
<i>Miscellaneous Tests</i>	15

5. OPERATING THE TEST MODES IN SUZUKI MODE	16
F1: SUZUKI MODE	16
<i>Suzuki Mode ECM Communications Status Displays</i>	18
MODE F0: DATA LIST	19
<i>Create Your Own Data Pairs</i>	19
MODE F1: PRINT DATA	21
<i>PRINT DATA</i>	21
MODE F3: SNAPSHOT	22
<i>Viewing Captured Data</i>	22
<i>Printing Captured Data</i>	23
MODE F4: MISC. TESTS	27
<i>RPM CONTROL</i>	27
<i>FIXED SPARK</i>	29
<i>IAC CAL</i>	31
<i>EGR SOL VALVE</i>	33
<i>EGR SOL (CHECK)</i>	35
<i>STEPPING EGR CONTROL</i>	37
<i>CANISTER AIR VALVE</i>	39
<i>TANK PRESSURE VALVE</i>	41
<i>CANISTER PURGE VALVE</i>	43
<i>RDT FAN CONTROL</i>	45
<i>FUEL PUMP CONTROL</i>	47
<i>PROGRAM ID</i>	49
6. OPERATING THE TEST MODES IN CARB MODE	50
F0: CARD MODE	50
MODE F0:CURRENT DATA	51
<i>Current Data Menu</i>	51
<i>Data List</i>	51
<i>Snapshot</i>	53
MODE F1: FREEZE FRAME DATA	56
<i>Freeze Frame Data Display</i>	56
MODE F2: DIAGNOSTIC TROUBLE CODES (DTCS)	57
MODE F3: CLEAR DIAGNOSTIC INFORMATION	58
MODE F4: OXYGEN SENSOR MONITORING TEST RESULTS	59
<i>O2 Sensor Test Menu</i>	59
<i>O2S Data Displays</i>	59
MODE F5: READINESS TESTS	60
MODE F6: ON-BOARD TESTS (PENDING DTCS)	61
7. OPERATING THE TEST MODES FOR THE SQ SERIES, SY418, AND JA627	62
ECM COMMUNICATIONS STATUS DISPLAYS FOR THE SQ SERIES, SY418, AND JA627	63

MODE F0: DATA LIST	63
MODE F1: PRINT DATA	63
MODE F2: TROUBLE CODES MODE	64
MODE F3: SNAPSHOT	66
MODE F4: MISC. TESTS	66
<i>F0: Output Tests</i>	67
<i>MIL Control</i>	68
<i>A/C Cond Fan</i>	69
MODE: ECU ID	72
8. <i>FINISHING UP</i>	73
9. <i>IF YOU'RE HAVING A PROBLEM</i>	74
BLANK SCREEN	74
SCREEN DISPLAYS SOLID BARS	75
MASTER CARTRIDGE MISSING OR MALFUNCTIONING	75
KEYBOARD/DISPLAY LOCKED UP OR PROGRAM RETURNS TO FIRST PAGE	76
DATA NOT BEING RECEIVED	76
PARAMETERS FLASH ON/OFF	77
TESTER IS NOT ABLE TO COMMUNICATE WITH THE VEHICLE	77
TESTER STOPS COMMUNICATING WITH THE VEHICLE	78
PARAMETER UPDATE RATE IS SLOW	78
NOT ALL PARAMETERS ARE DISPLAYED	79
A. <i>UNDERSTANDING SUZUKI ECMS</i>	80
B. <i>GLOSSARY</i>	81
ECM (OBD I) APPLICATION	
1. <i>SUZUKI ECM APPLICATION DESCRIPTION</i>	84
SUZUKI ECM APPLICATION COVERAGE	85
<i>Other Than North American Market</i>	85
<i>North American Market (1991-1995)</i>	88
HOW THE SUZUKI ECM APPLICATION WORKS WITH THE VETRONIX TESTER	88
2. <i>GETTING STARTED</i>	89
SETTING UP THE TESTER	89

3. OPERATING PRECAUTIONS	94
REMOVING THE CARTRIDGE WHILE POWER IS APPLIED	94
REMOVING OR CHANGING MASTER CARTRIDGES CONTAINING SNAPSHOT DATA	94
4. SELECTING THE VEHICLE	95
SELECTING A COMMUNICATION MODE	95
SELECTING A VEHICLE TYPE	95
SELECTING A TRANSMISSION TYPE	96
SELECTING THE TEST MODES	96
<i>Applicable Communication Mode Other Than North American Market</i>	97
<i>North American Market (1991-1995)</i>	98
SELECTING THE VEHICLE	99
5. SELECTING AND OPERATING THE TEST MODES	100
SELECTING TEST MODES	101
<i>Main Test Modes</i>	102
<i>ECM (or PCM) Communications Status Displays</i>	104
MODE F0: DATA LIST	106
<i>Viewing Data Parameters</i>	106
<i>Create Your Own Data Pairs</i>	107
<i>Release A "Fixed" Parameter</i>	107
<i>Printing Data</i>	107
MODE F1: PRINT DATA	108
<i>Print Data</i>	108
MODE F2: DTC(S)	110
<i>Diagnostic Trouble Codes Description</i>	110
MODE F3: SNAPSHOT	115
<i>Trigger Condition</i>	115
<i>Viewing Captured Data</i>	115
<i>Printing Captured Data</i>	116
MODE F4: MISC TESTS	122
<i>Misc Tests Mode Abort Conditions</i>	122
<i>Selecting a Miscellaneous Test</i>	124
<i>RPM Control</i>	124
<i>Fixed Spark Mode</i>	126
<i>IAC CAL</i>	127
<i>EGR Control</i>	128
<i>Stepping EGR Control</i>	129
<i>SOV Test</i>	131
<i>Cani Purg Val (Duty Type)</i>	132
<i>Cani Purg Val (On/off Type)</i>	133
<i>Fuel Pump Cont</i>	134
<i>MIL Control</i>	134
<i>Radiator Fan Control</i>	135
<i>A/C Condenser Fan</i>	136

<i>ECU No. 39 All Output Tests</i>	137
<i>ECU No. 40 All Output Tests</i>	138
<i>Readiness Test</i>	138
MODE F5: ECU ID	139
6. FINISHING UP	141
7. DTCS	142
8. DATA LIST PARAMETER DESCRIPTIONS	147
CATEGORY DESCRIPTIONS	147
DESCRIPTOR FORMAT	148
GENERAL PARAMETERS	151
ELECTRICAL PARAMETERS	152
SPARK CONTROL PARAMETERS	152
FUEL DELIVERY PARAMETERS	153
EMISSIONS AND DRIVEABILITY PARAMETERS	159
TRANSMISSION PARAMETERS	162
MISCELLANEOUS PARAMETERS	164
A. IF YOU'RE HAVING A PROBLEM	167
BLANK SCREEN	167
DISPLAYS SOLID BARS	168
MASTER CARTRIDGE MISSING/MALFUNCTIONING	168
KEYBOARD OR DISPLAY LOCKED UP OR PROGRAM SPORADICALLY RETURNS TO FIRST PAGE	169
TESTER IS NOT RECEIVING DATA	169
DATA LIST PARAMETERS FLASH ON AND OFF	170
COMPANION APPLICATION MISSING	170
B. UNDERSTANDING SUZUKI ECMS	171
C. GLOSSARY OF TERMS	172
BCM APPLICATION	
1. DESCRIPTION	176
HOW THE SUZUKI BCM APPLICATION WORKS WITH THE TECH 1A	177

2. GETTING STARTED	178
SETTING UP THE TESTER	178
<i>MTS 3100</i>	179
<i>Tech 1A</i>	180
<i>Tech 1</i>	181
3. OPERATING PRECAUTIONS	183
4. SELECTING THE VEHICLE	185
SELECTING THE SYSTEM	185
<i>Transmission</i>	185
<i>ABS</i>	185
<i>Airbag</i>	186
5. SELECTING AND OPERATING THE TEST MODES	190
SELECTING TEST MODES	191
ECU COMMUNICATIONS STATUS DISPLAYS	192
MODE F0: DATA LIST	194
<i>Viewing ECU Data Parameters</i>	194
<i>Create Your Own Data Pairs</i>	195
<i>Printing Data</i>	195
MODE F1: PRINT DATA	196
MODE F2: TROUBLE CODES	198
<i>Airbag System</i>	199
<i>Clear Codes Phase</i>	201
MODE F3: SNAPSHOT	203
<i>Trigger Condition</i>	203
<i>Viewing Captured Data</i>	203
<i>Printing Captured Data</i>	204
<i>Snapshot Setup Phase</i>	204
<i>Data Capture Phase</i>	205
<i>Data Display Phase</i>	206
MODE F4: MISCELLANEOUS TESTS	210
<i>Submode F0: Hydraulic Control</i>	210
6. FINISHING UP	213
7. TROUBLE CODE DESCRIPTIONS	214
8. PARAMETER DESCRIPTIONS	221
CATEGORY DESCRIPTIONS	221
DESCRIPTOR FORMAT	222
TRANSMISSION	224
<i>General Parameters</i>	224
<i>Electrical Parameters</i>	225

<i>Miscellaneous Parameters</i>	225
ABS	226
<i>General Parameters</i>	226
<i>Electrical Parameters</i>	226
<i>Miscellaneous Parameters</i>	227
AIRBAG	227
<i>Electrical Parameters</i>	227
<i>Miscellaneous Parameters</i>	229
A. IF YOU'RE HAVING A PROBLEM	230
BLANK SCREEN	230
DISPLAYS SOLID BARS	231
MASTER CARTRIDGE IS MISSING OR MALFUNCTIONING	231
KEYBOARD OR DISPLAY LOCKED UP OR PROGRAM SPORADICALLY RETURNS TO FIRST PAGE	232
TESTER IS NOT RECEIVING DATA	232
DATA LIST PARAMETERS FLASH ON AND OFF	233
COMPANION APPLICATION MISSING	233
B. GLOSSARY	235

ABS/AIRBAG APPLICATION

1. SUZUKI ABS/AIRBAG APPLICATION DESCRIPTION	238
HOW THE SUZUKI ABS/AIRBAG APPLICATION WORKS WITH THE VETRONIX TESTER	239
2. GETTING STARTED	241
SETTING UP THE TESTER	241
3. OPERATING PRECAUTIONS	246
CONNECTING AND DISCONNECTING THE TESTER WHILE THE IGNITION KEY IS ON	246
REMOVING THE CARTRIDGE WHILE POWER IS APPLIED	246
REMOVING OR CHANGING MASTER CARTRIDGES CONTAINING SNAPSHOT DATA	247
4. SELECTING THE SYSTEM	248
SELECTING THE ABS TYPE	249
SELECTING THE MODEL	249

SELECTING THE MODEL YEAR	249
SELECT MODE MENU	250
SELECT MODE MENU FOR ABS DBC7	251
5. SELECTING AND OPERATING THE TEST MODES	252
SELECTING THE TEST MODES	252
<i>Test Modes Available</i>	252
TEST MODES DESCRIPTIONS	253
MISCELLANEOUS TESTS AVAILABLE	253
<i>Miscellaneous Tests Descriptions</i>	254
MODE F0: DATA LIST	255
<i>Create Your Own Data Pairs</i>	256
<i>Data List Parameters</i>	257
MODE F1: PRINT DATA	258
<i>Print Data (SQ Series Airbag Only)</i>	258
MODE F1: DTC HISTORY	259
<i>First Five (Or Fewer) Failures</i>	259
<i>Last Failure</i>	260
<i>Drive Cycles</i>	260
MODE F2: DTC(S)/DTC INFO	262
MODE F3: ABS SNAPSHOT	266
<i>Trigger Point</i>	266
<i>Trigger Condition</i>	266
<i>Viewing Captured Data</i>	267
<i>Printing Captured Data</i>	268
<i>Setup Phase</i>	268
<i>Data Capture Phase</i>	270
<i>Data Display Phase</i>	272
MODE F4: MISC. TESTS (DELCO ABS VI)	274
<i>Submode F0: Manual Control</i>	274
<i>Submode F2: Hydraulic Control</i>	277
<i>Submode F3: Idle Up Test</i>	279
<i>Submode F4: Motor Test</i>	280
<i>Submode F5: Gear Tension Relief Test</i>	284
<i>Submode F6: Relay Test</i>	285
<i>Submode F7: Voltage Load Test</i>	287
<i>F8: Lamp Test</i>	289
<i>Submode F9: System ID</i>	290
MODE F4: MISC. TESTS (DELPHI ABS DBC7)	292
<i>Submode F0: Solenoid Test</i>	292
<i>Submode F1: Pump Motor Test</i>	293
<i>Submode F2: Relay Test</i>	293
<i>Submode F3: Auto Bleed</i>	294
<i>F4: Lamp TEST</i>	296
MODE F5: MOTOR REHOME (DELCO ABS VI)	296

6. FINISHING UP	299
A. IF YOU'RE HAVING A PROBLEM	300
BLANK SCREEN	300
DISPLAYS SOLID BARS	301
MASTER CARTRIDGE MISSING OR MALFUNCTIONING	301
WRONG DISPLAY AFTER POWER IS APPLIED	302
NO DATA RECEIVED/NO RESPONSE/COMMUNICATION FAILED	302
NO COMMUNICATION WITH VEHICLE	303
KEYBOARD/DISPLAY LOCKED OR PROGRAM RETURNS TO FIRST PAGE	304
COMPANION APPLICATION MISSING	304
B. GLOSSARY OF TERMS	306

ECM (OBD II) Application

Operator's Manual

1. SUZUKI ECM (OBD II) APPLICATION DESCRIPTION

The SUZUKI ECM (OBD II) Application is used to diagnose and troubleshoot the Engine and Emission Control systems used on 1996 and later Suzuki vehicles. It takes full advantage of advanced diagnostic features introduced in these vehicles.

The SUZUKI ECM (OBD II) Application and the Vetronix tester team up to become a diagnostic tool which is both powerful and easy to use. With the Vetronix tester, you can select test modes which let you:

- Read engine data parameters.
- Diagnose intermittent problems by capturing and storing multiple samples of system data BEFORE AND AFTER THE PROBLEM OCCURS, then examining the data to determine the problem. This data is saved in the tester memory for at least 24 hours even if the power is removed from the tester!
- Control engine functions such as RPM (except CARB mode).
- Control various solenoids, and valves on or off to check for proper operation (except CARB mode).
- Read ECM configuration information (SUZUKI mode only).
- Print data and vehicle information.
- Read A/T data parameters (vehicle equipped with PCM).
- Read diagnostic trouble codes (except SUZUKI mode).
- Clear diagnostic information (except SUZUKI mode).
- Read freeze frame data (except SUZUKI mode).
- Read the status of various on-board tests (except SUZUKI mode).
- Read pending diagnostic trouble codes (except SUZUKI mode).

VEHICLE COVERAGE

The Suzuki ECM (OBD II) Application is capable of monitoring and diagnosing the Suzuki engine and emission control systems on all models equipped as follows:

YEAR	MODEL	ENGINE SIZE	FUEL SYS. TYPE	TRANS. TYPE	ECU TYPE	ECU MFG.
1996-97	ESTEEM (SY416)	1.6L	MFI	MT	ECM	DENSO
				4AT		
1998 -	ESTEEM (SY416)	1.6L	SFI	MT	ECM	DENSO
				4AT		
1996 -	SWIFT (SW310)	1.0L	TBI	MT	ECM	DENSO
1996-97	SWIFT (SW413)	1.3L	TBI	MT	ECM	DENSO
				3AT	PCM	
1998 -	SWIFT (SW413)	1.3L	SFI	MT	ECM	DENSO
				3AT	PCM	
1996	SIDEKICK (SE416)	1.6L	SFI	MT	ECM	MITSUBISHI
				4AT		
1997-98	SIDEKICK (SE416)	1.6L	SFI	MT	ECM	MITSUBISHI
				4AT	PCM	
1996	X-90 (SZ416)	1.6L	SFI	MT	ECM	MITSUBISHI
				4AT		
1997-98	X-90 (SZ416)	1.6L	SFI	MT	ECM	MITSUBISHI
				4AT	PCM	
1996	SIDEKICK 1800 (SV418)	1.8L	SFI	MT	ECM	HITACHI
				4AT		
1997-98	SIDEKICK 1800 (SV418)	1.8L	SFI	MT	ECM	HITACHI
				4AT	PCM	
1999 -	VITARA (SQ416)	1.6L	SFI	MT	ECM	MITSUBISHI
				4AT	PCM	
1999 -	VITARA (SQ420)	2.0L	SFI	MT	ECM	MITSUBISHI
				4AT	PCM	
1999 -	GRAND VITARA (SQ625)	2.5L	SFI	MT	ECM	HITACHI
				4AT	PCM	

YEAR	MODEL	ENGINE SIZE	FUEL SYS. TYPE	TRANS. TYPE	ECU TYPE	ECU MFG.
1999 -	ESTEEM (SY418)	1.8L	SFI	MT	ECM	HITACHI
				4AT		
2001 -	XL-7 (JA627)	2.7L	SFI	MT	ECM	MITSUBISHI
				4AT	PCM	

DIAGNOSTIC MODES AVAILABLE

CARB MODE

The CARB (California Air Resources Board) Mode of operation provides standardized testing of emission related components.

A further description of the CARB Mode and instructions for operating the CARB Mode test procedures are included in [Chapter 6](#).

SUZUKI MODE

The Suzuki Mode provides tests specifically designed for Suzuki vehicles. The operation is included in [Chapter 5](#).

DIAGNOSIS OF THE SQ SERIES, SY418, AND JA627

Operation of tests designed for the SQ series, SY418, and JA627 are described in [Chapter 7](#).

ACTIVE KEYS	
YES & NO	Answer questions asked on tester display and select data parameters to monitor.
ENTER	Move to next screen. Activate menu selection.
EXIT	Return to previous step.
↑ & ↓	Scroll through test mode selection menus and control display of captured data.
F0 - F9	Select and control test mode.
F7	Toggles between Metric and English units.
F8	Print Data List parameters.

2. GETTING STARTED

SETTING UP THE TESTER

The proper Data Link Connector (DLC) adapter or adapter cable for the vehicle being tested must be connected to the tester DLC Cable in order to connect the tester to the vehicle.

The following Vehicle Adapter Chart identifies which adapters and cables are required to connect each type of tester to the various Suzuki vehicles.

All adapters, cables, and any other hardware required to connect the tester to the vehicle are listed in the chart. The figure number in the chart refers to the adapter and cable illustrations on the following pages.

SYSTEM	TESTER	ADAPTER DESCRIPTION	FIGURE
Engine System with 16-Pin Connector (OBD II)	MTS 3100	Type 3 16/14-Pin (P/N 02001969)	Figure 2-1
	Tech 1A	Type 3 16/14-Pin (P/N 02001969)	Figure 2-2
	Tech 1	OBD II VIM (P/N 02001808) 16/14-Pin VIM Adapter Cable (P/N 02001744)	Figure 2-3

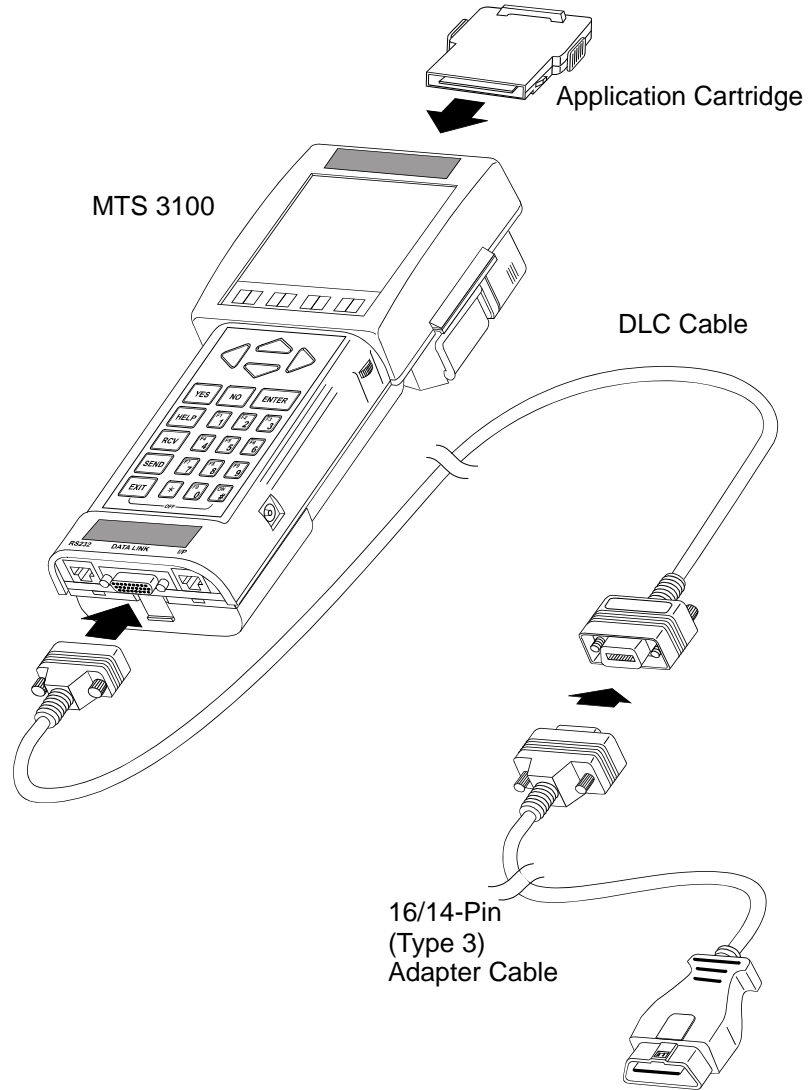

FIGURE 2-1. MTS 3100 Adapter and Cables

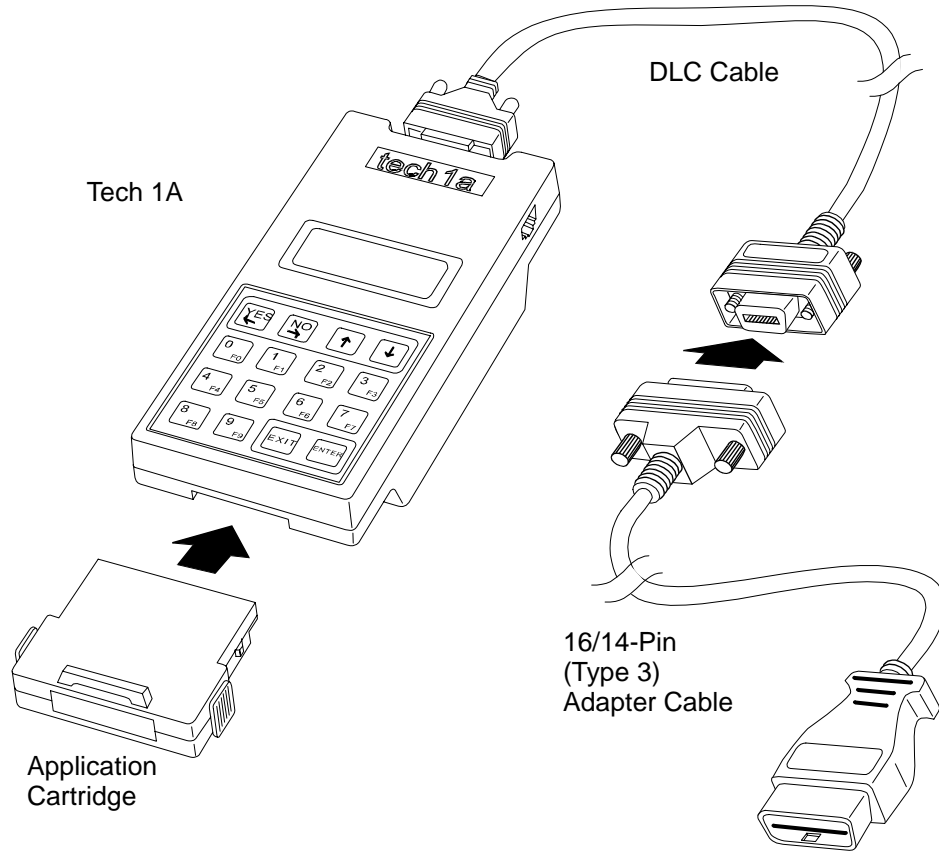

FIGURE 2-2. Tech 1A Adapter and Cables Using the 16-Pin DLC Type 3

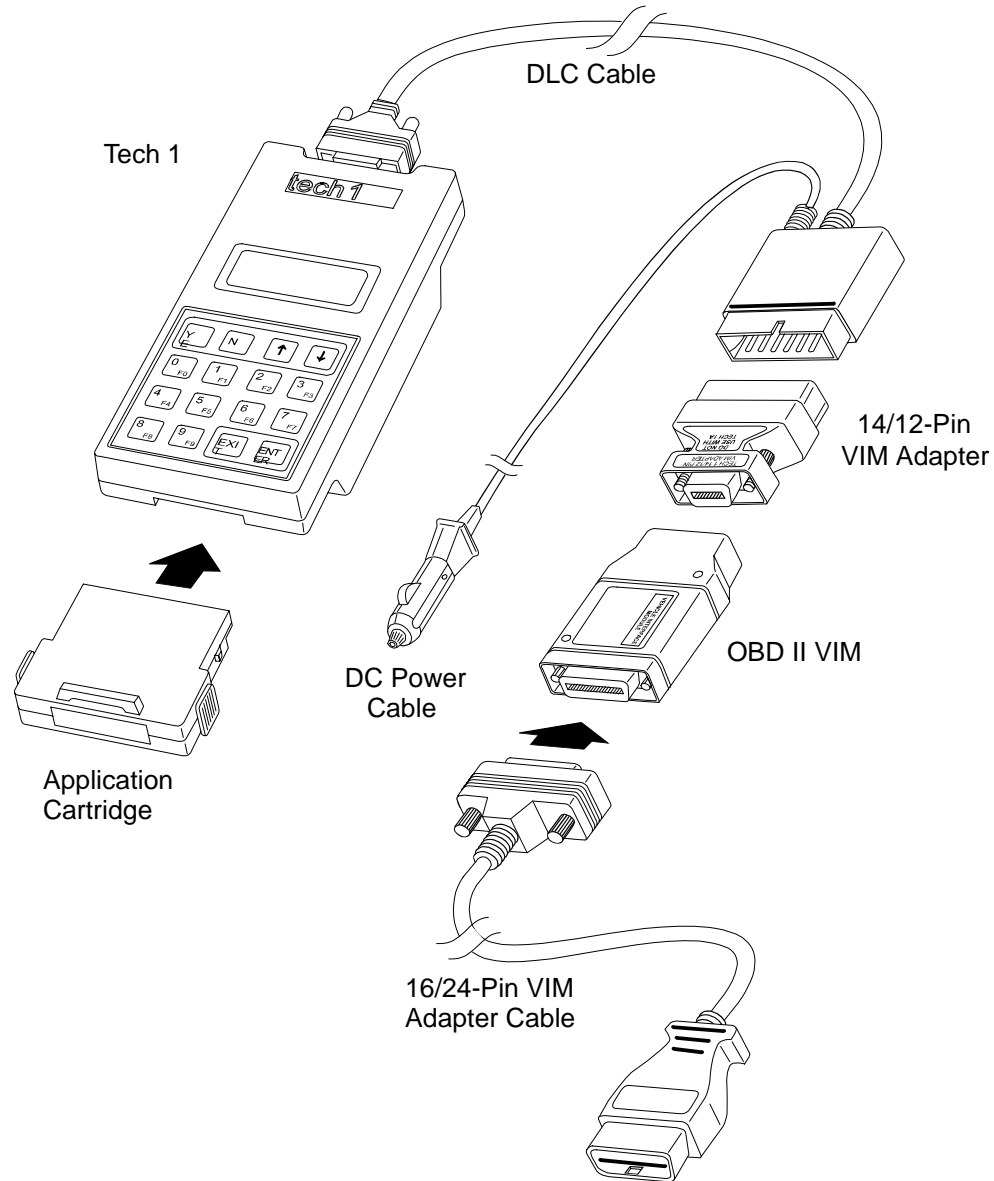

FIGURE 2-3. Tech 1 Adapter and Cables

Before operating the SUZUKI ECM (OBD II) Application with the TECH 1A, the following steps must be performed:

1. Insert the SUZUKI ECM (OBD II) Application cartridge into the bottom slot of the Tech 1A or Tech 1 or into the back slot of the MTS 3100. Verify that no other application cartridge (e.g. SUZUKI 91-94 Cartridge) is installed in the top slot of the Tech 1A or Tech 1.

If you are using a TECH 1 tester and intend to connect it to a peripheral device such as a printer or terminal, install the RS232C Cartridge in the top cartridge slot. The RS232C Cartridge is not required if you are using a TECH 1 Series A tester.

2. Connect the Data Link Connector (DLC) cable to the tester and tighten the screws.

3. Make sure the vehicle ignition is OFF.
4. Locate the vehicle's serial Data Link Connector (DLC). The vehicle DLC is usually under the dash on the driver's side. Refer to the vehicle service manual if you are in doubt.
5. Connect the cable to the tester as shown in the preceding figures.
6. Connect the DLC Adapter Cable to the vehicle DLC.
7. Turn ignition switch ON.
8. Verify that the tester displays the screen below.



SUZUKI
MASS STORAGE
CARTRIDGE - VX.X
<ENTER>

9. Press **ENTER** to display the APPLICATIONS menu.



APPLICATIONS
F3: ECM (OBD II)

10. If Snapshot data has been stored when the tester is powered up, <ENTER> = PREVIOUS is displayed at the top of the screen.

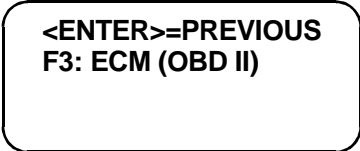

<ENTER>=PREVIOUS
F3: ECM (OBD II)

11. Press **F3** to select ECM (OBD II) from the APPLICATIONS menu.

If the display informs you that the companion application is missing, contact your tester distributor.

If more than three applications are available, use **↑** or **↓** to scroll the display.

12. Verify that the tester displays the screen below:

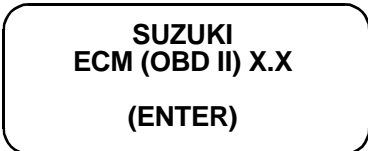

SUZUKI
ECM (OBD II) X.X
(ENTER)

If the display is not correct, refer to [Appendix 9](#).

13. If the display is correct, press **ENTER**. How to select the test modes is explained in [Chapter 4](#).

3. OPERATING PRECAUTIONS

REMOVING THE CARTRIDGE WHILE POWER IS APPLIED

You should not remove or install mass storage or auxiliary cartridges while power is applied. If you wish to change or add a cartridge, disconnect the power plug, install the cartridge, then reconnect the power plug.

REMOVING OR CHANGING MASS STORAGE CARTRIDGES CONTAINING SNAPSHOT DATA

SNAPSHOT data that has been captured can be printed on a VP-411 (or compatible) printer, transferred to a computer for further analysis, or displayed on a terminal. The SNAPSHOT data will be retained within the tester memory for at least 24 hours, even if the tester is disconnected from the vehicle. However, IF YOU POWER UP THE TESTER WITHOUT AN APPLICATION CARTRIDGE OR WITH A DIFFERENT APPLICATION CARTRIDGE, THE SNAPSHOT DATA WILL BE LOST.

4. SELECTING THE MODEL YEAR, COMMUNICATIONS MODE & TEST MODE

SELECTING THE MODEL YEAR

Once you've pressed **ENTER** to confirm the Suzuki ECM (OBD II) display (as explained in [Chapter 2](#)), the next step is to select the model year of the vehicle being tested.

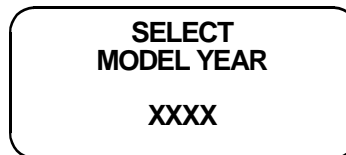

Enter the model year of the vehicle being tested.

SELECTING A MODEL

After the model year is selected, a SELECT MODEL menu appears.

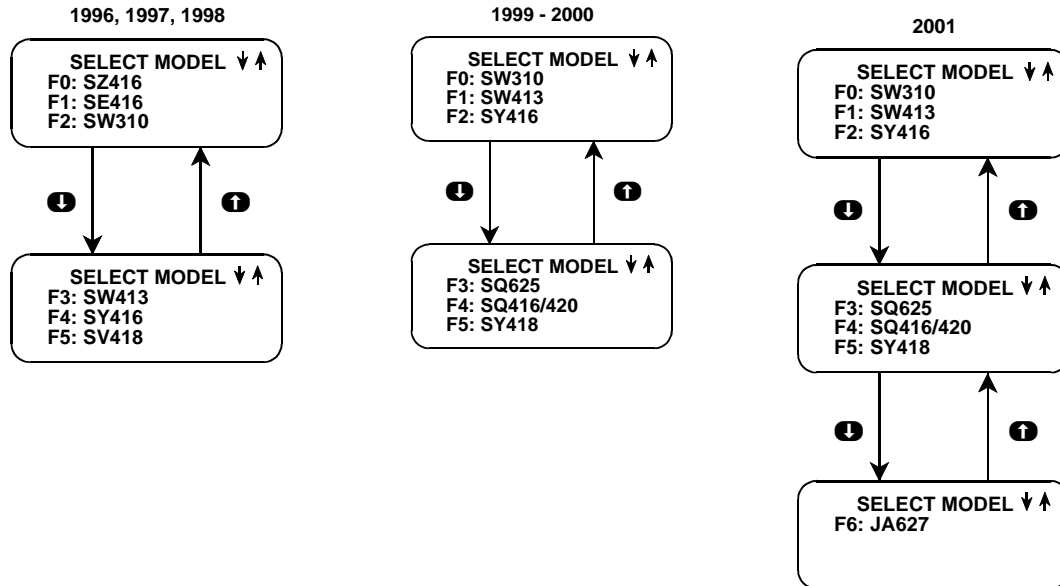

Press the function key corresponding to the model of the vehicle being tested. More information about each model and model year is included in [Chapter 1](#).

SELECTING A COMMUNICATIONS MODE

For models other than SY418, SQ series, and JA627, the Communications Mode display lists two options; F0: CARB MODE and F1: SUZUKI MODE. The CARB MODE provides diagnosis of OBD II equipped vehicles using CARB OBD II methods. The SUZUKI MODE provides enhancements specific to Suzuki vehicles. Press **F0** to select CARB MODE, or **F1** to select SUZUKI MODE.

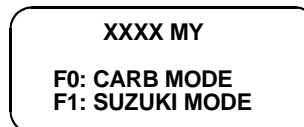

If Snapshot data has been stored on the CARB MODE side when **F0** is pressed, the following screen is displayed.

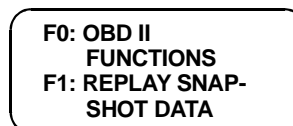

F0: CARB MODE - INITIALIZATION OF COMMUNICATIONS

When F0: CARB MODE or F0: OBD II FUNCTIONS is selected from the start-up menu, the tester will attempt to communicate with the vehicle. Be sure the ignition key is on.



After F0: CARB MODE or F0: OBD II FUNCTIONS is selected, communication initialization can take up to four seconds.

In some cases, a SWITCHING COMMUNICATION MODE screen is displayed prior to the screen shown above.

COMMUNICATION FAILURE

If the tester fails to get a response from the vehicle, it will display a retry count and one of two error messages. At that point, it will continue to retry the communications approximately every 3 seconds. If the communication problem is resolved (e.g. the ignition is switched to ON) and communications begin, the tester will automatically proceed to the next phase.

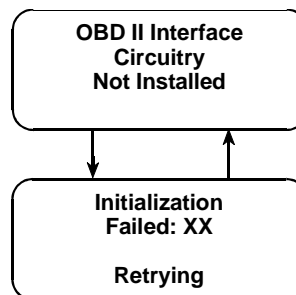

SELECTING THE TEST MODES

The tester makes selecting the test mode easy by displaying a list of tests (a test mode “menu”). The menu also displays which key is used to select each test mode. To select a test mode, simply press the key listed to the left of the test mode on the menu.

SELECT MODE FUNCTIONS MENU FOR CARB MODE

Once communications with the vehicle have been established, the SELECT MODE menu is displayed (In some cases, a Readiness Tests warning message is displayed prior to the menu. See the READINESS TESTS section.).

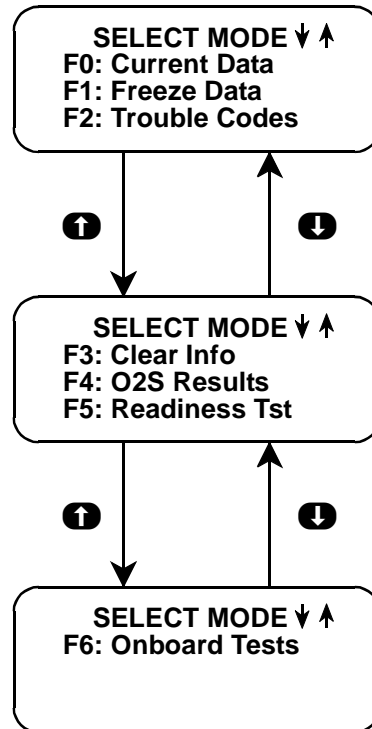

Select the desired function by pressing the key indicated to the left of the function.

NOTE



F4: O2S Results is only available for 1996-97 Model Year vehicles.

The menu scrolls every 3 seconds until **↑** or **↓** is pressed, at which time scrolling stops.

Pressing **↑** or **↓** will then manually scroll the menu.

How to use the CARB MODE test modes is explained in [Chapter 6](#).

SELECT MODE FUNCTIONS MENU FOR F1: SUZUKI MODE

The first three test modes are shown as soon as the vehicle is selected. The other test modes will automatically scroll onto the display after three seconds. The display will automatically scroll between the two or three screens. To stop the automatic scrolling, press either the **↑** or **↓** key. The menu may then be manually changed by pressing either the **↑** or **↓** key. All multiple menus of more than three items scroll in this way. Regardless of which test modes are displayed, any test mode can be selected at any time from the menu.

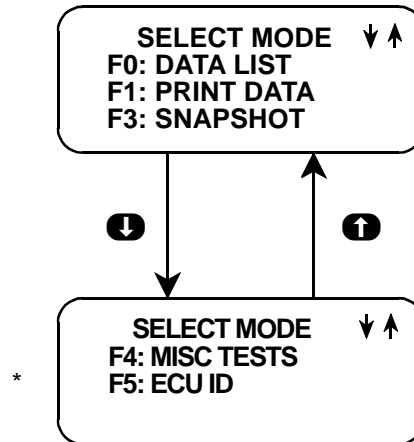

* Not available for all ECUs

MISCELLANEOUS TESTS (FOR SUZUKI MODE)

The Suzuki Mode F4: Misc. Test menu item is used to select a submenu of tests. Pressing **F4** displays the miscellaneous tests available for the selected vehicle. To return to the Select Mode menu just press **EXIT**. A list of the miscellaneous tests available is included in the following section.

SELECT MODE MENU

How to use the SUZUKI MODE test modes is explained in [Chapter 5](#).

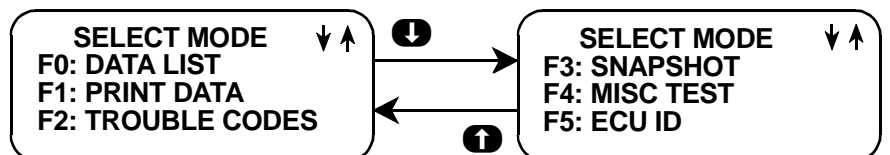

* Not available for all ECUs

SELECT TRANSMISSION TYPE

For 1999 SQ models, a Transmission type selection menu appears:

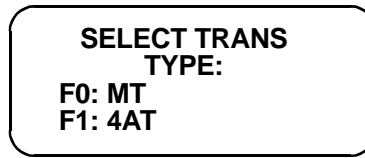

Press the function key corresponding to the transmission type being tested.

SELECT MODE MENU FOR SQ SERIES, SY418, AND JA627

Once the transmission type has been selected, the SELECT MODE menu appears.

MISCELLANEOUS TESTS

The F4: MISC. TEST menu item is used to select a submenu of tests. Pressing **F4** displays the miscellaneous tests available for the selected vehicle. To return to the Select Mode menu just press **EXIT**. A list of the miscellaneous tests available is included in [Chapter 7](#).

How to use the test modes is also explained in [Chapter 7](#).

ACTIVE KEYS	
F0 - F9	Select a menu option.
YES & NO	Answer questions on the tester display.
EXIT	Return to the previous menu.

5. OPERATING THE TEST MODES IN SUZUKI MODE

The following section contains a brief description of test modes available in the SUZUKI ECM (OBD II) application. Note that the test modes are different for F0: CARB MODE and F1: SUZUKI MODE. Also, note that descriptions of test modes for the SQ series, SY418, and JA627 are provided in [Chapter 7](#).

F1: SUZUKI MODE

Mode F0: Data List

Monitor enhancement data parameters for SUZUKI vehicles from the engine computer.

Mode F1: Print Data

Send one data stream of information to a serial printer, terminal or smart device.

Mode F3: Snapshot

Capture and store ECM data parameters. Data is captured before and after a “trigger” point. Triggers can be on any trouble code, a particular trouble code, or manual tester key press. Captured data can then be displayed as well as trouble codes.

Mode F4: Miscellaneous Tests

Displays sub-modes to operate single tests. A chart of the tests available is provided on the following page.

YEAR	MODEL	RPM CONTROL	FIXED SPARK	IAC CAL AIR	EGR SOL VAL	EGR SOL (CHK)	STEP EGR	CANI AIR VAL	TANK PRES VAL	CANI PURGE VAL	RDT FAN CONT	FUEL PUMP CONT	PROGRAM ID
1996-97	SY416	x	x		x	x				x			x
1998 -	SY416	x	x				x	x	x	x	x	x	x
1996-97	SW310	x	x		x	x				x			x
1998 -	SW310	x	x		x	x		x	x	x	x	x	x
1996-97	SW413	x	x		x	x		x	x	x			x
1998 -	SW413	x	x					x	x	x	x	x	x
1996-97	SE416	x	x	x	x	x		x	x	x			x
1998	SE416	x	x	x	x	x		x	x	x		x	x
1996-97	SZ416	x	x	x	x	x		x	x	x			x
1998	SZ416	x	x	x	x	x		x	x	x		x	x
1996-97	SV418	x	x	x			x			x			x
1998	SV418	x	x	x			x	x	x	x		x	x

NOTE

While the tester is connected to the serial data link connector and conversing with the ECM, the ECM ignores input signals from the TEST switch and the DIAG switch in the vehicle service connector.

SUZUKI MODE ECM COMMUNICATIONS STATUS DISPLAYS

Most test modes display data. Therefore, these test modes require the ECM to send data to the tester. When you select a SUZUKI MODE test, you may see one or more of the following ECM communications status displays.

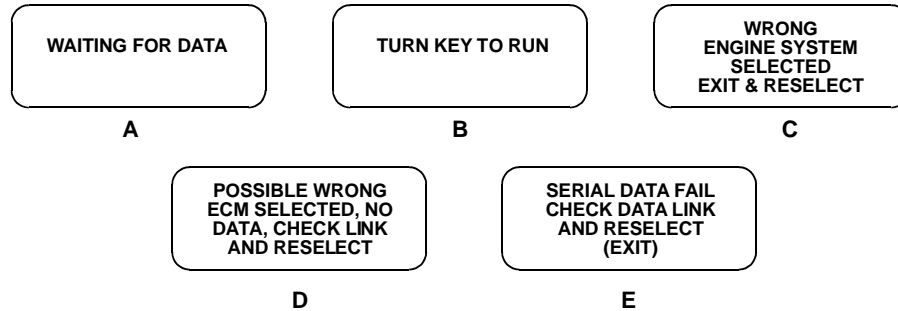

Display A:

This means that the tester cannot yet display data as it has not yet received a complete data message from the ECM. This display is sometimes seen right after selecting a test mode.

Display B:

This is a reminder that the ignition key needs to be in the ON position for the tester to communicate with the vehicle.

Display C:

This occurs when the tester determines that the data stream it receives from the ECM does not match the vehicle that you have selected. If this happens, return to the vehicle select step by pressing **EXIT**. Double-check your selection.

Display D:

This occurs when the tester has not received any data from the ECM. In this case, you should verify that the ignition is ON and check the serial data link connections. An incorrect engine type selection may also cause this condition.

Display E:

This occurs when communication with a vehicle has failed after communication has already been established.

ACTIVE KEYS	
EXIT	Return to the vehicle select mode.

MODE F0: DATA LIST

The purpose of the DATA LIST mode is to passively monitor data which is being transmitted from the ECM during normal operation of the vehicle. This mode does not affect vehicle operation and you can use it to read data to see if it is correct, or at least reasonable. The current value of the parameter is displayed with the parameter units. This means you don't have to hunt through manuals to find out what is being displayed.

The data parameters are displayed in pre-programmed pairs. You can also create your own pairs through the process explained on the following pages.

To operate the Data List mode, do the following:

1. Press **F0** to select the DATA LIST mode from the Select Mode menu.
2. In order to maximize the information that can be seen at one time, the tester displays data parameters in preassigned pairs. The first data pair is displayed after you press **F0**.

You can select the data parameters to be displayed by pressing the **YES** and **NO** keys. Pressing **YES** scrolls forward through the Data List. Pressing the **NO** key scrolls backwards through the Data List.

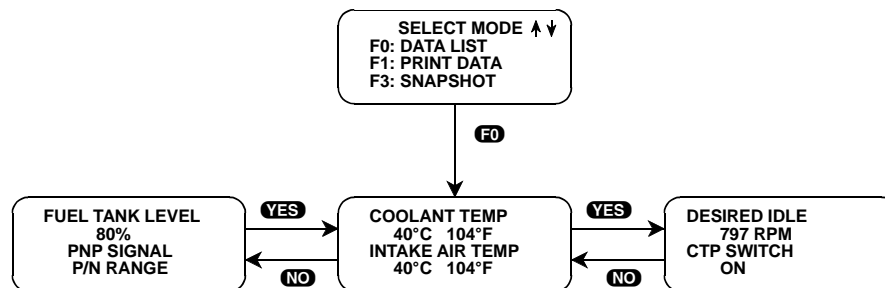

3. The currently displayed sample may be printed by pressing **F3**. If you are using a TECH 1 tester, an RS232C I/F Cartridge (P/N TK05030A) is required. The RS232C I/F Cartridge is not required if you are using a TECH 1 Series A tester.
4. You may return to the Select Mode menu at any time by pressing **EXIT**.

CREATE YOUR OWN DATA PAIRS

You can create data parameter pairs which are different from the preassigned pairs. Any two parameters can be displayed as a pair by simply scrolling either the bottom or top display parameter, while the other display parameter is fixed. To “fix” the top parameter press **F0**, an asterisk will appear by the fixed parameter. Press **F1** to “fix” the lower parameter. The tester will not allow both the top and bottom parameters to be fixed at the same time.

As an example, let's say you wish to create a pair with ENGINE SPEED and IGNITION ADVANCE. To do so, scroll through the preassigned pairs with the **YES** and **NO** key until you find a pair with ENGINE SPEED. Fix the ENGINE SPEED by pressing the **F0** key if ENGINE SPEED is the top parameter, or the **F1** key if it is the bottom. Then scroll the other half of the display with either the **YES** or **NO** key until IGNITION ADVANCE is displayed.

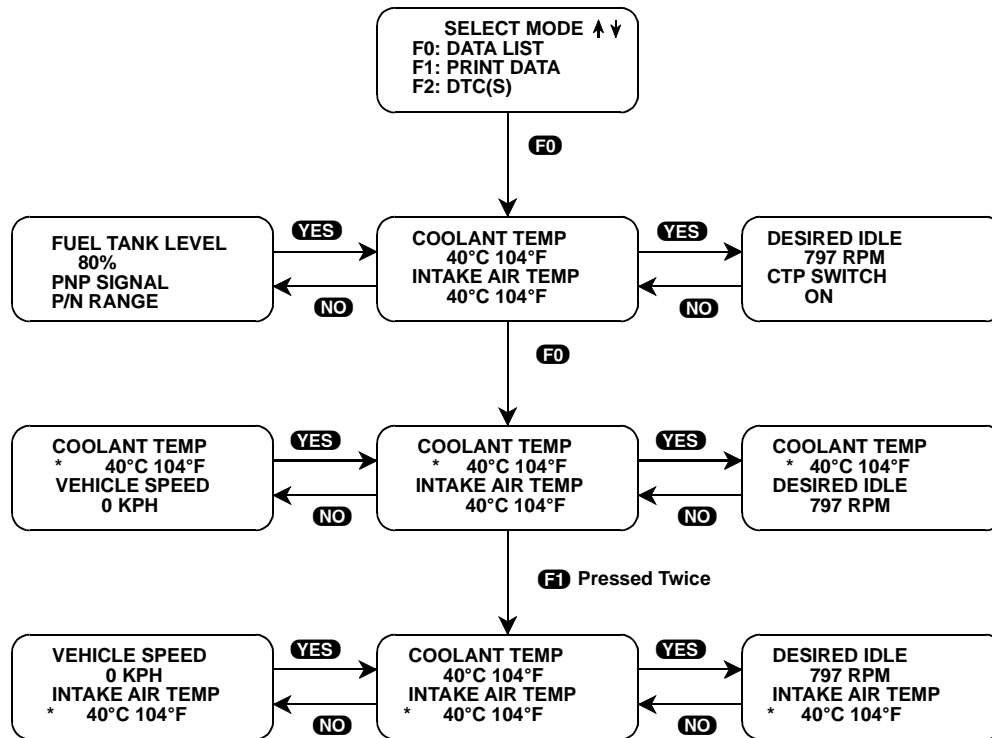
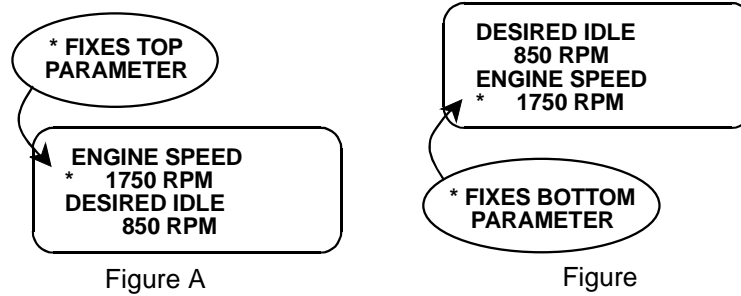

FIGURE 5-1. Data List Mode Operation

ACTIVE KEYS	
YES & NO	Scroll through displayed data parameters.
F0	Mark top displayed parameter as “fixed” for creating your own data pairs.
F1	Mark bottom displayed parameter as “fixed” for creating your own data pairs.
EXIT	Return to the Select Mode menu.

MODE F1: PRINT DATA

PRINT DATA

When the RS232C I/F Cartridge is installed in the TECH 1, or if you are using a TECH 1 Series A tester, the Print Data mode allows you to print the VIN, engine type and Data List to a serial printer or terminal. This is the data list sent by the engine computer to the tester. The data list parameters can be printed without printing the VIN or engine type by pressing the **F8** key in the Data List or Snapshot Replay mode.

To operate the Print Data mode, do the following:

1. Press **F1** to select the Print Data mode from the Select Mode menu. The VIN entry screen is the first screen displayed in this mode. Only the last 6 digits of the VIN are entered on this screen. This information is then printed out as part of the header information that accompanies each data list print out. The VIN is entered via the numeric portion of the key pad and the **ENTER** key is pressed to move to the next section of the print function.
2. The next screen requires the **ENTER** key to be pressed to start printing the data. This screen allows the cable to be connected between the RS232C Cartridge and the receiving device.
3. When the **ENTER** key is pressed the "WAITING TO PRINT DATA" screen is displayed until printing begins. If this screen is displayed for more than a few seconds, something is wrong with the set up. Check that all connections are secure, and that any receiving device is turned on and in the proper receive mode.
4. As printing begins, the tester displays the % COMPLETE of the print procedure. After the printing is 100% complete, the VIN screen is immediately displayed with the previously selected VIN. Pressing the **ENTER** key twice from this screen will cause another data stream to be buffered for printing as soon as the current data stream is output from the tester.
5. Pressing the **EXIT** key at any point will cause the select mode menu to be displayed. If the **EXIT** key is pressed before printing is completed, only the data that has already been sent to the RS232C Cartridge will be printed. SOME DATA WILL BE LOST.

PRINT DATA
ENTER LAST 6 VIN
DIGITS 000000
THEN PRESS ENTER

PRINT DATA VIN
ENTRY SCREEN

PRESS ENTER TO
PRINT DATA

SET UP RS232C
CARTRIDGE

RS232C NOT
CONNECTED

RS232C INTERFACE
CARTRIDGE
NOT CONNECTED

WAITING TO
PRINT DATA

PRINT
INITIALIZATION

99% COMPLETE
PRINT DATA

PRINT IN PROGRESS
SCREEN

1996 SUZUKI		
VEHICLE: SZ416		
VIN: 012345		
TECH 1 DATA LIST		
NO.	DESCRIPTION	VALUE
1.	COOLANT TEMP	82°C 108°F
2.	INTAKE AIR TEMP	21°C 70°
3.	DESIRED IDLE	875 RPM
4.	CTP SWITCH	ON
5.	IAC FLOW DUTY	52%

FIGURE 5-2. Print Sample

ACTIVE KEYS	
ENTER	Move to the next section of the Print Data function.
0 - 9	VIN entry keys.
EXIT	Terminate the Print Data mode and return to the Select Mode menu.

MODE F3: SNAPSHOT

The purpose of the SNAPSHOT test mode is to help you isolate an intermittent or transient problem by **STORING ENGINE DATA PARAMETERS BEFORE AND/OR AFTER THE PROBLEM OCCURS.**

When the tester is operating in SNAPSHOT mode, it is constantly storing information about data parameters. A time and position index for the stored information is also saved.

The tester stores all of the Data List parameters for the vehicle selected. When the memory is full, the oldest (earliest) data collected is erased to make room for new information.

A “TRIGGER” tells the tester which data to save. While operating the SNAPSHOT mode, you can always cause the trigger to be set by pressing **ENTER**. Once the trigger occurs, the tester saves the data for review.

VIEWING CAPTURED DATA

By selecting F3: REPLAY DATA from the SNAPSHOT menu you have the option of bypassing the Data Capture phase and displaying previously captured data. All data captured during SNAPSHOT will be

retained in the tester until it is overwritten by a new SNAPSHOT, or if the tester is disconnected from the serial data link connector or the cigarette lighter for at least 24 hours.

PRINTING CAPTURED DATA

The Snapshot data can be printed, providing a hard copy of any selected data sample. A VP-411 (or compatible) printer is required to support this print function. See [Step 11](#).

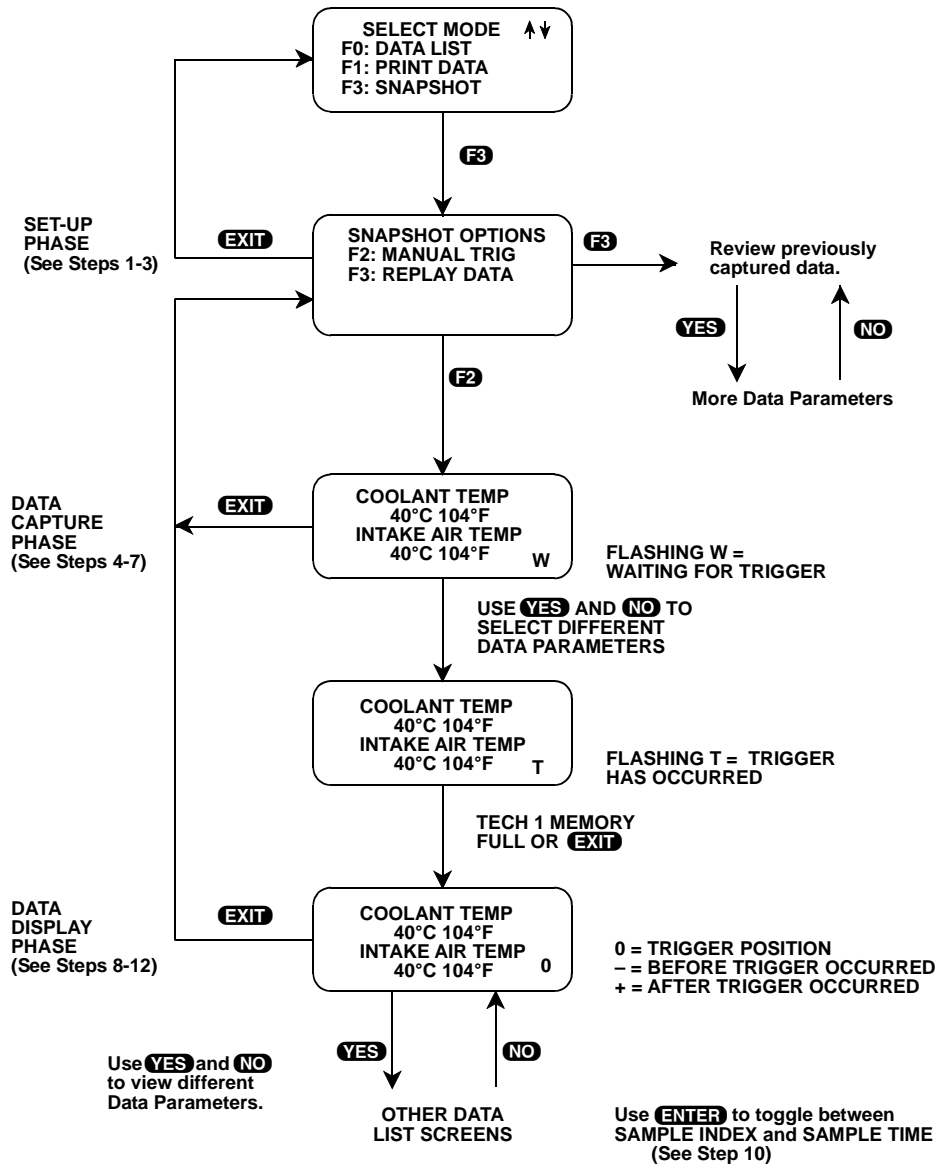

To operate the Snapshot mode, do the following:

1. Press **F3** to select SNAPSHOT from the Select Mode menu.
2. The trigger condition and review data options are displayed next in a Snapshot Options menu. Press **F2** to select Manual Trigger or press **F3** to bypass the data capture phase and replay previously captured data.
3. If F3: Replay Data is selected, the data from the previous Snapshot is displayed. See [Step 8](#) for an explanation of Data Display.
4. If Manual Trigger is selected, the tester begins storing engine data parameters while displaying the Data List parameters.

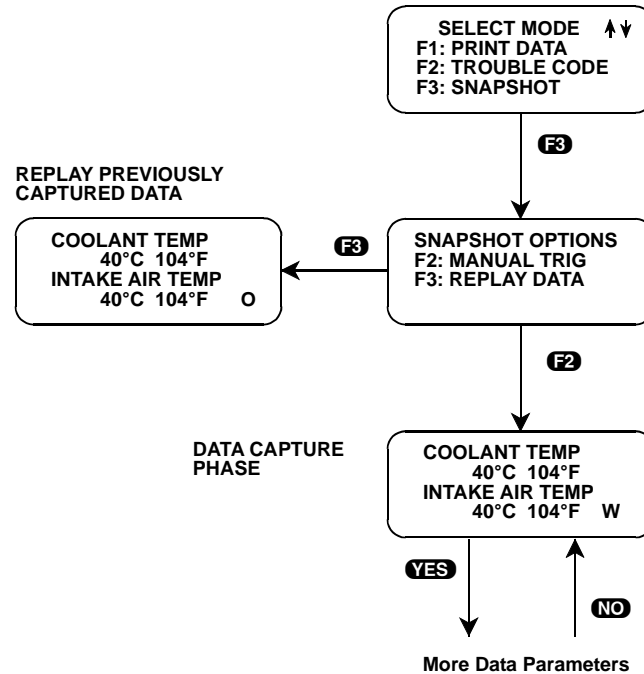

5. The data is organized as a number of data “samples”. The value or state of each parameter as well as all trouble codes are saved for each sample. The data display will indicate the “waiting for trigger” condition with a flashing “W” in the lower right-hand corner of the display. While waiting for the selected trigger, the **ENTER** key can always be used to force a trigger.
6. Once the trigger occurs, the tester will continue to save data samples until its memory is full. The data display indicates that the trigger has occurred by replacing the flashing “W” with a flashing “T”. As soon as the memory is full, the data capture terminates automatically and the tester goes to the Data Display phase.

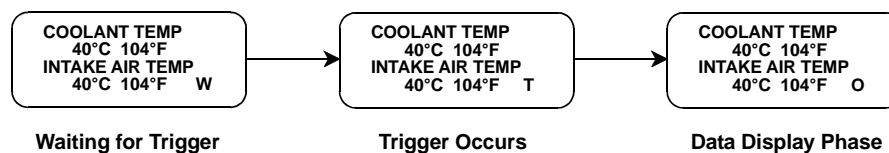

7. Pressing **EXIT** will terminate the Data Capture phase. If the trigger has already occurred, the Snapshot mode will move to the Data Display Phase.

8. The Data Display phase is indicated with a number (initially zero) in the lower right-hand corner of the display. Select the data to be displayed by using the **YES** and **NO** keys.
9. Use the **↑** and **↓** keys to select the desired sample. An index is displayed in the lower right corner of the tester display. Sample "0" corresponds to the trigger sample; sample "-1" is the sample immediately preceding the trigger; sample "+1" is immediately after the trigger, and so on. The index range may be less than the maximum number of samples if not enough time was allowed for data capture before or after the trigger

You can advance directly to the first, last, or trigger sample with the press of a button:

- F4**: Display first (earliest) sample
- F5**: Display trigger sample (0)
- F6**: Display last (most recent) sample.

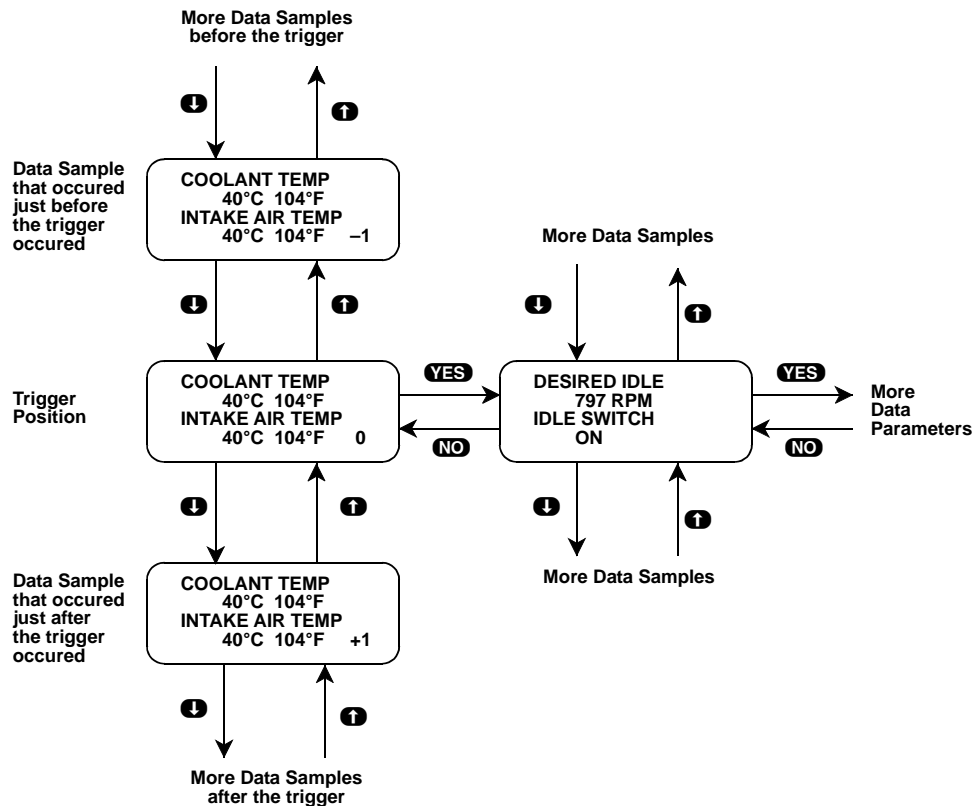

10. While in the data display phase, pressing **ENTER** will cause the tester to toggle between the sample index and sample time.

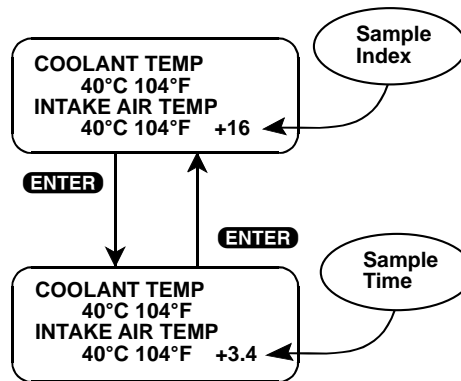

The sample time display gives the time in seconds (relative to the trigger sample) at which the tester received the currently displayed sample. For example, a sample time of +3.4 means the sample was received 3.4 seconds after the trigger sample. A sample time of -2.6 seconds means the sample was received 2.6 seconds before the trigger.

11. The currently displayed sample may be printed if the tester is connected to a compatible printer. To print the data, press **F8**. The tester keyboard will be disabled while data is being sent to the printer.

SNAPSHOT data can also be printed in a tabular format using the Screen Print feature if the RS232C I/F Cartridge is installed or if you are using a TECH 1 Series A tester. Screen Print is enabled by pressing **F6** until an "RS232 SET-UP" menu is displayed. Press **F1** to enable the Screen Print function. Refer to the RS232C I/F or TECH 1 Series A Operator's Manual for more detail.

12. When you are finished viewing the sampled data, press **EXIT** to return to the Snapshot Options menu. If you are finished with the SNAPSHOT mode, press **EXIT** again to return to the select mode menu.

ACTIVE KEYS	
YES & NO	Scroll through displayed data parameters.
↑ & ↓	Scroll through selected samples.
F0 & F1	Fix top or bottom display parameter respectively.
F4	Advance to first (earliest) sample.
F5	Advance to trigger sample (sample 0).
F6	Advance to last (most recent) sample.
F6 (Hold)	(Hold) Select "RS232C SET-UP" menu.
F7	Toggle between English and Metric units.
F8	Print current data sample (if equipped with RS232C I/F Cartridge or TECH 1 Series A and printer).
ENTER	Toggle between sample index and sample time display.
EXIT	Return to Snapshot Options menu.

MODE F4: MISC. TESTS

RPM CONTROL

RPM Control allows you to control the RPM. If diagnosis of the IAC valve is required for any reason, this mode allows quick and easy control of the RPM.

CAUTION!

This test should only be run with the PARKING BRAKE ON and the wheels adequately secured. Any other mode of operation is not recommended and is unsafe.

To operate RPM Control, do the following:

1. Press **↑** or **↓** to position the “*” on the display menu next to RPM Control, then press **ENTER**. Press **YES** if the DTCs have been cleared.
2. Block the wheels, set the parking brake, put the transmission in Park or Neutral, then start the engine. Warm the engine to operating temperature (at least 80°C). Press **ENTER** to begin the test.
3. The tester first automatically controls the engine speed to the current desired idle. When the RPM Control Testing Screen is displayed, increase the engine RPM by pressing the **↑** key or press **↓** to decrease the RPM. Holding down either key will cause the RPM to change in the appropriate direction.

If the tester detects any of the following conditions, the RPM Control mode will be terminated:
 - Vehicle speed detected.
 - Coolant temperature is below 80°C.
 - CTP switch or closed throttle position is OFF.
4. While in the RPM CONTROL mode, parameters can be displayed as in the DATA LIST mode. RPM appears at the end of line two of the display, and the currently commanded value of RPM is displayed at the end of line four. Data parameters can be scrolled and fixed as in the DATA LIST mode.
5. Press **ENTER** to return to the initial desired idle control RPM.
6. Press **EXIT** to return control of the IAC valve to the ECM and return to the Miscellaneous Tests menu.

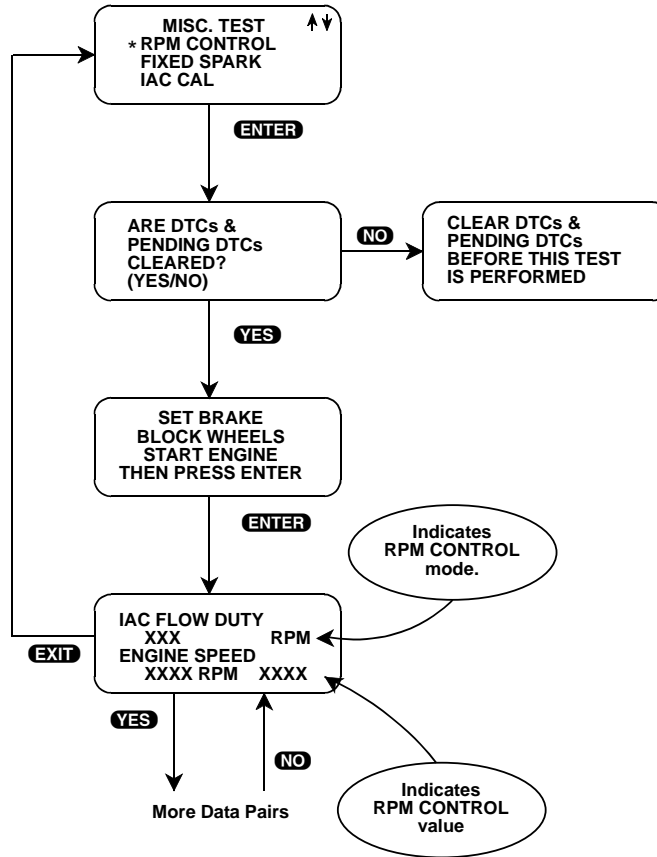

ACTIVE KEYS	
↑	Increase engine speed.
↓	Decrease engine speed.
YES & NO	Scroll through displayed data parameters.
F0 & F1	Mark top or bottom displayed parameter as fixed for creating your own data pairs.
F7	Toggle between English and Metric units.
ENTER	Return to initial desired idle RPM control.
EXIT	Terminate the RPM Control mode and return to the Miscellaneous Test menu.

FIXED SPARK

When check or adjustment of initial ignition timing is required, the Fixed Spark mode allows you to reset the ignition to the initial timing.

CAUTION!



- This test should only be run with the PARKING BRAKE ON and the wheels adequately secured. Any other mode of operation is not recommended and is unsafe.
- Use timing light when checking ignition timing.

To operate the Fixed Spark mode, do the following:

1. Press **↑** or **↓** to position the “*” on the display menu next to FIXED SPARK, then press **ENTER**. Press **YES** if the DTCs have been cleared.
2. Set the parking brake, block the wheels, then start the engine. Warm the engine to operating temperature (at least 80°C).
3. Press **ENTER** to begin the test.
4. The Data List display for monitoring the engine's response is available while operating in the Fixed Spark mode. Select the data parameters to be displayed by scrolling through the parameters with the **YES** and **NO** keys. Fixed spark operation is indicated by the letters “FXS” in the lower right corner of the tester display as shown on the following page.

If the tester detects any of the following conditions, Fixed Spark will be terminated.

- Vehicle speed detected.
 - Coolant temperature is below 80°C.
 - CTP switch or closed throttle position OFF.
5. Press **EXIT** to terminate the Fixed Spark mode and return to the Miscellaneous Tests menu.

Operation of the Fixed Spark mode is summarized in the following flow diagram.

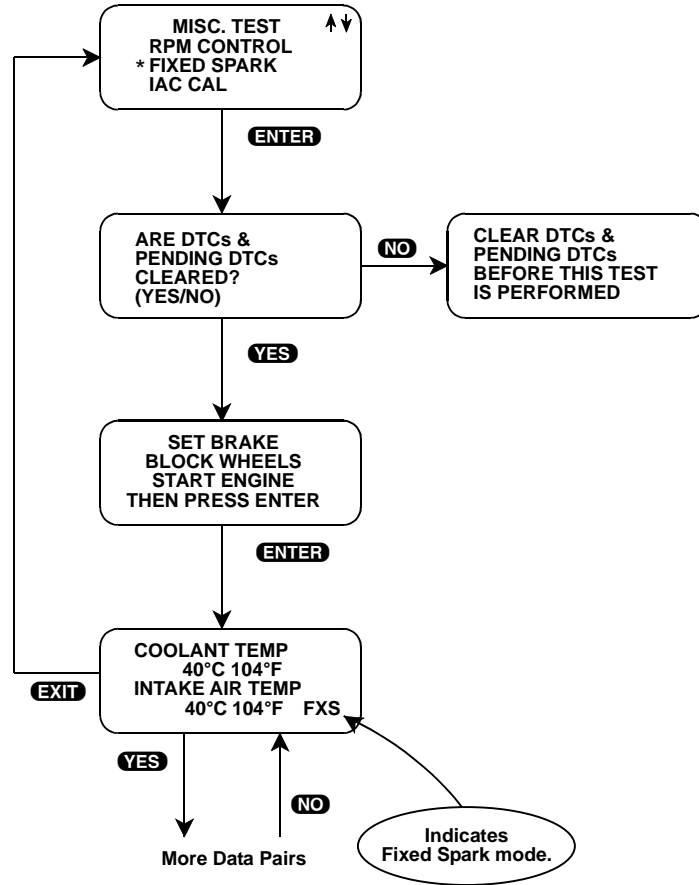

ACTIVE KEYS	
YES & NO	Scroll through displayed parameters.
ENTER	Begin test.
F0 & F1	Mark top or bottom displayed parameter as fixed for creating your own data pairs.
F7	Toggle between English and Metric units.
EXIT	Return to Miscellaneous Test menu.

IAC CAL

The purpose of the IAC CAL mode is to adjust the duty of the IAC valve to a certain value at idle speed. This is done by adjusting the Idle adjustment screw in the throttle body. The IAC CAL mode allows monitoring of engine data parameters in a manner identical to that in the DATA LIST mode.

To operate the IAC CAL mode, do the following:

1. Press **↑** or **↓** to position the “*” on the display menu next to IAC CAL, then press **ENTER**.
2. Press **YES** if the DTCs and Pending DTCs have been cleared. If the DTCs have not been cleared, press **NO** to return to the Misc. Test menu.
3. Block the wheels, shift to Park and set the parking brake.
4. Make sure the vehicle is in Park with the parking brake engaged, start the engine unless it is already running. Warm the engine to operating temperature (at least 80°C).
5. Press **ENTER** to begin the test.
6. The Data List display for monitoring the engine's response is available while operating in the IAC CAL mode. Select the data parameters to be displayed by scrolling through the parameters with the **YES** and **NO** keys. The letters “IAC” appearing at the end of line two of the display indicate that the IAC valve is being controlled. At the end of line four of the display, “CAL” (Calibrated Air) will be displayed.

If the tester detects any of the following conditions, IAC CAL mode will be terminated.

- Vehicle speed.
 - Coolant temperature is below 80°C.
 - CTP switch or closed throttle position OFF.
7. Press **EXIT** to return to the Miscellaneous Tests menu and return control of the IAC system to the ECM.

Operation of the IAC CAL function is summarized in the following flow diagram.

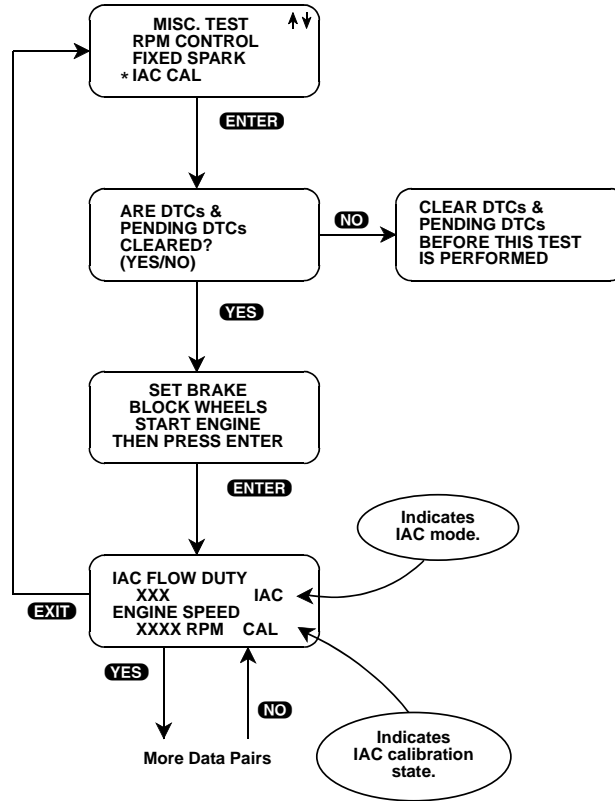

ACTIVE KEYS	
YES & NO	Scroll through displayed data parameters.
F0 & F1	Mark top or bottom displayed parameter as fixed for creating your own data pairs.
F7	Toggle between English and Metric units.
ENTER	Advance to IAC Control, provided vehicle is in Park or Neutral.
EXIT	Return to Miscellaneous Test menu.

EGR SOL VALVE

The purpose of the EGR SOL VALVE mode is to diagnose the EGR solenoid vacuum valve (EGR vacuum regulator solenoid valve). This mode allows you to control the EGR solenoid vacuum valve ON or OFF.

To operate the EGR SOL Valve mode, do the following:

1. Press **↑** or **↓** to position the “*” on the display menu next to EGR SOL VAL, then press **ENTER**.
2. Press **YES** if the DTCs and Pending DTCs have been cleared. If the DTCs have not been cleared, press **NO** to return to the Misc. Test menu.
3. Set the parking brake and block the wheels. Warm the engine to operating temperature (at least 80°C).
4. The Data List display for monitoring the engine's response is available while the EGR Solenoid Vacuum Valve is being controlled. Select the data parameters to be displayed by scrolling through the parameters with the **YES** and **NO** keys. EGR is displayed at the end of line two and ON or OFF is displayed at the end of line four indicating that the EGR Solenoid Vacuum Valve is being controlled.

If the tester detects any of the following conditions, EGR Solenoid Vacuum Valve control will be terminated.

- Vehicle speed detected.
 - Engine speed less greater than 3000 RPM.
 - Coolant temperature is below 80°C.
5. The test begins with the EGR solenoid vacuum valve on. To control the EGR solenoid vacuum valve off, press the **↓** key. To control EGR solenoid vacuum valve on again press the **↑** key. The Data List display for monitoring the engine's response is available while the EGR solenoid vacuum valve is being controlled.
 6. Press **EXIT** to return to the Miscellaneous Test menu and return EGR solenoid vacuum valve control to the ECM.

Operation of the EGR Solenoid Vacuum Valve test is summarized in the following flow diagram.

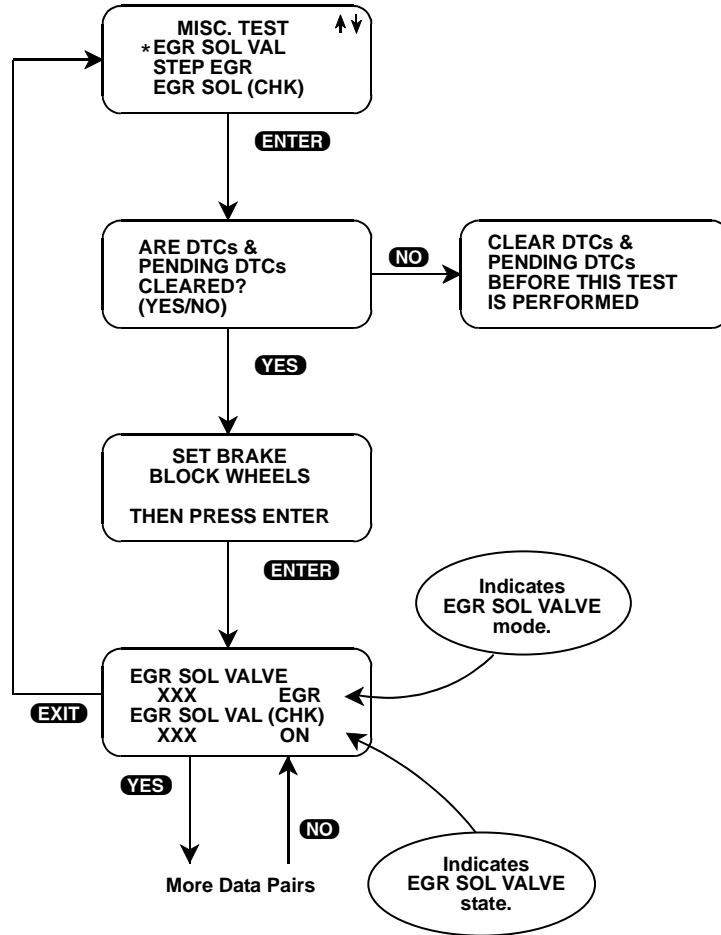

ACTIVE KEYS	
YES & NO	Scroll through displayed data parameters.
F0 & F1	Mark top or bottom displayed parameter as fixed for creating your own data pairs.
F7	Toggle between English and Metric units.
ENTER	Advance to EGR SOL VALVE Control, provided vehicle is in Park or Neutral.
↑	Switch the EGR Solenoid Vacuum Valve on while viewing parameters.
↓	Switch the EGR Solenoid Vacuum Valve off while viewing parameters.
EXIT	Return to Miscellaneous Test menu.

EGR SOL (CHECK)

The purpose of EGR SOL (CHECK) mode is to diagnose the EGR Diagnostic Valve/EGR Solenoid Vacuum Valve (for system check). This mode allows you to control the valve ON or OFF.

To operate the EGR SOL (CHECK) mode, do the following:

1. Press **↑** or **↓** to position the “*” on the display menu next to EGR SOL (CHK), then press **ENTER**.
2. Press **YES** if the DTCs and Pending DTCs have been cleared. If the DTCs have not been cleared, press **NO** to return to the Misc. Test menu.
3. Set the parking brake and block the wheels. Warm the engine to operating temperature (at least 80°C).
4. The Data List display for monitoring the engine's response is available while the EGR Solenoid Vacuum Valve (for system check) is being controlled. Select the data parameters to be displayed by scrolling through the parameters with the **YES** and **NO** keys.

EGR is displayed at the end of line two. ON or OFF is displayed at the end of line four indicating that the EGR Solenoid Vacuum Valve (for system check) is being controlled.

If the tester detects any of the following conditions, the EGR Solenoid Vacuum Valve (for system check) will be terminated.

- Engine speed greater than 3000 RPM.
 - Coolant temperature is below 80°C.
 - Vehicle speed detected.
5. To control the EGR Solenoid Vacuum Valve (for system check) off, press the **↓** key. To turn it on press the **↑** key.
 6. Press **EXIT** to return to the Miscellaneous Test menu and return EGR Solenoid Vacuum Valve (for system check) control to the ECM.

Operation of the EGR Solenoid Vacuum Valve (for system check) mode is summarized in the following flow diagram.

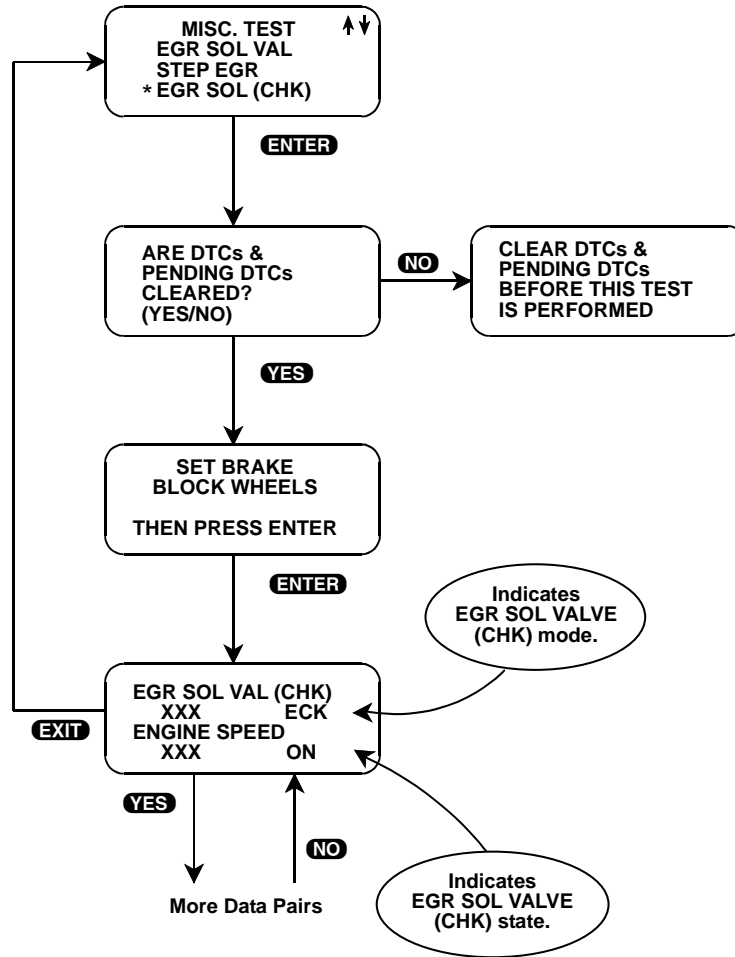

ACTIVE KEYS	
YES & NO	Scroll through displayed data parameters.
F0 & F1	Mark top or bottom displayed parameter as fixed for creating your own data pairs.
F7	Toggle between English and Metric units.
ENTER	Advance to EGR Solenoid Vacuum Valve (for system check), provided vehicle is in Park or Neutral.
↑	Switch EGR Solenoid Vacuum Valve (for system check) on while viewing parameters.
↓	Switch EGR Solenoid Vacuum Valve (for system check) off while viewing parameters.
EXIT	Return to Miscellaneous Test menu.

STEPPING EGR CONTROL

The purpose of Stepping EGR mode is to diagnose the EGR valve. The Stepping EGR Control mode allows you to regulate the Stepping EGR opening in increments from 0 to 100, and displays the stepping EGR monitor value as a percentage.

To operate the Stepping EGR mode, do the following:

1. Press **↑** or **↓** to position the “*” on the display menu next to STEP EGR, then press **ENTER**.
2. Press **YES** if the DTCs and Pending DTCs have been cleared. If the DTCs have not been cleared, press **NO** to return to the Misc. Test menu.
3. Set the parking brake, block the wheels, put the transmission in Park or Neutral, then start the engine. Warm the engine to operating temperature (at least 80°C).
4. Press **ENTER** to begin the test.
5. The Data List display for monitoring the engine's response is available while the EGR valve is being controlled. Select the data parameters to be displayed by scrolling through the parameters with the **YES** and **NO** keys.

The test begins with the STEPPING EGR at 0%. “EGR” is displayed at the end of line 2 and the Stepping EGR value is displayed at the end of line 4. To increase the Stepping EGR value, press the **↑** key. To decrease the Stepping EGR value, press the **↓** key. The STEPPING EGR value is displayed as a percentage (%).

If the tester detects any of the following conditions, Stepping EGR Control will be terminated and the cause will be displayed.

- Vehicle speed detected.
- Engine speed greater than 3000 RPM.
- Coolant temperature falls below 80°C.

6. Press **EXIT** to return to the Miscellaneous Test menu.

Operation of the STEPPING EGR Control mode is summarized in the following flow diagram.

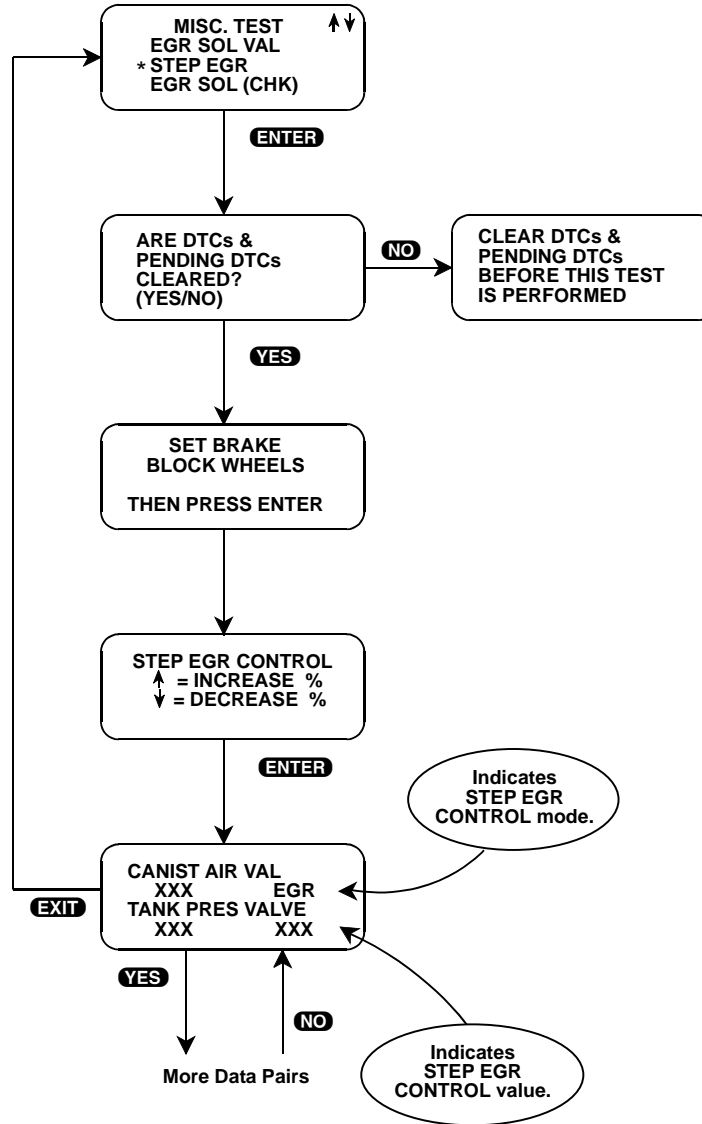

ACTIVE KEYS	
YES & NO	Scroll through displayed data parameters.
F0 & F1	Mark top or bottom displayed parameter as fixed for creating your own data pairs.
F7	Toggle between English and Metric units.
ENTER	Advance to STEPPING EGR Control provided vehicle is in Park or Neutral.
↑	Increase STEPPING EGR control value while viewing parameters.
↓	Decrease STEPPING EGR control value while viewing parameters.
EXIT	Return to Miscellaneous Test menu.

CANISTER AIR VALVE

The purpose of CANI AIR VAL mode is to diagnose the EVAP canister air valve. This mode allows you to control EVAP canister air valve ON or OFF.

To operate the CANI AIR VAL mode, do the following:

1. Press **↑** or **↓** to position the “*” on the display menu next to CANI AIR VAL, then press **ENTER**.
2. Press **YES** if the DTCs and Pending DTCs have been cleared. If the DTCs have not been cleared, press **NO** to return to the Miscellaneous Test menu.
3. Set the parking brake, stop the engine, and turn the ignition switch to ON.
4. The Data List display for monitoring the engine's response is available while the EVAP Canister Air Valve is being controlled. Select the data parameters to be displayed by scrolling through the parameters with the **YES** and **NO** keys.

VNT is displayed at the end of line two. ON or OFF is displayed at the end of line four indicating that the EVAP Canister Air Valve is being controlled.

If the tester detects any of the following conditions, the EVAP Canister Air Valve mode will be terminated.

- Engine speed detected.
 - Vehicle speed detected.
5. To control the EVAP Canister Air Valve off, press the **↓** key. To turn it on press the **↑** key.
 6. Press **EXIT** to return to the Miscellaneous Test menu and return the EVAP Canister Air Valve control to the ECM.

Operation of the EVAP Canister Air Valve mode is summarized in the following flow diagram.

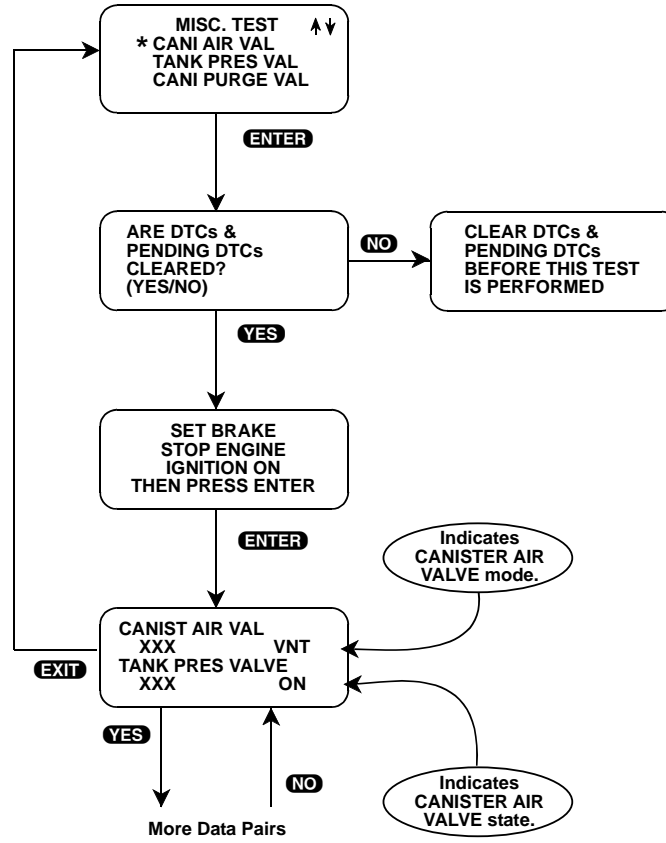

ACTIVE KEYS	
YES & NO	Scroll through displayed data parameters.
F0 & F1	Mark top or bottom displayed parameter as fixed for creating your own data pairs.
F7	Toggle between English and Metric units.
ENTER	Advance to EVAP Canister Air Valve test.
↑	Switch EVAP Canister Air Valve on while viewing parameters.
↓	Switch EVAP Canister Air Valve off while viewing parameters.
EXIT	Return to Miscellaneous Test menu.

TANK PRESSURE VALVE

The purpose of TANK PRES VAL mode is to diagnose the tank pressure control solenoid vacuum valve (tank pressure control solenoid valve). This mode allows you to control tank pressure control solenoid vacuum valve ON or OFF.

To operate the TANK PRES VAL mode, do the following:

1. Press **↑** or **↓** to position the “*” on the display menu next to TANK PRES VAL, then press **ENTER**.
2. Press **YES** if the DTCs and Pending DTCs have been cleared. If the DTCs have not been cleared, press **NO** to return to the Miscellaneous Test menu.
3. Set the parking brake, stop the engine, and turn the ignition switch to ON.
4. The Data List display for monitoring the engine's response is available while the Tank Pressure Control Valve is being controlled. Select the data parameters to be displayed by scrolling through the parameters with the **YES** and **NO** keys.

VAL is displayed at the end of line two. ON or OFF is displayed at the end of line four indicating that the Tank Pressure Control Valve is being controlled.

If the tester detects any of the following conditions, the Tank Pressure Control Valve mode will be terminated.

- Engine speed detected.
 - Vehicle speed detected.
5. To control the Tank Pressure Control Valve off, press the **↓** key. To turn it on press the **↑** key.
 6. Press **EXIT** to return to the Miscellaneous Test menu and return the Tank Pressure Control Valve control to the ECM.

Operation of the Tank Pressure Control Valve mode is summarized in the following flow diagram.

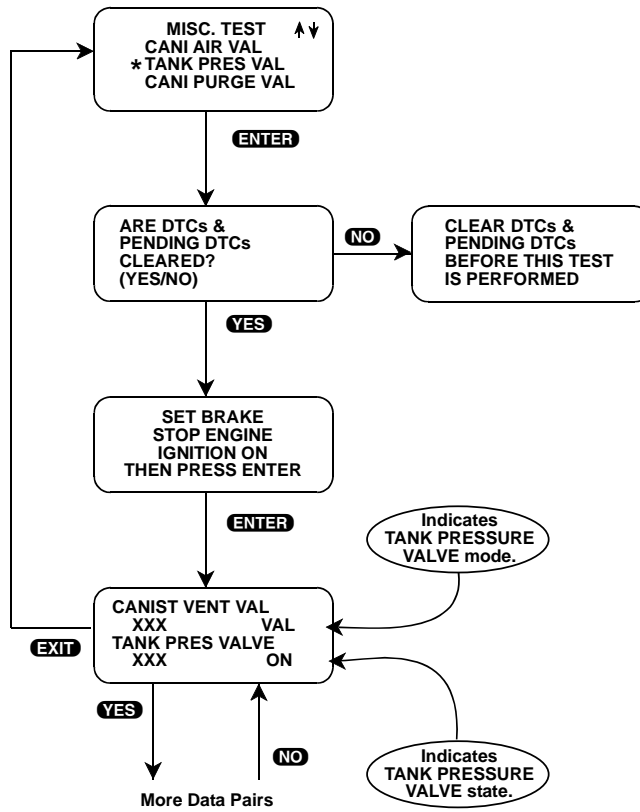

ACTIVE KEYS	
YES & NO	Scroll through displayed data parameters.
F0 & F1	Mark top or bottom displayed parameter as fixed for creating your own data pairs.
F7	Toggle between English and Metric units.
ENTER	Advance to Tank Pressure Control Valve test.
↑	Switch the Tank Pressure Control Valve on while viewing parameters.
↓	Switch Tank Pressure Control Valve off while viewing parameters.
EXIT	Return to Miscellaneous Test menu.

CANISTER PURGE VALVE

The EVAP Canister Purge Valve mode allows you to control the canister purge valve open in xx% increments from 0 to 99.6% while monitoring the EVAP Canister Purge Valve duty value.

To operate the Canister Purge Valve mode, do the following:

1. Press **↑** or **↓** to position the “*” on the display menu next to CANI PURG VAL, then press **ENTER**.
2. Press **YES** if the DTCs and Pending DTCs have been cleared. If the DTCs have not been cleared, press **NO** to return to the Miscellaneous Test menu.
3. Set the parking brake, stop the engine, and turn the ignition switch to ON.
4. The Data List display for monitoring the engine's response is available while the EVAP Canister Purge Valve is being controlled. Select the data parameters to be displayed by scrolling through the parameters with the **YES** and **NO** keys.

PRG is displayed at the end of line two. The current EVAP Canister Purge Valve duty ratio is displayed at the end of line four.

If the tester detects any of the following conditions, the EVAP Canister Purge Valve mode will be terminated.

- Engine speed detected.
 - Vehicle speed detected.
5. Pressing the **↑** key opens the EVAP Canister Purge Valve 8%. Press the **↓** key to close the EVAP Canister Purge Valve 8%.
 6. Press **EXIT** to return to the Miscellaneous Test menu and return the EVAP Canister Purge Valve control to the ECM.

Operation of the EVAP Canister Purge valve mode is summarized in the following flow diagram.

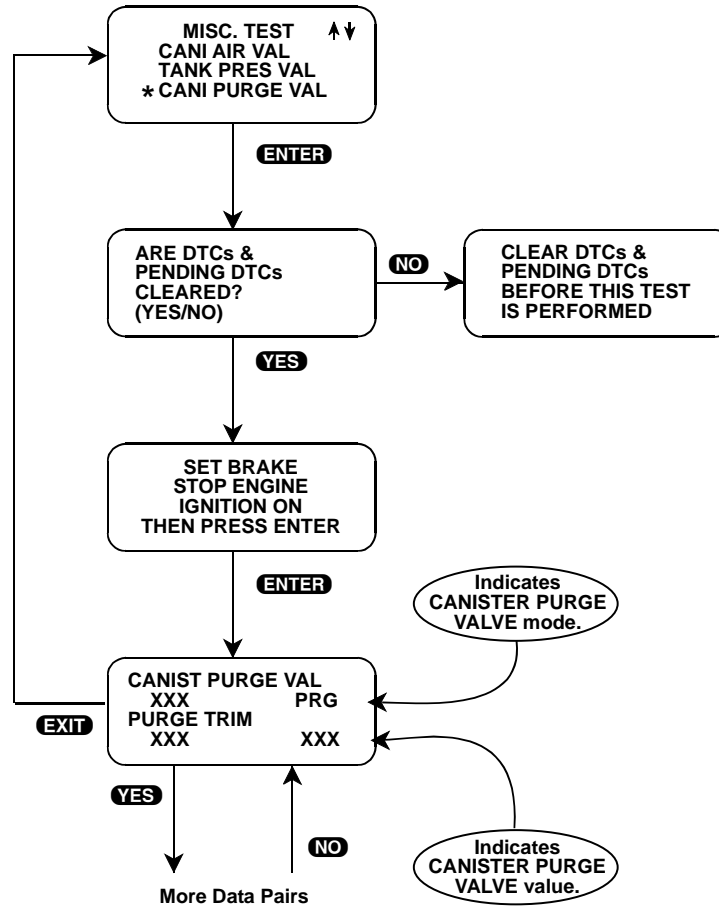

ACTIVE KEYS	
YES & NO	Scroll through displayed data parameters.
F0 & F1	Mark top or bottom displayed parameter as fixed for creating your own data pairs.
F7	Toggle between English and Metric units.
ENTER	Advance to EVAP Canister Purge Valve test.
↑	Open EVAP Canister Purge Valve 8% while viewing parameters.
↓	Close EVAP Canister Purge Valve 8% while viewing parameters.
EXIT	Return to Miscellaneous Test menu.

RDT FAN CONTROL

The purpose of RDT FAN CONT mode is to diagnose the radiator fan motor and its circuit. This mode allows you to control radiator fan motor to running or not running.

To operate the RDT FAN CONT mode, do the following:

1. Press **↑** or **↓** to position the “*” on the display menu next to RDT FAN CNT, then press **ENTER**.
2. Press **YES** if the DTCs and Pending DTCs have been cleared. If the DTCs have not been cleared, press **NO** to return to the Miscellaneous Test menu.
3. Set the parking brake and block the wheels.
4. The Data List display for monitoring the engine's response is available while the radiator fan motor is being controlled. Select the data parameters to be displayed by scrolling through the parameters with the **YES** and **NO** keys.

RDT is displayed at the end of line two. ON or OFF is displayed at the end of line four indicating that the radiator fan motor is being controlled.

If the tester detects any of the following conditions, the RDT Fan Control mode will be terminated.

- CTP switch (closed throttle position) is off.
 - Vehicle speed detected.
 - Coolant Temp > 110°
5. To control the radiator fan motor off, press the **↓** key. To turn it on press the **↑** key.
 6. Press **EXIT** to return to the Miscellaneous Test menu and return the RDT Fan control to the ECM.

Operation of the RDT Fan Control mode is summarized in the following flow diagram.

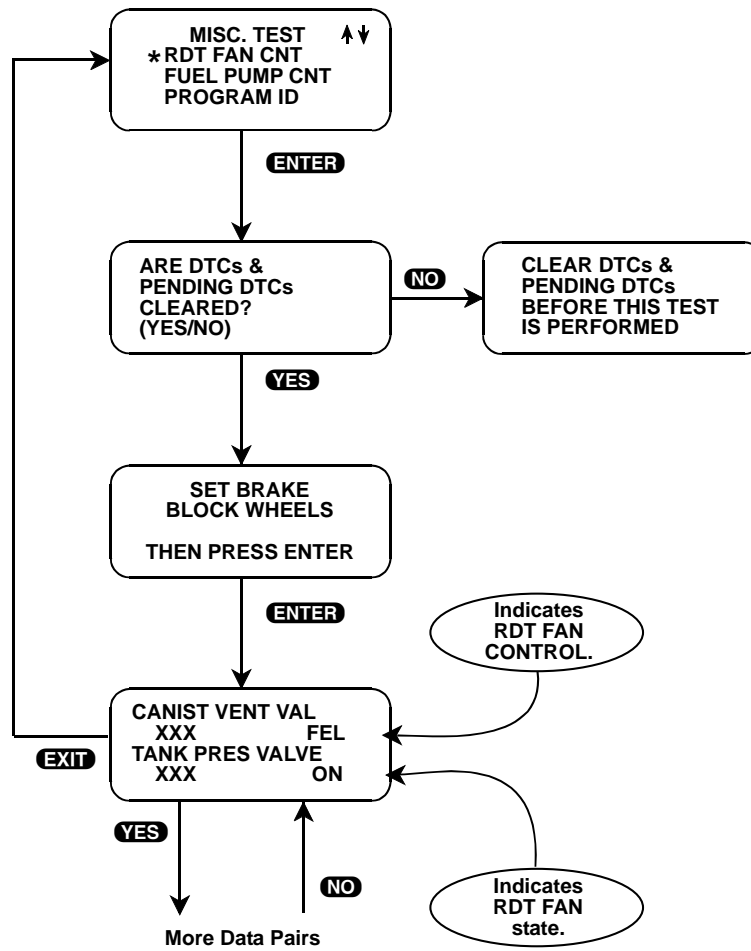

ACTIVE KEYS	
YES & NO	Scroll through displayed data parameters.
F0 & F1	Mark top or bottom displayed parameter as fixed for creating your own data pairs.
F7	Toggle between English and Metric units.
ENTER	Advance to RDT Fan Control test.
↑	Switch the RDT Fan Control on while viewing parameters.
↓	Switch RDT Fan Control off while viewing parameters.
EXIT	Return to Miscellaneous Test menu.

FUEL PUMP CONTROL

The purpose of FUEL PUMP CONT mode is to diagnose the fuel pump and its circuit. This mode allows you to control fuel pump ON or OFF.

To operate the Fuel Pump Control mode, do the following:

1. Press **↑** or **↓** to position the “*” on the display menu next to FUEL PUMP CNT, then press **ENTER**.
2. Press **YES** if the DTCs and Pending DTCs have been cleared. If the DTCs have not been cleared, press **NO** to return to the Miscellaneous Test menu.
3. Set the parking brake, stop the engine, then turn the ignition switch to ON.
4. The Data List display for monitoring the engine's response is available while the Fuel Pump is being controlled. Select the data parameters to be displayed by scrolling through the parameters with the **YES** and **NO** keys.

FEL is displayed at the end of line two. ON or OFF is displayed at the end of line four indicating that the Fuel Pump is being controlled.

If the tester detects any of the following conditions, the Fuel Pump Control mode will be terminated.
 - Engine speed detected.
 - Vehicle speed detected.
 - Fuel tank level < 15%.
5. To control the Fuel Pump off, press the **↓** key. To turn it on press the **↑** key.
6. Press **EXIT** to return to the Miscellaneous Test menu and return the Fuel Pump control to the ECM.

Operation of the Fuel Pump Control mode is summarized in the following flow diagram.

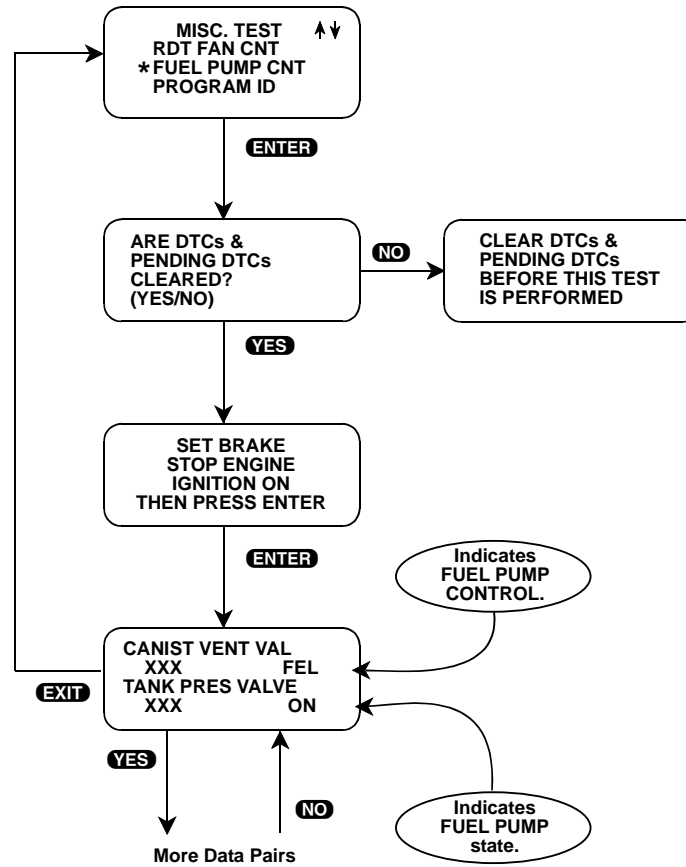

ACTIVE KEYS	
YES & NO	Scroll through displayed data parameters.
F0 & F1	Mark top or bottom displayed parameter as fixed for creating your own data pairs.
F7	Toggle between English and Metric units.
ENTER	Advance to Fuel Pump Control test.
↑	Switch the Fuel Pump on while viewing parameters.
↓	Switch the Fuel Pump off while viewing parameters.
EXIT	Return to Miscellaneous Test menu.

PROGRAM ID

The Program ID mode allows you to display the Program Identification number.

To operate the Program ID mode, do the following:

1. Press **↑** or **↓** to position the “*” on the display menu next to PROGRAM ID, then press **ENTER**.
2. The Program ID is displayed.
3. Press **EXIT** to return to the Miscellaneous Test menu.

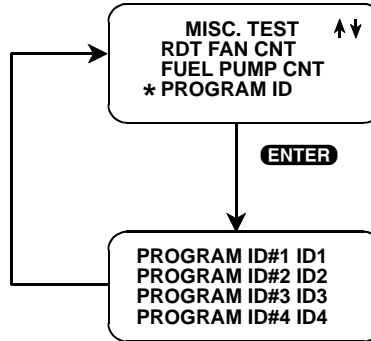

ACTIVE KEYS	
EXIT	Return to Miscellaneous Test menu.

6. OPERATING THE TEST MODES IN CARB MODE

The following section contains a brief description of test modes available in the SUZUKI ECM (OBD II) application. Note that the test modes are different for F0: CARB MODE and F1: SUZUKI MODE. Also, note that descriptions of the test modes for the SQ series and SY418 are provided in [Chapter 7](#).

F0: CARB MODE

Mode F0: Current Data

Monitors data parameters from the engine computer. Allows you to select which data parameters are displayed.

Mode F1: Freeze Data

Displays certain data parameters that were present in the ECM when a DTC occurred. Active DTCs are also displayed.

Mode F2: Trouble Code

Displays Diagnostic Trouble Codes (DTCs) that are stored in the ECM.

Mode F3: Clear Info

Clears stored DTCs, Freeze Frame data, Oxygen Sensor test data, On-Board monitoring test (pending DTCs) results, and resets the status of the system monitoring tests (readiness test).

Mode F4: O2S Test Result

Displays Oxygen Sensor (O2S) test results.

Mode F5: Readiness Test

Allows you to monitor the state of various on-board tests which are performed by the ECU(s).

Mode F6: On-Board Test (Pending DTCs)

Displays results of pending DTCs performed by the ECU(s).

MODE F0:CURRENT DATA

The Current Data function is used to display any or all of the vehicle parameters.

CURRENT DATA MENU

When you select Current Data from the SELECT MODE Functions menu, the Tester will display a CURRENT DATA Menu. This menu allows you to either go directly to displaying data, to go to the Data List Setup mode in order to select what data you want to display, or to go to Snapshot.

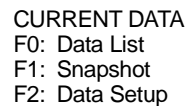

CURRENT DATA
F0: Data List
F1: Snapshot
F2: Data Setup

DATA LIST

You can select Data List from the CURRENT DATA menu, and monitor the vehicle parameters available from the ECM. The Data List selection will display either All Data List Parameters or the User Data List Parameters depending on which selection was last made since the tester was powered up. The Data List will default to the All Data List Parameters mode when the tester is first powered up. Depending on the vehicle, the update rate of the All Data List Parameters mode can be four seconds or longer.

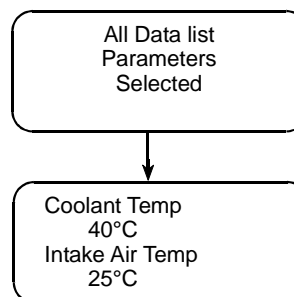

Data List Setup

The DATA LIST SETUP mode allows you to select the data you want to display. You can select either All Data List Parameters or User Data List Parameters which allows you to monitor any combination of parameters (from 1 parameter to all parameters). The update rate for the parameters is a function of the number of parameters selected. A single parameter can be sampled as fast as 8 times per second.

```

DATA LIST SETUP
F0: All Data
F1: User Data
F2: Sel User Data
  
```

If you select the Sel User Data in DATA LIST SETUP, the tester will display a list of parameters from which to select.

1. Select the desired parameters by scrolling through the list using the **↑** and **↓** keys, and then pressing **YES** to select the parameter or **NO** to deselect it.

```

Engine Speed
***Selected***
YES: Select      3
NO: De-Select
  
```

2. When the parameters have been selected, press **ENTER** to go to the display mode. The tester will remember the selected parameters (until the tester is turned off) so you won't have to re-select them every time.

```

Engine Speed
YES: Select      2
NO: De-Select
  
```

SNAPSHOT

Setup

The SNAPSHOT mode provides another way of looking at the diagnostic data (in addition to the Data List of Current Data mode described previously). In the SNAPSHOT mode, data is saved in tester memory while the tester is waiting for a trigger condition. The trigger can be:

- A Manual Trigger (via an **ENTER**, **EXIT** or **F9** key press).
- An Any Code Trigger (trigger on the occurrence of any DTC).
- A Single Code Trigger (trigger on a DTC you specify).

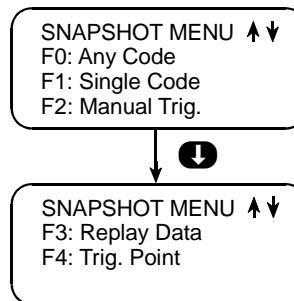

Selecting F0: Any Code or F2: Manual Trigger causes the tester to proceed directly to the DATA CAPTURE phase of the SNAPSHOT mode.

When the trigger condition F1: Single Code is selected the tester displays a code entry screen that allows you to enter the code desired. Use the numeric keys **0-9** to enter the desired Diagnostic Trouble Code (DTC) number, then press the **ENTER** key to begin the Data Capture Phase. The **YES** and **NO** keys can be used to move the cursor between numbers.

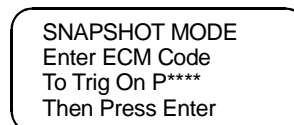

Trigger Point Setup

Once the trigger occurs, data continues to be saved in the tester's Snapshot memory until the memory is full. This allows data to be saved both before and after the trigger. A TRIGGER POINT (which sampled data is saved) can be selected. To change the trigger point, select F4: TRIGGER POINT from the SNAPSHOT MENU. Pressing F0: Beginning will save only the data after the trigger, F1: Center will save an equal amount of data before and after the trigger, and F2: End will save only data before the trigger. If no Trigger Point has been selected since the Tester was turned on, the default is Center.

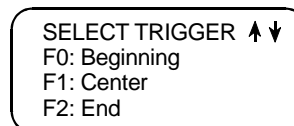

Data Capture

The Snapshot data capture process is started by selecting one of the Trigger modes. Once it is started, the tester will display diagnostic data parameters plus a status message (a flashing “W”) in the lower right of the screen indicating that the tester is Waiting for the trigger.

NOTE



While waiting for the selected trigger, the **ENTER**, **EXIT** or **F9** key can always be used to force a manual trigger.

Engine Speed
1052 RPM
Ign. Timing
18.5° W

When the trigger condition occurs, the status message will change to a **T**.

NOTE



Note: Pressing **EXIT** after a trigger has occurred will end the data capture phase. When the memory in the tester is full, the status message will change to **0**, representing the Snapshot data sample 0.

Snapshot Replay

Once you have captured Snapshot data, you can examine it by pressing the **↑** and **↓** keys to scroll through the samples. The last Snapshot is retained in the tester unless:

- It is overwritten by a new Snapshot.
- Suzuki Mode is selected from the start-up menu.
- A new application cartridge is installed in the tester.
- The tester is unplugged from power for more than 24 hours.

You can review the captured Snapshot without vehicle communications by selecting “F1: Replay Snapshot Data” from the following screen.

NOTE



This menu option is only displayed if a Snapshot has been taken. A Snapshot can also be replayed after communications is established by selecting F3: REPLAY DATA from the SNAPSHOT MENU.

F0: OBD II
Functions
F1: Replay Snap-
Shot Data

When the REPLAY DATA mode is first entered, the tester displays information about the saved Snapshot. The Snapshot's trigger point (Beginning, Center, or End) and trigger type (Manual, Any DTC or Single

DTC) are displayed briefly before the Snapshot data is displayed. When replaying a saved Snapshot, the sample at the time of the trigger (sample number 0 at time 0.0 seconds) is initially displayed. Samples before and/or after the trigger can be viewed by pressing the **↑** and **↓** keys to scroll through the samples.

SNAPSHOT TRIGGER
Point: Center
Type: Manual

The sample number of a Snapshot is displayed in the lower right of the display. This index number will initially be a "0", samples after the trigger will be displayed as positive numbers and samples before the trigger will be displayed as negative numbers. While replaying a Snapshot, pressing **ENTER** will cause the tester to toggle between the sample index and the sample time.

Engine Speed
1024 RPM
Ignition Advance
29.5° -2

The sample time display gives the time in seconds (relative to the trigger sample) at which the tester received the currently displayed sample. For example, a sample time of +3.4 means the sample was received 3.4 seconds after the trigger sample. A sample time of -2.6 seconds means the sample was received 2.6 seconds before the trigger

Engine Speed
1024 RPM
Ignition Advance
29.5° -7.1

ACTIVE KEYS	
YES & NO	Scroll through displayed data parameters, or for Select User Data, Select or Deselect Parameters.
↑ ↓	Scroll through parameters in Select User Data.
F0	Mark top displayed parameter as "fixed" for creating your own data pairs.
F1	Mark bottom displayed parameter as "fixed" for creating your own data pairs.
F4	Display first (earliest) sample.
F5	Display trigger sample ("0").
F6	Display last (most recent) sample.
F7	Toggle unit conversions for applicable parameters, between English and Metric.
F8	Print data list (if equipped with serial printer).
EXIT	Return to DATA LIST MENU or SNAPSHOT MENU.

MODE F1: FREEZE FRAME DATA

The vehicle's ECM saves diagnostic data information about the state of the vehicle when a Diagnostic Trouble Code (DTC) occurs. This data is referred to as Freeze Frame Data and can be read by the tester using the FREEZE FRAME DATA mode. You can select this mode from the SELECT MODE FUNCTIONS menu.

FREEZE FRAME DATA DISPLAY

1996-97 Vehicles and 1998 SV418 Vehicle

The Freeze Frame Data is displayed in the same format as the Data List format described in the DATA LIST of the Current Data mode. The first parameter in the list is the DTC which caused the Freeze Frame Data to be saved. Note that Freeze Frame Data is only available for the first DTC which was detected by the vehicle.

Trouble Code P0130 Engine Speed 1000 RPM

1998 and Later Vehicles (except 1998 SV418 Vehicle)

The PXXXX numbers are the DTCs for each frame. Once the Frame is selected, the Data List is displayed.

F0: PXXXX F1: PXXXX (1st) F2: PXXXX (2nd) F3: PXXXX (3rd)
--

The ECM has 4 frames where the Freeze Frame Data can be stored. F0 displays the Freeze Frame Data of the malfunction which was detected first. However, the Freeze Frame Data in F0 is updated according to the priority described below.

PRIORITY	FREEZE FRAME DATA IN FRAME 1
1	Freeze Frame Data at initial detection of malfunction among misfire detected (P0300 - P0304), fuel system too lean (P0171) and fuel system too rich (P0172)
2	Freeze Frame Data when a malfunction other than those in "1" above is detected.

In F1 through F3, the Freeze Frame Data of each malfunction is displayed in the order as the malfunction is detected. These data are not updated.

ACTIVE KEYS	
YES & NO	Scroll through displayed data parameters.
F0	Mark top displayed parameter as “fixed” for creating your own data pairs.
F1	Mark bottom displayed parameter as “fixed” for creating your own data pairs.
F7	Toggle unit conversions for applicable parameters between English and Metric.
F8	Print Freeze Frame Data (if equipped with serial printer).

MODE F2: DIAGNOSTIC TROUBLE CODES (DTCS)

When you select the DTCs mode, the tester reads all DTCs which have been saved by the vehicle's controllers and then displays:

- A two column list of all DTCs.
- How many codes have been reported by the ECM.

Trouble Codes * P0443 P0110 P0111
--

A DTC description can be displayed for any DTC by moving the * next to the desired DTC and pressing **ENTER**. The * is moved by pressing the **↑** or **↓** keys.

ACTIVE KEYS	
↑ or ↓	Move * up or down.
ENTER	Display DTC description.

MODE F3: CLEAR DIAGNOSTIC INFORMATION

The Clear Diagnostic Information mode is used to clear DTCs from the vehicle's ECM along with any other diagnostic information which the controller has saved. When you select Clear Info, you are first prompted with a warning message. This is to prevent accidental clearing of codes. If you press **YES** in response to the prompt, the tester will clear all emissions related information. The Clear Info mode will clear the following information from the vehicle's ECM:

- Clears number of diagnostic trouble codes
- Clears all diagnostic trouble codes
- Clears diagnostic trouble code for Freeze Frame data
- Clears Freeze Frame data
- Clears oxygen sensor test data
- Resets status of system monitoring tests (Readiness Tests)
- Clears on-board monitoring test results (pending DTCs)

Clear All
Diagnostic Info?
YES = Continue
NO = Quit

ACTIVE KEYS	
YES	Clears all emission-related information.
NO	Returns to Select Mode menu without clearing information.

MODE F4: OXYGEN SENSOR MONITORING TEST RESULTS

The F4: OXYGEN SENSOR MONITORING TEST RESULTS MODE is only available for 1996-97 vehicles.

The Oxygen Sensor (O2S) Monitoring Test Results mode displays the results of the Oxygen Sensor testing performed by the vehicle's engine controller. These tests are "once per trip" tests and are performed after the ignition is turned on under conditions defined by the vehicle manufacturer. The F5: Readiness Tests mode indicates whether or not these tests have been completed. If the tests have not been completed, the tester will display a warning message to indicate that the test results may not be valid.

O2 Sensor Tests
NOT Completed
YES = Continue
NO = Quit

O2 SENSOR TEST MENU

When the O2S Test Results mode is selected, the tester checks the ECM to determine which Oxygen Sensors are present, then displays a list of the sensors so you can select which sensor's test results to examine. To select a sensor, press the function key listed on the left. If no sensors are detected, the tester displays a warning message indicating that the O2S Tests may not be supported.

BANK 1 SENSOR
F0: SENSOR 1
F1: SENSOR 2

O2S DATA DISPLAYS

Once the sensor has been selected, the tester determines which O2 Sensor data parameters are available for display. It then displays data for each of the parameters. Only parameters which are supported by the vehicle ECM are displayed.

R → L Sw Time
0.16 Secs
L → R Sw Time
0.088 Secs

ACTIVE KEYS	
YES & NO	Scroll through displayed data parameters.
F0	Mark top displayed parameter as "fixed" for creating your own data pairs.
F1	Mark bottom displayed parameter as "fixed" for creating your own data pairs.
F8	Print data list (if equipped with serial printer).
EXIT	Return to Select Mode menu.

MODE F5: READINESS TESTS

Once the tester has established communications with the vehicle, it checks the status of the ECM "Readiness Tests". If the tester determines that the ECM has not completed all of the Readiness Tests, it will display a warning message. You can then select the Readiness Tests menu item from the SELECT MODE FUNCTIONS menu to examine the status of these tests.

Not All Vehicle
System Readiness
Tests Have Been
Completed

Press **F5** to select READINESS from the SELECT MODE FUNCTIONS menu. This mode allows you to monitor the state of various on-board tests which are performed by the vehicle's ECM.

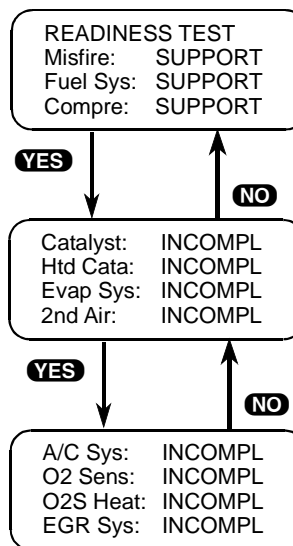

The first three items on the display indicate the vehicle's monitoring capability for continuously monitored systems:

- Misfire Monitoring
- Fuel System Monitoring
- Comprehensive Component Monitoring

These are indicated as either being SUPPORTED or NOT SUPPORTED (N/A), depending on the vehicle's ECM.

The other 8 display items indicate the status of the tests. These tests can be Completed, Incomplete, or Not Supported. Press **YES** to advance to the next screen or press **NO** to return to the previous screen.

MODE F6: ON-BOARD TESTS (PENDING DTCS)

When you select the F1: Pending DTCs in the ON-BOARD TESTS menu, the tester reads all pending DTCs which have been saved by the ECM and then displays:

- A two-column list of all DTCs
- How many codes have been reported

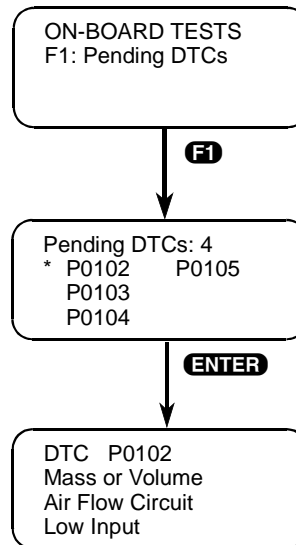

A pending DTC description can be displayed for any Pending DTC by moving the * next to the desired DTC and pressing **ENTER**.

The * is moved by pressing the **↑** or **↓**.

ACTIVE KEYS	
↑ or ↓	Moves the * up or down.
ENTER	Display pending DTC description.

7. OPERATING THE TEST MODES FOR THE SQ SERIES, SY418, AND JA627

The following section contains a brief description of test modes available in the SUZUKI ECM (OBD II) application. Note that the test modes are different from F0: CARB MODE and F1: SUZUKI MODE.

Mode F0: Data List

Monitor enhancement data parameters for SUZUKI vehicles from the engine computer.

Mode F1: Print Data

Send one data stream of information to a serial printer, terminal or smart device.

Mode F2: Trouble Codes

Monitor Diagnostic Trouble Codes. Codes may also be cleared with this mode. Monitor Freeze Frame data stored in the ECU.

Mode F3: Snapshot

Capture and store ECM data parameters. Data is captured before and after a “trigger” point. Triggers can be on any trouble code, a particular trouble code, or manual tester key press. Captured data can then be displayed as well as trouble codes.

Mode F4: Miscellaneous

Displays a submenu of Miscellaneous Test modes, including Output Control tests and Readiness tests.

Mode F5: ECU ID

Displays the ECU number and the software version.

ECM COMMUNICATIONS STATUS DISPLAYS FOR THE SQ SERIES, SY418, AND JA627

Most test modes display data. Therefore, these test modes require the ECM to send data to the tester. When you select a test, you may see one or more of the following ECM communications status displays.



A

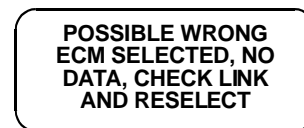

B

Display A:

This means that the tester cannot yet display data as it has not yet received a complete data message from the ECM. This display is sometimes seen right after selecting a test mode.

Display B:

This occurs when the tester has not received any data from the ECM. In this case, you should verify that the ignition is ON and check the serial data link connections. An incorrect engine type selection may also cause this condition.

ACTIVE KEYS	
EXIT	Return to the vehicle select mode.

MODE F0: DATA LIST

For a description of the DATA LIST mode, see [Mode F0: Data List on page 5-19](#).

MODE F1: PRINT DATA

For a description of the PRINT DATA mode, see [Mode F1: Print Data on page 5-21](#).

MODE F2: TROUBLE CODES MODE

Trouble codes are set by the ECU when an abnormal condition is detected. They are a key to diagnosing many of the problems which can occur in the vehicle. The F2 mode allows you quick access to trouble codes for initial vehicle checks and to check that a repair procedure has been successful.

To operate the Trouble Codes mode, do the following:

NOTE



When checking and clearing trouble codes, be sure to follow instructions in the Service Manual, or correct reading or clearing of the DTC(s) may not occur.

Press **F2** to select the TROUBLE CODES mode from the Select Mode menu. The Trouble Code menu appears:

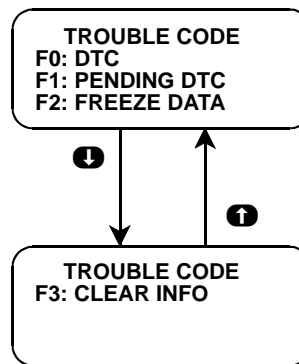

F0 or F1: DTC or Pending DTC

When you select F0: or F1: for DTC or Pending DTCs, the tester reads all DTCs which have been saved by the vehicle's controllers and then displays:

- A two column list of all DTCs.
- How many codes have been reported by the ECM.

DTC 3
* P0443
P0110
P0111

OR

PENDING DTC 3
* P0443
P0110
P0111

A DTC description can be displayed for any DTC by moving the * next to the desired DTC and pressing **ENTER**. The * is moved by pressing the **↑** or **↓** keys.

* RCV ENTER ENTER YES SEND	
↑ or ↓	Move * up or down.
ENTER	Display DTC description.

F2: Freeze Data

For a description of Freeze Frame data, see [Mode F1: Freeze Frame Data on page 56](#)

F3: Clear Diagnostic Information

The Clear Diagnostic Information mode is used to clear DTCs from the vehicle's ECM along with any other diagnostic information which the controller has saved. When you select Clear Info, you are first prompted with a warning message. This is to prevent accidental clearing of codes. If you press **YES** in response to the prompt, the tester will clear all emissions related information. The Clear Info mode will clear the following information from the vehicle's ECM:

- Clears number of diagnostic trouble codes
- Clears all diagnostic trouble codes
- Clears diagnostic trouble code for Freeze Frame data
- Clears Freeze Frame data
- Resets status of system monitoring tests (Readiness Tests)

Clear All
Diagnostic Info?
YES = Continue
NO = Quit

ACTIVE KEYS	
YES	Clears all emission-related information.
NO	Returns to Select Mode menu without clearing information.

MODE F3: SNAPSHOT

MODE F3: SNAPSHOT is identical to the *Mode F3: Snapshot on page 22*, except for the Trigger Condition section which is described below.

Trigger Condition

The trigger condition defines the specific circumstances under which you want the trigger to be set. The possible trigger conditions are:

- ANY DTC: If any DTC is detected by the tester, it will cause the trigger to be set.
- SINGLE DTC: You can select a specific DTC that must be detected before the trigger will be set. Step 3 in the Operating Procedure tells you how to enter the code.
- MANUAL TRIGGER: While operating the SNAPSHOT mode, you can always cause the trigger to be set by pressing the **ENTER** key.

Once the trigger occurs, the tester will retain data according to which trigger point you have selected.

MODE F4: MISC. TESTS

When F4: MISC TESTS is selected from the SELECT MODE menu, this submenu will appear.



MISC TEST
F0: OUTPUT TESTS
F1: READINESS TST

F0: OUTPUT TESTS

F0: OUTPUT TESTS displays sub-modes to operate single tests. A chart of the tests available is provided below.

YEAR	MODEL	RPM CONTROL	FIXED SPARK	CANI AIR VAL	TANK PRESS VAL	CANI PURGE VAL	STEP EGR	FUEL PUMP CONT	MIL CONTROL	IAC CAL	A/C COND FAN
1999	SQ SERIES	x	x	x	x	x	x	x	x		
1999-2000	SY418	x	x	x	x	x	x	x	x	x	
2001		x	x	x		x	x	x	x	x	
2001	JA627	x	x	x		x	x	x	x		x

NOTE



Regarding MY 2001 SY418, "TANK PRESS VAL" is indicated on the output tests screen, but disregard this item because MY 2001 SY418 is not equipped with the tank pressure control solenoid valve.

Descriptions of the following output tests are provided in [Mode F4: Misc. Tests on page 27](#).

- RPM CONTROL
- FIXED SPARK
- CANI AIR VAL
- TANK PRESS VAL
- CANI PURGE VAL
- STEP EGR
- FUEL PUMP CONT
- IAC CAL

The following pages give a description of the MIL CONTROL output test and the A/C COND FAN output test.

MIL CONTROL

The purpose of MIL CONT mode is to diagnose the malfunction indicator light and its circuit. This mode allows you to control the MIL ON or OFF.

To operate the MIL CONT mode, do the following:

1. Press **↑** or **↓** to position the “*” on the display menu next to MIL CONTROL, then press **ENTER**.
2. Set the parking brake and block the wheels.
3. The Data List display for monitoring the engine's response is available while the MIL is being controlled. Select the data parameters to be displayed by scrolling through the parameters with the **YES** and **NO** keys.

MIL is displayed at the end of line two. ON or OFF is displayed at the end of line four indicating that the MIL is being controlled.

If the tester detects the following condition, the MIL Control mode will be terminated:

- Vehicle speed detected.
4. To control the MIL off, press the **↓** key. To turn it on press the **↑** key.
 5. Press **EXIT** to return to the Miscellaneous Test menu and return the MIL control to the ECM.

Operation of the MIL Control mode is summarized in the following flow diagram.

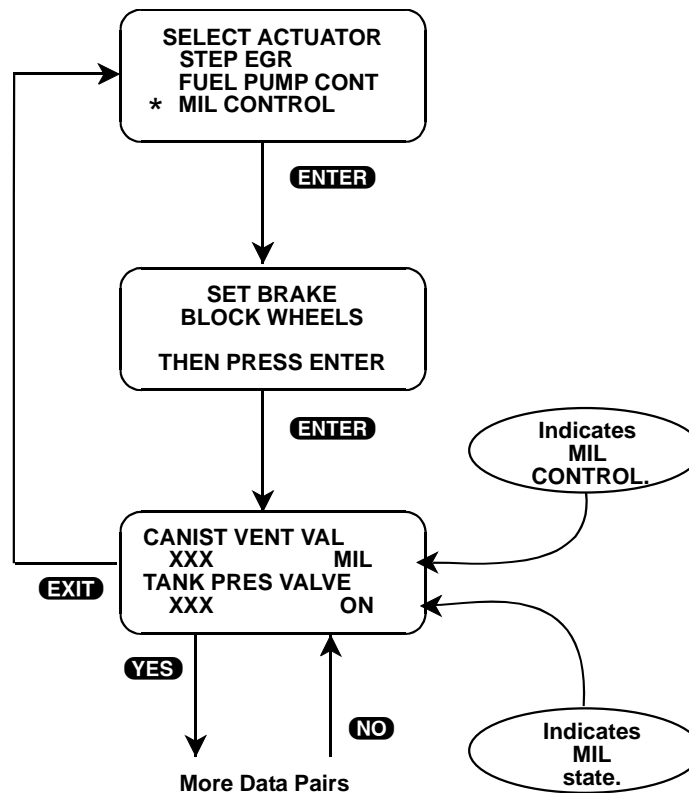

ACTIVE KEYS	
YES & NO	Scroll through displayed data parameters.
F0 & F1	Mark top or bottom displayed parameter as fixed for creating your own data pairs.
ENTER	Advance to MIL Control test.
↑	Switch the MIL on while viewing parameters.
↓	Switch the MIL off while viewing parameters.
EXIT	Return to Miscellaneous Test menu.

A/C COND FAN

The purpose of A/C COND FAN mode is to diagnose the air conditioning fan and its circuit. This mode allows you to control the A/C FAN ON or OFF.

To operate the A/C COND FAN mode, do the following:

1. Press **↑** or **↓** to position the “*” on the display menu next to A/C COND FAN, then press **ENTER**.
2. Set the parking brake and block the wheels.
3. The Data List display for monitoring the engine's response is available while the A/C COND FAN is being controlled. Select the data parameters to be displayed by scrolling through the parameters with the **YES** and **NO** keys.

A/C is displayed at the end of line two. ON or OFF is displayed at the end of line four indicating that the A/C COND FAN is being controlled.

If the tester detects the following condition, the A/C COND FAN mode will be terminated:

- Vehicle speed detected.
 - Idle SW OFF
 - Coolant temp >110°C.
 - A/C FAN ON
4. To control the A/C COND FAN off, press the **↓** key. To turn it on press the **↑** key.
 5. Press **EXIT** to return to the Miscellaneous Test menu and return the A/C COND FAN control to the ECM.

Operation of the A/C COND FAN Control mode is summarized in the following flow diagram.

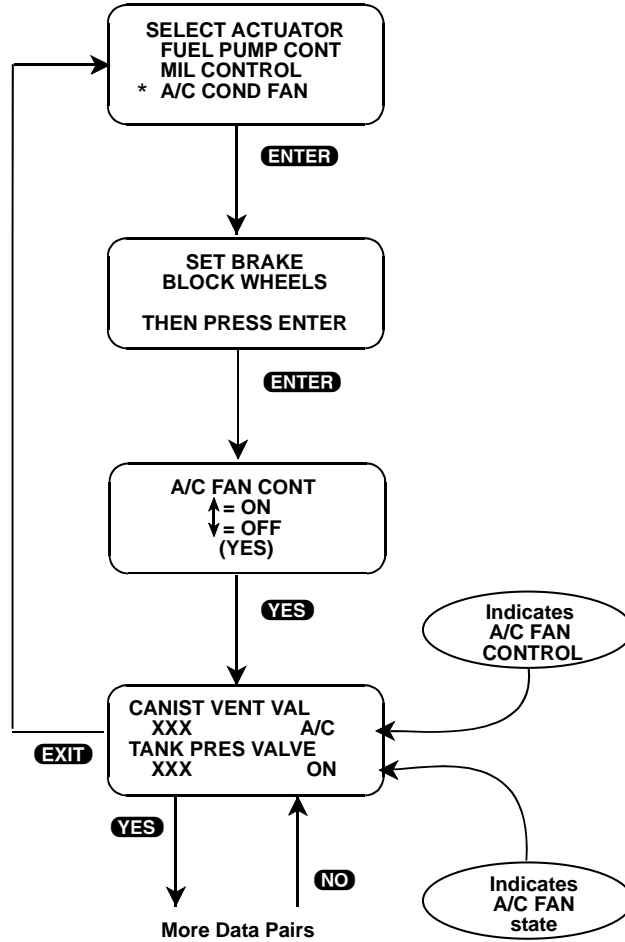

ACTIVE KEYS	
YES & NO	Scroll through displayed data parameters.
F0 & F1	Mark top or bottom displayed parameter as fixed for creating your own data pairs.
ENTER	Advance to A/C COND FAN Control test.
↑	Switch the A/C COND FAN on while viewing parameters.
↓	Switch the A/C COND FAN off while viewing parameters.
EXIT	Return to Miscellaneous Test menu.

F1: Readiness Tests

Press **F1** to select READINESS TESTS from the MISC TEST menu. This mode allows you to monitor the state of various on-board tests which are performed by the vehicle's ECM.

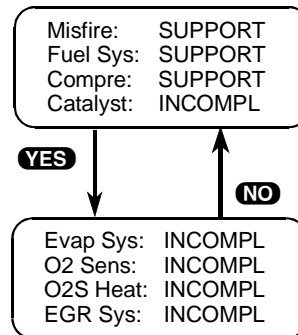

The first three items on the display indicate the vehicle's monitoring capability for continuously monitored systems:

- Misfire Monitoring
- Fuel System Monitoring
- Comprehensive Component Monitoring

These are indicated as either being supported or NOT SUPPORTED (N/A), depending on the vehicle's ECM.

The other 5 display items indicate the status of the tests. These tests can be Completed, Incomplete, or Not Supported. Press **YES** to advance to the next screen or press **NO** to return to the previous screen.

MODE: ECU ID

ECU ID mode is NOT available for all vehicles.

The ECU ID mode allows you to view the ECU identification number, as well as the Software Version number.

Select the ECU ID mode from the Select Mode menu by pressing **F5**.

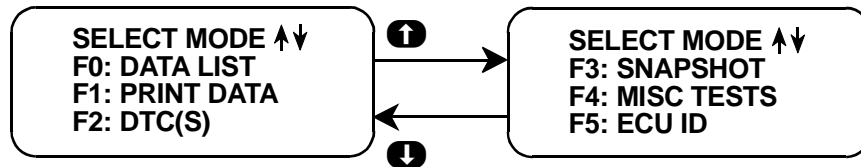

The tester will display the following screen.

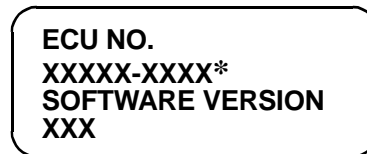

To return to the Select Mode menu, press **EXIT**.

8. FINISHING UP

After using the SUZUKI Application Cartridge, a few simple steps will insure that you get the most life out of your diagnostic tool.

First, remove power to the tester by disconnecting the serial data link cable from the serial data link connector. You may want to inspect the cable and connector for any damage or corrosion.

Next, unplug the cartridge and store it and the cable in the travelling case.

If the tester should become dirty you may wipe it off with a clean cloth and mild detergent or hand soap. Avoid using harsh solvents such as petroleum based cleaning agents, Benzene, Trichloroethylene, etc. Although the tester is water resistant, it is not waterproof so be sure to thoroughly dry off the tester prior to storage.

9. IF YOU'RE HAVING A PROBLEM

Although the tester was designed to give you years of trouble-free service, occasional problems may occur that require special attention. Some of these problems may be corrected with a few simple steps. Examples of most of the displays which you might see under abnormal conditions are shown. In addition, the most likely cause for the condition is given as well as other possible causes and recommendations on how to isolate or eliminate the problem. If the problem appears to be in the tester, perform the Self-test (described in the tester Operators Manual.)

BLANK SCREEN

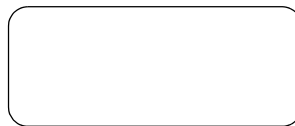

Most Likely Cause

- Tester power supply is malfunctioning.

Other Possible Causes

- Faulty cable.
- No power is applied to the tester.

Recommendations

- Plug the tester into another vehicle to verify proper operation.

SCREEN DISPLAYS SOLID BARS

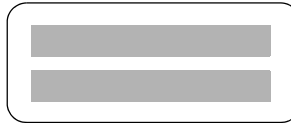

Most Likely Cause

- Two application cartridges are installed.

Other Possible Causes

- Application Cartridge is malfunctioning.
- Tester is malfunctioning.

Recommendations

- Make sure that only one application cartridge is installed in the tester.
- Remove all cartridges and see if “MASS STORAGE CARTRIDGE MISSING OR MALFUNCTIONING” message is displayed. If it is, try installing another mass storage cartridge.

MASTER CARTRIDGE MISSING OR MALFUNCTIONING

MASTER CARTRIDGE
IS MISSING OR
MALFUNCTIONING

Most Likely Cause

- Application Cartridge is not installed in bottom slot of tester.

Other Possible Causes

- Dirty contacts on the application cartridge connector.
- Two application cartridges installed.

Recommendations

- Verify that an application cartridge is installed.
- Clean contacts on application cartridge connector with alcohol.
- Try a different application cartridge.

KEYBOARD/DISPLAY LOCKED UP OR PROGRAM RETURNS TO FIRST PAGE

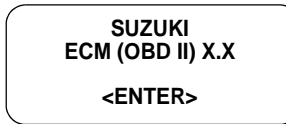

Keyboard or display locked up or program sporadically returns to first page

Most Likely Cause

- Serial data link cable loose or bad.

Other Possible Causes

- Application Cartridge loose or dirty contacts.
- Tester malfunction.

Recommendations

- Cycle power to the tester (unplug and replug the serial data link connector).
- Check tester cartridge socket and cartridge edge connector.
- Check serial data link cable and connector for wear or corrosion.

DATA NOT BEING RECEIVED

POSSIBLE WRONG ECM
SELECTED, NO DATA,
CHECK LINK AND
RESELECT

SERIAL DATA FAIL
CHECK DATA LINK
AND RESELECT
(EXIT)

Tester is not receiving data

Most Likely Cause

- ECM-serial data link connector cable problems.

Other Possible Causes

- Serial data link cable loose or bad or connector pins loose or corroded.
- Bad ECM.

Recommendations

- Verify a good serial data link cable connection.
- Cycle power to the tester.
- Run the tester Self-test.

PARAMETERS FLASH ON/OFF

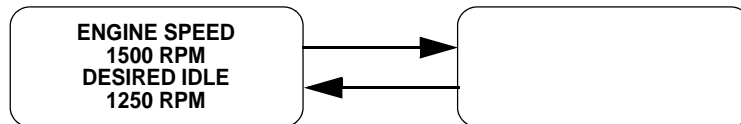

Data List parameters flash on and off

Most Likely Cause

- Serial data link cable loose or bad.

Other Possible Causes

- Serial data link cable connector pins loose or corroded.
- ECM-serial data link connector cable problems.
- Intermittent ECM problem.

Recommendations

- Verify a good serial data link cable connection.
- Cycle power to the tester.

TESTER IS NOT ABLE TO COMMUNICATE WITH THE VEHICLE

* CHECK CABLE
* IGNITION ON?
* DOES VEHICLE
SUPPORT OBD II

Possible Causes

- Vehicle's ignition is off.
- Diagnostic cable is not plugged into vehicle's diagnostic connector.
- Vehicle is not OBD II compatible.

Recommendations

- Verify vehicle's ignition is on.
- Verify cable is plugged into vehicle's diagnostic connector.
- Check underhood decal for OBD II certification.

TESTER STOPS COMMUNICATING WITH THE VEHICLE

LOSS OF VEHICLE COMMUNICATIONS

Possible Causes

- Vehicle's ignition was turned off.
- Diagnostic cable came loose from vehicle's diagnostic connector.
- Vehicle failed to respond to query from tester.

Recommendations

- Verify vehicle's ignition is on.
- Verify cable is plugged into vehicle's diagnostic connector.
- Turn tester and vehicle's ignition off. Then turn ignition to on, followed by turning on the tester and attempting to reestablish communications.
- Some vehicle's fail to respond properly to tester queries for certain tests. This is particularly true with oxygen sensor tests if all Readiness Tests have not been completed. If possible, drive the vehicle to complete the Readiness Tests and then rerun the tests.

PARAMETER UPDATE RATE IS SLOW

Probable Cause:

- A slow update rate is characteristic of OBD II communications. A typical update rate is approximately 125 to 150 ms per parameter (7 or 8 updates per second for a single parameter). Therefore, a typical list of 20 parameters will only be updated approximately every 3 seconds.

Recommendations

- If a faster update rate is needed, select fewer parameters using the SEL USER DATA function. Select only the parameters needed for a test. For example, you can look at just an oxygen sensor signal and get an update of 7 or 8 times a second.

NOT ALL PARAMETERS ARE DISPLAYED

Probable Cause

- The vehicle is not reporting all of the parameters. The CARB MODE queries the vehicle's ECM to determine what parameters are supported by the ECM. The tester then creates a Data List based on these parameters. If the vehicle contains a particular sensor but does not tell the tester that it supports that parameter (e.g. a downstream oxygen sensor) the tester will not display that parameter.
- A custom parameter list was defined in the Select User Data mode.

Recommendations

- Diagnosis must be performed based on other diagnostic data or procedures.

A. UNDERSTANDING SUZUKI ECMS

The serial data link uses message-oriented transmissions with a UART type data format. The communication is via a single-wire half-duplex bus using a master/slave protocol. The serial data link can be used for communications during normal operation or as an interface to a test device for diagnostic operations. If there is no requirement for data sharing between the vehicle's components during normal operation, the link can be implemented as a diagnostics only link. Numerous diagnostic modes provide a maximum of system flexibility.

Interface to the serial data link can be implemented using standard UART type devices communicating at a 10.4k baud rate. The interface devices required for this phase are available as stand-alone devices or integrated with CPUs (or MPUs) in a large number of micro-controllers.

Network access is via a master/slave protocol. The serial data link can have at most one device functioning as the master at any point in time. The tester controls all communications on the serial data link. A slave device (ECM) can transmit data only after it has been interrogated by the master device. A typical operating scenario is for the master device to periodically send a polling message to one or more of the slave devices. The slaves can then send a response message (containing, for example, the states of the slave's inputs or internal parameters) back to the master.

Once the tester has control of the serial data link, it can perform diagnostics on any of the devices connected to serial data link which support serial data diagnostics. It is important to note that the tester can only perform diagnostics which were provided for in the design of the various components. Some components might implement minimum diagnostics such as trouble code and diagnostic parameter readout. Other components might implement high-end diagnostics including provision for extensive control over the operation of the component and override of internal parameters. This can be used to exercise specific circuits in order to assist in the isolation of faults.

B. GLOSSARY

This section describes the abbreviations and terminology which are used in this manual

ABS	Absolute	ECM	Engine Control Module
A/C	Air Conditioning	ECT	Engine Coolant Temperature
A/T	Automatic Transmission	EFI	Electronic Fuel Injection
B1	Bank 1 (LH Bank)	EFFI	Efficiency
B2	Bank 2 (RH Bank)	EGR	Exhaust Gas Recirculation
BTDC	Before Top Dead Center	EGRT	Exhaust Gas Recirculation Temperature
CAL	Calibration	EVAP	Evaporative Emission
CANI	Canister	FCC	Federal Communications Commission
CARB	California Air Resources Board	FT	Fuel Trim
CHK	Check	FXS	Fixed Spark Mode
CMP	Camshaft Position	g/sec	Grams Per Second
CNT	Control	gs	Grams Per Second
COND	Condition	IAC	Idle Air Control
CONT	Control	IAT	Intake Air Temperature
CONTR	Control	in. Hg	Inches of Mercury
CTP	Closed Throttle Position	INJ	Injector
DEG	Degree	ISC	Idle Speed Control
DIAG	Diagnostic	KPa	Kilo Pascal
DLC	Data Link Connector (SDL connector)	KPa (A)	Kilo Pascal (Absolute)
DTC	Diagnostic Trouble Code	KPH	Kilometers Per Hour

LH	Left Hand	SENS	Sensor
lbm	Pounds Per Minute	SOL	Solenoid
MAF	Mass Air Flow	SP valve	Solenoid Purge Valve
MANI	Manifold	SPD	Speed
MANUF	Manufacturer	SYS	System
MAP	Manifold Absolute Pressure	TEMP	Temperature
MFG	Manufacturer	TBI	Throttle Body Fuel Injection (Single Port Fuel Injection, SPI)
MISC	Miscellaneous	THROT	Throttle
MFI	Multiport Fuel Injection (Multi Port Fuel Injection, MPI)	TP	Throttle Position
mmHg	Millimeters of Mercury	UART	Universal Asynchronous Receiver Transmitter
MONIT	Monitor	VAF	Volume Air Flow
MPH	Miles Per Hour	VAL	Value
MPU	Micro Processing Unit	VIN	Vehicle Identification Number
ms	Millisecond	VNT	Vent
mV	Millivolt	VSS	Vehicle Speed Sensor
O2S	Oxygen Sensor		
OBD II	On Board Diagnostics (Level II)		
PCM	Powertrain Control Module		
PNP	Park Neutral Position		
POS	Position		
PRESS	Pressure		
PRG	Purge		
PSP	Power Steering Pressure		
PS SV Valve	Power Steering Solenoid Vacuum Valve (Power Steering Vacuum Switching Valve, PS VSV)		
RDT	Radiator		
RH	Right Hand		
RPM	Revolutions Per Minute		
RS232C	Standard Serial Communication interface		
S1	Sensor 1		
S2	Sensor 2		
SDL	Serial Data Link		

ECM (OBD I) Application

Operator's Manual

1. SUZUKI ECM APPLICATION DESCRIPTION

The Suzuki ECM Application is used with the tester to diagnose and troubleshoot the engine systems controlled by the Engine Control Module (ECM) and the Engine and Automatic Transmission systems controlled by Powertrain Control Module (PCM) that are used on Suzuki vehicles (except OBD II vehicles that are for the North American market from 1996 to present).

The Suzuki ECM Application and the tester team up to become a diagnostic tool which is both powerful and easy to use. With the Vetronix tester, you can select test modes which let you:

- read engine data parameters
- read diagnostic trouble codes
- clear diagnostic trouble codes
- diagnose intermittent problems by capturing and storing multiple samples of system data before and after the problem occurs, then examining the data to determine the problem. This data is saved in the tester memory for at least 24 hours even if the power is removed from the tester!
- control some actuators
- fix spark advance
- fix Idle Air Control Calibration (IAC CAL)
- print data and vehicle information

This information can be analyzed and displayed to assist service technicians in diagnosing engine and driveability problems.

The Suzuki ECM Application is included in the Suzuki Application Cartridge. When used with the tester, it is capable of monitoring and diagnosing the engine with ECM or engine/AT with PCM on the models listed in the chart on the following page.

SUZUKI ECM APPLICATION COVERAGE

OTHER THAN NORTH AMERICAN MARKET

MODEL	ENGINE TYPE	ECU TYPE	ECU MFT.	ECU NO.	REMARKS
SE416	TBI, 2 Valve/ Cylinder	ECM	mitsubishi	1	-
		ECM	DENSO	2	-
	SFI, 4 Valve/ Cylinder	ECM	mitsubishi	3	-
		PCM	mitsubishi	11	4AT only/See NOTE on page 87
		ECM	mitsubishi	37	Vehicle with HO2S-2 (rear)
SZ416	SFI, 4 Valve/ Cylinder	ECM	mitsubishi	3	-
SV420G	SFI	ECM	HITACHI	7	For MT vehicle
		PCM	HITACHI	10	For AT vehicle
SV620	SFI	ECM	HITACHI	7	-
		PCM	HITACHI	10	4AT only/See NOTE
SQ416/420	SFI	ECM	mitsubishi	15	For MT vehicle
		PCM	mitsubishi	15	For AT vehicle
		ECM	mitsubishi	24, 44	For MT vehicle/See NOTE
		PCM	mitsubishi	24, 44	For AT vehicle/See NOTE
SQ625	SFI	ECM	HITACHI	16	For MT vehicle
		PCM	HITACHI	16	For AT vehicle
		ECM	HITACHI	25, 43	For MT vehicle/See NOTE
		PCM	HITACHI	25, 43	For AT vehicle/See NOTE
SQ420WD	DIESEL	ECM	BOSCH	39	RHZ engine
SF series	TBI (Bypass Air Type)	ECM	DENSO	4	-
	TBI (Throttle Position Type)	ECM	DENSO	5	-
	SFI/TBI	ECM	DENSO	31	For MT vehicle with HO2S-2 (rear)
		PCM	DENSO	31	For AT vehicle with HO2S-2 (rear)
MF413 (SF413)	SFI	ECM	DENSO	26	For MT vehicle
		PCM	DENSO	26	For AT vehicle

MODEL (CONT.)	ENGINE TYPE	ECU TYPE	ECU MFT.	ECU NO.	REMARKS
SY413/415/416	MFI	ECM	DENSO	5	-
		PCM	DENSO	5	3AT/See <i>NOTE</i>
	SFI	ECM	DENSO	13, 18	See <i>NOTE</i>
		PCM	DENSO	13, 18	3AT only/See <i>NOTE</i>
		ECM	DENSO	29	Vehicle with HO2S-2 (rear)
		PCM	DENSO	29	Vehicle with HO2S-2 (rear) (3AT)
SY418	SFI	ECM	HITACHI	8	-
				14	Vehicle with step EGR
				36	Vehicle with HO2S-2 (rear)
SY419	DIESEL	SOV	LUCAS	20	-
		ECM	BOSCH	40	Electronic controlled type
MB308 (SB308)	SFI	ECM	DENSO	27	-
SH410	TBI	ECM	mitsubishi	6	-
	MFI	ECM	mitsubishi	9	For MT vehicle
		PCM	mitsubishi	9	For AT vehicle
	SFI	ECM	DENSO	30	Vehicle with HO2S-2 (rear) (MT)
		PCM	DENSO	30	Vehicle with HO2S-2 (rear) (AT)
MH410 (SH410)	SFI	ECM	DENSO	27	For MT vehicle
		PCM	DENSO	27	For AT vehicle
SR series	SFI	ECM	HITACHI	12	-
			MITSUBISHI	28	For Chinese Market (F10A engine)
MRD410 (RD410)	SFI	ECM	DENSO	27	For MT vehicle
		PCM	DENSO	27	For AT vehicle
RB series	SFI	ECM	DENSO	21	For vehicle with EGR
				22	For vehicle without EGR
RG413	SFI	ECM	DENSO	23	Vehicle with HO2S-2 (rear)
				42	Vehicle without HO2S-2 (rear)
RH413/416	SFI	ECM	DENSO	34	Vehicle with HO2S-2 (rear)
				47	Vehicle without HO2S-2 (rear)
MRF series (RF series)	SFI	ECM	DENSO	27	For MT vehicle
		PCM	DENSO	27	For AT vehicle
MG413W (SJ413W)	SFI	ECM	DENSO	27	-
SJ413	SFI	ECM	DENSO	33	Vehicle with HO2S-2 (rear)

MODEL (CONT.)	ENGINE TYPE	ECU TYPE	ECU MFT.	ECU NO.	REMARKS
SN413	SFI	ECM	DENSO	17	-
				32	Vehicle with HO2S-2 (rear)
				41	SN413V/See <i>NOTE</i>
GA413	SFI	ECM	DENSO	19	-
				35	Vehicle with HO2S-2 (rear)
MT308 (ST308)	SFI	ECM	MITSUBISHI	28	-

NOTE

The ECUs of the following models are applicable to vehicles on and after the following VIN Nos.

ECU NO.	MODEL	FOR EUROPEAN MARKETS	FOR OTHER MARKETS
5	SY413	JSAEGC11S00109522 JSAEGA11S00108641	
10	SV620	JSAETD11V00150001	TD11V-200001
11	SE416	JSAETA02C01200001 JSAETA02V01200001 JSAETD01V01200001	TD01V-200001
13	SY413	JSAEGA11S00140001 JSAEGC11S00140001 JSAEGC11W00140001	GA11S-140001 GC11S-140001
13	SY415 SY416	JSAEGA31S00140001 JSAEGB31S00140001 JSAEGC31S00140001 JSAEGC31SV5140001 JSAEGC31SW0140001 JSAEGD31S00140001 JSAEGC31W00140001 JSAEGC31WW0140001 JSAEGD31W00140001	GA31S-140001 GC31S-140001 GC31S-140001 GD31S-140001 JS2GA31S/W5140001 JS2GB31S/W5140001
24 44	SQ416 SQ420	JSAFTA03V00150001 JSAFTA03V10150001 JSAFTA03V14150001 JSAFTA52V00150001 JSAFTA52V14150001 JSAFTL52V00150001 JSAFTL52V10150001 JSAFTL52V14150001	JS3TA03V14150001 JS3TA52V14150001 JS3TL52V14150001 2S2GTA03C00470001 2S2GTA03C10470001 2S2GTA03C16470001 2S3TA03C16100001 2S3TA52C16100001 2S2GTA52C00470001 2S2GTA52C10470001
25 43	SQ625	JSAFTD62V00150001 JSAFTD62V10150001 JSAFTD62V14150001	JS3TD62V14150001

ECU NO.	MODEL	FOR EUROPEAN MARKETS	FOR OTHER MARKETS
32 41	SN413V	JSAFJA43V00100001 JSAFJB43V00100001 JSAFJB43VY0100001 JSAFJB43V14100001	JS3JB43V14100001

NORTH AMERICAN MARKET (1991-1995)

MODEL	ENGINE TYPE	ECU TYPE	ECU MFG.	ECU NO.	REMARKS
SE416	TBI	ECM	MITSUBISHI	1	-
	SFI	ECM	MITSUBISHI	3	-
SF series	TBI (Bypass Air Type)	ECM	DENSO	4	-
	TBI (Throttle Position Type)	ECM	DENSO	5	-
SW series	TBI	ECM	DENSO	5	-
SY series	MFI	ECM	DENSO	5	-

HOW THE SUZUKI ECM APPLICATION WORKS WITH THE VETRONIX TESTER

The tester lets you monitor data and control ECM (or PCM) operation by communicating with the ECM (or PCM) via the serial data link connector (DLC) present in the vehicle. The tester consists of a microcomputer, which communicates with the ECM (or PCM) and controls its operation, a keypad to receive directions from you, and a display to provide the data you need to diagnose vehicle electronic problems. The tester communicates with the ECM (or PCM) by applying an electrical signal to a serial data link connector Enable pin, then reads the ECM (or PCM) data signal from the serial data link connector pins, and translates it into an intelligible data display. The Suzuki ECM Application is the software program which performs all of the functions described in this operator's manual.

2. GETTING STARTED

SETTING UP THE TESTER

The proper Data Link Connector (DLC) adapter or adapter cable for the vehicle being tested must be connected to the tester DLC Cable in order to connect the tester to the vehicle.

The following Vehicle Adapter Chart identifies which adapters and cables are required to connect each type of tester to the various Suzuki vehicles.

All adapters, cables, and any other hardware required to connect the tester to the vehicle are listed in the chart. The Figure Number in the chart refers to the adapter and cable illustrations on the pages following the charts.

SYSTEM	TESTER	ADAPTER DESCRIPTION	FIGURE
Engine System with 12-Pin Connector	MTS 3100	GM 12/14-Pin (P/N 02001381)	Figure 2-1
	Tech 1A	GM 12/14-Pin (P/N 02001381)	Figure 2-2
	Tech 1	None	Figure 2-3

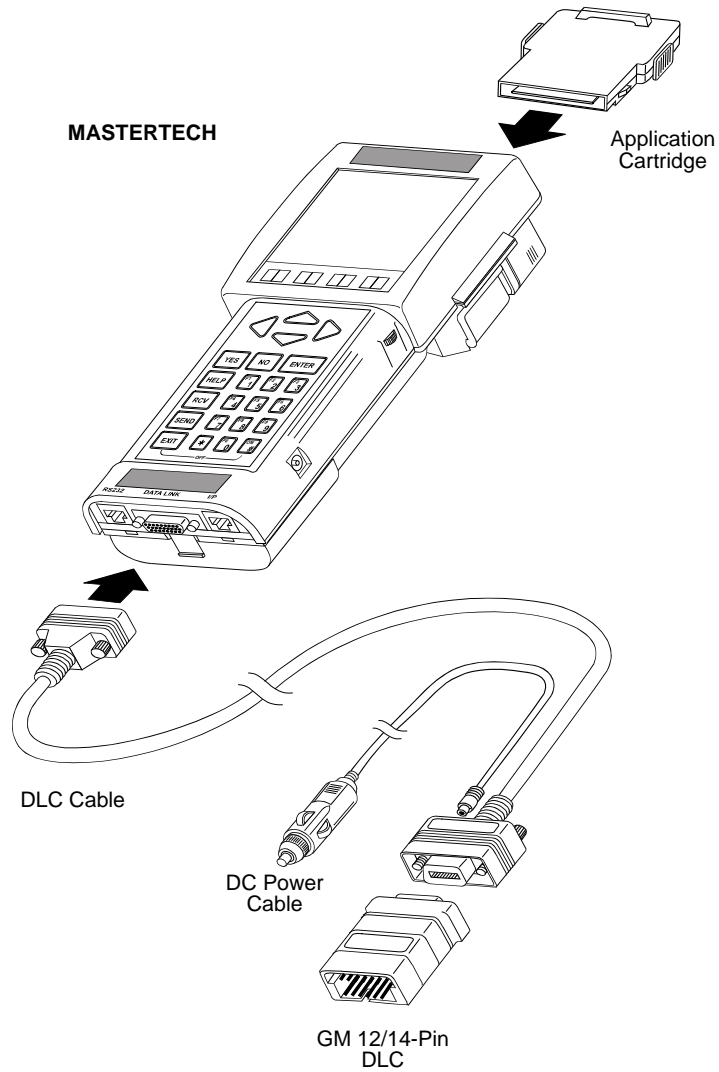

FIGURE 2-1. MTS 3100 Cable Configuration

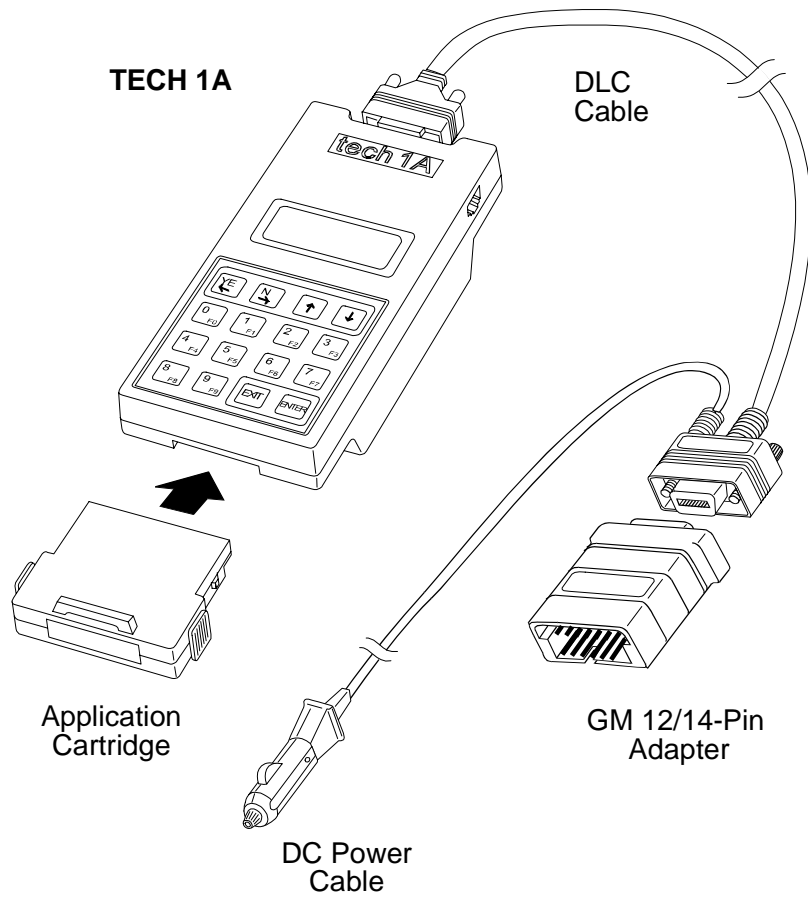

FIGURE 2-2. Tech 1A Cable Configuration

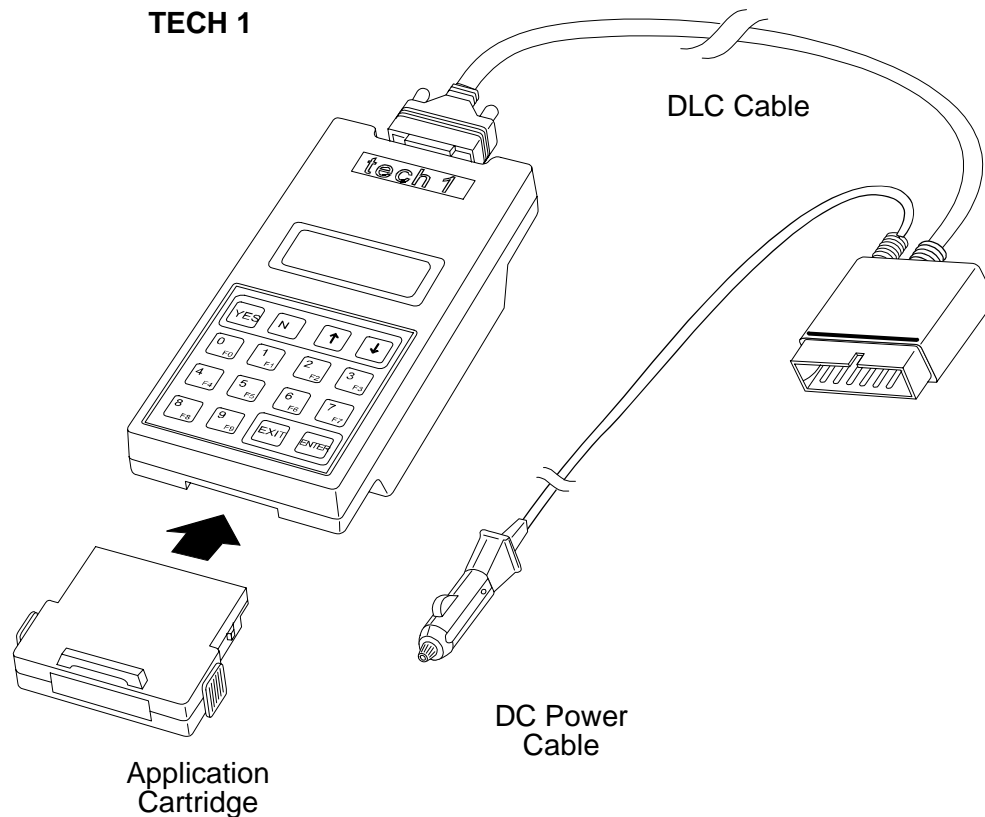

FIGURE 2-3. Tech 1 Cable Configuration

Before operating the Suzuki ECM Application with a Vetronix tester, the following steps must be performed:

1. Insert the Application Cartridge that contains the Suzuki ECM Application into the cartridge slot at the back of the MTS 3100 or the bottom slot of the TECH 1/TECH 1A. Verify that no other application cartridge is installed in the top slot of the TECH 1/TECH 1A.
2. Make sure the vehicle ignition is OFF.
3. Connect the DLC Cable to the tester and tighten the screws.
4. Refer to [Setting Up The Tester on page 89](#) for the necessary hardware configuration.
5. Locate the vehicle's serial Data Link Connector (DLC). It is usually under the dash on the driver's side. Refer to the vehicle service manual if you are in doubt.
Connect the 12-pin adapter to the vehicle's DLC.
6. Turn the ignition switch on.

NOTE

For vehicles equipped with an Immobilizer control system, power is supplied to the tester when the ignition switch is ON.

7. Verify that the tester displays the software title screen.

**SUZUKI
MASS STORAGE
CARTRIDGE - VX.X
<ENTER>**

8. Press **ENTER** to display the APPLICATIONS menu.

**APPLICATIONS ↑↓
F0: ECM
F1: BCM
F2: ABS/AIRBAG**

Press the key to the left of ECM to select the Suzuki ECM Application from the APPLICATIONS menu. If more than three applications are available, use **↑** or **↓** to scroll the display.

If the tester display informs you that the companion application is missing, contact your tester distributor.

9. Verify that the tester displays the screen below, and then press **ENTER**.

**SUZUKI
ECM X.X

(ENTER)**

If the display is incorrect, refer to [Appendix A](#).

10. After the application is selected, the Language Selection menu is displayed.

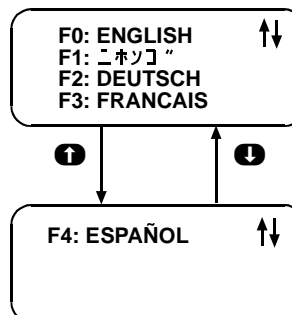

Press the function key to the left of the language you wish to select. After the language is selected, proceed to [Chapter 4](#).

3. OPERATING PRECAUTIONS

REMOVING THE CARTRIDGE WHILE POWER IS APPLIED

You should not remove or install master or auxiliary cartridges while power is applied. If you wish to change or add a cartridge, disconnect the power plug, install the cartridge, then reconnect the power plug.

REMOVING OR CHANGING MASTER CARTRIDGES CONTAINING SNAPSHOT DATA

SNAPSHOT data that has been captured by a master cartridge can be printed on a VP-411 (or compatible) printer, transferred to a computer for further analysis, or displayed on a terminal. The SNAPSHOT data will be retained within the tester memory for at least 24 hours, even if the tester is disconnected from the vehicle. However, IF YOU POWER UP THE TESTER WITHOUT A MASTER CARTRIDGE OR WITH A DIFFERENT MASTER CARTRIDGE, THE SNAPSHOT DATA WILL BE LOST.

4. SELECTING THE VEHICLE

Once you've connected the tester to the vehicle and selected a language, turn the key to the RUN position. The next step is to select the communication mode. Depending on the communication mode selected, other information such as the vehicle type (model) and transmission type may be required.

SELECTING A COMMUNICATION MODE

The Communication Mode display lists two options; F0: EURO MODE and F1: SUZUKI MODE. The EURO MODE provides diagnosis of Suzuki vehicles equipped with emission-related systems (except for North American Market vehicles on and after 1996 model year) using EURO OBD methods. The SUZUKI MODE provides diagnostic functions and enhancements specific to Suzuki vehicles. Press the key to the left of the communication mode you wish to use.



SELECT MODE
F0: EURO MODE
F1: SUZUKI MODE

See the applicable Communication Mode chart ([Applicable Communication Mode Other Than North American Market on page 97](#) or [North American Market \(1991-1995\) on page 98](#)) for specific communication modes by vehicle ECU and model type.

SELECTING A VEHICLE TYPE

If you selected F1: SUZUKI MODE, you need to input the type of vehicle you are testing.

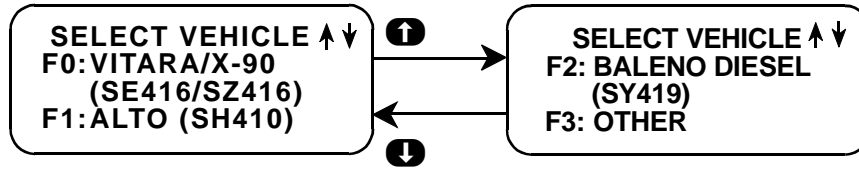

Press the key to the left of the vehicle you are testing. There may be a slight pause while the tester attempts to establish communications with the vehicle and requests the vehicle identification.

If you selected F0: VITARA/X-90 (SE416/SZ416) from the Select Vehicle menu, the tester will display a Select System screen. Press **YES** if the car you are testing has Throttle Body Injection; otherwise press **NO**.

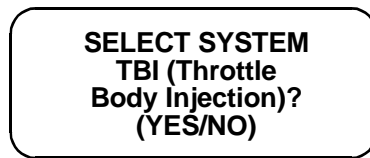

SELECTING A TRANSMISSION TYPE

For some vehicles, the Transmission Type must be selected. Press the key to the left of the Transmission Type of the vehicle you are testing.

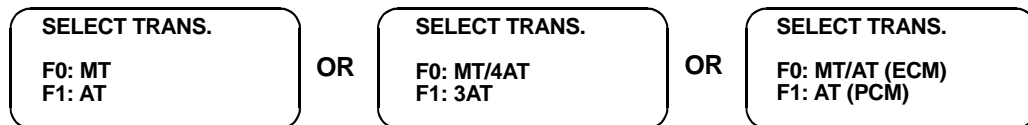

SELECTING THE TEST MODES

If you selected F0: EURO MODE from the Communication Mode menu, or after selecting the type of vehicle you are testing, the tester will display the Select Mode menu. Detailed operating instructions for the various test modes listed on the menu are given in [Chapter 5](#) of this manual.

ACTIVE KEYS	
↑ & ↓	Stop automatic menu scrolling, then used to manually control the menu display.
F0 - F9	Select a menu item.
YES & NO	Answer questions on the tester display.
EXIT	Return to previous display.

APPLICABLE COMMUNICATION MODE OTHER THAN NORTH AMERICAN MARKET

The following tables list the communication modes for specific ECU and model types. (X = support, blank = no support.) For the details of ECU NO, see [Suzuki ECM Application Coverage on page 85](#).

MODEL	ECU NO.	SUZUKI MODE	EURO MODE
SE416	1	X	
	2	X	
	3	X	
	11	X	
	37	X	
SZ416	3	X	
SV420G	7	X	
	10	X	
SV620	7	X	
	10	X	
SQ416/420	15	X	
	24	X	X
	44	X	
SQ625	16	X	
	25	X	X
	43	X	
SF series	4	X	
	5	X	
	31	X	X
MF413 (SF413)	26	X	
SY413/415/416	5	X	
	13, 18	X	
	29	X	X
SY418	8	X	
	14	X	
	36	X	X
SY419	20	X	
MB308 (SB308)	27	X	
SH410	6	X	
	9	X	
	30	X	X
MH410 (SH410)	27	X	
SR series	12	X	
MRD410 (RD410)	27	X	

MODEL (CONT.)	ECU NO.	SUZUKI MODE	EURO MODE
RB series	21	X	X
	22	X	
RG413	23	X	X
	42	X	
MRF series (RF series)	27	X	
MG413W (SJ413W)	27	X	
SJ413	33	X	X
SN413	17	X	
	32	X	X
	41	X	
GA413	19	X	
	35	X	X
MT308 (ST308)	28	X	
RH413/416	34	X	X
	47	X	

NORTH AMERICAN MARKET (1991-1995)

MODEL	ECU NO.	SUZUKI MODE	EURO MODE
SE416	1	X	
	3	X	
SF series	4	X	
	5	X	
SW series	5	X	
SY series	5	X	

SELECTING THE VEHICLE

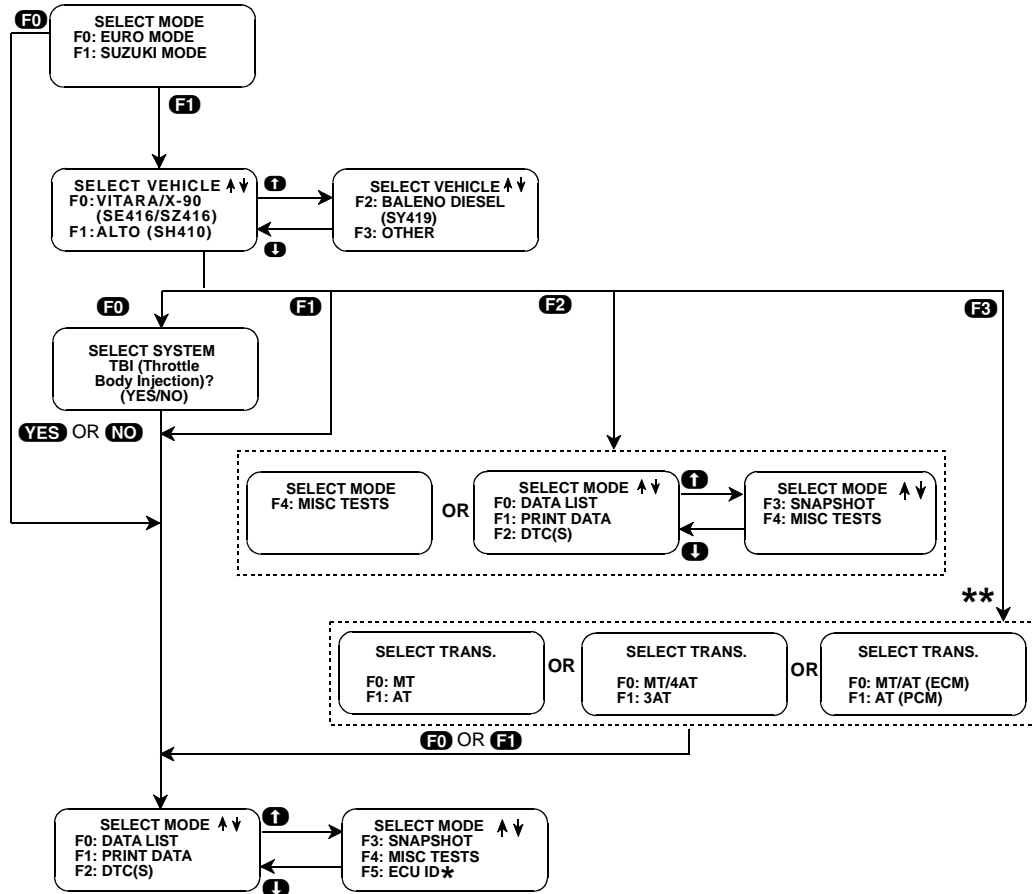

* ECU ID option not available for all vehicles

** SELECT TRANS. menus not available for all vehicles

5. SELECTING AND OPERATING THE TEST MODES

Press the function key to the left of the test you wish to perform. The tester will display test modes for the vehicle you have selected.

The following section contains a brief description of each test mode in the SUZUKI ECM Application. A more detailed description of each test mode is given in the section discussing each test mode.

Mode F0: Data List

Monitor engine and/or automatic transmission data parameters from the ECM (or PCM).

Mode F1: Print Data

Send one data stream of information to a serial printer, terminal or smart device.

Mode F2: DTC(s)

Display and/or clear stored Diagnostic Trouble Codes.

Mode F3: Snapshot

Capture and store data parameters. Data is captured before and after a “trigger” point. Triggers can be on any DTC, a particular DTC, or manual tester key press. Captured data can then be displayed as well as DTC(s) (SUZUKI mode only).

Mode F4: Miscellaneous Tests

Display sub-modes to operate single tests.

Mode F5: ECU ID

Display the ECU number and the software version.

NOTE

While the tester is connected to the serial data link connector and conversing with the ECM (or PCM), the ECM (or PCM) ignores input signals from the TEST switch and the DIAG switch in the vehicle service connector (monitor coupler).

SELECTING TEST MODES

The tester makes selecting the test mode easy by displaying a list of tests (a test mode “menu”). The menu also displays which key is used to select each test mode. An example test mode menu is shown below.

To select a test mode, simply press the tester key listed to the left of the test mode on the menu. Since there are six test modes, the keys **F0** - **F5** are used.

The first three test modes are shown as soon as the model is selected. The other test modes will automatically scroll onto the display after three seconds. The display will automatically scroll between the two screens. To stop the automatic scrolling, press either the **↑** or **↓** key. The menu may then be manually changed by pressing either the **↑** or **↓** key. All menus of more than three items scroll in this way.

Regardless of which test modes are displayed, any test mode can be selected at any time from the menu.

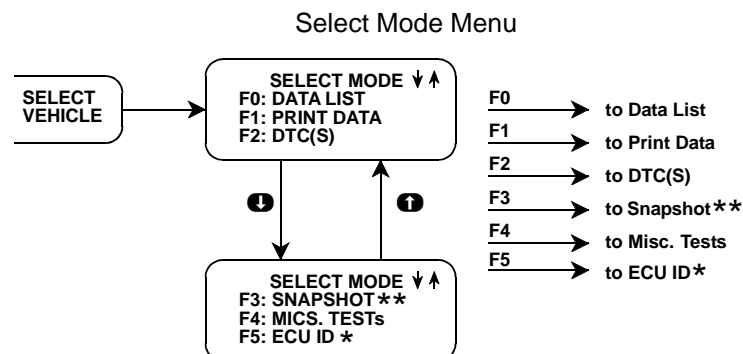

*Not Available For All Vehicles
 ** Not Available for Euro Mode

The Miscellaneous Tests mode is used to select a submenu of tests. Pressing **F4** displays the miscellaneous tests available. To return to the Select Mode menu just press **EXIT**.

NOTE

For the Diesel System only, F4: MISC TESTS appears on the SELECT MODE MENU.

ACTIVE KEYS	
F0 - F5	Select Test Mode.
↑ & ↓	Stop automatic menu scrolling, then used to manually control the menu display.
EXIT	Return to Vehicle Select step or return to Select Mode menu from Miscellaneous Tests menu.

MAIN TEST MODES

The following tables list the test modes for specific ECUs. (X = support, blank = no support.) For applicable model corresponding to ECU Nos, see *Suzuki ECM Application Coverage on page 85*.

Suzuki Mode

SELECT MODE	SUB MENU	ECU NO.															
		1	2	3,4,8,9,11	5,12, 17	6	7,10,14,15	13,16,18	22	26,27,28	41,43,44,45	42	47	48			
F0: Data List	-	x	x	x	x	x	x	x	x	x	x	x	x	x	x	x	
F1: Print Data	-	x	x	x	x	x	x	x	x	x	x	x	x	x	x	x	
F2: Trouble Code	-	x	x	x	x	x	x	x	x	x	x	x	x	x	x	x	
(Clear DTC)	-			x	x	x	x	x	x	x	x	x	x	x	x	x	
F3: Snapshot	Any Code	x	x	x	x	x	x	x	x	x	x	x	x	x	x	x	
	Single Code	x	x	x	x	x	x	x	x	x	x	x	x	x	x	x	
	Manual Trig	x	x	x	x	x	x	x	x	x	x	x	x	x	x	x	
	Replay Data	x	x	x	x	x	x	x	x	x	x	x	x	x	x	x	
F4: Misc Test	RPM Control	x	x	x	x		x	x	x	x	x	x	x	x	x	x	
	Fixed Spark	x	x	x	x	x	x	x	x	x	x	x	x	x	x	x	
	IAC Cal	x	x	x			x										
	EGR	x		x	x	x											
	Step EGR						x	x			x						
	Evap Cani Purg (Duty)									x							
	Evap Cani Purg (On/Off)										x					x	
	Fuel Pump Cont																
	MIL Control									x							
	Radiator Fan									x			x	x	x		
A/C Condenser Fan													x				

SELECT MODE	SUB MENU	ECU NO.	
		20	40
F0: Data List	-		x
F1: Print Data	-		x
F2: Trouble Code	-		x
(Clear DTC)	-		x
F3: Snapshot	Any Code		x
	Single Code		x
	Manual Trig		x
	Replay Data		x
F4: Misc Test	SOV Test	x	
	EGR Valve #1		x
	EGR Valve #2		x
	Glow Plug Controller		x
	Glow Lamp Indicator		x
	MIL		x
	Timing Control Valve		x

SELECT MODE	SUB MENU 1	SUB MENU 2	ECU NO.				
			21,23,31,35,46	24,25,32,38	29,30,34	36	33,37
F0: Data List	-	-	x	x	x	x	x
F1: Print Data	-	-	x	x	x	x	x
F2: Trouble Info	F0: DTC	-	x	x	x	x	x
	F1: Pending DTC	-	x	x	x	x	x
	F2: Freeze Data	-	x	x	x	x	x
	F3: Clear Info	-	x	x	x	x	x
F3: Snapshot	F0: Any Code	-	x	x	x	x	x
	F1: Single Code	-	x	x	x	x	x
	F2: Manual Trig	-	x	x	x	x	x
	F3: Replay Data	-	x	x	x	x	x
F4: Misc Test	F0: Output Test	RPM Control	x	x	x	x	x
		Fixed Spark	x	x	x	x	x
		IAC Cal				x	
		Step EGR	x	x	x	x	x
		Evap Cani Purg (Duty)	x	x	x	x	x
		Fuel Pump Cont	x	x	x	x	x
		MIL Control	x	x	x	x	x
		Radiator Fan	x		x	x	
	A/C Condenser Fan		x	x	x		
F1: Readiness Test	-	x	x	x	x	x	
F5: ECU ID	-	-	x	x	x	x	x

SELECT MODE	SUB MENU 1	ECU NO.
		39
F0: Data List	-	x
F1: Print Data	-	x
F2: Trouble Info	F0: DTC	x
	F3: Clear Info	x
F3: Snapshot	F0: Any Code	x
	F1: Single Code	x
	F2: Manual Trig	x
	F3: Replay Data	x
F4: Misc Test	Double Relay	x
	A/C Cut Off	x
	Pre/Post Heat Relay	x
	Rad Fan High	x
	Rad Fan Low	x
	3rd Piston Deactivator	x
	MIL	x
	Glow Indicator Lamp	x
	Coolant Temp Warning Lamp	x

Euro Mode

SELECT MODE	SUB MENU 1	
		.
F0: Data List	-	x
F1: Print Data	-	x
F2: Trouble Info	F0: DTC	x
	F1: Pending DTC	x
	F2: Freeze Data	x
	F3: Clear Info	x
F4: Misc Test	F1: Readiness Test	x
F5: ECU ID	-	x

ECM (OR PCM) COMMUNICATIONS STATUS DISPLAYS

Most tester test modes display data. Therefore, these test modes require the ECM (or PCM) to send data to the tester. When you select a test mode, you may see one or more of the following ECM (or PCM) communications status displays.

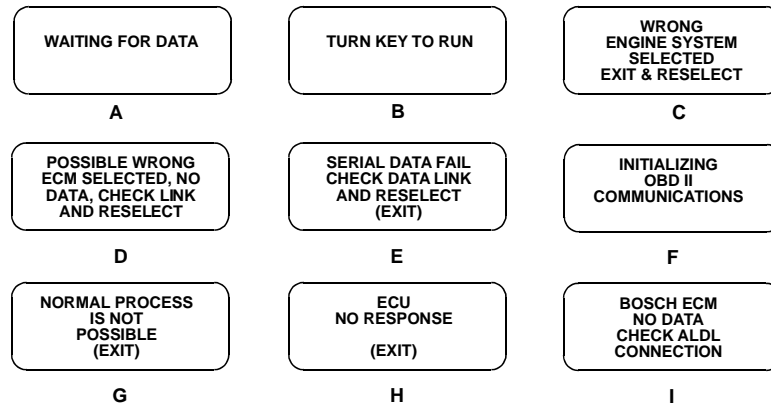

Display A

This means that the tester cannot yet display data as it has not yet received a complete data message from the ECM (or PCM). This display is sometimes seen right after selecting a test mode.

Display B

This is a reminder that the ignition key needs to be in the RUN position for the tester to communicate with the vehicle.

Display C

This occurs when the tester determines that the data stream it receives from the ECM (or PCM) does not match the vehicle that you have selected. If this happens, return to the vehicle select step by pressing **EXIT**. Double check your selection.

Display D, H, and I

This occurs when the tester has not received any data from the ECM (or PCM). In this case, you should verify that the ignition is ON and check the serial data link connections and then return to the vehicle select step by pressing **EXIT**. Double check your selection. **An incorrect engine type selection may also cause this condition.**

DISPLAY E, G, H, and I

This occurs when communication with a vehicle has failed after communication has already been established.

DISPLAY F

If this screen flashes for more than 10 seconds, the tester cannot communicate with the vehicle using OBDII communications. Press **EXIT** to return to the communication mode selection menu and select a different communication mode.

ACTIVE KEYS	
EXIT	Return to vehicle select mode.

MODE F0: DATA LIST

The purpose of the DATA LIST mode is to passively monitor data which is being transmitted from the ECM (or PCM) during normal operation of the vehicle. This mode does not affect vehicle operation and you can use it to read data to see if it is correct, or at least reasonable. The current value of the parameter is displayed with the parameter units. This means you don't have to hunt through manuals to find out what is being displayed.

The data parameters are displayed in pre-programmed pairs. You can also create your own pairs through the process explained on the following pages.

To select Data List mode, do the following:

1. Press **F0** to select the DATA LIST mode from the Select Mode menu.
2. Select the data parameters to be displayed by scrolling through the parameters with the **YES** and **NO** keys.
3. Return to the Select Mode menu at any time by pressing **EXIT**.

Operation of the DATA LIST mode is summarized in the flow diagrams on the following pages.

ACTIVE KEYS FOR DATA LIST	
YES & NO	Scroll through displayed data parameters.
F0	Mark top displayed parameter as "fixed" for creating your own data pairs.
F1	Mark bottom displayed parameter as "fixed" for creating your own data pairs.
F8	Print Data List.
EXIT	Return to select mode menu.

VIEWING DATA PARAMETERS

In order to maximize the information that can be seen at one time, the tester displays data parameters in preassigned pairs. A typical first data pair which would be displayed after you press **F0** is shown in the figure below. Also shown is how to scroll through the Data List with the **YES** and **NO** keys and how to create your own data pairs with the **F0** and **F1** keys.

To see other preassigned pairs, press either the **YES** or **NO** key. The **YES** key will cause the tester to scroll forward through the list of preassigned pairs, while the **NO** key will cause scrolling backwards.

[Chapter 8](#) contains descriptions of all engine data parameters.

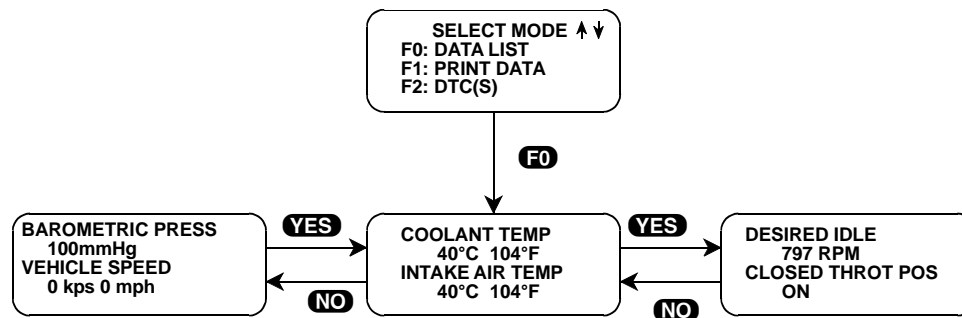

CREATE YOUR OWN DATA PAIRS

You can create data parameter pairs which are different from the preassigned pairs. Any two parameters can be displayed as a pair by simply scrolling either the bottom or top display parameter, while the other display parameter is fixed. To “fix” the top parameter, press **F0**; an asterisk will appear by the fixed parameter. Press **F1** to “fix” the lower parameter. The tester will not allow both the top and bottom parameters to be fixed at the same time.

As an example, let's say you wish to create a pair with ENGINE SPEED and SPARK ADVANCE. To do so, scroll through the preassigned pairs with the **YES** and **NO** key until you find a pair with ENGINE SPEED. Fix the ENGINE SPEED by pressing the **F0** key if ENGINE SPEED is the top parameter, or the **F1** key if it is the bottom. Then scroll the other half of the display with either the **YES** or **NO** key until SPARK ADVANCE is displayed.

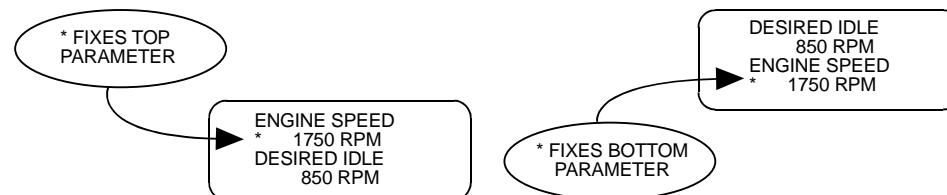

RELEASE A “FIXED” PARAMETER

If the top parameter has been “fixed” with **F0** the key, press **F1** to release it and proceed scrolling through the preassigned data parameter pairs. Likewise, if **F1** has been pressed to “fix” the bottom parameter, press **F0** to release it.

PRINTING DATA

The currently displayed sample may be printed if the tester is connected to a compatible printer. To print the data, press **F8**. The tester keyboard is disabled while data is being sent to the printer.

NOTE



The RS232C I/F Cartridge is required if you are using a TECH 1 tester.

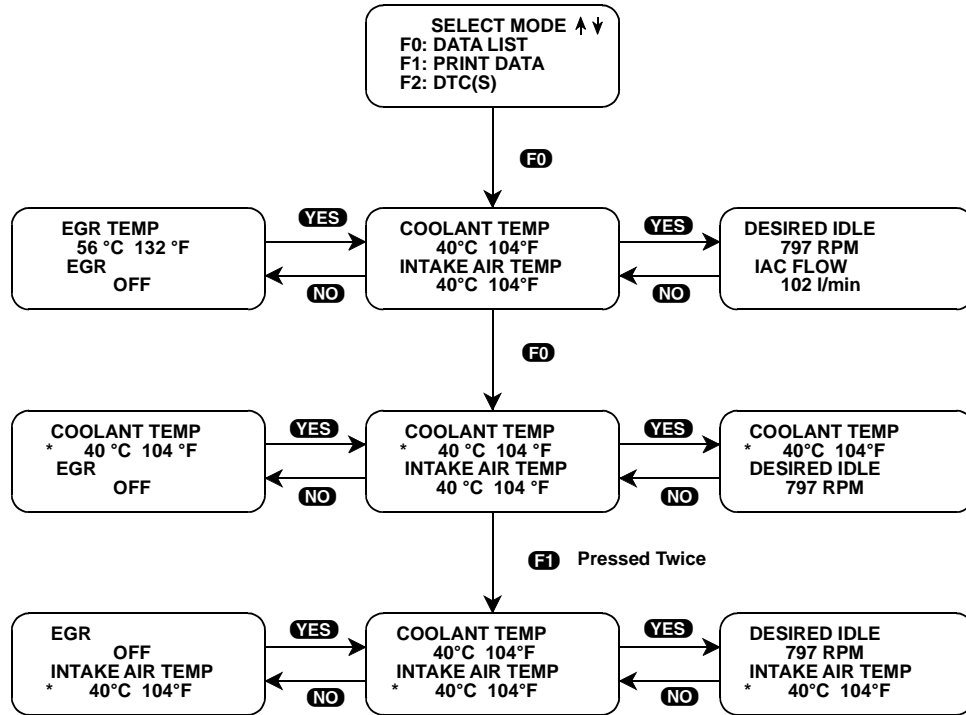

ACTIVE KEYS FOR CREATING DATA PAIRS

YES , NO	Scroll through displayed data parameters.
EXIT	Return to the Select Mode menu.
F0 & F1	“FIX” the upper or lower parameter.

MODE F1: PRINT DATA

PRINT DATA

When the RS232C I/F Cartridge is installed in the TECH 1, or if you are using a TECH 1 Series A or MTS 3100 tester, the Print Data mode allows you to print the VIN, engine type and Data List to a serial printer or terminal. This is the data list sent by the ECM (or PCM) to the tester (The data list parameters can be printed without printing the VIN or engine type by pressing the **F8** key in the Data List or Snapshot Replay mode).

To select the Print Data mode, do the following:

1. Press **F1** to select the Print Data mode from the Select Mode menu. The VIN entry screen is the first screen displayed in this mode. Only the last 6 digits of the VIN are entered on this screen. This information is then printed out as part of the header information that accompanies each data list print out. The VIN is entered via the numeric portion of the key pad and the **ENTER** key is pressed to move to the next section of the print function.
2. The next screen requires the **ENTER** key to be pressed to start printing the data. This screen allows the cable to be connected between the tester and the receiving device.
3. When the **ENTER** key is pressed the "WAITING TO PRINT DATA" screen is displayed until printing begins. If this screen is displayed for more than a few seconds, something is wrong with the set up. Check that all connections are secure, and that any receiving device is turned on and in the proper receive mode.
4. As printing begins, the tester displays the % COMPLETE of the print procedure. After the printing is 100% complete, the VIN screen is immediately displayed with the previously selected VIN. Pressing the **ENTER** key twice from this screen will cause another data stream to be buffered for printing as soon as the current data stream is output from the tester.
5. Pressing the **EXIT** key at any point will cause the select mode menu to be displayed. If the **EXIT** key is pressed before printing is completed, only the data that has already been sent to the printer will be printed. SOME DATA WILL BE LOST.

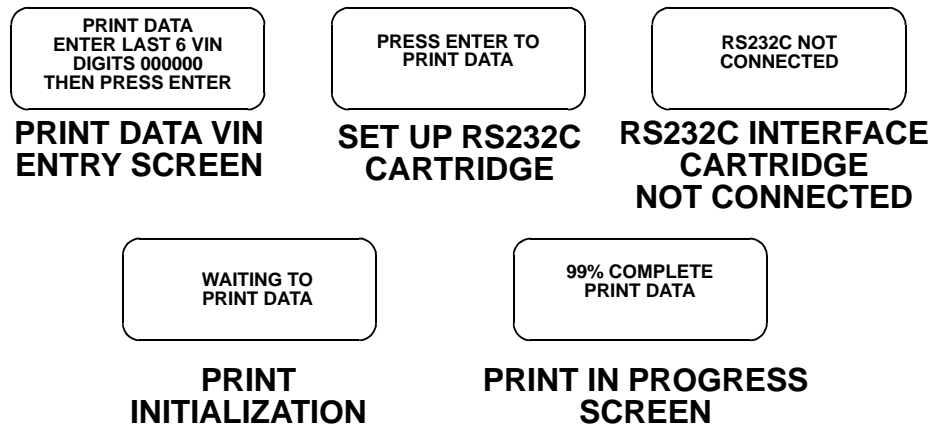
**Print Sample**

SUZUKI MOTOR CORPORATION		
ENGINE TYPE: TBI		
VIN: 123456		
TECH 1 DATA LIST		
NO.	DESCRIPTION	VALUE
1.	COOLANT TEMP	82°C 180°F
2.	INTAKE AIR TEMP	21°C 70°F
3.	DESIRED IDLE	875 RPM
4.	IAC FLOW	102 l/min
5.	IAC ADJUST MONI	2%

ACTIVE KEYS TO PRINT DATA	
ENTER	Move to the next section of the Print Data function.
0 - 9	VIN entry keys.
EXIT	Terminate the Print Data mode and return to the Select Mode menu.

MODE F2: DTC(S)

DIAGNOSTIC TROUBLE CODES DESCRIPTION

Diagnostic Trouble Codes or DTC(s) are set by the ECM (or PCM) when an abnormal condition is detected. They are a key to diagnosing many of the problems which can occur in the vehicle. The DTC(s) mode allows you quick access to trouble codes for initial vehicle checks and to check that a repair procedure has been successful. The displays for the DTC(s) mode are shown on the following pages.

The tester can clear all stored DTC(s) on vehicles except vehicles equipped with ECM Numbers 1 and 2 (SE416 [TBI] and SE416 [MFI]) as illustrated in the ECM Cartridge Coverage charts beginning on [page 85](#). To clear DTC(s) on vehicles equipped with ECM Numbers 1 and 2, turn the ignition switch OFF, then turn it ON again.

Diagnostic Trouble Code display screens may vary from vehicle to vehicle. When F2: DTC(s) is selected from the SELECT MODE menu, some vehicles will display a TROUBLE INFO menu, while other vehicles will automatically display DTC information. The operating procedures for vehicles with the TROUBLE INFO menu are different from the operating procedures for vehicles without the TROUBLE INFO menu.

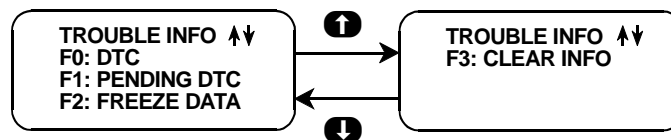

Vehicles without a Trouble Info Menu

To select the DTC(s) mode, do the following:

1. Press **F2** to select the DTC(s) mode from the Select Mode menu.
If no DTC(s) are present, the tester will display a message to that effect.
2. If DTC(s) are present, the tester will automatically display each DTC for three seconds.

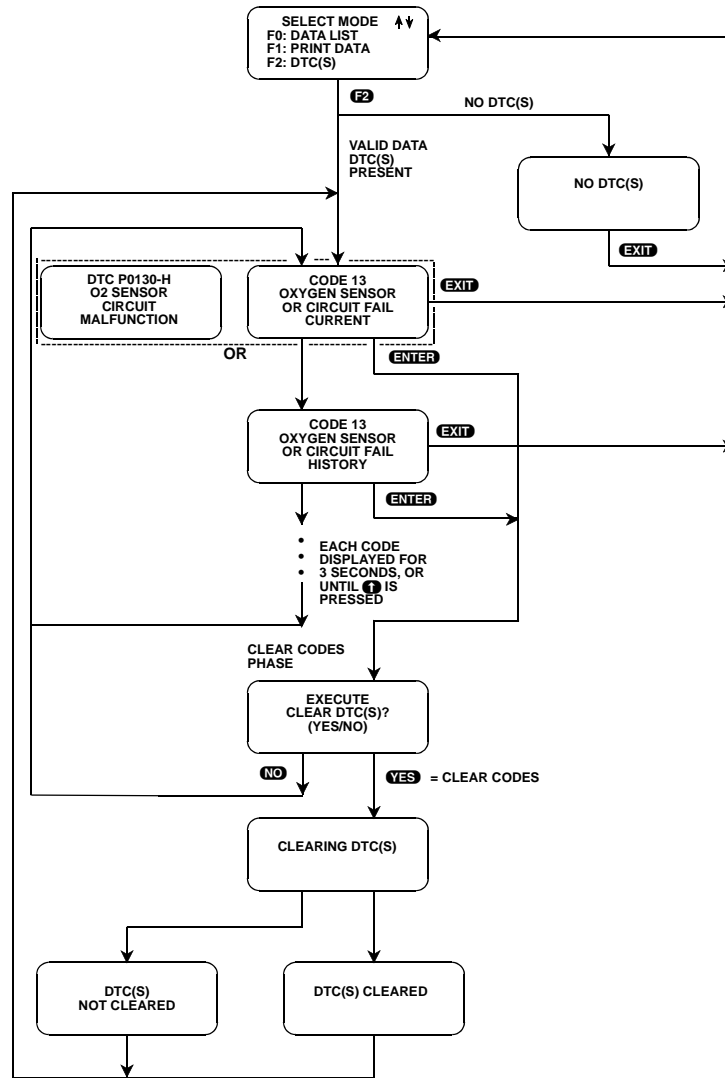

Vehicles without a Trouble Info Menu

3. The DTC(s) will be continuously displayed, wrapping around to the first code automatically after the last code has been displayed. DTC display screens will appear in one of the following formats:

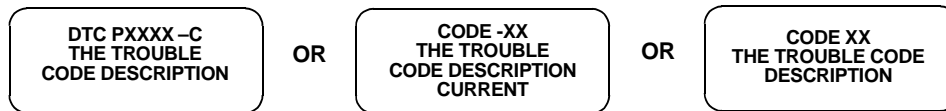

In each case, the status indication of the DTC will be displayed as follows:

- C or Current
- H or History
- P or Pending

CLEAR CODES PHASE

4. To clear all stored DTC(s), press **ENTER** to go to Clear Codes Phase. When the tester displays “EXECUTE CLEAR DTC(S)?”, select either **YES** for clearing DTC(s) or **NO** for not clearing them.

When **YES** is pressed, tester will display a “CLEARING DTC(S)” message, followed by either a “DTC(S) CLEARED” or a “DTC(S) NOT CLEARED” message. After a few seconds the tester will automatically start displaying DTC(s) again. If no DTC(s) are present at this time the “NO DTC(S)” screen is displayed. When **NO** is pressed, the DTC(s) are retained in the ECM (or PCM) and the tester will start displaying DTC(s) again.

5. Pressing **EXIT** will terminate the DTC(s) mode returning you to the select mode menu.

Vehicles with a Trouble Info Menu

To select DTC(s) mode, do the following:

1. Press **F2** to select the DTC(s) mode from the Select Mode menu.
2. Rather than automatically displaying the DTC information, some vehicles will display the following menu:

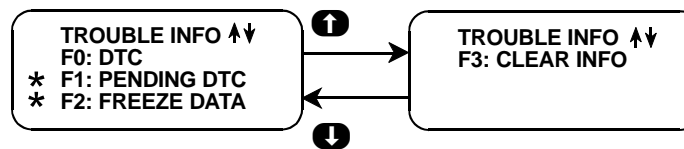

* Pending DTC and Freeze Frame not available for all ECUs.

F0: DTC

To view current or history DTC(s), press **F0**. The following screen will display the DTC number, the status of the DTC, and the DTC description. To scroll through multiple DTC(s), use **↑** to advance the screen, and **↓** to return to the previous screen.

DTC P0130-C
O2S SENSOR
CIRCUIT
MALFUNCTION

The status of the DTC is indicated by a single letter as follows:

C for Current
H for History
P for Pending

F1: Pending DTC

To view any pending DTC(s), press **F1**. If any pending DTC(s) are present, they will be displayed in the format described above, and will have a “P” as the status indication. If there are no pending DTC(s) present, the tester will display a message to that effect.

F2: Freeze Frame Data

The vehicle's ECM saves diagnostic data information about the state of the vehicle when a Diagnostic Trouble Code (DTC) occurs. This data is referred to as Freeze Frame Data and can be read by the tester using the FREEZE FRAME DATA mode. You can select this mode from the TROUBLE INFO menu.

Freeze Frame Data Display

For Vehicles with a Single Freeze Frame (EURO Mode)

Trouble Code
P0130
Engine Speed
1000 RPM

The Freeze Frame Data is displayed in the same format as the Data List format described in the DATA LIST of the Current Data mode. The first parameter in the list is the DTC which caused the Freeze Frame Data to be saved. Note that Freeze Frame Data is only available for the first DTC which was detected by the vehicle.

For Vehicles with Multiple Freeze Frames (SUZUKI Mode)

F0: PXXXX
F1: PXXXX (1st)
F2: PXXXX (2nd)
F3: PXXXX (3rd)

The PXXXX numbers are the DTCs for each frame. Once the Frame is selected, the Data List is displayed.

The ECM (or PCM) has 4 frames where the Freeze Frame Data can be stored. F0 displays the Freeze Frame Data of the malfunction which was detected first. However, the Freeze Frame Data in F0 is updated according to the priority described below.

PRIORITY	FREEZE FRAME DATA IN FRAME 1
1	Freeze Frame Data at initial detection of malfunction among misfire detected (P0300 ~ P0304), fuel system too lean (P0171) and fuel system too rich (P0172)
2	Freeze Frame Data when a malfunction other than those in "1" above is detected.

In F1 through F3, the Freeze Frame Data of each malfunction is displayed in the order as the malfunction is detected. These data are not updated.

F3: Clear Data

To get to the Clear Codes Phase, press **F3**. When the tester displays "CLEAR ALL DIAGNOSTIC INFO?", press **YES** to clear all information, or **NO** to retain the information.

When **YES** is pressed, the tester will display "ALL DIAGNOSTIC INFORMATION CLEARING". Following this display the tester will confirm whether the diagnostic information was successfully cleared by either displaying "ALL DIAGNOSTIC INFORMATION CLEARED" or "ALL DIAGNOSTIC INFORMATION NOT CLEARED". The tester will then return to the TROUBLE INFO menu.

When **NO** is pressed, all diagnostic information is retained in the ECM (or PCM) and the tester will return to the TROUBLE INFO menu.

- Press **EXIT** while using any of the above functions to return to the TROUBLE INFO menu.

4. Press **EXIT** from the TROUBLE INFO menu to return to the SELECT MODE menu.

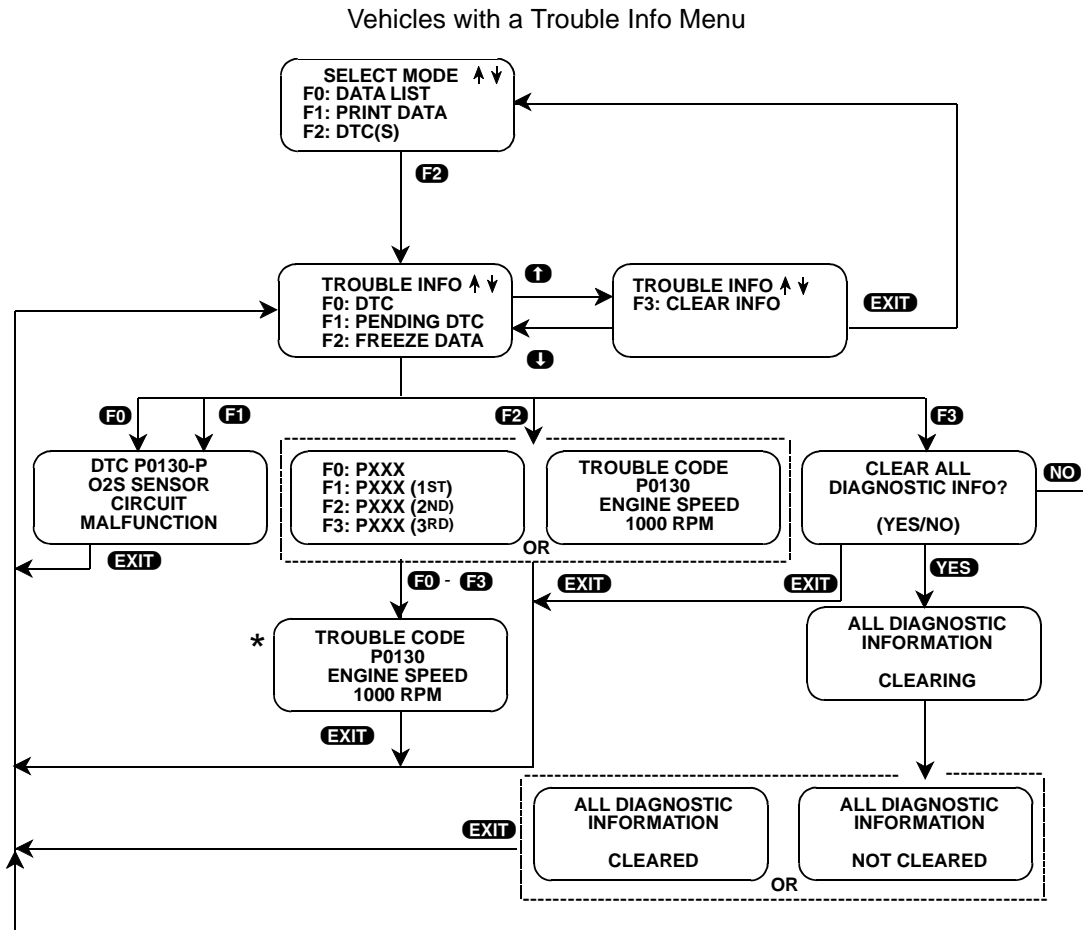

*The Freeze Frame display works like a Data List. You can cycle through parameter pairs using **YES** and **NO**. You can also use **F0** and **F1** to create your own data pairs. See [Mode F0: Data List on page 106](#) for more details.

NOTE



DTC(s) can also be displayed in SNAPSHOT mode.

DTC(s) can also be printed in a tabular format using the Screen Print feature. Screen Print is enabled by pressing **F6** until an “RS232 SET-UP” menu is displayed. Press **F1** to enable the Screen Print function. Refer to the RS232C I/F, TECH 1A, or MTS 3100 Operator’s Manual for more detail.

ACTIVE KEYS

ENTER	Clear all stored ECM (or PCM) DTC(s).
YES	Clear all stored ECM (or PCM) DTC(s).

ACTIVE KEYS	
NO	Return to display DTC(s). DTC(s) are not cleared.
↑	Display next DTC.
F0 - F3	Selection keys.
F6 (Hold)	Select "RS232C SET-UP" menu.
F7	Toggle unit conversions for applicable parameters between English and Metric.
F8	Print Freeze Frame Data (if equipped with serial printer.
EXIT	Terminate the DTC(s) display and return to the select mode menu.

MODE F3: SNAPSHOT

The purpose of the SNAPSHOT test mode is to help you isolate an intermittent or transient problem by **STORING ENGINE DATA PARAMETERS BEFORE AND/OR AFTER THE PROBLEM OCCURS.**

When the tester is operating in SNAPSHOT mode, it is constantly storing information about data parameters and DTC(s). A time and position index for the stored information is also saved.

The tester stores all of the Data List parameters and DTC(s) for the vehicle selected. When the memory is full, the oldest (earliest) data collected is erased to make room for new information.

A "TRIGGER" tells the tester when to stop collecting data. You can specify a "TRIGGER CONDITION" so the tester collects data that will be most useful in diagnosing the current problem.

TRIGGER CONDITION

The trigger condition defines the specific circumstances under which you want the trigger to be set. The possible trigger conditions are:

- ANY DTC: If any DTC is detected by the tester, it will cause the trigger to be set.
- SINGLE DTC: You can select a specific DTC that must be detected before the trigger will be set. Step 3 in the Operating Procedure tells you how to enter the code.
- MANUAL TRIGGER: While operating the SNAPSHOT mode, you can always cause the trigger to be set by pressing the **ENTER** key.

Once the trigger occurs, the tester will retain data according to which trigger point you have selected.

VIEWING CAPTURED DATA

By selecting F3: REPLAY DATA from the SNAPSHOT menu you have the option of bypassing the Data Capture phase and displaying previously captured data. All data captured during SNAPSHOT will be retained in the tester until it is overwritten by a new SNAPSHOT, or if the tester is disconnected from the serial data link connector or the cigarette lighter for at least one-half hour.

NOTE

Please note that all data captured during SNAPSHOT will be erased from tester once you select F0: EURO MODE in the communication mode display.

You can also view Snapshot data when you are not connected to a vehicle. Answer vehicle selection prompts and select any Suzuki Mode vehicle. The tester will attempt to communicate with a vehicle in order to complete the vehicle selection process. Since it is not connected to a vehicle, it will display the following screen:

**POSSIBLE WRONG
ECM SELECTED, NO
DATA, CHECK LINK
AND RESELECT**

Press the **EXIT** key. If the tester detects the presence of previously stored snapshot data, it will display the following screen:

**REPLAY SNAPSHOT
DATA?**

(YES/NO)

Press the **YES** key to replay the snapshot data.

PRINTING CAPTURED DATA

In addition, you can print the captured data, providing a hard copy of any selected data sample. A VP-411 printer is required to support this print function. See [Step 11](#) on [page 120](#).

To select Snapshot mode, do the following:

The operation of SNAPSHOT mode is divided into three phases: Set-Up (Steps 1-3), Data Capture (Steps 4-7), and Data Display (Steps 8-12).

Set-Up Phase

1. Press **F3** to select the SNAPSHOT mode from the Select Mode menu.
2. The trigger condition and review data options are displayed next in a self-scrolling Snapshot Options menu.

To select a trigger option, just press the Function Key displayed to the left of the desired trigger condition. To replay previously captured data, press **F3**.

3. To choose a specific DTC, press **F1** in the Snapshot Options menu.

When the tester screen displays “SNAPSHOT MODE, ENTER DTC TO TRIGGER ON xx”, use numeric keys **0** - **9** to enter the two digit DTC number that you have selected, then press the **ENTER** key. The tester will continue to store data until the specified DTC is detected, or until you press the **EXIT** key. If the DTC you enter does not exist for the engine type being tested, an “INVALID DTC” message will be displayed and the code will have to be reentered.

ACTIVE KEYS IN SNAPSHOT SET-UP PHASE	
EXIT	Return to Snapshot Options menu.
F0 - F2	Select trigger condition.
F3	Select Replay Data.
0 - 9	Select specific DTC.
ENTER	Enter selected DTC.

To select a trigger condition, press the function key to the left of the desired trigger condition. To bypass the Data Capture phase and review previously captured data, press **F3**.

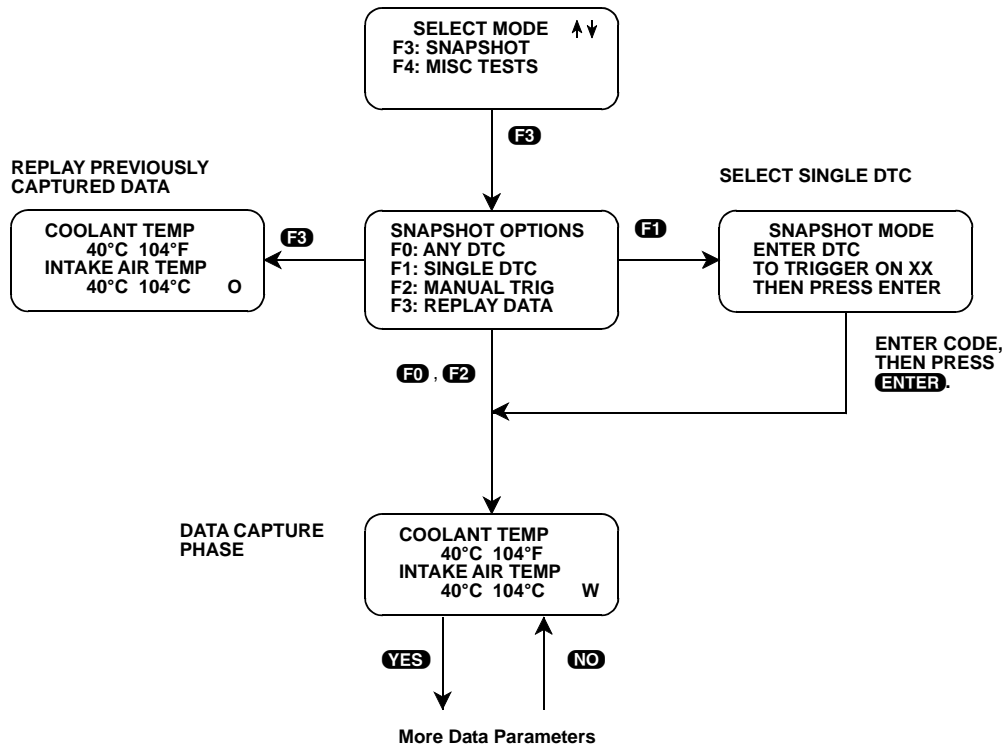

Data Capture Phase

- Once the trigger condition is specified, the tester begins storing engine (or transmission) data parameters and DTC(s) while displaying the Data List parameters.
- The data is organized as a number of data 'samples'. The value or state of each parameter as well as all DTC(s) are saved for each sample. The data display will indicate the 'waiting for trigger' condition with a flashing 'W' in the lower right-hand corner of the display. While waiting for the selected trigger, the **ENTER** key can always be used to force a trigger.

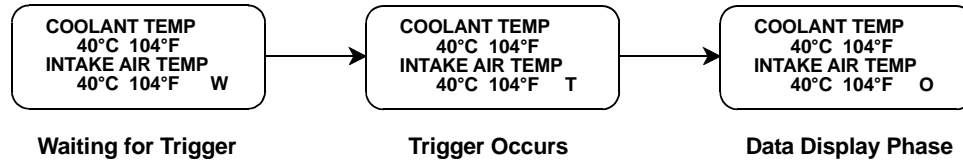

6. Once the trigger occurs, the tester will continue to save data samples until its memory is full. The data display indicates that the trigger has occurred by replacing the flashing 'W' with a flashing 'T'. As soon as the memory is full, the data capture terminates automatically and the tester goes to the Data Display phase.
7. Pressing **EXIT** will terminate the Data Capture phase. If the trigger has already occurred, the Snapshot mode will move to the Data Display Phase.

ACTIVE KEYS IN SNAPSHOT DATA CAPTURE PHASE	
YES & NO	Scroll through displayed data parameters.
F0	Mark top displayed parameter as “fixed” for creating your own data pairs.
F1	Mark bottom displayed parameter as “fixed” for creating your own data pairs.
ENTER	Manual trigger.
EXIT	Display captured data if trigger has already occurred.

Data Display Phase

8. The Data Display phase is indicated with a number (initially zero) in the lower right-hand corner of the display. Select the data to be displayed by using the **YES** and **NO** keys.

NOTE



During the Data Display phase, the DTC(s) present during each sample can be displayed by pressing **F2**.

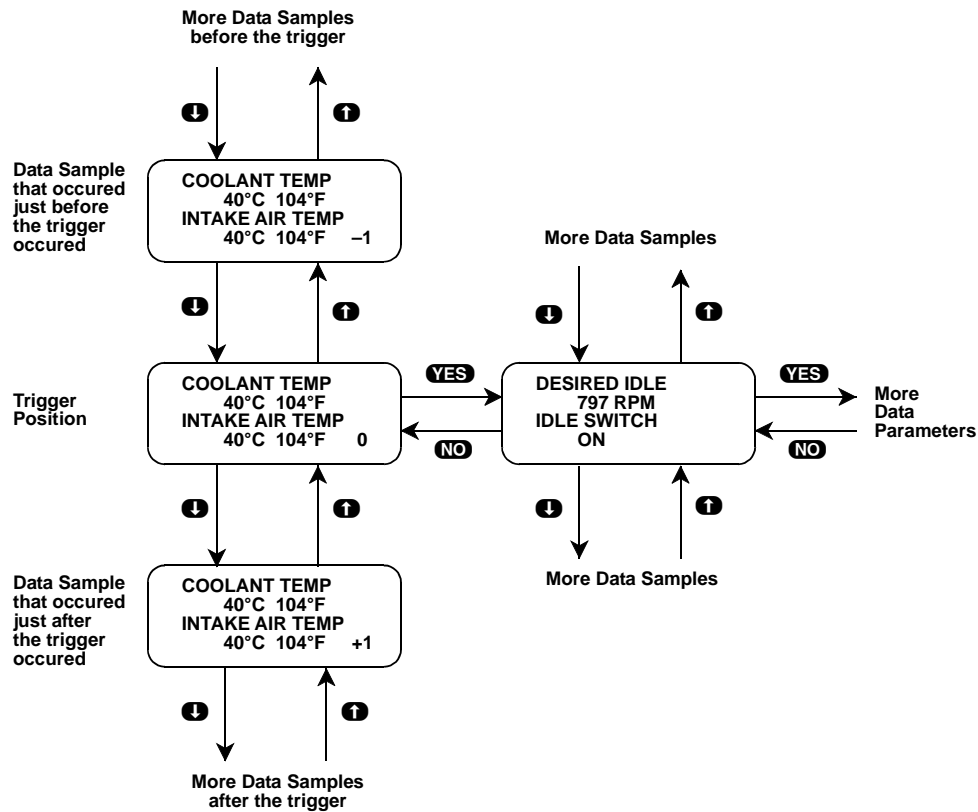

9. Use the **↑** and **↓** keys to select the desired sample. An index is displayed in the lower right-hand corner of the tester display. Sample “0” corresponds to the trigger sample; sample “-1” is the sample immediately preceding the trigger; sample “+1” is immediately after the trigger, and so on. The index range may be less than the maximum number of samples if not enough time was allowed for data capture before or after the trigger.

You can advance directly to the first, last, or trigger sample with the press of a button.

- F4: Display first (earliest) sample
- F5: Display trigger sample (0)
- F6: Display last (most recent) sample

10. While in the data display phase, pressing **ENTER** will cause the tester to toggle between the sample index and sample time.

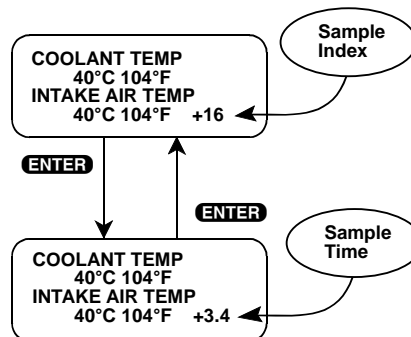

The sample time display gives the time in seconds (relative to the trigger sample) at which the tester received the currently displayed sample. For example, a sample time of +3.4 means the sample was received 3.4 seconds after the trigger sample. A sample time of -2.6 seconds means the sample was received 2.6 seconds before the trigger.

11. The currently displayed sample may be printed if the tester is connected to a compatible printer. To print the data, press **F8**. The tester keyboard will be disabled while data is being sent to the printer.

SNAPSHOT data can also be printed in a tabular format using the Screen Print feature if the RS232C I/F Cartridge is installed or if you are using a TECH 1 Series A tester. Screen Print is enabled by pressing **F6** until an "RS232 SET-UP" menu is displayed. Press **F1** to enable the Screen Print function. Refer to the RS232C I/F or TECH 1 Series A Operator's Manual for more detail.

12. When you are finished viewing the sampled data, press **EXIT** to return to the Snapshot Options menu. If you are finished with the SNAPSHOT mode, press **EXIT** again to return to the select mode menu.

ACTIVE KEYS IN SNAPSHOT DATA DISPLAY PHASE	
YES & NO	Scroll through displayed data parameters.
↑ & ↓	Scroll through selected samples.
F0 & F1	Fix top or bottom display parameter respectively.
F2	Display DTC(s) for current sample.
F4	Advance to first (earliest) sample.
F5	Advance to trigger sample (sample 0).
F6	Advance to last (most recent) sample.
F6 (Hold)	Select "RS232C SET-UP" menu.
F8	Print current data sample (if equipped with RS232C I/F Cartridge or TECH 1 Series A and printer).
ENTER	Toggle between sample index and sample time display.
EXIT	Return to Snapshot Options menu.

Snapshot Mode Flow Chart

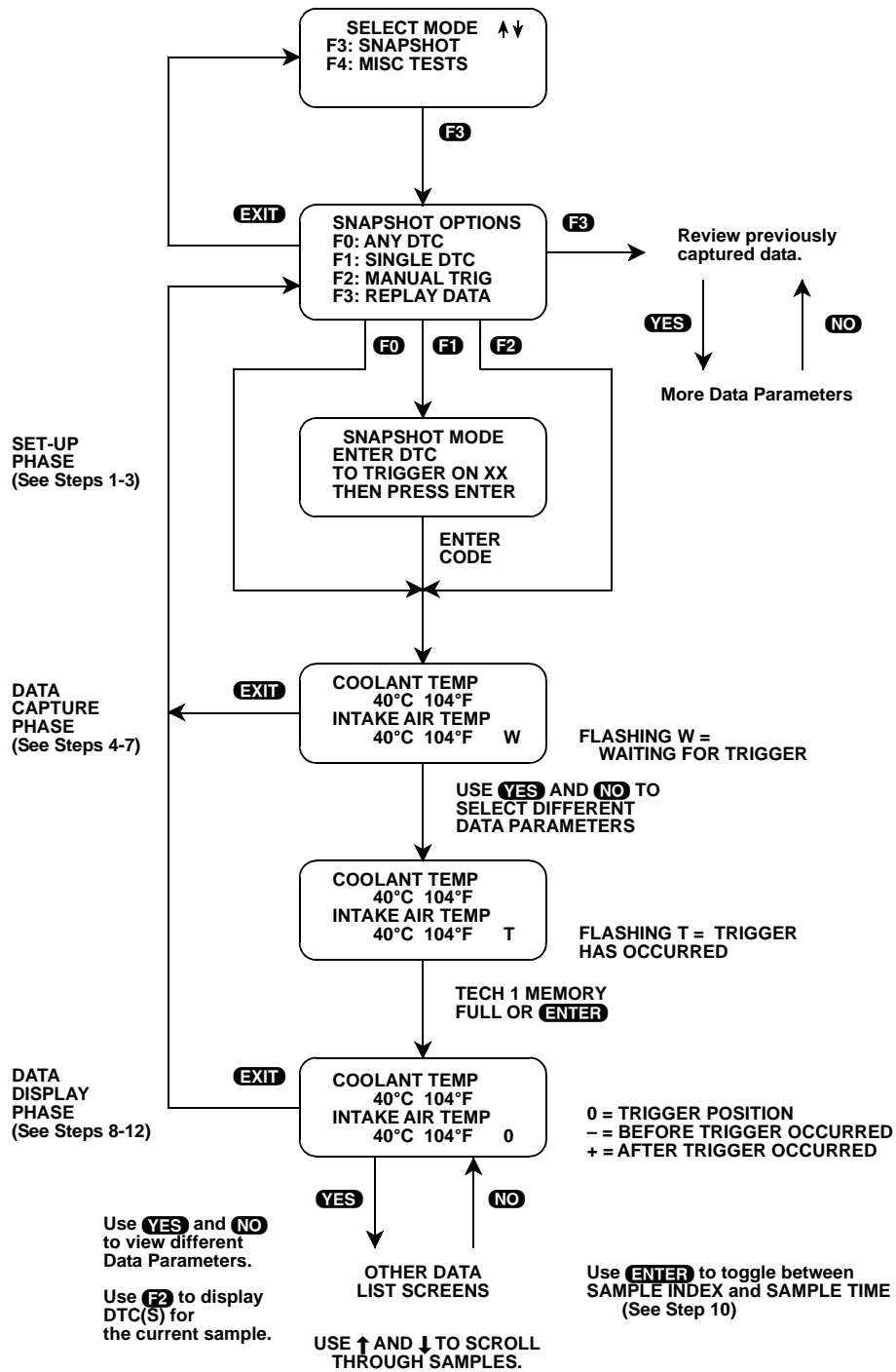

MODE F4: MISC TESTS

MISC TESTS MODE ABORT CONDITIONS

The following chart lists the vehicle conditions that will cause the Miscellaneous Tests to abort (stop). If you are unable to perform the test or if the test aborts after it starts, confirm that none of the following conditions exists before starting the test again.

ECM NO.	OUTPUT CONTROL	CONDITION
1-5, 9, 11-13, 17	RPM Control	Engine Speed greater than 2000 RPM. Vehicle speed detected.
7, 8, 10, 14, 16	RPM Control	Engine speed less than 500 RPM or greater than 2000 RPM. Vehicle speed detected. Coolant Temperature less than 70°C. CTP Switch (Closed Throttle Position) OFF.
15	RPM Control	CTP Switch (Closed Throttle Position) OFF. Vehicle speed detected. Diagnostic trouble code No. 24 is set.
18, 21-38, 41-48	RPM Control	CTP Switch (Closed Throttle Position) OFF. DTC(s) detected. Vehicle speed detected. Coolant Temperature less than 80°C.
1-6, 9, 11-13, 17	Fixed Spark	Engine Speed greater than 2000 RPM. Vehicle speed detected.
7, 8, 10, 14, 16	Fixed Spark	Engine Speed greater than 2000 RPM. Coolant Temperature less than 70°C. CTP Switch (Closed Throttle Position) OFF.
15	Fixed Spark	Engine Speed greater than 2000 RPM.
18, 21-38, 41-48	Fixed Spark	CTP Switch (Closed Throttle Position) OFF. DTC(s) detected. Vehicle speed detected. Coolant Temperature less than 80°C.
1-4, 9, 11	IAC CAL	Engine Speed greater than 2000 RPM.
7, 8, 10, 14	IAC CAL	Coolant Temperature less than 70°C or greater than 105°C.
15	IAC CAL	Coolant Temperature less than 76°C. A/C Control Signal ON. Power steering pressure switch ON. Blower fan motor switch ON. Transmission range other than "P" or "N" range (for A/T vehicle).
36	IAC CAL	CTP Switch (Closed Throttle Position) OFF. DTC(s) detected. Vehicle speed detected. Coolant Temperature less than 80°C.

ECM NO. (CONT.)	OUTPUT CONTROL	CONDITION
1, 3, 4-6, 9, 11, 12	EGR Control	Engine Speed less than 1500 RPM or greater than 4000 RPM. Coolant Temperature less than 70°C.
8	EGR Control	Engine Speed less than 1500 RPM or greater than 4000 RPM. Coolant Temperature less than 70°C. CTP Switch (Closed Throttle Position) OFF.
7, 10, 14	Stepping EGR Control	Engine Speed less than 200 RPM. Coolant Temperature less than 70°C. CTP Switch (Closed Throttle Position) OFF.
13	Stepping EGR Control	Engine Speed less than 200 RPM. Coolant Temperature less than 55°C. CTP Switch (Closed Throttle Position) OFF.
15	Stepping EGR Control	Engine Speed greater than 3500 RPM. Vehicle speed detected. Coolant Temperature less than 76°C.
16	Stepping EGR Control	Vehicle Speed detected. Coolant Temperature less than 70°C. CTP Switch (Closed Throttle Position) OFF.
17	EGR Control	Engine Speed less than 1500 RPM or greater than 4000 RPM. Vehicle Speed detected.
18	Stepping EGR Control	Engine Speed less than 3000 RPM. DTC(s) detected. Vehicle speed detected. Coolant Temperature less than 80°C.
21, 23-25, 29-38, 41, 43-46	Stepping EGR Control	Engine Speed greater than 3000 RPM. DTC(s) detected. Vehicle speed detected.
21-38, 46, 48	Cani Purge Valve	Engine speed detected. DTC(s) detected. Vehicle speed detected.
21, 23-25, 29-38, 46	Fuel Pump Control	Engine speed detected. DTC(s) detected. Vehicle speed detected. Fuel tank less than 15%.
21-25, 29-38, 46	MIL Control	Vehicle speed detected.
24, 25, 29, 30, 32, 34, 36, 38, 47	A/C Condenser Fan	CTP Switch (Closed Throttle Position) OFF. DTC(s) detected. Vehicle speed detected. Coolant Temperature greater than 110°C. A/C Switch ON.
21-23, 29-31, 34- 36, 42, 46-48	Radiator Fan Control	CTP Switch (Closed Throttle Position) OFF. DTC(s) detected. Vehicle speed detected. Coolant Temperature greater than 110°C. A/C Switch ON.

SELECTING A MISCELLANEOUS TEST

Selection of a Miscellaneous Test or Output Control Test may vary from vehicle to vehicle. Some vehicles will allow you to choose between an Output Control Test and a Readiness Test from the MISC TEST menu.

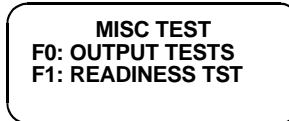

From this display, press **F0** to view the Output Control Test menu. For a description of the READINESS TST see [Readiness Test on page 138](#).

For some vehicles, the tester will display a menu of output tests immediately after you press F4: MISC TEST from the SELECT MODE menu.

The Miscellaneous Test or Output Control Test menu allows you to choose the control test you wish to perform on the vehicle.

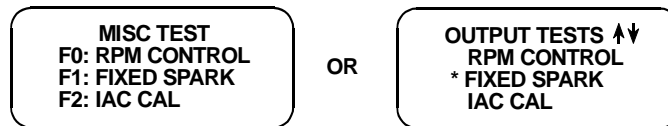

To select a control test from the MISC TEST menu, press the tester key to the left of the test name.

From the OUTPUT TESTS menu, you can select the individual tests by using **↑** and **↓** to scroll through the list of tests until the * is next to the test you want to perform, then press **ENTER**.

Detailed descriptions of the individual output control tests start on the following pages.

Press **EXIT** to return to the SELECT MODE menu from the MISC TEST menu.

ACTIVE KEYS	
F0 - F9	Selection Keys.
↑ - ↓	Scroll through menu.
ENTER	Selection Key.
EXIT	Return to Select Mode menu.

RPM CONTROL

RPM Control is not an engine test, but it allows you to control the RPM. If an elevated RPM or diagnosis of the IAC valve is required for any reason, this mode allows quick and easy control of the RPM from any area of the vehicle.

	<p>CAUTION! This test should only be run with the parking brake on and the wheels adequately secured. Any other mode of operation is not recommended and is unsafe.</p>
---	--

To select RPM Control Miscellaneous Test, do the following:

1. Select RPM CONTROL from the Output Tests menu or the Misc. Test menu. The RPM CONTROL instruction screen is displayed, followed by the BLOCK WHEELS screen.
2. Block the wheels, set the parking brake, put the transmission in Park or Neutral, then start the engine. Warm the engine to operating temperature.
3. Press **ENTER** to begin the test.
4. The tester first automatically controls the engine speed to the current desired idle. When the RPM Control Testing Screen is displayed, you can increase the engine RPM by pressing the **↑** key. To decrease the RPM, press the **↓** key. Holding down either key will cause the RPM to change in the appropriate direction.

If the tester detects any of the conditions listed on the Misc. Tests Mode Abort Conditions tables, the test will be terminated and the cause will be displayed.

5. While in the RPM CONTROL mode, parameters can be displayed as in the DATA LIST mode. RPM appears at the end of line 2 of the display, and the currently commanded value of RPM is displayed at the end of line 4. Data parameters can be scrolled and fixed as in the DATA LIST mode.

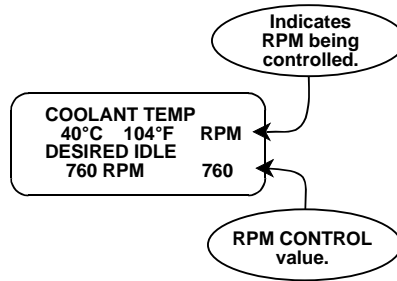

RPM Control Mode Screen

6. To return to the initial desired idle control RPM, press the **ENTER** key.
7. Press the **EXIT** key to return control of the IAC valve to the ECM (or PCM) and to return to the Miscellaneous Tests menu.

ACTIVE KEYS FRO RPM CONTROL	
↑	Increase engine speed.
↓	Decrease engine speed.
YES & NO	Scroll through displayed data parameters.
F0 & F1	Mark top or bottom displayed parameter as fixed for creating your own data pairs.

ACTIVE KEYS FRO RPM CONTROL (CONT.)	
ENTER	Advance to RPM control, provided vehicle is in Park or Neutral. Return to initial desired idle RPM control.
EXIT	Terminate the RPM CONTROL mode and return to the Miscellaneous Test menu.

FIXED SPARK MODE

The purpose of the Fixed Spark mode is to continuously monitor data parameters while commanding ECM (or PCM) operation in the fixed spark mode. The Fixed Spark mode allows you to set the ignition timing.

The Fixed Spark mode allows monitoring of data parameters in a manner identical to that of the Data List mode. Fixed spark operation is indicated by the letters "FXS" in the lower right corner of the display as shown on the following page.

To select Fixed Spark Miscellaneous Test, do the following:

1. Select FIXED SPARK mode from the Output Tests menu or the Misc. Test menu.
2. Block the wheels, set the parking brake, put the transmission in Park or Neutral, and then start the engine. Warm the engine to operating temperature.
3. Press **ENTER** to begin the test and then check that the ignition timing is within the specification by using a timing light.

Refer to the Service Manual for the specifications of initial ignition timings.

4. Select the data parameters to be displayed by scrolling through the parameters with the **YES** and **NO** keys.

If the tester detects any of the conditions listed on the Misc. Tests Mode Abort Conditions tables, the test will be terminated and the cause will be displayed.

5. Press **EXIT** to terminate the Fixed Spark mode and return to the Miscellaneous Tests menu.

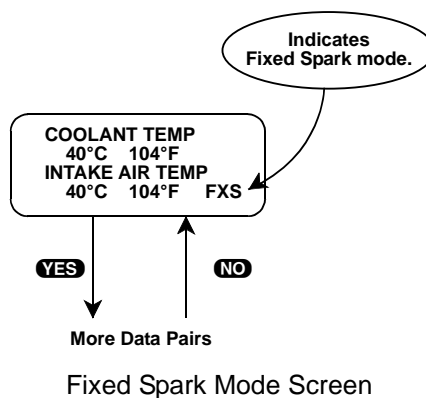

ACTIVE KEYS FOR FIXED SPARK MODE	
YES & NO	Scroll through displayed parameters.
F0	Mark top displayed parameter as “fixed” for creating your own data pairs.
F1	Mark bottom displayed parameter as “fixed” for creating your own data pairs.
ENTER	Advance to FIXED SPARK mode, provided vehicle is in Park or Neutral.
EXIT	Return to Miscellaneous Test menu.

IAC CAL

The purpose of the IAC CAL mode is to set the duty of the IAC valve to a certain value at idle speed. This is done by adjusting the Idle adjustment screw in the throttle body. The IAC CAL mode allows monitoring of data parameters in a manner identical to that of the DATA LIST mode.

To select IAC CAL mode of Miscellaneous Tests, do the following:

1. Select IAC CAL from the Output Tests menu or the Misc. Test menu.
2. Block the wheels, set the parking brake, and put the transmission in Park or Neutral.
3. Make sure the vehicle is in Park with the parking brake engaged, start the engine unless it is already running. Warm the engine to operating temperature.
4. Press **ENTER** to begin the test.
5. Select the data parameters to be displayed by scrolling through the parameters with the **YES** and **NO** keys. The letters “IAC” appearing at the end of line 2 of the display indicate that the IAC valve is being controlled. At the end of line 4 of the display, “CAL” (Calibrated Air) will be displayed.

If the tester detects any of the conditions listed on the Misc. Tests Mode Abort Conditions tables, the test will be terminated and the cause will be displayed.

6. Press **EXIT** to return to the Miscellaneous Tests menu and return control of the IAC system to the ECM (or PCM).

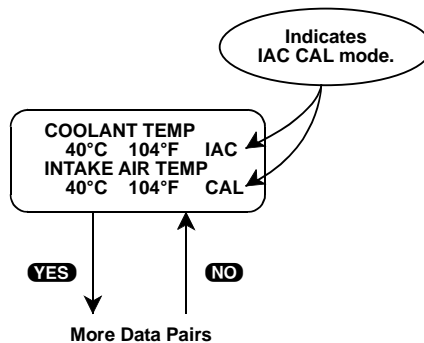

Idle Air Control Calibration (IAC CAL) Mode Screen

ACTIVE KEYS FOR IAC CAL	
YES & NO	Scroll through displayed data parameters.
F0	Mark top displayed parameter as "fixed".
F1	Mark bottom displayed parameter as "fixed".
ENTER	Advance to IAC Control, provided vehicle is in Park or Neutral.
EXIT	Return to Miscellaneous Test menu.

EGR CONTROL

The EGR Control mode allows you to continuously monitor Data List parameters while commanding the EGR control ON and OFF. When EGR control is ON, exhaust gas is introduced into the intake manifold. The engine should be warmed to control operating temperature before performing the EGR Control mode test.

To select EGR Control mode in Miscellaneous Tests, do the following:

1. Select the EGR Control mode from the Output Tests menu or the Misc. Test menu.
2. Block the wheels, set the parking brake, put the transmission in Park or Neutral, and then start the engine. Warm the engine to operating temperature.
3. Control the engine speed to 1500-4000 RPM, then press **ENTER**.
4. Select the data parameters to be displayed by scrolling through the parameters with the **YES** and **NO** keys. "EGR" is displayed at the end of line 2 and "ON" is displayed at the end of line 4 indicating that the EGR system is being controlled.

If the tester detects any of the conditions listed on the Misc. Tests Mode Abort Conditions tables, the test will be terminated and the cause will be displayed.
5. The test begins with the EGR on. To control the EGR off, press the **↓** key. To control EGR on again press the **↑** key. The Data List display for monitoring the engine's response is available while the EGR is being controlled.
6. Press **EXIT** to return to the Miscellaneous Test menu and return EGR Control to the ECM (or PCM).

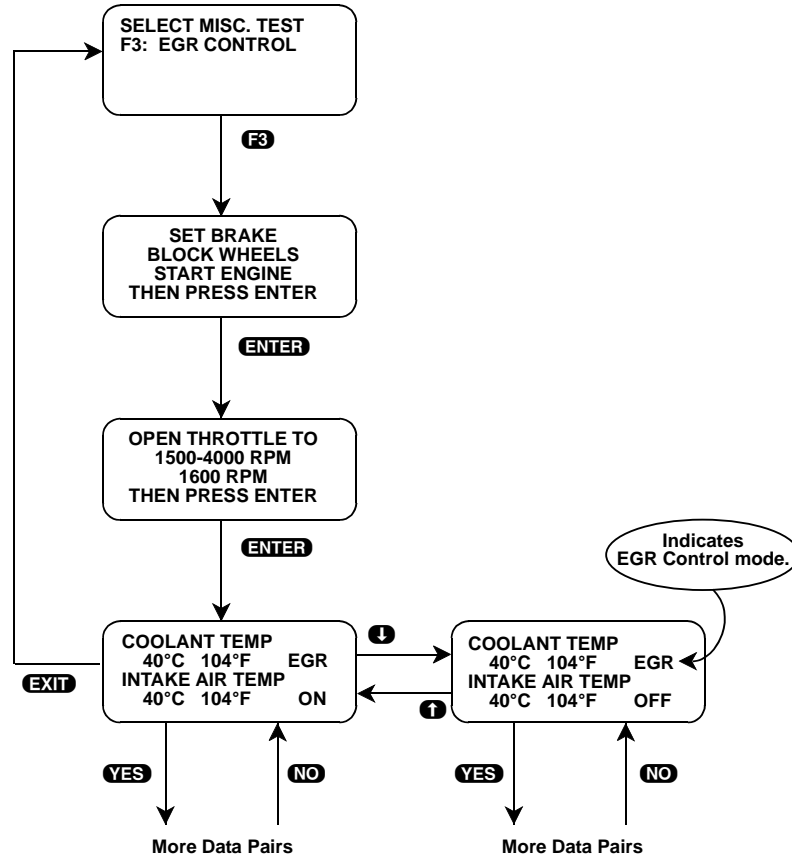

ACTIVE KEYS FOR EGR CONTROL MODE	
YES & NO	Scroll through displayed data parameters.
F0	Mark top displayed parameter as “fixed”.
F1	Mark bottom displayed parameter as “fixed”.
ENTER	Advance to EGR Control, provided vehicle is in Park or Neutral.
↑	Switch EGR control on while viewing parameters.
↓	Switch EGR control off while viewing parameters.
EXIT	Return to Miscellaneous Test menu.

STEPPING EGR CONTROL

The Stepping EGR Control mode allows you to regulate the Stepping EGR opening in increments from 0 to 100, and displays the stepping EGR monitor value as a percentage. The tester initializes the Stepping EGR opening to the current value (=0%).

To select Stepping EGR Control mode in Miscellaneous Tests, do the following:

1. Select the STEPPING EGR Control mode from the Output Tests menu or Misc. Test menu.
2. Set the parking brake, block the wheels, put the transmission in Park or Neutral, then start the engine.
3. Press **ENTER** to begin the test.
4. "EGR" is displayed at the end of line 2 and the Stepping EGR value is displayed at the end of line 4.
Press the **↑** key to increase the Stepping EGR value. To decrease the Stepping EGR value, press the **↓** key. The Stepping EGR value is displayed as a percentage (%).

If the tester detects any of the conditions listed on the Misc. Tests Mode Abort Conditions tables, the test will be terminated and the cause will be displayed.

5. Press **EXIT** to return to the Miscellaneous Test menu.

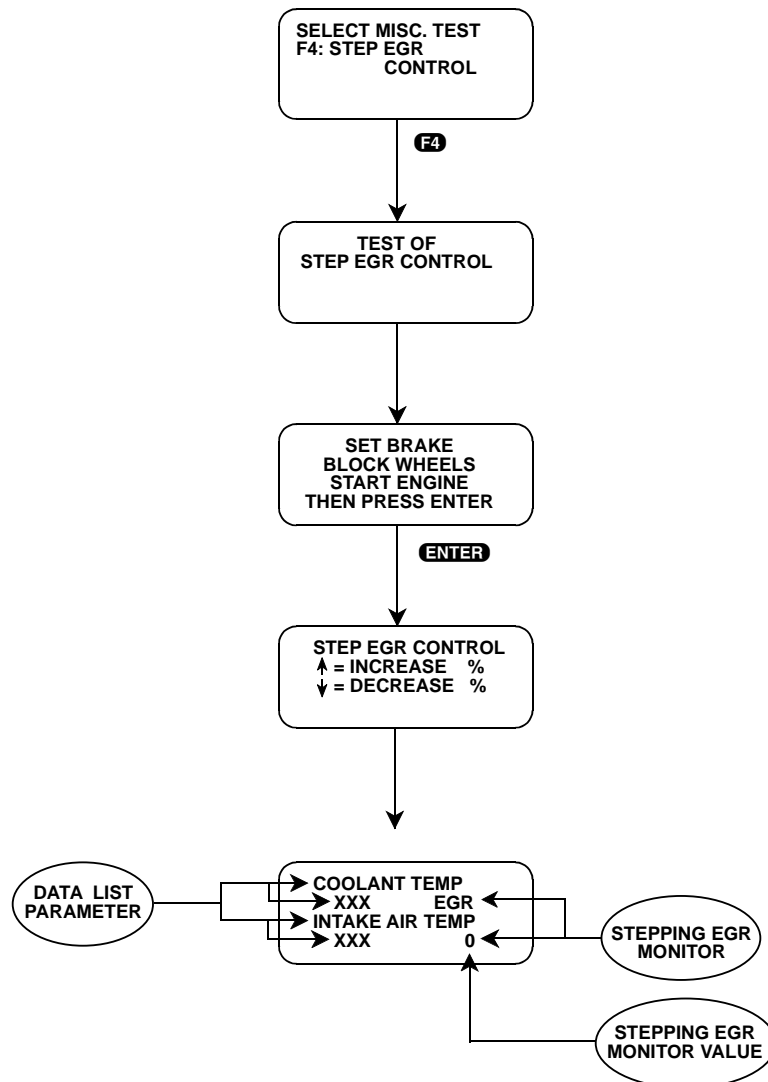

ACTIVE KEYS FOR STEPPING EGR CONTROL MODE	
YES & NO	Scroll through displayed data parameters.
ENTER	Advance to STEPPING EGR Control provided vehicle is in Park or Neutral.
↑	Increase STEPPING EGR control value while viewing parameters.
↓	Decrease STEPPING EGR control value while viewing parameters.
EXIT	Return to Miscellaneous Test menu.

SOV TEST

The SOV (Shut Off Valve) test mode allows you to check whether the valve turns on and off.

To select the SOV Test mode in Miscellaneous Tests, do the following:

1. Confirm that the engine is stopped.
2. Select the SOV Test mode from the Output Tests menu or the Misc. Test menu.
3. Disconnect the immobilizer coupler at the immobilizer control module and then press **↓**.
4. Turn the ignition switch “OFF”, and then “ON” again, and then press **↓**.
5. Wait three seconds for the SOV control to be enabled.
6. Press **↑** to initiate the SOV Test.
7. When the test has concluded, the tester will either display CONTINUE or it will show one of four screens. The “COMPLETE WITHOUT ERROR” screen indicates that the SOV has been controlled. The “FAIL WITHOUT ERROR” screen indicates that SOV has not been controlled due to the fuel pump/immobilizer control module code not being matched. The “COMPLETE WITH ERROR” screen indicates that the SOV has not been controlled due to a fault in the SOV. The “FAIL WITH ERROR” screen indicates that the SOV has not been controlled due to a fault in the SOV, and the fuel pump/immobilizer control module code was not found either.

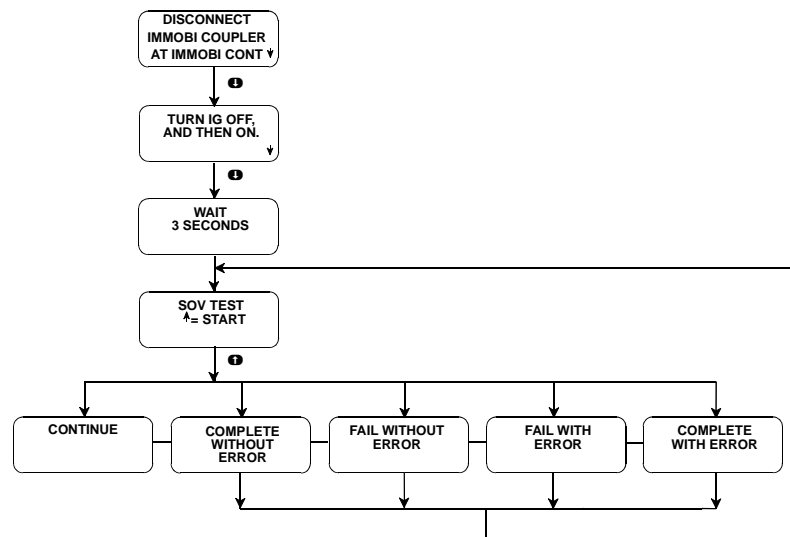

ACTIVE 1 KEYS FOR SOV TEST MODE	
↑	Initiate the SOV test.
↓	Scroll to next screen.
EXIT	Return to Miscellaneous Test menu.

CANI PURG VAL (DUTY TYPE)

The canister purge valve output control mode allows you to regulate the valve opening in increments from 0 to 100 and displays the canister purge valve monitor value as a percentage.

To select Cani Purg Val (Duty Type) in Miscellaneous Tests, do the following:

1. Select the CANI PURG VAL Test from the Output Tests menu or the Misc. Test menu.
2. Set the parking brake, stop the engine and turn the ignition to the on position.
3. Press **ENTER** to begin the test.
4. Press **YES** to acknowledge that the ↑ means increase % and ↓ means decrease %.
5. The test begins with the Cani purge valve at the current value. "PRG" is displayed at the end of line 2 and the canister purge valve value is displayed at the end of line 4. Press the ↑ key to increase the canister purge valve value and the ↓ key to decrease the value.

If the tester detects any of the conditions listed on the Misc. Tests Mode Abort Conditions table, the test will be terminated and the cause will be displayed.

6. Press **EXIT** to return to the Output Tests menu.
7. Press **EXIT** to return to the Miscellaneous Test menu.

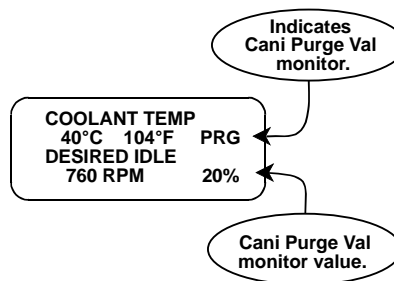

Cani Purg Val Control Mode Screen

ACTIVE KEYS FOR CANI PURGE VAL CONTROL MODE	
ENTER	Select the CANI PURGE VAL Test and start the test.
YES	Acknowledge instruction screen.
↑	Increase Cani Purge Value while viewing parameters.

ACTIVE KEYS FOR CANI PURGE VAL CONTROL MODE (CONT.)	
↓	Decrease Cani Purge Value while viewing parameters.
EXIT	Terminate the Cani Purge Value Control test and return to the Output Control menu or the Miscellaneous Test menu.

CANI PURG VAL (ON/OFF TYPE)

The canister purge valve output control mode allows you to turn the canister purge valve ON (open) and OFF (closed).

To select the Cani Purg Val (On/Off) in Miscellaneous Tests, do the following:

1. Select the CANI PURG VAL Test from the Output Tests menu or the Misc. Test menu.
2. Set the parking brake, stop the engine and turn the ignition to the on position.
3. Press **ENTER** to begin the test.
4. Press **YES** to acknowledge that the **↑** means ON and **↓** means OFF.
5. "PRG" is displayed at the end of line 2 and the canister purge valve state is displayed at the end of line 4. Press the **↑** key to turn the canister purge valve ON and the **↓** key to turn the valve OFF.

If the tester detects any of the conditions listed on the Misc. Tests Mode Abort Conditions table, the test will be terminated and the cause will be displayed.

6. Press **EXIT** to return to the Output Tests menu.
7. Press **EXIT** to return to the Miscellaneous Test menu.

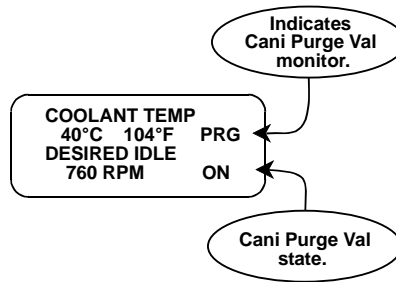

Cani Purg Val Control Mode Screen

ACTIVE KEYS FOR CANI PURGE VAL CONTROL MODE	
ENTER	Select the CANI PURGE VAL Test and start the test.
YES	Acknowledge instruction screen.
↑	Turn on Cani Purge Valve.
↓	Turn off Cani Purge Valve.
EXIT	Terminate the Cani Purge Value Control test and return to the Output Control menu or the Miscellaneous Test menu.

FUEL PUMP CONT

The Fuel Pump Control mode allows you to turn the fuel pump relay on and off.

To select Fuel Pump Control in Miscellaneous Tests, do the following:

1. Select the FUEL PUMP CONT Test from the Output Tests menu or the Misc. Test menu.
 2. Set the parking brake, stop the engine and turn the ignition to the on position.
 3. Press **ENTER** to begin the test.
 4. Press **YES** to acknowledge that the **↑** means ON and **↓** means OFF.
 5. Press **↑** to turn the fuel pump on and **↓** to turn the fuel pump off. Notice the letters "FEL" displayed at the end of line 2 and the fuel pump state of operation (ON/OFF) is displayed at the end of line.
- If the tester detects any of the conditions listed on the Misc. Tests Mode Abort Conditions tables, the test will be terminated and the cause will be displayed.
6. Press **EXIT** to return to the Output Tests menu.
 7. Press **EXIT** again to return to the Miscellaneous Tests menu.

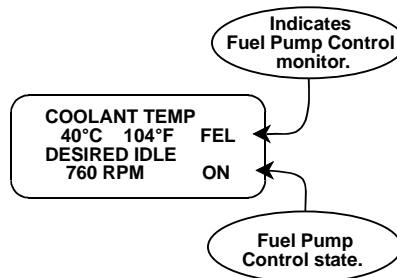

Fuel Pump Control Mode Screen

ACTIVE KEYS FOR FUEL PUMP CONTROL MODE	
ENTER	Select the FUEL PUMP CONTROL Test and start the test.
YES	Acknowledge instruction screen.
↑	Turn on the Fuel Pump.
↓	Turn off the Fuel Pump.
EXIT	Terminate the Fuel Pump Control test and return to the Output Control menu or the Miscellaneous Test menu.

MIL CONTROL

The MIL Control mode allows you to turn the MIL on and off.

To select MIL Control in the Miscellaneous Tests, do the following:

1. Select the MIL Control test from the Output Tests selection menu or the Misc. Test menu.

2. Set the parking brake, and securely block the wheels of the vehicle.
3. Press **ENTER** to begin the test.
4. Press **YES** to acknowledge that **↑** means ON and **↓** means OFF.
5. Press **↑** to turn the MIL ON and **↓** to turn the MIL OFF. Notice the letters "MIL" displayed at the end of line 2 and the MIL Control state of operation (ON/OFF) is displayed at the end of line 4.

If the tester detects any of the conditions listed on the Misc. Tests Mode Abort Conditions tables, the test will be terminated and the cause will be displayed.

6. Press **EXIT** to return to the Output Tests menu.
7. Press **EXIT** again to return to the Miscellaneous Tests menu.

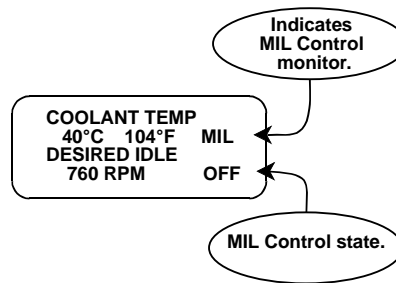

Mil Control Mode Screen

ACTIVE KEYS FOR MIL CONTROL MODE	
ENTER	Select the MIL CONTROL Test and start the test.
YES	Acknowledge instruction screen.
↑	Turn on the MIL Control.
↓	Turn off the MIL Control.
EXIT	Terminate the MIL Control test and return to the Output Control menu or the Miscellaneous Test menu.

RADIATOR FAN CONTROL

Radiator Fan Control mode allows you to turn the radiator fan relay on and off.

To select Radiator Fan Control in Miscellaneous Tests, do the following:

1. Select the RAD FAN CTL test from the Output Tests selection menu or the Misc. Test menu.
2. Set the parking brake, and securely block the wheels of the vehicle.
3. Press **ENTER** to begin the test.
4. Press **YES** to acknowledge that **↑** means ON and **↓** key means OFF.

5. Press **↑** to turn the Radiator Fan ON and **↓** to turn the Radiator Fan OFF. Notice the letters “RAD” displayed at the end of line 2 and the Radiator Fan state of operation (ON/OFF) is displayed at the end of line 4.

If the tester detects any of the conditions listed on the Misc. Tests Mode Abort Conditions tables, the test will be terminated and the cause will be displayed.

6. Press **EXIT** to return to the Output Tests menu.
7. Press **EXIT** again to return to the Miscellaneous Tests menu.

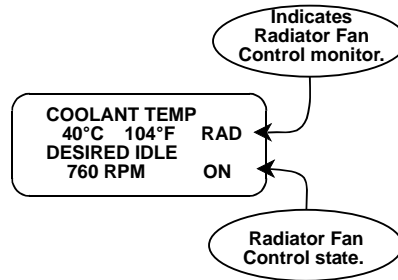

Radiator Fan Control Mode Screen

ACTIVE KEYS FOR RADIATOR FAN CONTROL MODE	
ENTER	Select the RADIATOR FAN CONTROL Test and start the test.
YES	Acknowledge instruction screen.
↑	Turn on the Radiator Fan.
↓	Turn off the Radiator Fan.
EXIT	Terminate the Radiator Fan Control test and return to the Output Control menu or the Miscellaneous Test menu.

A/C CONDENSER FAN

The A/C Condenser Fan Control mode allows you to turn the A/C condenser fan control relay on and off.

To select A/C Condenser Fan in Miscellaneous Tests, do the following:

1. Select the A/C COND FAN test from the Output Tests menu or the Misc. Test menu.
2. Set the parking brake, and securely block the wheels of the vehicle.
3. Press **ENTER** to begin the test.
4. Press **YES** to acknowledge that **↑** means ON and **↓** means OFF.
5. Press **↑** to turn the A/C Condenser Fan ON and **↓** to turn the A/C Condenser Fan OFF. Notice the letters “A/C” displayed at the end of line 2 and the A/C Condenser Fan state of operation (ON/OFF) is displayed at the end of line 4.

If the tester detects any of the conditions listed on the Misc. Tests Mode Abort Conditions tables, the test will be terminated and the cause will be displayed.

6. Press **EXIT** to return to the Output Tests menu. Press **EXIT** again to return to the Miscellaneous Tests menu.

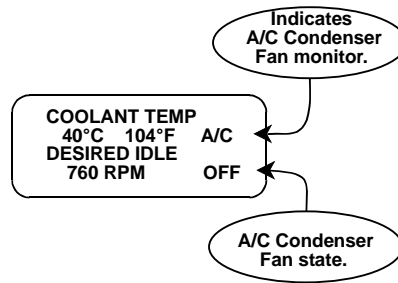

A/C Condenser Fan Control Mode Screen

ACTIVE KEYS FOR A/C CONDENSER FAN CONTROL MODE	
ENTER	Select the A/C CONDENSER FAN CONTROL Test and start the test.
YES	Acknowledge instruction screen.
↑	Turn on the A/C Condenser Fan.
↓	Turn off the A/C Condenser Fan.
EXIT	Terminate the A/C Condenser Fan Control test and return to the Output Control menu or the Miscellaneous Test menu.

ECU NO. 39 ALL OUTPUT TESTS

To select ECU No. 39 All Output Tests in Miscellaneous Tests, do the following:

1. Select the test you want from the Output Tests menu.
2. Set the parking brake, stop the engine, and turn the ignition to the ON position.
3. Press **YES** to begin the test.
4. The tester displays one of the following messages:

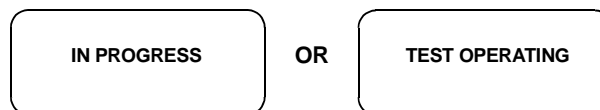

5. Within about 10 seconds, the tester displays one of the following messages:

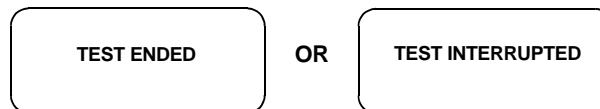

6. After the "TEST ENDED" or "TEST INTERRUPTED" message is displayed, the tester returns to the Output Tests menu.

ECU NO. 40 ALL OUTPUT TESTS

To select ECU No. 40 All Output Tests in Miscellaneous Tests, do the following:

1. Select the test you want from the Output Control menu. The tester displays:

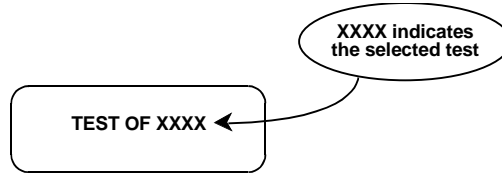

2. Set the parking brake, and securely block the wheels of the vehicle.
3. Press **ENTER** to begin the test. The tester displays:

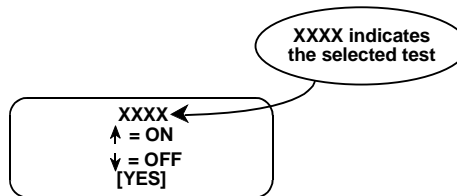

4. Press **YES**. The tester displays a data list, as well as information about the test status on the right side of the screen.

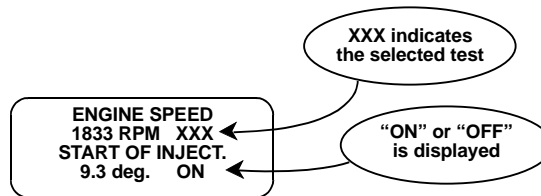

5. Press **↑** or **↓** to toggle the ECU function ON or OFF. The tester displays:

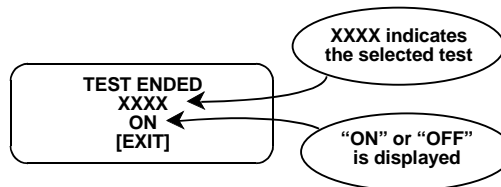

6. Press **EXIT** to return to Step 4.
7. After the test runs for 30 seconds, the tester returns to the Output Tests menu.

READINESS TEST

The Readiness Test mode allows you to monitor the state of various on-board tests, which are performed by the vehicle's ECM.

Press **F1** to select READINESS TST from the MISC TEST menu.

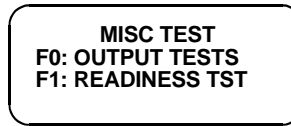

The first three items on the Readiness Test display indicate the vehicle's monitoring capability for continuously monitoring systems:

- Misfire Monitoring
- Fuel System Monitoring
- Comprehensive Component Monitoring

These are indicated as either being SUPPORTED or NOT SUPPORTED, depending on the vehicle's ECM.

The other display items indicate the status of the tests. These tests can be COMPLETE, INCOMPLETE, or NOT SUPPORTED. Press the **↑** key to advance the screen and the **↓** key to return to the previous screen when viewing these tests.



ACTIVE KEYS FOR READINESS TESTS

F0 - F1	Selection keys.
-----------------------	-----------------

MODE F5: ECU ID

ECU ID mode is NOT available for all vehicles.

The ECU ID mode allows you to view the ECU identification number, as well as the Software Version number.

Select the ECU ID mode from the Select Mode menu by pressing **F5**.

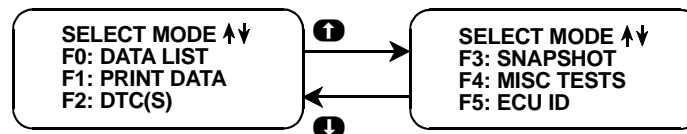

The tester will display the following screen.

ECU NO.
XXXXX-XXXX*
SOFTWARE VERSION
XXX

To return to the Select Mode menu, press **EXIT**.

6. FINISHING UP

After using the Suzuki ECM Application, a few simple steps will insure that you get the most life out of your diagnostic tool.

1. Remove power to the tester by disconnecting the serial data link cable from the serial data link connector.
You may want to inspect the cable and connector for any damage or corrosion.
2. Unplug the cartridge and store it and the cable in the travelling case.

If the tester should become dirty you may wipe it off with a clean cloth and mild detergent or hand soap. Avoid using harsh solvents such as petroleum based cleaning agents, Benzene, Trichloroethylene, etc. Although the tester is water resistant it is not waterproof so be sure to thoroughly dry off the tester prior to storage.

7. DTCS

Listed below is a brief description for all DTC(S) that can be displayed with the Suzuki ECM Application.

NOTE



For Powertrain Diagnostic Trouble Codes of the Pxxxx format, see the related vehicle service manual provided by Suzuki.

ECM TROUBLE CODE	TESTER DISPLAY DESCRIPTOR	TROUBLE CODE DESCRIPTION
1	ENGINE POSITION SENSOR CKT MALF	Engine position sensor circuit open.
3	COOLANT TEMP. SENSOR CKT MALF (HIGH VOLTAGE)	Coolant temp. sensor circuit open.
3	COOLANT TEMP. SENSOR CKT MALF (LOW VOLTAGE)	Coolant temp. sensor circuit short.
4	THROTTLE POS SENSOR CKT MALF (HIGH VOLTAGE)	Throttle position sensor circuit open.
4	THROTTLE POS SENSOR CKT MALF (LOW VOLTAGE)	Throttle position sensor circuit short.
12	NO CODES	No Codes.
13	OXYGEN SENSOR OR CIRCUIT FAIL	Oxygen sensor or circuit malfunction.
13	OXYGEN SENSOR B1 OR CIRCUIT FAIL	Bank 1 Oxygen Sensor or circuit malfunction.

ECM TROUBLE CODE	TESTER DISPLAY DESCRIPTOR	TROUBLE CODE DESCRIPTION
13	BAROMETRIC PRES. SENSOR CKT MALF (HIGH VOLTAGE)	Barometric pressure sensor failure.
13	BAROMETRIC PRES. SENSOR CKT MALF (LOW VOLTAGE)	Barometric pressure sensor failure.
14	ECT SENSOR OR CIRCUIT OPEN	Engine coolant temperature sensor or circuit open.
14	NEEDLE MOVEMENT SENSOR MALF	Needle movement sensor failure.
14	NEEDLE MOVEMENT SENSOR CKT MALF	Needle movement sensor circuit open or short.
15	ECT SENSOR OR CIRCUIT SHORT	Engine coolant temperature sensor or circuit short.
16	SOI GOVERNING	Actual start of injection deviates from the command by a certain amount for a given period of time.
17	BATTERY VOLTAGE SENSING CKT MALF (HIGH VOLTAGE)	Battery supply voltage input is too high.
17	BATTERY VOLTAGE SENSING CKT MALF (LOW VOLTAGE)	Battery supply voltage input is too low.
21	TP SENSOR VOLTAGE HIGH	Throttle position sensor signal voltage too high. Throttle position sensor or circuit failure.
22	TP SENSOR VOLTAGE LOW	Throttle position sensor signal voltage too low. Throttle position sensor or circuit failure.
22	GLOW PLUG FEEDBK CKT MALF (LOW VOLTAGE)	Glow plug control monitor voltage low when control voltage should be high.
23	IAT SENSOR OR CIRCUIT OPEN	Intake air temperature too low. Intake air temperature sensor or circuit open.
23	GLOW PLUG CONTROL CKT MALF (OPEN CIRCUIT)	Glow plug control circuit open or short to power supply circuit.
23	GLOW PLUG CONTROL CKT MALF (SHORT CIRCUIT)	Glow plug control circuit short to ground.
24	VSS NO SIGNAL	Vehicle Speed Sensor signal not received by the ECM (or PCM). Vehicle speed sensor circuit failure.
24	VSS (METER) NO SIGNAL	Vehicle Speed Sensor signal from the Meter Cluster not received by the ECM (or PCM).
25	IAT SENSOR OR CIRCUIT SHORT	Intake air temperature too high. Intake air temperature sensor or circuit short.

ECM TROUBLE CODE	TESTER DISPLAY DESCRIPTOR	TROUBLE CODE DESCRIPTION
26	OXYGEN SENSOR B2 OR CIRCUIT FAIL	Bank 2 Oxygen Sensor or Circuit malfunction.
31	MAP SENSOR VOLTAGE HIGH	Manifold Absolute Pressure sensor signal voltage too high. MAP sensor or circuit failure.
31	MAP SENSOR VOLTAGE LOW	Manifold Absolute Pressure sensor signal voltage too low. MAP sensor or circuit failure.
32	MAP SENSOR VOLTAGE LOW	Manifold Absolute Pressure sensor signal voltage too low. MAP sensor or circuit failure.
32	MAP SENSOR VOLTAGE HIGH	Manifold Absolute Pressure sensor signal voltage too high. MAP sensor or circuit failure.
32	GLOW PLUG FEEDBK CKT MALF (HIGH VOLTAGE)	Glow plug control monitor voltage high when control voltage should be low.
33	AIR FLOW SENSOR VOLTAGE HIGH/LOW	Volume Air Flow sensor voltage too high or too low. MAF sensor or circuit failure.
33	MAF SENSOR VOLTAGE HIGH	Mass Air Flow sensor voltage too high. MAF sensor or circuit failure.
33	EGR 1 CIRCUIT MALFUNCTION (OPEN CIRCUIT)	EGR valve 1 circuit open.
33	EGR 1 CIRCUIT MALFUNCTION (SHORT CIRCUIT)	EGR valve 1 circuit short.
34	MAF SENSOR VOLTAGE LOW	Mass Air Flow sensor voltage too low. MAF sensor or circuit failure.
34	SOI ACTUATOR CKT MALF (OPEN CIRCUIT)	SOI actuator circuit open.
34	SOI ACTUATOR CKT MALF (SHORT CIRCUIT)	SOI actuator circuit short.
36	EGR 2 CIRCUIT MALFUNCTION (OPEN CIRCUIT)	EGR valve 2 circuit open.
36	EGR 2 CIRCUIT MALFUNCTION (SHORT CIRCUIT)	EGR valve 2 circuit short.
37	A/C CONTROL RELAY CKT MALF (OPEN CIRCUIT)	A/C control relay circuit open.

ECM TROUBLE CODE	TESTER DISPLAY DESCRIPTOR	TROUBLE CODE DESCRIPTION
37	A/C CONTROL RELAY CKT MALF (SHORT CIRCUIT)	A/C control relay circuit short.
38	MALF INDICATOR LAMP CKT MALF (OPEN CIRCUIT)	MIL circuit open.
38	MALF INDICATOR LAMP CKT MALF (SHORT CIRCUIT)	MIL circuit short.
39	GLOW PLUG LAMP CKT MALF (OPEN CIRCUIT)	Glow plug lamp circuit open.
39	GLOW PLUG LAMP CKT MALF (SHORT CIRCUIT)	Glow plug lamp circuit short.
41	IGNITION SIGNAL FAIL	Ignition signal not received by the ECM. Ignition system problem.
42	CMP SENSOR NO SIGNAL	Camshaft Position sensor signal not received by the ECM (or PCM). CMP sensor or circuit failure.
42	CKP SENSOR NO SIGNAL	Crankshaft Position sensor signal not received by the ECM (or PCM). CKP sensor or circuit failure.
43	KNOCK SENSOR OR CIRCUIT OPEN	Knock Sensor failure or circuit open.
43	KNOCK SENSOR OR CIRCUIT SHORT	Knock Sensor failure or circuit short.
44	CTP SWITCH OR CIRCUIT OPEN	CTP Switch failure or circuit open.
45	CTP SWITCH OR CIRCUIT SHORT	CTP Switch failure or circuit short.
46	ISC SYSTEM FAIL	Idle Speed Control system failure.
47	CMP SENSOR NO SIGNAL	Camshaft Position sensor signal not received by the ECM (or PCM). CMP sensor or circuit failure.
51	EGR SYSTEM FAIL	Exhaust gas recirculation system malfunction.
51	EGR SYSTEM FAIL EGRT SENS. SHORT	Exhaust gas recirculation temperature sensor or circuit short.
51	EGR SYSTEM FAIL EGRT SENSOR OPEN	Exhaust gas recirculation temperature sensor or circuit open.
51	EGR VALVE CIRCUIT OPEN	EGR valve circuit open.
52	INJECTOR FAIL	Fuel Injector failure.
53	ECM WRONG ASSEMBLY	Improper ECM installation. ECM other than California (USA) Version installed.

ECM TROUBLE CODE	TESTER DISPLAY DESCRIPTOR	TROUBLE CODE DESCRIPTION
53	GND CIRCUIT OPEN/ ECM WRONG ASSEM	Ground circuit for 1991-93 California spec. vehicle is open. Wrong ECM installed in a 1994 USA spec. vehicle.
61	SHIFT SOLENOID NO. 1 OPEN	Shift solenoid No. 1 circuit open.
62	SHIFT SOLENOID NO. 1 SHORT	Shift solenoid No. 1 circuit short.
63	SHIFT SOLENOID NO. 2 OPEN	Shift solenoid No. 2 circuit open.
64	SHIFT SOLENOID NO. 2 SHORT	Shift solenoid No. 2 circuit short.
65	TCC SOLENOID OPEN	Torque Converter Clutch circuit open.
65	PRESS REGULATOR SOLENOID OPEN	Pressure Regulator circuit open.
66	PRESS REGULATOR SOLENOID SHORT	Pressure Regulator circuit short.
66	TCC SOLENOID SHORT	Torque Converter Clutch circuit short.
72	TRANS. RANGE SWITCH FAIL	Transmission Range switch failure
75	VSS (TRANS.) NO SIGNAL	Signal of the Vehicle Speed Sensor in transmission not received by ECM (or PCM).
76	INPUT SHAFT SPEED SEN. FAIL	Input Shaft Speed Sensor failure.
127	ECU FAULT	ECU internal failure.

8. DATA LIST PARAMETER DESCRIPTIONS

The tester is capable of displaying a wide variety of ECM (or PCM) parameters in Data List, Snapshot, RPM Control and Output Test modes. The ECM (or PCM) sends the tester information regarding the state of the engine (and transmission) as the ECM (or PCM) sees it. The tester “translates” and displays this information in the form of parameters selected by the service technician. This section describes those parameters.

There are two basic types of parameters: discrete and analog. Discrete parameters are 'bits' of information and can be in only one of two distinct states (on/off, open/closed, etc.). Switches and solenoids are examples of discrete parameters. Analog parameters are used to represent quantities and are displayed as a value with appropriate units. Examples of analog parameters include Engine Speed, Coolant Temperature, Oxygen Sensor Voltage, etc.

Parameters are grouped by ECM (or PCM) function. The categories are:

- General and Electrical
- Fuel Delivery and Spark Control
- Emissions & Driveability
- Transmission
- Miscellaneous

CATEGORY DESCRIPTIONS

- General Parameters are those that effect or are affected by many different ECM (or PCM) systems. Included are: Engine Speed, Vehicle Speed, Engine Coolant Temperature and Charging Efficiency related parameters.

Electrical Parameters can be used to help diagnose vehicle electrical problems and include Battery Voltage, Electric Load.

- Fuel Delivery Parameters describe the ECM (or PCM) fuel control system in action. After the engine has warmed up, the ECM (or PCM) controls the air/fuel mixture ratio based on the values of certain engine

sensor inputs. Examples of such inputs include Intake Air Temperature and Pressure, and Oxygen Sensor Voltage. The output signals of the fuel control system depend on the fuel delivery system.

Spark Control Parameters are associated with spark timing calculations. Engine sensor values are used by the ECM (or PCM) to increase or decrease (retard) spark advance.

- Emissions & Driveability refer to all parameters that are related to improvements in performance or air pollution reduction.

Systems included are:

- Idle Air Control/Idle Speed Control
- Exhaust Gas Recirculation
- Evaporative Emission Control
- Transmission Parameters represent signals from the transmission to the ECM (or PCM).
- The Miscellaneous Parameters include the states of various switches.

DESCRIPTOR FORMAT

Following is a description of every parameter that can be displayed with the Suzuki ECM Application. Included is: 1) a listing of all the parameters available for each category; 2) a description, and the units of the analog parameters.

GENERAL

Calc. Load
Charging Efficiency
ECT Sensor Voltage
Engine Coolant Temperature
Engine Load
Engine Speed
Fuel Temperature
Vehicle Speed
VSS (METER)

ELECTRICAL

Battery Positive Voltage
Battery Voltage
Electric Load

SPARK CONTROL

Ignition Advance
Ignition Timing Level
Spark Advance
Spark Advance Switch

FUEL DELIVERY

Air Flow
Barometric Pressure
Barometric Sensor Voltage
EGR Throttle
Fuel Cut
Fuel Pressure Control Valve
Fuel Pump
Fuel Rail Pressure
Fuel System B1, B2
Fuel System Status
Fuel Tank Level
Injector Flow 1, 2, 3, 4
Injector Pulse Width, B1, B2
Intake Air Temperature
Long Ft B1, B2
Manifold Absolute Pressure (MAP)
Mass Air Flow (MAS)
Mixture Control Dwell, B1, B2
Mixture Control Learn, B1, B2
Mixture Control Monitor, B1, B2
Needle Sensor Voltage
O2S Activation, B1, B2
O2S B1 S1
O2S B1 S2
O2S B2 S1
O2S B2 S2
O2S Signal
Oxygen Sensor, B1, B2
Pedal Pos Sensor
Rail Pressure Regulator
Rich/Lean Monitor, B1, B2
Short Ft B1, B2
Start of Injection
Throttle Angle
Throttle Opener Solenoid
Throttle Position
Throttle Position Sensor
Total Ft B1, B2
Total Fuel Trim
TP Sensor Volt
Turbo Pressure

EMISSIONS & DRIVEABILITY PARAMETERS

Canister Purge Duty
Canister Purge Solenoid
Closed Throttle Position
CTP Switch
Desired Idle Speed
EGR
EGR Temperature
EGR Valve
EVAP Canist
EVAP Purge Duty
EVAP Solenoid Purge (SP) Valve

IAC Adjust Monitor
IAC Duty
IAC Flow
IAC Flow Duty
IAC/ISC Duty
IAC Motor Position
Power Steering Pressure (PSP) Switch
Power Steering Solenoid Vacuum (PS SV) Valve

TRANSMISSION PARAMETERS

4WD-L Switch
D-Range Shift Switch
Gear Position
Gear Position CON, MON
Input Shaft
Inp. Shaft Speed
Mode Select Switch
O/D OFF Switch
PNP Signal
Pressure Regulator Solenoid CON, MON
Shift Solenoid #1 CON, MON
Shift Solenoid #2 CON, MON
TCC Solenoid CON, MON
Throttle Open Rate
Throttle Position Level
Trans Range
Trans. Range
VSS (A/T)
VSS (TRANS)

MISCELLANEOUS PARAMETERS

ABS Switch
A/C Condenser Fan
A/C Control Signal
A/C Cooling Fan
A/C Evaporator Temperature
A/C Magnetic Clutch
A/C Pressure Switch
A/C Switch
Blower Fan Switch
Brake Switch
Heater Fan
Radiator Fan
Starter

GENERAL PARAMETERS

CALC LOAD

UNITS
%

Calc Load is engine load displayed as a percentage. Its value is calculated mathematically using the following formula: actual (current) intake air volume ÷ maximum possible intake air volume x 100%.

CHARGING EFFICIENCY

UNITS
%

Charging efficiency is calculated using data from the mass air flow and camshaft position sensors. A higher charging efficiency indicates a larger engine load.

ECT SENSOR VOLTAGE

UNITS
V

Engine coolant temperature sensor is a temperature variable resistor. The ECM receives the output signal to use various controls.

ENGINE COOLANT TEMPERATURE

UNITS
DEGREES C
DEGREES F

Engine Coolant Temperature is an analog input to the ECM (or PCM). The Coolant Temperature sensor is a temperature variable resistor in series with a fixed resistor in the ECM (or PCM) and biased with a reference voltage. The ECM (or PCM) reads the voltage across the Coolant Temperature sensor and converts this voltage into temperature.

ENGINE LOAD

UNITS
mg/str

Engine load value is calculated from throttle position and engine speed. Load is referred to in terms of fuel quantity per stroke.

ENGINE SPEED

UNITS
RPM

Engine speed is an ECM (or PCM) internal parameter. It is computed by reference pulses from the Camshaft Position Sensor (or Crankshaft Position Sensor) and is used by virtually all ECM (or PCM) systems.

FUEL TEMPERATURE

UNITS
DEGREES C
DEGREES F

Fuel temperature is an internal ECM parameter and is installed on common rail. This parameter controls fuel injection.

VEHICLE SPEED VSS (METER)

UNITS
km/h or KPH MPH

Vehicle Speed Sensor (VSS) parameter is an ECM (or PCM) internal parameter. It is computed by timing pulses coming from the vehicle speed sensor. Vehicle speed is used for the IAC/ISC control in the ECM (or PCM).

ELECTRICAL PARAMETERS

BATTERY POSITIVE VOLTAGE BATTERY VOLTAGE

UNITS
V

Battery Positive Voltage is an analog input signal read by the ECM (or PCM). This parameter is used for voltage correction of the fuel injection quantity.

ELECTRIC LOAD

STATES
ON/OFF

The electrical system load affects the engine load, which causes variations in engine speed. The Electric Load parameter will read ON or OFF depending on the state of certain electrical components (such as the radiator fan motor, head lights, parking lights, blower fan motor, rear defogger, brake lights, etc.) The ECM (or PCM) uses the ON or OFF signal to compensate for variations in engine load by controlling the IAC valve/ISC motor.

SPARK CONTROL PARAMETERS

IGNITION ADVANCE SPARK ADVANCE

UNITS
DEGREES

The Ignition Spark Advance angle references cylinder #1 top dead center. It is calculated by comparing the relationship between the crankshaft position sensor (Ne) and crankshaft position sensor (G) signals. The two missing teeth on the (Ne) timing rotor identify #1 cylinder TDC. The (G) signal identifies the approach of the #1 cylinder compression stroke, occurring at 90° BTDC.

IGNITION TIMING LEVEL

STATES
ON/OFF

This parameter indicates which ignition timing adjust resistor is installed. The function of an ignition timing adjust resistor is to correct basic ignition timing advance. If no adjust resistor is installed in the vehicle, "225" appears here.

SPARK ADVANCE SWITCH

STATES
ON/OFF

This parameter indicates whether or not the test switch terminal (on the monitor coupler) circuit is grounded.

ON: Test switch terminal (on the monitor coupler) circuit is grounded.

OFF: Test switch terminal (on the monitor coupler) circuit is not grounded.

While communication with the tester is active, the IGNITION ADVANCE is not fixed even if the test switch terminal (on the monitor coupler) circuit is grounded. The tester indicates the test switch terminal (on the monitor coupler) circuit condition only.

FUEL DELIVERY PARAMETERS**AIR FLOW**

UNITS
l/min

The Air Flow sensor measures the rate of volume air flow into the intake manifold in liters per minute.

BAROMETRIC PRESSURE

UNITS
inHg
KPa
mmHg

This parameter represents a measurement of barometric air pressure and is used for altitude correction of the fuel injection quantity and IAC valve control.

BAROMETRIC SENSOR VOLTAGE

UNITS
V

This parameter represents a measurement of barometric air pressure and is used for altitude correction of the fuel injection quantity.

EGR THROTTLE

UNITS
%

EGR throttle value indicates the opening duty of the valve.

FUEL CUT

STATES
ON/OFF

This parameter reflects the ON/OFF status of the deceleration program in the ECM. The signal will be ON whenever deceleration fuel cut is commanded as a result of a closed throttle position with engine spin above fuel cut speed.

FUEL PRESSURE CONTROL VALVE

STATES
ON/OFF

This parameter shows the state of the fuel pressure control valve installed on intake manifold to control fuel pressure.

FUEL PUMP

STATES
ON/OFF

ON is displayed when the ECM (or PCM) activates the fuel pump via the fuel pump relay switch.

FUEL RAIL PRESSURE

UNITS
Bar

This parameter shows the fuel pressure at the fuel rail captured at the fuel temp sensor.

FUEL SYSTEM STATUS

FUEL SYSTEM B1 FUEL SYSTEM B2

STATES
OPEN/CLOSED/OPEN-DRIVE CONDITION
OPEN SYS FAULT/CLOSED-ONE 02S/RESERVED

Status of the air/fuel ratio feedback loop is displayed as either an open or a closed loop. Open indicates that the ECM ignores feedback from the exhaust oxygen sensor. Closed indicates that the injection duration is corrected for oxygen sensor feedback.

FUEL TANK LEVEL

UNITS
%

The fuel tank level indicates the approximate fuel level in the fuel tank. The detectable range of the fuel level sensor is set as 0 to 100%; however, vehicles with smaller fuel tank capacity may have an indicated fuel level of only 70% when the fuel tank is full.

INJECTOR FLOW 1 INJECTOR FLOW 2 INJECTOR FLOW 3 INJECTOR FLOW 4

UNITS
mm ³

These parameters show the volume of fuel injected at the injector of each cylinder.

INJECTOR PULSE WIDTH INJECTOR PULSE WIDTH B1 INJECTOR PULSE WIDTH B2

B1:BANK1 (LH BANK)
B2:BANK2 (RH BANK)

UNITS
mSEC

The Pulse Width is the length of time (in milliseconds) the ECM (or PCM) is commanding the fuel injectors on. Injector 'on' time is how EFI systems control fuel mixture. A longer 'on' time yields a richer mixture.

INTAKE AIR TEMPERATURE

UNITS
DEGREES C
DEGFRES F

Intake Air Temperature is needed to determine the amount of air passing into the intake manifold as air density varies with temperature.

LONG FT B1 B1: BANK 1 (LH BANK)
LONG FT B2 B2: BANK 2 (RH BANK)

UNITS
%

This parameter provides learned value (adaptive memory) correction to the air/fuel ratio feedback control system for Bank 1 or Bank 2. It is the percentage of rich or lean correction that has been applied to the basic injection duration calculation.

**MANIFOLD ABSOLUTE
PRESSURE (MAP)**

UNITS
inHg
KPa
mmHg

The Manifold Absolute Pressure sensor voltage is read by the ECM (or PCM) and is used (among other things) to compute engine load.

MASS AIR FLOW (MAF)

UNITS
g/sec
lb/min

Certain engines have a Mass Air Flow (MAF) sensor which measures air flow into the intake manifold. This data is used by the ECM (or PCM) in determining engine load.

MIXTURE CONTROL DWELL
MIXTURE CONTROL DWELL B1 & B2
B1:BANK1 (LH BANK)
B2:BANK2 (RH BANK)

UNITS
NONE

Mixture Control Dwell value represents short term corrections to the air/fuel mixture computation. A value of 0 indicates no correction, a value greater than 0 means an enrichment correction, and a value less than 0 implies a deficiency correction. If “***” appears in the tester screen, the vehicle being tested is not equipped with this sensor.

MIXTURE CONTROL LEARN
MIXTURE CONTROL LEARN B1 & B2
B1:BANK1 (LH BANK)
B2:BANK2 (RH BANK)

UNITS
NONE

The Mixture Control Learn Value represents long term corrections to the air/fuel mixture computation. A value of 0 indicates no correction, a value greater than 0 means an enrichment correction, and a value less than 0 implies a deficiency correction. If “***” appears in the tester screen, the vehicle being tested is not equipped with this sensor.

MIXTURE CONTROL MONITOR
MIXTURE CONTROL MONITOR B1 & B2
B1:BANK1 (LH BANK)
B2:BANK2 (RH BANK)

UNITS
NONE

The value of Mixture Control Monitor is obtained by combining the values of the Mixture CONTROL DWELL and MIXTURE CONTROL LEARN values. This value indicates the necessary correction to keep the air/fuel mixture stoichiometrical.

If “***” appears in the tester screen, the vehicle being tested is not equipped with this sensor.

NEEDLE SENSOR VOLTAGE

UNITS
V

The ECM detects the start of needle movement by triggering on the rising edge of the needle movement sensor signal.

O2S ACTIVATION
O2S B1 ACTIVATION
O2S B2 ACTIVATION
O2S SIGNAL
B1:BANK1 (LH BANK)
B2:BANK2 (RH BANK)

STATES
ACTIVATION/DEACTIVATION ACTIVE/INACTIVE

ACTIVATION is displayed when the oxygen sensor is operating within the activation temperature range and producing the expected output over a certain period of time. The oxygen sensor is deactivated by the ECM (or PCM) and DEACTIVATION is displayed if it does not reach the activation temperature or if it does not produce an adequate reading over a certain period of time.

O2S
OXYGEN SENSOR
OXYGEN SENSOR B1
OXYGEN SENSOR B2
B1:BANK1 (LH BANK)
B2:BANK2 (RH BANK)

O2S B1 S1
O2S B1 S2
O2S B2 S1
O2S B2 S2

UNITS

mV
V

The Oxygen Sensor, located in the exhaust stream, is the primary input to the fuel delivery system. A high voltage indicates a rich mixture while a low voltage indicates a lean mixture. After the ECM (or PCM) is in the closed loop mode of operation the fuel mixture is adjusted based upon the voltage of this sensor.

If “****” appears in the tester screen, the vehicle being tested is not equipped with this sensor.

NOTE

The oxygen sensor must be hot (>260 deg C, >500 deg F) before it will function properly.

PEDAL POS SENSOR**UNITS**

%

Pedal position (TP) sensor reading provides pedal position information in the form of voltage. This information is used for calculating engine load and A/C control.

RAIL PRESSURE REGULATOR**UNITS**

%

This parameter shows the fuel pressure regulator opening cycle ratio.

RICH/LEAN MONITOR
RICH/LEAN MONITOR B1
RICH/LEAN MONITOR B2
B1:BANK1 (LH BANK)
B2:BANK2 (RH BANK)

STATES

RICH/LEAN

This parameter tells whether the oxygen sensor voltage is above or below a programmed threshold. The threshold is normally computed to be the oxygen sensor voltage corresponding to an intake air/fuel ratio of 14.7 or about 450 mV. An Oxygen sensor voltage reading above the threshold means the intake mixture is rich whereas an oxygen sensor voltage below the threshold corresponds to a lean mixture.

SHORT FT B1 **B1: BANK 1 (LH BANK)**
SHORT FT B2 **B2: BANK 2 (RH BANK)**

UNITS

%

Bank #2 provides the air/fuel ratio feedback correction value for Bank #1. It is the percentage of rich or lean correction being applied to correct injection duration. Short fuel trim is based on rapidly switching exhaust oxygen sensor values. A positive value indicates that fuel delivery is being increased to correct for a lean air/fuel ratio. A negative value indicates that fuel delivery is being decreased to correct for a rich air/fuel ratio.

START OF INJECTION**UNITS**

deg.

For ECU Number 39: Start of injection control is performed by calculating an optimal desired start of injection and closing the loop on it. ECM controls the injection start timing.

For ECU Number 40: Start of injection control is performed by calculating an optimal desired start of injection and closing the loop on it. A control valve in the fuel pump is the actuation mechanism for controlling the start of injection.

THROTTLE ANGLE**UNITS**

DEGREE

The Throttle Angle parameter displays the throttle position related to the fully closed position. 0-0.5 refers to a fully closed throttle while about 80 is a wide open throttle.

THROTTLE OPENER SOLENOID**STATES**

ON/OFF

The Throttle Opener Solenoid Vacuum Valve improves starting ability by opening the throttle valve slightly at the engine start. When this signal is ON, the solenoid valve turns ON to open the throttle valve. Once the engine has started, the solenoid valve turns OFF and the throttle valve closes completely after a programmed time.

THROTTLE POSITION**UNITS**

%

This parameter displays the throttle opening rate.

**THROTTLE POSITION SENSOR
TP SENSOR VOLT****UNITS**

V

The Throttle Position Sensor reading provides throttle valve opening information in the form of voltage. This information is used for correction, such as enrichment correction during acceleration.

The voltage reading should increase as the throttle is opened. 0 V indicates a broken or shorted sensor.

**TOTAL FUEL TRIM B1: BANK 1 (LH BANK)
TOTAL FT B1 B2: BANK 2 (RH BANK)
TOTAL FT B2****UNITS**

%

This parameter displays the total fuel trim correction applied to the injectors that feed cylinder banks 1 and 2, respectively. Values less than 0% indicate a reduction in fuel injection duration to correct for an overall rich condition. Values greater than 0% indicate an increase in fuel injection duration to correct for an overall lean condition.

TURBO PRESSURE**UNITS**

HPa

Turbo pressure value indicates air pressure compressed by the turbo charger.

EMISSIONS AND DRIVEABILITY PARAMETERS

CANISTER PURGE SOLENOID CANISTER PURGE DUTY

UNITS
%

The Canister Purge Solenoid parameter displays the degree to which the purge valve is either open or closed. 0% means that the purge valve is completely closed while 100% is fully open valve.

CLOSED THROTTLE POSITION

STATES
ON/OFF

The Closed Throttle Position parameter indicates whether the throttle position is in the idle state or not. "ON" means that the throttle position is within the range for the idle state and "OFF" indicates that the throttle position is not within the idle state range.

CTP SWITCH

STATES
ON/OFF

The CTP Switch parameter will read ON when the throttle valve is fully closed, or OFF when the throttle is not fully closed.

DESIRED IDLE SPEED

UNITS
RPM

The Desired Idle Speed is an ECM (or PCM) internal parameter which indicates the ECM (or PCM) requested idle. If the engine is not running, this number is not valid.

EGR EGR VALVE

STATES
ON/OFF

For vehicles with ECU Numbers 7, 10, 11, 13, 14 and 20 as described in the [Suzuki ECM Application Coverage on page 85](#): ON is displayed when the EGR valve is not fully closed (when EGR gas flows into the intake manifold), and OFF is displayed when the EGR valve is fully closed (when EGR gas does not flow into the intake manifold). The EGR gas flow is regulated according to driving conditions by the stepper motor, which is operated by signals from the ECM.

For all other vehicles: ON is indicated when the EGR SV valve turns on (when EGR gas flows into the intake manifold), and OFF is displayed when the EGR SV valve turns off (when EGR gas does not flow into the intake manifold). The EGR gas flow is regulated according to driving conditions by the EGR modulator and the solenoid vacuum valve, which switches the vacuum passage to the diaphragm of the EGR valve.

EGR TEMPERATURE

UNITS
DEGREES C
DEGREES F

EGR Temperature is an internal ECM (or PCM) parameter. The EGR temperature sensor is installed on the EGR valve. When the EGR valve opens and EGR gas flows, the temperature parameter should rise. If the temperature does not rise, the EGR system is faulty.

EVAP CANIST

STATES
ON/OFF

EVAP Canist displays the state of the evaporative purge canister valve

EVAP PURGE DUTY

UNITS
%

The EVAP Purge Duty is used to control the EVAP solenoid purge valve. 0% means that the purge valve is completely closed while 100% is a fully open valve.

EVAP SOLENOID PURGE (SP) VALVE

STATES
ON/OFF

The EVAP Canister is used to trap gasoline vapors from the fuel tank. When the EVAP Solenoid Purge Valve is ON, gas fumes can flow from the canister to the intake manifold. When the solenoid valve is OFF, fumes are trapped in the canister.

IAC ADJUST MONITOR

UNITS
%

IAC flow must be adjusted to a specified standard when adjusting idle speed. The IAC adjust monitor indicates the amount by which the current IAC flow is deviated from its standard value for idle adjustment. This value is effective only in the idle adjust mode (IAC CAL MODE). Therefore, 0% indicated in any other mode than IAC CAL MODE is meaningless.

IAC DUTY

UNITS
%

The IAC Valve uses a duty solenoid valve. It controls the engine idle speed by varying the valve open time within a certain set cycle and thus controls the amount of bypass air.

Idle Air Control Duty is obtained by using $T_{on} \div T \times 100 (\%)$

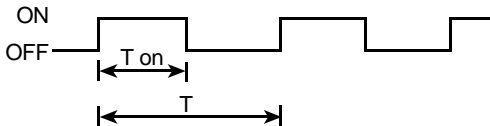
**IAC FLOW**

UNITS
l/min

This parameter represents the quantity of the bypass air flow in liters per minute through the IAC valve.

IAC FLOW DUTY

UNITS
%

This parameter indicates the open or closed percentage of the IAC valve. The IAC valve is driven by the stepping motor which is controlled by signals from the ECM. 100% indicates that the valve is fully open and 0% indicates that it is completely closed.

IAC/ISC DUTY**UNITS**

%

BYPASS AIR TYPE

The IAC Valve uses a duty solenoid valve. It controls the engine idle speed by varying the valve open time within a certain set cycle and thus controls the amount of bypass air.

Idle Air Control Duty is obtained by using $T_{on} \div T \times 100 (\%)$

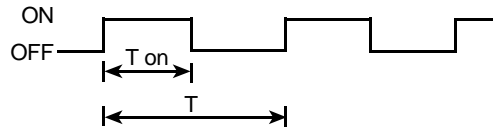
**THROTTLE POSITION TYPE**

For ISC systems, engine idle speed is controlled by the ISC motor which is attached to the throttle body. The ISC motor moves the throttle valve by the ECM based on engine speed and throttle opening signals. The ISC DUTY parameter indicates the opening of the throttle valve in terms of percentage to the opening controllable by the ISC motor.

Idle Speed Control Duty is obtained by using:

$$\text{ISC DUTY} = (\text{TAS} - 10^*) \div \text{TAMAX} \times 100 (\%)$$

TAS: Throttle Angle for ISC

TAMAX: Controllable opening

10*: Offset

IAC MOTOR POSITION**UNITS**

STEP

This parameter represents the position of the IAC valve driven by the stepping motor. "0 step" means that the IAC valve is closed. When the step value is large, it means that the IAC valve opening is large.

POWER STEERING PRESSURE (PSP) SWITCH**STATES**

ON/OFF

The Power Steering Pressure Switch parameter displays ON when the steering wheel is cranked all the way to the right or left.

SOLENOID VACUUM (PS SV) VALVE**STATES**

ON/OFF

The PSP ON signal is fed to the ECM (or PCM), which actuates the IAC Valve and PS SV for compensating idle speed. This control is effective at both idling and driving.

TRANSMISSION PARAMETERS

4WD-L SW

STATES
ON/OFF

This parameter indicates the state of the 4-wheel drive low gear switch. ON indicates the Low or Neutral position, and OFF indicates the 4WD high or 2WD high position. This signal is used to prevent the gear change into Overdrive and TCC lockup.

GEAR POSITION

STATES
4AT: 1st / 2nd / 3rd / 4th / INVALID
3AT: 1st / 2nd / 3rd / INVALID

This parameter indicates the A/T gear position which is computed on signals from the Transmission Range Switch, VSS, TP Sensor, and so forth.

GEAR POSITION CON

STATES
1st / 2nd / 3rd / INVALID

This parameter indicates the A/T gear position which is computed on signals from the Transmission Range Switch, VSS, TP Sensor, and so forth.

GEAR POSITION MON

STATES
1st / 2nd / 3rd / INVALID

The monitor result of the A/T gear position computed on shift solenoid (#1 and #2) position is displayed.

INPUT SHAFT INP. SHAFT SPEED

UNITS
RPM

The Input Shaft parameter is a PCM internal parameter. It is computed by reference pulses from the input shaft speed sensor and is used for torque reduction control in the PCM.

MODE SELECT SWITCH

STATES
POWER/NORMAL

This parameter indicates the position of the Power/Normal change switch and is used to select the automatic gear shift schedule, Power or Normal mode.

O/D OFF SWITCH

STATES
ON/OFF

This parameter indicates the state of the O/D OFF Switch (Overdrive cut switch). When this switch is ON, the gear position is not shifted to 4th.

PNP SIGNAL

STATES
P/N RANGE
D RANGE

PNP Signal displays the transmission gear range based on the state of the Park Neutral Position signal.

PRESSURE REGULATOR SOLENOID-CON

STATES
ON/OFF

This parameter indicates the PCM has commanded the pressure regulator solenoid ON or OFF.

PRESSURE REGULATOR SOLENOID-MON

STATES
ON/OFF

The monitor result of the pressure regulator solenoid circuit is displayed.

ON: Electricity is being passed to the pressure regulator solenoid.

OFF: Electricity is not being passed to the pressure regulator solenoid.

SHIFT SOLENOID #1 - CON SHIFT SOLENOID #2 - CON

STATES
ON/OFF

This parameter indicates the PCM has commanded the shift solenoid ON or OFF.

SHIFT SOLENOID #1 - MON SHIFT SOLENOID #2 - MON

STATES
ON/OFF

The monitor result of the shift solenoid circuit is displayed.

ON: Electricity is being passed to the shift solenoid.

OFF: Electricity is not being passed to the shift solenoid.

TCC SOLENOID - CON

STATES
ON/OFF

This parameter indicates that the PCM has commanded the Torque Converter Clutch (TCC) Solenoid ON or OFF.

TCC SOLENOID - MON

STATES
ON/OFF

The monitor result of the TCC solenoid circuit is displayed.

ON: Electricity is being passed to the TCC solenoid.

OFF: Electricity is not being passed to the TCC solenoid.

THROTTLE OPEN RATE**UNITS**

%

This parameter represents the signal which ECM outputs to TCM to inform the throttle opening. Receiving a signal from the TP sensor, ECM converts it into this parameter. The parameter value increases as the throttle opening increases.

THROTTLE POSITION LEVEL**UNITS**

NONE

This parameter indicates the level (zone) of the throttle valve opening. The throttle opening is divided into 8 levels (zones) from "0" (about idle position) to "7" (about full open) and signals are assigned to each opening level (zone). The PCM controls the automatic gear changes of the automatic transmission by using these signals according to the signal from the TP sensor.

**TRANS RANGE
D-RANGE SHIFT SWITCH****STATES**

D RANGE/P-N RANGE

The Trans Range parameter reads D RANGE when the transmission is shifted to any drive range (R, D, 2, or L range). This signal informs the ECM (or PCM) that a load has been applied to the engine so the ECM (or PCM) can adjust fuel compensation and IAC accordingly.

The Trans Range shift signal is also indicated for manual transmissions but should be ignored.

TRANS. RANGE**STATES**

P / R / N / D / 2 / L

This parameter indicates the position of the transmission range switch. It is used as one of the signals to control the fuel injector, IAC valve and automatic transmission.

**VSS (TRANS)
VSS (A/T)****UNITS**KPH
MPH
km/h

The PCM controls the automatic gear changes of the automatic transmission by using these signals according to the signal from the Vehicle Speed Sensor (VSS) in the automatic transmission.

MISCELLANEOUS PARAMETERS**ABS SWITCH****STATES**

ON/OFF

This parameter indicates the state of the ABS operation signal which is input to the ECM (or PCM) from the ABS control module.

ON is displayed when the ABS is operating.

OFF is displayed when the ABS is not operating.

This parameter is used for the engine speed control in the ECM (or PCM).

A/C CONDENSER FAN

STATES
ON/OFF

This parameter indicates the state of the A/C Condenser Fan control signal.

A/C CONTROL SIGNAL

STATES
ON/OFF

This parameter indicates the state of the A/C Control Signals, that is, ON when outputting A/C ON command and OFF when not outputting.

A/C COOLING FAN

STATES
ON/OFF

This parameter indicates the state

of the A/C condenser control

signal. ON is indicating when the A/C condenser is operating (signal is outputting) and OFF when the A/C condenser is not operating (signal is not outputting).

A/C EVAPORATOR TEMPERATURE

UNITS
DEGREES C
DEGREES F

This parameter is an analog input to the ECM (or PCM) from the A/C evaporator thermistor and is used to prevent the A/C evaporator from frosting or icing.

A/C MAGNETIC CLUTCH

STATES
ON/OFF

This parameter indicates the state of the A/C magnetic clutch control signal. ON is indicated when the A/C compressor is operating (signal is outputting) and OFF when the A/C compressor is not operating (signal is not outputting).

A/C PRESSURE SWITCH

STATES
ON/OFF

This parameter indicates the state of the A/C dual pressure switch.

A/C SWITCH

STATES
ON/OFF

This parameter indicates the state of the A/C ON signal which is input to the ECM (or PCM).

ON is displayed when all of the A/C related switches (A/C switch, fan switch, pressure switch, etc.) are turned ON.

OFF is displayed when one of the above switches is turned OFF.

BLOWER FAN SWITCH

STATES
ON/OFF

This parameter indicates the state of the blower fan motor switch.

BRAKE SWITCH

STATES
ON/OFF

This parameter indicates the state of the Brake Switch.

HEATER FAN

STATES
ON/OFF

This parameter indicates the state of the heater fan motor switch.

RADIATOR FAN

STATES
ON/OFF

This parameter indicates the state of the Radiator Fan.

STARTER

STATES
ON/OFF

This parameter indicates the state of the starter signal.

A. IF YOU'RE HAVING A PROBLEM

Although the tester was designed to give you years of trouble-free service, occasional problems may occur that require special attention. Some of these problems may be corrected with a few simple steps. Examples of most of the displays which you might see under abnormal conditions are shown. In addition, the most likely cause for the condition is given as well as other possible causes and recommendations on how to isolate or eliminate the problem. If the problem appears to be in the tester, perform the Self-test (described in the Operators Manual).

BLANK SCREEN



Most Likely Cause

- Ignition switch OFF.

Other Possible Causes

- Faulty cable.
- Tester power supply is malfunctioning.
- No power is applied to the tester.

Recommendations

- Plug the tester into another vehicle to verify proper operation.

DISPLAYS SOLID BARS



Most Likely Cause

- Two master cartridges are installed.

Other Possible Causes

- Master cartridge is malfunctioning.
- Tester is malfunctioning.

Recommendations

- Make sure that only one master cartridge is installed in the tester.
- Remove all cartridges and see if “MASTER CARTRIDGE MISSING OR MALFUNCTIONING” message is displayed. If it is, try installing another master cartridge.

MASTER CARTRIDGE MISSING/ MALFUNCTIONING



MASTER CARTRIDGE
IS MISSING OR
MALFUNCTIONING

Most Likely Cause

- Master cartridge is not installed.

Other Possible Causes

- Dirty contacts on the master cartridge connector.
- Two master cartridges installed.

Recommendations

- Verify that a master cartridge is installed.
- Clean contacts on master cartridge connector with alcohol.
- Try a different master cartridge.

KEYBOARD OR DISPLAY LOCKED UP OR PROGRAM SPORADICALLY RETURNS TO FIRST PAGE

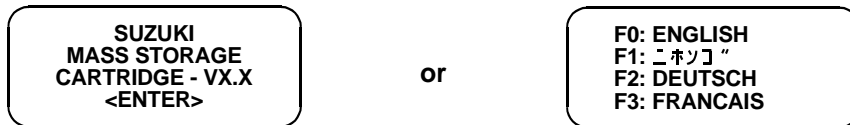

Most Likely Cause

- Serial data link cable loose or bad.

Other Possible Causes

- Master Cartridge loose or dirty contacts.
- Tester malfunction.

Recommendations

- Cycle power to the tester (unplug & replug the serial data link connector).
- Check tester cartridge socket and cartridge edge connector.
- Check serial data link cable & connector for wear or corrosion.

TESTER IS NOT RECEIVING DATA

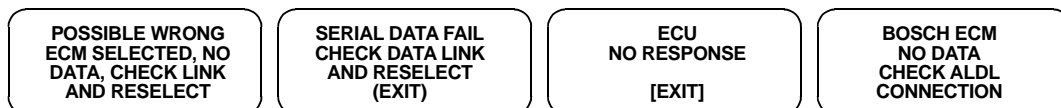

Most Likely Cause

- ECM (or PCM) serial data link connector cable problems.

Other Possible Causes

- Serial data link cable loose or bad or connector pins loose or corroded.
- Bad ECM (or PCM).

Recommendations

- Verify a good serial data link cable connection.
- Cycle power to the tester.
- Run the tester Self-test.

DATA LIST PARAMETERS FLASH ON AND OFF

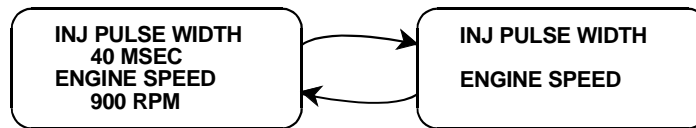

Most Likely Cause

- Serial data link cable loose or bad.

Other Possible Causes

- Serial data link cable connector pins loose or corroded.
- ECM (or PCM) serial data link connector cable problems.
- Intermittent ECM (or PCM) problem.

Recommendations

- Verify a good serial data link cable connection.
- Cycle power to the tester.

COMPANION APPLICATION MISSING



Most Likely Cause

- ECM Application is not installed in the Application Cartridge.

Other Possible Causes

- Application Cartridge is not installed correctly.
- Wrong cartridge is installed in the tester.

Recommendations

- Confirm that the Suzuki Application Cartridge is correctly installed in the bottom cartridge slot of the tester.
- Confirm that no other Master or Mass Storage Cartridge is installed in the top cartridge slot.
- Contact your tester distributor to have the application installed in the cartridge.

B. UNDERSTANDING SUZUKI ECMS

The serial data link uses message-oriented transmissions with a UART type data format. The communication is via a single-wire half-duplex bus using a master/slave protocol. The serial data link can be used for communications during normal operation or as an interface to a test device for diagnostic operations. If there is no requirement for data sharing between the vehicle's components during normal operation, the link can be implemented as a diagnostics only link. Numerous diagnostic modes provide a maximum of system flexibility.

Interface to the serial data link can be implemented using standard UART type devices communicating at a 7812 or 15625 baud rate. The interface devices required for this phase are available as stand-alone devices or integrated with CPUs (or MPUs) in a large number of micro-controllers.

Network access is via a master/slave protocol. The serial data link can have at most one device functioning as the master at any point in time. The tester controls all communications on the serial data link. A slave device (ECM) can transmit data only after it has been interrogated by the master device. A typical operating scenario is for the master device to periodically send a polling message to one or more of the slave devices. The slaves can then send a response message (containing, for example, the states of the slave's inputs or internal parameters) back to the master.

Once the tester has gotten control of the serial data link, it can perform diagnostics on any of the devices connected to serial data link which support serial data diagnostics. It is important to note that the tester can only perform diagnostics which were provided for in the design of the various components. "Hooks" in the software of the on-board components must be provided in order to allow diagnostics to be performed. The more "hooks" that are provided, the more sophisticated the diagnostics which can be performed. Some components might implement minimum diagnostics such as trouble code and diagnostic parameter readout. Other components might implement high-end diagnostics including provision for extensive control over the operation of the component and override of internal parameters. This can be used to exercise specific circuits in order to assist in the isolation of faults.

C. GLOSSARY OF TERMS

A/C	Air Conditioning	CTP	Closed Throttle Position
A/T	Automatic Transmission	CTRL	Control
ACCEL	Accelerator	D	Drive
ADV	Advance	DEFIC	Deficient
BTDC	Before Top Dead Center	DEG	Degrees
C	Centigrade	DIFF	Difference
CAL	Calibration	DLC	Data Link Connector (SDL connector)
CAM	Camshaft	DTC	Diagnostic Trouble Code
CANI	Canister	ECM	Engine Control Module
CANIST	Canister	ECT	Engine Coolant Temperature
CARB	California Air Resource Board	ECU	Electronic Control Unit
CKT	Circuit	EFI	Electronic Fuel Injection
CLUT	Clutch	EGR	Exhaust Gas Recirculation
CMP	Camshaft Position	EGRT	Exhaust Gas Recirculation Temperature
COHER	Coherence	ENG	Engine
COMM	Communication	EVAP	Evaporative Emission
CON	Control	F	Fahrenheit
COND	Condition	FCC	Federal Communications Commission
CONDENS	Condenser	FLT	Fault
CONT	Control		
CONTR	Control		

FREQ	Frequency	mV	Millivolt
FRZ	Freeze	OBD	On Board Diagnostic
FT	Fuel Trim	O/D	Overdrive
FUNC	Function	O2S	Oxygen Sensor
FXS	Fixed Spark Mode	P/N	Park/Neutral
g	Grams	PCM	Powertrain Control Module (= ECM + TCM)
GND	Ground	PERF	Performance
IAC	Idle Air Control	PNP	Park Neutral Position
IAT	Intake Air Temperature	POS	Position
IGN	Ignition	PRESS	Pressure
INJ	Injector	PRG	Purge
INP	Input	PS SV Valve	Power Steering Solenoid Vacuum Valve (Power Steering Vacuum Switching Valve, PS VSV)
INTERN	Internal	PSP	Power Steering Pressure
ISC	Idle Speed Control	RAD	Radiator
KPH	Kilometers Per Hour (km/h)	REF	Reference
L/min	Liters Per Minute	REG	Regulator
LEV	Level	RL	Rich Lean
LITT	Little	RPM	Revolutions Per Minute
MAF	Mass Air Flow	RS232C	Standard Serial Communication interface
MALF	Malfunction	SDL	Serial Data Link
MANI	Manifold	SEC	Seconds
MAP	Manifold Absolute Pressure	SEN	Sensor
MAX	Maximum	SENS	Sensor
MC	Mixture Control	SFI	Sequential Multiport Fuel Injection
MFI	Multiport Fuel Injection	SOI	Start of Injection
MIL	Malfunction Indicator Lamp	SOL	Solenoid
MISC	Miscellaneous	SOV	Shut Off Valve
mmHg	Millimeters of Mercury	SP valve	Solenoid Purge Valve
MON	Monitor	SPEC	Specification
MONIT	Monitor	SPD	Speed
MPH	Miles Per Hour	S/W	Software
MPU	Micro Processing Unit		
mSEC	Milliseconds		
MT	Manual Transmission		

SW	Switch
SYS	System
TBI	Throttle Body Fuel Injection
TCC	Torque Converter Clutch
TCM	Transmission Control Module
TEMP	Temperature
THROT	Throttle
TP	Throttle Position
TRANS	Transmission
TRIG	Trigger
TST	Test
UART	Universal Asynchronous Receiver Transmitter
V	Volts
VAF	Volume Air Flow
VAL	Valve
VIM	Vehicle Interface Module
VIN	Vehicle Identification Number
VLV	Valve
VSS	Vehicle Speed Sensor
WID	Width

BCM Application

Operator's Manual

1. DESCRIPTION

The Suzuki BCM Application is included in the Suzuki Application Cartridge and is used to diagnose and troubleshoot the Automatic Transmission (A/T), Continuous Variable Transmission (CVT), Antilock Brake System (ABS), Electrical Power Steering (EPS), Airbag, and Immobilizer systems used on the following models.

NORTH AMERICAN MARKET				
YEAR	MODEL	SYSTEM	ECU MANUFACTURER	ECU NO.
95-00	ESTEEM 1600 (SY416)	4AT	AISIN A.W.	1
		ABS (4 CHANNEL)	SUMITOMO DENKO	2
		AIRBAG	SIEMENS AG.	3
01-	ESTEEM 1600 (SY416)	4AT	AISIN A.W.	1
		ABS (4 CHANNEL)	SUMITOMO DENKO	21
		AIRBAG	SIEMENS AG.	3
99-00	ESTEEM 1800 (SY418)	4AT	AISIN A.W.	1
		ABS (4 CHANNEL)	SUMITOMO DENKO	2
		AIRBAG	SIEMENS AG.	3
01-	ESTEEM 1800 (SY418)	4AT	AISIN A.W.	1
		ABS (4 CHANNEL)	SUMITOMO DENKO	21
		AIRBAG	SIEMENS AG.	3
96-98	SIDEKICK 1800 (SV418)	ABS (3 CHANNEL)	SUMITOMO DENKO	2

NORTH AMERICAN MARKET (CONTINUED)				
YEAR	MODEL	SYSTEM	ECU MANUFACTURER	ECU NO.
99-00	GRAND VITARA (SQ625)	ABS (3 CHANNEL)	SUMITOMO DENKO	2
01-				15
01-	XL-7 (JA627)	ABS (3 CHANNEL)	NISSHINBO	27
		AIRBAG	DENSO	28

HOW THE SUZUKI BCM APPLICATION WORKS WITH THE TECH 1A

The tester lets you monitor data and control ECU operation by communicating with the ECU via the serial Data Link Connector (DLC) present in the vehicle. The tester consists of a microcomputer, which communicates with the ECU and controls its operation, a keypad to receive directions from you, and a display to provide the data you need to diagnose vehicle electronic problems. The tester communicates with the ECU by applying an electrical signal to the serial data link connector Diagnostic Enable pin, then reads the ECU data signal from one of the serial data link connector pins, and translates it into an intelligible data display. The Suzuki BCM Application is the software program which performs all of the functions described in this operator's manual.

General Tester Key Functions	
YES , NO	Answer questions asked on tester display and select data parameters to monitor.
EXIT	Return to previous step.
↑ , ↓	Scroll through test mode selection menus and control display of captured data.
0 - 9	Designate trouble codes.
F0 - F9	Select and control test mode.
F6	On-board function menu (for details, refer to the tester Operator's Manual).
F8	Print Data List parameters.
ENTER	Enter designated trouble code and proceed to the next step.

2. GETTING STARTED

SETTING UP THE TESTER

The proper Data Link Connector (DLC) adapter or adapter cable for the vehicle being tested must be connected to the tester DLC Cable in order to connect the tester to the vehicle.

The following Vehicle Adapter Chart identifies which adapters and cables are required to connect each type of tester to the various Suzuki vehicles.

All adapters, cables, and any other hardware required to connect the tester to the vehicle are listed in the chart. The figure number in the chart refers to the adapter and cable illustrations on the following pages.

SYSTEM	TESTER	ADAPTER DESCRIPTION	FIGURE
Body System with 12-Pin Connector	MTS 3100	GM 12/14-Pin (P/N 02001384)	Figure 2-1
	Tech 1A	GM 12/14-Pin (P/N 02001969)	Figure 2-3 Figure 2-2
	Tech 1	None	Figure 2-4

MTS 3100

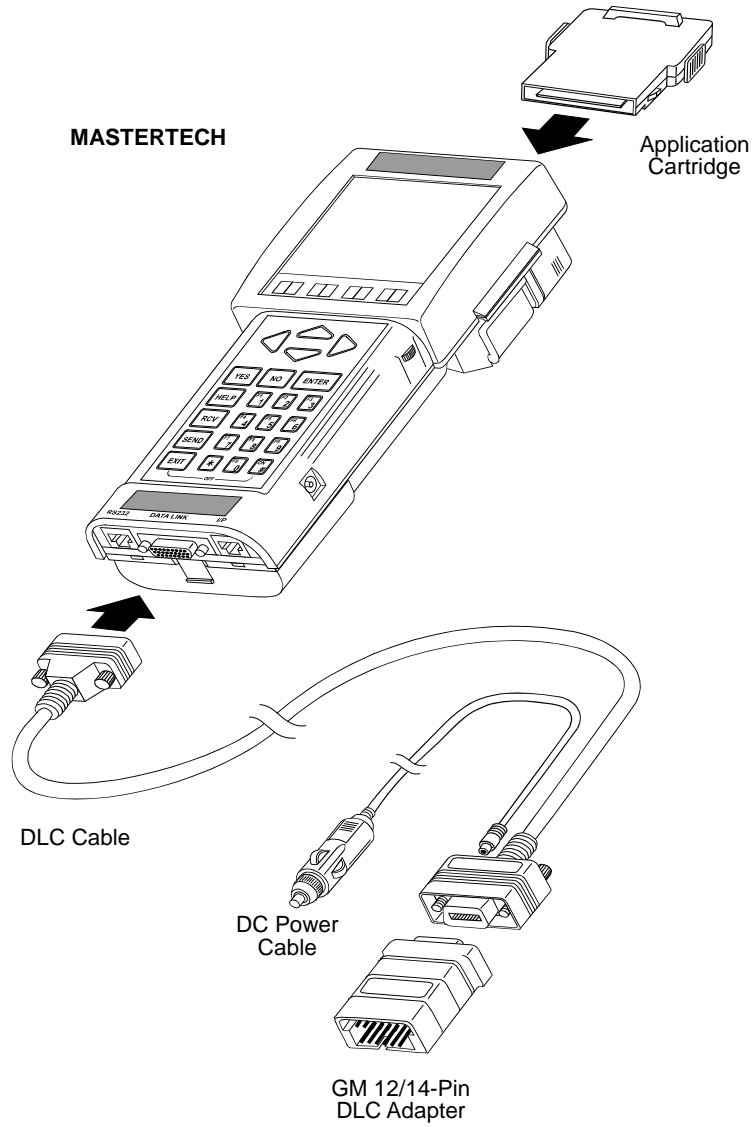

FIGURE 2-1. MTS 3100 Adapter and Cables

TECH 1A

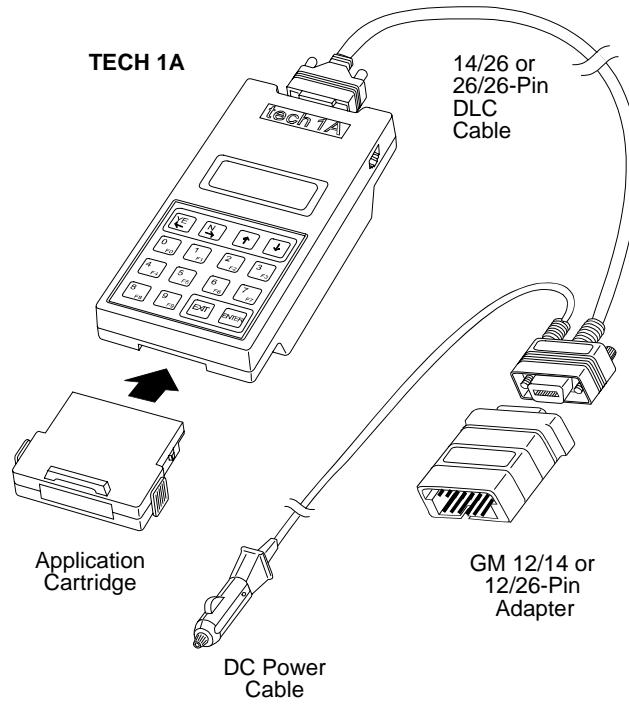

FIGURE 2-2. Tech 1A Adapter and Cables Using the 12-Pin DLC

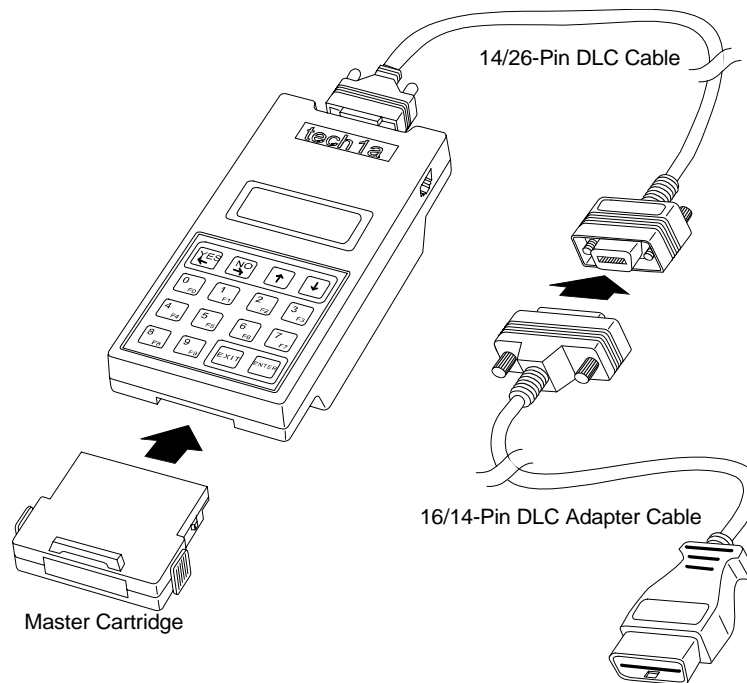

FIGURE 2-3. Tech 1A Adapter and Cables Using the 16-Pin DLC Type I

TECH 1

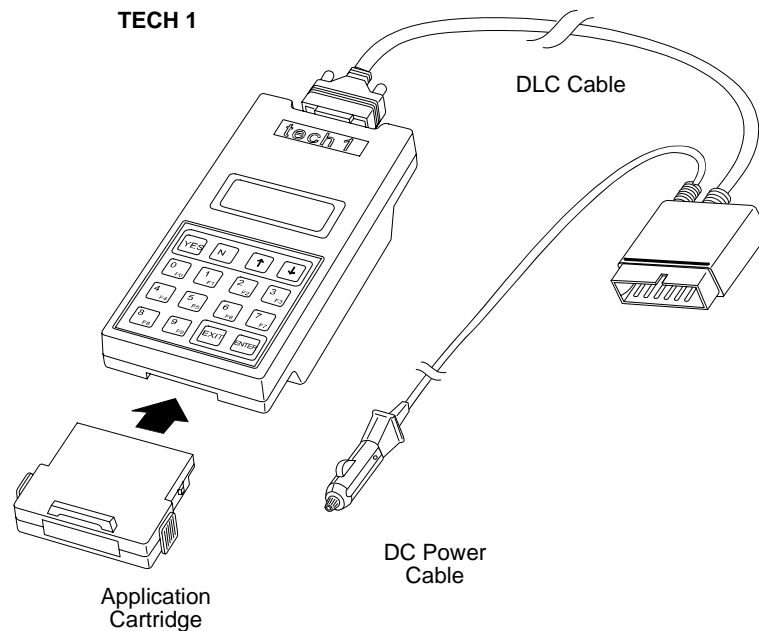

FIGURE 2-4. Tech 1 Cables

Before operating the Suzuki BCM Application, do the following:

1. Insert the Suzuki BCM Application Cartridge into the bottom slot of the Tech 1A or Tech 1 or into the back slot of the MTS 3100. Verify that no other master cartridge is installed in the top slot of the Tech 1A or Tech 1.
2. Make sure the vehicle ignition is OFF.
3. Locate the vehicle's serial Data Link Connector (DLC) and identify which type it is, 12-pin or 16-pin. The vehicle DLC is usually under the dash on the driver's side. Refer to the vehicle service manual if you are in doubt.
4. Connect the cable to the tester as shown in the preceding figures.
5. Plug the cable into the vehicle's 12-pin or 16-pin DLC.
6. Turn the ignition switch on.
7. Verify that the tester displays the screen below.

**SUZUKI
MASS STORAGE
CARTRIDGE - VX.X
<ENTER>**

8. Press **ENTER** to display the APPLICATIONS menu.

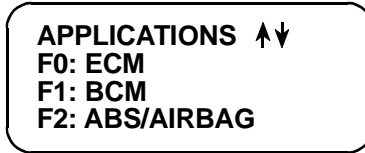

Press the key to the left of BCM to select the Suzuki BCM Application from the APPLICATIONS menu. If more than three applications are available, use **↑** or **↓** to scroll the display.

If the tester display informs you that the companion application is missing, contact your tester distributor.

9. Verify that the tester displays the screen below, then press **ENTER**.

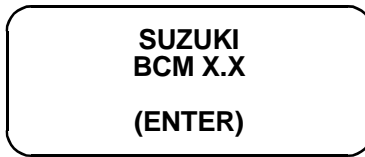

10. After the application is selected, the Language Selection menu is displayed.

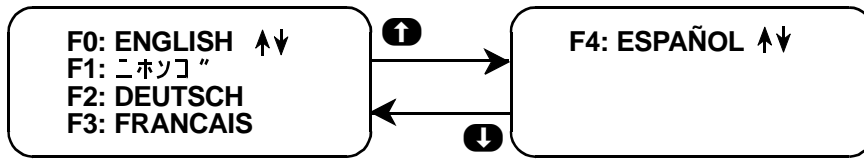

Press the function key to the left of the language you wish to select. Then proceed to [Chapter 4](#).

3. OPERATING PRECAUTIONS

CAUTION!



**CONNECTING AND DISCONNECTING THE
TESTER WHILE THE IGNITION KEY IS ON**

Due to the possibility of voltage spikes that could damage the ECU or tester, you should not connect or disconnect the tester while the ignition key is ON or while the engine is running.

CAUTION!



**REMOVING OR CHANGING MASTER CAR-
TRIDGES CONTAINING SNAPSHOT DATA**

SNAPSHOT data that has been captured by a master cartridge can be printed on a tester (or compatible) printer, transferred to a computer for further analysis, or displayed on a terminal. The SNAPSHOT data will be retained within the tester memory for at least 24 hours, even if the tester is disconnected from the vehicle. However, **IF YOU POWER UP THE TESTER WITHOUT A MASTER CARTRIDGE OR WITH A DIFFERENT MASTER CARTRIDGE, THE SNAPSHOT DATA WILL BE LOST.**

REMOVING THE CARTRIDGE WHILE POWER IS APPLIED

You should not remove or install master or auxiliary cartridges while the ignition key is ON, or while the engine is running.

If you wish to change or add a cartridge, do the following:

1. Disconnect the power plug.
2. Install the cartridge.
3. Reconnect the power plug.

CAUTION!



If the tester does not appear to be functioning properly, reset the tester by doing the following:

1. Turn the ignition off.
2. Disconnect the power plug.
3. Remove all cartridges from the tester.
4. Connect the power plug to the tester.
5. When “MASTER CARTRIDGE IS MISSING” is displayed, disconnect the power plug.
6. Install the cartridge.
7. Reconnect the power plug.

4. SELECTING THE VEHICLE

When you have selected a language (see [page 182](#)), the next step is to select a system to test.

SELECTING THE SYSTEM

The tester displays the systems available for testing. Press the key listed to the left of the system you wish to test.

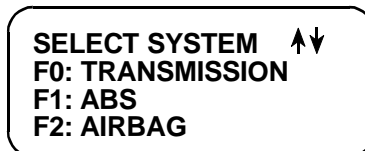

TRANSMISSION

When F0: Transmission is selected, the Select Mode Menu is displayed.

ABS

When F1: ABS is selected, the ECU Manufacturer must be identified.



The Select Mode Menu is then displayed.

AIRBAG

When F2: Airbag is selected, the ECU Manufacturer must be identified.

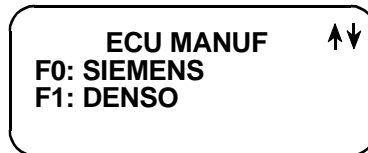

Next, the following screen is displayed.

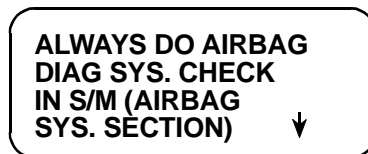

Perform the Airbag Diagnostic System Check as described in the Suzuki Service Manual, then press **↓** to proceed to the Select Mode menu.

ACTIVE KEYS	
F0 - F4	Select language.
F0 - F2	Select system or model.
↓	Proceed to the Select Mode menu.
↑ , ↓	Step automatic menu scrolling, then used to manually control the menu display.

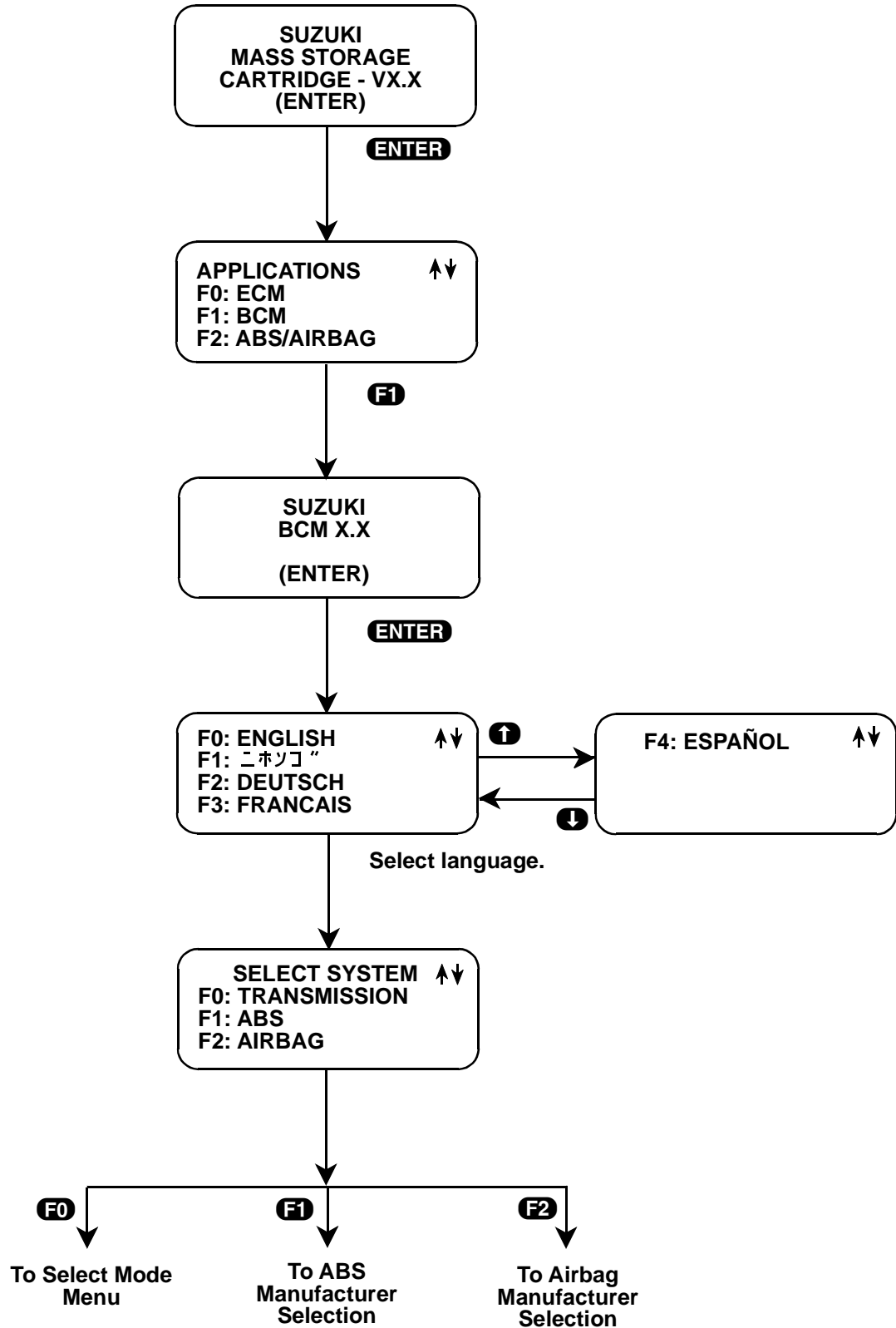

FIGURE 4-1. Select System Menu

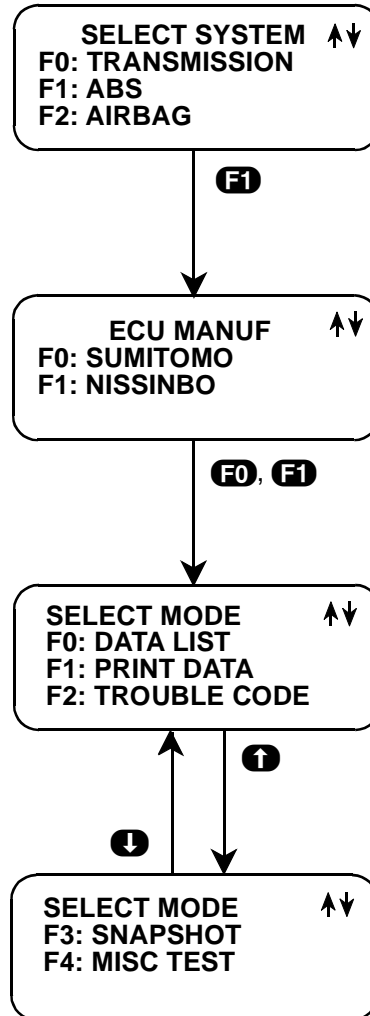

FIGURE 4-2. F1: ABS Manufacturer Selection

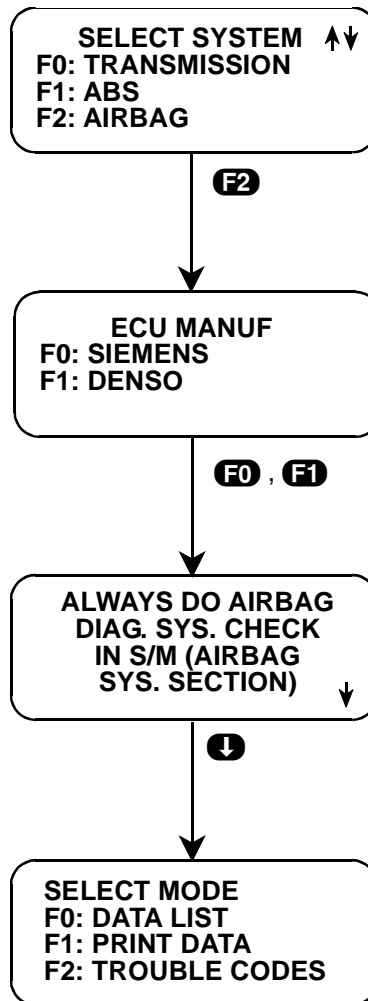

FIGURE 4-3. F2: Airbag Manufacturer Selection

5. SELECTING AND OPERATING THE TEST MODES

This chapter contains a brief description of each test mode available in the Suzuki BCM Application. A more detailed description is included later in this chapter, along with the operating procedure for each test mode.

Mode F0: Data List

Monitor data parameters from the ECU.

Mode F1: Print Data

Send one data stream of information to a serial printer, terminal, or smart device.

Mode F2: Trouble Codes

Display stored trouble codes on all models and clear stored trouble codes on certain models.

NOTE



When checking and clearing trouble codes, be sure to follow the instructions in the Service Manual, or the correct reading or clearing of the DTC(s) may not occur.

Mode F3: Snapshot

Capture and store ECU data parameters. Data is captured before and after a “trigger” point. Triggers can be on any trouble code, a particular trouble code, or manual tester key press. Captured data can then be displayed as well as trouble codes.

NOTE



The Snapshot mode is not available when testing the Airbag system.

Mode F4: Miscellaneous Tests

The Miscellaneous Tests mode is used to select a submenu of tests. Pressing **F4** displays the miscellaneous tests available. To return to the Select Mode menu, just press **EXIT**.

ECU NO.	SYSTEM	DATA LIST	PRINT DATA	TROUBLE CODE	SNAP SHOT	MISC. TEST
1	A/T	•	•	•	•	
2	ABS	•	•	•	•	
3	AIRBAG	•	•	•		
15	ABS	•	•	•	•	•
21	ABS	•	•	•	•	•
27	ABS	•	•	•	•	•
28	AIRBAG	•	•	•		

SELECTING TEST MODES

The tester makes selecting the test mode easy by displaying a list of tests (a test mode “menu”). The menu also displays which key is used to select each test mode. An example test mode menu is shown in Figure 5-1.

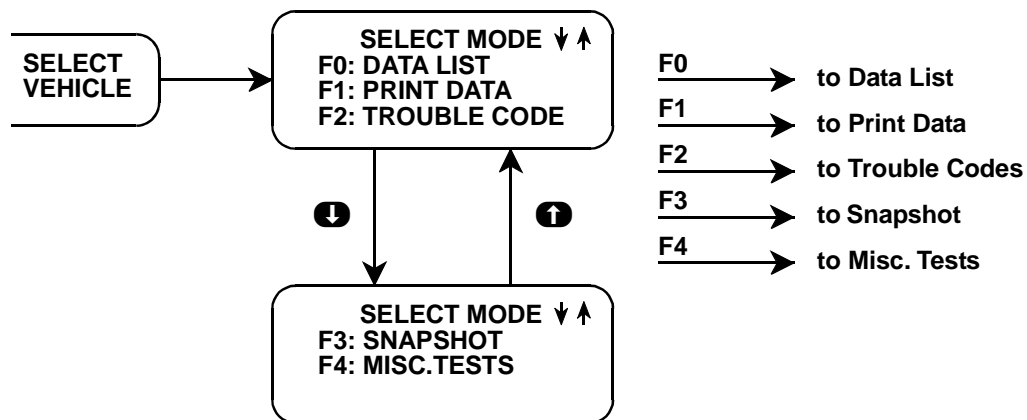

FIGURE 5-1. Select Mode Menu

To select a test mode, simply press the tester key listed to the left of the test mode on the menu. Since there are up to five test modes, the keys **F0** - **F4** are used.

Up to three test modes are shown as soon as the ECU is selected. If other test modes are available, the display automatically scrolls to the next display after three seconds. The display automatically scrolls

between the menu screens. To stop the automatic scrolling, press either the **↑** or **↓** key. The menu may then be manually changed by pressing either the **↑** or **↓** key. All multiple menus of more than three items scroll in this way.

Regardless of which test modes are displayed, any test mode can be selected at any time from the menu.

ACTIVE KEYS	
F0 - F4	Select Test mode.
↑ , ↓	Stop automatic menu scrolling, then used to manually control the menu display.
EXIT	Return to System Selection menu.

ECU COMMUNICATIONS STATUS DISPLAYS

Most tester test modes display data. Therefore, these test modes require the ECU to send data to the tester. When you select a test mode, you may see one or more of the following tester-ECU communications status displays.

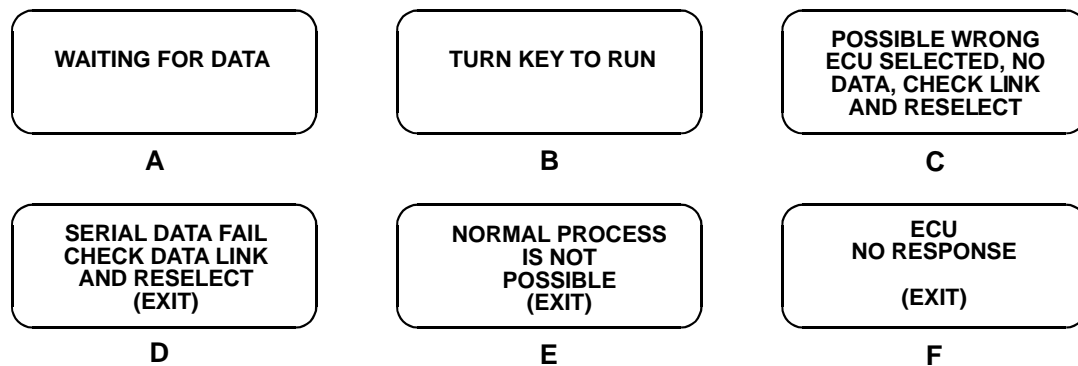

Display A means that the tester has not yet received a complete data message from the ECU. This display is sometimes seen right after selecting a test mode.

Display B is a reminder that the ignition key needs to be in the RUN position for the tester to communicate with the vehicle.

Displays C and F occur when the tester has not received any data from the selected ECU. In this case, you should verify that the ignition is ON and check the serial data link connections.

Displays D and E occur when communication with a vehicle has failed after communication has already been established.

NOTE

If display C or D appears when the ABS control module is selected, the probable cause is a stop in the communication function on the ABS control module. To correct the problem, perform either of the following two steps:

1. Use a service wire to short between the diagnostic switch terminal of the diagnostic 2 monitor coupler for the ABS and the ground terminal of the diagnostic 1 monitor coupler. Refer to the applicable service manual for the location of each terminal position.
2. Spin one of the four wheels.

If the problem persists, refer to *Tester Is Not Receiving Data* on page 232.

ACTIVE KEYS

EXIT	Return to vehicle select step.
-------------	--------------------------------

MODE F0: DATA LIST

The purpose of the DATA LIST mode is to passively monitor data which is being transmitted from the ECU during normal operation of the vehicle. This mode does not affect vehicle operation, and you can use it to read data to see if it is correct, or at least reasonable. The current value of the parameter is displayed with the parameter units. This means you don't have to hunt through manuals to find out what is being displayed.

The data parameters are displayed in preprogrammed pairs. You can also create your own pairs through the process explained on the following pages.

To view the Data List, do the following:

1. Press **F0** to select DATA LIST mode from the Select Mode menu.

FOR ECU NO. 2 (MADE BY SUMITOMO DENKO)

When you are testing the ABS, if a current trouble code is present when Data List is selected, or if a current trouble code is detected while the Data List mode is active, the tester displays the following message.

NOTE



**CURRENT TROUBLE
CODE SET, DATA
NO LONGER VALID
(ENTER)**

For the ABS, current trouble codes cause the ABS control module to send invalid data to the tester. Therefore, data displayed in Data List, Print Data, and Snapshot modes is not valid and should not be used for diagnosing the vehicle. To clear the trouble codes, use Mode F2: TROUBLE CODES to display the current Trouble Codes. Repair the cause of the trouble code(s), then clear the codes using Mode F2. When all current trouble codes have been cleared, select F0: DATA LIST again to display vehicle data.

2. Select the data parameters to be displayed by scrolling through the parameters with the **YES** and **NO** keys.
3. You may return to the select mode menu by pressing **EXIT**.

VIEWING ECU DATA PARAMETERS

In order to maximize the information that can be seen at one time, the tester displays data parameters in preassigned pairs. The first data pair displayed after you press **F0** is shown in the following figure. Also shown is how to scroll through the Data List with the **YES** and **NO** keys and how to create your own data pairs with the **F0** and **F1** keys.

To see other preassigned pairs, press either the **YES** or **NO** key (For ECU No.13, press either **↓** or **↑** instead of **YES** or **NO**). The **YES** (or **↓**) key will cause the tester to scroll forward through the list of preassigned pairs, while the **NO** (or **↑**) key will cause scrolling backwards.

Chapter 8 contains descriptions of all data parameters.

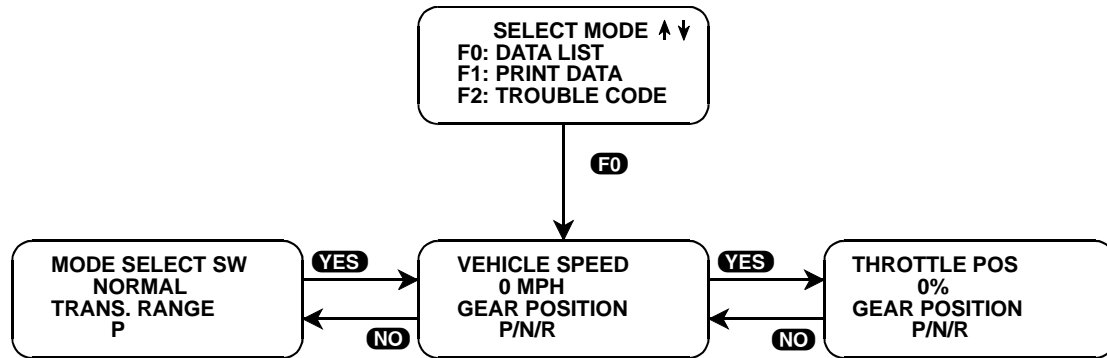

CREATE YOUR OWN DATA PAIRS

You can create data parameter pairs which are different from the preassigned pairs. Any two parameters can be displayed as a pair by simply scrolling either the bottom or top display parameter, while the other display parameter is fixed. To “fix” the top parameter press **F0**. An asterisk will appear by the fixed parameter. Press **F1** to “fix” the lower parameter. The tester will not allow both the top and bottom parameters to be fixed at the same time.

As an example, let's say you wish to create a pair with VEHICLE SPEED and THROTTLE POS. To do so, scroll through the preassigned pairs with the **YES** and **NO** (**↓** and **↑**) key until you find a pair with VEHICLE SPEED. Fix the VEHICLE SPEED by pressing the **F0** key if VEHICLE SPEED is the top parameter, or the **F1** key if it is the bottom. Then scroll the other half of the display with either the **YES** or **NO** (**↓** and **↑**) key until THROTTLE POS. is displayed.

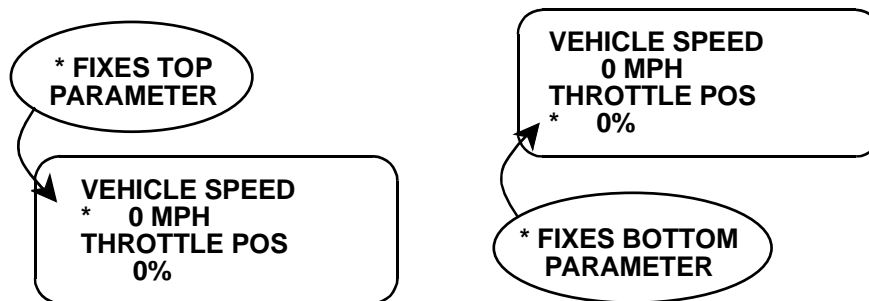

PRINTING DATA

When the RS232C I/F Cartridge is installed in the Tech 1, or if you are using a Tech 1A or MTS 3100 tester, the Print Data mode allows you to print the VIN, system type, and Data List to a serial printer or terminal. This is the data list sent by the engine computer to the tester. The data list parameters can be printed without printing the VIN or type by pressing the **F8** key in the Data List or Snapshot Replay modes.

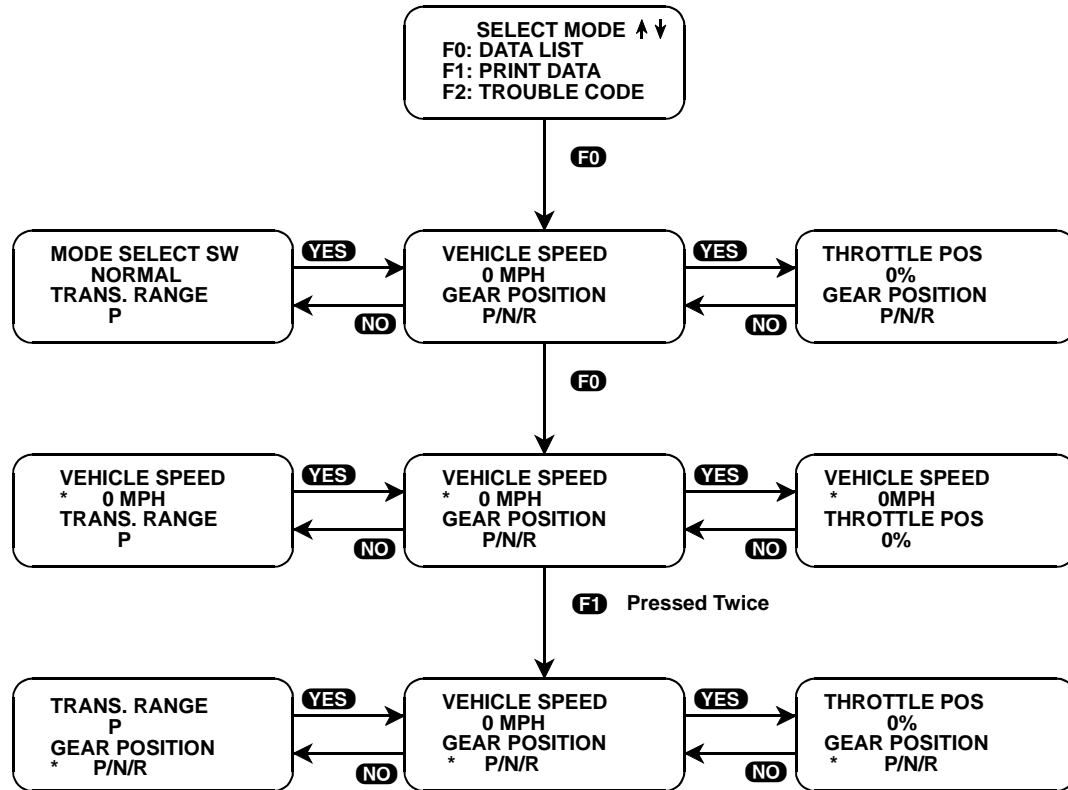

FIGURE 5-2. Example of Selecting and Displaying Data Pairs

ACTIVE KEYS	
YES , NO	Scroll through displayed data parameters.
F0	Mark top displayed parameter as “fixed” for creating your own data pairs.
F1	Mark bottom displayed parameter as “fixed” for creating your own data pairs.
F6 (hold)	Select “RS232C Set-Up” menu.
F8	Print data list parameters.
EXIT	Return to the Select Mode menu.

MODE F1: PRINT DATA

When the RS232C I/F Cartridge is installed in the Tech 1, or if you are using a Tech 1A or MTS 3100 tester, the Print Data mode allows you to print the VIN, system type and Data List to a serial printer or terminal. This is the data list sent by the ECU to the tester. The data list parameters can be printed without printing the VIN or type by pressing the **F8** key in the Data List or Snapshot Replay mode.

To print the data, do the following:

1. Press **F1** to select Print Data from the Select Mode menu.

FOR ECU NO. 2 (MADE BY SUMITOMO-DENKO)

When you are testing the ABS, if a current trouble code is present when Print Data is selected, or if a current trouble code is detected while the Print Data mode is active, the tester displays the following message.

NOTE



**CURRENT TROUBLE
CODE SET, DATA
NO LONGER VALID
(ENTER)**

For the ABS, current trouble codes cause the ABS control module to send invalid data to the tester. Therefore, data displayed in Data List, Print Data, and Snapshot modes is not valid and should not be used for diagnosing the vehicle. To clear the trouble codes, use Mode F2: TROUBLE CODES to display the current Trouble Codes. Repair the cause of the trouble code(s), then clear the codes using Mode F2. When all current trouble codes have been cleared, select F1: PRINT DATA again to print the vehicle data.

2. The VIN entry screen is the first screen displayed in this mode. Use the **0** - **9** keys on the tester keypad to enter the last six digits of the vehicle's VIN, then press **ENTER**. This information is printed out as part of the header information that accompanies each Data List print out.
3. The next screen requires the **ENTER** key to be pressed to start printing the data. This screen allows the cable to be connected between the tester and the receiving device.
4. When the **ENTER** key is pressed "WAITING TO PRINT DATA" is displayed until printing begins. If this screen is displayed for more than a few seconds, something is wrong with the set up procedure. Check that all connections are secure, and that the printer is turned on and in the proper receive mode.
5. As printing begins, the tester displays the % COMPLETE of the print procedure. After the printing is 100% complete, the VIN screen is immediately displayed with the previously selected VIN number. Pressing the **ENTER** key twice from this screen will cause another data stream to be buffered for printing as soon as the current data stream is output from the tester.
6. Pressing the **EXIT** key at any point will cause the select mode menu to be displayed. If the **EXIT** key is pressed before printing is completed, only the data that has already been sent to the RS232C Cartridge will be printed. SOME DATA WILL BE LOST.

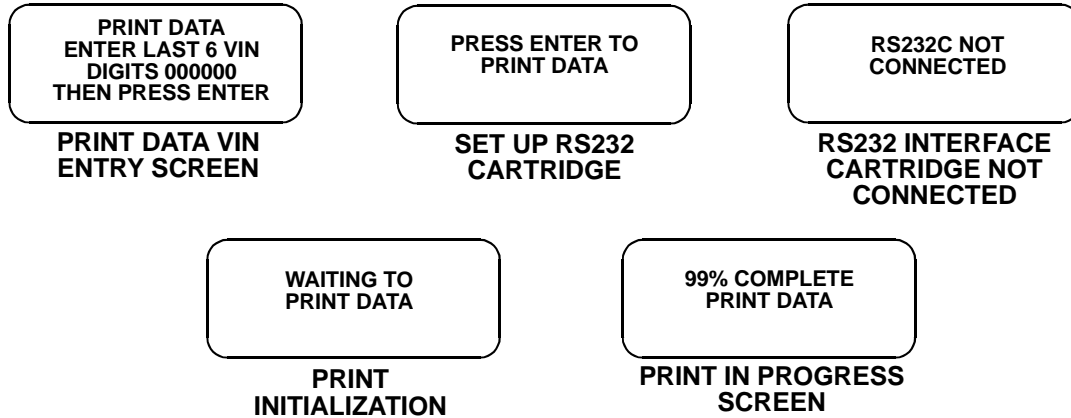

ACTIVE KEYS	
ENTER	Move to the next section of the Print Data function.
0 - 9	VIN entry keys.
F6 (hold)	Select "RS232C Set-Up" menu.
EXIT	Terminate the Print Data mode and return to the select mode menu.

MODE F2: TROUBLE CODES

Trouble codes or diagnostic codes are set by the ECU when an abnormal condition is detected. They are a key to diagnosing many of the problems which can occur in the vehicle. The F2 mode allows you quick access to trouble codes for initial vehicle checks and to check that a repair procedure has been successful.

NOTE



Trouble codes can also be displayed in Snapshot replay mode.

To access the Trouble Codes, do the following:

NOTE



When checking and clearing trouble codes, be sure to follow instructions in the Service Manual, or correct reading or clearing of the DTC(s) may not occur.

1. Press **F2** to select the TROUBLE CODES mode from the Select Mode menu.

The tester informs you if no trouble codes are present.

AIRBAG SYSTEM

FOR ECU NO. 3 (MADE BY SIEMENS)

When testing the Airbag system, the following menu is displayed.

NOTE



TRouble CODES
F0: DISPLAY CODES
F1: LAMP CLEAR
F2: LOCK CLEAR

- Press **F0** to display the Airbag system codes.
- Press **F1** to clear the Airbag Warning Lamp.
- Press **F2** to clear the Near-Deploy Lock.

2. When **F0** is selected, if trouble codes are present, the tester automatically displays each trouble code for three seconds.
3. The trouble codes are continuously displayed, wrapping around to the first code automatically after the last trouble code has been displayed. First, a listing of all Current trouble codes is displayed, followed by History trouble codes. Current or History is displayed indicating the type of code.

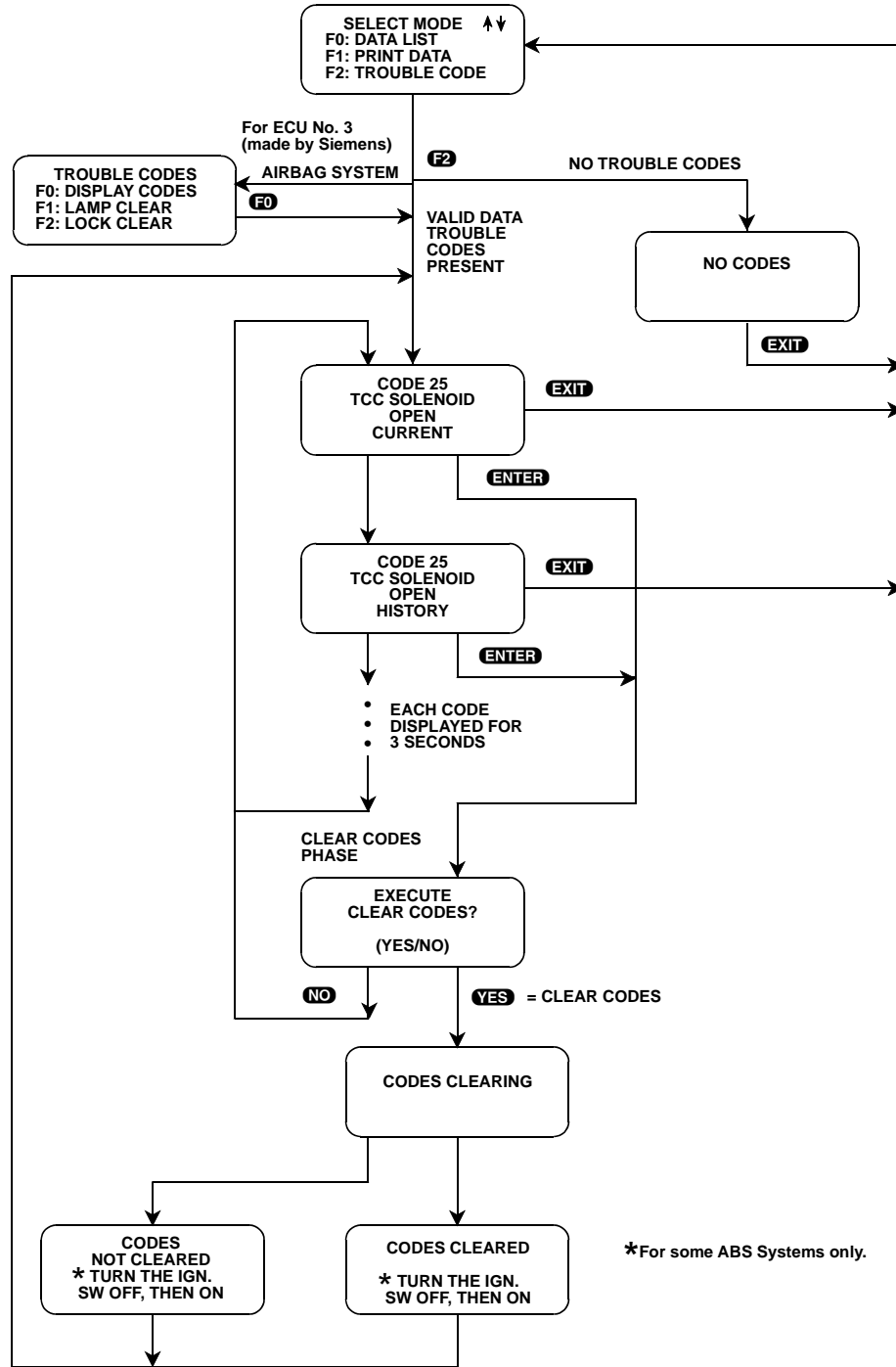

FIGURE 5-3. Trouble Codes Mode Flowchart for A/T, ABS, and Airbag F0: Display Codes

CLEAR CODES PHASE

4. To clear stored trouble codes, press the **ENTER** key to go to Clear Codes Phase. The tester will display “EXECUTE CLEAR CODES?”. Press **YES** to clear the codes, or press **NO** to return to the trouble code display without clearing the codes.

When **YES** is pressed, the tester displays a “CLEARING CODES” message, followed by either a “CODES CLEARED” or a “CODES NOT CLEARED” message. After a few seconds the tester automatically starts displaying trouble codes again. If no trouble codes are present, the “NO CODES” screen is displayed.

When the **NO** key is pressed, the trouble codes are retained in the ECU and the tester starts displaying trouble codes again.

LAMP CLEAR AND LOCK CLEAR FOR AIR-BAG SYSTEM FOR ECU NO. 3 (MADE BY SIEMENS)

For the Airbag system, after the trouble codes are displayed, press **EXIT** to return to the Trouble Codes menu.

NOTE



Lamp Clear: Select F1: Lamp Clear from the Trouble Codes menu, then press **YES** when the tester asks if you wish to clear the Warning Lamp. The tester attempts to clear the codes and informs you if the clearing was successful. If the Warning Lamp was not cleared, the tester informs you and instructs you to replace the SDM. Press **EXIT** to return to the Trouble Codes menu.

Lock Clear: Select F2: Lock Clear from the Trouble Codes menu, press **YES** when the tester asks if you wish to clear the Near-Deploy Lock. The tester attempts to clear the Near-Deploy Lock, then informs you if the clearing was successful or not. If the clearing was successful, the tester instructs you to turn the ignition switch off, then on. Press **EXIT** to return to the Trouble Codes menu.

5. Press **EXIT** to terminate the trouble codes mode and return to the Select Mode menu.

ACTIVE KEYS

F6 (hold)	Select “RS232C Set-Up” menu.
ENTER	Clear all stored ECU trouble codes.
YES	Clear all stored ECU trouble codes.
NO	Return to display trouble codes. Codes are not cleared.
↑ , ↓	Stop automatic display scrolling, then used to manually control the display.
EXIT	Terminate the trouble code display and return to the Select Mode menu.

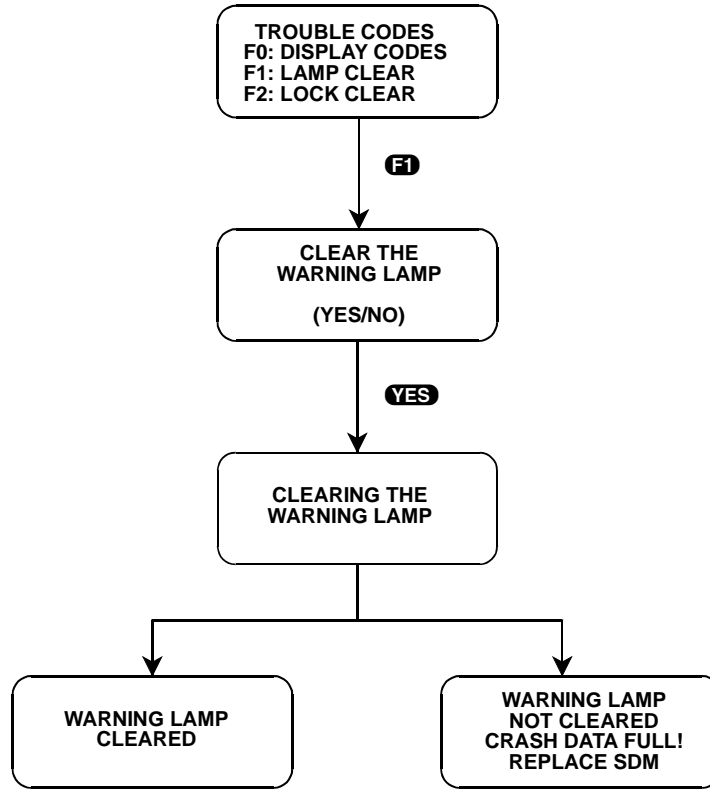

FIGURE 5-4. F1: Lamp Clear

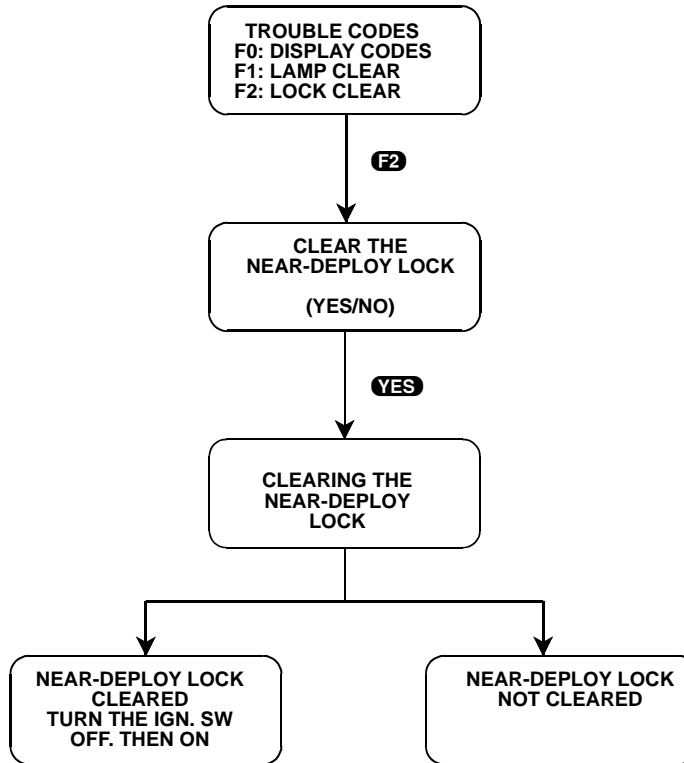

FIGURE 5-5. F2: Lock Clear

MODE F3: SNAPSHOT

The SNAPSHOT mode is not available when testing Airbag systems or ABS ECU No. 13 (made by BOSCH).

The purpose of the SNAPSHOT test mode is to help you isolate an intermittent or transient problem by storing data parameters before and or after the problem occurs.

NOTE



For ABS with ECU No. 2 (made by Sumitomo-Denko), the tester stops saving data when a current trouble code occurs.

When the tester is operating in SNAPSHOT mode, it is constantly storing information about data parameters and trouble codes. A time and position index for the stored information is also saved.

The tester stores all of the Data List parameters and trouble codes for the selected system. When the memory is full, the oldest (earliest) data collected is erased to make room for new information.

A “TRIGGER” tells the tester when to stop collecting data. For the SUZUKI BCM Application, a trigger occurs when any trouble code is detected by the ECU.

TRIGGER CONDITION

The trigger condition defines the specific circumstances under which you want the trigger to be set. The possible trigger conditions are:

F0: ANY CODE: If any trouble code is detected by the ECU, it will cause the trigger to be set.

F1: SINGLE CODE: For A/T systems you can select a specific trouble code that must be detected before the trigger will be set. [Step 3 on page 204](#) tells you how to enter the code.

NOTE



F1: Single Code is not available when testing ABS ECU No. 2 (made by Sumitomo-Denko).

F2: MANUAL TRIGGER: While operating the SNAPSHOT mode, you can always cause the trigger to be set by pressing **ENTER**.

VIEWING CAPTURED DATA

By selecting F3: REPLAY DATA from the SNAPSHOT menu you have the option of bypassing the Data Capture phase and displaying previously captured data. All data captured during SNAPSHOT will be retained in the tester until it is overwritten by a new SNAPSHOT, or if the tester is disconnected from the serial data link connector or the cigarette lighter for at least 24 hours.

PRINTING CAPTURED DATA

In addition, you can print the captured data, providing a hard copy of any selected data sample. A VP-411 (or compatible) printer is required to support this print function. See [Step 11](#).

The operation of SNAPSHOT mode is divided into three phases: Set-Up (beginning at [Step 1](#)), Data Capture (beginning at [Step 4](#)), and Data Display (beginning at [Step 8](#)).

SNAPSHOT SETUP PHASE

To enter the Setup phase of Snapshot mode, do the following:

1. Press **F3** to select the SNAPSHOT mode from the Select Mode menu.
2. The trigger condition and review data options are displayed next in a self-scrolling Snapshot Options menu.

To select a trigger option, just press the Function Key displayed to the left of the desired trigger condition. To replay previously captured data, press **F3**.

FOR ECU NO. 2 (ABS MADE BY SUMITOMO-DENKO)

When you are testing the ABS, if a current trouble code is present when Snapshot Trigger Condition is selected, the tester displays the following message.

NOTE



CURRENT TROUBLE
CODE SET, DATA
NO LONGER VALID
(ENTER)

To clear the trouble code(s), use Mode F2: TROUBLE CODES to display the current Trouble Codes. Repair the cause of the trouble code(s), then clear the codes using Mode F2. When all current trouble codes have been cleared, select F3: SNAPSHOT again to capture or display vehicle data.

3. To choose a specific ECU trouble code, press **F1** in the Snapshot Options menu. How to enter the code is explained below.

NOTE



This selection is not available when testing the ABS with ECU No. 2 (made by Sumitomo-Denko).

When the tester screen displays “SNAPSHOT MODE, ENTER ECU CODE:, xx”, use numeric keys **0** - **9** to enter the two digit trouble code number that you have selected, then press the **ENTER** key. The tester will continue to store data until the specified trouble code is detected, or until you press the **EXIT** key. If the code you enter does not exist for the ECU being tested, an “INVALID CODE” message will be displayed and the code will have to be reentered.

ACTIVE KEYS	
F0 - F2	Select trigger condition.
F3	Select Replay Data.
F6 (hold)	Select "RS232C Set-Up" menu.
0 - 9	Select specific trouble code.
ENTER	Enter selected trouble code.
EXIT	Return to Snapshot Options menu.

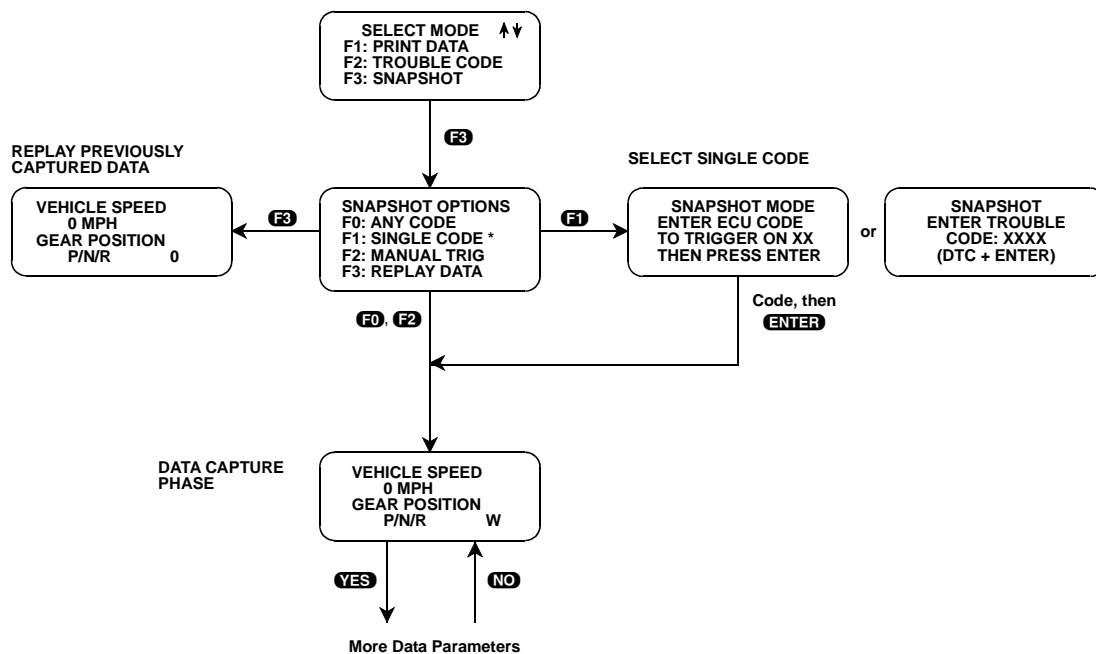

* For ABS with ECU No. 2 (made by Sumitomo-Denko), "F1: NOT AVAIL." is displayed.

FIGURE 5-6. Snapshot Setup Phase (Select Trigger Condition or Display Previously Captured Data)

To select a trigger condition, press the function key to the left of the desired trigger condition. To bypass the Data Capture phase and review previously captured data, press F3: REPLAY DATA.

DATA CAPTURE PHASE

To capture data in the Snapshot mode, do the following:

- Once the trigger condition is selected, the tester begins storing A/T or ABS data parameters and trouble codes while displaying the Data List parameters.

5. The data is organized as a number of data “samples”. The value or state of each parameter as well as all trouble codes are saved for each sample. The data display will indicate the “waiting for trigger” condition with a flashing “W” in the lower right-hand corner of the display. While waiting for the selected trigger, the **ENTER** key can always be used to force a trigger.

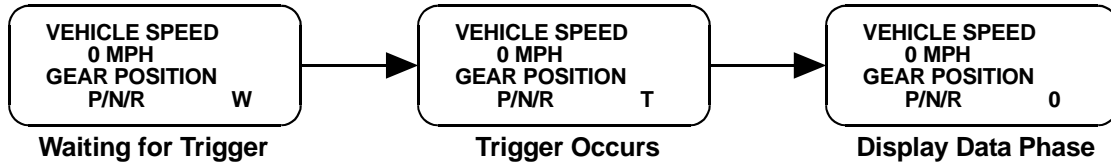

6. Once the trigger occurs, the tester will continue to save data samples until its memory is full. The data display indicates that the trigger has occurred by replacing the flashing “W” with a flashing “T”. As soon as the memory is full, the data capture terminates automatically and the tester goes to the Data Display phase.

For the ABS, if a current trouble code is detected while the Snapshot mode is active, a trigger automatically occurs and the tester advances to the data display phase. The trouble code that caused the trigger can be viewed by selecting sample +1.

7. Pressing **EXIT** will terminate the Data Capture phase. If the trigger has already occurred, the Snapshot mode will move to the Data Display Phase.

ACTIVE KEYS	
YES , NO	Scroll through displayed data parameters.
F0	Mark top displayed parameter as “fixed” for creating your own data pairs.
F1	Mark bottom displayed parameter as “fixed” for creating your own data pairs.
F6 (hold)	Select “RS232C Set-Up” menu.
ENTER	Manual trigger.
EXIT	Display captured data if trigger has already occurred.

DATA DISPLAY PHASE

To Display data in Snapshot Mode, do the following:

8. The Data Display phase is indicated with a number (initially zero) in the lower right hand corner of the display. Select the data to be displayed by using the **YES** and **NO** keys.

NOTE



During the Data Display phase, the trouble codes present during each sample can be displayed by pressing **F2**.

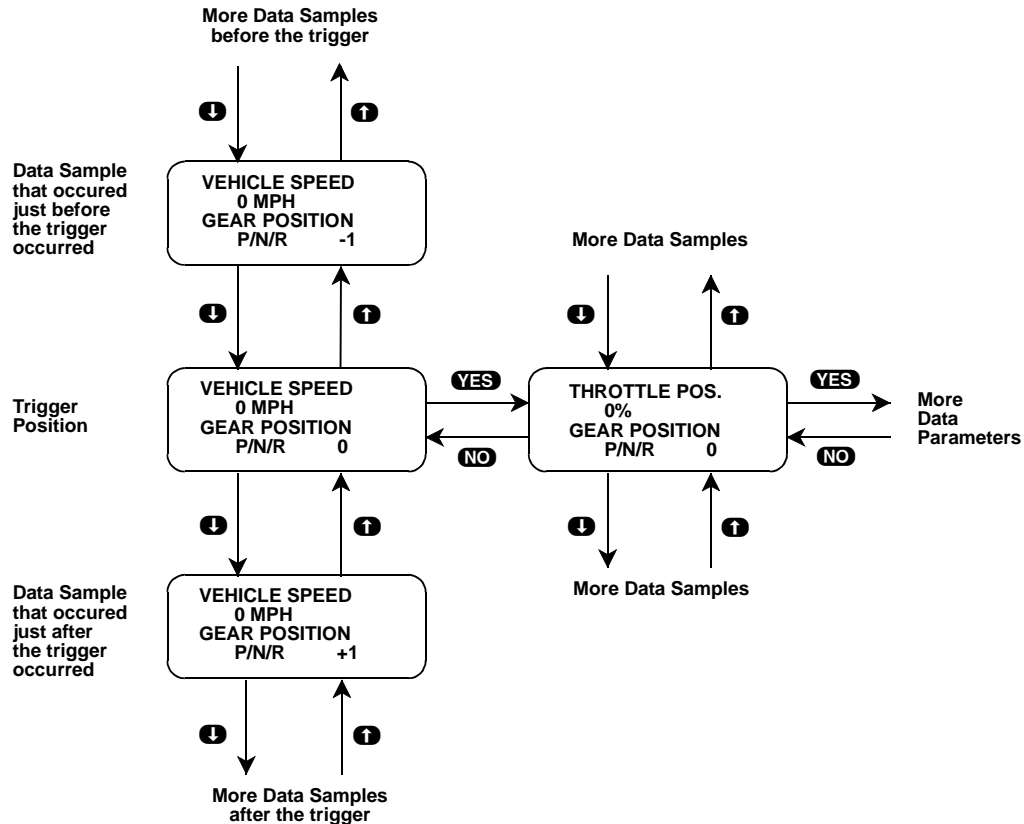

9. Use the **↑** and **↓** keys to select the desired sample. An index is displayed in the lower right-hand corner of the tester display.

The trigger occurs between samples 0 and +1. Sample "0" is the sample immediately preceding the trigger; sample "-1" is the second sample preceding the trigger, and so on. The trouble code that caused the trigger can be viewed in sample +1. For ABS systems, parameter data displayed in sample +1 is invalid.

The index range may be less than the maximum number of samples if not enough time was allowed for data capture before or after the trigger.

You can advance directly to the first, last, or trigger sample with the press of a button.

- F4: Display first (earliest) sample
- F5: Display trigger sample (0)
- F6: Display last (most recent) sample

10. While in the data display phase, pressing **ENTER** will cause the tester to toggle between the sample index and sample time.

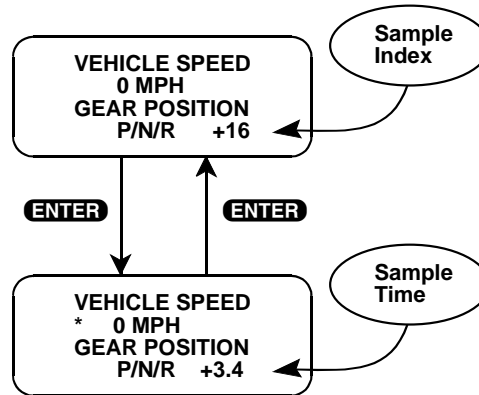

The sample time display gives the time in seconds (relative to the trigger sample) at which the tester received the currently displayed sample. For example, a sample time of +3.4 means the sample was received 3.4 seconds after the trigger sample. A sample time of -2.6 seconds means the sample was received 2.6 seconds before the trigger.

11. The currently displayed sample may be printed if the tester connected to a compatible printer. To print the data, press **F8**. The tester keyboard will be disabled while data is being sent to the printer.

SNAPSHOT data can also be printed in a tabular format using the Screen Print feature if the RS232C I/F Cartridge is installed or if you are using a Tech 1A Series A tester. Screen Print is enabled by pressing **F6** until an "RS232 SETUP" menu is displayed. Press **F1** to enable the Screen Print function. Refer to the appropriate Operators Manual for more detail.

12. When you are finished viewing the sampled data, press **EXIT** to return to the Snapshot Options menu. If you are finished with the SNAPSHOT mode, press **EXIT** again to return to the select mode menu.

ACTIVE KEYS	
YES , NO	Scroll through displayed data parameters.
↑ , ↓	Scroll through selected samples.
F0 , F1	Fix top or bottom display parameter respectively.
F2	Display trouble codes for current sample.
F4	Advance to first (earliest) sample.
F5	Advance to trigger sample (sample 0).
F6	Advance to last (most recent) sample.
F6 (hold)	Select "RS232C Set-Up" menu.
F8	Print current data sample (if equipped with RS232C I/F Cartridge or Tech 1A Series A and printer).
ENTER	Toggle between sample index and sample time display.
EXIT	Return to Snapshot Options menu.

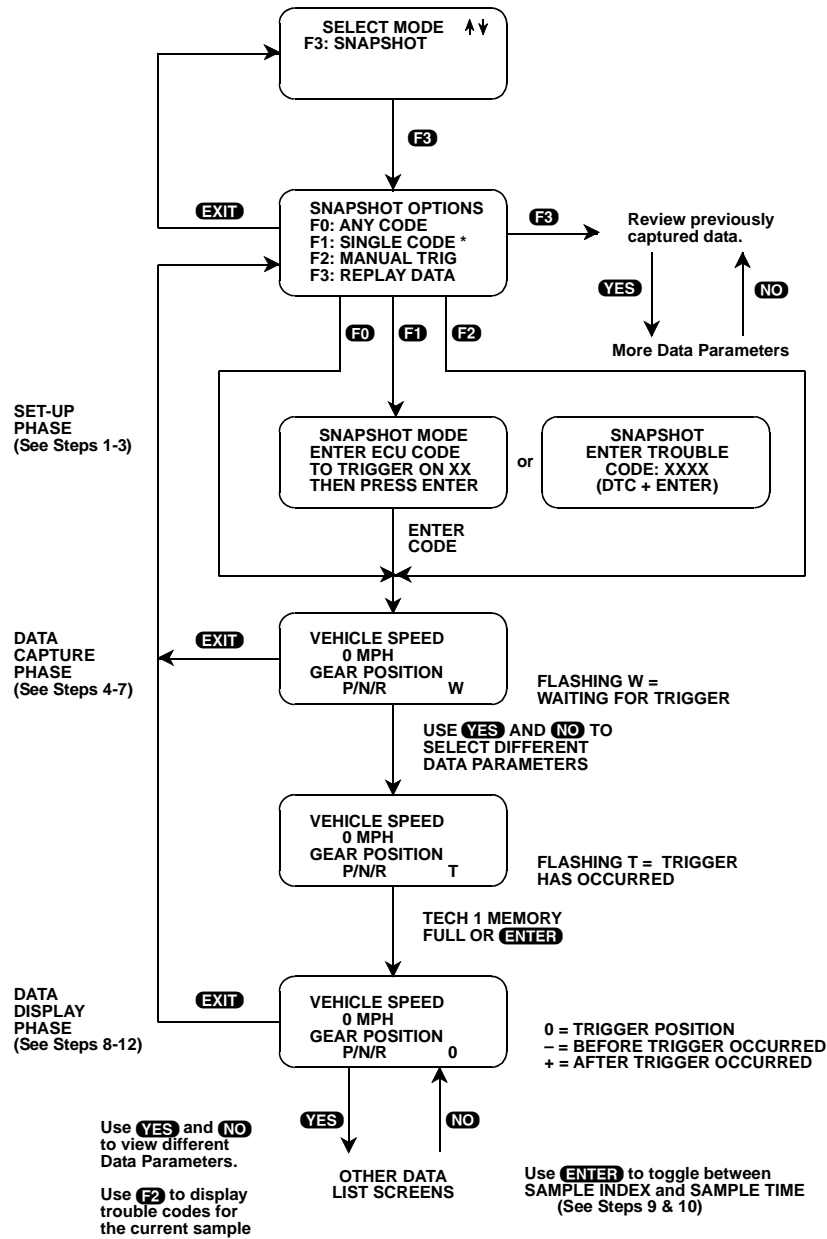

* For ECU No. 2 (ABS made by Sumitomo-Denko), "F1: NOT AVAIL." is displayed.

FIGURE 5-7. Snapshot Mode Flowchart

MODE F4: MISCELLANEOUS TESTS

SUBMODE F0: HYDRAULIC CONTROL

WARNING!



To perform the Hydraulic Control test, both vehicle drive wheels must be securely raised and the engine must be off, or there will be unintended vehicle movement that could result in injury.

The HYDRAULIC CONTROL mode allows you to manually perform the APPLY and RELEASE ABS functions for brake system diagnosis for the following:

ECU NO.	MANUFACTURER
15	Sumitomo - Denko
21	Sumitomo - Denko
27	Nisshinbo

To operate Hydraulic Control, do the following:

- Before performing this test, check the following items:
 - Basic brake system other than ABS is in good condition.
 - Battery voltage is 11V or higher.
- Press **F4** to select Misc. Tests from the Select Mode menu.
- Press **F0** to select the Hydraulic Control test.
- The tester display confirms that you are in the ABS Hydraulic Control Test and waits for 2 seconds before instructing you to stop the engine, raise the vehicle, put the transmission in neutral. Press **ENTER** when these instructions are completed.
- Release the parking brake, turn the ignition on, and then press **ENTER**.
- Press **F0** - **F3** to select the wheel to test, or press **EXIT** to return to the Select Mode menu.
- Depress the brake pedal and then press **ENTER**.
- The tester will display the wheel that you have selected to test. Press **↑** to start the test and perform the following checks with the help of another person:
 - The operational sound of the solenoid is heard and the wheel turns only about 0.5 sec (brake force is depressurized).
 - The operational sound of the pump motor is heard and pulsation is felt at the brake pedal.

NOTE



If a wheel speed is detected on two or more tires, or if a trouble code is detected, the test will end and a corresponding screen will be displayed. Press **EXIT** to return to the Select Mode menu. If neither of these conditions is detected, the tester will count down from 5 seconds. If the ABS unit is No. 15, made by Sumitomo - Denko and the battery voltage is >16V or <10V, the test will end and a corresponding screen will be displayed.

9. When instructed, remove your foot from the brake pedal and press **ENTER** to return to the Select Wheel menu. If necessary, repeat Step 6, Step 7, and Step 8 until all four wheels are checked.
10. Press **EXIT** to return to the Select Mode menu.

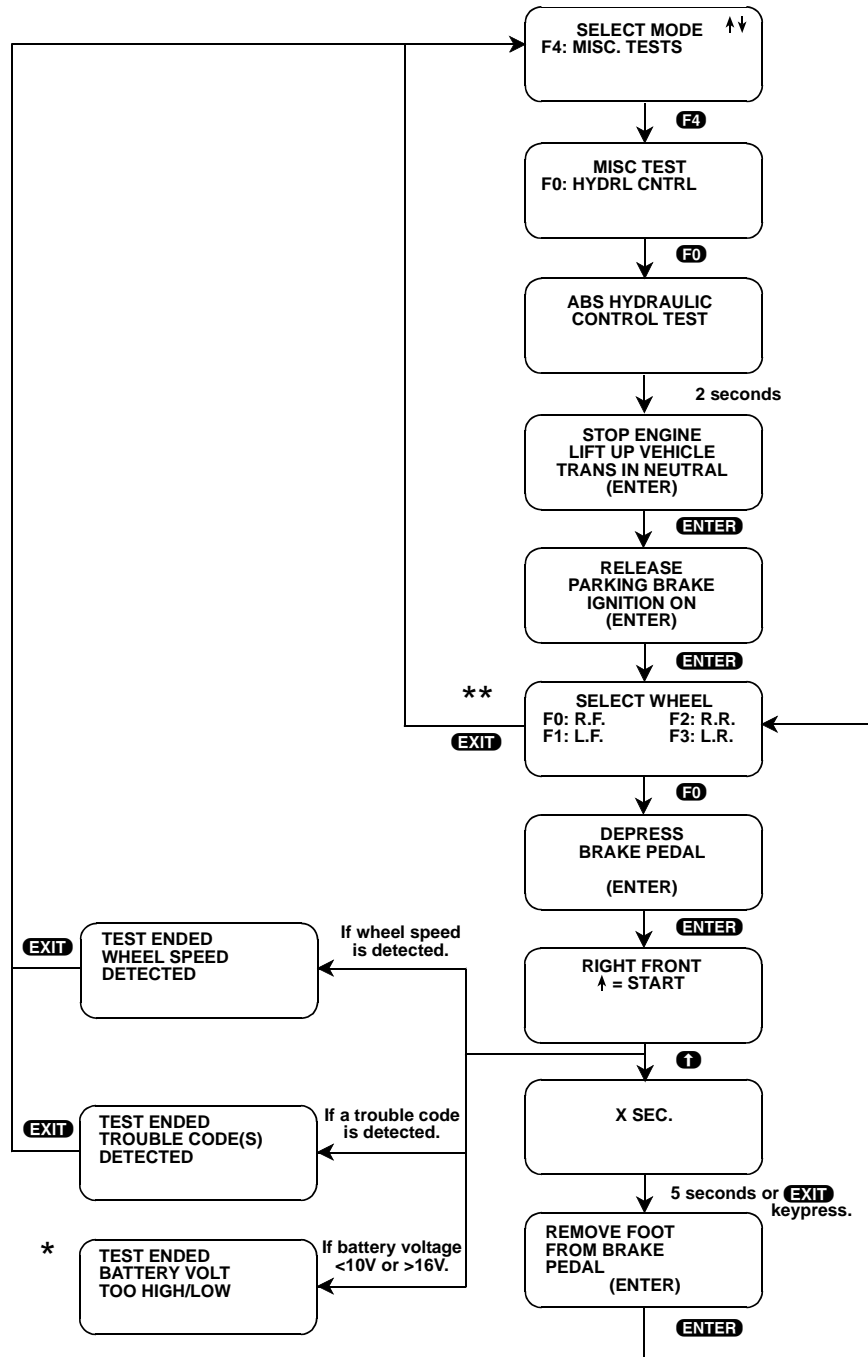

* Only for ECU No. 15 Sumitomo Denko.

** For ECU No. 15 Sumitomo Denko and ECU No. 27 Nisshinbo, this screen reads as follows:

SELECT WHEEL
F0: RIGHT FRONT
F1: LEFT FRONT
F2: REAR

ACTIVE KEYS	
↑	Start the test.
F0 - F4	Select a menu item.
ENTER	Proceed to the next screen.
EXIT	Stop the test or return to the Select Mode menu.
↓	Continue with test.
NO	Indicate failure.
YES	Continue with test.

6. FINISHING UP

To get the most life out of your diagnostic tool after using the Suzuki BCM Application, do the following:

1. Remove power to the tester by disconnecting the serial data link cable from the serial data link connector.
You may want to inspect the cable and connector for any damage or corrosion.
2. Unplug the cartridge and store it and the cable in the travelling case.

CAUTION!



If the tester should become dirty, you may wipe it off with a clean cloth and mild detergent or hand soap. Avoid using harsh solvents such as petroleum based cleaning agents, Benzene, Trichloroethylene, etc. Although the tester is water resistant it is not waterproof, so be sure to thoroughly dry off the tester prior to storage.

7. TROUBLE CODE DESCRIPTIONS

All trouble codes that can be displayed with the Suzuki BCM Application, along with a brief description of each code, are listed on the following pages.

TRANSMISSION TROUBLE CODES		
ECU TROUBLE CODE	TESTER DISPLAY DESCRIPTOR	TROUBLE CODE DESCRIPTION
17	SHIFT SOL NO. 1 PERF/STUCK OFF	Actual gear position (ratio) does not agree with gear position commanded from TCM to A/T.
21	SHIFT SOLENOID NO. 1 OPEN	Shift Solenoid No. 1 open.
22	SHIFT SOLENOID NO. 1 SHORT	Shift Solenoid No. 1 short.
23	SHIFT SOLENOID NO. 2 OPEN	Shift Solenoid No. 2 open.
24	SHIFT SOLENOID NO. 2 SHORT	Shift Solenoid No. 2 short.
25	TCC SOLENOID OPEN	TCC Solenoid open.
26	TCC SOLENOID SHORT	TCC Solenoid short.
27	TORQUE REDUCTION CKT MALF	Voltage at torque reduction signal circuit is low while torque reduction signal OFF is commanded.
28	SHIFT SOL NO. 2 PERF/STUCK OFF	Actual gear position (ratio) does not agree with gear position commanded from TCM to A/T.

TRANSMISSION TROUBLE CODES (CONTINUED)		
ECU TROUBLE CODE	TESTER DISPLAY DESCRIPTOR	TROUBLE CODE DESCRIPTION
29	TCC SYSTEM PERF/STUCK OFF	TCC is not locked up while TCC solenoid ON is commanded. Or TCC is locked up while TCC solenoid OFF is commanded.
31	VSS NO SIGNAL	Vehicle Speed Sensor signal not received by the TCM. Vehicle Speed Sensor circuit failure.
32	THROTTLE POS. SIGNAL HIGH	Throttle Position Signal too high. Throttle Position Sensor or circuit failure.
33	THROTTLE POS. SIGNAL LOW	Throttle Position Signal too low. Throttle Position Sensor or circuit failure.
34	TRANS. RANGE SWITCH FAIL	Two transmission range signals or more fed to the TCM. Transmission range switch or circuit failure.
35	ENGINE SPEED INPUT CKT MALF	No engine speed signal inputted while engine running.
36	ATF TEMP SEN CKT MALF (HIGH VOLT)	Voltage at sensor terminal of TCM is high.
36	VSS (TRANS. & METER) NO SIGNAL	Vehicle Speed Sensor (Transmission & Meter) Signal not received by the TCM. Vehicle Speed Sensor (Transmission & Meter) circuit failure.
37	INPUT REVOLUTION SENSOR FAIL	Input Revolution Sensor signal not received by the TCM. Input Revolution Sensor circuit failure.
38	ATF TEMP SEN CKT MALF (LOW VOLT)	Voltage at sensor terminal of TCM is low.
41	PRESS. CONT. SOL OPEN	Pressure Control Solenoid open.
42	PRESS. CONT. SOL SHORT	Pressure Control Solenoid short.
51	COOLANT TEMP. SIGNAL FAIL	Coolant Temperature Signal is held low too long. Coolant Temperature Signal system or circuit problem.
52	MEMORY CHECK SUM ERROR	Power supply relay voltage monitor in the TCM fails to comply with the command from the CPU.

ABS TROUBLE CODES		
ECU TROUBLE CODE	TESTER DISPLAY DESCRIPTOR	TROUBLE CODE DESCRIPTION
C1013	ABS CONT MODULE WRONG ASSEMBLY	ABS control module of wrong specification installed.
15 or C1015	G SENSOR FAIL	A failure condition is detected in the G sensor or its circuit. (4WD ONLY)
16	STOP LAMP SWITCH OPEN	Stop lamp switch open.
C1016	STOP LAMP SWITCH CIRCUIT OPEN	Stop lamp switch open.
18	SENSOR ROTOR FAIL	ABS control time error is detected in the sensor rotor of one of the four wheels.
21	RF WHEEL SPEED SENSOR OPEN	Right front wheel speed sensor or circuit open. Unusual data is detected.
C1021	RF WHEEL SPEED SENSOR FAIL	Right front wheel speed sensor or circuit has failed.
22	RF WHEEL SPEED SENSOR SHORT	Right front wheel speed sensor or circuit short. Unusual data is detected.
C1022	RF WHEEL SPEED SEN. SIGNAL FAIL	Right front wheel speed sensor signal input is abnormal.
25	LF WHEEL SPEED SENSOR OPEN	Left front wheel speed sensor or circuit open. Unusual data is detected.
C1025	LF WHEEL SPEED SENSOR FAIL	Left front wheel speed sensor or its circuit has failed.
26	LF WHEEL SPEED SENSOR SHORT	Left front wheel speed sensor or circuit short. Unusual data is detected.
C1026	LF WHEEL SPEED SEN. SIGNAL FAIL	Left front wheel speed sensor signal input is abnormal.
C1031	RR WHEEL SPEED SENSOR FAIL	Right rear wheel speed sensor or its circuit has failed.
31	RR WHEEL SPEED SENSOR OPEN	Right rear wheel speed sensor or circuit open. Unusual data is detected.
32	RR WHEEL SPEED SENSOR SHORT	Right rear wheel speed sensor or circuit short. Unusual data is detected.
C1032	RR WHEEL SPEED SEN. SIGNAL FAIL	Right rear wheel speed sensor signal input is abnormal.
35	LR WHEEL SPEED SENSOR OPEN	Left rear wheel speed sensor or circuit open. Unusual data is detected.

ABS TROUBLE CODES (CONTINUED)		
ECU TROUBLE CODE	TESTER DISPLAY DESCRIPTOR	TROUBLE CODE DESCRIPTION
C1035	LR WHEEL SPEED SENSOR FAIL	Left rear wheel speed sensor or its circuit has failed.
36	LR WHEEL SPEED SENSOR SHORT	Left rear wheel speed sensor or circuit short. Unusual data is detected.
C1036	LR WHEEL SPEED SEN. SIGNAL FAIL	Left rear wheel speed sensor signal input is abnormal.
41	RF SOLENOID FAIL	A failure condition is detected in the right front solenoid.
41 or C1041	RF INLET SOLENOID FAIL	Monitor voltage of RF inlet solenoid and the CPU command fail to agree.
42 or C1042	RF OUTLET SOLENOID FAIL	Monitor voltage of RF outlet solenoid and the CPU command fail to agree.
45	LF SOLENOID FAIL	A failure condition is detected in the left front solenoid.
45 or C1045	LF INLET SOLENOID FAIL	Monitor voltage of LF inlet solenoid and the CPU command fail to agree.
46 or C1046	LF OUTLET SOLENOID FAIL	Monitor voltage of LF outlet solenoid and the CPU command fail to agree.
51	RR SOLENOID FAIL (4 CHANNEL ONLY)	A failure condition is detected in the right rear solenoid.
51 or C1051	RR INLET SOLENOID FAIL	Monitor voltage of RR inlet solenoid and the CPU command fail to agree.
52 or C1052	RR OUTLET SOLENOID FAIL	Monitor voltage of RR outlet solenoid and the CPU command fail to agree.
55	LR SOLENOID FAIL (4 CHANNEL ONLY)	A failure condition is detected in the left rear solenoid.
55 or C1055	LR INLET SOLENOID FAIL	Monitor voltage of LR inlet solenoid and the CPU command fail to agree.
C1055	REAR INLET SOLENOID FAIL	Monitor voltage of rear inlet solenoid and the CPU command fail to agree.
56	REAR SOLENOID FAIL (3 CHANNEL ONLY)	A failure condition is detected in the rear solenoid.
56 or C1056	LR OUTLET SOLENOID FAIL	Monitor voltage of LR outlet solenoid and the CPU command fail to agree.
C1056	REAR OUTLET SOLENOID FAIL	Monitor voltage of rear outlet solenoid and the CPU command fail to agree.
57 or C1057	POWER SUPPLY FAIL	The voltage of the power supply has fallen.
61	PUMP MOTOR FAIL	A failure condition is detected in the pump motor (open, short).

ABS TROUBLE CODES (CONTINUED)		
ECU TROUBLE CODE	TESTER DISPLAY DESCRIPTOR	TROUBLE CODE DESCRIPTION
C1061	PUMP MOTOR RELAY FAIL	A failure condition is detected in the pump motor relay.
63 or C1063	FAIL-SAFE RELAY FAIL	A failure condition is detected in the fail-safe relay (open, short).
71 or C1071	ABS CONTROL MODULE FAIL	A failure condition is detected in the ABS control module.
81	BASE BRAKE OR DIFFEREN SW FAIL (3 CHANNEL ONLY)	A failure condition is detected in the Base Brake or the Differential Switch circuit is open.
82	4WD SIGNAL CIRCUIT OPEN (3 CHANNEL ONLY)	4WD signal circuit open.

AIRBAG TROUBLE CODES		
ECU TROUBLE CODE	TESTER DISPLAY DESCRIPTOR	TROUBLE CODE DESCRIPTION
15	PASSENGER INI. RES. TOO HIGH	Passenger airbag initiator circuit resistances too high or open circuit.
15 or B1015	PSG AIRBAG INI. RES. TOO HIGH	Passenger airbag initiator circuit resistances too high or open circuit.
16	PASSENGER INI. RES. TOO LOW	Passenger airbag initiator circuit resistances too low.
16 or B1016	PSG AIRBAG INI. RES. TOO LOW	Passenger airbag initiator circuit resistances too low.
18 or B1018	PSG AIRBAG INI. SHORT TO GROUND	Passenger airbag initiator circuit short to ground.
19 or B1019	PSG AIRBAG INI. SHORT TO BATTERY	Passenger airbag initiator circuit short to battery.
21	DRIVER INITIATOR RES. TOO HIGH	Driver airbag initiator circuit resistance is too high or open circuit.
21 or B1021	DRV AIRBAG INI. RES. TOO HIGH	Driver airbag initiator circuit resistance is too high or open circuit.
22	DRIVER INITIATOR RES. TOO LOW	Driver airbag initiator circuit resistance is too low.

AIRBAG TROUBLE CODES (CONTINUED)		
ECU TROUBLE CODE	TESTER DISPLAY DESCRIPTOR	TROUBLE CODE DESCRIPTION
22 or B1022	DRV AIRBAG INI. RES. TOO LOW	Driver airbag initiator circuit resistance is too low.
24	DRV. OR PSG INI. SHORT TO GROUND	Driver or passenger airbag initiator circuit short to ground.
24 or B1024	DRV AIRBAG INI. SHORT TO GROUND	Driver airbag initiator circuit short to ground.
25	DRV. OR PSG INI. SHORT TO BATTERY	Driver or passenger airbag initiator circuit short to battery voltage.
25 or B1025	DRV. AIRBAG INI. SHORT TO BATTERY	Driver airbag initiator circuit short to battery.
31	IGNITION VOLTAGE TOO HIGH	Ignition voltage is too high.
B1031	POWER SUPPLY VOLTAGE TOO HIGH	Power supply voltage to SDM is too high.
32	IGNITION VOLTAGE TOO LOW	Ignition voltage is too low.
B1032	POWER SUPPLY VOLTAGE TOO LOW	Power supply voltage to SDM is too low.
35	CRASH SENSOR OR CIRCUIT FAIL	External crash sensor circuit short to ground or battery voltage or circuit open.
B1035	FRONT G SNSR OPEN (RIGHT)	Front G sensor (right side) circuit is open or shorted to power supply circuit.
36	CRASH SENSOR FAIL	A failure condition is detected in the external crash sensor or circuit.
B1036	FRONT G SNSR SHORT (RIGHT)	Front G sensor (right side) circuit is short to ground.
37	LOW PRES. SENSOR CIRCUIT SHORT	Low pressure sensor circuit short to ground or battery voltage or short in wiring.
B1037	FRONT G SNSR OPEN (LEFT)	Front G sensor (left side) is open or shorted to ground.
38	LOW PRES. SENSOR CIRCUIT OPEN	Low pressure sensor open (faulty inflator) or circuit open.
B1038	FRONT G SNSR SHORT (LEFT)	Front G sensor (left side) circuit is shorted to ground.
41 or B1041	DRV PRETEN INI. RES. TOO HIGH	Resistance of driver pretensioner initiator circuit is too high.
42 or B1042	DRV PRETEN INI. RES. TOO LOW	Resistance of driver pretensioner initiator circuit is too low.

AIRBAG TROUBLE CODES (CONTINUED)		
ECU TROUBLE CODE	TESTER DISPLAY DESCRIPTOR	TROUBLE CODE DESCRIPTION
43 or B1043	DRV. PRETEN INI. SHORT TO GROUND	Driver pretensioner initiator circuit short to ground.
44 or B1044	DRV. PRETEN INI. SHORT TO BATTERY	Driver pretensioner initiator circuit short to battery.
45 or B1045	PSG PRETEN INI. RES. TOO HIGH	Resistance of passenger pretensioner initiator circuit is too high.
46 or B1046	PSG PRETEN INI. RES. TOO LOW	Resistance of passenger pretensioner initiator circuit is too low.
47 or B1047	PSG. PRETEN INI. SHORT TO GROUND	Passenger pretensioner initiator circuit short to ground.
48 or B1048	PSG. PRETEN INI. SHORT TO BATTERY	Passenger pretensioner initiator circuit short to battery.
51 or B1051	CRASH RECORDED	SDM recorded crash condition.
B1053	A/B MODULE DISPOSED	Airbag module has already been arranged for disposition.
61 or B1061	WARNING LAMP DEFECT	A failure condition is detected in the warning lamp circuit.
71 or B1071	SDM FAIL	A failure condition is detected in the SDM. Replace SDM.

8. PARAMETER DESCRIPTIONS

The tester is capable of displaying a wide variety of data parameters in Data List and Snapshot modes. The ECU sends the tester information regarding the state of the ECU and the tester “translates” and displays this information in the form of parameters selected by the service technician. This chapter describes those parameters.

There are two basic types of ECU parameters: discrete and analog. Discrete parameters are 'bits' of information and can be in only one of two distinct states (ON/OFF, OPEN/CLOSED, etc.). Switches and solenoids are examples of discrete parameters. Analog parameters are used to represent quantities and are displayed as a value with appropriate units. Examples of analog parameters include Vehicle Speed, Throttle Position, Battery Voltage, etc.

Parameters are grouped by ECU function. The parameters are listed in alphabetical order within each category. The categories are:

- General
- Electrical
- Miscellaneous

CATEGORY DESCRIPTIONS

- General Parameters are those that affect or are affected by many different ECU systems such as Vehicle Speed, Coolant Temp. Signal, and Wheel Speed.
- Electrical Parameters can be used to help diagnose vehicle electrical problems and include Battery Voltage and Pump Motor Voltage.
- The Miscellaneous Parameters section includes parameters such as Brake Switch, Warning Lamp, and Gear Position.

DESCRIPTOR FORMAT

Following is a description of all parameters that can be displayed with the Suzuki BCM Application. Included is:

- a listing of all the parameters available for each category
- a description of the parameter
- the units and the range of the analog parameters
- the state of the discreet parameters.

The parameters are listed below according to category. The ECU related to the parameter is also indicated.

Transmission

General Parameters	System
Coolant Temp. Signal	A/T
Input Revolution	A/T
Pressure Control Solenoid	A/T
Throttle Position	A/T
Vehicle Speed	A/T

Electrical Parameters	System
Battery Voltage	A/T

Miscellaneous Parameters	System
4WD-L Switch	A/T
Brake Switch	A/T
Gear Position	A/T
Mode Select Switch	A/T
O/D Off Switch, CON, MON	A/T
Park/Neutral Position Signal	A/T
Shift Solenoid No. 1 & No. 2	A/T
TCC Solenoid	A/T
Transmission Range	A/T

ABS

General Parameters	System
Wheel Speed (RF, LF, RR, LR)	ABS

Electrical Parameters	System
Battery Voltage	ABS
Fail-Safe Relay	ABS
G-Sensor	ABS
Pump Motor Relay	ABS
Pump Motor Voltage	ABS

Miscellaneous Parameters	System
Brake Switch	ABS
Hydraulic System	ABS
Hydraulic Unit Switch	ABS

Airbag

Electrical Parameters	System
Backup Voltage	Airbag
Battery Voltage	Airbag
Driver Airbag Initiator Resistance	Airbag
Driver Initiator Resistance	Airbag
Driver Pretensioner Initiator Resistance	Airbag
Ignition Voltage	Airbag
Passenger Airbag Initiator Resistance	Airbag
Passenger Initiator Resistance	Airbag
Passenger Pretensioner Initiator Resistance	Airbag
System ID	Airbag

Miscellaneous Parameters	System
Warning Lamp	Airbag

TRANSMISSION

GENERAL PARAMETERS

COOLANT TEMP SIGNAL

STATES
High/Low

Coolant Temperature Signal is used for the overdrive control. When this signal is LOW, the gear position is not shifted to 4th.

INPUT REVOLUTION

UNITS	RANGE
RPM	0 - 6375

Input shaft revolution is the revolution of the input shaft (torque converter turbine shaft) in the transmission case. It is computed by reference pulses coming from the input shaft revolution sensor or turbine shaft revolution sensor in the transmission.

PRESSURE CONTROL SOLENOID

UNITS	RANGE
%	0.0 - 100

Pressure Control Solenoid is used for the shift change control in the transmission. It is operated by timing pulses coming from the TCM.

THROTTLE POSITION

UNITS	RANGE
%	0.0 - 100

Throttle Position is a TCM internal parameter. It is computed by duty signal coming from the ECM. Throttle Position is used for the shift solenoid control in the TCM.

VEHICLE SPEED

UNITS	RANGE
KPH	0 - 255
MPH	0 - 159

Vehicle speed is a TCM internal parameter. It is computed by timing pulses coming from the vehicle speed sensor for A/T. Vehicle speed is used for the shift solenoid control in the TCM.

ELECTRICAL PARAMETERS

BATTERY VOLTAGE

UNITS	RANGE
Volts	0.0 - 25.4

Battery Voltage is an analog input signal read by the TCM.

MISCELLANEOUS PARAMETERS

4WD-L SWITCH

STATES
Off/On

4WD-L signal is fed to the TCM from the 4WD-L switch. This switch signal is used for timing of shift change.

BRAKE SWITCH

STATES
Off/On

This switch signal informs the TCM whether the brake is active or not.

GEAR POSITION

STATES
R/P or N/1/2/3/4/**

This parameter indicates the current gear position. It is computed by the throttle position coming from the ECM and the vehicle speed.

MODE SELECT SWITCH

STATES
Normal/Power/Snow

The Mode signal is fed to the TCM from the Mode Select Switch. This switch signal is used for timing of the shift change.

O/D OFF SWITCH CON: CONTROL MON: MONITOR

STATES
Off/On

O/D Off Switch is used for the over drive control. When this signal is ON, the gear position is not shifted to 4th.

PARK/NEUTRAL POSITION SIGNAL

STATES
R/D/2/L or P/N

This parameter indicates whether the D, R, 2, L-range position is selected or if P, N-range is selected. When this signal is ON, the idle speed is increased.

SHIFT SOLENOID NO. 1 SHIFT SOLENOID NO. 2

STATES
Off/On

Shift Solenoid is used for shifting the transmission up and down. It is turned ON or OFF by a signal from the TCM. Gear position is decided by combination of ON or OFF.

TCC SOLENOID

STATES
Off/On

TCC Solenoid is used for the TCC Control mode. It is turned ON or OFF by a signal from the TCM.

TRANSMISSION RANGE

STATES
P/R/N/D/2/L/FAIL

Transmission Range is fed to the TCM from the transmission range switch. This signal indicates when the gear is shifted to each range.

ABS

GENERAL PARAMETERS

RF WHEEL SPEED
LF WHEEL SPEED
RR WHEEL SPEED
LR WHEEL SPEED

UNITS	RANGE
KPH	0 - 285
MPH	0 - 177

Wheel speed is an ABS control module internal parameter. It is computed by reference pulses from the Wheel Speed Sensor.

ELECTRICAL PARAMETERS

BATTERY VOLTAGE

STATES
Low/High

Battery Voltage is an analog input signal read by the ABS control module. Certain ABS control module functions will be modified if the Battery Voltage falls below or rises above programmed thresholds.

FAIL-SAFE RELAY (ABS)

UNITS
Volts

This parameter indicates the voltage applied to the coil of the fail-safe relay.

G-SENSOR

UNITS	RANGE
Volts	0 - 9.80
G	-2.50 - 7.32

The G-Sensor converts Gs during the vehicle acceleration/deceleration into a voltage signal and transmits it to the controller. Based on this signal, the controller judges the road surface conditions and controls the ABS while running in the 4WD mode.

PUMP MOTOR RELAY

UNITS
Volts

This parameter indicates the voltage applied to the relay coil.

PUMP MOTOR VOLTAGE

STATES
Low/High

Pump Motor Voltage is an analog input signal read by the ABS control module. Certain ABS control module functions will be modified if the Pump Motor voltage falls below or rises above programmed thresholds.

MISCELLANEOUS PARAMETERS**BRAKE SWITCH**

STATES
Off/On

This switch signal informs the ABS control module whether the brake is active or not.

HYDRAULIC SYSTEM

STATES
Operating/Not Operating

This parameter indicates whether the ABS is functional or not.

HYDRAULIC UNIT SWITCH

STATES
Off/On

This parameter indicates whether the ABS is functional or not.

AIRBAG**ELECTRICAL PARAMETERS****BATTERY VOLTAGE**

UNITS
Volts

Battery Voltage is an analog input signal read by the SDM.

BACKUP VOLTAGE

UNITS
Volts

This parameter indicates the capacity of the backup condenser installed to maintain the ignition current (as much as possible) even when the power supply that ignites the inflator is shut off.

DRIVER INITIATOR RESISTANCE
DRIVER AIRBAG INITIATOR RESISTANCE

UNITS	RANGE
Ohms (Ω)	0 - 12.75

This parameter indicates the resistance of the driver's airbag initiator circuit.

DRIVER PRETENSIONER
INITIATOR RESISTANCE

UNITS
Ohms (Ω)

This parameter indicates the resistance of the driver's seatbelt pretensioner initiator circuit.

IGNITION VOLTAGE

UNITS	RANGE
Volts	0 - 28.5

Ignition Voltage is an analog input signal read by the SDM.

PASSENGER INITIATOR RESISTANCE
PASSENGER AIRBAG INITIATOR
RESISTANCE

UNITS	RANGE
Ohms (Ω)	0 - 12.75

This parameter indicates the resistance of the passenger's airbag initiator circuit.

PASSENGER PRETENSIONER
INITIATOR RESISTANCE

UNITS
Ohms (Ω)

This parameter indicates the resistance of the passenger's seatbelt pretensioner initiator circuit.

SYSTEM ID

STATES
Airbag ID
Driver/Passenger
Driver Only
Pretensioner ID
Driver/Passenger

This parameter indicates where the airbag and seatbelt pretensioner are installed.

SYSTEM ID (FOR ECU NO. 28)

STATES
1CH/4CH/***

This parameter indicates the number of initiator circuits.

MISCELLANEOUS PARAMETERS

WARNING LAMP

STATES
Off/On

This parameter tells whether the warning lamp is ON or OFF.

A. IF YOU'RE HAVING A PROBLEM

Although the tester was designed to give you years of trouble-free service, occasional problems may occur that require special attention. Some of these problems may be corrected with a few simple steps. Examples of most of the displays which you might see under abnormal conditions are shown. In addition, the most likely cause for the condition is given as well as other possible causes and recommendations on how to isolate or eliminate the problem. If the problem appears to be in the tester, perform the Self-test (described in the tester Operator's Manual.)

BLANK SCREEN

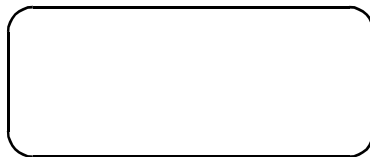

Most Likely Cause:

- Ignition switch OFF.

Other Possible Causes:

- Faulty cable.
- tester power supply is malfunctioning.
- No power is applied to the tester.

Recommendations:

- Plug the tester into another vehicle to verify proper operation.

DISPLAYS SOLID BARS

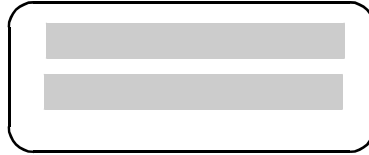
**Most Likely Cause:**

- Two master cartridges are installed.

Other Possible Causes:

- Master cartridge is malfunctioning.
- tester is malfunctioning.

Recommendations:

- Make sure that only one master cartridge is installed in the tester.
- Remove all cartridges and see if “MASTER CARTRIDGE MISSING OR MALFUNCTIONING” message is displayed. If it is, try installing another master cartridge.

MASTER CARTRIDGE IS MISSING OR MALFUNCTIONING

A rectangular box with rounded corners containing the text "MASTER CARTRIDGE IS MISSING OR MALFUNCTIONING" in all caps.**Most Likely Cause:**

- Master cartridge is not installed.

Other Possible Causes:

- Dirty contacts on the master cartridge connector.
- Two master cartridges installed.

Recommendations:

- Verify that a master cartridge is installed.
- Clean contacts on master cartridge connector with alcohol.
- Try a different master cartridge.

KEYBOARD OR DISPLAY LOCKED UP OR PROGRAM SPORADICALLY RETURNS TO FIRST PAGE

SUZUKI
MASS STORAGE
CARTIRDGE - VX.X
<ENTER>

SUZUKI
BCM
(ENTER)

Most Likely Cause:

- Serial data link cable loose or bad.

Other Possible Causes:

- Master Cartridge loose or dirty contacts.
- tester malfunction.

Recommendations:

- Cycle power to the tester (unplug and replug the serial data link connector).
- Check tester cartridge socket and cartridge edge connector.
- Check serial data link cable and connector for wear or corrosion.

TESTER IS NOT RECEIVING DATA

POSSIBLE WRONG
ECU SELECTED, NO
DATA, CHECK LINK
AND RESELECT

SERIAL DATA FAIL
CHECK DATA LINK
AND RESELECT
(EXIT)

ECU
NO RESPONSE
(EXIT)

Most Likely Cause:

- ECU-serial data link connector cable problems.
- Stop in ABS control module communication function (refer to the note on [page 193](#)).

Other Possible Causes:

- Serial data link cable loose or bad or connector pins loose or corroded.
- Bad ECU.

Recommendations:

- Verify a good serial data link cable connection.

- Cycle power to the tester.
- Run the tester Self-test.

DATA LIST PARAMETERS FLASH ON AND OFF

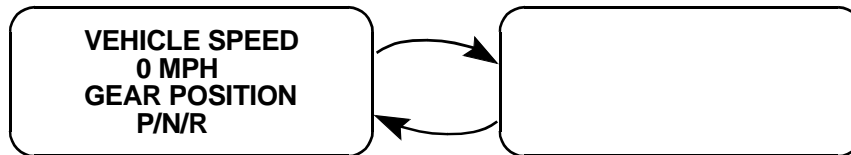

Most Likely Cause:

- Serial data link cable loose or bad.

Other Possible Causes:

- Serial data link cable connector pins loose or corroded.
- ECU-serial data link connector cable problems.
- Intermittent ECU problem.

Recommendations:

- Verify a good serial data link cable connection.
- Cycle power to the tester.

COMPANION APPLICATION MISSING



Most Likely Cause:

- BCM Application is not installed in the Application Cartridge.

Other Possible Causes:

- Application Cartridge is not installed correctly.
- Wrong cartridge is installed in the tester.

Recommendations:

- Confirm that the Suzuki Application Cartridge is correctly installed in the bottom cartridge slot of the tester.
- Confirm that no other Master or Mass Storage Cartridge is installed in the top cartridge slot.
- Contact your tester distributor to have the application installed in the Application Cartridge.

B. GLOSSARY

4WD	Four wheel drive	FC	Fix Code
A/B	Airbag	ID	Identification
A/T	Automatic Transmission	IMMOBI	Immobilizer
ABS	Antilock Brake system	in hg	Inches Mercury
ATF	Automatic Transmission Fluid	INI	Initiator
CKT	Circuit	KPA	Kilopascals
CNTL	Control	LF	Left Front
CON	Control	LR	Left Rear
CONTR	Control	MALF	Malfunction
CVT	Continuous Variable Transmission	MON	Monitor
DIFF	Differential	O/D	Overdrive
DIFFEREN	Differential	P/T	Pretensioner
DLC	Data Link Connector (SDL connector)	PCS	Pressure Control Solenoid
DNS	Diagnosis	PERF	Performance
DRV	Driver	POS	Position
ECU	Electronic Control Unit	PRES	Pressure
ECT	Engine Coolant Temperature	PRESS	Pressure
ELEC	Electrical	PRETEN	Pretensioner
EPS	Electrical Powersteering System	PSG	Passenger
		RES	Resistance
		REV	Revolution

RF	Right Front
RLY	Relay
RPM	Revolutions Per Minute
RR	Right Rear
RS232C	Standard Serial Communication interface
SDL	Serial Data Link
SDM	Sensing and Diagnostic Module
SENS	Sensor
SNSR	Sensor
SKC	Secret Key Code
SIG	Signal
SOL	Solenoid
SPD	Speed
STR	Starter
SW	Switch
SYS	System
TCC	Torque Converter Clutch
TCM	Transmission Control Module
TEMP	Temperature
TFT	Transmission Fluid Temperature
THROT	Throttle
TOS	Torque Sensor
TP	Throttle Position
TRANS	Transmission (Transmission)
TRANS	Transponder (Immobilizer)
TURB	Turbine
VIN	Vehicle Identification Number
VOLT	Voltage
VSS	Vehicle Speed Sensor
WSS	Wheel Speed Sensor

ABS/Airbag Application

Operator's Manual

1. SUZUKI ABS/AIRBAG APPLICATION DESCRIPTION

The Suzuki ABS/Airbag Application is included in the Suzuki Application Cartridge and is used with the Vetronix tester to diagnose and troubleshoot the Antilock Brake System (ABS) and Airbag system used on the following models.

NORTH AMERICAN MARKET			
YEAR	MODEL	SYSTEM	MFG.
1995	SWIFT 1000/1300 (SW310/413)	ABS (ABS-VI): 2WD. 4WSS AIRBAG (SDM-AI)	DELCO DELCO
1996-99	SWIFT 1000/1300 (SW310/413)	ABS (ABS-VI): 2WD. 4WSS AIRBAG (SDM-I)	DELCO DELCO
1996-98	SIDEKICK/X90 (SE416/SZ416)	ABS (ABS-VI): 2WD. 3WSS ABS (ABS-VI): 4WD. 3WSS AIRBAG (SDM-I)	DELCO DELCO DELCO
1999-	VITARA (SQ416/420)	ABS (DBC7): 2WD. 4WSS ABS (DBC7): 4WD. 4WSS AIRBAG (SDM-I)	DELPHI DELPHI DELCO
1999-	GRAND VITARA (SQ625)	AIRBAG (SDM-I)	DELCO

OTHER THAN NORTH AMERICAN MARKET		
MODEL	SYSTEM	MANUFACTURER
SE416	ABS (ABS-VI): 2WD. 3WSS ABS (ABS-VI): 4WD. 3WSS	DELCO DELCO
SZ416	ABS (ABS-VI): 2WD. 3WSS ABS (ABS-VI): 4WD. 3WSS AIRBAG (SDM -I)	DELCO DELCO DELCO

The Suzuki ABS/Airbag Application and the Vetronix tester team up to become a diagnostic tool which is both powerful and easy to use. With the Vetronix tester, you can select test modes which let you:

- Display diagnostic data parameters.
- Display and clear Diagnostic Trouble Codes (DTCs).
- Diagnose intermittent problems by capturing and storing multiple samples of system data before and after the problem occurs, then examining the data to determine the problem. This data is saved in memory for at least one-half hour even if the power is removed.
- Display information about the state of the vehicle at the time the DTC occurred.
- Control various components (solenoids, relays, pump motors).
- Perform special diagnostic procedures on vehicles equipped with ABS.
- Print data if the tester is connected to a serial printer.

This information can be analyzed and displayed to assist you in diagnosing ABS and Airbag problems.

HOW THE SUZUKI ABS/AIRBAG APPLICATION WORKS WITH THE VETRONIX TESTER

The tester lets you monitor data and control Electronic Control Unit (ECU) operation by communicating with the ECU via the serial Data Link Connector (DLC) present in the vehicle. The tester consists of a microcomputer, which communicates with the ECU and controls its operation, a keypad to receive directions from you, and a display to provide the data you need to diagnose vehicle electronic problems. The tester communicates with the ECU by applying an electrical signal to the serial DLC pin, then reads the ECU data signal from one of the DLC pins, translates it, and then displays the serial data on the display screen. The SUZUKI ABS/AIRBAG Application in the Suzuki Application Cartridge is the software program which performs all of the functions described in this manual.

General Key Functions	
YES , NO	Answer questions asked on tester display and select data parameters to monitor.
EXIT	Return to previous step.

General Key Functions (Continued)	
↑ , ↓	Scroll through test mode selection menus and control display of captured data. For some device control tests, the up/down arrows turn the function ON or OFF.
1 - 9	Designate trouble codes.
F0 - F9	Select and control test mode.
F3	Print Data List parameters.
ENTER	Enter designated trouble code.

2. GETTING STARTED

SETTING UP THE TESTER

The proper Data Link Connector (DLC) adapter or adapter cable for the vehicle being tested must be connected to the tester DLC Cable in order to connect the tester to the vehicle.

The following Vehicle Adapter Chart identifies which adapters and cables are required to connect each type of tester to the various Suzuki vehicles.

All adapters, cables, and any other hardware required to connect the tester to the vehicle are listed in the chart. The figure number in the chart refers to the adapter and cable illustrations on the following pages.

SYSTEM	TESTER	ADAPTER DESCRIPTION	FIGURE
ABS Delphi Brake Control 7 with 16-Pin Connector (OBD II)	MTS 3100 (OBD II compliant)	Type 3 16/14-Pin (P/N 02001969)	Figure 2-1
	Tech 1A	Type 3 16/14-Pin (P/N 02001969) OBD II I/F Cartridge (P/N 02002178)	Figure 2-2
	Tech 1	OBD II VIM (P/N 02001808) 16/24-Pin VIM Adapter Cable (P/N 02001744)	Figure 2-3
ABS/Airbag with 12-Pin Connector	MTS 3100	GM 12/14-Pin (P/N 02001364)	Figure 2-4
	Tech 1A	GM 12/14-Pin (P/N 02001364)	Figure 2-5
	Tech 1	None	Figure 2-6

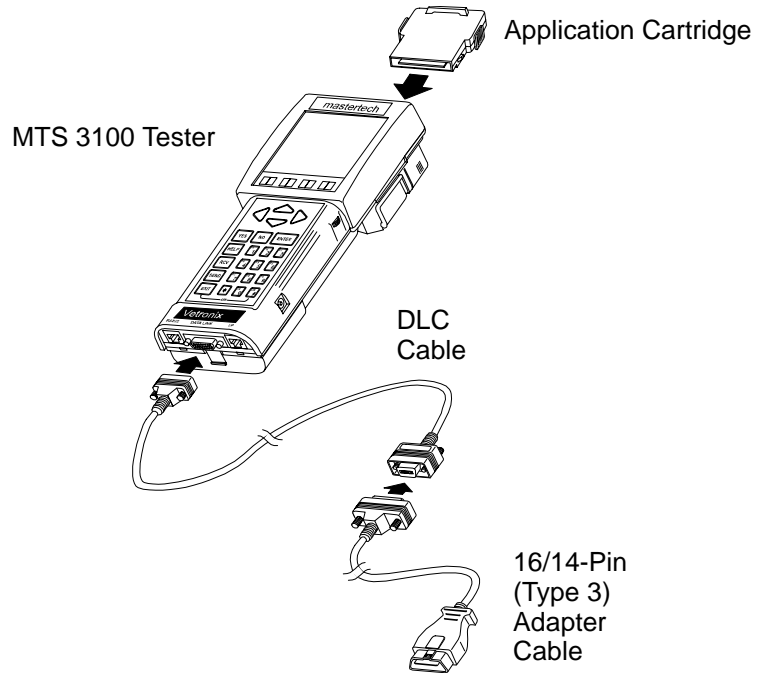

FIGURE 2-1. MTS 3100 ABS Delphi Brake Control 7 with 16-Pin Connector (OBD II)

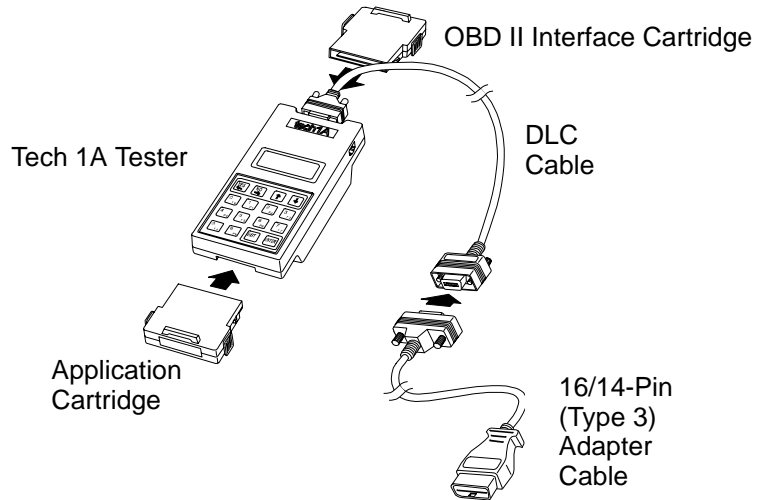

FIGURE 2-2. Tech 1A ABS Delphi Brake Control 7 with 16-Pin Connector (OBD II)

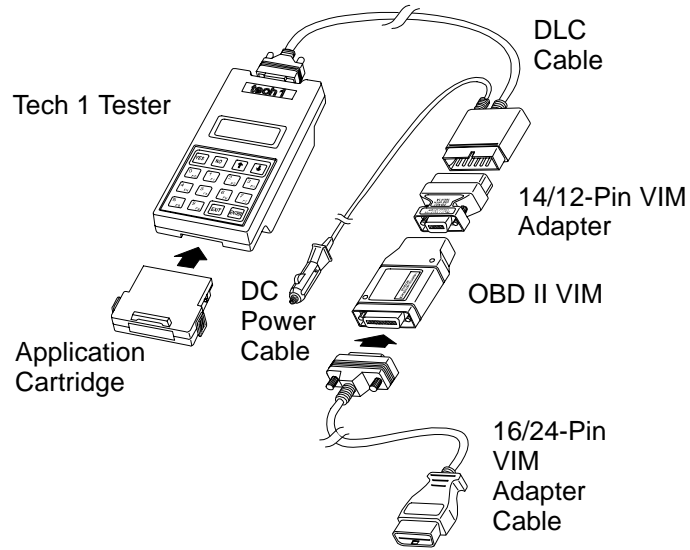

FIGURE 2-3. Tech 1ABS Delphi Brake Control 7 with 16-Pin Connector (OBD II)

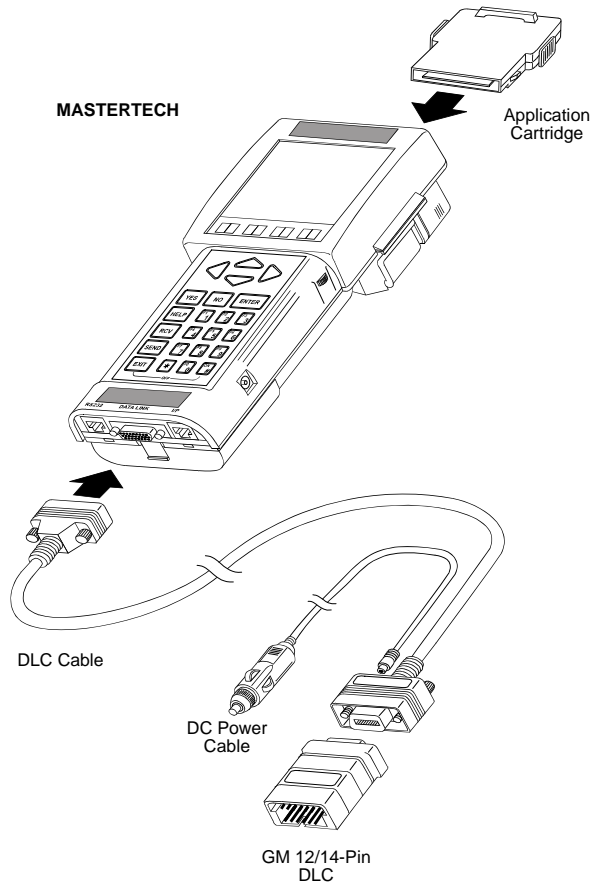

FIGURE 2-4. MTS 3100 ABS/Airbag with 12-Pin Connector

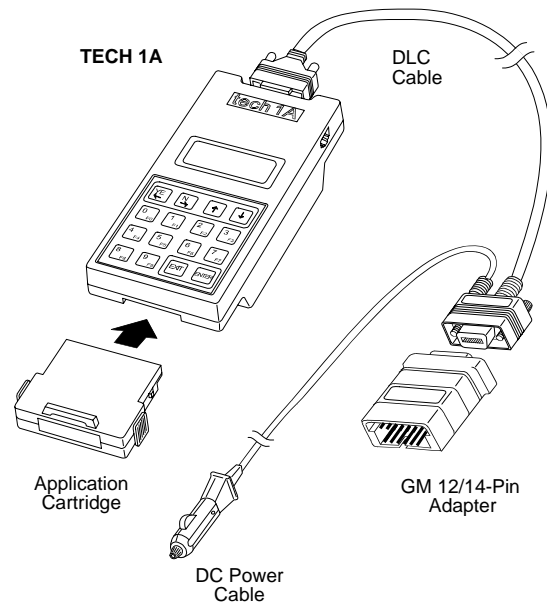

FIGURE 2-5. Tech 1A ABS/Airbag with 12-Pin Connector

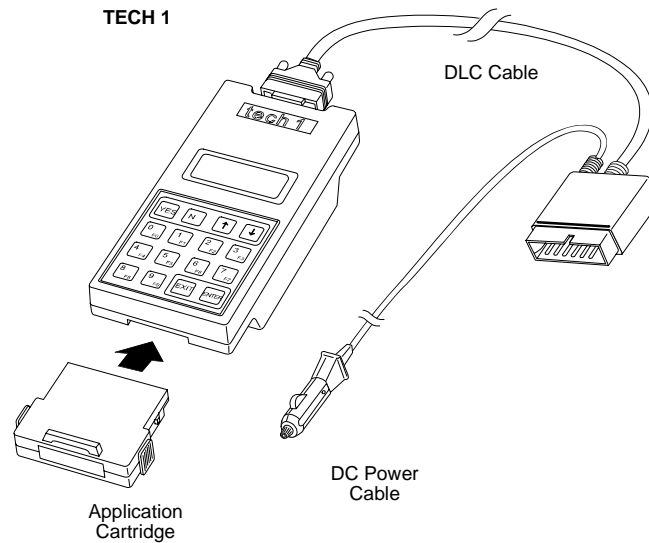

FIGURE 2-6. Tech 1 ABS/Airbag with 12-Pin Connector

Before operating the Suzuki ABS/Airbag Application, do the following:

1. Insert the Suzuki ABS/Airbag Application Cartridge into the bottom slot of the Tech 1A or Tech 1 or into the back slot of the MTS 3100. Verify that no other master cartridge is installed in the top slot of the Tech 1A or Tech 1.

NOTE

If diagnosing an ABS DBC7 system, the OBD II Interface Cartridge (P/N: 09932-66530) must be installed in the top slot along with the master cartridge in the bottom slot.

2. Make sure the vehicle ignition is OFF.
3. Locate the vehicle's serial Data Link Connector (DLC). The vehicle DLC is usually under the dash on the driver's side. Refer to the vehicle service manual if you are in doubt.
4. Connect the cable to the tester as shown in the preceding figures.
5. Plug the cable into the vehicle's DLC.
6. Turn the ignition switch on.
7. Verify that the tester displays the screen below.

**SUZUKI
MASS STORAGE
CARTRIDGE - VX.X
<ENTER>**

8. Press **ENTER** to display the APPLICATIONS menu.

**APPLICATIONS ↑↓
F0: ECM
F1: BCM
F2: ABS/AIRBAG**

Press the key to the left of ABS/AIRBAG from the APPLICATIONS menu. If more than three applications are available, use **↑** or **↓** to scroll the display.

9. Verify that the tester displays the screen below, then press **ENTER**.

**SUZUKI
ABS/AIRBAG X.X
FOR DELCO/DELPHI
(ENTER)**

If the display is incorrect, refer to [Appendix A](#).

If the tester display informs you that the companion application is missing, contact your tester distributor.

Then proceed to [Chapter 4](#).

3. OPERATING PRECAUTIONS

CONNECTING AND DISCONNECTING THE TESTER WHILE THE IGNITION KEY IS ON

Due to the possibility of voltage spikes that could damage the ECU or tester, you should not connect or disconnect the tester while the ignition key is ON or while the engine is running.

REMOVING THE CARTRIDGE WHILE POWER IS APPLIED

You should not remove or install master or auxiliary cartridges while the ignition key is ON, or while the engine is running.

If you wish to change or add a cartridge, do the following:

1. Turn the ignition off.
2. Disconnect the Data Link Connector (DLC) from the vehicle.
3. Install the cartridge in the appropriate cartridge slot.
4. Reconnect the DLC.
5. Turn the ignition ON.

If the Tester does not appear to be functioning properly, do the following to reset the tester:

1. Turn the ignition off.
2. Disconnect the DLC from the vehicle.
3. Remove all cartridges from the tester.
4. Connect the DLC to the vehicle.

5. When “MASTER CARTRIDGE IS MISSING OR MALFUNCTIONING” is displayed, disconnect the DLC from the vehicle.
6. Install the cartridge in the appropriate cartridge slot.
7. Reconnect the DLC to the vehicle.
8. Turn the ignition ON.

REMOVING OR CHANGING MASTER CARTRIDGES CONTAINING SNAPSHOT DATA

SNAPSHOT data that has been captured by a master cartridge can be printed on a tester, or compatible printer, transferred to a computer for further analysis, or displayed on a terminal. The SNAPSHOT data will be retained within the tester memory for at least 24 hours, even if the tester is disconnected from the vehicle. However, **IF YOU POWER UP THE TESTER WITHOUT A MASTER CARTRIDGE OR WITH A DIFFERENT MASTER CARTRIDGE, THE SNAPSHOT DATA WILL BE LOST.**

4. SELECTING THE SYSTEM

Press **ENTER** from the ABS/AIRBAG identification screen to continue to the Select System displays.

If stored data is available when the tester is powered up, <ENTER> = PREVIOUS is displayed at the top of the screen. Pressing **ENTER** automatically selects the last system that was selected. Since only the ABS system has Snapshot capabilities, only ABS data will be available for review.

Press **F0** to test the ABS, or press **F1** to test the Airbag system.

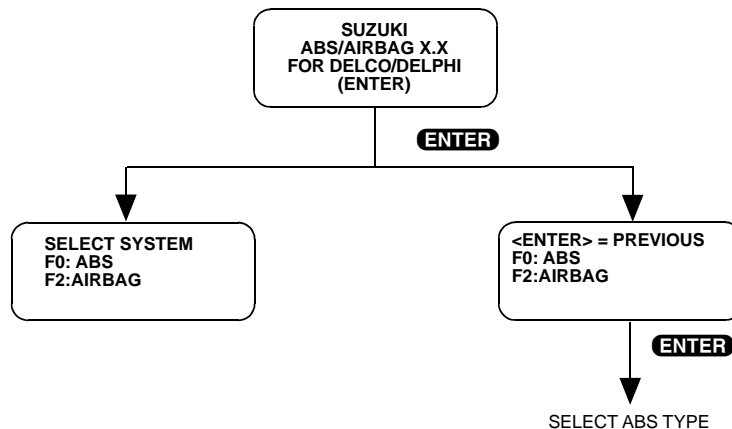

SELECTING THE ABS TYPE

If you are testing the ABS system, the tester asks which type of ABS system is installed on the vehicle. Press the key to the left of the ABS type you are testing.

SELECT ABS TYPE
F0: 2WD-4WSS
F1: 2WD-3WSS
F2: 4WD-3WSS
F3: 4WD-4WSS

SELECTING THE MODEL

If you are testing the AIRBAG system, the tester asks you to select a model. Press the key to the left of the model year you are testing.

SELECT MODEL
F0: SW SERIES
F1: SE416/SZ416
F2: SQ SERIES

SELECTING THE MODEL YEAR

If you are testing the SW series model, the tester asks you if the model year is 1995. Press **YES** if the vehicle you are testing is a 95, or press **NO** if the vehicle is not a 95.

SW SERIES
MODEL YEAR: 95?

(YES/NO)

SELECT MODE MENU

Once a system is selected, the tester displays the Select Mode menu. Detailed instructions for selecting and operating the various test modes are provided in Chapter 5 of this manual.

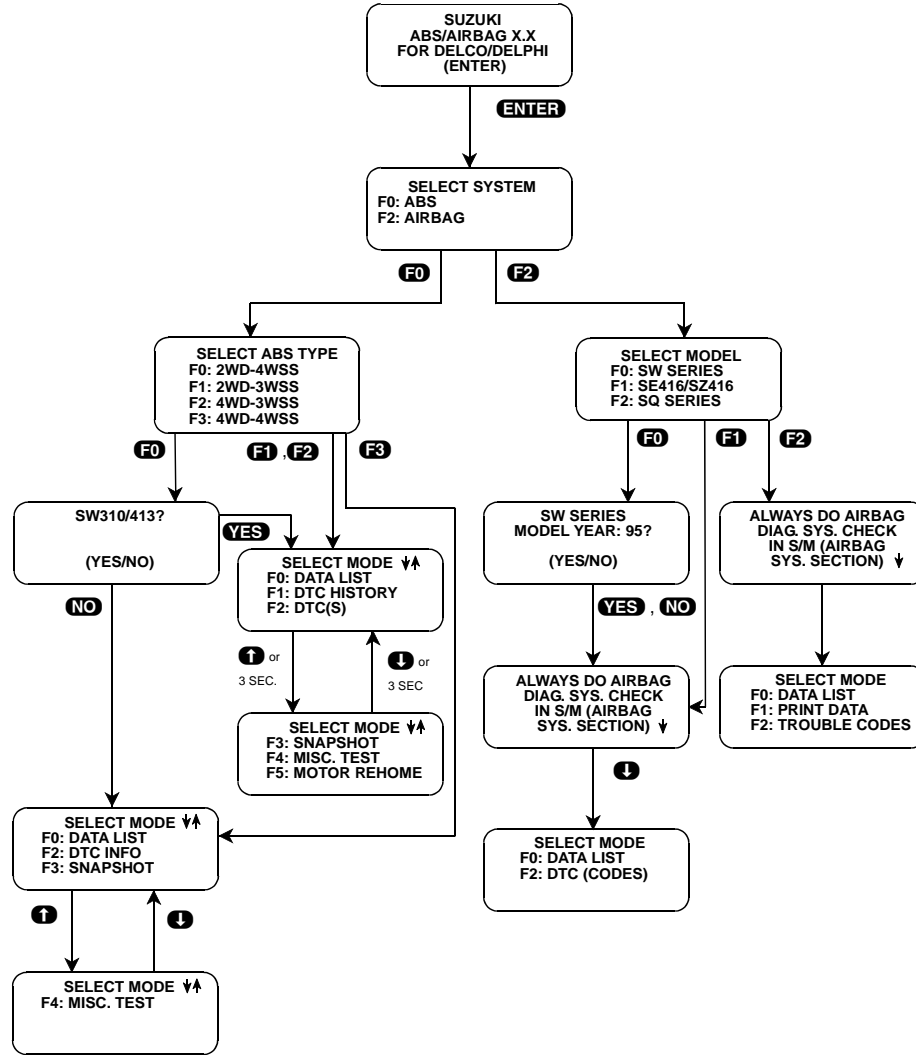

ACTIVE KEYS	
F0 - F2	Select System to Test.
YES , NO	Select vehicle.
EXIT	Return to previous step.

SELECT MODE MENU FOR ABS DBC7

Once a system is selected, the tester displays the Select Mode menu. Detailed instructions for selecting and operating the various test modes are provided in [Chapter 5](#) of this manual.

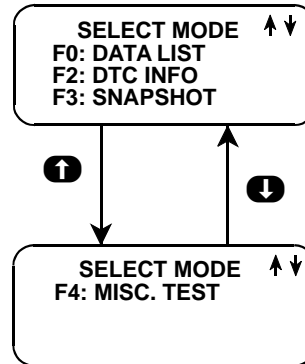

5. SELECTING AND OPERATING THE TEST MODES

SELECTING THE TEST MODES

After selecting the system to test, the tester displays a Select Mode “menu.”

Since all of the test modes cannot be displayed on the tester at the same time, the tester automatically sequences between all pages of the menu. To stop the automatic scrolling, press the **↑** or **↓** key. The menu may then be scrolled manually with the **↑** and **↓** keys.

To select a test mode, press the tester key listed to the left of the test mode on the menu. Regardless of which test modes are displayed, any test mode can be selected from the menu.

TEST MODES AVAILABLE

Once a test mode is selected, operation begins. The following test modes are available for ABS and Airbag systems. Each test mode is described on the following pages.

ABS	AIRBAG
F0: DATA LIST	F0: DATA LIST
F1: DTC HISTORY	F1: PRINT DATA (SQ SERIES ONLY)
F2: DTC(s)	F2: DTC (CODES) OR TROUBLE CODES
F2: DTC INFO (ABS DBC7 ONLY)	
F3: SNAPSHOT	
F4: MISC. TESTS	
F5: MOTOR REHOME (NOT AVAILABLE FOR DBC7)	

NOTE**Important!**

For SW, SE and SZ series vehicles:

When F4: Misc. Tests is selected from the Select Mode menu, the following message is displayed and should be ignored: **FOR ALL ABS TESTS THE TESTER MUST BE POWERED DIRECTLY FROM THE BATTERY USING A BATTERY ADAPTER CABLE.** Power is provided to the tester through the DLC even when the ignition switch is off; therefore, the battery adapter cable is not required.

TEST MODES DESCRIPTIONS

MODE F0: DATA LIST - Displays diagnostic data parameters.

MODE F1: DTC HISTORY - Displays additional information about the state of the vehicle at the time the DTC occurred.

MODE F1: PRINT DATA- Sends a copy of the DATA LIST to a printer or terminal via an RS-232 cable.

MODE F2: DTC(s), DTC (CODES), TROUBLE CODES - Displays Diagnostic Trouble Codes which have been stored. Trouble codes can also be cleared using Mode F2.

NOTE

ABS DBC7 systems will display Current or History DTCs to the right of the code number.

MODE F3: SNAPSHOT - Records data before and after the occurrence of an intermittent fault condition.

MODE F4: MISC. TESTS - The Miscellaneous Tests mode allows the user to perform specialized tests on the ABS system.

MODE F5: MOTOR REHOME - Returns all ABS actuator pistons to the “home” position.

MISCELLANEOUS TESTS AVAILABLE

The following Miscellaneous Test modes are available for testing the ABS. Press **F4** from the Select Mode menu to display the Misc. Tests menu.

- F0: MANUAL CONTROL
- F0: SOLENOID TEST (ABS DBC7 ONLY)
- F1: PUMP MOTOR (ABS DBC7 ONLY)
- F2: HYDRAULIC CONTROL
- F2: RELAY TEST (ABS DBC7 ONLY)
- F3: AUTO BLEED (ABS DBC7 ONLY)
- F4: LAMP TEST (ABS DBC7 ONLY)
- F4: MOTOR TEST

F5: GEAR TENSION RELIEF
 F6: RELAY TEST
 F7: VOLTAGE LOAD
 F8: LAMP TEST
 F9: SYSTEM ID

NOTE



When F4: MISC. TESTS is selected for SE and SZ series vehicles with 4WD-3WSS, the tester displays the following menu.

SELECT SYSTEM
F0: ABS
F3: IDLE UP

Press **F0** to perform the Miscellaneous Tests listed above.

If **F3** is pressed, the tester will display a menu with one option: "F0: MANUAL CNTRL." Press **F0** to perform the Manual Control Test on the Idle Up circuit.

MISCELLANEOUS TESTS DESCRIPTIONS

Delco ABS VI Miscellaneous Test Descriptions

F0: MANUAL CONTROL: Allows you to manually control ABS actuators including the Solenoids and Motors.

F2: HYDRAULIC CONTROL: Allows testing of the ABS brake hydraulic channels by automatically sequencing through RELEASE, HOLD, and APPLY functions on the channel you select.

F4: MOTOR TEST: Once the motor pack has been separated from the ABS hydraulic modulator, the Motor test guides you through an automated ABS Motor Pack test.

F5: GEAR TENSION RELIEF: Allows you to relieve tension from the motor gears in order to allow the motor pack to be separated from the modulator assembly.

F6: RELAY TEST: Allows you to test the Enable Relay while displaying the ABS relay battery voltage. This allows verification of relay operation.

F7: VOLTAGE LOAD TEST: Allows you to check the battery for adequate capacity for ABS operation. Appropriate messages are displayed that indicate any required area of service.

F8: LAMP TEST: Allows manual control of ABS amber warning lamp circuit, red brake telltale circuit, and light blue ABS active lamp if equipped.

F9: SYSTEM ID: The System ID function displays data about the vehicle's ABS Controller.

Idle Up Circuit Test (4WD-3WSS Type Only)

F3: IDLE UP TEST: Allows you to perform the Manual Control test on the Idle Up Circuit while displaying the circuit's feedback.

DBC7 Miscellaneous Test Descriptions

F0: SOLENOID TEST: Allows manual control of the hydraulic circuit valves for each channel.

F1: PUMP MOTOR: Allows the user to command the ABS pump motor ON and OFF in order to confirm ABS pump motor operation.

F2: RELAY TEST: Allows you to test the Enable Relay while displaying the ABS relay battery voltage. This allows verification of relay operation.

F3: AUTOBLEED: Removes air from the secondary hydraulic circuits by running the ABS motor.

F4: LAMP TEST: Allows manual control of the ABS warning lamp circuit.

ACTIVE KEYS	
↑ ↓	Stop the automatic scrolling, then manually scroll the menu up or down.
F0 - F9	Select Test Mode or Miscellaneous Test.
EXIT	Return to vehicle selection.

MODE F0: DATA LIST

The purpose of the DATA LIST mode is to continuously monitor vehicle parameters. The tester allows you to display diagnostic parameters for the ABS and Airbag systems.

The tester displays data parameters in pairs. You can use preprogrammed pairs, or you can create your own pairs through the process explained on the following pages.

The tester display tells you which parameters are being monitored. The current value of the parameter is displayed with the parameter units. This means you don't have to hunt through manuals to determine what is being displayed.

To access the Data List, do the following:

1. Press **F0** to select DATA LIST from the Select Mode menu.
2. For ABS DBC7, press **F2** or **F3** from the Select Data List Menu.
3. Select the data parameters to be displayed by scrolling through the parameters with the **YES** and **NO** keys. If you hold either key down, the tester sequences through all parameter pairs.
4. Pressing the **F8** key while in the Data List mode allows one sample of all data parameters to be printed, if the tester is connected to a serial printer.
5. If communication with the component being tested is lost, the tester will inform you. The tester will attempt to reestablish communications. If the attempt is successful the tester returns to the Data List display. If after five seconds there is still no communication, the tester displays messages indicating the cause of the fault.
6. Press **EXIT** to return to the Select Mode menu.

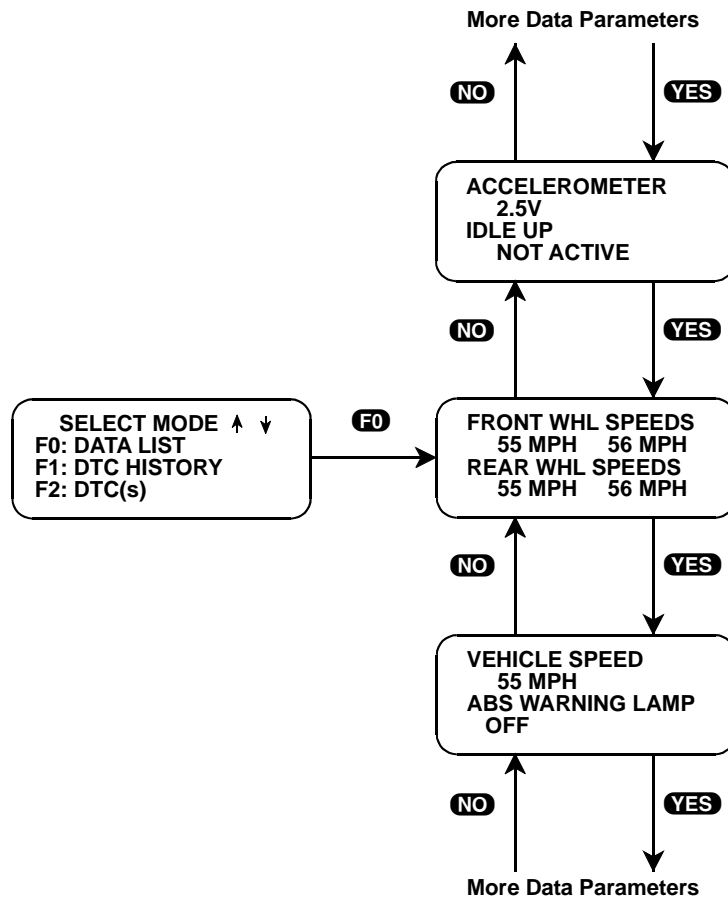

FIGURE 5-1. Example of Data List Mode Operation for ABS
(For 4WD-3WSS Type)

CREATE YOUR OWN DATA PAIRS

You can create data parameter pairs different from the preprogrammed pairs. Any two parameters can be made into a pair.

New data pairs are created by simply scrolling either the top or bottom display parameter, while the other display parameter is fixed. Pressing **F0** causes the top display parameter to be fixed, which is indicated with an “*” in the left column of the second line of the display, as shown in Figure A. Pressing **F1** causes the bottom display parameter to be fixed, as shown in Figure B. To “unfix” the top parameter, press **F1**. Press **F0** to “unfix” the bottom parameter. The tester won't allow both the top and bottom parameters to be fixed at the same time.

As an example, let's say you wish to create a pair with FRONT WHEEL SPEED and VEHICLE SPEED. To do so, scroll through the preprogrammed pairs with the **YES** or **NO** key until you find a pair with FRONT WHEEL SPEED. Fix FRONT WHEEL SPEED by pressing **F0** since it is the top parameter. Then scroll the other half of the display with the **YES** or **NO** key until VEHICLE SPEED is displayed.

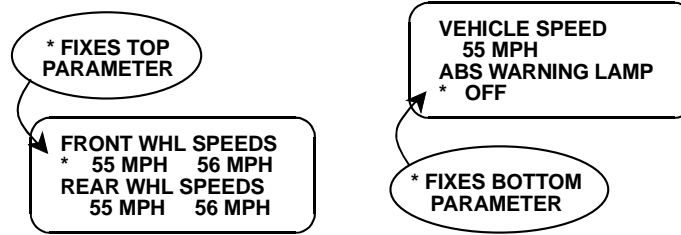

Figure A

Figure B

DATA LIST PARAMETERS

Some Data List parameters are discrete parameters (they can only have two or three values), and their units are the descriptors for the states they can have. For example, the ABS RELAY CMD is either ON or OFF.

ACTIVE KEYS	
YES & NO	Scroll through displayed data parameters.
F0	Mark the top display parameters as “fixed” or cancel the bottom display parameters as “fixed” for creating your own pairs.
F1	Mark the bottom display parameter as “fixed” or cancel the top display parameters as “fixed” for creating your own pairs.
F7	Toggle between English and Metric units (MPH vs. km/h).
F8	Output DATA LIST parameters to a printer.
EXIT	Return to the Select Mode menu.

MODE F1: PRINT DATA

PRINT DATA (SQ SERIES AIRBAG ONLY)

When the RS232C I/F Cartridge is installed in the tester, or if you are using a tester Series A or MTS 3100 tester, the Print Data mode allows you to print the VIN, engine type and Data List to a serial printer or terminal. This is the data list sent by the ECM (or PCM) to the tester. The data list parameters can be printed without printing the VIN or engine type by pressing the **F8** key in the Data List or Snapshot Replay mode.

To Print Data, do the following:

1. Press **F1** to select the Print Data mode from the Select Mode menu. The VIN entry screen is the first screen displayed in this mode. Only the last 6 digits of the VIN are entered on this screen. This information is then printed out as part of the header information that accompanies each data list print out. The VIN is entered via the numeric portion of the key pad and the **ENTER** key is pressed to move to the next section of the print function.
2. The next screen requires the **ENTER** key to be pressed to start printing the data. This screen allows the cable to be connected between the tester and the receiving device.
3. When the **ENTER** key is pressed the "WAITING TO PRINT DATA" screen is displayed until printing begins. If this screen is displayed for more than a few seconds, something is wrong with the set up. Check that all connections are secure, and that any receiving device is turned on and in the proper receive mode.
4. As printing begins, the tester displays the % COMPLETE of the print procedure. After the printing is 100% complete, the VIN screen is immediately displayed with the previously selected VIN. Pressing the **ENTER** key twice from this screen will cause another data stream to be buffered for printing as soon as the current data stream is output from the tester.
5. Pressing the **EXIT** key at any point will cause the select mode menu to be displayed. If the **EXIT** key is pressed before printing is completed, only the data that has already been sent to the RS232C Cartridge will be printed. SOME DATA WILL BE LOST.

PRINT DATA
ENTER LAST 6 VIN
DIGITS 000000
THEN PRESS ENTER

**PRINT DATA VIN
ENTRY SCREEN**

PRESS ENTER TO
PRINT DATA

**SET UP RS232C
CARTRIDGE**

RS232C NOT
CONNECTED

**RS232C INTERFACE
CARTRIDGE
NOT CONNECTED**

WAITING TO
PRINT DATA

**PRINT
INITIALIZATION**

99% COMPLETE
PRINT DATA

**PRINT IN PROGRESS
SCREEN**

ACTIVE KEYS

ENTER	Move to the next section of the Print Data function.
0 - 9	VIN entry keys.
EXIT	Terminate the Print Data mode and return to the Select Mode menu.

Print Sample

SUZUKI MOTOR CORPORATION		
TYPE: AIRBAG		
VIN: 123456		
TECH 1 DATA LIST		
NO.	DESCRIPTION	VALUE
1.	WARNING LAMP	OFF
2.	IGNITION VOLTAGE	0.76V
3.	DRIVER VOLT	2.0 - 6.0V
4.	PASSENGER VOLT	2.0 - 6.0V

MODE F1: DTC HISTORY

The DTC History mode is only available when testing the ABS system.

NOTE



DTC History is not available on ABS DBC7 systems.

DTC History is a feature that provides you with additional fault information for the purpose of increasing serviceability. This information, when used in conjunction with standard diagnostic procedures, can reduce the time you spend trying to locate the cause of intermittent faults, by identifying the degree of intermittence. Highly intermittent (rarely occurring) faults are difficult to recreate and therefore are usually diagnosed differently from frequent or current faults. DTC History identifies the following information:

Two “pages” of information are displayed for each of the first five failures and five pages of information are displayed for the last failure.

FIRST FIVE (OR FEWER) FAILURES

The first five faults are displayed in the order in which they occurred. This information can be used to identify situations where an initial fault that was detected no longer remains, but the fault conditions explain the occurrence of a later fault.

The first page of information displays how often each of the first five faults have occurred. The second page informs you how many drive cycles have occurred since the code was last set.

This information identifies intermittent fault conditions and the degree of intermittence. If a fault occurred 1 out of 35 drive cycles, an unusual condition may have occurred, such as a severe pot hole, that caused the fault. In any case, a fault this intermittent is going to be difficult to locate. Up front, you know special diagnosis techniques are needed to identify the cause. If the fault occurred 10 out of 15 drive cycles, your chances of identifying the fault are much greater and recreation is probably much easier. Again, you know

this before an attempt is made to identify the cause. If the fault occurs every drive cycle, the fault is easy to duplicate and diagnosis should be easier.

LAST FAILURE

The last failure that occurred is identified specifically. This fault is what brought the customer in for repair. Additionally, the following information identifies what was happening when the last fault occurred:

1. The first page of information about the last failure indicates the speed the ABS controller believes the vehicle was going at the time the fault occurred. An unreasonable number here may lead you to suspect wheel speed sensor problems.

The status of the brake switch at the time of the fault (Off or On). This tells you if there was any brake application when the fault occurred. Only the state of the brake switch is known, the brake pedal may have simply been depressed or shorted without any vehicle deceleration.

2. The second, third, and fourth pages of information about the last failure display the status of the brake telltale at the time of the fault (ON or OFF), and whether or not the brake had been depressed during this ignition cycle. If the brake switch circuit was OPEN, no brake input is seen. Also, many drivers do not depress the brake when starting the car but do prior to putting the car in gear. If no brake input was seen prior to the fault and the brake switch circuit is OK, this information tells you the fault was probably detected shortly after the ignition switch was turned on.

Also on the second, third, and fourth pages is whether or not the vehicle has been driven at a speed greater than 25 MPH during this ignition cycle and whether or not an ABS stop was in progress when the fault occurred. This may point to a fault caused by additional stresses or vibration the vehicle encountered when in an ABS stop.

3. The fourth and fifth pages of information about the last failure display the code set and how many drive cycles since this code set.

DRIVE CYCLES

A drive cycle occurs when the ignition is turned "ON" and the vehicle is driven faster than 10 MPH. However, if a current code is set, a drive cycle occurs (counter increment) for that code even if 10 MPH is not reached prior to turning off the ignition.

NOTE



If no ABS faults have occurred for 100 drive cycles, the ABS controller will clear itself of all fault information.

To access DTC History, do the following:

1. Press **F1** to select DTC History from the Select Mode menu.
2. The tester displays two "pages" of information about the first failure which occurred. The first page indicates how many times the failure has occurred over how many drive cycles. The second page tells how many drive cycles have occurred since the code was last set.

The pages automatically sequence at 5-second intervals. Press **↑** to manually sequence through the pages or **↓** to stop the sequencing.
3. **Step 2** is repeated to display information from the first five failures. If fewer failures have occurred, only information from failures that have occurred is displayed.

4. After the first five (or fewer) trouble codes have been viewed, the tester displays additional information from the most recent failure. Five “pages” are needed to display all of the information about the last failure as shown in the flow chart on the following page. These pages automatically sequence at 5-second intervals, or you can press **F1** to manually sequence through them, or **↓** to freeze the display.

In the following sample flow char, the first failure (code 27) demonstrates an intermittent fault that was the first code set, but it hasn't occurred for the past 13 drive cycles. The second failure of the flow chart demonstrates an intermittent fault that was the second code set, but it hasn't occurred in the present drive cycle. In the example the last failure is the same as the second failure, since only two failures had occurred. It is also possible for the last failure to be the same as the first because the first is an intermittent problem and could possibly cause another trouble code to be set after the second failure has been set.

5. Press **EXIT** to return to the Select Mode menu.

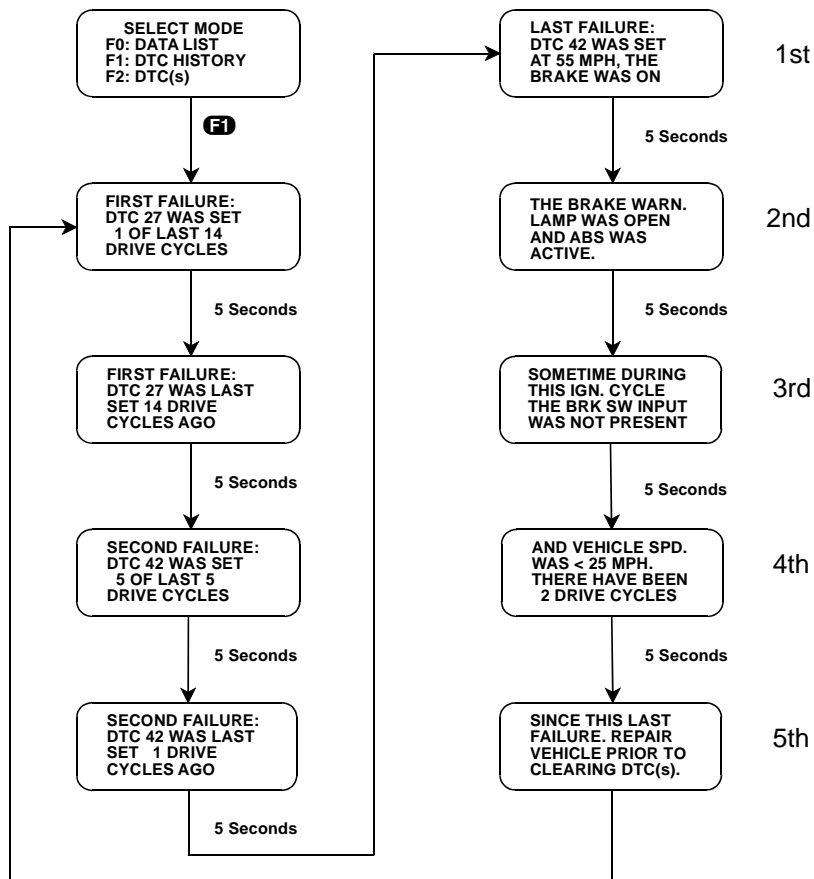

ACTIVE KEYS	
F1	Select DTC History from the Select Mode menu.
F7	Toggle between MPH and km/h display.
↑	Manually scroll the display.
↓	Stop the display from sequencing.
EXIT	Return to the Select Mode menu.

MODE F2: DTC(S)/DTC INFO

The DTC(s) or DTC (CODES) mode displays Diagnostic Trouble Codes which have been set by the vehicle. You can also use the DTC mode to clear the codes after the codes have been displayed.

DTC(s) or DTC (CODES) are set when an abnormal condition is detected. They are a key to diagnosing many of the problems which can occur in the vehicle. Therefore, you should look to see if any trouble codes are set at the beginning of every diagnostic session.

To access DTC Info, do the following:

1. Verify that the ignition is in the "ON" position.
2. Press **F2** to select the DTC(s) or DTC INFO mode from the Select Mode menu.
3. If the ABS or AIRBAG is being tested and the vehicle's ABS or AIRBAG fails to respond to the tester within 6 seconds, the tester will display:

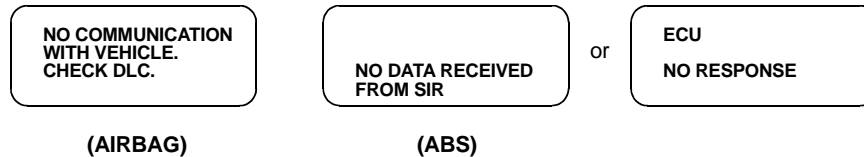

Under these conditions, or if the tester displays "WAITING FOR DATA" for more than 6 seconds, you should:

- Cycle power on the tester.
- Cycle the vehicle's ignition and leave it in the ON position.
- Verify that the vehicle contains an ABS or AIRBAG system.
- Check the connection to the DLC.

If this message persists, you should check for a shorted serial data link or a faulty ABS or AIRBAG controller. This can happen if power or ground is not available to the ABS or AIRBAG controller. Refer to the ABS Diagnostic Circuit Check or AIRBAG Diagnostic System Check in the service manual.

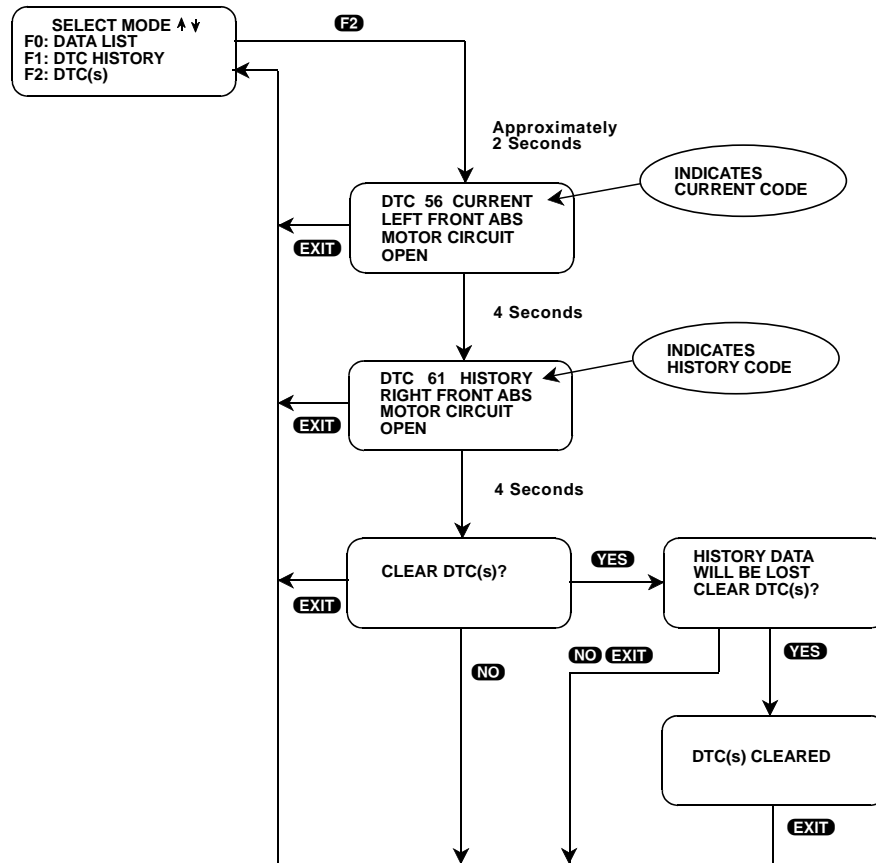

FIGURE 5-2. Example of MODE F2: DTC Display and Clearing for ABS

4. Once data has been received, the tester displays each code for 4 seconds. You can freeze the display by pressing the **↓** key. Pressing **↑** causes the tester to sequence to the next code. Refer to the Service Manual for a description of the trouble codes.
5. The DTCs are identified as either current or history codes.

Current Code: A fault which is currently present in the vehicle during this ignition cycle.

History Code: A fault which occurred during a previous cycle.

The tester distinguishes between current and history codes by displaying “CURRENT” for Current codes, and “HISTORY” for History codes.
6. For the ABS-VI system, the tester performs analysis on the codes which are present and displays information on the most likely cause of the codes. This information is displayed immediately after the ABS DTC display has been completed. See [Figure 5-3](#).

The Antilock Brake System features a sophisticated on-board diagnostic system that, under most fault conditions, will specifically identify the cause of the fault detected. Because of this “pinpointing” ability, there are some conditions where more than one trouble code will be stored when certain faults occur.

The “ABS FAULT ISOLATION” feature identifies multiple trouble codes that can be caused by common area faults, and will display the probable source of the fault (not available for ABS DBC7). Consult the service manual to verify the isolation has not been caused by a catastrophic failure or a series of faults that

occurred over a period of time. Under these conditions, the “FAULT ISOLATION” information may not identify the actual source of the fault.

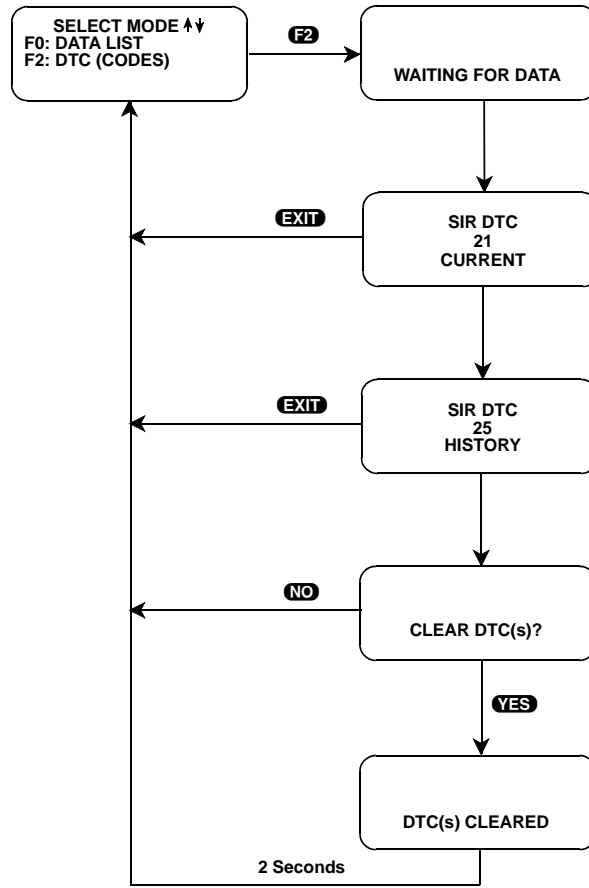

FIGURE 5-3. Example of MODE F2: DTC Display & Clearing for Airbag

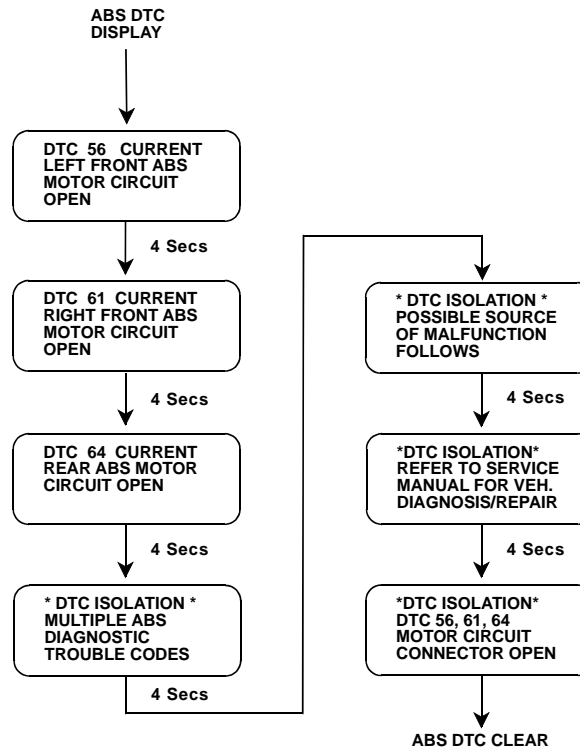

FIGURE 5-4. Example of ABS Fault Isolation

Code Clearing:

- 7a. ABS: After all DTCs and ABS fault isolation messages (ABS-VI) have been displayed, the tester prompts you to “CLEAR DTC(s)”. If you press **NO**, you leave the TROUBLE CODE mode without clearing the codes.
- 7b. AIRBAG: To clear all stored DTCs on the vehicle, press **EXIT** to go to the Clear DTC(s) Phase (for SQ Series AIRBAG, press **ENTER** to go to the Clear DTC(s) Phase). When “CLEAR DTC(s)?” is displayed, press **YES** to clear the DTCs, or press **NO** for not clearing them.
- 8a. ABS-VI: If you press **YES**, the following message is displayed on the tester:

HISTORY DATA
WILL BE LOST.
CLEAR DTC(s)?

If you are testing the ABS, this gives you the opportunity to examine more information which the ABS controller has saved about the ABS trouble codes. Press **NO** if you do not want to clear the codes. Pressing **YES** will cause ABS codes to be cleared. Press **EXIT** to return to the Select Mode menu.

For ABS DBC7: If you press **YES**, the tester will display either “DTC(s) CLEARED” or “DTC(s) NOT CLEARED.”

- 8b. AIRBAG: When the **YES** key is pressed, the tester will display either “DTC(s) CLEARED” or a “DTC(s) NOT CLEARED.” After a few seconds the tester will automatically display the Select Mode menu (For SQ series, tester displays “NO CODE” or trouble codes). When the **NO** key is pressed, the

DTCs are retained in the AIRBAG controller and the tester will display the Select Mode menu (For SQ series, tester displays “NO CODE” or trouble codes).

9. If the “CODE CLEAR FAIL” message is displayed, reenter the DTC mode and try to clear codes again. If it fails again, then you probably have an intermittent connection to the DLC. It is also possible that the controller is malfunctioning. You can also try cycling the ignition ON/OFF.

ACTIVE KEYS	
YES , NO	Used to determine whether DTCs should be cleared or not.
↓	Freeze the display of the latest DTC.
↑	Display the next DTC.
EXIT	Terminate DTC display.
ENTER	Display “EXECUTE CLEAR CODES?” (AIRBAG only).

MODE F3: ABS SNAPSHOT

The SNAPSHOT mode is only available when ABS is selected from the System Select menu.

The purpose of the SNAPSHOT test mode is to help you isolate an intermittent or transient problem by storing data parameters before and/or after the problem occurs.

When the tester is operating in SNAPSHOT mode, it is constantly storing information about data parameters and trouble codes. A time and position index for the stored information is also saved. When the memory is full, the oldest (earliest) data collected is erased to make room for new information.

A “TRIGGER” tells the tester the start, center, and end points of data collection. You can specify a “TRIGGER CONDITION” so the tester collects data that will be most useful in diagnosing the current problem. You can also select the location of the “TRIGGER POINT.”

TRIGGER POINT

If F9: TRIG. POINT is selected from the SNAPSHOT OPTIONS menu, a trigger point selection menu is displayed. The Trigger Point menu allows you to specify which data to capture data that occurs before, after, or both before and after the point at which the trigger occurs. If no trigger point is selected, the center trigger point will be used and a similar number of data samples before and after the trigger will be saved. Trigger point is fully explained in [Step 4](#) of the procedure.

TRIGGER CONDITION

The trigger condition defines the specific circumstances under which you want the trigger to occur. The possible trigger conditions are:

- MANUAL TRIGGER **F1**: While operating the SNAPSHOT mode, you can always cause the trigger to occur by pressing the **F9**, **ENTER**, or **EXIT** keys.

- **AUTOMATIC TRIGGER (F2)**: The tester examines the ABS data and triggers the SNAPSHOT if an abnormal condition occurs. The ABS automatic trigger feature is intended to identify deviations in data or input signals that may not set an ABS trouble code. If an automatic trigger condition is encountered, it may provide information to support customer complaints of irregular ABS performance or intermittent ABS warning lights. The automatic trigger will occur if one of the following conditions exists:
 - A sudden change in speed of one wheel. Be sure you are driving at a constant speed on a clean, dry, smooth surface when a trigger occurs. Spinning the tires, locking the wheels while braking, driving through pot holes, or performing ABS stops will cause a trigger that is NOT identifying a system problem.
 - Very short loss of brake switch input that may not set a code, but will cause a momentary loss of ABS.
 - Very short loss of brake switch circuit input that may not set a code, but will cause a momentary loss of ABS.
 - If the red brake telltale turns on.
 - If the battery voltage falls below 11.0 volts or goes above 16 volts.
 - Loss of data.

The intent of the ABS automatic trigger feature is to identify short duration intermittent problems. For this reason, the data is taken at a high rate of speed: approximately every 1/20th of a second.

NOTE



Automatic trigger is not available on ABS DBC7 systems.

10. **ANY CODE (F3)**: Any trouble code detected will cause the trigger.

11. **SINGLE CODE (F4)**: You can select a specific trouble code that must be detected before the trigger will be set. [Step 3](#) in the procedure tells you how to enter the code.

NOTE



Single Code Trigger is not available on ABS DBC7 systems.

Once the trigger occurs, the tester will retain data according to which trigger point you have selected.

VIEWING CAPTURED DATA

You have the option of bypassing the Data Capture phase and displaying previously captured data by selecting **REPLAY DATA** from the **SNAPSHOT** menu. All data captured during **SNAPSHOT** will be retained in the tester until it is overwritten by a new **SNAPSHOT**, or if the tester is unplugged from the DLC for at least 24 hours.

If no data has been captured, or if data stored in the tester memory is not data from the vehicle currently being tested (i.e., it's from a previously tested vehicle), the tester will display the following message for 4 seconds (or until the **↑** or **EXIT** key is pressed):

CAPTURED DATA
NOT FROM
SELECTED
VEHICLE

CAPTURED DATA
NOT FROM
SELECTED
SYSTEM

PRINTING CAPTURED DATA

In addition, the cartridge has the capability to print the captured data, providing a hard copy of any selected data sample. The VP-411 (or compatible) printer is required to support this print function. See [Step 14](#) of the procedure.

The operation of SNAPSHOT mode is divided into three phases: Set-Up (Steps 1-4), Data Capture (Steps 5-8), and Data Display (Steps 9-15).

SETUP PHASE

To setup Snapshot mode, do the following:

1. Press **F3** to select SNAPSHOT mode from the Select Mode menu.
2. The trigger condition and review data options are displayed in a self-scrolling SNAPSHOT MODE menu. To select a trigger option, just press the function key displayed to the left of the desired trigger condition. To replay previously captured data, press **F0**.
3. You can choose a specific ABS trouble code for the trigger condition by pressing **F4**.

When the tester screen displays “ENTER DTC XXX,” use numeric keys **0** - **9** to enter the two digit trouble code number that you have selected, then press the **ENTER** key. The tester will continue to store data until the specified trouble code is detected, or until you press the **F9**, **ENTER**, or **EXIT** key. If the code you enter does not exist for the vehicle being tested, an “INVALID DTC” message will be displayed and the code will have to be reentered.

To select a trigger condition, press the function key to the left of the desired trigger condition. To bypass the Data Capture phase and review previously captured data, press **F0**: REPLAY DATA.

NOTE



Single Code Trigger is not available on ABS DBC7 systems.

4. In addition to offering a trigger condition selection, this cartridge offers the option of selecting a trigger point. If you select **F9**: TRIG. POINT from the SNAPSHOT OPTION menu, the following options are displayed: **F0**: BEGINNING, **F1**: CENTER, and **F2**: END OF DATA.

NOTE



Trigger Point is not available on ABS DBC7 system.

F0: BEGINNING: The trigger will be at the beginning of the captured data. After the trigger occurs, the tester will continue to capture data until the memory is full, then the data will be displayed. If not enough

data samples have been collected to fill the tester memory (because the **EXIT** key was pressed before the tester memory was full), fewer than the maximum number of samples will be saved.

F1: CENTER: A similar number of data samples that occurred before and after the trigger point are captured. However, if the trigger occurs at or near the start of the Data Capture phase, there will be fewer samples before the trigger point is available for display. Also, if the **EXIT** key is pressed after the trigger occurs, but before the tester memory is full, fewer data samples captured after the trigger point will be available for display.

F2: END OF DATA: Data that occurred before the trigger is captured.

ACTIVE KEYS	
F0	Replay previously captured data.
F1	Select the manual trigger mode.
F2	Select the automatic trigger mode.
F3	Select the trigger on any code mode.
F4	Select the trigger on specified code.
F9	Select Trigger Point.
0 - 9	Select specific trouble code.
ENTER	Enter selected trouble code.
EXIT	Terminate the SNAPSHOT mode and return to the Select Mode menu.

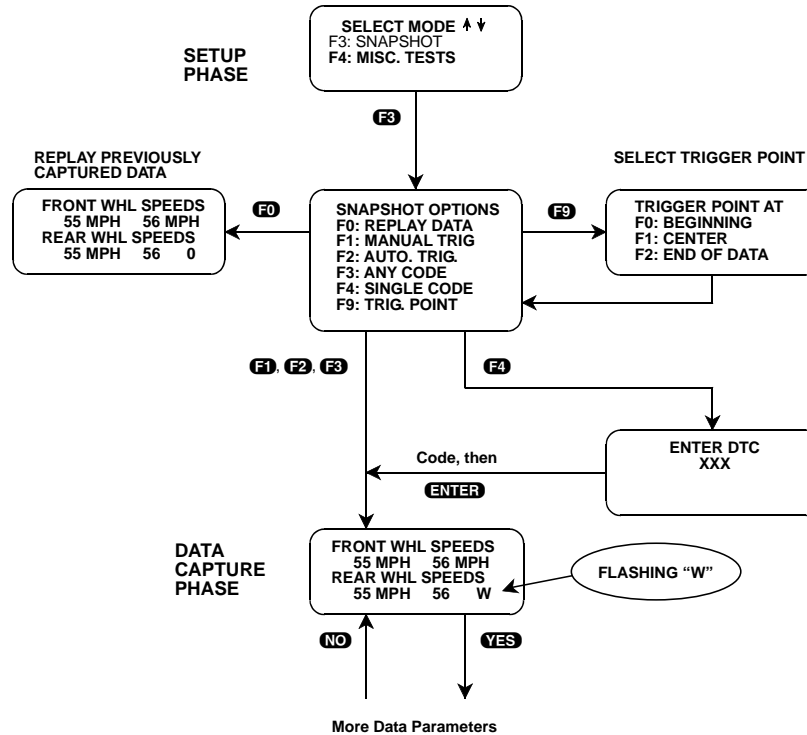

FIGURE 5-5. Snapshot Setup Phase

DATA CAPTURE PHASE

- Once the trigger condition is specified, the tester begins storing data parameters and trouble codes while displaying the Data List parameters. Trouble codes for some systems are also stored and can be displayed in the Data Display phase.
- The data is organized as a number of data “samples.” The value or state of each parameter as well as all trouble codes are saved for each sample. The data display indicates the “waiting for trigger” condition with a flashing “W” in the lower right-hand corner of the display. While waiting for the selected trigger, the **F9**, **EXIT**, or **ENTER** keys can always be used to force a trigger.

The number of samples saved by the tester is a function of the system being tested. Normally, the trigger point occurs in the center of the data and half of the samples are before the trigger and half are after. If you selected a different trigger point during setup (using the **F9** function) the trigger point (sample 0) will be near the beginning or end of the samples.

- Once the trigger occurs, the tester continues to save data samples until its memory is full. The data display indicates that the trigger has occurred by replacing the flashing “W” (wait) with a fixed “T” (trigger). As soon as the memory is full, the data capture terminates automatically.

After the data capture terminates, the tester briefly displays the cause of the trigger. This display can also be seen by pressing **F3** in the Data Display Phase (Step 12).

- Pressing **EXIT** after the trigger has occurred terminates the Data Capture phase early, and the SNAPSHOT mode will move to the Data Display phase.

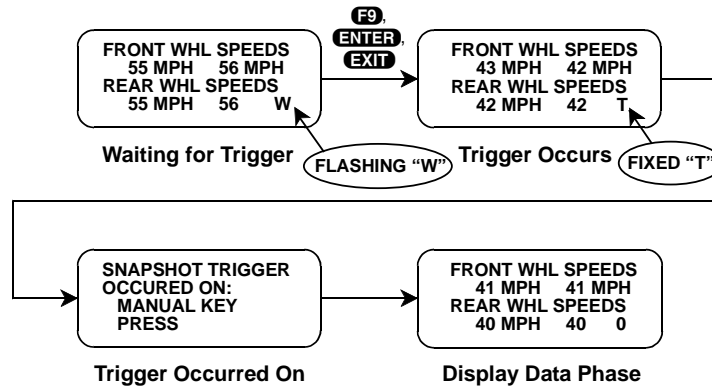

FIGURE 5-6. Data Capture Phase

ACTIVE KEYS	
YES, NO	Scroll through displayed data parameters.
F0	Mark the top displayed parameter as “fixed” or cancel the bottom displayed parameter as “fixed” for creating your own data pairs.
F1	Mark the bottom displayed parameter as “fixed” or cancel the top displayed parameter as “fixed” for creating your own data pairs.
F7	Toggle between MPH and km/h display.
F9	Manual trigger.
ENTER	Manual trigger.
EXIT	Manual trigger, or Display captured data if trigger has already occurred.

DATA DISPLAY PHASE

9. The Data Display phase is indicated with a number (initially 0) in the lower right-hand corner of the display. Select the data to be displayed by using the **YES** and **NO** keys.
10. The “current” DTCs present during each sample can be displayed by pressing **F2**. The DTCs automatically scroll once, then the display returns to the Data Display list. “CURRENT” displayed at the end of line two in the DTC display indicates the code is a current code. History codes are not read during SNAPSHOT mode.

The DTC display can be “frozen” using the **↓** key, then “unfrozen” by pressing the **↑** key.

11. Use the **↑** and **↓** keys to select the desired sample. An index is displayed in the lower right-hand corner of the tester display. Sample “0” corresponds to the trigger sample; sample “-1” is the sample immediately preceding the trigger; sample “+1” is immediately after the trigger, and so on. The index range may be less than the maximum number of samples if not enough time was allowed for data capture before or after the trigger.

You can advance directly to the first, last, or trigger sample with the press of a button.

- F4: Display first (earliest) sample
 - F5: Display trigger sample (0)
 - F6: Display last (most recent) sample
12. Pressing **F3** allows you to determine what caused the SNAPSHOT trigger to occur. For example, if you selected the Automatic Trigger option, pressing **F3** might result in the following display:

SNAPSHOT TRIGGER
OCCURRED ON:
INTERMITTENT
WHEEL SPEED

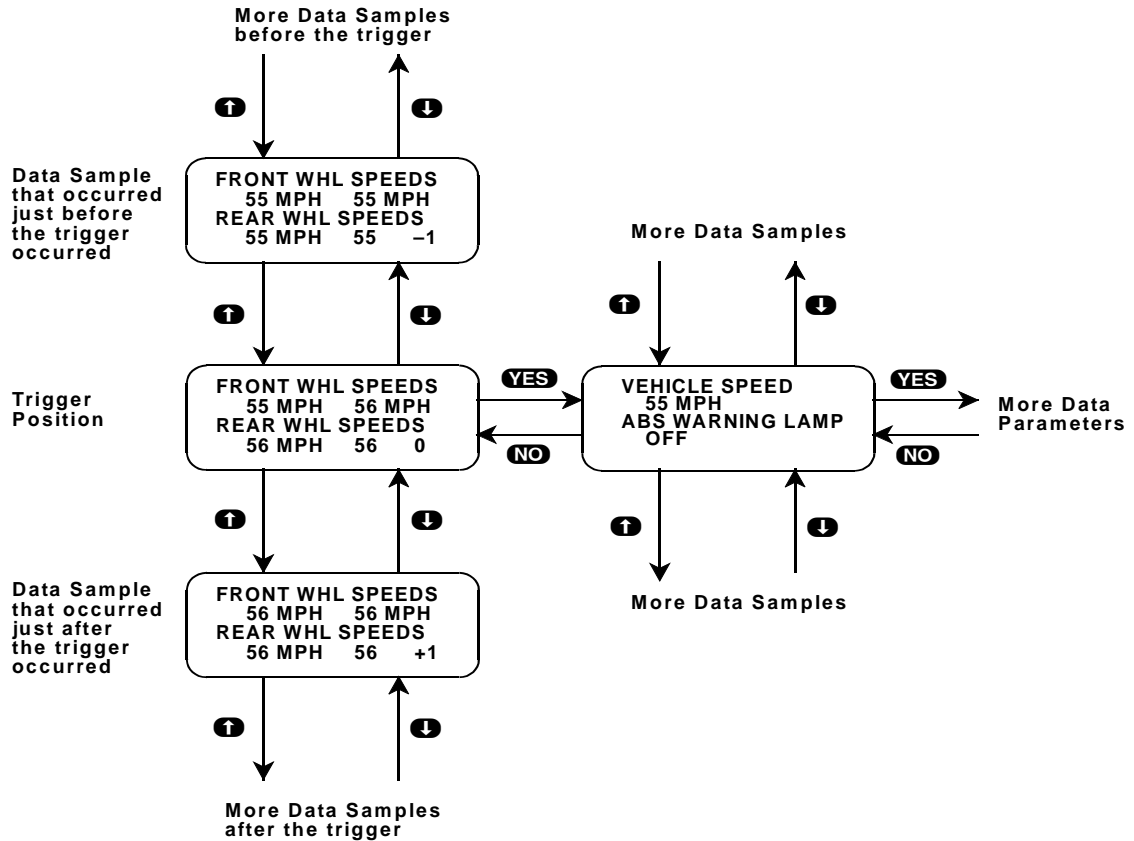
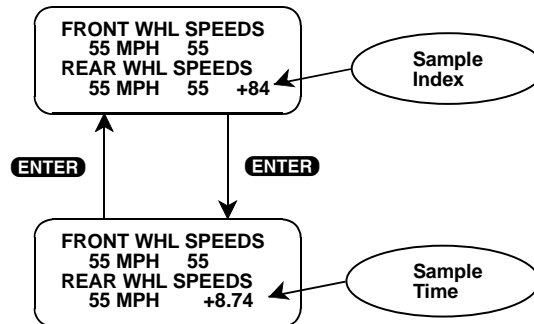

FIGURE 5-7. Data Display Phase

13. While in the data display phase, pressing **ENTER** causes the tester to toggle between the sample index and sample time.



The sample time display gives the time in seconds (relative to the trigger sample) at which the tester received the currently displayed sample. For example, a sample time of +8.74 means the sample was received 8.74 seconds after the trigger sample. A sample time of -2.71 seconds means the sample was received 2.71 seconds before the trigger.

14. The currently displayed sample may be printed if the tester is connected to a compatible printer. To print the data, press **F8**. While the tester is sending data to the printer, the keyboard is disabled.

SNAPSHOT data can also be printed in a tabular format using the SCREEN PRINT feature. Refer to the Operator's Manual for more detail.

15. When you are finished viewing the sampled data, press **EXIT** to return to the Snapshot Option menu. If you are finished with the SNAPSHOT mode, press **EXIT** again to return to the Select Mode menu.

ACTIVE KEYS	
YES & NO	Scroll through displayed data parameters.
↑ & ↓	Scroll through selected samples.
F0 & F1	Fix top or bottom display parameter respectively.
F2	Display trouble codes for current sample.
F3	Display cause of SNAPSHOT trigger.
F4	Advance to first (earliest) sample.
F5	Advance to trigger sample (sample 0).
F6	Advance to last (most recent) sample.
F7	Toggle between MPH and km/h display.
F8	Print current data sample.
ENTER	Toggle between sample index and sample time display.
EXIT	Return to Snapshot Option menu.

MODE F4: MISC. TESTS (DELCO ABS VI)

SUBMODE F0: MANUAL CONTROL

The Manual Control functions allow you to manually control each motor and solenoid for component diagnosis. You can turn the solenoids on and off, turn the ABS motors on and off, and control their direction (apply or release). Opens, shorts to ground, and shorts to battery can be confirmed by comparing what is commanded by the tester, what the ABS controller sees as a response (motor feedbacks), and what the actual output is at the actuator. When the motor is moving, the feedback current will be less than the command current. When the piston is at the top or bottom of the bore or stuck, the feedback current will equal the command current. The solenoids will automatically be turned off if left on for more than 30 seconds and must be allowed to cool before being turned back on. An "INHIBITED" message is displayed on line 1 if additional cooling time is required.

To run the Manual Control test, do the following:

1. Press **F4** to select Misc. Tests from the Select Mode menu. See *Important!* on page 253.
2. For 4WD-3WSS type, press **F0** to select ABS from the Select System menu.
3. Press **F0** to select the Manual Control Test.
4. A display confirming that you have entered the Manual Control test is displayed for four seconds, or until the **↑** key is pressed.

5. A screen explaining which tester keys are used to control the various functions is displayed until you press the **YES** key.
6. The function selection menu displays all of the functions which you can control in this test along with the function key to press to select a function.

Note that the top row of function keys (**F0** - **F2**) control tests for the Left Front wheel functions. The next row of function keys (**F4** - **F6**) control the same functions for the Right Front wheel. Rear wheel components are controlled by function keys on the bottom row (**F8** and **F9**). The selection is arranged so the first key in a row controls motor apply, the second key controls motor release, and the third key controls solenoids.

	MOTOR APPLY	MOTOR RELEASE	SOLENOID
LF	F0 LF APPLY	F1 LF RELEASE	F2 SOLENOID
RF	F4 RF APPLY	F5 RF RELEASE	F6 SOLENOID
RA (Rear Axle)	F8 APPLY	F9 RELEASE	

Once you have selected a function to test, use the corresponding keys from the chart to turn the function ON or OFF.

During a motor apply or a motor release, the command and feedback currents for that motor are sampled. Those samples can be replayed immediately after the motor is turned off.

During solenoid tests, pressing the **↑** key turns ON the COMMAND and pressing the **↓** key turns it OFF, or it will go to OFF **↓** after 5 seconds have elapsed. If "INHIBITED" appears on the display when trying to turn ON the COMMAND from OFF, wait until it disappears.

To select a different function to test, you can either press **EXIT** to return to the function selection menu to choose a different test, or just press the function key for the test you want to perform.

7. Press **EXIT** to return to the Manual Control Test menu. Press **EXIT** again to display the Select Test menu.

When you exit from the Manual Control test, the tester will rehome the motors and display a message informing you that the motors have been rehomed.

ACTIVE KEYS	
F0	Select Manual Control test.
F0 - F2 , F4 - F6 , F8 - F9	Select function to control.
F4 , F5	Advance to first (earliest) sample.
F6	Advance to last (most recent) sample.
↑	Turn function ON, scroll through selected samples.

ACTIVE KEYS (Continued)	
↓	Turn function OFF, scroll through selected samples.
YES	Continue Manual Control test.
EXIT	Return to the Select Test menu.

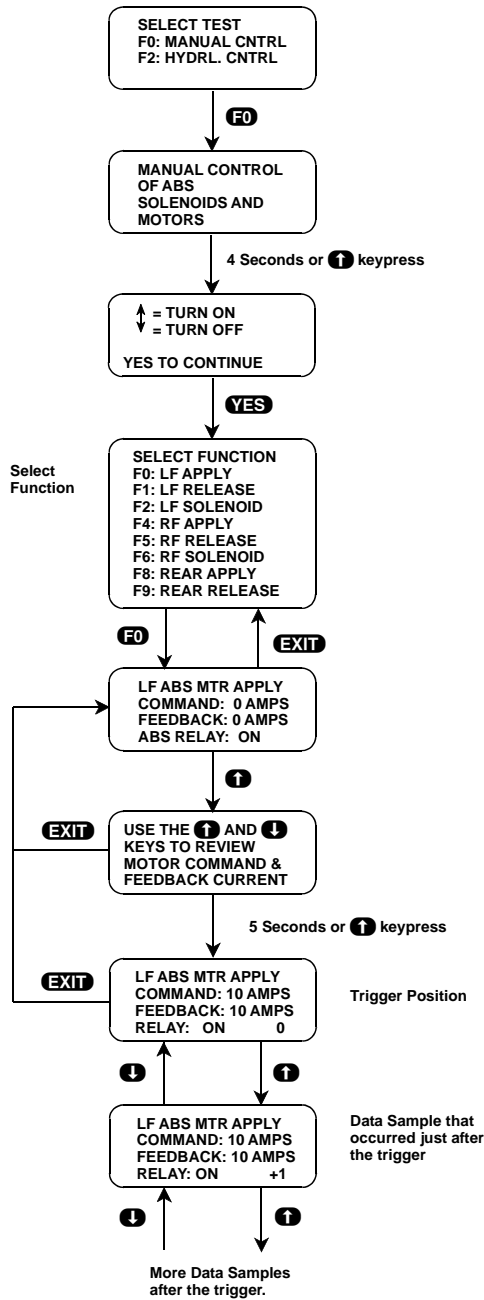

FIGURE 5-8. Manual Control

SUBMODE F2: HYDRAULIC CONTROL

CAUTION!



To perform the following test, both vehicle drive wheels must be securely raised or there will be unintended vehicle movement that could injure someone.

This test allows you to manually perform the APPLY, HOLD, and RELEASE ABS functions for brake system diagnosis.

To run the Hydraulic Control Test, do the following:

1. Press **F4** to select Misc. Tests from the Select Mode menu. Refer to the NOTE on [page 253](#).
2. For 4WD-3WSS type, press **F0** to select ABS from the Select System menu.
3. Press **F2** to select the Hydraulic Control Test.
4. The tester display confirms that you are in the ABS Hydraulic Functional Test and instructs you to raise the wheel to be tested. When the wheel has been raised, press the **↑** key.
5. If the parking brake is on, the tester will tell you to release it. If the parking brake is released within 10 seconds the tester automatically continues to the Select Channel menu.

If the parking brake is not released within 10 seconds, or if the red telltale light remains on even when the parking brake is released, the tester instructs you to release the parking brake or correct the cause of the red telltale staying on. When the problem is resolved, the tester displays the Select Channel menu.

6. Choose the wheel you wish to test from the Select Channel menu.
7. When a wheel has been selected, the tester instructs you to place the transmission in neutral, then firmly depress the brake pedal. Do not release the pedal until the tester instructs you to do so.
8. Have an assistant try to spin the wheel selected. It should not spin. This is to verify base brake apply.
9. Press the **↑** key to start the test. The tester will display “RELEASE” on the screen and your assistant should be able to spin the wheel selected. This verifies ABS brake pressure release. The tester will then display “HOLD” on the screen and a countdown timer. During this portion of the test, the brake pressure previously released is being held and your assistant should be able to spin the selected wheel. This verifies that the ABS unit can “HOLD” the released pressure and checks for internal leaks. The tester then commands the ABS modulator to “APPLY” (APPLY is displayed on the screen). Your assistant should not be able to spin the wheel selected at this point. This test verifies that the ABS modulator can reapply brake pressure to the selected channel. Refer to the vehicle's Service Manual for component servicing if a problem is found during this test.
10. At the conclusion of the test, the tester instructs you to take your foot off the brake pedal. When the pedal is released, the tester returns to the beginning of the Hydraulic test. Run the test on another wheel, or press **EXIT** to return to the Select Test menu.

When you exit from the Hydraulic Control test, the tester will rehome the motors and display a message informing you that the motors have been rehomed.

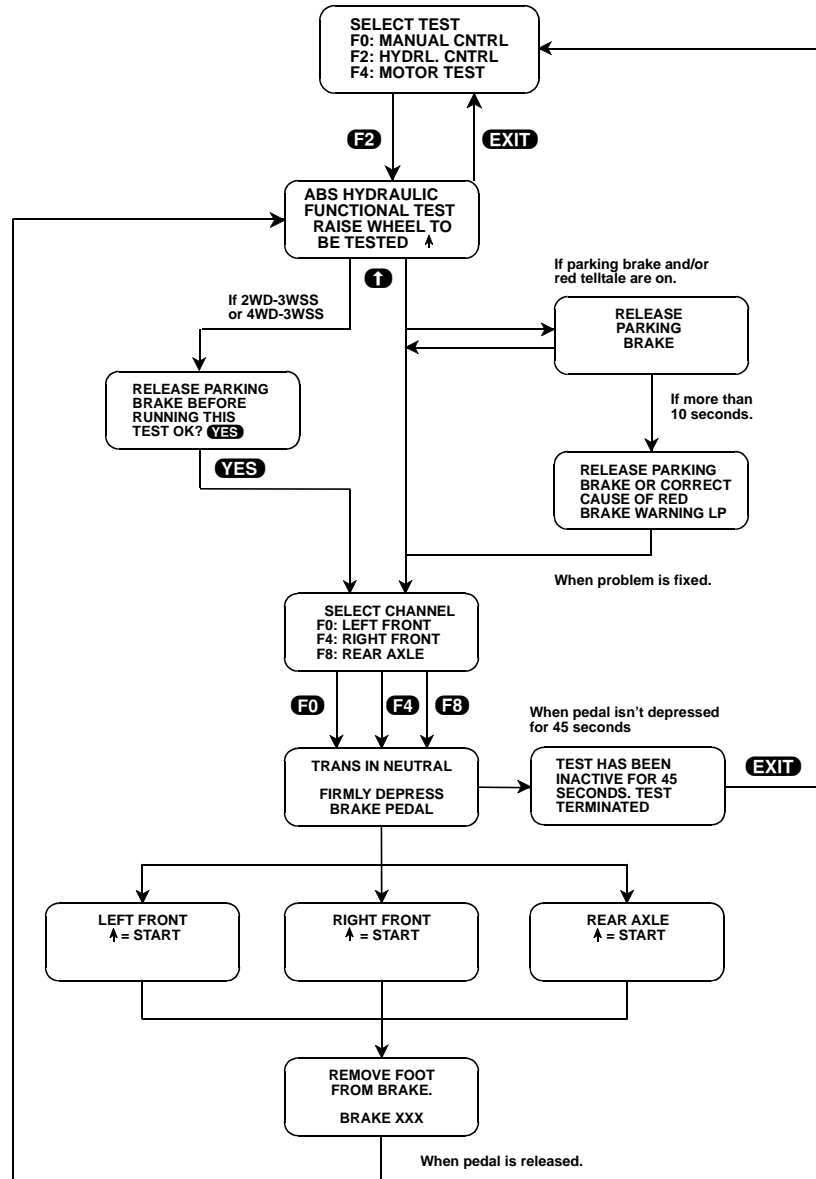

FIGURE 5-9. Hydraulic Control Test

ACTIVE KEYS	
F2	Select Hydraulic Control test.
↑	Confirm that all wheels are off the ground.
YES NO	Respond to tester questions.
EXIT	Return to the Select Test menu.

SUBMODE F3: IDLE UP TEST

The Idle Up test controls the idle up circuit and displays the Idle Up status on 4WD-3WSS equipped vehicles.

To run the Idle Up Test, do the following:

1. Press **F4** to select Misc. Tests from the Select Mode menu.
2. Press **F3** to select Idle Up from the Select ABS Test menu.
3. Press **F0** to select Manual Control from the Select Test menu.
4. The tester display confirms that you have manual control of the idle up circuit, then advances to a display of instructions for controlling the idle up circuit.
5. The instruction display shows that the **↑** key is used to turn the idle up circuit ON and the **↓** key is used to turn the idle up circuit OFF. Press **YES** to continue to the next display.
6. The tester displays the state to which you have commanded the idle up circuit (ON or OFF), the circuit's status (ACTIVE or INACTIVE), and the circuit's condition (OK or FAILED). When you press the **↑** or **↓** key, the tester will command the idle up circuit to the state you select.
7. Press **EXIT** to return to the Select Test menu. Press **EXIT** again to display the Select System menu.

ACTIVE KEYS	
F0	Select Manual Control test.
F3	Select Idle Up system.
↑	Turns idle up circuit ON.
↓	Turns idle up circuit OFF.
EXIT	Return to Select Tests menu.

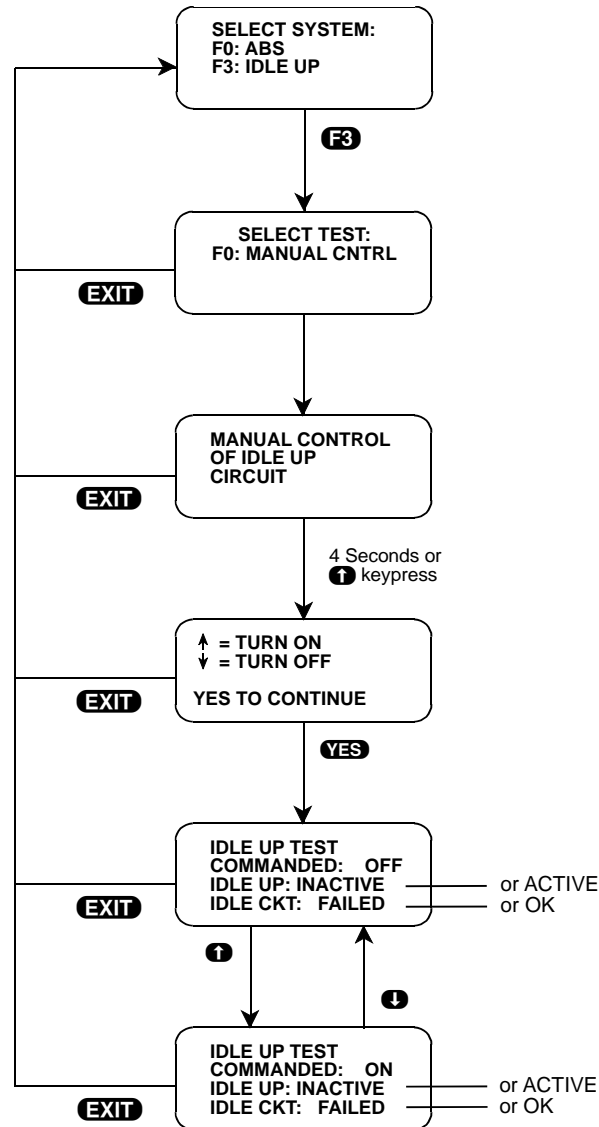

FIGURE 5-10. Idle Up Test

SUBMODE F4: MOTOR TEST

Once the motor pack has been separated from the ABS hydraulic modulator, the Motor Pack Test will functionally test the motor pack for proper operation. If the motor pack is still attached to the modulator, the tester will perform the gear tension relief sequence to allow you to remove it.

CAUTION!



Prior to removing the motor pack from the ABS hydraulic modulator, prevailing motor torque or gear tension must be removed from the gear train to ease the motor pack separation process and prevent personal injury.

NOTE**Important!**

For SE and SZ series vehicles equipped with an immobilizer system, a battery adapter cable (Suzuki P/N 09932-56020) is necessary, because power is not provided to the tester through the DLC when the ignition switch is off.

When testing, be sure to disconnect the connector from the immobilizer controller and supply power to the tester by using a battery adapter cable.

To run the Motor Test, do the following:

1. Press **F4** to select Misc. Tests from the Select Mode menu. See *Important!* on page 281.
2. For 4WD-3WSS type, press **F0** to select ABS from the Select System menu.
3. Press **F4** to select the MOTOR Test.
4. The tester display confirms that you are in the Automated ABS Motor Pack Diagnosis test. The display automatically scrolls after four seconds, or after pressing the **↑** key.
5. The tester asks if the motor pack has been separated from the modulator. Answer by pressing the **YES** or **NO** key.

If the answer is **YES**, the tester instructs you to turn the ignition OFF.

If the answer is **NO**, the tester performs a gear tension relief sequence and then informs you that the sequence has been completed. Press the **↑** key to scroll to the next screen, which instructs you to turn the ignition OFF. After the ignition key is turned OFF, the tester instructs you to remove the motor pack from the hydraulic modulator assembly. Refer to the service manual for the proper procedure.
6. The tester instructs you to connect the motor pack wiring to the motor pack, position the motor pack so that the gears are clear of all objects, and then turn the ignition back ON.
7. The tester will guide you through a series of actions to perform and questions to answer. If an “↑” is displayed in the lower right corner of the display, press the **↑** key after the action is completed to continue to the next page of instructions. If the tester asks a question, answer by pressing the **YES**, **NO**, or **ENTER** key.
8. After all tests have been performed the tester displays the test results. If the test failed, rerun the Motor Test to verify the results.
9. Press **EXIT** to return to the Select Test menu.

ACTIVE KEYS

ACTIVE KEYS	
F4	Select Motor Pack test.
↑	Advance screen after performing requested action.
YES & NO	Answer questions on the tester display.
ENTER	Start motor pack diagnosis.
EXIT	Return to the Select Test menu.

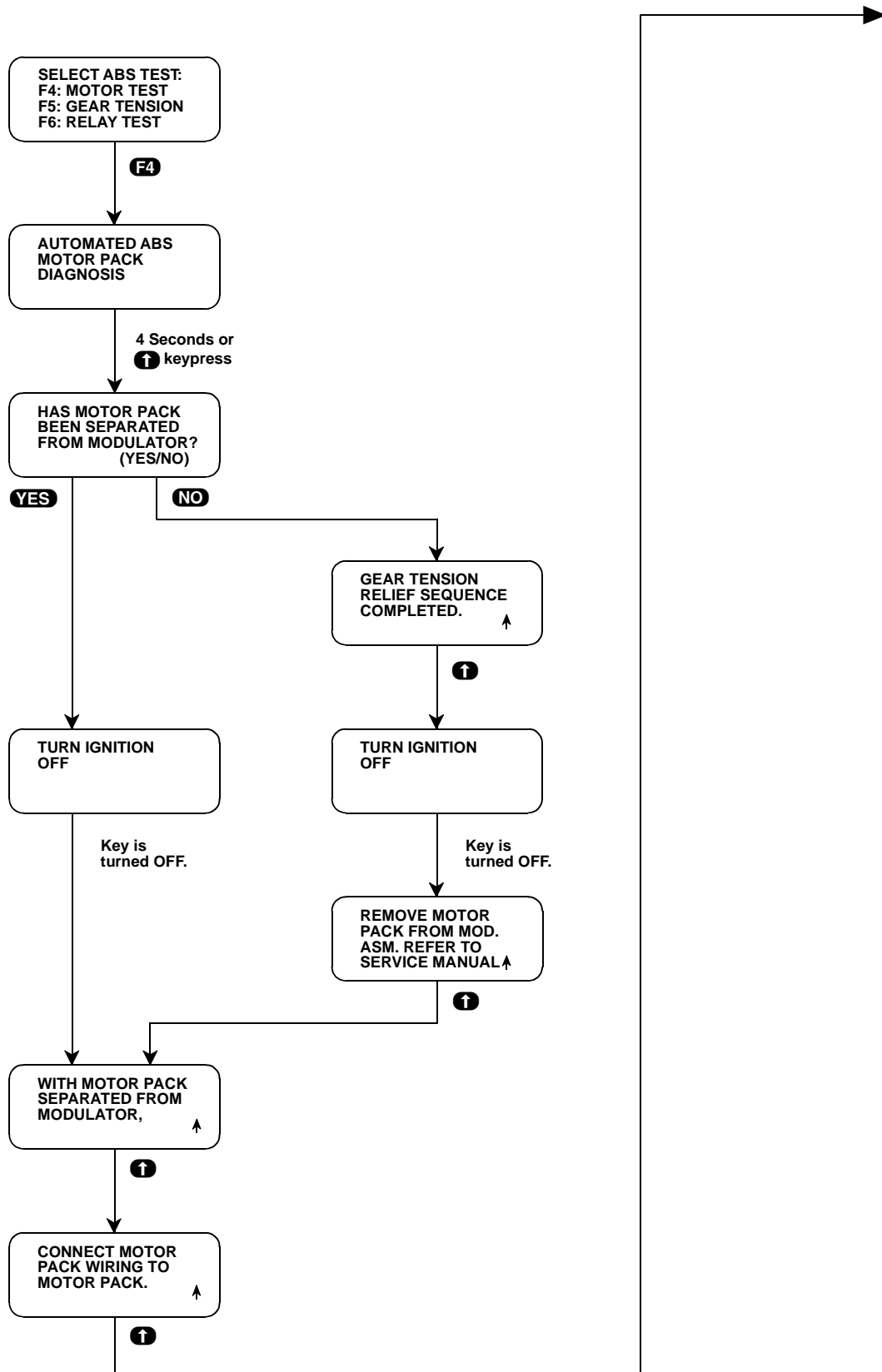

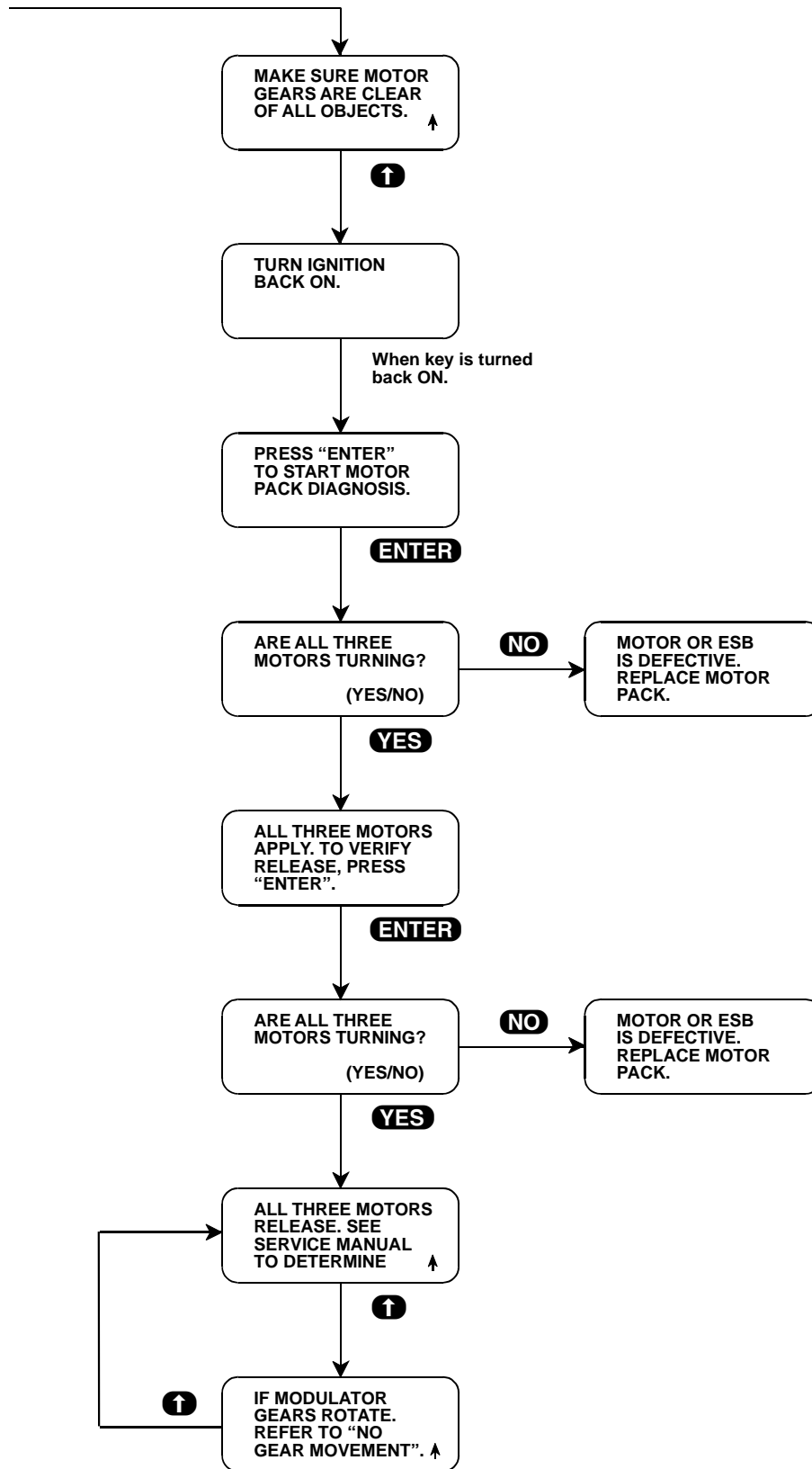

SUBMODE F5: GEAR TENSION RELIEF TEST

The Gear Tension Relief test relieves tension from the motor gears so the motor pack can be removed for off-vehicle service.

CAUTION!



Prior to removing the motor pack from the ABS hydraulic modulator, prevailing motor torque, or gear tension must be removed from the gear train to ease the motor pack separation process and prevent personal injury and/or gear train damage.

To run the Gear Tension Relief Test, do the following:

1. Press **F4** to select Misc. Tests from the Select Mode menu. See *Important!* on page 253.
2. For 4WD-3WSS type, press **F0** to select ABS from the Select System menu.
3. Press **F5** to select the Gear Tension Relief Test.
4. The tester will confirm that you are in the Gear Tension Relief test. Consult the service manual for pretest preparations. The display will automatically scroll after 4 seconds, or after pressing the **↑** key.
5. The tester will ask you to press the **ENTER** key to start the Gear Tension Relief sequence. Press the **ENTER** key.
6. The tester will inform you when the Gear Tension Relief sequence has been completed. Press the **↑** key to scroll to the next page of instructions.
7. To finish the test, turn the ignition key OFF, then follow the instructions on the next screen. Press the **EXIT** key after the motor pack is separated from the hydraulic modulator. The tester will return to the Select Test menu.

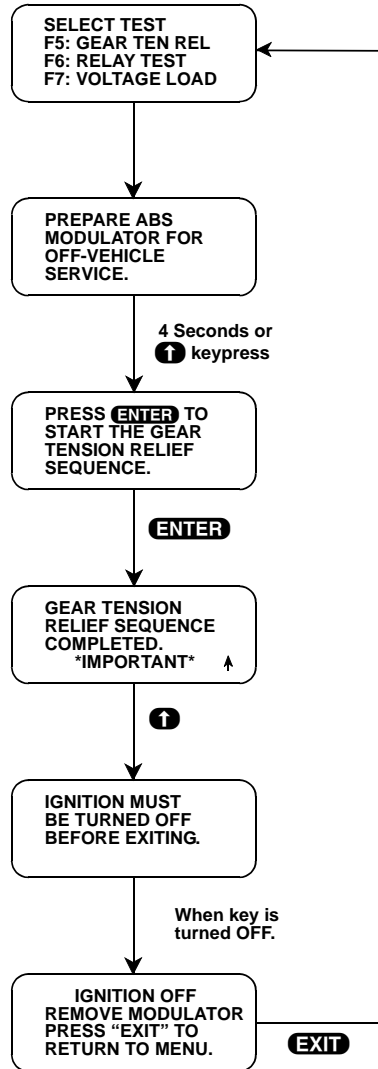

ACTIVE KEYS	
F5	Select Gear Tension test.
↑	Scroll to the next page of instructions.
ENTER	Start the Gear Tension Relief sequence.
EXIT	Return to the Select Test menu.

SUBMODE F6: RELAY TEST

The Relay test controls the enable relay while displaying the switched battery voltage into the ABS Controller. This tests allows verification of relay operation and also displays “Command Relay” On or Off.

To run the Relay Test, do the following:

1. Press **F4** to select Misc. Tests from the Select Mode menu. See *Important!* on page 253.
2. For 4WD-3WSS type, press **F0** to select ABS from the Select System menu.
3. Press **F6** to select the Relay Test.
4. The tester display will confirm that you are in the Relay test. The display will automatically scroll after 4 seconds, or after pressing the **↑** key.
5. The tester will display the keys used to control the relay, the status of the relay (whether it is commanded OFF or ON), and the current battery voltage as seen by the ABS controller.
6. Use the **↓** key to turn the relay OFF and the **↑** key to turn the relay back ON. If the relay is commanded OFF, the battery voltage should drop to below 5.0V within 2 seconds. If it fails to do this, the tester will inform you that the relay contacts appear to be closed. Consult the service manual to make the necessary repairs.
7. Press the **EXIT** key to return to the Select Test menu.

ACTIVE KEYS	
F6	Select Relay test.
↑	Turns relay ON.
↓	Turns relay OFF.
EXIT	Return to the Select Test menu.

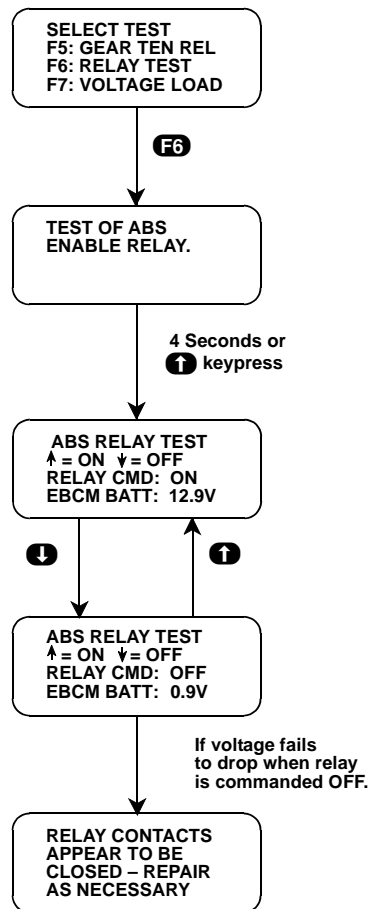

SUBMODE F7: VOLTAGE LOAD TEST

In the Voltage Load test you can energize many of the ABS components to create a significant current draw. Ignition voltage and ABS battery voltage are then monitored. If one or both voltages drop significantly, appropriate messages are displayed to direct you to the required area or service.

To run the Voltage Load Test, do the following:

1. Press **F4** to select Misc. Tests from the Select Mode menu. See *Important!* on page 253.
2. For 4WD-3WSS, press **F0** to select ABS from the Select System menu.
3. Press **F7** to select the Voltage Load Test.
4. The tester display will confirm that you are in the ABS Voltage Load test. The display will automatically scroll after 4 seconds, or after pressing the **↑** key.
5. Press the **↑** key to sequence through the 3 message displays that caution you against abusing or overusing this test.
6. When "ABS VOLTAGE TEST" is displayed on the tester screen, start the engine and leave the transmission in park/neutral. Press the **↑** key to continue the test.

7. The tester will ask you to press on the brake pedal firmly. Do so and the tester display will inform you of the current ABS ignition voltage and the ABS battery voltage. Press the **1** key to start the test.

If the Voltage Load test has just been performed, you may have to wait up to 60 seconds for the components to cool before the test can be run again. If you attempt to run the Voltage Load test again too soon, the tester displays a warning and a countdown timer showing how long before the test can be run again.

8. The test will take 6 to 10 seconds to complete during which time you must keep the brake pedal depressed. The tester will inform you that the test is in progress. When the tester concludes the test, the results of the tests are displayed.

9. Press the **EXIT** key to return to the Select Test menu.

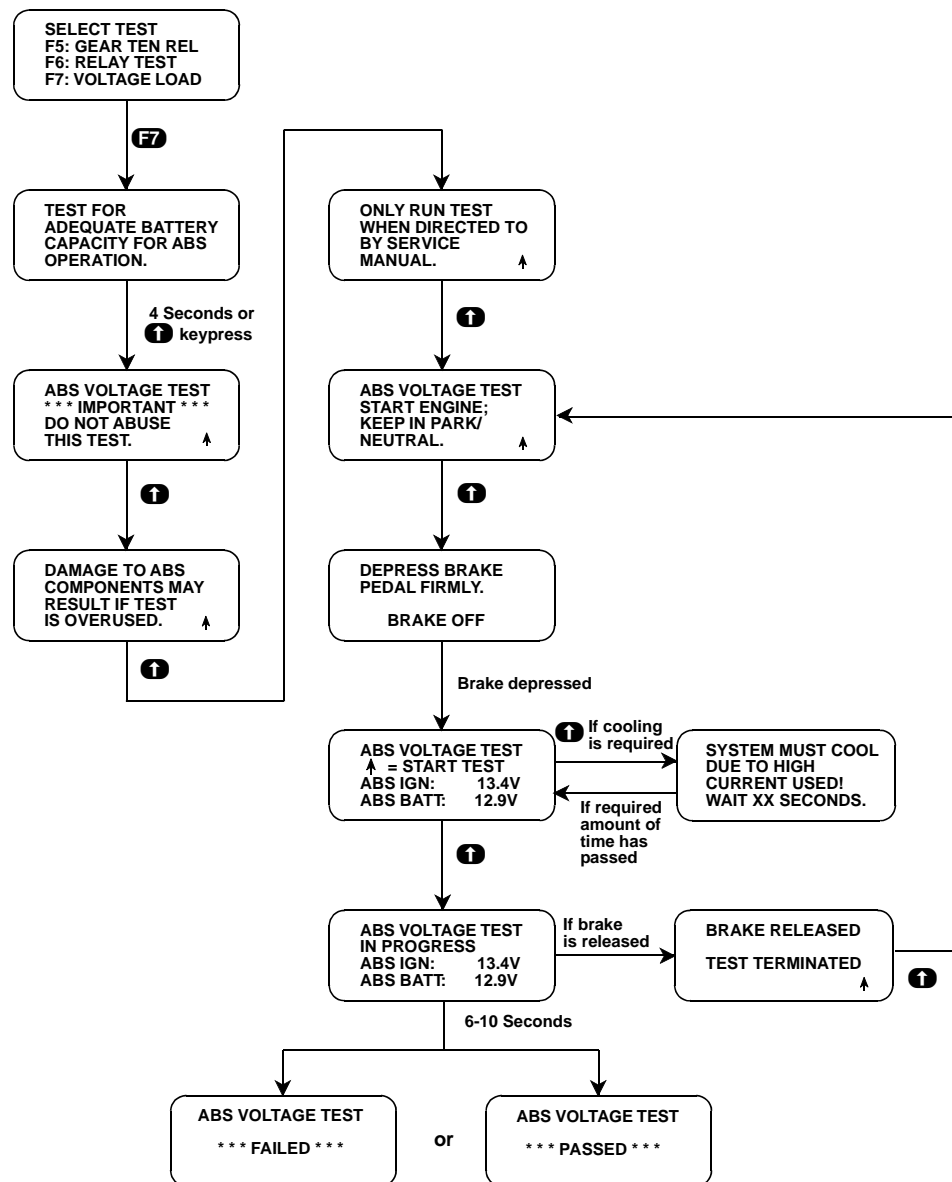

ACTIVE KEYS	
F7	Select Voltage Load test.
↑	Advance the tester display after performing a requested action.
EXIT	Return to the Select Test menu.

F8: LAMP TEST

The Lamp test allows you to manually control Lamps for diagnostic purposes. The tester displays the list of Lamps for the vehicle you are testing.

To run the Lamp Test, do the following:

1. Press **F4** to select Misc. Tests from the Select Mode menu. See *Important!* on page 253.
2. For 4WD-3WSS type, press **F0** to select ABS from the Select System menu.
3. Press **F8** to select the LAMP Test.
4. The tester display confirms that you are in the ABS Lamp test. The display will automatically scroll after 4 seconds, or when you press the **↑** key.
5. A Select Lamp menu is displayed. Press the key (**F0**, **F1**, **F2**) that corresponds to the Lamp you want to test. [Figure 5-11](#) shows an example for the Red Brake Lamp.
Use the **↑** and **↓** keys to turn the Lamp ON and OFF (or flash). The commanded state of the Lamp is displayed on line 3 and depending on the Lamp, the feedback state may be displayed on line 4.
6. Press **EXIT** to return to the Select Lamp menu, or press **EXIT** twice to return to the Select Test menu.

ACTIVE KEYS	
F0, F1, F2	Select the Lamp you want to test from the Select Lamp menu.
↑	Turn the selected Lamp ON.
↓	Turn the selected Lamp OFF.
EXIT	Return to the Select Lamp menu. Press EXIT twice to return to the Select Test menu.

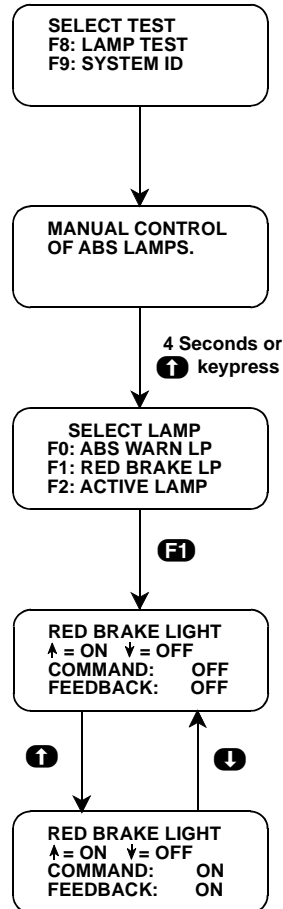

FIGURE 5-11. Lamp Test Example

SUBMODE F9: SYSTEM ID

This feature allows you to identify the ABS VI vehicle application, the ABS version, Electronic Brake Control Module (EBCM) manufacturer, and calibration information without having to access or remove the EBCM.

NOTE



The software ID is not related to a PROM version in the ABS controller. The ABS controller has NO SERVICEABLE OR REMOVABLE PROM. The ID and sequence number are for controller identification purposes only.

To access System ID, do the following:

1. Press **F4** to select Misc. Tests from the Select mode menu. See *Important!* on page 253.
2. For 4WD-3WSS type, press **F0** to select ABS from the Select System menu.
3. Press **F9** to select the SYSTEM ID.
4. The tester will display information about the Delco Chassis Division ABS controller on 3 screens.

- a. System identification screen
- b. Model year, platform, and ABS version number screen
- c. Software identification screen

This information may be referenced by service manuals or service bulletins. It can be used to determine that the correct ABS controller is installed in the vehicle. It may also be used for warranty purposes.

- 5. The tester will continuously scroll through the 3 screens at 4-second intervals. The display can be frozen by pressing the **↓** key and unfrozen by pressing the **↑** key.
- 6. Press the **EXIT** key to return to the Select Test menu.

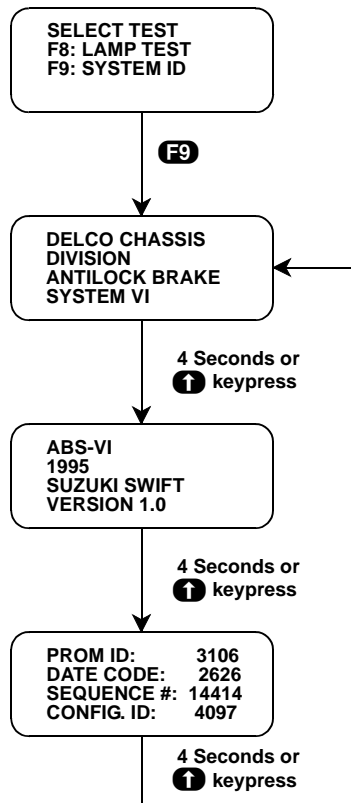

FIGURE 5-12. Examples of System ID Displays

ACTIVE KEYS	
F9	Select System ID from the Select Test menu.
↑	Manually scroll the display screen.
↓	Freeze the display screen.
EXIT	Return to the Select Test menu.

MODE F4: MISC. TESTS (DELPHI ABS DBC7)

SUBMODE F0: SOLENOID TEST

The Solenoid Test allows the user to manually control solenoids for component diagnosis. You can control the solenoids “ON” and “OFF” by controlling their direction (Hold or Release).

Pressure Hold

The pressure hold mode activates the selected wheel circuit inlet valve placing it in the pressure hold position. While in the pressure hold position, the valve will not allow master cylinder pressure to be delivered to the hydraulic wheel circuit.

Pressure Release

The pressure release mode activates the selected hydraulic wheel circuit valves, placing them in the pressure reduce position. When in the pressure reduce position, the valve will allow wheel caliper pressure to be returned to the master cylinder circuit.

To run the Solenoid Test, do the following:

1. Turn ignition to the run position.
2. Raise tested wheel(s) about 6 inches off the floor with the transmission in neutral.
3. Press **F4** to select Misc. Test from the Select Mode Menu.
4. Select **F0** to select the Solenoid Test.
5. Select from the following Solenoid Test menu:
 - F0: LF HOLD
 - F1: RF HOLD
 - F3: RA HOLD (Rear Axle)
 - F4: LF RELEASE
 - F5: RF RELEASE
 - F7: RA RELEASE (Rear Axle)
6. Have the assistant command the Hold or Release pressure by pressing **↑** for ON or **↓** for OFF using the tester.

NOTE



The ABS solenoids will automatically be turned OFF if left in the ON position for more than 3 seconds.

7. While solenoid is commanded in the ON position for either Hold or Release, attempt to rotate the wheel being tested; it should move even though the assistant is applying pressure to the brake pedal. The front wheels may be difficult to rotate if the system is working properly.
8. Press **EXIT** to return to the solenoid test menu. Press **EXIT** again to display the Select Test menu.

NOTE

When you exit from the solenoid test, the tester will rehome the motors and display a message informing you that the motors have been rehomed.

SUBMODE F1: PUMP MOTOR TEST

The Pump Motor Test allows the user to command the ABS pump motor ON and OFF in order to confirm ABS pump motor operation.

To run the Pump Motor Test, do the following:

1. Press **F4** to select Misc. Tests from the Select Mode menu.
2. Press **F1** to select the Pump Motor Test.

During the pump motor test, the command for that motor is sampled. Those samples are displayed on the tester screen.

During the Pump Motor Test, pressing the **↑** key turns ON the COMMAND and pressing the **↓** key turns it OFF, or it will go to OFF **↓** after 5 seconds have elapsed. If “INHIBITED” appears on the display when trying to turn ON the COMMAND from OFF, wait until it disappears.

3. Press **EXIT** to return to the Select Mode menu.

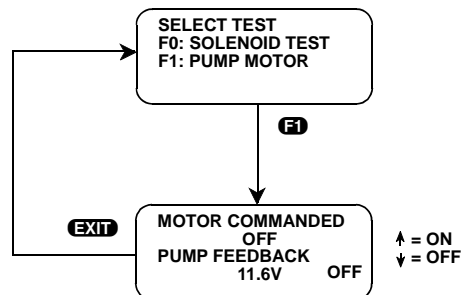

FIGURE 5-13. Pump Motor Test

SUBMODE F2: RELAY TEST

The Relay test allows monitoring the voltage available to the EBCM while turning the Electronic Brake Control Relay ON and OFF.

When the relay is commanded ON, the voltage should be equal to the battery voltage. When the relay is OFF, the voltage should drop below five volts.

NOTE

Voltage will not drop to zero when the relay contacts are open due to capacitors in the EBCM. If voltage drops below five volts, the relay is operating properly.

To run the Relay Test, do the following:

1. Press **F4** to select Misc. Tests from the Select Mode menu.
2. Press **F2** to select the Relay Test.
3. Use the **↓** key to turn the relay OFF and the **↑** key to turn the relay back ON. If the relay is commanded OFF, the battery voltage should drop to below 5.0V within 2 seconds. If it fails to do this, the tester will inform you that the relay contacts appear to be closed. Consult the service manual to make the necessary repairs.
4. Press the **EXIT** key to return to the Select Test menu.

ACTIVE KEYS	
F2	Select Relay test.
↑	Turns relay ON.
↓	Turns relay OFF.
EXIT	Return to the Select Test menu.

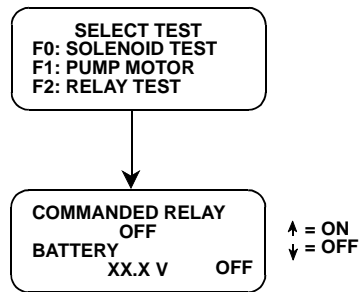
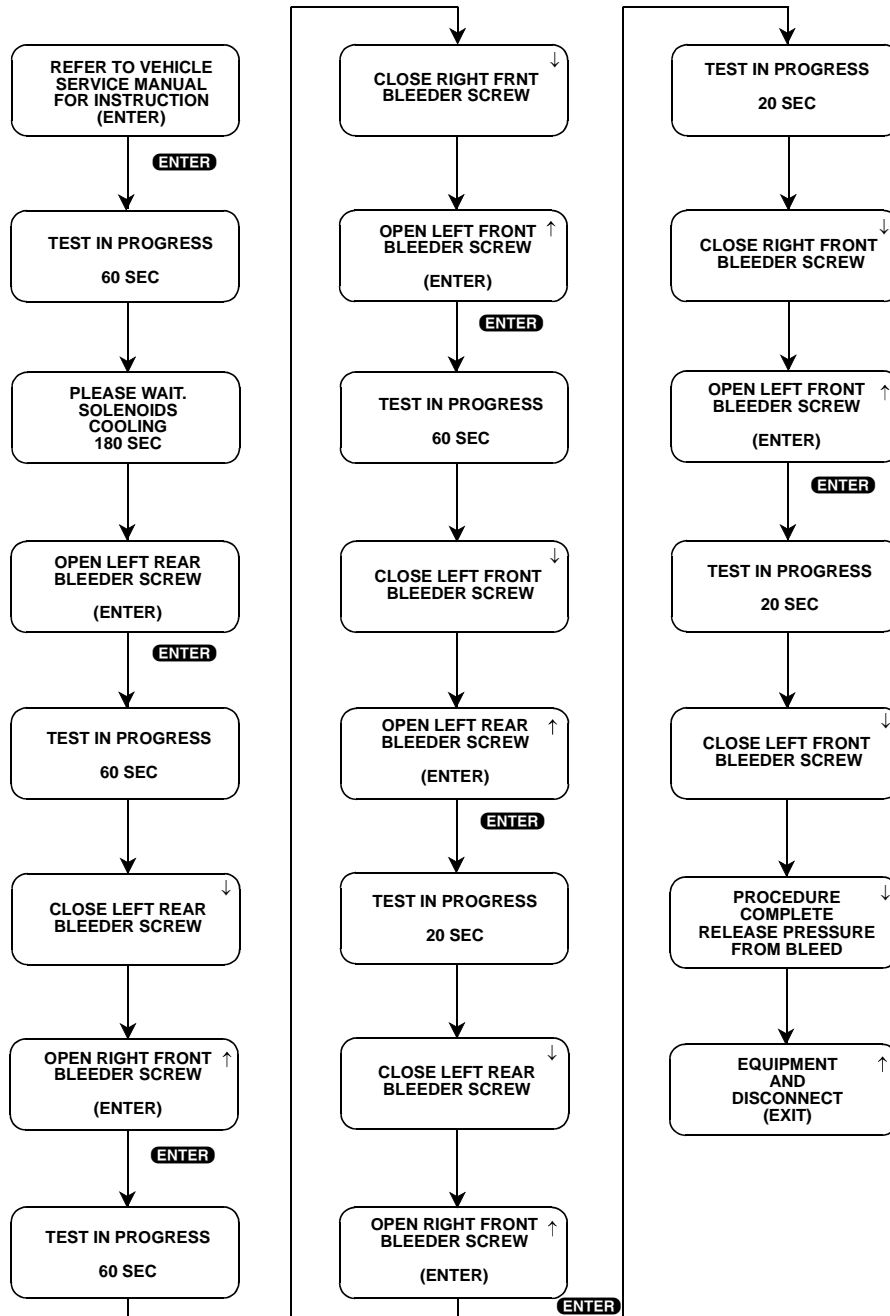

FIGURE 5-14. Relay Test (ABS DBC7)

SUBMODE F3: AUTO BLEED

The Auto Bleed procedure is used to provide a complete brake system bleed for the 3-channel ABS DBC7 system. The Auto Bleed procedure cycles the system valves and runs the ABS/TCS pump to purge air from all secondary circuits that are normally closed off during non-ABS/TCS mode operation and bleeding. The Auto Bleed test should be used when it is suspected that air has been ingested into the system secondary circuits, or when the ABS actuator assembly has been replaced with a new unit. Refer to the Suzuki Service Manual for specific bleeding procedures.



F4: LAMP TEST

The Lamp test allows you to manually control lamps for diagnostic purposes. The tester displays the list of Lamps for the vehicle you are testing.

To run the Lamp Test, do the following:

1. Press **F4** to select Misc. Tests from the Select Mode menu.
2. Press **F4** to select the LAMP Test.

Use the **↑** and **↓** keys to turn the Lamp ON and OFF. The commanded state of the lamp is displayed in the right corner on line 4 of the tester screen.

3. Press **EXIT** to return to the Select Test menu.

ACTIVE KEYS	
↑	Turn the selected Lamp ON.
↓	Turn the selected Lamp OFF.
EXIT	Return to the Select Test menu.

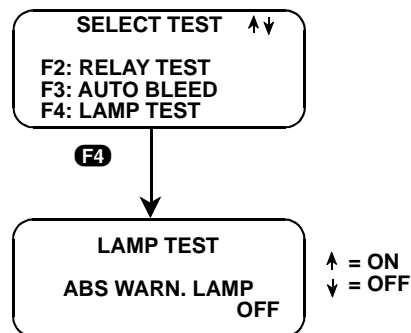

FIGURE 5-15. Lamp Test (ABS DBC7)

MODE F5: MOTOR REHOME (DELCO ABS VI)

This feature allows you to command the ABS motors to drive the pistons to the home position at the top of each bore.

To run Motor Rehome, do the following:

1. Press **F5** to select Motor Rehome from the Select Mode menu.

The tester will not perform a motor rehome if the vehicle is moving, if certain codes are set, or if the brakes are applied.

2. The tester informs you that the motors are being rehomed.

3. "MOTOR REHOME COMPLETE" is displayed when the motors are rehomed, then the tester returns to the Select Mode menu.

NOTE

ABS DBC7 systems will automatically reset when exiting each output control test.

ACTIVE KEYS

F5	Select Motor Rehome from the Select Mode menu.
EXIT	Return to the Select Mode menu.

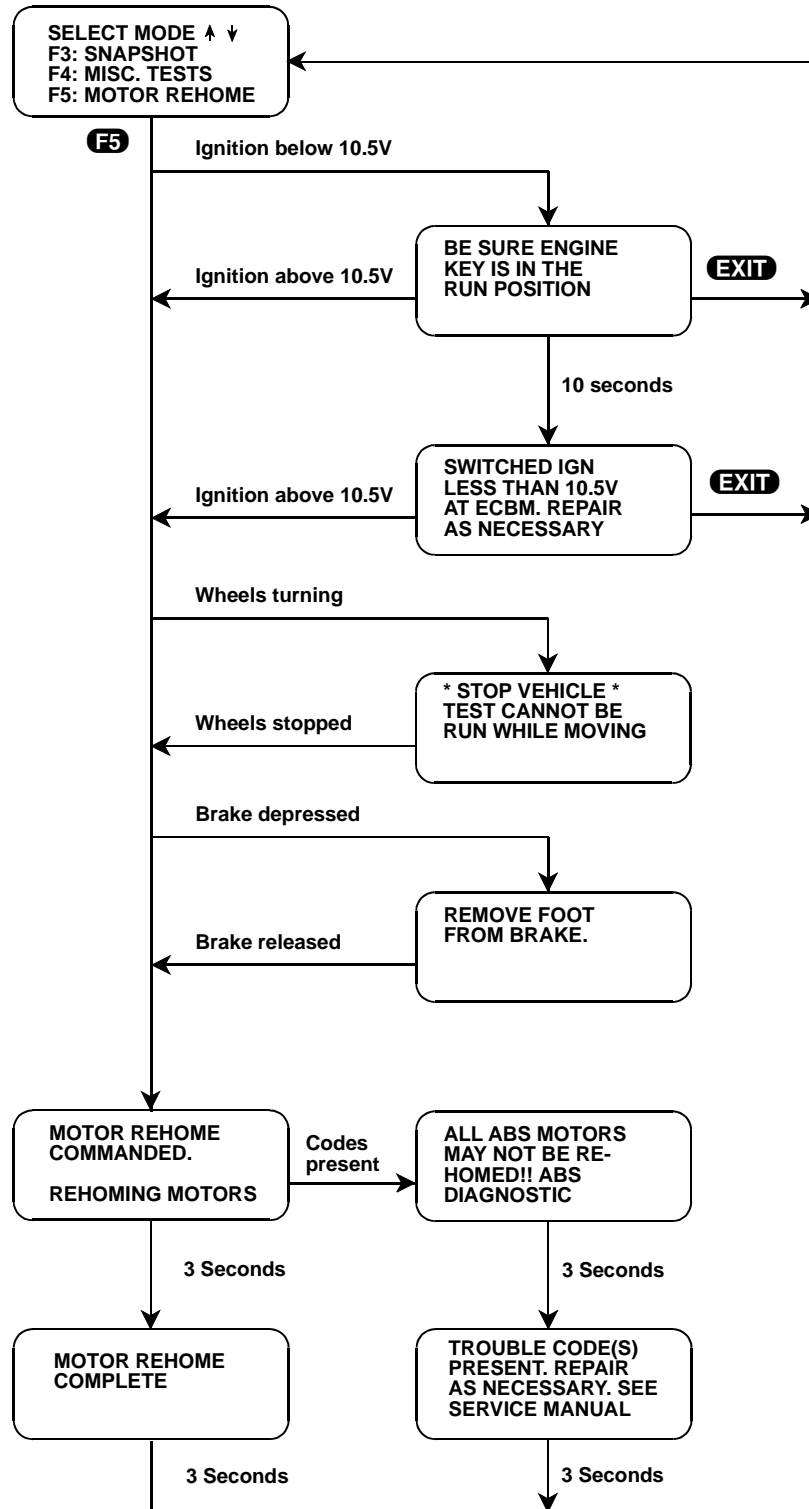

FIGURE 5-16. Motor Rehome

6. FINISHING UP

When you've finished testing, the following procedure should be followed:

1. Check to see if any Trouble Codes are still set. If you've already cleared codes for a component, but the codes are still set, then the conditions which caused the codes to be set are probably still present. Do not clear codes prior to diagnosing or repairing the ABS system if a fault is present. Valuable Code History information that would help isolate the problem will be lost. You should refer to the Suzuki Service Manual to isolate the problem.
2. Disconnect the TECH1 from the vehicle's DLC.

NOTE



If the tester should become dirty, you may clean it with a mild detergent or hand soap. Avoid using harsh solvents, such as petroleum based cleaning agents: Benzene, Trichloroethylene, etc. Although the tester is water resistant, it is not waterproof, so be sure to thoroughly dry off your tester prior to storage.

A. IF YOU'RE HAVING A PROBLEM

This section is intended to help you get back on track if the tester appears to be operating abnormally. Examples of most of the displays which you might see under abnormal conditions are shown. In addition, the most likely cause for the condition is given as well as other possible causes and recommendations on how to isolate or eliminate the problem.

BLANK SCREEN



Most Likely Cause:

- No power is applied to the tester.

Other Possible Causes:

- Tester power supply is malfunctioning.

Recommendations:

- Plug the tester into another vehicle to verify proper operation.

DISPLAYS SOLID BARS



Most Likely Cause:

- Cartridge was inserted while power was applied to the tester.

Other Possible Causes:

- Two master cartridges are installed.
- Master cartridge is malfunctioning.
- Tester is malfunctioning.

Recommendations:

- Make sure that only one master cartridge is installed in the tester.
- Remove all cartridges and see if “MASTER CARTRIDGE MISSING OR MALFUNCTIONING” message is displayed. If it is, try installing another master cartridge.

MASTER CARTRIDGE MISSING OR MALFUNCTIONING

A rectangular box with rounded corners containing the text "MISSING CARTRIDGE IS MISSING OR MALFUNCTIONING" in all caps, representing the error message display.

Most Likely Cause:

- Master cartridge is not installed.

Other Possible Causes:

- Dirty contacts on the master cartridge connector.
- Master cartridge is malfunctioning.

Recommendations:

- Verify that a master cartridge is installed.

- Clean contacts on master cartridge connector with methyl (wood) alcohol.
- Try a different master cartridge.

WRONG DISPLAY AFTER POWER IS APPLIED

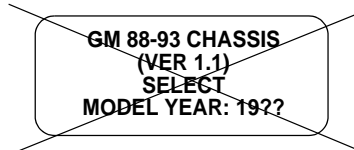

Most Likely Cause:

- Wrong master cartridge is installed.

Other Possible Causes:

- Master cartridge is malfunctioning.
- Tester is malfunctioning.

Recommendations:

- Verify that the correct cartridge is installed in the bottom slot of the tester and that there isn't a master cartridge in the top slot.
- Try another cartridge.
- Remove the master cartridge and perform the tester Self-test (refer to the Operator's Manual).

NO DATA RECEIVED/NO RESPONSE/ COMMUNICATION FAILED

NO DATA RECEIVED
FROM SIR

NO DATA
RECEIVED FROM
EBCM

COMMUNICATION
WITH EBCM
FAILED

ECU
NO RESPONSE

Most Likely Cause:

- Tester cable is not plugged securely into DLC.

Other Possible Causes:

- Ignition switch is not in "ON" position.
- Serial data link is shorted or open-circuited.
- ABS or AIRBAG is malfunctioning.
- Tester is malfunctioning.

Recommendations:

- Verify that the tester is plugged securely into DLC.
- Cycle power on the tester and then cycle the ignition.
- Verify that ignition is in "ON" position.
- Check for serial data link shorted or open.
- Remove the cartridge and perform the tester Self-test (refer to the Operator's Manual).

NO COMMUNICATION WITH VEHICLE

NO COMMUNICATION
WITH VEHICLE.
CHECK DLC.

Most Likely Cause:

- Tester cable has come loose from DLC.

Other Possible Causes:

- Ignition switch has been turned "OFF."
- Cable is not plugged securely into the tester.
- Serial data link is shorted or open-circuited.
- ABS controller is malfunctioning.

Recommendations:

- Verify that ignition is in "ON" position.
- Verify that the tester is plugged securely into DLC.
- Check for serial data link shorted or open.

KEYBOARD/DISPLAY LOCKED OR PROGRAM RETURNS TO FIRST PAGE

SUZUKI
MASS STORAGE
CARTRIDGE - VX.X
<ENTER>

or

SUZUKI
ABS/AIRBAG 2.0
FOR DELCO/DELPHI
(ENTER)

Most Likely Cause:

- DLC cable loose.

Other Possible Causes:

- Master cartridge has loose or dirty contacts.
- Tester is malfunctioning.

Recommendations:

- Cycle power to the tester (unplug and replug the DLC).
- Check tester cartridge socket and cartridge edge connector.
- Check DLC cable and connector for wear and corrosion.

COMPANION APPLICATION MISSING

COMPANION
APPLICATION
MISSING

Most Likely Cause:

- ABS/AIRBAG Application not installed in the Application Cartridge.

Other Possible Causes:

- Application Cartridge is not installed correctly.
- Wrong cartridge is installed in the tester.

Recommendations:

- Confirm that the Suzuki Application Cartridge is correctly installed in the bottom cartridge slot of the tester.

- Confirm that no other Master or Mass Storage Cartridge is installed in the top cartridge slot.
- Contact your Vetronix distributor to have the application installed in the Application Cartridge.

B. GLOSSARY OF TERMS

This section describes the abbreviations and terminology which are used in this manual and in the tester displays.

36 VEN	The Status of the 36 Volts Enable
ABS	Antilock Brake System
ADS	The Status of the Auxiliary Discriminating Sensor
ADSMISS	The Status of the Auxiliary Discriminating Sensor (ADS Missing)
B+	Battery voltage.
BATT or BAT	Battery
BCM	Body Computer Module
BRK	Brake
CAL	Calibration
CMD	Command
CNTRL	Control
CNTRLR	Controller
CNTS or CNTCS	Contacts
Control Test	A test where the TECH1 controls some of the vehicle's functions.
CTL or CNTL	Control
DBC7	Delphi Brake Control 7
DCD ABS VI	Delco Chassis Division's ABS VI system
DATA LIST	TECH1 operating mode where DLC diagnostic information is displayed.

Data Parameter	A parameter which represents a quantity and is displayed as a value with appropriate units (volts, C, %, etc.).
DCD	Delco Chassis Division
Diagnostic Codes	Trouble codes. Set by the ABS or SIR to indicate the occurrence of abnormal conditions.
Discrete Parameter	A parameter which can be in one of only two possible states (HIGH/LOW, ON/OFF).
DLC	Data Link Connector
DRIVER 36 VLR	Driver Side 36 Volt Loop Resistance
EBCM	Electronic Brake Control Module (ABS controller)
ECM	Engine Control Module
ECU	Electronic Control Unit
ESB	Expansion Spring Brake
FDBK or FB or FBK	Feedback
FREQ	Frequency
FRT	Front
Function Keys	Keys on the tester which can be used to select a particular function: F0, F1-F9. These keys double as numeric keys: 0-9.
GND	Ground potential (low side of battery)
HYDRL	Hydraulic
ID	Identification
IGN	Ignition
km/h	Kilometers per hour
LF	Left Front
LR	Left Rear
LT or LITE	Light
MPH	Miles per hour
MS	Milliseconds (1000ths of a second)
MTR	Motor
MV	Millivolts (1000ths of a volt)
Numeric Keys	Keys (0,1...9) which are used to enter numeric values such as trouble codes. These keys double as function keys: F0...F9.
P/N	Park/Neutral Switch
Parameter	A piece of information which is displayed by the tester.
PASS.	Passenger

PRESS	Pressure
PRNDL	Transmission shifter indicator (Park, Reverse, Neutral, Drive, and Low)
PROM	Programmable Read Only Memory
PSI	Pounds per square inch
RA	Rear Axle
REL	Relay
REL	Release (when used with "solenoid")
RF	Right Front
RLY	Relay
RR	Right Rear
SDL	Serial Data Link
SHRT	Short
Snapshot Test	Tester operating mode which is used to isolate intermittent problems.
SOL	Solenoid
SW	Switch
TCS	Traction Control System
Trouble Codes	Same as Diagnostic Trouble Codes. Set by the ABS or SIR to indicate the occurrence of abnormal conditions.
TST	Test
TT	Telltails: Indicator lights
V	Volts
VDIF	Voltage Difference
VSS	Vehicle Speed Sensor
WHL	Wheel
WSS	Wheel Speed Sensor