

Pictorial Index	Interior, exterior views and part identification of your Toyota.
1 Essential Safety Equipment	Important information about safety equipment, including seats, seat belt system, child-restraint systems and SRS air bags.
2 Before Driving	Use of various features, including keys, doors, mirrors and windows.
3 When Driving	Information concerning safe driving and stopping.
4 Interior Features	Use of various features for ride comfort, including air-conditioning and audio system.
5 Maintenance and Care	How to keep your Toyota in top condition.
6 If Trouble Arises	Helpful information on what to do if a problem arises with the vehicle.
7 Customer Information and Reporting Safety Defects	Important consumer information including warranties and add-on equipment.
8 Specifications	Technical information about your Toyota.
Index	Search alphabetically

How to Use This Manual..... 9
 Pictorial Index 12

1 Essential Safety Equipment

1-1. Seats
 Seat Precautions 20
 Front Seat 23
 Rear Seat 26
 Head Restraints 30

1-2. Seat Belt Systems
 Seat Belt Precautions..... 33
 Seat Belt..... 37
 Seat Belt Pretensioner
 and Load Limiting
 Systems 39
 Seat Belt Extender 42

1-3. Child Restraint
 Child-Restraint
 Precautions 44
 Child-Restraint System
 Installation 49
 Installing Child-Restraint
 Systems 51

1-4. SRS Air Bags
 Supplemental Restraint
 System (SRS)
 Precautions 66
 Supplemental Restraint
 System Components 73
 How the SRS Air Bags
 Work 74
 SRS Air Bag Deployment
 Criteria 78
 Limitations to
 SRS Air Bag 80
 Front Passenger
 Occupant Classification
 System 82
 Constant Monitoring 87

2 Before Driving

2-1. Keys
 Keys..... 90
 Keyless Entry System..... 92

2-2. Advanced Keyless Entry System
 Advanced Keyless Entry
 System 99

2-3. Door and Locks
 Door Locks 101
 Liftgate/Trunk Lid..... 113

2-4. Fuel and Emission
 Fuel and Engine Exhaust
 Precautions 121
 Fuel-Filler Lid and Cap 124

2-5. Steering Wheel			
Steering Wheel.....	127		
2-6. Mirrors			
Mirrors	129		
2-7. Windows			
Power Windows	132		
2-8. Security System			
Modification and Add-On Equipment	135		
Immobilizer System.....	136		
Theft Deterrent System	138		
2-9. Driving Tips			
Break-In Period	141		
Saving Fuel and Protection of the Environment.....	142		
Hazardous Driving.....	143		
Floor Mat.....	144		
Rocking the Vehicle	145		
Winter Driving.....	146		
Driving In Flooded Area	149		
Overloading.....	150		
Driving on Uneven Road	151		
2-10. Towing			
Trailer Towing	152		
Recreational Towing	153		
		3 When Driving	
		3-1. Start/Stop Engine	
		Ignition Switch	156
		Starting the Engine	158
		Turning the Engine Off	163
		3-2. Combination Meter and Display	
		Meters and Gauges	164
		Warning/Indicator Lights.....	173
		3-3. Transaxle	
		Manual Transaxle Operation.....	177
		Automatic Transaxle Controls	181
		3-4. Switches and Controls	
		Lighting Control	192
		Fog Lights.....	198
		Turn and Lane-Change Signals.....	199
		Windshield Wipers and Washer	201
		Rear Window Wiper and Washer	206
		Rear Window Defogger.....	207
		Hazard Warning Flasher	208
		3-5. Brake	
		Brake System	209
		Hill Launch Assist (HLA)....	213

3-6. ABS/TCS/DSC	
Antilock Brake System (ABS)	215
Traction Control System (TCS)	216
Dynamic Stability Control (DSC)	218
3-7. Fuel Economy Monitor	
Fuel Economy Monitor	221
3-8. Drive Selection	
Drive Selection (Automatic Transaxle)	224
3-9. Power Steering	
Power Steering	226
3-10. Active Safety System	
Active Safety System	227
Low Speed Pre-Collision System	228
Laser Sensor	234
3-11. Cruise Control	
Cruise Control	236
3-12. Tire Pressure Monitoring System	
Tire Pressure Monitoring System	241
3-13. Rear View Monitor	
Rear View Monitor	245

4 Interior Features

4-1. Climate Control System	
Operating Tips	256
Vent Operation	257
Manual Type	259
Fully Automatic Type	266
4-2. Audio System	
Antenna	271
Operating Tips for Audio System	273
Audio Set	283
Audio Control Switch Operation	304
AUX/USB mode	307
4-3. Bluetooth®	
Bluetooth®	327
Bluetooth® Hands-Free	339
Bluetooth® Audio	353
Troubleshooting	366
4-4. Interior Equipment	
Sunvisors	374
Interior Lights	375
Accessory Socket	378
Cup Holder	379
Bottle Holder	380
Storage Compartments	381

5 Maintenance and Care

5-1. Essential Information	
Introduction	386
5-2. Scheduled Maintenance	
Maintenance Monitor.....	388
5-3. Owner Maintenance	
Owner Maintenance	
Precautions	390
Hood.....	392
Engine Compartment	
Overview	394
Engine Oil.....	395
Engine Coolant.....	398
Brake/Clutch Fluid.....	401
Window Washer Fluid	402
Body Lubrication	403
Wiper Blades	404
Battery	408
Key Battery	
Replacement.....	410
Tires	413
Light Bulbs	419
Fuses	435
5-4. Appearance Care	
Exterior Care	442
Interior Care	450

6 If Trouble Arises

6-1. Parking in an Emergency	
Parking in an	
Emergency	456
6-2. Flat Tire	
Spare Tire and Tool	
Storage	457
Changing a Flat Tire	463
6-3. Battery Runs Out	
Jump-Starting	478
6-4. Emergency Starting	
Starting a Flooded	
Engine	482
Push-Starting.....	483
6-5. Overheating	
Overheating	484
6-6. Emergency Towing	
Towing Description	486
Tiedown Hooks	487
6-7. Warning/Indicator Lights and Warning Sounds	
If a Warning Light Turns	
On or Flashes	489
Message Indicated on	
Display.....	500
Warning Sound is	
Activated.....	502
6-8. When Trunk Lid Cannot be Opened	
When Liftgate/Trunk Lid	
Cannot be Opened	506

7	Customer Information and Reporting Safety Defects	
	7-1. Reporting Safety Defects	
	Reporting Safety Defects (U.S.A.).....	510
	Reporting Safety Defects (Canada).....	511
	7-2. Warranty	
	Warranties for Your Toyota	512
	Outside the United States/Canada	513
	Add-On Non-Genuine Parts and Accessories.....	514
	7-3. Cell Phones	
	Cell Phones Warning	515
	7-4. Event Data Recorder	
	Event Data Recorder (U.S.A. and Canada).....	516
	7-5. Vehicle Data Recordings	
	Vehicle Data Recordings.....	518
	7-6. Uniform Tire Quality Grading System (UTQGS)	
	Uniform Tire Quality Grading System (UTQGS)	519
	7-7. Tire Information (U.S.A.)	
	Tire Labeling.....	522
	Location of the Tire Label (Placard).....	528
	Tire Maintenance.....	531
	Vehicle Loading	534
	Steps for Determining the Correct Load Limit	539
	7-8. Declaration of Conformity	
	Declaration of Conformity	540

8 Specifications

8-1. Identification Numbers
Vehicle Information
Labels 546

8-2. Specifications
Specifications 548

8-3. Customizable Features
Customizable
Features 555

Index

Alphabetical index 564



Please be aware that this manual applies to all models, equipment and options. As a result, you may find some explanations for equipment not installed on your vehicle.

■ **Important Notes About This Manual**

Keep this manual in the glove box as a handy reference for the safe and enjoyable use of your Toyota. Should you resell the vehicle, leave this manual with it for the next owner.

All specifications and descriptions are accurate at the time of printing. Because improvement is a constant goal at Toyota, we reserve the right to make changes in specifications at any time without notice and without obligation.

■ **Air Conditioning and the Environment**

Your Toyota's genuine air conditioner is filled with a refrigerant that has been found not to damage the earth's ozone layer. If the air conditioner does not operate properly, consult your Toyota dealer.

■ **Perchlorate**

Certain components of this vehicle such as [air bag modules, seat belt pretensioners, lithium batteries,...] may contain Perchlorate Material-- Special handling may apply for service or vehicle end of life disposal. See www.dtsc.ca.gov/hazardouswaste/perchlorate.

How to Use This Manual

We want to help you get the most driving pleasure from your vehicle. Your owner's manual, when read from cover to cover, can do that in many ways.

Illustrations complement the words of the manual to best explain how to enjoy your Toyota. By reading your manual, you can find out about the features, important safety information, and driving under various road conditions.

This manual addresses configurations, systems and options available among all the variations of the vehicle. Therefore, this manual may cover and depict things that are not on your vehicle.

The symbol below in this manual means "Do not do this" or "Do not let this happen".

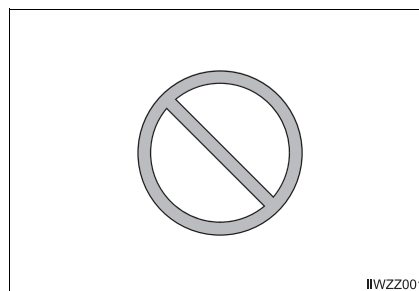

Index:

A good place to start is the Index, an alphabetical listing of all information in your manual.

1 **2** **3** ... Indicates operating or working procedures. Follow the steps in numerical order.

You'll find several WARNINGS and NOTICES in the manual.



WARNING:

Explains something that, if not obeyed, could cause death or serious injury to people.



NOTICE:

Explains something that, if not obeyed, could cause damage to or a malfunction in the vehicle or its equipment.

The symbol below, located on some parts of the vehicle, indicates that this manual contains information related to the part.

Please refer to the manual for a detailed explanation.



IIVZZ002

Pictorial Index

■ Interior Equipment (View A)

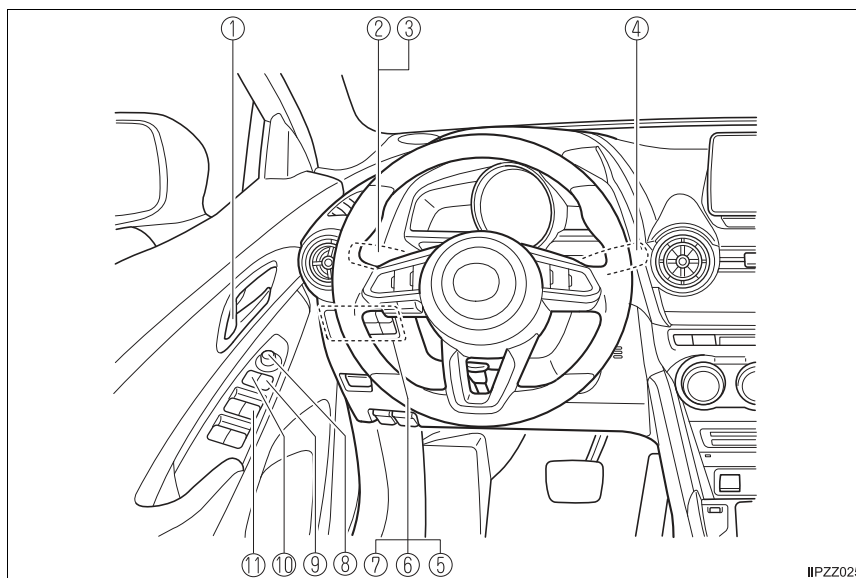

- ① Door-lock knob P. 111
- ② Turn and lane-change signal P. 199
- ③ Lighting control P. 192
- ④ Wiper and washer lever P. 201
- ⑤ DSC OFF switch P. 219
- ⑥ Tire pressure monitoring system set switch P. 244
- ⑦ Low Speed Pre-Collision System OFF switch P. 233
- ⑧ Outside mirror switch P. 129
- ⑨ Door-lock switch P. 107
- ⑩ Power window lock switch P. 133
- ⑪ Power window switches P. 132

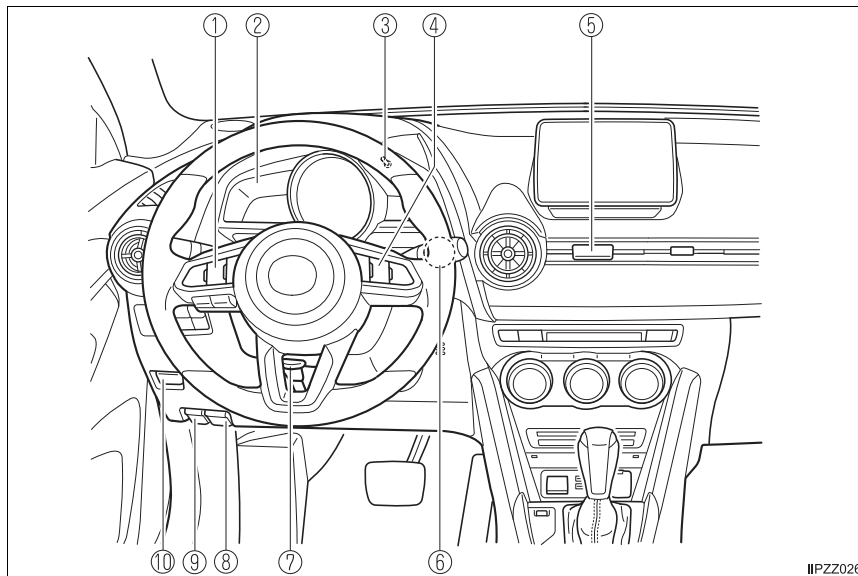

- | | | |
|---|---|---------------|
| ① | Audio control switches | P. 304 |
| ② | Combination meter | P. 164 |
| ③ | Dashboard illumination knob | P. 169 |
| ④ | Cruise control switches | P. 236 |
| ⑤ | Hazard warning flasher switch | P. 208 |
| ⑥ | Push button start | P. 156 |
| ⑦ | Lock release lever | P. 127 |
| ⑧ | Hood release handle | P. 392 |
| ⑨ | Remote fuel-filler lid release | P. 125 |
| ⑩ | Trunk release button | P. 115 |

The equipment and installation position varies by vehicle

Interior Equipment (View B)

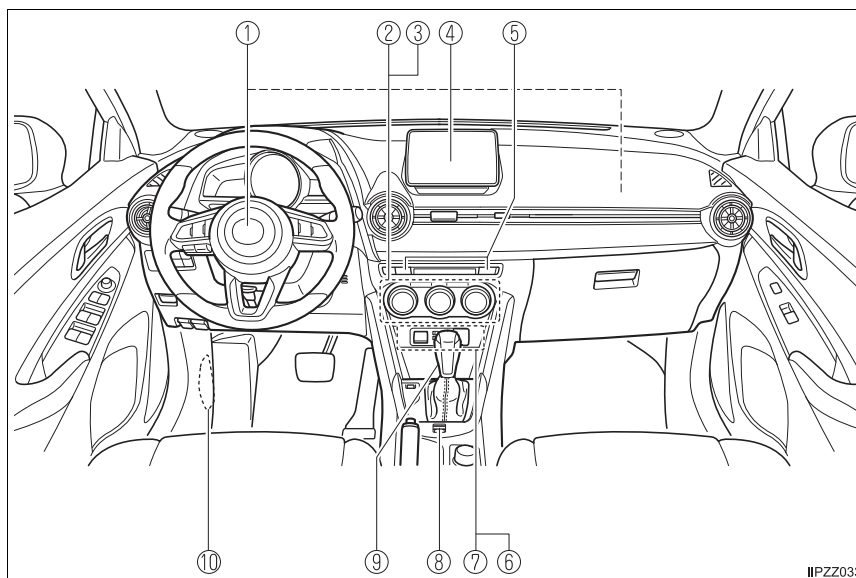

- ① SRS air bags. P. 66
- ② Climate control system P. 256
- ③ Rear window defogger switch P. 207
- ④ Audio system P. 271
- ⑤ Seat warmer switches P. 24
- ⑥ Accessory socket P. 378
- ⑦ External input terminal P. 307
- ⑧ Drive selection switch P. 224
- ⑨ Shift lever/Selector lever P. 177, 181
- ⑩ Fuse block (Left side) P. 435

Interior Equipment (View C)

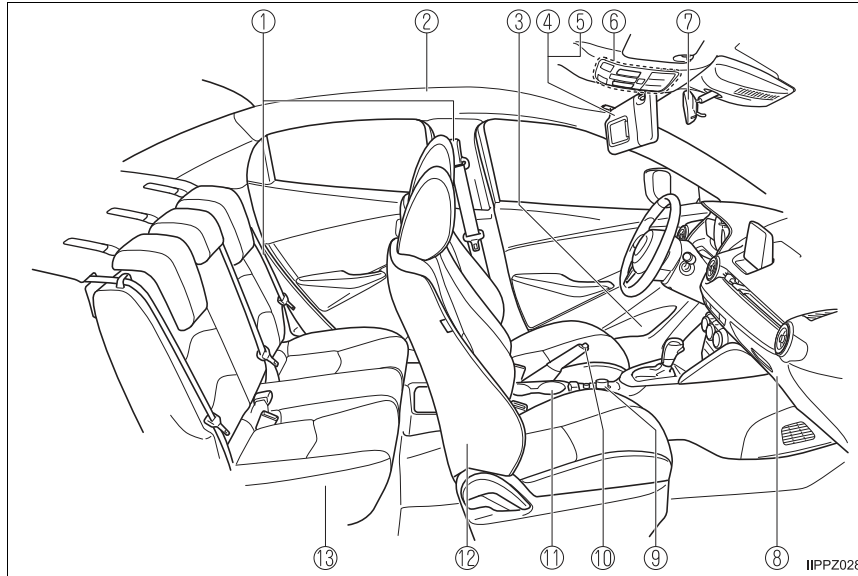

①	Seat belts	P. 33
②	SRS air bag	P. 66
③	Bottle holder	P. 380
④	Sunvisor	P. 374
⑤	Vanity mirror	P. 374
⑥	Overhead lights	P. 375
⑦	Rearview mirror	P. 130
⑧	Glove compartment	P. 382
⑨	Commander switch	P. 283
⑩	Parking brake	P. 210
⑪	Cup holders	P. 379
⑫	Front seat	P. 23
⑬	Rear seat	P. 26

The equipment and installation position varies by vehicle

■ Exterior Overview

► 4-Door

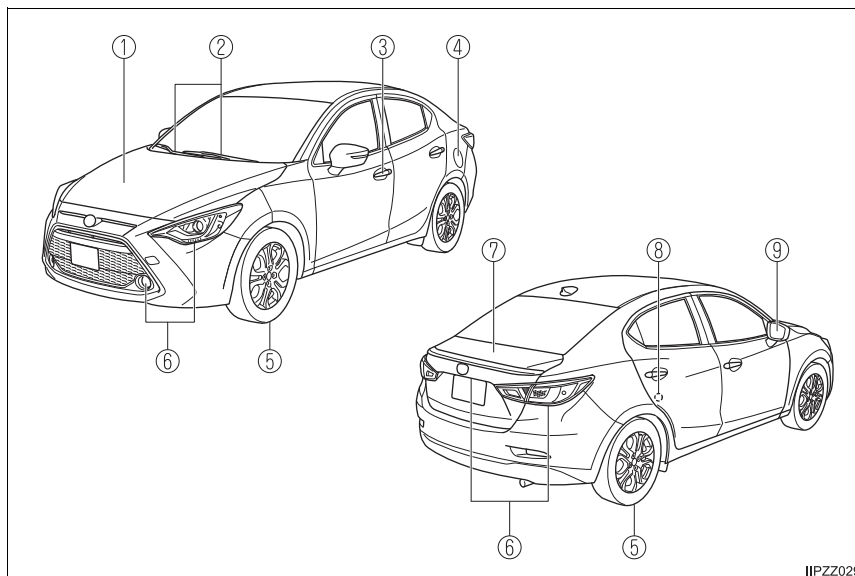

①	Hood	P. 392
②	Windshield wiper blades	P. 404
③	Door and key	P. 103
④	Fuel-filler lid	P. 124
⑤	Wheels and Tires	P. 413
⑥	Exterior lights	P. 419
⑦	Trunk lid	P. 115
⑧	Child safety lock	P. 112
⑨	Outside mirror	P. 129

The equipment and installation position varies by vehicle

► 5-Door

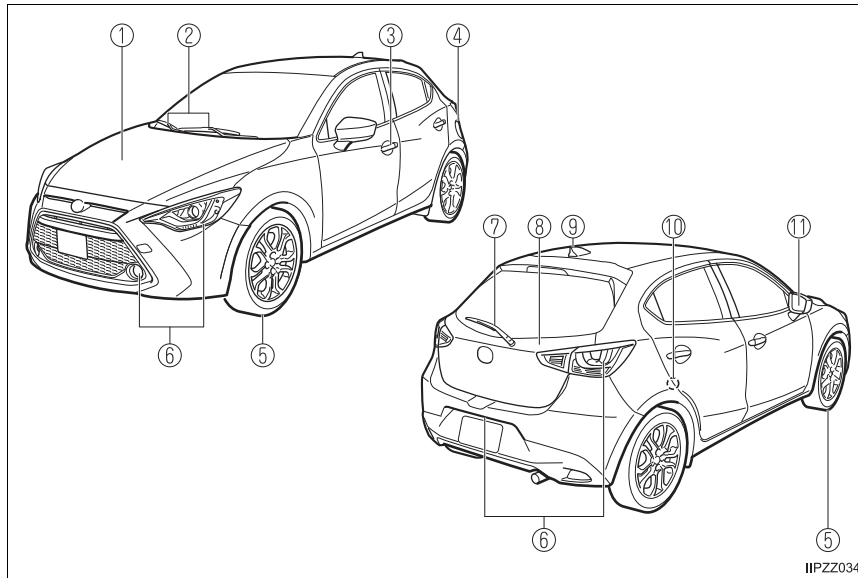

① Hood	P. 392
② Windshield wiper blades	P. 404
③ Door and key	P. 103
④ Fuel-filler lid	P. 124
⑤ Wheels and Tires	P. 413
⑥ Exterior lights	P. 419
⑦ Rear window wiper blade	P. 406
⑧ Liftgate	P. 115
⑨ Antenna	P. 271
⑩ Child safety lock	P. 112
⑪ Outside mirror	P. 129

The equipment and installation position varies by vehicle

Essential Safety Equipment

1

1-1. Seats		1-3. Child Restraint	
Seat Precautions.....	20	Child-Restraint	
Front Seat	23	Precautions	44
Rear Seat	26	Child-Restraint System	
Head Restraints	30	Installation.....	49
1-2. Seat Belt Systems		Installing Child-Restraint	
Seat Belt Precautions	33	Systems	51
Seat Belt	37	1-4. SRS Air Bags	
Seat Belt Pretensioner		Supplemental Restraint	
and Load Limiting		System (SRS)	
Systems	39	Precautions	66
Seat Belt Extender	42	Supplemental Restraint	
		System Components	73
		How the SRS Air Bags	
		Work	74
		SRS Air Bag Deployment	
		Criteria	78
		Limitations to	
		SRS Air Bag.....	80
		Front Passenger	
		Occupant Classification	
		System	82
		Constant Monitoring	87

Seat Precautions

When returning a rear seat to its original position, place the seat belt in its normal position. Verify that the seat belt pulls out and retracts.

WARNING

■ **Make sure the adjustable components of a seat are locked in place**

Adjustable seats and seatbacks that are not securely locked are dangerous. In a sudden stop or collision, the seat or seatback could move, causing injury. Make sure the adjustable components of the seat are locked in place by attempting to slide the seat forward and backward and rocking the seatback.

■ **Never allow children to adjust a seat**

Allowing children to adjust a seat is dangerous as it could result in serious injury if a child's hands or feet become caught in the seat.

■ **Do not drive with the seatback unlocked**

All of the seatbacks play an important role in your protection in a vehicle. Leaving the seatback unlocked is dangerous as it can allow passengers to be ejected or thrown around and baggage to strike occupants in a sudden stop or collision, resulting in severe injury. After adjusting the seatback at any time, even when there are no other passengers, rock the seatback to make sure it is locked in place.

■ **Adjust a seat only when the vehicle is stopped**

If the seat is adjusted while the vehicle is being driven, the seating posture may become unstable and the seat could move unexpectedly resulting in injury.

■ **Do not modify or replace the front seats**

Modifying or replacing the front seats such as replacing the upholstery or loosening any bolts is dangerous. The front seats contain air bag components essential to the supplemental restraint system. Such modifications could damage the supplemental restraint system and result in serious injury. Consult your Toyota dealer if there is any need to remove or reinstall the front seats.

■ **Do not drive with damaged front seats**

Driving with damaged front seats, such as seat cushions torn or damaged down to the urethane, is dangerous. A collision, even one not strong enough to inflate the air bags, could damage the front seats which contain essential air bag components. If there was a subsequent collision, an air bag may not deploy which could lead to injuries. Always have your Toyota dealer inspect the front seats, front seat belt pretensioners and air bags after a collision.

 **WARNING****■ Do not drive with either front seats reclined**

Sitting in a reclined position while the vehicle is moving is dangerous because you do not get the full protection from seat belts. During sudden braking or a collision, you can slide under the lap belt and suffer serious injuries. For maximum protection, sit well back and upright.

■ Do not place an object such as a cushion between the seatback and your back

Putting an object such as a cushion between the seatback and your back is dangerous because you will be unable to maintain a safe driving posture and the seat belt cannot function at its full capacity in a collision, which could result in a serious accident, injury or death.

■ Do not place objects under the seat

The object could get stuck and cause the seat to not be fixed securely, and result in an accident.

■ Do not stack cargo higher than the seatbacks

Stacking luggage or other cargo higher than the seatbacks is dangerous. During sudden braking or a collision, objects can fly around and become projectiles that may hit and injure passengers.

■ Make sure luggage and cargo is secured before driving

Not securing cargo while driving is dangerous as it could move or be crushed during sudden braking or a collision and cause injury.

■ Never allow a passenger to sit or stand on the folded seatback while the vehicle is moving

Driving with a passenger on the folded seatback is dangerous. Allowing a child to sit up on the folded seatback while the vehicle is moving is particularly dangerous. In a sudden stop or even a minor collision, a child not in a proper seat or child-restraint system and seat belt could be thrown forward, back or even out of the vehicle resulting in serious injuries or death. The child in the baggage area could be thrown into other occupants and cause serious injury.

■ Never give the car keys to children and do not allow them to play in the vehicle

Playing with the folding rear seats is dangerous. Once the seatbacks are back up, a child in the trunk would not be able to get out the way they had entered. If you have small children, keep the seatbacks locked.

 **WARNING****■ Always leave your car locked and keep the car keys safely away from children**

Leaving your car unlocked or the keys in reach of children is dangerous. Children who find their way into the trunk through an unlocked rear seatback or an open trunk can become accidentally locked in the trunk. This could result in death or brain damage from heat prostration, particularly in the summer. Always lock the doors and the trunk, and as an added measure, keep the rear seatbacks locked, whether you have children in your home or not.

■ When operating a seat

- When operating a seat, be careful not to put your hands or fingers near the moving parts of the seat or on the side trim to prevent injury.
- When moving the seats forward and rearward or returning a rear-reclined seatback to its upright position, make sure you hold onto the seatback with your hand while operating. If the seatback is not held, the seat will move suddenly and could cause injury.
- When inserting your hand under the seat to clean the cabin or pick up something you dropped under the seat, be careful not to hurt yourself. If you contact the moving parts of the seat rail or seat frame, it could result in injury.

 **NOTICE**

When moving the seats, make sure there is no cargo in the surrounding area. If the cargo gets caught it could damage the cargo.

Front Seat

Seat Operation

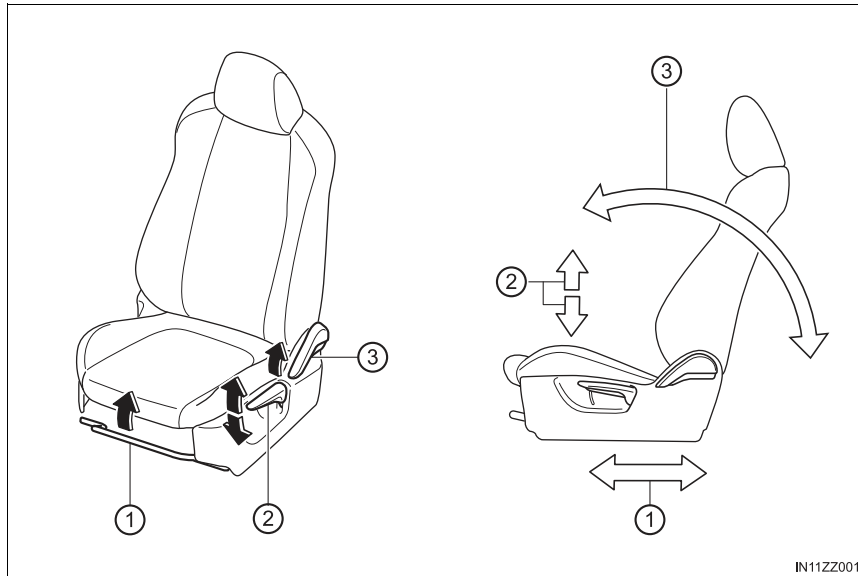

① Seat Slide

To move a seat forward or backward, raise the lever and slide the seat to the desired position and release the lever.

Make sure the lever returns to its original position and the seat is locked in place by attempting to push it forward and backward.

② Height Adjustment (Driver's Seat)

To adjust the seat height, move the lever up or down.

③ Seat Recline

To change the seatback angle, lean forward slightly while raising the lever. Then lean back to the desired position and release the lever.

Make sure the lever returns to its original position and the seatback is locked in place by attempting to push it forward and backward.

Seat Warmer (if equipped)

The front seats are electrically heated. The ignition must be switched ON.

Press the seat warmer switch to illuminate the indicator light while the ignition is switched ON. The mode changes as follows each time the seat warmer switch is pressed.

- ① OFF
- ② High
- ③ Mid
- ④ Low

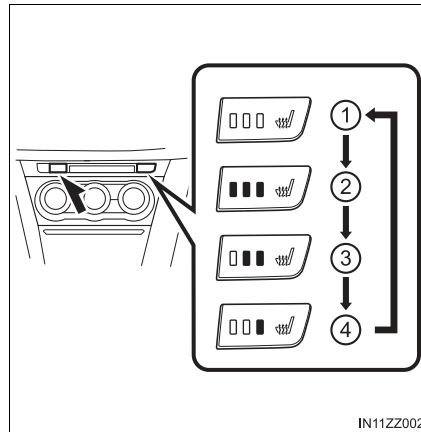

- If the ignition is switched off while the seat warmer is operating (High, Mid or Low) and then switched ON again, the seat warmer will automatically operate at the temperature set before switching off the ignition.
- Use the seat warmer when the engine is running. Leaving the seat warmer on for long periods with the engine not running could cause the battery power to be depleted.
- The temperature of the seat warmer cannot be adjusted beyond High, Mid and Low because the seat warmer is controlled by a thermostat.

⚠ WARNING

■ Be careful when using the seat warmer

The heat from the seat warmer may be too hot for some people, as indicated below, and could cause a low-temperature burn.

- Infants, small babies, elderly people, and physically challenged people
- People with delicate skin
- People who are excessively fatigued
- People who are intoxicated
- People who have taken sleep-inducing medicine such as sleeping pills or cold medicine

■ Do not use the seat warmer with anything having high moisture-retention ability such as a blanket or cushion on the seat

The seat may be heated excessively and cause a low-temperature burn.

 WARNING**■ Do not use the seat warmer even when taking a short nap in the vehicle**

The seat may be heated excessively and cause a low-temperature burn.

■ Do not place heavy objects with sharp projections on the seat, or insert needles or pins into it

This could cause the seat to become excessively heated and result in injury from a minor burn.

 NOTICE

Do not use solvents to clean the seat. It may damage the seat surface and the heater.

1

Essential Safety Equipment

Rear Seat

Split Folding the Seatback

By lowering the rear seatbacks the luggage compartment space can be expanded.

WARNING

■ **Do not drive the vehicle with occupants on folded down seatbacks or in the luggage compartment.**

Putting occupants in the luggage compartment is dangerous because seat belts cannot be fastened which could lead to serious injury or death during sudden braking or a collision.

■ **Do not allow children to play inside the vehicle with the seatbacks lowered.**

Allowing children to play in the vehicle with the seatbacks folded down is dangerous. If a child enters the luggage compartment and the seatbacks were raised back up, the child may become trapped in the luggage compartment which could lead to an accident.

■ **Tightly secure cargo in the luggage compartment when it is transported with the seatbacks folded down.**

Driving without tightly securing cargo and luggage is dangerous as it could move and become an obstruction to driving during emergency braking or a collision resulting in an unexpected accident.

■ **When transporting cargo, do not allow the cargo to exceed the height of the seatbacks.**

Transporting cargo stacked higher than the seatbacks is dangerous as visibility to the rear and sides of the vehicle is reduced which could interfere with driving operations and lead to an accident.

Lowering the seatbacks

► 4-Door

- 1 Lower the head restraint all the way down.
Refer to Head Restraints on P. 30.
- 2 Open the trunk lid and pull the lever of the seatback you want to fold down.

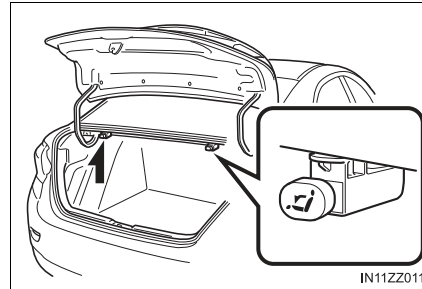

- 3 Open a rear door and fold the rear seat forward.

► 5-Door

- 1 Lower the head restraint all the way down.
Refer to Head Restraints on P. 30
- 2 Press the push knob to fold down the seatback you want to fold down.

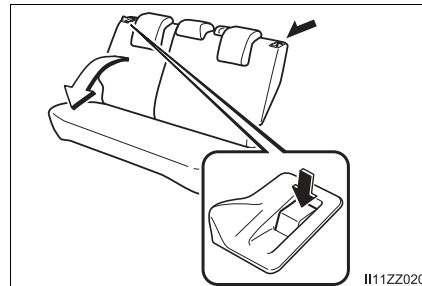

- 3 Secure the rear seat belt in the belt clip.

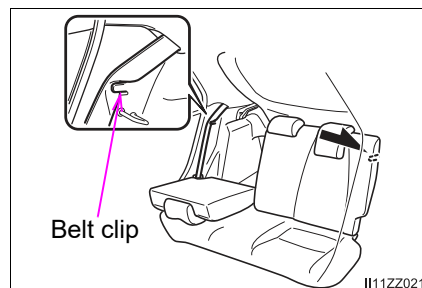

 NOTICE

- 5-Door: When folding the seatback forward, always support the seatback with your hand. If it is not supported by a hand, fingers or the hand pressing the push knob could be injured.
- Check the position of a front seat before folding a rear seatback. Depending on the position of a front seat, it may not be possible to fold a rear seatback all the way down because it may hit the seatback of the front seat which could scratch or damage the front seat or its pocket. Lower or remove the head restraint on the rear outboard seat if necessary.

To return the seatback to its upright position

► 4-Door

- 1 Make sure that the seat belt passes through the seat belt guide correctly and it is not twisted, then raise the seatback while preventing the seat belt from being caught in the seatback.

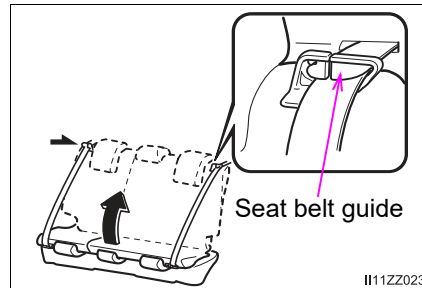

- 2 Press the seatback rearward and lock it in place. After returning the seatback to its upright position, make sure it is securely locked.

► 5-Door

- 1 Verify that the seat belt is secured in the belt clip.

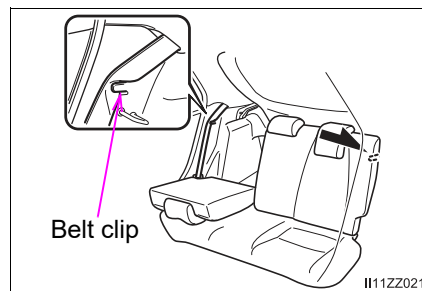

- 2 Lift the seatback upright.
- 3 Press the seatback rearward and lock it in place. After returning the seatback to its upright position, make sure it is securely locked.
- 4 Make sure that the seat belt is neither stuck in the rear seat nor twisted, then remove the seat belt from the belt clip.

⚠ WARNING

■ **When returning a seatback to its upright position, make sure the 3-point seat belt is not caught in the seatback and the 3-point seat belt is not twisted.**

- If the seat belt is used while it is twisted and caught in the seatback, the seat belt cannot function at its full capacity, which could cause serious injury or death.
- When returning a seatback to its upright position, make sure that it is firmly locked and the red indication is not visible (5-Door).
- If the red indication is visible behind the push knob, it means the seatback is not locked. If the vehicle is driven without the seatback locked, it could fold down suddenly and cause an accident.

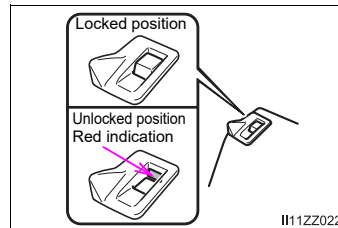

Head Restraints

Your vehicle is equipped with head restraints on all outboard seats and the rear center seat. The head restraints are intended to help protect you and the passengers from neck injury.

WARNING

- **Always drive with the head restraints installed when seats are being used and make sure they are properly adjusted. In addition, always raise the head restraints on all rear seats when they are being used**

Driving with the head restraints adjusted too low or removed is dangerous. With no support behind your head, your neck could be seriously injured in a collision.

Height Adjustment

Adjust the head restraint so that the center is even with the top of the passenger's ears.

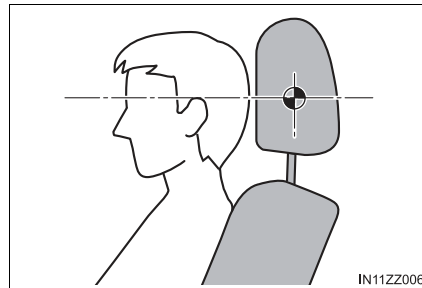

To raise a head restraint, pull it up to the desired position.

To lower the head restraint, press the stop-catch release, then push the head restraint down.

■ Front seats

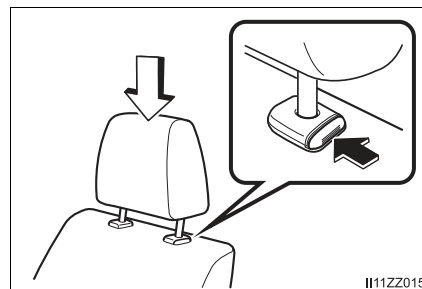

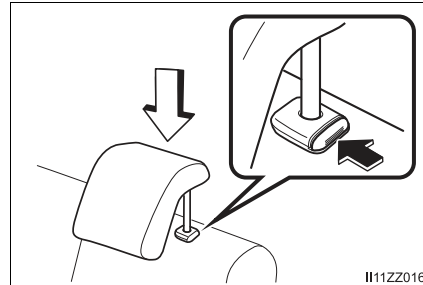
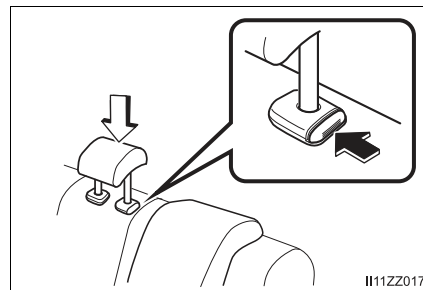
■ Rear outboard seats**■ Rear center seat**

1

Essential Safety Equipment

Removal/Installation

To remove the head restraint, pull it up while pressing the stop-catch.
To install the head restraint, insert the legs into the holes while pressing the stop-catch.

 **WARNING****■ Always drive with the head restraints installed when seats are being used and make sure they are properly installed**

- Driving with the head restraints not installed is dangerous. With no support behind your head, your neck could be seriously injured in a collision.
- When installing a head restraint, make sure that it is installed correctly with the front of the head restraint facing forward. If the head restraint is installed incorrectly, it could detach from the seat during a collision and result in injury.
- The head restraints on each of the front and rear seats are specialized to each seat. Do not switch around the head restraint positions. If a head restraint is not installed to its correct seat position, the effectiveness of the head restraint during a collision will be compromised which could cause injury.

■ After installing a head restraint, try lifting it to make sure that it does not pull out

Driving with an unsecured head restraint is dangerous as the effectiveness of the head restraint will be compromised which could cause it to unexpectedly detach from the seat.

Seat Belt Precautions

Seat belts help to decrease the possibility of severe injury during accidents and sudden stops. Toyota recommends that the driver and all passengers always wear seat belts.

All of the seat belt retractors are designed to keep the lap/shoulder belts out of the way when not in use.

The driver's seat belt has no provisions for child-restraint systems and has only an emergency locking mode. The driver may wear it comfortably, and it will lock during a collision.

However, the front passenger's seat and all rear lap/shoulder belt retractors operate in two modes: emergency locking mode, and for child-restraint systems, automatic locking mode. While we recommend you put all children in the rear seats, if you must use the front passenger seat for a child, slide the front passenger seat as far back as possible and make sure any child-restraint system is secured properly.

WARNING

■ **Always wear your seat belt and make sure all occupants are properly restrained**

Not wearing a seat belt is extremely dangerous. During a collision, occupants not wearing seat belts could hit someone or things inside the vehicle or even be thrown out of the vehicle. They could be seriously injured or even killed. In the same collision, occupants wearing seat belts would be much safer.

1

Essential Safety Equipment

 **WARNING****■ Do not wear twisted seat belts**

Twisted seat belts are dangerous. In a collision, the full width of the belt is not available to absorb the impact. This puts more force on the bones beneath the belt, which could cause serious injury or death. So, if your seat belt is twisted, you must straighten the seat belt to remove any twists and to allow the full width of the belt to be used.

■ Never use one seat belt on more than one person at a time

Using one seat belt for more than one person at a time is dangerous. A seat belt used in this way cannot spread the impact forces properly and the two passengers could be crushed together and seriously injured or even killed. Never use one belt for more than one person at a time and always operate the vehicle with each occupant properly restrained.

■ Do not operate a vehicle with a damaged seat belt

Using a damaged seat belt is dangerous. An accident could damage the belt webbing of the seat belt in use. A damaged seat belt cannot provide adequate protection in a collision. Have your Toyota dealer inspect all seat belt systems in use during an accident before they are used again.

■ Have your seat belts changed immediately if the pretensioner or load limiter has been expended

Always have your Toyota dealer immediately inspect the seat belt pretensioners and air bags after any collision. Like the air bags, the seat belt pretensioners and load limiters will only function once and must be replaced after any collision that caused them to deploy. A seat belt with an expended pretensioner or load limiter is still better than wearing no seat belt at all; however, if the seat belt pretensioners and load limiters are not replaced, the risk of injury in a collision will increase.

■ Positioning the Shoulder Portion of the Seat Belt

Improper positioning of the shoulder portion of the seat belt is dangerous. Always make sure the shoulder portion of the seat belt is positioned across your shoulder and near your neck, but never under your arm, on your neck, or on your upper arm.

■ Positioning the Lap Portion of the Seat Belt

The lap portion of the seat belt worn too high is dangerous. In a collision, this would concentrate the impact force directly on the abdominal area, causing serious injury. Wear the lap portion of the belt snugly and as low as possible.

 NOTICE

Belt retraction may become difficult if the belts and rings are soiled, so try to keep them clean. For more details about cleaning the seat belts, refer to “Cleaning the Lap/Shoulder Belt Webbing” (→P. 453).

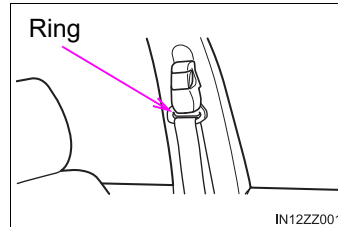
**Pregnant Women and Persons with Serious Medical Conditions**

Pregnant women should always wear seat belts. Ask your doctor for specific recommendations.

The lap belt should be worn **SNUGLY AND AS LOW AS POSSIBLE OVER THE HIPS**. The shoulder belt should be worn across your shoulder properly, but never across the stomach area.



Persons with serious medical conditions also should wear seat belts. Check with your doctor for any special instructions regarding specific medical conditions.

Emergency Locking Mode

When the seat belt is fastened, it will always be in the emergency locking mode.

In the emergency locking mode, the belt remains comfortable on the occupant and the retractor will lock in position during a collision.

If the belt is locked and cannot be pulled out, retract the belt once, and then try pulling it out slowly. If this fails, pull the belt strongly one time and loosen, then pull it out again slowly.

Seat Belt with Automatic Locking Mode:

When the seat belt is fastened, it will always be in the emergency locking mode until it is switched to automatic locking mode by pulling it all the way out to its full length. If the belt feels tight and hinders comfortable movement while the vehicle is stopped or in motion, it may be in the automatic locking mode because the belt has been pulled too far out. To return the belt to the more comfortable emergency locking mode, wait until the vehicle has stopped in a safe, level area, retract the belt fully to convert it back to emergency locking mode and then extend it around you again.

Automatic Locking Mode (if equipped)

Always use the automatic locking mode to keep the child-restraint system from shifting to an unsafe position in the event of an accident.

To enable seat belt automatic locking mode, pull it all the way out and connect it as instructed on the child-restraint system. It will retract down to the child-restraint system and stay locked on it. See the section on child restraint (→P. 44).

Seat Belt

Fastening the Seat Belt

Position the lap belt as low as possible, not on the abdominal area, then adjust the shoulder belt so that it fits snugly against your body.

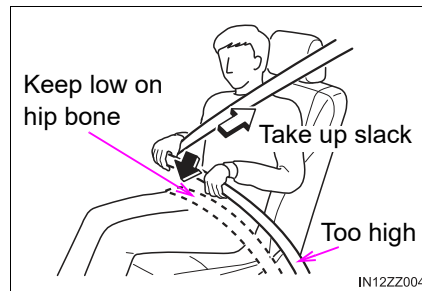
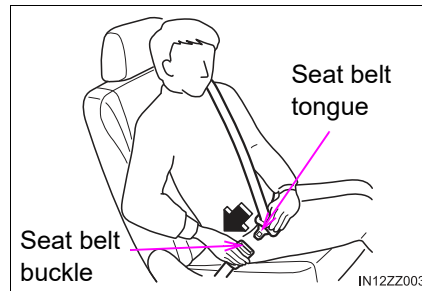

► 4-Door

Before fastening the rear seat belt, make sure that the seat belt passes through the seat belt guide correctly and it is not twisted.

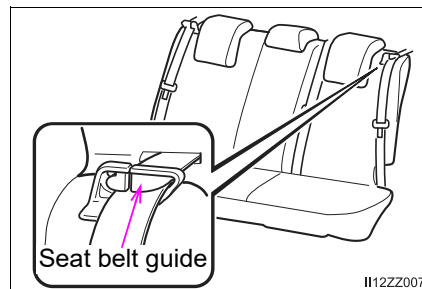

1

Essential Safety Equipment

Unfastening the Seat Belt

Depress the button on the seat belt buckle. If the belt does not fully retract, pull it out and check for kinks or twists. Then make sure it remains untwisted as it retracts.

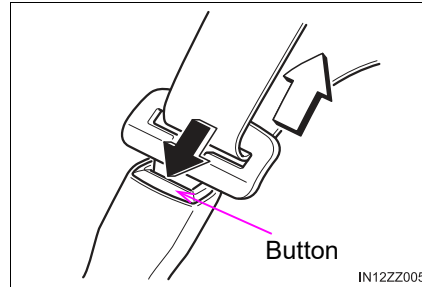

If a belt does not fully retract, inspect it for kinks and twists. If it is still not retracting properly, have it inspected at your Toyota dealer.

Front Shoulder Belt Adjuster

- ① To raise
- ② To lower

Make sure the adjuster is locked.

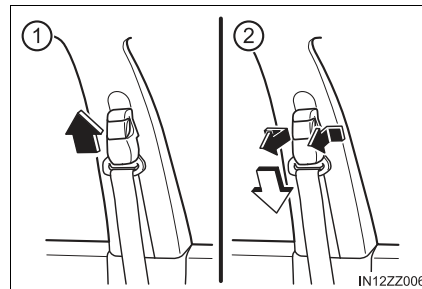

Seat Belt Warning Systems

If it detects that the occupant seat belt is unfastened, the warning light or beep alerts the occupant.

Refer to Taking Action on P. 496.

Refer to Seat Belt Warning Beep on P. 503.

Seat Belt Pretensioner and Load Limiting Systems

For optimum protection, the driver and front passenger seat belts are equipped with pretensioner and load limiting systems. For both these systems to work properly you must wear the seat belt properly.

1

Essential Safety Equipment

◆ Pretensioners

When a collision is detected, the pretensioners deploy simultaneously with the air bags.

The pretensioners deploy simultaneously with the air bags when a roll-over is also detected.

For deployment details, refer to the SRS Air Bag Deployment Criteria (→P. 78).

The front seat belt retractors remove slack quickly as the air bags are expanding. Any time the air bags and seat belt pretensioners have fired they must be replaced.

A system malfunction or operation conditions are indicated by a warning.

Refer to Warning/Indicator Lights on P. 173.

Refer to Air Bag/Front Seat Belt Pretensioner System Warning Beep on P. 503.

In addition, the pretensioner system for the front passenger, like the front and side passenger air bag, is designed to only deploy when the front passenger occupant classification sensor detects a passenger sitting on the front passenger's seat.

For details, refer to the front passenger occupant classification sensor (→P. 82).

◆ Load limiter

The load limiting system releases belt webbing in a controlled manner to reduce belt force on the occupant's chest. While the most severe load on a seat belt occurs in frontal collisions, the load limiter has an automatic mechanical function and can activate in any accident mode with sufficient occupant movement.

Even if the pretensioners have not fired, the load limiting function must be checked by your Toyota dealer.

-
- The pretensioner system may not operate depending on the type of the collision. For details, refer to the SRS Air Bag Deployment Criteria (→P. 78)
 - Some smoke (non-toxic gas) will be released when the air bags and pretensioners deploy. This does not indicate a fire. This gas normally has no effect on occupants, however, those with sensitive skin may experience light skin irritation. If residue from the deployment of the air bags or the front pretensioner system gets on the skin or in the eyes, wash it off as soon as possible.

 **WARNING****■ Wear seat belts only as recommended in this owner's manual**

Incorrect positioning of the driver and front passenger seat belts is dangerous. Without proper positioning, the pretensioner and load limiting systems cannot provide adequate protection in an accident and this could result in serious injury. For more details about wearing seat belts, refer to "Fastening the seat belts" (→P. 37).

■ Have your seat belts changed immediately if the pretensioner or load limiter has been expended

Always have your Toyota dealer immediately inspect the seat belt pretensioners and air bags after any collision. Like the air bags, the seat belt pretensioners and load limiters will only function once and must be replaced after any collision that caused them to deploy. A seat belt with an expended pretensioner or load limiter is still better than wearing no seat belt at all; however, if the seat belt pretensioners and load limiters are not replaced, the risk of injury in a collision will increase.

■ Do not modify the components or wiring, or use electronic testing devices on the pretensioner system

Modifying the components or wiring of the pretensioner system, including the use of electronic testing devices is dangerous. You could accidentally activate it or make it inoperable which would prevent it from activating in an accident. The occupants or repairers could be seriously injured.

■ Properly dispose of the pretensioner system

Improper disposal of the pretensioner system or a vehicle with non-deactivated pretensioners is dangerous. Unless all safety procedures are followed, injury could result. Have your Toyota dealer safely dispose of the pretensioner system or scrap a pretensioner system equipped vehicle.

Seat Belt Extender

If your seat belt is not long enough, even when fully extended, a seat belt extender may be available to you at no charge from your Toyota dealer.

This extender will be only for you and for the particular vehicle and seat. Even if it plugs into other seat belts, it may not hold in the critical moment of a crash.

When ordering an extender, only order one that provides the necessary additional length to fasten the seat belt properly.

Please contact your Toyota dealer for more information.

When not in use, remove the seat belt extender and store it in the vehicle. If the seat belt extender is left connected, the seat belt extender might get damaged as it will not retract with the rest of the seat belt and can easily fall out of the door when not in use and be damaged. In addition, the seat belt warning light will not illuminate and function properly.

WARNING

■ **Do not use a seat belt extender unless it is necessary**

Using a seat belt extender when not necessary is dangerous. The seat belt will be too long and not fit properly. In an accident, the seat belt will not provide adequate protection and you could be seriously injured. Only use the extender when it is required to fasten the seat belt properly.

■ **Do not use an improper extender**

Using a seat belt extender that is for another person or a different vehicle or seat is dangerous. The seat belt will not provide adequate protection and the user could be seriously injured in an accident. Only use the extender provided for you and for the particular vehicle and seat. NEVER use the extender in a different vehicle or seat. If you sell your Toyota, do not leave your seat belt extender in the vehicle. It could be used accidentally by the new owner of the vehicle. After removing the seat belt extender, discard it. Never use the seat belt extender in any other vehicle you may own in the future.

 **WARNING****■ Do not use an extender that is too long**

Using an extender that is too long is dangerous. The seat belt will not fit properly. In an accident, the seat belt will not provide adequate protection and you could be seriously injured. Do not use the extender or choose one shorter in length if the distance between the extender's buckle and the center of the user's body is less than 6 in. (150 mm).

■ Do not leave a seat belt extender connected to the buckle

Leaving a seat belt extender connected to the buckle without using the seat belt is dangerous. When the seat belt extender is connected to the driver's seat belt buckle (or front passenger's seat belt buckle), the SRS driver's (or front passenger's) air bag system will determine that the driver (or front passenger) is wearing the seat belt even if the driver (or front passenger) is not wearing it. This condition could cause the driver's (or front passenger's) air bag to not activate correctly and result in death or serious injury in the event of collision. Always wear the seat belt with the seat belt extender.

■ Do not use the seat belt extender when installing a child-restraint system on the front or rear passenger seat

Using a seat belt extender to fasten a child-restraint system on any seat is dangerous. Always follow the child-restraint system manufacturer's installation instructions and never use a seat belt extender.

Child-Restraint Precautions

Toyota strongly urges the use of child-restraint systems for children small enough to use them.

You are required by law to use a child-restraint system for children in the U.S. and Canada.

Check your local and state or provincial laws for specific requirements regarding the safety of children riding in your vehicle.

Whatever child-restraint system you consider, please pick the appropriate one for the age and size of the child, obey the law and follow the instructions that come with the individual child-restraint system.

A child who has outgrown child-restraint systems should sit in the rear and use seat belts, both lap and shoulder. If the shoulder belt crosses the neck or face, move the child closer to the center of the vehicle in the outboard seats, and towards the buckle on the right if the child is seated on the center seat.

Statistics confirm that the rear seat is the best place for all children up to 12 years of age, and more so with a supplemental restraint system (air bags).

A rear-facing child-restraint system should NEVER be used on the front seat with the air bag system activated. The front passenger's seat is also the least preferred seat for other child-restraint systems.

To reduce the chance of injuries caused by deployment of the front passenger air bag, the front passenger occupant classification sensor works as a part of the supplemental restraint system. This system deactivates the front passenger front and side air bags and also the front passenger seat belt pretensioner system when the front passenger air bag deactivation indicator light illuminates.

When an infant or small child sits on the front passenger seat, the system shuts off the front passenger front and side air bags and seat belt pretensioner system, so make sure the front passenger air bag deactivation indicator light illuminates.

Even if the front passenger air bag is shut off, Toyota strongly recommends that children be properly restrained and child-restraint systems of all kinds are properly secured on the rear seats which are the best place for children.

For more details, refer to “Front passenger occupant classification sensor” (→P. 82).

Your Toyota is equipped with LATCH lower anchors for attachment of specially designed LATCH child-restraint systems on the rear seats. When using these anchors to secure a child-restraint system, refer to “Using LATCH Lower Anchor” (→P. 61).

WARNING

■ Use the correct size child-restraint system

For effective protection in vehicle accidents and sudden stops, a child must be properly restrained using a seat belt or child-restraint system depending on age and size. If not, the child could be seriously injured or even killed in an accident.

■ Follow the manufacturer's instructions and always keep the child-restraint system buckled down

An unsecured child-restraint system is dangerous. In a sudden stop or a collision it could move causing serious injury or death to the child or other occupants. Make sure any child-restraint system is properly secured in place according to the child-restraint system manufacturer's instructions. When not in use, remove it from the vehicle or fasten it with a seat belt, or attach it to BOTH LATCH lower anchors for LATCH child-restraint systems and the corresponding tether anchor.

■ Always secure a child in a proper child-restraint system

Holding a child in your arms while the vehicle is moving is extremely dangerous. No matter how strong the person may be, he or she cannot hold onto a child in a sudden stop or collision and it could result in serious injury or death to the child or other occupants. Even in a moderate accident, the child may be exposed to air bag forces that could result in serious injury or death to the child, or the child may be slammed into an adult, causing injury to both child and adult.

⚠ WARNING

■ **Never use a rear-facing child-restraint system in the front seat with an air bag that could deploy**

Rear-facing child-restraint systems on the front seat are particularly dangerous even though you may feel assured that a front passenger air bag will not deploy based on the fact that the front passenger air bag deactivation indicator light illuminates. The child-restraint system can be hit by a deploying air bag and moved violently backward resulting in serious injury or death to the child.

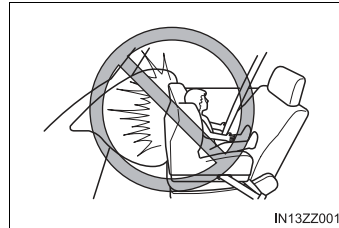

Vehicles with a front passenger air bag have a warning label attached as shown below.

The warning label reminds you not to put a rear-facing child-restraint system on the front passenger seat at any time.



■ **Do not install a front-facing child-restraint system on the front passenger seat unless it is unavoidable**

In a collision, the force of a deploying air bag could cause serious injury or death to the child. If installing a front-facing child-restraint system on the front passenger seat is unavoidable, move the front passenger seat as far back as possible.

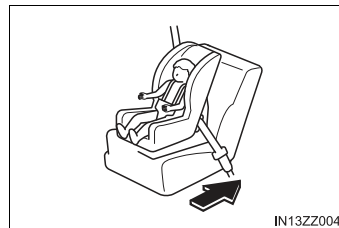

 **WARNING****■ Seating a child in a child-restraint system on the front passenger seat is dangerous under certain conditions**

Your vehicle is equipped with front passenger occupant classification sensor. Even with the front passenger occupant classification sensor, if you must use the front passenger seat to seat a child, using a child-restraint system on the front passenger seat under the following conditions increases the danger of the front passenger air bag deploying and could result in serious injury or death to the child.

- The front passenger air bag deactivation indicator light does not illuminate when seating a child in the child-restraint system.
- Luggage or other items are placed on the seat with the child in the child-restraint system.
- A rear passenger or luggage pushing or pulling down on the front passenger seatback.
- Luggage or other items are placed on the seatback or hung on the head restraint.
- The seat is washed.
- Liquids are spilled on the seat.
- The front passenger seat is moved backward, pushing into luggage or other items placed behind it.
- The front passenger seatback contacts the rear seat.
- Luggage or other items are placed between the front passenger seat and driver seat.
- An electric device is put on the front passenger's seat.
- An additional electrical device, such as a seat warmer is installed to the surface of the front passenger seat.

The designated positions with seat belts on the rear seats are the safest places for children. Always use seat belts and child restraints.

 **WARNING****■ Do not allow a child or anyone to lean over or against the side window of a vehicle with side and curtain air bags**

It is dangerous to allow anyone to lean over or against the side window, the area of the front passenger seat, the front and rear window pillars and the roof edge along both sides from which the side and curtain air bags deploy, even if a child-restraint system is used. The impact of inflation from a side or curtain air bag could cause serious injury or death to an out of position child. Furthermore, leaning over or against the front door could block the side and curtain air bags and eliminate the advantages of supplemental protection. With the front air bag and the additional side air bag that comes out of the front seat, the rear seat is always a better location for children. Take special care not to allow a child to lean over or against the side window, even if the child is seated in a child-restraint system.

■ Never use one seat belt on more than one person at a time

Using one seat belt for more than one person at a time is dangerous. A seat belt used in this way cannot spread the impact forces properly and the two passengers could be crushed together and seriously injured or even killed. Never use one belt for more than one person at a time and always operate the vehicle with each occupant properly restrained.

■ To prevent burns

A seat belt or child-restraint system can become very hot in a closed vehicle during warm weather. To avoid burning yourself or a child, check them before you or your child touches them.

Child-Restraint System Installation

Child-Restraint System Types

In this owner's manual, explanation of child-restraint systems is provided for the following three types of popular child-restraint systems: infant seat, child seat, booster seat.

► Infant seat

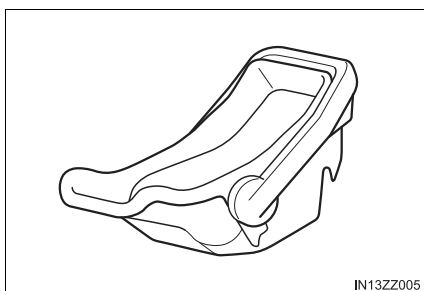

An infant seat provides restraint by bracing the infant's head, neck and back against the seating surface.

► Child seat

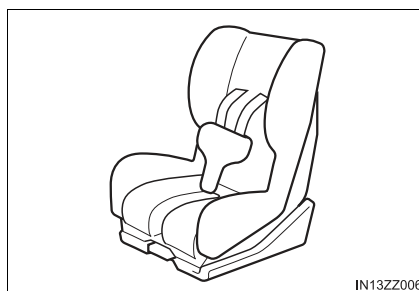

A child seat restrains a child's body using the harness.

► Booster seat

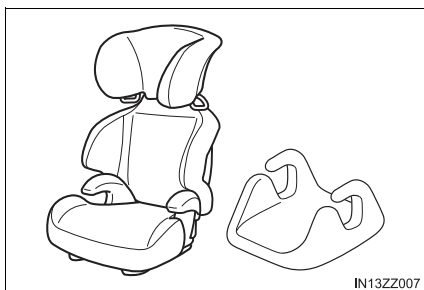

A booster seat is a child restraint accessory designed to improve the fit of the seat belt system around the child's body.

- Installation position is determined by the type of child-restraint system. Always read the manufacturer's instructions and this owner's manual carefully.
- Due to variations in the design of child-restraint systems, vehicle seats and seat belts, all child-restraint systems may not fit all seating positions. Before purchasing a child-restraint system, it should be tested in the specific vehicle seating position (or positions) where it is intended to be used. If a previously purchased child-restraint system does not fit, you may need to purchase a different one that will.

Installing Child-Restraint Systems

Accident statistics reveal that a child is safer in the rear seat. The front passenger's seat is clearly the worst choice for any child under 12, and with rear-facing child-restraint systems it is clearly unsafe due to air bags.

Some child-restraint systems now come with tethers and therefore must be installed on the seats that take tethers to be effective. In your Toyota, tethered child-restraint systems can only be accommodated in the three positions on the rear seat.

Some child-restraint systems also employ specially designed LATCH attachments; refer to "Using LATCH Lower Anchor" (→P. 61).

Even if your vehicle is equipped with front passenger occupant classification sensor (→P. 82), which automatically deactivates the front passenger air bag, a rear seat is the safest place for a child of any age or size.

WARNING

■ Tethered Child-Restraint Systems Work Only on Tether-Equipped Rear Seats

Installation of a tether equipped child-restraint system in the front passenger's seat defeats the safety design of the system and will result in an increased chance of serious injury if the child-restraint system goes forward without benefit of being tethered.

Place tether equipped child-restraint systems where there are tether anchors.

Anchor Bracket

Anchor brackets for securing child-restraint systems are equipped in the vehicle. Locate each anchor position using the illustration.

To install a child-restraint system, if the seat is equipped with a head restraint, remove it. Always follow the instruction manual accompanying the child-restraint system.

■ Anchor bracket location

Use the indicated anchor bracket locations when installing a child-restraint system equipped with a tether.

- ① For right
- ② For center
- ③ For left

► 4-Door

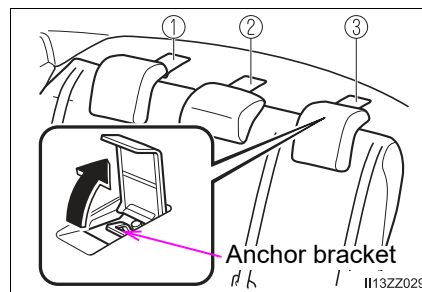

► 5-Door

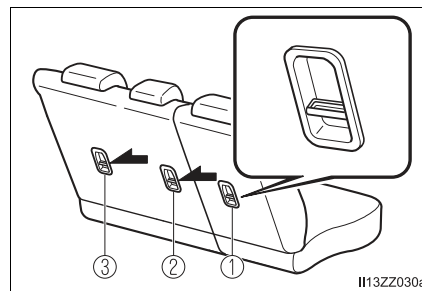

⚠ WARNING

■ **Always attach the tether strap to the correct tether anchor position**

Attaching the tether strap to the incorrect tether anchor position is dangerous. In a collision, the tether strap could come off and loosen the child-restraint system. If the child-restraint system moves it could result in death or injury to the child.

■ **Always remove the head restraint and install child-restraint system**

Installing a child-restraint system without removing the head restraint is dangerous. The child-restraint system cannot be installed correctly which may result in death or injury to the child in a collision.

► 4-Door

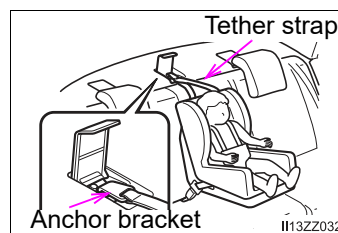
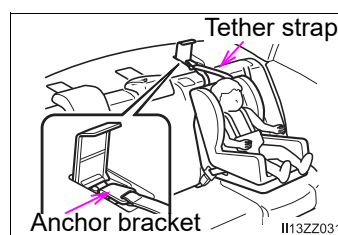

► 5-Door

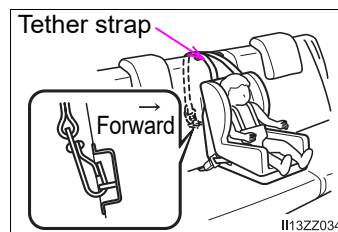
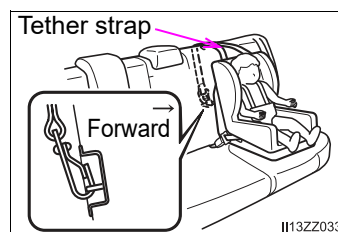

1

Essential Safety Equipment

⚠ WARNING**■ Always install the head restraint and adjust it to the appropriate position after removing the child-restraint system**

Driving with the head restraint removed is dangerous as impact to the occupant's head cannot be prevented during emergency braking or in a collision, which could result in a serious accident, injury or death.
Refer to Head Restraints on P. 30.

Using Automatic Locking Mode (if equipped)

Follow these instructions when using a child-restraint system, unless you are attaching a LATCH-equipped child-restraint system to the rear LATCH lower anchors. Refer to "Using LATCH Lower Anchor" (→P. 61).

- 1 Make sure the seatback is securely latched by pushing it back until it is fully locked.
- 2 Remove the head restraint.
Refer to Head Restraints on P. 30.
- 3 Secure the child-restraint system with the lap portion of the lap/shoulder belt.
See the manufacturer's instructions on the child-restraint system for belt routing instructions.
- 4 To get the retractor into the automatic locking mode, pull the shoulder belt portion of the seat belt until the entire length of the belt is out of the retractor.

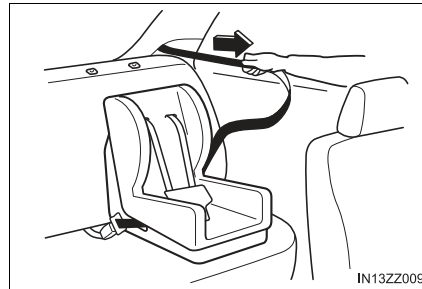

- 5 Push the child-restraint system firmly into the vehicle seat. Be sure the belt retracts as snugly as possible. A clicking noise from the retractor will be heard during retraction if the system is in the automatic locking mode. If the belt does not lock the seat down tight, repeat this step.

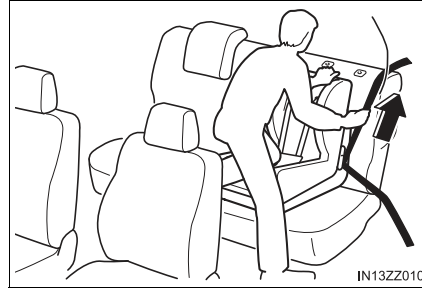

- Inspect this function before each use of the child-restraint system. You should not be able to pull the shoulder belt out of the retractor while the system is in the automatic locking mode. When you remove the child-restraint system, be sure the belt fully retracts to return the system to emergency locking mode before occupants use the seat belts.
- 6 If your child-restraint system requires the use of a tether strap, refer to the manufacturer's instructions to hook and tighten the tether strap.

Follow the child-restraint system manufacturer's instructions carefully. If you are not sure whether you have a LATCH system or tether, check in the child-restraint system manufacturer's instructions and follow them accordingly. Depending on the type of child-restraint system, it may use LATCH system instead of seat belts or if the belt goes across the child's chest, may recommend against using automatic locking mode.

⚠ WARNING

■ **Use the tether and tether anchor only for a child-restraint system**

Using the tether or tether anchor to secure anything but a child-restraint system is dangerous. This could weaken or damage the tether or tether anchor and result in injury.

■ **Always remove the head restraint and install child-restraint system**

Installing a child-restraint system without removing the head restraint is dangerous. The child-restraint system cannot be installed correctly which may result in death or injury to the child in a collision.

► 4-Door

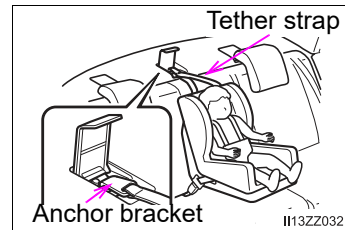
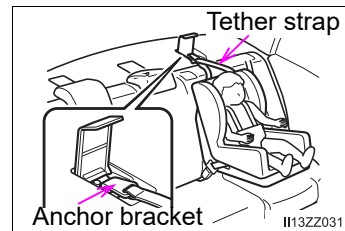

► 5-Door

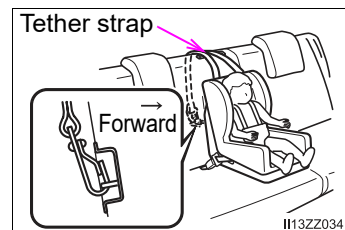
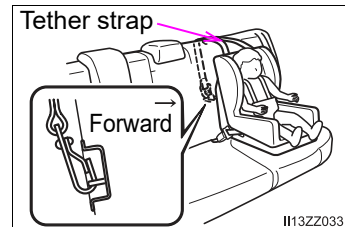

⚠ WARNING**■ Always attach the tether strap to the correct tether anchor position**

Attaching the tether strap to the incorrect tether anchor position is dangerous. In a collision, the tether strap could come off and loosen the child-restraint system. If the child-restraint system moves it could result in death or injury to the child.

■ Always install the head restraint and adjust it to the appropriate position after removing the child-restraint system

Driving with the head restraint removed is dangerous as impact to the occupant's head cannot be prevented during emergency braking or in a collision, which could result in a serious accident, injury or death. Refer to Head Restraints on P. 30.

If You Must Use a Child-Restraint System in the Front Seat for Children

If you cannot put all children in the rear seat, at least put the smallest children in the rear and be sure the largest child up front uses a front-facing child-restraint system.

NEVER put a rear-facing child-restraint system on the front passenger seat whether your vehicle is equipped with a occupant classification sensor or not.

This seat is also not set up for tethered child-restraint systems, put them in one of the rear seat positions set up with tether anchors.

Likewise the LATCH child-restraint system cannot be secured in the front passenger's seat and should be used in the rear seat.

Do not allow anyone to lean over or against the side window since your vehicle has side and curtain air bags, it could cause serious injuries to an out of position occupant. As children more often sleep in cars, it is better to put them in the rear seat.

If installing the child-restraint system on the front seat is unavoidable, follow these instructions when using a front-facing child-restraint system in the front passenger's seat.

- To check if your front seats have side air bags:
The vehicle equipped with side air bag will have a "SRS AIRBAG" tag on the outboard shoulder of the front seats.
- To check if your vehicle has curtain air bags:
The vehicle equipped with curtain air bag will have an "SRS AIRBAG" marking on the window pillars along the roof edge.

 **WARNING****■ Always move the front passenger seat as far back as possible if installing a front-facing child-restraint system on it is unavoidable**

As your vehicle has front air bags and doubly so because your vehicle has side air bags, a front-facing child-restraint system should be put on the front passenger seat only when it is unavoidable.

Even if the front passenger air bag deactivation indicator light illuminates, always move the seat as far back as possible, because the force of a deploying air bag could cause serious injury or death to the child.

■ Never use a rear-facing child-restraint system in the front seat with an air bag that could deploy

Rear-facing child-restraint systems on the front seat are particularly dangerous.

Even in a moderate collision, the child-restraint system can be hit by a deploying air bag and moved violently backward resulting in serious injury or death to the child. Even though you may feel assured that the front passenger air bag will not deploy based on the fact that the front passenger air bag deactivation indicator light illuminates, never use a rear-facing child-restraint system in the front seat.

■ Do not allow a child or anyone to lean over or against the side window of a vehicle with side and curtain air bags

It is dangerous to allow anyone to lean over or against the side window, the area of the front passenger seat, the front and rear window pillars and the roof edge along both sides from which the side and curtain air bags deploy, even if a child-restraint system is used. The impact of inflation from a side or curtain air bag could cause serious injury or death to an out of position child. Furthermore, leaning over or against the front door could block the side and curtain air bags and eliminate the advantages of supplemental protection. With the front air bag and the additional side air bag that comes out of the front seat, the rear seat is always a better location for children. Take special care not to allow a child to lean over or against the side window, even if the child is seated in a child-restraint system.

⚠ WARNING**■ Always remove the head restraint and install child-restraint system**

Installing a child-restraint system without removing the head restraint is dangerous. The child-restraint system cannot be installed correctly which may result in death or injury to the child in a collision.

■ Always install the head restraint and adjust it to the appropriate position after removing the child-restraint system

Driving with the head restraint removed is dangerous as impact to the occupant's head cannot be prevented during emergency braking or in a collision, which could result in a serious accident, injury or death. Refer to Head Restraints on P. 30.

Front Passenger's Seat Child-Restraint System Installation

- 1 Make sure the ignition is switched off.
- 2 Slide the seat as far back as possible.



- 3 Remove the head restraint.
- 4 Place the child-restraint system on the seat without putting your weight on the seat and fasten the seat belt. See the manufacturer's instructions on the child-restraint system for belt routing instructions.
- 5 To get the retractor into the automatic locking mode, pull the shoulder belt portion of the seat belt until the entire length of the belt is out of the retractor.

- 6 Push the child-restraint system firmly into the vehicle seat. Be sure the belt retracts as snugly as possible. A clicking noise from the retractor will be heard during retraction if the system is in automatic locking mode. If the belt does not lock the seat down tight, repeat the previous step and also this one.

Inspect this function before each use of the child-restraint system. You should not be able to pull the shoulder belt out of the retractor while the system is in the automatic locking mode. When you remove the child-restraint system, be sure the belt fully retracts to return the system to emergency locking mode before occupants use the seat belts.

- 7 Seat your child safely in the child-restraint system and secure the child according to the instructions from the child-restraint system manufacturer.

- 8 Switch the ignition ON and make sure the front passenger air bag deactivation indicator light illuminates after installing a child-restraint system on the front passenger seat.

If the front passenger air bag deactivation indicator light does not illuminate, remove the child-restraint system, switch the ignition to OFF, and then re-install the child-restraint system (→P. 82).

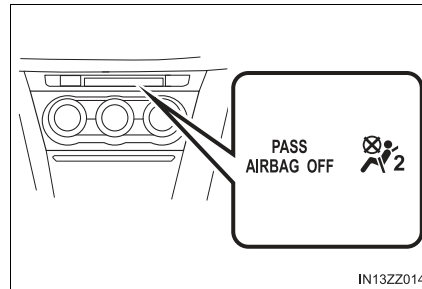

Follow the child-restraint system manufacturer's instructions carefully.

Depending on the type of child-restraint system, it may not employ seat belts which are in automatic locking mode.

⚠ WARNING**■ Do not seat a child in a child-restraint system on the front passenger seat if the front passenger air bag deactivation indicator light does not illuminate**

While it is always better to install any child-restraint system on the rear seat, it is imperative that a child-restraint system ONLY be used on the front passenger seat if the deactivation indicator light illuminates when the child is seated in the child-restraint system (→P. 82). Seating a child in a child-restraint system installed on the front passenger seat with the front passenger air bag deactivation indicator light not illuminated is dangerous. If this indicator light does not illuminate, this means that the front passenger front and side air bags, and seat belt pretensioners are ready for deployment. If an accident were to deploy an air bag, a child in a child-restraint system sitting in the front passenger seat could be seriously injured or killed. If the indicator light does not illuminate after seating a child in a child-restraint system on the front passenger seat, seat a child in a child-restraint system on the rear seat and consult your Toyota dealer as soon as possible.

Using LATCH Lower Anchor

Your Toyota is equipped with LATCH lower anchors for attachment of specially designed LATCH child-restraint systems in the rear seats. Both anchors must be used, otherwise the seat will bounce around and put the child in danger. Most LATCH child-restraint systems must also be used in conjunction with a tether to be effective. If they have a tether you must use it to better assure your child's safety.

⚠ WARNING**■ Follow the manufacturer's instructions for the use of the child-restraint system**

An unsecured child-restraint system is dangerous. In a sudden stop or a collision it could move causing serious injury or death to the child or other occupants. Make sure the child-restraint system is properly secured in place according to the child-restraint system manufacturer's instructions.

 **WARNING****■ Never attach two child-restraint systems to the same LATCH lower anchor**

Attaching two child-restraint systems to the same LATCH lower anchor is dangerous. In a collision, one anchor may not be strong enough to hold two child-restraint system attachments, and it may break, causing serious injury or death. If you use the seat position for another child-restraint system when an outboard LATCH position is occupied, use the center seat belts instead, and the tether if tether-equipped.

■ Make sure the child-restraint system is properly secured

An unsecured child-restraint system is dangerous. In a sudden stop or a collision it could move causing serious injury or death to the child or other occupants. Follow the child-restraint system manufacturer's instructions on belt routing to secure the seat just as you would with a child in it so that nobody is tempted to put a child in an improperly secured seat later on. When not in use, remove it from the vehicle or fasten it with a seat belt, or latch it down to BOTH LATCH lower anchors for LATCH child-restraint systems.

■ Make sure there are no seat belts or foreign objects near or around the LATCH child-restraint system

Not following the child-restraint system manufacturer's instructions when installing the child-restraint system is dangerous. If seat belts or a foreign object prevent the child-restraint system from being securely attached to the LATCH lower anchors and the child-restraint system is installed improperly, the child-restraint system could move in a sudden stop or collision causing serious injury or death to the child or other occupants. When installing the child-restraint system, make sure there are no seat belts or foreign objects near or around the LATCH lower anchors. Always follow the child-restraint system manufacturer's instructions.

Installation on rear outboard seats

- 1 First, adjust the front seat to allow clearance between the child-restraint system and the front seat (→P. 23).
- 2 Make sure the seatback is securely latched by pushing it back until it is fully locked.

- 3 Expand the open seams on the rear of the seat bottom slightly to verify the locations of the LATCH lower anchors.

The markings above the LATCH lower anchors indicate the locations of the LATCH lower anchors for the attachment of a child-restraint system.

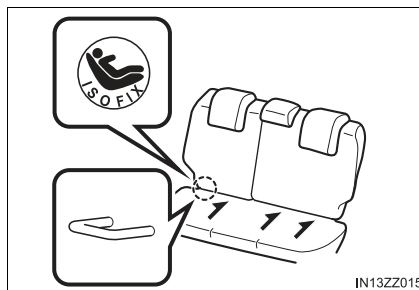

- 4 Remove the head restraint. Refer to Head Restraints on P. 30.
- 5 Secure the child-restraint system using BOTH LATCH lower anchors, following the child-restraint system manufacturer's instruction. Pull on the child-restraint to be sure both anchors are engaged.
- 6 If your child-restraint system came equipped with a tether, that means it is very important to properly secure the tether for child safety. Please carefully follow the child-restraint system manufacturer's instructions when installing tethers.

1
Essential Safety Equipment

⚠ WARNING

- **Use the tether and tether anchor only for a child-restraint system**
Using the tether or tether anchor to secure anything but a child-restraint system is dangerous. This could weaken or damage the tether or tether anchor and result in injury.
- **Always remove the head restraint and install child-restraint system**
Installing a child-restraint system without removing the head restraint is dangerous. The child-restraint system cannot be installed correctly which may result in death or injury to the child in a collision.

▶ 4-Door

▶ 5-Door

⚠ WARNING**■ Always attach the tether strap to the correct tether anchor position**

Attaching the tether strap to the incorrect tether anchor position is dangerous. In a collision, the tether strap could come off and loosen the child-restraint system. If the child-restraint system moves it could result in death or injury to the child.

■ Always install the head restraint and adjust it to the appropriate position after removing the child-restraint system

Driving with the head restraint removed is dangerous as impact to the occupant's head cannot be prevented during emergency braking or in a collision, which could result in a serious accident, injury or death. Refer to Head Restraints on P. 30.

Installation on rear center seat

The LATCH lower anchors at the center of the rear seat are much further apart than the sets of LATCH lower anchors for child-restraint system installation at other seating positions. Child-restraint systems with rigid LATCH attachments cannot be installed on the center seating position. Some LATCH equipped child-restraint systems can be placed in the center position and will reach the nearest LATCH lower anchors which are 14.2 in. (360 mm) apart. LATCH compatible child-restraint systems (with attachments on belt webbing) can be used at this seating position only if the child-restraint system manufacturer's instructions state that the child-restraint system can be installed to LATCH lower anchors that are 14.2 in. (360 mm) apart. Do not attach two child-restraint systems to the same LATCH lower anchor. If your child-restraint system has a tether, it must also be used for your child's optimum safety.

The procedure for installation on the rear outboard seats is the same.

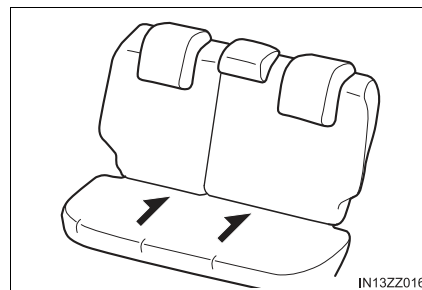
■ LATCH lower anchor location

⚠ WARNING

■ **Always remove the head restraint and install child-restraint system**

Installing a child-restraint system without removing the head restraint is dangerous. The child-restraint system cannot be installed correctly which may result in death or injury to the child in a collision.

▶ 4-Door

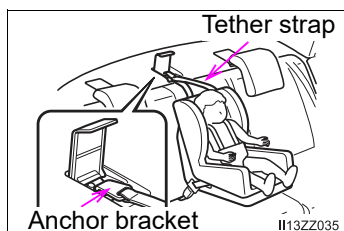

▶ 5-Door

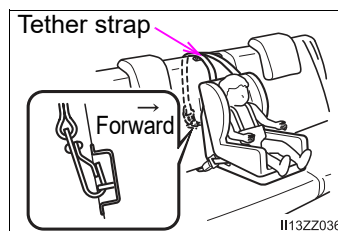

■ **Always attach the tether strap to the correct tether anchor position**

Attaching the tether strap to the incorrect tether anchor position is dangerous. In a collision, the tether strap could come off and loosen the child-restraint system. If the child-restraint system moves it could result in death or injury to the child.

■ **Always install the head restraint and adjust it to the appropriate position after removing the child-restraint system**

Driving with the head restraint removed is dangerous as impact to the occupant's head cannot be prevented during emergency braking or in a collision, which could result in a serious accident, injury or death.

Refer to Head Restraints on P. 30.

Supplemental Restraint System (SRS) Precautions

The front and side supplemental restraint systems (SRS) include different types of air bags. Please verify the different types of air bags which are equipped on your vehicle by locating the “SRS AIRBAG” location indicators. These indicators are visible in the area where the air bags are installed.

The air bags are installed in the following locations:

- The steering wheel hub (driver air bag)
- The front passenger dashboard (front passenger air bag)
- The outboard sides of the front seatbacks (side air bags)
- The front and rear window pillars, and the roof edge along both sides (curtain air bags)

Vehicles with the Front Passenger Occupant Classification System have a sensor which detects an impending roll-over accident.

The air bag supplemental restraint systems are designed to provide supplemental protection in certain situations so seat belts are always important in the following ways:

Without seat belt usage, the air bags cannot provide adequate protection during an accident. Seat belt usage is necessary to:

- Keep the occupant from being thrown into an inflating air bag.
- Reduce the possibility of injuries during an accident that is not designed for air bag inflation, such as rear impact.
- Reduce the possibility of injuries in frontal, near frontal or side collisions or roll-over accidents that are not severe enough to activate the air bags.
- Reduce the possibility of being thrown from your vehicle.
- Reduce the possibility of injuries to lower body and legs during an accident because the air bags provide no protection to these parts of the body.
- Hold the driver in a position which allows better control of the vehicle.

If your vehicle is also equipped with a front passenger occupant classification system, refer to the Front Passenger Occupant Classification System (→P. 82) for details.

If your vehicle is equipped with a front passenger occupant classification system, the front passenger air bag deactivation indicator light illuminates for a specified time after the ignition is switched ON.

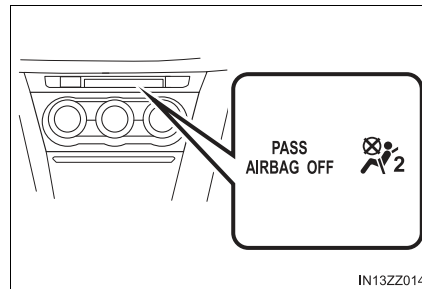

Small children must be protected by a child-restraint system as stipulated by law in every state and province. In certain states and provinces, larger children must use a child-restraint system (→P. 44).

Carefully consider which child-restraint system is necessary for your child and follow the installation directions in this Owner's Manual as well as the child-restraint system manufacturer's instructions.

- If it becomes necessary to have the components or wiring system for the supplementary restraint system modified to accommodate a person with certain medical conditions in accordance with a certified physician, contact your Toyota dealer.
- When an air bag deploys, a loud inflation noise can be heard and some smoke will be released. Neither is likely to cause injury, however, the texture of the air bags may cause light skin injuries on body parts not covered with clothing through friction.
- Should you sell your Toyota, we urge you to tell the new owner of its air bag systems and that familiarization with all instructions about them, from the Owner's Manual, is important.
- This highly-visible label is displayed which warns against the use of a rear-facing child-restraint system on the front passenger seat.



⚠ WARNING**■ Seat belts must be worn in air bag equipped vehicles**

Depending only on the air bags for protection during an accident is dangerous. Alone, air bags may not prevent serious injuries. The appropriate air bags can be expected to inflate only in the first accident, such as frontal, near frontal or side collisions or roll-over accidents that are at least moderate. Vehicle occupants should always wear seat belts.

■ Children should not ride in the front passenger seat

Placing a child, 12 years or under, in the front seat is dangerous. The child could be hit by a deploying air bag and be seriously injured or even killed. A sleeping child is more likely to lean against the door and be hit by the side air bag in moderate collision to the front-passenger side of the vehicle. Whenever possible, always secure a child 12 years and under on the rear seats with an appropriate child-restraint system for the child's age and size.

■ Never use a rear-facing child-restraint system in the front seat with an air bag that could deploy

Rear-facing child-restraint systems on the front seat are particularly dangerous even though you may feel assured that a front passenger air bag will not deploy based on the fact that the front passenger air bag deactivation indicator light illuminates. The child-restraint system can be hit by a deploying air bag and moved violently backward resulting in serious injury or death to the child.

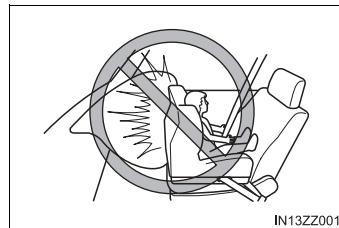
**■ Do not sit too close to the driver and front passenger air bags**

Sitting too close to the driver and front passenger air bag modules or placing hands or feet on them is extremely dangerous. The driver and front passenger air bags inflate with great force and speed. Serious injuries could occur if someone is too close. The driver should always hold onto only the rim of the steering wheel. The front seat passenger should keep both feet on the floor. Front seat occupants should adjust their seats as far back as possible and always sit upright against the seatbacks with seat belts worn properly.

 **WARNING****■ Sit in the center of the seat and wear seat belts properly**

Sitting too close to the side air bag modules or placing hands on them, or sleeping up against the door or hanging out the windows is extremely dangerous. The side and curtain air bags inflate with great force and speed directly expanding along the door on the side the car is hit. Serious injury could occur if someone is sitting too close to the door or leaning against a window, or if rear seat occupants grab the sides of the front seatbacks. Give the side and curtain air bags room to work by sitting in the center of the seat while the vehicle is moving with seat belts worn properly.

■ Do not attach objects on or around the area where driver and front passenger air bags deploy

Attaching an object to the driver and front passenger air bag modules or placing something in front of them is dangerous. In an accident, an object could interfere with air bag inflation and injure the occupants.

■ Do not attach objects on or around the area where a side air bag deploys

Attaching objects to the front seat in such a way as to cover the outboard side of the seat in any way is dangerous. In an accident the object could interfere with the side air bag, which inflates from the outboard side of the front seats, impeding the added protection of the side air bag system or redirecting the air bag in a way that is dangerous. Furthermore, the bag could be cut open releasing the gas.

Do not hang net bags, map pouches, backpacks with side straps or any other objects on the front seats. Never use seat covers on the front seats. Always keep the side air bag modules in your front seats free to deploy in the event of a side collision.

■ Do not attach objects on or around the area where a curtain air bag deploys

Attaching objects to the areas where the curtain air bag activates such as on the windshield glass, side door glass, front and rear window pillars and along the roof edge and assist grips is dangerous. In an accident the object could interfere with the curtain air bag, which inflates from the front and rear window pillars and along the roof edge, impeding the added protection of the curtain air bag system or redirecting the air bag in a way that is dangerous. Furthermore, the bag could be cut open releasing the gas.

Do not place hangers or any other objects on the assist grips. When hanging clothes, hang them on the coat hook directly. Always keep the curtain air bag modules free to deploy in the event of a side collision or roll-over accident.

 **WARNING****■ Do not touch the components of the supplemental restraint system after the air bags have inflated**

Touching the components of the supplemental restraint system after the air bags have inflated is dangerous. Immediately after inflation, they are very hot. You could get burned.

■ Never install any front-end equipment to your vehicle

Installation of front-end equipment, such as frontal protection bar (kangaroo bar, bull bar, push bar, or other similar devices), snowplow, or winches, is dangerous. The air bag crash sensor system could be affected. This could cause air bags to inflate unexpectedly, or it could prevent the air bags from inflating during an accident. Front occupants could be seriously injured.

■ Do not modify the suspension

Modifying the vehicle suspension is dangerous. If the vehicle's height or the suspension is modified, the vehicle will be unable to accurately detect a collision or roll-over accident resulting in incorrect or unexpected air bag deployment and the possibility of serious injuries.

■ To prevent false detection by the air bag sensor system, heed the following

- Do not use tires or wheels other than those specified for your Toyota:
Use of any tire or wheel other than those specified for your Toyota (→P. 553) is dangerous. Use of such wheels will prevent the vehicle's accident detections system from accurately detecting a collision or roll-over accident resulting in incorrect or unexpected air bag deployment and the possibility of serious injuries.
- Do not overload your vehicle:
Overloading your vehicle is dangerous as it could prevent the air bag crash sensor system from accurately detecting a collision or roll-over accident resulting in incorrect or unexpected air bag deployment and the possibility of serious injuries. The gross axle weight rating (GAWR) and the gross vehicle weight rating (GVWR) for your vehicle are on the Motor Vehicle Safety Standard Label on the driver's door frame. Do not exceed these ratings.
- Do not drive the vehicle off-road:
Driving your Toyota off-road is dangerous because the vehicle has not been designed to do so. Driving the vehicle off-road could prevent the air bag crash sensor system from accurately detecting a collision or roll-over accident resulting in incorrect or unexpected air bag deployment and the possibility of serious injuries.

 **WARNING****■ Do not modify a front door or leave any damage unrepaired. Always have your Toyota dealer inspect a damaged front door**

Modifying a front door or leaving any damage unrepaired is dangerous. Each front door has a side crash sensor as a component of the supplemental restraint system. If holes are drilled in a front door, a door speaker is left removed, or a damaged door is left unrepaired, the sensor could be adversely affected causing it to not detect the pressure of an impact correctly during a side collision. If a sensor does not detect a side impact correctly, the side and curtain air bags and the front seat belt pretensioner may not operate normally which could result in serious injury to occupants.

■ Do not modify the supplemental restraint system

Modifying the components or wiring of the supplemental restraint system is dangerous. You could accidentally activate it or make it inoperable. Do not make any modifications to the supplemental restraint system. This includes installing trim, badges, or anything else over the air bag modules. It also includes installing extra electrical equipment on or near system components or wiring. Your Toyota dealer can provide the special care needed in the removal and installation of front seats. It is important to protect the air bag wiring and connections to assure that the bags do not accidentally deploy, and that the front passenger occupant classification system and the seats retain an undamaged air bag connection.

■ Do not place luggage or other objects under the front seats

Placing luggage or other objects under the front seats is dangerous. The components essential to the supplemental restraint system could be damaged, and in the event of a side collision, the appropriate air bags may not deploy, which could result in death or serious injury. To prevent damage to the components essential to the supplemental restraint system, do not place luggage or other objects under the front seats.

■ Do not operate a vehicle with damaged air bag/seat belt pretensioner system components

Expended or damaged air bag/seat belt pretensioner system components must be replaced after any collision which caused them to deploy or damage them. Only a trained Authorized Toyota Dealer can fully evaluate these systems to see that they will work in any subsequent accident. Driving with an expended or damaged air bag or pretensioner unit will not afford you the necessary protection in the event of any subsequent accident which could result in serious injury or death.

 WARNING**■ Do not remove interior air bag parts**

Removing any components such as the front seats, front dashboard, the steering wheel or parts on the front and rear window pillars and along the roof edge, containing air bag parts or sensors is dangerous. These parts contain essential air bag components. The air bag could accidentally activate and cause serious injuries. Always have your Toyota dealer remove these parts.

■ Properly dispose of the air bag system

Improper disposal of an air bag or a vehicle with live air bags in it can be extremely dangerous. Unless all safety procedures are followed, injury could result. Have your Toyota dealer safely dispose of the air bag system or scrap an air bag equipped vehicle.

Supplemental Restraint System Components

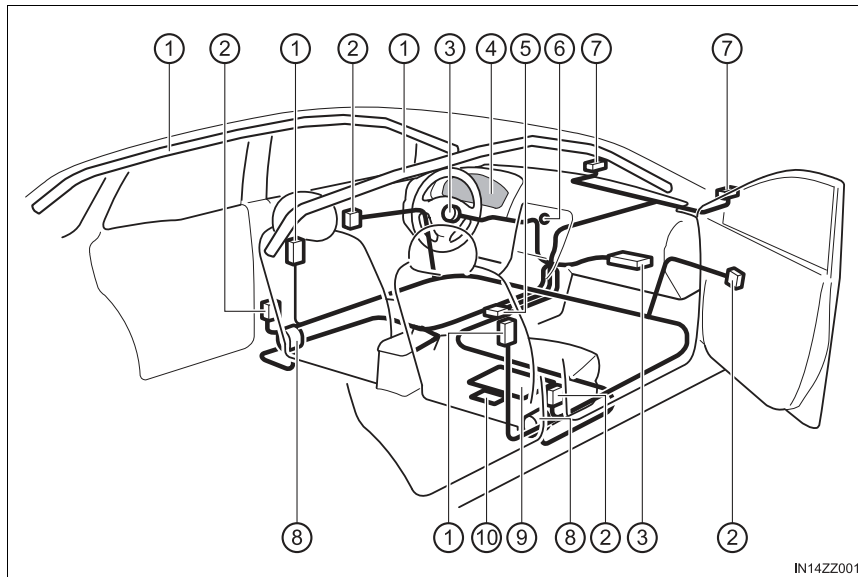

IN14ZZ001

- ① Side and curtain inflators and air bags
- ② Side crash sensors
- ③ Driver/Front passenger inflators and air bags
- ④ Air bag/seat belt pretensioner system warning light (→P. 173)
- ⑤ Roll-over sensor, crash sensors, and diagnostic module (SAS unit)
- ⑥ Front passenger air bag deactivation indicator light (→P. 83)
- ⑦ Front air bag sensors
- ⑧ Seat belt pretensioners (→P. 39)
- ⑨ Front passenger occupant classification sensor (→P. 82)
- ⑩ Front passenger occupant classification module

1

Essential Safety Equipment

How the SRS Air Bags Work

Your Toyota is equipped with the following types of SRS air bags. SRS air bags are designed to work together with the seat belts to help to reduce injuries during an accident. The SRS air bags are designed to provide further protection for passengers in addition to the seat belt functions. Be sure to wear seat belts properly.

◆ Front Seat Belt Pretensioners

The front seat belt pretensioners are designed to deploy in moderate or severe frontal, near frontal collisions.

In addition, the pretensioners operate when a side collision or a roll-over accident is detected. The pretensioners operate differently depending on what types of air bags are equipped. For more details about the seat belt pretensioner operation, refer to the SRS Air Bag Deployment Criteria (→P. 78).

◆ Driver Air Bag

The driver's air bag is mounted in the steering wheel.

When air bag crash sensors detect a frontal impact of greater than moderate force, the driver's air bag inflates quickly helping to reduce injury mainly to the driver's head or chest caused by directly hitting the steering wheel.

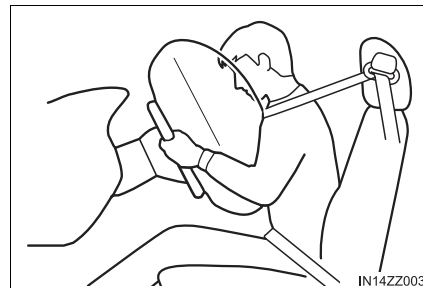

For more details about air bag deployment, refer to "SRS Air Bag Deployment Criteria" (→P. 78).

The driver's dual-stage air bag controls air bag inflation in two energy stages. During an impact of moderate severity, the driver's air bag deploys with lesser energy, whereas during more severe impacts, it deploys with more energy.

◆ Front Passenger Air Bag

The front passenger air bag is mounted in the front passenger dashboard.

The inflation mechanism for the front passenger air bag is the same as the driver's air bag, as mentioned above.

For more details about air bag deployment, refer to "SRS Air Bag Deployment Criteria" (→P. 78).



In addition, the front passenger air bag is designed to only deploy in accordance with the total seated weight on the front passenger seat. For details, refer to the front passenger occupant classification system (→P. 82).

◆ Side Air Bags

The side air bags are mounted in the outboard sides of the front seatbacks.

When the air bag crash sensors detect a side impact of greater than moderate force, the system inflates the side air bag only on the side in which the vehicle was hit. The side air bag inflates quickly to reduce injury to the driver or front passenger's chest caused by directly hitting interior parts such as a door or window.

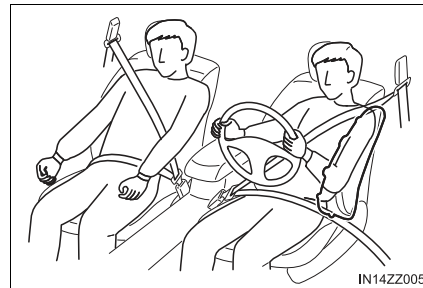

For more details about air bag deployment, refer to "SRS Air Bag Deployment Criteria" (→P. 78).

In addition, the front passenger side air bag is designed to only deploy when the front passenger occupant classification sensor detects a passenger sitting on the front passenger's seat. For details, refer to the front passenger occupant classification system (→P. 82).

◆ Curtain Air Bags

The curtain air bags are mounted in the front and rear window pillars, and the roof edge along both sides.

When the air bag crash sensors detect a side impact of greater than moderate force, the curtain air bag inflates quickly and helps to reduce injury mainly to the rear outboard passenger's head caused by directly hitting interior parts such as a door or window.

For more details about air bag deployment, refer to "SRS Air Bag Deployment Criteria" (→P. 78).

▶ In a side impact

Greater than moderate impact to one side of the vehicle will cause the curtain air bag on that side only to inflate.

Only one side curtain air bag will deploy on the side of the vehicle that receives the force of an impact.

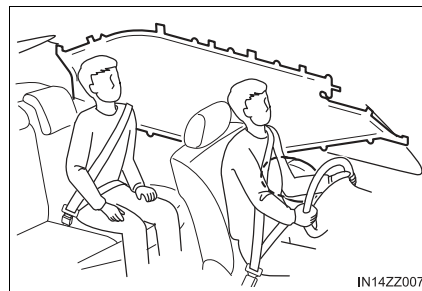

▶ In a roll-over

In response to a vehicle roll-over, both curtain air bags inflate.

Both curtain air bags will deploy after the roll-over accident is detected.

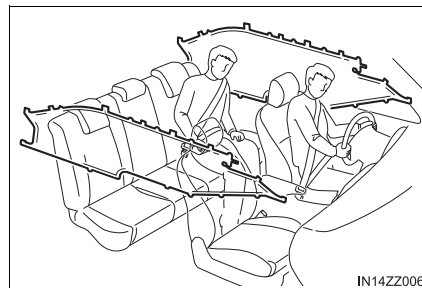

◆ Warning Light/Beep

A system malfunction or operation conditions are indicated by a warning.

Refer to Warning/Indicator Lights on P. 173.

Refer to Warning Sound is Activated on P. 502.





1

Essential Safety Equipment

SRS Air Bag Deployment Criteria

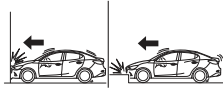
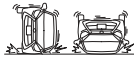
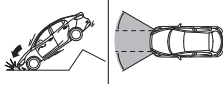
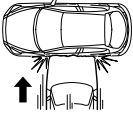
This chart indicates the applicable SRS equipment that will deploy depending on the type of collision.

(The illustrations are the representative cases of collisions.)

	Types of collision			
	A severe frontal/near frontal collision	A severe side collision*2	A roll-over/near roll-over*3	A rear collision
SRS equipment				
				
				
Front seat belt pretensioner	X*1	X*1	X*1	No air bag and front seat belt pretensioner will be activated in a rear collision.
Driver air bag	X			
Front passenger air bag	X*1			
Side air bag		X*1 (impact side only)		
Curtain air bag		X (impact side only)	X (both sides)	

X: The SRS air bag equipment is designed to deploy in a collision.

- *1: The front passenger front and side air bags and the seat belt pretensioner are designed to deploy when the front passenger occupant classification sensor detects a passenger sitting on the front passenger's seat.
- *2: In a side collision, the seat belt pretensioners and the side/curtain air bags deploy.
- *3: In a roll-over accident, the seat belt pretensioners and the curtain air bags deploy.

In a frontal offset collision, the equipped air bags and pretensioners may all deploy depending on the direction, angle, and rate of impact.

Limitations to SRS Air Bag

In severe collisions such as those described previously in “SRS Air Bag Deployment Criteria”, the applicable SRS air bag equipment will deploy. However, in some accidents, the equipment may not deploy depending on the type of collision and its severity.

Limitations to front/near front collision detection

The following illustrations are examples of front/near front collisions that may not be detected as severe enough to deploy the SRS air bag equipment.

Impacts involving trees or poles

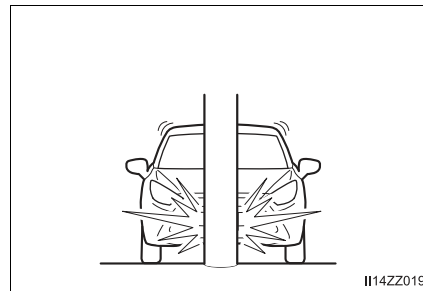

Frontal offset impact to the vehicle

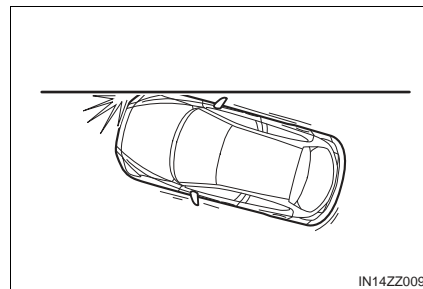

Rear-ending or running under a truck's tail gate

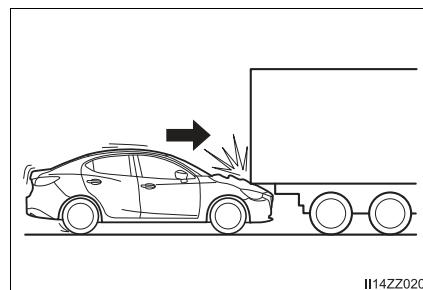

Limitations to side collision detection

The following illustrations are examples of side collisions that may not be detected as severe enough to deploy the SRS air bag equipment.

Side impacts involving trees or poles

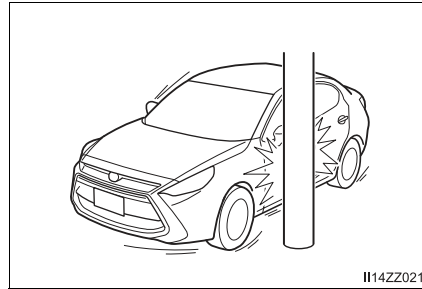

Side impacts with two-wheeled vehicles

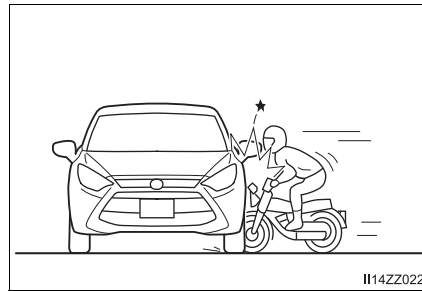

Limitations to roll-over detection

The following illustration is an example of an accident that may not be detected as a roll-over accident. Therefore, the front seat belt pretensioners and curtain air bags may not deploy.

Pitch end over end

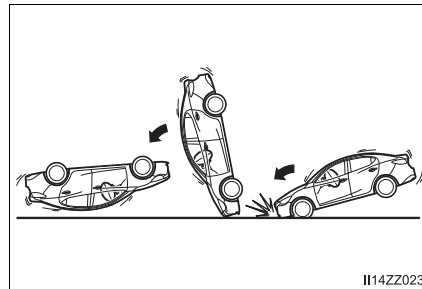

1

Essential Safety Equipment

Front Passenger Occupant Classification System

First, please read “Supplemental Restraint System (SRS) Precautions” (→P. 66) carefully.

Front Passenger Occupant Classification Sensor

Your vehicle is equipped with a front passenger occupant classification sensor as a part of the supplemental restraint system. This sensor is equipped in the front passenger's seat cushion. This sensor measures the electrostatic capacity of the front passenger's seat. The SAS unit is designed to prevent the front passenger front and side air bags and seat belt pretensioner system from deploying if the front passenger air bag deactivation indicator light turns on.

To reduce the chance of injuries caused by deployment of the front passenger air bag, the system deactivates the front passenger front and side air bags and also the seat belt pretensioner system when the front passenger air bag deactivation indicator light turns on. Refer to the following table for the front passenger air bag deactivation indicator light illumination conditions.

This system shuts off the front passenger front and side air bags and seat belt pretensioner system, so make sure the front passenger air bag deactivation indicator light turns on according to the following table.

The air bag/front seat belt pretensioner system warning light flashes and the front passenger air bag deactivation indicator light illuminates if the sensors have a possible malfunction. If this happens, the front passenger front and side air bags and seat belt pretensioner system will not deploy.

■ Front passenger air bag deactivation indicator light

This indicator light turns on to remind you that the front passenger front and side air bags and seat belt pretensioner will not deploy during a collision.

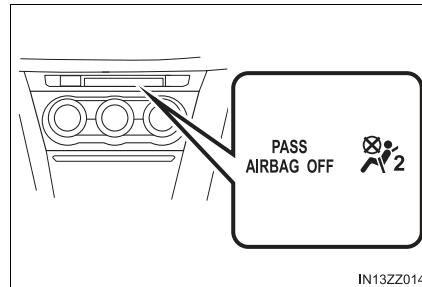

If the front passenger occupant classification sensor is normal, the indicator light turns on when the ignition is switched ON. The light turns off after a few seconds. Then, the indicator light turns on or is off under the following conditions:

■ Front passenger air bag deactivation indicator light on/off condition chart

Condition detected by the front passenger occupant classification system	Front passenger air bag deactivation indicator light	Front passenger front and side air bags	Front passenger seat belt pretensioner system
Empty (Not occupied)	On	Deactivated	Deactivated
A child less than 1 year old is seated in a child-restraint system	On	Deactivated	Deactivated
Child*1	On or off	Deactivated or ready	Deactivated or ready
Adult*2	Off	Ready	Ready

*1: The occupant classification sensor may not detect a child seated on the seat, in a child-restraint system, or a junior seat depending on the child's physical size and seated posture.

*2: If a smaller adult sits on the front passenger seat, the sensors might detect the person as being a child depending on the person's physique.

The curtain air bag is ready for inflating regardless of what the front passenger air bag deactivation indicator light on/off condition chart indicates.

If the front passenger air bag deactivation indicator light does not turn on when the ignition is switched ON and does not turn on as indicated in the front passenger air bag deactivation indicator light on/off condition chart, do not allow an occupant to sit in the front passenger seat and consult your Toyota dealer as soon as possible. The system may not work properly in an accident.

- The system requires about 10 seconds to alternate between turning the front passenger front and side air bags and seat belt pretensioner system on or off.
- The front passenger air bag deactivation indicator light may turn on repeatedly if luggage or other items are put on the front passenger seat, or if the temperature of the vehicle's interior changes suddenly.
- The front passenger air bag deactivation indicator light may turn on for 10 seconds if the electrostatic capacity on the front passenger seat changes.
- The air bag/front seat belt pretensioner system warning light might turn on if the front passenger seat receives a severe impact.
- If the front passenger air bag deactivation indicator light does not turn on after installing a child-restraint system on the front passenger seat, first, re-install your child-restraint system according to the procedure in this owner's manual. Then, if the front passenger air bag deactivation indicator light still does not turn on, install the child-restraint system on the rear seat and consult your Toyota dealer as soon as possible.
- If the front passenger air bag deactivation indicator light turns on when an occupant is seated directly in the front passenger seat, have the passenger re-adjust their posture by sitting with their feet on the floor, and then re-fastening the seat belt. If the front passenger air bag deactivation indicator light remains turned on, move the passenger to the rear seat. If sitting in the rear seat is not possible, slide the front passenger seat as far back as possible. Consult your Toyota dealer as soon as possible.

⚠ WARNING**■ Do not allow an occupant in the front passenger's seat to sit with a posture which makes it difficult for the front passenger occupant classification sensor to detect the occupant correctly**

Sitting in the front passenger's seat with a posture which makes it difficult for the front passenger occupant classification sensor to detect the occupant correctly is dangerous. If the front passenger occupant classification sensor cannot detect the occupant sitting on the front passenger's seat correctly, the front passenger front and side air bags and pretensioner system may not operate (deploy) or they may operate (deploy) accidentally. The front passenger will not have the supplementary protection of the air bags or the accidental operation (deployment) of the air bags could result in serious injury or death. Under the following conditions, the front passenger occupant classification sensor cannot detect a passenger sitting on the front passenger's seat correctly and the deployment/non-deployment of the air bags cannot be controlled as indicated in the front passenger air bag deactivation indicator light on/off condition chart. For example:

- A front passenger is seated as shown in the following figure:

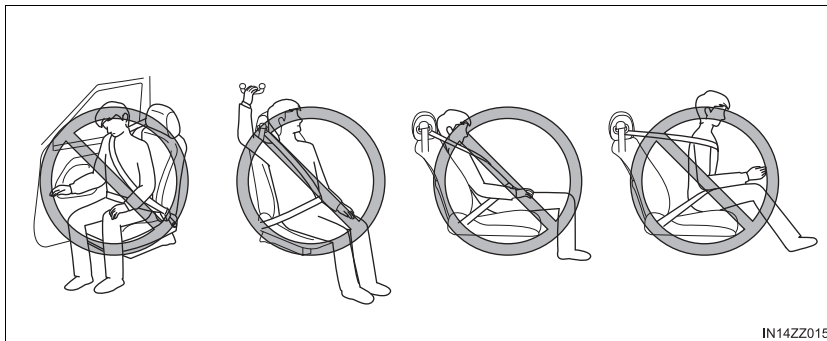

- A rear passenger pushes up on the front passenger seat with their feet.
- Luggage or other items placed under the front passenger seat or between the front passenger seat and driver seat that push up the front passenger seat bottom.
- An object, such as a seat cushion, is put on the front passenger's seat or between the passenger's back and the seatback.

 **WARNING**

■ **Do not allow an occupant in the front passenger's seat to sit with a posture which makes it difficult for the front passenger occupant classification sensor to detect the occupant correctly**

- A seat cover is put on the front passenger's seat.
- Luggage or other items are placed on the seat with the child in the child-restraint system.
- A rear passenger or luggage push or pull down on the front passenger seatback.
- Luggage or other items are placed on the seatback or hung on the head restraint.
- The seat is washed.
- Liquids are spilled on the seat.
- The front passenger seat is moved backward, pushing into luggage or other items placed behind it.
- The front passenger seatback contacts the rear seat.
- Luggage or other items are placed between the front passenger seat and driver seat.
- An electric device is put on the front passenger's seat.
- An additional electrical device, such as a seat warmer is installed to the surface of the front passenger seat.

The front passenger front and side air bags and seat belt pretensioner systems will deactivate if the front passenger air bag deactivation indicator light turns on.

 **NOTICE**

- To assure proper deployment of the front air bag and to prevent damage to the sensor in the front seat cushion:
 - Do not place sharp objects on the front seat cushion or leave heavy luggage on them.
 - Do not spill any liquids on the front seats or under the front seats.
- To allow the sensors to function properly, always perform the following:
 - Adjust the front seats as far back as possible and always sit upright against the seatbacks with seat belts worn properly.
 - If you place your child on the front passenger seat, secure the child-restraint system properly and slide the front passenger seat as far back as possible (→P. 57).

Constant Monitoring

The following components of the air bag systems are monitored by a diagnostic system:

- Crash sensors, and diagnostic module (SAS unit)
- Front air bag sensors
- Air bag modules
- Side crash sensors
- Air bag/Front seat belt pretensioner system warning light
- Front seat belt pretensioners
- Related wiring
- Front passenger air bag deactivation indicator light
- Front passenger occupant classification sensor
- Front passenger occupant classification module

The diagnostic module continuously monitors the system's readiness. This begins when the ignition is switched ON and continues while the vehicle is being driven.

Before Driving

2

2-1. Keys		2-7. Windows	
Keys	90	Power Windows	132
Keyless Entry System	92	2-8. Security System	
2-2. Advanced Keyless Entry System		Modification and Add-On Equipment	135
Advanced Keyless Entry System	99	Immobilizer System.....	136
2-3. Door and Locks		Theft Deterrent System.....	138
Door Locks	101	2-9. Driving Tips	
Liftgate/Trunk Lid	113	Break-In Period	141
2-4. Fuel and Emission		Saving Fuel and Protection of the Environment.....	142
Fuel and Engine Exhaust Precautions	121	Hazardous Driving	143
Fuel-Filler Lid and Cap.....	124	Floor Mat.....	144
2-5. Steering Wheel		Rocking the Vehicle	145
Steering Wheel	127	Winter Driving	146
2-6. Mirrors		Driving In Flooded Area	149
Mirrors	129	Overloading.....	150
		Driving on Uneven Road	151
		2-10. Towing	
		Trailer Towing	152
		Recreational Towing	153

Keys

- ① Smart key
- ② Auxiliary key
- ③ Key code number plate

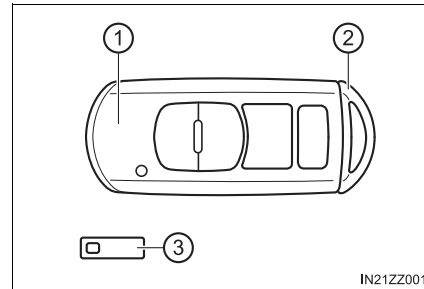

To use the auxiliary key, press the knob and pull out the auxiliary key from the smart key.

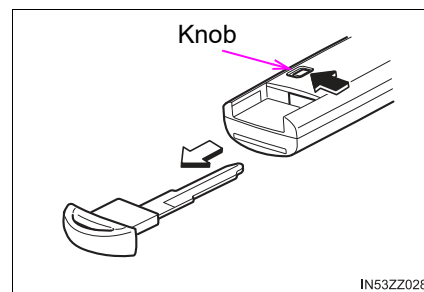

A code number is stamped on the plate attached to the key set; detach this plate and store it in a safe place (not in the vehicle) for use if you need to make a replacement key (auxiliary key).

Also write down the code number and keep it in a separate safe and convenient place, but not in the vehicle.

If your key (auxiliary key) is lost, consult your Toyota dealer and have your code number ready.

- The driver must carry the key to ensure the system functions properly.
- Always keep a spare key in case one is lost. If a key is lost, consult your Toyota dealer as soon as possible.

⚠ WARNING**■ Do not leave the key in your vehicle with children and keep them in a place where your children will not find or play with them**

Leaving children in a vehicle with the key is dangerous. This could result in someone being badly injured or even killed. Children may find these keys to be an interesting toy to play with and could cause the power windows or other controls to operate, or even make the vehicle move.

⚠ NOTICE

- Because the key (smart key) uses low-intensity radio waves, it may not function correctly under the following conditions:
 - The key is carried with communication devices such as cellular phones.
 - The key contacts or is covered by a metal object.
 - The key is near electronic devices such as personal computers.
 - Non-Toyota genuine electronic equipment is installed in the vehicle.
 - There is equipment which discharges radio waves near the vehicle.
- The key (smart key) may consume battery power excessively if it receives high-intensity radio waves. Do not place the key near electronic devices such as televisions or personal computers.
- To avoid damage to the key (smart key), DO NOT:
 - Drop the key.
 - Get the key wet.
 - Disassemble the key.
 - Expose the key to high temperatures on places such as the dashboard or hood, under direct sunlight.
 - Expose the key to any kind of magnetic field.
 - Place heavy objects on the key.
 - Put the key in an ultrasonic cleaner.
 - Put any magnetized objects close to the key.

Keyless Entry System

This system uses the key buttons to remotely lock and unlock the doors and the liftgate, and opens the trunk lid.

The system can start the engine without having to take the key out of your purse or pocket.

It can also help you signal for attention.

Operating the theft deterrent system is also possible on theft deterrent system-equipped vehicles.

Press the buttons slowly and carefully.

System malfunctions or warnings are indicated by the following warning lights or beeps.

- KEY Warning Light (Red)

Refer to Warning/Indicator Lights on P. 173.

- Ignition Not Switched Off (STOP) Warning Beep

Refer to Ignition Not Switched Off (STOP) Warning Beep on P. 504.

- Key Removed from Vehicle Warning Beep

Refer to Key Removed from Vehicle Warning Beep on P. 504.

If you have a problem with the key, consult your Toyota dealer.

If your key is lost or stolen, consult your Toyota dealer as soon as possible for a replacement and to make the lost or stolen key inoperative.

- The keyless entry system operation may vary due to local conditions.
- The keyless entry system is fully operational (door/liftgate lock/unlock) when the ignition is switched off. The system does not operate if the ignition is switched to any position other than off.
- If the key does not operate when pressing a button or the operational range becomes too small, the battery may be dead. To install a new battery, refer to Key Battery Replacement (→P. 410).

- Battery life is about one year. Replace the battery with a new one if the KEY indicator light (green) flashes in the combination meter. Replacing the battery about once a year is recommended because the KEY warning light/indicator light may not illuminate or flash depending on the rate of battery depletion.

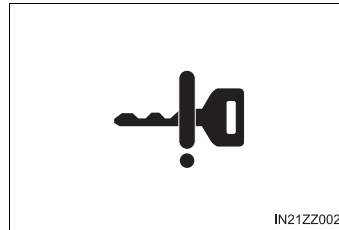

- Additional keys can be obtained at your Toyota dealer. Up to 6 keys can be used with the keyless functions per vehicle. Bring all keys to your Toyota dealer when additional keys are required.

 NOTICE

Radio equipment like this is governed by laws in the United States. Changes or modifications not expressly approved by the party responsible for compliance could void the user's authority to operate the equipment.

Smart Key

- ① Operation indicator light
- ② Operation buttons

The operation indicator light flashes when the buttons are pressed.

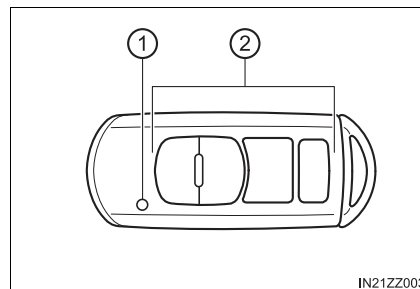

■ Lock button

To lock the doors and the liftgate, press the lock button and the hazard warning lights will flash once.

With the advanced keyless function:

A beep sound will be heard once.

To confirm that all doors and the liftgate have been locked, press the lock button again within 5 seconds. If they are closed and locked, the horn will sound.

**■ Unlock button**

To unlock the driver's door, press the unlock button and the hazard warning lights will flash twice.

With the advanced keyless function:

A beep sound will be heard twice.

To unlock all doors and the liftgate, press the unlock button again within three seconds and two more beep sounds will be heard.

**■ Trunk button (4-Door)**

To open the trunk lid, press and hold the trunk button until the trunk lid opens.

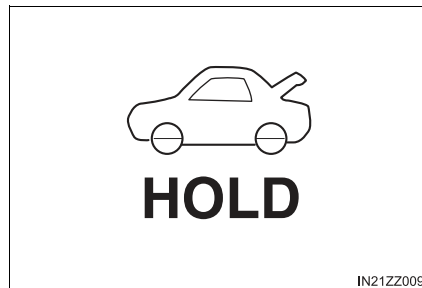

■ Panic button

If you witness from a distance someone attempting to break into or damage your vehicle, press and hold the panic button to activate the vehicle's alarm. Call emergency services if necessary.



● Turning on the alarm

Pressing the panic button for 1 second or longer will trigger the alarm for about 2 minutes and 30 seconds, and the following will occur:

- The horn sounds intermittently.
- The hazard warning lights flash.

● Turning off the alarm

The alarm stops by pressing any button on the key.

■ Smart Key

- With theft deterrent system:
The hazard warning lights flash when the theft deterrent system is armed or turned off.
Refer to Theft Deterrent System on P. 138.
- With the advanced keyless function:
A beep sound can be heard for confirmation when the doors and the liftgate are locked/unlocked using the key. If you prefer, the beep sound can be turned off. The volume of the beep sound can also be changed.
Refer to Customizable Features on P. 555.
Use the following procedure to change the setting.
 - 1 Switch the ignition off and close all of the doors and the liftgate/trunk lid.
 - 2 Open the driver's door.
 - 3 Within 30 seconds of opening the driver's door, press and hold the LOCK button on the key for 5 seconds or longer (All of the doors and the liftgate are locked and unlocked when the LOCK button on the key is pressed and held for 5 seconds.).

The beep sound activates at the currently set volume. The setting changes each time the LOCK button on the key is pressed and the beep sound activates at the set volume. (If the beep sound has been set to not activate, it will not activate.)
 - 4 The setting change is completed by doing any one of the following:
 - Switching the ignition to ACC or ON.
 - Closing the driver's door.
 - Opening the liftgate/trunk lid.
 - Not operating the key for 10 seconds.
 - Pressing any button except the LOCK button on the key.
 - Pressing a request switch.

■ Lock button

- The doors and the liftgate can be locked by pressing the lock button while any other door or the liftgate/trunk lid is open. The hazard warning lights will not flash.
- When the lock button is pressed while any door is open and then the door is closed, all the doors and the liftgate are locked.
- Confirm that all doors and the liftgate are locked visually or audibly by use of the double click.
- Make sure all doors and the liftgate are locked after pressing the button.
- With theft deterrent system:
When the doors are locked by pressing the lock button on the key while the theft deterrent system is armed, the hazard warning lights will flash once to indicate that the system is armed.

■ Unlock button

- The system can be set to unlock all doors by performing a single operation. Refer to Customizable Features on P. 555.

Use the following procedure to change the setting.

- 1 Switch the ignition off and close all of the doors and the liftgate/trunk lid.
- 2 Open the driver's door
- 3 Within 30 seconds of opening the driver's door, press and hold the UNLOCK button on the key for 5 seconds or longer (the sound of the doors locking/unlocking can be heard).

After this, the system switches the setting each time the UNLOCK button is pressed (the sound of the doors locking/unlocking can be heard).

- 4 The setting change is completed by doing any one of the following:
 - Switching the ignition to ACC or ON.
 - Closing the driver's door.
 - Opening the liftgate/trunk lid.
 - Not operating the key for 10 seconds.
 - Pressing any button except the UNLOCK button on the key.
 - Pressing a request switch.

- Auto re-lock function:

After unlocking with the key, all doors and the liftgate will automatically lock if any of the following operations are not performed within about 60 seconds. If your vehicle has a theft deterrent system, the hazard warning lights will flash for confirmation.

The time required for the doors to lock automatically can be changed. Refer to Customizable Features on P. 555.

- A door or the liftgate/trunk lid is opened.
- The ignition is switched to any position other than off.

- With theft deterrent system:

When the doors are unlocked by pressing the unlock button on the key while the theft deterrent system is turned off, the hazard warning lights will flash twice to indicate that the system is turned off.

■ Panic button

The panic button will work whether any door or the liftgate/trunk lid is open or closed.

Operational Range

The system operates only when the driver is in the vehicle or within operational range while the key is being carried.

■ Starting the Engine

- ▶ With the advanced keyless function
- ▶ Without the advanced keyless function

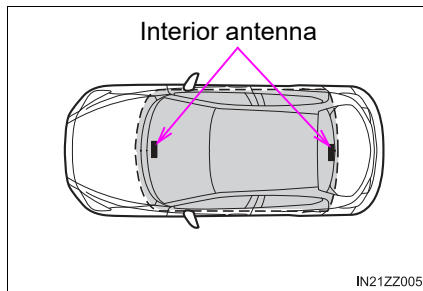

● Operational range

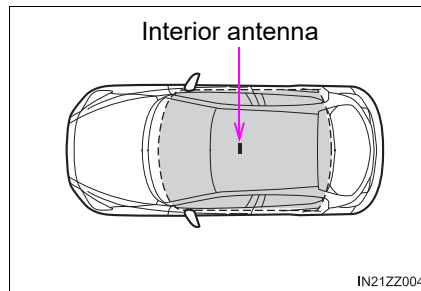

● Operational range

- Starting the engine may be possible even if the key is outside of the vehicle and extremely close to a door and window, however, always start the engine from the driver's seat.
If the vehicle is started and the key is not in the vehicle, the vehicle will not restart after it is shut off and the ignition is switched to off.
- The luggage compartment/trunk is out of the assured operational range, however, if the key (smart key) is operable the engine will start.
- The engine may not start if the key is placed in the following areas:
 - Around the dashboard
 - In the storage compartments such as the glove compartment
 - On the rear parcel shelf (4-door)

Key Suspend Function

If a key is left in the vehicle, the functions of the key left in the vehicle are temporarily suspended to prevent theft of the vehicle.

To restore the functions, press the unlock button on the functions-suspended key in the vehicle.

Advanced Keyless Entry System*

The advanced keyless function allows you to lock/unlock the door and the liftgate or open the liftgate/trunk lid while carrying the key.

System malfunctions or warnings are indicated by the following warning lights or beeps.

- **Request switch Inoperable Warning Beep**
Refer to Request Switch Inoperable Warning Beep (With the advanced keyless function) on P. 504.
- **Key Left-in-luggage Compartment/Trunk Warning Beep**
Refer to Key Left-in-luggage Compartment/Trunk Warning Beep (With the advanced keyless function) on P. 504.
- **Key Left-in-vehicle Warning Beep**
Refer to Key Left-in-vehicle Warning Beep (With the advanced keyless function) on P. 505.

The advanced keyless entry system functions can be deactivated to prevent any possible adverse effect on a user wearing a pacemaker or other medical device. If the system is deactivated, you will be unable to start the engine by carrying the key. Consult your Toyota dealer for details. If the advanced keyless entry system has been deactivated, you can start the engine by following the procedure indicated when the key battery goes dead. Refer to Engine Start Function When Key Battery is Dead on P. 161.

WARNING

■ **Radio waves from the key may affect medical devices such as pacemakers**

Before using the key near people who use medical devices, ask the medical device manufacturer or your physician if radio waves from the key will affect the device.

*: If equipped

Operational Range

The system operates only when the driver is in the vehicle or within operational range while the key is being carried.

■ Locking, Unlocking the Doors and the Liftgate

● Operational range

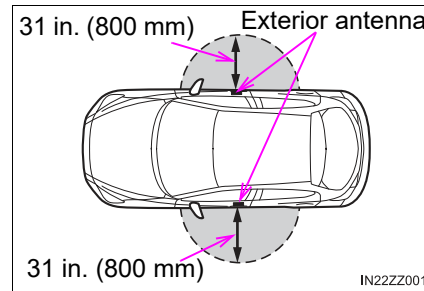

■ Opening the Liftgate/Trunk Lid

● Operational range

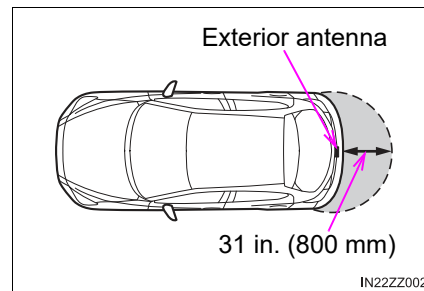

- When the battery power is low, or in places where there are high-intensity radio waves or noise, the operational range may become narrower or the system may not operate. For determining battery replacement, Refer to Keyless Entry System on P. 92.
- The system may not operate if you are too close to the windows or door handles.
- If the key is left in the following areas and you leave the vehicle, the doors may be locked depending on the radio wave conditions even if the key is left in the vehicle.
 - Around the dashboard
 - In the storage compartments such as the glove compartment or the center console
 - On the rear parcel shelf (4-door)
 - Next to a communication device such as a mobile phone

Door Locks

When the ignition is switched to ACC or ON, the vehicle lock-out prevention feature prevents you from locking yourself out of the vehicle.

All doors and the liftgate will automatically unlock if they are locked using the power door locks with any door or the liftgate open.

The vehicle lock-out prevention feature does not operate while the ignition is switched off.

When all doors and the liftgate are locked using the power door lock with any door or the liftgate/trunk lid open, the closed doors and the liftgate are locked. After that, when all doors and the liftgate/trunk lid are closed, all doors and the liftgate are locked. However, if the key is inside the vehicle, all doors and the liftgate are automatically unlocked.

With the advanced keyless function:

The beep sound is heard for about 10 seconds to notify the driver that the key has been left in the vehicle.

Without the advanced keyless function:

The horn sound is heard twice to notify the driver that the key has been left in the vehicle.

■ Door unlock (control) system with collision detection

This system automatically unlocks the doors and the liftgate in the event the vehicle is involved in an accident to allow passengers to get out of the vehicle immediately and prevent being trapped inside. While the ignition is switched ON and in the event the vehicle receives an impact strong enough to inflate the air bags, all the doors and the liftgate are automatically unlocked after about 6 seconds have elapsed from the time of the accident.

The doors and the liftgate may not unlock depending on how an impact is applied, the force of the impact, and other conditions of the accident.

If door-related systems or the battery is malfunctioning, the doors and the liftgate will not unlock.

 **WARNING****■ Always take all children and pets with you or leave a responsible person with them**

Leaving a child or a pet unattended in a parked vehicle is dangerous. In hot weather, temperatures inside a vehicle can become high enough to cause brain damage or even death.

■ Do not leave the key in your vehicle with children and keep them in a place where your children will not find or play with them

Leaving children in a vehicle with the key is dangerous. This could result in someone being badly injured or even killed.

■ Keep all doors locked when driving

Unlocked doors in a moving vehicle are dangerous. Passengers can fall out if a door is accidentally opened and can more easily be thrown out in an accident.

■ Always close all the windows, lock the doors and the liftgate and take the key with you when leaving your vehicle unattended

Leaving your vehicle unlocked is dangerous as children could lock themselves in a hot vehicle, which could result in death. Also, a vehicle left unlocked becomes an easy target for thieves and intruders.

■ After closing the doors and the liftgate/trunk lid, always verify that they are securely closed

Doors and the liftgate/trunk lid not securely closed are dangerous, if the vehicle is driven with a door and the liftgate/trunk lid not securely closed, the door and the liftgate/trunk lid could open unexpectedly resulting in an accident.

■ Always confirm the safety around the vehicle before opening a door and the liftgate/trunk lid

Suddenly opening a door and the liftgate/trunk lid is dangerous. A passing vehicle or a pedestrian could be hit and cause an accident.

■ When opening or closing a door and the trunk lid

Always confirm the conditions around the vehicle before opening/closing the doors and the liftgate/trunk lid and use caution during strong winds or when parked on an incline. Not being aware of the conditions around the vehicle is dangerous because fingers could get caught in the door and the liftgate/trunk lid or a passing pedestrian could be hit, resulting in an unexpected accident or injury.

Locking, Unlocking with Auxiliary Key

Turn the auxiliary key toward the front to lock, toward the back to unlock.

- ① Lock
- ② Unlock

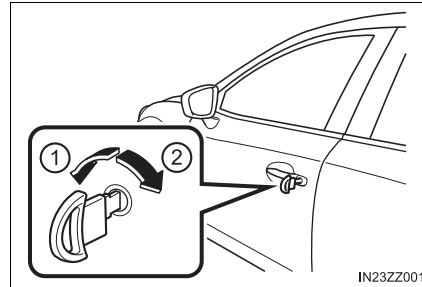

■ To lock

All doors and the liftgate lock automatically when the driver's door is locked using the auxiliary key.

■ To unlock

The driver's door unlocks when the auxiliary key is turned briefly to the unlock position and then immediately returned to the center position.

All doors and the liftgate unlock when the driver's door is unlocked and the auxiliary key is held in the unlock position for one second or longer.

Locking, Unlocking with Request Switch (With the advanced keyless function)

All doors and the liftgate can be locked/unlocked by pressing the request switch while the key is being carried.

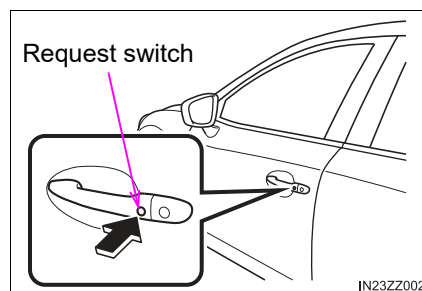

2

Before Driving

■ To lock

To lock the doors and the liftgate, press the request switch and the hazard warning lights will flash once.

A beep sound will be heard once.

■ To unlock**● Driver's door request switch**

To unlock the driver's door, press the request switch. A beep sound will be heard twice and the hazard warning lights will flash twice.

To unlock all doors and the liftgate, press the request switch again within three seconds and two more beep sounds will be heard.

● Front passenger door request switch

To unlock all doors and the liftgate, press the request switch. A beep sound will be heard twice and the hazard warning lights will flash twice.

-
- The system can be set to unlock all doors by performing a single operation. Refer to Customizable Features on P. 555.

Use the following procedure to change the setting.

- 1 Switch the ignition off and close all of the doors and the liftgate/trunk lid.
- 2 Open the driver's door.
- 3 Within 30 seconds of opening the driver's door, press and hold the UNLOCK button on the key for 5 seconds or longer (the sound of the doors locking/unlocking can be heard).

After this, the system switches the setting of pressing the driver's request switch once or twice to unlock all doors and the liftgate each time the UNLOCK button is pressed (the sound of the doors locking/unlocking can be heard).

- 4 The setting change is completed by doing any one of the following:
 - Switching the ignition to ACC or ON.
 - Closing the driver's door.
 - Opening the liftgate/trunk lid.
 - Not operating the key for 10 seconds.
 - Pressing any button except the UNLOCK button on the key.
 - Pressing a request switch.

- Confirm that all doors and the liftgate are securely locked.
For the liftgate/trunk lid, move it without pressing the electric liftgate/trunk lid opener to verify that the liftgate/trunk lid has not been left ajar.
- All doors and the liftgate cannot be locked when any door or the liftgate is open.
- It may require a few seconds for the doors to unlock after the request switch is pressed.
- A beep sound is heard for confirmation when the doors and the liftgate are locked/unlocked using the request switch. If you prefer, the beep sound can be turned off.

The volume of the beep sound can also be changed. Refer to Customizable Features on P. 555.

Use the following procedure to change the setting.

- 1 Switch the ignition off and close all of the doors and the liftgate/trunk lid.
- 2 Open the driver's door.
- 3 Within 30 seconds of opening the driver's door, press and hold the LOCK button on the key for 5 seconds or longer (All of the doors and the liftgate are locked and unlocked when the LOCK button on the key is pressed and held for 5 seconds.).

The beep sound activates at the currently set volume. The setting changes each time the LOCK button on the key is pressed and the beep sound activates at the set volume. (If the beep sound has been set to not activate, it will not activate.)

- 4 The setting change is completed by doing any one of the following:
 - Switching the ignition to ACC or ON.
 - Closing the driver's door.
 - Opening the liftgate/trunk lid.
 - Not operating the key for 10 seconds.
 - Pressing any button except the LOCK button on the key.
 - Pressing a request switch.

- With theft deterrent system:
The hazard warning lights flash when the theft deterrent system is armed or turned off.
Refer to Theft Deterrent System on P. 138.
- The setting can be changed so that the doors and the liftgate are locked automatically without pressing the request switch.
Refer to Customizable Features on P. 555.
Walk-away auto lock function:
A beep sound is heard when all doors and the liftgate are closed while the advanced key is being carried. All doors and the liftgate are locked automatically after about three seconds when the advanced key is out of the operational range. Also, the hazard warning lights flash once. (Even if the driver is in the operational range, all doors and the liftgate are locked automatically after about 30 seconds.) If you are out of the operational range before the doors and the liftgate/trunk lid are completely closed or another key is left in the vehicle, the function will not work. Always make sure that all doors and the liftgate/trunk lid are closed and locked before leaving the vehicle. The function does not close the power windows.
- Auto re-lock function:
After unlocking with the request switch, all doors and the liftgate will automatically lock if any of the following operations are not performed within about 60 seconds. If your vehicle has a theft deterrent system, the hazard warning lights will flash for confirmation.
The time required for the doors to lock automatically can be changed. Refer to Customizable Features on P. 555.
 - Opening a door or the liftgate/trunk lid.
 - Switching the ignition to any position other than off.

Locking, Unlocking with Smart Key

All doors and the liftgate can be locked/unlocked by operating the keyless entry system smart key, refer to Keyless Entry System (→P. 92).

Locking, Unlocking with Door-Lock Switch

All doors and the liftgate lock automatically when the lock side is pressed. They all unlock when the unlock side is pressed.

Driver's door

- ① Lock
- ② Unlock

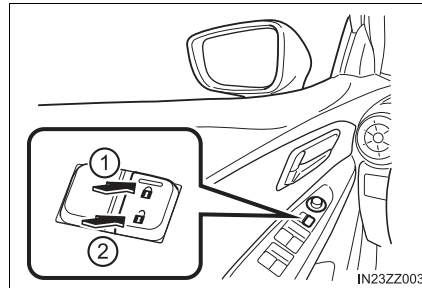

Front passenger's door

- ① Lock
- ② Unlock

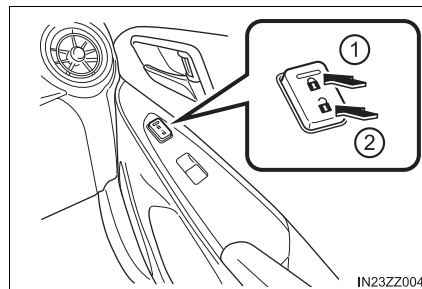

To lock all the doors and the liftgate from an open front door, press the lock side of the door lock switch and then close the door.

When locking the doors this way, be careful not to leave the key inside the vehicle.

2

Before Driving

Auto Lock/Unlock Function

- When the vehicle speed exceeds 12 mph (20 km/h), all doors and the liftgate lock automatically.
- When the ignition is switched off, all doors and the liftgate unlock automatically.

These functions can also be disabled so that they do not operate.

■ Auto lock/unlock function setting change using door-lock switch

The doors and the liftgate can be set to lock or unlock automatically by selecting any one of the functions from the following table and using the driver's door-lock switch on the interior door panel.

Function number	Function*1
1	The auto door-lock function is disabled.
2	All the doors and the liftgate lock automatically when the vehicle speed is about 12 mph (20 km/h) or more.
3	All the doors and the liftgate lock automatically when the vehicle speed is about 12 mph (20 km/h) or more. All the doors and the liftgate unlock when the ignition is switched from ON to Off.
4	Automatic transaxle vehicles only: When the ignition is switched ON and the shift lever is shifted from park (P) to any other gear position, all the doors and the liftgate lock automatically.
5	Automatic transaxle vehicles only: When the ignition is switched ON and the shift lever is shifted from park (P) to any other gear position, all the doors and the liftgate lock automatically. When the shift lever is shifted to park (P) while the ignition is switched ON, all the doors and the liftgate unlock automatically.
6	Automatic transaxle vehicles only: All the doors and the liftgate lock automatically when the vehicle speed is about 12 mph (20 km/h) or more. When the shift lever is shifted to park (P) while the ignition is switched ON, all the doors and the liftgate unlock automatically.

*1: Other settings for the auto door lock function are available at your Toyota dealer. For details consult your Toyota dealer. Refer to Customizable Features on P. 555.

Settings can be changed using the following procedure.

- 1 Safely park the vehicle. All doors and the liftgate must remain closed.
- 2 Switch the ignition ON.
- 3 Press and hold the lock side of the driver's door-lock switch within 20 seconds of switching the ignition ON, and make sure a beep sound is heard about eight seconds afterwards.
- 4 Refer to the auto lock/unlock function setting table, determine the function number for the desired setting. Press the unlock side of the driver's door-lock switch the same number of times as the selected function number (Ex. If you select function 2, press the unlock side of the switch only 2 times).
- 5 Three seconds after the function setting has been changed, a beep sound will beep in the amount of the selected function number. (Ex. Function number 3 = 3 beep sounds)

► Manual transaxle vehicles

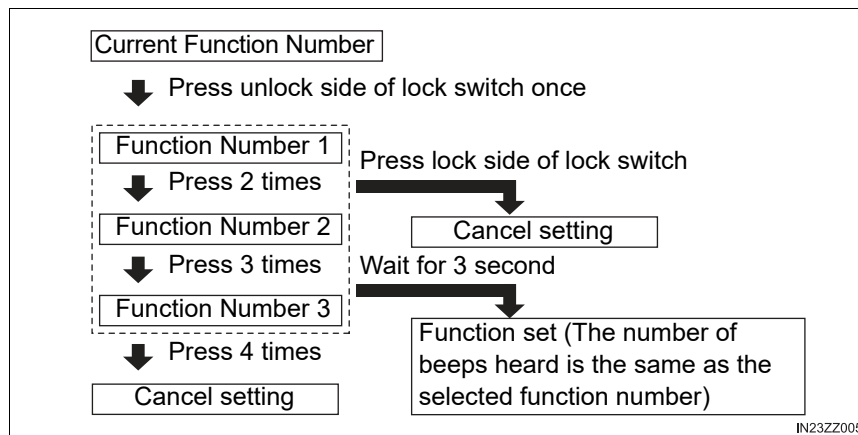

2
Before Driving

► Automatic transaxle vehicles

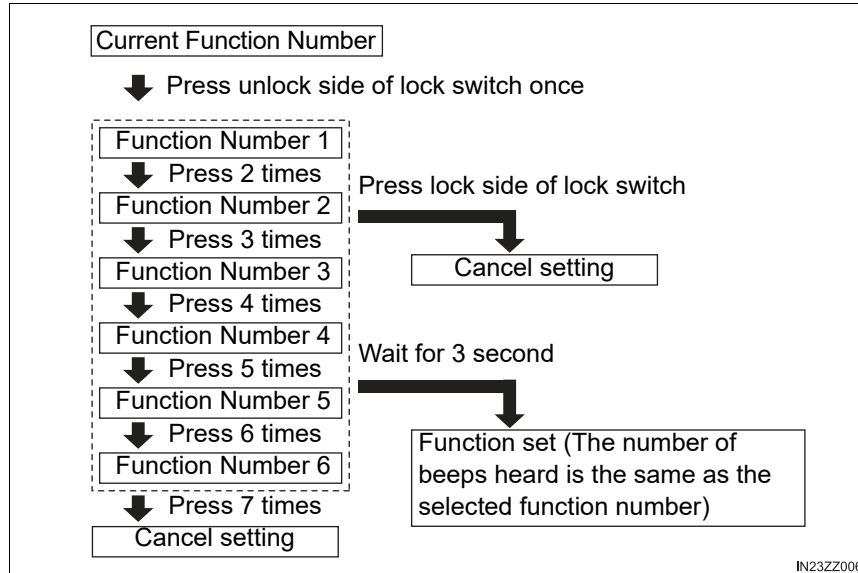

- Function number 3 is the factory setting for your vehicle.
- There are only a total of three auto lock/unlock settings available for manual transaxle vehicles, and six for automatic transaxle vehicles. Be sure to press the unlock side of the driver's door-lock switch the correct number of times according to the selected function number. If the switch is mistakenly pressed four times on a manual transaxle vehicle or seven times on an automatic transaxle, the procedure will be cancelled. If this occurs, start the procedure from the beginning.
- The doors and the liftgate cannot be locked or unlocked while the setting function is being performed.
- The procedure can be cancelled by pressing the lock side of the driver's door-lock switch.

⚠ WARNING

■ **Do not pull the inner handle on a front door**
 Pulling the inner handle on a front door while the vehicle is moving is dangerous. Passengers can fall out of the vehicle if the door opens accidentally, which could result in death or serious injury.

Locking, Unlocking with Door-Lock Knob

■ Operation from inside

① Lock

To lock any door from the inside, press the door-lock knob.

② Unlock

To unlock, pull it outward.

This does not operate the other door locks.

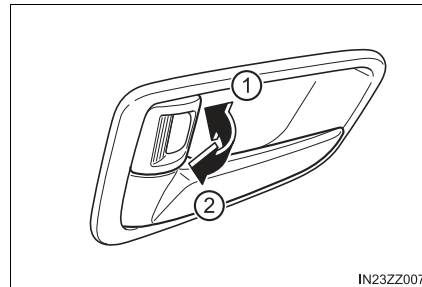

■ Operation from outside

To lock any door using its door-lock knob from the outside, press the door-lock knob to the lock position and close the door (holding the door handle in the open position is not required).

This does not operate the other door locks.

When locking the door this way:

- Be careful not to leave the key inside the vehicle.
- The doors cannot be locked using the driver's door lock knob if any door is open when the ignition is switched to ACC or ON.

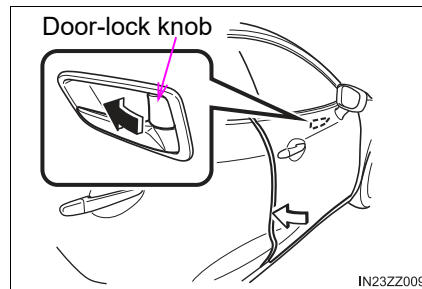

The red indication can be seen when the door-lock knob is unlocked.

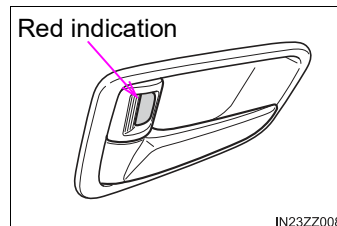

Rear Door Child Safety Locks

These locks are intended to help prevent children from accidentally opening the rear doors. Use them on both rear doors whenever a child rides in the rear seat of the vehicle.

- ① Unlock
- ② Lock

If you slide the child safety lock to the lock position before closing that door, the door cannot be opened from the inside. The door can only be opened by pulling the outside handle.

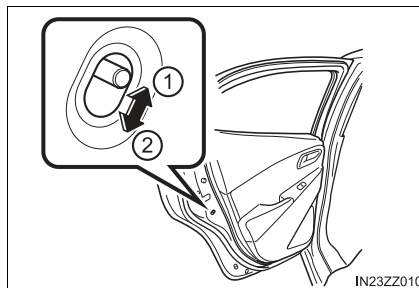

Liftgate/Trunk Lid

WARNING

■ **Never allow a person to ride in the luggage compartment/trunk**

Allowing a person to ride in the luggage compartment/trunk is dangerous. The person in the luggage compartment/trunk could be seriously injured or killed during sudden braking or a collision.

■ **Do not drive with the liftgate/trunk lid open**

Exhaust gas in the cabin of a vehicle is dangerous. An open liftgate/trunk lid in a moving vehicle will cause exhaust gas to be drawn into the cabin. This gas contains CO (carbon monoxide), which is colorless, odorless, and highly poisonous, and it can cause loss of consciousness and death. Moreover, an open liftgate/trunk lid could cause occupants to fall out in an accident.

■ **Do not stack or leave loaded luggage unsecured in the luggage compartment**

Otherwise, the luggage may move or collapse, resulting in injury or an accident. In addition, do not load luggage higher than the seatbacks. It may affect the side or rear field of view.

2

Before Driving

⚠ WARNING**■ Using the trunk**

- Before opening the liftgate/trunk lid, remove any snow and ice accumulation on it. Otherwise, the liftgate/trunk lid could close under the weight of the snow and ice resulting in injury.
- Be careful when opening/closing the liftgate/trunk lid during strong winds. If a strong gust blows against the liftgate/trunk lid, it could close suddenly resulting in injury.
- Fully open the liftgate/trunk lid and make sure that it stays open. If the liftgate/trunk lid is only opened partially, it could slam shut by vibration or wind gusts resulting in injury.
- When loading or unloading luggage in the luggage compartment/trunk, turn off the engine. Otherwise, you could get burned by the heat of the exhaust gas.
- Be careful not to apply excessive force to the damper stay on the liftgate such as by putting your hand on the stay. Otherwise, the damper stay may bend and affect the liftgate operation.
- Do not modify or replace the liftgate damper stay. Consult an Authorized Toyota Dealer if a liftgate damper stay is deformed or damaged for reasons such as a collision or if there is some other problem.

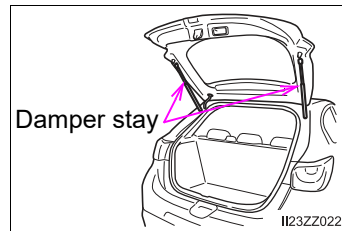

Opening and Closing the Liftgate/Trunk Lid

■ Opening the liftgate (5-Door)

Using the electric liftgate opener

Unlock the doors and liftgate, then press the electric liftgate opener on the liftgate and raise the liftgate when the latch releases.

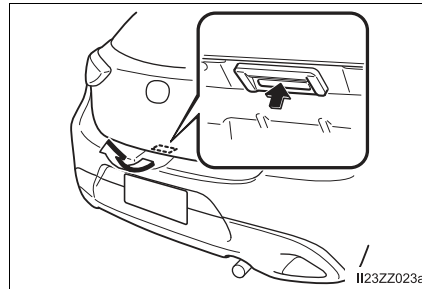

■ Opening the liftgate (With the advanced keyless function)

- A locked liftgate can also be opened while the key is being carried.
- When opening the liftgate with the doors and the liftgate locked, it may require a few seconds for the liftgate latch to release after the electric liftgate opener is pressed.
- The liftgate can be closed when the doors are locked with the key left in the vehicle. However, to prevent locking the key in the vehicle, the liftgate can be opened by pressing the electric liftgate opener. If the liftgate cannot be opened despite doing this procedure, first push the liftgate completely closed, then press the electric liftgate opener to fully open the liftgate.
- When the liftgate latch is released by pressing the electric liftgate opener, the liftgate raises slightly. If the liftgate is not operated for a certain period of time, the liftgate cannot be raised.

To open

Press the electric liftgate opener again.

To close

To close the liftgate from its slightly raised position, open it first by pressing the electric liftgate opener, then close it after waiting at least 1 second.

- If the liftgate is not fully closed, the driver is notified by a warning indicated in the instrument cluster.
- If the vehicle battery is dead or there is a malfunction in the electrical system and the liftgate cannot be unlocked, the liftgate can be opened by performing the emergency procedure.

Refer to When Liftgate/Trunk Lid Cannot be Opened on P. 506

■ **Opening the trunk lid (4-Door)**

● Using the remote release button

Push the remote release button.

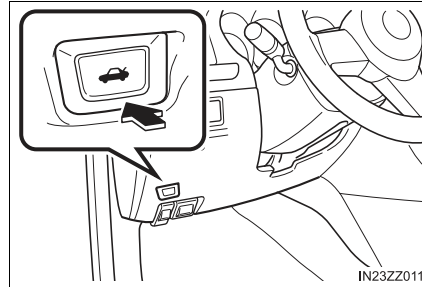

● Using the electric trunk lid opener (With the advanced keyless function)

A locked trunk lid can also be opened while the key is being carried.

Press the electric trunk lid opener on the trunk lid, then raise the trunk lid when the latch releases.

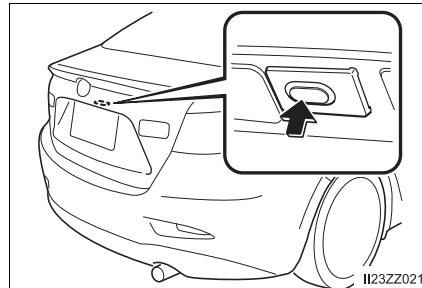

■ **Closing the liftgate/trunk lid**

▶ 5-Door

Lower the liftgate slowly using the liftgate grip recess, then push the liftgate closed using both hands. Do not slam it. Pull up on the liftgate to make sure it is secure.

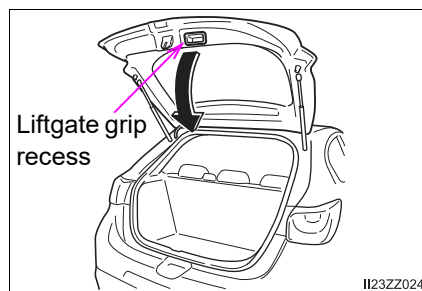

▶ 4-Door

Use both hands to push the trunk lid down until the lock snaps shut. Do not slam it. Pull up on the trunk lid to make sure it is secure.

■ Opening the trunk lid

- When opening the trunk lid with the doors locked, it may require a few seconds for the trunk lid latch to release after the electric trunk lid opener is pressed.
- The trunk lid can be closed when the doors are locked with the key left in the vehicle. However, to prevent locking the key in the vehicle, the trunk lid can be opened by pressing the electric trunk lid opener. If the trunk lid cannot be opened despite doing this procedure, press the electric trunk lid opener to fully open the trunk lid after pushing the trunk lid completely closed.
- If the vehicle battery is dead or there is a malfunction in the electrical system and the trunk lid cannot be unlocked, the trunk lid can be opened by performing the emergency procedure.
Refer to When Liftgate/Trunk Lid Cannot be Opened on P. 506.

Luggage Compartment

■ Luggage compartment cover (5-Door)

The luggage compartment can be accessed by opening the liftgate when the straps are attached to the sides of the liftgate.

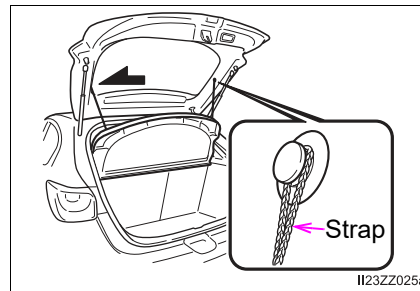

⚠ WARNING

■ Do not place anything on top of the cover

Placing luggage or other cargo on top of the luggage compartment cover is dangerous. During sudden braking or a collision, the cargo could become a projectile that could hit and injure someone. The vehicle has a light weight luggage compartment cover to keep the contents of your luggage area out of sight; it will not retain heavy objects that are not tied down in an accident such as a rollover. Tie down all heavy objects, whether luggage or cargo, using the tie down hooks.

■ Make sure luggage and cargo are secured before driving

- Not securing cargo while driving is dangerous as it could move or be crushed during sudden braking or a collision and cause injury.
- Make sure the luggage compartment cover is firmly secured. If it is not firmly secured, it could unexpectedly disengage resulting in injury.

■ **Loading golf bags (only 4-door)**

Up to two golf bags can be carried in the trunk.

- 1 Place the bottom of the first golf bag in the trunk with its bottom pointed to the left and fit it into the front of the trunk.

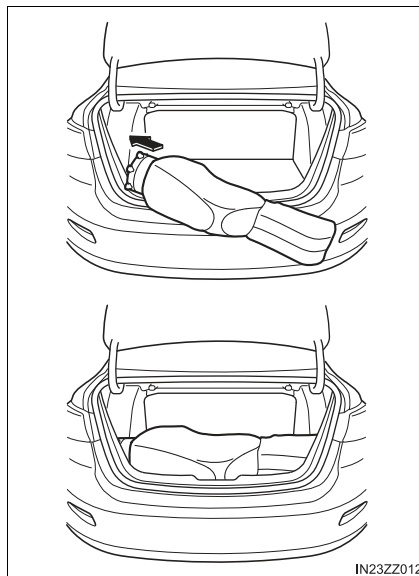

- 2 Place the second golf bag in the trunk with its bottom pointed to the left and fit it into the back of the trunk.

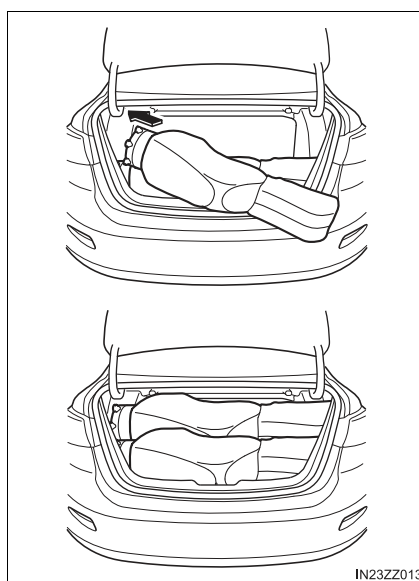

Some golf bags cannot fit depending on their size.

■ Removing the cover

This cover can be removed for more room.

- 1 Remove the straps from the hooks.
- 2 Lift the end of the luggage compartment cover a little, pull it outward, and remove it from the pins.
- 3 Lift the front end of the luggage compartment cover and remove it.

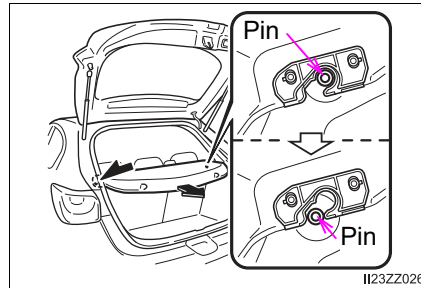

2

Before Driving

Inside Trunk Release Lever

Your vehicle is equipped with an inside trunk release lever that provides a means of escape for children and adults in the event they become locked inside the trunk.

No matter how careful adults might be with keys and locking their cars, parents should be aware that children may be tempted to play around vehicles and use the trunk as a hiding place.

Adults are advised to familiarize themselves with the operation and location of the inside trunk release lever so that all children can be told about it in an appropriate way, keeping in mind that most vehicles do not have such levers.

■ Opening the Trunk Lid from the Inside

Slide the inside trunk release lever in the direction of the arrow. The lever is made of material that will glow for hours in the darkness of the trunk following a brief exposure to ambient light.

The inside trunk release lever is located on the inside of the trunk lid.

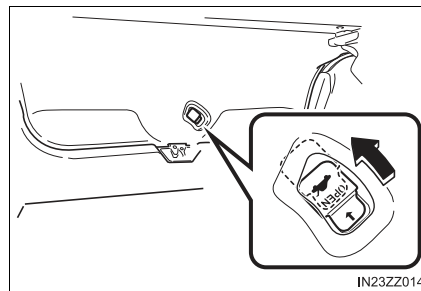

**WARNING****■ Close the trunk lid, be sure the seat backs are latched and do not allow children to play inside the vehicle**

Leaving the trunk lid open or leaving children in the vehicle with the keys is dangerous. Children could open the trunk lid and climb inside resulting in possible injury or death from heat exposure.

■ Always keep the car from being a tempting place to play by latching the rear seats, doors and the trunk, and keeping the keys where children can not play with them

Leaving children or animals unattended in a parked vehicle is dangerous. Babies left sleeping and children who lock themselves in cars or trunks can die very quickly from heat prostration. Do not leave your children or pets alone in a car at any time. Do not leave the car, the rear folding seats or the trunk unlocked.

Fuel and Engine Exhaust Precautions

Fuel Requirements

Vehicles with catalytic converters or oxygen sensors must use **ONLY UNLEADED FUEL**, which will reduce exhaust emissions and keep spark plug fouling to a minimum.

To achieve maximum engine performance, use the specified fuel.

Fuel	Octane Rating* ¹ (Anti-knock index)
Regular unleaded fuel	87 [(R+M)/2 method] or above (91 RON or above)

*¹: U.S. federal law requires that octane ratings be posted on gas station pumps.

Fuel with a rating lower than 87 octane (91 RON) could cause the emission control system to lose effectiveness. It could also cause engine knocking and serious engine damage.

Gasoline blended with oxygenates such as alcohol or ether compounds are generally referred to as oxygenated fuels. The common gasoline blend that can be used with your vehicle is ethanol blended at no more than 10 %. Gasoline containing alcohol, such as ethanol or methanol, may be marketed under the name "Gasohol".

Vehicle damage and drivability problems resulting from the use of the following may not be covered by the warranty.

- Gasohol containing more than 10 % ethanol.
- Gasoline or gasohol containing methanol.
- Leaded fuel or leaded gasohol.

 NOTICE

- **USE ONLY UNLEADED FUEL.**
Leaded fuel is harmful to the catalytic converter and oxygen sensors and will lead to deterioration of the emission control system and or failures.
- This vehicle can only use oxygenated fuels containing no more than 10 % ethanol by volume. Damage to the vehicle may occur when ethanol exceeds this recommendation, or if the gasoline contains any methanol. Stop using gasohol of any kind if your vehicle engine is performing poorly.
- Never add fuel system additives other than a Toyota genuine product, otherwise the emission control system could be damaged. Consult your Toyota dealer for details.

Emission Control System

This vehicle is equipped with an emission control system (the catalytic converter is part of this system) that enables the vehicle to comply with existing exhaust emissions requirements.

- Under U.S. federal law, any modification to the original-equipment emission control system before the first sale and registration of a vehicle is subject to penalties. In some states, such modification made on a used vehicle is also subject to penalties.
- While the engine is off, the sound of a valve opening and closing can be heard at the rear of the vehicle, however this does not indicate an abnormality. The vehicle has a selfchecking device and it operates while the engine is off.

WARNING

■ Never park over or near anything flammable

Parking over or near anything flammable, such as dry grass, is dangerous. Even with the engine turned off, the exhaust system remains very hot after normal use and could ignite anything flammable. A resulting fire could cause serious injury or death.

NOTICE

Ignoring the following precautions could cause lead to accumulate on the catalyst inside the converter or cause the converter to get very hot. Either condition will damage the converter and cause poor performance.

- USE ONLY UNLEADED FUEL.
- Do not drive your Toyota with any sign of engine malfunction.
- Do not coast with the ignition switched off.
- Do not descend steep grades in gear with the ignition switched off.
- Do not operate the engine at high idle for more than 2 minutes.
- Do not tamper with the emission control system. All inspections and adjustments must be made by a qualified technician.
- Do not push-start or pull-start your vehicle.

Engine Exhaust (Carbon monoxide)**⚠ WARNING****■ Do not drive your vehicle if you smell exhaust gas inside the vehicle**

Engine exhaust gas is dangerous. This gas contains carbon monoxide (CO), which is colorless, odorless, and poisonous. When inhaled, it can cause loss of consciousness and death. If you smell exhaust gas inside the vehicle, keep all windows fully open and contact your Toyota dealer immediately.

■ Do not run the engine when inside an enclosed area

Running the engine inside an enclosed area, such as a garage, is dangerous. Exhaust gas, which contains poisonous carbon monoxide, could easily enter the cabin. Loss of consciousness or even death could occur.

■ Open the windows or adjust the heating or cooling system to draw fresh air when idling the engine:

Exhaust gas is dangerous. When the vehicle is stopped with the windows closed and the engine running for a long time even in an open area, exhaust gas, which contains poisonous carbon monoxide, could enter the cabin. Loss of consciousness or even death could occur.

■ Clear snow from underneath and around your vehicle, particularly the tail pipe, before starting the engine:

Running the engine when a vehicle is stopped in deep snow is dangerous. The exhaust pipe could be blocked by the snow, allowing exhaust gas to enter the cabin. Because exhaust gas contains poisonous carbon monoxide, it could cause loss of consciousness or even death to occupants in the cabin.

Fuel-Filler Lid and Cap

WARNING

■ **When removing the fuel-filler cap, loosen the cap slightly and wait for any hissing to stop, then remove it**

Fuel spray is dangerous. Fuel can burn skin and eyes and cause illness if ingested. Fuel spray is released when there is pressure in the fuel tank and the fuel-filler cap is removed too quickly.

■ **Before refueling, stop the engine, and always keep sparks and flames away from the filler neck**

Fuel vapor is dangerous. It could be ignited by sparks or flames causing serious burns and injuries.

Additionally, use of the incorrect fuel-filler cap or not using a fuel-filler cap may result in a fuel leak, which could result in serious burns or death in an accident.

■ **Do not continue refueling after the fuel pump nozzle shuts off automatically**

Continuing to add fuel after the fuel pump nozzle has shut off automatically is dangerous because overfilling the fuel tank may cause fuel overflow or leakage. Fuel overflow and leakage could damage the vehicle and if the fuel ignites it could cause a fire and explosion resulting in serious injury or death.

NOTICE

Always use only a genuine Toyota fuel-filler cap or an approved equivalent, available at your Toyota dealer. The wrong cap can result in a serious malfunction of the fuel and emission control systems.

It may also cause the check engine light in the combination meter to illuminate.

Refueling

Before refueling, close all the doors, windows, and the liftgate/trunk lid, and switch the ignition OFF.

- 1 To open the fuel-filler lid, pull the remote fuel-filler lid release.

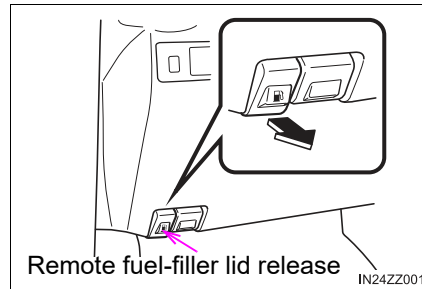

- 2 To remove the fuel-filler cap, turn it counterclockwise.
- 3 Attach the removed cap to the inner side of the fuel-filler lid.

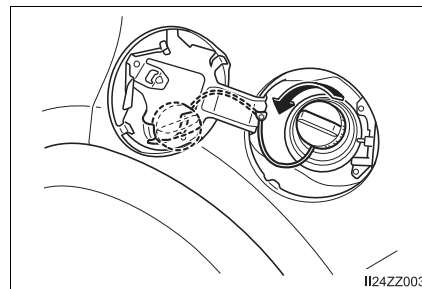

- 4 Insert the refueling nozzle all the way and begin refueling. Pull out the refueling nozzle after the refueling stops automatically.
- 5 To close the fuel-filler cap, turn it clockwise until a click is heard.
- 6 To close, press the fuel-filler lid until it locks securely.

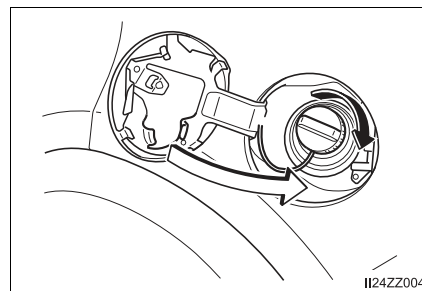

2

Before Driving

Fuel-Filler Cap**① Open**

To remove the fuel-filler cap, turn it counterclockwise. Attach the removed cap to the inner side of the fuel lid.

② Close

To close the fuel-filler cap, turn it clockwise until a click is heard.

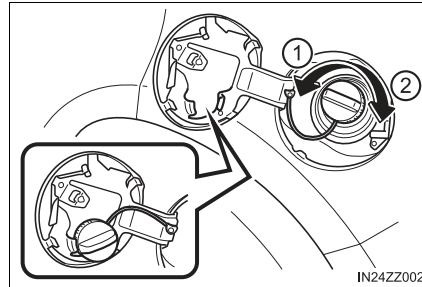
**⚠ NOTICE**

If the check fuel cap warning light illuminates, the fuel-filler cap may not be properly installed. If the warning light illuminates, park your vehicle safely off the right-of-way, remove the fuel-filler cap and reinstall it correctly. After the cap has been correctly installed, the fuel cap warning light may continue to illuminate until a number of driving cycles have been completed. A drive cycle consists of starting the engine (after four or more hours with the engine off) and driving the vehicle on city and highway roads.

Continuing to drive with the check fuel cap warning light illuminated could cause the check engine light to illuminate as well.

Steering Wheel

Steering Wheel Adjustment

To change the angle or length of the steering wheel:

- 1 Stop the vehicle, and then pull down the lock release lever under the steering column.
- 2 Tilt the steering wheel and/or adjust the steering column length to the desired positions, then push the lever up to lock the column.
- 3 Attempt to push the steering wheel up and down to make sure it's locked before driving.

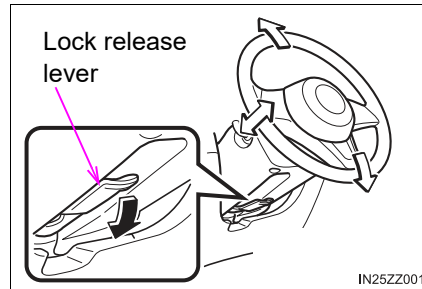

2

Before Driving

⚠ WARNING

■ **Make sure that the steering wheel is locked firmly in place**

If it is difficult to raise the lever, lightly move the steering wheel forward and back to pull up the lever.

■ **Never adjust the steering wheel while the vehicle is moving**

Adjusting the steering wheel while the vehicle is moving is dangerous. Moving it can very easily cause the driver to abruptly turn to the left or right. This can lead to loss of control or an accident.

■ **After adjusting the steering wheel position, make sure it is securely locked by trying to move it up and down**

Driving with the steering wheel not securely locked in position is dangerous. If the steering wheel moves unexpectedly while driving, you could lose control of the steering resulting in an accident.

Heated Steering Wheel (if equipped)

The grips on the left and right of the steering wheel can be warmed up.

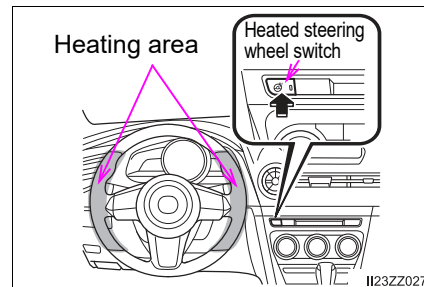

The ignition must be switched ON.

Press the switch to turn on the heated steering wheel. The heated steering wheel operates for about 30 minutes and then turns off automatically.

The indicator light illuminates when the heater is operating.

To turn off the heated steering wheel before the 30 minutes has elapsed, press the switch again.

WARNING

■ **The following types of persons should be careful not to touch the steering wheel. Otherwise, it could cause a low-temperature burn.**

- Infants, small children, elderly people, and physically challenged people
- People with delicate skin
- People who are excessively fatigued
- People who are intoxicated
- People who have taken sleep-inducing medicine such as sleeping pills or cold medicine

Horn

To sound the horn, press the  mark on the steering wheel.

Mirrors

Before driving, adjust the inside and outside mirrors.

Outside Mirrors

■ Mirror type

- ▶ Flat type (driver's side)

Flat surface mirror.

- ▶ Convex type (front passenger side)

The mirror has single curvature on its surface.

■ Power mirror adjustment

The ignition must be switched to ACC or ON position.

To adjust:

- 1 Rotate the mirror switch to the left L or right R to choose the left or right side mirror.
- 2 Press the mirror switch in the appropriate direction.

After adjusting the mirror, lock the control by rotating the switch in the center position.

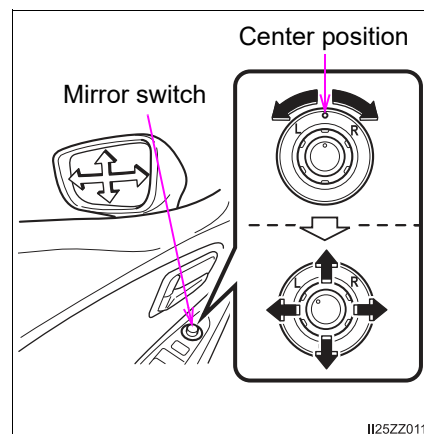

■ Folding mirror

Fold the outside mirror rearward until it is flush with the vehicle.

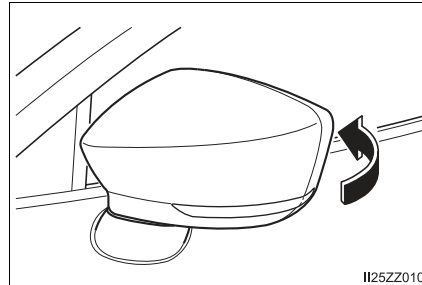

⚠ WARNING

■ Be sure to look over your shoulder before changing lanes

Changing lanes without taking into account the actual distance of the vehicle in the convex mirror is dangerous. You could have a serious accident. What you see in the convex mirror is closer than it appears.

■ Always return the outside mirrors to the driving position before you start driving

Driving with the outside mirrors folded in is dangerous. Your rear view will be restricted, and you could have an accident.

Rearview Mirror

■ Rearview mirror adjustment

Before driving, adjust the rearview mirror to center on the scene through the rear window.

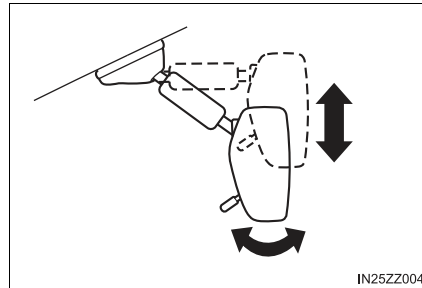

■ Reducing glare from headlights

Adjust the mirror with the day/night lever in the day position.

Push the day/night lever forward for day driving. Pull it back to reduce glare of headlights from vehicles at the rear.

- ① Day
- ② Night

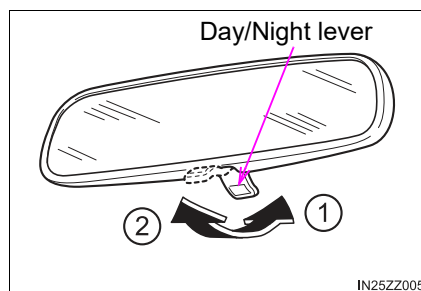

⚠ WARNING

■ Do not stack cargo or objects higher than the seatbacks

Cargo stacked higher than the seatbacks is dangerous. It can block your view in the rearview mirror, which might cause you to hit another car when changing lanes.

■ Caution while driving

Do not adjust the position of the mirror while driving. Doing so may lead to mishandling of the vehicle and cause an accident, resulting in death or serious injury.

Power Windows

The windows can be opened/closed by operating the power window switches.

When driving with only one of the rear windows open, your ears might experience a resonating sound. However, this does not indicate a problem. The sound can be reduced by slightly opening a front window or by changing the size of the rear window opening.

WARNING

■ **Make sure the opening is clear before closing a window**

Closing a power window is dangerous. A person's hands, head, or even neck could be caught by the window and result in serious injury or even death. This warning applies especially to children.

■ **Never allow children to play with power window switches**

Power window switches that are not locked with the power window lock switch would allow children to operate power windows unintentionally, which could result in serious injury if a child's hands, head or neck becomes caught by the window.

■ **Make sure nothing blocks the window just before it reaches the fully closed position or while holding up the power window switch**

Blocking the power window just before it reaches the fully closed position or while holding up the power window switch is dangerous.

In this case, the jam-safe function cannot prevent the window from closing all the way. If fingers are caught, serious injuries could occur.

Opening/Closing Windows

The window opens while the switch is pressed and it closes while the switch is pulled up with the ignition switched ON. Do not open or close three or more windows at the same time.

The front passenger's side and rear windows can be opened/closed when the power window lock switch on the driver's door is in the unlock position. Keep this switch in the locked position while children are in the vehicle.

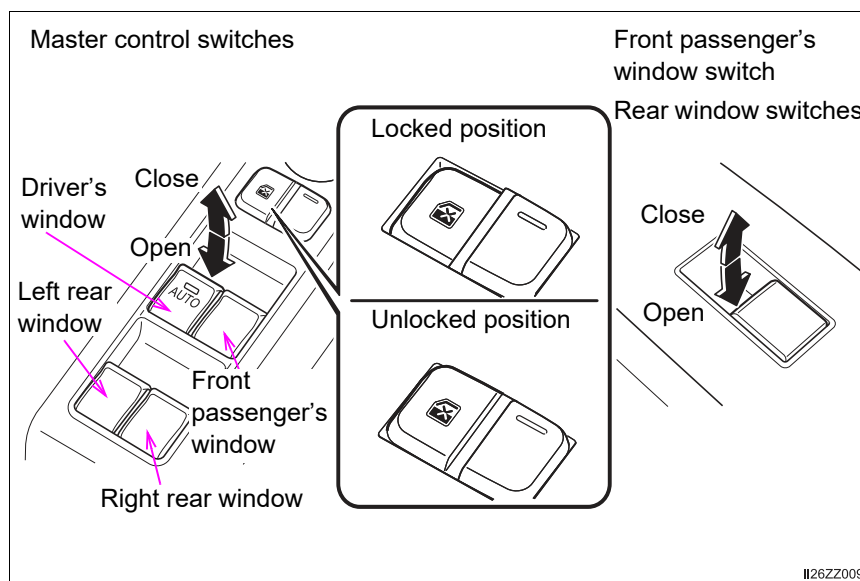

2

Before Driving

■ Opening/Closing windows

- A power window may no longer open/close if you continue to press the switch after fully opening/closing the power window. If the power window does not open/close, wait a moment and then operate the switch again.
- The passenger windows may be opened or closed using the master control switches on the driver's door.
- The power window can be operated for about 40 seconds after the ignition is switched from ON to ACC or off with all doors closed. If any door is opened, the power window will stop operating. For engine-off operation of the power window, the switch must be held up firmly throughout window closure because the auto-closing function will be inoperable.

Auto-opening/closing

To fully open the window automatically, press the switch completely down, then release. The window will fully open automatically.

To fully close the window automatically, pull the switch completely up, then release. The window will fully close automatically.

To stop the window partway, pull or press the switch in the opposite direction and then release it.

This function is only equipped on the driver's side.

Power window system initialization procedure

If the battery was disconnected during vehicle maintenance, or for other reasons (such as a switch continues to be operated after the window is fully open/closed), the window will not fully open and close automatically.

The power window auto function will only resume on a power window that has been reset.

- 1 Switch the ignition ON.
- 2 Make sure that the power window lock switch located on the driver's door is not depressed.
- 3 Press the switch and fully open the window.
- 4 Pull up the switch to fully close the window and continue holding the switch for about 2 seconds after the window fully closed.
- 5 Make sure that the power windows operate correctly using the door switches.

Jam-safe window

If foreign matter is detected between the window and the window frame while the window is closing automatically, the window stops closing and automatically opens partway.

■ Jam-safe window

- The jam-safe function may operate under the following conditions
 - A strong impact is detected while the window is closing automatically.
 - Window is closing automatically in very low temperatures.
- In the event the jam-safe function activates and the power window cannot be closed automatically, pull and hold the switch and the window will close.
- The jam-safe window function does not operate until the system has been reset.

Modification and Add-On Equipment

Toyota cannot guarantee the immobilizer and the theft deterrent systems' operation if the system has been modified or if any add-on equipment has been installed.

 NOTICE

To avoid damage to the vehicle, do not modify the system or install any add-on equipment to the immobilizer and the theft deterrent systems or the vehicle.

2

Before Driving

Immobilizer System

The immobilizer system allows the engine to start only with a key the system recognizes.

If someone attempts to start the engine with an unrecognized key, the engine will not start, thereby helping to prevent vehicle theft.

If you have a problem with the immobilizer system or the key, consult your Toyota dealer.

- The keys carry a unique electronic code. For this reason, and to assure your safety, obtaining a replacement key requires some waiting time. They are only available through your Toyota dealer.
- Always keep a spare key in case one is lost. If a key is lost, consult your Toyota dealer as soon as possible.
- If you lose a key, your Toyota dealer will reset the electronic codes of your remaining keys and immobilizer system. Bring all the remaining keys to your Toyota dealer to reset.
Starting the vehicle with a key that has not been reset is not possible.

 NOTICE

- Radio equipment like this is governed by laws in the United States. Changes or modifications not expressly approved by the party responsible for compliance could void the user's authority to operate the equipment.
- To avoid damage to the key, do not:
 - Drop the key.
 - Get the key wet.
 - Expose the key to any kind of magnetic field.
 - Expose the key to high temperatures on places such as the dashboard or hood, under direct sunlight.
- If the engine does not start with the correct key, and the security indicator light keeps illuminating or flashing, the system may have a malfunction. Consult your Toyota dealer.

Operation

■ Arming

The system is armed when the ignition is switched from ON to off.

The security indicator light in the combination meter flashes every 2 seconds until the system is disarmed.

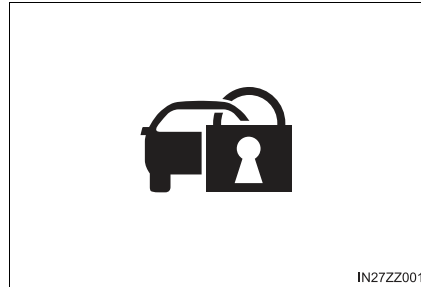

■ Disarming

The system is disarmed when the ignition is switched ON with the correct programmed key. The security indicator light illuminates for about 3 seconds and then turns off. If the engine does not start with the correct key, and the security indicator light remains illuminated or flashing, try the following:

Make sure the key is within the operational range for signal transmission. Switch the ignition off, and then restart the engine. If the engine does not start after 3 or more tries, contact your Toyota dealer.

- The engine may not start and security indicator light may illuminate or flash if the key is placed in an area where it is difficult for the system to detect the signal, such as on the dashboard or in the glove compartment. Move the key to a location within the signal range, switch the ignition off, and then restart the engine.
- Signals from a TV or radio station, or from a transceiver or mobile telephone could interfere with your immobilizer system. If you are using the proper key and the engine fails to start, check the security indicator light.
- If the security indicator light flashes continuously while you are driving, do not shut off the engine. Go to your Toyota dealer and have it checked. If the engine is shut off while the indicator light is flashing, you will not be able to restart it.
- Because the electronic codes are reset when the immobilizer system is repaired, the keys are needed. Make sure to bring all the keys to your Toyota dealer so that they can be programmed.

Theft Deterrent System*

If the theft deterrent system detects an inappropriate entry into the vehicle, which could result in the vehicle or its contents being stolen, the alarm alerts the surrounding area of an abnormality by sounding the horn and flashing the hazard warning lights.

The system will not function unless it's properly armed. So when you leave the vehicle, follow the arming procedure correctly.

Operation

■ System triggering conditions

The horn sounds intermittently and the hazard warning lights flash for about 30 seconds when the system is triggered by any one of the following:

- Unlocking a door with the auxiliary key, door lock switch, or an inside door-lock knob.
- Forcing open a door, the hood or the liftgate/trunk lid.
- Opening the hood by operating the hood release handle.
- Switching the ignition ON without using the push button start.

If the system is triggered again, the lights and horn will activate until the driver's door or the liftgate/trunk lid is unlocked with the smart key.

With the advanced keyless function:

The lights and horn can also be deactivated by pressing the request switch on a door.

-
- The liftgate/trunk lid does not open while the theft deterrent system is operating.
 - If the battery goes dead while the theft deterrent system is armed, the horn will activate and the hazard warning lights will flash when the battery is charged or replaced.

*: If equipped

How to Arm the System

- 1 Close the windows securely.
- 2 Switch the ignition OFF.
- 3 Make sure the hood, the doors, and the liftgate/trunk lid are closed.
- 4 Press the lock button on the smart key or lock the driver's door from the outside with the auxiliary key.

The hazard warning lights will flash once.

The following method will also arm the theft deterrent system:

Press the door-lock switch “” while any door is open and then close all of the doors.

With the advanced keyless function:

Press a request switch.

The security indicator light in the instrument panel flashes twice per second for 20 seconds.

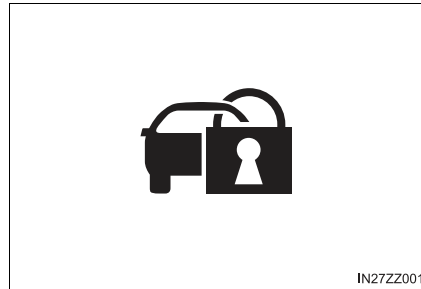

- 5 After 20 seconds, the system is fully armed.

- The theft deterrent system can also be armed by activating the auto relock function with all the doors, the liftgate/trunk lid and the hood closed. Refer to Smart Key on P. 93.
- The system will disarm if one of the following operations takes place within 20 seconds after pressing the lock button:
 - Unlocking any door.
 - Opening any door.
 - Opening the hood.
 - Switching the ignition ON.
 To rearm the system, do the arming procedure again.
- When the doors are locked by pressing the lock button on the smart key or using the auxiliary key while the theft deterrent system is armed, the hazard warning lights will flash once to indicate that the system is armed.

To Turn Off an Armed System

An armed system can be turned off using any one of the following methods:

- Pressing the unlock button on the smart key.
- Starting the engine with the push button start.
- With the advanced keyless function:

Pressing a request switch on the doors.

The hazard warning lights will flash twice.

When the doors are unlocked by pressing the unlock button on the smart key while the theft deterrent system is turned off, the hazard warning lights will flash twice to indicate that the system is turned off.

To Stop the Alarm

A triggered alarm can be turned off using any one of the following methods:

- Pressing the unlock button or the trunk button (4-door) on the smart key.
- Starting the engine with the push button start.
- With the advanced keyless function:

Pressing a request switch on the doors.

The hazard warning lights will flash twice.

Break-In Period

No special break-in is necessary, but a few precautions in the first 600 miles (1,000 km) may add to the performance, economy, and life of the vehicle.

- Do not race the engine.
- Do not maintain one constant speed, either slow or fast, for a long period of time.
- Do not drive constantly at full-throttle or high engine rpm for extended periods of time.
- Avoid unnecessary hard stops.
- Avoid full-throttle starts.

Saving Fuel and Protection of the Environment

How you operate your Toyota determines how far it will travel on a tank of fuel. Use these suggestions to help save fuel and reduce CO₂.

- Avoid long warm-ups. Once the engine runs smoothly, begin driving.
- Avoid fast starts.
- Drive at lower speeds.
- Anticipate when to apply the brakes (avoid sudden braking).
- Follow the maintenance schedule and have your Toyota dealer perform inspections and servicing.
- Use the air conditioner only when necessary.
- Slow down on rough roads.
- Keep the tires properly inflated.
- Do not carry unnecessary weight.
- Do not rest your foot on the brake pedal while driving.
- Keep the wheels in correct alignment.
- Keep windows closed at high speeds.
- Slow down when driving in crosswinds and headwinds.

WARNING

■ **Never stop the engine when going down a hill**

Stopping the engine when going down a hill is dangerous. This causes the loss of power steering and power brake control, and may cause damage to the drivetrain. Any loss of steering or braking control could cause an accident.

Hazardous Driving

When driving on ice or in water, snow, mud, sand, or similar hazards:

- Be cautious and allow extra distance for braking.
- Avoid sudden braking and sudden maneuvering.
- Do not pump the brakes. Continue to press down on the brake pedal. Refer to Antilock Brake System (ABS) on P. 215.
- If you get stuck, select a lower gear and accelerate slowly. Do not spin the front wheels.
- For more traction in starting on slippery surfaces such as ice or packed snow, use sand, rock salt, chains, carpeting, or other non-slip material under the front wheels.

Use snow chains only on the front wheels.

WARNING

■ Be extremely careful if it is necessary to downshift on slippery surfaces

Downshifting into lower gear while driving on slippery surfaces is dangerous. The sudden change in tire speed could cause the tires to skid. This could lead to loss of vehicle control and an accident.

Floor Mat

Use only floor mats designed specifically for vehicles of the same model and model year as your vehicle.

When setting a floor mat, position the floor mat so that its grommets are inserted over the pointed end of the retention posts.

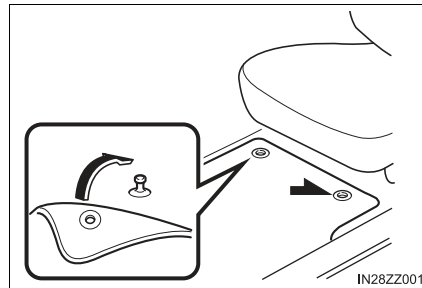

⚠ WARNING

■ **Make sure the floor mats are hooked on the retention pins to prevent them from bunching up under the foot pedals**

Using a floor mat that is not secured is dangerous as it will interfere with the accelerator and brake pedal operation, which could result in an accident.

■ **Do not install two floor mats, one on top of the other, on the driver's side**

Installing two floor mats, one on top of the other, on the driver's side is dangerous as the retention pins can only keep one floor mat from sliding forward.

If using an all weather mat for winter use always remove the original floor mat.

Loose floor mat(s) will interfere with the foot pedal and could result in an accident.

Rocking the Vehicle

If you must rock the vehicle to free it from snow, sand or mud, depress the accelerator slightly and slowly move the shift lever from 1 (D) to R position.

 **WARNING**

■ **Do not spin the wheels at more than 35 mph (56 km/h), and do not allow anyone to stand behind a wheel when pushing the vehicle**

When the vehicle is stuck, spinning the wheels at high speed is dangerous. The spinning tire could overheat and explode. This could cause serious injuries.

 **NOTICE**

Too much rocking may cause engine overheating, transaxle failure, and tire damage.

2

Before Driving

Winter Driving

Carry emergency gear, including tire chains, window scraper, flares, a small shovel, jumper cables, and a small bag of sand or salt.

Ask your Toyota dealer to check the following:

- Have the proper ratio of antifreeze in the radiator.
Refer to Engine Coolant on P. 398.
- Inspect the battery and its cables. Cold reduces battery capacity.
- Use an engine oil appropriate for the lowest ambient temperatures that the vehicle will be driven in (→P. 395).
- Inspect the ignition system for damage and loose connections.
- Use washer fluid made with antifreeze—but do not use engine coolant antifreeze for washer fluid (→P. 402).

-
- Do not use the parking brake in freezing weather as it may freeze. Instead, shift to 1 or R with a manual transaxle and to P with an automatic transaxle. Block the rear wheels.
 - Remove snow before driving. Snow left on the windshield is dangerous as it could obstruct vision.
 - Do not apply excessive force to a window scraper when removing ice or frozen snow on the mirror glass and windshield.
 - Never use warm or hot water for removing snow or ice from windows and mirrors as it could result in the glass cracking.
 - Drive slowly. Braking performance can be adversely affected if snow or ice adheres to the brake components. If this situation occurs, drive the vehicle slowly, releasing the accelerator pedal and lightly applying the brakes several times until the brake performance returns to normal.

Snow Tires

■ Use snow tires on all four wheels

Do not go faster than 75 mph (120 km/h) while driving with snow tires. Inflate snow tires 30 kPa (0.3 kgf/cm², 4.3 psi) more than recommended on the tire pressure label (driver's door frame), but never more than the maximum cold-tire pressure shown on the tires.

The vehicle is originally equipped with all season radials designed to be used all year around. In some extreme climates you may find it necessary to replace them with snow tires during the winter months to further improve traction on snow and ice covered roads.

WARNING

■ Use only the same size and type tires (snow, radial, or non-radial) on all four wheels

Using tires different in size or type is dangerous. Your vehicle's handling could be greatly affected and result in an accident.

NOTICE

Check local regulations before using studded tires.

Tire Chains

Check local regulations before using tire chains.

Install the chains on the front tires only.

Do not use chains on the rear tires.

Please consult your Toyota dealer.

■ Installing the chains

- 1 If your vehicle is equipped with wheel covers remove them, otherwise the chain bands will scratch them.
- 2 Secure the chains on the front tires as tightly as possible. Always follow the chain manufacturer's instructions.
- 3 Retighten the chains after driving 1/4—1/2 mile (1/2—1 km).

If your vehicle is equipped with the tire pressure monitoring system, the system may not function correctly when using tire chains.

 **WARNING**

■ **Driving with tire chains**

- Chains may affect handling.
- Do not go faster than 30 mph (50 km/h) or the chain manufacturer's recommended limit, whichever is lower.
- Drive carefully and avoid bumps, holes, and sharp turns.
- Avoid locked-wheel braking.

 **NOTICE**

- Do not use chains on a temporary spare tire; it may result in damage to the vehicle and to the tire.
- Do not use chains on roads that are free of snow or ice. The tires and chains could be damaged.
- Chains may scratch or chip aluminum wheels.

Driving In Flooded Area

 **WARNING**

■ **Dry off brakes that have become wet by driving slowly, releasing the accelerator pedal and lightly applying the brakes several times until the brake performance returns to normal**

Driving with wet brakes is dangerous. Increased stopping distance or the vehicle pulling to one side when braking could result in a serious accident. Light braking will indicate whether the brakes have been affected.

 **NOTICE**

Do not drive the vehicle on flooded roads as it could cause short circuiting of electrical/electronic parts, or engine damage or stalling from water absorption. If the vehicle has been immersed in water, consult your Toyota dealer.

2

Before Driving

Overloading

 **WARNING**

■ **Be careful not to overload your vehicle**

The gross axle weight rating (GAWR) and the gross vehicle weight rating (GVWR) of the vehicle are on the Motor Vehicle Safety Standard Label on the driver's door frame. Exceeding these ratings can cause an accident or vehicle damage. You can estimate the weight of the load by weighing the items (or people) before putting them in the vehicle.

Driving on Uneven Road

Your vehicle's suspension and underbody can be damaged if driven on rough/uneven roads or over speed bumps at excessive speeds. Use care and reduce speed when traveling on rough/uneven roads or over speed bumps.

Use care not to damage the vehicle's underbody, bumpers or muffler(s) when driving under the following conditions:

- Ascending or descending a slope with a sharp transition angle
- Ascending or descending a driveway or trailer ramp with a sharp transition angle

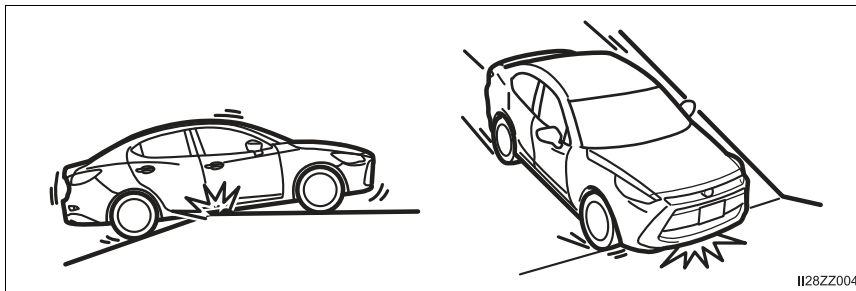

 **NOTICE**

This vehicle is equipped with low profile tires allowing class-leading performance and handling. As a result, the sidewall of the tires are very thin and the tires and wheels can be damaged if driven through potholes or on rough/uneven roads at excessive speeds. Use care and reduce speed when traveling on rough/uneven roads or through potholes.

2
Before Driving

Trailer Towing

Your Toyota is not designed for towing. Never tow a trailer with your Toyota.

Recreational Towing

An example of “recreational towing” is towing your vehicle behind a motorhome.

The transaxle is not designed for towing this vehicle on all 4 wheels.

When doing recreational towing refer to “Towing Description” (→P. 486) and “Tiedown Hooks” (→P. 487) and carefully follow the instructions.

2

Before Driving

When Driving

3

3-1. Start/Stop Engine		3-5. Brake	
Ignition Switch.....	156	Brake System.....	209
Starting the Engine	158	Hill Launch Assist (HLA) ...	213
Turning the Engine Off.....	163	3-6. ABS/TCS/DSC	
3-2. Combination Meter and Display		Antilock Brake System (ABS)	215
Meters and Gauges	164	Traction Control System (TCS)	216
Warning/Indicator Lights	173	Dynamic Stability Control (DSC).....	218
3-3. Transaxle		3-7. Fuel Economy Monitor	
Manual Transaxle Operation	177	Fuel Economy Monitor	221
Automatic Transaxle Controls.....	181	3-8. Drive Selection	
3-4. Switches and Controls		Drive Selection (Automatic Transaxle).....	224
Lighting Control.....	192	3-9. Power Steering	
Fog Lights	198	Power Steering	226
Turn and Lane-Change Signals	199	3-10. Active Safety System	
Windshield Wipers and Washer.....	201	Active Safety System	227
Rear Window Wiper and Washer.....	206	Low Speed Pre-Collision System	228
Rear Window Defogger	207	Laser Sensor.....	234
Hazard Warning Flasher	208	3-11. Cruise Control	
		Cruise Control	236
		3-12. Tire Pressure Monitoring System	
		Tire Pressure Monitoring System	241
		3-13. Rear View Monitor	
		Rear View Monitor	245

Ignition Switch

Push Button Start Positions

The system operates only when the driver is in the vehicle or within operational range while the key is being carried.

Each time the push button start is pressed, the ignition switches in the order of off, ACC, and ON. Pressing the push button start again from ON switches the ignition off.

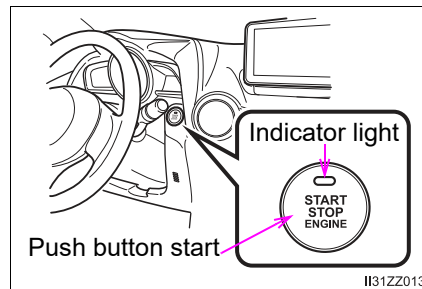

■ Off

The power supply to electrical devices turns off and the push button start indicator light (amber) also turns off.

In this position the steering wheel is locked.

■ ACC (Accessory)

Some electrical accessories will operate and the indicator light (amber) illuminates.

■ ON

This is the normal running position after the engine is started. The indicator light (amber) turns off. (The indicator light (amber) illuminates when the ignition is switched ON and the engine is not running.)

Some indicator lights/warning lights should be inspected before the engine is started (→P. 173).

■ Push Button Start Positions

- The engine starts by pressing the push button start while depressing the clutch pedal (manual transaxle) or the brake pedal (automatic transaxle). To switch the ignition position, press the push button start without depressing the pedal.
- Do not leave the ignition switched ON while the engine is not running. Doing so could result in the battery going dead. If the ignition is left in ACC (For automatic transaxle, the selector lever is in the P position, and the ignition is in ACC), the ignition switches off automatically after about 25 minutes.

■ ACC (Accessory)

The keyless entry system does not function while the push button start has been pressed to ACC, and the doors will not lock/unlock even if they have been locked manually.

■ ON

When the push button start is pressed to ON, the sound of the fuel pump motor operating near the fuel tank can be heard. This does not indicate an abnormality.

**WARNING**

- **Before leaving the driver's seat, set the parking brake, make sure the selector lever is in 1st gear or R (manual transaxle) or in P (automatic transaxle), and always switch the ignition off**

Leaving the driver's seat without setting the parking brake, shifting the selector lever to 1st gear or R (manual transaxle) or to P (automatic transaxle), and switching the ignition off is dangerous. Unexpected vehicle movement could occur which could result in an accident.

In addition, if your intention is to leave the vehicle for even a short period, it is important to switch the ignition off, as leaving it in another position will disable some of the vehicle's security systems and run the battery down.

Starting the Engine

- 1 Make sure you are carrying the key.
- 2 Occupants should fasten their seat belts.
- 3 Make sure the parking brake is on.
- 4 Continue to press the brake pedal firmly until the engine has completely started.
- 5 Manual transaxle:
Continue to press the clutch pedal firmly until the engine has completely started.

The starter will not operate if the clutch pedal is not depressed sufficiently.

Automatic transaxle:

Put the vehicle in park (P). If you must restart the engine while the vehicle is moving, shift into neutral (N).

The starter will not operate if the selector lever is not in P or N and the brake pedal is not depressed sufficiently.

- 6 Verify that the KEY indicator light (green) in the combination meter and the push button start indicator light (green) illuminate.

If the push button start indicator light (green) flashes, make sure that the key is being carried.

If the push button start indicator light (green) flashes with the key being carried, touch the key to the push button start and start the engine. Refer to Engine Start Function When Key Battery is Dead on P. 161.

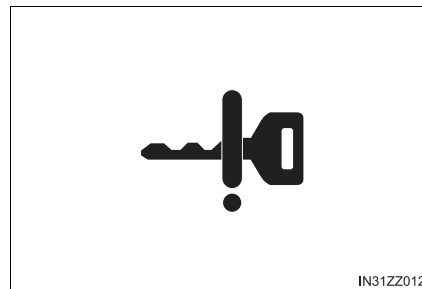

IN31ZZ012

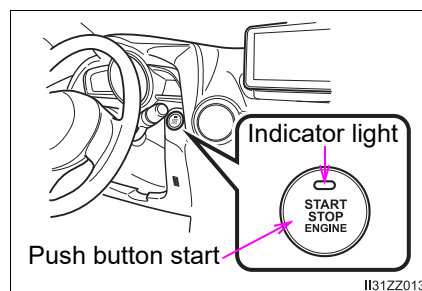

II31ZZ013

- 7 Press the push button start after both the KEY indicator light (green) in the combination meter and the push button start indicator light (green) illuminate.

After starting the engine, the push button start indicator light (amber) turns off and the ignition switches to the ON position.

8 After starting the engine, let it idle for about ten seconds.

- The key must be carried because the key carries an immobilizer chip that must communicate with the engine controls at short range.
- The engine can be started when the push button start is pressed from off, ACC, or ON.
- The push button start system functions (function which can start the engine by only carrying the key) can be deactivated to prevent any possible adverse effect on a user wearing a pacemaker or other medical device. If the system is deactivated, you will be unable to start the engine by carrying the key. Consult your Toyota dealer for details. If the push button start system functions have been deactivated, you can start the engine by following the procedure indicated when the key battery goes dead. Refer to Engine Start Function When Key Battery is Dead on P. 161.
- After starting a cold engine, the engine speed increases and a whining sound from the engine compartment can be heard. This is for improved exhaust gas purification and does not indicate defect of the parts.
- Engine-starting is controlled by the spark ignition system. This system meets all Canadian Interference-Causing Equipment Standard requirements regulating the impulse electrical field strength of radio noise.
- Under the following conditions, the KEY warning light (red) flashes after the push button start is pressed to inform the driver that the push button start will not switch to ACC even if it is pressed from off.
 - The key battery is dead.
 - The key is out of operational range.
 - The key is placed in areas where it is difficult for the system to detect the signal (→P. 98).
 - A key from another manufacturer similar to the key is in the operational range.

- **Forced engine starting method:**
If the KEY warning light (red) illuminates, or the push button start indicator light (amber) flashes, this could indicate that the engine may not start using the usual starting method. Have your vehicle inspected at your Toyota dealer as soon as possible. If this occurs, the engine can be force-started. Press and hold the push button start until the engine starts. Other procedures necessary for starting the engine such as having the key in the cabin, and depressing the clutch pedal (manual transaxle) or the brake pedal (automatic transaxle) are required.
- When the engine is force-started, the KEY warning light (red) remains illuminated and the push button start indicator light (amber) remains flashing.
- **Automatic transaxle:**
When the selector lever is in the neutral (N) position, the KEY indicator light (green) and the push button start indicator light (green) do not illuminate.
- After pressing the push button start and before the engine starts, the operation sound of the fuel pump motor from near the fuel tank can be heard, however, this does not indicate a malfunction.
- Whether the engine is cold or warm, it should be started without the use of the accelerator.
- If the engine does not start the first time, refer to Starting a Flooded Engine under Emergency Starting. If the engine still does not start, have your vehicle inspected by your Toyota dealer (→P. 482).

 **WARNING** **Radio waves from the key may affect medical devices such as pacemakers**

Before using the key near people who use medical devices, ask the medical device manufacturer or your physician if radio waves from the key will affect the device.

 **NOTICE**

If the KEY warning light (red) illuminates, or the push button start indicator light (amber) flashes, this could indicate a problem with the engine starting system and the inability to start the engine or switch the ignition to ACC or ON. Have your vehicle inspected at your Toyota dealer as soon as possible.

Engine Start Function When Key Battery is Dead

If the engine cannot be started due to a dead key battery, the engine can be started using the following procedure:

- 1 Continue to depress the brake pedal firmly until the engine has completely started.
- 2 Manual transaxle:
Continue to depress the clutch pedal firmly until the engine has completely started.
- 3 Make sure that the push button start indication light (green) flashes.

The push button start indicator light (green) will flash even if the push button start is pressed before depressing the clutch pedal (manual transaxle) or the brake pedal (automatic transaxle). If the clutch pedal is depressed (manual transaxle) or the brake pedal is depressed (automatic transaxle) under this condition, the engine can be started by resuming the procedure following this.

- 4 Touch the push button start using the backside of the key (as shown) while the push button start indicator light (green) flashes.

When touching the push button start using the backside of the key as shown in the illustration, touch the push button start with the lock switch side of the key facing up.

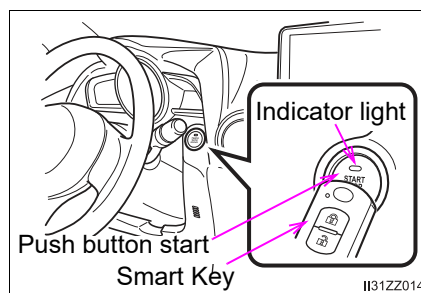

- 5 Make sure that the push button start indicator light (green) turns on.
- 6 Press the push button start to start the engine.

- The engine cannot be started unless the clutch pedal is fully depressed (manual transaxle) or the brake pedal is fully depressed (automatic transaxle).
- If there is a malfunction with the push button start function, the push button start indicator light (amber) flashes. In this case, the engine may start, however, have the vehicle checked at your Toyota dealer as soon as possible.
- If the push button start indicator light (green) does not illuminate, perform the operation from the beginning again. If it does not illuminate, have the vehicle checked at your Toyota dealer.
- To switch the ignition position without starting the engine, perform the following operations after the push button start indicator light (green) turns on.
 - 1 Release the clutch pedal (manual transaxle) or brake pedal (automatic transaxle).

- 2 Press the push button start to switch the ignition position. The ignition switches in the order of ACC, ON, and off each time the push button start is pressed. To switch the ignition position again, perform the operation from the beginning.

 NOTICE

When starting the engine by holding the smart key over the push button start due to a dead key battery or a malfunctioning key, be careful not to allow the following, otherwise the signal from the key will not be received correctly and the engine may not start.

- Metal parts of other keys or metal objects touch the key.

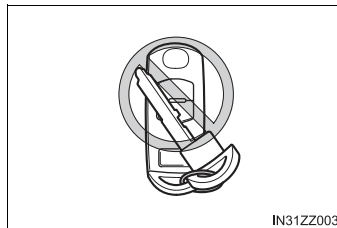

- Spare keys or keys for other vehicles equipped with an immobilizer system touch or come near the key.

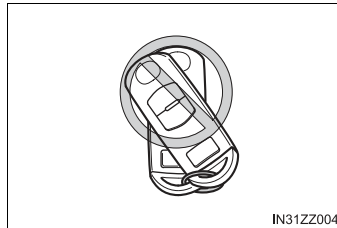

- Devices for electronic purchases, or security passage touch or come near the key.

Emergency Operation for Starting the Engine

If the KEY warning light (red) illuminates, or the push button start indicator light (amber) flashes, this could indicate that the engine may not start using the usual starting method. Have your vehicle inspected at your Toyota dealer as soon as possible. If this occurs, the engine can be force-started. Press and hold the push button start until the engine starts. Other procedures necessary for starting the engine such as having the key in the cabin, and depressing the clutch pedal (manual transaxle) or the brake pedal (automatic transaxle) are required.

Turning the Engine Off

- 1 Stop the vehicle completely.
- 2 Manual transaxle:
Shift into neutral and set the parking brake.
Automatic transaxle:
Shift the selector lever to the P position and set the parking brake.
- 3 Press the push button start to turn off the engine. The ignition position is off.

- The cooling fan in the engine compartment could turn on for a few minutes after the ignition is switched from ON to OFF, whether or not the A/C is on or off, to cool the engine compartment quickly.
- When the push button start is pressed from ON to ACC or OFF, the KEY indicator light (green) may flash for approximately 30 seconds indicating that the remaining battery power of the key is low.
Replace with a new battery before the key becomes unusable.
Refer to Key Battery Replacement on P. 410.
- Automatic transaxle:
If the engine is turned off while the selector lever is in a position other than P, the ignition switches to ACC.

WARNING

Do not stop the engine while the vehicle is moving

Stopping the engine while the vehicle is moving for any reason other than in an emergency is dangerous. Stopping the engine while the vehicle is moving will result in reduced braking ability due to the loss of power braking, which could cause an accident and serious injury.

NOTICE

When leaving the vehicle, make sure the push button start is off.

Emergency Engine Stop

Continuously pressing the push button start or quickly pressing it two or more times while the engine is running or the vehicle is being driven will turn the engine off immediately. The ignition switches to ACC.

Meters and Gauges

◆ Combination meter

- ① Speedometer (→P. 164)
- ② Dashboard Illumination (→P. 169)
- ③ Odometer, Trip Meter and Trip Meter Selector (→P. 165)
- ④ Fuel Gauge (→P. 168)
- ⑤ Outside Temperature Display (→P. 170)
- ⑥ Tachometer (→P. 167)

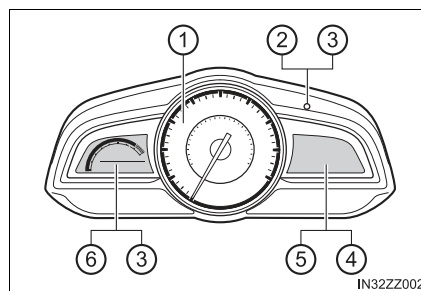

◆ Steering Switch (if equipped)

- ① Trip Computer and INFO Switch (→P. 171)

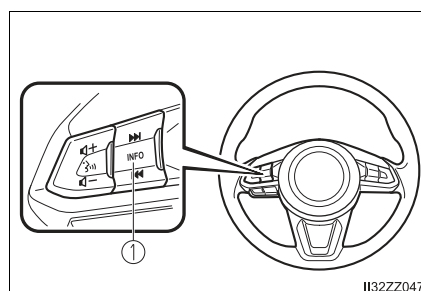

Speedometer

The speedometer indicates the speed of the vehicle.

If a few seconds have elapsed after switching the ignition off, the needle may deviate. However, this does not indicate a problem.

Odometer, Trip Meter and Trip Meter Selector

The display mode can be changed from odometer to trip meter A to trip meter B and then back to odometer by pressing the selector while one of them is displayed. The selected mode will be displayed.

- ① Odometer
- ② Trip meter A
- ③ Trip meter B

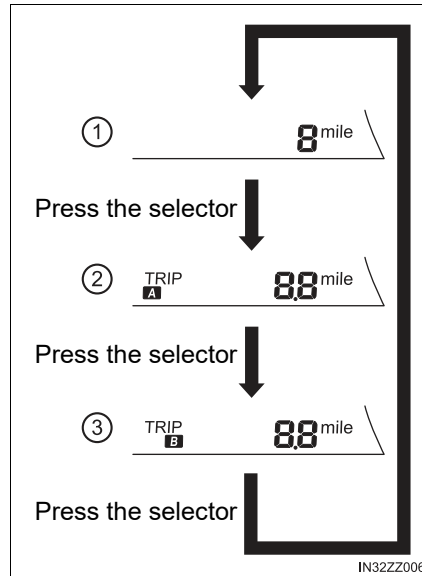

3

When Driving

■ Odometer

The odometer records the total distance the vehicle has been driven.

■ Trip meter

The trip meter can record the total distance of two trips. One is recorded in trip meter A, and the other is recorded in trip meter B.

For instance, trip meter A can record the distance from the point of origin, and trip meter B can record the distance from where the fuel tank is filled.

When trip meter A is selected, pressing the selector again within one second will change to trip meter B mode.

When trip meter A is selected, TRIP A will be displayed. When trip meter B is selected, TRIP B will be displayed.

The trip meter records the total distance the vehicle is driven until the meter is again reset. Return it to "0.0" by depressing and holding the selector for one second or more. Use this meter to measure trip distances and to compute fuel consumption.

■ Odometer, Trip Meter and Trip Meter Selector

When the ignition is switched to ACC or off, the odometer or trip meters cannot be displayed, however, pressing the selector can inadvertently switch the trip meters or reset them during an approximate ten-minute period in the following cases:

- After the ignition is switched to off from ON.
- After the driver's door is opened.

■ Trip meter

- If TRIP A is reset using the trip meter when the function which synchronizes (resets) the fuel economy monitor and the trip meter (TRIP A) is on, the fuel economy data resets in conjunction with TRIP A. Refer to Fuel Economy Monitor on P. 221.
- Only the trip meters record tenths of miles (kilometers).
- The trip record will be erased when:
 - The power supply is interrupted (blown fuse or the battery is disconnected).
 - The vehicle is driven over 9999.9 mile (km).

Tachometer

The tachometer shows engine speed in thousands of revolutions per minute (rpm).

- ① Striped zone*1
- ② Red zone*1

*1: The range varies depending on the type of gauge.

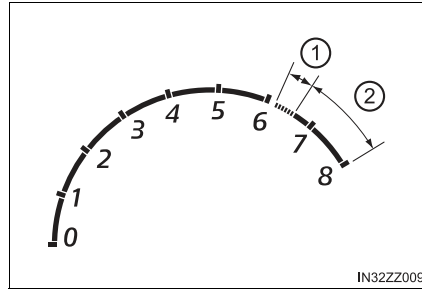

When the tachometer needle enters the STRIPED ZONE, this indicates to the driver that the gears should be shifted before entering the RED ZONE.

 NOTICE

Do not run the engine with the tachometer needle in the RED ZONE. This may cause severe engine damage.

Fuel Gauge

The fuel gauge shows approximately how much fuel is remaining in the tank when the ignition is switched ON. We recommend keeping the tank over 1/4 full.

- ① Full
- ② 1/4 Full
- ③ Empty

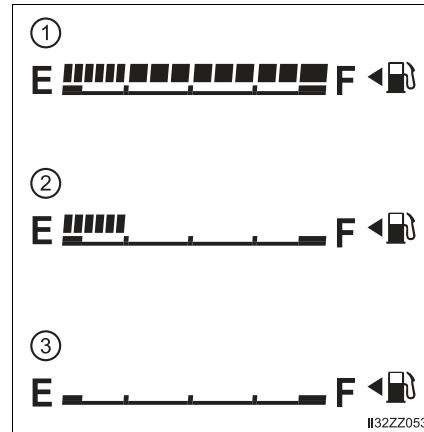

If the low fuel warning light illuminates or the fuel level is very low, refuel as soon as possible.

If inconsistency in engine performance or stalling occurs due to low fuel level conditions, refuel the vehicle as soon as possible and add at least 10 L (2.7 US gal, 2.2 Imp gal) of fuel.

Refer to Warning/Indicator Lights on P. 173.

- After refueling, it may require some time for the indicator to stabilize. In addition, the indicator may deviate while driving on a slope or curve since the fuel moves in the tank.
- The display indicating a quarter or less remaining fuel has more segments to show the remaining fuel level in greater detail.
- The direction of the arrow (←) indicates that the fuel-filler lid is on the left side of the vehicle.

Dashboard Illumination

When the position lights are turned on with the ignition switched ON, the brightness of the instrument panel illumination is dimmed.

When the position lights are turned on, the position lights indicator light in the combination meter turns on.

Refer to Headlights on P. 192.

The brightness of the instrument panel and dashboard illuminations can be adjusted by rotating the knob.

① Dim

The brightness decreases by rotating the knob to the left. A beep sound will be heard when the knob has been rotated to the maximum dim position.

② Bright

The brightness increases by rotating the knob to the right.

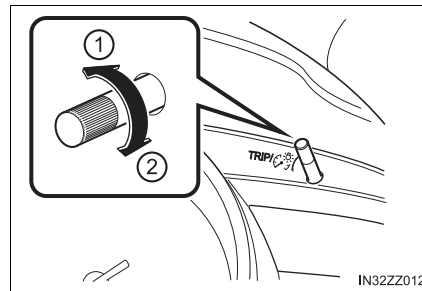

■ Function for cancelling illumination dimmer

The illumination dimmer can be canceled by rotating the dashboard illumination knob to the right until a beep sound is heard while the combination meter is dimmed with the ignition switched ON. If the combination meter's visibility is reduced due to glare from surrounding brightness, cancel the illumination dimmer.

- When the illumination dimmer is canceled, the combination meter cannot be dimmed even if the position lights are turned on.
- When the illumination dimmer is canceled, the screen in the center display switches to constant display of the daytime screen.

Outside Temperature Display

When the ignition is switched ON, the outside temperature is displayed.

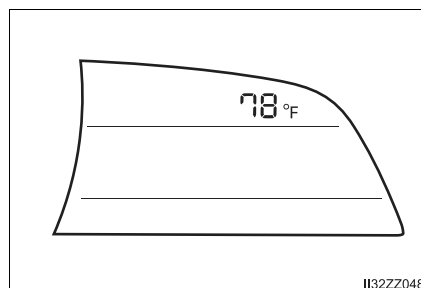

■ Changing the Temperature Unit of the Outside Temperature Display

The outside temperature unit can be switched between Celsius and Fahrenheit. Settings can be changed by operating the center display screen.

Refer to Customizable Features on P. 555.

- Under the following conditions, the outside temperature display may differ from the actual outside temperature depending on the surroundings and vehicle conditions:
 - Significantly cold or hot temperatures.
 - Sudden changes in outside temperature.
 - The vehicle is parked.
 - The vehicle is driven at low speeds.
- When the temperature unit indicated in the outside temperature display is changed, the temperature unit indicated in the engine coolant gauge display changes in conjunction with it.

Trip Computer and INFO Switch

The following information can be selected by pressing the INFO switch with the ignition switched ON.

- Distance-to-empty mode
- Average fuel economy mode
- Current fuel economy mode
- Average vehicle speed

If you have any problems with your trip computer, consult your Toyota dealer.

■ Distance-to-empty mode



This mode displays the approximate distance you can travel on the remaining fuel based on the fuel economy.

The distance-to-empty will be calculated and displayed every second.

■ Average fuel economy mode

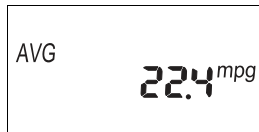

This mode displays the average fuel economy by calculating the total traveled distance and the total fuel consumption since the vehicle was purchased or the past data was reset.

The average fuel economy is calculated and displayed every minute.

To clear the data being displayed, press the INFO switch for more than 1.5 seconds or longer.

After resetting the data, - - - mpg (- - - L/100 km) is displayed for one minute before the fuel economy is recalculated and displayed.

■ Current fuel economy mode

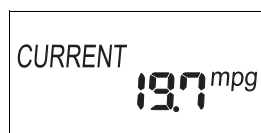

This mode displays the current fuel economy by calculating the amount of fuel consumption and the distance traveled.

Current fuel economy will be calculated and displayed every 2 seconds.

When you've slowed to about 3 mph (5 km/h), - - - mpg (- - - L/100 km) will be displayed.

■ Average vehicle speed mode



This mode displays the average vehicle speed by calculating the distance and the time traveled since connecting the battery or resetting the data.

Average vehicle speed will be calculated and displayed every 10 seconds.

To clear the data being displayed, press the INFO button for more than 1.5 seconds.

After pressing the INFO button, - - - mph (- - - km/h) will be displayed for about 1 minute before the vehicle speed is recalculated and displayed.

■ Distance-to-empty mode

- Even though the distance-to-empty display may indicate a sufficient amount of remaining driving distance before refueling is required, refuel as soon as possible if the fuel level is very low or the low fuel warning light illuminates.
- The display may not change unless you add more than approximately 2.3 gal. (9 L, 1.9 Imp.gal.) of fuel.
- The distance-to-empty is the approximate remaining distance the vehicle can be driven until all the graduation marks in the fuel gauge (indicating the remaining fuel supply) disappear.
- If there is no past fuel economy information such as after first purchasing your vehicle or the information is deleted when the battery cables are disconnected, the actual distance-to empty/range may differ from the amount indicated.

■ Average fuel economy mode

If TRIP A is reset using the trip meter when the function which synchronizes (resets) the fuel economy monitor and the trip meter (TRIP A) is on, the displayed past data is reset.

Warning/Indicator Lights

Combination Meter



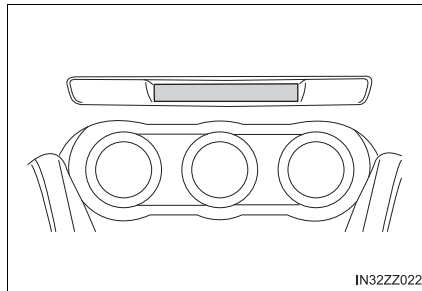
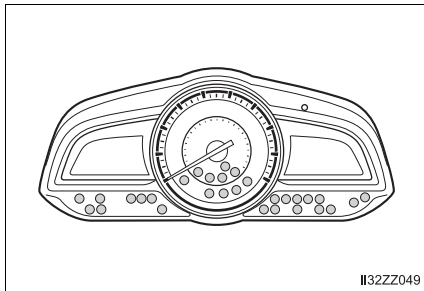







- ▶ Analog Speedometer Type ▶ Center of Dashboard (With Tachometer)











Warning/Indicator lights will appear in any of the highlighted areas

Warning Lights

These lights turn on or flash to notify the user of the system operation status or a system malfunction.

- | | |
|--|--|
| <p>^{*1}
 Master Warning Light (→P. 489)</p> | <p>^{*1}
 Check Engine Light (→P. 489)</p> |
| <p>^{*1, 2}
 Brake System Warning Light (→P. 489)</p> | <p>^{*1}
 High Engine Coolant Temperature Warning Light (→P. 489)
(Red)</p> |
| <p>^{*1}
 ABS Warning Light (→P. 489)</p> | <p>^{*1}
 Automatic Transaxle Warning Light (→P. 489)
(If equipped)</p> |
| <p>^{*1}
 Charging System Warning Light (→P. 489)</p> | <p>^{*1}
 Power Steering Malfunction Indicator Light (→P. 489)</p> |
| <p>^{*1}
 Engine Oil Warning Light (→P. 489)</p> | <p>^{*1}
 Air Bag/Front Seat Belt Pretensioner System Warning Light (→P. 489)</p> |

3
When Driving







*1  (If equipped)	LED Headlight Warning Light (→P. 489)	*1  (If equipped)	Low Washer Fluid Level Warning Light (→P. 489)
	Low Fuel Warning Light (→P. 489)	*1  (If equipped)	Tire Pressure Monitoring System Warning Light (→P. 489)
*1 	Check Fuel Cap Warning Light (→P. 489)	*1  (Red)	KEY Warning Light (→P. 489)
 PASS	Seat Belt Warning Light (Front seat) (→P. 489)	*1  (Amber)	Low Speed Pre-Collision System Warning Light (→P. 489)
	Door-Ajar Warning Light (→P. 489)		









*1: The light turns on when the ignition is switched on for an operation check, and turns off a few seconds later or when the engine is started. If the light does not turn on or remains turned on, have the vehicle inspected at your Toyota dealer.

*2: The light turns on continuously when the parking brake is applied.

Indicator Lights

These lights turn on or flash to notify the user of the system operation status or a system malfunction.

 (Green)	KEY Indicator Light (→P. 158)	*1  OFF	DSC OFF Indicator Light (→P. 219)
*1  (If equipped)	Wrench Indicator Light (→P. 175)	 (Red)	Low Speed Pre-Collision System Indicator Light (→P. 232)
*1 	TCS/DSC Indicator Light (→P. 217, 219)	*1  OFF	Low Speed Pre-Collision System OFF Indicator Light (→P. 233)

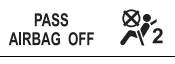
 (Blue)	Low Engine Coolant Temperature Indicator Light (→P. 176)	 (If equipped)	Cruise Main Indication (→P. 237)
 (If equipped)	Shift Position Indication (→P. 182)	 (If equipped)	Cruise Set Indication/Indicator Light (→P. 237)
	Headlight High-Beam Indicator Light (→P. 196, 196)	 (If equipped)	Select Mode Indicator Light (→P. 225)
	Turn Signal/Hazard Warning Indicator Lights (→P. 199, 208)		Lights-On Indicator Light (→P. 192)
 *1	Security Indicator Light (→P. 137)	 *1	Front Passenger Air Bag Deactivation Indicator Light (→P. 82)

*1: The light turns on when the ignition is switched on for an operation check, and turns off a few seconds later or when the engine is started. If the light does not turn on or remains turned on, have the vehicle inspected at your Toyota dealer.

3

When Driving

Wrench Indicator Light

When the ignition is switched ON, the wrench indicator light is illuminated and then turns off after a few seconds.

The wrench indicator light is illuminated when the preset maintenance period arrives. Verify the content and perform maintenance.

Refer to Maintenance Monitor on P. 388.

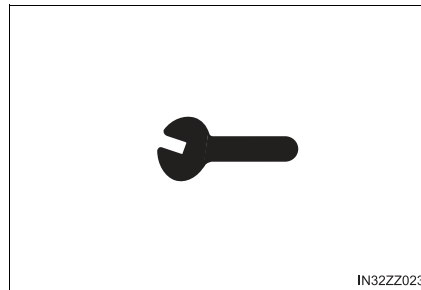

IN32ZZ023

Low Engine Coolant Temperature Indicator Light (Blue)

The light illuminates continuously when the engine coolant temperature is low and turns off after the engine is warm.

If the low engine coolant temperature indicator light remains illuminated after the engine has been sufficiently warmed up, the temperature sensor could have a malfunction. Consult your Toyota dealer.



IN32Z024

Manual Transaxle Operation

Manual Transaxle Shift Pattern

The shift pattern of the transaxle is conventional, as shown.

Depress the clutch pedal all the way down while shifting; then release it slowly.

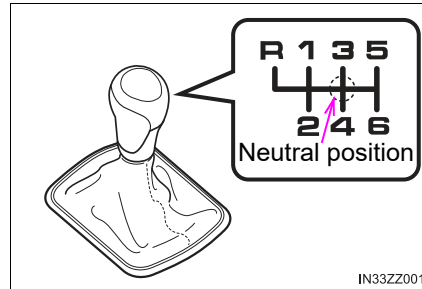

Your vehicle is equipped with a device to prevent shifting to R (reverse) by mistake. Push the shift lever downward and shift to R.

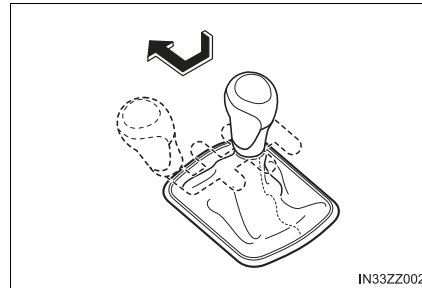

If shifting to R is difficult, shift back into neutral, release the clutch pedal, and try again.

WARNING

■ **Do not use sudden engine braking on slippery road surfaces or at high speeds**

Shifting down while driving on wet, snowy, or frozen roads, or while driving at high speeds causes sudden engine braking, which is dangerous. The sudden change in tire speed could cause the tires to skid. This could lead to loss of vehicle control and an accident.

■ **Always leave the shift lever in 1 or R position and set the parking brake when leaving the vehicle unattended**

Otherwise the vehicle could move and cause an accident.

 NOTICE

- Keep your foot off the clutch pedal except when shifting gears. Also, do not use the clutch to hold the vehicle on an upgrade. Riding the clutch will cause needless clutch wear and damage.
- Do not apply any excessive lateral force to the shift lever when changing from 5th to 4th gear. This could lead to the accidental selection of 2nd gear, which could result in damage to the transaxle.
- Make sure the vehicle comes to a complete stop before shifting to R. Shifting to R while the vehicle is still moving may damage the transaxle.

Gear Shift Indicator

The gear shift indicator supports you to obtain optimum fuel economy and smooth driving. It displays the selected gear position in the combination meter as well as notifies the driver to change to the most suitable gear position corresponding to the actual driving condition.

- ① Selected gear position
- ② Suitable gear position

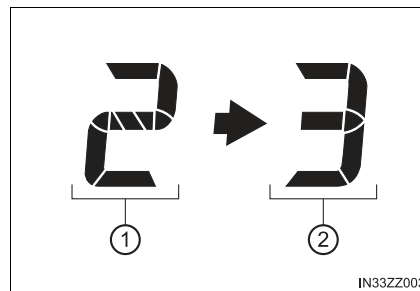

Indication	Condition
Numeral	The selected gear position is displayed.
 and numeral	Shift up or down to the indicated gear position is recommended.

The gear shift indicator turns off when the following operations are performed.

- The vehicle is stopped.
- The vehicle is put in neutral.
- The vehicle is driven in reverse.
- The clutch is not fully engaged when accelerating from a stop.
- The clutch pedal remains depressed for 2 seconds or longer while driving.

⚠ WARNING

Do not rely solely on the shift-up/shift-down recommendations by indications. The actual driving situation might require shift operations different from indication. To avoid the risk of accidents, the road and traffic conditions have to be judged correctly by the driver before shifting.

Recommendations for Shifting**■ Upshifting**

For normal acceleration, Toyota recommends these shift points:

Gear	Vehicle speed
1 to 2	17 mph (27 km/h)
2 to 3	27 mph (43 km/h)
3 to 4	37 mph (60 km/h)
4 to 5	47 mph (76 km/h)
5 to 6	55 mph (89 km/h)

For cruising, Toyota recommends these shift points:

Gear	Vehicle speed
1 to 2	11 mph (18 km/h)
2 to 3	19 mph (30 km/h)
3 to 4	30 mph (48 km/h)
4 to 5	39 mph (63 km/h)
5 to 6	51 mph (82 km/h)

■ **Downshifting**

When you must slow down in heavy traffic or on a steep upgrade, downshift before the engine starts to overwork. This reduces the chance of stalling and gives better acceleration when you need more speed.

On a steep downgrade, downshifting helps maintain safe speed and prolongs brake life.

Automatic Transaxle Controls

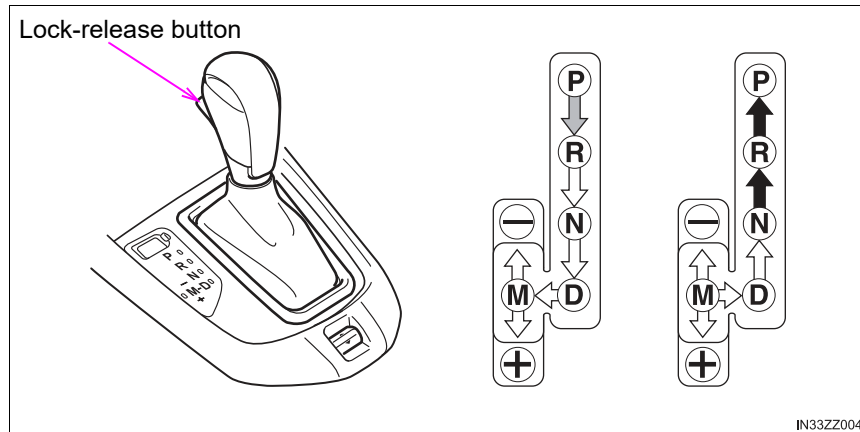

Various Lockouts:

- ➔ Indicates that you must depress the brake pedal and hold in the lock-release button to shift (The ignition must be switched ON).
- ➞ Indicates the selector lever can be shifted freely into any position.
- ➡ Indicates that you must hold in the lock-release button to shift.

The Sport AT has an option that is not included in the traditional automatic transaxle that gives the driver the option of selecting each gear instead of leaving it to the transaxle to shift gears. Even if you intend to use the automatic transaxle functions as a traditional automatic, you should also be aware that you can inadvertently shift into manual shift mode and an inappropriate gear may be retained as the vehicle speed increases. If you notice the engine speed going higher or hear the engine racing, confirm you have not accidentally slipped into manual shift mode (→P. 185).

Shift Position Indication

The selector position is indicated when the ignition is switched ON.

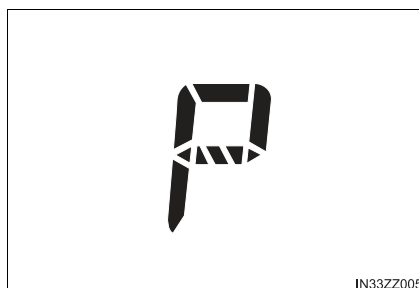

■ Gear position indication

In manual shift mode, the “M” of the shift position indication illuminates and the numeral for the selected gear is displayed.

Warning Light

The warning light turns on when the system has a malfunction. Refer to Warning Lights on P. 173.

Transaxle Ranges

- The shift position indicator light in the combination meter illuminates. Refer to Warning/Indicator Lights on P. 173.
- The selector lever must be in P or N to operate the starter.

■ P (Park)

P locks the transaxle and prevents the front wheels from rotating.

■ R (Reverse)

In position R, the vehicle moves only backward. You must be at a complete stop before shifting to or from R, except under rare circumstances as explained in Rocking the Vehicle (→P. 145).

■ N (Neutral)

In N, the wheels and transaxle are not locked. The vehicle will roll freely even on the slightest incline unless the parking brake or brakes are on.

Apply the parking brake or depress the brake pedal before moving the selector lever from N to prevent the vehicle from moving unexpectedly.

■ D (Drive)

D is the normal driving position. From a stop, the transaxle will automatically shift through a 6-gearsequence.

■ M (Manual)

M is the manual shift mode position. Gears can be shifted up or down by operating the selector lever. Refer to Manual Shift Mode on P. 185.

⚠ WARNING**■ Always set the selector lever to P and set the parking brake when parking**

Only setting the selector lever to the P position without using the parking brake to hold the vehicle is dangerous. If P fails to hold, the vehicle could move and cause an accident.

■ If the engine is running faster than idle, do not shift from N or P into a driving gear

It's dangerous to shift from N or P into a driving gear when the engine is running faster than idle. If this is done, the vehicle could move suddenly, causing an accident or serious injury.

■ Do not shift into N when driving the vehicle

Shifting into N while driving is dangerous. Engine braking cannot be applied when decelerating which could lead to an accident or serious injury.

⚠ NOTICE

- Shifting into P, N or R while the vehicle is moving can damage your transaxle.
- Shifting into a driving gear or reverse when the engine is running faster than idle can damage the transaxle.
- Do not shift into N when driving the vehicle. Doing so can cause transaxle damage.

Active Adaptive Shift (AAS)

Active Adaptive Shift (AAS) automatically controls the transaxle shift points to best suit the road conditions and driver input. This improves driving feel. The transaxle may switch to AAS mode when driving up and down slopes, cornering, driving at high elevations, or depressing the accelerator pedal quickly while the selector lever is in the D position. Depending on the road and driving conditions/vehicle operations, gear shifting could be delayed or not occur, however, this does not indicate a problem because the AAS mode will maintain the optimum gear position.

Shift-Lock System

The shift-lock system prevents shifting out of P unless the brake pedal is depressed.

To shift from P:

- 1 Depress and hold the brake pedal.
- 2 Start the engine.
- 3 Press and hold the lock-release button.
- 4 Move the selector lever.

-
- When the ignition is switched to ACC or the ignition is switched off, the selector lever cannot be shifted from P.
 - The ignition cannot be switched to OFF if the selector lever is not in P.

Shift-Lock Override

If the selector lever will not move from P using the proper shift procedure, continue to hold down the brake pedal.

- 1 Remove the shift-lock override cover using a cloth-wrapped flat head screwdriver.
- 2 Insert a screwdriver and push it down.
- 3 Press and hold the lock-release button.

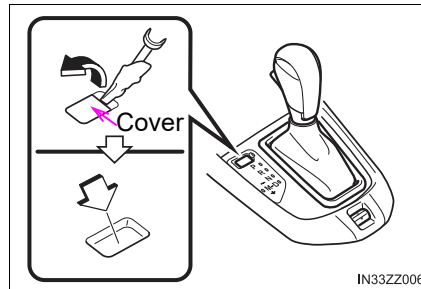

- 4 Move the selector lever.
- 5 Take the vehicle to your Toyota dealer to have the system checked.

Manual Shift Mode

The manual shift mode gives you the feel of driving a manual transaxle vehicle by allowing you to operate the selector lever manually. This allows you to control engine rpm and torque to the drive wheels much like a manual transaxle when more control is desired.

To change to manual shift mode, shift the lever from D to M.

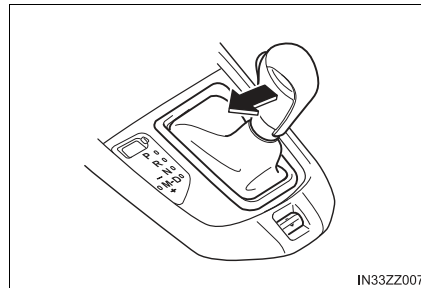

To return to automatic shift mode, shift the lever from M to D.

■ Indicators

- ① Manual shift mode indication
In manual shift mode, the “M” of the shift position indication in the instrument panel illuminates.
- ② Gear position indication
The numeral for the selected gear illuminates.

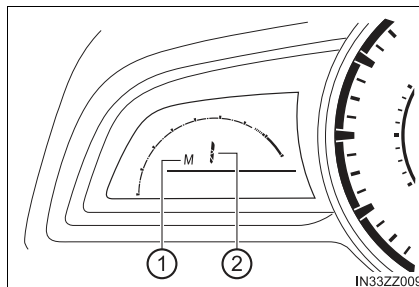

■ Manually shifting up

You can shift gears up by operating the shift lever.

M1 → M2 → M3 → M4 → M5 → M6

To shift up to a higher gear, tap the shift lever back + once.

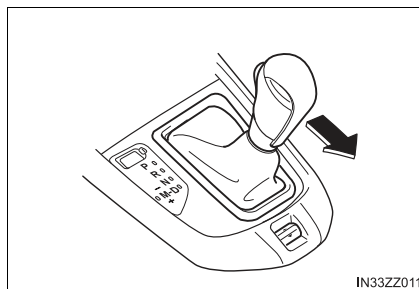

Manually shifting down

You can shift gears down by operating the shift lever.

M6 → M5 → M4 → M3 → M2 → M1

To shift down to a lower gear, tap the selector lever forward – once.

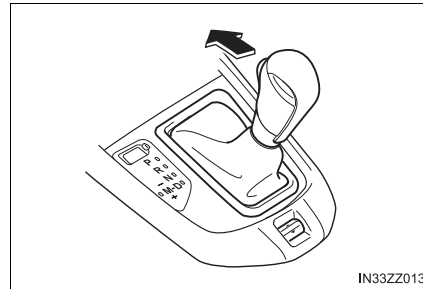
**Second gear fixed mode**

When the selector lever is moved back + while the vehicle speed is about 6.2 mph (10 km/h) or less, the transaxle is set in the second gear fixed mode. The gear is fixed in second while in this mode for easier acceleration from a stop and driving on slippery roads such as snow-covered roads.

If the selector lever is moved back + or forward – while in the second gear fixed mode, the mode will be canceled.

■ Shift gear (shifting) speed limit

For each gear position while in the manual mode, the speed limit is set as follows: When the selector lever is operated within the range of the speed limit, the gear is shifted.

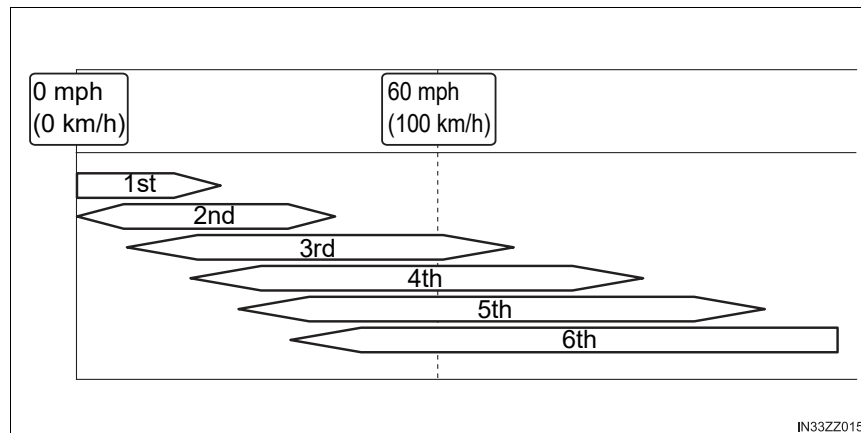

● Shift up

The gear does not shift up while the vehicle speed is lower than the speed limit.

● Shift down

The gear does not shift down while the vehicle speed exceeds the speed limit.

If the vehicle speed exceeds the speed limit and the gear does not shift down, the gear position indication flashes 2 times to notify the driver that the gear cannot be shifted.

● Kickdown

When the accelerator pedal is depressed fully while driving, the gear shifts down.

The gear also shifts down using kickdown while in the second gear fixed mode.

● Auto-shift down

The gear shifts down automatically depending on the vehicle speed during deceleration.

If the vehicle comes to a stop while in the second gear fixed mode, the gear remains in second.

■ Recommendations for shifting

● Upshifting

For normal acceleration and cruising, Toyota recommends these shift points:

Gear	Vehicle speed ^{*1}
M1 to M2	15 mph (24 km/h)
M2 to M3	25 mph (40 km/h)
M3 to M4	40 mph (65 km/h)
M4 to M5	45 mph (73 km/h)
M5 to M6	50 mph (81 km/h)

*1: Always observe local speed limit regulations.

● Downshifting

When you must slow down in heavy traffic or on a steep upgrade, downshift before the engine starts to overwork. This gives better acceleration when you need more speed.

On a steep downgrade, downshifting helps maintain safe speed and prolongs brake life.

■ Manual Shift Mode

- Changing to manual shift mode while driving will not damage the transaxle.
- If you change to manual shift mode when the vehicle is stopped, the gear will shift to M1.
- If you change to manual shift mode without depressing the accelerator pedal when driving in D range, 5th gear/6th gear, the gear will shift to M4/M5.

■ Indicators

- If the gears cannot be shifted down when driving at higher speeds, the gear position indication will flash twice to signal that the gears cannot be shifted down (to protect the transaxle).
- If the automatic transaxle fluid (ATF) temperature becomes too high, there is the possibility that the transaxle will switch to automatic shift mode, canceling manual shift mode and turning off the gear position indication illumination. This is a normal function to protect the AT. After the ATF temperature has decreased, the gear position indication illumination turns back on and driving in manual shift mode is restored.

■ Manually shifting up

- When driving slowly, the gears may not shift up.
- In manual shift mode, do not run the engine with the tachometer needle in the RED ZONE. When the engine rpm is high, a gear may shift up automatically to protect the engine.
- When depressing the accelerator fully, the transaxle will shift to a lower gear, depending on vehicle speed.

■ Manually shifting down

- When driving at high speeds, the gear may not shift down.
- During deceleration, the gear may automatically shift down depending on vehicle speed.
- When depressing the accelerator fully, the transaxle will shift to a lower gear, depending on vehicle speed.

**WARNING****■ Do not use engine braking on slippery road surfaces or at high speeds**

Shifting down while driving on wet, snowy, or frozen roads, or while driving at high speeds causes sudden engine braking, which is dangerous. The sudden change in tire speed could cause the tires to skid. This could lead to loss of vehicle control and an accident.

Driving Tips

■ Passing

For extra power when passing another vehicle or climbing steep grades, depress the accelerator fully. The transaxle will shift to a lower gear, depending on vehicle speed.

Some models:

The accelerator pedal may initially feel heavy as it is being depressed, then feel lighter as it is depressed further. This change in pedal force aids the engine control system in determining how much the accelerator pedal has been depressed for performing kickdown, and functions to control whether or not kickdown should be performed.

■ Climbing steep grades from a stop

To climb a steep grade from a stopped position:

- 1 Depress the brake pedal.
- 2 Shift to D or M1, depending on the load weight and grade steepness.
- 3 Release the brake pedal while gradually accelerating.

■ Descending steep grades

When descending a steep grade, shift to lower gears, depending on load weight and grade steepness. Descend slowly, using the brakes only occasionally to prevent them from overheating.

WARNING

■ Do not let the vehicle move in a direction opposite to the direction selected by the selector lever

Do not let the vehicle move backward with the selector lever in a forward position, or do not let the vehicle move forward with the selector lever in the reverse position. Otherwise, the engine may stop, causing the loss of the power brake and power steering functions, and make it difficult to control the vehicle which could result in an accident.

Lighting Control

Headlights

- Without auto-light control

Turn the headlight switch to turn the headlights, other exterior lights and dashboard illumination on or off.

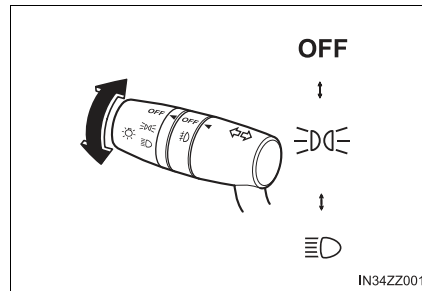

Switch Position	OFF		☰☱☲		☰☱☲☳	
	ON	ACC or OFF	ON	ACC or OFF	ON	ACC or OFF
Headlights	Off	Off	Off	Off	On	On*2
Daytime running lights	On*1	Off	On*1	Off	Off	Off
Taillights Parking lights License plate lights Side-marker lights Dashboard illumination	Off	Off	On	On*2	On	On*2

*1: The lights are turned on while the vehicle is driven.

*2: The lights are turned on for the specified period by the auto headlight off function.

● With auto-light control

Turn the headlight switch to turn the headlights, other exterior lights and dashboard illumination on or off.

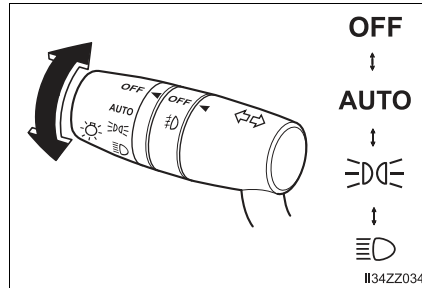

Switch Position	OFF		AUTO		☰☽☻		☰☽	
	ON	ACC or OFF	ON	ACC or OFF	ON	ACC or OFF	ON	ACC or OFF
Headlights	Off	Off	Auto*2	Auto*3	Off	Off	On	On*5
Daytime running lights	On*1	Off	On*4	Off	On*1	Off	Off	Off
Taillights Parking lights License plate lights Side-marker lights Dashboard illumination	Off	Off	Auto*2	Auto*3	On	On*5	On	On*5

- *1: The lights are turned on while the vehicle is driven.
- *2: The lights are turned on by the auto light function.
- *3: The lights are turned on continuously if the ignition is switched from ON to any other position with the lights turned on. The lights are turned on for the specified period by the auto headlight off function.
- *4: The lights are turned on while the vehicle is driven, and turned off when the headlights are turned on by the auto light function.
- *5: The lights are turned on for the specified period by the auto headlight off function.

3

When Driving

When the lights are turned on, the lights-on indicator light in the combination meter turns on.

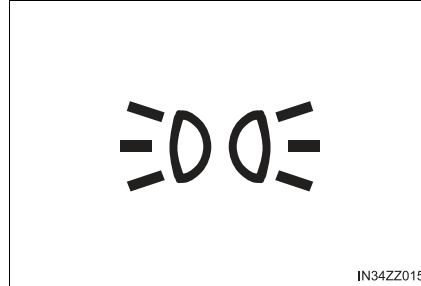

■ Auto-light control (if equipped)

When the headlight switch is in the AUTO position and the ignition is switched ON, the light sensor senses the surrounding lightness or darkness and automatically turns the headlights, other exterior lights and dashboard illumination on or off.

■ Headlights

- If the light switch is left on, the lights will automatically switch off approximately 30 seconds after switching the ignition off.
The time setting can be changed.
Refer to Customizable Features on P. 555.
- To prevent discharging the battery, do not leave the lights on while the engine is off unless safety requires them.

■ Auto-light control

- The headlights, other exterior lights and dashboard illumination may not turn off immediately even if the surrounding area becomes well-lit because the light sensor determines that it is night time if the surrounding area is continuously dark for several minutes such as inside long tunnels, traffic jams inside tunnels, or in indoor parking lots.
In this case, the lights turn off if the light switch is turned to the OFF position.
- If the headlight switch and the windshield wiper switch are in AUTO, and the wipers are operated at low or high speed by the auto wiper control for several seconds, bad weather conditions are determined and the headlights may be turned on.
- The dashboard illumination can be adjusted by rotating the knob in the instrument cluster.
Also, the day/night mode can be changed by rotating the knob until a beep sound is heard.
To adjust the brightness of the dashboard illumination:
Refer to Dashboard Illumination on P. 169.
- The sensitivity of the auto-light control may be changed.
Refer to Customizable Features on P. 555.

 NOTICE

- Do not shade the light sensor by adhering a sticker or a label on the windshield. Otherwise the light sensor will not operate correctly.

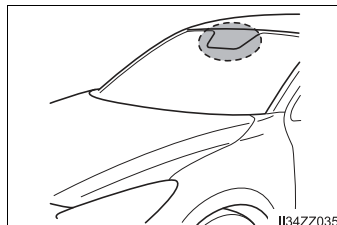

- The light sensor also works as a rain sensor for the auto-wiper control. Keep hands and scrapers clear of the windshield when the wiper lever is in the AUTO position and the ignition is switched ON as fingers could be pinched or the wipers and wiper blades could be damaged when the wipers activate automatically. If you are going to clean the windshield, be sure the wipers are turned off completely when it is particularly tempting to leave the engine running. This is particularly important when clearing ice and snow.

Headlight High-Low Beam

The headlights switch between high and low beams by moving the lever forward or backward.

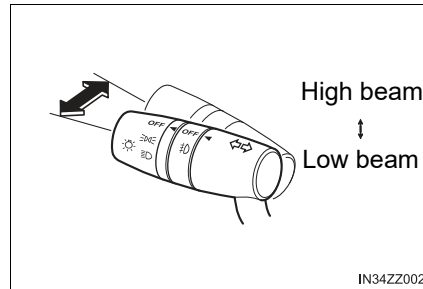

When the headlight high-beams are on, the headlight high-beam indicator light is turned on.

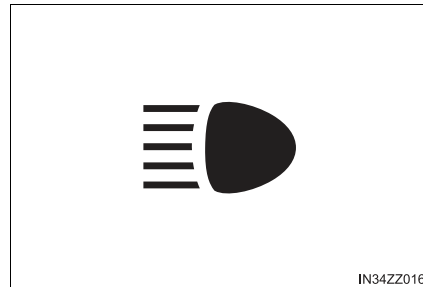

Flashing the Headlights

- ① OFF
- ② Flashing

To flash the headlights, pull the lever fully towards you (the headlight switch does not need to be on).

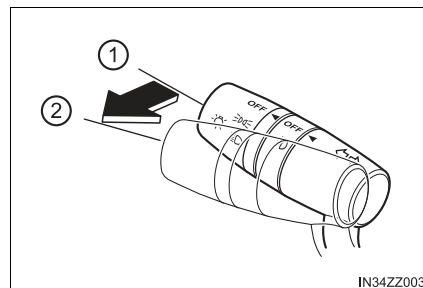

The headlight high-beam indicator light in the combination meter illuminates simultaneously. The lever will return to the normal position when released.

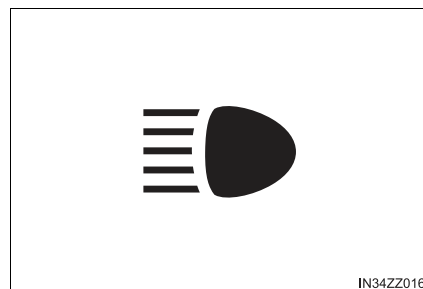

Headlight Leveling (if equipped)

The number of passengers and weight of cargo in the luggage compartment change the angle of the headlights.

The angle of the headlights will be automatically adjusted when turning on the headlights.

Daytime Running Lights

Some countries require moving vehicles to have their lights on (daytime running lights) during the daytime.

The daytime running lights turn on automatically when the vehicle starts moving.

They turn off when the parking brake is operated or the shift lever is shifted to the P position (automatic transaxle vehicle).

Except Canada:

The daytime running lights can be deactivated.

Refer to Customizable Features on P. 555.

Fog Lights*

Use this switch to turn on the fog lights. The fog lights will improve visibility at night and during foggy conditions.

The fog lights can be used when the ignition is switched ON.

The fog lights turn on when the fog light switch is turned to the  position and turn off when the switch is turned to the OFF position.

The fog lights turn on when the headlights are turned on. They will not turn on if the headlight switch is in the  position or OFF position.

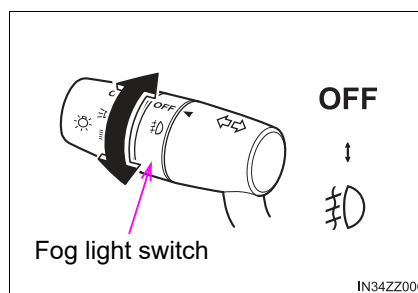

- The fog lights will turn off when the headlights are set at high beams.
- With auto-light control:
If the fog light switch is in the  position and the headlight switch is in the AUTO position, the fog lights will turn on when the headlights, the exterior lights and dashboard illumination turn on.

*: If equipped

Turn and Lane-Change Signals

The ignition must be switched ON to use the turn and lane-change signals.

Turn Signals

Move the signal lever down (for a left turn) or up (for a right turn) to the stop position. The signal will self-cancel after the turn is completed.

If the indicator light continues to flash after a turn, manually return the lever to its original position.

The turn signal indicators (green) in the combination meter flash according to the operation of the turn signal lever to show which signal is working.

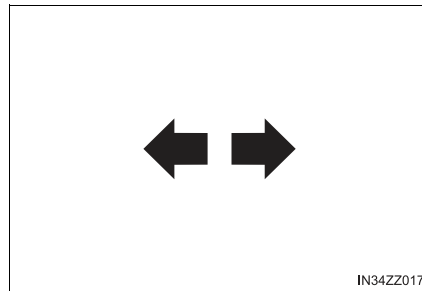
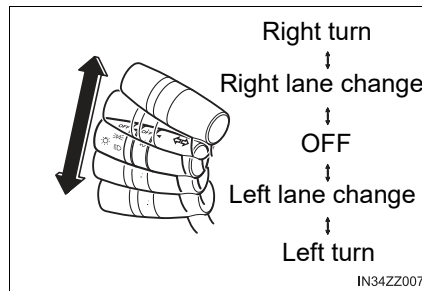

3

When Driving

- If an indicator light stays on without flashing or if it flashes abnormally, one of the turn signal bulbs may be burned out.
- A customized function is available to change the turn indicator sound volume. (→P. 555)

Lane-Change Signals

Move the lever halfway toward the direction of the lane change—until the indicator flashes—and hold it there. It will return to the off position when released.

Three-Flash Turn Signal

After releasing the turn signal lever, the turn signal indicator flashes 3 times. The operation can be cancelled by moving the lever in the direction opposite to which it was operated.

The three-flash turn signal function can be switched to operable/inoperable using the customization function.
Refer to Customizable Features on P. 555.

Windshield Wipers and Washer

The ignition must be switched ON to use the wipers.

Because heavy ice and snow can jam the wiper blades, the wiper motor is protected from motor breakdown, overheating and possible fire by a circuit breaker. This mechanism will automatically stop operation of the blades, but only for about 5 minutes.

If this happens, turn off the wiper switch and park off the right-of-way, and remove the snow and ice.

After 5 minutes, turn on the switch and the blades should operate normally. If they do not resume functioning, consult your Toyota dealer as soon as possible. Drive to the side of the road and park off the right-of-way. Wait until the weather clears before trying to drive with the wipers inoperative.

WARNING

■ **Use only windshield washer fluid or plain water in the reservoir**

Using radiator antifreeze as washer fluid is dangerous. If sprayed on the windshield, it will dirty the windshield, affect your visibility, and could result in an accident.

■ **Only use windshield washer fluid mixed with anti-freeze protection in freezing weather conditions**

Using windshield washer fluid without anti-freeze protection in freezing weather conditions is dangerous as it could freeze on the windshield and block your vision which could cause an accident. In addition, make sure the windshield is sufficiently warmed using the defroster before spraying the washer fluid.

Windshield Wipers

● With intermittent wiper

Turn the wipers on by pressing the lever up or down.

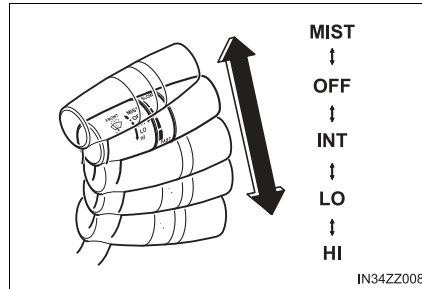

IN34ZZ008

Switch Position	Wiper operation
MIST	Operation while pulling up lever
OFF	Stop
INT	Intermittent
LO	Low speed
HI	High speed

■ Variable-speed intermittent wipers

Set the lever to the intermittent position and choose the interval timing by rotating the ring.

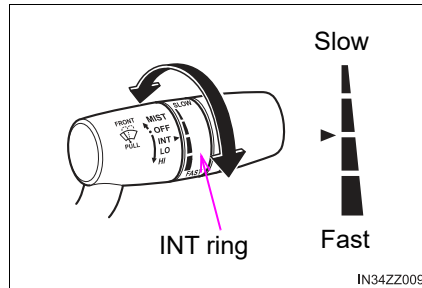

IN34ZZ009

● With auto-wiper control

Turn the wipers on by pressing the lever up or down.

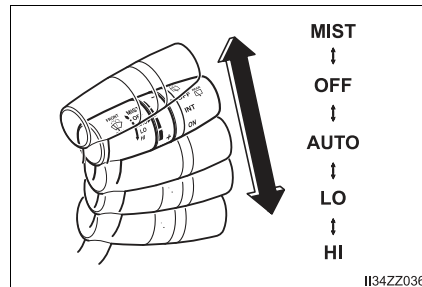

Switch Position	Wiper operation
MIST	Operation while pulling up lever
OFF	Stop
AUTO	Auto control
LO	Low speed
HI	High speed

■ Auto-wiper control (if equipped)

When the wiper lever is in the AUTO position, the rain sensor senses the amount of rainfall on the windshield and turns the wipers on or off automatically (off—intermittent—low speed—high speed).

The sensitivity of the rain sensor can be adjusted by turning the switch on the wiper lever.

From the center position (normal), rotate the switch upward for higher sensitivity (faster response) or rotate it downward for less sensitivity (slower response).

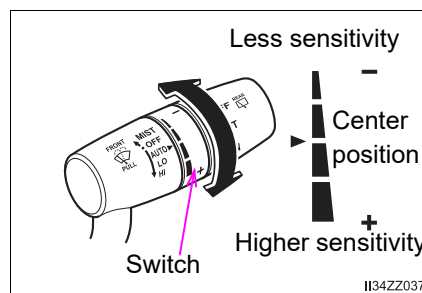

3
When Driving

- Switching the auto-wiper lever from the OFF to the AUTO position while driving activates the windshield wipers once, after which they operate according to the rainfall amount.
- The auto-wiper control may not operate when the rain sensor temperature is about $-10\text{ }^{\circ}\text{C}$ ($14\text{ }^{\circ}\text{F}$) or lower, or about $85\text{ }^{\circ}\text{C}$ ($185\text{ }^{\circ}\text{F}$) or higher.
- If the windshield is coated with water repellent, the rain sensor may not be able to sense the amount of rainfall correctly and the auto-wiper control may not operate properly.
- If dirt or foreign matter (such as ice or matter containing salt water) adheres to the windshield above the rain sensor, or if the windshield is iced, it could cause the wipers to move automatically. However, if the wipers cannot remove this ice, dirt or foreign matter, the auto-wiper control will stop operation. In this case, set the wiper lever to the low speed position or high speed position for manual operation, or remove the ice, dirt or foreign matter by hand to restore the auto-wiper operation.
- If the auto-wiper lever is left in the AUTO position, the wipers could operate automatically from the effect of strong light sources, electromagnetic waves, or infrared light because the rain sensor uses an optical sensor. It is recommended that the auto-wiper lever be switched to the OFF position other than when driving the vehicle under rainy conditions.
- The auto-wiper control functions can be turned off. Refer to Customizable Features on P. 555

 NOTICE

- Do not shade the rain sensor by adhering a sticker or a label on the windshield. Otherwise the rain sensor will not operate correctly.

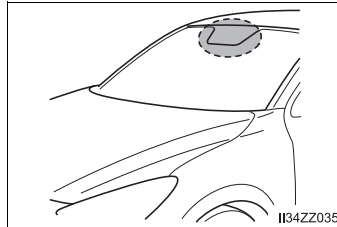

- When the wiper lever is in the AUTO position and the ignition is switched ON, the wipers may move automatically in the following cases:
 - If the windshield above the rain sensor is touched or wiped with a cloth.
 - If the windshield is struck with a hand or other object from either outside or inside the vehicle.

Keep hands and scrapers clear of the windshield when the wiper lever is in the AUTO position and the ignition is switched ON as fingers could be pinched or the wipers and wiper blades damaged when the wipers activate automatically. If you are going to clean the windshield, be sure the wipers are turned off completely (when it is most likely that the engine is left running) this is particularly important when clearing ice and snow.

Windshield Washer

- ① OFF
- ② Washer

Pull the lever toward you and hold it to spray washer fluid.

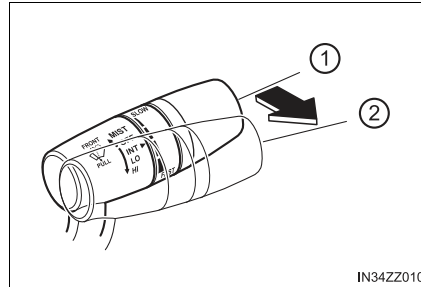

If the washer does not work, inspect the fluid level (→P. 402). If the fluid level is normal, consult your Toyota dealer.

With the wiper lever in the OFF or INT position/AUTO position, the wipers will operate continuously until the lever is released.

Rear Window Wiper and Washer*

The ignition must be switched ON to use the wiper.

Rear Window Wiper

Turn the wiper on by turning the rear wiper/washer switch.

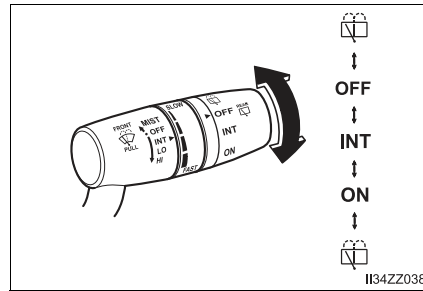

Switch Position	Wiper operation
OFF	Stop
INT	Intermittent
ON	Normal

Rear Window Washer

To spray washer fluid, turn the rear wiper/washer switch to either of the  position. After the switch is removed, the washer will stop.

If the washer does not work, inspect the fluid level (→P. 402). If the fluid level is normal and the washer still does not work, consult your Toyota dealer.

*: If equipped

Rear Window Defogger

The rear window defogger clears fog from the rear window.

The ignition must be switched ON to use the defogger.

Press the switch to turn on the rear window defogger. The rear window defogger operates for about 15 minutes and then turns off automatically.

The indicator light illuminates when the defogger is operating.

To turn off the rear window defogger before the 15 minutes has elapsed, press the switch again.

▶ Manual Climate Control

▶ Fully Automatic Climate Control

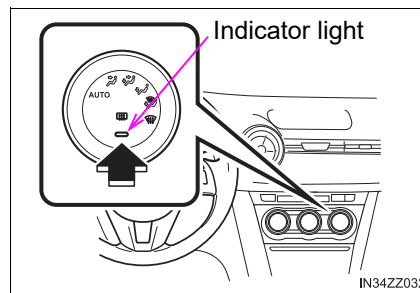
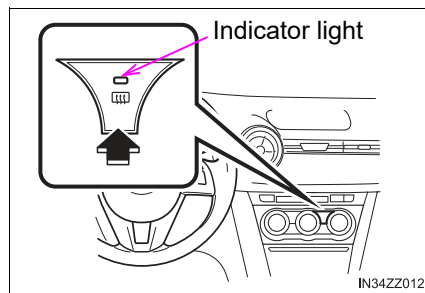

This defogger is not designed for melting snow. If there is an accumulation of snow on the rear window, remove it before using the defogger.

NOTICE

Do not use sharp instruments or window cleaners with abrasives to clean the inside of the rear window surface. They may damage the defogger grid inside the window.

Mirror Defogger (if equipped)

To turn on the mirror defoggers, switch the ignition ON and press the rear window defogger switch (→P. 207).

Hazard Warning Flasher

The hazard warning lights should always be used when you stop on or near a roadway in an emergency.

The hazard warning lights warn other drivers that your vehicle is a traffic hazard and that they must take extreme caution when near it.

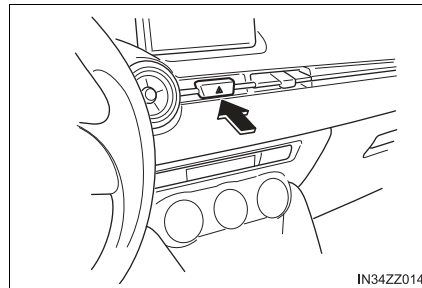

Depress the hazard warning flasher and all the turn signals will flash. The hazard warning indicator lights in the combination meter flash simultaneously.

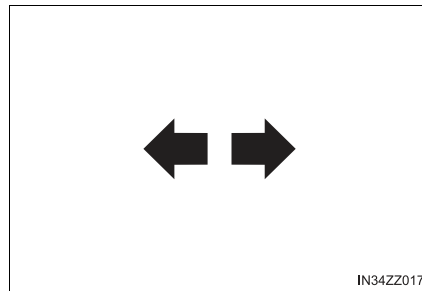

- The turn signals do not work when the hazard warning lights are on.
- Check local regulations about the use of hazard warning lights while the vehicle is being towed to verify that it is not in violation of the law.

Brake System

Foot Brake

This vehicle has power-assisted brakes that adjust automatically through normal use.

Should power-assist fail, you can stop by applying greater force than normal to the brake pedal. But the distance required to stop will be greater than usual.

WARNING

■ **Do not coast with the engine stalled or turned off, find a safe place to stop**

Coasting with the engine stalled or turned off is dangerous. Braking will require more effort, and the brake's power-assist could be depleted if you pump the brake. This will cause longer stopping distances or even an accident.

■ **Shift to a lower gear when going down steep hills**

Driving with your foot continuously on the brake pedal or steadily applying the brakes for long distances is dangerous. This causes overheated brakes, resulting in longer stopping distances or even total brake failure. This could cause loss of vehicle control and a serious accident. Avoid continuous application of the brakes.

■ **Dry off brakes that have become wet by driving slowly, releasing the accelerator pedal and lightly applying the brakes several times until the brake performance returns to normal**

Driving with wet brakes is dangerous. Increased stopping distance or the vehicle pulling to one side when braking could result in a serious accident. Light braking will indicate whether the brakes have been affected.

■ **To apply the brakes correctly**

- Always depress the brake pedal with the right foot. Applying the brakes with the unaccustomed left foot could slow your reaction time to an emergency situation resulting in insufficient braking operation.

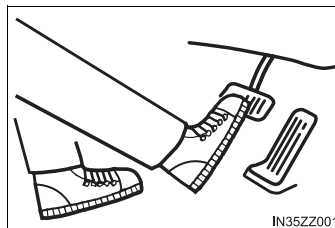

- Wear shoes appropriate for driving in order to avoid your shoe contacting the brake pedal when depressing the accelerator pedal.

 NOTICE

Do not drive with your foot held on the clutch pedal or brake pedal, or hold the clutch pedal depressed halfway unnecessarily. Doing so could result in the following:

- The clutch and brake parts will wear out more quickly.
- The brakes can overheat and adversely affect brake performance.

Parking Brake**■ Setting the parking brake**

Depress the brake pedal and then firmly pull the parking brake lever fully upwards with sufficient force to hold the vehicle in a stationary position.

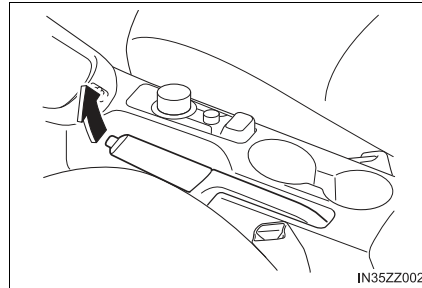
**■ Releasing the parking brake**

Depress the brake pedal and pull the parking brake lever upwards, then press the release button. While holding the button, lower the parking brake lever all the way down to the released position.

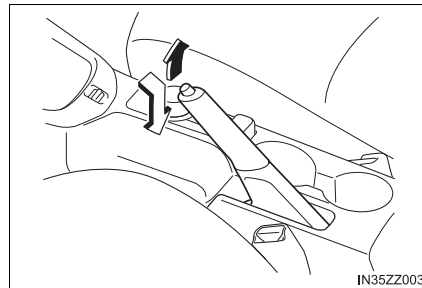

For parking in snow, refer to Winter Driving (→P. 146) regarding parking brake use.

 NOTICE

Driving with the parking brake on will cause excessive wear of the brake parts.

Warning Light

The warning light turns on when the system has a malfunction. Refer to Contact Your Toyota Dealer and Have Vehicle Inspected on P. 493.

Brake Pad Wear Indicator

When the disc brake pads become worn, the built-in wear indicators contact the disc plates. This causes a screeching noise to warn that the pads should be replaced.

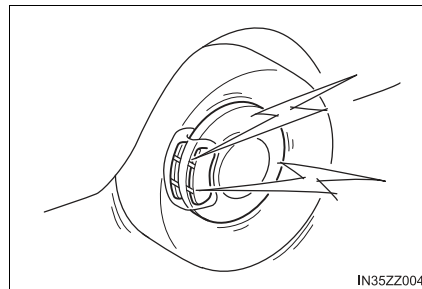

When you hear this noise, consult your Toyota dealer as soon as possible.

 WARNING

■ Do not drive with worn disc pads

Driving with worn disc pads is dangerous. The brakes could fail and cause a serious accident. As soon as you hear a screeching noise consult your Toyota dealer.

In high humidity weather conditions, brake noises, such as brake squeak or brake squeal can be heard. It does not indicate a malfunction.

Brake Assist

During emergency braking situations when it is necessary to depress the brake pedal with greater force, the brake assist system provides braking assistance, thus enhancing braking performance.

When the brake pedal is depressed hard or depressed more quickly, the brakes apply more firmly.

-
- When the brake pedal is depressed hard or depressed more quickly, the pedal will feel softer but the brakes will apply more firmly. This is a normal effect of the brake assist operation and does not indicate a malfunction.
 - When the brake pedal is depressed hard or depressed more quickly, a motor/pump operation noise may be heard. This is a normal effect of the brake assist and does not indicate a malfunction.
 - The brake assist equipment does not supersede the functionality of the vehicle's main braking system.

Hill Launch Assist (HLA)*

Hill Launch Assist (HLA) is a function which assists the driver in accelerating from a stop while on a slope. When the driver releases the brake pedal and depresses the accelerator pedal while on a slope, the function prevents the vehicle from rolling. The braking force is maintained automatically after the brake pedal is released on a steep grade.

For vehicles with a manual transaxle, Hill Launch Assist (HLA) operates on a downward slope when the shift lever is in the reverse (R) position, and on an upward slope when the shift lever is in a position other than the reverse (R) position.

For vehicles with an automatic transaxle, Hill Launch Assist (HLA) operates on a downward slope when the shift lever is in the reverse (R) position, and on an upward slope when the shift lever is in a forward gear.

- Hill Launch Assist (HLA) does not operate on a gentle slope. In addition, the gradient of the slope on which the system will operate changes depending on the vehicle's load.
- Hill Launch Assist (HLA) does not operate if the parking brake is applied, the vehicle has not stopped completely, or the clutch pedal is released.
- While Hill Launch Assist (HLA) is operating, the brake pedal may feel stiff and vibrate, however, this does not indicate a malfunction.
- Hill Launch Assist (HLA) does not operate while the TCS/DSC indicator light is illuminated.
Refer to Contact Your Toyota Dealer and Have Vehicle Inspected on P. 493.
- Hill Launch Assist (HLA) does not turn off even if the DSC OFF switch is pressed to turn off the TCS/DSC.

3

When Driving

*: If equipped

 **WARNING****■ Do not rely completely on Hill Launch Assist (HLA)**

Hill Launch Assist (HLA) is an auxiliary device for accelerating from a stop on a slope. The system only operates for about 2 seconds and therefore, relying only on the system, when accelerating from a stop is dangerous because the vehicle may move (roll) unexpectedly and cause an accident.

The vehicle could roll depending on the vehicle's load or if it is towing something. In addition, for vehicles with a manual transaxle, the vehicle could still roll depending on how the clutch pedal or the accelerator pedal is operated.

Always confirm the safety around the vehicle before starting to drive the vehicle.

Antilock Brake System (ABS)

The ABS control unit continuously monitors the speed of each wheel. If one wheel is about to lock up, the ABS responds by automatically releasing and reapplying that wheel's brake.

The driver will feel a slight vibration in the brake pedal and may hear a chattering noise from the brake system. This is normal ABS system operation. Continue to depress the brake pedal without pumping the brakes.

The warning light turns on when the system has a malfunction. Refer to Contact Your Toyota Dealer and Have Vehicle Inspected on P. 493.

- Braking distances may be longer on loose surfaces (snow or gravel, for example) which usually have a hard foundation. A vehicle with a normal braking system may require less distance to stop under these conditions because the tires will build up a wedge of surface layer when the wheels skid.
- The sound of the ABS operating may be heard when starting the engine or immediately after starting the vehicle, however, it does not indicate a malfunction.

WARNING

Do not rely on ABS as a substitute for safe driving

The ABS cannot compensate for unsafe and reckless driving, excessive speed, tailgating (following another vehicle too closely), driving on ice and snow, and hydroplaning (reduced tire friction and road contact because of water on the road surface). You can still have an accident.

Traction Control System (TCS)

The Traction Control System (TCS) enhances traction and safety by controlling engine torque and braking. When the TCS detects driving wheel slippage, it lowers engine torque and operates the brakes to prevent loss of traction.

This means that on a slick surface, the engine adjusts automatically to provide optimum power to the drive wheels, limiting wheel spin and loss of traction.

The warning light turns on when the system has a malfunction. Refer to Contact Your Toyota Dealer and Have Vehicle Inspected on P. 493.

To turn off the TCS, press the DSC OFF switch (→P. 219).

WARNING

■ **Do not rely on the Traction Control System (TCS) as a substitute for safe driving**

The Traction Control System (TCS) cannot compensate for unsafe and reckless driving, excessive speed, tailgating (following another vehicle too closely), and hydroplaning (reduced tire friction and road contact because of water on the road surface). You can still have an accident.

■ **Use snow tires or tire chains and drive at reduced speeds when roads are covered with ice and/or snow**

Driving without proper traction devices on snow and/or ice-covered roads is dangerous. The Traction Control System (TCS) alone cannot provide adequate traction and you could still have an accident.

TCS/DSC Indicator Light

This indicator light stays on for a few seconds when the ignition is switched ON. If the TCS or DSC is operating, the indicator light flashes.

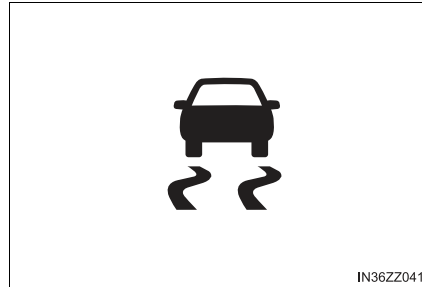

If the light stays on, the TCS, DSC or the brake assist system may have a malfunction and they may not operate correctly. Take your vehicle to your Toyota dealer.

- In addition to the indicator light flashing, a slight lugging sound will come from the engine. This indicates that the TCS/DSC is operating properly.
- On slippery surfaces, such as fresh snow, it will be impossible to achieve high rpm when the TCS is on.

3

When Driving

Dynamic Stability Control (DSC)

The Dynamic Stability Control (DSC) automatically controls braking and engine torque in conjunction with systems such as ABS and TCS to help control side slip when driving on slippery surfaces, or during sudden or evasive maneuvering, enhancing vehicle safety.

Refer to ABS (→P. 215) and TCS (→P. 216).

DSC operation is possible at speeds greater than 12 mph (20 km/h).

The warning light turns on when the system has a malfunction.

Refer to Contact Your Toyota Dealer and Have Vehicle Inspected on P. 493.

WARNING

■ Do not rely on the Dynamic Stability Control as a substitute for safe driving

The Dynamic Stability Control (DSC) cannot compensate for unsafe and reckless driving, excessive speed, tailgating (following another vehicle too closely), and hydroplaning (reduced tire friction and road contact because of water on the road surface). You can still have an accident.

NOTICE

- The DSC may not operate correctly unless the following are observed:
 - Use tires of the correct size specified for your Toyota on all 4 wheels.
 - Use tires of the same manufacturer, brand and tread pattern on all 4 wheels.
 - Do not mix worn tires.
- The DSC may not operate correctly when tire chains are used or a temporary spare tire is installed because the tire diameter changes.

TCS/DSC Indicator Light

This indicator light stays on for a few seconds when the ignition is switched ON. If the TCS or DSC is operating, the indicator light flashes.

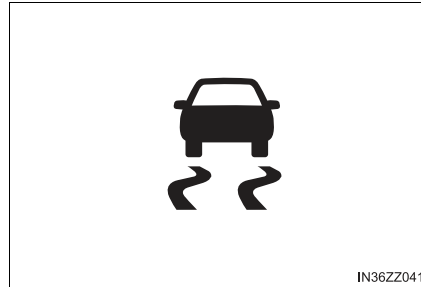

If the light stays on, the TCS, DSC or the brake assist system may have a malfunction and they may not operate correctly. Take your vehicle to your Toyota dealer.

DSC OFF Indicator Light

This indicator light stays on for a few seconds when the ignition is switched ON.

It also illuminates when the DSC OFF switch is pressed and TCS/DSC is switched off.

Refer to DSC OFF Switch on P. 219.



If the light remains illuminated and the TCS/DSC is not switched off, take your vehicle to your Toyota dealer. The DSC may have a malfunction.

DSC OFF Switch

Press the DSC OFF switch to turn off the TCS/DSC. The DSC OFF indicator light in the combination meter will illuminate.

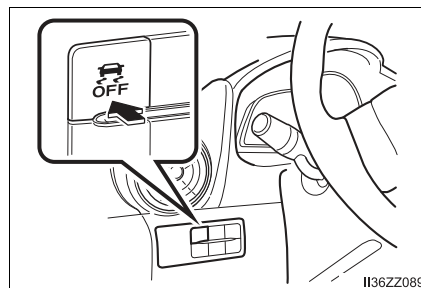

Press the switch again to turn the TCS/DSC back on. The DSC OFF indicator light will turn off.

- When DSC is on and you attempt to free the vehicle when it is stuck, or drive it out of freshly fallen snow, the TCS (part of the DSC system) will activate. Depressing the accelerator will not increase engine power and freeing the vehicle may be difficult. When this happens, turn off the TCS/DSC.
- If the TCS/DSC is off when the engine is turned off, it automatically activates when the ignition is switched ON.
- Leaving the TCS/DSC on will provide the best traction.
- If the DSC OFF switch is pressed and held for 10 seconds or more, the DSC OFF switch malfunction detection function operates and the DSC system activates automatically. The DSC OFF indicator light turns off while the DSC system is operative.
- If the Low Speed Pre-Collision System operates with the TCS/DSC turned off, the TCS/DSC becomes operational automatically.

Fuel Economy Monitor*

The Fuel Consumption information is displayed by operating each icon in the display.

In addition, after completing a trip, the total energy efficiency to date is displayed in the ending display when the ending display is turned on.

- 1 Select the  icon on the home screen to display the Applications screen.
- 2 Select the "Fuel Economy Monitor".
- 3 Operate the commander switch or touch the screen and display the menu.

When the menu is displayed by touching the screen, the display is hidden automatically after 6 seconds.

- 4 Select the icon in the menu and perform the operation. Each icon operates as follows:

- ① Hides the menu display.
- ② Displays the Applications screen.
- ③ Resets the fuel economy data.
- ④ Displays the following setting screen.
 - Ending display on/off switching
 - On/off switching for function which synchronizes (links) reset of fuel economy data with trip meter (TRIP A)

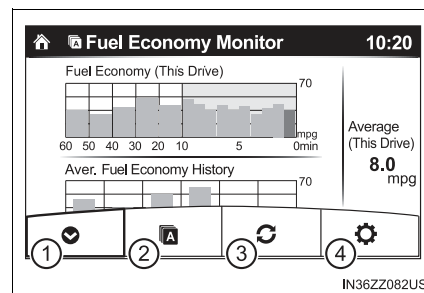

3

When Driving

*: If equipped

Fuel Consumption Display

Information regarding the fuel economy is displayed.

- ① Displays the fuel economy for the past 60 minutes.
 - Displays the fuel economy every minute for the past 1 to 10 minutes.
 - Displays the fuel economy every 10 minutes for the past 10 to 60 minutes.

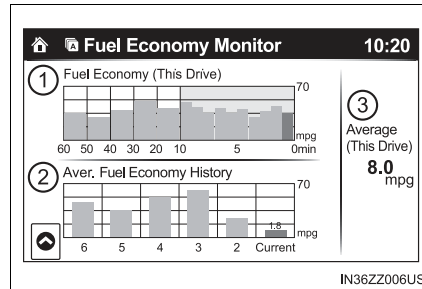

- ② Displays the average fuel economy over the past 5 resets and after the current reset.
- ③ Calculates the average fuel economy every minute after vehicle travel begins, and displays it.

- The fuel economy data is synchronized (linked) with the average fuel economy displayed in the trip computer.
- To reset the fuel economy data, press the  icon in the menu. (The average fuel economy displayed in the trip computer resets at the same time.)
- After resetting the fuel economy data, "--" is displayed while the average fuel economy is being calculated.

Ending Screen Display

If the ending display on the fuel economy monitor is on when the ignition is switched from ON to OFF, the information regarding the fuel economy is displayed.

Fuel Economy Data Reset and Trip Meter (TRIP A) Synchronization (Linking)

Because the average fuel economy indication on the instrument cluster display is linked with the “Average Fuel Economy History” (Current) indication on the center display, when one is reset the other is also reset.

In addition, switching between reset and no reset of the average fuel economy indication on the instrument cluster display and the “Average Fuel Economy History” (Current) indication on the center display when resetting the trip meter (Trip A) is possible.

Reset operation item	Synchronized (linked) and reset information		
	Trip meter (Trip A)	Average fuel economy on instrument cluster display	“Average Fuel Economy History” (Current) indication on the center display
Trip meter (Trip A)	X	X/-*1	X/-*1
Average fuel economy on instrument cluster display	-	X	X
“Average Fuel Economy History” (Current) indication on the center display	-	X	X

X: Reset

-: Not reset

*1: Can be personalized.

Refer to Customizable Features on P. 555.

3
When Driving

Drive Selection (Automatic Transaxle)

Drive selection is a system to switch the vehicle's drive mode. When the sport mode is selected, vehicle's response against accelerator operation is enhanced. This provides additional quick acceleration which may be needed to safely make maneuvers such as lane changes, merging onto free ways, or passing other vehicles.

- When the sport mode is selected, driving at higher engine speeds increases and it may increase fuel consumption. Toyota recommends that you cancel the sport mode on normal driving.
- Drive mode cannot be switched in the following conditions:
 - ABS/TCS/DSC is operating
 - Cruise control is operating.
 - Steering wheel is being operated abruptly

WARNING

Do not use the sport mode when driving on slippery roads such as wet or snow-covered roads. It may cause tire slipping.

Drive Selection Switch

Press the drive selection switch to the **SPORT** side (forward) to select the sport mode.

Pull the drive selection switch to the **—** side (backward) to cancel the sport mode.

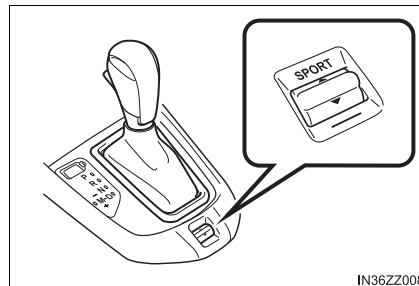

- In the following cases, the drive selection is canceled.
 - The ignition is switched OFF.
 - Cruise control is set.
- Depending on the driving conditions when sport mode is selected, the vehicle may perform shift-down or slightly accelerate.

Select Mode Indicator Light

When the sport mode is selected, the select mode indicator light turns on in the combination meter.



If the mode cannot be switched to drive mode, the select mode indicator light flashes to notify the driver.

3

When Driving

Power Steering

- Power steering is only operable when the engine is running. If the engine is off or if the power steering system is inoperable, you can still steer, but it requires more physical effort.
If the steering feels stiffer than usual during normal driving or the steering vibrates, consult your Toyota dealer.
- The warning light notifies the driver of system abnormalities and operation conditions.
In addition, the buzzer may also activate depending on the system abnormality or operation condition.
Refer to Stop Vehicle in Safe Place Immediately on P. 489.
Refer to Power Steering Warning Buzzer on P. 505.

 NOTICE

Never hold the steering wheel to the extreme left or right for more than 5 seconds with the engine running. This could damage the power steering system.

Active Safety System

◆ Pre-Crash Safety Technology

Pre-crash safety technology is designed to assist the driver in averting collisions or reduce their severity in situations where they cannot be avoided.

- Collision damage reduction in low vehicle speed range

Forward driving:

Low Speed Pre-Collision System (→P. 228)

◆ Sensor

- Laser sensor

The laser sensor emits a near-infrared laser beam and receives the beam reflected off the reflective surface of a vehicle or obstruction in front, and the detected beam is then used for measurement. The laser sensor is used for the Low Speed Pre-Collision System.

The laser sensor is installed at the top of the windshield near the rearview mirror.

Refer to Laser Sensor on P. 234.

Low Speed Pre-Collision System

The Low Speed Pre-Collision System is designed to reduce damage in the event of a collision by operating the brake control (Low Speed Pre-Collision System brake) when the system's laser sensor detects a vehicle ahead and determines that a collision with a vehicle ahead is unavoidable. It may also be possible to avoid a collision if the relative speed between your vehicle and a vehicle ahead is less than about 12 mph (20 km/h).

In addition, when the driver depresses the brake pedal while the system is in the operation range at about 2 to 18 mph (4 to 30 km/h), the brakes are applied firmly and quickly to assist. (Brake Assist (Low Speed Pre-Collision System brake assist))

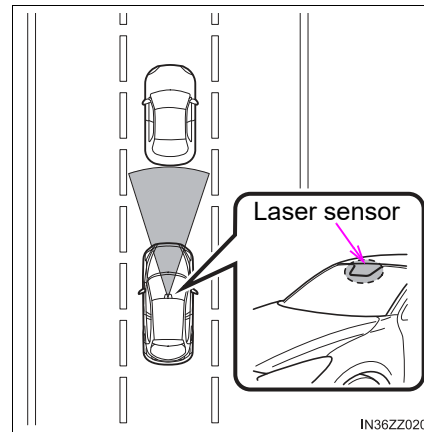

- The Low Speed Pre-Collision System will not operate if the driver is deliberately performing driving operations (accelerator pedal and steering wheel).
- The Low Speed Pre-Collision System will operate under the following conditions.
 - The engine is running.
 - The Low Speed Pre-Collision System warning light (amber) does not illuminate.
 - The vehicle speed is between about 2 to 18 mph (4 to 30 km/h).
 - The Low Speed Pre-Collision System is not turned off.
 - The DSC is not malfunctioning.
- The Low Speed Pre-Collision System detects a vehicle ahead by emitting a near-infrared laser beam and receiving the beam reflected off the reflector of the vehicle ahead, and then using it for the measurement. Consequently, the Low Speed Pre-Collision System may not operate under the following conditions:
 - Reflection of the laser is poor due to the shape of the vehicle ahead.
 - The vehicle ahead is significantly dirty.
 - Under bad weather condition, such as rain, fog and snow.
 - The window washer is being used or the windshield wipers are not used when it's raining.
 - The windshield is dirty.
 - The steering wheel is turned completely left or right, or the vehicle is accelerated rapidly and comes close to the vehicle ahead.
 - Trucks with low loading platforms and vehicles with an extremely low or high profile.
 - Vehicles with certain shapes such as a vehicle carrier.
- Under the following conditions, the Low Speed Pre-Collision System may not operate normally.
 - Heavy luggage is loaded in the luggage compartment or on the rear seat.
 - If there is the possibility of partial contact with a vehicle ahead.
 - When driving on continuously curving roads, and entering and exiting exits.
 - Elongated luggage or cargo is loaded onto installed roof rails and covers the laser sensor.
 - Exhaust gas from the vehicle in front, sand, snow, and water vapor rising from manholes and grating, and water splashed into the air.
 - When towing a malfunctioning vehicle.
 - When driving with tires having significantly different wear.

- In the following cases, the laser sensor may inadvertently determine that there is a vehicle ahead and the Low Speed Pre-Collision System may operate.
 - Objects on the road at the entrance to a curve.
 - Vehicles passing in the opposite lane while making a curve.
 - Metal objects, bumps, or protruding objects on the road.
 - When passing through a toll gate equipped with a bar.
 - When passing under a vinyl curtain or flag.
 - Plastic objects such as pylons.
 - Two-wheeled vehicles, pedestrians, animals or standing trees.
- Manual transaxle:
If the vehicle is stopped by the Low Speed Pre-Collision System operation and the clutch pedal is not depressed, the engine stops.
- The Low Speed Pre-Collision System warning light (amber) turns on when the system has a malfunction.
Refer to Warning Lights on P. 173.

 **WARNING****■ Do not rely on the Low Speed Pre-Collision System as a substitute for safer driving**

The Low Speed Pre-Collision System cannot compensate for unsafe and reckless driving, excessive speed, tailgating (following another vehicle too closely), and driving on slippery roads such as wet, snowy, and icy roads (reduced tire friction and road contact because of water on the road surface). You can still have an accident.

■ Do not rely completely on the Low Speed Pre-Collision System

- The Low Speed Pre-Collision System is only designed to reduce damage in the event of a collision. Over reliance on the system leading to the accelerator pedal or brake pedal being mistakenly operated could result in an accident.
- The Low Speed Pre-Collision System is a system which operates in response to a vehicle ahead. The system may not be able to detect or react to two-wheeled vehicles or pedestrians.
- The laser sensor for the Low Speed Pre-Collision System is installed near the rearview mirror. To assure the correct operation of the Low Speed Pre-Collision System, heed the following cautions.
 - Do not apply stickers to the surface of the windshield near the laser sensor (including transparent stickers). Otherwise, the laser sensor may not be able to detect vehicles ahead which could result in an accident.
 - Do not apply coating agent to the windshield. Otherwise, the laser sensor may not be able to detect vehicles or obstructions in front which could result in an accident.
 - Do not disassemble the laser sensor.
 - If cracks or damage caused by flying gravel or debris is visible near the laser sensor, stop using the Low Speed Pre-Collision System immediately and have your vehicle inspected by your Toyota dealer. If the vehicle continues to be driven with cracks or scratch marks left on the windshield near the laser sensor, the system may operate unnecessarily and cause an unexpected accident.
Refer to Stopping The Low Speed Pre-Collision System Operation on P. 233.
 - When replacing the windshield wipers or windshield, consult your Toyota dealer.
- The laser sensor includes a function for detecting a soiled windshield and informing the driver, however, depending on the conditions, it may not detect plastic shopping bags, ice or snow on the windshield. In such cases, the system cannot accurately determine a vehicle ahead and may not be able to operate normally. Always drive carefully and pay attention to the road ahead.

⚠ WARNING**■ Do not modify the suspension**

If the vehicle height or inclination is changed, the system will not be able to correctly detect vehicles ahead. This will result in the Low Speed Pre-Collision System not operating normally or mistakenly operating, which could cause a serious accident.

■ Turn off the Low Speed Pre-Collision System when the vehicle is running on a chassis roller or being towed

Turn off the Low Speed Pre-Collision System to prevent mistaken operation when the vehicle is running on a chassis roller or being towed. Refer to Stopping The Low Speed Pre-Collision System Operation on P. 233.

⚠ NOTICE

- When driving off-road in areas where there is grass or forage, it is recommended that the Low Speed Pre-Collision System be turned off.
- Always use tires for all wheels that are of the specified size, and the same manufacturer, brand, and tread pattern. In addition, do not use tires with significantly different wear patterns on the same vehicle as the Low Speed Pre-Collision System may not operate normally.

Low Speed Pre-Collision System Indicator Light (Red)

If the Low Speed Pre-Collision System is operating, the indicator light (red) flashes.

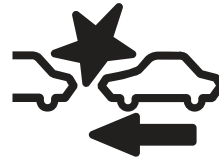

IN36ZZ045

Stopping the Low Speed Pre-Collision System Operation

The Low Speed Pre-Collision System can be temporarily deactivated.

When the Low Speed Pre-Collision System is turned off, the Low Speed Pre-Collision System OFF indicator light turns on.

When the engine is restarted, the system becomes operational.



- ▶ Without Low Speed Pre-Collision System OFF switch

Refer to Customizable Features on P. 555.

- ▶ With Low Speed Pre-Collision System OFF switch

Press the Low Speed Pre-Collision System OFF switch to turn off the system. The Low Speed Pre-Collision System OFF indicator light in the combination meter will illuminate.

Press the switch again to turn the system back on. The Low Speed Pre-Collision System OFF indicator light will turn off.

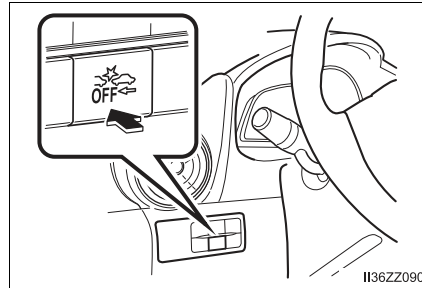

Laser Sensor

The Low Speed Pre-Collision System laser sensor is installed at the top of the windshield near the rearview mirror.

Always keep the surface of the windshield around the laser sensor clean to assure proper operation of the Low Speed Pre-Collision System.

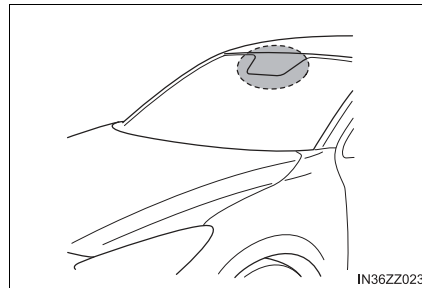

WARNING

■ **As there is the possibility of eye damage occurring from the laser, always heed the following precautions**

- Never remove the sensor.
- A removed sensor will not meet the conditions for a class 1M laser under the IEC 60825-1 specification and therefore eye safety cannot be assured.
- Do not peer into the sensor using optical instruments with a magnification function such as magnifying glasses, and microscopic and objective lenses within a distance of 3.94 in. (100 mm) from the sensor.

Laser classification label:

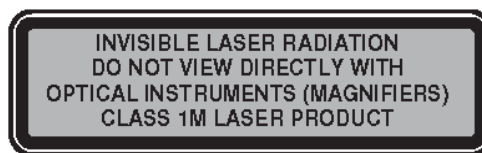

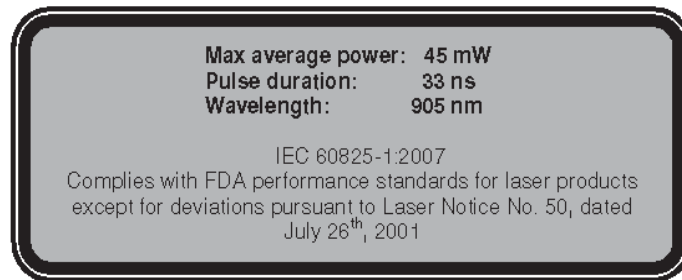
⚠ WARNING**Laser explanatory label:****Laser sensor radiation data****Maximum average power: 45 mW****Pulse duration: 33 ns****Wavelength: 905 nm****Divergence angle (horizontal × vertical): 28 degrees × 12 degrees**

3

When Driving

Cruise Control

With cruise control, you can set and automatically maintain any speed of more than about 16 mph (25 km/h).

WARNING

Do not use the cruise control under the following conditions

Using the cruise control under the following conditions is dangerous and could result in loss of vehicle control.

- Hilly terrain
- Steep inclines
- Heavy or unsteady traffic
- Slippery or winding roads
- Similar restrictions that require inconsistent speed

Cruise Control Switch

- ① OFF/CAN switch
- ② ON switch
- ③ RES/+ switch
- ④ SET/- switch

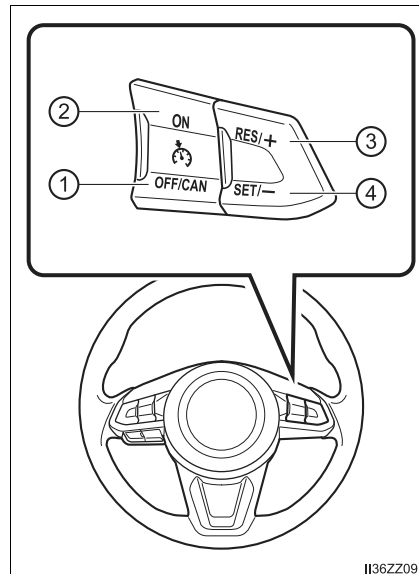

II36ZZ091

Cruise Main Indication (White), Cruise Set Indication (White)/Indicator Light (Green)

■ Cruise main indication (white)

The cruise main indication (white) is displayed in the instrument cluster when the cruise control system is activated.

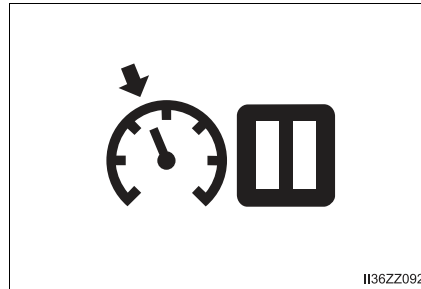

■ Cruise set indication (white)/indicator light (green)

The cruise set indication (white) is displayed in the instrument cluster and the cruise set indicator light (green) turns on when a cruising speed has been set.

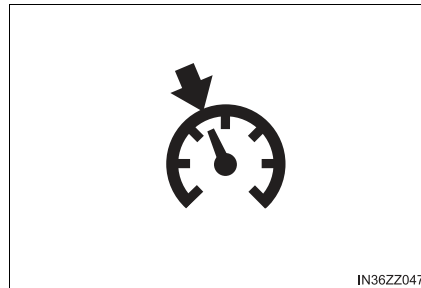

3

When Driving

Activation/Deactivation

To activate the system, press the ON switch. The cruise main indication (white) is displayed.

To deactivate the system, press the OFF/CAN switch.

The cruise main indication (white) turns off.

When the ignition is switched OFF, the system status before it was turned off is maintained. For example, if the ignition is switched OFF with the cruise control system operable, the system will be operable when the ignition is switched ON the next time.

⚠ WARNING

■ Always turn off the cruise control system when it is not in use

Leaving the cruise control system in an activation-ready state while the cruise control is not in use is dangerous as the cruise control could unexpectedly activate if the activation button is accidentally pressed, and result in loss of vehicle control and an accident.

To Set Speed

- 1 Activate the cruise control system by pressing the ON switch. The cruise main indication (white) is displayed.
 - 2 Accelerate to the desired speed, which must be more than 16 mph (25 km/h).
 - 3 Set the cruise control by pressing the SET/– switch at the desired speed. The cruise control is set at the moment the SET/– switch is pressed. Release the accelerator pedal simultaneously. The cruise set indication (white) is displayed and the cruise set indicator light (green) turns on.
-
- The cruise control speed setting cannot be performed under the following conditions:
 - Manual transaxle: The shift lever is in the neutral position.
 - Automatic transaxle: The selector lever is in the P or N position.
 - The parking brake is applied.
 - Release the SET/– or RES/+ switch at the desired speed, otherwise the speed will continue increasing while the RES/+ switch is pressed and held, and continue decreasing while the SET/– switch is pressed and held (except when the accelerator pedal is depressed).
 - On a steep grade, the vehicle may momentarily slow down while ascending, or speed up while descending.
 - The cruise control will cancel if the vehicle speed decreases below 13 mph (21 km/h) when climbing a steep grade.
 - The cruise control may cancel at about 9 mph (15 km/h) below the preset speed such as when climbing a long, steep grade.

To Increase Cruising Speed

Follow either of these procedures.

■ To increase speed using cruise control switch

Press the RES/+ switch and hold it. Your vehicle will accelerate. Release the switch at the desired speed.

Press the RES/+ switch and release it immediately to adjust the preset speed. Multiple operations will increase the preset speed according to the number of times it is operated.

● Increasing speed with a single RES/+ switch operation

Instrument cluster display for vehicle speed indicated in mph:

1 mph (1.6 km/h)

Instrument cluster display for vehicle speed indicated in km/h:

1 km/h (0.6 mph)

■ To increase speed using accelerator pedal

Depress the accelerator pedal to accelerate to the desired speed. Press the SET/– switch and release it immediately.

Accelerate if you want to speed up temporarily when the cruise control is on. Greater speed will not interfere with or change the set speed. Take your foot off the accelerator to return to the set speed.

To Decrease Cruising Speed

Press the SET/– switch and hold it. The vehicle will gradually slow. Release the switch at the desired speed.

Press the SET/– switch and release it immediately to adjust the preset speed. Multiple operations will decrease the preset speed according to the number of times it is operated.

● Decreasing speed with a single SET/– switch operation

Instrument cluster display for vehicle speed indicated in mph:

1 mph (1.6 km/h)

Instrument cluster display for vehicle speed indicated in km/h:

1 km/h (0.6 mph)

To Resume Cruising Speed at More Than 16 mph (25 km/h)

If the cruise control system temporarily canceled (such as applying the brake pedal) and the system is still activated, the most recent set speed will automatically resume when the RES/+ switch is pressed.

If vehicle speed is below 16 mph (25 km/h), increase the vehicle speed up to 16 mph (25 km/h) or more and press the RES/+ switch.

To Temporarily Cancel

To temporarily cancel the system, use one of these methods:

- Slightly depress the brake pedal.
- Manual transaxle: Depress the clutch pedal.
- Press the OFF/CAN switch.

If the RES/+ switch is pressed when the vehicle speed is 16 mph (25 km/h) or higher, the system reverts to the previously set speed.

- If any of the following conditions occur, the cruise control system is temporarily canceled.
 - The parking brake is applied.
 - Manual transaxle: The shift lever is in the neutral position.
 - Automatic transaxle: The selector lever is in the P or N position.
- When the cruise control system is temporarily canceled by even one of the applicable cancel conditions, the speed cannot be re-set.
- Automatic transaxle:
The cruise control cannot be cancelled while driving in manual mode (selector lever shifted from D to M position). Therefore, engine braking will not be applied even if the transaxle is shifted down to a lower gear. If deceleration is required, lower the set speed or depress the brake pedal.

To Deactivate

- **When a cruising speed has been set (cruise set indication (white) is displayed/cruise set indicator light (green) turns on)**

Long-press the OFF/CAN switch or press the OFF/CAN switch 2 times.

- **When a cruising speed has not been set (cruise main indication (white) is displayed)**

Press the OFF/CAN switch.

Tire Pressure Monitoring System*

The Tire Pressure Monitoring System (TPMS) monitors the air pressure of all four tires. If the air pressure of one or more tires is too low, the system warns the driver by indicating the tire pressure monitoring system warning light in the combination meter and operating a beep sound.

The system monitors the tire pressures indirectly using the data sent from the ABS wheel speed sensors.

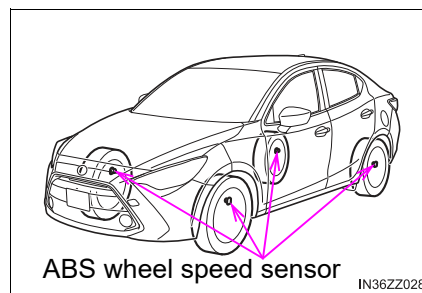

To allow the system to operate correctly, the system needs to be initialized with the specified tire pressure (value on the tire pressure label). Follow the procedure and perform the initialization.

Refer to Tire Pressure Monitoring System Initialization on P. 244.

The warning light flashes when the system has a malfunction.

Refer to Warning Lights on P. 173.

3

When Driving

*: If equipped

Because this system detects slight changes in tire conditions, the timing of the warning may be faster or slower in the following cases:

- The size, manufacturer, or the type of tires is different from the specification.
- The size, manufacturer, or the type of a tire is different from the others, or the level of tire wear is excessively different between them.
- A run-flat tire, studless tire, snow tire, or tire chains are used.
- An emergency tire is used (The tire pressure monitoring system warning light may flash and then continue illuminating).
- A tire is repaired using the emergency flat tire repair kit.
- The tire pressure is excessively higher than the specified pressure, or the tire pressure is suddenly lowered for some reason such as a tire burst during driving.
- The vehicle speed is lower than about 9.3 mph (15 km/h) (including when the vehicle is stopped), or the drive period is shorter than 5 minutes.
- The vehicle is driven on an extremely rough road or a slippery, icy road.
- Hard steering and rapid acceleration/deceleration are repeated such as during aggressive driving on a winding road.
- Load on the vehicle is applied to a tire such as by loading heavy luggage to one side of the vehicle.
- System initialization has not been implemented with the specified tire pressure.

 NOTICE

- Each tire, including the spare (if provided), should be checked monthly when cold and inflated to the inflation pressure recommended by the vehicle manufacturer on the vehicle placard or tire inflation pressure label. (If your vehicle has tires of a different size than the size indicated on the vehicle placard or tire inflation pressure label, you should determine the proper tire inflation pressure for those tires.)

As an added safety feature, your vehicle has been equipped with a tire pressure monitoring system (TPMS) that illuminates a low tire pressure telltale when one or more of your tires is significantly under-inflated. Accordingly, when the low tire pressure telltale illuminates, you should stop and check your tires as soon as possible, and inflate them to the proper pressure. Driving on a significantly under-inflated tire causes the tire to overheat and can lead to tire failure. Under-inflation also reduces fuel efficiency and tire tread life, and may affect the vehicle's handling and stopping ability.

Please note that the TPMS is not a substitute for proper tire maintenance, and it is the driver's responsibility to maintain correct tire pressure, even if under-inflation has not reached the level to trigger illumination of the TPMS low tire pressure telltale.

Your vehicle has also been equipped with a TPMS malfunction indicator to indicate when the system is not operating properly.

The TPMS malfunction indicator is combined with the low tire pressure telltale. When the system detects a malfunction, the telltale will flash for approximately one minute and then remain continuously illuminated. This sequence will continue upon subsequent vehicle start-ups as long as the malfunction exists. When the malfunction indicator is illuminated, the system may not be able to detect or signal low tire pressure as intended. TPMS malfunctions may occur for a variety of reasons, including the installation of replacement or alternate tires or wheels on the vehicle that prevent the TPMS from functioning properly. Always check the TPMS malfunction telltale after replacing one or more tires or wheels on your vehicle to ensure that the replacement or alternate tires and wheels allow the TPMS to continue to function properly.

- To avoid false readings, the system samples for a little while before indicating a problem. As a result it will not instantaneously register a rapid tire deflation or blow out.

Tire Pressure Monitoring System Initialization

In the following cases, system initialization must be performed so that the system operates normally.

- A tire pressure is adjusted.
- Tire rotation is performed.
- A tire or wheel is replaced.
- The battery is replaced or completely drained.
- The tire pressure monitoring system warning light is illuminated.

■ Initialization method

- 1 Park the car in a safe place and firmly apply the parking brake.
- 2 Let the tires cool, then adjust the tire pressure of all four (4) tires to the specified pressure indicated on the tire pressure label located on the door jamb of the driver's door (door open). Refer to Tires on P. 553.
- 3 Switch the ignition ON.
- 4 While the vehicle is parked, press and hold the tire pressure monitoring system set switch and verify that the tire pressure monitoring system warning light in the combination meter flashes twice and a beep sound is heard once.

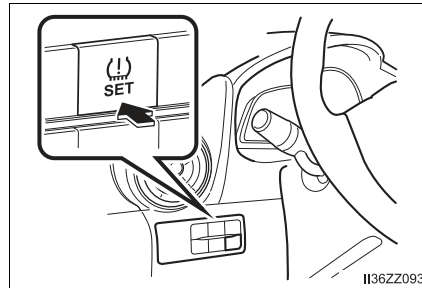

⚠ NOTICE

If the system initialization is performed without adjusting the tire pressure, the system cannot detect the normal tire pressure and it may not illuminate the tire pressure monitoring system warning light even if a tire pressure is low, or it may illuminate the light even if the pressures are normal.

Adjust the tire pressure on all four tires and initialize the system when the warning light is turned on. If the warning light turns on for a reason other than a flat tire, the tire pressure of all four tires may have decreased naturally.

The system initialization will not be performed if the switch is pressed while the vehicle is being driven.

Rear View Monitor

The rear view monitor provides visual images of the rear of the vehicle when reversing.

- If water, snow, or mud is stuck on the camera lens, wipe it off using a soft cloth. If it cannot be wiped off, use a mild detergent.
- If the camera temperature changes rapidly (Hot to cold, cold to hot), the rear view monitor may not operate correctly.
- When replacing the tires, consult your Toyota dealer. Replacing the tires could result in deviation of the guide lines which appear on the display.
- If the vehicle's front, side, or rear has been involved in a collision, the alignment of the rear view parking camera (location, installation angle) may have deviated. Always consult your Toyota dealer to have the vehicle inspected.
- If "No Video Signal Available" is indicated in the display, there could be a problem with the camera. Have your vehicle inspected at your Toyota dealer.



WARNING

■ **Always drive carefully confirming the safety of the rear and the surrounding conditions by looking directly with your eyes**

Reversing the vehicle by only looking at the screen is dangerous as it may cause an accident or a collision with an object. The rear view monitor is only a visual assist device when reversing the vehicle. The images on the screen may be different from the actual conditions.

■ **Do not use the rear view monitor under the following conditions**

Using the rear view monitor under the following conditions is dangerous and could result in injury or vehicle damage or both.

- Icy or snow-covered roads.
- Tire chains or a temporary spare tire is installed.
- The liftgate/trunk lid is not fully closed.
- The vehicle is on a road incline.

■ **Rear view monitor display precautions in cold temperatures**

When the display is cold, images may course across the monitor or the screen and may be dimmer than usual, which could cause difficulty in confirming the surrounding conditions of the vehicle. Always drive carefully confirming the safety of the rear and the surrounding conditions by looking directly with your eyes.

 NOTICE

- Do not apply excessive force to the camera. The camera position and angle may deviate.
- Do not disassemble, modify, or remove it as it may no longer be waterproof.
- The camera cover is made of plastic. Do not apply degreasing agents, organic solvents, wax, or glass coating agents to the camera cover. If any are spilled on the cover, wipe off with a soft cloth immediately.
- Do not rub the camera cover forcefully with an abrasive or hard brush. The camera cover or lens may be scratched which might affect the images.

Rear View Parking Camera Location

▶ 4-Door

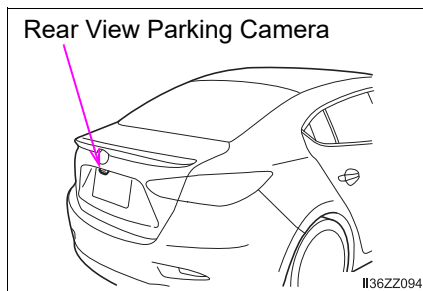

▶ 5-Door

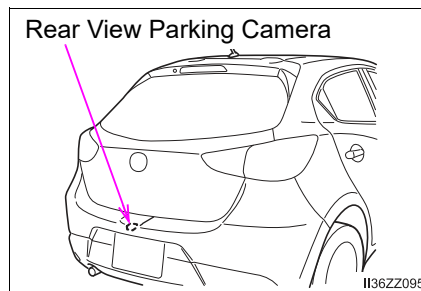
**Switching to the Rear View Monitor Display**

Shift the shift lever to R with the ignition switched ON to switch the display to the rear view monitor display.

When the shift lever is shifted from R to another shift lever position, the screen returns to the previous display.

Displayable Range on the Screen

The images on the screen may be different from the actual conditions.

- Screen display

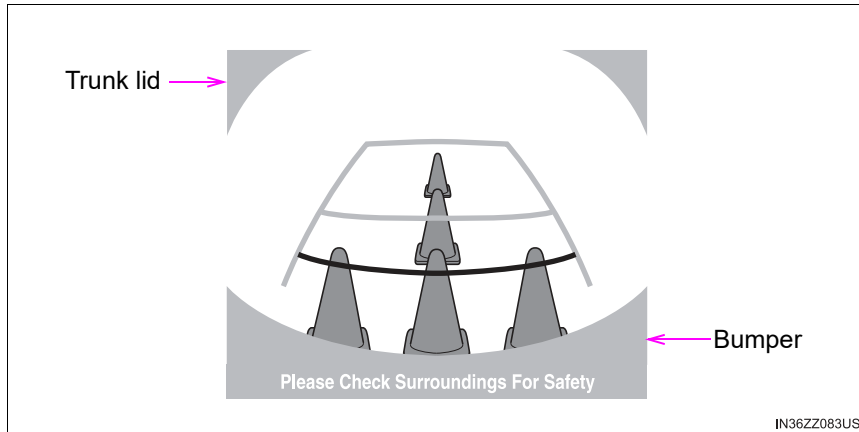

- Actual view

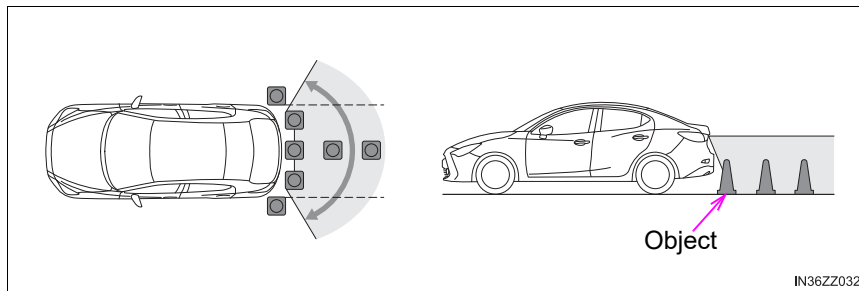

3
When Driving

- The displayable range varies depending on the vehicle and road conditions.
- The displayable range is limited. Objects under the bumper or around the bumper ends cannot be displayed.
- The distance appearing in the displayed image is different from the actual distance because the rear view parking camera is equipped with a specific lens.
- Some optionally installed vehicle accessories may be picked up by the camera. Do not install any optional parts that can interfere with the camera view, such as illuminating parts or parts made of reflective material.
- It may be difficult to see the display under the following conditions, however, it does not indicate a malfunction.
 - In darkened areas.
 - When the temperature around the lens is high/low.
 - When the camera is wet such as on a rainy day or during periods of high humidity.
 - When foreign material such as mud is stuck around the camera.
 - When the camera lens reflects sunlight or headlight beams.
- Image display may be delayed if the temperature around the camera is low.

Viewing the Display

Guide lines which indicate the width of the vehicle (yellow) are displayed on the screen as a reference to the approximate width of the vehicle in comparison to the width of the parking space you are about to back into.

Use this display view for parking your vehicle in a parking space or garage.

- ① Vehicle width guide lines (yellow)

These guide lines serve as a reference to the approximate width of the vehicle.

- ② Distance guide lines

These guide lines indicate the approximate distance to a point measured from the vehicle's rear (from the end of the bumper).

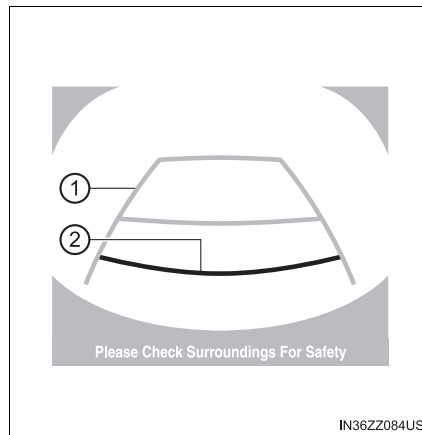

The red and yellow lines indicate the points about 19 in. (500 mm) for the red line and 39.3 in. (1000 mm) for the yellow lines from the rear bumper (at the center point of each of the lines).

⚠ WARNING

The guide lines on the screen are fixed lines. They are not synced to the driver's turning of the steering wheel. Always be careful and check the area to the vehicle's rear and the surrounding area directly with your eyes while backing up.

3
When Driving

Rear View Monitor Operation

The operation of the rear view monitor when reversing the vehicle varies depending on the traffic, road, and vehicle conditions. The amount of steering and the timing also varies depending on conditions, so confirm the surrounding conditions directly with your eyes and steer the vehicle in accordance with the conditions.

Be well aware of the above cautions prior to using the rear view monitor.

- 1 Shift the shift lever to R to switch the display to the rear view monitor display.
- 2 Confirming the surrounding conditions, reverse the vehicle.

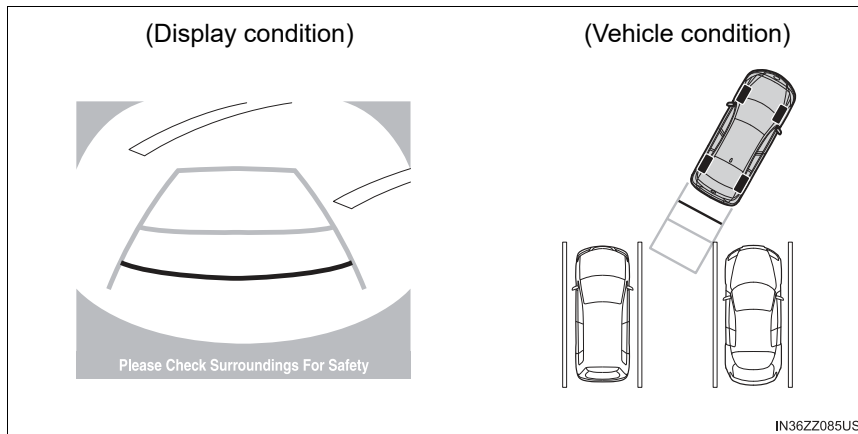

- 3 After your vehicle begins entering the parking space, continue backing up slowly so that the distance between the vehicle width lines and the sides of the parking space on the left and right are roughly equal.
- 4 Continue to adjust the steering wheel until the vehicle width guide lines are parallel to the left and right sides of the parking space.

- 5 Once they are parallel, straighten the wheels and back your vehicle slowly into the parking space. Continue checking the vehicle's surroundings and then stop the vehicle in the best possible position. (If the parking space has division lines, check whether the vehicle width guide lines are parallel to them.)

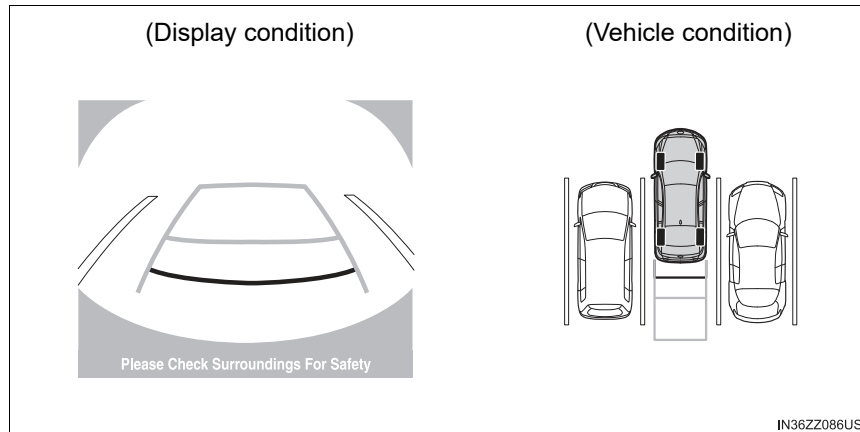

- 6 When the shift lever is shifted from R to another shift lever position, the screen returns to the previous display.

- Images displayed on the monitor from the rear view parking camera are reversed images (mirror images).
- Because there may be a difference between the displayed image, such as indicated below, and the actual conditions when parking, always verify the safety at the rear of the vehicle and the surrounding area directly with your eyes.
 - In the image of the parking space (or garage) displayed below, even though the back end and distance guide lines appear parallel in the monitor, they may not actually be parallel on the ground.

- When parking in a space with a division line on only one side of the parking space, the division line and the vehicle width guide line may appear parallel on the monitor, but they may not actually be parallel on the ground.

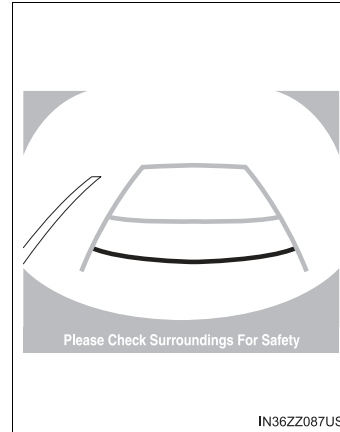

Variance Between Actual Road Conditions and Displayed Image

Some variance occurs between the actual road and the displayed road. Such variance in distance perspective could lead to an accident. Note the following conditions that may cause a variance in distance perspective.

■ When the vehicle is tilted due to the weight of passengers and load

When the vehicle rear is lowered, the object displayed on the screen appears farther than the actual distance.

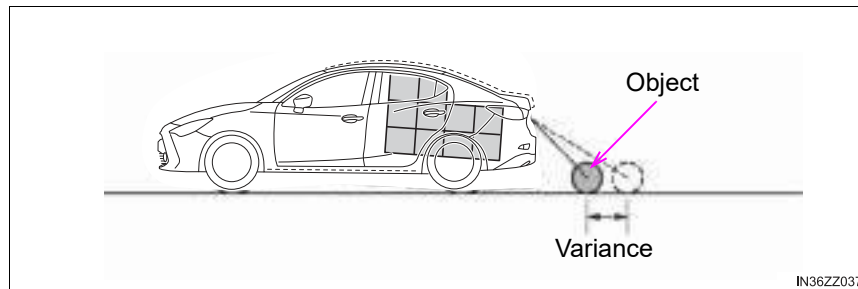

■ **When there is a steep grade behind the vehicle**

When there is a steep upgrade (downgrade) behind the vehicle, the object displayed on the screen appears farther (downgrade: closer) than the actual distance.

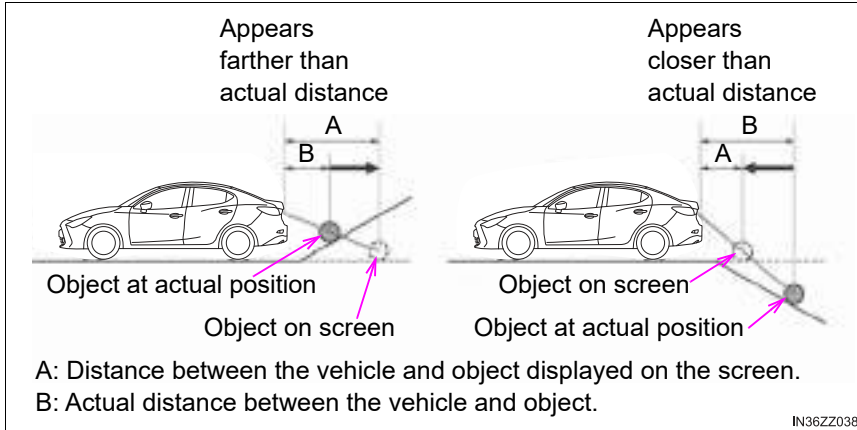

■ **Three-dimensional object on vehicle rear**

Because the distance guide lines are displayed based on a flat surface, the distance to the three-dimensional object displayed on the screen is different from the actual distance.

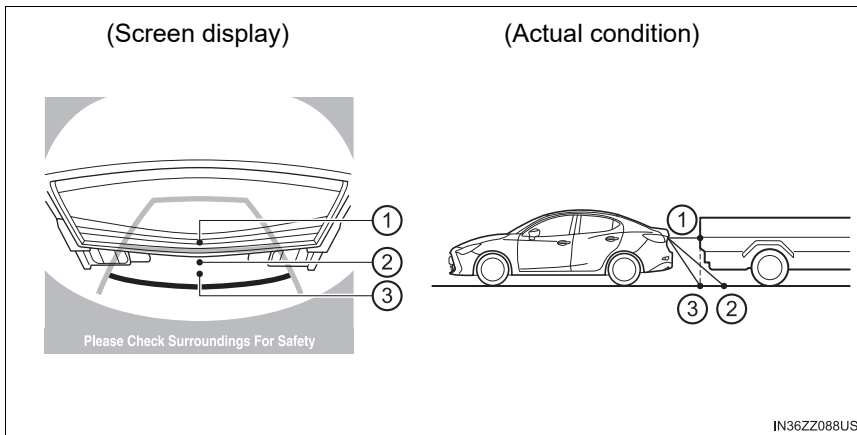

Sensed distance on screen: ① > ② > ③



Actual distance: ② > ③ = ①

3
When Driving

Picture Quality Adjustment

Picture quality adjustment can be done while the shift lever is in reverse (R).

There are four settings which can be adjusted including, brightness, contrast, tint, and color. When adjusting, pay sufficient attention to the vehicle surroundings.

- 1 Select the  icon on the screen to display the tabs.
- 2 Select the desired tab item.
- 3 Adjust the brightness, contrast, tint, and color using the slider.
If you need to reset, press the reset button.
- 4 Select the  icon on the screen to close the tab.



WARNING

Always adjust the picture quality of the rear view monitor while the vehicle is stopped

Do not adjust the picture quality of the rear view monitor while driving the vehicle. Adjusting the picture quality of the rear view monitor such as brightness, contrast, color, and tint while driving the vehicle is dangerous as it could distract your attention from the vehicle operation which could lead to an accident.

Interior Features**4****4-1. Climate Control System**

Operating Tips	256
Vent Operation	257
Manual Type	259
Fully Automatic Type	266

4-2. Audio System

Antenna	271
Operating Tips for Audio System	273
Audio Set	283
Audio Control Switch Operation	304
AUX/USB mode	307

4-3. Bluetooth®

Bluetooth®	327
Bluetooth® Hands-Free	339
Bluetooth® Audio	353
Troubleshooting	366

4-4. Interior Equipment

Sunvisors	374
Interior Lights	375
Accessory Socket	378
Cup Holder	379
Bottle Holder	380
Storage Compartments	381

Operating Tips

- Operate the climate control system with the engine running.
- To prevent the battery from being discharged, do not leave the fan control dial on for a long period of time with the ignition switched ON when the engine is not running.
- Clear all obstructions such as leaves, snow and ice from the hood and the air inlet in the cowl grille to improve the system efficiency.
- Use the climate control system to defog the windows and dehumidify the air.
- The recirculate mode should be used when driving through tunnels or while in a traffic jam, or when you would like to shut off outside air for quick cooling of the interior.
- Use the outside air position for ventilation or windshield defrosting.
- If the vehicle has been parked in direct sunlight during hot weather, open the windows to let warm air escape, then run the climate control system.
- Run the air conditioner about 10 minutes at least once a month to keep internal parts lubricated.
- Have the air conditioner checked before the weather gets hot. Lack of refrigerant may make the air conditioner less efficient.

The refrigerant specifications are indicated on a label attached to the inside of the engine compartment. Check the label before refilling the refrigerant. If the wrong type of refrigerant is used, it could result in a serious malfunction of the air conditioner.

For details, consult your Toyota dealer.

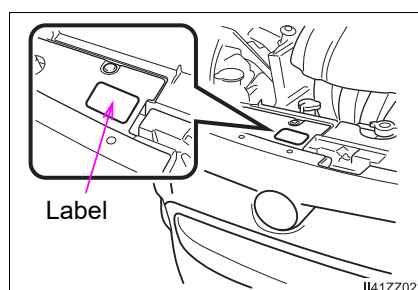

Vent Operation

Adjusting the Vents

■ Air vent open/close

The air vents can be fully opened and closed by operating the knob.

- ▶ Center vents (driver) and Side vents
- ▶ Center vents (front passenger) vents

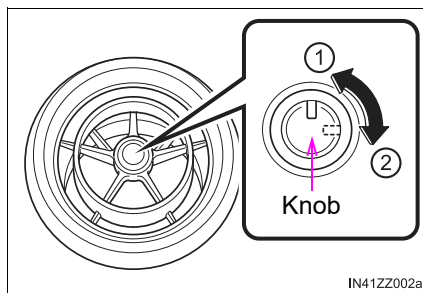

IN41ZZ002a

- ① Open
- ② Close

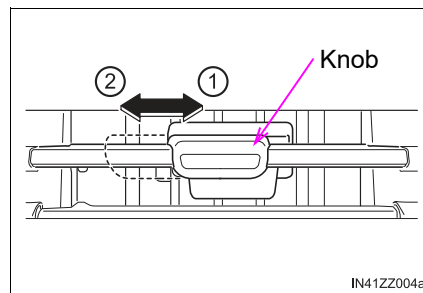

IN41ZZ004a

- ① Open
- ② Close

■ Directing airflow

To adjust the direction of airflow, move the adjustment knob.

- ▶ Center vents (driver) and Side vents
- ▶ Center vents (front passenger) vents

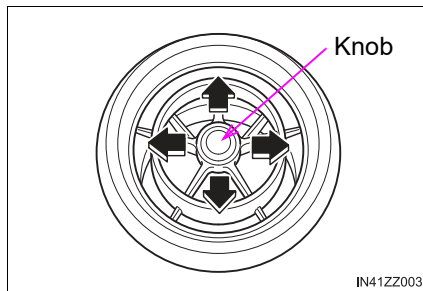

IN41ZZ003

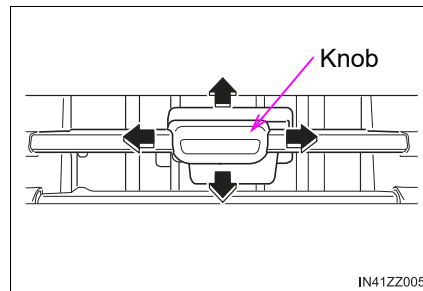

IN41ZZ005

When using the air conditioner under humid ambient temperature conditions, the system may blow fog from the vents. This is not a sign of trouble but a result of humid air being suddenly cooled.

Selecting the Airflow Mode

► Dashboard Vents

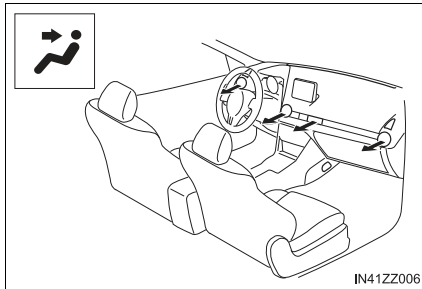

► Dashboard and Floor Vents

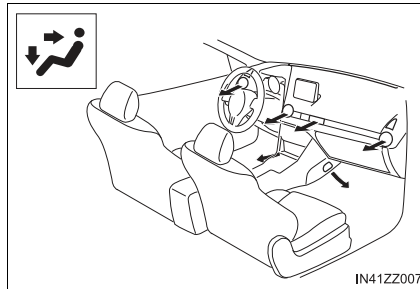

► Floor Vents

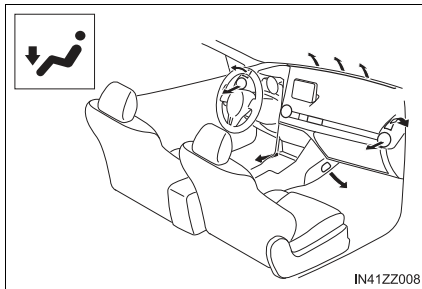

► Defroster and Floor Vents

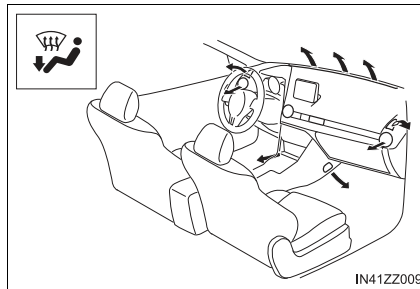

► Defroster Vents

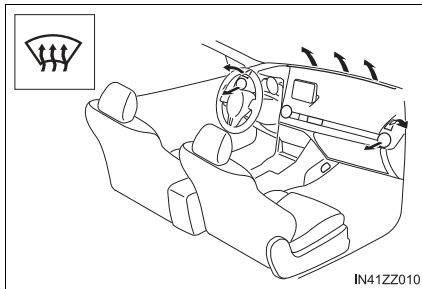

Manual Type

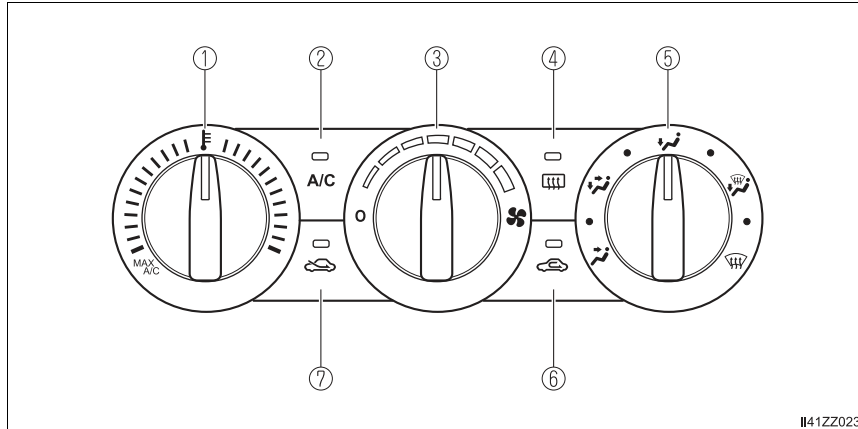

- ① Temperature control dial
- ② A/C switch
- ③ Fan control dial
- ④ Rear window defogger switch
- ⑤ Mode selector dial
- ⑥ Air intake selector (recirculated air position)
- ⑦ Air intake selector (outside air position)

Control Switches

■ Temperature control dial

This dial controls temperature. Turn it clockwise for hot and counterclockwise for cold.

■ Fan control dial

This dial allows variable fan speeds.

The fan has seven speeds.

■ Mode selector dial

Turn the mode selector dial to select airflow mode (→P. 258).

■ A/C switch

Press the A/C switch to turn the air conditioner on. The indicator light on the switch will illuminate when the fan control dial is in any position except OFF.

■ Air intake selector

This switch controls the source of air entering the vehicle.

Press the air intake selector switch to alternate between the outside air and recirculated air positions.



● Recirculated air position ()

Outside air is shut off. Air within the vehicle is recirculated.



● Outside air position ()

Outside air is allowed to enter the cabin. Use this mode for ventilation or windshield defrosting.

■ Temperature control dial

When the mode is set to  or  with the fan control dial in a position other than 0 and the temperature control dial in the maximum cold position, the air intake selector switches to the recirculated air position and the A/C turns on automatically. If A/C is not desired, press the A/C switch to turn it off.

■ Mode selector dial

- The mode selector dial can be set at the intermediate positions (●) between each mode. Set the dial to an intermediate position if you want to split the airflow between the two modes.
- For example, when the mode selector dial is at the ● position between the  and  positions, airflow from the floor vent is less than that of the  position.



■ A/C switch

The air conditioner may not function when the outside temperature approaches 32 °F (0 °C).



⚠ WARNING**■ Do not use the recirculated air position in cold or rainy weather**

Using the recirculated air position in cold or rainy weather is dangerous as it will cause the windows to fog up. Your vision will be hampered, which could lead to a serious accident.

Heating

- 1 Set the mode selector dial to the  position.
 - 2 Set the air intake selector to the outside air position.
 - 3 Set the temperature control dial to the hot position.
 - 4 Set the fan control dial to the desired speed.
 - 5 If dehumidified heating is desired, turn on the air conditioner.
-
- If the windshield fogs up easily, set the mode selector dial to the  position.
 - If cooler air is desired at face level, set the mode selector dial to the  position and adjust the temperature control dial to maintain maximum comfort.
 - The air to the floor is warmer than air to the face (except when the temperature control dial is set at the extreme hot or cold position).

Cooling

- 1 Set the mode selector dial to the  position.
 - 2 Set the temperature control dial to the cold position.
 - 3 Set the fan control dial to the desired speed.
 - 4 Turn on the air conditioner by pressing the A/C switch.
 - 5 After cooling begins, adjust the fan control dial and temperature control dial as needed to maintain maximum comfort.
-
- When maximum cooling is desired, set the temperature control dial to the extreme cold position and set the air intake selector to the recirculated air position, then turn the fan control dial fully clockwise.
 - If warmer air is desired at floor level, set the mode selector dial to the  position and adjust the temperature control dial to maintain maximum comfort.
 - The air to the floor is warmer than air to the face (except when the temperature control dial is set at the extreme hot or cold position).

 NOTICE

If the air conditioner is used while driving up long hills or in heavy traffic, monitor the engine coolant temperature warning light to see if it is illuminated or flashing (→P. 164).





The air conditioner may cause engine overheating. If the warning light is illuminated or flashing, turn the air-conditioning off (→P. 484).

Ventilation

- 1 Set the mode selector dial to the  position.
- 2 Set the air intake selector to the outside air position.
- 3 Set the temperature control dial to the desired position.
- 4 Set the fan control dial to the desired speed.



Windshield Defrosting and Defogging

- 1 Set the mode selector dial to the  position.
- 2 Set the temperature control dial to the desired position.
- 3 Set the fan control dial to the desired speed.
- 4 If dehumidified heating is desired, turn on the air conditioner.

- For maximum defrosting, turn on the air conditioner, set the temperature control dial to the extreme hot position, and turn the fan control dial fully clockwise.
- If warm air is desired at the floor, set the mode selector dial to the  position.
- In the  or  position, the air conditioner is automatically turned on and the outside air position is automatically selected to defrost the windshield. In the  or  position, the outside air position cannot be changed to the recirculated air position.

WARNING

■ Do not defog the windshield using the  position with the temperature control set to the cold position

Using the  position with the temperature control set to the cold position is dangerous as it will cause the outside of the windshield to fog up. Your vision will be hampered, which could lead to a serious accident. Set the temperature control to the hot or warm position when using the  position.

Dehumidifying

Operate the air conditioner in cool or cold weather to help defog the windshield and side windows.

- 1 Set the mode selector dial to the desired position.
- 2 Set the air intake selector to the outside air position.
- 3 Set the temperature control dial to the desired position.
- 4 Set the fan control dial to the desired speed.
- 5 Turn on the air conditioner by pressing the A/C switch.

One of the functions of the air conditioner is dehumidifying the air and, to use this function, the temperature does not have to be set to cold. Therefore, set the temperature control dial to the desired position (hot or cold) and turn on the air conditioner when you want to dehumidify the cabin air.

Fully Automatic Type

► Type A

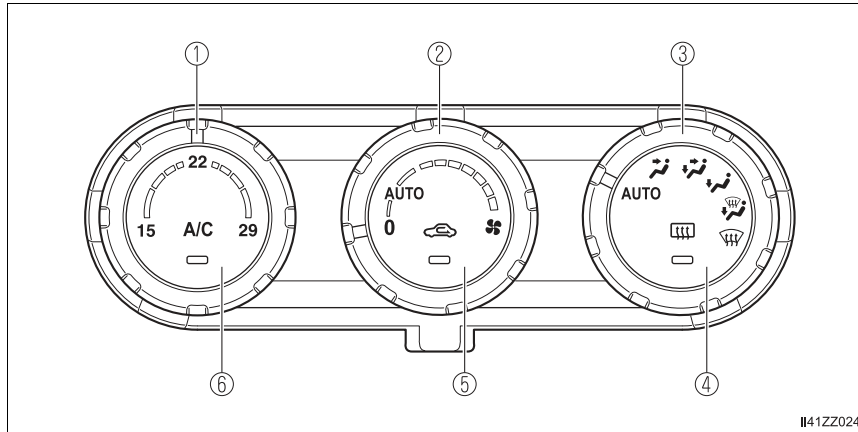

► Type B

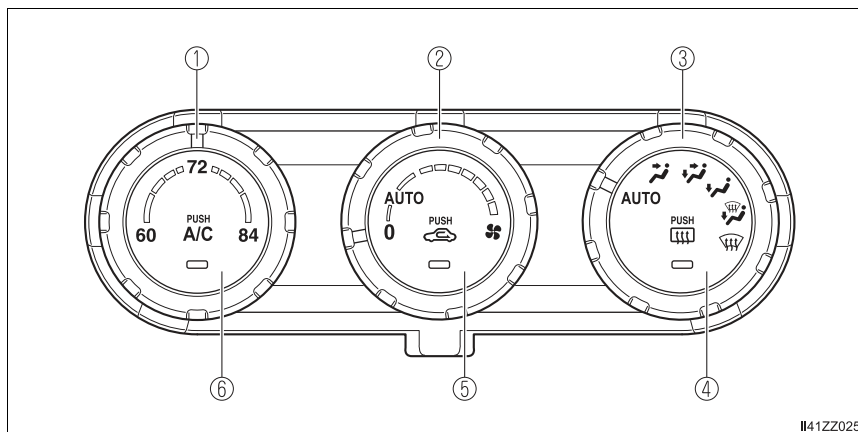

- | | |
|----------------------------|-------------------------------|
| ① Temperature control dial | ④ Rear window defogger switch |
| ② Fan control dial | ⑤ Air intake selector switch |
| ③ Mode selector dial | ⑥ A/C switch |

Control Switches

■ Temperature control dial

This dial controls temperature. Turn it clockwise for hot and counterclockwise for cold.

■ Fan control dial

The fan has seven speeds.

● AUTO position

The amount of airflow will be automatically controlled in accordance with the set temperature.

● Except AUTO position

The airflow amount can be adjusted to the desired level by turning the dial.

● 0 position

To turn off the system, set the dial to 0 position.

■ Mode selector dial

Turn the mode selector dial to select airflow mode (→P. 258).

● AUTO position

The airflow mode automatically adjusts to the selected temperature.

● Except AUTO position

The desired airflow position can be selected by turning the dial.

■ A/C switch

The air conditioner (cooling/dehumidifying functions) can be turned on or off by pressing the switch while the fan control dial is at a position other than 0.

The indicator light turns on while the air conditioner is operating.

■ Air intake selector

Outside or recirculated air positions can be selected. Press the switch to select outside/ recirculated air positions.

● Recirculated air position (indicator light illuminated)

Outside air is shut off. Use this position when going through tunnels, driving in congested traffic (high engine exhaust areas) or when quick cooling is desired.

● Outside air position (indicator light turned off)





Outside air is allowed to enter the cabin. Use this mode for ventilation or windshield defrosting.

■ Rear window defogger switch

Press the rear window defogger switch to defrost the rear window.

Refer to Rear Window Defogger on P. 207.

■ Mode selector dial

- With the airflow mode set to the  position and the temperature control dial set at a medium temperature, heated air is directed to the feet and air at a comparably lower temperature will flow through the central, left and right vents.
- When the fan control dial is ON, and the mode selector dial is in the  or  position, the air conditioner is automatically turned on and the outside air position is automatically selected to defrost the windshield. In the  or  position, the outside air position cannot be changed to the recirculated air position.

■ A/C switch

The air conditioner may not function when the outside temperature approaches 0 °C (32 °F).

WARNING

■ Do not use the position in cold or rainy weather:

Using the  position in cold or rainy weather is dangerous as it will cause the windows to fog up. Your vision will be hampered, which could lead to a serious accident.

Operation of Automatic Air Conditioner

- 1 Set the mode selector dial to the AUTO position.
- 2 Set the air intake selector to the outside air position (indicator light turned off).
- 3 Set the fan control dial to the AUTO position.
- 4 Press the A/C switch to operate the air conditioner (turn indicator light on).
- 5 Set the temperature control dial to the desired position.
- 6 To turn off the system, set the fan control dial to the 0 position.

Operation of Automatic Air conditioner

- If the recirculated air position is used for long periods in cold weather or high humidity, the windshield may fog up more easily.
- Setting the temperature to maximum hot or cold will not provide the desired temperature at a faster rate.
- When selecting heat, the system will restrict airflow until it has warmed to prevent cold air from blowing out of the vents.

Windshield Defrosting and Defogging

Set the mode selector dial to the  position and turn the fan control dial to the desired speed.

In this position, the outside air position is automatically selected, and when the fan control dial is ON, the air conditioner automatically turns on. The air conditioner will directly dehumidify the air to the front windshield and side windows (→P. 258). Airflow amount will be increased.

Use the temperature control dial to increase the air flow temperature and defog the windshield more quickly.

WARNING

■ Set the temperature control to the hot or warm position when defogging (position):

Using the  position with the temperature control set to the cold position is dangerous as it will cause the outside of the windshield to fog up. Your vision will be hampered, which could lead to a serious accident.

Sunlight/Temperature Sensor

■ Rear window defogger switch

● Sunlight sensor

Do not place objects on the sunlight sensor. Otherwise, the interior temperature may not adjust correctly.

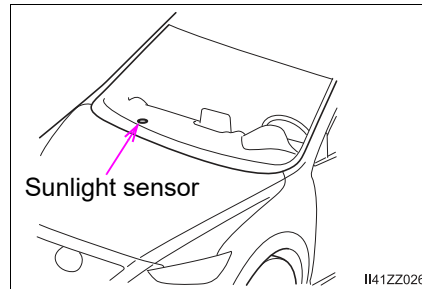

● Interior temperature sensor

Do not cover the interior temperature sensor. Otherwise, the interior temperature may not adjust correctly.

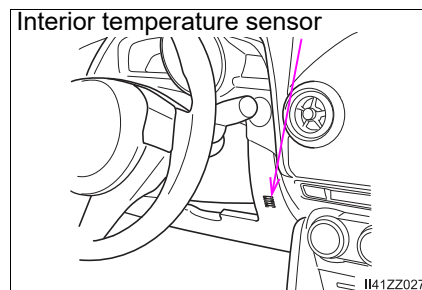

Antenna

▶ 4-Door

■ AM/FM Radio Antenna

The AM/FM radio antenna receives both AM and FM signals.
The antenna is embedded into the window glass.

■ Satellite Radio Antenna (if equipped)

The satellite radio antenna receives SiriusXM signals.

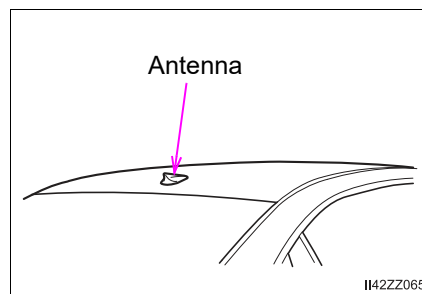

NOTICE

■ AM/FM Radio Antenna

When washing the inside of the window which has an antenna, use a soft cloth dampened in lukewarm water, gently wiping the antenna lines. Use of glass cleaning products could damage the antenna.

▶ 5-Door

■ AM/FM Radio Antenna (if equipped)

The AM/FM radio antenna receives both AM and FM signals.

▶ Type A

- ① To remove the antenna, turn it counterclockwise.
- ② To install the antenna, turn it clockwise.

Make sure the antenna is securely installed.

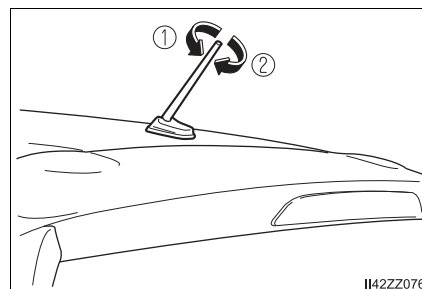

► Type B

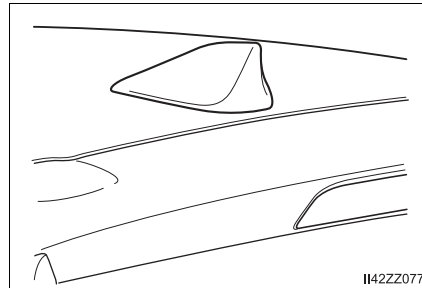

 NOTICE

■ **AM/FM Radio antenna**

Type A only:

- To prevent damage to the antenna, remove it before entering a car wash facility or passing beneath a low overhead clearance.
- Be careful around the antenna when removing snow from the roof. Otherwise the antenna could be damaged.
- When leaving your vehicle unattended, we recommend that you remove the antenna and store it inside the vehicle.

■ **Antenna for AM/FM and Satellite Radio Antenna (if equipped)**

The antenna for AM/FM and satellite radio antenna receives both AM and FM signals and SiriusXM signals.

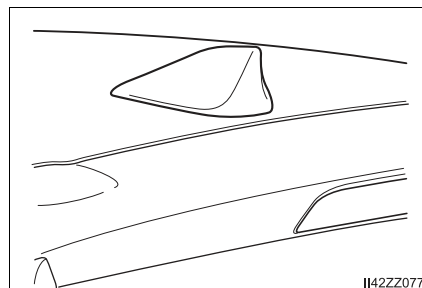

Operating Tips for Audio System

Do not spill any liquid on the audio system.

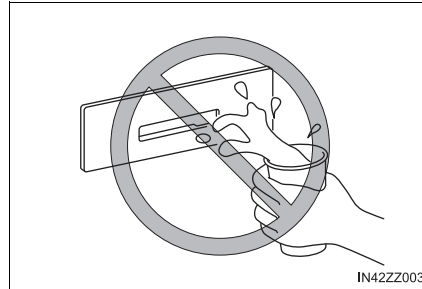

- To prevent the battery from being discharged, do not leave the audio system on for a long period of time when the engine is not running.
- If a cellular phone or CB radio is used in or near the vehicle, it could cause noise to occur from the audio system, however, this does not indicate that the system has been damaged.

WARNING

■ Always adjust the audio while the vehicle is stopped

Do not adjust the audio control switches while driving the vehicle. Adjusting the audio while driving the vehicle is dangerous as it could distract your attention from the vehicle operation which could lead to a serious accident.

Even if the audio control switches are equipped on the steering wheel, learn to use the switches without looking down at them so that you can keep your maximum attention on the road while driving the vehicle.

NOTICE

For the purposes of safe driving, adjust the audio volume to a level that allows you to hear sounds outside of the vehicle including car horns and particularly emergency vehicle sirens.

Radio Reception

■ AM characteristics

AM signals bend around such things as buildings or mountains and bounce off the ionosphere.

Therefore, they can reach longer distances than FM signals.

Because of this, 2 stations may sometimes be picked up on the same frequency at the same time.

- ① Ionosphere
- ② Station 1
- ③ Station 2

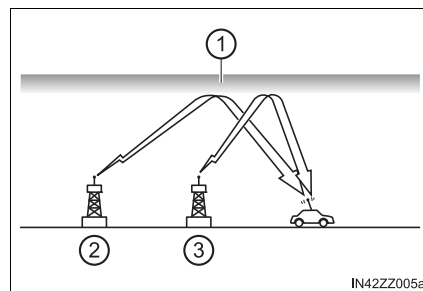

■ FM characteristics

An FM broadcast range is usually about 25 - 30 miles (40 - 50 km) from the source. Because of extra coding needed to break the sound into 2 channels, stereo FM has even less range than monaural (non-stereo) FM.

- ① FM Station
- ② 25 - 30 miles (40 - 50 km)

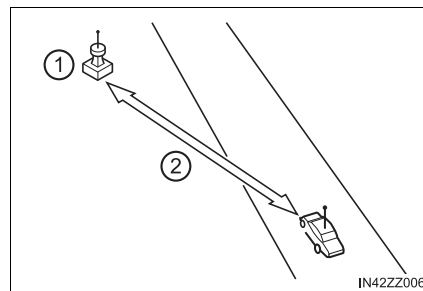

Signals from an FM transmitter are similar to beams of light because they do not bend around corners, but they do reflect. Unlike AM signals, FM signals cannot travel beyond the horizon. Therefore, FM stations cannot be received at the great distances possible with AM reception.

- ① Ionosphere
- ② FM wave
- ③ AM wave
- ④ 60 - 120 miles (100 - 200 km)
- ⑤ Obstruction

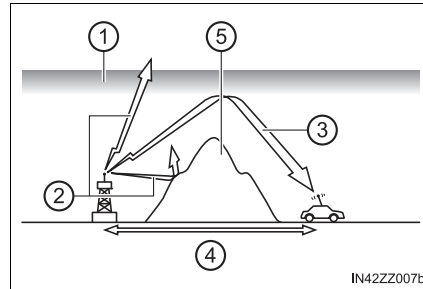

Atmospheric conditions can also affect FM reception. High humidity will cause poor reception. However, cloudy days may provide better reception than clear days.

● Multipath noise

Since FM signals can be reflected by obstructions, it is possible to receive both the direct signal and the reflected signal at the same time. This causes a slight delay in reception and may be heard as a broken sound or a distortion. This problem may also be encountered when in close proximity to the transmitter.

- ① Direct
- ② Reflected wave

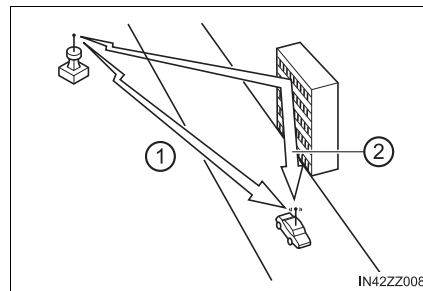

● Flutter/Skip noise

Signals from an FM transmitter move in straight lines and become weak in valleys between tall buildings, mountains, and other obstacles. When a vehicle passes through such an area, the reception conditions may change suddenly, resulting in annoying noise.

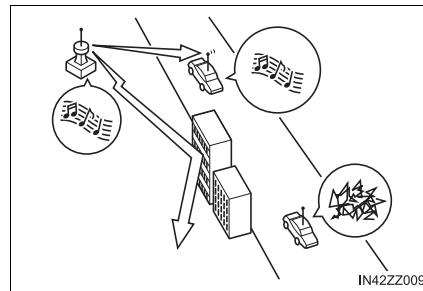

● Weak signal noise

In suburban areas, broadcast signals become weak because of distance from the transmitter. Reception in such fringe areas is characterized by sound breakup.

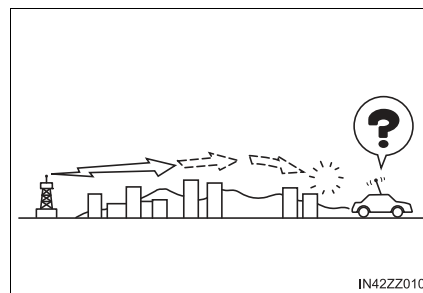

● Strong signal noise

This occurs very close to a transmitter tower. The broadcast signals are extremely strong, so the result is noise and sound breakup at the radio receiver.

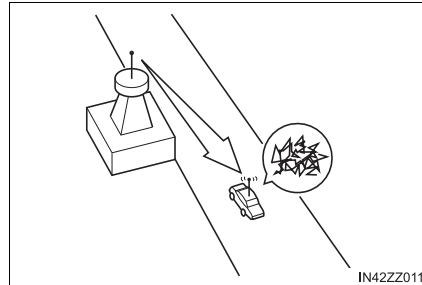

● Station drift noise

When a vehicle reaches the area of 2 strong stations broadcasting at similar frequencies, the original station may be temporarily lost and the second station picked up. At this time there will be some noise from this disturbance.

- ① Station 1
88.1 MHz
- ② Station 2
88.3 MHz

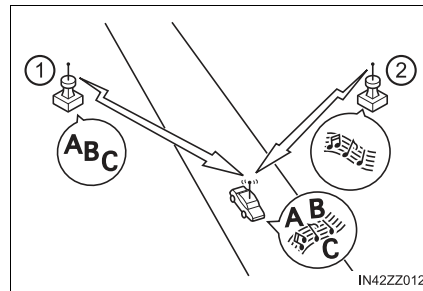

4
Interior Features

Operating Tips for MP3

MP3 stands for MPEG Audio Layer 3, which is standardized voice compression established by the ISO*1 working group (MPEG).

Use of MP3 allows for audio data to be compressed to approximately a tenth of the source data size.

This unit plays files with the extension (.mp3) as MP3 files.

*1: International Organization for Standardization

- When naming an MP3 file, be sure to add an MP3 file extension (.mp3) after the file name.
- The number of characters which can be displayed is restricted.

Supply of this product only conveys a license for private, non-commercial use and does not convey a license nor imply any right to use this product in any commercial (i.e. revenue-generating) real time broadcasting (terrestrial, satellite, cable and/or any other media), broadcasting/streaming via the Internet, intranets and/or other networks or in other electronic content distribution systems, such as pay-audio or audio-on-demand applications. An independent license for such use is required.

For details, please visit <http://www.mp3licensing.com>.

 NOTICE

Do not use an audio file extension on files other than audio files. In addition, do not change the audio file extension. Otherwise, the unit will not recognize the file correctly resulting in noise or a malfunction.

Operating Tips for WMA

WMA is short for Windows Media Audio and is the audio compression format used by Microsoft.

Audio data can be created and stored at a higher compression ratio than MP3.

This unit plays files with the extension (.wma) as WMA files.

*: Microsoft and Windows Media are registered trademarks of Microsoft Corporation U.S. in the United States and other countries.

- WMA files written under specifications other than the indicated specification may not play normally or files or folder names may not display correctly.
- The file extension may not be provided depending on the computer operating system, version, software, or settings. In this case, add the file extension “.wma” to the end of the file name, and then write it to the memory.

 NOTICE

Do not use an audio file extension on files other than audio files. In addition, do not change the audio file extension. Otherwise, the unit will not recognize the file correctly resulting in noise or a malfunction.

Operating Tips for AAC

AAC stands for Advanced Audio Coding, which is standardized voice compression established by the ISO*¹ working group (MPEG). Audio data can be created and stored at a higher compression ratio than MP3.

This unit plays files with the extensions (.aac/.m4a/.wav) as the AAC files.

- AAC files written under specifications other than the indicated specification may not play normally or files or folder names may not display correctly.
- The file extension may not be provided depending on the computer operating system, version, software, or settings. In this case, add the file extension “.aac”, “.m4a”, or “.wav” to the end of the file name, and then write it to the memory.

*1: International Organization for Standardization



NOTICE

Do not use an audio file extension on files other than audio files. In addition, do not change the audio file extension. Otherwise, the unit will not recognize the file correctly resulting in noise or a malfunction.

Operating Tips for OGG

OGG is the audio compression format for Xiph. Org Foundation.

Audio data can be created and stored at a higher compression ratio than MP3.

This unit plays files with the extension (.ogg) as OGG files.

- OGG files written under specifications other than the indicated specification may not play normally or files or folder names may not display correctly.
- The file extension may not be provided depending on the computer operating system, version, software, or settings. In this case, add the file extension “.ogg” to the end of the file name, and then write it to the disc.



NOTICE

Do not use an audio file extension on files other than audio files. In addition, do not change the audio file extension. Otherwise, the unit will not recognize the file correctly resulting in noise or a malfunction.

Operating Tips for USB device

This unit plays audio files as follows:

Extension	Playback with this unit
.mp3	MP3
.wma	WMA
.aac	AAC
.m4a	
.wav	
.ogg	OGG

MP3/WMA/AAC/OGG*1 files written under specifications other than the indicated specification may not play normally or files/folder names may not display correctly.

- Playback may not be possible depending on the type and condition of the USB flash memory even if the audio file complies with the standard above.
- A copyright protected WMA/AAC file cannot be played in this unit.
- The order of the music data stored in the device may differ from the playback order.
- To prevent loss or damage of stored data, we recommend that you always back up your data.
- If the current consumption of the connected device exceeds the following current value, it may not operate or recharge.
 - Apple device is connected: 2,100mA
 - Device compatible with BC1.2 is connected: 1,500 mA
 - Device other than the above is connected: 500 mA
- Do not pull out the USB device while in the USB mode (only pull it out while in FM/AM radio mode).
- The device will not operate if the data is password protected.

 NOTICE

Do not use an audio file extension on files other than audio files. In addition, do not change the audio file extension. Otherwise, the unit will not recognize the file correctly resulting in noise or a malfunction.

Agreements and disclaimers related to Apple CarPlay™

This unit is compatible with Apple CarPlay™ which can operate an iPhone® using the vehicle's audio device.

- iPhone, Siri and Apple Music are registered trademarks of Apple Inc.
- Apple CarPlay is trademarks of Apple Inc.
- iOS is a trademark or registered trademark of Cisco in the U.S. and other countries and is used under license.

May not be compatible depending on the model or OS version.

To prevent loss or damage of stored data, we recommend that you always back up your data.

 NOTICE

- For the purposes of safety, do not operate your iPhone® while driving.
- Disconnect the iPhone® when it is not in use. If the device is left in the cabin, it could be damaged or the battery may deteriorate due to the excessive temperature or humidity inside the cabin.
- If the iPhone® battery has deteriorated, it may not recharge or play audio even if it is connected to this unit.
- Before use, carefully read the user instructions for the iPhone®.

Operating Tips for Android™

Requires the Android Auto app on Google Play and an Android compatible smartphone running Android™ 5.0 Lollipop or higher.

- Google, Android, Android Auto and other related marks are trademarks of Google LLC.

To prevent loss or damage of stored data, we recommend that you always back up your data.

 NOTICE

- For the purposes of safety, do not operate your Android™ Smartphone while driving.
- Disconnect the Android™ Smartphone when it is not in use. If the device is left in the cabin, it could be damaged or the battery may weaken due to the excessive temperature or humidity inside the cabin.
- If the Android™ Smartphone battery has deteriorated, it may not recharge or play audio even if it is connected to this unit.
- Before use, carefully read the user instructions for the Android™ Smartphone.

Audio Set

Audio Set has 3 different human interfaces.

- Commander switch
- Touch panel
- Voice recognition with steering switch and microphone

The explanation of functions described in this manual may differ from the actual operation, and the shapes of screens and buttons and the letters and characters displayed may also differ from the actual appearance.

Additionally, depending on future software updates, the content may successively change without notice.

■ Commander switch operation

For safety reasons, some operations are disabled while the vehicle is being driven.

● Volume dial operation

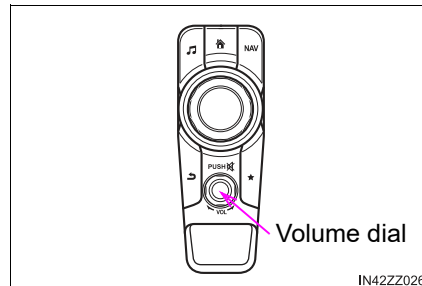

Press the volume dial to mute and pause. However, while an audio source which cannot be paused such as FM radio is playing, only mute is available. Press the volume dial again to resume the audio.

Turn the volume dial to adjust the volume. The volume increases by turning the dial clockwise, and decreases by turning it counterclockwise.





● Switches around commander knob

The following operations can be done by pressing the switches around the commander knob.

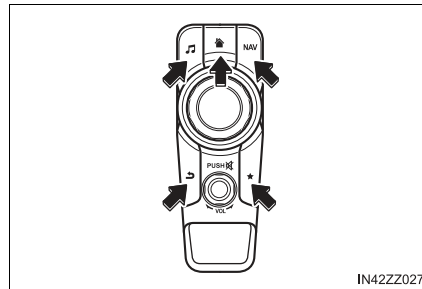
-  : Displays the home screen.
-  : Displays the Entertainment screen.
- NAV** : Displays the Navigation screen (Only navigation-equipped vehicles).



For operation of the Navigation screen, refer to the navigation system manual. If the SD card for the navigation system is not inserted, the compass indicating the direction in which the vehicle is moving is displayed.

-  : Displays the Favorites screen. Long-press to store particular items in Favorites. (Radio, phonebook and destination of the navigation system can be programmed.)
-  : Returns to previous screen.

● Commander knob operation

Selection of icons on screen:

- 1 Tilt or turn the commander knob and move the cursor to the desired icon.
- 2 Press the commander knob and select the icon.

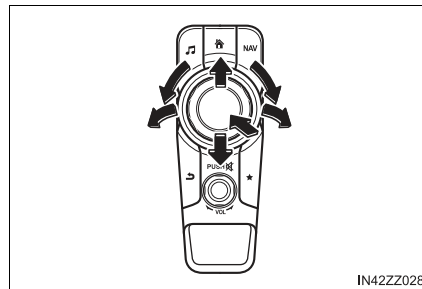

■ **Touch panel operation**

For safety reasons, operation of the center display is disabled while the vehicle is being driven. However, items not displayed in gray can be operated using the commander switch while the vehicle is being driven.

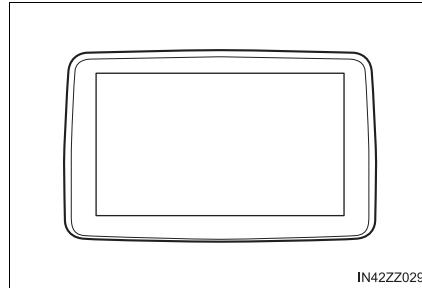

■ **Commander switch operation**

Long-press operation of the commander knob is also possible for some functions.

NOTICE

■ **Touch panel operation**

Do not press the screen strongly or press it with a sharp-pointed object. Otherwise, the screen could be damaged.

Basic Operation Method

■ **TOUCH & TAP**

- 1 Touch or tap on the item indicated on the screen.
- 2 The operation is launched and the next item is displayed.

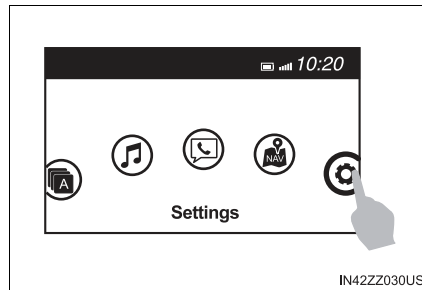

4
Interior Features

■ SLIDE

- 1 Touch the setting item displaying a slider bar.
- 2 Touch the slider with your finger and move to the desired level.

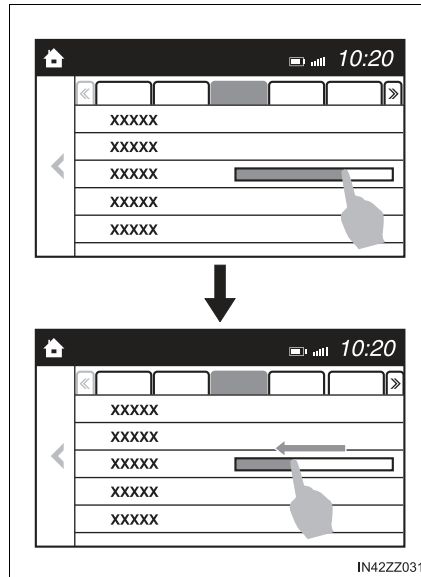

■ SWIPE

- 1 Touch the screen with your finger and move up or down.
- 2 Items which were not displayed can be displayed.

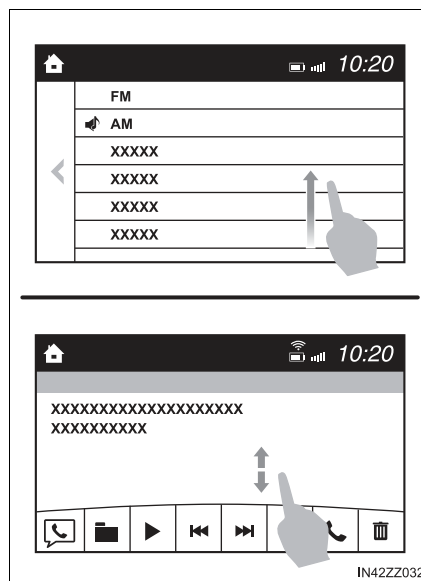







■ **Return to previous screen**

Touch the  .

■ **Displaying the home screen**

Touch the  .

Home screen

Icon	Function
	<p>Applications Information such as average fuel economy, maintenance, and warnings can be verified. Depending on the grade and specification, the screen display may differ.</p>
	<p>Entertainment Operates audio such as the radio. The audio source most recently used is displayed. An audio source which cannot be used at that time is skipped and the previous audio source is displayed. To change the audio source, select the  icon displayed at the bottom of the screen.</p>
	<p>Communication Bluetooth® related functions are available.</p>
	<p>Navigation Navigation screen is displayed (vehicles with navigation system). If the SD card for the navigation system is not inserted, the compass indicating the direction in which the vehicle is moving is displayed. The compass may not indicate the correct bearing when the vehicle is stopped or traveling at a slow speed.</p>
	<p>Settings Overall setting menu (Such as display, sound, Bluetooth® and Language). Depending on the grade and specification, the screen display may differ.</p>

Volume/Display/Sound Controls

▶ Commander switch

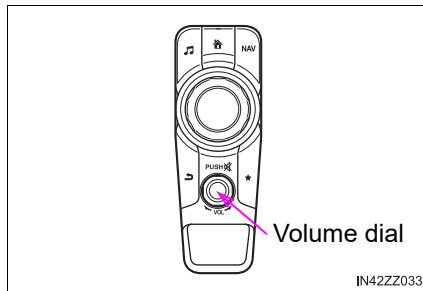

▶ Audio control switch

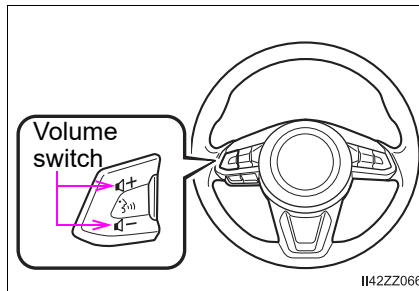

■ Volume adjustment

Turn the commander switch volume dial. The volume switch on the steering switch can also be pressed.

Press the volume dial to mute and pause. However, while an audio source which cannot be paused such as FM radio is playing, only mute is available. Press the volume dial again to resume the audio.

■ Display setting

Select the  icon on the home screen and display the Settings screen.

Select the **Display** tab to select the item you would like to change.

● Display OFF/Clock

The center display can be turned off. Select **Turn Display Off** to turn the display off. When **Turn Display Off and Show Clock** is selected the center display turns off and the clock is displayed.

The center display can be turned back on as follows:

- Touch the center display.
- Operate the commander switch.

● Daytime/nighttime (System) screen setting

The daytime or nighttime screen can be selected.

Auto: Switches screen automatically according to parking lights illumination condition*1

Day: Daytime screen setting

Night: Nighttime screen setting

*1: The display is constantly on daytime screen when the illumination dimmer is cancelled.

- **Brightness adjustment**
Adjust the center display brightness using the slider.
- **Contrast adjustment**
Adjust the center display contrast using the slider.
- **Display setting reset**
All of the screen setting values can be reset to their initial settings.

1 Select **Restore Factory settings**.

2 Select **Yes**.

■ Audio sound adjustment

Select the  icon on the home screen and display the Settings screen.

Select the **Sound** tab to select the item you would like to change.

Indication	Setting value
Bass (Low pitch sound)	+ Side: Low pitch enhancement - Side: Low pitch reduction
Treble (Treble sound)	+ Side: Treble enhancement - Side: Treble reduction
Fade (Front/Rear volume balance)	Front: Front speaker volume enhancement Rear: Rear speaker volume enhancement
Balance (Left/right volume balance)	Right: Right speaker volume enhancement Left: Left speaker volume enhancement
ALC (Automatic volume adjustment)	Off—Adjustment at seven levels
Beep (Audio operation sound)	On/Off

- ALC (Automatic volume adjustment)





The automatic level control (ALC) is a feature that automatically adjusts audio volume according to the vehicle speed. The volume increases in accordance with the increase in vehicle speed, and decreases as vehicle speed decreases.





Operating the Radio

■ Radio ON

Select the  icon on the home screen to display the Entertainment screen. When selecting the desired radio, the following icons are indicated in the lower part of the center display.

- AM/FM Radio

Icon	Function
	Displays the Entertainment menu. Use to switch to a different audio source.
	Displays the station list. Select Update Station List to display the frequencies of up to ten radio stations on the auto memory preset list. Select the desired frequency.
	Displays the Favorites list. Long-press to store radio station currently being aired.
	Switches the HD Radio on and off. Displays the multicast channel list of the HD Radio .
	You can search for receivable radio stations. Scanning stops at each station for about five seconds. Select again to continue receiving the radio station.

Icon	Function
	<p>You can change the radio frequency manually. Rotate the commander knob, slide the screen, or touch the radio frequency.</p> <p>Press ◀ or ▶ to change the radio frequency one step at a time.</p> <p>When ◀ or ▶ is long-pressed, the radio frequency changes continually. It stops when you remove your hand from the icon or the commander knob.</p>
	<p>Launches the iTunes Tagging function (for Apple devices with USB use only). Can be used when the HD Radio is on.</p>
	<p>Automatic radio station selection.</p>
	<p>When long-pressed, the radio frequency changes continually. It stops when you remove your hand from the icon or the commander knob.</p>
	<p>Displays sound settings to adjust audio quality level. Refer to Volume/Display/Sound Controls on P. 288.</p>

■ Favorites Radio

Selected stations can be registered for convenient operation. Up to 50 stations can be registered. The Favorites list is common to AM, FM, and satellite radio.

● Registering to Favorites

Long-press the ★ icon to register the current radio station. The registration can also be performed using the following procedure.

- 1 Select the ★ icon to display the Favorites list.
- 2 Select **Add/Edit Radio Favorites**.
- 3 Select **Add <active station>**.
- 4 The station is added to the bottom of the Favorites list.

● Selecting radio station from Favorites

- 1 Select the ★ icon to display the Favorites list.
- 2 Select the radio frequency to tune in the radio station.

● Deleting from Favorites

- 1 Select the ★ icon to display the Favorites list.
- 2 Select **Add/Edit Radio Favorites**.
- 3 Select **Delete**.
- 4 Select the radio frequency you want to delete.
- 5 Select **Delete**.

● Changing Favorites list order

- 1 Select the ★ icon to display the Favorites list.
- 2 Select **Add/Edit Radio Favorites**.
- 3 Select **Move**.
- 4 Select a radio frequency. The selected radio station can be moved.
- 5 Slide the radio station or move it using the commander switch, then select **OK**.

■ Radio Broadcast Data System (RBDS) (if equipped)





● Radio text information display

Radio text information sent from a broadcasting station is displayed in the center display.

● Genre Seek

Some FM stations transmit Genre codes (Program type like a Rock, News, and so on). This code enables alternative stations transmitting the same Genre code to be found quickly.

To scan for Genre Seek:

- 1 Select the  icon while in the FM mode.
- 2 Select  to open the genre list.
- 3 Select the genre type you want to select.
- 4 Select the  ,  icon.

Ex.)

89.3 is currently being received. With Rock selected as the Genre, the radio stations broadcasting Rock are at the following frequencies.

98.3*1, 98.7, 104.3*1, 107.1

*1: Radio stations with good reception

The frequency changes as follows each time  is pressed.
89.3→98.3→104.3→98.3

■ HD Radio

● What is HD Radio™ Technology and how does it work?

HD Radio™ Technology is the digital evolution of analog AM/FM radio. Your radio product has a special receiver which allows it to receive digital broadcasts (where available) in addition to the analog broadcasts it already receives. Digital broadcasts have better sound quality than analog broadcasts as digital broadcasts provide free, crystal clear audio. For more information, and a guide to available radio stations and programming, please visit www.hdradio.com.

- Benefits of HD Radio™ Technology

Information:



The song title, artist name, album name and genre will appear on the screen when available by the radio station.

Multicast:

On the FM radio frequency most digital stations have “multiple” or supplemental programs on each FM station.

- Listening to HD Radio™ Technology

If  icon turns on by selecting a radio station which is an HD Radio broadcasting station, the analog broadcast is switched to an HD Radio broadcast automatically after a few seconds and then received.

If the HD Radio broadcast is stopped and changed to an analog broadcast, press down  to turn off  .

- **Multicast channel selection (FM)**

If multi-cast channels are available for an HD Radio broadcast currently being received, the multi-cast channel list is displayed. Select the desired radio station.

- **iTunes Tagging (for Apple devices with USB use only)**

By tagging a song currently being aired, the song can later be purchased from the iTunes Store. One hundred tags can be stored. A maximum of 100 tags (for 100 songs) can be stored for later downloading.

- 1 Select the  icon. The tag is stored in the audio unit.
- 2 Connect the device via the vehicle's USB. Any stored tag(s) will be sent automatically to the connected device.
- 3 Once at home or after parking the vehicle safely, log onto the iTunes Store with your device. Your previously tagged song(s) can now be easily purchased.





- **Favorites Radio**

If the battery is disconnected, your Favorites list will not be deleted.

- **Radio Broadcast Data System (RBDS)**

- Radio text information is a function of FM radio only. There is no text function on AM radio. Text information is not displayed in the following:
 - During HD Radio reception
 - Not an RBDS broadcast
 - RBDS broadcast, but radio text is not transmitted from the radio station
- To change the desired genre, select the  icon.
- Only one Genre can be selected.
- It may not be possible to receive any station even if the Genre Seek function is used.
- If a program in the selected genre is not broadcast to a region, reception is not possible even if the Genre Seek function is used.
- The Genre Seek function searches for genre code (program type) which FM analog broadcasts transmit. HD Radio specialty programs (HD2-HD8) cannot be searched because they are not FM analog broadcasts.
- If radio stations which are selected by scanning using the Genre Seek function are HD Radio broadcasting stations, they are changed from analog broadcasts to HD Radio broadcast.

■ HD Radio

- If an analog broadcast is received once and HD Radio is received while HD1 is selected, the audio unit switches to the HD Radio station automatically.
- When the  icon is illuminated, there could be a noticeable difference in sound quality and volume when a change from digital to analog signals occurs. If the sound quality and volume become noticeably diminished or cut off, select the  icon to turn off HD Radio ( icon is not illuminated).
- Once an analog broadcast is received when HD1 is selected from the Favorite channels, it is switched to HD Radio automatically. If the radio reception conditions are poor, or HD is off, switching to HD Radio broadcasts is not possible.
- When an HD specialty channel (HD2 to HD8) is selected from the Favorite channels, "Signal Lost" is displayed and no audio is output until HD Radio is received. If the radio reception conditions are poor, "Signal Lost" continues to be displayed.
- If the  icon is not illuminated, information such as song titles of the HD Radio station are received, however, the audio output is analog.

■ iTunes Tagging (for Apple devices with USB use only)

- Both AM and FM HD Radio can be used.
- Because iTunes tagging only supports purchases from the iTunes Store, direct downloading of music from the vehicle's audio unit is not possible.
- If the available memory for the connected device is insufficient, the tag is not sent.
- If an error occurs while the tag is being sent, reconnect the device.

Operating the Satellite Radio (if equipped)

■ What is satellite radio?

- SiriusXM[®] Satellite Radio



SiriusXM satellite radio is a subscription-based satellite radio service that broadcasts a variety of music, sports, news, weather, traffic and entertainment programming.

Your new Toyota vehicle is factory-installed with SiriusXM satellite radio hardware and includes a limited trial subscription term that begins on the date of sale or lease of your vehicle. See an authorized dealer for availability.

The satellite radio service should be active in your vehicle, if you cannot hear SiriusXM audio, please activate online by visiting siriusxm.com/refresh or by calling SiriusXM Listener Care at 1-877-447-0011 (U.S.A.)/1-888-539-7474 Customer Care (Canada).

You can find the radio ID by turning to Channel 0 or visiting siriusxm.com/activationhelp (U.S.A), and siriusxm.ca/subscribe-now/ (Canada).

For more information on extended subscription terms (a service fee is required), the online media player and a list of SiriusXM satellite radio channels, and other features, please visit www.siriusxm.com (U.S.A), and www.siriusxm.ca (Canada), or call SiriusXM at 1-877-447-0011 (U.S.A.)/1-888-539-7474 (Canada).









This feature may not be available in all markets and requires an active subscription. SiriusXM reserves the unrestricted right to change, rearrange, add or delete programming. This includes canceling, moving or adding particular channels, and its prices, at any time, with or without notice to you. Toyota shall not be responsible for any such programming changes.

■ Displaying the Radio ID (ESN)

When channel 0 is selected, the radio ID is displayed. Use the PREVIOUS or NEXT channel buttons to select channel 0.

■ SiriusXM operation

Select the  icon on the home screen to display the Entertainment screen. When **XM** is selected, the following icons are indicated in the bottom part of the center display.

Icon	Function
	Displays the Entertainment menu. Use to switch to a different audio source.
	Displays the channel list of the current category.
	Displays the favorites list. Long-press to store the channel currently being aired. Refer to Operating the Radio on P. 290.
	Indicates that the parental lock function is in use. Switching of Lock/Unlock and PIN code setting changes can be performed.
	Plays each channel in the current channel list for 5 seconds. Select again to continue receiving the channel.
	Plays the previous channel.
	Plays the next channel.
	Displays sound settings to adjust audio quality level. Refer to Volume/Display/Sound Controls on P. 288.

● Selection from channel list

Receivable channels can be displayed on the channel list screen. You can easily select the channel you want to listen from the list. Each category can be also displayed.

- 1 Select the  icon to display the channel list.
- 2 Select a desired channel.

Select from category list:

- 1 Select the  icon to display the channel list.
- 2 Select **Category:** to display the category list.
- 3 Select a desired category.

How to use Auxiliary jack/USB port

Audio can be heard from the vehicle's speakers by connecting a commercially-available portable audio unit to the auxiliary jack.

Use a commercially-available, non-impedance (3.5Ø) stereo mini plug cable.

In addition, audio can be played from the vehicle audio device by connecting a USB device to the USB port.

Refer to AUX/USB mode on P. 307.

Settings

Select the  icon on the home screen and display the Settings screen. Switch the tab and select the setting item you want to change.

You can customize settings in the setup display as follows:

Tab	Item	Function
Display	Refer to Volume/Display/Sound Controls on P. 288.	
Safety	Low Speed Pre-Collision System	Refer to Customizable Features on P. 555.
Sound	Refer to Volume/Display/Sound Controls on P. 288.	
Clock	Adjust Time	Displays the currently set time is displayed. Press + to advance the hour/minute, and select - to move the hour/minute back. AM/PM can only be selected with the 12-hour clock display.
	GPS Sync	Synchronizes with GPS when turned on. When turned off, the time can be changed from "Adjust Time".
	Time Format	Changes the display between 12 and 24-hour clock time.
	Time Zone Select	When it's not synchronized with GPS, select the region you want to specify.
	Daylight Savings Time	Turns the daylight saving time setting on/off. When ON, the time advances 1 hour. When OFF, it returns to normal time.
Vehicle	Rain Sensing Wiper Door Locks Other	Refer to Customizable Features on P. 555.
Devices	Bluetooth®	Refer to Bluetooth® Preparation on P. 330.

Tab	Item	Function
Devices	Android Auto	<p>An Android Auto™ mode connection can be set on or off when connecting an Android™ Smartphone.</p> <p>For setting to take effect, it is necessary to connect the Android Phone Again</p> <p>Displays in gray and cannot be selected if an Android™ Smartphone is not connected.</p>
	Apple CarPlay	<p>An Apple CarPlay™ connection can be set on or off when connecting an iPhone®.</p> <p>For setting to take effect, it is necessary to connect the iPhone® again.</p> <p>Displays in gray and cannot be selected if an iPhone® is not connected.</p>

Tab	Item	Function
System	Tool Tips	Turns button explanations ON/OFF.
	Language	Changes the language.
	Temperature	Changes the setting between Fahrenheit and Celsius.
	Distance	Changes the setting between miles and kilometers.
	Music Database Update	Used to update Gracenote®. Gracenote® is used with USB Audio and Bluetooth® Audio, and provides: <ul style="list-style-type: none"> • Supplemental music information (Such as song name, artist name) • Voice recognition assistance for Play Artist and Play Album Gracenote® can be downloaded from the Toyota website. Refer to Gracenote® Database on P. 313.
	Restore All Factory Settings	Memory and settings are initialized to the factory settings. The initialization launches by selecting the <input type="checkbox"/> Yes button.
	About	Agreements and Disclaimers
Version Information		Can verify the current audio unit OS version and Gracenote® Database version.

Depending on the grade and specification, the screen display may differ.

Applications

Select the  icon on the home screen to display the Applications screen. The following information can be verified.

Top screen		Item	Function
Fuel Economy Monitor		Fuel Consumption Display	Refer to Fuel Economy Monitor on P. 221.
Vehicle Status Monitor	Warning Guidance	Warnings currently active can be verified.	Refer to If a Warning Light Turns On or Flashes on P. 489.
	Maintenance	<ul style="list-style-type: none"> • Scheduled Maintenance • Tire Rotation • Oil Change 	Refer to Maintenance Monitor on P. 388.
Apple CarPlay		—	Refer to How to use Apple CarPlay™ on P. 317
Android Auto		—	Refer to How to use Android Auto™ mode on P. 321

Depending on the grade and specification, the screen display may differ.

Audio Control Switch Operation

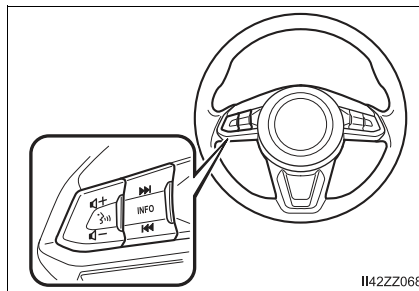

Adjusting the Volume



To increase the volume, press up the volume switch (+).

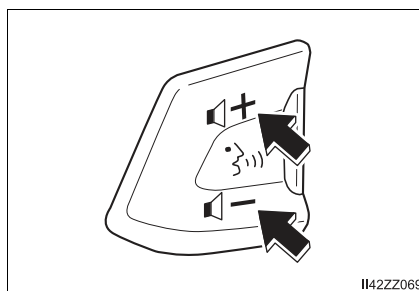

To decrease the volume, press down the volume switch (-).







Seek Switch

■ AM/FM radio

Press the seek switch ( , ). The radio switches to the next/previous stored station in the order that it was stored.

Press and hold the seek switch ( , ) to seek all usable stations at a higher or lower frequency whether programmed or not.

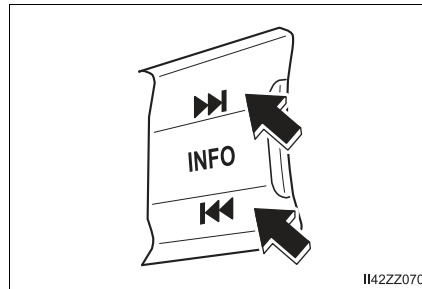

Radio stations which have been previously stored in the favorite radio can be called up by pressing the seek switch ( , ) while any radio station stored in the favorite radio is being received. Radio stations can be called up in the order they were stored with each press of the switch ( , ).



■ USB Audio/Bluetooth® Audio

Press the seek switch () to skip forward to the beginning of the next track.

Press the seek switch () within a few seconds after playback begins to track down to the beginning of the previous track.

Press the seek switch () after a few seconds have elapsed to start playback from the beginning of the current track. Press and hold the seek switch ( , ) to continuously switch the tracks up or down.

■ Pandora®/Aha™/Stitcher™ Radio

Press the seek switch () to skip forward to the beginning of the next track.

Press and hold the seek switch () to evaluate the playback of the current song as “Like”.

Press and hold the seek switch () to evaluate the playback of the current song as “Dislike”.

AUX/USB mode

Audio can be heard from the vehicle's speakers by connecting a commercially-available portable audio unit to the auxiliary jack.

A commercially-available, non-impedance (3.5 ϕ) stereo mini plug cable is required. Contact your Toyota dealer for details.

In addition, audio can be played from the vehicle audio device by connecting a USB device to the USB port.

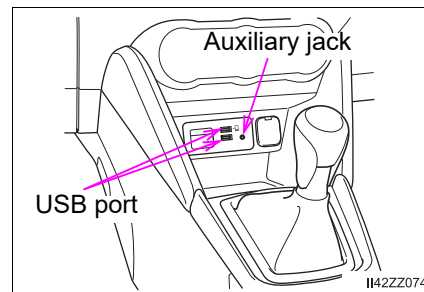

- How to use AUX mode (→P. 310)
- How to use USB mode (→P. 310)
- How to use Apple CarPlay™ (→P. 317)
- How to use Android Auto™ mode (→P. 321)

- The SD card slot is for the navigation system. For vehicles with the navigation system, the SD card (Toyota genuine) with stored map data is inserted into the SD card slot and used.
- This mode may not be usable depending on the portable audio device to be connected.
- Before using the auxiliary jack/USB port, refer to the instruction manual for the portable audio device.
- Use a commercially-available, non-impedance (3.5 ϕ) stereo mini plug for connecting the portable audio unit to the auxiliary jack. Before using the auxiliary jack, read the manufacturer's instructions for connecting a portable audio unit to the auxiliary jack.
- To prevent discharging of the battery, do not use the auxiliary input for long periods with the engine off or idling.
- When connecting a device to the auxiliary jack or USB port, noise may occur depending on the connected device. If the device is connected to the vehicle's accessory socket, the noise can be reduced by unplugging it from the accessory socket.

 **WARNING****■ Do not adjust the portable audio unit or a similar product while driving the vehicle**

Adjusting the portable audio unit or a similar product while driving the vehicle is dangerous as it could distract your attention from the vehicle operation which could lead to a serious accident. Always adjust the portable audio unit or a similar product while the vehicle is stopped.

 **NOTICE**

Depending on the portable audio device, noise may occur when the device is connected to the vehicle accessory socket. (If noise occurs, do not use the accessory socket.)

How to connect USB port/Auxiliary jack

- ① USB port
- ② Auxiliary jack

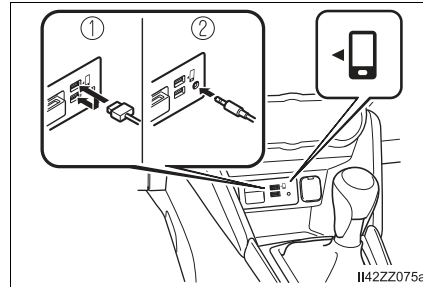

■ Connecting a device

Connect the connector on the device to the USB port.

■ Connecting with a connector cable

Connect the device plug/connector cable to the auxiliary jack/USB port.

- Insert the plug into the auxiliary jack/USB port securely.
- Insert or pull out the plug with the plug perpendicular to the auxiliary jack/USB port hole.
- Insert or remove the plug by holding its base.
- Use the USB terminal indicated by the  mark when using Apple CarPlay™ and Android Auto™.

WARNING

■ Do not allow the connection plug cord to get tangled with the parking brake or the shift lever



Allowing the plug cord to become tangled with the parking brake or the shift lever is dangerous as it could interfere with driving, resulting in an accident.

NOTICE

Do not place objects or apply force to the auxiliary jack/USB port with the plug connected.

How to use AUX mode

- 1 Select the  icon on the home screen and display the Entertainment screen.
- 2 Select **AUX** to switch to the AUX mode. The following icons are displayed in the lower part of the center display.

Icon	Function
	Displays the Entertainment menu. Use to switch to a different audio source.
	Displays sound settings to adjust audio quality level. Refer to Volume/Display/Sound Controls on P. 288.

- If a device is not connected to the auxiliary jack, the mode does not switch to the AUX mode.
- Adjust the audio volume using the portable audio device, commander switch, or audio control switch.
- Audio adjustments can also be made using the portable audio device's volume setting.
- If the connection plug is pulled out from the auxiliary jack while in AUX mode, noise may occur.











How to use USB mode

Type	Playable data
USB mode	MP3/WMA/AAC/OGG file

This unit does not support a USB 3.0 device. In addition, other devices may not be supported depending on the model or OS version. USB devices formatted to FAT32 are supported (USB devices formatted to other formats such as NTFS are not supported).

■ Playback

- 1 Select the  icon on the home screen and display the Entertainment screen.
- 2 Select **USB 1** or **USB 2** to switch the USB mode. The following icons are displayed in the lower part of the center display.

Icon	Function
	Displays the Entertainment menu. Use to switch to a different audio source.
	Category list is displayed.
	Current track list is displayed. Select a desired track to play it.
	Plays the current track repeatedly. Select it again to play the tracks in the current track list repeatedly. When selected again, the function is canceled.
	Tracks in the current track list are played randomly. Select it again to cancel.
	Starts playing a track similar to the current track using Gracenote®'s More Like This™. Select the desired song from the category list to cancel More Like This™.
	If selected within a few seconds from the beginning of a song which has started to play, the previous song is selected. If more than a few seconds have elapsed, the song currently being played is replayed from the beginning. Long-press to fast reverse. It stops when you remove your hand from the icon or the commander knob.
	Track is played. When selected again, playback is temporarily stopped.
	Advances to the beginning of the next song. Long-press to fast forward.
	Displays sound settings to adjust audio quality level. Refer to Volume/Display/Sound Controls on P. 288.

● Category list

Select the  icon and display the following category list.

Select a desired category and item.

Category	Function
Playlist	Displays playlists on the device.
Artist	Displays the artist name list. All the tracks or tracks for each album of the selected artist can be played.
Album	Displays the album name list.
Song	All the tracks in the device are displayed.
Genre	Displays the genre list. All the tracks or tracks per album or artist in the selected genre can be played.
Audiobook	Displays the audiobook list. Chapters can be selected and played.
Podcast	Displays the podcast list. Episode can be selected and played. (Special service for some Apple devices.)
Apple Music Radio	Displays Apple Music Radio stations. A station can be selected and played.
Folder	Displays the folder/file list.

● Example of use (to play all tracks in USB device)

▶ Method 1

1 Select  to display the category list.

2 Select **Song**.

All the tracks in the USB device are displayed.

3 Select a desired track.

The selected track is played. All the tracks in the USB device can be played by continuing playback.

Only the tracks in the desired category selected in Step 2 are played.

▶ Method 2*1

- 1 Select  to display the category list.
- 2 Select **Folder**.
All the folders in the USB device are displayed.
- 3 Select **All Songs**.
All the tracks in the USB device are displayed.
- 4 Select a desired track.
The selected track is played. All the tracks in the USB device can be played by continuing playback.
Only the tracks in the desired folder selected in Step 3 are played.

*1: Can be operated using an Android™ device or USB flash memory.

■ Playback

- If a file name in the USB memory is too long, it could cause operation problems such as not being able to playback the song.
(Recommended: Within 80 characters)
- The album art may not display depending on the album art size.
- To move to the desired location on the track, move the slider indicating the playback time.
- The appearance of the repeat and shuffle icons changes depending on the type of operation in which the function is used.

■ Gracenote® Database

When a USB device or Bluetooth® device is connected to this unit and the audio is played, the album name, artist name, genre and title information are automatically displayed if there is a match in the vehicle's database compilation to the music being played. The information stored in this device uses database information in the Gracenote® music recognition service.

■ Introduction

Music recognition technology and related data are provided by Gracenote®. Gracenote is the industry standard in music recognition technology and related content delivery. For more information visit www.gracenote.com.

CD and music-related data from Gracenote, Inc., copyright © 2000 to present Gracenote. Gracenote Software, copyright © 2000 to present Gracenote. One or more patents owned by Gracenote apply to this product and service. See the Gracenote website for a non-exhaustive list of applicable Gracenote patents. Gracenote, CDDB, MusicID, MediaVOCS, the Gracenote logo and logotype, and the “Powered by Gracenote” logo are either registered trademarks or trademarks of Gracenote in the United States and/or other countries.

**Gracenote® End User License Agreement**

This application or device contains software from Gracenote, Inc. of Emeryville, California (“Gracenote”). The software from Gracenote (the “Gracenote Software”) enables this application to perform disc and/or file identification and obtain music-related information, including name, artist, track, and title information (“Gracenote Data”) from online servers or embedded databases (collectively, “Gracenote Servers”) and to perform other functions. You may use Gracenote Data only by means of the intended End-User functions of this application or device.

You agree that you will use Gracenote Data, the Gracenote Software, and Gracenote Servers for your own personal non-commercial use only. You agree not to assign, copy, transfer or transmit the Gracenote Software or any Gracenote Data to any third party. YOU AGREE NOT TO USE OR EXPLOIT GRACENOTE DATA, THE GRACENOTE SOFTWARE, OR GRACENOTE SERVERS, EXCEPT AS EXPRESSLY PERMITTED HEREIN.

You agree that your non-exclusive license to use the Gracenote Data, the Gracenote Software, and Gracenote Servers will terminate if you violate these restrictions. If your license terminates, you agree to cease any and all use of the Gracenote Data, the Gracenote Software, and Gracenote Servers. Gracenote reserves all rights in Gracenote Data, the Gracenote Software, and the Gracenote Servers, including all ownership rights. Under no circumstances will Gracenote become liable for any payment to you for any information that you provide. You agree that Gracenote, Inc. may enforce its rights under this Agreement against you directly in its own name.

The Gracenote service uses a unique identifier to track queries for statistical purposes. The purpose of a randomly assigned numeric identifier is to allow the Gracenote service to count queries without knowing anything about who you are. For more information, see the web page for the Gracenote Privacy Policy for the Gracenote service.

The Gracenote Software and each item of Gracenote Data are licensed to you "AS IS."

Gracenote makes no representations or warranties, express or implied, regarding the accuracy of any Gracenote Data from in the Gracenote Servers. Gracenote reserves the right to delete data from the Gracenote Servers or to change data categories for any cause that Gracenote deems sufficient. No warranty is made that the Gracenote Software or Gracenote Servers are error-free or that functioning of Gracenote Software or Gracenote Servers will be uninterrupted. Gracenote is not obligated to provide you with new enhanced or additional data types or categories that Gracenote may provide in the future and is free to discontinue its services at any time.

GRACENOTE DISCLAIMS ALL WARRANTIES EXPRESS OR IMPLIED, INCLUDING, BUT NOT LIMITED TO, IMPLIED WARRANTIES OF MERCHANTABILITY, FITNESS FOR A PARTICULAR PURPOSE, TITLE, AND NON-INFRINGEMENT. GRACENOTE DOES NOT WARRANT THE RESULTS THAT WILL BE OBTAINED BY YOUR USE OF THE GRACENOTE SOFTWARE OR ANY GRACENOTE SERVER. IN NO CASE WILL GRACENOTE BE LIABLE FOR ANY CONSEQUENTIAL OR INCIDENTAL DAMAGES OR FOR ANY LOST PROFITS OR LOST REVENUES.

© 2000 to present. Gracenote, Inc.

■ Updating the database

The Gracenote® media database can be updated using USB device.

- 1 Connect a USB device containing the software for updating Gracenote®.
- 2 Select the  icon on the home screen and display the Settings screen.
- 3 Select the **System** tab and select **Music Database Update**.
- 4 Select **Search**. The list of the update package stored in the USB device and the version are displayed.
- 5 Select the package to use the update.
- 6 Select **Install**.

Gracenote® can be downloaded from the Toyota website.

NOTICE

For information related to the most recent Gracenote database which can be used and how to install it, go to the Toyota website:

- U.S.A.
<http://www.toyota.com>
- Canada
<http://www.toyota.ca>

How to use Apple CarPlay™

■ What is Apple CarPlay™?

Apple CarPlay™ allows you to make calls, send or receive messages, and listen to music using your iPhone® with the vehicle's audio system, or search for destinations using the maps. In addition, voice recognition operation is possible using Siri®.

 NOTICE

● YOU EXPRESSLY ACKNOWLEDGE AND AGREE THAT USE OF APPLE CARPLAY™ (“THE APPLICATION”) IS AT YOUR SOLE RISK AND THAT THE ENTIRE RISK AS TO SATISFACTORY QUALITY, PERFORMANCE, ACCURACY AND EFFORT IS WITH YOU TO THE MAXIMUM EXTENT PERMITTED BY APPLICABLE LAW, AND THAT THE APPLICATION AND INFORMATION ON THE APPLICATION IS PROVIDED “AS IS” AND “AS AVAILABLE”, WITH ALL FAULTS AND WITHOUT WARRANTY OF ANY KIND, AND TOYOTA HEREBY DISCLAIMS ALL WARRANTIES AND CONDITIONS WITH RESPECT TO THE APPLICATION AND INFORMATION ON THE APPLICATION, EITHER EXPRESS, IMPLIED OR STATUTORY, INCLUDING, BUT NOT LIMITED TO, THE IMPLIED WARRANTIES AND/OR CONDITIONS OF MERCHANTABILITY, SATISFACTORY QUALITY, FITNESS FOR A PARTICULAR PURPOSE, ACCURACY, QUIET ENJOYMENT, AND NONINFRINGEMENT OF THIRD PARTY RIGHTS. AS EXAMPLES, AND WITHOUT LIMITATION, TOYOTA DISCLAIMS ANY WARRANTY REGARDING THE ACCURACY OF DATA PROVIDED BY THE APPLICATION, SUCH AS THE ACCURACY OF DIRECTIONS, ESTIMATED TRAVEL TIME, SPEED LIMITS, ROAD CONDITIONS, NEWS, WEATHER, TRAFFIC, OR OTHER CONTENT PROVIDED BY APPLE, ITS AFFILIATES, OR THIRD PARTY PROVIDERS; TOYOTA DOES NOT GUARANTEE AGAINST LOSS OF APPLICATION DATA, WHICH MAY BE LOST AT ANY TIME; TOYOTA DOES NOT GUARANTEE THAT THE APPLICATION OR ANY SERVICES PROVIDED THROUGH THEM WILL BE PROVIDED AT ALL TIMES OR THAT ANY OR ALL SERVICES WILL BE AVAILABLE AT ANY PARTICULAR TIME OR LOCATION. FOR EXAMPLE, SERVICES MAY BE SUSPENDED OR INTERRUPTED WITHOUT NOTICE FOR REPAIR, MAINTENANCE, SECURITY FIXES, UPDATES, ETC., SERVICES MAY BE UNAVAILABLE IN YOUR AREA OR LOCATION, ETC. IN ADDITION, YOU UNDERSTAND THAT CHANGES IN THIRD PARTY TECHNOLOGY OR GOVERNMENT REGULATION MAY RENDER THE SERVICES AND/OR APPLICATIONS OBSOLETE AND/OR UNUSABLE.

TO THE EXTENT NOT PROHIBITED BY LAW, IN NO EVENT SHALL TOYOTA OR ITS AFFILIATES BE LIABLE FOR PERSONAL INJURY, OR ANY

INCIDENTAL, SPECIAL, INDIRECT OR CONSEQUENTIAL DAMAGES WHATSOEVER, INCLUDING, WITHOUT LIMITATION, DAMAGES FOR LOSS OF PROFITS, CORRUPTION OR LOSS OF DATA, FAILURE TO TRANSMIT OR RECEIVE ANY DATA, BUSINESS INTERRUPTION OR ANY OTHER COMMERCIAL DAMAGES OR LOSSES, ARISING OUT OF OR RELATED TO THE APPLICATION OR YOUR USE OF OR INABILITY TO USE THE APPLICATION OR INFORMATION ON THE APPLICATION.

 NOTICE

- When using Apple CarPlay™, please avoid distraction and use Apple CarPlay™ responsibly. Stay fully aware of driving conditions and always obey applicable laws.

- Apple CarPlay™ is provided by Apple® and its use is subject to your agreement to the Apple CarPlay™ terms of use, which are included as part of the Apple iOS terms of use.
- When using Apple CarPlay™, location, speed, and other vehicle data is transferred to your iPhone®. For further details, refer to Apple®'s Privacy Policy.

■ Switching to Apple CarPlay™



Connect the iPhone® by inserting the Apple® -genuine connector cord to the USB terminal indicated by the  mark.

Refer to How to connect USB port/Auxiliary jack on P. 309

- When you switch your iPhone® connection from Bluetooth® to the vehicle's USB terminal, the system switches to Apple CarPlay™. The applications which was being used via Bluetooth® connection can be used continuously. However, the available functions of the applications using Bluetooth® connection and those on Apple CarPlay™ may differ.
- If the iPhone® is connected to the USB terminal not indicated by the  mark, the system operates in USB mode.

■ Display of Apple CarPlay™ Screen



Use any of the following methods to display the Apple CarPlay™ screen in the center display.

- Select  on the home screen.
- Long press  on the commander switch.
- Select  on the home screen, and select **Apple CarPlay** from the Applications screen.

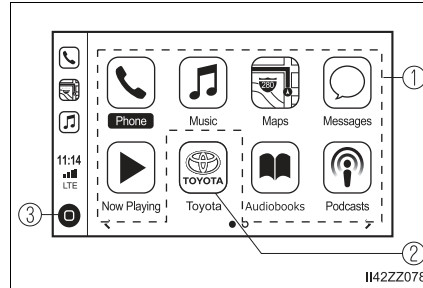

■ **Apple CarPlay™ home screen**



The icons and icon positions displayed on the Apple CarPlay™ home screen may differ depending on the connected iPhone® and iOS version.

No.	Icon	Explanation
①		Launches the Apple CarPlay™ application. Refer to the help information available with each application for the method of using each application.
②		Switches to the Toyota home screen.
③		Displays the Apple CarPlay™ home screen.

■ Convenient Ways to Use Apple CarPlay™

Item	Operation method
Activating the voice recognition function (Siri®)	Activate Siri® using any of the following two methods to operate Apple CarPlay™ by voice. <ul style="list-style-type: none"> • Press and hold/Long press the talk button on the audio control switch. • Press and hold 
To display the NowPlaying screen	When music is playing in Apple CarPlay™ and a screen other than the NowPlaying screen is being displayed, press  on the commander switch to display the NowPlaying screen.
To display the MAP screen	When using map route guidance in Apple CarPlay™ and a screen other than the MAP screen is being displayed, press NAV on the commander switch to display the MAP screen.
To return to Toyota screen	Press and hold  on the commander switch.

■ To End Apple CarPlay™

To end Apple CarPlay™, disconnect the Apple® -genuine connector cord from the USB terminal and disconnect the iPhone® from the connector cord.

If the connector cord is disconnected from the USB terminal during music playback using Apple CarPlay™, the audio source selection will no longer be available and the vehicle's audio device will be muted.

How to use Android Auto™ mode

■ What is Android Auto™?

Android Auto™ is an application which allows the operation of an Android™ Smartphone using the vehicle's audio. Android Auto™ functions such as the phone, messages, music, and map can be used with the vehicle's audio system.

 NOTICE

● YOU EXPRESSLY ACKNOWLEDGE AND AGREE THAT USE OF ANDROID AUTO™ (“THE APPLICATION”) IS AT YOUR SOLE RISK AND THAT THE ENTIRE RISK AS TO SATISFACTORY QUALITY, PERFORMANCE, ACCURACY AND EFFORT IS WITH YOU TO THE MAXIMUM EXTENT PERMITTED BY APPLICABLE LAW, AND THAT THE APPLICATION AND INFORMATION ON THE APPLICATION IS PROVIDED “AS IS” AND “AS AVAILABLE,” WITH ALL FAULTS AND WITHOUT WARRANTY OF ANY KIND, AND TOYOTA HEREBY DISCLAIMS ALL WARRANTIES AND CONDITIONS WITH RESPECT TO THE APPLICATION AND INFORMATION ON THE APPLICATION, EITHER EXPRESS, IMPLIED OR STATUTORY, INCLUDING, BUT NOT LIMITED TO, THE IMPLIED WARRANTIES AND/OR CONDITIONS OF MERCHANTABILITY, SATISFACTORY QUALITY, FITNESS FOR A PARTICULAR PURPOSE, ACCURACY, QUIET ENJOYMENT, AND NONINFRINGEMENT OF THIRD PARTY RIGHTS. AS EXAMPLES, AND WITHOUT LIMITATION, TOYOTA DISCLAIMS ANY WARRANTY REGARDING THE ACCURACY OF DATA PROVIDED BY THE APPLICATION, SUCH AS THE ACCURACY OF DIRECTIONS, ESTIMATED TRAVEL TIME, SPEED LIMITS, ROAD CONDITIONS, NEWS, WEATHER, TRAFFIC, OR OTHER CONTENT PROVIDED BY GOOGLE, ITS AFFILIATES, OR THIRD PARTY PROVIDERS; TOYOTA DOES NOT GUARANTEE AGAINST LOSS OF APPLICATION DATA, WHICH MAY BE LOST AT ANY TIME; TOYOTA DOES NOT GUARANTEE THAT THE APPLICATION OR ANY SERVICES PROVIDED THROUGH THEM WILL BE PROVIDED AT ALL TIMES OR THAT ANY OR ALL SERVICES WILL BE AVAILABLE AT ANY PARTICULAR TIME OR LOCATION. FOR EXAMPLE, SERVICES MAY BE SUSPENDED OR INTERRUPTED WITHOUT NOTICE FOR REPAIR, MAINTENANCE, SECURITY FIXES, UPDATES, ETC., SERVICES MAY BE UNAVAILABLE IN YOUR AREA OR LOCATION, ETC. IN ADDITION, YOU UNDERSTAND THAT CHANGES IN THIRD PARTY TECHNOLOGY OR GOVERNMENT REGULATION MAY RENDER THE SERVICES AND/OR APPLICATIONS OBSOLETE AND/OR UNUSABLE.

TO THE EXTENT NOT PROHIBITED BY LAW, IN NO EVENT SHALL TOYOTA OR ITS AFFILIATES BE LIABLE FOR PERSONAL INJURY, OR ANY INCIDENTAL, SPECIAL, INDIRECT OR CONSEQUENTIAL DAMAGES WHATSOEVER, INCLUDING, WITHOUT LIMITATION, DAMAGES FOR LOSS OF PROFITS, CORRUPTION OR LOSS OF DATA, FAILURE TO TRANSMIT OR RECEIVE ANY DATA, BUSINESS INTERRUPTION OR ANY OTHER COMMERCIAL DAMAGES OR LOSSES, ARISING OUT OF OR RELATED TO THE APPLICATION OR YOUR USE OF OR INABILITY TO USE THE APPLICATION OR INFORMATION ON THE APPLICATION.

 NOTICE

- When using Android Auto™, please avoid distraction and use Android Auto™ responsibly. Stay fully aware of driving conditions and always obey applicable laws.

- Android Auto™ is provided by Google and its use is subject to your agreement to the Android Auto™ terms of use.
- When using Android Auto™, location, speed, and other vehicle data is transferred to your smart phone. For further details, refer to Google's Privacy Policy.



■ How to use the Android Auto™ mode

Insert an Android™ Smartphone-genuine connector cord into the USB terminal indicated by the  icon to connect the Smartphone. Refer to How to connect USB port/Auxiliary jack on P. 309

- When an Android™ Smartphone connected to Bluetooth® is connected to the vehicle's USB terminal, Bluetooth® is used by Android Auto™ and the system switches to Android Auto™ mode.
- If the Android™ Smartphone is connected to a USB terminal with no  icon indicated, the system operates in USB mode.

■ Display of Android Auto™ Mode Screen

Use any of the following methods to display the Android Auto™ mode screen in the center display.

- Select  on the home screen, and select **Android Auto** from the Applications screen.
- Select  on the home screen.
- Press and hold  on the commander switch.

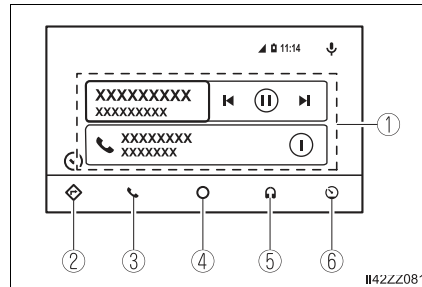

■ Android Auto™ mode home screen



The media displayed on the Android Auto™ home screen may differ depending on the use conditions and version of the connected Android™ Smartphone.

No.	Icon	Explanation
①	—	Displays the use history of each application. The displayed contents differ depending on the application that has been started and its status.
②		Switches to the map application.
③		Switches to the call mode.
④		Displays the Android Auto™ home screen.
⑤		Switches to the Music application.
⑥		Switches to the Toyota home screen.

■ Convenient ways to use Android Auto™ mode

Item	Operation method
Operation using voice recognition	Any of the following methods can be used to start the voice recognition mode and operate Android Auto™ by voice. <ul style="list-style-type: none"> • Speak the words, "OK Google". • Select the  icon on the Android Auto™ screen. • Press and hold the talk button on the audio remote control switch.
To display the NowPlaying screen	When music is playing in Android Auto™ and a screen other than the NowPlaying screen is being displayed, press  on the commander switch to display the NowPlaying screen.
To display the MAP screen	When using map route guidance in Android Auto™ and a screen other than the MAP screen is being displayed, press NAV on the commander switch to display the Android Auto™ MAP screen.
To return to the Toyota screen	Press and hold  on the commander switch.

■ To end Android Auto™

To end the Android Auto™ mode, disconnect the Android™-genuine connector cord from the USB terminal or disconnect the Android™ Smartphone from the connector cord.

If Android Auto™ cannot be connected

When the message, "Mobile Device Error", is displayed and Android Auto™ cannot be connected.

Make sure that the Android™ Smartphone in question is compatible with Android Auto™.

Before trying to reconnect your Android™ Smartphone to the connector cord, do the Bluetooth® device pairing again.

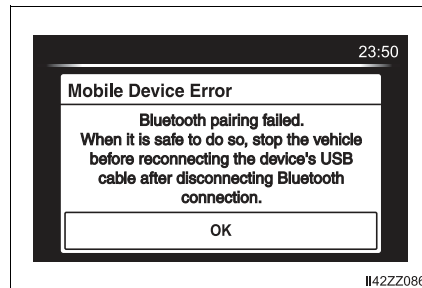

■ **If the Android Auto™ connection setting cannot be changed**

Depending on your Android™ Smartphone, the connection setting may have been in charging mode only when the connector cord is connected.

In this case, switch off the Android Auto™ connection setting once, and then switch it back on while connected to USB mode.

The connection setting can be changed to the Android Auto™ connection in the **Devices** tab on the Settings screen (→P. 300).

Bluetooth®

■ Bluetooth® Hands-Free outline

When a Bluetooth® device (mobile phone) is connected to the vehicle's Bluetooth® unit via radio wave transmission, a call can be made or received by pressing the talk button, pick-up button, or hang-up button on the audio remote control switch, or by operating the center display.

■ Bluetooth® audio outline

When a portable audio unit equipped with the Bluetooth® communication function is paired to the vehicle, you can listen to music stored on the paired portable audio device from the vehicle's speakers. It is not necessary to connect the portable audio device to the vehicle's external input terminal. After programming, operate the vehicle audio control panel to play/stop the audio.

■ Applicable Bluetooth® specification (Recommended)

Ver. 1.1/1.2/2.0 + EDR/2.1 + EDR/3.0 (conformity)

- For your safety, a device can be paired only when the vehicle is parked. If the vehicle starts to move, the pairing procedure will end. Park the vehicle in a safe place before pairing.
- The communication range of a Bluetooth® equipped device is about 32 ft. (10 m) or less.
- Basic audio operation is available using voice commands even if Bluetooth® is not connected.
- For safety reasons, operation of the center display is disabled while the vehicle is being driven. However, items not displayed in gray can be operated using the commander switch while the vehicle is being driven.

NOTICE

Some Bluetooth® mobile devices are not compatible with the vehicle. Consult your Toyota dealer, Toyota Customer Experience Center (U.S.A. Only), Toyota Canada Customer Interaction Centre (Canada Only) or Web support center for information regarding Bluetooth® mobile device compatibility:

- U.S.A.
Phone: 1-800-331-4331 (Toll-free)
Web: <http://www.toyota.com/entune>
- Canada
Phone: 1-888-TOYOTA-8 or 1-888-869-6828 (Toll-free)
Web: <http://www.toyota.ca>

Component Parts

▶ Audio unit

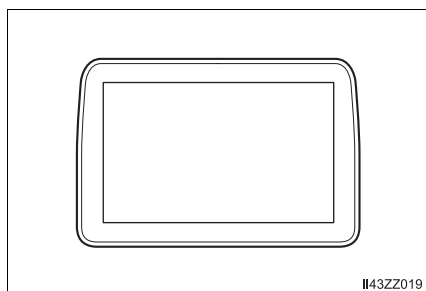

▶ Talk button, Pick-up button and Hang-up button

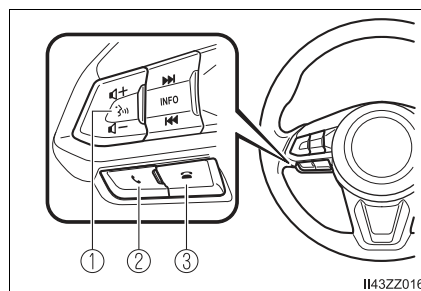

- ① Talk button
- ② Pick-up button
- ③ Hang-up button

▶ Microphone

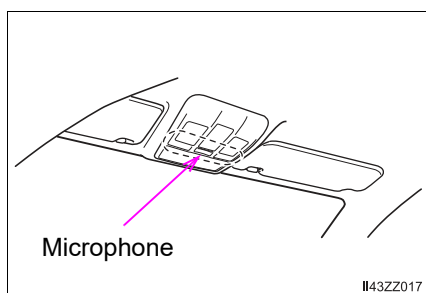

■ Microphone (hands-free)

The microphone is used for speaking voice commands or when making a Hands-free call.

■ Talk button, Pick-Up button and Hang-Up button (hands-free)

The basic functions of Bluetooth® Hands-Free can be used for such things as making calls or hanging up using the talk, pick-up and hang-up buttons on the steering wheel.

■ Commander switch

The commander switch is used for volume adjustment and display operation. Tilt or turn the commander knob to move the cursor. Press the commander knob to select the icon.

■ Volume adjustment

The volume dial of the commander switch is used to adjust the volume. Turn the dial to the right to increase volume, to the left to decrease it.

The volume can also be adjusted using the volume button on the steering wheel.

- Press the volume dial to switch the audio MUTE on and off.
- If the volume is lower compared to other audio modes, increase the volume from the device side.

Conversation volume and the volume of the voice guidance and ringtone can each be set in advance.

- 1 Select the  icon on the home screen and display the Communication screen.
- 2 Select **Settings**.
- 3 Adjust the **Phone Volume** and the **VR and Ringtone** using the slider.

Bluetooth® Preparation

■ Device pairing

To use Bluetooth® audio and Hands-Free, the device equipped with Bluetooth® has to be paired to the unit using the following procedure. A maximum of 7 devices including Bluetooth® audio devices and hands-free mobile phones can be paired.

● Pairing Procedure

- 1 Select the  icon on the home screen and display the Settings screen.
- 2 Select the **Devices** tab.
- 3 Select **Bluetooth**.
- 4 Turn the Bluetooth® setting on.
- 5 Select **Add New Device** to display the message and switch to the device operation.
- 6 Using your device, perform a search for the Bluetooth® device (Peripheral device).
- 7 Select "Toyota" from the device list searched by the device.
- 8 Device with Bluetooth® version 2.0:
Input the displayed 4-digit pairing code into the device.
Device with Bluetooth® version 2.1 or higher:
Make sure the displayed 6-digit code on the audio is also displayed on the device, and touch the **Yes**.
Connection permission and phonebook access permission for your mobile device may be required depending on the mobile device.
- 9 If pairing is successful, the functions of the device connected to Bluetooth® are displayed.

10 Devices compatible with Toyota Email/SMS function: SMS (Short Message Service) messages, and E-mail for the device are downloaded automatically. A download permission operation for your device may be required depending on the device.

When Call history and messages are downloaded automatically, each automatic download setting must be on.

Refer to Communication Settings on P. 351.

After a device is registered, the system automatically identifies the device. By activating Bluetooth® Hands-Free again, or by activating Bluetooth® Hands-Free first after switching the ignition from OFF to ACC, the device connection condition is indicated in the center display.

- **IMPORTANT** note about pairing and automatic reconnection:
 - If pairing is redone on the same mobile phone device, first clear “Toyota” displayed on the Bluetooth® setting screen of the mobile device.
 - When the OS of the device is updated, the pairing information may be deleted. If this happens, reprogram the pairing information to the Bluetooth® unit.
 - Before you pair your device, make sure that Bluetooth® is “ON”, both on your phone and on the vehicle.

■ Device selection

If several devices have been paired, the Bluetooth® unit links the device last paired. If you would like to link a different paired device, it is necessary to change the link. The order of device priority after the link has been changed is maintained even when the ignition is switched off.

● Connecting other devices

- 1 Select the  icon on the home screen and display the Settings screen.
- 2 Select the **Devices** tab.
- 3 Select **Bluetooth**.
- 4 Turn the Bluetooth® setting on.
- 5 Select the name of the device you would like to connect.
- 6 **Phone and Audio** selection:
Connects both devices as hands-free and Bluetooth® audio.
Phone Only selection:
Connects as a hands-free device.
Audio Only selection:
Connects as Bluetooth® audio.

● Disconnecting a device

- 1 Select the  icon on the home screen and display the Settings screen.
- 2 Select the **Devices** tab.
- 3 Select **Bluetooth**.
- 4 Turn the Bluetooth® setting on.
- 5 Select the device name which is currently connected.
- 6 Select **Disconnect**.

■ Deleting a device

● Selecting and deleting devices



- 1 Select the  icon on the home screen and display the Settings screen.
- 2 Select the **Devices** tab.
- 3 Select **Bluetooth**.
- 4 Turn the Bluetooth® setting on.
- 5 Select the device name which you would like to delete.
- 6 Select **Unpair This Device**.
- 7 Select **Yes**.

● Deleting all devices

- 1 Select the  icon on the home screen and display the Settings screen.
- 2 Select the **Devices** tab.
- 3 Select **Bluetooth**.
- 4 Select **Custom Settings**.
- 5 Select **Unpair All Paired Devices**.
- 6 Select **Yes**.

■ Changing PIN code

PIN code (4 digits) can be changed.

- 1 Select the  icon on the home screen and display the Settings screen.
- 2 Select the **Devices** tab.
- 3 Select **Bluetooth**.
- 4 Select **Custom Settings**.
- 5 Select **Change Pairing Code**.
- 6 Input the new PIN code to be set.
- 7 Select .

■ Bluetooth® Preparation

The Bluetooth® system may not operate for 1 or 2 minutes after the ignition is switched to ACC or ON. However, this does not indicate a problem. If the Bluetooth® system does not connect automatically after 1 or 2 minutes have elapsed, make sure that the Bluetooth® setting on the device is normal and attempt to reconnect the Bluetooth® device from the vehicle side.

■ Device selection

The following functions can be used for the Hands-free or audio.

- Hands-free: Phone calls and E-mail/SMS
- Audio: Bluetooth® audio, Pandora®, Aha™, Stitcher™ radio

Available Language

The Bluetooth® Hands-Free System applies to the following languages:

- English
- Spanish
- French

Refer to Settings on P. 300.

Voice Recognition

In this section, the basic operation of the voice recognition is explained.

■ Activating Voice Recognition

Press the talk button.

■ Ending Voice Recognition

Use one of the following methods:

- Press the hang-up button.
- Say, "Cancel".
- Operate the commander switch or the center display (only when vehicle is stopped).

■ Skipping Voice Guidance (for faster operation)

Press and release the talk button.

■ Troubleshooting for Voice Recognition

If you do not understand an operation method while in the voice recognition mode, say "Tutorial" or "Help".

■ Commands useable anytime during voice recognition

"Go Back" and "Cancel" are commands which can be used at any-time during voice recognition.

● Returning to previous operation

To return to the previous operation, say, "Go Back" while in voice recognition mode.

● Cancel

To put the Bluetooth® Hands-Free system in standby mode, say, "Cancel" while in voice recognition mode.

■ **To prevent a deterioration in the voice recognition rate and voice quality, the following points should be observed:**

- The voice recognition cannot be performed while voice guidance or the beep sound is operating. Wait until the voice guidance or the beep sound is finished before saying your commands.
- Phone related commands are available only when your phone is connected via Bluetooth®. Make sure your phone is connected via Bluetooth® before you operate phone related voice commands.
- Music play commands, such as Play Artist and Play Album can be used only in USB audio mode.
- Do not speak too slowly or loudly (no loud voice).
- Speak clearly, without pausing between words or numbers.
- Dialects or different wording other than hands-free prompts cannot be recognized by voice recognition. Speak in the wording specified by the voice commands.
- It is not necessary to face the microphone or approach it. Speak the voice commands while maintaining a safe driving position.
- Close the windows to reduce loud noises from outside the vehicle, or turn down the airflow of the air-conditioning system while Bluetooth® Hands-Free is being used.
- Make sure the vents are not directing air up towards the microphone.

If the voice recognition performance is not satisfactory.
Refer to Troubleshooting on P. 366.

Voice Command List

■ Voice command

When the talk button is pressed and the following command is spoken, the audio or navigation can be operated. The commands in the () can be omitted. The specified name and number are put into the {}.

■ Standard command

Voice command	Function
Help	Usable commands can be verified.
Tutorial	Basic voice commands and methods of use can be verified.
(Navigate/Take me/Drive) Home	Set the destination to Home.

■ Communication (phone) related command

Voice command	Function
Call {name in phonebook} (mobile/home/work/other) Example: "Call John Mobile"	Call to the contact in the downloaded phonebook. Refer to Making a Call on P. 339.
Redial	Call to the last contact you called. Refer to Making a Call on P. 339.
Callback	Call to the last contact who called you. Refer to Making a Call on P. 339.

■ Entertainment (audio) related command

Voice command	Function	Corresponding audio source
(Go to/Play) Bluetooth (Audio)	Switches the audio source to BT audio. Can also switch to each audio source by similarly using commands such as FM, AM, or USB.	All
Play Artist {Artist name}	Plays the selected artist.	USB

■ **Navigation related command (if equipped)**

For the navigation screen voice commands, refer to the separate navigation system manual.

- Some commands cannot be used depending on the grade and specification.
- Some commands cannot be used depending on the device connection conditions and the use conditions.
- The commands are examples of the available commands.

Bluetooth® Hands-Free

Making a Call

■ Phonebook Usage

Telephone calls can be made by saying the contact name in the downloaded phonebook or the name of a person whose phone number has been registered in the Bluetooth® Hands-Free. Refer to Import contact (Download Phonebook).

- 1 Press the talk button.
- 2 Wait for the beep sound.
- 3 Say: "Call XXXXX... (Ex. "John") Mobile". (You can also say, "Home", "Work", or "Other" instead of "Mobile", depending on how you set up your contact information.)
- 4 Follow the voice guidance to make the call, or simple press the pick-up button on the steering switch during or after the guidance to make the call.

● Screen operation

- 1 Select the  icon on the home screen and display the Communication screen.
- 2 Select **Contacts** to display the contact list.
- 3 Select the contact you would like to call to display the details for the contact.
- 4 Select the desired phone number to make the call.

● Import contact (Download Phonebook)

Phonebook data from your device (Mobile phone) can be sent and registered to your Bluetooth® Hands-Free phonebook using Bluetooth®.

▶ Automatic downloading

The “Auto Download Contacts” setting must be on. When hands-free is connected to the device, the phonebook is downloaded automatically.

Refer to Communication Settings on P. 351.

▶ Manually downloading

If the “Auto Download Contacts” setting is off, download the phonebook using the following procedure.

- 1 Select the  icon on the home screen and display the Communication screen.
- 2 Select **Contacts** to display the contact list.
- 3 Select **Edit Contacts**.
- 4 Select **Import All Contacts** or **Import Selected Contact** to switch to the device operation.
- 5 If **Import All Contacts** is selected, select **Download**.
- 6 Download will be started from the mobile phone.

If “Import All Contacts” is performed after saving the phonebook to the Bluetooth® unit, the phonebook will be overwritten.

■ Favorites Contacts

A maximum of 50 contacts can be registered. It will take less time to make a call after registering the telephone number. In addition, you do not have to look for the person you want to call in the phone-book.

● Registering to your favorites

- 1 Select the  icon on the home screen and display the Communication screen.
- 2 Select **Favorites** to display the favorites list.
- 3 Select **Add/Edit Communication Favorites**.
- 4 Select **Add New Contact** or **Add New Contact Details**.
- 5 Select from the displayed list.

When “Add New Contact” is selected, information such as the selected person’s name is also registered. In addition, when “Add New Contact Details” is selected, only the telephone number of the selected person is registered.

● Making a call from your favorites

- 1 Select the  icon on the home screen and display the Communication screen.
- 2 Select **Favorites** to display the favorites list.
- 3 Only one phone number is registered to contact:
Select the contact information you would like to call. Go to Step 5.
Multiple phone numbers are registered to contact:
Select the contact you would like to call to display the screen indicating the details for the contact. Go to Step 4.
- 4 Select the phone number you would like to call.
- 5 Select **Yes**.

● Deleting from your favorites

- 1 Select the  icon on the home screen and display the Communication screen.
- 2 Select **Favorites** to display the favorites list.
- 3 Select **Add/Edit Communication Favorites**.
- 4 Select **Delete**.
- 5 Select the contact information which you would like to delete.
- 6 Select **Delete**.





● Changing the display order of your favorites list

- 1 Select the  icon on the home screen and display the Communication screen.
- 2 Select **Favorites** to display the favorites list.
- 3 Select **Add/Edit Communication Favorites**.
- 4 Select **Move**.
- 5 The contact can be moved after it is selected.
- 6 Slide the contact or move it using the commander switch, then select **OK**.

● Changing contact name of your favorites

- 1 Select the  icon on the home screen and display the Communication screen.
- 2 Select **Favorites** to display the favorites list.
- 3 Select **Add/Edit Communication Favorites**.
- 4 Select **Rename**.
- 5 Select the contact to display the keyboard screen.
- 6 If a new name is input and **OK** is selected, the contact name is stored.

■ Telephone Number Input

- 1 Select the  icon on the home screen and display the Communication screen.
- 2 When **Dial Phone** is pressed, the dial pad is displayed.
- 3 Input the telephone number using the dial pad.
- 4 Select  to make the call.
 - Numeral or symbol entry
 - Use the dial pad.
 - Long-press the  to input +.
 - Select  to delete the currently input value.
 - Long-press  to delete all input values.

■ Redial Function

Makes a call to the last person called (latest person on outgoing call record) from the mobile phone/vehicle.

- 1 Press the talk button.
- 2 Wait for the beep sound.
- 3 Say: "Redial"

■ Call back Function

Makes a call to the last person who called your (latest person on incoming call record) mobile phone/vehicle.

- 1 Press the talk button.
- 2 Wait for the beep sound.
- 3 Say: "Call back"

● Automatic 911 dialing

If the vehicle is involved in a moderate to severe collision, a call is made automatically to 911 from the connected device. The "Emergency Assistance Call" setting must be on. Refer to Communication Settings on P. 351.

- 1 If the vehicle is involved in a moderate to severe collision, notification of the call to 911 is made via audio and screen display. To cancel the call, press **Cancel Emergency Assistance Call** or hang-up button within 10 seconds.
- 2 If **Cancel Emergency Assistance Call** or hang-up button is not pressed within 10 seconds, the call is made to 911 automatically.

■ Phonebook Usage

- A maximum of 1000 contacts can be registered to the phonebook.
- Phonebook, incoming/outgoing call record, and favorite memories are exclusive to each mobile phone to protect privacy.
- Contacts with no telephone number are not registered.

■ Favorites Contacts

If the contact is long-pressed when the favorites list is displayed, the contact information can be edited (deleted, moved).

■ Telephone Number Input

Practice this while parked until you are confident you can do it while driving in a non-taxing road situation. If you are not completely comfortable, make all calls from a safe parking position, and only start driving when you can devote your full attention to driving.

■ Mobile 911 (U.S.A./Canada only)

- Automatic 911 dialing is a secondary function of the audio entertainment system. Therefore, the Automatic 911 dialing function does not assure that the call is always made to 911 after an accident occurs.
- A Hands-free device must be paired and connected. The 911 operator can verify the vehicle's position information using the Hands-free device GPS if equipped. The 911 operator can verify the vehicle's position information.

**NOTICE****■ Mobile 911 (U.S.A./Canada only)**

Though the system can be set to not call 911, doing so will defeat the purpose of the system. Toyota recommends that the Automatic 911 dialing system remain activated.

Receiving an Incoming Call







When an incoming call is received, the incoming call notification screen is displayed. The “Incoming Call Notifications” setting must be on.



Refer to Communication Settings on P. 351.

To accept the call, press the pick-up button on the audio control switch or select **Answer** on the screen.

To reject the call, press the hang-up button on the audio control switch or select **Ignore** on the screen.

The following icons are displayed on the screen during a call. Icons which can be used differ depending on use conditions.

Icon	Function
	Displays the Communication menu.
	Ends the call.
	Transferring a call from hands-free to a mobile phone Communication between the Bluetooth® unit and a device (mobile phone) is canceled, and an incoming call will be received by the device (mobile phone) like a standard call.
	Transferring a call from a device (mobile phone) to hands-free Communication between devices (mobile phone) can be switched to Bluetooth® Hands-Free.
	Mute The microphone can be muted during a call. When selected again, the mute is canceled.
	A call is made to other person during a call and a 3-way call can be made. Select the contact from the following to make a call. Call History : Call History is displayed. Contacts : The phonebook is displayed. Dial : The dial pad is displayed. Input the phone number. The device may be unusable depending on the contractual content.
	The call on hold is made to make a 3-way call. The device may be unusable depending on the contractual content.

Icon	Function
	Switches the call on hold.
	DTMF (Dual Tone Multi-Frequency Signal) Transmission This function is used when transmitting DTMF via the dial pad. The receiver of a DTMF transmission is generally a home telephone answering machine or a company's automated guidance call center. Input the number using a dial pad.

- If the ignition is switched off during a hands-free call, the line is transferred to the device (Mobile phone) automatically.
- If the DTMF code has two or more digits or symbols, each one must be transmitted individually.

Call Interrupt

A call can be interrupted to receive an incoming call from a third party. When **Hold + Answer** is selected or the pick-up button on the steering wheel is pressed, the current call is held and the system switches to the new incoming call.

When **End + Answer** is selected, the current call is ended and the system switches to the new incoming call (GSM network only).

When **Ignore** is selected or the hang-up button on the steering wheel is pressed, an incoming call is refused.

- The function may not be available depending on the contractual content of the mobile device.
- The function may not be operable depending on the type of the telephone network and the mobile device.

Receiving and Replying to Messages (available only with E-mail/SMS compatible phones)

SMS (Short Message Service) messages, and E-mail received by connected devices can be downloaded, displayed, and played (read by the system).

Additionally, replies can also be made to calls and messages in the received messages.

■ Downloading messages

Up to 20 new messages can be downloaded and displayed from a connected device.

For e-mail, 20 messages for each account can be downloaded.

▶ Automatic downloading

The “Auto Download Email” (E-mail) or “Auto Download Text Message” (SMS) setting must be on. A message is downloaded automatically when the Bluetooth® unit is connected to the device. Refer to Communication Settings on P. 351.

▶ Manually downloading

When the “Auto Download Email” (E-mail) or “Auto Download Text Message” (SMS) setting is off, the message is downloaded using the following procedure.

- 1 Select the  icon on the home screen and display the Communication screen.

- 2 Select **Email** or **Text Messages** to display the Inbox.
- 3 Select **Update Inbox**.
- 4 Download will be started from the mobile phone.

■ Receiving messages

▶ Method 1

When a device receives a message, a message received notification is displayed. The “Email Notifications” (E-mail) or “Text Notifications” (SMS) setting must be on.







Refer to Communication Settings on P. 351.



Select **Read** and display the message.

▶ Method 2

- 1 Select the  icon on the home screen and display the Communication screen.
- 2 Select **Notifications** and display the new message list for e-mail and SMS.
- 3 Select the message you would like to display.

The following icons are displayed in the lower part of the details on the message. Icons which can be used differ depending on use conditions.

Icon	Function
	Displays the Communication menu.
	Displays the inbox.
	Plays back a message. When selected again, playback is temporarily stopped.
	Displays the previous message.
	Displays the next message.
	Only replies to the sender of the currently displayed message. Select the sentence on the displayed reply screen and select the sentence for sending from the preset message. Select Send .

Icon	Function
	Only E-mail: Replies to all members including CC. Select the sentence on the displayed reply screen and select the sentence for sending from the preset message. Select Send .
	Makes a call to a person who sent a message. For E-mail, this function may not work depending on the device.
	Deletes a message. The messages stored in a device is also deleted.

Up to three preset messages can be selected.

● Example of use (verify unread E-mail)

- 1 Select the  icon on the home screen and display the Communication screen.
- 2 Select **Email** to display the inbox.
- 3 Select the unread message displayed in bold.

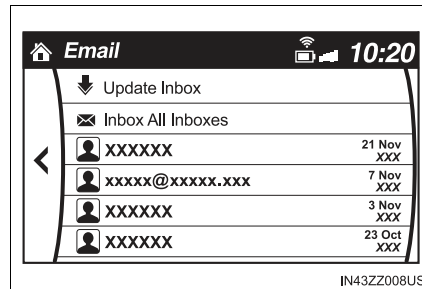





- 4 The details of the message are displayed and replying to the message, making a call, or playback can be performed.

- Changing account for displaying (E-mail only)

- 1 Select .
- 2 Select the account which you would like to display. Only the messages for the selected account are displayed in the inbox.



- Editing preset messages

- 1 Select the  icon on the home screen and display the Communication screen.
- 2 Select .
- 3 Select .
- 4 Select the preset message which you would like to edit. The keyboard screen is displayed.
- 5 When the message is input and  is selected, the message is stored as a preset message.

- **Downloading messages**

- Attached data is not downloaded.
- Messages up to 1 kilobyte (e-mail)/140-bytes (SMS) can be downloaded.
- A message list is created for each device.
- If the connected device does not correspond to MAP 1.0, the AT command is used to download. The downloaded message indicates that it is already read.
- Downloading using the AT command may not function depending on the connected device.

- **Editing preset messages**

- Select the  icon to change the language.
- Select the  icon to switch between capitalized and lower-case characters.
- Select the  icon to return to the previous screen without storing the edit.

Communication Settings

Select the  icon on the home screen and display the Communication screen. Select **Settings** to change the setting.

Item	Setting	Function
Bluetooth®	-	Go to Bluetooth® setting menu. Refer to Bluetooth® Preparation on P. 330.
Incoming Call Notifications	On/Off	Notifies when an incoming call is received.
Auto Download Text Message	On/Off	Downloads SMS automatically when the Bluetooth® unit is connected to the device.
Text Notifications	On/Off	Notifies when a new SMS is received.
Auto Download Email*1	On/Off	Downloads E-mail automatically when the Bluetooth® unit is connected to the device.
Email Notifications	On/Off	Notifies when a new Email is received.
Auto Download Call History	On/Off	Downloads Call History automatically when the Bluetooth® unit is connected to the device.
Auto Download Contacts*1	On/Off	Downloads the phonebook automatically when the Bluetooth® unit is connected to the device.
Ringtone	Car/Phone/Off	The type of ring tone can be changed. Three selections are available including the standard ring tone set on the vehicle, the ring tone registered to your Bluetooth® device, or no ring tone.
Phone Volume	Adjusts using the slider.	Adjusts the conversation volume.
VR and Ringtone	Adjusts using the slider.	Adjusts the voice guidance and ringtone volume.
Contacts Display Order	First Name, Last Name	Displays the contact information in alphabetical order of the first name.
	Last Name, First Name	Displays the contact information in alphabetical order of the last name.

Item	Setting	Function
Edit Preset Messages	-	Edits the preset message. Refer to Receiving and Replying to Messages (available only with E-mail/SMS compatible phones) on P. 347.
Emergency Assistance Call	On/Off	Mobile Utilizes the Automatic 911 dialing function.
Restore Factory settings	-	Initializes all Communication Settings.

*1: Depending on the device, it may be necessary to acquire download permission on the device side.

Bluetooth® Audio

- Applicable Bluetooth® specification (Recommended)
Ver. 1.1/1.2/2.0 + EDR/2.1 + EDR/3.0 (conformity)
- Response profile
 - A2DP (Advanced Audio Distribution Profile) Ver. 1.0/1.2
 - AVRCP (Audio/Video Remote Control Profile) Ver. 1.0/1.3/1.4

A2DP is a profile which transmits only audio to the Bluetooth® unit. If your Bluetooth® audio device corresponds only to A2DP, but not AVRCP, you cannot operate it using the control panel of the vehicle's audio system. In this case, only the operations on the mobile device are available the same as when a portable audio device for a non-compliant Bluetooth® device is connected to the AUX terminal.

Function	A2DP	AVRCP		
		Ver. 1.0	Ver. 1.3	Ver. 1.4
Playback	X	X	X	X
Pause	X	X	X	X
File (Track) up/down	-	X	X	X
Reverse	-	-	X	X
Fast-forward	-	-	X	X
Text display	-	-	X	X
Repeat	-	-	Depends on device	Depends on device
Shuffle	-	-	Depends on device	Depends on device
Scan	-	-	Depends on device	Depends on device
Folder up/down	-	-	-	Depends on device

X: Available

-: Not available

- The battery consumption of Bluetooth® audio devices increases while Bluetooth® is connected.
- If a general mobile phone device is USB connected during music playback over the Bluetooth® connection, the Bluetooth® connection is disconnected. For this reason, you cannot have music playback over a Bluetooth® connection and music playback using a USB connection at the same time.
- If a device which supports AVRCP Ver. 1.6 or higher is connected, song information may not display correctly.
- The system may not operate normally depending on the Bluetooth® audio device.

How to Use the Bluetooth® Audio System

■ Switching to Bluetooth® audio mode

To listen to music or voice audio recorded to a Bluetooth® audio device, switch to the Bluetooth® audio mode to operate the audio device using the audio system control panel. Any Bluetooth® audio device must be paired to the vehicle's Bluetooth® unit before it can be used.









Refer to Bluetooth® Preparation on P. 330.

- 1 Turn on the Bluetooth® audio device's power.
- 2 Switch the ignition to ACC or ON.
- 3 Select the  icon on the home screen to display the Entertainment screen.
- 4 When **Bluetooth** is selected, switches to the Bluetooth® audio mode to begin playback.

■ Playback

To listen to a Bluetooth® audio device over the vehicle's speaker system, switch the mode to Bluetooth® audio mode. (Refer to "Switching to Bluetooth® audio mode")

After switching to the Bluetooth® audio mode, the following icons are displayed in the lower part of the display. Icons which can be used differ depending on the version of the Bluetooth® audio device which you are currently using.

Icon	Function
	Displays the Entertainment menu. Use to switch to a different audio source.
	AVRCP Ver. 1.4 only: Displays the top level folder/file list. Select the folder which you want to select. The files in the selected folder are displayed. Select the file you want to play.
	AVRCP Ver. 1.3 or higher: Replays the song currently being played repeatedly. When selected again, the songs in the folder are played repeatedly. Select it again to cancel. Icons change when the song is repeated or the folder is repeated.
	AVRCP Ver. 1.3 or higher: Plays songs in the folder in random order. When selected again, the songs on the device are played in random order. Select it again to cancel. Icons change during folder shuffle or device shuffle.
	Scans the titles in a folder and plays the beginning of each song to aid in finding a desired song. When selected again, the beginning of each song on the device is played. When selected again, the operation is canceled and the song currently being played continues.
	Returns to the beginning of the previous song. Long-press to fast reverse. It stops when you remove your hand from the icon or the commander knob.
	Plays the Bluetooth® audio. When selected again, playback is temporarily stopped.
	Advances to the beginning of the next song. Long-press to fast forward. It stops when you remove your hand from the icon or the commander knob.
	Displays sound settings to adjust audio quality level. Refer to Volume/Display/Sound Controls on P. 288.

- Example of use (When searching for a song from the top level of a device)

1 Select the  icon to display the folder/file list at the top level.

2 When the folder is selected, folders/file lists in the folder are displayed. When the playlist is selected, the file list is displayed.

3 Select the desired song.

Select  to move to a folder one level higher.

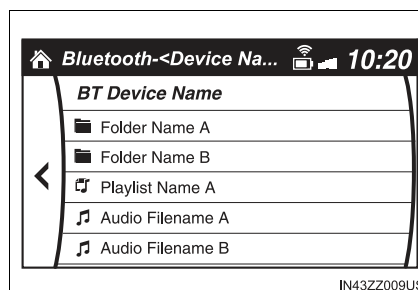

■ Switching to Bluetooth® audio mode

- If the Applications screen is not displayed on the device, Bluetooth® audio may not play on the center display.
- If Bluetooth® audio is used after using Pandora®, Aha™ or Stitcher™ radio, the application on the mobile device has to be closed first.
- If the Bluetooth® audio device does not begin playback, select the  icon.
- If the mode is switched from Bluetooth® audio mode to another mode (radio mode), audio playback from the Bluetooth® audio device stops.

Bluetooth® Audio Device Information Display

When connecting a Bluetooth® audio device, the unit searches the following information from the database stored in the vehicle and it is displayed on the screen. The database information stored in this device uses database information in the Gracenote® music recognitions service.

	AVRCP Ver. lower than 1.3	AVRCP Ver. 1.3	AVRCP Ver. 1.4 or higher
Device name	X	X	X
Remaining battery charge of device	X	X	X
Song name	-	X	X
Artist name	-	X	X
Album name	-	X	X
Playback time	-	X	X
Genre name	-	X	X
Album art image	-	X	X

X: Available

-: Not available

- Some information may not display depending on the device, and if the information cannot be displayed, "Unknown - - -" is indicated.
- Refer to Gracenote® Database on P. 313 for the method of updating the database.

How to Use Pandora® (if equipped)











■ What is Pandora®?

Pandora®*1 is free personalized Internet radio. Simply enter a favorite artist, track, genre, and Pandora® will create a personalized station that plays their music and more like it. Rate songs by giving thumbs-up and thumbs-down feedback to further refine your station, discover new music and help Pandora® play only music you like.

*1: Pandora®, the Pandora® logo, and the Pandora® trade dress are trademarks or registered trademarks of Pandora Media, Inc., used with permission.

■ Playback

Select the  icon on the home screen to display the Entertainment screen. When **Pandora** is selected, the following icons are indicated in the bottom part of the center display.

Icon	Function
	Displays the Entertainment menu. Use to switch to a different audio source.
	Displays the station list. Use to switch to other stations.
	Thumbs-Down Press the  icon to tell Pandora® not to play this track.
	Thumbs-Up Press the  icon to tell Pandora® “you like this track” and it helps to bring in more tracks like it to your station.
	Bookmarking Bookmarks the song or artist currently being played.
	Plays the track. When selected again, playback is temporarily stopped.
	Goes to the next song.
	Displays sound settings to adjust audio quality level. Refer to Volume/Display/Sound Controls on P. 288.

■ Selection from station list

Selection can be made from a programmed radio station list.

- 1 Select the  icon.
- 2 Select the desired radio station.

When **Shuffle** is selected, songs randomly selected from the radio station list are played.

● Selecting the sort method

The displayed order of the station list can be changed.

- 1 Select the  icon.
- 2 Select **Sort By**.
- 3 Select **Date** to display in the order starting from the newly created station.
- 4 Select **A-Z** to display in alphabetical order.

The displayed order of **Shuffle** cannot be changed.

■ Bookmarking

You can bookmark song or artist to check out later on the Web.

- 1 Select the  icon.
- 2 Select **Bookmark Song** to bookmark the song.
- 3 Select **Bookmark Artist** to bookmark the artist.

■ How to Use Pandora®

- Pandora® may not be available outside of the U.S.A..
- To operate Pandora® from your Bluetooth® device, perform the following in advance:
 - Create Pandora® account on the Web.
 - Create Pandora® station using Pandora® application.
 - Install Pandora® application on your device.

■ Playback

- The skip function may not be available depending on the device.
- The number of skips is limited by Pandora®.
- If the  icon is selected when the skip song function is running, the next song is skipped.

How to Use Aha™



Aha*1 is an application which can be used to enjoy various Internet content such as Internet radio and podcasts.

Stay connected to your friends activities by getting updates from Facebook and Twitter. Using the location-based service, nearby services and destinations can be searched or real-time local information can be obtained.









For details on Aha, refer to “<http://www.aharadio.com/>”.





*1: Aha, the Aha logo, and the Aha trade dress are trademarks or registered trademarks of Harman International Industries, Inc., used with permission.

■ Playback

Select the  icon on the home screen to display the Entertainment screen. When  is selected, the following icons are displayed at the bottom of the center display. The displayed icon differs depending on the selected station.

In addition, icons other than the following icons may be displayed.

Icon	Function
	Displays the Entertainment menu. Use to switch to a different audio source.
	Displays the main menu. Use to switch to other stations.
	Displays the content list. Use to switch to other desired content on the station.
	Like*1 Evaluates the current content as “Like”.
	Dislike*1 Evaluates the current content as “Dislike”.
	Reverses for 15 seconds.
	Map (vehicles with navigation system) Displays the destination searched by the location based services on the navigation system.
	Call A call can be made to the telephone number of a shop searched using the Location Based Services. Available when a device is connected as a Hands-Free.

Icon	Function
	Returns to the previous content.
	Pauses playback of the content. When selected again, playback resumes.
	Goes to the next content.
	Fast-forwards for 30 seconds.
	Displays sound settings to adjust audio quality level. Refer to Volume/Display/Sound Controls on P. 288.

*1: Some stations may use alternate variations of Like and Dislike, based on station type or provider.

● Main menu

Select the  icon.

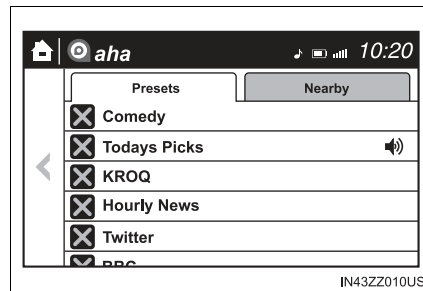

Switch the tab and select the station category.

Tab	Function
Presets	Displays the preset station list set on the device. Select the preset station name to play the station content.
Nearby	Select the desired station. Guidance is provided to the searched destination near the vehicle's position. You can designate desired categories previously set using the filter setting on your device.

● Example of use (Location Based Services)

1 Select the desired station from the “Nearby” tab on the main menu. The destination name or address playback starts in the order of the destination name list.

2 When the  icon is selected, the currently displayed destination is displayed on the navigation system (vehicles with navigation system).

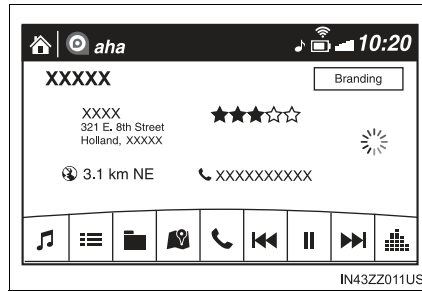

3 When the  icon is selected, a phone call is placed to the currently displayed destination.

4 Select the  icon to display the content list. Selection of other destinations from the list can be made.

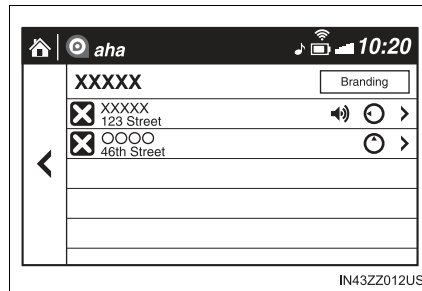

■ How to Use Aha™

- The service content provided by Aha varies depending on the country in which the user resides. In addition, the service is not available in some countries.
- To operate Aha from your Bluetooth® device, perform the following in advance:
 - Install the Aha application to your device.
 - Create an Aha account for your device.
 - Log onto Aha using your device.
 - Select the preset station on your device.
- If the Applications screen is not displayed on the device, Aha™ may not play on the center display.

■ Playback

The available Location Based Services may differ because the services depend on the content provided by Aha™.

■ Shout

- Recordable time varies depending on the station (Max. 30 seconds).
- Recording stops automatically when the recordable time has elapsed. You can then post or delete the recording.

How to Use Stitcher™ Radio

■ What is Stitcher™ Radio?



Stitcher™*1 radio is an application which can be used to listen to Internet radio or stream podcasts.









Recommended content is automatically selected by registering content which you put into your favorites, or by pressing the Like or Dislike button.

For details on Stitcher™ Radio, refer to “<http://stitcher.com/>”.

*1: Stitcher™, the Stitcher™ logo, and the Stitcher™ trade dress are trademarks or registered trademarks of Stitcher, Inc., used with permission.

■ Playback

Select the  icon on the home screen to display the Entertainment screen. When  is selected, the following icons are indicated in the bottom part of the center display.

Icon	Function
	Displays the Entertainment menu. Use to switch to a different audio source.
	Displays the station list. Use to switch to other stations.
	Dislike Evaluates the current program as “Dislike”.
	Like Evaluates the current program as “Like”.
	Adds the current station to your favorites or deletes the current station from your favorites.
	Reverses for 30 seconds.
	Plays the station. Select it again to pause playback.
	Goes to the next station.
	Displays sound settings to adjust audio quality level. Refer to Volume/Display/Sound Controls on P. 288.

● Station list

- 1 Select the  icon to display the station list.

- ① Favorites station name:
Select to display the program registered to your favorites.

- ② Category name:
A recommended category selected from your favorites by Stitcher™ is displayed.

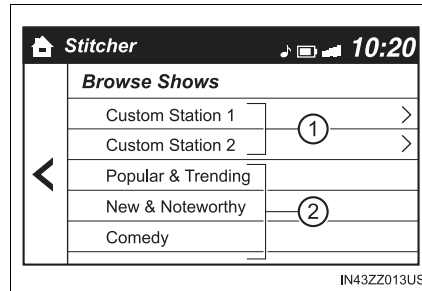

Select it to display the category program.

- 2 Select the program name to play it.

● Add to your favorites

If the current program has not been registered to your favorites, it can be registered to your favorites.

- 1 Select the  icon to display the favorites station which the registration can be added.
- 2 Select the station name which you want to register.
- 3 Select **OK** to add the program to the selected favorites station.
 - Multiple favorites stations can be selected and registered.
 - Favorites stations registered by oneself as well those set by default are displayed.

● Delete from your favorites

If the current program has already been registered to your favorites, the program can be deleted from your favorites.

- 1 Select the  icon.
- 2 The program is automatically deleted from the favorites station.

■ How to Use Stitcher™ Radio

- To operate Stitcher™ Radio from your Bluetooth® device, perform the following in advance:
 - Install the Stitcher™ Radio application to your device.
 - Create a Stitcher™ Radio account for your device.
 - Log onto Stitcher™ Radio using your device.
- If the Applications screen is not displayed on the device, Stitcher™ may not play on the center display.

Troubleshooting

If you have any problems with Bluetooth®, contact our toll-free customer service center.

- U.S.A.

Toyota Customer Experience Center

Phone: 1-800-331-4331 (Toll-free)

Web: <http://www.toyota.com/entune>

- Canada

Toyota Canada Customer Interaction Centre

Phone: 1-888-TOYOTA-8 or 1-888-869-6828 (Toll-free)

Web: <http://www.toyota.ca>

- **Apple CarPlay™ use-related issues**

Symptom	Cause	Solution method
Apple CarPlay™ cannot launch even though an Apple®-genuine connector cord is inserted into the USB port and it is connected to my iPhone®.	You used the wrong USB port.	Use the USB port displaying the  mark to start Apple CarPlay™.
The error message, "Mobile device error" is displayed after connecting my iPhone® to the USB port.	There is mis-communication between the vehicle's audio system and your iPhone®.	Disconnect the connector cord from the USB port once and then reconnect it.
The icon of the application I want to use is not displayed on the home screen of Apple CarPlay™.	Only applications compatible with Apple CarPlay™ are displayed on the screen.	Contact the application's supplier.

Symptom	Cause	Solution method
Voice recognition using Siri® is poor or incorrect for commands or contact names.	<p>There are many possible reasons for this such as:</p> <ol style="list-style-type: none"> 1. Poor network connectivity 2. Road noise/sound of air blowing from air conditioner 3. Incorrect iPhone® language setting 	<ol style="list-style-type: none"> 1. Use the commander switch to complete the task or wait until there is sufficient network connectivity before using Siri® again. 2. For better voice recognition, speak loud and clear. 3. Make sure that the iPhone® language is set correctly (Example: US English vs UK English). <p>If you are still having difficulty using Siri®, visit the Apple® support site or contact Apple®.</p>
There is a difference in the audio volume between Bluetooth® audio and Apple CarPlay™.	-	Check the volume of the audio on the device connected via Bluetooth®. The volume on some devices connected via Bluetooth® can be adjusted.

■ Android Auto™ use-related issues

Symptom	Cause	Solution method
The Android Auto™ mode does not launch even though the Android™-genuine connector cord is inserted into the USB port and it is connected to my Android™ Smartphone.	The Android Auto™ application has not been downloaded to your Android™ Smartphone.	To use Android Auto™ with your vehicle, the Android Auto™ application is required on your Android™ Smartphone. Download the Android Auto™ application from the Google Play™.
	You used the wrong USB port.	Use the USB port displaying the  mark to start the Android Auto™ mode.
The error message, "Mobile device error" is displayed after connecting my Android™ Smartphone to the USB port.	There is miscommunication between the vehicle's audio system and your Android™ Smartphone.	Disconnect the connector cord from the USB port once and then reconnect it.
	Your Android™ Smartphone cannot be paired because another device is connected via Bluetooth®.	Disconnect the other device's Bluetooth® connection, disconnect the connector cord of the Android™ Smartphone from the USB terminal once, and then reconnect it.
The icon of the application I want to use is not displayed on the home screen while in Android Auto™ mode.	Only applications compatible with Android Auto™ are displayed on the screen.	Contact the application's supplier.
<ul style="list-style-type: none"> • Voice recognition is poor or incorrect. • Voice recognition responds slowly or it does not work. 	-	If you are having difficulty using the voice recognition, visit the Android Auto™ support site or contact Google™.

Symptom	Cause	Solution method
There is a difference in the audio volume between Bluetooth® audio and Android Auto™.	-	Check the volume of the audio on the device connected via Bluetooth®. The volume on some devices connected via Bluetooth® can be adjusted.

■ Bluetooth® Device pairing, connection problems

Symptom	Cause	Solution method
Unable to perform pairing.	-	First make sure the device is compatible with the Bluetooth® unit, and then check whether the Bluetooth® function and the Find Mode/Visible setting*1 on the device are turned on. If pairing is still not possible after this, contact your Toyota dealer or Toyota Canada Customer Interaction Centre.
Pairing cannot be performed again.	The pairing information paired to the Bluetooth® unit or device is not recognized correctly.	Perform pairing using the following procedure. <ul style="list-style-type: none"> • Clear “Toyota” stored in the device. • Perform pairing again.
It takes time for automatic connection.	There are a lot of paired Bluetooth® devices.	Delete the pairing information for unused Bluetooth® devices. If it takes time for an automatic connection even though the above operation has been done, do a manual connection.

Symptom	Cause	Solution method
Unable to perform pairing.	The Bluetooth® function and the Find Mode/Visible setting*1 on the device may turn off automatically after a period of time has elapsed depending on the device.	Check whether the Bluetooth® function and the Find Mode/Visible setting*1 on the device are turned on and pairing or reconnect.
Does not connect automatically when starting the engine.		
Automatically connects, but then disconnects suddenly.		
Disconnects intermittently.	The device is in a location in which radio wave interference can occur easily, such as inside a bag in a rear seat, in a rear pocket of a pair of pants.	Move the device to a location in which radio wave interference is less likely to occur.
Does not connect automatically when starting the engine.	The pairing information is updated when the device OS is updated.	Perform pairing again.

*1: Setting which detects the existence of a device external to the Bluetooth® unit

■ Voice recognition related problems

Symptom	Cause	Solution method
Poor voice recognition.	<ul style="list-style-type: none"> Excessive, slow speech. Excessive, forceful speech (shouting). Speaking before the beep sound has ended. Loud noise (speaking or noise from outside/inside vehicle). Airflow from A/C is blowing against the microphone. Speaking in off-standard expressions (dialect). 	Regarding the causes indicated on the left, be careful with how you speak. In addition, when numbers are spoken in a sequence, recognition ability will improve if no stop is placed between the numbers.
False recognition of numbers.		
Poor voice recognition.	There is a malfunction in the microphone.	A poor connection or malfunction with the microphone may have occurred. Consult your Toyota dealer.
Phone-related voice recognition is disabled.	There is a problem with the connection between the Bluetooth® unit and the device.	If there is any malfunction after checking the pairing situation, check for device pairing or connection problems.
Names in the phonebook are not easily recognized.	The Bluetooth® system is under a condition in which recognition is difficult.	<p>By carrying out the following measures, the rate of recognition will improve.</p> <ul style="list-style-type: none"> Clear memory from the phonebook which is not used very often. Avoid shortened names, use full names. (Recognition improves the longer the name is. By not using names such as "Mom", "Dad", recognition will improve.)

Symptom	Cause	Solution method
When operating the audio, a song name is not recognized.	Song names cannot be recognized by voice.	-
You want to skip guidance.	-	Guidance can be skipped by quickly pressing and releasing the Talk button.

■ Regarding problems with calls

Symptom	Cause	Solution method
When starting a call, vehicle noise from the other party can be heard.	For about 3 seconds after starting a call, the Bluetooth® unit's Noise Suppression function requires time to adapt to the call environment.	This does not indicate a problem with the device.
The other party cannot be heard or the speaker's voice is quiet.	The volume is set at zero or low.	Increase the volume.
The phone does not receive calls.	The "Incoming Call Notifications" setting in the Communication Settings is off.	Turn the "Incoming Call Notifications" setting on.

■ Other problems

Symptom	Cause	Solution method
The indication for the remaining battery is different between the vehicle and the device.	The indication method is different between the vehicle and the device.	-
When a call is made from the vehicle, the telephone number is updated in the incoming/outgoing call record but the name does not appear.	The number has not been registered into the phonebook.	If the number has been registered into the phonebook, the incoming/outgoing call record is updated by the name in the phonebook when the engine is restarted.

Symptom	Cause	Solution method
The cell phone does not synchronize with the vehicle regarding the incoming/outgoing call record.	Some types of cell phones do not synchronize automatically.	Operate the cell phone for synchronization.
It takes a long time to complete the function for changing the language.	A maximum of 60 seconds is required.	-

■ Bluetooth® Device pairing, connection problems

- When the OS of the device is updated, the pairing information may be deleted. If this happens, reprogram the pairing information to the Bluetooth® unit.
- If you pair your phone which has already been paired to your vehicle more than once in the past, you need to delete "Toyota" on your mobile device. Then, execute the Bluetooth® search on your mobile device once again, and pair to a newly detected "Toyota".
- Before you pair your device, make sure that Bluetooth® is "ON", both on your phone and on the vehicle.

Sunvisors

When you need a sunvisor, lower it for use in front or swing it to the side.

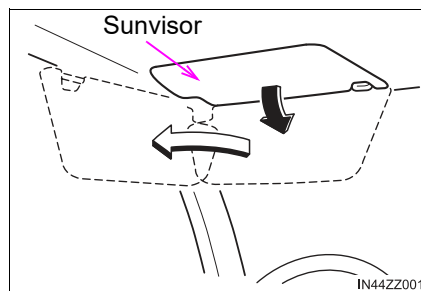

Vanity Mirrors

To use the vanity mirror, lower the sunvisor.

Interior Lights

■ Overhead Lights

- ① OFF
- ② DOOR
- ③ ON

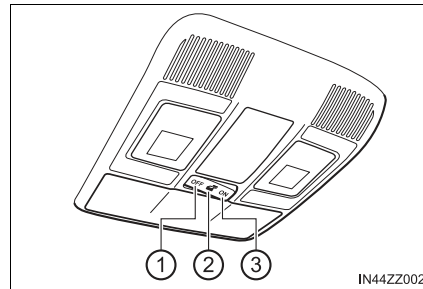

Switch Position	Overhead Lights
OFF	Light off
DOOR	<ul style="list-style-type: none"> • Light is on when any door is open • Light is on or off when the illuminated entry system is on
ON	Light on

■ Map Lights

When the overhead light switch is in the door or off position, press the lens to illuminate the map lights, and then press the lens again to turn them off.

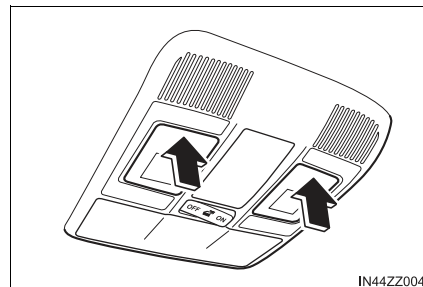

■ Luggage Compartment Lights (5-Door)

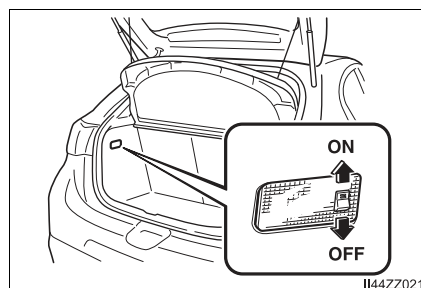

Switch Position	Overhead Lights
OFF	Light off
ON	Light on when the liftgate is open

■ Trunk Light (4-Door)

The trunk light is on when the lid is open and off when it's closed.

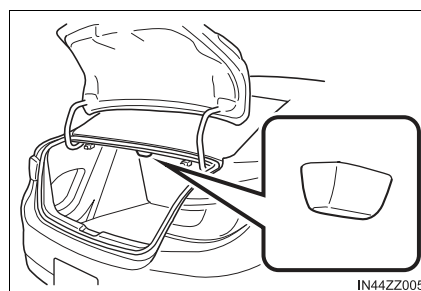

■ Map Lights

The map lights will not turn off even if the lens is pressed in the following cases:

- The overhead light switch is in the ON position.
- The overhead light switch is in the door position with the door open.
- The illuminated entry system is on.

⚠ NOTICE

■ Overhead Lights and Map Lights

Do not leave the lights on for long periods while the engine is turned off. Otherwise, the battery power could be depleted.

■ Trunk Light

To prevent the battery from being discharged, do not leave the trunk open for a long period when the engine is not running.

Illuminated Entry System

The overhead lights turn on when any of the following operations is done with the overhead light switch in the DOOR position and the ignition switched off.

- Turn on for about 30 seconds when the driver's door is unlocked.
- Turn on for about 15 seconds when a door is opened with a key left in the vehicle and then the door is closed.
- Turn on for about 5 seconds when a door is opened from the outside with a key being carried and then the door is closed.

The overhead lights turn on for about 15 seconds when the ignition is switched off with the overhead light switch in the DOOR position.

The overhead lights turn off immediately in the following cases:

- The ignition is switched on and all doors are closed.
- The driver's door is locked.

● Battery saver

If any door is left open with the overhead light switch in the DOOR position, or the trunk lid is left open, the overhead light or trunk light turns off after about 30 minutes to prevent battery depletion.

● To prevent battery depletion, if the interior lights remain turned on (the interior light switch is in the ON position or an interior light is turned on by pressing the lens of the interior light), they turn off automatically under the following conditions:

- No operations are done for about 30 minutes after the ignition is switched off.
- When the LOCK button on the key is pressed after the ignition is switched off (interior lights turn off a few seconds).

In addition, if the following operations are performed after turning the interior lights off, they will turn on again.

- The ignition is switched to a position other than OFF.
- A door is opened.
- A door is unlocked.

● The operation of the illuminated entry system can be changed.

Refer to Customizable Features on P. 555.

Accessory Socket

Only use genuine Toyota accessories or the equivalent requiring no greater than 120 W (DC 12 V, 10 A).

The ignition must be switched to ACC or ON.

► Type A

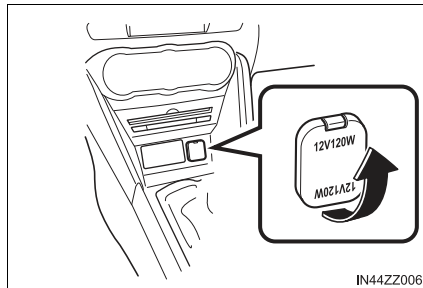

► Type B

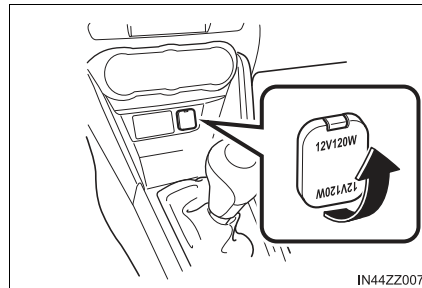

⚠ NOTICE

- To prevent accessory socket damage or electrical failure, pay attention to the following:
 - Do not use accessories that require more than 120 W (DC 12 V, 10 A).
 - Do not use accessories that are not genuine Toyota accessories or the equivalent.
 - Close the cover when the accessory socket is not in use to prevent foreign objects and liquids from getting into the accessory socket.
 - Correctly insert the plug into the accessory socket.
 - Do not insert the cigarette lighter into the accessory socket.
- Noise may occur on the audio playback depending on the device connected to the accessory socket.
- Depending on the device connected to the accessory socket, the vehicle's electrical system may be affected, which could cause the warning light to illuminate. Disconnect the connected device and make sure that the problem is resolved. If the problem is resolved, disconnect the device from the socket and switch the ignition off. If the problem is not resolved, consult your Toyota dealer.
- To prevent discharging of the battery, do not use the socket for long periods with the engine off or idling.

Cup Holder

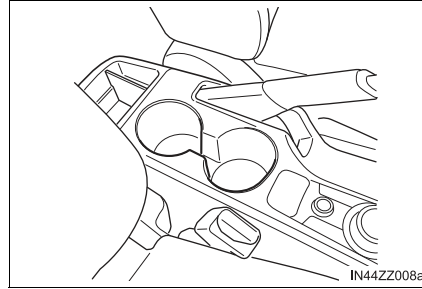



WARNING

- **Never use a cup holder to hold hot liquids while the vehicle is moving**
Using a cup holder to hold hot liquids while the vehicle is moving is dangerous. If the contents spill, you could be scalded.
- **Do not put anything other than cups or drink cans in cup holders**
Putting objects other than cups or drink cans in a cup holder is dangerous. During sudden braking or maneuvering, occupants could be hit and injured, or objects could be thrown around the vehicle, causing interference with the driver and the possibility of an accident. Only use a cup holder for cups or drink cans.

Bottle Holder

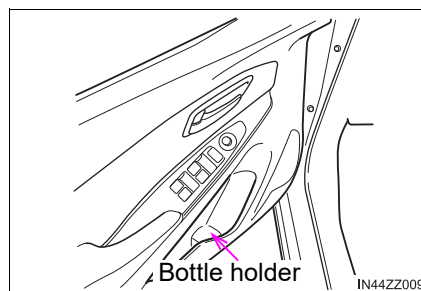
Bottle holders are on the inside of the front doors.



 NOTICE

Do not use the bottle holders for containers without caps. The contents may spill when opening/closing the door or while driving the vehicle.

Storage Compartments

WARNING

■ Keep storage boxes closed when driving

Driving with the storage boxes open is dangerous. To reduce the possibility of injury in an accident or a sudden stop, keep the storage boxes closed when driving.

■ Do not put articles in storage spaces with no lid

Putting articles in storage spaces with no lid is dangerous as they could be thrown around the cabin if the vehicle is suddenly accelerated and cause injury depending on how the article is stored.

NOTICE

Do not leave lighters or eyeglasses in the storage boxes while parked under the sun. A lighter could explode or the plastic material in eyeglasses could deform and crack from high temperature.

Overhead Console

This console box is designed to store eyeglasses or other accessories.

Push and release to open.

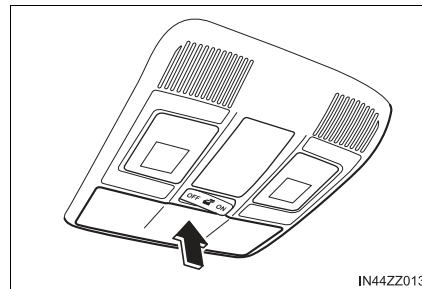

Glove Compartment

To open the glove compartment, pull the latch toward you.

To close the glove compartment, firmly press in the center of the glove compartment lid.

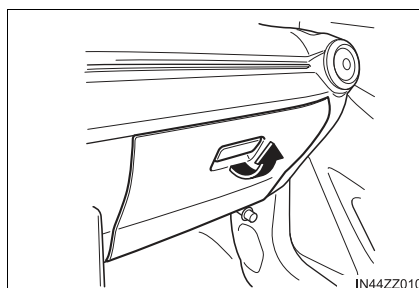

Center Console Tray

A cup or small items can be placed on the center console tray using the center console divider.

The center console tray is large enough to place a small item when the center console divider is not in use.

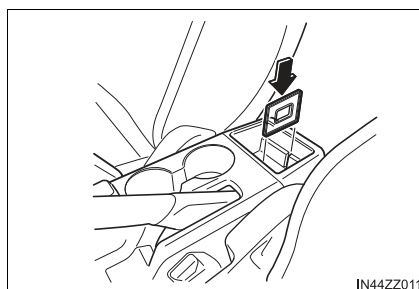

WARNING

■ **Never use a cup holder to hold hot liquids while the vehicle is moving**

Using a cup holder to hold hot liquids while the vehicle is moving is dangerous. If the contents spill, you could be scalded.

Cargo Sub-Compartment (4-Door)

Lift the trunk mat.

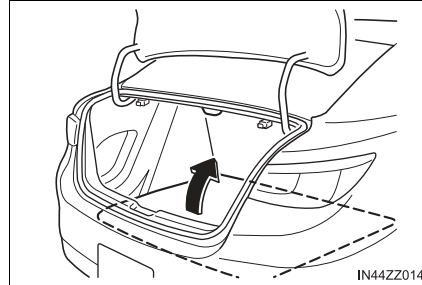
**Rear Coat Hooks**

Always hang clothes on the coat hooks and the assist grips without hangers.

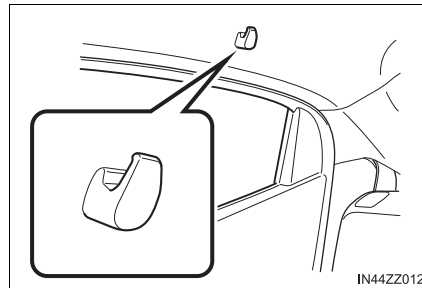
**⚠ WARNING****■ Never hang heavy or sharp objects on the assist grips and coat hooks**

Hanging heavy or sharp-ended objects such as a coat hanger from the assist grips or coat hooks is dangerous as they can fly off and hit an occupant in the cabin if a curtain air bag was to deploy, which could result in serious injury or death.

Maintenance and Care**5**

5-1. Essential Information	
Introduction	386
5-2. Scheduled Maintenance	
Maintenance Monitor	388
5-3. Owner Maintenance	
Owner Maintenance	
Precautions	390
Hood	392
Engine Compartment	
Overview	394
Engine Oil	395
Engine Coolant	398
Brake/Clutch Fluid.....	401
Window Washer Fluid	402
Body Lubrication	403
Wiper Blades.....	404
Battery.....	408
Key Battery	
Replacement.....	410
Tires	413
Light Bulbs	419
Fuses	435
5-4. Appearance Care	
Exterior Care	442
Interior Care	450

Introduction

Be careful not to hurt yourself when inspecting your vehicle, replacing a tire, or doing some kind of maintenance such as car washing. In particular, wear thick work gloves such as cotton gloves when touching areas that are difficult to see while inspecting or working on your vehicle. Doing inspections or procedures with your bare hands could cause injury.

If you are unsure about any procedure this manual describes, we strongly urge you to have a reliable and qualified service shop perform the work, preferably your Toyota dealer.

Factory-trained Toyota technicians and genuine Toyota parts are best for your vehicle. Without this expertise and the parts that have been designed and made especially for your Toyota, inadequate, incomplete, and insufficient servicing may result in problems. This could lead to vehicle damage or an accident and injuries.

For expert advice and quality service, consult your Toyota dealer.

To continue warranty eligibility and to protect your investment, it is your responsibility to properly maintain your vehicle according to factory recommended schedules outlined in this manual. Keep a copy of the repair order. It proves that the maintenance that has been performed is under warranty coverage. If any problem should arise while your vehicle is under warranty, your Toyota dealer will promptly take care of it.

This evidence may consist of the following:

- The Maintenance Log, found within the Warranty and Maintenance Guide, must be completely filled out showing mileage, repair order number, date for each service, and signed by a qualified automotive service technician who service vehicles.
- Original copies of repair orders or other receipts that include the mileage and date the vehicle was serviced. Each receipt should be signed by a qualified automotive service technician.
- For self maintenance, a statement that you completed the maintenance yourself, displaying mileage and the date the work was performed. Also, receipts for the replacement parts (fluid, filters, etc.) indicating the date and mileage must accompany this statement.

Claims against the warranty resulting from lack of maintenance, as opposed to defective materials or authorized Toyota workmanship, will not be honored.

Any auto repair shop using parts equivalent to your Toyota's original equipment may perform maintenance. But we recommend that it always be done by your Toyota dealer using genuine Toyota parts.

Selecting "Maintenance Monitor" enables the system to notify you of your vehicle's approaching inspection/servicing period (→P. 388).

The malfunction diagnosis connector is designed exclusively for connecting the specially designed device to perform on-board diagnosis.

Do not connect any devices other than the specially designed malfunction diagnosis devices for servicing. If any device other than the malfunction diagnosis device is connected, it may affect the vehicle's electrical devices or lead to damage such as battery depletion.

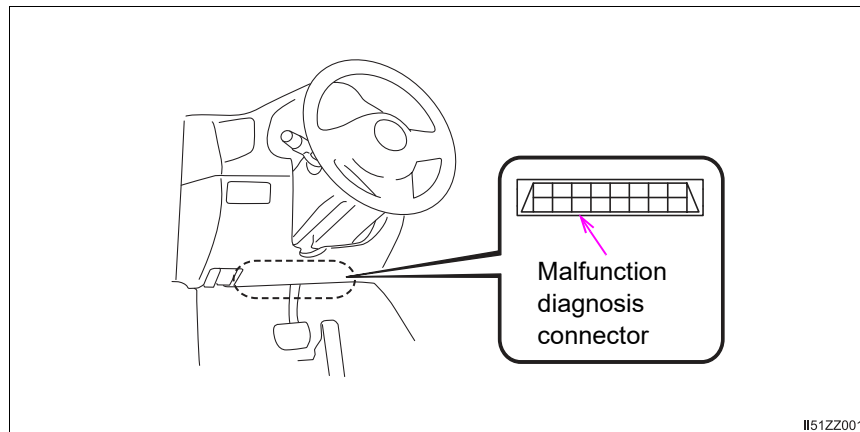

If you elect to perform maintenance yourself or have your vehicle serviced at a location other than your Toyota dealer, Toyota requires that all fluids, parts and materials must meet Toyota standards for durability and performance as described in this manual.

Maintenance Monitor

Maintenance Monitor

- 1 Select the  icon on the home screen to display the “Applications” screen.
- 2 Select “Maintenance” to display the maintenance list screen.
- 3 Switch the tab and select the setting item you want to change.

You can customize settings in the setup display as follows:

Tab	Item	Explanation
Scheduled	Setting	Notification can be switched on/off.
	Time (months)	Displays the time or distance until maintenance is due. Select this item to set the maintenance period. “Scheduled Due!” is displayed in red and the wrench indicator light in the combination meter will be illuminated when the remaining distance is less than 250 miles or 500 km, or the remaining number of days is less than 15 (whichever comes first).
	Distance (mile or km)	Displays the time or distance until maintenance is due. Select this item to set the maintenance period. “Scheduled Due!” is displayed in red and the wrench indicator light in the combination meter will be illuminated when the remaining distance is less than 250 miles or 500 km, or the remaining number of days is less than 15 (whichever comes first).
	Reset	Resets the time and distance to the initial values. Once the system turns on, it needs to be reset whenever carrying out maintenance.
Tire Rotation	Setting	Notification can be switched on/off.
	Distance (mile or km)	Displays the distance until tire rotation is due. Select this item to set the tire rotation distance. “Tire Rotation Due!” is displayed in red and the wrench indicator light in the combination meter will be illuminated when the remaining distance is less than 250 miles or 500 km.
	Reset	Resets the remaining distance to the initial value. Once the system turns on, it needs to be reset whenever rotating the tires.

Tab	Item	Explanation
Oil Change	Setting Interval	<p>The oil replacement period can be selected from the flexible setting or fixed setting, or it can be set to non-display.</p> <p>The flexible setting is available only in the United States and Puerto Rico. Once engine oil flexible maintenance is selected, the vehicle calculates the remaining oil life based on the engine operating conditions. The vehicle lets you know when an oil change is due by illuminating the wrench indicator light in the combination meter. Toyota Genuine Motor Oil or equivalent are required to achieve optimum performance.</p>
	Distance (mile or km) (Displays only in fixed setting)	<p>Displays the distance until the oil replacement is due.</p> <p>Select this item to set the oil replacement distance.</p> <p>“Oil Change Due!” is displayed in red and the wrench indicator light in the combination meter will be illuminated when the remaining distance is less than 250 miles or 500 km.</p>
	Oil life (%) (Displays only in flexible setting)	<p>Displays the engine oil life until the oil replacement is due.</p> <p>“Oil Change Due!” is displayed in red and the wrench indicator light in the combination meter will be illuminated when the remaining oil life distance is less than 250 miles (500 km), or remaining days are less than 15 (whichever comes first).</p>
	Reset	<p>In flexible setting: Resets the remaining oil life to 100%.</p> <p>In fixed setting: Resets the remaining distance to the initial value.</p> <p>Once the Flexible Oil Maintenance Setting is selected, the system must be reset whenever replacing the engine oil.</p>

Owner Maintenance Precautions

The owner or a qualified service technician should make these vehicle inspections at the indicated intervals to ensure safe and dependable operation.

Bring any problem to the attention of your Toyota dealer or qualified service technician as soon as possible.

■ When Refueling

- Brake and clutch fluid level (→P. 401)
- Engine coolant level (→P. 398)
- Engine oil level (→P. 397)
- Washer fluid level (→P. 402)

■ At Least Monthly

- Tire inflation pressures (→P. 413)

■ At Least Twice a Year (For Example, Every Spring and Fall)

You can do the following scheduled maintenance items if you have some mechanical ability and a few basic tools and if you closely follow the directions in this manual.

- Engine coolant (→P. 398)
- Engine oil (→P. 395)

Improper or incomplete service may result in problems. This section gives instructions only for items that are easy to perform.

As explained in the Introduction (→P. 386), several procedures can be done only by a qualified service technician with special tools.

Improper owner maintenance during the warranty period may affect warranty coverage. Refer to Introduction (→P. 386) for owner's responsibility in protecting your investment. For details, read the separate Toyota Warranty and Maintenance Guide provided with the vehicle. If you are unsure about any servicing or maintenance procedure, have it done by your Toyota dealer.

There are strict environmental laws regarding the disposal of waste oil and fluids. Please dispose of your waste properly and with due regard to the environment.

We recommend that you entrust the oil and fluid changes of your vehicle to your Toyota dealer.

 **WARNING**

- **Do not perform maintenance work if you lack sufficient knowledge and experience or the proper tools and equipment to do the work. Have maintenance work done by a qualified technician**

Performing maintenance work on a vehicle is dangerous if not done properly. You can be seriously injured while performing some maintenance procedures.

- **If you must run the engine while working under the hood, make certain that you remove all jewelry (especially rings, bracelets, watches, and necklaces) and all neckties, scarves, and similar loose clothing before getting near the engine or cooling fan which may turn on unexpectedly**

Working under the hood with the engine running is dangerous. It becomes even more dangerous when you wear jewelry, loose clothing or have long hair or a long beard.

Either can become entangled in moving parts and result in injury.

-  **Switch the ignition to off and make sure the fan is not running before attempting to work near the cooling fan**

Working near the cooling fan when it is running is dangerous. The fan could continue running indefinitely even if the engine has stopped and the engine compartment temperature is high. You could be hit by the fan and seriously injured.

- **Do not leave items in the engine compartment**

After you have finished checking or doing servicing in the engine compartment, do not forget and leave items such as tools or rags in the engine compartment.

Tools or other items left in the engine compartment could cause engine damage or a fire leading to an unexpected accident.

Hood

Opening the Hood

- 1 With the vehicle parked, pull the release handle to unlock the hood.

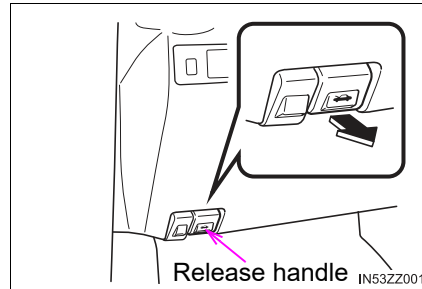

- 2 Insert your hand into the hood opening, slide the latch lever to the right, and lift up the hood.

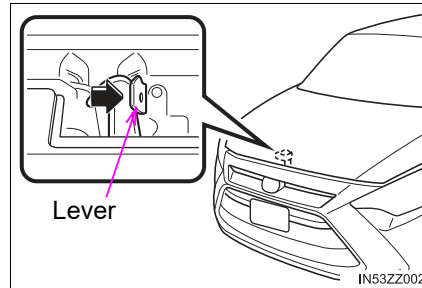

- 3 Grasp the support rod in the padded area and secure it in the support rod hole indicated by the arrow to hold the hood open.

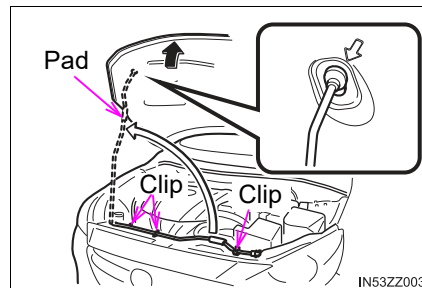

Closing the Hood

- 1 Check under the hood area to make certain all filler caps are in place and all loose items (e.g. tools, oil containers, etc.) have been removed.
- 2 Lift the hood, grasp the padded area on the support rod, and secure the support rod in the clip. Verify that the support rod is secured in the clip before closing the hood.

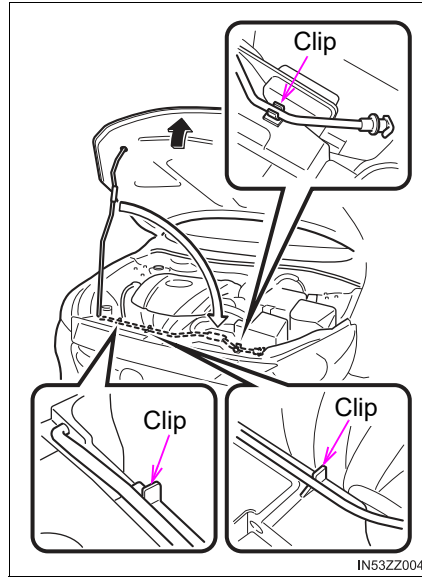

- 3 Lower the hood slowly to a height of about 7.9 in. (200 mm) above its closed position and then let it drop.

WARNING

■ Always check that the hood is closed and securely locked

A hood that is not closed and securely locked is dangerous as it could fly open while the vehicle is moving and block the driver's vision which could result in a serious accident.

NOTICE

When closing the hood, do not push it excessively such as by applying your weight. Otherwise, the hood could be deformed.

Engine Compartment Overview

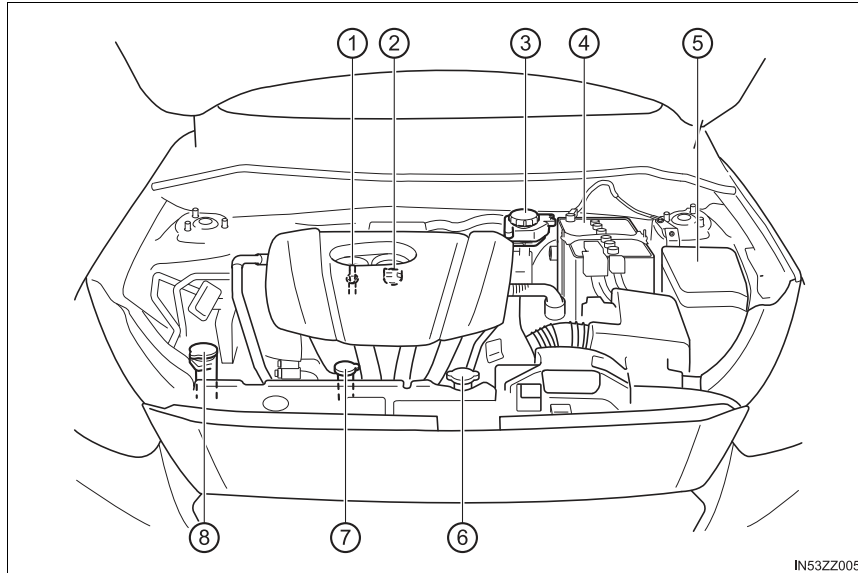

- | | |
|--------------------------------|-------------------------------------|
| ① Engine oil dipstick | ⑤ Fuse block |
| ② Engine oil-filler cap | ⑥ Cooling system cap |
| ③ Brake/Clutch fluid reservoir | ⑦ Engine coolant reservoir |
| ④ Battery | ⑧ Windshield washer fluid reservoir |

Engine Oil

Changing the engine oil should be performed by your Toyota dealer. Refer to Introduction (→P. 386) for owner’s responsibility in protecting your investment.

Recommended Oil

Use SAE 0W-20 engine oil.

Toyota Genuine Motor Oil is used in your Toyota vehicle. Toyota Genuine Motor Oil 0W-20 is required to achieve optimum fuel economy.

For maintenance service, Toyota recommends Toyota Genuine Motor Oil or equivalent.

Only use SAE 0W-20 oil “Certified For Gasoline Engines” by the American Petroleum Institute (API).

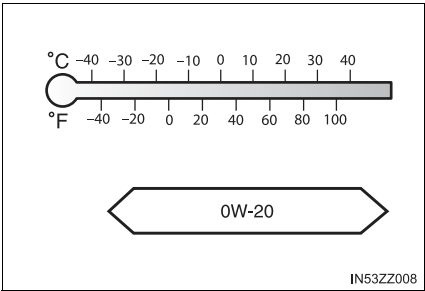

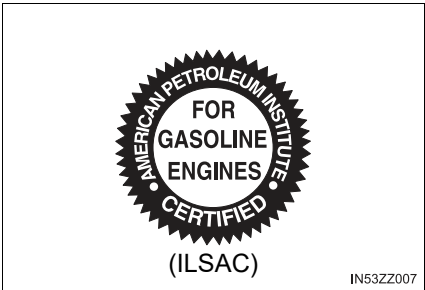

Oil with this trademark symbol conforms to the current engine and emission system protection standards and fuel economy requirements of the International Lubricant Standardization and Approval Committee (ILSAC), comprised of U.S. and Japanese automobile manufacturers.



Vehicle Engine Control Unit Reset Procedure

After replacing the engine oil, have a repair shop such as your Toyota dealer perform the initialization (engine oil data resetting) of the recorded value. If the value recorded by the computer is not initialized, the wrench indicator light may not turn off or it may turn on earlier than normal.

- This procedure is intended for vehicles with the engine oil flexible maintenance setting selected.
- The initialization (engine oil data resetting) of the recorded value can be performed using the following procedure:

- 1 Switch the ignition OFF.
- 2 Switch the ignition ON with the selector pressed and continue pressing the selector for about 5 seconds until the master warning light  flashes.
- 3 After the master warning light  flashes for several seconds, the initialization is completed.

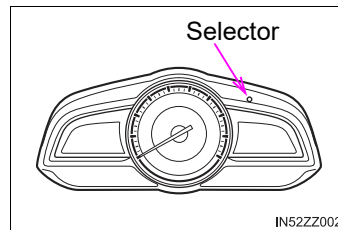

Inspecting Engine Oil Level

- 1 Be sure the vehicle is on a level surface.
- 2 Warm up the engine to normal operating temperature.
- 3 Turn it off and wait at least 5 minutes for the oil to return to the oil pan.
- 4 Pull out the dipstick, wipe it clean, and reinsert it fully.

- ① Full
- ② OK
- ③ Low

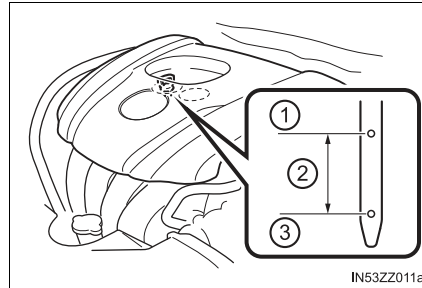

- 5 Pull it out again and examine the level. The level is normal if it is between Low and Full.
If it is near or below Low, add enough oil to bring the level to Full.
- 6 Make sure the O-ring on the dipstick is positioned properly before reinserting the dipstick.
- 7 Reinsert the dipstick fully.

 NOTICE

Do not overfill the engine oil. This may cause engine damage.

Engine Coolant

Inspecting Coolant Level

Inspect the antifreeze protection and coolant level in the coolant reservoir at least once a year—at the beginning of the winter season—and before traveling where temperatures may drop below freezing.

Inspect the condition and connections of all cooling system and heater hoses.

Replace any that are swollen or deteriorated.

The coolant should be at full in the radiator and between the F and L marks on the coolant reservoir when the engine is cool.

- ① Cooling fan
- ② Cooling system cap
- ③ Coolant reservoir

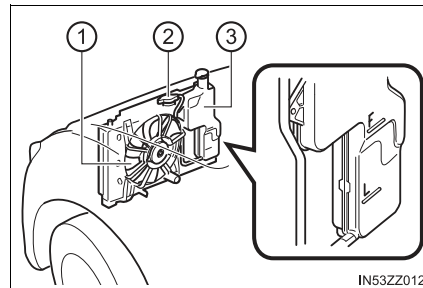

If it is at or near L, add enough coolant to the coolant reservoir to provide freezing and corrosion protection and to bring the level to F.

Securely tighten the coolant reservoir tank cap after adding coolant.

If the coolant reservoir is empty or new coolant is required frequently, consult your Toyota dealer.

Changing the coolant should be done by your Toyota dealer.

 **WARNING**

■ **Do not use a match or live flame in the engine compartment. DO NOT ADD COOLANT WHEN THE ENGINE IS HOT**

A hot engine is dangerous. If the engine has been running, parts of the engine compartment can become very hot. You could be burned. Carefully inspect the engine coolant in the coolant reservoir, but do not open it.

■  **Pull over to a safe location, then switch the ignition to off and make sure the fan is not running before attempting to work near the cooling fan**

Working near the cooling fan when it is running is dangerous. The fan could continue running indefinitely even if the engine has stopped and the engine compartment temperature is high. You could be hit by the fan and seriously injured.

■  **Do not remove either cooling system cap when the engine and radiator are hot**

When the engine and radiator are hot, scalding coolant and steam may shoot out under pressure and cause serious injury.

 NOTICE

- Radiator coolant will damage paint. Rinse it off quickly if spilled.
- Use only soft (deionized) water in the coolant mixture. Water that contains minerals will cut down on the coolant's effectiveness.
- Do not add only water. Always add a proper coolant mixture.
- The engine has aluminum parts and must be protected by an ethylene-glycol-based coolant to prevent corrosion and freezing.
- DO NOT USE coolants Containing Alcohol, methanol, Borate or Silicate. These coolants could damage the cooling system.
- DO NOT MIX alcohol or methanol with the coolant. This could damage the cooling system.
- Do not use a solution that contains more than 60% antifreeze. This would reduce effectiveness.
- Use of engine coolant specifically designed for the YARIS/YARIS HATCHBACK is required when replacing engine coolant. Using engine coolant that is not specifically designed for this vehicle may cause serious damage to the engine and cooling system. For questions on how to obtain this specially designed coolant, contact your Toyota dealer.

Brake/Clutch Fluid

Inspecting Brake/Clutch Fluid Level

The brakes and clutch draw fluid from the same reservoir.

Inspect the fluid level in the reservoir regularly. It should be kept between the MAX and MIN lines.

The level normally drops with accumulated distance, a condition associated with wear of brake and clutch linings. If it is excessively low, have the brake/clutch system inspected by your Toyota dealer.

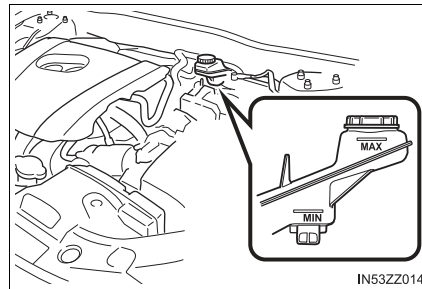

WARNING

■ **If the brake/clutch fluid level is low, have the brakes inspected**

A low brake/clutch fluid level is dangerous.

A low level could indicate brake lining wear or a brake system leak which could cause the brakes to fail and lead to an accident.

Window Washer Fluid

Inspecting Washer Fluid Level

Inspect fluid level in the washer fluid reservoir; add fluid if necessary.

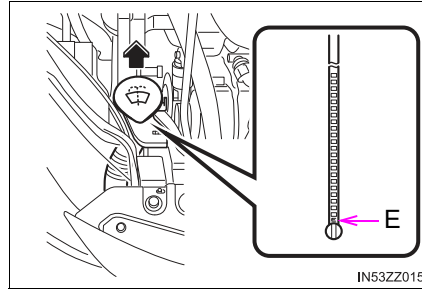

Use plain water if washer fluid is unavailable.

But use only washer fluid in cold weather to prevent it from freezing.

- State or local regulations may restrict the use of volatile organic compounds (VOCs), which are commonly used as anti-freeze agents in washer fluid. A washer fluid with limited VOC content should be used only if it provides adequate freeze resistance for all regions and climates in which the vehicle will be operated.
- Front and rear washer fluid is supplied from the same reservoir.

WARNING

■ Use only windshield washer fluid or plain water in the reservoir

Using radiator antifreeze as washer fluid is dangerous. If sprayed on the windshield, it will dirty the windshield, affect your visibility, and could result in an accident.

■ Using Washer Fluid Without Anti-freeze Protection in Cold Weather

Operating your vehicle in temperatures below 40 °F (4 °C) using washer fluid without anti-freeze protection is dangerous as it could cause impaired windshield vision and result in an accident. In cold weather, always use washer fluid with anti-freeze protection.

Body Lubrication

All moving points of the body, such as door and hood hinges and locks, should be lubricated each time the engine oil is changed. Use a nonfreezing lubricant on locks during cold weather.

Make sure the hood's secondary latch keeps the hood from opening when the primary latch is released.

Wiper Blades

Contamination of either the windshield or the blades with foreign matter can reduce wiper effectiveness. Common sources are insects, tree sap, and hot wax treatments used by some commercial car washes.

If the blades are not wiping properly, clean the window and blades with a good cleaner or mild detergent; then rinse thoroughly with clean water. Repeat if necessary.

WARNING

When the wiper lever is in the AUTO position and the ignition is switched ON, the wipers may move automatically in the following cases

- If the windshield above the rain sensor is touched.
- If the windshield above the rain sensor is wiped with a cloth.
- If the windshield is struck with a hand or other object.
- If the rain sensor is struck with a hand or other object from inside the vehicle.

Be careful not to pinch hands or fingers as it may cause injury, or damage the wipers. When washing or servicing the vehicle, make sure the wiper lever is in the OFF position.

NOTICE

- Hot waxes applied by automatic car washers have been known to affect the wiper's ability to clean windows.
- To prevent damage to the wiper blades, do not use gasoline, kerosene, paint thinner, or other solvents on or near them.

Replacing Windshield Wiper Blades

When the wipers no longer clean well, the blades are probably worn or cracked.

Replace the wiper blades using the following procedure.

- 1 Raise the wiper arm and turn the blade assembly to expose the plastic locking clip. Compress the clip and slide the assembly downward; then lift it off the arm.

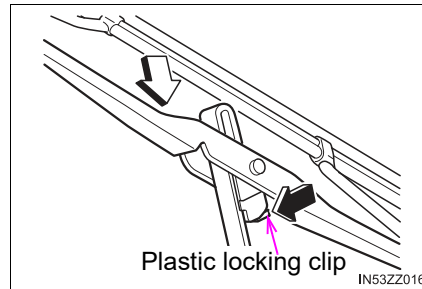

- 2 Hold the end of the rubber and pull until the tabs are free of the metal support.

- ① Metal support
- ② Tab

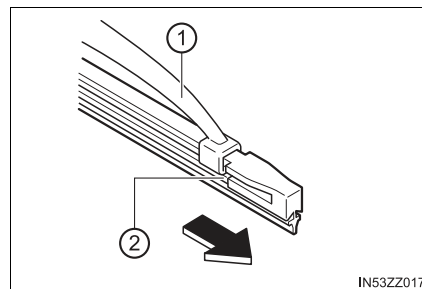

- 3 Remove the metal stiffeners from each blade rubber and install them in the new blade.

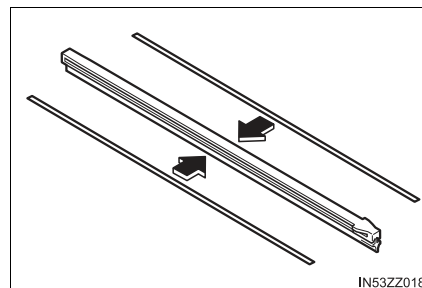

- 4 Carefully insert the new blade rubber. Then install the blade assembly in the reverse order of removal.

Install the blade so that the tabs are toward the bottom of the wiper arm.

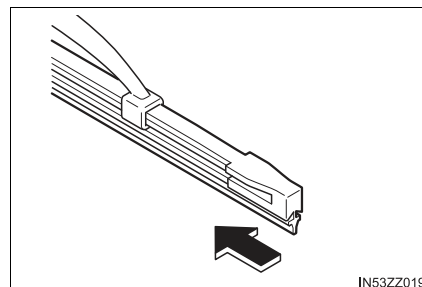

Replacing Rear Window Wiper Blade (5-Door)

When the wiper no longer cleans well, the blade is probably worn or cracked.

Replace it.

- 1 Remove the cover.

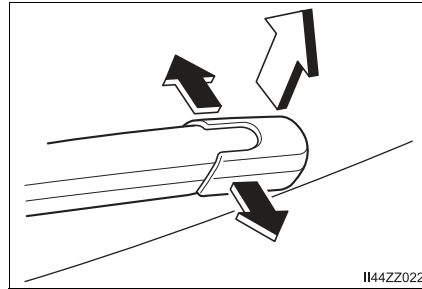

- 2 Remove the stopper and raise the wiper arm.

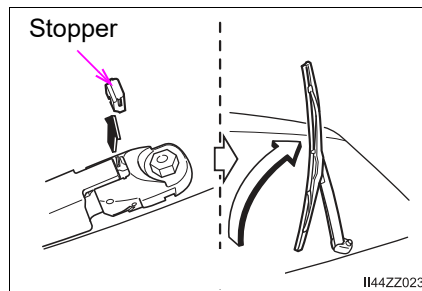

- 3 Firmly rotate the wiper blade to the right until it unlocks, then remove the blade.

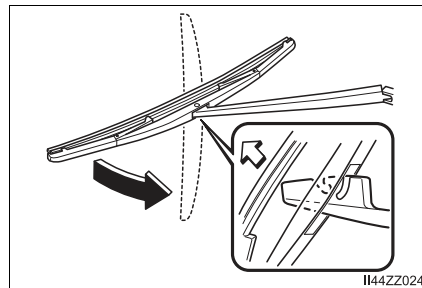

- 4 Pull down the blade rubber and slide it out of the blade holder.

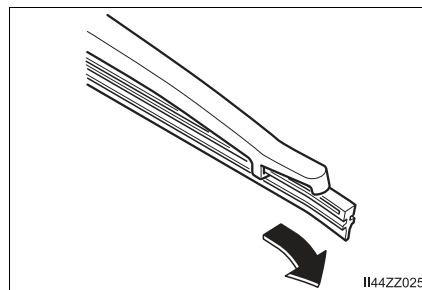

- 5 Remove the metal stiffeners from the blade rubber and install them in the new blade.

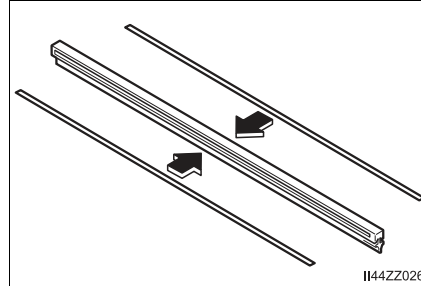

- 6 Carefully insert the new blade rubber. Then install the blade assembly in the reverse order of removal.

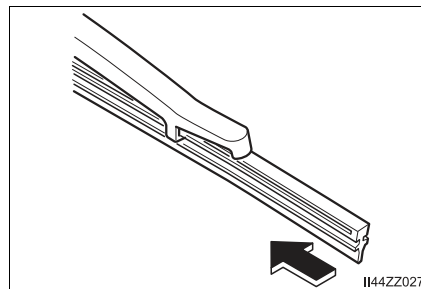

 NOTICE

- To prevent damage to the wiper arms and other components, do not try to sweep the wiper arm by hand.
- To prevent damage to the windshield let the wiper arm down easily, do not let it slap down on the windshield.
- To prevent damage to the rear window, do not let the wiper arm fall on it.
- Do not bend or discard the stiffeners. You need to use them again.
- If the metal stiffeners are switched, the blade's wiping efficiency could be reduced.
So don't use the driver's side metal stiffeners on the passenger's side, or vice versa.
- Be sure to reinstall the metal stiffeners in the new blade rubber so that the curve is the same as it was in the old blade rubber.
- When raising both windshield wiper arms, raise the driver's side wiper arm first. When lowering the wiper arms, slowly lower the wiper arm from the passenger's side first while supporting it with your hand. Forcefully lowering the wiper arms could damage the wiper arm and blade, and may scratch or crack the windshield.

Battery

Before performing battery maintenance, remove the battery cover by pressing the tab.

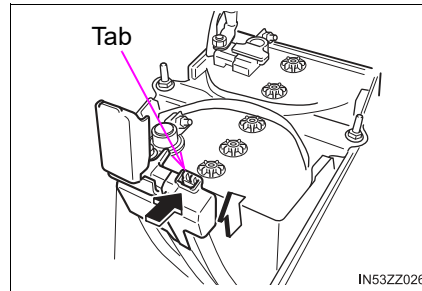

WARNING

■ **Wash hands after handling the battery and related accessories**

Battery posts, terminals and related accessories contain lead and lead compounds, chemicals known to the State of California to cause cancer and reproductive harm.

■ **Read the following precautions carefully before using the battery or inspecting to ensure safe and correct handling**

■ **Always wear eye protection when working near the battery**

Working without eye protection is dangerous. Battery fluid contains SULFURIC ACID which could cause blindness if splashed into your eyes. Also, hydrogen gas produced during normal battery operation, could ignite and cause the battery to explode.

■ **Wear eye protection and protective gloves to prevent contact with battery fluid**

Spilled battery fluid is dangerous.

Battery fluid contains SULFURIC ACID which could cause serious injuries if it gets in eyes, or on the skin or clothing. If this happens, immediately flush your eyes with water for 15 minutes or wash your skin thoroughly and get medical attention.

■ **Always keep batteries out of the reach of children**

Allowing children to play near batteries is dangerous. Battery fluid could cause serious injuries if it gets in the eyes or on the skin.

⚠ WARNING

-  **Keep flames and sparks away from open battery cells and do not allow metal tools to contact the positive (+) or negative (-) terminal of the battery when working near a battery. Do not allow the positive (+) terminal to contact the vehicle body**

Flames and sparks near open battery cells are dangerous. Hydrogen gas, produced during normal battery operation, could ignite and cause the battery to explode. An exploding battery can cause serious burns and injuries. Keep all flames including cigarettes and sparks away from open battery cells.

-  **Keep all flames and sparks away from open battery cells because hydrogen gas is produced from open battery cells while charging the battery or adding battery fluid:**

Flames and sparks near open battery cells are dangerous. Hydrogen gas, produced during normal battery operation, could ignite and cause the battery to explode. An exploding battery can cause serious burns and injuries. Keep all flames including cigarettes and sparks away from open battery cells.

Battery Maintenance

To get the best service from a battery:

- Keep it securely mounted.
- Keep the top clean and dry.
- Keep terminals and connections clean, tight, and coated with petroleum jelly or terminal grease.
- Rinse off spilled electrolyte immediately with a solution of water and baking soda.
- If the vehicle will not be used for an extended time, disconnect the battery cables and charge the battery every 6 weeks.

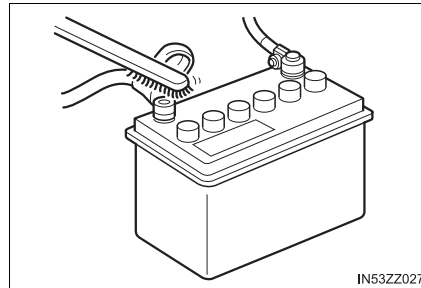
**Battery Replacement**

Contact your Toyota dealer for a battery replacement purchase.

Key Battery Replacement

If the buttons on the smart key are inoperable and the operation indicator light does not flash, the battery may be dead.

Replace with a new battery before the smart key becomes unusable.

The following conditions indicate that the battery power is low:

- The KEY indicator light (green) flashes in the combination meter for about 30 seconds after the engine is switched OFF.
- The system does not operate and the operation indicator light on the smart key does not flash when the buttons are pressed.
- The system's operational range is reduced.

Replacing the battery at your Toyota dealer is recommended to prevent damage to the key. If replacing the battery by yourself, follow the instruction below.

■ Replacing the key battery

- 1 Press the knob and pull out the auxiliary key.

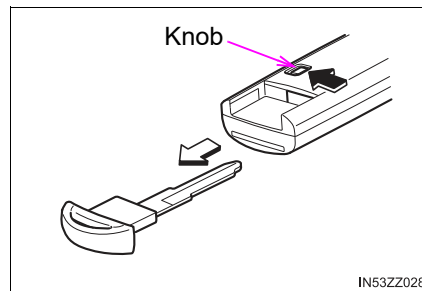

- 2 Twist a tape-wrapped flat-head screwdriver in the direction of the arrow and open the cover slightly.

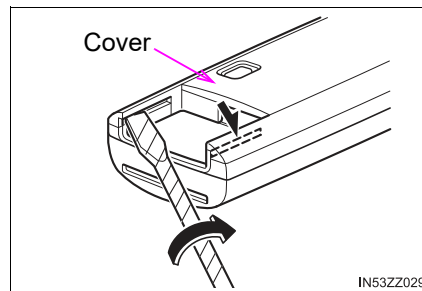

- 3 Insert the tape-wrapped flat-head screwdriver into the gap and slide it in the direction of the arrow.

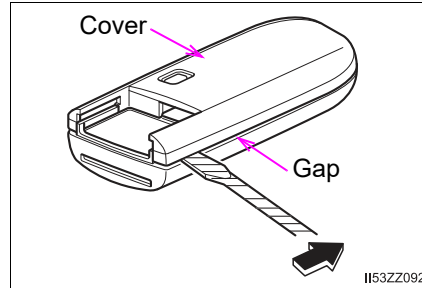

- 4 Twist the flathead screwdriver in the direction of the arrow and remove the cover.

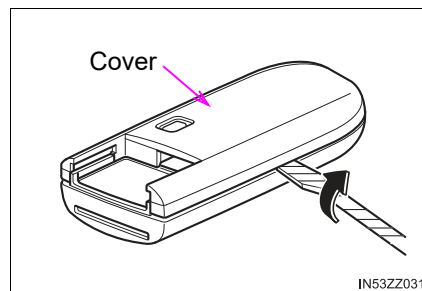

- 5 Remove the battery cap, then remove the battery.

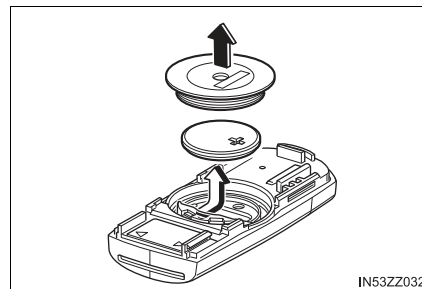

- 6 Insert a new battery with the positive pole facing up, and then cover the battery with the battery cap.

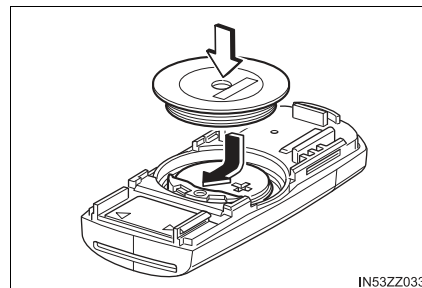

- 7 Close the cover.

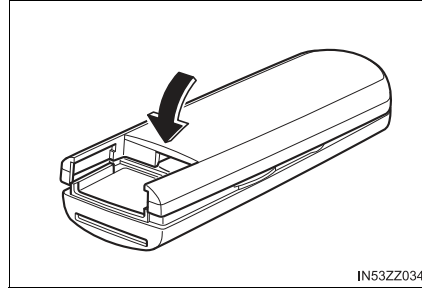

- 8 Reinsert the auxiliary key.

 NOTICE

- Make sure the battery is installed correctly. Battery leakage could occur if it is not installed correctly.
- When replacing the battery, be careful not to touch any of the internal circuitry and electrical terminals, bend the electrical terminals, or get dirt in the smart key as the smart key could be damaged.
- There is the danger of explosion if the battery is not correctly replaced.
- Dispose of used batteries according to the following instructions.
 - Insulate the plus and minus terminals of the battery using cellophane or equivalent tape.
 - Never disassemble.
 - Never throw the battery into fire or water.
 - Never deform or crush.
- Replace only with the same type battery (CR2025 or equivalent).
- Be careful not to allow the rubber ring shown in the figure to be scratched or damaged.
- If the rubber ring detaches, reattach it before inserting a new battery.

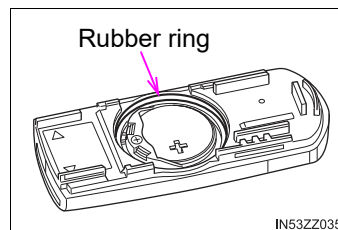

Tires

For reasons of proper performance, safety, and better fuel economy, always maintain recommended tire inflation pressures and stay within the recommended load limits and weight distribution.

WARNING

■ Using Different Tire Types

Driving your vehicle with different types of tires is dangerous. It could cause poor handling and poor braking; leading to loss of control.

Except for the limited use of the temporary spare tire, use only the same type tires (radial, bias-belted, bias-type) on all four wheels.

■ Using Wrong-Sized Tires

Using any other tire size than what is specified for the vehicle (→P. 553) is dangerous. It could seriously affect ride, handling, ground clearance, tire clearance, and speedometer calibration. This could cause you to have an accident. Use only tires that are the correct size specified for the vehicle.

Tire Inflation Pressure

Inspect all tire pressures monthly (including the spare) when the tires are cold. Maintain recommended pressures for the best ride, handling, and minimum tire wear.

Refer to the specification charts (→P. 553).

With tire pressure monitoring system:

After adjusting the tire pressure, initialization of the tire pressure monitoring system is necessary to make the system operate normally.

Refer to Tire Pressure Monitoring System Initialization on P. 244.

- Always check tire pressure when tires are cold.
 - Warm tires normally exceed recommended pressures. Do not release air from warm tires to adjust the pressure.
 - Underinflation can cause reduced fuel economy, uneven and accelerated tire wear, and poor sealing of the tire bead, which will deform the wheel and cause separation of tire from rim.
 - Overinflation can produce a harsh ride, uneven and accelerated tire wear, and a greater possibility of damage from road hazards.
- Keep your tire pressure at the correct levels. If one frequently needs inflating, have it inspected.

⚠ WARNING

■ **Always inflate the tires to the correct pressure**

Overinflation or underinflation of tires is dangerous. Adverse handling or unexpected tire failure could result in a serious accident. Refer to Tires on (→P. 553).

■ **Use only a Toyota-genuine tire valve cap**

Use of a non-genuine part is dangerous as the correct tire air pressure cannot be maintained if the tire valve becomes damaged. If the vehicle is driven under this condition, the tire air pressure will decrease which could result in a serious accident. Do not use any part for the tire valve cap that is not a Toyota-genuine part.

Tire Rotation

During rotation, inspect them for correct balance.

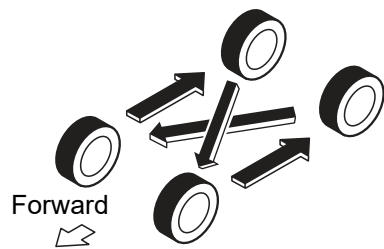

Do not include
(TEMPORARY USE ONLY)
spare tire in rotation.

IN53ZZ036a

Also, inspect them for uneven wear and damage. Abnormal wear is usually caused by one or a combination of the following:

- Incorrect tire pressure
- Improper wheel alignment
- Out-of-balance wheel
- Severe braking

After rotation, inflate all tire pressures to specification (→P. 553) and inspect the lug nuts for tightness.

With tire pressure monitoring system:

After adjusting the tire pressure, initialization of the tire pressure monitoring system is necessary to make the system operate normally.

Refer to Tire Pressure Monitoring System Initialization on P. 244.

 **WARNING**

 **Rotate tires periodically**

Irregular tire wear is dangerous. To equalize tire wear and extend tire life, Toyota recommends that tire rotation is carried out at the same interval as tire inspection.

For scheduled maintenance information, please refer to the “Owner’s Manual Supplement/Scheduled Maintenance Guide”.

 **NOTICE**

Rotate unidirectional tires and radial tires that have an asymmetrical tread pattern or studs only from front to rear, not from side to side. Tire performance will be reduced if rotated from side to side.

Replacing a Tire

If a tire wears evenly, a wear indicator will appear as a solid band across the tread.

Replace the tire when this happens.

- ① New tread
- ② Worn tread
- ③ Tread wear indicator

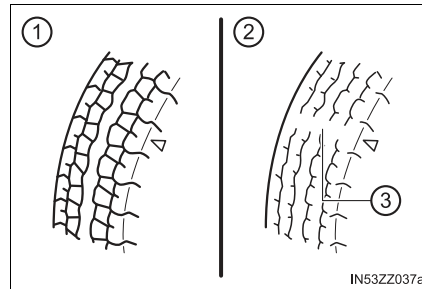

You should replace the tire before the band crosses the entire tread.

With tire pressure monitoring system:

After adjusting the tire pressure, initialization of the tire pressure monitoring system is necessary to make the system operate normally.

Refer to Tire Pressure Monitoring System Initialization on P. 244.

Tires degrade over time, even when they are not being used on the road. It is recommended that tires generally be replaced when they are 6 years or older. Heat caused by hot climates or frequent high loading conditions can accelerate the aging process. You should replace the spare tire when you replace the other road tires due to the aging of the spare tire. The period in which the tire was manufactured (both week and year) is indicated by a 4-digit number.

Refer to Tire Labeling on P. 522.

WARNING

■ Always use tires that are in good condition

Driving with worn tires is dangerous. Reduced braking, steering, and traction could result in an accident.

■ Replace all four tires at the same time

Replacing just one tire is dangerous. It could cause poor handling and poor braking resulting in loss of vehicle control. Toyota strongly recommends that you replace all four tires at the same time. If you replace only two tires, the new tires should be installed on the rear of the vehicle.

Temporary Spare Tire

Inspect the temporary spare tire at least monthly to make sure it is properly inflated and stored.

The temporary spare tire is easier to handle because of its construction which is lighter and smaller than a conventional tire. This tire should be used only for an emergency and only for a short distance.

Use the temporary spare tire only until the conventional tire is repaired, which should be as soon as possible.

Refer to Tires on P. 553.

- The temporary spare tire condition gradually deteriorates even if it has not been used.
- Tires degrade over time, even when they are not being used on the road. It is recommended that tires generally be replaced when they are 6 years or older. Heat caused by hot climates or frequent high loading conditions can accelerate the aging process. You should replace the spare tire when you replace the other road tires due to the aging of the spare tire. The period in which the tire was manufactured (both week and year) is indicated by a 4-digit number. Refer to Tire Labeling on P. 522.



NOTICE

- Do not use your temporary spare tire rim with a snow tire or a conventional tire. Neither will properly fit and could damage both tire and rim.
- The temporary spare tire has a tread life of less than 3,000 miles (5,000 km). The tread life may be shorter depending on driving conditions.
- The temporary spare tire is for limited use, however, if the tread wear solid-band indicator appears, replace the tire with the same type of temporary spare (→P. 417).

Replacing a Wheel

Proper tire balancing provides the best riding comfort and helps reduce tread wear. Out-of-balance tires can cause vibration and uneven wear, such as cupping and flat spots.

When replacing a wheel, make sure the new one is the same as the original factory wheel in diameter, rim width, and offset (inset/outset).

For details, contact your Toyota dealer.

 **WARNING**

■ **Always use wheels of the correct size on your vehicle**

Using a wrong-sized wheel is dangerous. Braking and handling could be affected, leading to loss of control and an accident.

 **NOTICE**

A wrong-sized wheel may adversely affect:

- Tire fit
- Wheel and bearing life
- Ground clearance
- Snow-chain clearance
- Speedometer calibration
- Headlight aim
- Bumper height
- Tire Pressure Monitoring System (if equipped)

Light Bulbs

■ Front

▶ With Halogen Headlights

- ① Headlights (Low/High beam)/
Daytime running lights
- ② Front side-marker lights
- ③ Overhead lights/Map lights
- ④ Side turn signal lights (if
equipped)
- ⑤ Front turn signal lights/Park-
ing lights
- ⑥ Fog lights (if equipped)

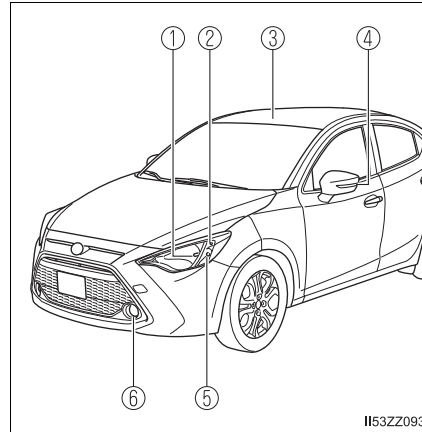

▶ With LED Headlights

- ① Headlights (High beam)
- ② Headlights (Low beam)
- ③ Front side-marker lights
- ④ Overhead lights/Map lights
- ⑤ Side turn signal lights (if
equipped)
- ⑥ Front turn signal lights/Park-
ing lights
- ⑦ Daytime running light/Park-
ing light
- ⑧ Fog lights

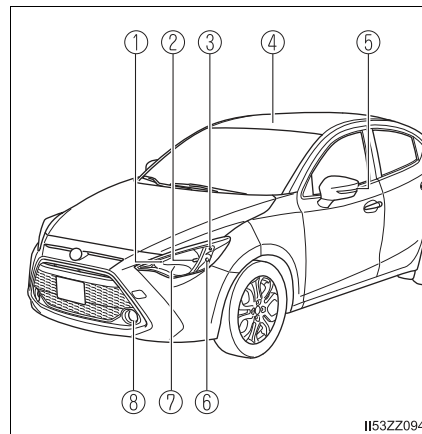

■ **Rear**

▶ **4-Door**

- ① Trunk light
- ② High-mount brake lights
- ③ License plate lights
- ④ Reverse lights
- ⑤ Rear turn signal lights
- ⑥ Brake lights/Taillights/Rear side-marker lights

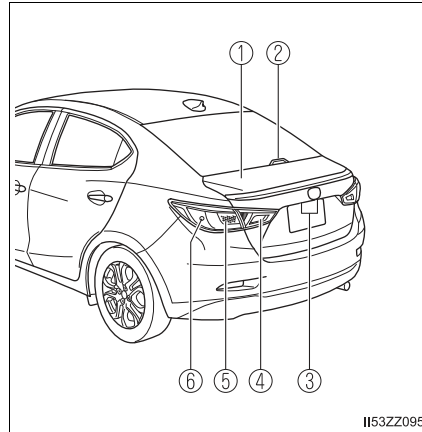

▶ **5-Door**

- ① High-mount brake light
- ② License plate lights
- ③ Reverse lights
- ④ Rear turn signal lights
- ⑤ Brake lights/Tail lights
- ⑥ Rear side-marker lights
- ⑦ Luggage compartment light

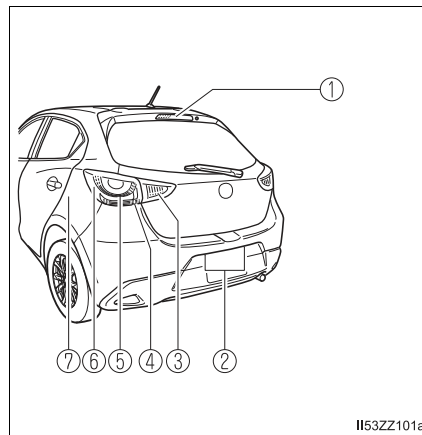

- To replace the bulb, contact your Toyota dealer.
- If the halogen bulb is accidentally touched, it should be cleaned with rubbing alcohol before being used.
- Use the protective cover and carton of the replacement bulb to dispose of the old bulb promptly out of the reach of children.

 **WARNING**

■ **Never touch the glass portion of a halogen bulb with your bare hands and always wear eye protection when handling or working around the bulbs**

When a halogen bulb breaks, it is dangerous. These bulbs contain pressurized gas. If one is broken, it will explode and serious injuries could be caused by the flying glass.

If the glass portion is touched with bare hands, body oil could cause the bulb to overheat and explode when lit.

■ **Always keep halogen bulbs out of the reach of children**

Playing with a halogen bulb is dangerous. Serious injuries could be caused by dropping a halogen bulb or breaking it some other way.

 **NOTICE**

When removing the lens or lamp unit using a flathead screwdriver, make sure that the flathead screwdriver does not contact the interior terminal. If the flathead screwdriver contacts the terminal, a short circuit may occur.

Replacing Exterior Light Bulbs

■ Headlights/Daytime running lights (With halogen headlights)

- 1 Make sure the ignition is switched off, and the headlight switch is off.
- 2 Lift the hood.
- 3 Disconnect the connector from the bulb.

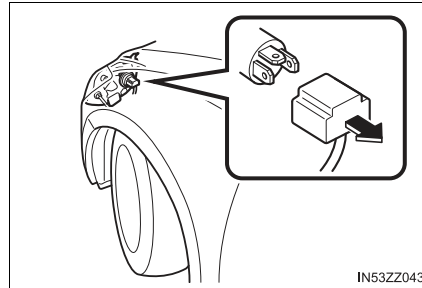

- 4 Detach the sealing cover from the bulb.
 - ① Retaining spring
 - ② Sealing cover

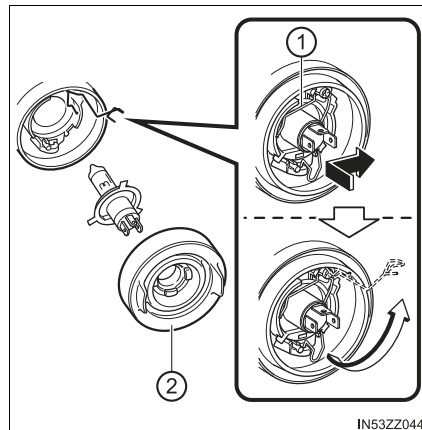

- 5 Unhook the bulb retaining spring.
- 6 Swing the retaining spring out and away to free the headlight bulb.
- 7 Carefully remove the headlight bulb from the socket by pulling it straight back.
- 8 Replace the bulb.
- 9 Install the new bulb in the reverse order of the removal procedure.

■ Front turn signal lights/Parking lights, Front side-marker lights

- 1 Make sure the ignition is switched off, and the headlight switch is off.
- 2 Lift the hood.
- 3 Front turn signal lights/Parking lights: Remove the fuse block cover.

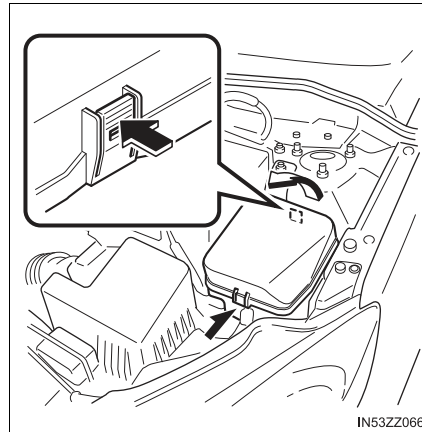

- 4 Turn the socket and bulb assembly counterclockwise and remove it.
- 5 Disconnect the bulb from the socket.

- Front turn signal lights/Parking lights ► Front side-marker lights

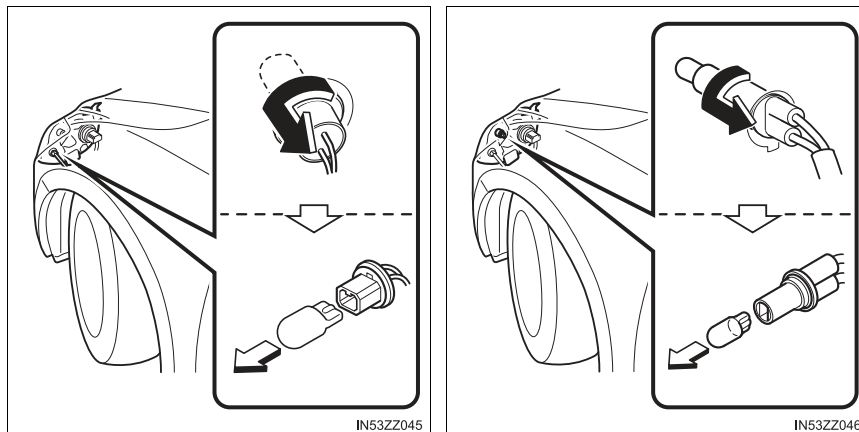

- 6 Install the new bulb in the reverse order of the removal procedure.

■ Fog lights (if equipped)

- 1 Make sure the ignition is switched off, and the fog light switch is off.
- 2 Turn the screws counter-clockwise and remove them.

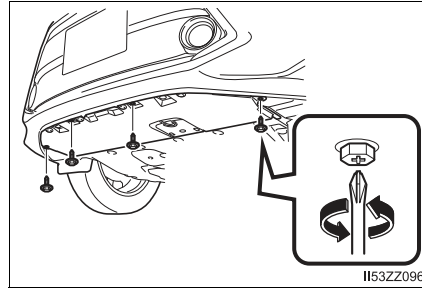

- 3 Pull the center of each retainers and remove them, and then partially peel back the front under cover.

- ① Removal
- ② Installation

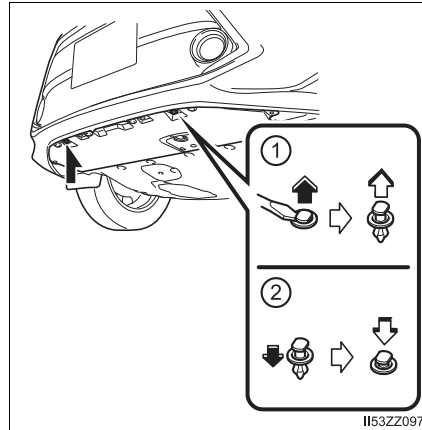

- 4 Disconnect the connector from the unit by pressing the tab on the connector with your finger and pulling the connector downward.

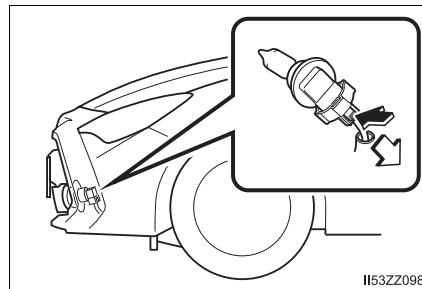

- 5 Turn the socket and bulb assembly to remove it. Carefully remove the bulb from its socket in the reflector by gently pulling it straight backward out of the socket.

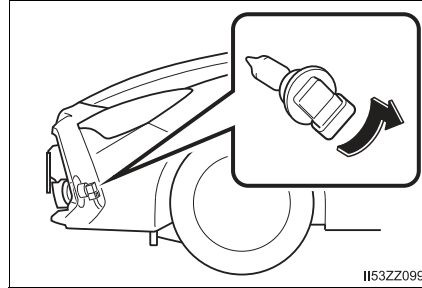

- 6 Install the new bulb in the reverse order of the removal procedure.

■ **Rear turn signal lights, Brake lights/Taillights/Rear side-marker lights**

▶ 4-Door

- 1 Make sure the ignition is switched off, and the headlight switch is off.
- 2 Remove the cover.

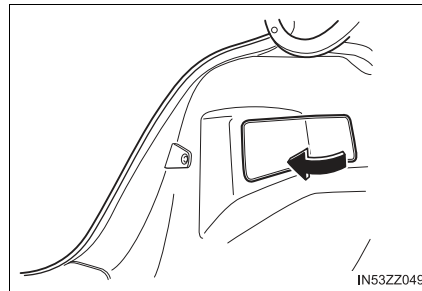

- 3 Turn the socket and bulb assembly counterclockwise and remove it.
- 4 Disconnect the bulb from the socket.

Rear turn signal lights:

Brake lights/Taillights/Rear side-marker lights:

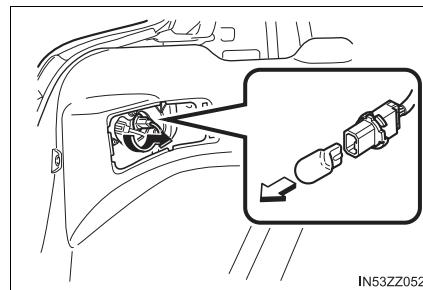
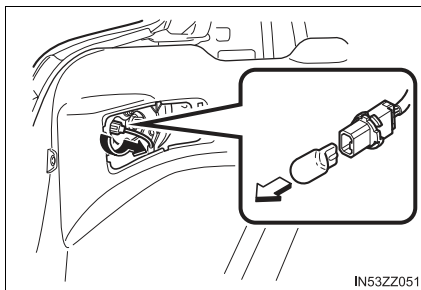

- 5 Install the new bulb in the reverse order of the removal procedure.
- 6 Insert the cover tabs and install the cover.
Verify that the cover is securely installed.

► 5-Door

- 1 Make sure the ignition is switched off, and the headlight switch is off.
- 2 Turn the bolts counterclockwise and remove them.

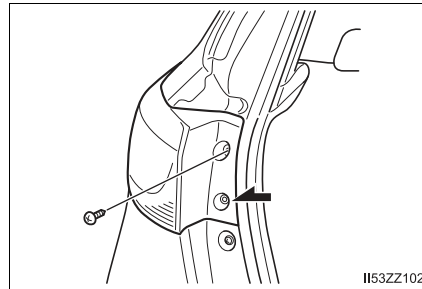

- 3 Pull the unit rearward to remove it.

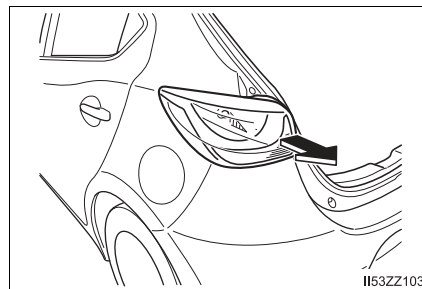

- 4 Turn the socket and bulb assembly counterclockwise and remove it.
- 5 Disconnect the bulb from the socket.

Rear turn signal lights:

Brake lights/Taillights:

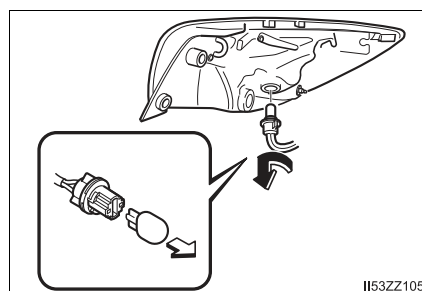
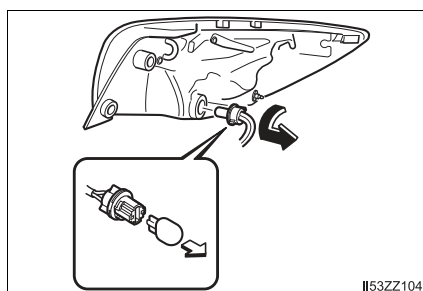

Rear side-marker lights:

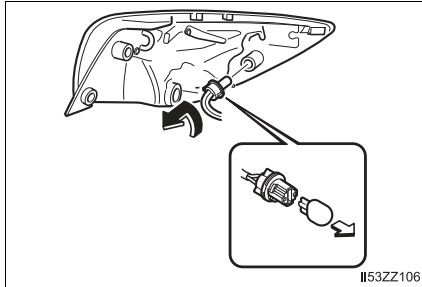

- 6 Install the new bulb in the reverse order of the removal procedure.

Reverse lights

► 4-Door

- 1 Make sure the ignition is switched off, and the headlight switch is off.
- 2 Pull the center of each plastic retainers and remove them.
 - ① Removal
 - ② Installation

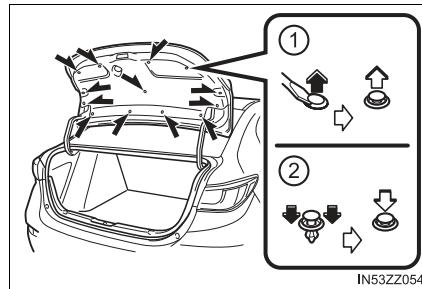

- 3 Remove the trunk lid trim.
- 4 Disconnect the electrical connector from the bulb by pressing the tab on the connector with your finger and pulling the connector.

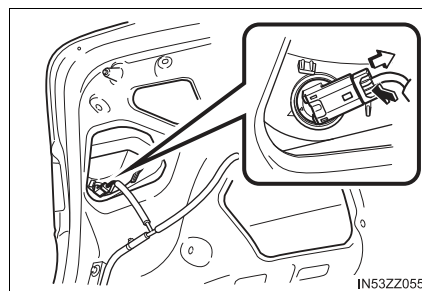

- 5 Turn the socket and bulb assembly counterclockwise and remove it.
- 6 Disconnect the bulb from the socket.

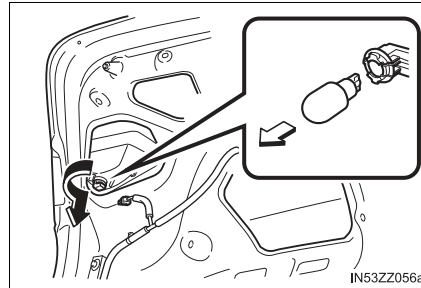

- 7 Install the new bulb in the reverse order of the removal procedure.

► 5-Door

- 1 Make sure the ignition is switched off, and the headlight switch is off.
- 2 Pull the center of each plastic retainer and remove the retainers.

- ① Removal
- ② Installation

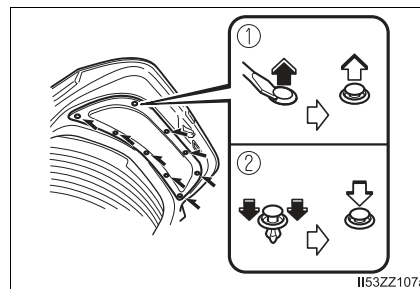

- 3 Remove the trunk lid trim.
- 4 Disconnect the connector from the socket.

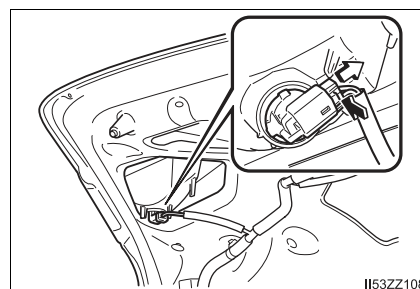

- 5 Turn the socket and bulb assembly counterclockwise and remove it.
- 6 Disconnect the bulb from the socket.

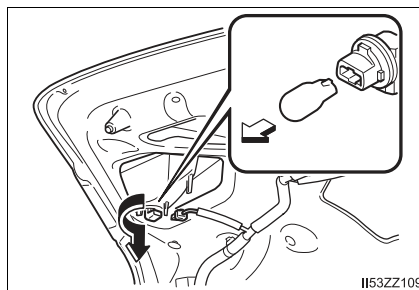

- 7 Install the new bulb in the reverse order of the removal procedure.

■ License plate lights

▶ 4-Door

- 1 Make sure the ignition is switched off, and the headlight switch is off.
- 2 Pull the center of each plastic retainers and remove them.

- ① Removal
- ② Installation

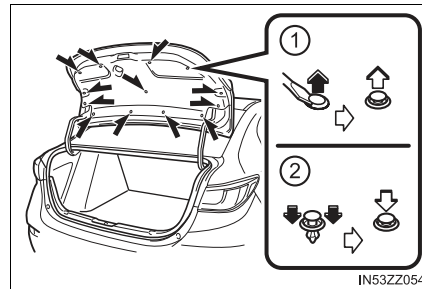

- 3 Peel back the trunk lid trim.
- 4 Turn the socket and bulb assembly counterclockwise and remove it.
- 5 Disconnect the bulb from the socket.

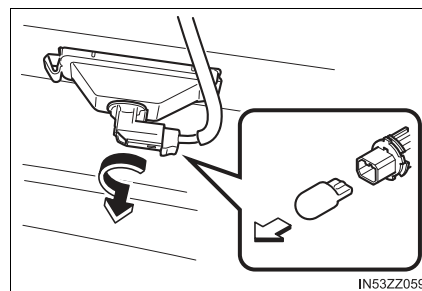

- 6 Install the new bulb in the reverse order of the removal procedure.

▶ 5-Door

- 1 Make sure the ignition is switched off, and the headlight switch is off.
- 2 Wrap a flathead screwdriver with a soft cloth to prevent damage to the light unit.
- 3 Insert a flathead screwdriver into the position shown in the figure and pull the light unit outward.

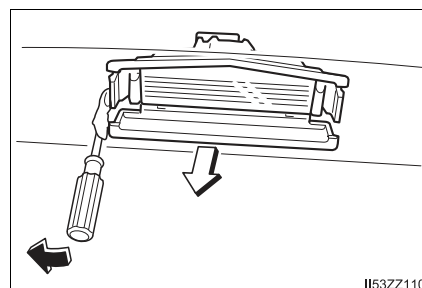

- 4 Disconnect the connector from the bulb by pressing the tab on the connector with your finger and pulling the connector.

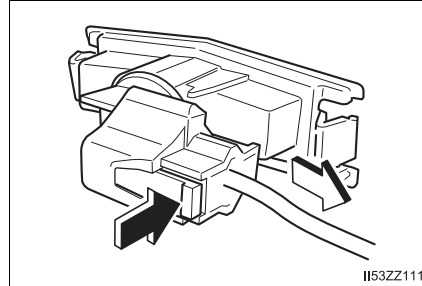

- 5 Turn the socket and bulb assembly counterclockwise and remove it.
- 6 Disconnect the bulb from the socket.

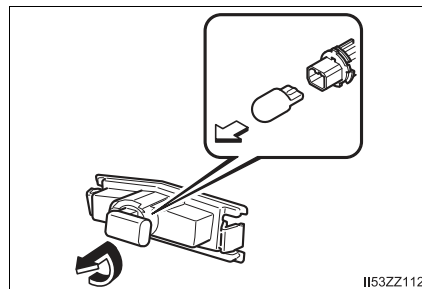

- 7 Install the new bulb in the reverse order of the removal procedure.

■ **Headlights/Daytime running lights (With LED headlights), Side turn signal lights (if equipped), High-mount brake light**

The LED bulb cannot be replaced as a single unit because it is an integrated unit. The LED bulb has to be replaced with the unit. We recommend your Toyota dealer when the replacement is necessary.

■ **Headlights/Daytime running lights**

- To replace the bulb, contact your Toyota dealer.
- If the halogen bulb is accidentally touched, it should be cleaned with rubbing alcohol before being used.
- Use the protective cover and carton of the replacement bulb to dispose of the old bulb promptly out of the reach of children.
- When reinstalling the sealing cover, make sure it is fitted correctly.

Replacing Interior Light Bulbs

■ Overhead lights/Map lights

- 1 Wrap a small flathead screwdriver with a soft cloth to prevent damage to the lens, and then remove the lens by carefully prying on the edge of the lens with the flathead screwdriver.
- 2 Disconnect the bulb by pulling it out.

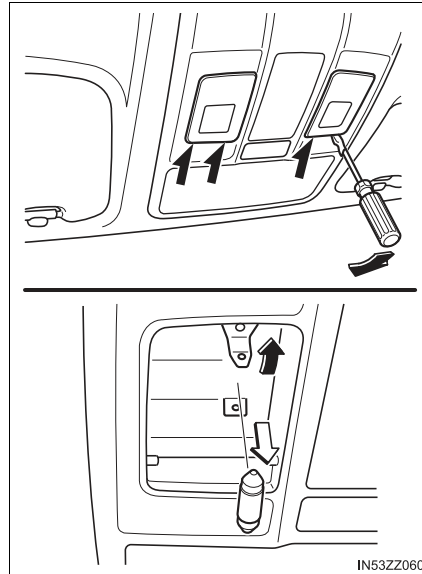

- 3 Install the new bulb in the reverse order of the removal procedure.

■ **Trunk light (4-Door)**

- 1 Press both sides of the lens cap to remove it.
- 2 Disconnect the bulb by pulling it out.

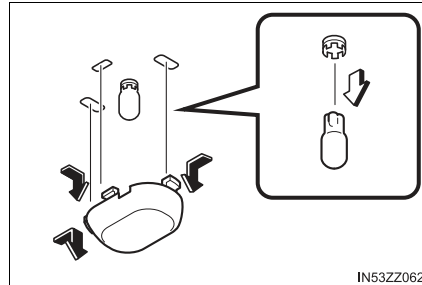

- 3 Install the new bulb in the reverse order of the removal procedure.

■ **Luggage compartment light (5-Door)**

- 1 Wrap a small flathead screwdriver with a soft cloth to prevent damage to the lens and remove the lens by carefully prying on the edge of the lens with the flathead screwdriver.
- 2 Disconnect the bulb by pulling it out.
- 3 Install the new bulb in the reverse order of the removal procedure.

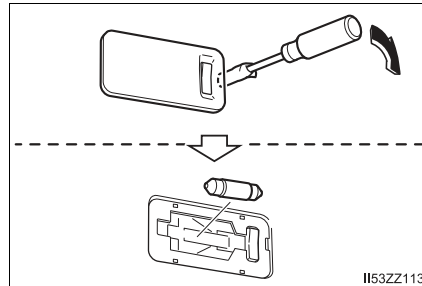

Fuses

Your vehicle's electrical system is protected by fuses.

If any lights, accessories, or controls do not work, inspect the appropriate circuit protector. If a fuse has blown, the inside element will be melted.

If the same fuse blows again, avoid using that system and consult your Toyota dealer as soon as possible.

Fuse Replacement

■ Replacing the fuses on the vehicle's left side

If the electrical system does not work, first inspect the fuses on the vehicle's left side.

- 1 Make sure the ignition is switched off, and other switches are off.
- 2 Open the fuse panel cover.

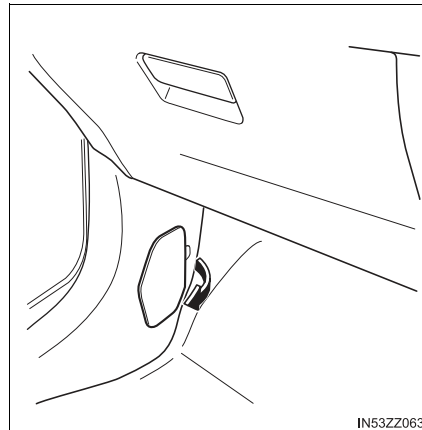

- 3 Pull the fuse straight out with the fuse puller provided on the fuse block located in the engine compartment.

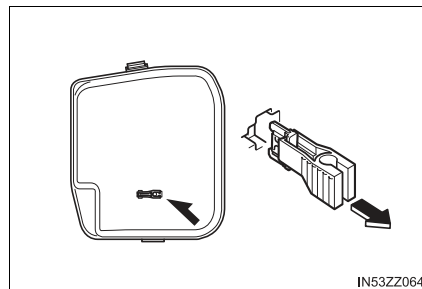

- 4 Inspect the fuse and replace it if it is blown.

- ① Normal
- ② Blown

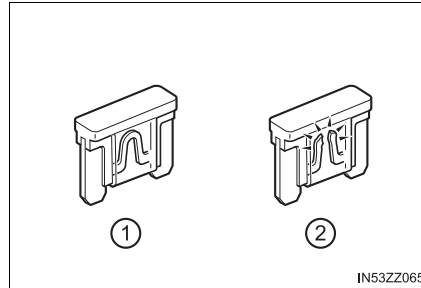

- 5 Insert a new fuse of the same amperage rating, and make sure it fits tightly. If it does not fit tightly, have an expert install it. We recommend your Toyota dealer.

If you have no spare fuses, borrow one of the same rating from a circuit not essential to vehicle operation, such as the AUDIO or OUTLET circuit.

- 6 Reinstall the cover and make sure that it is securely installed.

■ Replacing the fuses under the hood

If the headlights or other electrical components do not work and the fuses in the cabin are normal, inspect the fuse block under the hood.

If a fuse is blown, it must be replaced.

Follow these steps:

- 1 Make sure the ignition is switched off, and other switches are off.
- 2 Remove the fuse block cover.

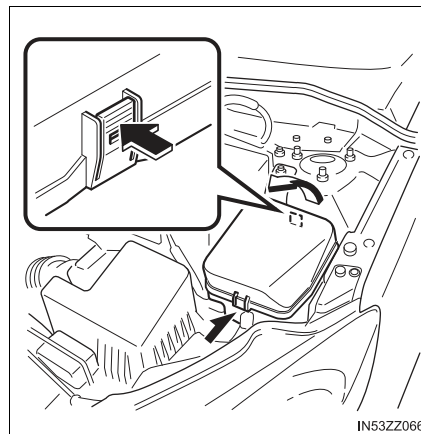

- 3 If any fuse but the MAIN fuse is blown, replace it with a new one of the same amperage rating.

- ① Normal
- ② Blown

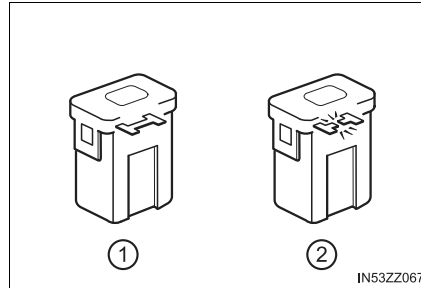

- 4 Reinstall the cover and make sure that it is securely installed.

⚠ WARNING

- **Do not replace the main fuse and multiplex slow blow fuse by yourself. Have your Toyota dealer perform the replacement**

Replacing these fuses by yourself is dangerous because they are high current fuses. Incorrect replacement could cause an electrical shock or a short circuit resulting in a fire.

⚠ NOTICE

Always replace a fuse with a genuine Toyota fuse or equivalent of the same rating. Otherwise you may damage the electric system.

Fuse Panel Description

■ **Fuse block (Engine compartment)**

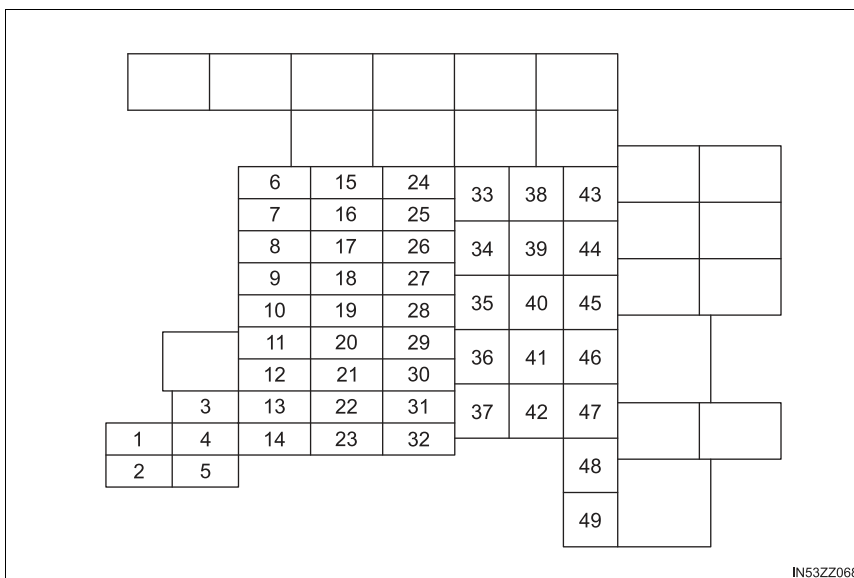

IN53Z068

DESCRIPTION		FUSE RATING	PROTECTED COMPONENT
1	C/U IG1	15 A	For protection of various circuits
2	ENGINE IG1	7.5 A	Engine control system
3	SUNROOF	10 A	—
4	INTERIOR	15 A	For protection of various circuits
5	ENG+B	7.5 A	Engine control system
6	AUDIO2 ENGINE4	15 A	Engine control system
7	METER1	10 A	Combination meter
8	SRS1	7.5 A	Air bag
9	METER2	7.5 A	—
10	RADIO	7.5 A	Audio system
11	ENGINE3	15 A	Engine control system
12	ENGINE1	15 A	—
13	ENGINE2	15 A	Engine control system

DESCRIPTION		FUSE RATING	PROTECTED COMPONENT
14	AUDIO1	25 A	Audio system
15	A/C MAG	7.5 A	Air conditioner
16	AT PUMP	15 A	—
17	AT	15 A	Transaxle control system (if equipped), Ignition switch
18	D.LOCK	25 A	Power door locks
19	H/L RH	20 A	Headlight (RH)
20	ENG+B2	7.5 A	Engine control system
21	TAIL	20 A	Taillights, License plate lights, Parking lights
22	ST.HEATER	20 A	Heated steering wheel (if equipped)
23	ROOM	25 A	For protection of various circuits
24	FOG	15 A	Fog lights (if equipped)
25	H/CLEAN	20 A	—
26	STOP	10 A	Brake lights
27	HORN	15 A	Horn
28	H/L LH	20 A	Headlight (LH)
29	ABS/DSC S	30 A	ABS, Dynamic stability control system
30	HAZARD	15 A	Hazard warning flashers, Turn signal lights
31	FUEL PUMP SCR	15 A	Fuel system
32	FUEL WARM	25 A	—
33	WIPER	20 A	Windshield wipers
34	CABIN+B	50 A	For protection of various circuits
35	FAN2 EPB L	30 A	Cooling fan
36	FUEL PUMP	30 A	—
37	ABS/DSC M	50 A	ABS, Dynamic stability control system
38	EVVT	20 A	—
39	—	—	—

DESCRIPTION		FUSE RATING	PROTECTED COMPONENT
40	FAN1 EPB R	30 A	Cooling fan
41	FAN3	40 A	—
42	ENG.MAIN	40 A	Engine control system
43	EPS	60 A	—
44	DEFOG	40 A	Rear window defogger
45	IG2	30 A	For protection of various circuits
46	INJECTOR ENG.SUB	30 A	Engine control system
47	HEATER	40 A	Air conditioner
48	P.WINDOW1	30 A	Power windows
49	DCDC DE	40 A	—

■ Fuse block (Left side)

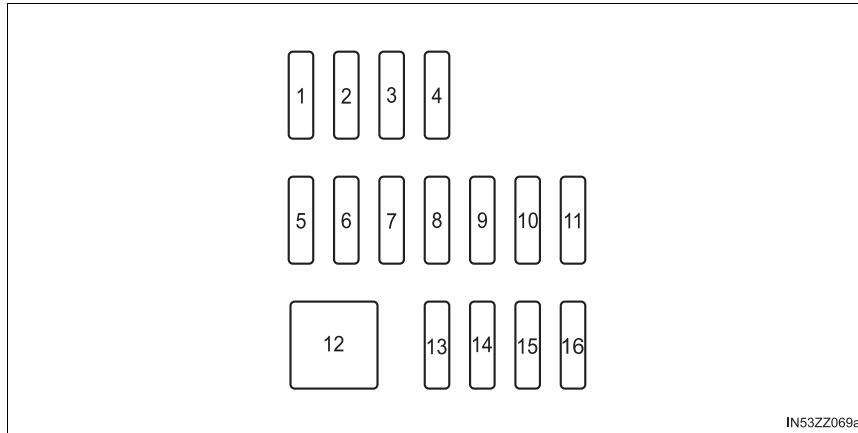

	DESCRIPTION	FUSE RATING	PROTECTED COMPONENT
1	—	—	—
2	—	—	—
3	AUDIO2	15 A	Audio system
4	ST.HEATER	10 A	Heated steering wheel (if equipped)
5	F.OUTLET	15 A	Accessory sockets
6	—	—	—
7	AT IND	7.5 A	AT shift indicator (if equipped)
8	MIRROR	7.5 A	Power control mirror
9	—	—	—
10	P.WINDOW2	25 A	Power windows
11	R.WIPER	15 A	Rear window wiper
12	—	—	—
13	—	—	—
14	SRS2/ESCL	15 A	—
15	SEAT WARM	20 A	Seat warmer (if equipped)
16	M.DEF	7.5 A	Mirror defogger (if equipped)

Exterior Care

The paintwork on your Toyota represents the latest technical developments in composition and methods of application.

Environmental hazards, however, can harm the paint's protective properties, if proper care is not taken.

Here are some examples of possible damage, with tips on how to prevent them.

■ Etching Caused by Acid Rain or Industrial Fallout

● Occurrence

Industrial pollutants and vehicle emissions drift into the air and mix with rain or dew to form acids. These acids can settle on a vehicle's finish. As the water evaporates, the acid becomes concentrated and can damage the finish.

And the longer the acid remains on the surface, the greater the chance is for damage.

● Prevention

It is necessary to wash and wax your vehicle to preserve its finish according to the instructions in this section. These steps should be taken immediately after you suspect that acid rain has settled on your vehicle's finish.

■ Damage Caused by Bird Dropping, Insects, or Tree Sap

● Occurrence

Bird droppings contain acids. If these are not removed they can eat away the clear and color base coat of the vehicle's paintwork. When insects stick to the paint surface and decompose, corrosive compounds form.

These can erode the clear and color base coat of the vehicle's paintwork if they are not removed.

Tree sap will harden and adhere permanently to the paint finish. If you scratch the sap off while it is hard, some vehicle paint could come off with it.

- **Prevention**

It is necessary to have your Toyota washed and waxed to preserve its finish according to the instructions in this section. This should be done as soon as possible.

Bird droppings can be removed with a soft sponge and water. If you are traveling and these are not available, a moistened tissue may also take care of the problem. The cleaned area should be waxed according to the instructions in this section.

Insects and tree sap are best removed with a soft sponge and water or a commercially available chemical cleaner.

Another method is to cover the affected area with dampened newspaper for 1 to 2 hours. After removing the newspaper, rinse off the loosened debris with water.

- **Water Marks**

- **Occurrence**

Rain, fog, dew, and even tap water can contain harmful minerals such as salt and lime. If moisture containing these minerals settles on the vehicle and evaporates, the minerals will concentrate and harden to form white rings. The rings can damage your vehicle's finish.

- **Prevention**

It is necessary to wash and wax your vehicle to preserve its finish according to the instructions in this section. These steps should be taken immediately after you find water marks on your vehicle's finish.

- **Paint Chipping**

- **Occurrence**

Paint chipping occurs when gravel thrown in the air by another vehicle's tires hits your vehicle.

- **How to avoid paint chipping**

Keeping a safe distance between you and the vehicle ahead reduces the chances of having your paint chipped by flying gravel.

Follow all label and container directions when using a chemical cleaner or polish. Read all warnings and cautions.

■ Paint Chipping

- The paint chipping zone varies with the speed of the vehicle. For example, when traveling at 56 mph (90 km/h), the paint chipping zone is 164 ft. (50 m).
- In low temperatures a vehicle's finish hardens. This increases the chance of paint chipping.
- Chipped paint can lead to rust forming on your Toyota. Before this happens, repair the damage by using Toyota touch-up paint according to the instructions in this section. Failure to repair the affected area could lead to serious rusting and expensive repairs.

Maintaining the Finish**■ Washing**

To help protect the finish from rust and deterioration, wash your Toyota thoroughly and frequently, at least once a month, with lukewarm or cold water.

If the vehicle is washed improperly, the paint surface could be scratched. Here are some examples of how scratching could occur.

Scratches occur on the paint surface when:

- The vehicle is washed without first rinsing off dirt and other foreign matter.
- The vehicle is washed with a rough, dry, or dirty cloth.
- The vehicle is washed at a car wash that uses brushes that are dirty or too stiff.
- Cleansers or wax containing abrasives are used.

To minimize scratches on the vehicle's paint finish:

- Rinse off any dirt or other foreign matter using lukewarm or cold water before washing.
- Use plenty of lukewarm or cold water and a soft cloth when washing the vehicle. Do not use a nylon cloth.
- Rub gently when washing or drying the vehicle.
- Take your vehicle only to a car wash that keeps its brushes well maintained.
- Do not use abrasive cleansers or wax that contain abrasives.

Pay special attention to removing salt, dirt, mud, and other foreign material from the underside of the fenders, and make sure the drain holes in the lower edges of the doors and rocker panels are clean.

Insects, tar, tree sap, bird droppings, industrial fallout, and similar deposits can damage the finish if not removed immediately. When prompt washing with plain water is ineffective, use a mild soap made for use on vehicles.

Thoroughly rinse off all soap with lukewarm or cold water. Do not allow soap to dry on the finish.

After washing the vehicle, dry it with a clean chamois to prevent water spots from forming.

- When using an automatic car wash
 - Retract the door mirrors.
 - The automatic car wash brushes could reduce the paint luster or hasten paint deterioration.

- When using a high water pressure car wash

High water temperature and high water pressure car washers are available depending on the type of car wash machine. If the car washer nozzle is put too close to the vehicle, the force of the spray could damage or deform the molding, affect the sealability of parts, and allow water to penetrate the interior. Keep a sufficient space (12 in. (300 mm) or more) between the nozzle and the vehicle. In addition, do not spend too much time spraying the same area of the vehicle, and be very careful when spraying between gaps in doors and around windows.

■ Waxing

Your vehicle needs to be waxed when water no longer beads on the finish. Always wash and dry the vehicle before waxing it. In addition to the vehicle body, wax the metal trim to maintain its luster.

- 1 Use wax which contains no abrasives. Waxes containing abrasive will remove paint and could damage bright metal parts.
- 2 Use a good grade of natural wax for metallic, mica, and solid colors.
- 3 When waxing, coat evenly with the sponge supplied or a soft cloth.
- 4 Wipe off the wax with a soft cloth.

■ Washing

- Toyota is not responsible for scratches caused by automatic car washes or improper washing.
- Scratches are more noticeable on vehicles with darker paint finishes.

■ Waxing

A spot remover to remove oil, tar, and similar materials will usually also take off the wax. Rewax these areas even if the rest of the vehicle does not need it.

⚠ WARNING**■ Dry off brakes that have become wet by driving slowly, releasing the accelerator pedal and lightly applying the brakes several times until the brake performance returns to normal**

Driving with wet brakes is dangerous. Increased stopping distance or the vehicle pulling to one side when braking could result in a serious accident. Light braking will indicate whether the brakes have been affected.

⚠ NOTICE

- When the wiper lever is in the AUTO position and the ignition is switched ON, the wipers may move automatically in the following cases:

- If the windshield above the rain sensor is touched or wiped with a cloth.
- If the windshield is struck with a hand or other object from either outside or inside the vehicle.

Keep hands and scrapers clear of the windshield when the wiper lever is in the AUTO position and the ignition is switched ON as fingers could be pinched or the wipers and wiper blades damaged when the wipers activate automatically.

If you are going to clean the windshield, be sure the wipers are turned off completely (when it is most likely that the engine is left running) this is particularly important when clearing ice and snow.

- Do not spray water in the engine compartment. Otherwise, it could result in engine-starting problems or damage to electrical parts.
- When washing and waxing the vehicle, be careful not to apply excessive force to any single area of the vehicle roof or the antenna. Otherwise, you could dent the vehicle or damage the antenna.
- Do not use steel wool, abrasive cleaners, or strong detergents containing highly alkaline or caustic agents on chrome-plated or anodized aluminum parts. This may damage the protective coating; also, cleaners and detergents may discolor or deteriorate the paint.

Repairing Damage to the Finish

Deep scratches or chips on the finish should be repaired promptly. Exposed metal quickly rusts and can lead to major repairs.

 NOTICE

If your Toyota is damaged and needs metal parts repaired or replaced, make sure the body shop applies anti-corrosion materials to all parts, both repaired and new. This will prevent them from rusting.

Bright-Metal Maintenance

- Use tar remover to remove road tar and insects. Never do this with a knife or similar tool.
- To prevent corrosion on bright-metal surfaces, apply wax or chrome preservative and rub it to a high luster.
- During cold weather or in coastal areas, cover bright-metal parts with a coating of wax or preservative heavier than usual. It would also help to coat them with noncorrosive petroleum jelly or some other protective compound.

 NOTICE

Do not use steel wool, abrasive cleaners, or strong detergents containing highly alkaline or caustic agents on chrome-plated or anodized aluminum parts. This may result in damage to the protective coating and cause discoloration or paint deterioration.

Underbody Maintenance

Road chemicals and salt used for ice and snow removal and solvents used for dust control may collect on the underbody. If not removed, they will speed up rusting and deterioration of such underbody parts as fuel lines, frame, floor pan, and exhaust system, even though these parts may be coated with anti-corrosive material.

Thoroughly flush the underbody and wheel housings with lukewarm or cold water at the end of each winter. Try also to do this every month.

Pay special attention to these areas because they easily hide mud and dirt. It will do more harm than good to wet down the road grime without removing it.

The lower edges of doors, rocker panels, and frame members have drain holes that should not be clogged. Water trapped there will cause rusting.

WARNING

- **Dry off brakes that have become wet by driving slowly, releasing the accelerator pedal and lightly applying the brakes several times until the brake performance returns to normal**

Driving with wet brakes is dangerous. Increased stopping distance or the vehicle pulling to one side when braking could result in a serious accident. Light braking will indicate whether the brakes have been affected.

Aluminum Wheel Maintenance (if equipped)

A protective coating is provided over the aluminum wheels. Special care is needed to protect this coating.

 NOTICE

- Do not use any detergent other than mild detergent. Before using any detergent, verify the ingredients.
Otherwise, the product could discolor or stain the aluminum wheels.
- Do not use a wire brush or any abrasive cleaner, polishing compound, or solvent on aluminum wheels. They may damage the coating.
- Always use a sponge or soft cloth to clean the wheels.
Rinse the wheels thoroughly with lukewarm or cold water. Also, be sure to clean the wheels after driving on dusty or salted roads to help prevent corrosion.
- Avoid washing your vehicle in an automatic car wash that uses high-speed or hard brushes.

Plastic Part Maintenance

- When cleaning the plastic lenses of the lights, do not use gasoline, kerosene, rectified spirit, paint, thinner, highly acidic detergents, or strongly alkaline detergents. Otherwise, these chemical agents can discolor or damage the surfaces resulting in a significant loss in functionality. If plastic parts become inadvertently exposed to any of these chemical agents, flush with water immediately.
- If plastic parts such as the bumpers become inadvertently exposed to chemical agents or fluids such as gasoline, oil, engine coolant, or battery fluid, it could cause discoloration, staining, or paint peeling. Wipe off any such chemical agents or fluids using a soft cloth immediately.
- High water temperature and high water pressure car washers are available depending on the type of high pressure car washer device. If the car washer nozzle is put too close to the vehicle or aimed at one area for an extended period of time, it could deform plastic parts or damage the paint.
- Do not use wax containing compounds (polish). Otherwise, it could result in paint damage.
- In addition, do not use an electrical or air tool to apply wax. Otherwise, the frictional heat generated could result in deformation of plastic parts or paint damage.

Interior Care

WARNING

■ Do not spray water in the cabin

Splashing water on electrical parts such as the audio unit and switches is dangerous as it could cause a malfunction or a fire.

Dashboard Precautions

Prevent caustic solutions such as perfume and cosmetic oils from contacting the dashboard. They will damage and discolor the dashboard. If these solutions get on the dashboard, wipe them off immediately.

■ Instrument panel top

- When cleaning, it is recommended that you use a clean towel dampened in a mild detergent to remove soiling.
- If the surface is rubbed harshly, it could result in the surface being damaged leaving white scratch marks.

NOTICE

Do not use glazing agents.
Glazing agents contain ingredients which may cause discoloration, wrinkling, cracks and peeling.

Cleaning the Upholstery and Interior Trim

■ Vinyl

Remove dust and loose dirt from vinyl with a whisk broom or vacuum cleaner. Clean vinyl with a leather-and-vinyl cleaner.

■ Leather (if equipped)

Remove dust and sand first using a vacuum cleaner or other means, then wipe dirt off using a soft cloth with a leather cleaner or a soft cloth soaked in mild soap. Wipe off the remaining cleaner or soap using a cloth soaked in clean water and wrung out well.

Remove moisture with a dry, soft cloth and allow the leather to further dry in a well-ventilated, shaded area. If the leather gets wet such as from rain, also remove moisture and dry it as soon as possible.

■ Fabric

Remove dust and loose dirt from fabric with a whisk broom or vacuum cleaner. Clean it with a mild soap solution good for upholstery and carpets. Remove fresh spots immediately with a fabric spot cleaner.

To keep the fabric looking clean and fresh, take care of it. Otherwise its color will be affected, it can be stained easily, and its fire-resistance may be reduced.

■ Panel

When the interior panels need to be cleaned, use soft material such as a soft cloth soaked in clean water and wrung out well and lightly wipe off dirt from the surface. If a panel requires further cleaning, use the following procedure.

- 1 Wipe dirt off using a soft cloth soaked in mild detergent (about 5% solution).
- 2 Wipe off any remaining detergent using a cloth soaked in clean water and wrung out well.

■ Leather

- Because genuine leather is a natural material, its surface is not uniform and it may have natural scars, scratches, and wrinkles.
- To maintain the quality for as long as possible, periodical maintenance, about twice a year, is recommended.

 **NOTICE****■ Leather**

- Sand and dust on the seat surface may damage the overcoat of the genuine leather surfaces and accelerate wear.
- Greasy soiling on genuine leather may cause molding and stains.
- Rubbing hard with a stiff brush or cloth may cause damage.
- Do not wipe the leather using alcohol, chlorine bleach, or organic solvents such as thinner, benzene, or gasoline. Otherwise, it may cause discoloration or stains.
- If the seats get wet, promptly remove moisture with a dry cloth. Remaining moisture on the surface may cause deterioration such as hardening and shrinkage.
- Exposure to direct sunlight for long periods may cause deterioration and shrinkage. When parking the car under direct sunlight for long periods, shade the interior using sunshades.
- Do not leave vinyl products on the seats for long periods as they may affect the leather quality and coloring. If the cabin temperature becomes hot, the vinyl may deteriorate and adhere to the genuine leather.

■ Fabric

Use only recommended cleaners and procedures. Others may affect appearance and fire-resistance.

■ Panel

- Do not wipe leather parts using alcohol, chlorine bleach, or organic solvents such as thinner, benzene, or gasoline. Otherwise, it may cause discoloration or stains.
- Scratches or nicks on the panels and metallic trim resulting from the use of a hard brush or cloth may not be repairable.
- Be particularly careful when cleaning high lustre panels and metallic trim as they can be easily scratched.

Cleaning the Lap/Shoulder Belt Webbing

Clean the webbing with a mild soap solution recommended for upholstery or carpets. Follow instructions. Do not bleach or dye the webbing; this may weaken it.

After cleaning the belts, thoroughly dry the belt webbing and make sure there is no remaining moisture before retracting them.

WARNING

■ **Have your Toyota dealer replace damaged seat belts immediately**

Using damaged seat belts is dangerous. In a collision, damaged belts cannot provide adequate protection.

Cleaning the Window Interiors

If the windows become covered with an oily, greasy, or waxy film, clean them with glass cleaner. Follow the directions on the container.

NOTICE

- Do not scrape or scratch the inside of the window glass. It could damage the thermal filaments and the antenna lines.
- When washing the inside of the window glass, use a soft cloth dampened in lukewarm water, gently wiping the thermal filaments and the antenna lines.
Use of glass cleaning products could damage the thermal filaments and the antenna lines.

Cleaning the Floor Mats

Rubber floor mats should be cleaned with mild soap and water only.

After removing the floor mats for cleaning, always reinstall them securely. (→P. 144)

WARNING

■ **Do not use rubber cleaners, such as tire cleaner or tire shine, when cleaning rubber floor mats**

Cleaning the rubber floor mats with rubber cleaning products makes the floor mats slippery.

This may cause an accident when depressing the accelerator, brake, or clutch (Manual transaxle) pedal or when getting in or out of the vehicle.

If Trouble Arises**6**

- 6-1. Parking in an Emergency**
Parking in an
Emergency..... 456
- 6-2. Flat Tire**
Spare Tire and Tool
Storage 457
Changing a Flat Tire 463
- 6-3. Battery Runs Out**
Jump-Starting..... 478
- 6-4. Emergency Starting**
Starting a Flooded
Engine..... 482
Push-Starting 483
- 6-5. Overheating**
Overheating 484
- 6-6. Emergency Towing**
Towing Description 486
Tiedown Hooks 487
- 6-7. Warning/Indicator Lights
and Warning Sounds**
If a Warning Light Turns
On or Flashes 489
Message Indicated on
Display 500
Warning Sound is
Activated 502
- 6-8. When Trunk Lid Cannot
be Opened**
When Liftgate/Trunk Lid
Cannot be Opened 506

Parking in an Emergency

The hazard warning lights should always be used when you stop on or near a roadway in an emergency.

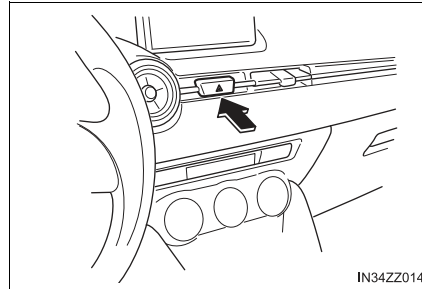

The hazard warning lights warn other drivers that your vehicle is a traffic hazard and that they must take extreme caution when near it.

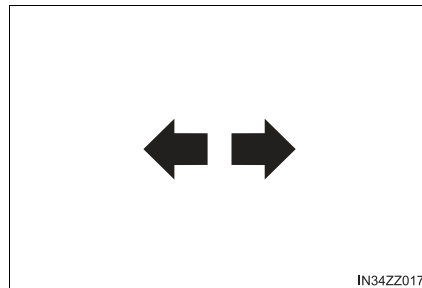

Depress the hazard warning flasher and all the turn signals will flash. The hazard warning indicator lights in the combination meter flash simultaneously.

-
- The turn signals do not work when the hazard warning lights are on.
 - Check local regulations about the use of hazard warning lights while the vehicle is being towed to verify that it is not in violation of the law.

Spare Tire and Tool Storage

Spare tire and tools are stored in the locations illustrated in the diagram.

► 4-Door

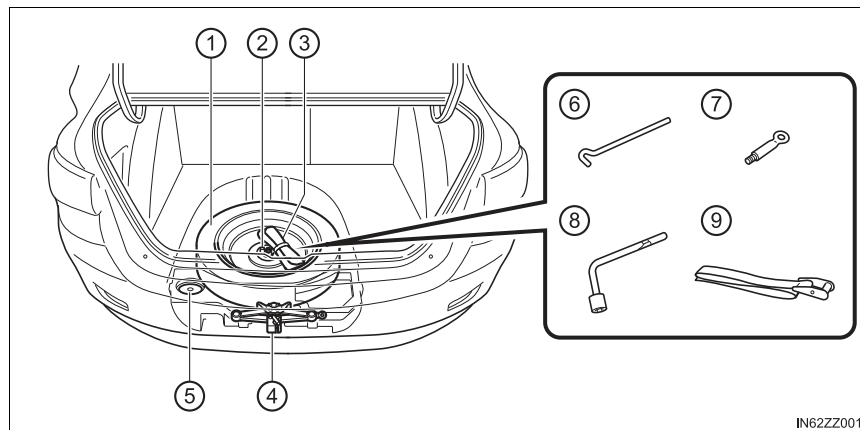

- | | |
|---------------------------------------|--------------------------------|
| ① Spare tire | ⑥ Jack lever |
| ② Spare tire hold-down bolt | ⑦ Tiedown eyelet (if equipped) |
| ③ Tool bag | ⑧ Lug wrench |
| ④ Jack | ⑨ Flat tire belt |
| ⑤ Jack point attachment* ¹ | |

*¹: The jack point attachment can be used by vehicle repair shops and road assistance services. Consult your Toyota dealer for details.

► 5-Door

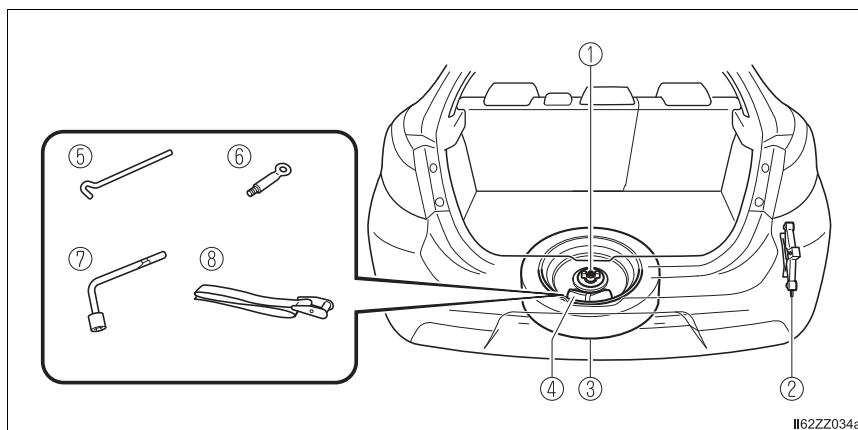

- | | |
|-----------------------------|--------------------------------|
| ① Spare tire hold-down bolt | ⑤ Jack lever |
| ② Jack | ⑥ Tiedown eyelet (if equipped) |
| ③ Spare tire | ⑦ Lug wrench |
| ④ Tool bag | ⑧ Flat tire belt |

Jack

■ To remove the jack

▶ 4-Door

- 1 Lift the trunk mat.
- 2 Remove trunk board.

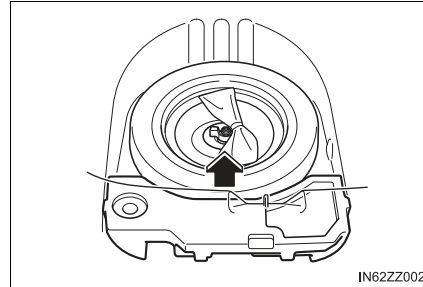

- 3 Turn the wing bolt and jack screw counterclockwise.

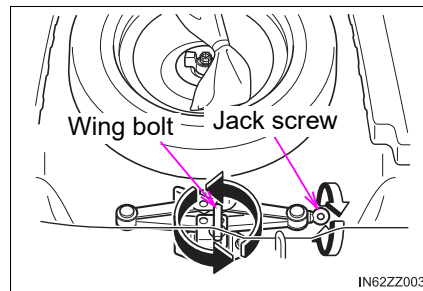

▶ 5-Door

- 1 Remove the cover.

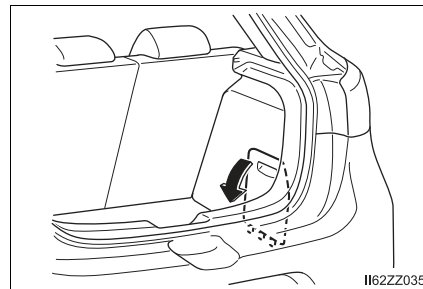

- 2 Turn the wing bolt and jack screw counterclockwise.

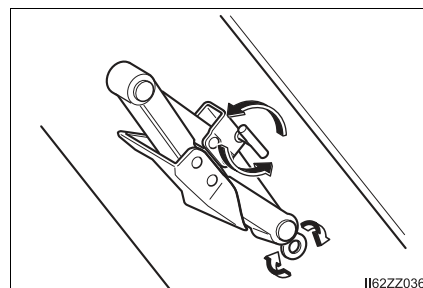

■ To secure the jack

- 1 Insert the wing bolt into the jack with the jack screw pointing to the right (4-Door) or down (5-Door) and turn the wing bolt clockwise to temporarily tighten it.
- 2 Turn the jack screw in the direction shown in the figure.

▶ 4-Door

▶ 5-Door

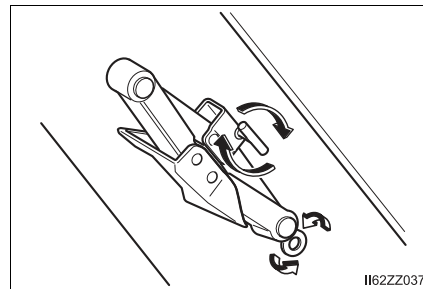
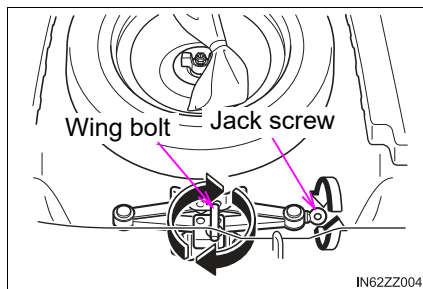

- 3 Turn the wing bolt completely to secure the jack.
If the jack is not completely secured, it could rattle while driving. Make sure the jack screw is sufficiently tightened.
- 4 Return the trunk board to its original position (4-Door), or insert the cover tabs and install the cover (5-Door).
Verify that the trunk board is securely installed.

■ Maintenance

- Always keep the jack clean.
- Make sure the moving parts are kept free from dirt or rust.
- Make sure the screw thread is adequately lubricated.

Spare Tire

Your Toyota has a temporary spare tire. The temporary spare tire is lighter and smaller than a conventional tire, and is designed only for emergency use and should be used only for VERY short periods. Temporary spare tires should NEVER be used for long drives or extended periods.

■ To remove the spare tire

- 1 Lift the trunk/luggage compartment mat.

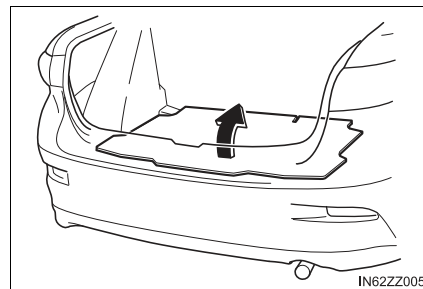

- 2 Turn the spare tire hold-down bolt counterclockwise.

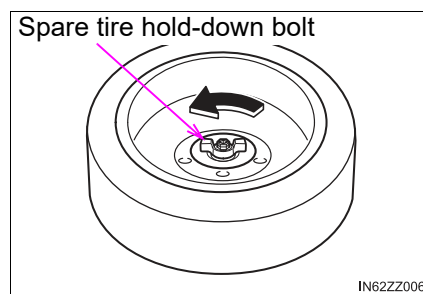

■ To secure the spare tire

Store the spare tire in the reverse order of removal. After storing, verify that the spare tire is stored securely.

WARNING

■ Do not install the temporary spare tire on the front wheels (driving wheels)

Driving with the temporary spare tire on one of the front driving wheels is dangerous. Handling will be affected. You could lose control of the vehicle, especially on ice or snow bound roads, and have an accident. Move a regular tire to the front wheel and install the temporary spare tire to the rear.

**NOTICE**

- When using the temporary spare tire, driving stability may decrease compared to when using only the conventional tire. Drive carefully.
- To avoid damage to the temporary spare tire or to the vehicle, observe the following precautions:
 - Do not exceed 50 mph (80 km/h).
 - Avoid driving over obstacles. Also, do not drive through an automatic car wash. This tire's diameter is smaller than a conventional tire, so the ground clearance is reduced.
 - Do not use a tire chain on this tire because it will not fit properly.
 - Do not use your temporary spare tire on any other vehicle, it has been designed only for your Toyota.
 - Use only one temporary spare tire on your vehicle at the same time.

Changing a Flat Tire

If you have a flat tire, drive slowly to a level spot that is well off the road and out of the way of traffic to change the tire.

Stopping in traffic or on the shoulder of a busy road is dangerous.

- 1 Park on a level surface off the right-of-way and firmly set the parking brake.
- 2 Put a vehicle with an automatic transaxle in Park (P), a manual transaxle in Reverse (R) or 1, and turn off the engine.
- 3 Turn on the hazard warning flasher.
- 4 Have everyone get out of the vehicle and away from the vehicle and traffic.
- 5 Remove the jack, tool, and spare tire (→P. 457).

- 6 Block the wheel diagonally opposite the flat tire. When blocking a wheel, place a tire block both in front and behind the tire.

When blocking a tire, use rocks or wood blocks of sufficient size if possible to hold the tire in place.

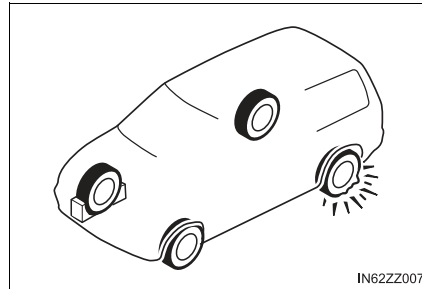

- If the following occurs while driving, it could indicate a flat tire.
 - Steering becomes difficult.
 - The vehicle begins to vibrate excessively.
 - The vehicle pulls in one direction.
- Make sure the jack is well lubricated before using it.

 **WARNING****■ Be sure to follow the directions for changing a tire**

Changing a tire is dangerous if not done properly. The vehicle can slip off the jack and seriously injure someone. No person should place any portion of their body under a vehicle that is supported by a jack.

■ Never allow anyone inside a vehicle supported by a jack

Allowing someone to remain in a vehicle supported by a jack is dangerous. The occupant could cause the vehicle to fall resulting in serious injury.

Removing a Flat Tire

- 1 If your vehicle is equipped with a wheel cover, pry off the wheel cover with the beveled end of the jack lever.

Force the end of the jack lever firmly between wheel and cover, or removal will be difficult.

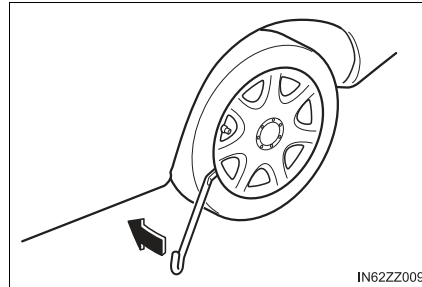

- 2 Loosen the lug nuts by turning them counterclockwise one turn each, but do not remove any lug nuts until the tire has been raised off the ground.

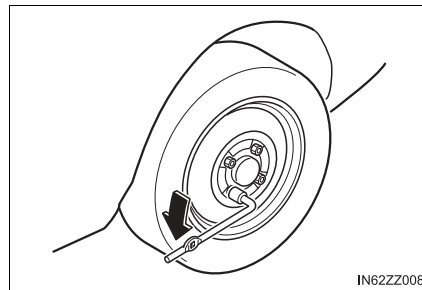

- 3 Place the jack on the ground.
- 4 Turn the jack screw in the direction shown in the figure and adjust the jack head so that it is close to the jack-up position.

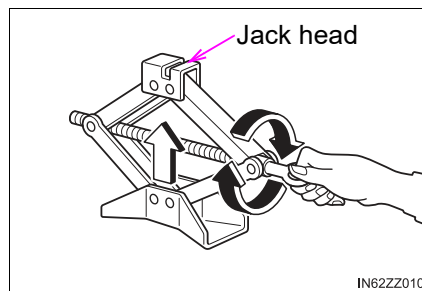

- 5 Place the jack under the jack-up position closest to the tire being changed with the jack head squarely under the jack-up point.

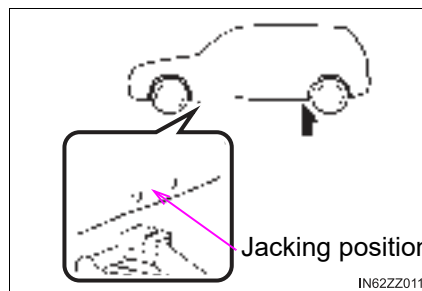

- 6 Continue raising the jack head gradually by rotating the screw with your hand until the jack head is inserted into the jack-up position.

When raising the jack head into the jacking position and aligning the groove in the jack head with the rail under the vehicle body, the top of the jack head contacts the vehicle's underbody without the rail contacting the bottom of the groove.

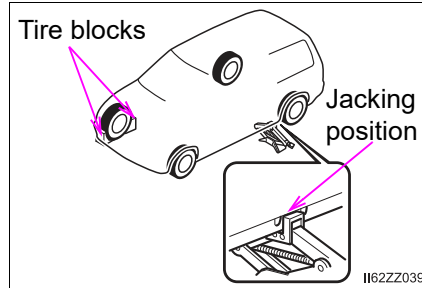

- 7 Insert the jack lever and attach the lug wrench to tire jack.

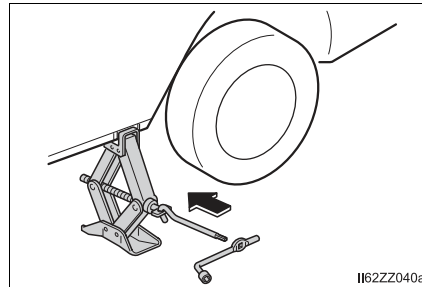

- 8 Turn the jack handle clockwise and raise the vehicle high enough so that the spare tire can be installed. Before removing the lug nuts, make sure your Toyota is firmly in position and that it cannot slip or move.

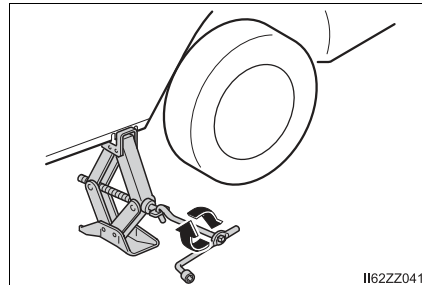

- 9 Remove the lug nuts by turning them counterclockwise; then remove the wheel and center cap.

⚠ WARNING

- **When jacking-up a vehicle, always shift the shift lever to 1st or R position (manual transaxle vehicle) or shift the selector lever to P position (automatic transaxle vehicle), apply the parking brake, and place wheel blocks in the position diagonally opposed to the jack**

Changing a flat tire without using wheel blocks is dangerous because the vehicle may move and fall off the jack even with the shift lever in 1st or R position, or the selector lever is in P position, which could result in an accident.

- **Use only the front and rear jacking positions recommended in this manual**

Attempting to jack the vehicle in positions other than those recommended in this manual is dangerous. The vehicle could slip off the jack and seriously injure or even kill someone. Use only the front and rear jacking positions recommended in this manual.

- **Do not jack up the vehicle in a position other than the designated jack-up position or place any objects on or under the jack**

Jacking up the vehicle in a position other than the designated jack-up position or placing objects on or under the jack is dangerous as it could deform the vehicle body or the vehicle could fall off the jack resulting in an accident.

- **Use only the jack provided with your Toyota**

Using a jack that is not designed for your Toyota is dangerous. The vehicle could slip off the jack and seriously injure someone.

- **Never place objects under the jack**

Jacking the vehicle with an object under the jack is dangerous. The jack could slip and someone could be seriously injured by the jack or the falling vehicle.

- **Do not jack up the vehicle higher than is necessary**

Jacking up the vehicle higher than is necessary is dangerous as it could destabilize the vehicle resulting in an accident.

- **Do not start the engine or shake the vehicle while it is jacked up**

Starting the engine or shaking the vehicle while it is jacked up is dangerous as it could cause the vehicle to fall off the jack resulting in an accident.

- **Never go under the vehicle while it is jacked up**

Going under the vehicle while it is jacked up is dangerous as it could result in death or serious injury if the vehicle were to fall off the jack.

Damage could occur during installation if the wheel cover is not properly aligned.

⚠ WARNING

■ **When installing the wheel cover**

Align the notch on the wheel cover with the valve stem.

Damage could occur during installation if the wheel cover is not properly aligned.

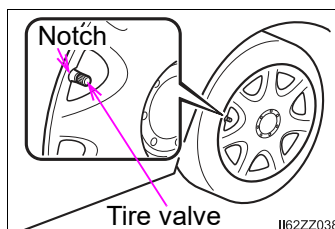

Locking Lug Nuts (if equipped)

If your Toyota is equipped with the optional antitheft wheel lug nuts, a special key must be used to unlock the locking lug nut for each wheel. The key is stored in the glove compartment, center console storage, storage box, or trunk. Register the key and lug nuts with the lock manufacturer by filling out the registration card and mailing it in using the accompanying envelope. If the key is lost, consult your Toyota dealer or use the lock manufacturer's order form to order a new key. Antitheft wheel lug nuts cannot be installed on a steel wheel spare tire. When installing a temporary spare tire, use one of the original lug nuts in place of the locking lug nut. The original lug nuts are stored inside your Toyota.

- ① Antitheft lug nut
- ② Special key

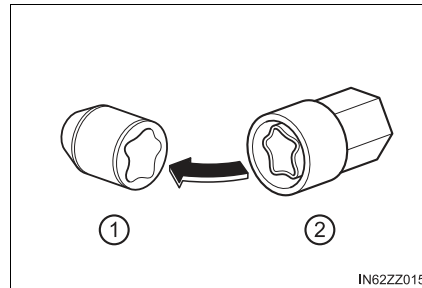

■ To remove an antitheft lug nut

- 1 Obtain the special key for the antitheft lug nut.
- 2 Place the special key on top of the antitheft lug nut, and be sure to hold the key square to it. If you hold the key at an angle, you may damage both key and nut. Do not use a power impact wrench.
- 3 Place the lug wrench on top of the key and apply pressure. Turn the wrench counterclockwise.

■ To install the antitheft lug nut

- 1 Place the special key on top of the nut, and be sure to hold the key square to it. If you hold the key at an angle, you may damage both key and nut. Do not use a power impact wrench.
- 2 Place the lug wrench on top of the special key, apply pressure, and turn it clockwise.

Nut tightening torque	
ft•lbf (N•m, kgf•m)	80-108 (108-147, 12-14)

Mounting the Spare Tire

► 4-Door

- 1 Remove dirt and grime from the mounting surfaces of the wheel and hub, including the hub bolts, with a cloth.

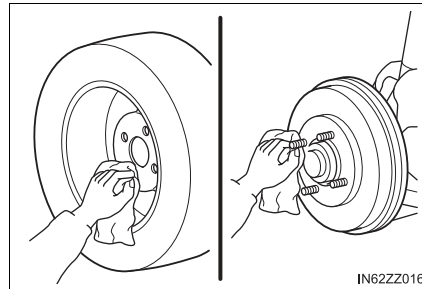

- 2 Mount the spare tire.
- 3 Install the lug nuts with the beveled edge inward; tighten them by hand.

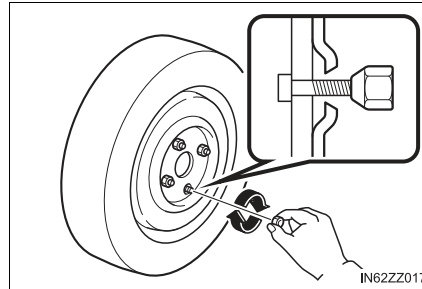

- 4 Turn the lug wrench counterclockwise and lower the vehicle.
- 5 Use the lug wrench to tighten the nuts in the order shown.

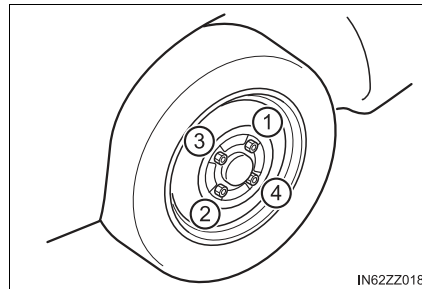

If you are unsure of how tight the nuts should be, have them inspected at your Toyota dealer.

Nut tightening torque	
ft•lbf (N•m, kgf•m)	80-108 (108-147, 12-14)

- 6 Open the trunk mat.

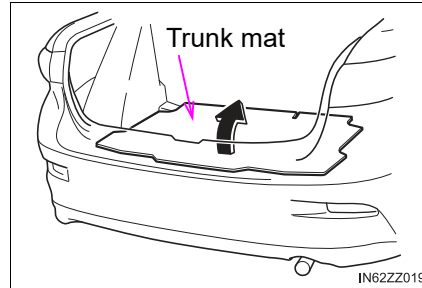

- 7 Remove the belt for securing the flat tire.

- 8 Put the flat tire into the trunk on the left and toward the back.

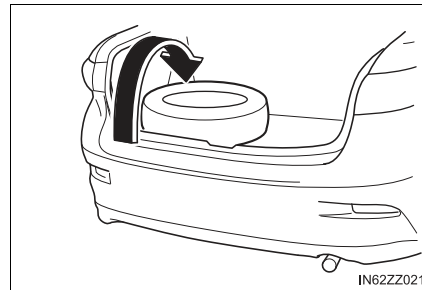

- 9 Fold the rear seatback forward on the right side of the rear seat.

- 10 Unlock the rear seatback on the left side and assure a clearance to pass the belt.

- 11 Pass the belt through the rear seatback as shown in the figure.

After passing the belt through, return the rear seatback to the original position.

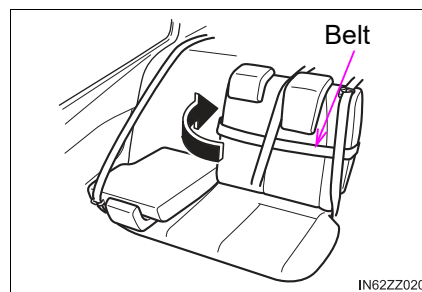

- 12 Pass the buckle through the wheel as shown in the figure and secure it so that the buckle does not contact the wheel.

▶ Aluminum wheel

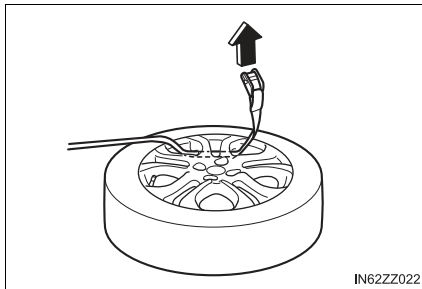

▶ Steel wheel

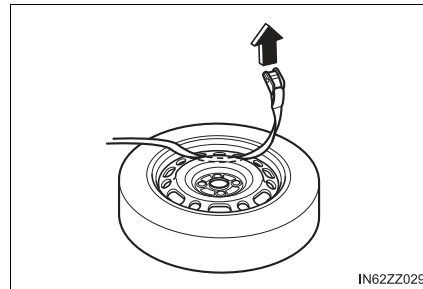

- 13 Pass the belt through the buckle, then pull the belt end to secure the flat tire.

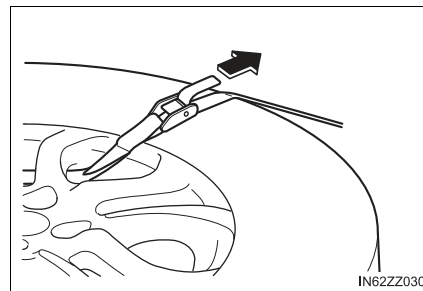

- 14 Return the rear seatback on the right side of the rear seatback to its original position.
- 15 Remove the tire blocks and store the tools and jack.
- 16 Check the inflation pressure.
Refer to Tires on P. 553.
- 17 Have the flat tire repaired or replaced as soon as possible.

► 5-Door

- 1 Remove dirt and grime from the mounting surfaces of the wheel and hub, including the hub bolts, with a cloth.

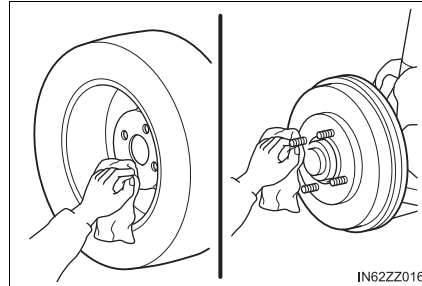

- 2 Mount the spare tire.
- 3 Install the lug nuts with the beveled edge inward; tighten them by hand.

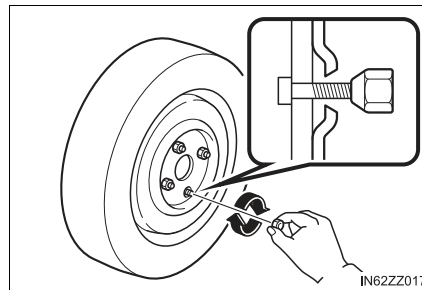

- 4 Turn the lug wrench counterclockwise and lower the vehicle.
- 5 Use the lug wrench to tighten the nuts in the order shown.

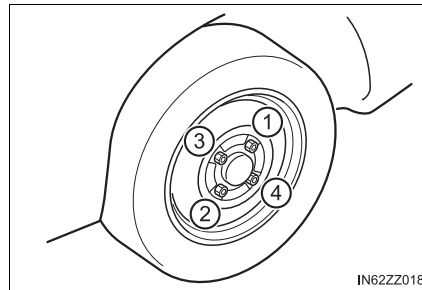

If you are unsure of how tight the nuts should be, have them inspected at your Toyota dealer.

Nut tightening torque	
ft•lbf (N•m, kgf•m)	80-108 (108-147, 12-14)

- 6 Remove the luggage compartment cover (if equipped).
Refer to Luggage Compartment on P. 117.

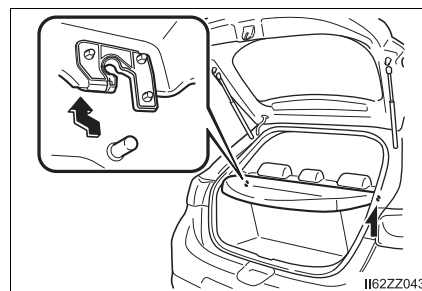
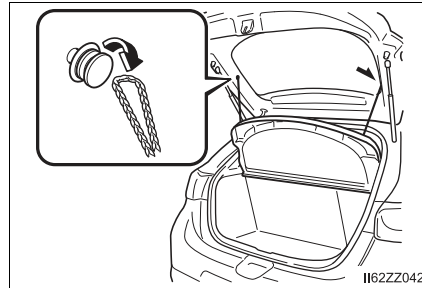

- 7 Remove the belt for securing the flat tire.
- 8 Return the rear seatback to its original position.
Refer to Rear Seat on P. 26.
- 9 Remove the tire blocks and store the tools and jack.
- 10 Remove the center cap by tapping it with the lug wrench.
- 11 Thread the belt through the rear seat as shown in the figure.

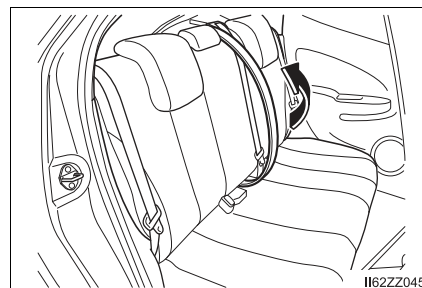
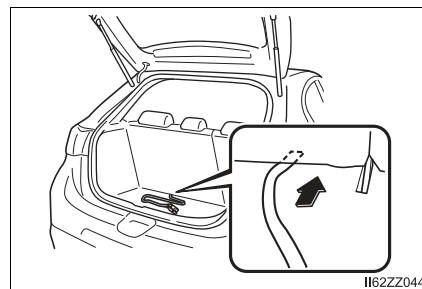

- 12 Place the flat tire in the luggage compartment.

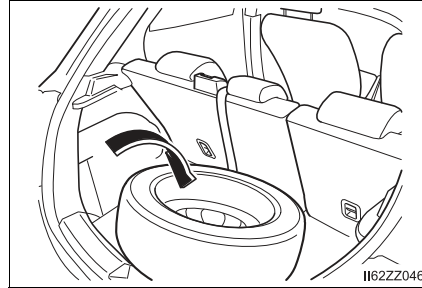

- 13 Thread the buckle through the wheel as shown in the figure.

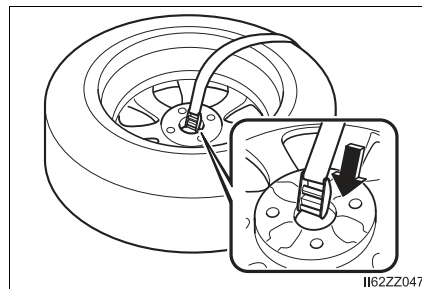

- 14 Thread the belt through the buckle while pressing the tire to the seatback.

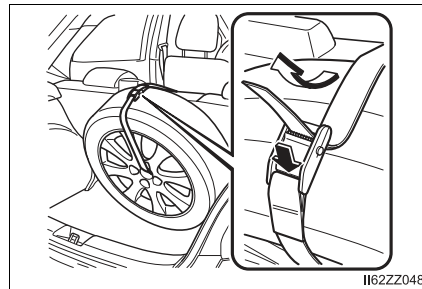

- 15 Pull the belt end to secure the flat tire.

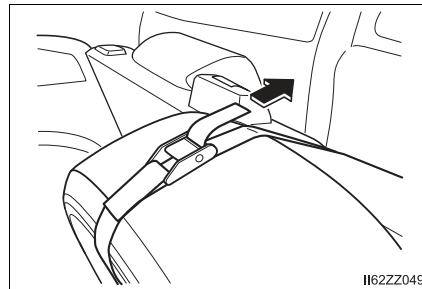

- 16 Insert the luggage compartment cover from the top of the luggage compartment opening with the cloth side of the cover facing outward, and slide it between the flat tire and the inside perimeter of the luggage compartment opening.

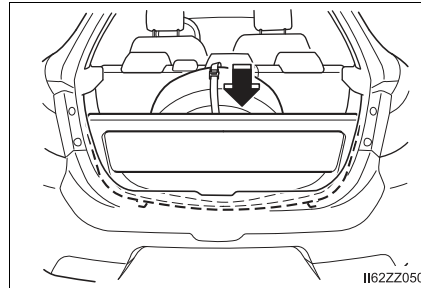

- 17 Check the tire inflation pressure.
Refer to the specification charts on P. 553.
- 18 Have the flat tire repaired or replaced as soon as possible.

- Pass the belt underneath the seat-belts.

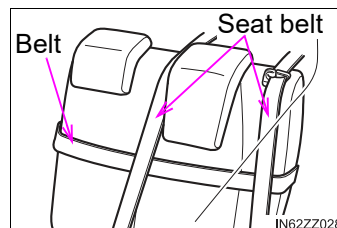

- Do not press the tire pressure monitoring system set switch after installing the spare tire. The switch is only to be pressed after installing the repaired flat tire or installing a replacement tire (→P. 164).
- To prevent the jack and tool from rattling, store them properly.

 **WARNING****■ Make sure the mounting surfaces of the wheel, hub and lug nuts are clean before changing or replacing tires**

When changing or replacing a tire, not removing dirt and grime from the mounting surfaces of the wheel, hub and hub bolts is dangerous. The lug nuts could loosen while driving and cause the tire to come off, resulting in an accident.

■ Do not apply oil or grease to lug nuts and bolts and do not tighten the lug nuts beyond the recommended tightening torque

Applying oil or grease to lug nuts and bolts is dangerous. The lug nuts could loosen while driving and cause the tire to come off, resulting in an accident. In addition, lug nuts and bolts could be damaged if tightened more than necessary.

■ Always securely and correctly tighten the lug nuts

Improperly or loosely tightened lug nuts are dangerous. The wheel could wobble or come off. This could result in loss of vehicle control and cause a serious accident.

■ Be sure to reinstall the same nuts you removed or replace them with metric nuts of the same configuration

Because the wheel studs and lug nuts on your Toyota have metric threads, using a non-metric nut is dangerous. On a metric stud, it would not secure the wheel and would damage the stud, which could cause the wheel to slip off and cause an accident.

■ Do not drive with any tires that have incorrect air pressure

Driving on tires with incorrect air pressure is dangerous. Tires with incorrect pressure could affect handling and result in an accident. When you check the regular tires' air pressure, check the spare tire, too.

Jump-Starting

Jump-starting is dangerous if done incorrectly. So follow the procedure carefully. If you feel unsure about jump-starting, we strongly recommend that you have a competent service technician do the work.

- 1 Move the booster vehicle so that its battery is as close as possible to your vehicle's battery.
- 2 Make sure that the power such as for the headlights and air conditioner is turned off.
- 3 Remove the battery cover.

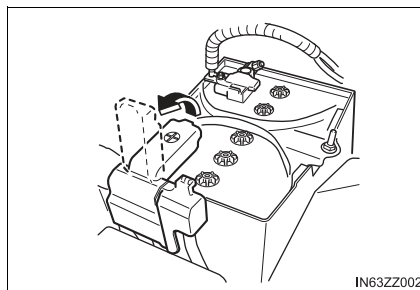

- 4 Turn off the booster vehicle's engine and connect the jumper cables in the following order.

Make sure that the jumper cables are securely connected so that they do not disconnect due to engine vibrations.

1st lead:

- ① Positive (+) terminal on the discharged battery
- ② Positive (+) terminal on booster vehicle's battery

2nd lead:

- ③ Negative (-) terminal on booster vehicle's battery
- ④ Location shown in the figure (do not connect to the negative (-) terminal of the battery)

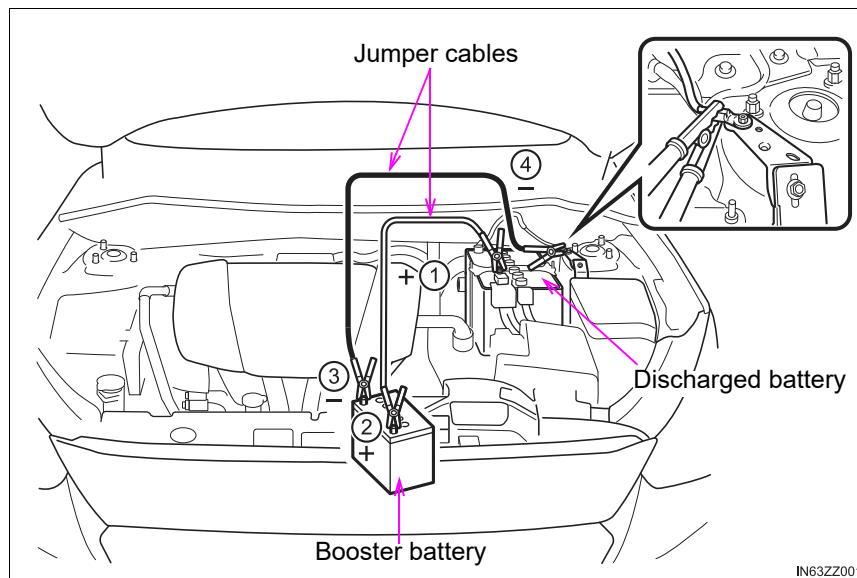

- 5 Start the booster vehicle's engine and rev the engine.
- 6 Start the engine of your vehicle. Run the engines for about 3 minutes to temporarily charge the battery of your vehicle.
- 7 Disconnect the jumper cables in the reverse order of their connection.
- 8 Install the battery cover.
- 9 Have your vehicle inspected by your Toyota dealer as soon as possible.

 **WARNING** **Follow These Precautions Carefully**

To ensure safe and correct handling of the battery, read the following precautions carefully before using the battery or inspecting it.

 **Keep flames and sparks away from open battery cells and do not allow metal tools to contact the positive (+) or negative (-) terminal of the battery when working near a battery. Do not allow the positive (+) terminal to contact the vehicle body**

Flames and sparks near open battery cells are dangerous. Hydrogen gas, produced during normal battery operation, could ignite and cause the battery to explode. An exploding battery can cause serious burns and injuries. Keep all flames including cigarettes and sparks away from open battery cells.

 **Keep all flames and sparks away from open battery cells because hydrogen gas is produced from open battery cells while charging the battery or adding battery fluid**

Flames and sparks near open battery cells are dangerous. Hydrogen gas, produced during normal battery operation, could ignite and cause the battery to explode. An exploding battery can cause serious burns and injuries. Keep all flames including cigarettes and sparks away from open battery cells.

 **Do not jump-start a frozen battery or one with a low fluid level**

Jump-starting a frozen battery or one with a low fluid level is dangerous. It may rupture or explode, causing serious injury.

 **Connect the negative cable to a good ground point away from the battery**

Connecting the end of the second jumper cable to the negative (-) terminal of the discharged battery is dangerous.

A spark could cause the gas around the battery to explode and injure someone.

 **Route the jumper cables away from parts that will be moving**

Connecting a jumper cable near or to moving parts (cooling fans, belts) is dangerous. The cable could get caught when the engine starts and cause serious injury.

 NOTICE

Use only a 12 V booster system. You can damage a 12 V starter, ignition system, and other electrical parts beyond repair with a 24 V power supply (two 12 V batteries in series or a 24 V motor generator set).

Starting a Flooded Engine

If the engine fails to start, it may be flooded (excessive fuel in the engine).

Follow this procedure:

- 1 If the engine does not start within 5 seconds on the first try, wait 10 seconds and try again.
- 2 Make sure the parking brake is on.
- 3 Depress the accelerator all the way and hold it there.
- 4 Depress the clutch pedal (Manual transaxle) or the brake pedal (Automatic transaxle), then press the push button start. If the engine starts, release the accelerator immediately because the engine will suddenly rev up.
- 5 If the engine fails to start, crank it without depressing the accelerator.

If the engine still does not start using the above procedure, have your vehicle inspected by your Toyota dealer.

Push-Starting

Do not push-start your Toyota.

You cannot start a vehicle with an automatic transaxle by pushing it.

WARNING

■ **Never tow a vehicle to start it**

Towing a vehicle to start it is dangerous. The vehicle being towed could surge forward when its engine starts, causing the 2 vehicles to collide. The occupants could be injured.

NOTICE

Do not push-start a vehicle that has a manual transaxle. It can damage the emission control system.

Overheating

If the high engine coolant temperature warning light turns on, the vehicle loses power, or you hear a loud knocking or pinging noise, the engine is probably too hot.

If the high engine coolant temperature warning light turns on:

- 1 Drive safely to the side of the road and park off the right-of-way.
- 2 Put a vehicle with an automatic transaxle in park (P), a manual transaxle in neutral.
- 3 Apply the parking brake.
- 4 Turn off the air conditioner.
- 5 Check whether coolant or steam is escaping from the engine compartment.

▶ If steam is coming from the engine compartment

Do not go near the front of the vehicle. Stop the engine.

Wait until the steam dissipates, then open the hood and start the engine.

▶ If neither coolant nor steam is escaping

Open the hood and idle the engine until it cools.

- 6 Make sure the cooling fan is operating, then turn off the engine after the temperature has decreased.
- 7 When cool, check the coolant level.
If it is low, look for coolant leaks from the radiator and hoses.

■ **If you find a leak or other damage, or if coolant is still leaking:**

Stop the engine and call your Toyota dealer.

- ① Cooling fan
- ② Cooling system cap
- ③ Coolant reservoir

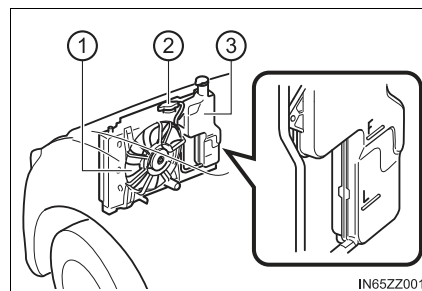

■ **If you find no problems, the engine is cool, and no leaks are obvious:**

Carefully add coolant as required (→P. 398).

 **WARNING**

-  **Pull over to a safe location, then switch the ignition to off and make sure the fan is not running before attempting to work near the cooling fan**

Working near the cooling fan when it is running is dangerous. The fan could continue running indefinitely even if the engine has stopped and the engine compartment temperature is high. You could be hit by the fan and seriously injured.

-  **Do not remove either cooling system cap when the engine and radiator are hot**

When the engine and radiator are hot, scalding coolant and steam may shoot out under pressure and cause serious injury.

- **Open the hood ONLY after steam is no longer escaping from the engine**

Steam from an overheated engine is dangerous. The escaping steam could seriously burn you.

 **NOTICE**

- If the cooling fan does not operate while the engine is running, the engine temperature will increase. Stop the engine and call your Toyota dealer.
- If the engine continues to overheat or frequently overheats, have the cooling system inspected. The engine could be seriously damaged unless repairs are made. Consult your Toyota dealer.

Towing Description

We recommend that towing be done only by your Toyota dealer or a commercial tow-truck service.

Proper lifting and towing are necessary to prevent damage to the vehicle. Government and local laws must be followed.

A towed vehicle usually should have its drive wheels (front wheels) off the ground. If excessive damage or other conditions prevent this, use wheel dollies.

When towing with the rear wheels on the ground, release the parking brake.

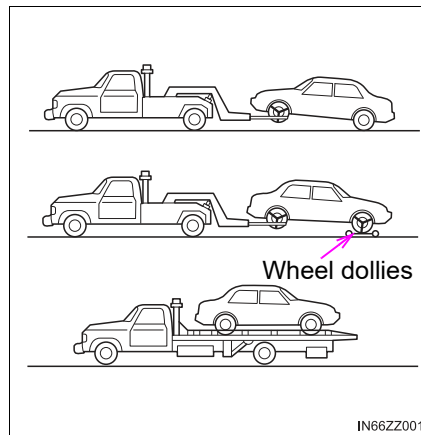

⚠ NOTICE

- Do not tow the vehicle pointed backward with driving wheels on the ground. This may cause internal damage to the transaxle.

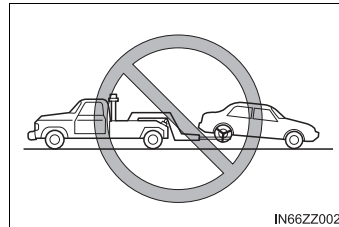

- Do not tow with sling-type equipment. This could damage your vehicle. Use wheel-lift or flatbed equipment.

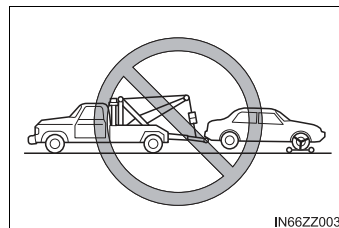

Tiedown Hooks*

NOTICE

Do not use the front tiedown eyelet for towing the vehicle. They have been designed only for securing the vehicle to a transport vessel during shipping. Using the eyelet for any other purpose could result in the vehicle being damaged.

Tiedown Hook-Front

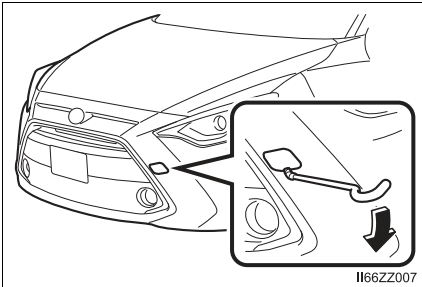
- 1 Remove the tiedown eyelet and the lug wrench from the luggage compartment (→P. 457).
- 2 Wrap a jack lever or similar tool with a soft cloth to prevent damage to a painted bumper, and open the cap located on the front bumper. Remove the cap completely and store it so as not to lose it.
 

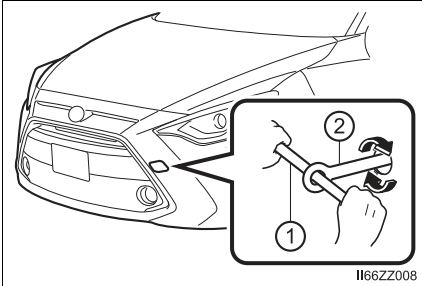
I166ZZ007
- 3 Securely install the tiedown eyelet using the lug wrench.
 - ① Lug wrench
 - ② Tiedown eyelet

I166ZZ008
- 4 Hook the tying rope to the tiedown eyelet.

*: If equipped

 NOTICE

- Do not use excessive force as it may damage the cap or scratch the painted bumper surface.
- If the tiedown eyelet is not securely tightened, it may loosen or disengage from the bumper when tying the vehicle. Make sure that the tiedown eyelet is securely tightened to the bumper.

Tiedown Hook-Rear

The hook positioned under the rear bumper on the right side is for tying down the vehicle during transport, and it cannot be used for towing other vehicles.

It can be used as a towing hook only when the vehicle must be towed by another vehicle in an emergency case such as when the vehicle is stuck in snow, however, it may damage the bumper.

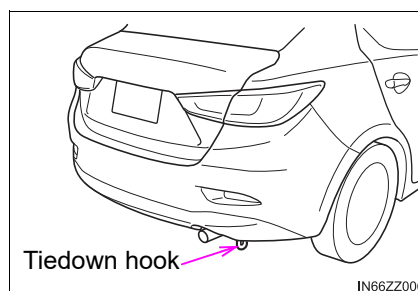

 NOTICE

- When using the hook in such emergency cases, observe the following so as not to damage the tiedown hook or the vehicle body.
- The vehicle must be pulled straight to the rear so that no load is applied to the vehicle in the lateral direction.
 - The bumper may be damaged if the tie down hook is used as a towing hook.
 - When using a metal chain or wire cable, wrap a cloth around the attachment area. If the metal chain or wire cable contacts the bumper directly, the bumper could be scratched or damaged.

If a Warning Light Turns On or Flashes

If any warning light turns on/flashes, take appropriate action for each light. There is no problem if the light turns off, however if the light does not turn off or turns on/flashes again, consult your Toyota dealer.



The details for some warnings can be viewed on the center display.



- 1 If the warning light is turned on, select the  icon on the home screen to display the applications screen.
- 2 Select "Vehicle Status Monitor".
- 3 Select "Warning Guidance" to display the current warnings.
- 4 Select the applicable warning to view the warning details.

Stop Vehicle in Safe Place Immediately

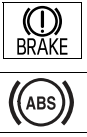
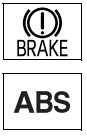
If any of the following warning lights turns on, the system may have a malfunction. Stop the vehicle in a safe place immediately and contact your Toyota dealer.

Signal	Warning
	<p>Brake System Warning Light</p> <p>This warning has the following functions:</p> <ul style="list-style-type: none"> • Parking brake warning/Warning light inspection The light illuminates when the parking brake is applied with the ignition switched to START or ON. It turns off when the parking brake is fully released. • Low brake fluid level warning If the brake warning light remains illuminated even though the parking brake is released, the brake fluid may be low or there could be a problem with the brake system. Park the vehicle in a safe place immediately and contact your Toyota dealer.

Signal	Warning
	<p>Electronic Brake Force Distribution System Warning</p> <p>If the electronic brake force distribution control unit determines that some components are operating incorrectly, the control unit may illuminate the brake system warning light and the ABS warning light simultaneously. The problem is likely to be the electronic brake force distribution system.</p>
	
	<p>Charging System Warning Light</p> <p>If the warning light illuminates while driving, it indicates a malfunction of the alternator or of the charging system. Drive to the side of the road and park off the right-of-way. Consult your Toyota dealer.</p>
	<p>Engine Oil Warning Light</p> <p>This warning light indicates low engine oil pressure. If the light illuminates or the warning indication is displayed while driving:</p> <ol style="list-style-type: none"> 1 Drive to the side of the road and park off the right-of-way on level ground. 2 Turn off the engine and wait 5 minutes for the oil to drain back into the oil pan. 3 Inspect the engine oil level P. 397. If it's low, add the appropriate amount of engine oil while being careful not to overfill. 4 Start the engine and check the warning light. <p>If the light remains illuminated even though the oil level is normal or after adding oil, stop the engine immediately and have your vehicle towed to your Toyota dealer.</p>

Signal	Warning
 <p>(Red)</p>	<p>High Engine Coolant Temperature Warning Light The light flashes when the engine coolant temperature is extremely high, and illuminates when the engine coolant temperature increases further. Handling Procedure:</p> <ul style="list-style-type: none"> • Flashing light Drive slowly to reduce engine load until you can find a safe place to stop the vehicle and wait for the engine to cool down. • Illuminated light This indicates the possibility of overheating. Park the vehicle in a safe place immediately and stop the engine. Refer to Overheating P. 484.
	<p>Power Steering Malfunction Indicator Light The light illuminates/flashes if the electric power steering has a malfunction. If the light illuminates/flashes, stop the vehicle in a safe place and do not operate the steering wheel. There is no problem if the light turns off after a while. Contact your Toyota dealer if the light illuminates/flashes continuously.</p>

■ Power Steering Malfunction Indicator Light

- If the indicator light illuminates/flashes, the power steering will not operate normally. If this happens, the steering wheel can still be operated, however, the operation may feel heavy compared to normal, or the steering wheel could vibrate when turning.
- Repeatedly jerking the steering wheel left and right while the vehicle is stopped or moving extremely slowly will cause the power steering system to go into protective mode which will make the steering feel heavy, but this does not indicate a problem. If this occurs, park the vehicle safely and wait several minutes for the system to return to normal.

WARNING

■ Do not drive with the brake system warning light illuminated. Contact your Toyota dealer to have the brakes inspected as soon as possible

Driving with the brake system warning light illuminated is dangerous. It indicates that your brakes may not work at all or that they could completely fail at any time. If this light remains illuminated, after checking that the parking brake is fully released, have the brakes inspected immediately.

In addition, the effectiveness of the braking may diminish so you may need to depress the brake pedal more strongly than normal to stop the vehicle.

■ Do not drive with both the ABS warning light and brake warning light illuminated. Have the vehicle towed to your Toyota dealer to have the brakes inspected as soon as possible

Driving when the brake system warning light and ABS warning light are illuminated simultaneously is dangerous.

When both lights are illuminated, the rear wheels could lock more quickly in an emergency stop than under normal circumstances.

NOTICE

■ Charging System Warning Light

Do not continue driving when the charging system warning light is illuminated because the engine could stop unexpectedly.

■ Engine Oil Warning Light







- Do not run the engine if the oil pressure is low. Otherwise, it could result in extensive engine damage.
- Do not run the engine if the oil level is low. Otherwise, it could result in extensive engine damage.



■ High Engine Coolant Temperature Warning Light

Do not drive the vehicle with the high engine coolant temperature warning light illuminated. Otherwise, it could result in damage to the engine.

Contact Your Toyota Dealer and Have Vehicle Inspected

If any of the following warning lights turns on/flashes, the system may have a malfunction. Contact your Toyota dealer to have your vehicle inspected.

Signal	Warning
	<p>Master Warning Light The light turns on when the system has a malfunction. Operate the center display and verify the content. Refer to If a Warning Light Turns On or Flashes on P. 489.</p>
 	<p>ABS Warning Light If the ABS warning light stays on while you're driving, the ABS control unit has detected a system malfunction. If this occurs, your brakes will function normally as if the vehicle had no ABS. Should this happen, consult your Toyota dealer as soon as possible.</p>
	<p>Check Engine Light If this light illuminates while driving, the vehicle may have a problem. It is important to note the driving conditions when the light illuminated and consult your Toyota dealer. The check engine light may illuminate in the following cases:</p> <ul style="list-style-type: none"> • The fuel tank level being very low or approaching empty. • The engine's electrical system has a problem. • The emission control system has a problem. • The fuel-filler cap is missing or not tightened securely. <p>If the check engine light remains on, or it flashes continuously, do not drive at high speeds and consult your Toyota dealer as soon as possible.</p>
 (if equipped)	<p>Automatic Transaxle Warning Light The light illuminates when the transaxle has a problem.</p>
 (Illuminate)	<p>TCS/DSC Indicator Light If the light stays on, the TCS, DSC or the brake assist system may have a malfunction and they may not operate correctly. Take your vehicle to your Toyota dealer.</p>
	<p>Air Bag/Front Seat Belt Pretensioner System Warning Light A system malfunction is indicated if the warning light constantly flashes, constantly illuminates or does not illuminate at all when the ignition is switched ON. If any of these occur, consult your Toyota dealer as soon as possible. The system may not operate in an accident.</p>

Signal	Warning
 <p>(Flashing) (if equipped)</p>	<p>Tire Pressure Monitoring System Warning Light</p> <p>If the tire pressure monitoring system has a malfunction, the tire pressure warning light flashes for about 1 minute when the ignition is switched ON and then continues illuminating. Have your vehicle checked by your Toyota dealer as soon as possible.</p>
 <p>(Red) (Illuminate)</p>	<p>KEY Warning Light</p> <p>If any malfunction occurs in the keyless entry system, it illuminates continuously. Refer to Emergency Operation for Starting the Engine on P. 162.</p>
 <p>(if equipped)</p>	<p>LED Headlight Warning Light</p> <p>This light illuminates if there is a malfunction in the LED headlight. Have your vehicle inspected by your Toyota dealer.</p>

■ ABS Warning Light

- When the engine is jump-started to charge the battery, uneven rpm occurs and the ABS warning light may illuminate. If this occurs, it is the result of the weak battery and does not indicate an ABS malfunction. Recharge the battery.
- The brake assist system does not operate while the ABS warning light is illuminated.

 **WARNING**

■ **Never tamper with the air bag/pretensioner systems and always have your Toyota dealer perform all servicing and repairs**

Self-servicing or tampering with the systems is dangerous. An air bag/pretensioner could accidentally activate or become disabled causing serious injury or death.

■ **If the tire pressure monitoring system warning light illuminates or flashes, or the tire pressure warning beep sound is heard, decrease vehicle speed immediately and avoid sudden maneuvering and braking**

If the tire pressure monitoring system warning light illuminates or flashes, or the tire pressure warning beep sound is heard, it is dangerous to drive the vehicle at high speeds, or perform sudden maneuvering or braking. Vehicle drivability could worsen and result in an accident.

To determine if you have a slow leak or a flat, pull over to a safe position where you can check the visual condition of the tire and determine if you have enough air to proceed to a place where air may be added and the system monitored again by your Toyota dealer or a tire repair station.

■ **Do not ignore the TPMS Warning Light**

Ignoring the TPMS warning light is dangerous, even if you know why it is illuminated. Have the problem taken care of as soon as possible before it develops into a more serious situation that could lead to tire failure and a dangerous accident.

 **NOTICE**

■ **Automatic Transaxle Warning Light**







If the automatic transaxle warning light illuminates, the transaxle has an electrical problem. Continuing to drive your Toyota in this condition could cause damage to your transaxle. Consult your Toyota dealer as soon as possible.



■ **KEY Warning Light**

If the key warning indicator light illuminates or the push button start indicator light (amber) flashes, the engine may not start. If the engine cannot be started, try starting it using the emergency operation for starting the engine, and have the vehicle inspected at your Toyota dealer as soon as possible.

Taking Action

Take the appropriate action and verify that the warning light turns off.

Signal	Warning	Action to be taken
	<p>Low Fuel Warning Light The light turns on when the remaining fuel is about 2.3 gal. (9.0 L, 1.9 Imp.gal.).</p>	Add fuel.
	<p>Check Fuel Cap Warning Light If the check fuel cap warning light illuminates while driving, the fuel-filler cap may not be installed properly.</p>	Stop the engine and reinstall the fuel-filler cap. Refer to Refueling on P. 125
 	<p>Seat Belt Warning Light The seat belt warning light turns on if the driver or front passenger's seat is occupied and the seat belt is not fastened with the ignition switched ON. If the driver or front passenger's seat belt is unfastened (only when the front passenger's seat is occupied) and the vehicle is driven at a speed faster than about 12 mph (20 km/h), the warning light flashes. After a short time, the warning light stops flashing, but remains illuminated.</p>	Fasten the seat belts.
	<p>Door-Ajar Warning Light The light turns on if any door/trunk lid/liftgate is not closed securely.</p>	Close the door/trunk lid/liftgate securely.
 (if equipped)	<p>Low Washer Fluid Level Warning Light This warning light indicates that little washer fluid remains.</p>	Add washer fluid (→P. 402).

Signal	Warning	Action to be taken
 (Illuminate) (if equipped)	Tire Pressure Monitoring System Warning Light When the warning light illuminates, and the warning beep sound is heard (about 3 seconds), tire pressure is too low in one or more tires.	Inspect the tires and adjust to the specified inflation pressure (→P. 413).
 (Amber)	Low Speed Pre-Collision System Warning Light The light turns on if the windshield is dirty or there is a malfunction in the system.	Verify the reason why the warning light is illuminated on the center display (→P. 489). If the reason why the warning light is illuminated is due to a dirty windshield, clean the windshield. For any other reasons, have the vehicle inspected at your Toyota dealer.

■ KEY Warning Light

Take the appropriate action and verify that the warning light turns off.

Signal	Cause	Action to be taken
 (Red) (Flashing)	The smart key battery is dead.	Replace the key battery (→P. 410).
	The smart key is not within the operation range.	Bring the smart key into the operation range (→P. 98).
	The smart key is placed in areas inside the cabin where it is difficult for the key to be detected.	
	A key from another manufacturer similar to the smart key is in the operation range.	Take the key from another manufacturer similar to the smart key out of the operation range.
	Without the ignition switched off, the smart key is taken out of the cabin, and then all the doors are closed.	Bring the smart key back into the cabin.

■ Low Fuel Warning Light

The light illumination timing may vary because fuel inside the fuel tank moves around according to the driving conditions and the vehicle posture.

■ Seat Belt Warning Light

- The warning light flashes for about 6 seconds if the driver's seat belt is not fastened when the ignition is switched ON.
- To allow the front passenger occupant classification sensor to function properly, do not place and sit on an additional seat cushion on the front passenger's seat. The sensor may not function properly because the additional seat cushion could cause sensor interference.
- If a small child is seated on the front passenger's seat, the warning light may not operate.

■ Tire Pressure Monitoring System Warning Light

- Perform tire pressure adjustment when the tires are cold. Tire pressure will vary according to the tire temperature, therefore let the vehicle stand for 1 hour or only drive it 1 mile (1.6 km) or less before adjusting the tire pressures. When pressure is adjusted on hot tires to the cold inflation pressure, the TPMS warning light/beep may turn on after the tires cool and pressure drops below specification. Also, an illuminated TPMS warning light, resulting from the tire air pressure dropping due to cold ambient temperature will remain illuminated even if the ambient temperature rises. In this case, it will also be necessary to adjust the tire air pressures. If the TPMS warning light illuminates due to a drop in tire air pressure, make sure to check and adjust the tire air pressures.
- Tires lose air naturally over time and the TPMS cannot tell if the tires are getting too soft over time or you have a flat. However, when you find one low tire in a set of four-that is an indication of trouble; you should have someone drive the vehicle slowly forward so you can inspect any low tire for cuts and any metal objects sticking through tread or sidewall. Put a few drops of water in the valve stem to see if it bubbles indicating a bad valve. Leaks need to be addressed by more than simply reinflating the tire as leaks are dangerous - take it to your Toyota dealer.

 **WARNING**

- **If the tire pressure monitoring system warning light illuminates or flashes, or the tire pressure warning beep sound is heard, decrease vehicle speed immediately and avoid sudden maneuvering and braking**

If the tire pressure monitoring system warning light illuminates or flashes, or the tire pressure warning beep sound is heard, it is dangerous to drive the vehicle at high speeds, or perform sudden maneuvering or braking. Vehicle drivability could worsen and result in an accident.

To determine if you have a slow leak or a flat, pull over to a safe position where you can check the visual condition of the tire and determine if you have enough air to proceed to a place where air may be added and the system monitored again by your Toyota dealer or a tire repair station.

- **Do not ignore the TPMS Warning Light**

Ignoring the TPMS warning light is dangerous, even if you know why it is illuminated. Have the problem taken care of as soon as possible before it develops into a more serious situation that could lead to tire failure and a dangerous accident.

Message Indicated on Display

If a message is displayed in the center display, take appropriate action (in a calm manner) according to the displayed message.

■ Display example

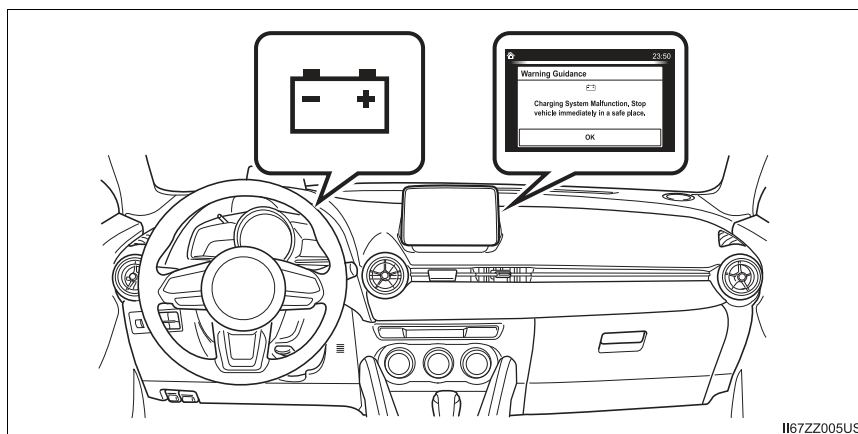

Stop Vehicle in Safe Place Immediately

If the following messages are displayed in the center display, a vehicle system may be malfunctioning. Stop the vehicle in a safe place and contact your Toyota dealer.

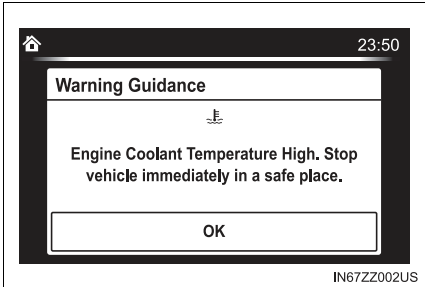
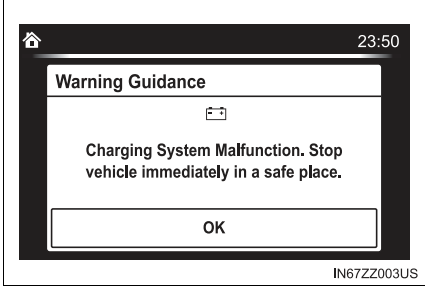
Display	Indicated Condition
	<p>Displays if the engine coolant temperature has increased excessively.</p>
	<p>Displays if the charging system has a malfunction.</p>

Verify Display Content

Displays in the following cases:

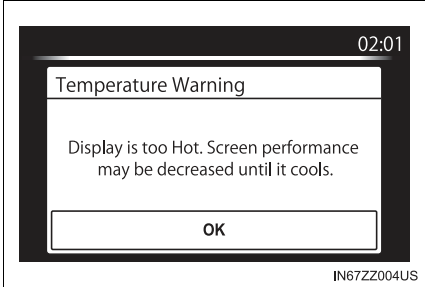
Display	Indicated Condition/ Action to be taken
	<p>The following message is displayed when the temperature around the center display is high. Lowering the temperature in the cabin or the temperature around the center display by avoiding direct sunlight is recommended.</p>

Warning Sound is Activated

Lights-On Reminder

The lights-on reminder is operable when the time setting^{*1} of the auto headlight off function is off.

If lights are on and the ignition is switched to ACC or the ignition is switched off, a continuous beep sound will be heard when the driver's door is opened.

^{*1}: If the light switch is left on, the auto headlight off function automatically turns off the lights about 30 seconds after switching the ignition off. The time setting can be changed.

Refer to Customizable Features on P. 555.

- When the ignition is switched to ACC, the "Ignition Not Switched Off (STOP) Warning Beep" (→P. 504) overrides the lights-on reminder.
- A personalized function is available to change the sound volume for the lights-on reminder.
Refer to Customizable Features on P. 555.

Air Bag/Front Seat Belt Pretensioner System Warning Beep

If there is a problem with the air bag/front seat belt pretensioner systems and the warning light illumination, a warning beep sound will be heard for about 5 seconds every minute.

The air bag and front seat belt pretensioner system warning beep sound will continue to be heard for approximately 35 minutes. Have your vehicle inspected at your Toyota dealer as soon as possible.

WARNING

■ Do not drive the vehicle with the air bag/front seat belt pretensioner system warning beep sounding

Driving the vehicle with the air bag/front seat belt pretensioner system warning beep sounding is dangerous. In a collision, the air bags and the front seat belt pretensioner system will not deploy and this could result in death or serious injury. Contact your Toyota dealer to have the vehicle inspected as soon as possible.

Seat Belt Warning Beep

If the driver's seat belt is not fastened when the ignition is switched ON, a beep sound will be heard for about 6 seconds. If the driver or the front passenger's seat belt is not fastened and the vehicle is driven at a speed faster than about 12 mph (20 km/h), a beep sound will be heard again for a specified period of time.

Until a seat belt is fastened or a given period of time has elapsed, the beep sound will not stop even if the vehicle speed falls below 12 mph (20 km/h).

- To allow the front passenger occupant classification sensor to function properly, do not place and sit on an additional seat cushion on the front passenger's seat. The sensor may not function properly because the additional seat cushion could cause sensor interference.
- If a small child is seated on the front passenger's seat, the warning beep may not operate.

Ignition Not Switched Off (STOP) Warning Beep

If the driver's door is opened while the ignition is switched to ACC, a continuous beep sound will be heard to notify the driver that the ignition has not been switched off (STOP). Left in this condition, the keyless entry system will not operate, the car cannot be locked, and the battery power will be depleted.

Key Removed from Vehicle Warning Beep**■ Vehicles with advanced keyless function**

If the key is taken out of the vehicle while the ignition is not switched OFF and all the doors are closed, the beep which sounds outside of the vehicle will be heard 6 times, the beep which sounds inside the vehicle will be heard 6 times.

■ Vehicles without advanced keyless function

If the key is taken out of the vehicle while the ignition is not switched OFF and all the doors are closed, a beep will be heard in the cabin 6 times.

Because the key utilizes low-intensity radio waves, the Key Removed From Vehicle Warning may activate if the key is carried together with a metal object or it is placed in a poor signal reception area.

Request Switch Inoperable Warning Beep (With the advanced keyless function)

If the request switch is pressed with the door open or ajar, or the ignition is not switched OFF with a key being carried, a beep will be heard outside for about 2 seconds to notify the driver that the door or liftgate/trunk lid cannot be locked.

Key Left-in-Compartment/trunk Warning Beep (With the advanced keyless function)

If the key is left in the luggage compartment/trunk with all the doors locked and the liftgate/trunk lid closed, a beep will be heard outside for about 10 seconds to notify the driver that the key is in the luggage compartment/trunk. In this case, take out the key by pressing the electric liftgate/trunk lid opener and opening the liftgate/trunk lid. The key taken out of the luggage compartment/trunk may not operate because its functions have been temporarily stopped. To restore the key's functions, perform the applicable procedure (→P. 98).

Key Left-in-vehicle Warning Beep (With the advanced keyless function)

If all the doors and luggage compartment/trunk are locked using another key while the key is left in the cabin, the beep which sounds outside of the vehicle will be heard for about 10 seconds to notify the driver that the key is in the cabin. In this case, take out the key by opening the door. A key taken out of the vehicle using this method may not operate because its functions have been temporarily stopped. To restore the key's functions, perform the applicable procedure (→P. 98).

Tire Inflation Pressure Warning Beep (if equipped)

The warning beep sound will be heard for about 3 seconds when there is any abnormality in tire inflation pressures (→P. 241).

Collision warning

If there is the possibility of a collision with a vehicle ahead, the beep sounds continuously and a warning is indicated in the display.

Power Steering Warning Buzzer

If the power steering system has a malfunction, the power steering malfunction indicator light turns on or flashes and the buzzer operates at the same time.

Refer to Stop Vehicle in Safe Place Immediately on P. 489.

When Liftgate/Trunk Lid Cannot be Opened

If the vehicle battery is dead or there is a malfunction in the electrical system and the liftgate/trunk lid cannot be opened, perform the following procedure as an emergency measure to open it:

WARNING

Perform the procedure using a cloth to cover sharp edges which could injure your hands.

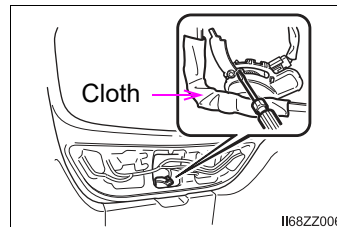

NOTICE

Perform the procedure carefully when using a flathead screwdriver as it could cause damage to the surrounding area or vehicle parts.

► 5-Door

- 1 Fold down the rear seatbacks.

Refer to Split Folding the Seatback on P. 26.

- 2 Pull the center section of the plastic fastener and remove the fasteners, then remove cover on the interior surface of the liftgate.

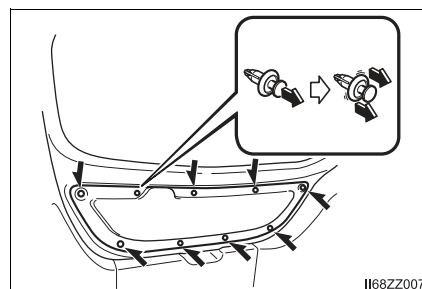

- 3 Using a flathead screwdriver, open the inner cover.

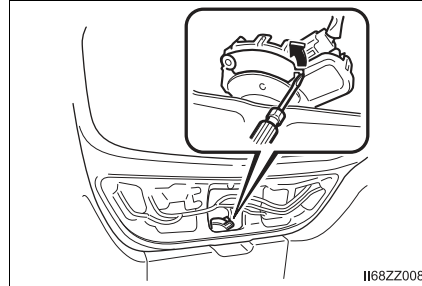

- 4 Using a flathead screwdriver, turn the lever to the right to unlock the liftgate.

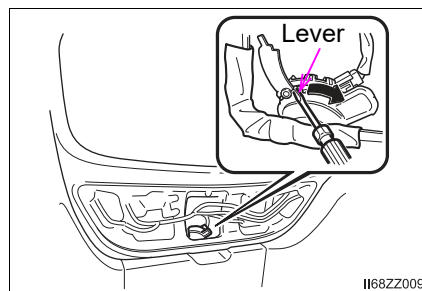

► 4-Door

- 1 Open the cover.
2 Move the lever to the left to fold the seatback.

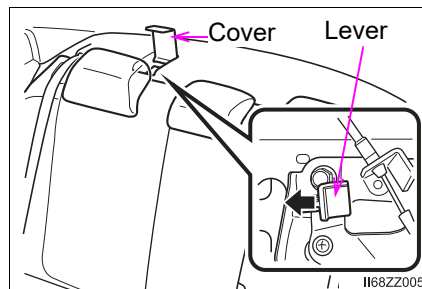

- 3 Move the lever to the left to open the trunk lid.

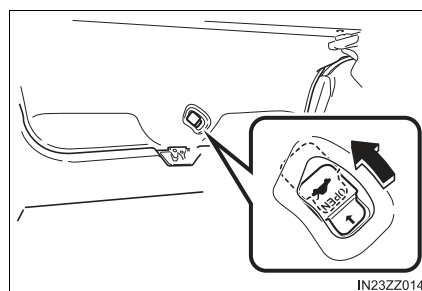

After performing this emergency measure, have the vehicle inspected at your Toyota dealer as soon as possible.

Customer Information and Reporting Safety Defects

7

- | | |
|---|--|
| <p>7-1. Reporting Safety Defects
 Reporting Safety Defects (U.S.A.) 510
 Reporting Safety Defects (Canada)..... 511</p> <p>7-2. Warranty
 Warranties for Your Toyota 512
 Outside the United States/Canada 513
 Add-On Non-Genuine Parts and Accessories..... 514</p> <p>7-3. Cell Phones
 Cell Phones Warning 515</p> | <p>7-4. Event Data Recorder
 Event Data Recorder (U.S.A. and Canada) 516</p> <p>7-5. Vehicle Data Recordings
 Vehicle Data Recordings..... 518</p> <p>7-6. Uniform Tire Quality Grading System (UTQGS)
 Uniform Tire Quality Grading System (UTQGS)..... 519</p> <p>7-7. Tire Information (U.S.A.)
 Tire Labeling 522
 Location of the Tire Label (Placard) 528
 Tire Maintenance 531
 Vehicle Loading 534
 Steps for Determining the Correct Load Limit 539</p> <p>7-8. Declaration of Conformity
 Declaration of Conformity 540</p> |
|---|--|

Reporting Safety Defects (U.S.A.)

If you believe that your vehicle has a defect which could cause a crash or could cause injury or death, you should immediately inform the National Highway Traffic Safety Administration (NHTSA) in addition to notifying Toyota Motor Sales, U.S.A., Inc. (Toll-free: 1-800-331-4331).

If NHTSA receives similar complaints, it may open an investigation, and if it finds that a safety defect exists in a group of vehicles, it may order a recall and remedy campaign. However, NHTSA cannot become involved in individual problems between you, your dealer, or Toyota Motor Sales, U.S.A., Inc.

To contact NHTSA, you may call the Vehicle Safety Hotline toll-free at 1-888-327-4236 (TTY: 1-800-424-9153); go to <http://www.safercar.gov>; or write to: Administrator, NHTSA, 1200 New Jersey Ave, S.E., Washington, DC 20590. You can also obtain other information about motor vehicle safety from <http://www.safercar.gov>.

Reporting Safety Defects (Canada)

Canadian customers who wish to report a safety-related defect to Transport Canada, Defect Investigations and Recalls, may telephone the toll free hotline 1-800-333-0510, or contact Transport Canada by mail at: Transport Canada, ASFAD, Place de Ville Tower C, 330 Sparks Street, Ottawa ON K1A 0N5.

For additional road safety information, please visit the Road Safety website at: <http://www.tc.gc.ca/roadsafety/menu.htm>

Warranties for Your Toyota

- New Vehicle Limited Warranty
- Powertrain Limited Warranty
- Safety Restraint System Limited Warranty
- Anti-perforation Limited Warranty
- Federal Emission Control Warranty/California Emission Control Warranty
 - Emission Defect Warranty
 - Emission Performance Warranty
- Emission Control Warranty
- Replacement Parts and Accessories Limited Warranty
- Tire Warranty

Warranty information varies depending on the country. Refer to the “Owner’s Warranty Information Booklet” or “Owner’s Manual Supplement/Scheduled Maintenance Guide” for detailed warranty information.

Outside the United States/Canada

Government regulations in the United States/Canada require that automobiles meet specific emission regulations and safety standards. Therefore, vehicles built for use in the United States/Canada may differ from those sold in other countries.

The differences may make it difficult or even impossible for your vehicle to receive satisfactory servicing in other countries. We strongly recommend that you NOT take your Toyota outside the United States/Canada.

► United States

However, in the event that you are moving to Canada permanently, Toyota vehicles built for use in the United States could be eligible for exportation to Canada with specific vehicle modifications to comply with the Canadian Motor Vehicle Safety Standards (CMVSS).

► Canada

However, in the event that you are moving to the United States permanently, Toyota vehicles built for use in Canada could be eligible for exportation to the United States with specific vehicle modifications to comply with the United States Federal Motor Vehicle Safety Standards (FMVSS).

You may have the following problems if you do take your vehicle outside of the United States/Canada:

- Recommended fuel may be unavailable. Any kind of leaded fuel or low-octane fuel will affect vehicle performance and damage the emission controls and engine.
- Proper repair facilities, tools, testing equipment, and replacement parts may not be available.

Please refer to your Manufacturer's "Owner's Warranty Information Booklet" or "Owner's Manual Supplement/Scheduled Maintenance Guide" for more information.

The above is applicable for a permanent import/export situation and not related to travelers on vacation.

Add-On Non-Genuine Parts and Accessories

Non-genuine parts and accessories for Toyota vehicles can be found in stores.

These may fit your vehicle, but they are not approved by Toyota for use with Toyota vehicles. When you install non-genuine parts or accessories, they could affect your vehicle's performance or safety systems; the Toyota warranty doesn't cover this. Before you install any non-genuine parts or accessories, consult your Toyota dealer.

Toyota assumes no responsibility for death, injury, or expenses that may result from the installation of add-on non-genuine parts or accessories.



WARNING

■ **Always consult your Toyota dealer before you install non-genuine parts or accessories**

Improperly designed parts or accessories could seriously affect your vehicle's performance or safety systems. This could cause you to have an accident or increase your chances of injuries in an accident.

■ **Be very careful in choosing and installing add-on electrical equipment, such as mobile telephones, two-way radios, stereo systems, and car alarm systems**

Incorrectly choosing or installing improper add-on equipment or choosing an improper installer is dangerous. Essential systems could be damaged, causing engine stalling, airbag (SRS) activation, ABS/TCS/DSC inactivation, or a fire in the vehicle.

Cell Phones Warning

WARNING

■ **Please comply with the legal regulations concerning the use of communication equipment in vehicles in your country**

Use of any electrical devices such as cell phones, computers, portable radios, vehicle navigation or other devices by the driver while the vehicle is moving is dangerous. Dialing a number on a cell phone while driving also ties-up the driver's hands. Use of these devices will cause the driver to be distracted and could lead to a serious accident. If a passenger is unable to use the device, pull off the right-of-way to a safe area before use.

If use of a cell phone is necessary despite this warning, use a hands-free system to at least leave the hands free to drive the vehicle. Never use a cell phone or other electrical devices while the vehicle is moving and, instead, concentrate on the full-time job of driving.

Event Data Recorder (U.S.A. and Canada)

This vehicle is equipped with an event data recorder (EDR). The main purpose of an EDR is to record, in certain crash or near crash-like situations, such as an air bag deployment or hitting a road obstacle, data that will assist in understanding how a vehicle's systems performed. The EDR is designed to record data related to vehicle dynamics and safety systems for a short period of time, typically 30 seconds or less. The EDR in this vehicle is designed to record such data as:

- How various systems in your vehicle were operating;
- Whether or not the driver and passenger safety belts were buckled/fastened;
- How far (if at all) the driver was depressing the accelerator and/or brake pedal; and,
- How fast the vehicle was traveling.

These data can help provide a better understanding of the circumstances in which crashes and injuries occur.

NOTE:

EDR data are recorded by your vehicle only if a non-trivial crash or near crash-like situation occurs; no data are recorded by the EDR under normal driving conditions and no personal data (e.g., name, gender, age, and crash location) are recorded. However, other parties, such as law enforcement, could combine the EDR data with the type of personally identifying data routinely acquired during a crash investigation.

To read data recorded by an EDR, special equipment is required, and access to the vehicle or the EDR is needed. In addition to the vehicle manufacturer, other parties, such as law enforcement, that have the special equipment, can read the information if they have access to the vehicle or the EDR.

Toyota will not disclose any of the data recorded in an EDR to a third party unless:

- A written agreement from the vehicle owner or the lessee is obtained
- Officially requested by the police or other law enforcement authorities
- Used as a defense for Toyota in a lawsuit, claim, or arbitration
- Ordered by a judge or court

However, if necessary Toyota will:

- Use the data for research on Toyota vehicle performance, including safety.
- Disclose the data or the summarized data to a third party for research purposes without disclosing vehicle or owner identification information.

Vehicle Data Recordings

Your Toyota is equipped with several sophisticated computers that will record certain data, such as:

- Engine speed
- Accelerator status
- Brake status
- Vehicle speed
- Shift position

The recorded data varies according to the vehicle grade level and options with which it is equipped.

● Data usage

Toyota may use the data recorded in these computers to diagnose malfunctions, conduct research and development, and improve quality.

Toyota will not disclose the recorded data to a third party except:

- With the consent of the vehicle owner or with the consent of the lessee if the vehicle is leased
- In response to an official request by the police, a court of law or a government agency
- For use by Toyota in a lawsuit
- For research purposes where the data is not tied to a specific vehicle or vehicle owner

Uniform Tire Quality Grading System (UTQGS)

This information relates to the tire grading system developed by the U.S. National Highway Traffic Safety Administration for grading tires by tread wear, traction, and temperature performance.

Tread Wear

The tread wear grade is a comparative rating based on the wear rate of the tire when tested under controlled conditions on a specified government test course.

For example, a tire graded 150 would wear one-and-a-half times as well on the government course as a tire graded 100.

The relative performance of tires depends upon the actual conditions of their use, however, and may depart significantly from the norm because of variations in driving habits, service practices and differences in road characteristics and climate.

Traction-AA, A, B, C

The traction grades, from highest to lowest, are AA, A, B, and C. These grades represent the tire's ability to stop on wet pavement as measured under controlled conditions on specified government test surfaces of asphalt and concrete. A tire marked C may have poor traction performance.

WARNING

The traction grade assigned to this tire is based on braking (straight ahead) traction tests and does not include acceleration cornering (turning), hydroplaning, or peak traction characteristics.

Temperature-A, B, C

The temperature grades A (the highest), B, and C, represent the tire's resistance to the generation of heat and its ability to dissipate heat when tested under controlled conditions on a specified indoor laboratory test wheel.

Sustained high temperature can cause the material of the tire to degenerate and reduce tire life, and excessive temperatures can lead to sudden tire failure.

Grade C corresponds to a level of performance which all passenger vehicle tires must meet under the Federal Motor Vehicle Safety Standard No. 109. Grades B and A represent higher levels of performance on the laboratory test wheel than the minimum required by law.

These grades will be added to the sidewalls of passenger vehicle tires over the next several years according to a schedule established by the NHTSA and the tire manufacturers.

The grade of tires available as standard or optional equipment on Toyota vehicles may vary with respect to grade.

ALL PASSENGER VEHICLE TIRES MUST CONFORM TO THESE GRADES AND TO ALL OTHER FEDERAL TIRE-SAFETY REQUIREMENTS.

WARNING

■ **Keep your vehicle's tires properly inflated and not overloaded**

Driving with improperly inflated or overloaded tires is dangerous. Excessive speed, underinflation, or excessive loading, either separately or in combination, can cause heat buildup and possible tire failure. The temperature grade for this tire is established for a tire that is properly inflated and not overloaded.

UNIFORM TIRE QUALITY GRADING

Quality grades can be found where applicable on the tire sidewall between tread shoulder and maximum section width.

For example:

TREADWEAR 200 TRACTION AA TEMPERATURE A

UTQGS MARK (example):

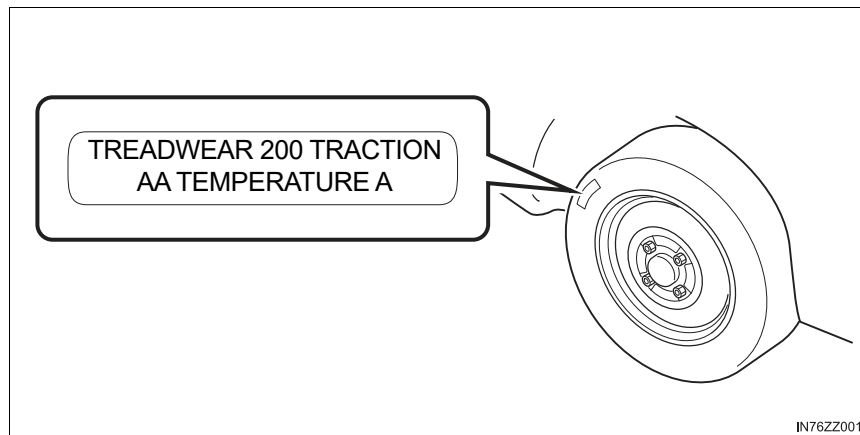

Tire Labeling

Federal law requires tire manufacturers to place standardized information on the sidewall of all tires. This information identifies and describes the fundamental characteristics of the tire and also provides a tire identification number for safety standard certification and in case of a recall.

Information on Passenger Vehicle Tires

Please refer to the sample below.

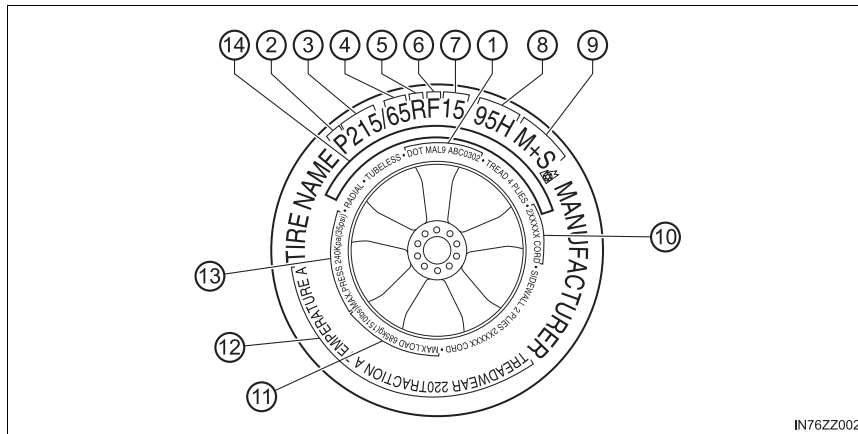

- | | |
|--|---|
| ① TIN: U.S. DOT tire identification number | ⑧ Load index & speed symbol |
| ② Passenger car tire | ⑨ Severe snow conditions |
| ③ Nominal width of tire in millimeters | ⑩ Tire ply composition and materials used |
| ④ Ratio of height to width (aspect ratio) | ⑪ Max. load rating |
| ⑤ Radial | ⑫ Tread wear, traction and temperature grades |
| ⑥ Run-flat tire | ⑬ Max. permissible inflation pressure |
| ⑦ Rim diameter code | ⑭ SAFETY WARNING |

P215/65R15 95H is an example of a tire size and load index rating. Here is an explanation of the various components of that tire size and load index rating. Note that the tire size and load index rating may be different from the example.

- P

Indicates a tire that may be installed on cars, SUVs, minivans and light trucks as designated by the Tire and Rim Association (T&RA).

If your tire size does not begin with a letter this may mean it is designated by either ETRTO (European Tire and Rim Technical Organization) or JATMA (Japan Tire Manufacturing Association).

- 215

“215” is the nominal width of the tire in millimeters. This three-digit number gives the width in millimeters of the tire from sidewall edge to sidewall edge. In general, the larger the number, the wider the tire.

- 65

“65” is the aspect ratio. This two-digit number indicates the tire’s ratio of height to width.

- R

“R” is the tire construction symbol. R indicates “Radial ply construction”.

- 15

“15” is the wheel rim diameter in inches.

- 95

“95” is the Load Index. This two-or three-digit number indicates how much weight each tire can support.

- H

“H” is the speed rating. The speed rating denotes the maximum speed for which the use of the tire is rated.

Letter Rating	Speed Rating
Q	99 mph
R	106 mph
S	112 mph
T	118 mph
U	124 mph
H	130 mph
V	149 mph
W	168* mph
Y	186* mph

*: For tires with a maximum speed capability over 149 mph, tire manufacturers sometimes use the letters ZR. For tires with a maximum speed capability over 186 mph, tire manufacturers always use the letters ZR.

■ **M+S or M/S: Mud and Snow**

AT: All Terrain.

AS: All Season. The “M+S” or “M/S” indicates that the tire has some functional use in mud and snow.

■ **U.S. DOT Tire Identification Number (TIN)**

This begins with the letters “DOT” which indicates the tire meets all federal standards. The next two numbers or letters are the plant code where it was manufactured, and the last four numbers represent the week and year the tire was manufactured. For example, the numbers 457 means the 45th week of 1997. After 2000 the numbers go to four digits. For example, the number 2102 means the 21th week of 2002. The other numbers are marketing codes used at the manufacturer’s discretion. This information is used to contact consumers if a tire defect requires a recall.

■ **Tire Ply Composition and Materials Used**

The number of plies indicates the number of layers of rubber-coated fabric in the tire.

In general, the greater the number of plies, the more weight a tire can support. Tire manufacturers also must indicate the tire materials, which include steel, nylon, polyester, and other.

■ **Maximum Load Rating**

This number indicates the maximum load in kilograms and pounds that can be carried by the tire.

■ **Maximum Permissible Inflation Pressure**

This number is the greatest amount of air pressure that should ever be put in the tire under normal driving conditions.

■ **Tread Wear, Traction and Temperature Grades**

- **Tread wear:** The tread wear grade is a comparative rating based on the wear rate of the tire when tested under controlled conditions on a specified government test course. For example, a tire graded 150 would wear one and one-half (1 1/2) times as well on the government course as a tire graded 100.
- **Traction:** The traction grades, from highest to lowest are AA, A, B, and C. The grades represent the tire's ability to stop on wet pavement as measured under controlled conditions on specified government test surfaces of asphalt and concrete. A tire marked C may have poor traction performance.
- **Temperature:** The temperature grades are A (the highest), B and C, representing the tire's resistance to the generation of heat and its ability to dissipate heat when tested under controlled conditions on a specified indoor laboratory test wheel.

■ **Snow Tires**

In some heavy snow areas, local governments may require true snow tires, those with very deeply cut tread. These tires should only be used in pairs or placed on all four wheels. Make sure you purchase snow tires that are the same size and construction type as the other tires on your vehicle.

■ **SAFETY WARNING**

The following safety warning appears on the tire's sidewall. SERIOUS INJURY MAY RESULT FROM:

- EXPLOSION OF TIRE/RIM ASSEMBLY DUE TO IMPROPER MOUNTING-MATCH TIRE DIAMETER TO RIM DIAMETER; NEVER EXCEED 40 psi (275 kPa) TO SEAT BEADS-ONLY SPECIALLY TRAINED PERSONS SHOULD MOUNT TIRES.
- TIRE FAILURE DUE TO UNDER-INFLATION/OVERLOADING/DAMAGE-FOLLOW OWNER'S MANUAL AND PLACARD IN VEHICLE-FREQUENTLY CHECK INFLATION PRESSURE AND INSPECT FOR DAMAGE.

Information on Temporary Tires

Please refer to the sample below.

- ① Temporary tires
- ② Nominal width of tire in millimeters
- ③ Ratio of height to width (aspect ratio)
- ④ Diagonal
- ⑤ Rim diameter code
- ⑥ Load index & speed symbol

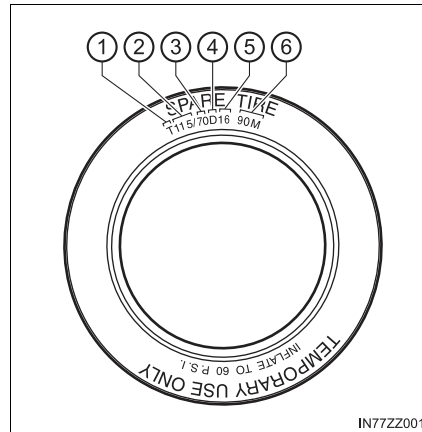

T115/70D16 90M is an example of a tire size and load index rating. Here is an explanation of the various components of that tire size and load index rating. Note that the tire size and load index rating may be different from the example.

- T

Indicates a tire that may be installed on cars, SUVs, minivans and light trucks as designated by the Tire and Rim Association (T&RA).

- 115

“115” is the nominal width of the tire in millimeters. This three-digit number gives the width in millimeters of the tire from sidewall edge to sidewall edge. In general, the larger the number, the wider the tire.

- 70

“70” is the aspect ratio. This two-digit number indicates the tire’s ratio of height to width.

- D

“D” is the tire construction symbol. D indicates “diagonal ply construction”.

- 16

“16” is the wheel rim diameter in inches.

● 90

“90” is the Load Index. This two-or three-digit number indicates how much weight each tire can support.

● M

“M” is the speed rating. The speed rating denotes the maximum speed for which the use of the tire is rated.

Letter Rating	Speed Rating
M	81 mph

Location of the Tire Label (Placard)

You will find the tire label containing tire inflation pressure by tire size and other important information on the driver's side B-pillar or on the edge of the driver's door frame.

SAMPLE

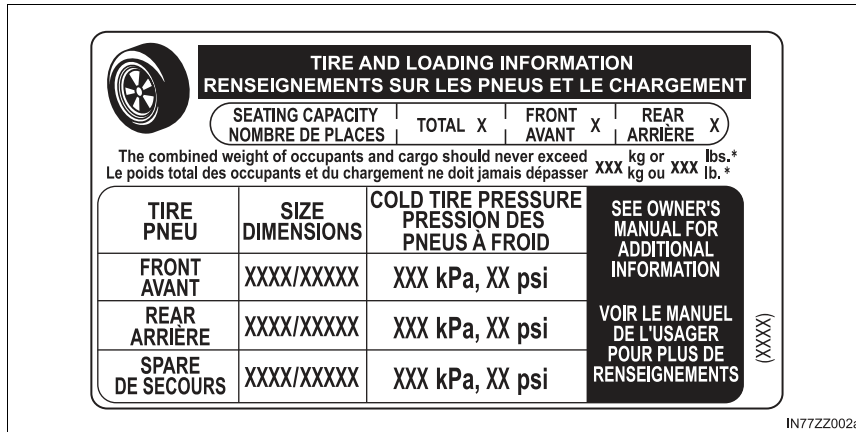

Recommended Tire Inflation Pressure

On the tire label you will find the recommended tire inflation pressure in both kPa and psi for the tires installed as original equipment on the vehicle. It is very important that the inflation pressure of the tires on your vehicle is maintained at the recommended pressure. You should check the tire pressure regularly to insure that the proper inflation pressure is maintained. Refer to Tires on P. 553.

Tire pressures listed on the vehicle placard or tire information label indicate the recommended cold tire inflation pressure, measured when the tires are cold, after the vehicle has been parked for at least 3 hours. As you drive, the temperature in the tire warms up, increasing the tire pressure.

⚠ WARNING

■ **Always check the tire inflation pressures on a regular basis according to the recommended tire inflation pressure on the tire label and in conjunction with the information in this owner's manual**

Driving your vehicle with under-inflated tires is dangerous.

Under-inflation is the most common cause of failures in any kind of tire and may result in severe cracking, tread separation or "blowout", with unexpected loss of vehicle control and increased risk of injury. Under-inflation increases sidewall flexing and rolling resistance, resulting in heat buildup and internal damage to the tire. It results in unnecessary tire stress, irregular wear, loss of control and accidents. A tire can lose up to half of its air pressure and not appear to be flat!

It is impossible to determine whether or not tires are properly inflated just by looking at them.

Checking Tire Pressure

- 1 When you check the air pressure, make sure the tires are cold - meaning they are not hot from driving even a mile.
- 2 Remove the cap from the valve on one tire.
- 3 Firmly press a tire gauge onto the valve.
- 4 Add air to achieve recommended air pressure.
- 5 If you overfill the tire, release air by pushing on the metal stem in the center of the valve. Then recheck the pressure with your tire gauge.
- 6 Replace the valve cap.
- 7 Repeat with each tire, including the spare.
- 8 Visually inspect the tires to make sure there are no nails or other objects embedded that could poke a hole in the tire and cause an air leak.
- 9 Check the sidewalls to make sure there are no gouges, cuts, bulges, cracks or other irregularities.

Some spare tires require higher inflation pressure.

Glossary of Terms

- Tire Placard: A label indicating the OE tire sizes, recommended inflation pressure, and the maximum weight the vehicle can carry.
- Tire Identification Number (TIN): A number on the sidewall of each tire providing information about the tire brand and manufacturing plant, tire size, and date of manufacture.
- Inflation Pressure: A measure of the amount of air in a tire.
- kPa: Kilopascal, the metric unit for air pressure.
- psi: Pounds per square inch, the English unit for air pressure.
- B-pillar: The structural member at the side of the vehicle behind the front door.
- Original Equipment (OE): Describes components originally equipped on the vehicle.
- Vehicle Load Limit: The maximum value of the combination weight of occupants and cargo.
- Bead Area of the Tire: Area of the tire next to the rim.
- Sidewall Area of the Tire: Area between the bead area and the tread.
- Tread Area of the Tire: Area on the perimeter of the tire that contacts the road when it's mounted on the vehicle.
- Seating capacity means the total allowable number of vehicle occupants. Seating capacity is described on the tire label.
- Production options weight is the combination weight of installed regular production options weighing over 2.3 kilograms in excess of the standard items which they replace, and not previously considered in the curb weight or accessory weight, including heavy duty brakes, ride levelers, roof rack, heavy duty battery, and special trim.
- Rim is the metal support (wheel) for a tire or a tire and tube assembly upon which the tire beads are seated.

Tire Maintenance

Improper or inadequate vehicle maintenance can cause tires to wear abnormally. Here are some important maintenance points:

Tire Inflation Pressure

Inspect all tire pressure monthly (including the spare) when the tires are cold. Maintain recommended pressures for the best ride, top handling, and minimum tire wear. Use the pressures specified on the vehicle tire information placard or tire label for optimum service.

Tire Rotation

To equalize tire wear and extend tire life, Toyota recommends that tire rotation is carried out at the same interval as tire inspection.

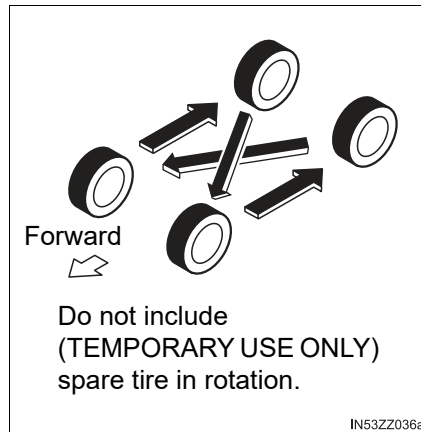

Inspect the tires for uneven wear and damage. Abnormal wear is usually caused by one or a combination of the following:

- Incorrect tire pressure
- Improper wheel alignment
- Out-of-balance wheel
- Severe braking

After rotation, inflate all tire pressures to specification (→P. 553) and inspect the lug nuts for tightness.

NOTICE

Rotate unidirectional tires and radial tires that have an asymmetrical tread pattern or studs only from front to rear, not from side to side. Tire performance will be weakened if rotated from side to side.

Replacing a Tire

If a tire wears evenly, a wear indicator will appear as a solid band across the tread. Replace the tire when this happens.

You should replace the tire before the band crosses the entire tread.

- ① New tread
- ② Worn tread
- ③ Tread wear indicator

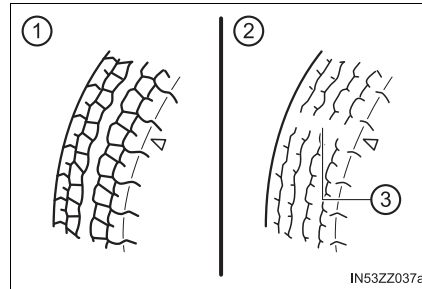

Tires degrade over time, even when they are not being used on the road. It is recommended that tires generally be replaced when they are 6 years or older. Heat caused by hot climates or frequent high loading conditions can accelerate the aging process. You should replace the spare tire when you replace the other road tires due to the aging of the spare tire. The period in which the tire was manufactured (both week and year) is indicated by a 4-digit number.

Refer to Tire Labeling on P. 522.

WARNING

■ Always use tires that are in good condition

Driving with worn tires is dangerous. Reduced braking, steering, and traction could result in an accident.

Safety Practices

The way you drive has a great deal to do with your tire mileage and safety. So cultivate good driving habits for your own benefit.

- Observe posted speed limits and drive at speeds that are safe for the existing weather conditions
- Avoid fast starts, stops and turns
- Avoid potholes and objects on the road
- Do not run over curbs or hit the tire against the curb when parking

 NOTICE

If you feel a sudden vibration or ride disturbance while driving or you suspect your tire or vehicle has been damaged, immediately reduce your speed. Drive with caution until you can safely pull off the road. Stop and inspect the tire for damage. If the tire is under-inflated or damaged, deflate it, remove the tire and rim and replace it with your spare tire. If you cannot detect a cause, have the vehicle towed to the nearest vehicle or tire dealer to have the vehicle inspected.

Vehicle Loading

This section will guide you in the proper loading of your vehicle, to keep your loaded vehicle weight within its design rating capability. Properly loading your vehicle will provide maximum return of vehicle design performance. Before loading your vehicle, familiarize yourself with the following terms for determining your vehicle's weight ratings, from the vehicle's Safety Certification Label and Tire and Load Information Label:

Base Curb Weight is the weight of the vehicle including a full tank of fuel and all standard equipment. It does not include passengers, cargo, or optional equipment.

Vehicle Curb Weight is the weight of your new vehicle when you picked it up from your dealer plus any aftermarket equipment.

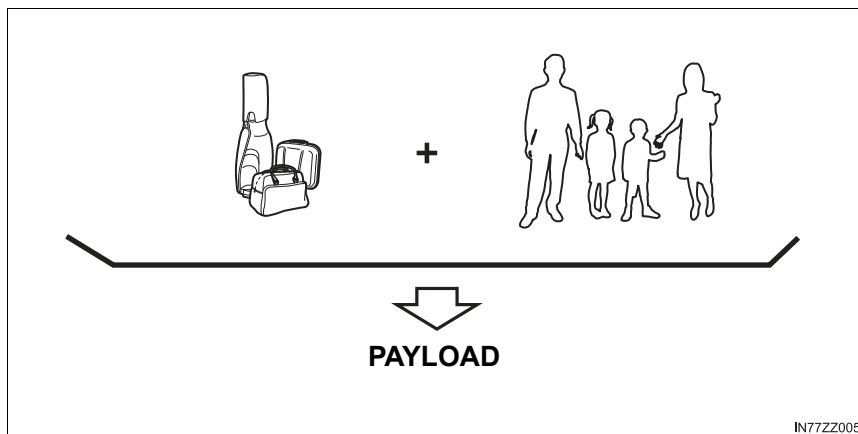

Payload is the combination weight of cargo and passengers that the vehicle is designed to carry. The maximum payload for your vehicle can be found on the Tire and Load Information label on the driver's door frame or door pillar. Look for "THE COMBINATION WEIGHT OF OCCUPANTS AND CARGO SHOULD NEVER EXCEED XXX kg or XXX lb." for your maximum payload. The payload listed on the tire label is the maximum payload for the vehicle as built by the assembly plant. If any aftermarket or dealer installed equipment has been installed on the vehicle, the weight of the equipment must be subtracted from the payload listed on the tire label in order to be accurate.

SAMPLE

TIRE AND LOADING INFORMATION
RENSEIGNEMENTS SUR LES PNEUS ET LE CHARGEMENT

SEATING CAPACITY | TOTAL X | FRONT X | REAR X
 NOMBRE DE PLACES | TOTAL X | AVANT X | ARRIÈRE X

The combined weight of occupants and cargo should never exceed **XXX** kg or **XXX** lbs.*
 Le poids total des occupants et du chargement ne doit jamais dépasser **XXX** kg ou **XXX** lb.*

TIRE PNEU	SIZE DIMENSIONS	COLD TIRE PRESSURE PRESSION DES PNEUS À FROID	SEE OWNER'S MANUAL FOR ADDITIONAL INFORMATION
FRONT AVANT	XXXX/XXXXX	XXX kPa, XX psi	VOIR LE MANUEL DE L'USAGER POUR PLUS DE RENSEIGNEMENTS
REAR ARRIÈRE	XXXX/XXXXX	XXX kPa, XX psi	
SPARE DE SECOURS	XXXX/XXXXX	XXX kPa, XX psi	

(XXX)

IN77ZZ002a

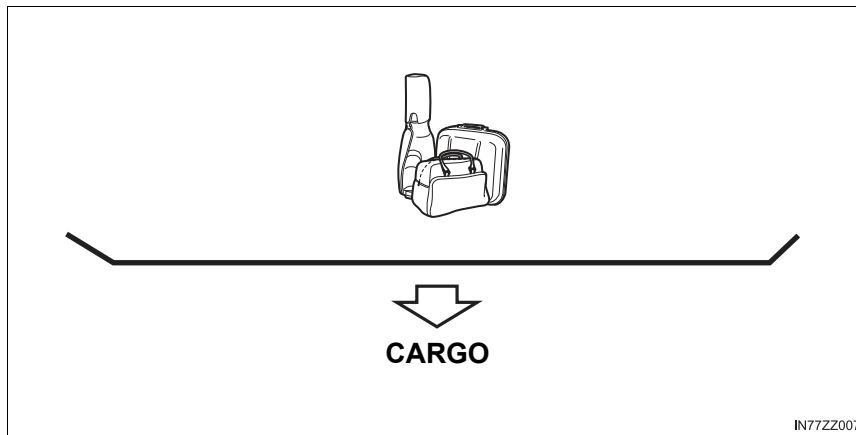

Cargo Weight includes all weight added to the Base Curb Weight, including cargo and optional equipment.

The cargo weight limit decreases depending on the number of vehicle occupants. The cargo weight limit can be calculated by subtracting the total weight of the vehicle occupants from the “combination weight of occupants and cargo should never exceed” value on the tire label.

Examples: Based on a single occupant weight of 150 lb. (68 kg), and a value of 849 lb. (385 kg) for the “combination weight of occupants and cargo should never exceed”:

The cargo weight limit with one occupant is 849 lb. (385 kg) - 150 lb. (68 kg) = 699 lb. (317 kg)

The cargo weight limit with two occupants is 849 lb. (385 kg) - (150 x 2) lb. ((68 x 2) kg) = 549 lb. (249 kg)

If the weight of the occupant increases, the cargo weight limit decreases by that much.

GAW (Gross Axle Weight) is the total weight placed on each axle (front and rear) - including vehicle curb weight and all payload.

GAWR (Gross Axle Weight Rating) is the maximum allowable weight that can be carried by a single axle (front or rear). These numbers are shown on the Safety Compliance Certification Label located on the driver’s door frame or door pillar. The total load on each axle must never exceed its GAWR.

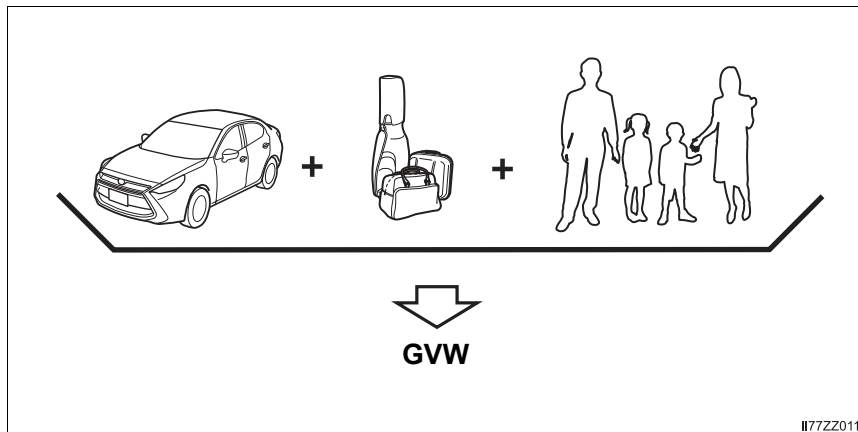

GVW (Gross Vehicle Weight) is the Vehicle Curb Weight + cargo + passengers.

GVWR (Gross Vehicle Weight Rating) is the maximum allowable weight of the fully loaded vehicle (including all options, equipment, passengers and cargo). The GVWR is shown on the Safety Compliance Certification Label located on the driver’s door frame or door pillar. The GVW must never exceed the GVWR.

GCWR (Gross Combination Weight Rating) is the maximum allowable weight of the vehicle - including all cargo and passengers - that the vehicle can handle without risking damage. The GCW must never exceed the GCWR.

 **WARNING**

■ **Do not tow a trailer with this vehicle**

Towing a trailer with this vehicle is dangerous because it has not been designed to tow a trailer and doing so will affect the drive system which could result in vehicle damage.

■ **Overloaded Vehicle**

Overloading a vehicle is dangerous. The results of overloading can have serious consequences in terms of passenger safety. Too much weight on a vehicle's suspension system can cause spring or shock absorber failure, brake failure, handling or steering problems, irregular tire wear, tire failure or other damage.

Overloading makes a vehicle harder to drive and control. It also increases the distance required for stopping. In cases of serious overloading, brakes can fail completely, particularly on steep grades. The load a tire will carry safely is a combination of the size of the tire, its load range, and corresponding inflation pressure.

Never overload the vehicle and always observe the vehicle's weight ratings from the vehicle's Safety Certification and Tire and Load Information labels.

■ **Never Exceed Axle Weight Rating Limits**

Exceeding the Safety Certification Label axle weight rating limits is dangerous and could result in death or serious injury as a result of standard vehicle handling, performance, engine, transmission and/or structural damage, serious damage to the vehicle, or loss of control.

Always keep the vehicle within the axle weight rating limits.

■ **Never Exceed GVWR or GAWR Specifications**

Exceeding the GVWR or the GAWR specified on the certification label is dangerous. Exceeding any vehicle rating limitation could result in a serious accident, injury, or damage to the vehicle.

Do not use replacement tires with lower load carrying capacities than the originals because they may lower the vehicle's GVWR and GAWR limitations. Replacement tires with a higher limit than the originals do not increase the GVWR and GAWR limitations. Never exceed the GVWR or the GAWR specified on the certification label.

Steps for Determining the Correct Load Limit

Steps for Determining Correct Load Limit-

- (1) Locate the statement "The combined weight of occupants and cargo should never exceed XXX kg or XXX lbs." on your vehicle's placard.
- (2) Determine the combined weight of the driver and passengers that will be riding in your vehicle.
- (3) Subtract the combined weight of the driver and passengers from XXX kg or XXX lbs.
- (4) The resulting figure equals the available amount of cargo and luggage load capacity. For example, if the "XXX" amount equals 1400 lbs. and there will be five 150 lb passengers in your vehicle, the amount of available cargo and luggage load capacity is 650 lbs. (1400 - 750 (5 x 150) = 650 lbs.)
- (5) Determine the combined weight of luggage and cargo being loaded on the vehicle. That weight may not safely exceed the available cargo and luggage load capacity calculated in Step 4.
- (6) If your vehicle will be towing a trailer, load from your trailer will be transferred to your vehicle. Consult this manual to determine how this reduces the available cargo and luggage load capacity of your vehicle.

Declaration of Conformity

Keyless Entry System/Immobilizer System

FCC CAUTION

Changes or modifications not expressly approved by the party responsible for compliance could void the user's authority to operate the equipment.

FCC/ISED

This device complies with part 15 of FCC Rules and Innovation, Science and Economic Development Canada's licence-exempt RSS(s). Operation is subject to the following two conditions: (1) this device may not cause harmful interference, and (2) this device must accept any interference received, including interference that may cause undesired operation. Le présent appareil est conforme à la partie 15 des règles de la FCC et aux normes des CNR d'Innovation, Sciences et Développement économique Canada applicables aux appareils radio exempts de licence. L'exploitation est autorisée aux deux conditions suivantes : (1) l'appareil ne doit pas produire de brouillage, et (2) l'appareil doit accepter tout brouillage subi, même si le brouillage est susceptible d'en compromettre le fonctionnement.

Audio System

Type A (non-touchscreen)

(U.S.A. and Canada)

FCC ID: NT8MBLUEC09

FCC

This device complies with part 15 of the FCC Rules. Operation is subject to the following two conditions:

- (1) This device may not cause harmful interference, and
- (2) This device must accept any interference received, including interference that may cause undesired operation.

Caution:

Changes or modifications not expressly approved by the party responsible for compliance could void the user's authority to operate the equipment.

IC: 3043A-MBLUEC09

ISED CANADA

This device complies with Industry Canada license-exempt RSS standard(s). Operation is subject to the following two conditions:

- (1) This device may not cause harmful interference, and
- (2) This device must accept any interference received, including interference that may cause undesired operation.

Le présent appareil est conforme aux CNR d'Industrie Canada applicables aux appareils radio exempts de licence.

L'exploitation est autorisée aux deux conditions suivantes :

- (1) l'appareil ne doit pas produire de brouillage, et
- (2) l'utilisateur de l'appareil doit accepter tout brouillage radioélectrique subi, même si le brouillage est susceptible d'en compromettre le fonctionnement.

Mazda Audio System Customer Service

* U.S.A.

Phone: 800-430-0153 (Toll-free)

Web: www.mazdausa.com/mazdaconnect

* Canada

Phone: 800-430-0153 (Toll-free)

Web: www.mazdahandsfree.ca

Type B (touchscreen)

(U.S.A. and Canada)

FCC ID: NT862932

FCC

This device complies with part 15 of the FCC Rules. Operation is subject to the following two conditions:

- (1) This device may not cause harmful interference, and
- (2) This device must accept any interference received, including interference that may cause undesired operation.

Caution:

Changes or modifications not expressly approved by the party responsible for compliance could void the user's authority to operate the equipment.

IC: 3043A-62932

ISED CANADA

This device complies with Industry Canada license-exempt RSS standard(s). Operation is subject to the following two conditions:

- (1) This device may not cause harmful interference, and
- (2) This device must accept any interference received, including interference that may cause undesired operation.

Le présent appareil est conforme aux CNR d'Industrie Canada applicables aux appareils radio exempts de licence.

L'exploitation est autorisée aux deux conditions suivantes :

- (1) l'appareil ne doit pas produire de brouillage, et
- (2) l'utilisateur de l'appareil doit accepter tout brouillage radioélectrique subi, même si le brouillage est susceptible d'en compromettre le fonctionnement.

Mazda Audio System Customer Service

• U.S.A.

Phone: 800-430-0153 (Toll-free)

Web: www.mazdausa.com/mazdaconnect

• Canada

Phone: 800-430-0153 (Toll-free)

Web: www.mazdahandsfree.ca

Model: MAZDA_GEN_65_CMU
 Brand: Visteon
 Manufacturer: Visteon Corporation
 Address: One Village Center, Van Buren Township
 48111-5711 Michigan, United States of America
 FCC ID: NT862932 IC: 3043A-62932

FCC/IC Regulatory Notice

Modification statement

Visteon Corporation has not approved any changes or modifications to this device by the user. Any changes or modifications could void the user's authority to operate the equipment.

Visteon Corporation n'approuve aucune modification apportée à l'appareil par l'utilisateur, quelle qu'en soit la nature. Tout changement ou modification peuvent annuler le droit d'utilisation de l'appareil par l'utilisateur.

Interference statement

This device complies with Part 15 of the FCC Rules and Industry Canada licence-exempt RSS standard(s). Operation is subject to the following two conditions: (1) this device may not cause interference, and (2) this device must accept any interference, including interference that may cause undesired operation of the device.

Le présent appareil est conforme aux CNR d'Industrie Canada applicables aux appareils radio exempts de licence. L'exploitation est autorisée aux deux conditions suivantes : (1) l'appareil ne doit pas produire de brouillage, et (2) l'utilisateur de l'appareil doit accepter tout brouillage radioélectrique subi, même si le brouillage est susceptible d'en compromettre le fonctionnement.

Radiation Exposure Statement

This device complies with FCC/IC radiation exposure limits set forth for an uncontrolled environment and meets the FCC radio frequency (RF) Exposure Guidelines in Supplement C to OET65 and RSS-102 of the IC radio frequency (RF) Exposure rules. The antenna should be installed and operated with minimum distance of 20 cm between the radiator and your body. This transmitter must not be co-located or operating in conjunction with any other antenna or transmitter.

Le présent appareil est conforme à l'exposition aux radiations FCC / IC définies pour un environnement non contrôlé et répond aux directives d'exposition de la fréquence de la FCC radiofréquence (RF) dans le Supplément C à OET65 et RSS-102 de la fréquence radio (RF) IC règles d'exposition. L'antenne doit être installée de façon à garder une distance minimale de 20 centimètres entre la source de rayonnements et votre corps. L'émetteur ne doit pas être colocalisé ni fonctionner conjointement avec à autre antenne ou autre émetteur.

Specifications

8

- 8-1. Identification Numbers**
 - Vehicle Information
 - Labels 546
- 8-2. Specifications**
 - Specifications 548
- 8-3. Customizable Features**
 - Customizable
 - Features 555

Vehicle Information Labels

Vehicle Identification Number

The vehicle identification number legally identifies your vehicle. The number is on a plate attached to the cowl panel located on the left corner of the dashboard. This plate can easily be seen through the windshield.

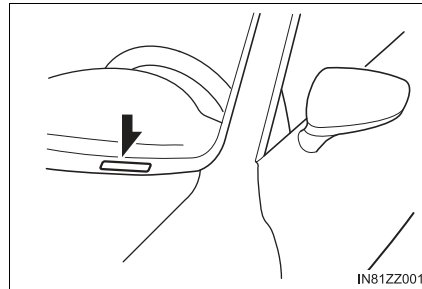

Motor Vehicle Safety Standard Label

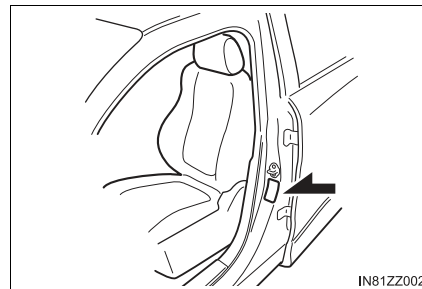

Chassis Number

Open the cover shown in the figure to check the chassis number.

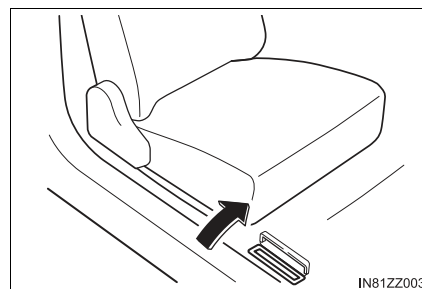

Vehicle Emission Control Information Label

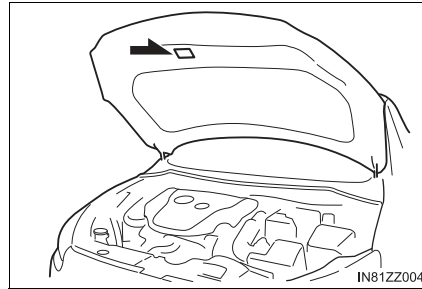

Tire Pressure Label

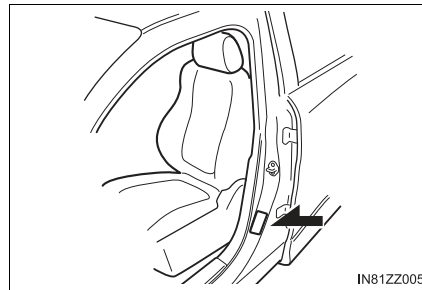

Engine Number

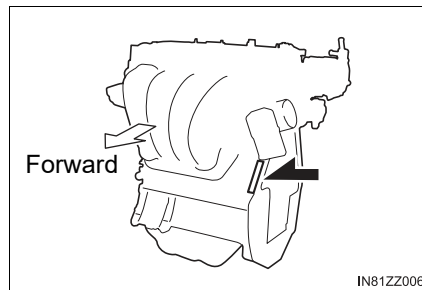

Specifications

Specifications

Engine

Item	Specification
Type	DOHC-16V in-line, 4-cylinder
Bore × Stroke	2.93 × 3.38 in. (74.5 × 85.8 mm)
Displacement	1,496.1 ml (1,496.1 cc)
Compression ratio	12.0

Electrical System

Item	Classification	
Battery	12V-60Ah/20HR	
Spark-plug number	spark plug required*	P51R-18-110

*: The spark plugs provide the engine its optimum performance. Consult your Toyota dealer for details.

NOTICE

When cleaning the iridium plugs, do not use a wire brush. The fine particulate coating on the iridium alloy and platinum tips could be damaged.

Lubricant Quality

Item	Classification	
Engine oil	Refer to Recommended Oil on P. 395.	
Coolant	FL-22 type	
Manual transaxle oil	API Service	GL-4
	SAE	75W-80
Automatic transaxle fluid	ATF required	
Brake/Clutch fluid	SAE J1703 or FMVSS116 DOT-3	

Refer to Introduction on P. 386 for owner's responsibility in protecting your investment.

Capacities

Approximate Quantities:

Item		Capacity
Engine oil	With oil filter replacement	4.4 qt. (4.2 L, 3.7 Imp.qt.)
	Without oil filter replacement	4.1 qt. (3.9 L, 3.4 Imp.qt.)
Coolant	Manual transaxle	5.6 qt. (5.3 L, 4.7 Imp.qt.)
	Automatic transaxle	5.8 qt. (5.5 L, 4.8 Imp.qt.)
Manual transaxle oil		1.68 qt. (1.59 L, 1.40 Imp.qt.)
Automatic transaxle fluid		7.6 qt. (7.2 L, 6.3 Imp.qt.)
Fuel tank		11.6 gal. (44.0 L, 9.68 Imp.gal.)

Check oil and fluid levels with dipsticks or reservoir gauges.

Dimensions

► 4-Door

Item	Vehicle specification
Overall length	171.9 in. (4,365 mm)
Overall width	66.7 in. (1,695 mm)
Overall height	58.3 in. (1,480 mm)
Front tread	58.8 in. (1,493 mm)
Rear tread	58.4 in. (1,483 mm)
Wheelbase	101.2 in. (2,571 mm)

► 5-Door

Item	Vehicle specification	
Overall length	159.8 in. (4,060 mm)	
Overall width	66.7 in. (1,695 mm)	
Overall height*	Type A	59.7 in. (1,515 mm)
	Type B	58.9 in. (1,495 mm)
Front tread	58.8 in. (1,493 mm)	
Rear tread	58.4 in. (1,483 mm)	
Wheelbase	101.2 in. (2,571 mm)	

*: The overall height is categorized according to the antenna type as follows:

Type A:

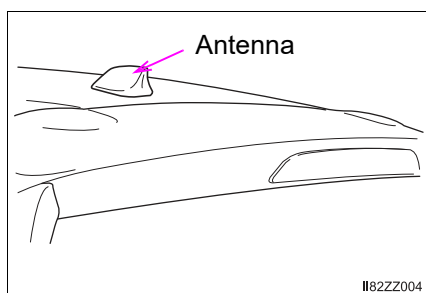

Type B:

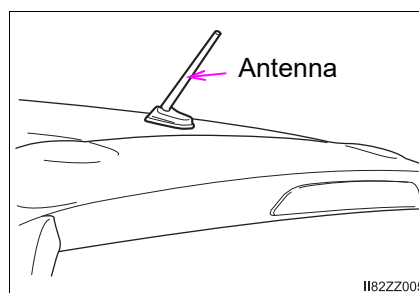

Weights

► 4-Door

Item		Weight	
		Manual transaxle	Automatic transaxle
GVWR (Gross Vehicle Weight Rating)		3,344 lb. (1,517 kg)	3,393 lb. (1,539 kg)
GAWR (Gross Axle Weight Rating)	Front	1,753 lb. (795 kg)	1,795 lb. (814 kg)
	Rear	1,638 lb. (743 kg)	1,627 lb. (738 kg)

► 5-Door

Item		Weight	
		Manual transaxle	Automatic transaxle
GVWR (Gross Vehicle Weight Rating)		3,314 lb. (1,503 kg)	3,360 lb. (1,524 kg)
GAWR (Gross Axle Weight Rating)	Front	1,733 lb. (786 kg)	1,786 lb. (810 kg)
	Rear	1,585 lb. (719 kg)	1,581 lb. (717 kg)

Air Conditioner

The type of refrigerant used is indicated on a label attached to the inside of the engine compartment. Check the label before recharging the refrigerant. Refer to Climate Control System on P. 256.

Item	Specification
Refrigerant Type	HFC134a (R-134a)

Light Bulbs

■ Exterior light

Light bulb		Category		
		Wattage	UN-R* ¹ (SAE)	
Headlights	Halogen headlights	High/Low beam	60/55	H4 (H4)
	LED headlights	High beam	LED* ²	— (—)
Low beam				
Daytime running lights	With halogen bulb headlights		60/55* ³	H4 (H4)
	With LED headlights		LED* ²	— (—)
Front side-marker lights			5	WY5W (—)
Front turn signal lights/Parking lights			28/8	— (7444NA)
Fog lights (if equipped)			55	H11 (H11)
Side turn signal lights (if equipped)			LED* ²	— (—)
High-mount brake light			LED* ²	— (—)
Rear turn signal lights			21	WY21W (7443NA)
Brake lights/Taillights/Rear side-marker lights (4-Door)			21/5	W21/5W (7443)
Brake lights/Taillights (5 Door)			21/5	W21/5W (7443)
Rear side-marker lights (5-Door)			5	W5W (—)
Reverse lights			18	W16W (921)
License plate lights			5	W5W (—)

*1: UN-R stands for United Nations Regulation.

*2: LED is the abbreviation for Light Emitting Diode.

*3: Double-filament light bulb, however, only 60 W filament bulb is used in the daytime running lights.

■ Interior light

Light bulb	Category	
	Wattage	UN-R* ¹
Trunk light (4-Door)	3	—
Luggage compartment light (5-Door)	5	—
Overhead lights/Map lights	8	—

*¹: UN-R stands for United Nations Regulation.

Tires

Check the tire pressure label for tire size and inflation pressure.

Refer to Tire Pressure Label on P. 547.

Refer to Tire Inflation Pressure on P. 413.

After adjusting the tire pressure, initialization of the tire pressure monitoring system is necessary to make the system operates normally.

Refer to Tire Pressure Monitoring System Initialization on P. 244.

■ Standard tire

Tire size	Inflation pressure	
	Front	Rear
P185/65R15 86H	255 kPa (37 psi)	230 kPa (33 psi)
P185/60R16 86H	250 kPa (36 psi)	230 kPa (33 psi)

■ Temporary spare tire

Tire size	Inflation pressure
T125/70D15 95M	420 kPa (60 psi)

■ **Lug nut tightening torque**

When installing a tire, tighten the lug nut to the following torque.
80-108 ft•lbf (108-147 N•m, 12-14 kgf•m)

The tires have been optimally matched with the chassis of your vehicle.
When replacing tires, Toyota recommends that you replace tires of the same type originally fitted to your vehicle. For details, contact your Toyota dealer.

Fuses

Refer to Fuses on P. 435.

Customizable Features

The following customizable features can be set or changed by your Toyota dealer. Consult your Toyota dealer for details.

Additionally, some of the customizable features can be changed by the customer depending on the feature.

Customizable features which can be changed differ depending on the market and specification.

Settings Change Method

- ① Settings can be changed by operating the center display screen.
A: Refer to Settings on P. 300.
B: Refer to Fuel Economy Monitor on P. 221.
- ② Settings can be changed by operating the vehicle switches.
C: Refer to Stopping The Low Speed Pre-Collision System Operation on P. 233.
D: Refer to Auto Lock/Unlock Function on P. 108.
E: Refer to Smart Key on P. 93.
F: Refer to Locking, Unlocking with Request Switch (With the advanced keyless function) on P. 103.
- ③ Settings can be changed by your Toyota dealer.

■ **Safety**

- Low Speed Pre-Collision System (→P. 228)

Feature	Factory Setting	Available Settings	Settings Change Method		
			①	②	③
The system can be changed so that Low Speed Pre-Collision System does not operate.*	On	On	A	C	-
		Off			

*: Though these systems can be turned Off, doing so will defeat the purpose of the system and Toyota recommends that these systems remain On.

8 Specifications

■ Vehicle

● Power Door locks (→P. 108)

Feature	Factory Setting	Available Settings	Settings Change Method		
			①	②	③
Changes the auto lock/unlock function setting for all the doors according to the vehicle speed, the vehicle power supply condition, and the selector lever position.	Lock: When Driving/ Unlock: IGN Off	Lock: Out of Park/Unlock: In Park	A	D	×
		Lock: Shifting Out of Park			
		Lock: When Driving/ Unlock: In Park			
		Lock: When Driving/ Unlock: IGN Off			
		Lock: When Driving			
		Off			

● Keyless entry system (→P. 92)

Feature	Factory Setting	Available Settings	Settings Change Method		
			①	②	③
The method for unlocking the doors using the smart key can be changed.	Driver's: Once/All Doors: Twice	All Doors: Once	A	E	×
		Driver's: Once/All Doors: Twice			
The time required for the doors to relock automatically after unlocking with the smart key can be changed.	60 seconds	90 seconds	A	-	×
		60 seconds			
		30 seconds			

● Advanced keyless entry system (→P. 99)

Feature	Factory Setting	Available Settings	Settings Change Method		
			①	②	③
The method for unlocking the doors using the request switch/transmitter can be changed.	Driver's: Once/ All Doors: Twice	All Doors: Once	A	E/F	×
		Driver's: Once/ All Doors: Twice			
The volume of the answer-back beep during advanced keyless entry system operation can be changed.	Medium	High	A	F	×
		Medium			
		Low			
		Off			
The function to automatically lock the doors when leaving the vehicle while carrying the key can be changed.	Off	On	A	-	×
		Off			
The time required for the doors to relock automatically after unlocking with the request switch/transmitter can be changed.	60 seconds	90 seconds	A	-	×
		60 seconds			
		30 seconds			

● Illuminated entry system (→P. 377)

Feature	Factory Setting	Available Settings	Settings Change Method		
			①	②	③
Time until interior lights turn off after closing door	15 seconds	60 seconds	A	-	×
		30 seconds			
		15 seconds			
		7.5 seconds			
Time until interior lights turn off automatically when any door is not closed completely	30 minutes	60 minutes	A	-	×
		30 minutes			
		10 minutes			

● Auto-wiper control (→P. 201)

Feature	Factory Setting	Available Settings	Settings Change Method		
			①	②	③
Operational/ non-operational	On	On	A	-	x
		Off*			

*: If the auto-wiper control is set to Off, the wiper lever **AUTO** position is set to intermittent operation.

● Daytime running lights (→P. 197)

Feature	Factory Setting	Available Settings	Settings Change Method		
			①	②	③
Operational/non-operational	On	On	A	-	x
		Off			

● Auto-light control (→P. 192)

Feature	Factory Setting	Available Settings	Settings Change Method		
			①	②	③
Timing by which lights turn on	Medium	High	A	-	x
		Med.High			
		Medium			
		Med.Low			
		Low			

● Auto headlight off (→P. 192)

Feature	Factory Setting	Available Settings	Settings Change Method		
			①	②	③
Time until headlights turn off	30 seconds	120 seconds	A	-	x
		90 seconds			
		60 seconds			
		30 seconds			
		Off*			

*: When set to Off, the lights-on reminder is operable.

● Lights-on reminder* (→P. 502)

Feature	Factory Setting	Available Settings	Settings Change Method		
			①	②	③
Warning beep volume	High	High	A	-	x
		Low			
		Off			

*: The setting of the lights-on reminder can be changed with the time setting of auto headlight off function set to Off. Refer to Lights-On Reminder on P. 502.

● Turn indicator (→P. 199)

Feature	Factory Setting	Available Settings	Settings Change Method		
			①	②	③
Beep volume	High	High	A	-	x
		Low			

● Three-flash turn signal (→P. 200)

Feature	Factory Setting	Available Settings	Settings Change Method		
			①	②	③
Operational/non-operational	On	On	A	-	x
		Off			

■ System

● Language

Feature	Factory Setting	Available Settings	Settings Change Method		
			①	②	③
Language indicated in display	US English	Depends on market*	A	–	×

*: Available only in display from the center display.

● Temperature unit

Feature	Factory Setting	Available Settings	Settings Change Method		
			①	②	③
Temperature unit indicated in display	°F or °C	°F	A	–	×
		°C			

● Distance unit

Feature	Factory Setting	Available Settings	Settings Change Method		
			①	②	③
Distance unit indicated in display	miles or km	miles	A	–	×
		km			

■ Fuel Economy Monitor (→P. 221)

● Ending display

Feature	Factory Setting	Available Settings	Settings Change Method		
			①	②	③
On/off	Off	On	B	–	×
		Off			

● Fuel economy resetting procedure

Feature	Factory Setting	Available Settings	Settings Change Method		
			①	②	③
Linkage/non-linkage with fuel economy reset and trip meter reset	Off	On	B	-	x
		Off			



Index	563
Alphabetical index	564

Alphabetical index

A

Accessory Socket	378
Active Safety System	227
Laser Sensor	234
Low Speed Pre-Collision System	228
Pre-Crash Safety Technology.....	227
Add-On Non-Genuine Parts and Accessories	514
Advanced Key	
Advanced keyless entry system.....	99
Operational range.....	100
Advanced Keyless Entry System	99
Air Bag/Front Seat Belt Pretensioner System	
Warning Beep	502
Air Bag Systems	66
Ambient Temperature Display	170
Antilock Brake System (ABS)	215
Audio Control Switch	
Adjusting the Volume.....	304
Seek Switch.....	305
Audio System	271
Antenna	271
Audio Control Switch	304
Audio Set	283
AUX/USB mode.....	307
Operating Tips for Audio System	273

Automatic Transaxle..... 181

Active Adaptive Shift (AAS).....	184
Driving tips.....	191
Manual shift mode	185
Shift-lock override.....	185
Shift-lock system	184
Shift position indication.....	182
Transaxle ranges.....	182
Warning light.....	182

B

Battery 408

Maintenance	409
Replacement	409
Specifications	548
Battery runs out	478
Jump-Starting	478

Beep Sounds

Key left-in-trunk compartment warning.....	504
Key left-in-vehicle warning.....	505
Request switch inoperable warning.....	504

Bluetooth® 327

Bluetooth® Audio	353
Bluetooth® Hands-Free	339
Troubleshooting.....	366

Body Lubrication..... 403

Bottle Holder..... 380

Brakes

Brake assist.....	212
Foot brake	209
Pad wear indicator.....	211
Parking brake	210
Warning light.....	211

Break-In Period..... 141

C

Capacities..... 549
Carbon Monoxide 123
Cargo Sub-Compartment..... 383
Cell Phones 515
Child Restraint
 Child-restraint precautions 44
 Child-restraint system
 installation 49
 Installing child-restraint
 systems 51
 LATCH child-restraint
 systems 61
Child Safety Locks for Rear
Doors..... 112
Climate Control System 256
 Fully automatic type 266
 Gas specifications 551
 Manual Type 259
 Operating Tips 256
 Vent Operation 257
Collision warning..... 505
Combination Meter 164
Cruise Control..... 236
 Cruise Control Switch 236
 Cruise Main Indicator
 Light (Amber)/Cruise Set
 Indicator Light (Green) 237
Cup Holder 379
Customizable Features 555

D

Dashboard Illumination..... 169
Daytime Running Lights 197
Defogger
 Mirror 207
 Rear window 207
Dimensions 550
Door Locks..... 101

Drive selection..... 224
Driving In Flooded Area..... 149
Driving Tips
 Automatic transaxle 191
 Break-in period 141
 Driving in flooded area 149
 Driving on uneven road 151
 Floor mat 144
 Hazardous driving 143
 Overloading 150
 Rocking the vehicle 145
 Saving fuel and protection
 of the environment 142
 Winter driving 146
Driving on Uneven Road..... 151
Dynamic Stability Control
(DSC) 218
 DSC OFF Indicator Light 219
 DSC OFF Switch 219
 TCS/DSC Indicator Light 219

E

Emergency Starting
 Push-Starting 483
 Starting a Flooded Engine 482
Emergency Towing
 Tiedown Hooks 487
 Towing Description 486
Emission Control System..... 122
Ending Display 222
Engine
 Coolant 398
 Engine Compartment
 Overview 394
 Exhaust gas 123
 Hood release 392
 Oil 395
Essential information..... 386
Event Data Recorder 516

Exhaust Gas 123
Exterior Care 442
 Aluminum Wheel
 Maintenance 448
 Bright-Metal Maintenance 447
 Maintaining the Finish 444
 Plastic Part Maintenance 449

F

Flasher
 Hazard warning 208
 Headlights 192
Flat Tire 457
 Mounting the Spare Tire 470
 Removing a Flat Tire 465
Floor Mat 144
Fluid
 Brake/Clutch 401
 Washer 402
Fluids
 Classification 549
Fog Lights 198
Foot Brake 209
Front Seat 23
Fuel
 Filler lid and cap 124
 Gauge 168
 Requirements 121
 Tank capacity 549
Fuel Consumption Display 222
Fuel Economy Monitor 221
 Ending display 222
 Fuel consumption display 222
Fuses 435
 Panel description 438
 Replacement 435

G

Gauges 164
Glove Compartment 382

H

Hazard Warning Flasher 208
Hazardous Driving 143
Head Restraint 30
Headlights
 Control 192
 Flashing 196
 High-low beam 196
 Leveling 197
Hill Launch Assist (HLA) 213
Hood Release 392
Horn 128

I

If a Warning Light Turns On or Flashes 489
Ignition
 Switch 156
Ignition not switched off (STOP) warning beep 504
Illuminated Entry System 377
Immobilizer System 136
Indicator Lights 174
 Low engine coolant temperature 176
 Wrench 175
Inside Trunk Release Lever 119
Inspecting Brake/Clutch Fluid Level 401
Inspecting Coolant Level 398
Inspecting Engine Oil Level ... 397
Inspecting Washer Fluid Level 402

Interior Care 450
 Cleaning the Lap/Shoulder
 Belt Webbing 453
 Cleaning the Upholstery and
 Interior Trim 451
 Cleaning the Window
 Interiors 453
 Dashboard Precautions 450
Interior Lights 375
 Map Lights 375
 Overhead Lights 375
 Trunk Light 376

J

Jack 459
Jump-Starting 478

K

**Key Left-in-trunk Compartment
 Warning Beep (With the
 advanced keyless
 function) 504**
**Key Left-in-vehicle Warning
 Beep (With the advanced
 keyless function) 505**
**Key removed from vehicle
 warning beep 504**
Key Suspend Function 98
Keyless Entry System 92
Keys 90
 Key suspend function 98
 Smart Key 93

L

Label Information 546
Lane-Change Signals 199
Laser Sensor 234
Light Bulbs
 Replacement 419
 Specifications 552

Lighting Control 192
Lights-on reminder 502
**Low Speed Pre-Collision
 System 228**
Lubricant Quality 549

M

Maintenance
 Information 386
Maintenance Monitor 388
Manual Transaxle
Operation 177
 Recommendations for
 shifting 179
Map Lights 375
**Message Indicated on
 Display 500**
Meters and Gauges 164
Mirror Defogger 207
Mirrors
 Outside Mirrors 129
 Rearview Mirror 130

O

Odometer and Trip
Meter 165
Outside Mirrors 129
Outside Temperature
Display 170
Overhead Console 381
Overhead Lights 375
Overheating 484
Overloading 150
Owner Maintenance
 Closing the Hood 393
 Engine Compartment
 Overview 394
 Key battery replacement 410
 Opening the Hood 392
 Owner Maintenance
 Precautions 390

P

Parking Brake	210
Power Steering	226
Power Windows	132
Power steering warning buzzer	505

R

Rear Coat Hooks	383
Rear Door Child Safety Locks	112
Rear Seat	26
Rear View Monitor	245
Displayable range on the screen.....	247
Picture quality adjustment.....	254
Rear view monitor operation	250
Rear view parking camera location	246
Switching to the rear view monitor display	246
Variance between actual road conditions and displayed Image	252
Viewing the display	249
Rear Window Defogger	207
Rearview Mirror	130
Recommended Oil	395
Recreational Towing	153
Replacement	
Fuse.....	435
Key battery.....	410
Light Bulbs	419
Tires.....	416
Wheel.....	417
Wiper	405
Request Switch Inoperable Warning Beep (With the advanced keyless function)	504
Rocking the Vehicle	145

S

Safety Defects, Reporting	510
Saving Fuel and Protection of the Environment	142
Seat Belt System	
Automatic locking	36
Emergency locking	36
Extender	42
Pregnant women	35
Seat belt precautions.....	33
Seat belt warning beep	503
Seats	
Front seat	23
Head restraint.....	30
Rear seat	26
Seat warmer	24
Security System	
Immobilizer system.....	136
Theft Deterrent system.....	138
Smart key	93
Spare Tire	461
Specifications	548
Speedometer	164
SRS Air Bags	
Front passenger occupant classification system	82
How the SRS air bags work.....	74
Limitations to SRS air bag	80
Monitoring	87
SRS air bag deployment criteria	78
Supplemental restraint system components	73

Starting the Engine..... 158
Steering Wheel..... 127
 Horn 128
Storage Compartments..... 381
 Cargo Sub-Compartment..... 383
 Glove compartment 382
 Overhead Console..... 381
 Rear coat hooks..... 383
Sunvisors 374

T

Tachometer 167
Theft Deterrent System 138
Tiedown
 Hook 487
Tire Information 522
Tire Pressure Monitoring System 241
Tire inflation pressure warning beep 505
Tires 413
 Flat Tire..... 457
 Replacing a Tire..... 416
 Replacing a Wheel..... 417
 Snow tires 147
 Specifications..... 553
 Temporary Spare Tire..... 417
 Tire Inflation Pressure..... 413
 Tire Rotation 414
 Tire chains 147
 Uniform tire quality grading system (UTQGS)..... 519
Towing
 Recreational towing 153
 Trailer Towing 152
Towing Description 486
Traction Control System (TCS)..... 216
 TCS/DSC Indicator Light 217
Trip Computer..... 171
Trip Meter 165

Trouble
 Battery runs out 478
 Emergency Starting 482
 Emergency Towing 486
 Flat Tire 457
 Overheating 484
 Parking in an Emergency 456
 When Trunk Lid Cannot be Opened 506
Trunk Lid 113
 Inside Trunk Release Lever 119
 When Trunk Lid Cannot be Opened 506
Trunk Light..... 376
Turn Signals..... 199

V

Vanity Mirrors 374
Vehicle Data Recordings 518
Vehicle Information Labels..... 546

W

Warning Lights	173
Warning Sound is Activated	
Air Bag/Front Seat Belt Pretensioner System Warning Beep.....	502
Collision warning.....	505
Ignition not switched off (STOP) warning beep.....	504
Key Left-in-trunk Compartment Warning Beep (With the advanced keyless function).....	504
Key Left-in-vehicle Warning Beep (With the advanced keyless function).....	505
Key removed from vehicle warning beep.....	504
Lights-on reminder.....	502
Power steering warning buzzer.....	505
Request Switch Inoperable Warning Beep (With the advanced keyless function).....	504
Seat belt warning beep	503
Tire inflation pressure warning beep.....	505
Warranty	512
Weights.....	551
Windows	
Power windows.....	132
Windshield Washer	205
Windshield Wipers	202
Winter Driving.....	146
Wiper	
Replacing Windshield Wiper Blades	405



