

**2015
Venza
Quick Reference Guide**

2015 Venza

This *Quick Reference Guide* is a summary of basic vehicle operations. It contains brief descriptions of fundamental operations so you can locate and use the vehicle's main equipment quickly and easily.

The *Quick Reference Guide* is not intended as a substitute for the *Owner's Manual* located in your vehicle's glove box. We strongly encourage you to review the *Owner's Manual* and supplementary manuals so you will have a better understanding of your vehicle's capabilities and limitations.

Your dealership and the entire staff of Toyota Motor Sales, U.S.A., Inc. wish you many years of satisfied driving in your new Venza.

A word about safe vehicle operations

This *Quick Reference Guide* is not a full description of Venza operations. Every Venza owner should review the *Owner's Manual* that accompanies this vehicle.

Pay special attention to the boxed information highlighted in color throughout the *Owner's Manual*. Each box contains safe operating instructions to help you avoid injury or equipment malfunction.

All information in this *Quick Reference Guide* is current at the time of printing. Toyota reserves the right to make changes at any time without notice.

INDEX

OVERVIEW

Engine maintenance	9
Fuel tank door release and cap	8
Hood release	8
Indicator symbols	4-5
Instrument cluster	4
Instrument panel	2-3
Keyless entry^{1,2}	6
Light control-Instrument panel	8
Smart Key system^{1,2}	7

FEATURES/OPERATIONS

Air Conditioning/Heating	16
Audio	18-19
Auto lock/unlock¹	11
Automatic Transmission	10
Bluetooth® Device Pairing for Android	30
Bluetooth® Device Pairing for iPhone	33
Bluetooth® Device Pairing for Windows Phone	36
Cruise control	20
Customizable features	23
Door Power back (liftgate)	23
Enhanced VSC OFF button	17
Garage door opener (HomeLink®) ³	21
Hill-start Assist Control (HAC)	20
Lights^{1,2} & turn signals	14-15
Moonroof	13
Multi-Information Display (clock)²	22
Parking brake	10
Power outlets-12V DC	17
Seat adjustments-Front	11
Seat adjustments-Rear	12
Seat heaters	16
Seats-Head restraints	13
Seats-Folding rear row seats	12
Tilt and telescopic steering wheel	23
Windows-Power	13
Windshield wipers & washers	15

SAFETY AND EMERGENCY FEATURES

Door locks^{1,2}	24
Doors-Child safety locks	25
Floor mat installation	27
Seat belts	24
Seat belts-Shoulder belt anchor	24
Spare tire & tools	25
Star Safety System™	26-27
Tire Pressure Monitoring (warning) System	24

¹ Visit your Toyota dealer for information on customizing this feature.

² Programmable by customer. Refer to the *Owner's Manual* for instructions and more information.

³ HomeLink® is a registered trademark of Gentex Corporation.

OVERVIEW

Instrument panel

Steering wheel controls

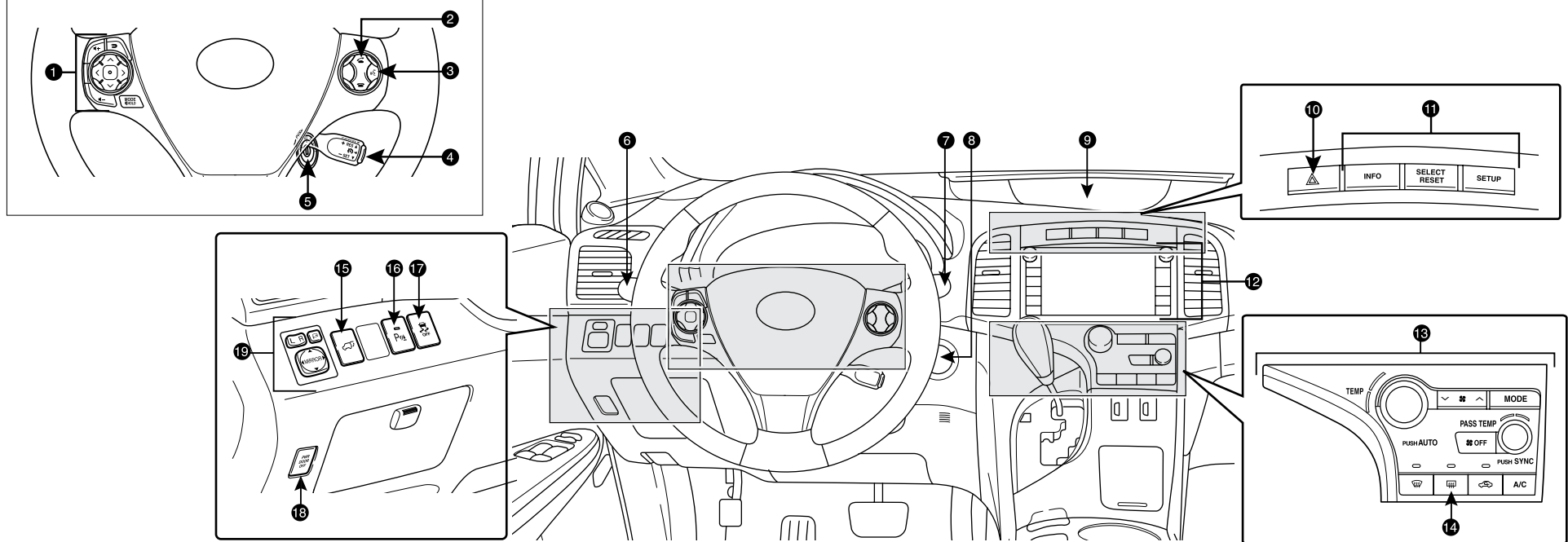

① Steering wheel audio controls^{1,2,3}

② Telephone controls^{1,2,3}

③ Voice command button^{1,2,3}

④ Cruise control

⑤ Ignition switch (standard key)¹

⑥ Headlight, turn signal and front fog light controls

⑦ Wiper and washer controls

⑧ “ENGINE START STOP” button (Smart Key)¹

⑨ Multi-Information Display

⑩ Emergency flasher button

⑪ Multi-Information Display switches

⑫ Navigation system^{1,2}/Display Audio system^{1,3}

⑬ Air Conditioning controls

⑭ Outside rearview mirror defoggers/Rear window defogger button/
Windshield wiper de-icer

⑮ Power back door switch¹

⑯ Intuitive parking assist switch

⑰ Enhanced VSC/TRAC OFF switch

⑱ Power back door main switch¹

⑲ Power outside rearview mirror controls

¹ If equipped

² For details, refer to the “Navigation System Owner’s Manual.”

³ For details, refer to the “Display Audio System Owner’s Manual.”

Instrument cluster

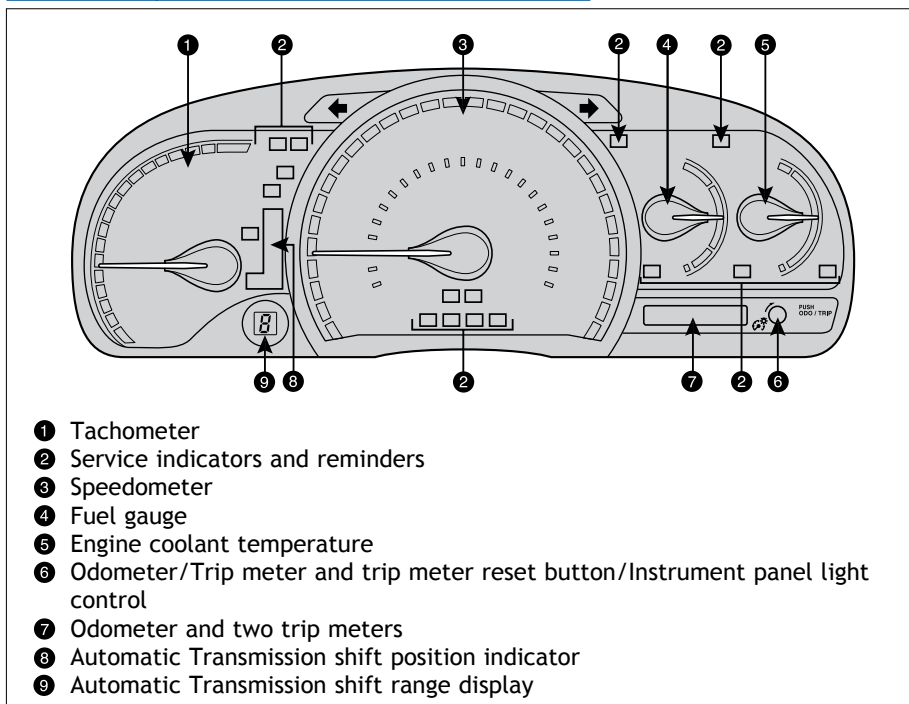

Indicator symbols

For details, refer to “Indicators and warning lights,” Section 2-2, 2014 Owner’s Manual.

- Brake system warning¹
- Driver seat belt reminder (alarm will sound if speed is over 12 mph)
- Front passenger seat belt reminder (alarm will sound if speed is over 12 mph)
- Charging system warning¹
- AIR BAG ON and AIR BAG OFF indicator
- Malfunction/Check Engine indicator¹
- Active torque control All-Wheel Drive system warning¹
- Electric power steering system warning¹

- Low windshield washer fluid level warning¹
- Smart Key system warning
- Low fuel level warning
- Open door warning
- Airbag SRS warning¹
- Master warning
- Low Tire Pressure Warning¹
- Headlight low/high beam indicator
- Turn signal indicator
- Fog light indicator
- Slip indicator/Hill-start Assist Control indicator¹
- SET** Cruise control/Cruise control SET indicator²
- ABS** Anti-lock Brake System warning¹
- AUTO** Automatic high beam indicator³
- Security indicator
- OFF** Vehicle Stability Control OFF indicator¹
- TRAC OFF** Traction Control OFF indicator
- Low Engine oil pressure warning¹
- Automatic headlight leveling system warning¹
- MAINT REQD** Engine oil replacement reminder¹

¹ If indicator does not turn off within a few seconds of starting engine, there may be a malfunction. Have vehicle inspected by your Toyota dealer.

² If this light flashes, refer to “Cruise control,” Section 2-4, 2014 Owner’s Manual.

³ For details, refer to “Headlight switch,” Section 2-3, 2014 Owner’s Manual.

Keyless entry

Locking operation

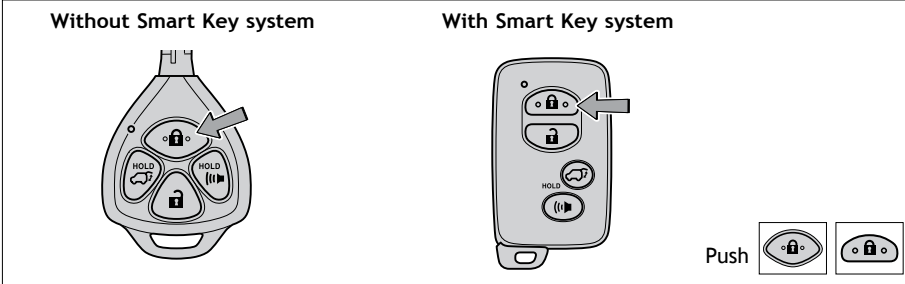

Unlocking operation

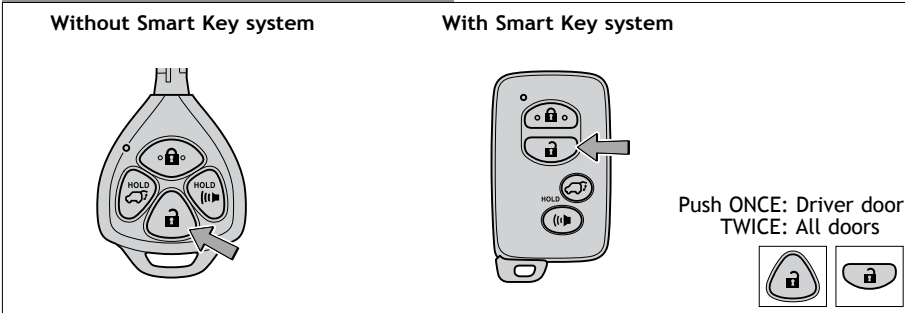

NOTE: If a door is not opened within 60 seconds of unlocking, all doors will relock for safety.

Panic button



Smart Key system (if equipped)

Start function

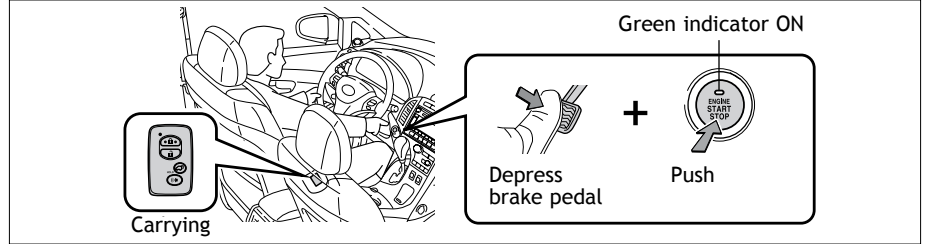

NOTE: Gear shift lever must be in Park and brake pedal depressed.

Power (without starting engine)

Without depressing the brake pedal, pressing the “ENGINE START STOP” button will change the operation mode in succession from:

ACCESSORY Accessories such as the radio will operate.

ON Power ON; the engine not running.

OFF All systems OFF.

Locking operation

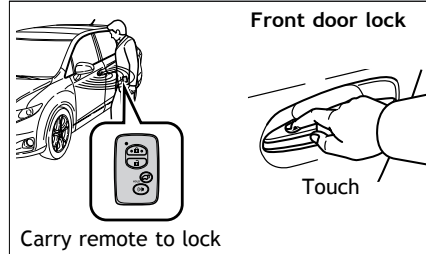

Unlocking operation

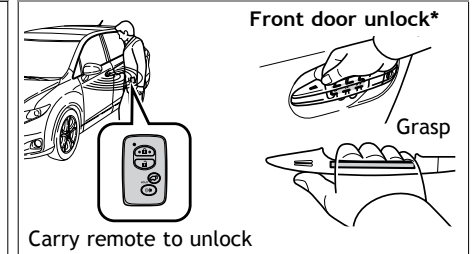

Back door lock/unlock

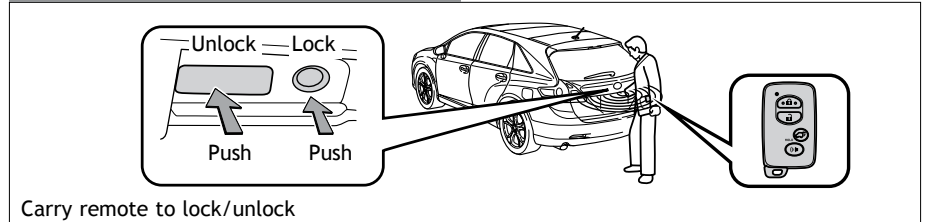

* Driver door unlocking function can be programmed to unlock driver door only, or all doors. Grasping passenger door handle will unlock all doors.

NOTE: Doors may also be locked/unlocked using remote.

Fuel tank door release and cap

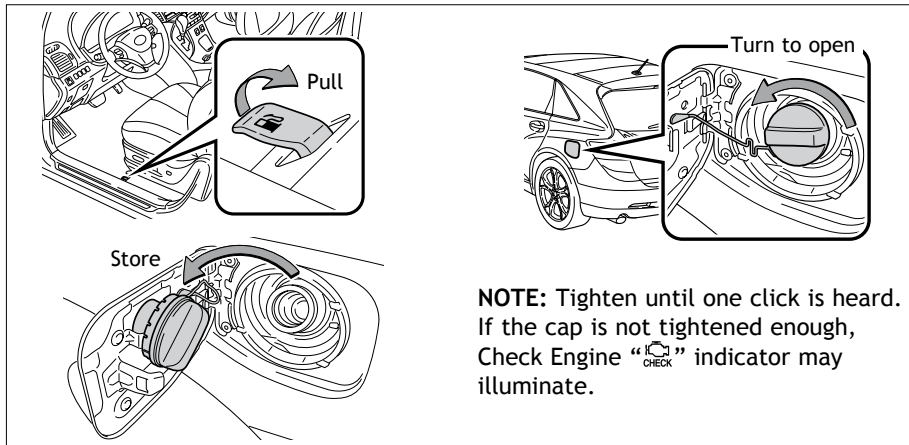

Light control-Instrument panel

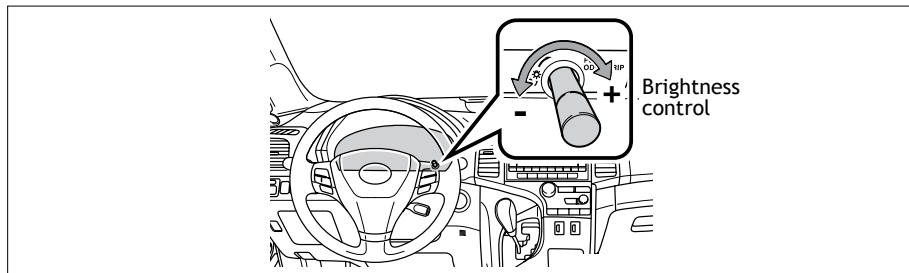

Hood release

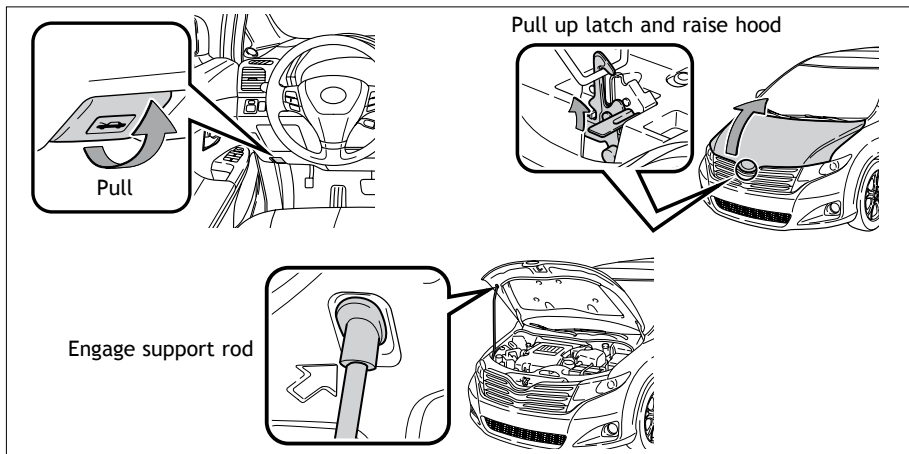

Engine maintenance

2.7 L 4-cylinder (1AR-FE) engine

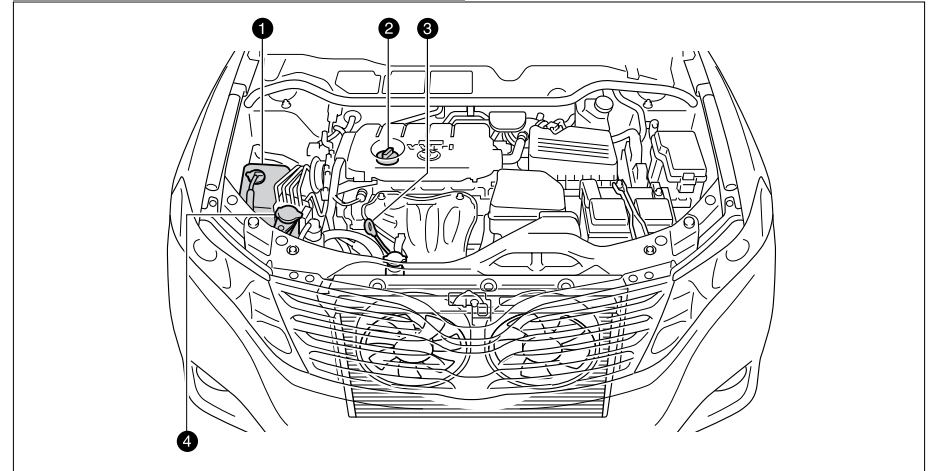

3.5 L V6 (2GR-FE) engine

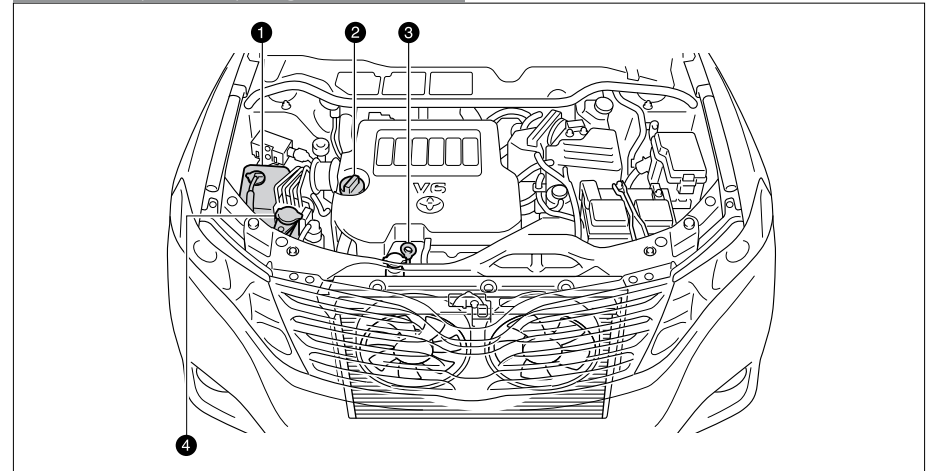

- ❶ Engine coolant reservoir
- ❷ Engine oil filler cap
- ❸ Engine oil level dipstick
- ❹ Windshield washer fluid tank

NOTE: Regularly scheduled maintenance, including oil changes, will help extend the life of your vehicle and maintain performance. Please refer to the “Warranty Maintenance Guide.”

FEATURES/OPERATIONS

Automatic Transmission

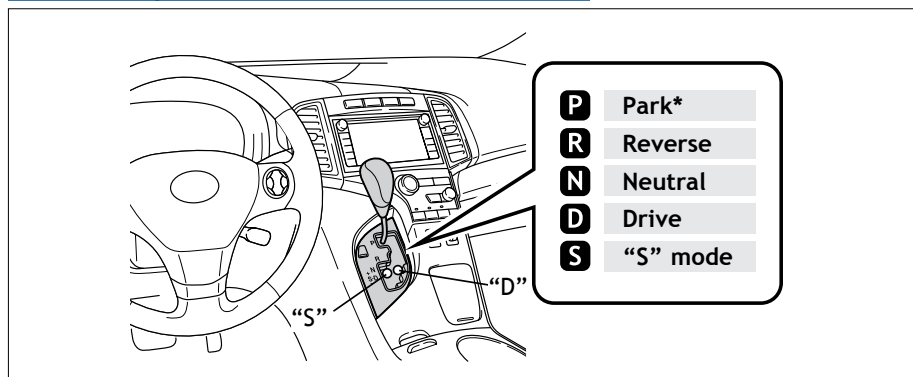

* The "ENGINE START STOP"/ignition switch must be "ON" and the brake pedal depressed to shift from Park.

"S" (Sequential) mode

Shift the shift lever to "S" position from "D" position.

- + : Upshift (push and release)
- : Downshift (pull and release)

Downshifting increases power going uphill, or provides engine braking downhill. For best fuel economy during normal driving conditions, always drive with the shift lever in the "D" position.

Parking brake

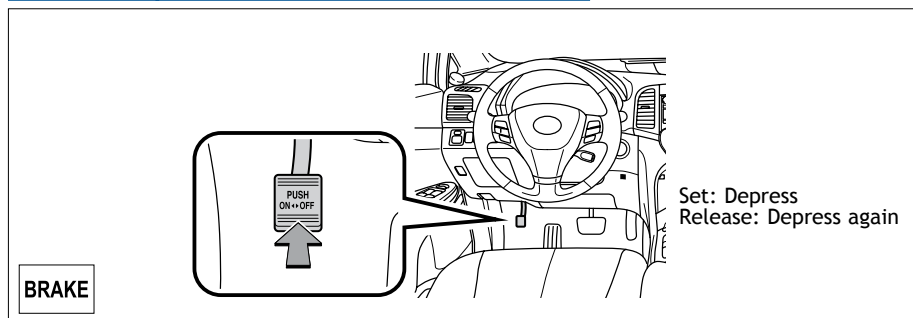

Auto lock/unlock

Automatic door locks can be programmed to operate in four different modes, or turned OFF.

- Doors lock when shifting from Park.
- Doors lock when the vehicle speed is approximately 12 mph or higher.
- Doors unlock when shifting into Park.
- Doors unlock when the driver's door is opened within 10 seconds after turning the "ENGINE START STOP" or ignition switch OFF.

Refer to the *Owner's Manual* for more details.

Seat adjustments-Front

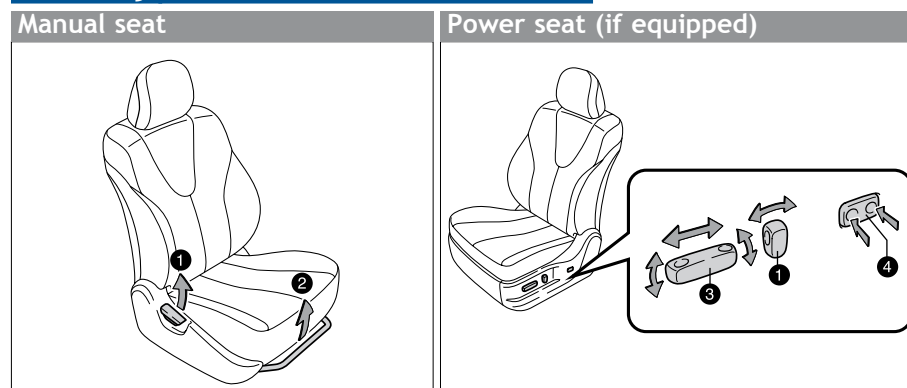

- 1 Seat back angle
- 2 Seat position (forward/backward)
- 3 Seat position; cushion angle and height (driver side only)
- 4 Lumbar support

Driving position memory

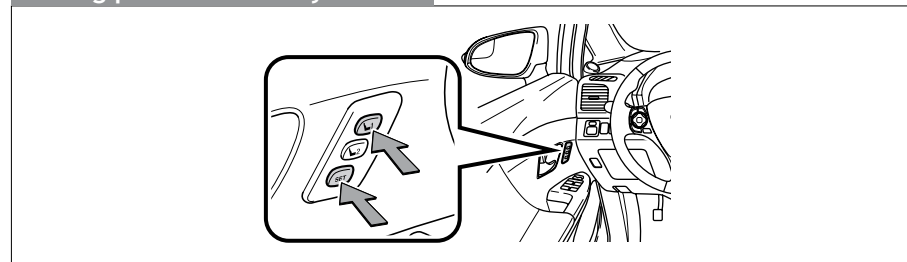

To set driver seat and outside rearview mirror positions:

- (1) The "ENGINE START STOP"/ignition switch must be "ON" and the shift lever in the "P" position.
- (2) Adjust driver seat and outside rearview mirrors to desired positions.
- (3) While pressing "SET" button, press button "1" or "2" until a beep sounds.

Press button "1" or "2" to recall set position.

Seat adjustments-Rear

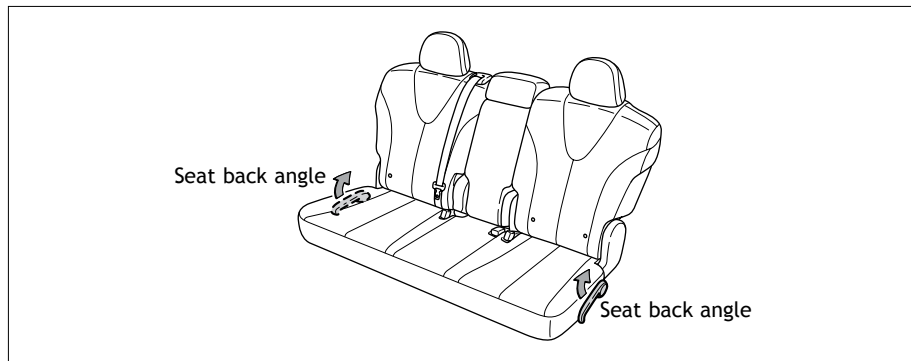

Refer to the *Owner's Manual* for more details.

Seats-Folding rear row seats

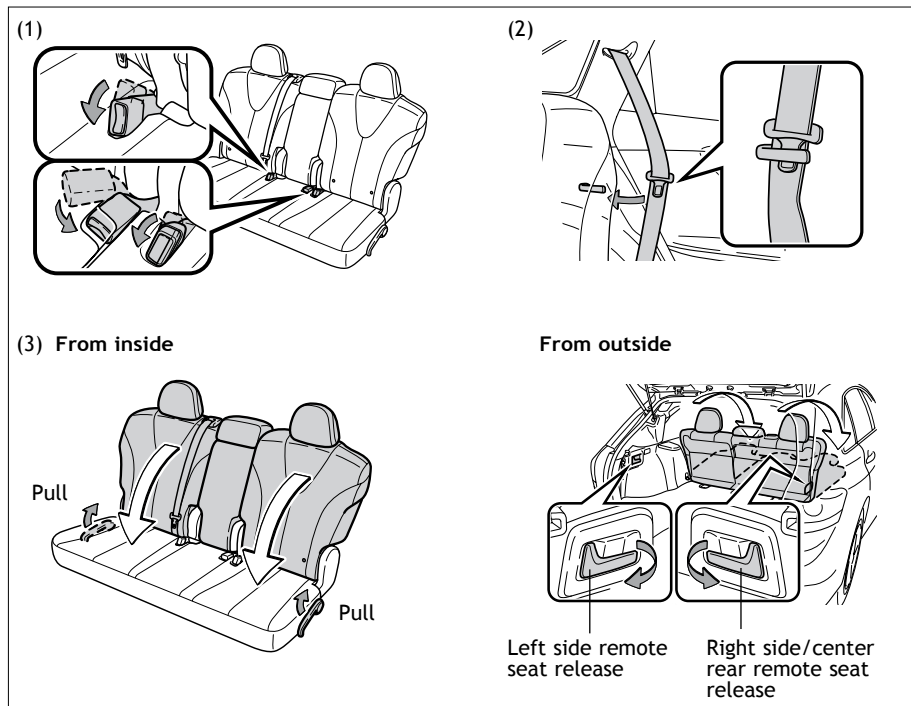

- (1) Stow the seat belt buckles.
- (2) Hook the seat belt to the seat belt hangers.
- (3) Fold down the seat backs.

Seats-Head restraints

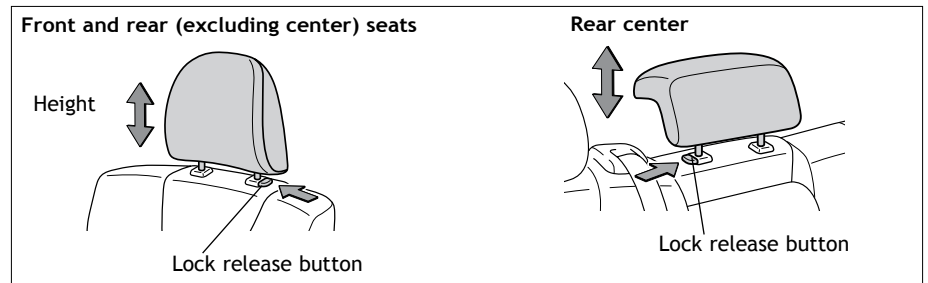

Windows-Power

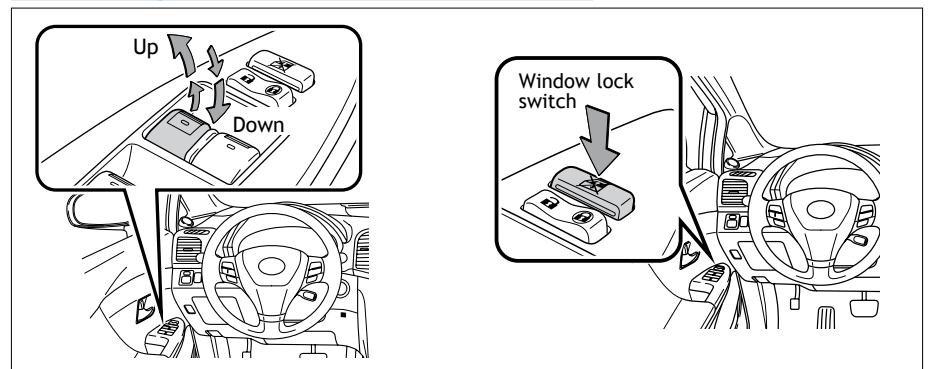

Automatic operation Push the switch completely down or pull it completely up and release to fully open or close. To stop window midway, lightly push the switch in the opposite direction.

Window lock switch Deactivates all passenger windows. Driver's window remains operable.

Moonroof (if equipped)

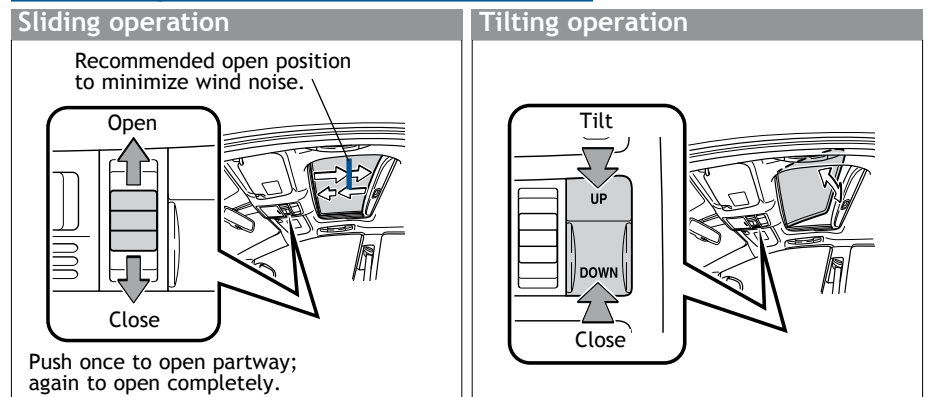

Lights & turn signals

Headlights

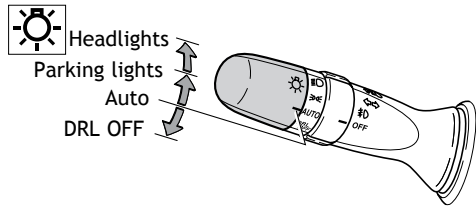

Without automatic high beam

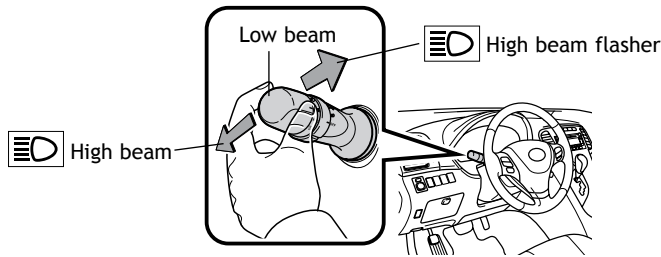

- Daytime Running Light system (DRL) Automatically turns on the headlights at a reduced intensity.
- Automatic light cut off system Automatically turns lights off after a delay of 30 seconds.

Automatic high beam (if equipped)

Activate*

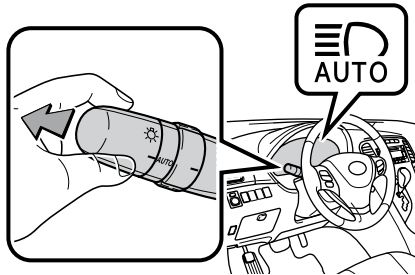

Manual high beam ON

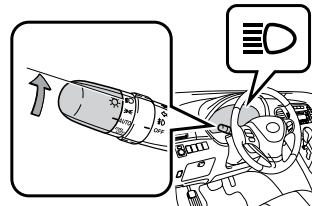

Deactivate

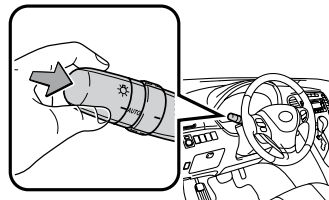

The Automatic High Beam uses a sensor to assess the brightness of nearby light and automatically turns high beam on or off as necessary. To activate, push the lever away from you with the headlight switch in the AUTO position with the engine on.*

* Refer to the *Owner's Manual* for more details on the automatic high beams.

Front fog lights (if equipped)

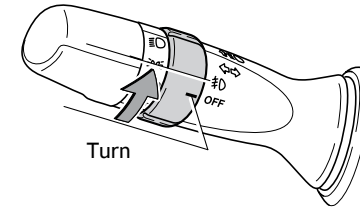

Front fog lights come on only when the headlights are on low beam.

Turn signals

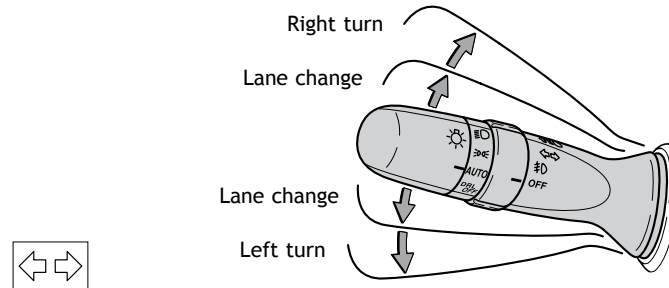

Windshield wipers & washers

Front

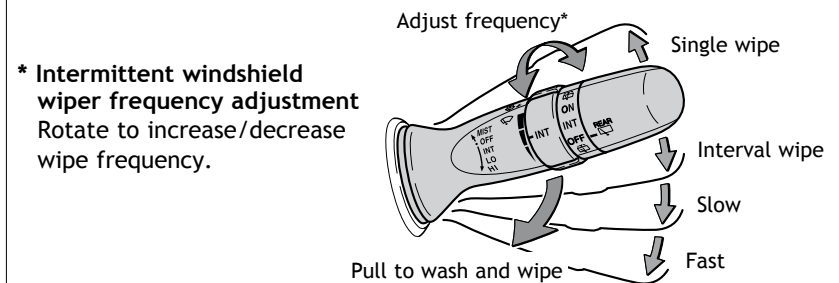

* Intermittent windshield wiper frequency adjustment
Rotate to increase/decrease wiper frequency.

Rear

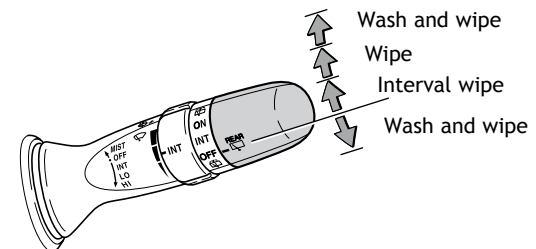

Seat heaters (if equipped)

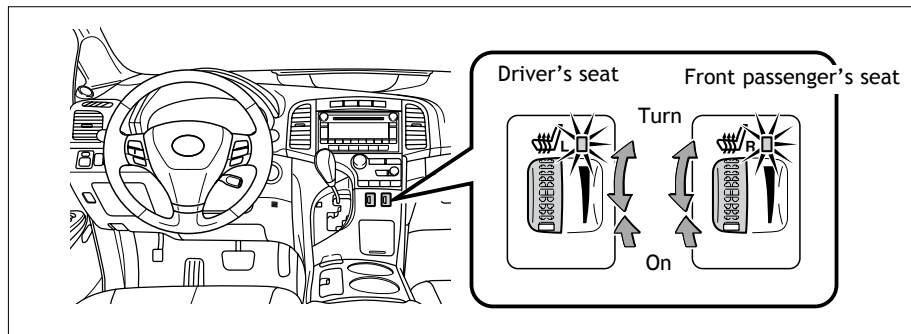

Air Conditioning/Heating

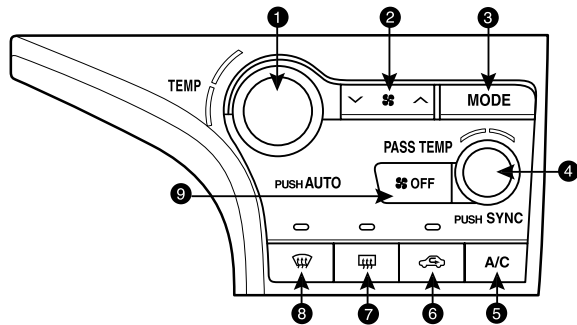

- 1 Push: Automatic climate control ON
Adjusting the temperature setting will cause the airflow vents, air intake and fan to adjust automatically.
- Turn: Temperature selector (driver side)
- 2 Fan speed
- 3 Airflow vent
In “” mode, use fresh air (“” indicator OFF) to reduce window fogging. “” mode uses fresh air only.
- 4 Push: Dual operation ON/OFF
Separate temperature setting or synchronized temperature setting for driver and passenger.
- Turn: Temperature selector (front passenger side)
- 5 Air Conditioning ON/OFF
- 6 Recirculate cabin air (fresh air when OFF)
- 7 Outside rearview mirror/Rear window defogger/Windshield wiper de-icer
- 8 Windshield defogger
- 9 Climate control OFF

Enhanced VSC OFF button

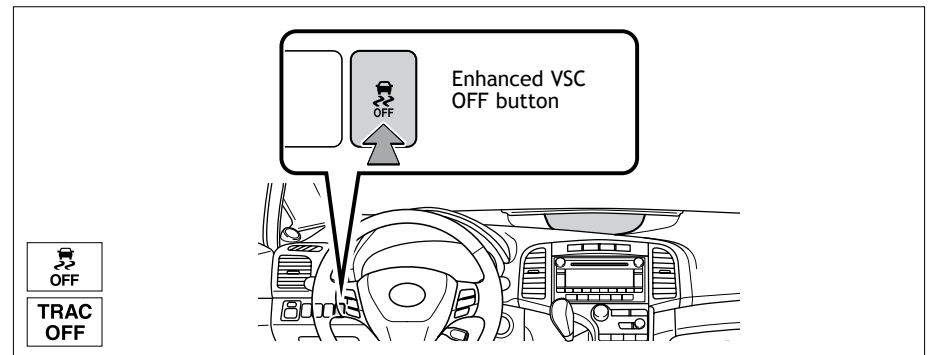

The Enhanced VSC OFF button is used to switch between modes related to the TRAC and Enhanced VSC functions.

Refer to Section 2-4 of the *Owner's Manual* for more information.

Power outlets-12V DC

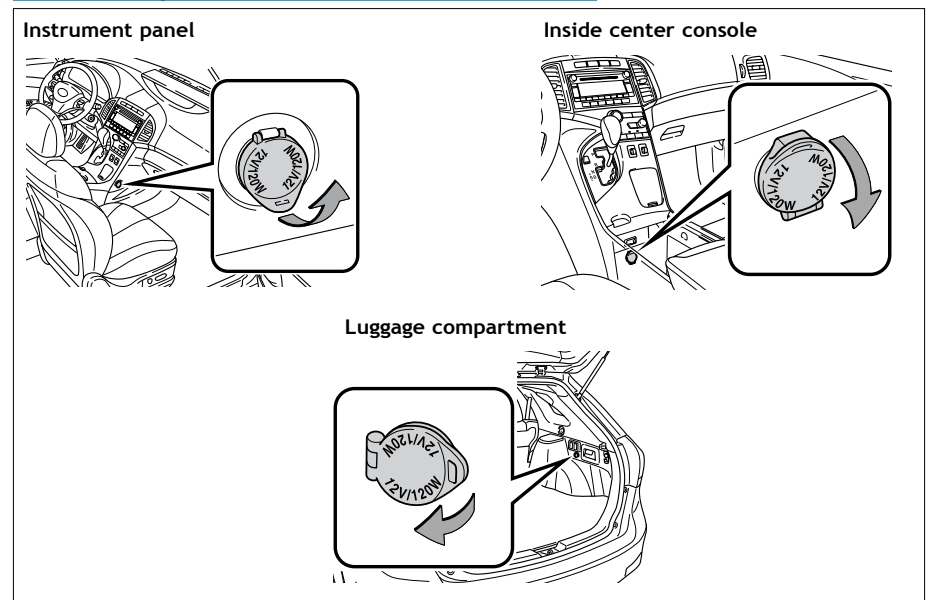

NOTE: Designed for car accessories. The “ENGINE START STOP”/ignition switch must be in the ACCESSORY or ON position to be used.

Audio

Type 1 - Entune Audio Plus*

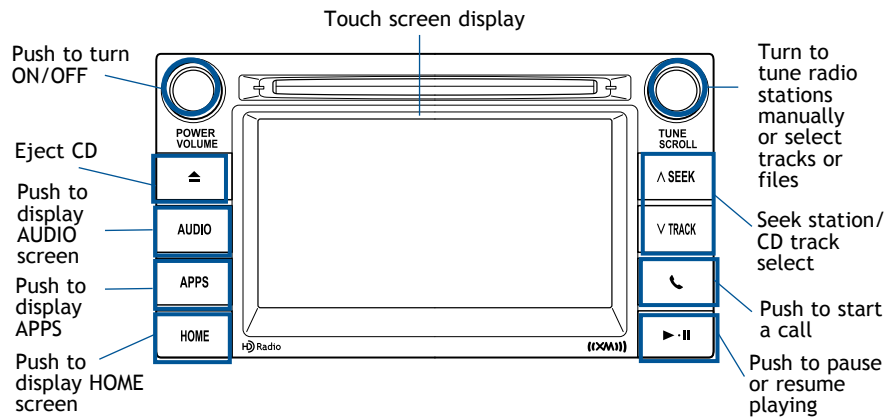

Type 2 - Entune Premium Audio with Navigation and App Suite*
Type 3 - Entune Premium JBL with Navigation and App Suite*

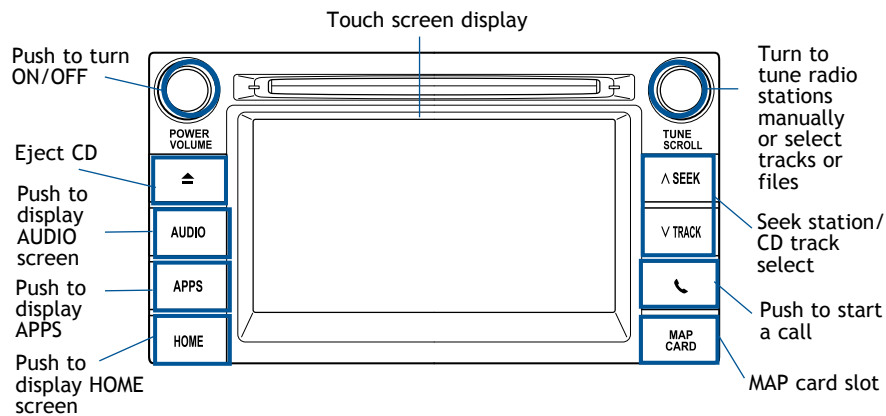

* Refer to the "Navigation and Multimedia System Owner's Manual" for instructions and more information.

USB/AUX port

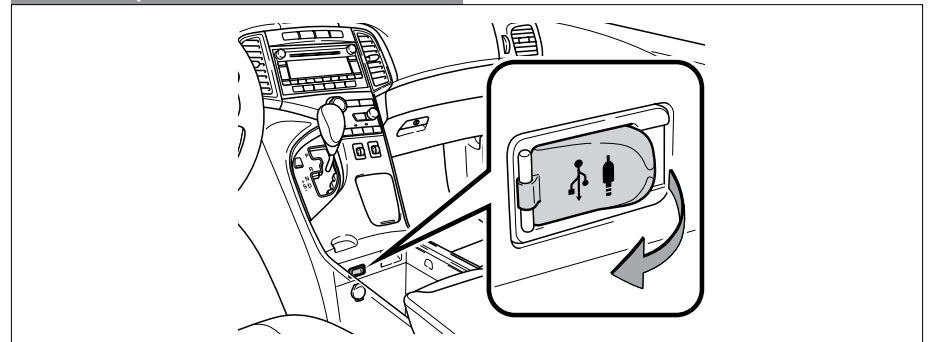

By inserting a mini plug into the USB/AUX port, you can listen to music from a portable audio device through the vehicle's speaker system while in USB/AUX mode.

Steering wheel switches

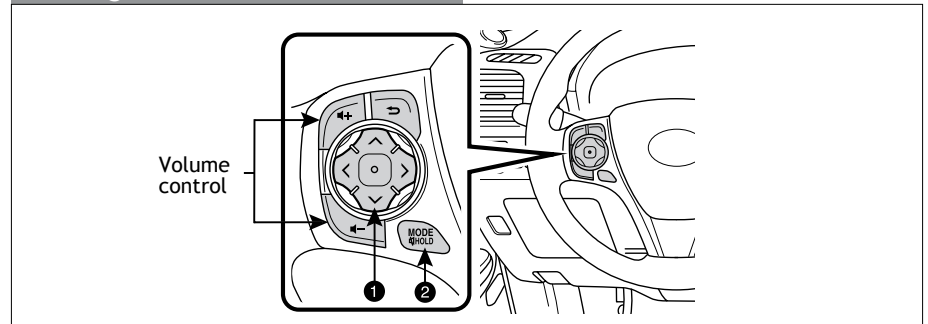

- 1 "v ^"
Use to search within the selected audio medium (radio, CD, iPod®, etc.).
- 2 "MODE"
Push to turn audio ON and to select an audio mode. Push and hold to mute/unmute or pause/resume current operation.

Cruise control

Turning system ON/OFF

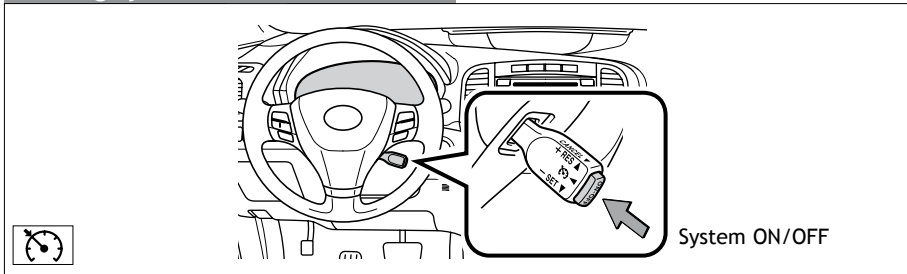

Functions

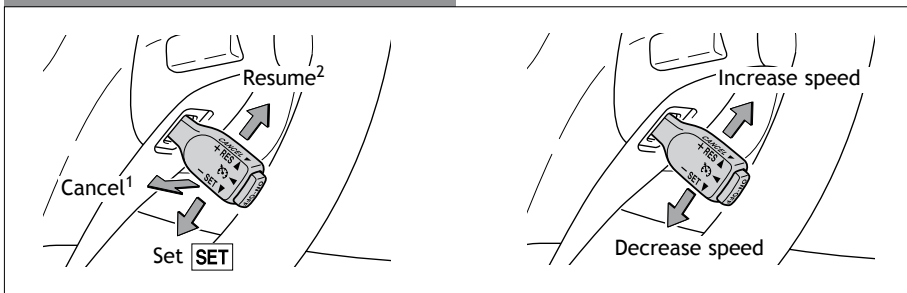

- ¹ The set speed may also be cancelled by depressing the brake pedal.
- ² The set speed may be resumed once vehicle speed exceeds 25 mph.

Hill-start Assist Control (HAC)

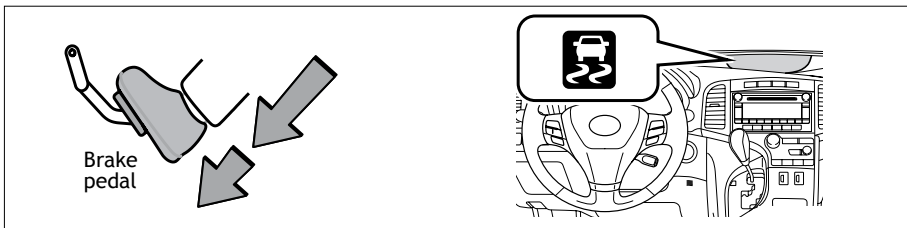

HAC helps prevent rolling backwards on an incline. To engage, push further down on brake pedal while at a complete stop until a beep sounds and slip indicator illuminates. HAC holds for approximately two seconds after releasing brake pedal. Refer to the *Owner's Manual* for more details.

Garage door opener (HomeLink®)* (if equipped)

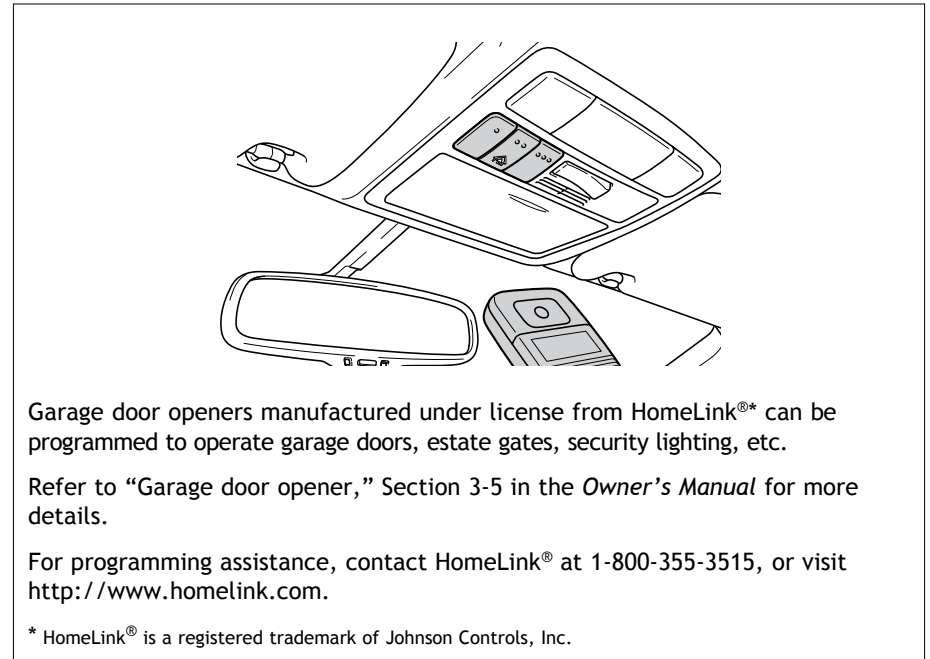

Garage door openers manufactured under license from HomeLink® can be programmed to operate garage doors, estate gates, security lighting, etc. Refer to “Garage door opener,” Section 3-5 in the *Owner's Manual* for more details. For programming assistance, contact HomeLink® at 1-800-355-3515, or visit <http://www.homelink.com>.

* HomeLink® is a registered trademark of Johnson Controls, Inc.

Multi-Information Display (clock)

TFT type

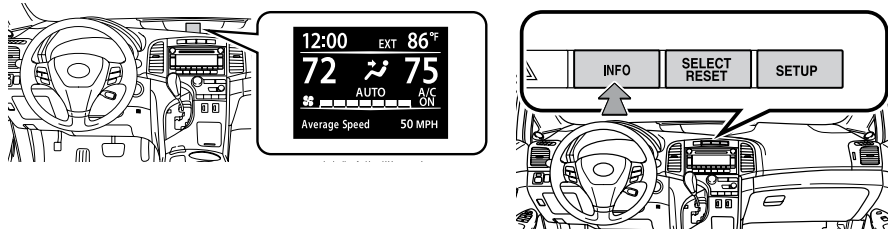

LCD type

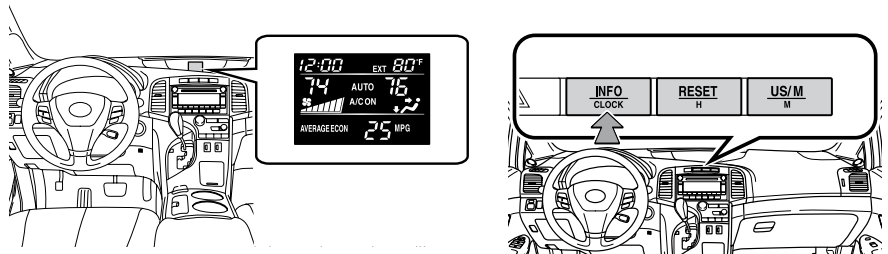

Push “INFO” or “INFO-CLOCK” to change information in the following:

- (1) Average fuel economy (AVERAGE ECON)
- (2) Current fuel economy (CURRENT ECON)
- (3) Distance to empty (RANGE)
- (4) Average speed (AVERAGE SPEED)
- (5) Trip timer (TFT type only)

Setting the clock

TFT type (1) Press the “SETUP” button for the “Custom Settings” screen. (2) Select “Clock” on the Display Settings screen, and press the “SELECT RESET” button. (3) Press the “INFO” button to adjust the hours and the “SETUP” button to adjust the minutes. (4) Press the “SELECT RESET” button to set the clock.

LCD type (1) Press and hold the “INFO-CLOCK” button until part of the display begins to flash. (2) Press and hold the “RESET-H” button to adjust the hours and the “US/M-M” button to adjust the minutes. (3) Press the “INFO-CLOCK” button to complete the setting.

Customizable features

If your vehicle has a TFT type Multi-Information Display, you will be able to customize certain electronic features. Press the “SETUP” button while stopped to access the “Custom Settings” screen.

Please see the *Owner’s Manual* for details.

Tilt and telescopic steering wheel

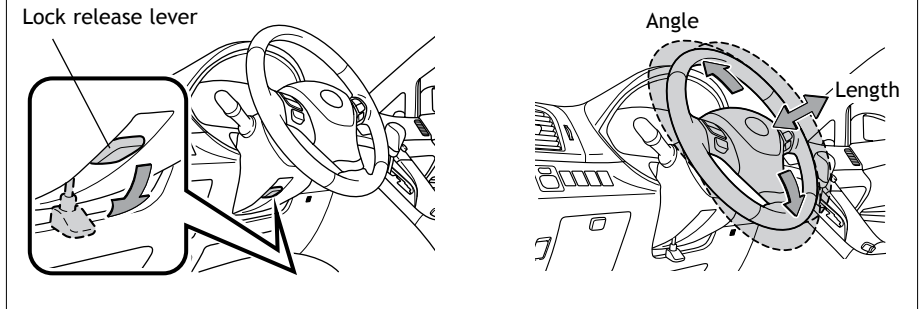

Hold wheel, push lever down, set angle and length, and return lever.

NOTE: Do not attempt to adjust while the vehicle is in motion.

Door-Power back (liftgate) (if equipped)

Instrument panel

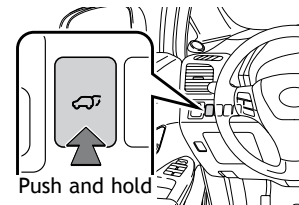

Open: Push and hold
Close: Push and hold again

Back door (liftgate) (open and close)

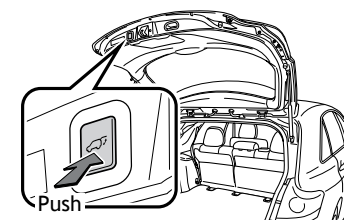

Back door (liftgate) (open only)

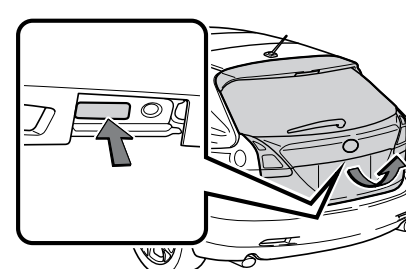

Remote control (without Smartkey)



Remote control (with Smartkey)

NOTE: If battery is disconnected, the power back door needs to be reinitialized. Refer to the *Owner’s Manual* for more details.

SAFETY AND EMERGENCY FEATURES

Door locks

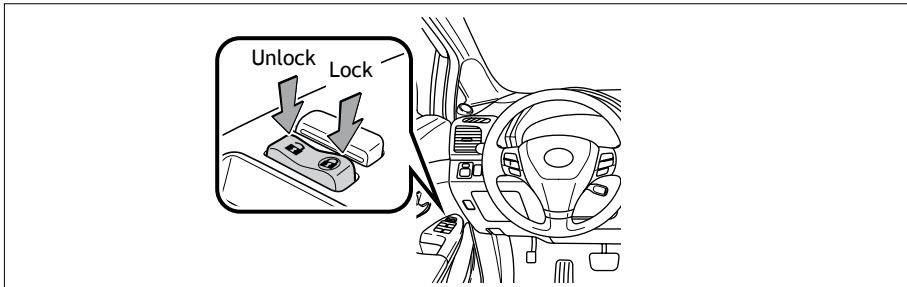

Seat belts

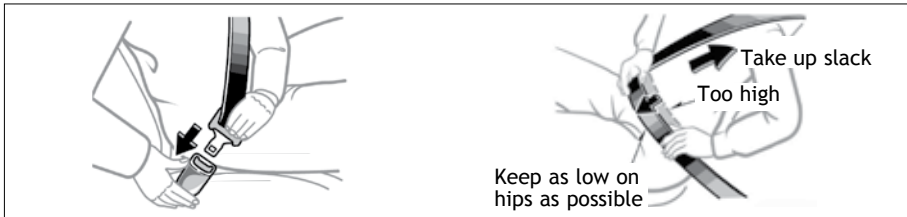

If belt is fully extended, then retracted even slightly, it cannot be re-extended beyond that point, unless fully retracted again. This feature is used to help hold child restraint systems securely.

To find more information about seat belts, and how to install a child restraint system, refer to the *Owner's Manual*.

Seat belts-Shoulder belt anchor

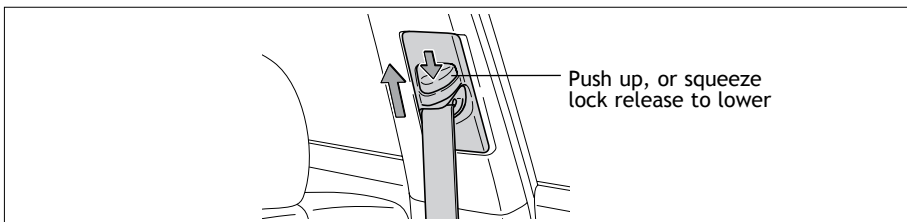

Tire Pressure Monitoring (warning) System

If tire pressure becomes critically low on any of the tires (excluding the spare), “(T)” indicator will illuminate. Correctly adjusting tire inflation will turn off the light after a few minutes. If the light does not turn off, have the system checked by your Toyota dealer.

Refer to the *Owner's Manual* for more details.

Doors-Child safety locks

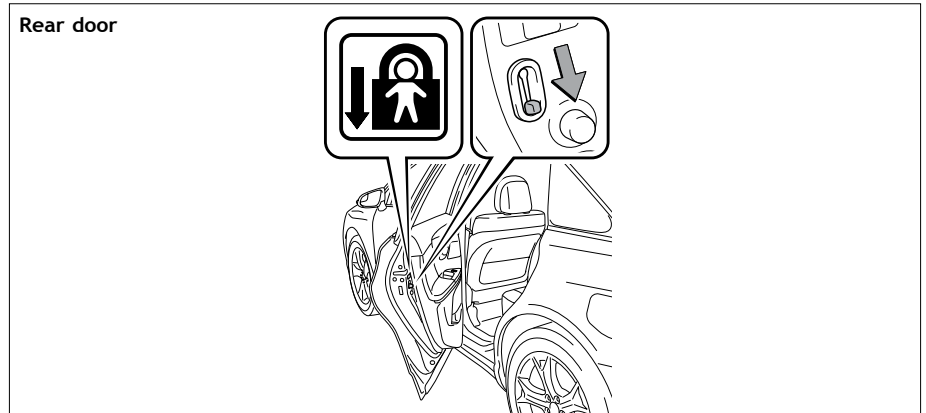

Moving the lever to the lower position will allow the door to be opened only from the outside.

Spare tire & tools

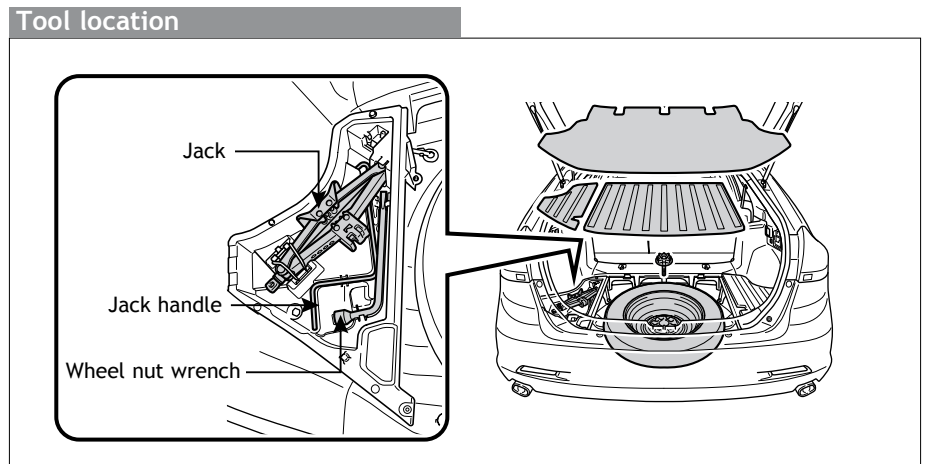

Removing the spare tire

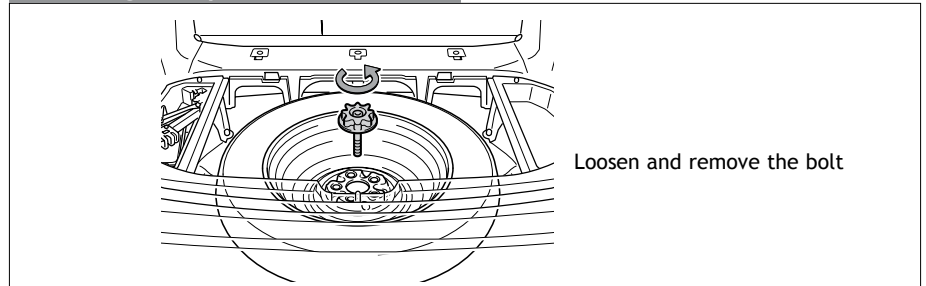

Refer to the *Owner's Manual* for tire changing and jack positioning procedures.

Star Safety System™

All new Toyota vehicles come standard with the Star Safety System™, which combines Vehicle Stability Control (VSC), Traction Control (TRAC), Anti-lock Braking System (ABS), Electronic Brake-force Distribution (EBD), Brake Assist (BA) and Smart Stop Technology (SST).

Vehicle Stability Control (VSC)

VSC helps prevent loss of traction during cornering by reducing engine power and applying brake force to selected wheels.

Toyota's VSC monitors steering angle and the direction your vehicle is traveling. When it senses that the front or rear wheels begin to lose traction, VSC reduces engine power and applies braking to selected wheels. This helps restore traction and vehicle control.

Traction Control (TRAC)

VSC helps prevent loss of traction during cornering by reducing engine power, and Traction Control helps maintain traction on loose gravel and wet, icy, or uneven surfaces by applying brake force to the spinning wheel(s).

Toyota's TRAC sensors are activated when one of the drive wheels starts to slip. TRAC limits engine output and applies the brakes to the spinning wheel. This transfers power to the wheels that still have traction to help keep you on track.

Anti-Lock Brake System (ABS)

ABS helps prevent brakes from locking up by "pulsing" brake pressure to each wheel. This limits brake lockup and helps provide directional control for the current road conditions.

Toyota's ABS sensors detect which wheels are locking up and limits wheel lockup by "pulsing" each wheel's brakes independently. Pulsing releases brake pressure repeatedly for fractions of a second. This helps the tires attain the traction that current road conditions will allow, helping you to stay in directional control.

Electronic Brake Force Distribution (EBD)

Toyota's ABS technology has Electronic Brake-force Distribution (EBD) to help maintain control and balance when braking. Abrupt stops can cause a vehicle to tilt forward, reducing the braking power of the rear wheels. EBD responds to sudden stops by redistributing brake force to enhance the braking effectiveness of all four wheels.

Brake Assist (BA)

Brake Assist is designed to detect sudden or "panic" braking, and then add braking pressure to help decrease the vehicle's stopping distance. When there's only a split second to react, Brake Assist can add additional brake pressure more quickly than just the driver alone can.

Smart Stop Technology (SST)

Smart Stop Technology automatically reduces engine power when the accelerator and brake pedals are pressed simultaneously under certain conditions.

SST engages when the accelerator is depressed first and the brakes are applied firmly for longer than one-half second at speeds greater than five miles per hour.

SST doesn't engage if the brake pedal is depressed before the accelerator pedal, allowing vehicles to start on a steep hill and safely accelerate without rolling backward.

Floor mat installation

There are two types of Toyota floor mats: carpeted and all-weather. Each vehicle has model-specific floor mats. Installation is easy.

To keep your floor mat properly positioned, follow these steps:

- Only use floor mats designed for your specific model.
- Use only one floor mat at a time, using the retaining hooks to keep the mat in place.
- Install floor mats right side up.

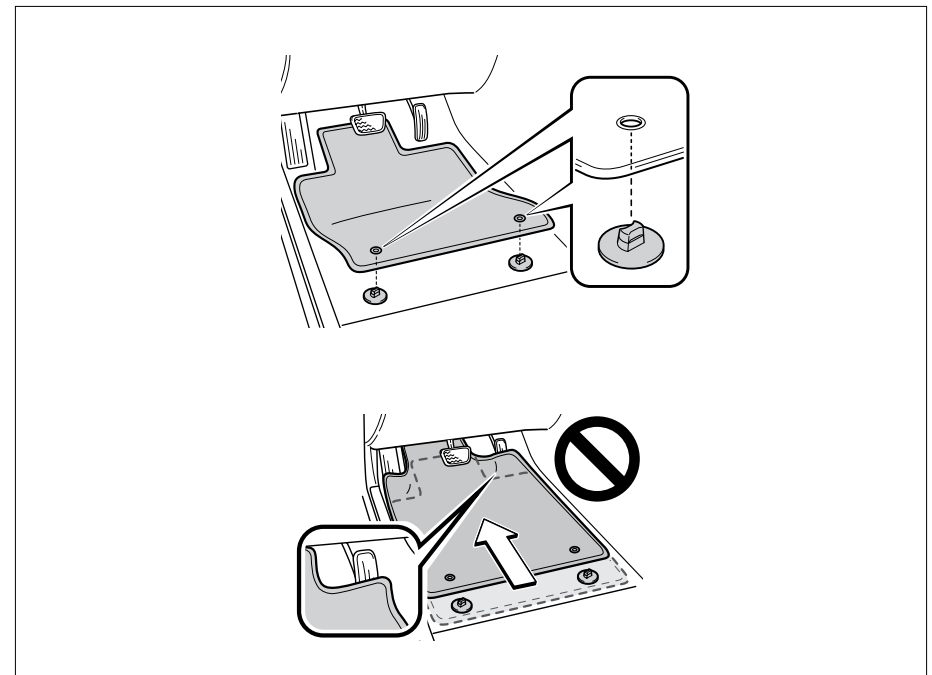

BLUETOOTH® DEVICE PAIRING SECTION

To begin the Bluetooth® Pairing process, press the **SETUP** button on the faceplate of your Toyota Vehicle Entune™ Multimedia Head Unit for vehicles equipped with Entune™ Audio. For vehicles equipped with Entune™ Audio Plus, Entune™ Premium or Entune™ Premium with JBL, begin by pressing the **HOME** button on the faceplate.

Bluetooth® Pairing for Android® phone and Entune™ touch screen system

Pairing your phone is the first step in connecting with your Toyota for hands-free calling and for audio streaming via Bluetooth. This pairing process is quick and easy: all Android mobile digital devices have Bluetooth integrated; all you have to do is setup the phone and multimedia system to “talk” to each other and form a connection.¹

Initiate Bluetooth® on your Android®

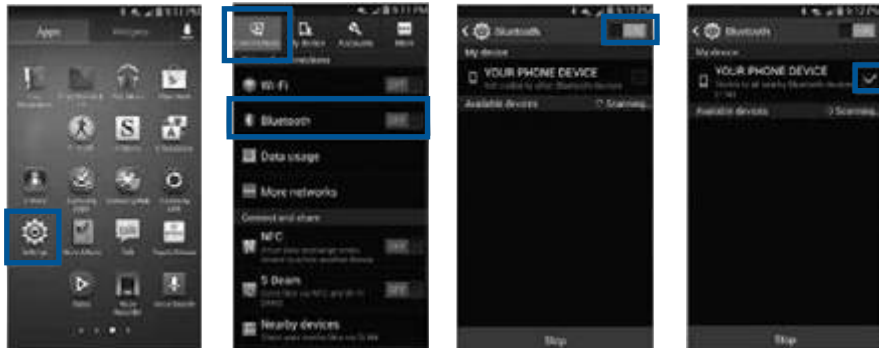

- STEP 1**
From your **APPS SCREEN**, select **SETTINGS**
- STEP 2**
Select **CONNECTIONS** and select **BLUETOOTH**
- STEP 3**
Ensure **BLUETOOTH** is **ON**
- STEP 4**
Select **YOUR PHONE DEVICE** to make it discoverable.
Phone will seek out Bluetooth devices while remaining discoverable.



- STEP 5**
While your Android device is seeking out Bluetooth devices, proceed to your Entune Multimedia Head Unit on your Toyota vehicle.

Initiate Bluetooth® on your Entune™ Multimedia Head Unit

Once you have Bluetooth enabled on your phone and ready to pair, you will need to initiate Bluetooth on your Entune head unit. Please follow the instructions below to pair your Bluetooth enabled phone to your Entune system.



- STEP 6**
On your Toyota Vehicle Entune Multimedia Head Unit, Select **SETUP BUTTON** on the Home Screen.
- STEP 7**
Select **BLUETOOTH**
- STEP 8**
Select **ADD**, to add your phone device



- STEP 9**
Back on your smartphone, you can now select your **TOYOTA VEHICLE** in Bluetooth Settings.
You may need to enter the provided Bluetooth PIN on your phone.
- STEP 10**
Your smartphone is now paired with Entune.
- STEP 11**
Once paired, Entune will attempt to connect audio and contacts on your phone.

¹ Some Android devices may have slightly different SETTINGS screen layout depending on manufacturer of device and Android OS version.

Initiate Bluetooth® on your Entune™ Multimedia Head Unit (continued)



STEP 12

Using your smartphone, you will need to allow Entune access to your messaging and contacts



STEP 13

A confirmation will appear once your phone has been paired and connected.

Additional Resources

If you're having trouble pairing your phone, Toyota has you covered. You can get more information from the following sources:

Online Pairing Guide:
www.toyota.com/connect

Your Toyota Owner's Manual
Located in the vehicle glovebox

Toyota Customer
Experience Center
(800) 331-4331

Disclosures

- This brochure is accurate at the time of print; content subject to change based on periodic multimedia software updates.
1. Concentrating on the road should always be your first priority while driving. Do not use the hands-free phone system if it will distract you.
 2. The Bluetooth word mark and logos are registered trademarks owned by Bluetooth SIG, Inc. and any use of such marks by Toyota is under license. A compatible Bluetooth enabled phone must first be paired. Phone performance depends on software, coverage & carrier.
 3. Android is a trademark of Google, Inc. All rights reserved. Google is not a participant in or sponsor of this promotion.
 4. Apps/services vary by phone/carrier; functionality depends on many factors. Select apps use large amounts of data; you are responsible for charges. Apps & services subject to change. See Toyota.com/entune for details.
 5. Bluetooth Pairing Guide for select 2015 models.

Bluetooth® Pairing for iPhone® and Entune™ touch screen system

Pairing your phone is the first step in connecting with your Toyota for hands-free calling and for audio streaming via Bluetooth. This pairing process is quick and easy: all iPhone mobile digital devices have Bluetooth integrated; all you have to do is setup the phone and multimedia system to “talk” to each other and form a connection. Bluetooth Pairing Guide for select 2015 models.

Initiate Bluetooth® on your iPhone®



STEP 1

From the HOME SCREEN, select SETTINGS

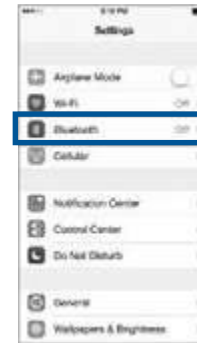

STEP 2

Select BLUETOOTH



STEP 3

Ensure BLUETOOTH is ON



STEP 4

Your iPhone will seek out Bluetooth devices while remaining discoverable



STEP 5

While your iPhone device is seeking out Bluetooth devices, proceed to your Entune Multimedia Head Unit on your Toyota vehicle.

CONTINUE ON THE NEXT PAGE...

Initiate Bluetooth® on your Entune™ Multimedia Head Unit (continued)

Once you have Bluetooth enabled on your phone and ready to pair, you will need to initiate Bluetooth on your Entune head unit. Please follow the instructions below to pair your Bluetooth enabled phone to your Entune system.



STEP 6
Select **SETUP** BUTTON on the Home Screen.



STEP 7
Select **BLUETOOTH**

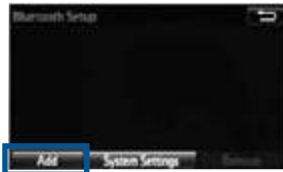

STEP 8
Select **ADD**, to add your phone device



STEP 9
Back on your smartphone, you can now select your **TOYOTA VEHICLE** in Bluetooth Settings.

You may need to enter the provided Bluetooth PIN on your phone.



STEP 10
Your smartphone is now paired with Entune.



STEP 11
Once paired, Entune will attempt to connect audio and contacts on your phone.

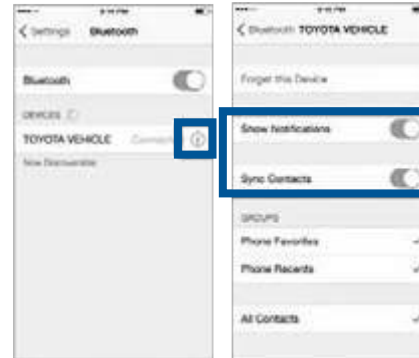

STEP 12
Using your smartphone, you may need to allow Entune access to your messaging and contacts



STEP 13
A confirmation will appear once your phone has been paired and connected.

Additional Resources

If you're having trouble pairing your phone, Toyota has you covered. You can get more information from the following sources:

Online Pairing Guide:
www.toyota.com/connect

Your Toyota Owner's Manual
Located in the vehicle glovebox

Toyota Customer Experience Center
(800) 331-4331

Disclosures

- This brochure is accurate at the time of print; content subject to change based on periodic multimedia software updates.
1. Concentrating on the road should always be your first priority while driving. Do not use the hands-free phone system if it will distract you.
 2. The Bluetooth word mark and logos are registered trademarks owned by Bluetooth SIG, Inc. and any use of such marks by Toyota is under license. A compatible Bluetooth enabled phone must first be paired. Phone performance depends on software, coverage & carrier.
 3. Android is a trademark of Google, Inc. All rights reserved. Google is not a participant in or sponsor of this promotion.
 4. Apps/services vary by phone/carrier; functionality depends on many factors. Select apps use large amounts of data; you are responsible for charges. Apps & services subject to change. See Toyota.com/entune for details.
 5. Bluetooth Pairing Guide for select 2015 models.

Bluetooth® Pairing for Windows Phone® and Entune™ touch screen system

Pairing your phone is the first step in connecting with your Toyota for hands-free calling and for audio streaming via Bluetooth. This pairing process is quick and easy: all Windows Phone mobile digital devices have Bluetooth integrated; all you have to do is setup the phone and multimedia system to “talk” to each other and form a connection. Bluetooth Pairing Guide for select 2015 models.

Initiate Bluetooth® on your Windows Phone®

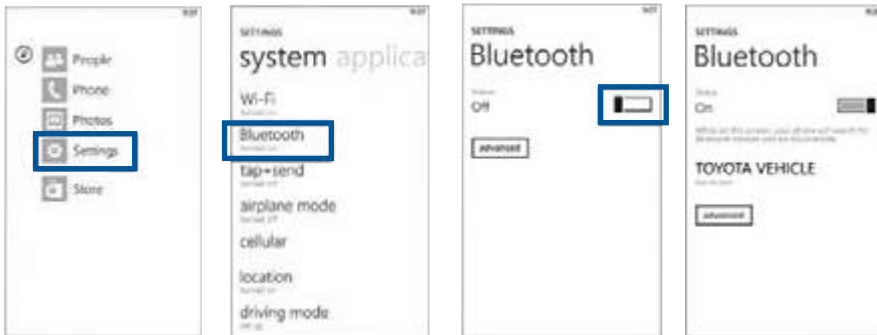

- STEP 1**
From your APP LIST, select **SETTINGS**
- STEP 2**
Select **BLUETOOTH**
- STEP 3**
Ensure **BLUETOOTH** is **ON**
- STEP 4**
Phone will seek out Bluetooth devices while remaining discoverable



- STEP 5**
While your iPhone device is seeking out Bluetooth devices, proceed to your Entune Multimedia Head Unit on your Toyota vehicle.
CONTINUE ON THE NEXT PAGE...

Initiate Bluetooth® on your Entune™ Multimedia Head Unit

Once you have Bluetooth enabled on your phone and ready to pair, you will need to initiate Bluetooth on your Entune head unit. Please follow the instructions below to pair your Bluetooth enabled phone to your Entune system.



- STEP 6**
On your Toyota Vehicle Entune Multimedia Head Unit, Select **SETUP BUTTON** on the Home Screen.
- STEP 7**
Select **BLUETOOTH**
- STEP 8**
Select **ADD**, to add your phone device



- STEP 9**
Back on your smartphone, you can now select your **TOYOTA VEHICLE** in Bluetooth Settings.
You may need to enter the provided Bluetooth PIN on your phone.
- STEP 10**
Your smartphone is now paired with Entune.
- STEP 11**
Once paired, Entune will attempt to connect audio and contacts on your phone.

Initiate Bluetooth® on your Entune™ Multimedia Head Unit (continued)



STEP 12

Using your smartphone, you may need to allow Entune access to your contacts



STEP 13

A confirmation will appear that your phone has been paired and connected.

Additional Resources

If you're having trouble pairing your phone, Toyota has you covered. You can get more information from the following sources:

Online Pairing Guide:
www.toyota.com/connect

Your Toyota Owner's Manual
Located in the vehicle glovebox

Toyota Customer Experience Center
 (800) 331-4331

- Disclosures
- This brochure is accurate at the time of print; content subject to change based on periodic multimedia software updates.
1. Concentrating on the road should always be your first priority while driving. Do not use the hands-free phone system if it will distract you.
 2. The Bluetooth word mark and logos are registered trademarks owned by Bluetooth SIG, Inc. and any use of such marks by Toyota is under license. A compatible Bluetooth enabled phone must first be paired. Phone performance depends on software, coverage & carrier.
 3. Android is a trademark of Google, Inc. All rights reserved. Google is not a participant in or sponsor of this promotion.
 4. Apps/services vary by phone/carrier; functionality depends on many factors. Select apps use large amounts of data; you are responsible for charges. Apps & services subject to change. See Toyota.com/entune for details.
 5. Bluetooth Pairing Guide for select 2015 models.

