



QUICK REFERENCE GUIDE



SEQUOIA

2020

2020

SEQUOIA

This Quick Reference Guide is a summary of basic vehicle operations. It contains brief descriptions of fundamental operations so you can locate and use the vehicle's main equipment quickly and easily.

The Quick Reference Guide is not intended as a substitute for the Owner's Manual located in your vehicle's glove box. We strongly encourage you to review the Owner's Manual and supplementary manuals so you will have a better understanding of your vehicle's capabilities and limitations.

Your dealership and the entire staff of Toyota Motor North America, Inc. wish you many years of satisfied driving in your new Sequoia.

A word about safe vehicle operations

This Quick Reference Guide is not a full description of Sequoia operations. Every Sequoia owner should review the Owner's Manual that accompanies this vehicle.

Pay special attention to the boxed information highlighted in color throughout the Owner's Manual. Each box contains safe operating instructions to help you avoid injury or equipment malfunction.

All information in this Quick Reference Guide is current at the time of printing. Toyota reserves the right to make changes at any time without notice.

OVERVIEW

Engine maintenance	11
Fuel tank door release & cap	10
Hood release	10
Indicator symbols	6-7
Instrument cluster	5
Instrument panel	2-4
Instrument panel light control	11
Keyless entry ^{1,2}	8-9
Smart Key system ^{1,2}	9

FEATURES & OPERATIONS

Air conditioning/heating	24-25
Audio	26
Auto lock/unlock ¹	12
Automatic transmission	12
AVS (Adaptive Variable Suspension System)	33
Blind Spot Monitor with Rear Cross Traffic Alert (BSM w/RCTA)	31
Cup holders	15
Door locks	16
Driving position memory	23
Electronically modulated air suspension	32
Four-wheel drive	13
Garage door opener (HomeLink [®]) ³	30
Intuitive parking assist	33
Lights ¹ & turn signals	20
Moonroof	23
Multi-Information Display (MID) ²	29
Parking brake	15
Power back door	22
Power outlets-12V DC	28
Power outlets-120V AC	27
Rear seat entertainment system	28
Rear view monitor system	30
Seat adjustments-Front	16
Seat adjustments-Rear	17
Seats-Folding 2nd row seats	18
Seats-Folding 3rd row seats	19
Seat heaters/ventilators	25

FEATURES & OPERATIONS (continued)

Seats-Head restraints	18
Steering lock release	14
Steering wheel switches & telephone controls (Bluetooth [®])	27
Tilt & telescopic steering wheel	14
TOW/HAUL switch	31
USB charge-ports	26
USB media port	26
Vehicle Stability Control (VSC) OFF switch	29
Window-Back door	22
Windows-Power	21
Windshield wipers & washers	21

TOYOTA SAFETY SENSE™ P (TSS-P)

Automatic High Beams (AHB)	44
Dynamic Radar	
Cruise Control (DRCC)	41-43
Lane Departure Alert (LDA)	37-40
Pre-Collision System with Pedestrian Detection (PCS w/PD)	35-37
Quick overview-	
Toyota Safety Sense™ P (TSS-P)	34
Sensors	34

SAFETY & EMERGENCY FEATURES

Floor mat installation	49
Rear door child safety locks	46
Safety Connect	46
Seat belts	45
Seat belts-Shoulder belt anchor	47
Spare tire & tools	47
Star Safety System™	48-49
Tire Pressure Monitoring (warning) System (TPMS)	45

BLUETOOTH® DEVICE PAIRING SECTION

50-52

¹ Visit your Toyota dealer for information on customizing this feature.

² Programmable by customer. Refer to the Owner's Manual for instructions and more information.

³ HomeLink[®] is a registered trademark of Genex Corporation.

Instrument panel

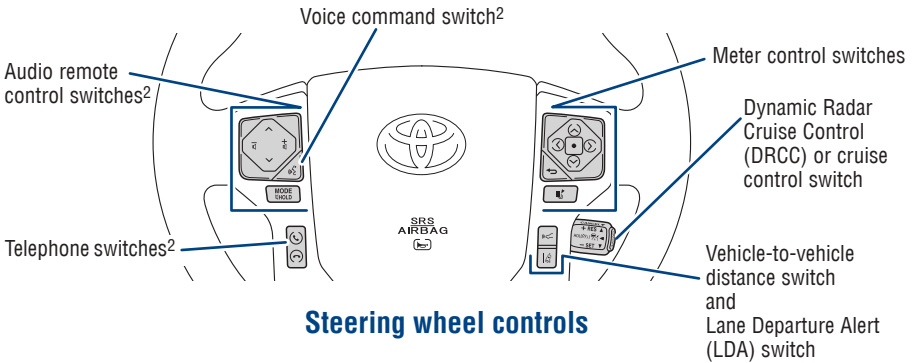

Steering wheel controls

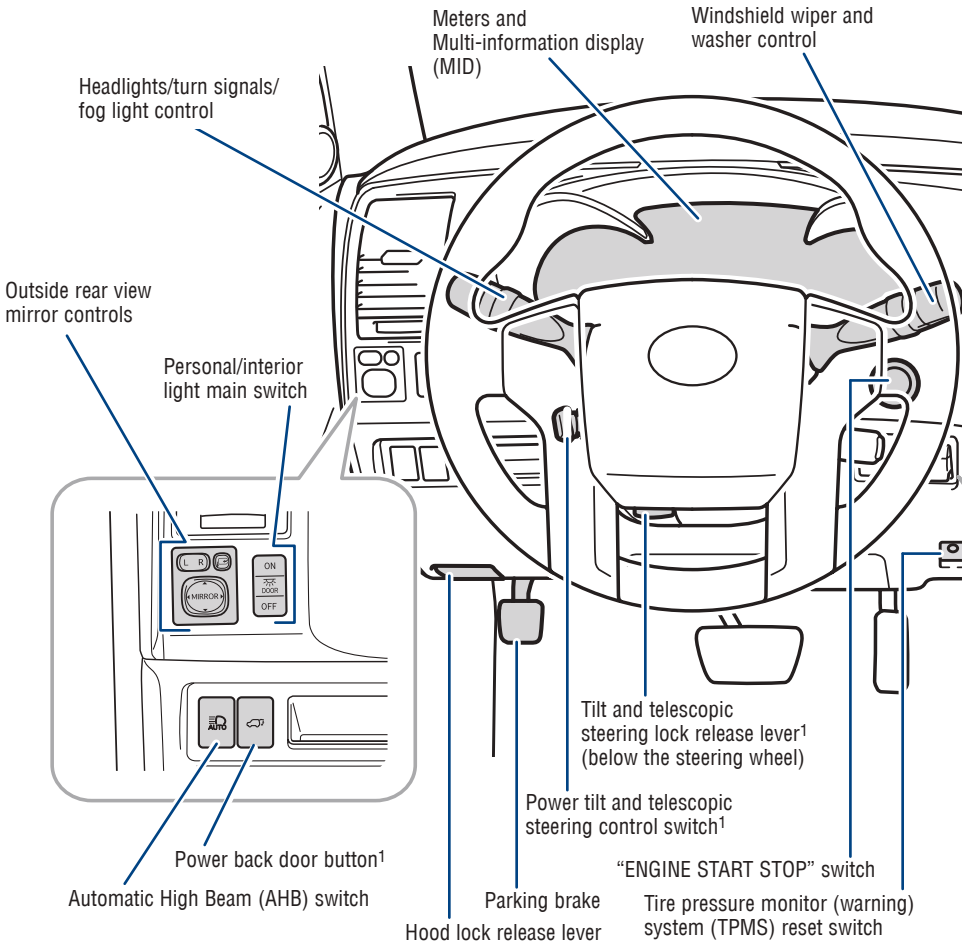

¹ If equipped

² For details, refer to the “Navigation and Multimedia System Owner’s Manual” or visit www.toyota.com/audio-multimedia for additional resources.

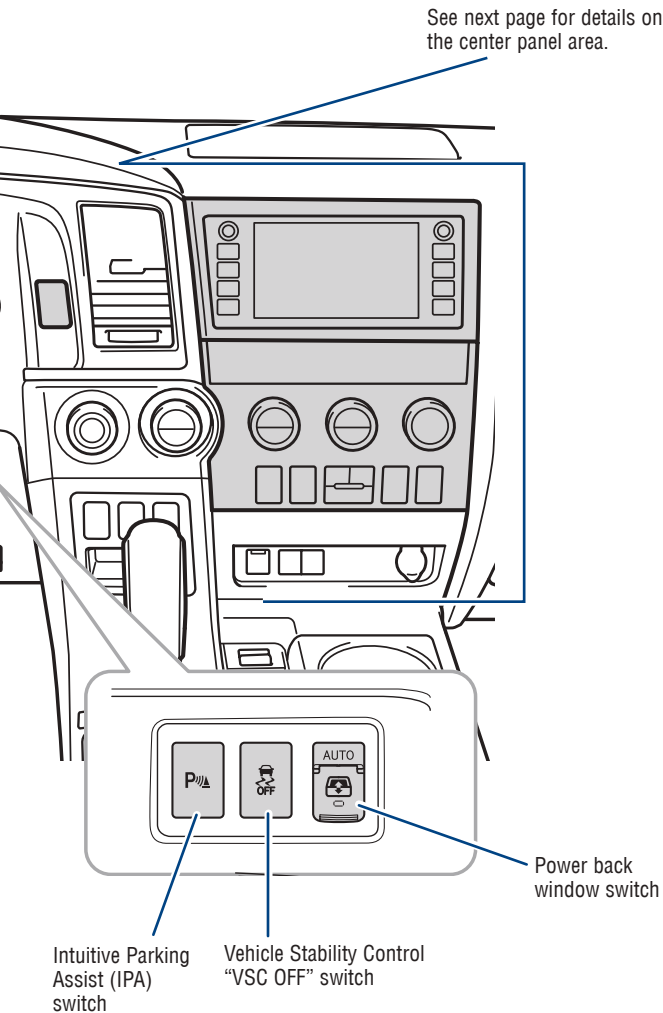

Instrument panel (continued)

CENTER PANEL AREA

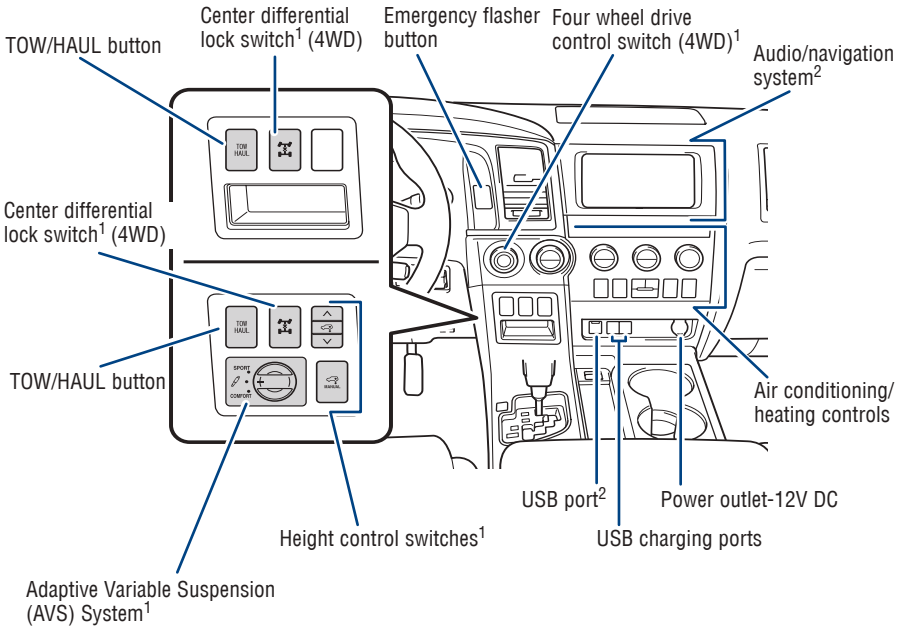

¹ If equipped

² For details, refer to the "Navigation and Multimedia System Owner's Manual" or visit www.toyota.com/audio-multimedia for additional resources.

Instrument cluster

See page 6 for indicator symbols.

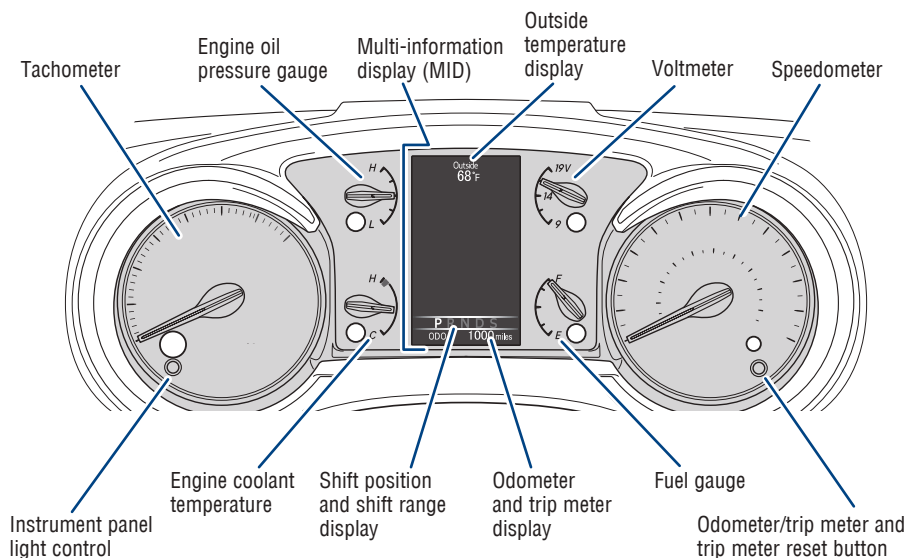













○ Service indicators and reminders

OVERVIEW

Indicator symbols

For details, refer to “Indicators and warning lights,” Section 2, 2020 Owner’s Manual.

	AIR BAG ON/OFF indicator ¹
	Airbag SRS warning ¹
ABS	Anti-lock Brake System (ABS) warning ¹
AUTO LSD	AUTO Limited Slip Differential indicator ^{1,4}
	Automatic High Beam (AHB) indicator
BSM	Blind Spot Monitor (BSM) indicator
	BSM outside rearview mirror indicator
RCTA	BSM w/Rear Cross Traffic Alert (RCTA) indicator
BRAKE	Brake system warning ¹
	Center differential lock indicator ⁴
	Charging system warning ¹
	SET Constant speed cruise control indicator/Constant speed cruise control SET indicator
	Driver's and/or front passenger's seat belt reminder (alarm will sound if speed is over 12 mph)
	SET Dynamic Radar Cruise Control (DRCC) indicator/DRCC SET indicator
	Front fog light indicator
	Fuel tank door position
	 Headlight low/high beam indicator
4 HI	4 LO High/Low speed four-wheel drive indicator ⁴



Lane Departure Alert (LDA) indicator
[green/yellow³ indicator]



Low fuel level warning



Low outside temperature indicator



Low Tire Pressure Warning¹



Malfunction/
Check Engine indicator¹



Master warning^{1,2}



Parking brake indicator



Pre-Collision System (PCS)
warning^{1,2}



Power steering warning¹



Security indicator



Slip indicator^{1,3}



TOW/HAUL mode indicator



Traction Control OFF indicator¹



Turn signal indicator



Vehicle Stability Control
(VSC) OFF indicator¹

¹ If the indicator does not turn off within a few seconds of starting the engine, there may be a malfunction. Have the vehicle inspected by your Toyota dealer.

² If the indicator flashes, there may be a malfunction. Refer to the Owner's Manual.

³ If the indicator flashes, it indicates that the system is operating.

⁴ If equipped.

OVERVIEW

Keyless entry

UNLOCKING OPERATION



Push

ONCE: Driver door
TWICE: All doors

Carry Smart
Key remote

Front door unlock*

Grasp

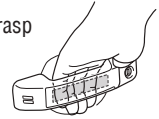

NOTE: If a door is not opened within 60 seconds of unlocking, all doors will relock for safety.

LOCKING OPERATION



Push

Carry Smart
Key remote

All-door lock

Touch



POWER BACK DOOR OPERATION (IF EQUIPPED)



HOLD



Push and hold

POWER BACK LOCL/UNLOCK



Carry Smart
Key remote

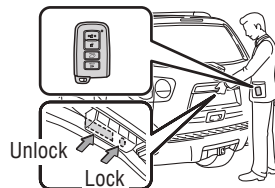

* Driver door unlocking function can be programmed to unlock driver door only, or all doors. Grasping passenger door handle will unlock all doors.

NOTE: Doors may also be locked/unlocked using remote.

PANIC BUTTON



Smart Key system

START FUNCTION

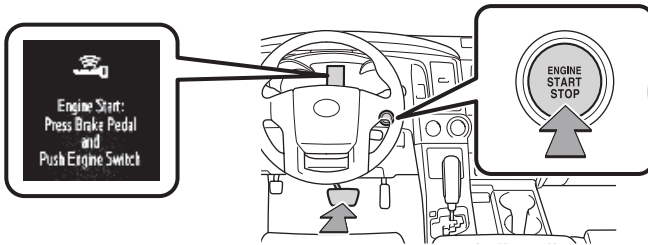

NOTE: The Smart Key must be carried to enable the start function. With the gear shift lever in Park and the brake pedal depressed, push the “ENGINE START STOP” switch.

POWER (WITHOUT STARTING ENGINE)

Without depressing the brake pedal, pressing the engine switch will change the operation mode in succession from:

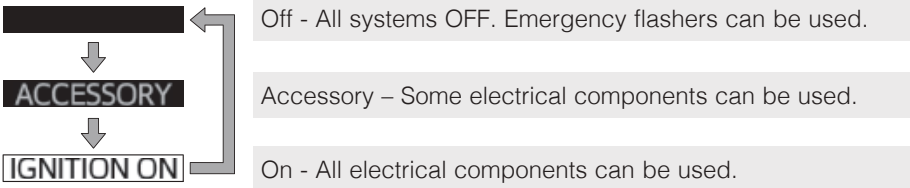

Fuel tank door release & cap

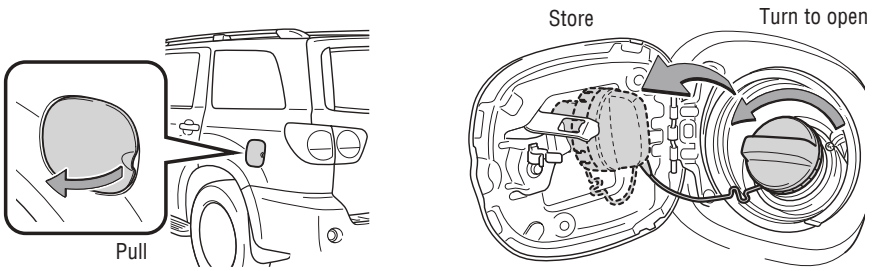

NOTE: To close, tighten until one click is heard. If the cap is not locked or tightened, Check Engine “” indicator may illuminate.

Hood release

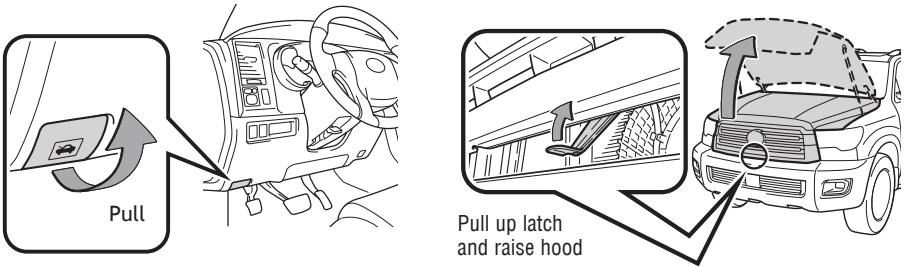

Instrument panel light control

Change brightness level

Short press: 1 step change
Long press: continues change

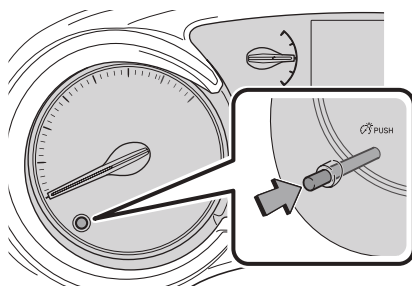

Engine maintenance

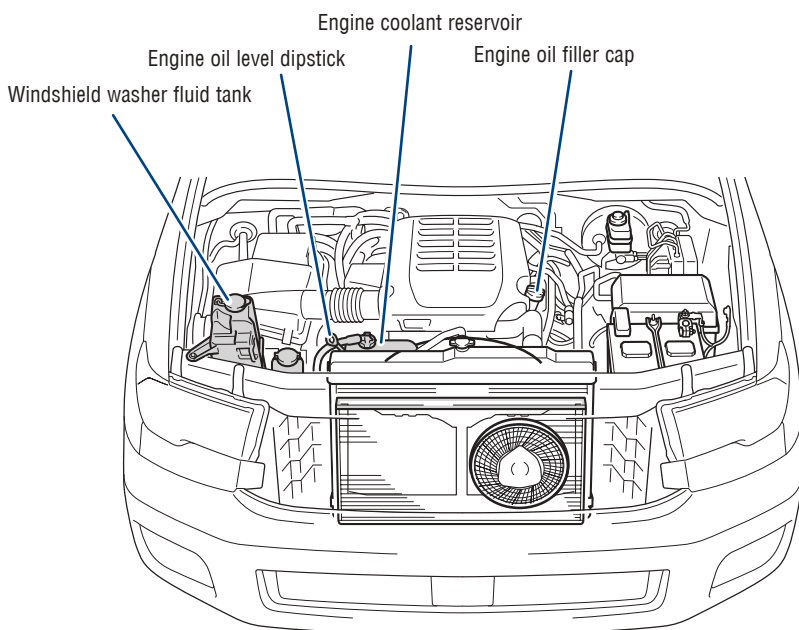

NOTE: Regularly scheduled maintenance, including oil changes, will help extend the life of your vehicle and maintain performance. Please refer to the "Warranty & Maintenance Guide."

FEATURES & OPERATIONS

Automatic transmission

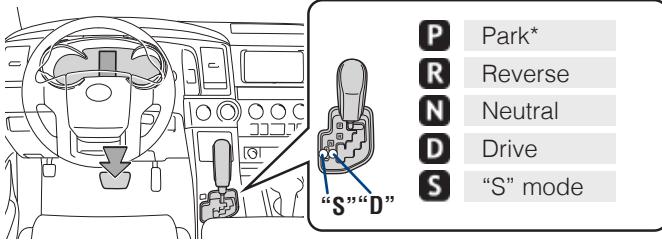

* The engine switch must be in the "IGNITION ON" mode and the brake pedal depressed to shift from Park.

"S" (SEQUENTIAL) MODE

Shift the shift lever to "S" position from "D" position.

- + : Upshift (push and release)
- : Downshift (pull and release)

Downshifting increases power going uphill, or provides engine braking downhill. For best fuel economy during normal driving conditions, always drive with the shift lever in the "D" position.

Auto lock/unlock

Automatic door locks can be programmed to operate in different modes, or turned OFF.

Shift position linked door locking/unlocking function

- Doors lock when shifting from Park.
- Doors unlock when shifting into Park.

Speed linked door locking function

- Doors lock when the vehicle speed goes above approximately 12 mph (20 km/h).

Driver's door linked door unlocking function

- Doors unlock when the engine switch is set from "ON" to "ACC" or "OFF" within 10 seconds of opening the driver's door.

Refer to the Owner's Manual for more details.

Four-wheel drive (if equipped)

FOUR-WHEEL DRIVE CONTROL SWITCH

4LO

4HI

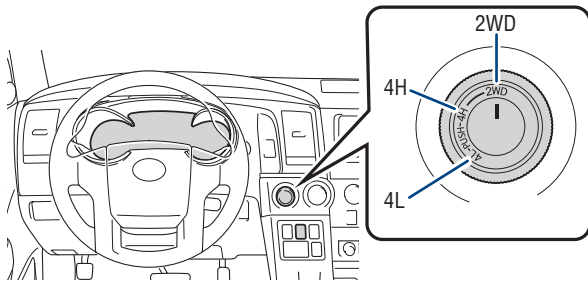

2WD

High speed (2WD)

Turn to "2WD" from "4H" with speed below 62 mph.

4H

High speed (4WD)

Turn to "4H" from "2WD" with speed below 62 mph.

Shift to "N" position when stopped, then turn to "4H" from "4L."

4L

Low speed (4WD)

Shift to "N" position when stopped, then push and turn to "4L" from "4H."

For best fuel economy and performance under normal driving conditions, keep in "2WD" position.

Refer to the Owner's Manual for more details.

CENTER DIFFERENTIAL LOCK/UNLOCK SWITCH

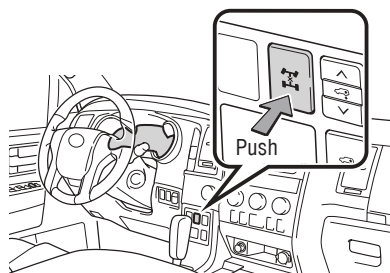

Lock the center differential if the vehicle's wheels get stuck in a ditch or when driving on a slippery or bumpy surface.

Refer to the Owner's Manual for more details on this system before attempting to use it.

Tilt & telescopic steering wheel

MANUAL

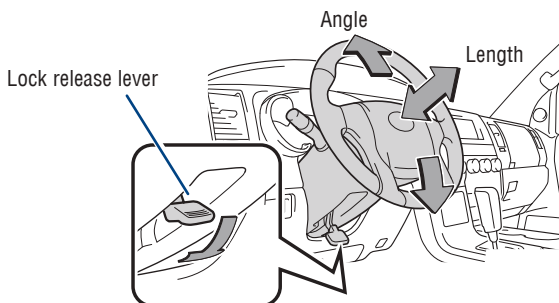

Hold wheel, push lever down, set angle and length and return lever.

POWER

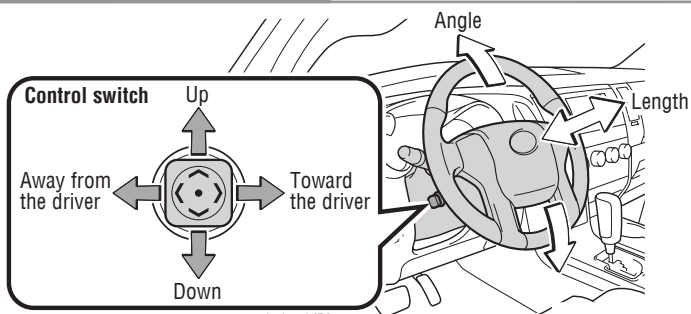

Toggle the control switch to set angle and length.

NOTE: Do not attempt to adjust while the vehicle is in motion.

Steering lock release

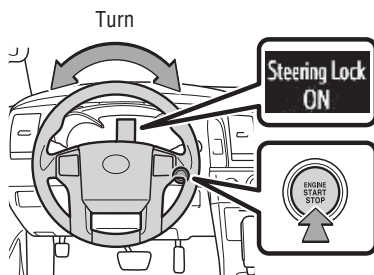

A message will be displayed on the multi-information display.

Check that the shift lever is in P. Press the engine switch while turning the steering wheel left and right.

Cup holders

FRONT

Front console

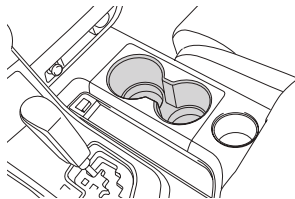

Back of the front console

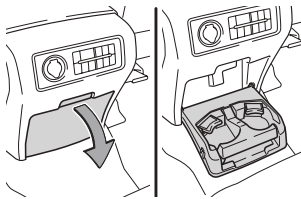

REAR

Rear side trim

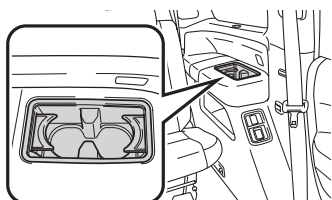

Rear console box (if equipped)

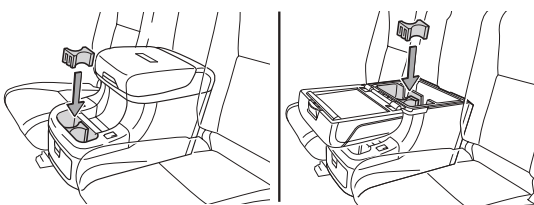

Parking brake

BRAKE

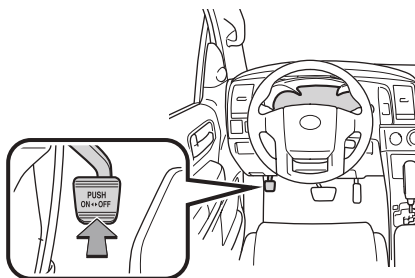

Set: Depress
Release: Depress again

Door locks

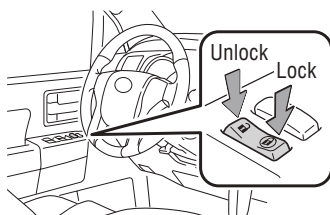

Seat adjustments-Front

POWER SEAT

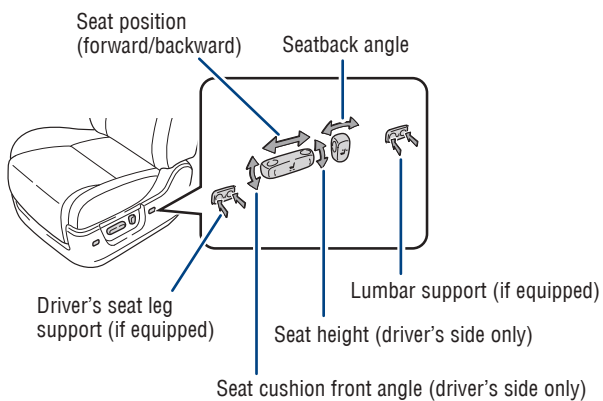

MANUAL SEAT

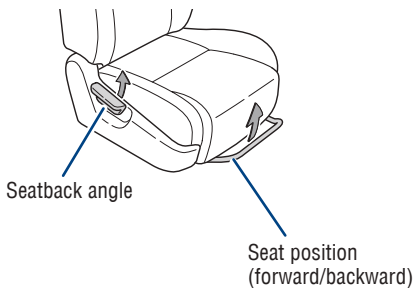

Seat adjustments-Rear

SECOND ROW

Separate seat

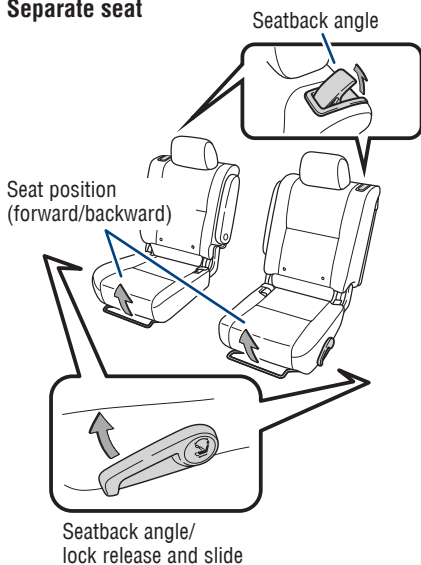

Bench seat

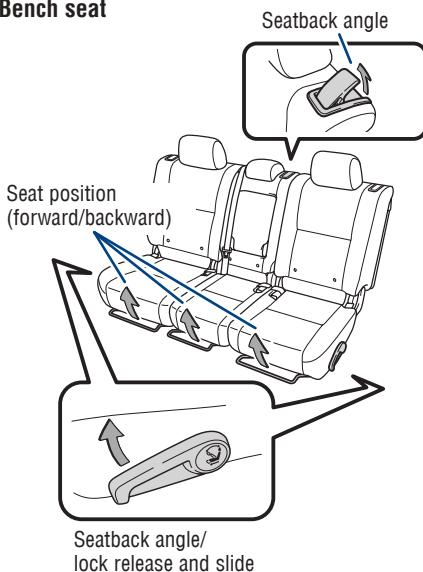

THIRD ROW

Manual seat

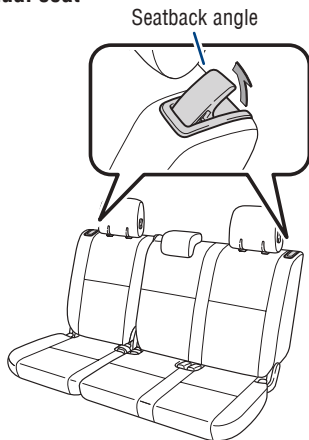

Power seat

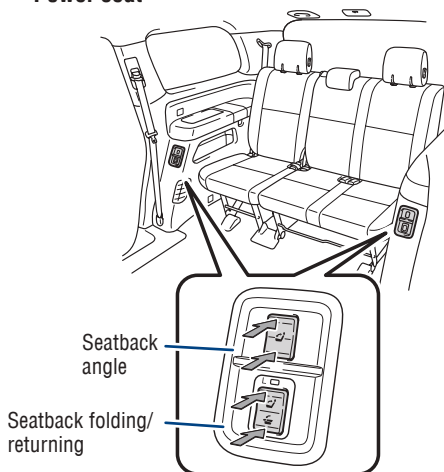

Refer to the Owner's Manual for more details.

FEATURES & OPERATIONS

Seats-Head restraints

Front

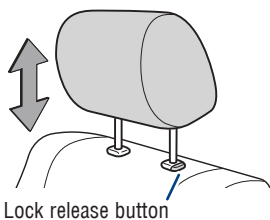

Second row

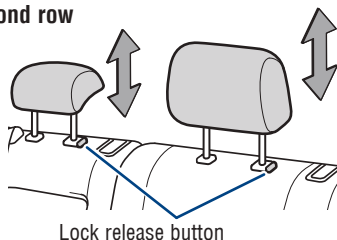

Middle head restraint in 8-passenger models only.

Third row (center)

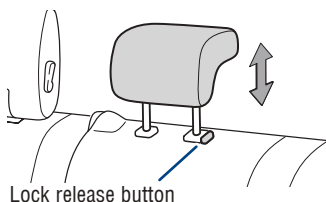

Third row (outside)

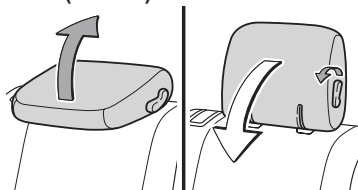

Seats-Folding 2nd row seats

(1)

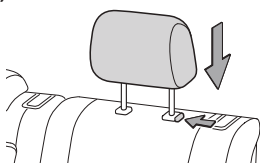

Lower the head restraints.

(2)

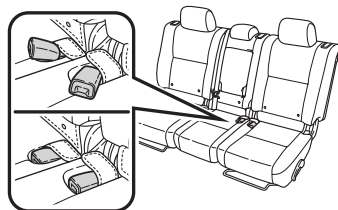

Stow the seat belt buckles.

Separated seat

(3)

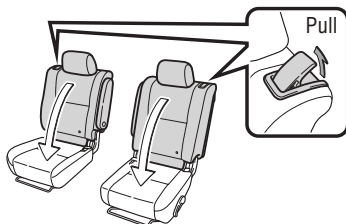

Fold down the seatback.

Bench seat

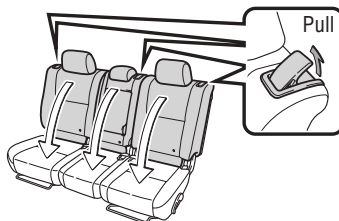

Fold down the seatback.

(4)

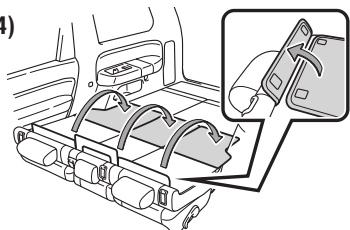

Fold out the board (if equipped) from the seatback.

Seats-Folding 3rd row seats

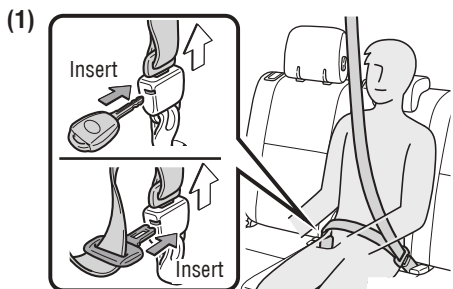

Release the center seat belt tab.

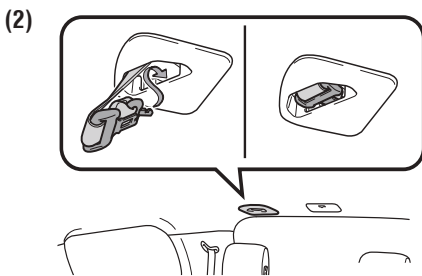

Stow the center seat belt tab.

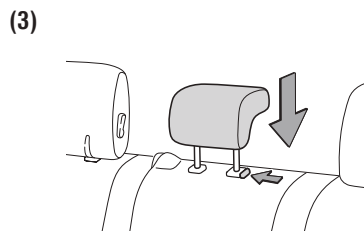

Lower the head restraint.

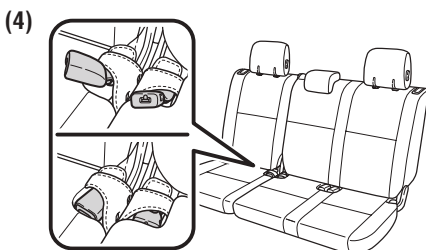

Stow the seat belt buckles.



Fold the head restraint.

(6) From rear door side

Manual seat

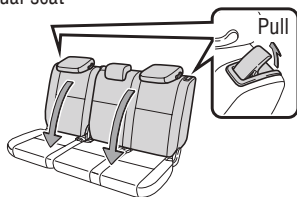

Power seat

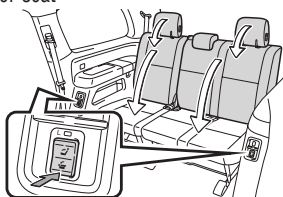

Fold the seats.

From back door side

Manual seat

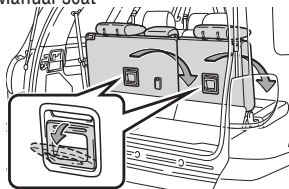

Power seat

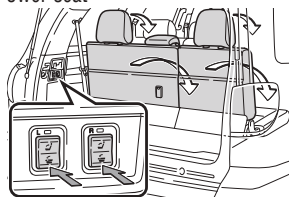

FEATURES & OPERATIONS

Lights & turn signals

HEADLIGHTS

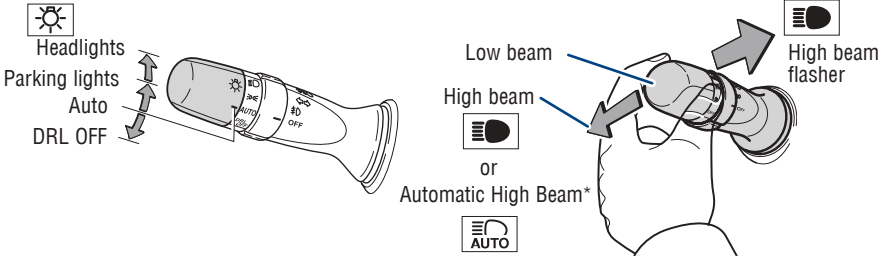

Daytime Running Light system (DRL) Automatically turns on under certain conditions to make vehicle more visible to other drivers. Not for use at night.

Automatic light cut off system Automatically turns lights off after 30 second delay, or the lock switch on remote is pushed after locking.

Automatic High Beam (AHB) system Automatically switches between high and low beams as appropriate to enhance vision at night.

Refer to *Toyota Safety Sense™ P (TSS-P)* in this guide or the *Owner's Manual* for more details on the Automatic High Beam feature.

* Operating conditions must be met. Refer to the *Owner's Manual* for details.

FRONT FOG LIGHTS

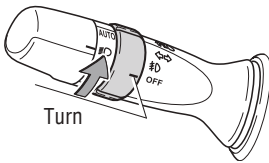

Front fog lights come on only when the headlights are on low beam.

TURN SIGNALS

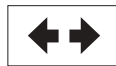
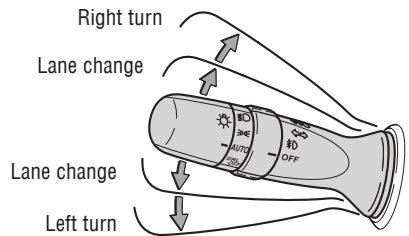

Windshield wipers & washers

FRONT

Type A

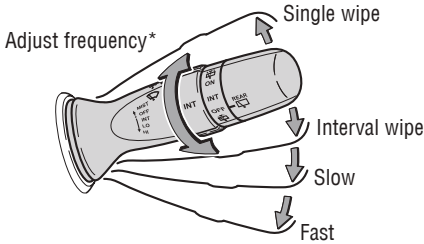

Type B

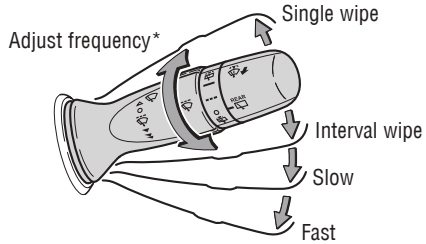

Pull to wash and wipe

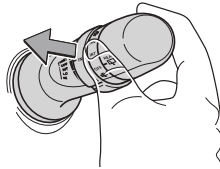

* **Intermittent windshield wiper frequency adjustment** Rotate to increase/decrease wipe frequency.

REAR

Type A

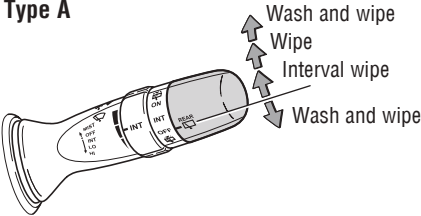

Type B

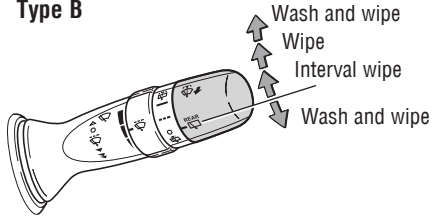

Windows-Power

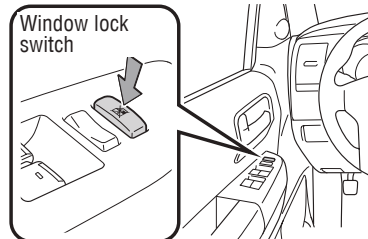
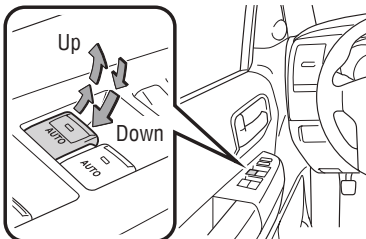

Automatic operation (front windows only) Push the switch completely down or pull it completely up and release to fully open or close. To stop window partway, lightly push the switch in the opposite direction.

Window lock switch Deactivates all passenger windows and back window. Driver's window remains operable.

FEATURES & OPERATIONS

Window-Back door

OPERATING FROM INSIDE

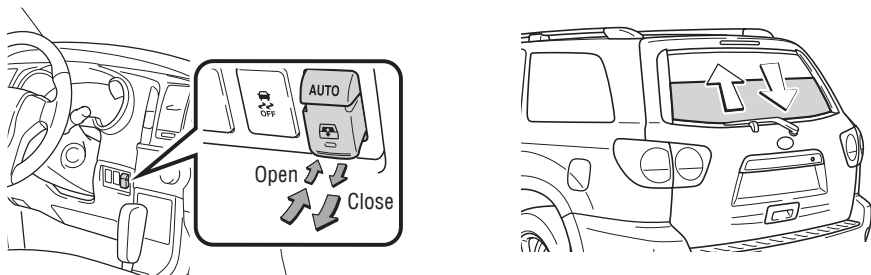

Automatic operation Push the switch completely in or pull it completely out and release to fully open or close. To stop window midway, lightly push the switch in the opposite direction.

OPERATING FROM OUTSIDE

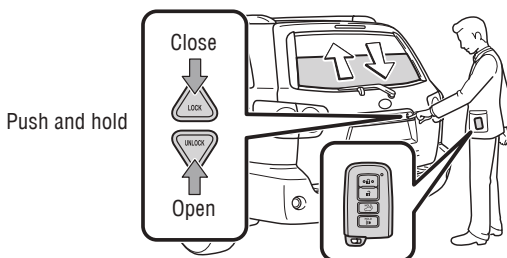

Power back door (if equipped)

Instrument panel

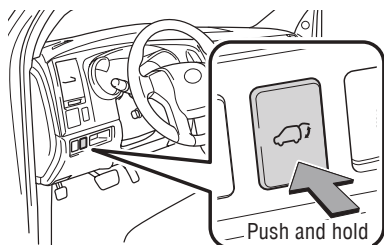

Back door (close only)

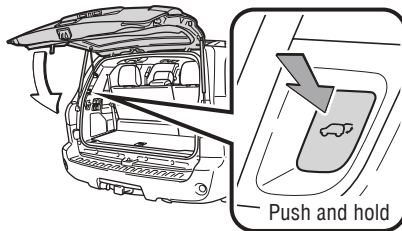

Open: Push and hold
Close: Push and hold again

NOTE: Door will stop closing if obstructed, or to manually stop door closing, push button again.

The power back door can be opened when the engine switch is in "IGNITION ON", and the shift lever is in P/the engine switch is in "ACCESSORY" or "OFF".

NOTE: If battery is disconnected, the power back door needs to be reinitialized. Refer to the Owner's Manual for more details.

Moonroof

SLIDING OPERATION

Push once to open partway; again to open completely.

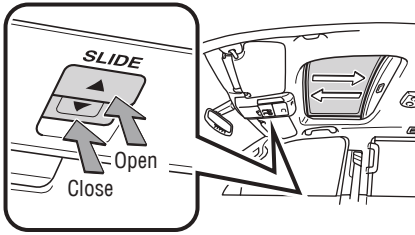

TILTING OPERATION

Push once to open completely.

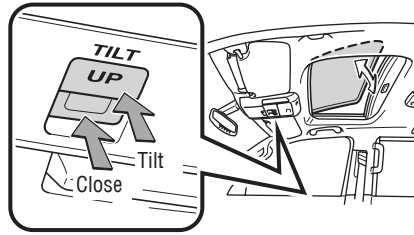

Lightly press either side of the moonroof switch while opening/tilting is in progress, the moonroof stops partway.

Driving position memory (if equipped)

DRIVER'S SEAT

To save

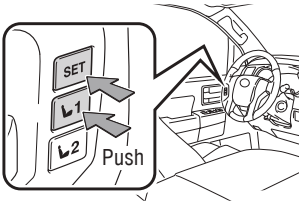

- (1) Adjust driver's seat, steering wheel, and outside rear view mirrors.
- (2) Push "SET" and "1" or "2" buttons to save until buzzer sounds.

To recall

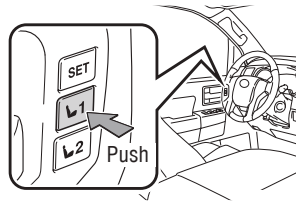

- (1) Press "1" or "2" to recall until buzzer sounds.

You can save up to two driving positions to memory and recall it with the touch of a button. Make sure shift lever is in "P" position and ignition switch is in the "ON" position.

Refer to the Owner's Manual for more details on this system.

Air conditioning/heating

FRONT

Display

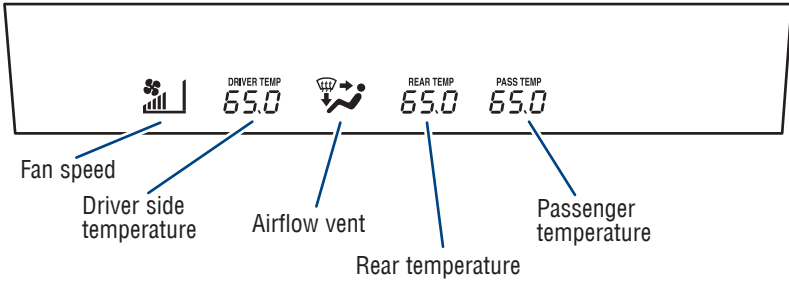

Control panel

Automatic climate control ON

Adjusting the temperature setting will cause the airflow vents, air intake and fan to adjust automatically to set temperature.

“SYNC” button

Indicator ON: Synchronized temperature settings for driver, front passenger and rear seats. *Indicator OFF:* Separate temperature settings for driver, front passenger and rear seats.

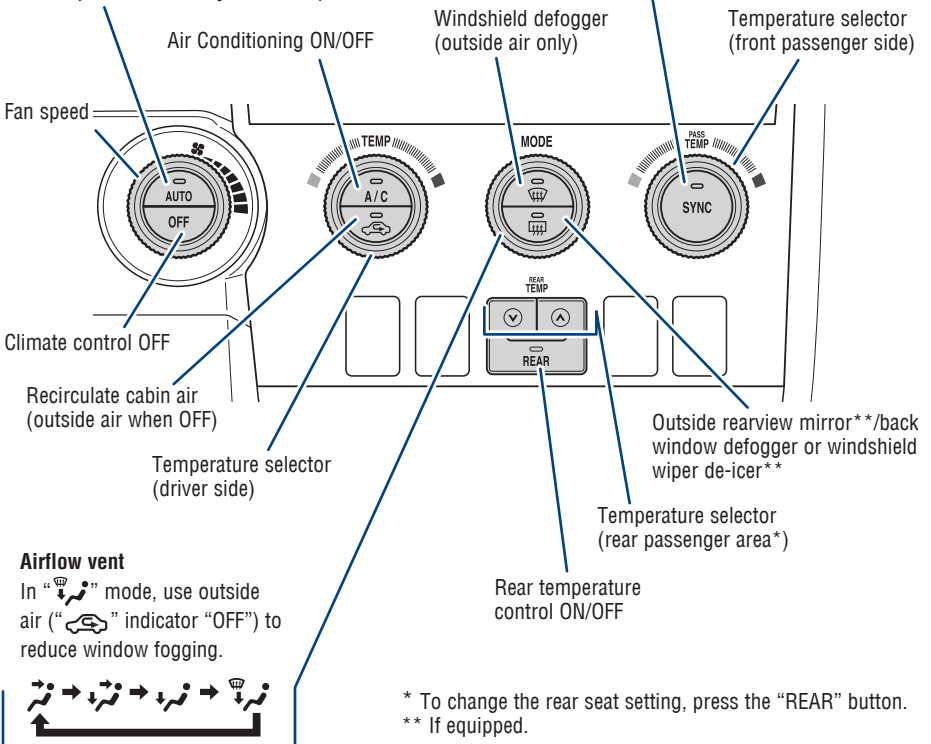

REAR

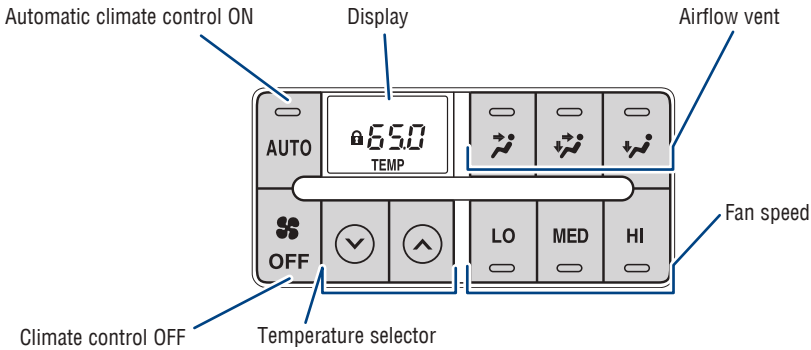

Seat heaters/ventilators (if equipped)

FRONT SEATS

Heaters and ventilators (if equipped)

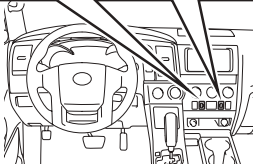
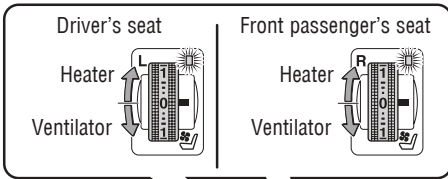

Heaters only (if equipped)

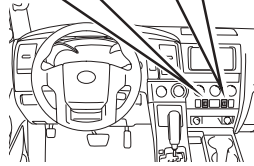
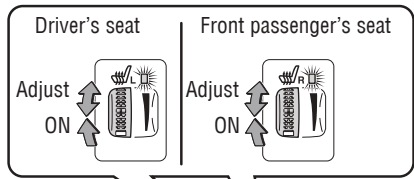

SECOND SEATS (WITH CONSOLE BOX)

High heat setting

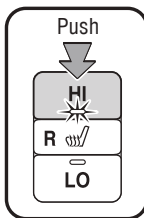

Low heat setting

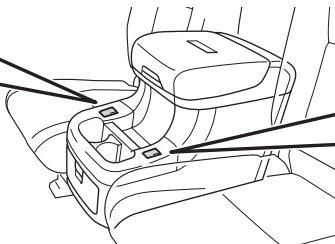
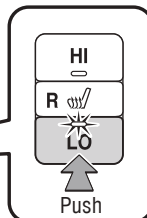

Push lightly in the opposite direction to turn off.

The engine switch must be in the "IGNITION ON" mode for use.

FEATURES & OPERATIONS

Audio

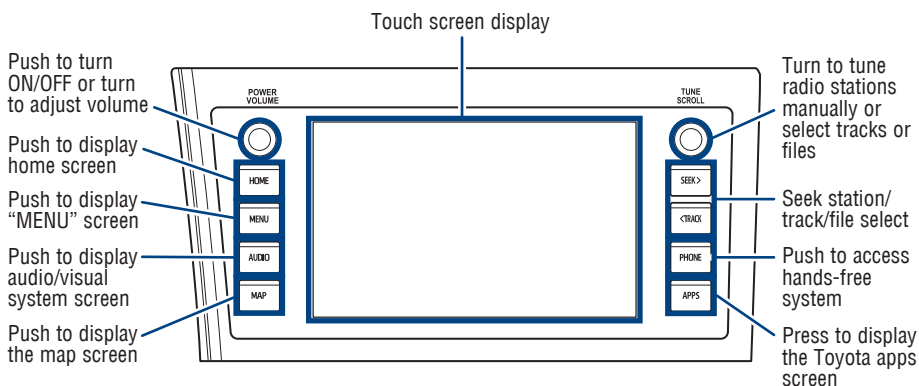

Refer to the "Navigation and Multimedia System Owner's Manual" or visit www.toyota.com/audio-multimedia for additional resources.

USB charge-ports

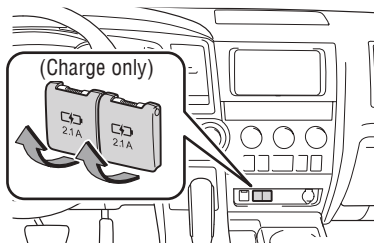

The engine switch must be in the "ACCESSORY" or IGNITION ON mode for use.

USB media port

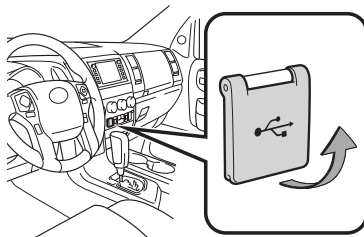

Connecting a compatible device and cable into the USB media port will support charging and music playback through the audio multimedia system.

Steering wheel switches & telephone controls (Bluetooth®)

Steering wheel switches

“ ^ v ”

Use to search within the selected audio feature.

“MODE/HOLD”

Push to turn audio ON and select audio mode. Push and hold to turn the audio off.

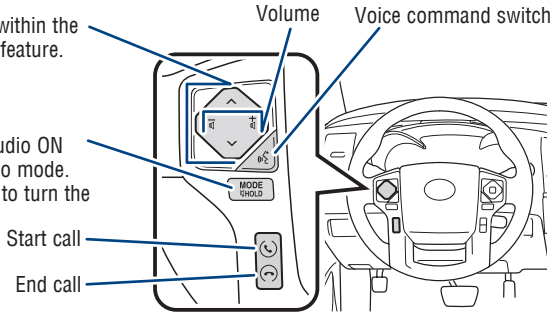

Microphone

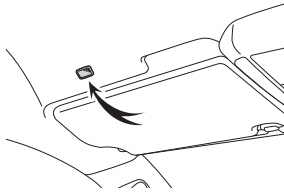

Bluetooth® technology allows dialing or receipt of calls without removing your hands from the steering wheel.

Refer to the Bluetooth® device pairing in this guide or the Navigation and Multimedia System Owner's Manual for additional user instructions.

NOTE: Concentrating on the road should always be your first priority while driving. Do not use the Audio Multimedia System if it will distract you.

Power outlets-120V AC (if equipped)

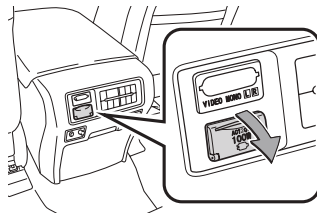

The engine switch must be in the “IGNITION ON” mode for use.

FEATURES & OPERATIONS

Power outlets-12V DC

Instrument panel

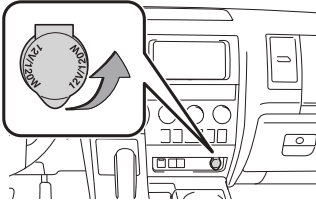

Inside of the center console box

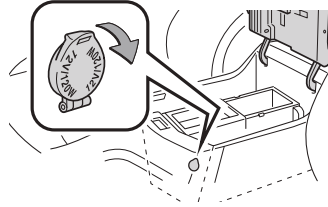

Back of the center console box (if equipped)

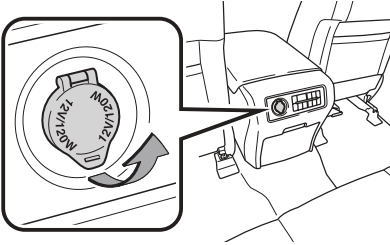

Luggage compartment

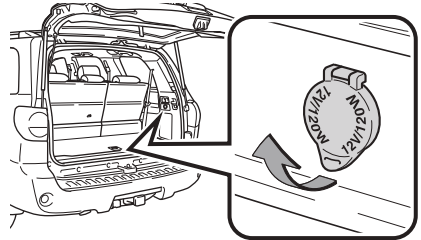

The engine switch must be in the "ACCESSORY" or "IGNITION ON" mode for use.

Rear seat entertainment system (if equipped)

Front audio/visual system

DVD player

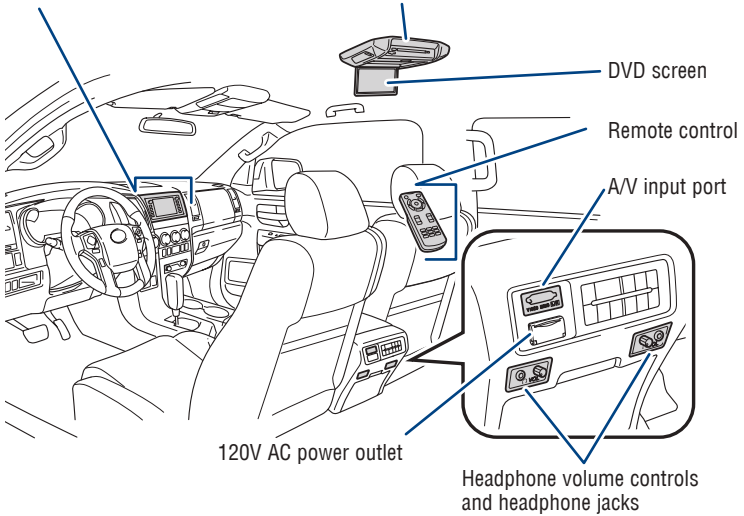

For details, refer to the Navigation and Multimedia System Owner's Manual.

Multi-Information Display (MID)

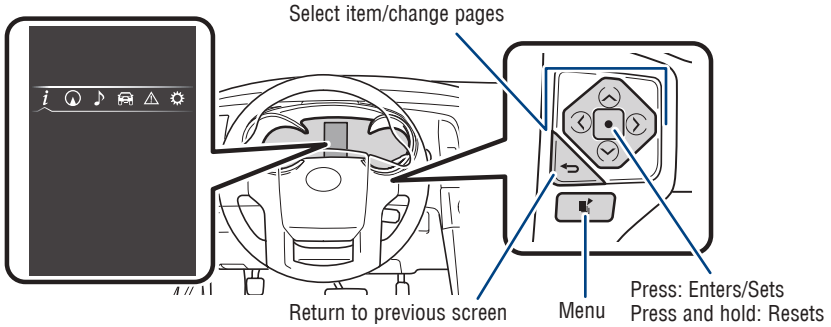

Use the meter control switches on the steering wheel to scroll through the following information screens:



Drive information



Navigation system-linked display (if equipped)



Audio system-linked display



Vehicle information



Warning message display



Settings display

Refer to the Owner's Manual, for more details.

Vehicle Stability Control (VSC) OFF switch

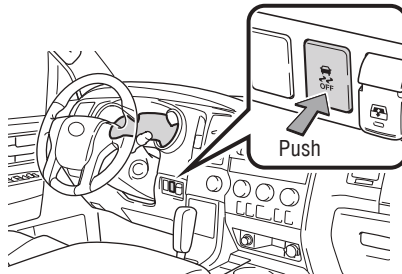

The VSC OFF switch is used to switch between modes related to the TRAC, VSC and AUTO LSD functions.

Refer to the Owner's Manual for limitations and more information.

FEATURES & OPERATIONS

Garage door opener (HomeLink®)*

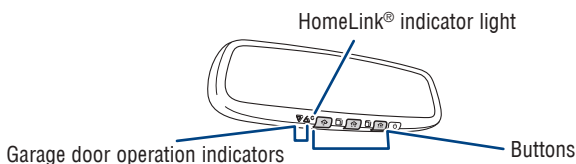

Garage door openers manufactured under license from HomeLink®* can be programmed to operate garage doors, estate gates, security lighting, etc.

Refer to “Garage door opener,” Section 5-4 in the Owner’s Manual for more details.

For programming assistance, contact HomeLink® at 1-800-355-3515, or visit <http://www.homelink.com/toyota>.

* HomeLink® is a registered trademark of Gentex Corporation.

Rear view monitor system

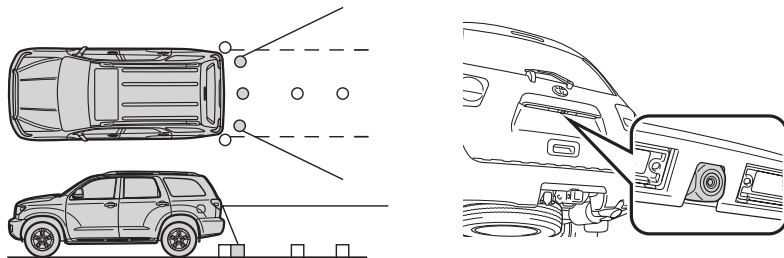

The rear view monitor system displays an image of the view from the bumper of the rear area of the vehicle. The camera for the rear view monitor system is located above the license plate.

To adjust the image on the rear view monitor screen, press the “MENU” button and select “Display”. Select “Camera” to adjust the screen contrast and brightness.

Refer to the Owner’s Manual for limitations and more details on this system.

Blind Spot Monitor with Rear Cross Traffic Alert (BSM w/RCTA)

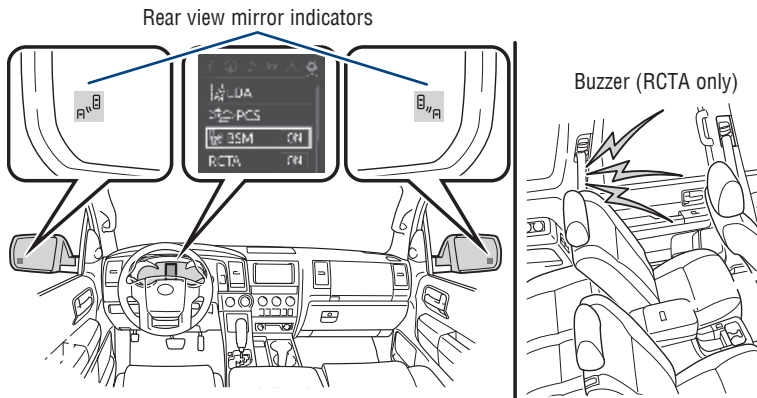

The Blind Spot Monitor is a system that has two functions:

- The Blind Spot Monitor function (assists the driver in making the decision when to change lanes)
- The Rear Cross Traffic Alert function (assists the driver when backing up)

The system is designed to use radar sensors to detect vehicles traveling in the Sequoia's blind spot. If a vehicle is detected, the driver will be alerted via the outside rear view side mirror indicators.

Rear Cross Traffic Alert function:

While in reverse, when a vehicle approaching from the right or left rear of the vehicle is detected, the outside rear view mirror indicators flash.

Refer to the Owner's Manual for limitations and more details on this system before attempting to use it.

TOW/HAUL switch

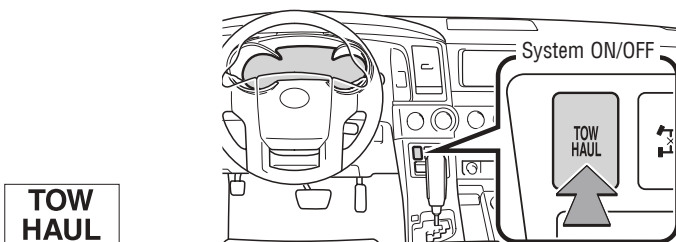

"TOW/HAUL" mode can be used when carrying or towing heavy loads. As fuel economy is reduced while in "TOW/HAUL" mode, deactivating when driving without a load is recommended.

Refer to the Owner's Manual for more details on this system before attempting to use it.

FEATURES & OPERATIONS

Electronically modulated air suspension (If equipped)

The electronically modulated air suspension allows the driver to control the vehicle's height in order to adjust for driving conditions. Select the desired height with the height control switch.

HEIGHT CONTROL SWITCH

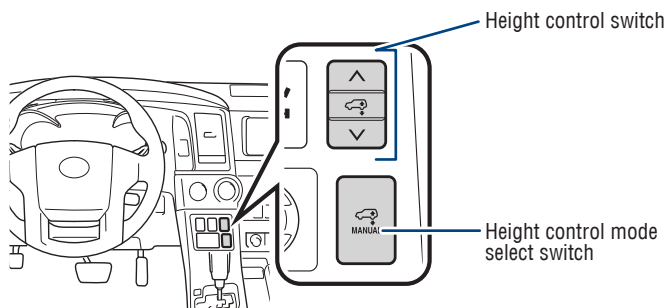

SELECTING VEHICLE HEIGHT

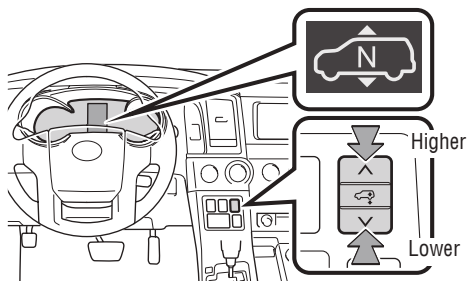

Vehicle height can be adjusted only when the engine is running. The selected height mode will be shown on the electronically modulated air suspension display. The selected mode will flash while the height mode is being change.

“N” mode (normal mode): For ordinary driving

“HI” mode (high mode): For driving on bumpy roads 1.2 in. (30 mm) higher than the normal height

“LO” mode (low mode): For the ease of egress/ingress and loading luggage 1.2 in. (30 mm) lower than the normal height

Refer to the Owner's Manual for limitations and more details on this system.

Intuitive parking assist

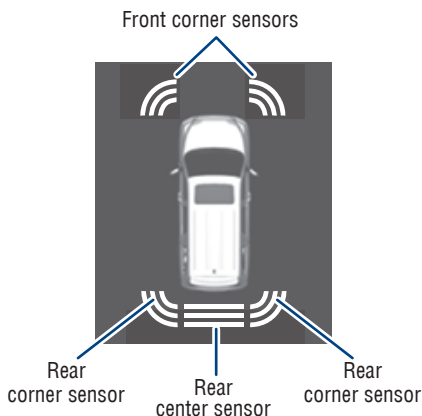
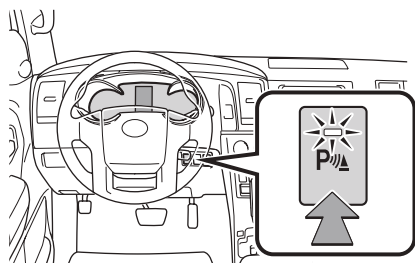

The parking assist sonar system operates when the vehicle approaches an obstacle. The distance from your vehicle to nearby obstacles when parallel parking or maneuvering into a garage is measured by sensors and communicated via the Multi-Information Display (MID) and audible beeps.

When the sensor detects an obstacle, the direction of and the approximate distance to the obstacle are displayed on the MID display by illuminating continuously (far) or blinking (near), and beeping sounds will switch from intermittent to continuous as you approach and get closer to a detected obstacle. When the sensors detect two or more obstacles, the audible alerts will respond to the nearest zone.

Always check the surrounding area when using this system.

Refer to the Owner's Manual for limitations and more details.

AVS (Adaptive Variable Suspension System) (If equipped)

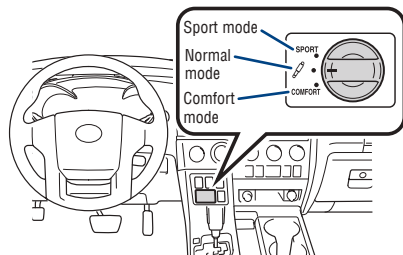

AVS controls the suspension according to the road and driving conditions. Selecting an optimum driving mode allows good vehicle posture and steering wheel operation.

Sport mode: For winding mountain road driving or high speed driving.

Normal mode: For ordinary driving.

Comfort mode: For driving on a bumpy road.

Refer to the Owner's Manual for limitations and more details on this system.

Quick overview-Toyota Safety Sense™ P (TSS-P)

Toyota Safety Sense™ P (TSS-P) is a set of active safety technologies designed to help mitigate or prevent collisions across a wide range of traffic situations, in certain conditions. TSS-P is designed to help support the driver's awareness, decision making and vehicle operation contributing to a safe driving experience.

Refer to the Owner's Manual for operation, setting adjustments, limitations and more details to understand these functions and complete safety precautions. For more information, please go to <http://www.toyota.com/safety-sense>



Pre-Collision System with Pedestrian Detection (PCS w/PD)

PCS w/PD is designed to provide alert, mitigation, and/or avoidance support in certain conditions, when the system detects a potential collision with a preceding vehicle is likely to occur.

The advanced millimeter-wave radar sensor system is designed to work with the camera sensor to help recognize a preceding pedestrian, and provide an alert, mitigation and/or avoidance support in certain conditions.



Lane Departure Alert (LDA)

LDA is designed to provide notification when the system detects an unintended lane departure.



Dynamic Radar Cruise Control (DRCC)

DRCC is designed to help maintain a pre-set distance to a preceding vehicle when the preceding vehicle is traveling at a lower speed.



Automatic High Beams (AHB)

AHB is designed to detect the headlights of oncoming vehicles and the tail lights of preceding vehicles and switch between high beams and low beams as appropriate.

Sensors

TSS-P combines an in-vehicle camera mounted in front of the inside rear view mirror and a millimeter-wave radar mounted in the front grille. These sensors support the driver assist systems.

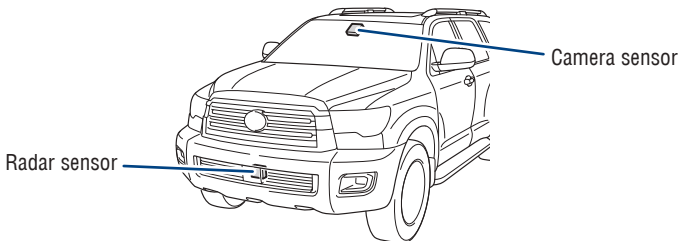

Pre-Collision System with Pedestrian Detection (PCS w/PD)

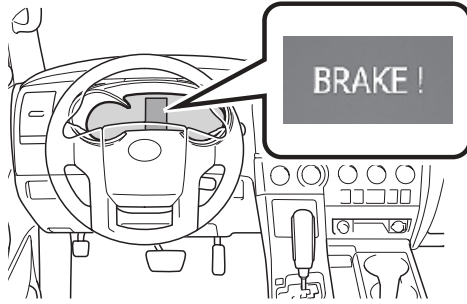

The Pre-Collision System uses a radar sensor and camera sensor to help detect a vehicle or pedestrian in front of your vehicle.

As there is a limit to the degree of recognition accuracy and control performance that this system can provide, do not overly rely on this system. This system will not prevent collisions or lessen collision damage or injury in every situation. Do not use PCS instead of normal braking operations under any circumstances. Do not attempt to test the operation of the pre-collision system yourself, as the system may not operate or engage, possibly leading to an accident. In some situations, such as when driving in inclement weather such as heavy rain, fog, snow or a sandstorm or while driving on a curve and for a few seconds after driving on a curve, a vehicle or pedestrian may not be detected by the radar and camera sensors, preventing the system from operating or engaging properly.

Refer to the Toyota Owner's Manual for a list of additional situations in which the system may not operate properly.

Pre-Collision Warning

When the system determines that the possibility of a frontal collision is high, a buzzer will sound and a warning message will be displayed on the Multi-Information Display (MID) to urge the driver to take evasive action.

Pre-Collision Brake Assist

If the driver notices the hazard and brakes, the system may provide additional braking force using Brake Assist. This system may prime the brakes and may apply greater braking force in relation to how strongly the brake pedal is depressed.

Pre-Collision Braking

If the driver does not brake in a set time and the system determines that the possibility of a frontal collision with a preceding vehicle is extremely high, the system may automatically apply the brakes, reducing speed in order to help the driver reduce the impact and in certain cases avoid the collision.

Suspension Control

When the system determines that the possibility of a frontal collision is high, the Adaptive Variable Suspension System will control the damping force of the shock absorbers to help maintain an appropriate vehicle posture.

Refer to the Toyota Owner's Manual for additional information on PCS w/PD operation, settings adjustments, limitations, and precautions before attempting to use it.

TOYOTA SAFETY SENSE™

PCS PEDESTRIAN DETECTION

Under certain conditions, the PCS system included with the TSS-P package may also help to detect a pedestrian in front of your vehicle using the in-vehicle camera and front grille-mounted radar. The in-vehicle camera of PCS detects a potential pedestrian based on size, profile, and motion of the detected pedestrian. However, a pedestrian may not be detected depending on the conditions, including the surrounding brightness and the motion, posture, size, and angle of the potential detected pedestrian, preventing the system from operating or engaging.

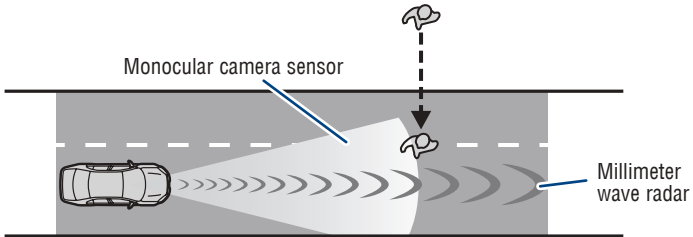



As part of the Pre-Collision System, this function is also designed to first provide an alert and then automatic braking if needed.

Refer to the Toyota Owner's Manual for additional limitations and information.

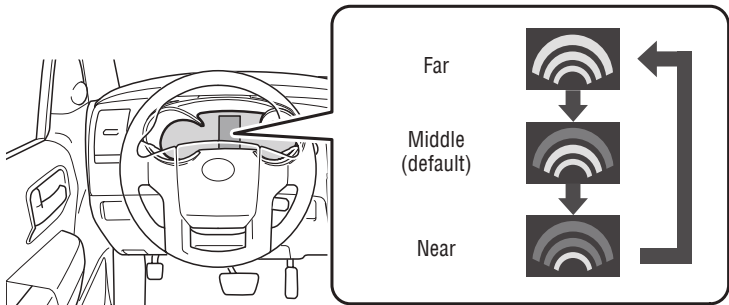
CHANGING PCS ALERT TIMING





- (1) Press “<” or “>” of meter control switches and select .
- (2) Press “^” or “v” of meter control switches and select “PCS”, and press .
- (3) Press “^” or “v” of meter control switches and select “Sensitivity”, and press  to select the desired setting.

Note: PCS is enabled each time the engine switch is turned to Ignition On. The system can be disabled/enabled and the alert timing of the system can be changed. (Alert timing only, brake operation remains the same).

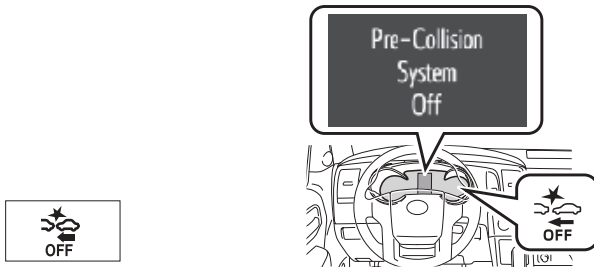
DISABLING PRE-COLLISION SYSTEM (PCS)



- (1) Press “<” or “>” of meter control switches and select .
- (2) Press “^” or “v” of meter control switches and select “PCS”, and press .
- (3) Press “^” or “v” of meter control switches and select “PCS”, and press  to select the desired setting (on/off).

Note: The system is enabled each time the power switch is turned to ON mode.

Refer to the Toyota Owner's Manual for additional information on PCS operation, settings adjustments, limitations, and precautions before attempting to use it.

Lane Departure Alert (LDA)

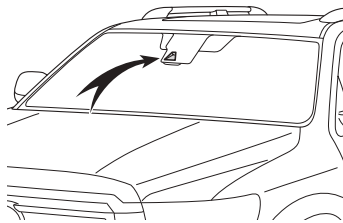

LDA in TSS-P uses an in-vehicle camera designed to detect visible white and yellow lane markers in front of the vehicle and the vehicle's position on the road. If the system determines that the vehicle is starting to unintentionally deviate from its lane, the system alerts the driver with an audio and visual alert. When the alerts occur, the driver must check the surrounding road situation and carefully operate the steering wheel to move the vehicle back to the center part of their lane.

LDA is designed to function at speeds of approximately 32 mph (50 km/h) or higher on relatively straight roadways.

TOYOTA SAFETY SENSE™

TURNING THE LDA SYSTEM ON/OFF



Press the LDA switch to turn the LDA system on. Depress again to turn it off.

Note: The system will continue in the last state it was in (ON or OFF) when the engine is started again.

Refer to the Toyota Owner's Manual for additional information on LDA operation, settings adjustments, limitations, and precautions before attempting to use it.

LANE DEPARTURE ALERT

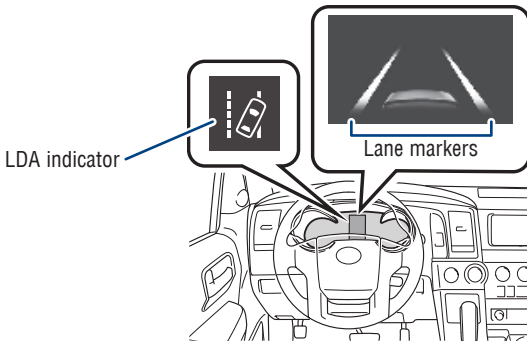

Lane Departure Alert (LDA) indicator flashes orange when operating.



LANE DEPARTURE ALERT (CONTINUED)

The LDA function  displays when the Multi-Information Display (MID) is switched to the driving assist system information screen.

(1) The system displays solid white lines on the LDA indicator when visible lane markers on the road are detected. A side flashes orange to alert the driver when the vehicle deviates from its lane.

(2) The system displays outlines on the LDA indicator when lane markers on the road are not detected or the function is temporarily cancelled.

Note: When operation conditions are no longer met, a function may be temporarily canceled. However, when the operation conditions are met again, operation of the function is automatically restored. For example, LDA may not function on the side(s) where white/yellow lines are not detectable.



Refer to the Toyota Owner's Manual for additional information on LDA operation, settings adjustments, limitations, and precautions before attempting to use it.

ADJUSTING LDA ALERT SENSITIVITY

The driver can adjust the sensitivity of the LDA (warning) function from the Multi-Information Display (MID) customization screen.

High - Is designed to warn approximately before the front tire crosses the lane marker.

Normal - Is designed to warn approximately when the front tire crosses the lane marker.

- (1) Press “<” or “>” of meter control switches and select .
- (2) Press “^” or “v” of meter control switches and select “LDA”, and press .
- (3) Press “^” or “v” of meter control switches and select “Sensitivity”, and press  to select the desired setting.

SWAY WARNING SYSTEM



Continuous lane deviations from swaying.





Gentle swaying from driver's inattentiveness.



Acute steering wheel operation after the number of operations decrease due to driver's inattentiveness.



SWS is a function of LDA and is designed to detect swaying based on the vehicle location in the lane and the driver's steering wheel operation. To help prevent swaying, the system alerts the driver using a buzzer sound and a warning displays in the MID.

DISABLING LDA SWAY WARNING SYSTEM

- (1) Press “<” or “>” of meter control switches and select .
- (2) Press “^” or “v” of meter control switches and select “LDA”, and press .
- (3) Press “^” or “v” of meter control switches and select “Sway Warning”, and press  to select the desired setting.

Note: Operation of the LDA system and setting adjustments continues in the same condition regardless of ignition cycle until changed by the driver or the system is reset.

ADJUSTING SWAY ALERT SENSITIVITY

- (1) Press “<” or “>” of meter control switches and select .
- (2) Press “^” or “v” of meter control switches and select “LDA”, and press .
- (3) Press “^” or “v” of meter control switches and select “Sway Warning Sensitivity”, and press  to select the desired setting.

Dynamic Radar Cruise Control (DRCC)

DRCC helps maintain a pre-set distance to a preceding vehicle when the preceding vehicle is traveling at a lower speed. This mode is always selected first when the cruise control button is depressed. Constant speed cruise control mode is also available. DRCC is designed to function at speeds between approximately 30 to 110 MPH and is intended for highway use.

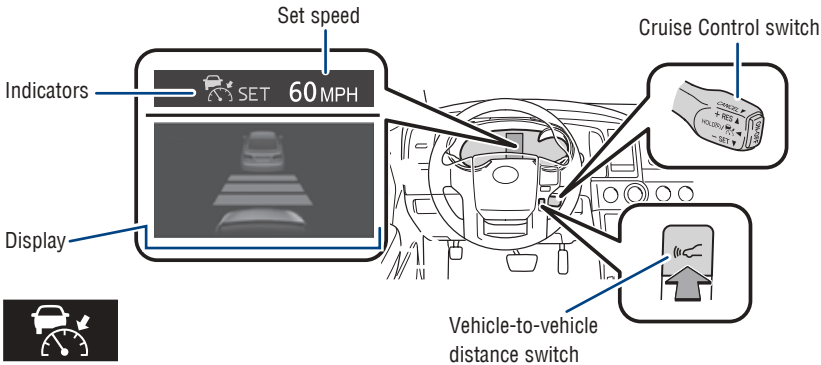

TURNING SYSTEM ON/OFF

- (1)
-
- Push once: On
Push twice: Off

Refer to page 43 for switching to Constant Speed (Cruise) Control Mode.

ADJUSTING SET SPEED

- (2)
-
- Cancel¹
Resume²
Set
- (3)
-
- Increase speed
Decrease speed

Vehicle will cruise at a set speed, decelerate to maintain selected distance from a slower vehicle traveling in front and accelerate back up to the selected speed if the vehicle in front changes lanes or speeds up.

- (1) Push the ON-OFF button. The “RADAR READY” and “” indicator will come on.
 (2) Push the lever down to SET speed, push it up to Resume and pull it or depress brake to Cancel.
 (3) Push up to increase the set speed, push down to decrease (1 mph [1.6 km/h] or 1 km/h [0.6 mph] increments).

¹ The set speed may also be cancelled by depressing the brake pedal.

² The set speed may be resumed once vehicle speed exceeds 25 mph.

ADJUSTING DISTANCE

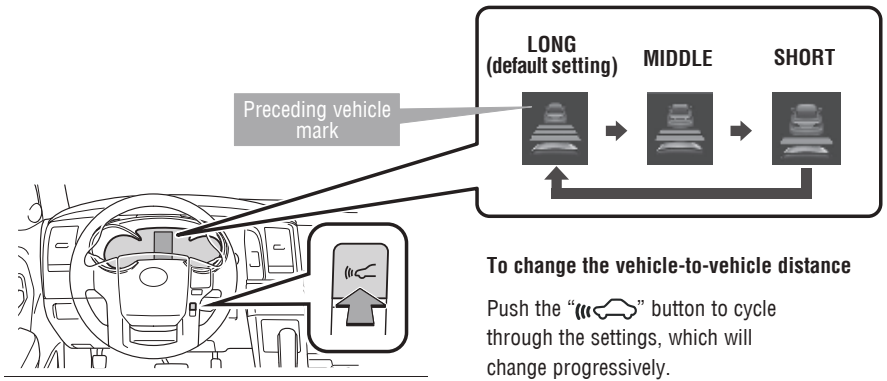

This mode employs a radar sensor to detect the presence of a preceding vehicle up to approximately 328 ft (100 m) ahead, determines the current vehicle-to-vehicle following distance and operates to maintain a preset following distance from the vehicle ahead. These distances vary based on vehicle speed.

Note: Vehicle-to-vehicle distance will close in when traveling on long downhill slopes.

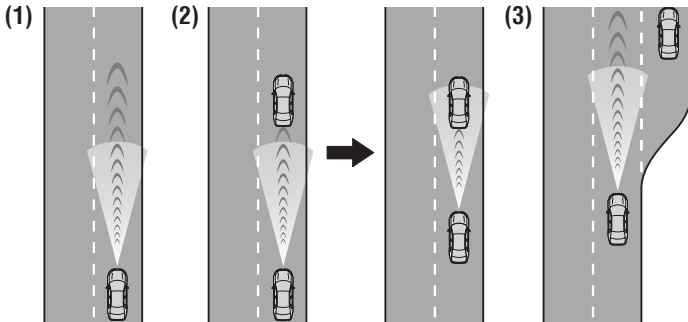

(1) Constant speed cruising when there are no vehicles ahead

The vehicle travels at the speed set by the driver. The desired vehicle-to-vehicle distance can also be set by operating the vehicle-to-vehicle distance control.

(2) Deceleration cruising and follow-up cruising when a preceding vehicle driving slower than the set speed appears

When a vehicle is detected running ahead of you, the system automatically decelerates your vehicle. When a greater reduction in vehicle speed is necessary, the system applies the brakes (the brake lights will come on at this time). The system will respond to changes in the speed of the vehicle ahead in order to maintain the vehicle-to-vehicle distance set by the driver. A warning tone warns you when the system cannot decelerate sufficiently to prevent your vehicle from closing in on the vehicle ahead.

ADJUSTING DISTANCE (CONTINUED)

(3) Acceleration when there are no longer any preceding vehicles driving slower than the set speed

The system accelerates until the set speed is reached. The system then returns to constant speed cruising.

Note: When your vehicle is too close to a vehicle ahead, and sufficient automatic deceleration via the cruise control is not possible, the display will flash and the buzzer will sound to alert the driver. An example of this would be if another driver cuts in front of you while you are following a vehicle. Depress the brake pedal to ensure an appropriate vehicle-to-vehicle distance.

SWITCHING TO CONSTANT SPEED (CRUISE) CONTROL MODE

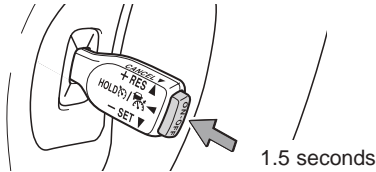

If you are already using DRCC , push ON-OFF button to turn the system off first, then push and hold ON-OFF button for at least 1.5 seconds to switch.

Note: When the engine is turned off, it will automatically default to DRCC.

SETTING CONSTANT SPEED (CRUISE) CONTROL

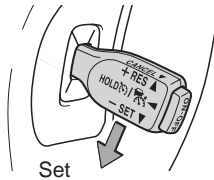

To adjust speed or cancel, see steps (2) and (3) of ADJUSTING SET SPEED on page 41.

Refer to the Toyota Owner's Manual for additional information on DRCC operation, settings adjustments, limitations, and precautions before attempting to use it.

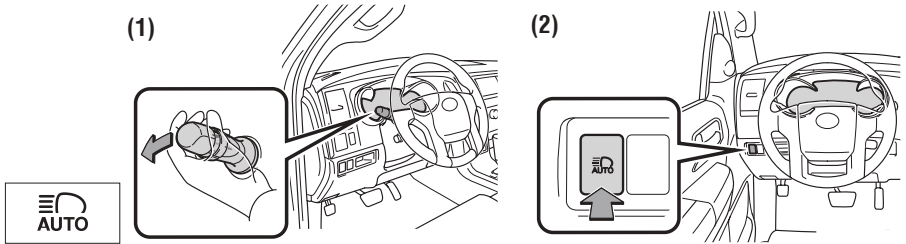

Automatic High Beams (AHB)



AHB is a safety system designed to help drivers see more of what's ahead at nighttime while reducing glare for oncoming drivers. When enabled, AHB uses an in-vehicle camera to help detect the headlights of oncoming vehicles and tail lights of preceding vehicles, then automatically switches between high and low beams as appropriate to provide the most light possible and enhance forward visibility. By using high beams more frequently, the system may allow earlier detection of pedestrians and obstacles.



Refer to the Toyota Owner's Manual for additional information on AHB operation, settings adjustments, limitations, and precautions before attempting to use it.

ACTIVATING THE AHB SYSTEM

- (1) With the engine switch in IGNITION ON mode, turn the headlight switch to  or "AUTO" position.
- (2) Push lever away from you.
- (3) Press the  switch.

The AHB indicator will come on when the headlights are turned on automatically to indicate that the system is active.

Note: Pull the lever back toward you, press the AHB switch to turn the AHB system off.

The AHB indicator will turn off. To turn switch to  position and the manual high beam indicator  turns on.

CONDITIONS WHERE AHB WILL TURN ON/OFF AUTOMATICALLY

When all of these conditions are met, high beams will be automatically turned on (after approximately 1 second):

- Vehicle speed is above approximately 21 mph (34 km/h.)
- The area ahead of the vehicle is dark.
- There are no oncoming or preceding vehicles with headlights or tail lights turned on.
- There are few street lights on the road ahead.

If any of these conditions occur, the system is designed to automatically turn off high beams:

- Vehicle speed drops below approximately 17 mph (27 km/h.)
- The area ahead of the vehicle is not dark.
- Oncoming or preceding vehicles have headlights or tail lights turned on.
- There are many streetlights on the road ahead.

Tire Pressure Monitoring (warning) System (TPMS)

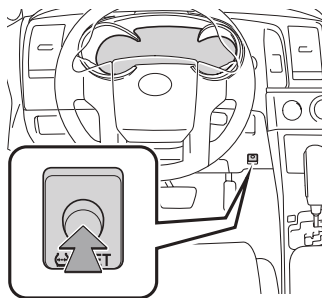

System reset initialization

1. Push and hold “ SET” button until the indicator blinks three times.
2. Wait a few minutes to allow initialization to complete.

After adjusting tire pressures, or after tires have been rotated or replaced, turn the ignition switch to “ON” and press and hold the “ SET” button until indicator blinks three times. Let the vehicle sit for a few minutes to allow initialization to complete.

Refer to the load label on the door jamb or the Owner's Manual for tire inflation specifications.

If the tire pressure indicator flashes for more than 60 seconds and then remains on, take the vehicle to your local Toyota dealer.

NOTE: The warning light may come on due to temperature changes or changes in tire pressure from natural air leakage. If the system has not been initialized recently, setting the tire pressures to factory specifications should turn off the light.

Seat belts

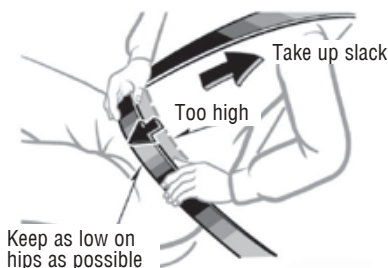

NOTE: If a passenger's seat belt is fully extended, then retracted even slightly, the Automatic locking retractor (ALR) will prevent it from being re-extended beyond that point, unless fully retracted again. This feature is used to help hold child restraint systems securely.

To find more information about seat belts, and how to install a child restraint system, refer to the Owner's Manual.

SAFETY & EMERGENCY FEATURES

Rear door child safety locks

Rear door

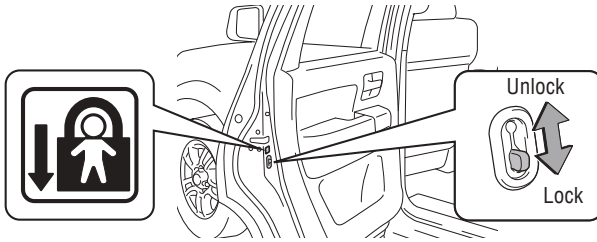

Moving the lever downward will allow the door to be opened only from the outside.

Safety Connect (if equipped)

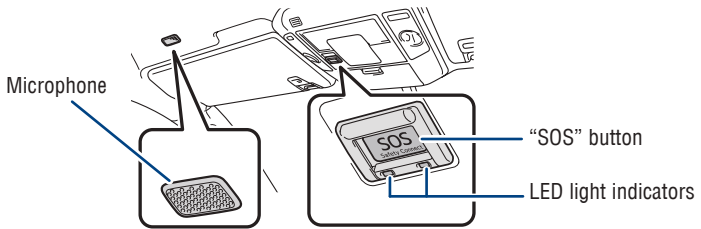

Safety Connect is a subscription-based telematics service that uses Global Positioning System (GPS) data and embedded cellular technology to provide safety and security features to subscribers. Safety Connect is staffed with live agents at the Toyota response center, which operates 24 hours per day, 7 days per week.

Services for subscribers include:

- Automatic collision notification
- Stolen vehicle locator
- Emergency assistance ("SOS" button)
- Enhanced roadside assistance

For additional information refer to the "Owner's Manual" or visit www.Toyota.com/connected-services.

Seat belts-Shoulder belt anchor

Squeeze lock release to lower

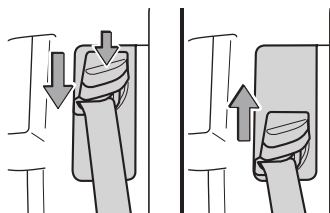

Spare tire & tools

SPARE TIRE, JACK AND TOOL LOCATION

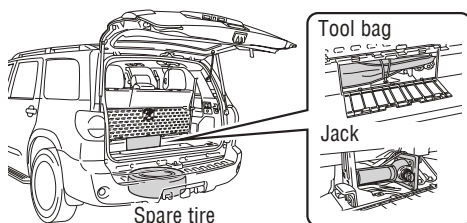

REMOVING THE SPARE TIRE

(1)

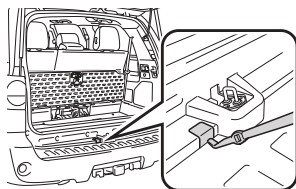

Remove the cover.

(2)

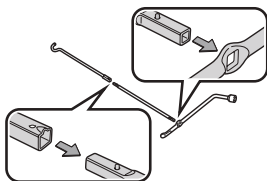

Assemble the jack handle.

(3)

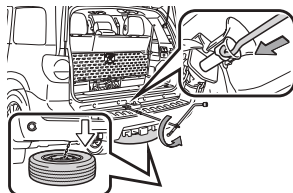

Insert the jack handle extension into the lowering screw. Lower the spare tire completely to the ground.

Refer to the Owner's Manual for tire changing and jack positioning procedures.

SAFETY & EMERGENCY FEATURES

Star Safety System™

Your vehicle comes standard with the Star Safety System™, which combines Anti-lock Braking System (ABS), Brake Assist (BA), Electronic Brake-force Distribution (EBD), Smart Stop Technology (SST), Traction Control (TRAC) and Vehicle Stability Control (VSC).

Refer to the Owner's Manual for more details and important information on limitations to these systems.

ANTI-LOCK BRAKE SYSTEM (ABS)

Toyota's ABS sensors detect which wheels are locking up and limits wheel lockup by "pulsing" each wheel's brakes independently. Pulsing releases brake pressure repeatedly for fractions of a second. This helps the tires attain the traction that current road conditions will allow, helping you to stay in directional control.

BRAKE ASSIST (BA)

Brake Assist is designed to detect sudden or "panic" braking, and then add braking pressure to help decrease the vehicle's stopping distance. When there's only a split second to react, Brake Assist can add additional brake pressure more quickly than just the driver alone can.

ELECTRONIC BRAKE FORCE DISTRIBUTION (EBD)

Toyota's ABS technology has Electronic Brake-force Distribution (EBD) to help maintain control and balance when braking. EBD responds to sudden stops by redistributing brake force to enhance the braking effectiveness of all four wheels.

SMART STOP TECHNOLOGY (SST)

Smart Stop Technology automatically reduces engine power when the accelerator and brake pedals are pressed simultaneously under certain conditions.

SST engages when the accelerator is depressed first and the brakes are applied firmly for longer than one-half second at speeds greater than five miles per hour.

SST doesn't engage if the brake pedal is depressed before the accelerator pedal, allowing vehicles to start on a steep hill and safely accelerate without rolling backward.

VEHICLE STABILITY CONTROL (VSC)

VSC helps prevent loss of traction during cornering by reducing engine power and applying brake force to selected wheels.

Toyota's VSC monitors steering angle and the direction your vehicle is traveling. When it senses that the front or rear wheels begin to lose traction, VSC reduces engine power and applies braking to selected wheels. This helps restore traction and vehicle control.

TRACTION CONTROL (TRAC)

VSC helps prevent loss of traction during cornering by reducing engine power, and Traction Control helps maintain traction on loose gravel and wet, icy, or uneven surfaces by applying brake force to the spinning wheel(s).

Toyota's TRAC sensors are activated when one of the drive wheels starts to slip. TRAC limits engine output and applies the brakes to the spinning wheel. This transfers power to the wheels that still have traction to help keep you on track.

Floor mat installation

There are two types of Toyota floor mats: carpeted and all-weather. Each vehicle has model-specific floor mats. Installation is easy.

To keep your floor mat properly positioned, follow these steps:

- Only use Toyota floor mats designed for your specific model.
- Use only one floor mat at a time, using the retaining hooks to keep the mat in place.
- Install floor mats right side up.

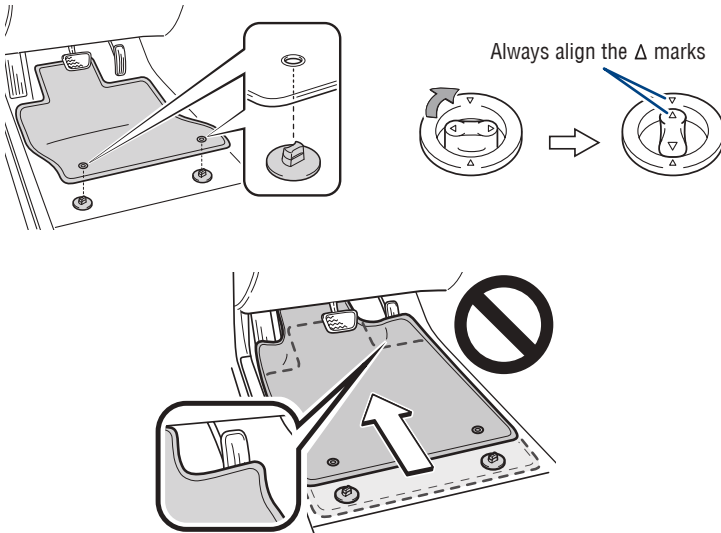

BLUETOOTH® DEVICE PAIRING SECTION

Do not attempt the Bluetooth® Pairing process while driving.

To begin the Bluetooth® Pairing process, press the HOME button on the faceplate of your multimedia system.

Bluetooth® Pairing for your phone

Pairing your phone is the first step in connecting with your Toyota. This pairing process is quick and easy. All you have to do is setup the phone and multimedia system to form a connection.¹



Audio / Audio Plus / Premium Audio

STEP 1 Press [MENU] on the audio system faceplate, then select "Setup" on display screen.



iPhone bluetooth Menu



Android bluetooth Menu



STEP 2 Ensure Bluetooth is turned on for your device.

STEP 3 Select "Bluetooth", then select "Add New Device" on display screen.



STEP 4 Select "Device Name".



STEP 5 Check the display on your smart phone. Does the PIN XXXX match the PIN displayed? If it does select "Pair".

¹ Some Android devices may have slightly different SETTINGS screen layout depending on manufacturer of device and Android OS version.

Bluetooth® Pairing for your phone (cont.)



STEP 6 "Connecting" displays while device is forming the connection to your multimedia system.



STEP 7 Enable Notifications (text message). While pairing your phone a message will be displayed: **"You may need to allow message access on your phone"**.

Note: You may also select "Skip" on display screen to skip enabling notifications. If skipped proceed to **Step 8**.

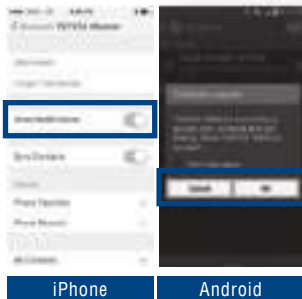

STEP 8 Turn on "Show Notifications" for iPhone or "ON" for Android.

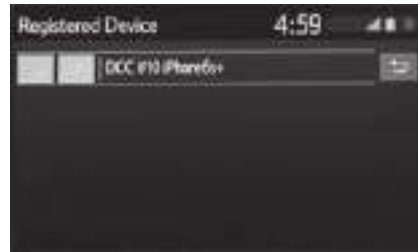

STEP 9 A confirmation will appear once your phone has been paired and connected.

NOTES



SEQUOIA

Quick Reference Guide 2020



00505QRG20SEQ

toyota.com



Printed in U.S.A. 8/19
19-MKG-13484