

QUICK REFERENCE GUIDE



2020

2020

HIGHLANDER

This Quick Reference Guide is a summary of basic vehicle operations. It contains brief descriptions of fundamental operations so you can locate and use the vehicle's main equipment quickly and easily.

The Quick Reference Guide is not intended as a substitute for the Owner's Manual located in your vehicle's glove box. We strongly encourage you to review the Owner's Manual and supplementary manuals so you will have a better understanding of your vehicle's capabilities and limitations.

Your dealership and the entire staff of Toyota Motor North America, Inc. wish you many years of satisfied driving in your new Highlander.

A word about safe vehicle operations

This Quick Reference Guide is not a full description of Highlander operations. Every Highlander owner should review the Owner's Manual that accompanies this vehicle.

Pay special attention to the boxed information highlighted in color throughout the Owner's Manual. Each box contains safe operating instructions to help you avoid injury or equipment malfunction.

All information in this Quick Reference Guide is current at the time of printing. Toyota reserves the right to make changes at any time without notice.

INDEX

OVERVIEW

Engine maintenance	11
Fuel tank door release & cap	10
Hood release	10
Indicator symbols	6-7
Instrument cluster	5
Instrument panel	2-4
Instrument panel light control	11
Keyless entry ^{1,2}	8-9
Smart Key system ^{1,2}	9

FEATURES & OPERATIONS

Air conditioning/heating	29-31
Audio	25
Auto lock/unlock ¹	12
Automatic transmission	12
Bird's Eye View Camera with Perimeter Scan function	38
Blind Spot Monitor (BSM) and Rear Cross Traffic Alert (RCTA)	37
Clock	23
Door locks ^{1,2}	15
Downhill Assist Control system (DAC)	41
Driver Easy Speak	33
Driving mode select switch	41
Electric parking brake	13
Front and Rear Parking Assist with Automated Braking	36
Garage door opener (HomeLink®) ³	34
Head-up display (HUD)	23
Intuitive parking assist	35
Lights ^{1,2} & turn signals ¹	21
Moonroof ¹	16
Multi-Information Display (MID) ²	22
Multi-terrain select (AWD)	40
Panoramic moonroof	16
Power Liftgate (back door) ^{1,2}	17
Power outlets-12V DC	27
Power outlets-120V AC	27
Qi wireless charger	26
Rear view monitor system	36
Seat adjustments-Front	18
Seat adjustments-Rear	19
Seat heaters/ventilators	32
Seats-Head restraints	18

FEATURES & OPERATIONS (continued)

Seats-Stowing & returning	
3rd row seats	19
Snow mode button	40
Steering lock release	14
Steering wheel switches & telephone controls (Bluetooth®)	24
Steering wheel-Heater	33
Stop & Start Engine System	39
Tilt & telescopic steering wheel	14
Toyota multi-operation touch	28
USB charge-ports	27
USB media port	26
Vehicle Stability Control (VSC)/ TRAC/Trailer Sway Control	
OFF switch	37
Windows-Power ¹	15
Windshield wipers & washers ¹	20

TOYOTA SAFETY SENSE™ 2.0 (TSS 2.0)

Automatic High Beams (AHB)	57
Full-Range Dynamic Radar Cruise Control (DRCC)	54-56
Lane Departure Alert with Steering Assist (LDA w/SA)	46-49
Lane Tracing Assist (LTA)	50-53
Pre-Collision System with Pedestrian Detection (PCS w/PPD)	43-45
Quick overview-Toyota Safety Sense™ 2.0 (TSS 2.0)	42
Road Sign Assist (RSA)	58
Sensors	43

SAFETY & EMERGENCY FEATURES

Floor mat installation	64
Rear door child safety locks	60
Safety Connect	62
Seat belts	59
Seat belts-3rd row center	59
Seat belts-Shoulder belt anchor	59
Spare tire & tools	61
Star Safety System™	63-64
Tire Pressure Monitoring (warning) System (TPMS)	60

BLUETOOTH® DEVICE PAIRING SECTION

66-68

¹ Visit your Toyota dealer for information on customizing this feature.

² Programmable by customer. Refer to the Owner's Manual for instructions and more information.

³ HomeLink® is a registered trademark of Gentex Corporation.

Instrument panel

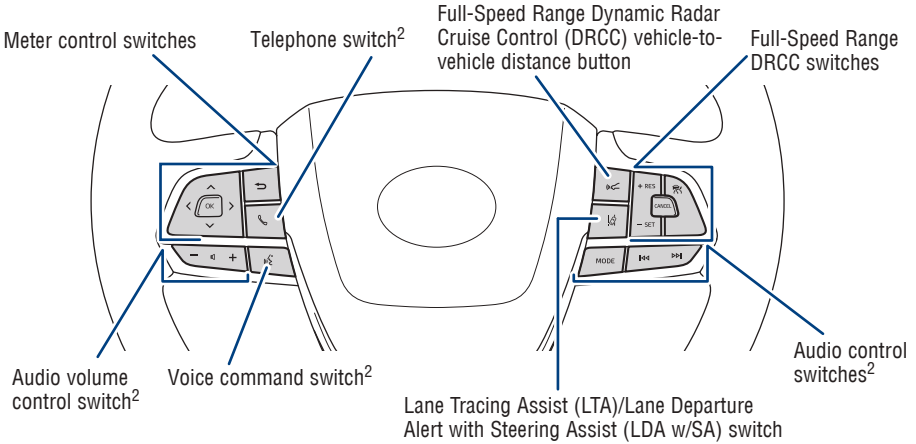

Steering wheel controls

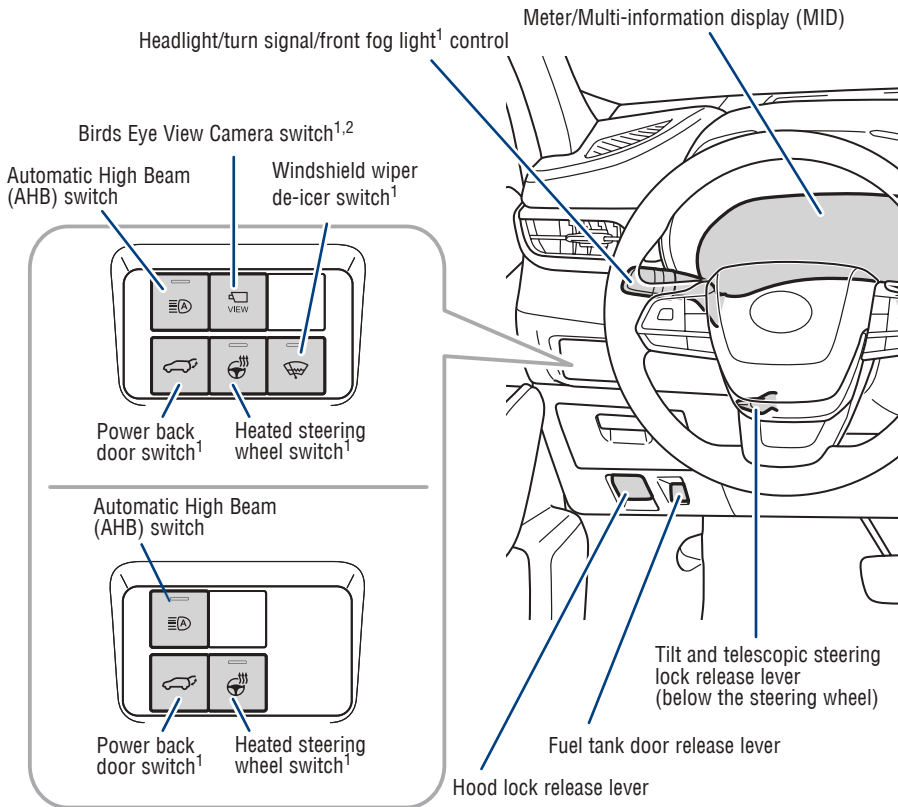

¹ If equipped.

² For details, refer to the “Navigation and Multimedia System Owner’s Manual” or visit www.toyota.com/audio-multimedia for additional resources.

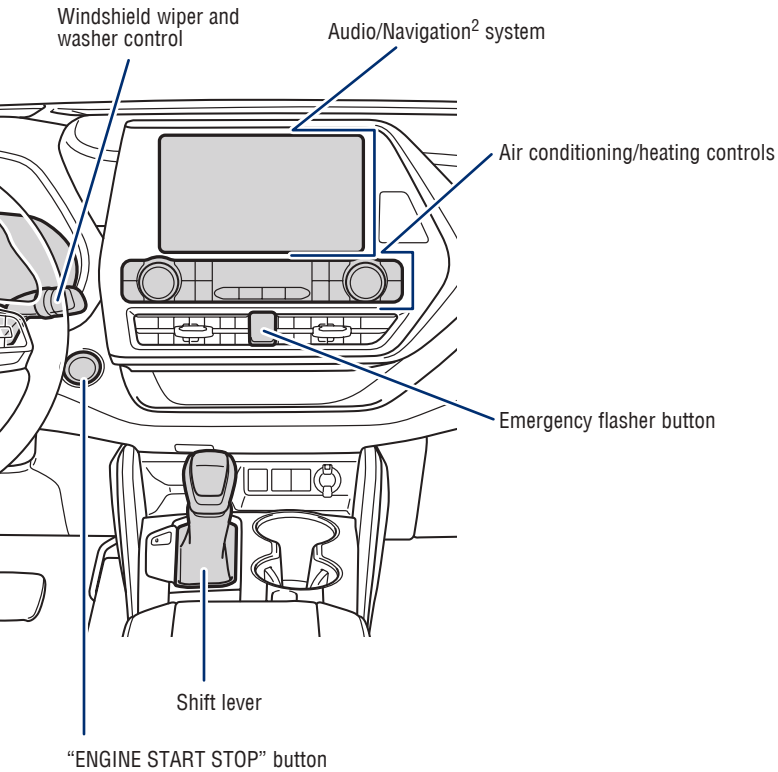

Instrument panel (continued)

CENTER CONSOLE AREA

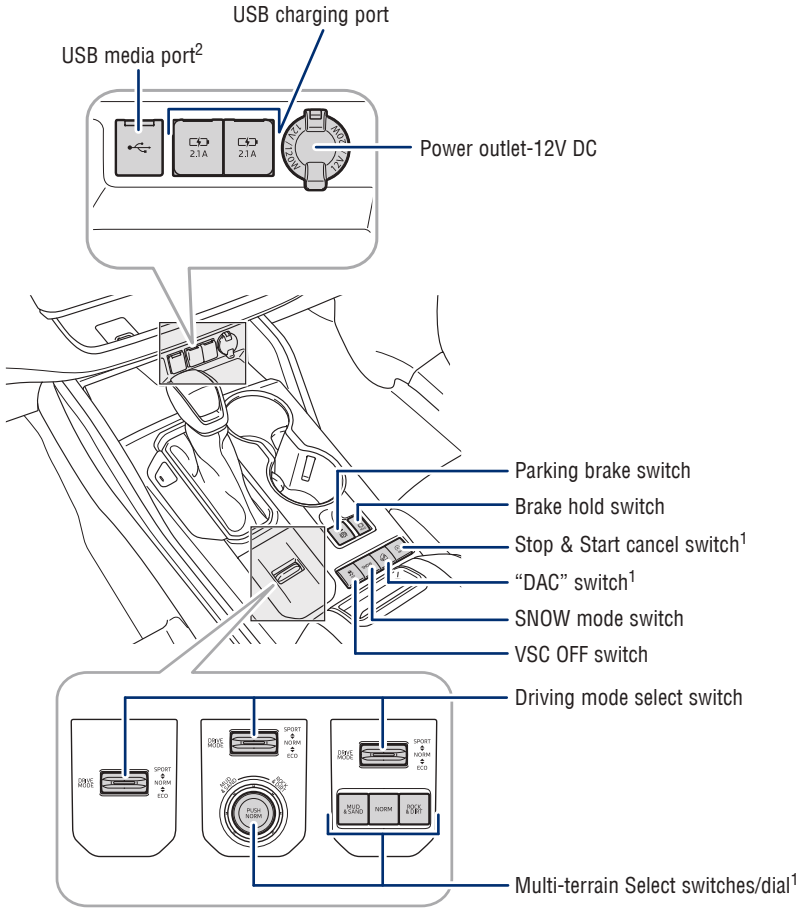

¹ If equipped.

² For details, refer to the "Navigation and Multimedia System Owner's Manual" or visit www.toyota.com/audio-multimedia for additional resources.

Instrument cluster

4.2-inch display

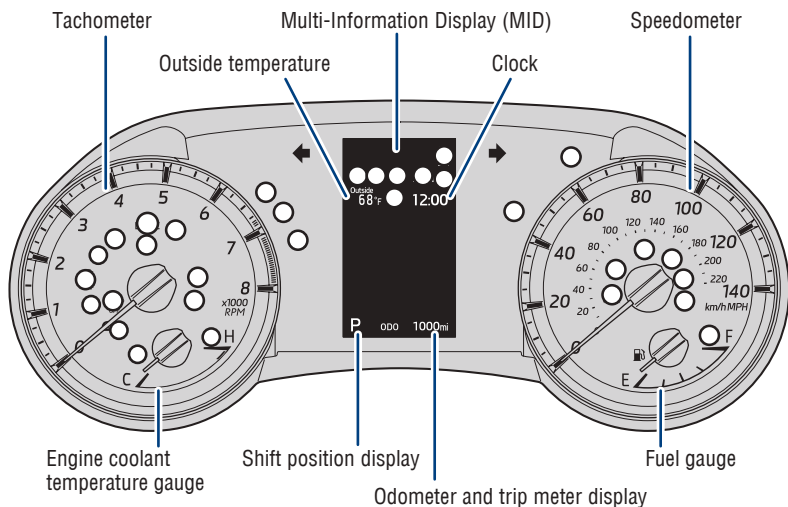

7-inch display (if equipped)

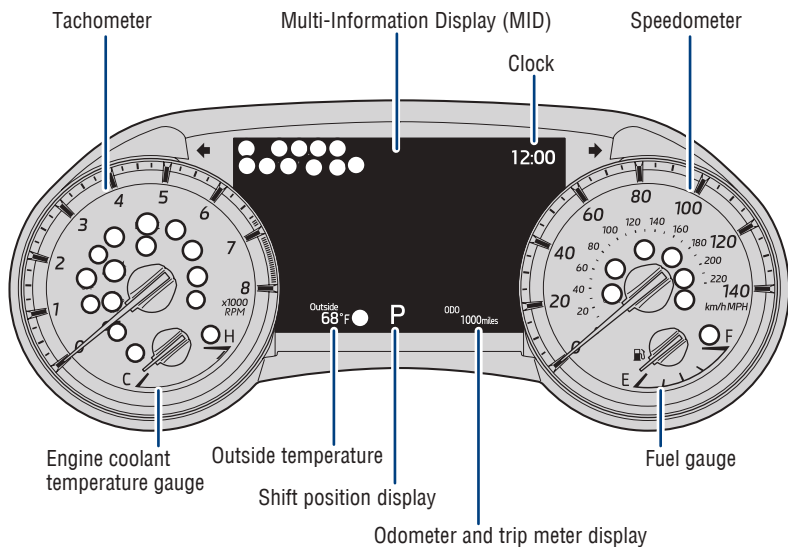

































○ Service indicators and reminders

OVERVIEW

Indicator symbols

For details, refer to "Indicators and warning lights," Section 2-1, 2020 Owner's Manual.

	Airbag SRS warning ¹		Front and Rear Parking Assist with Automated Braking OFF indicator ^{1,2,4,5,6}
	Air Bag ON/OFF indicator ¹		Front Fog light indicator ⁴
	Anti-lock Brake (ABS) System warning ¹		Fuel tank door position
	Automatic High Beam (AHB) indicator		Full-Speed Range Dynamic Radar Cruise Control indicator/DRCC SET indicator
	Blind Spot Monitor (BSM) OFF indicator ⁴		Headlight low/high beam indicator
	BSM outside rear view mirror indicator ⁴		High coolant temperature warning
	Brake hold operated indicator ^{1,2}		Intuitive parking assist OFF indicator ^{1,2,4,5}
	Brake hold standby indicator ¹		Lane Tracing Assist (LTA)/Lane Departure Alert (LDA) indicator [white/green/orange ³]
	Brake Override System/Drive-Start Control warning		Low engine oil pressure warning
	Brake system warning ¹		Low fuel level warning ¹
	Brake system warning ¹ [Yellow]		Low outside temperature indicator
	Constant speed cruise control indicator/Constant speed cruise control SET indicator		Malfunction/Check Engine indicator ¹
	Charging system warning ¹		Mud & sand mode indicator ⁴
	Downhill Assist Control indicator ⁴		Parking brake warning ^{1,2}
	Driver's and front passenger's seat belt reminder (alarm will sound when the engine switch is in the "IGNITION ON")		Pre-Collision System (PCS) warning ^{1,2}
	Eco Driving indicator ¹		
	Eco drive mode indicator		
	Electric power steering system warning [red/Yellow]		

RCTA OFF RCTA OFF indicator^{2,4}



Rear passengers' seat belt reminder

ROCK & DIRT Rock & dirt mode indicator⁴



Security indicator



Slip indicator^{1,3}



Smart Key system indicator

SNOW SNOW mode indicator

SPORT Sport mode indicator



Stop & Start Engine System indicator⁴



Stop & Start Engine System cancel indicator^{2,4}



Low tire pressure warning¹



Turn signal indicator



Vehicle Stability Control (VSC) OFF indicator¹

¹ If the indicator does not turn off within a few seconds of starting the engine, there may be a malfunction. Have the vehicle inspected by your Toyota dealer.

² If the indicator flashes, there may be a malfunction. Refer to the Owner's Manual.

³ If the indicator flashes, it indicates that the system is operating.

⁴ If equipped.

⁵ 7-inch display only.

⁶ Refer to section PKSB (Parking Support Braking function) in the Owner's Manual.

OVERVIEW

Keyless entry

UNLOCKING OPERATION



Push

ONCE: Driver door
TWICE: All doors

Carry
Smart Key remote
Front door unlock*

Grasp

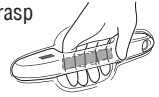

NOTE: If a door is not opened within 60 seconds of unlocking, all doors will relock for safety.

LOCKING OPERATION



Push

Carry
Smart Key remote
All-door lock

Touch



POWER LIFTGATE OPERATION (IF EQUIPPED)



Push and hold

Carry
Smart Key remote

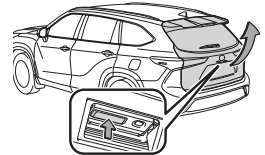

Push and hold

NOTE: Power back door will not open if glass hatch is open.

BACK DOOR LOCK/UNLOCK (IF EQUIPPED)

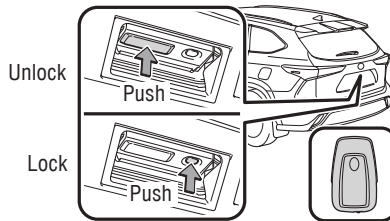

Carry
Smart Key remote

* Driver door unlocking function can be programmed to unlock driver door only, or all doors. Grasping passenger door handle will unlock all doors.

NOTE: Doors may also be locked/unlocked using remote.

PANIC BUTTON



HOLD

 Push and hold



Smart Key system

START FUNCTION

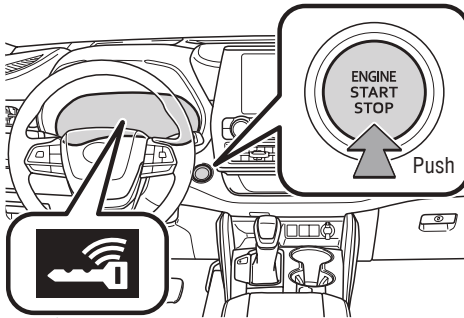

NOTE: The Smart Key must be carried to enable the start function. With the gear shift lever in Park and the brake pedal depressed, push the “ENGINE START STOP” switch.

POWER (WITHOUT STARTING ENGINE)

Without depressing the brake pedal, pressing the “ENGINE START STOP” switch will change the operation mode in succession from:

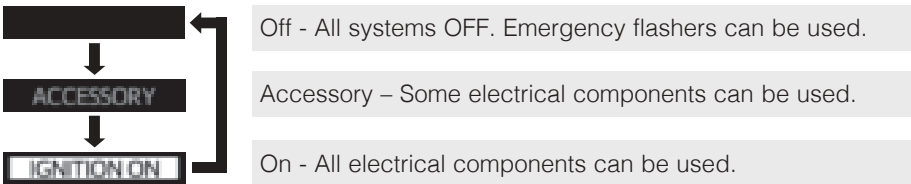

Fuel tank door release & cap

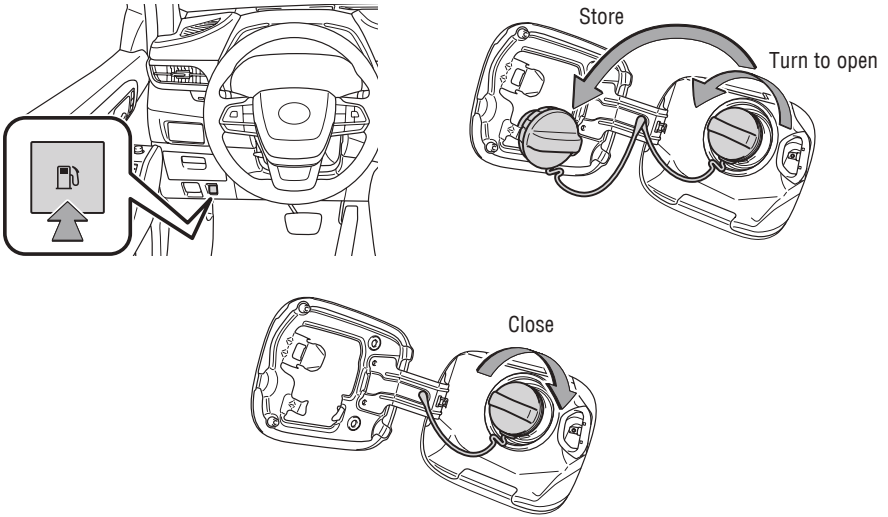

NOTE: To close, tighten until one click is heard. If the cap is not tightened enough, Check Engine "CHECK" indicator may illuminate.

Hood release

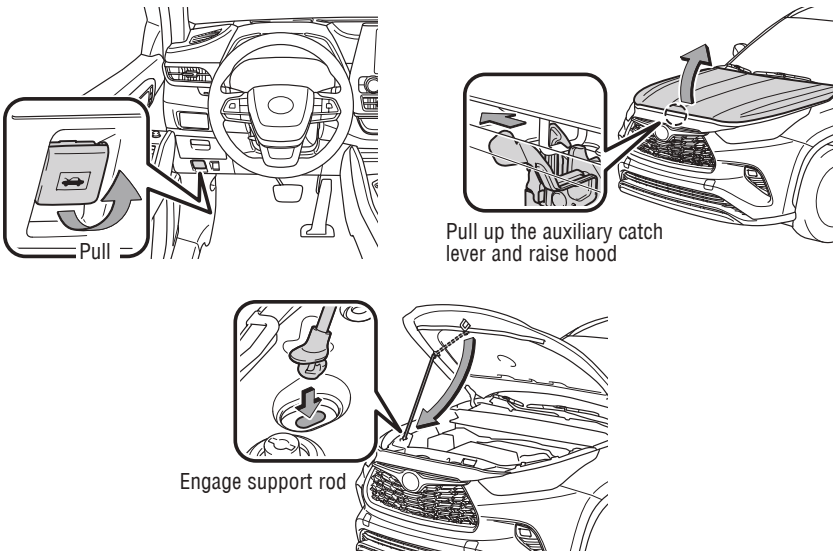

Instrument panel light control

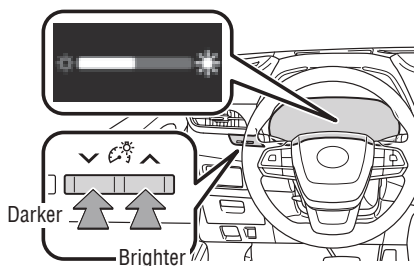

The brightness of the meters is changed between day mode and night mode.

- Day mode: When the surrounding area is bright
- Night mode: When the surrounding area is dark

Engine maintenance

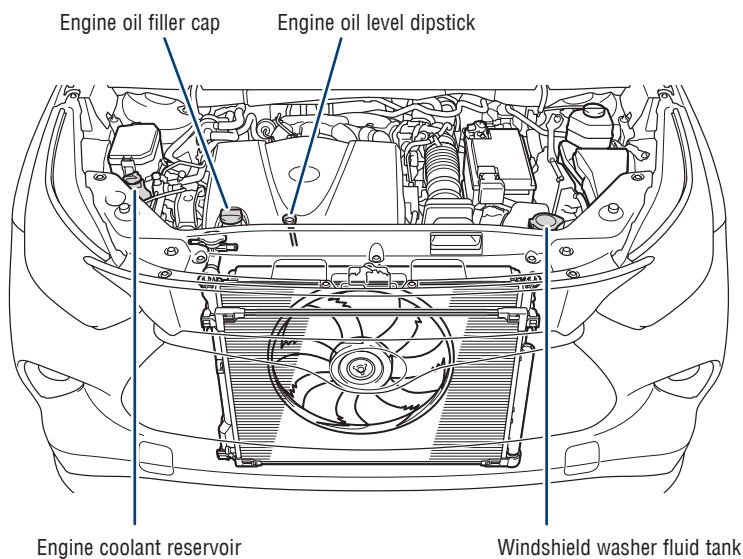

NOTE: Regularly scheduled maintenance, including oil changes, will help extend the life of your vehicle and maintain performance. Please refer to the "Warranty & Maintenance Guide."

FEATURES & OPERATIONS

Auto lock/unlock

Automatic door locks can be programmed to operate in different modes, or turned OFF.

Shift position linked door locking/unlocking function

- Doors lock when shifting from Park.
- Doors unlock when shifting into Park.

Speed linked door locking function

- Doors lock when the vehicle speed goes above approximately 12 mph (20 km/h).

Driver's door linked door unlocking function

- Doors unlock when the driver's door is opened.

Refer to the Owner's Manual for more details.

Automatic transmission

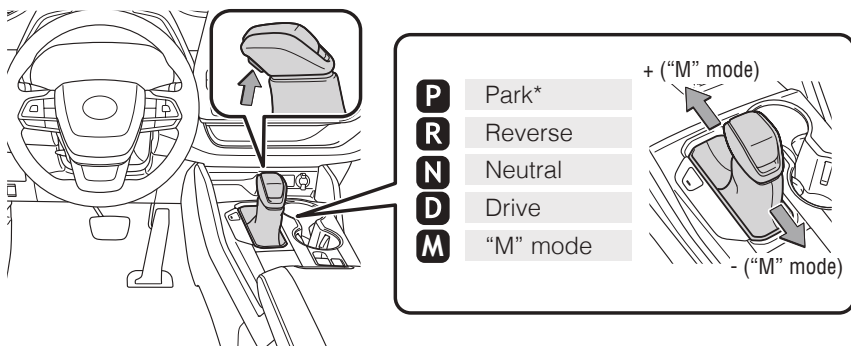

* The engine switch must be in the "IGNITION ON" mode and the brake pedal depressed to shift from Park.

"M" MODE

Shift the shift lever to "M" position from "D" position.

- + : Upshift (push and release)
- : Downshift (pull and release)

Downshifting increases power going uphill, or provides engine braking downhill. For best fuel economy during normal driving conditions, always drive with the shift lever in the "D" position.

Electric parking brake

PARKING BRAKE

Automatic mode

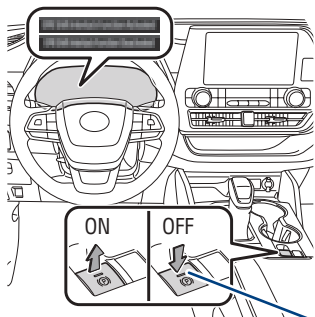

Manual mode

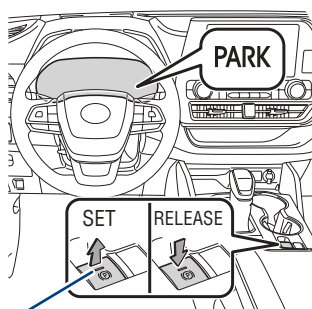

Parking brake light

Automatic (shift lever operation)

To turn automatic mode ON, while vehicle is stopped, pull and hold switch until “EPB Shift Interlock Function Activated” displays in Multi-Information Display (MID). While depressing brake, shifting into P position will automatically set the brake and turn the parking brake indicator and parking brake light on. To release brake, depress brake and shift out of P. The indicator light turns off.

To turn automatic mode OFF, push and hold parking brake switch until “EPB Shift Interlock Function Deactivated” displays on the MID.

Manual

While vehicle is stopped and brake pedal is depressed, pull to set parking brake and turn the parking brake indicator and parking brake light on. To release, press the brake pedal and push switch. The indicator light turns off.

Refer to the Owner's Manual for limitations and more details.

BRAKE HOLD

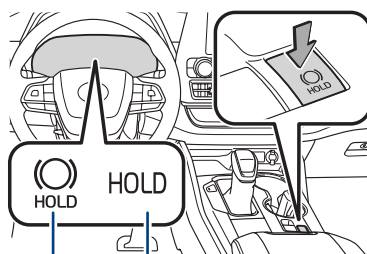

Standby indicator Operated indicator

The brake hold system keeps the brake applied when the shift lever is in D, M or N with the system on and the brake pedal has been depressed to stop the vehicle. The system releases the brake when the accelerator pedal is depressed with the shift lever in D or M to allow smooth start off.

Refer to the Owner's Manual for limitations and more details.

Steering lock release

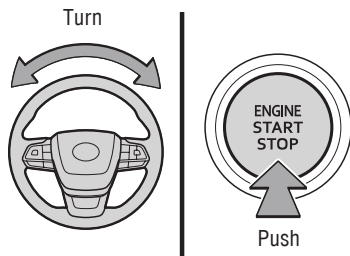

When the steering lock cannot be released, “Push Engine Switch while Turning Steering Wheel in Either Direction” will be displayed on the multi-information display. Check that the shift lever is in P. Press the engine switch shortly and firmly while turning the steering wheel left and right.

Tilt & telescopic steering wheel

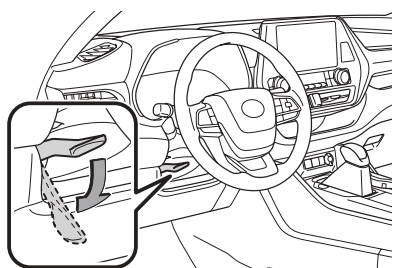

Lock release lever

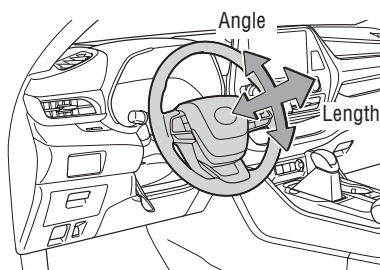

Hold wheel, push lever down, set angle and length, and return lever.

NOTE: Do not attempt to adjust while the vehicle is in motion.

Door locks

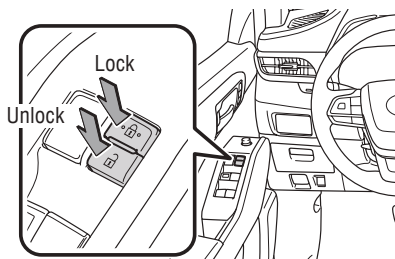

Windows-Power

Driver side

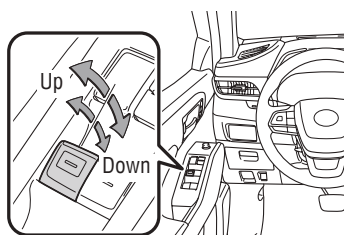

Window lock switch

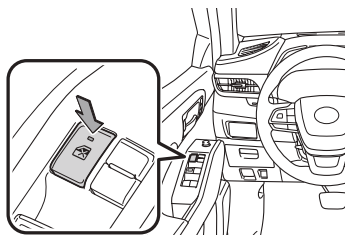

All window auto up/down Push the switch completely down or pull it completely up and release to fully open or close. To stop the window partway, operate the switch in the opposite direction.

Window lock switch Deactivates all passenger windows. Driver's window remains operable.

FEATURES & OPERATIONS

Moonroof (if equipped)

SLIDING OPERATION

Push once to open partway; again to open completely.

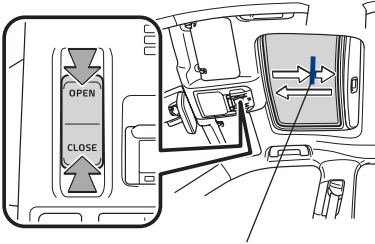

Recommended open position to minimize wind noise.

TILTING OPERATION

Push once to open completely.

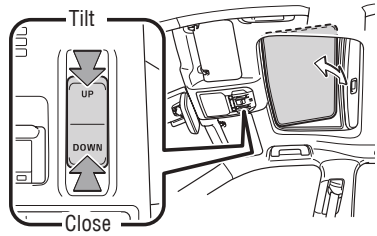

Lightly press either side of the moonroof switch while opening/tilting is in progress, the moonroof stops partway.

Panoramic moonroof (if equipped)

SHADE OPERATION

Lightly press either side of the sunshade switch to stop the electronic sunshade partway.

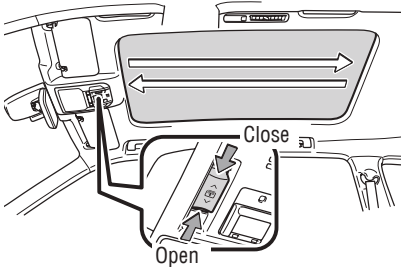

TILTING OPERATION

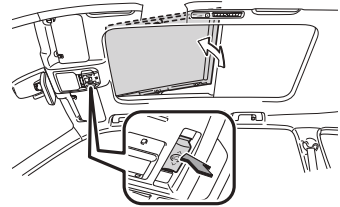

If the moonroof is open, pressing the switch closes it up to the tilt-up position.
If the shade is closed past the half-open position when the switch is pressed, it will open up to the half-open position.

SLIDING OPERATION

The moonroof stops slightly before the fully open position to reduce wind noise and the shade opens fully. Slide the switch again to fully open or close the moonroof.

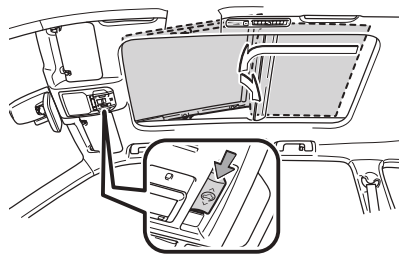
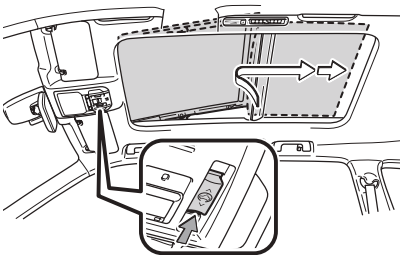

Power Liftgate (back door) (if equipped)

Instrument panel

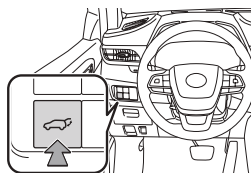

Open: Push and hold
Close: Push and hold again

Power Liftgate (back door)

(open only)

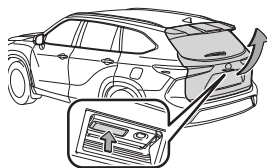

(close only)

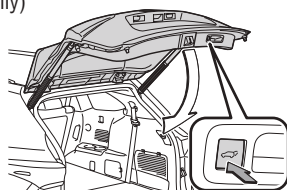

Hands-Free, Foot-Activated Power Liftgate (if equipped)

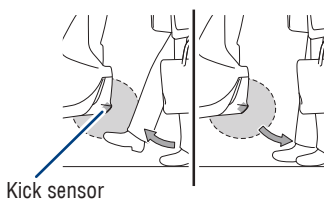

Kick sensor

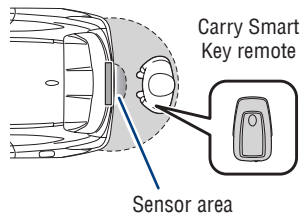







Carry Smart Key remote

Sensor area

To automatically open/close Power Liftgate Quickly swipe your foot near the lower center part of the rear bumper for within 1 second to trigger sensor. To operate, make sure that the touchless sensor operation is enabled and that you are carrying the remote.

NOTE: If battery is disconnected, the power back door needs to be reinitialized.

PROGRAMMABLE POWER LIFTGATE

1. When the liftgate reaches the desired height, push the rear liftgate close-button (on the door jam of the liftgate) once. Press and hold the button until the buzzer sounds (4 times).
2. To reset the height, with the liftgate open and not moving, press and hold the rear liftgate close-button until it buzzes, and continue to hold until it buzzes again -then let go. Push the same button to close the liftgate. When you next open the liftgate, it will open to the maximum height.
3. To set the height using the Multi-Information Display, press “<>” meter control switches and select “” from the MID. Press “” and select  and then press “.” Select Opening Adjustment, then press “.” Select desired position (5 height options to choose from,) then press “.”

Refer to the Owner's Manual for limitations and more details on this system.

FEATURES & OPERATIONS

Seat adjustments-Front

MANUAL SEAT

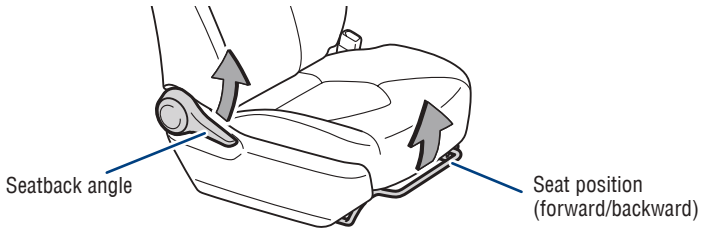

POWER SEAT

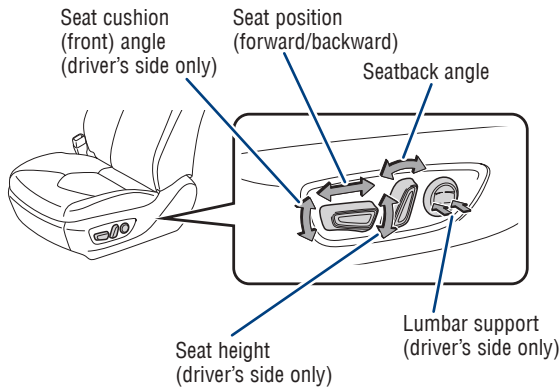

Refer to the Owner's Manual for more details.

Seats-Head restraints

Front

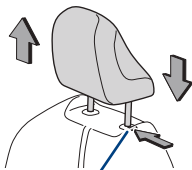

Lock release button

Second row

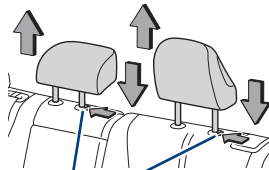

Lock release button

Third row

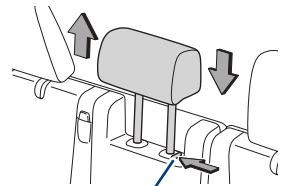

Lock release button

Seat adjustments-Rear

Second row (8-seat models)

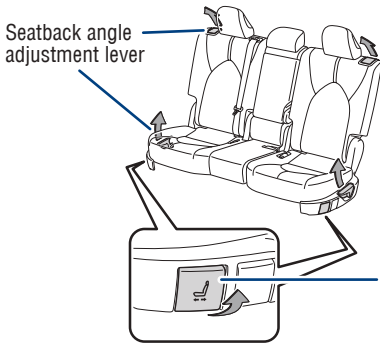

Second row (7-seat models)

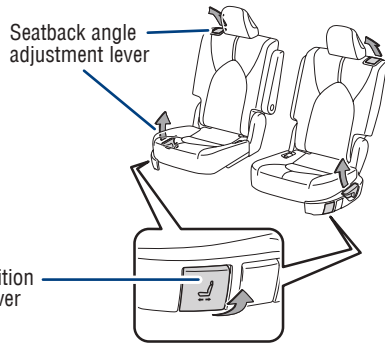

Third row seat

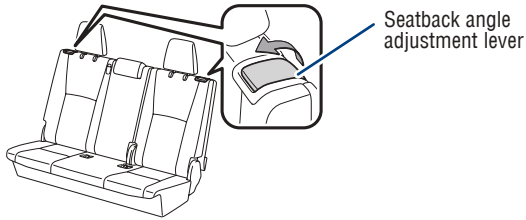

Refer to the Owner's Manual for more details.

Seats-Stowing & returning 3rd row seats

Stowing

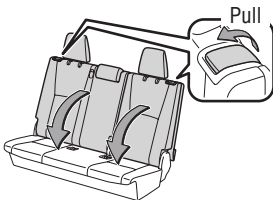

Returning (from outside)

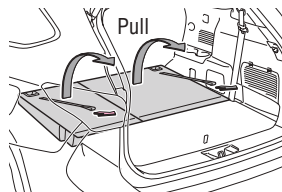

Returning (from inside)

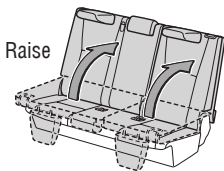

Returning the outer head restraints

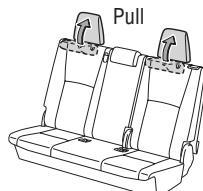

Refer to the Owner's Manual for more details.

Windshield wipers & washers

FRONT

With intermittent wiper

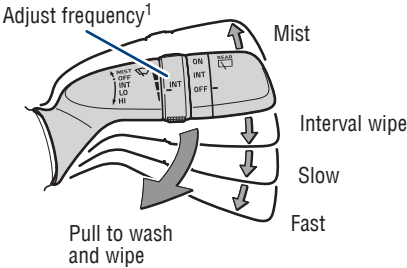

With rain-sensing wiper

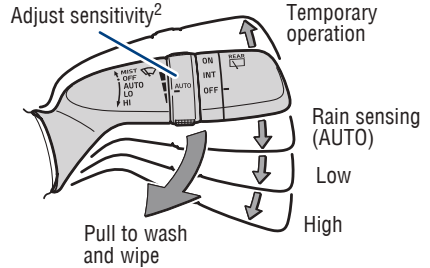

¹ **Intermittent windshield wiper frequency adjustment** Rotate to increase/decrease wipe frequency.

² **Rain-sensing windshield wipers** Rotate to increase/decrease sensor sensitivity.

REAR

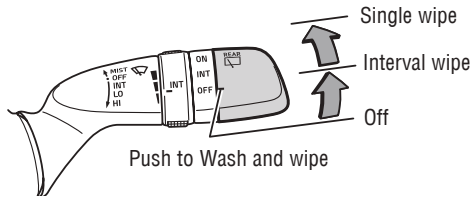

Lights & turn signals

HEADLIGHTS

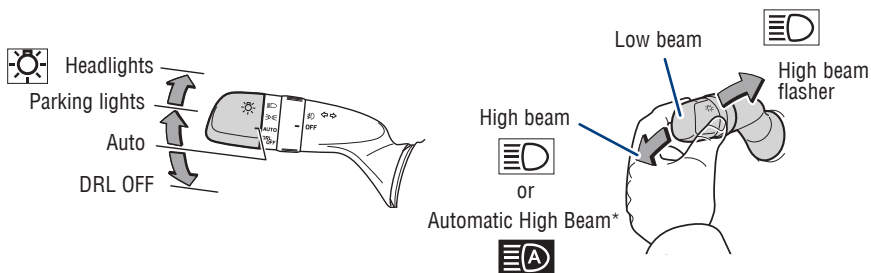

Daytime Running Light system (DRL) Automatically turns on under certain conditions to make vehicle more visible to other drivers. Not for use at night.

Automatic light cut off system Lights automatically turn off after 30 second delay, or when lock switch on remote is pushed after all doors are locked.

Automatic High Beam (AHB) system Automatically switches between high and low beams as appropriate to enhance vision at night.

Refer to *Toyota Safety Sense™ 2.0 (TSS 2.0)* in this guide or the *Owner's Manual* for more details on the Automatic High Beam feature.

* Operating conditions must be met. Refer to the Owner's Manual for details.

FRONT FOG LIGHTS (IF EQUIPPED)

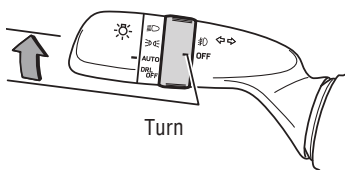

Front fog lights come on only when the headlights are on low beam.

TURN SIGNALS

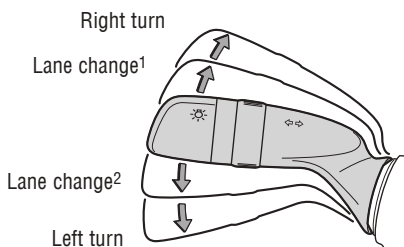
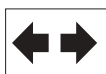

1 The right hand signals will flash three times.

2 The left hand signals will flash three times.

FEATURES & OPERATIONS

Multi-Information Display (MID)



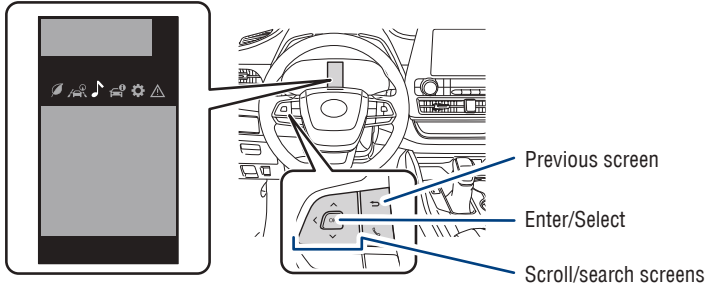

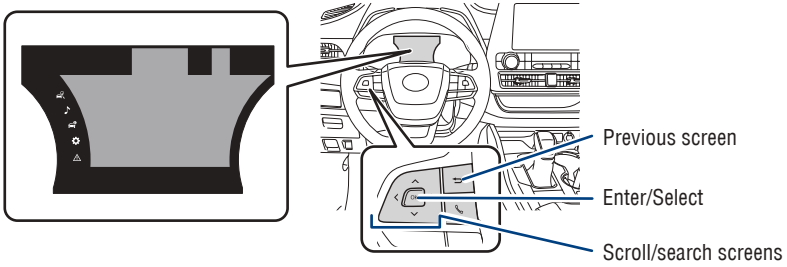

4.2" DISPLAY (IF EQUIPPED)



7" DISPLAY (IF EQUIPPED)



Push MID control switches to view or change information in the following:



-  Driving information display
-  Driving support system information display
-  Audio system-linked display
-  Vehicle information display
-  Settings display
-  Warning message display

Refer to the Owner's Manual for more details.

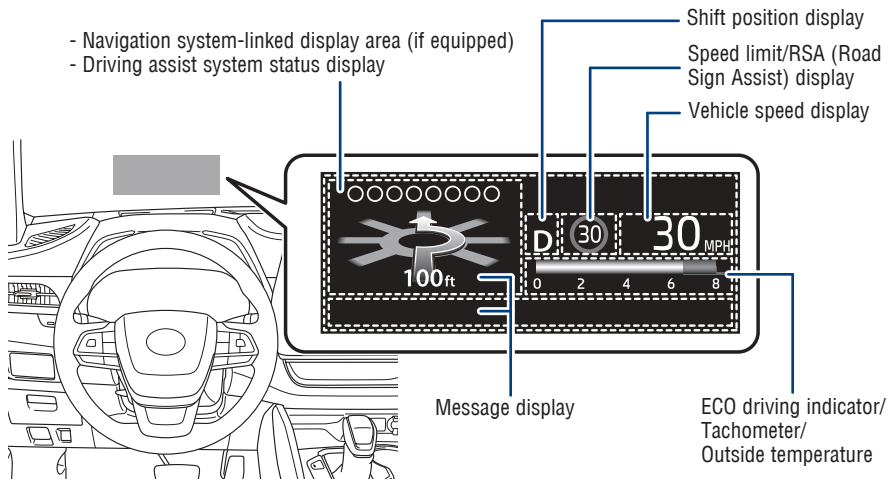
Head-up display (HUD) (if equipped)



The head-up display can display the current vehicle speed and ECO driving indicator in front of the driver. Also, it can display various types of information to assist the driver.

Select  and then  in the Multi-Information Display (MID) to access Head-up display settings. And push , to enter selection.

Refer to the *Owner's Manual* for more details.

Clock

- Select to change time zone
- Select to daylight savings time ON/OFF/AUTO*.
- Select to set to automatic GPS adjustment of clock.
- Select to set hour display to 12 or 24 hour time.

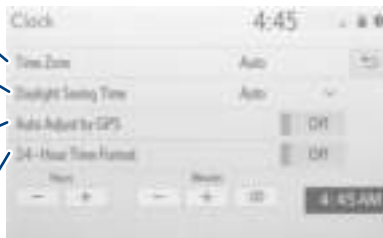

- 1) Push **"MENU"** button next to the screen.
- 2) Select **"Setup"** or **"General"** in the touch screen to access the general settings screen.
- 3) Select **"Clock."**
- 4) Then select desired items to be reset.

Refer to the *"Navigation and Multimedia System Owner's Manual"* for more details.

* Premium Audio/12.3-inch display model only

FEATURES & OPERATIONS

Steering wheel switches & telephone controls (Bluetooth®)

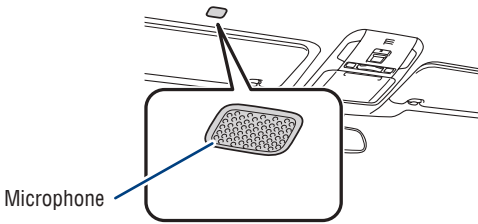
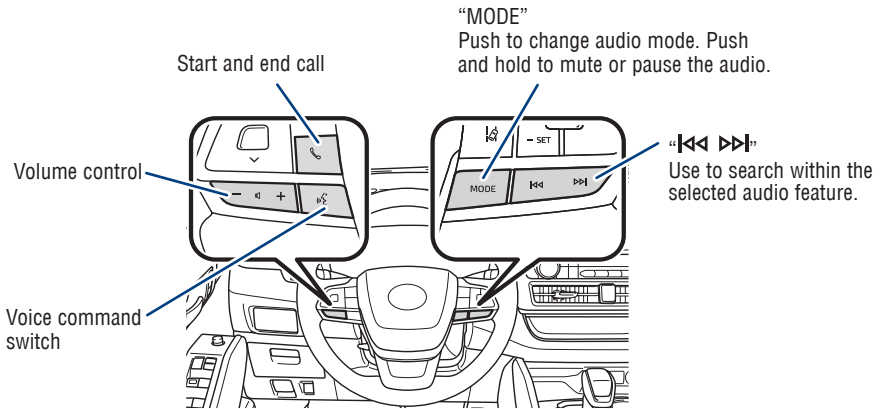

Bluetooth® technology allows dialing or receipt of calls without removing your hands from the steering wheel.

Refer to the Bluetooth® device pairing in this guide or the Navigation and Multimedia System Owner's Manual for additional user instructions.

NOTE: Concentrating on the road should always be your first priority while driving. Do not use the Audio Multimedia System if it will distract you.

Audio

8-inch display

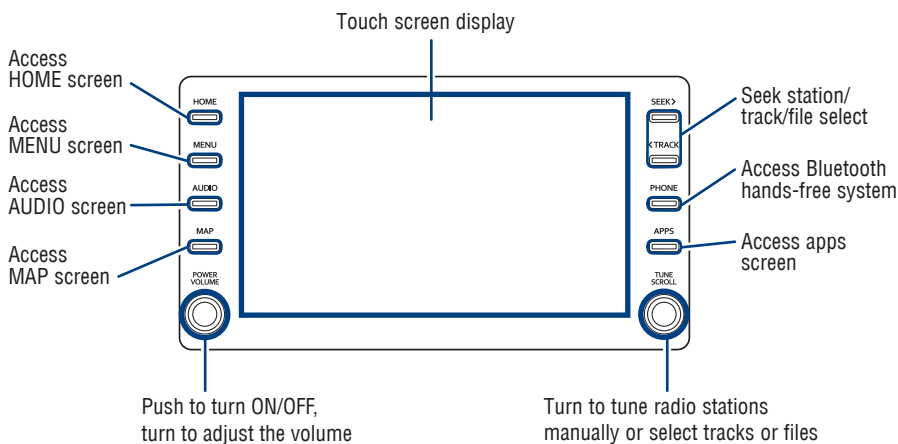

12.3-inch display (if equipped)

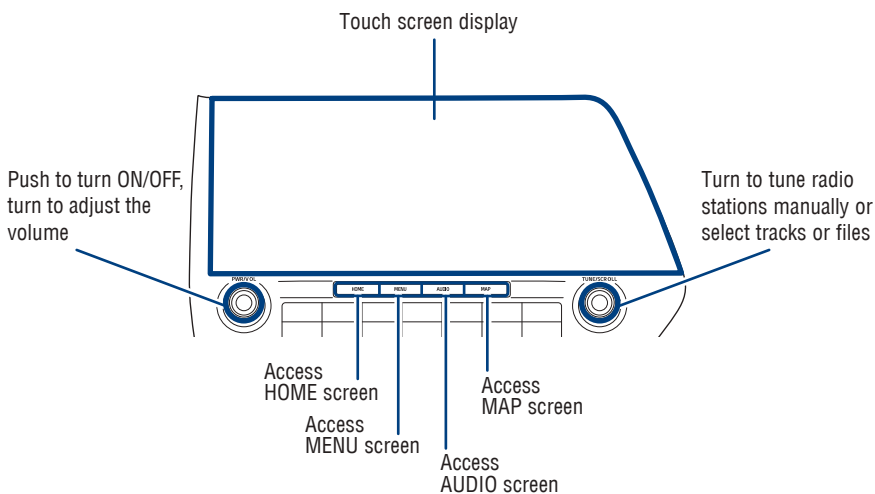

Refer to the "Navigation and Multimedia System Owner's Manual" or visit www.toyota.com/audio-multimedia for additional resources.

NOTE: Concentrating on the road should always be your first priority while driving. Do not use the Audio Multimedia System if it will distract you.

FEATURES & OPERATIONS

Qi Wireless charger (if equipped)

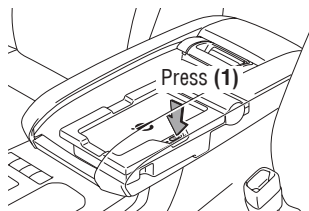
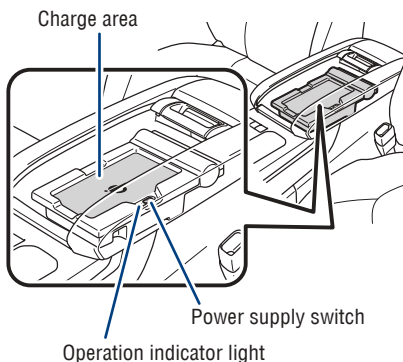

When the engine is turned off, the last state (ON/OFF) of the charger is memorized.

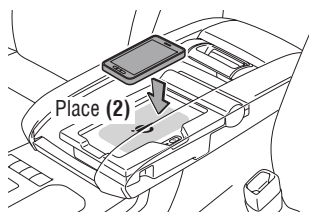

Place device nearest the center of charging area for best results. Moving device may result in stopping or restarting the charging process.

A mobile device can be charged wirelessly on the tray. Push the tab and slide the console box lid. **(1)** Press the power supply switch and the green operation indicator light turns on. **(2)** Place a compatible mobile device on the tray as shown in the illustration. An amber indicator illuminates while charging is in progress. When charging is complete, the indicator illuminates green. Some phones, cases or cover type wireless chargers may not cause the green indicator to illuminate even though it is fully charged.

The engine switch must be in the "ACCESSORY" or "IGNITION ON" mode for use.

Refer to the Owner's Manual for limitations and more details on this system before attempting to use it.

USB media port

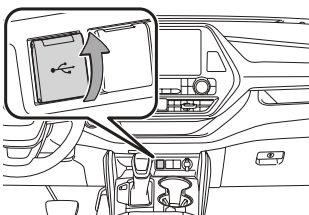

Connecting a compatible device and cable into the USB media port will support charging and music playback through the audio multimedia system.

Power outlets- 12V DC

Front

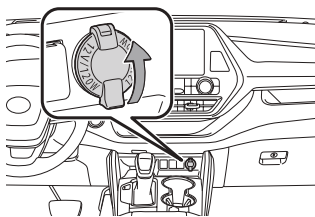

Center console

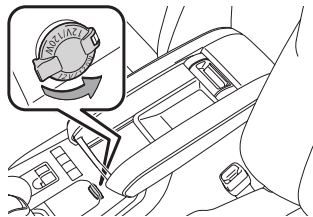

The engine switch must be in the “ACCESSORY” or “IGNITION ON” mode for use.

Power outlets- 120V AC (if equipped)

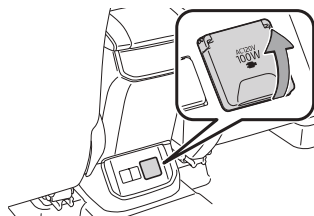

The engine switch must be in the “IGNITION ON” mode for use.

USB charge-ports

Front

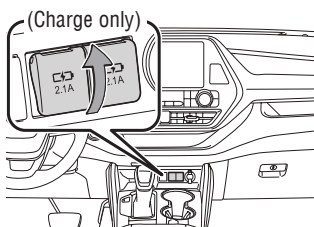

Rear

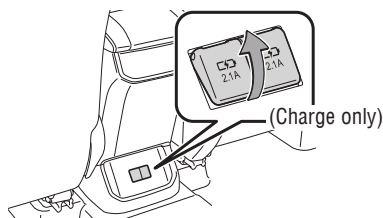

The engine switch must be in the “ACCESSORY” or “IGNITION ON” mode for use.

FEATURES & OPERATIONS

Toyota multi-operation touch*

* © 1982-2013, QNX Software Systems Limited. All rights reserved.

The Toyota multi-operation touch allows a screen, such as the air conditioning control screen, and the navigation screen to be displayed and operated simultaneously. Available only on vehicles with 12.3-inch display.

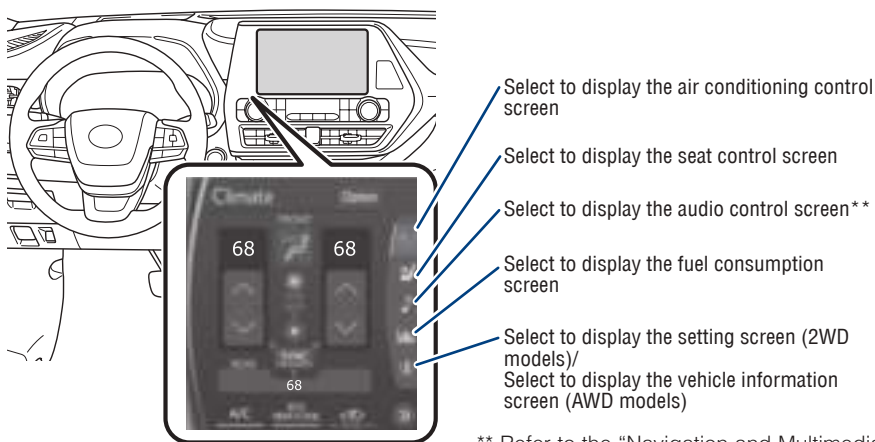

** Refer to the "Navigation and Multimedia System Owner's Manual.

OPERATION

Moving screens:

Select "◀ ▶" to change its displayed position on the Toyota multi-operation touch. The screen position can also be changed by perform a left or right flick operation on a screen.

Full screen display/split screen display:

Select "◀ ▶" on the energy monitor/consumption screen or vehicle information screen will display that screen in full screen. Select "◀ ▶" to return to the split-screen display.

SETTINGS

AWD models: Select "Setting" on the vehicle information screen to display the setting screen.

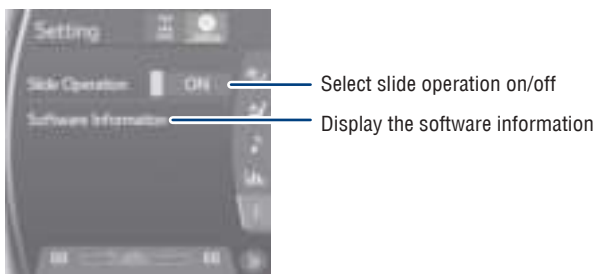

Air conditioning/heating

FRONT AUTOMATIC AIR CONDITIONING

8-inch display

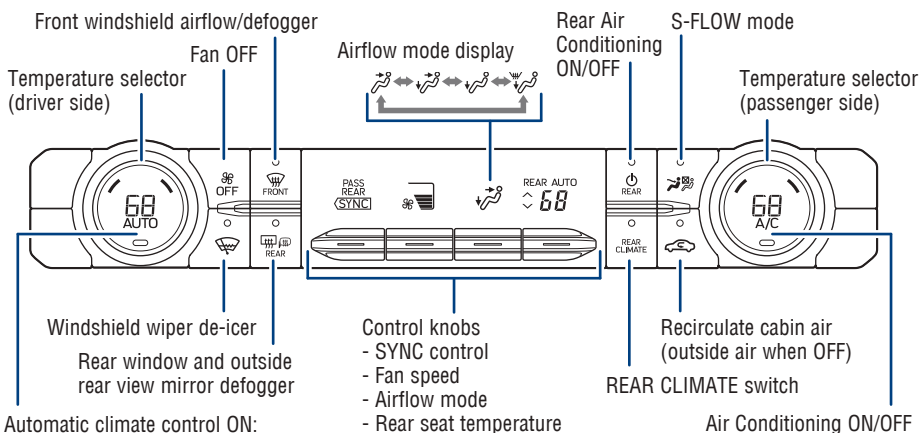

Automatic climate control ON:
Adjusting the temperature setting will cause the airflow vents, air intake and fan to adjust automatically to set temperature.

12.3-inch display (if equipped)

Automatic climate control ON:
Adjusting the temperature setting will cause the airflow vents, air intake and fan to adjust automatically to set temperature.

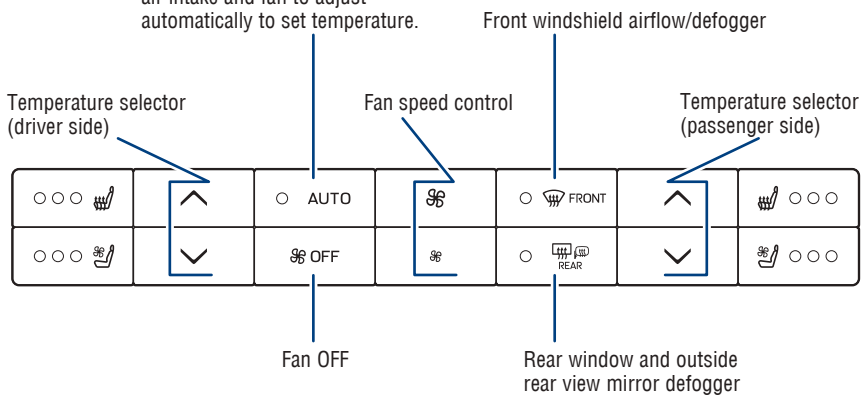

FEATURES & OPERATIONS

Air conditioning/heating (continued)

FRONT AUTOMATIC AIR CONDITIONING (CONTINUED)

Front air conditioning control screen (12.3-inch display)

Main control screen

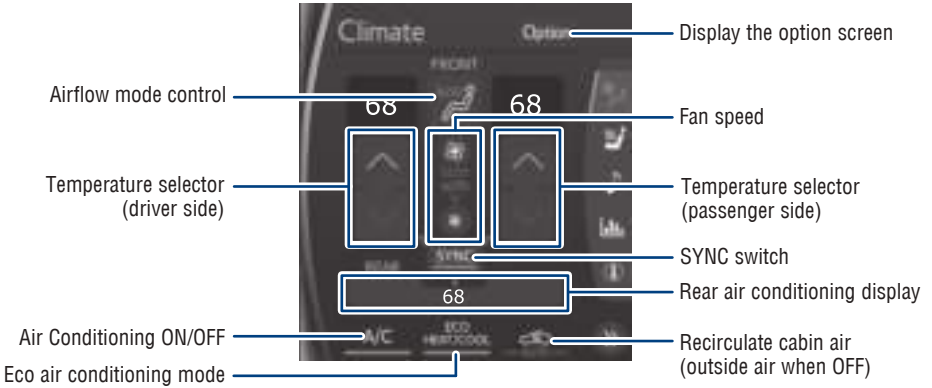

Option control screen

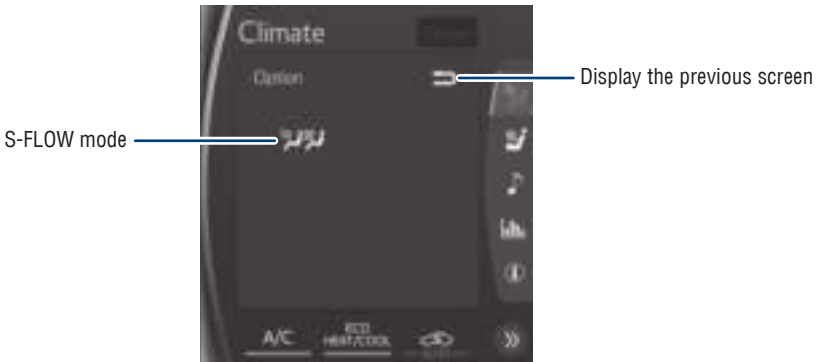

FRONT MANUAL AIR CONDITIONING (IF EQUIPPED)

Front windshield airflow/defogger

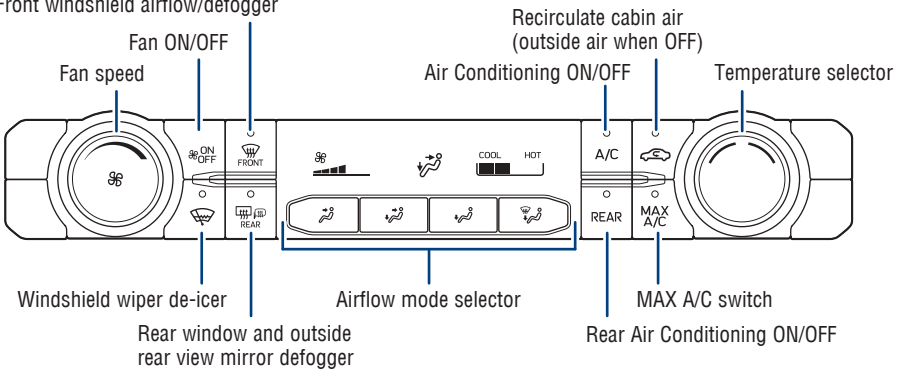

REAR MANUAL AIR CONDITIONING (IF EQUIPPED)

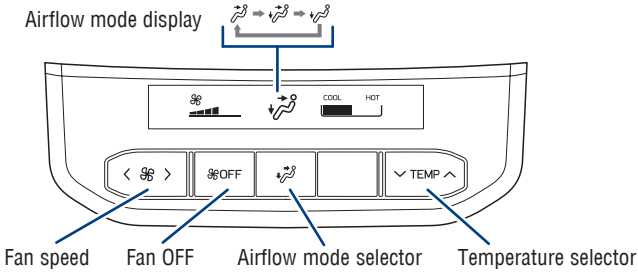

REAR AUTOMATIC AIR CONDITIONING (IF EQUIPPED)

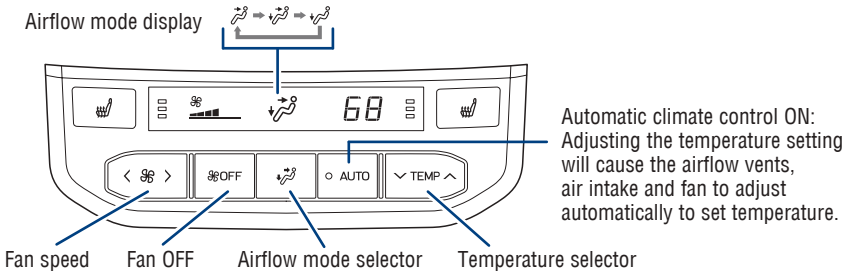

Front air conditioning control panel (8-inch display)

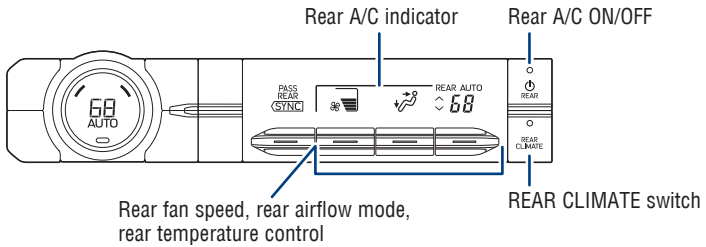

Front air conditioning control panel (12.3-inch display)

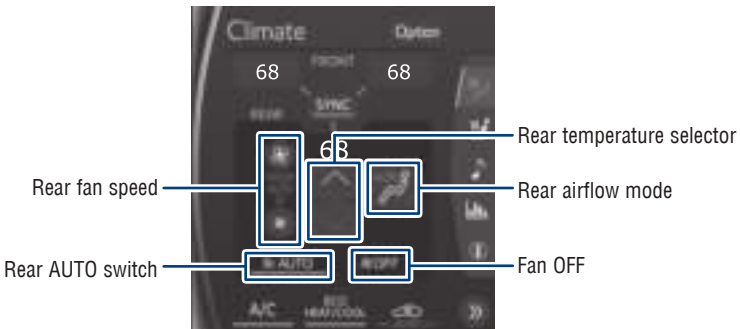

FEATURES & OPERATIONS

Seat heaters/ventilators

FRONT - FRONT A/C CONTROL PANEL (IF EQUIPPED)

Driver and passenger seat heaters -
8-inch display

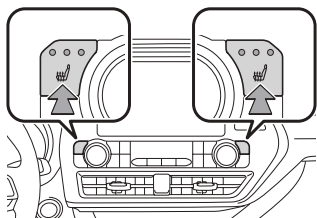

Driver and passenger seat ventilators -
8-inch display

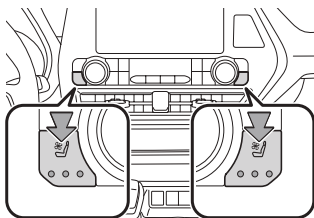

Driver and passenger seat heaters -
12.3-inch display

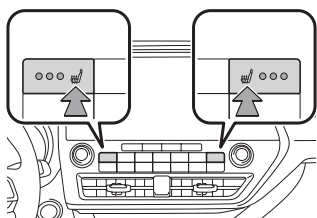

Driver and passenger seat ventilators -
12.3-inch display

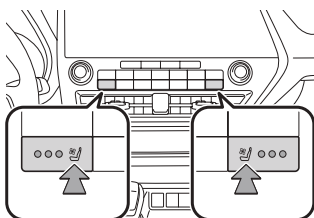

FRONT - TOYOTA MULTI-OPERATION TOUCH* (IF EQUIPPED)

Seat heaters



Ventilators



* 12.3-inch display only

REAR (SEAT HEATERS ONLY) (IF EQUIPPED)

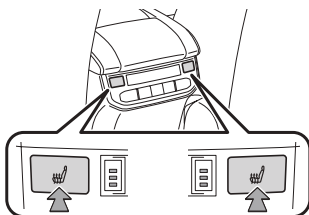

The engine switch must be in the "IGNITION ON" mode for use.

Steering wheel-Heater (if equipped)

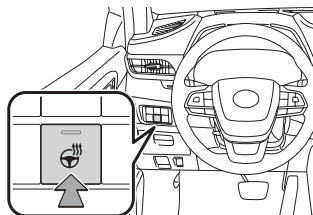

The engine switch must be in the “IGNITION ON” mode for use.

Driver Easy Speak*

* Premium Audio/12.3-inch display model

This feature utilizes the vehicle’s built-in microphone to amplify the driver’s voice through the rear speakers. The feature must be turned on every time you enter the vehicle, and automatically turns off when any door (including the liftgate) is opened. There are 7 volume settings.

To activate:

- (1) Select “MENU” on the Audio Multimedia System and then select “Setup”.
- (2) Select “Driver Easy Speak” from “Audio” screen.

Garage door opener (HomeLink®)* (if equipped)

Vehicles with auto anti-glare inside rear view mirror (if equipped)

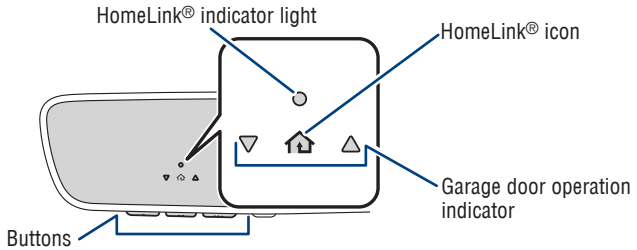

Vehicles with Digital Rearview mirror (if equipped)

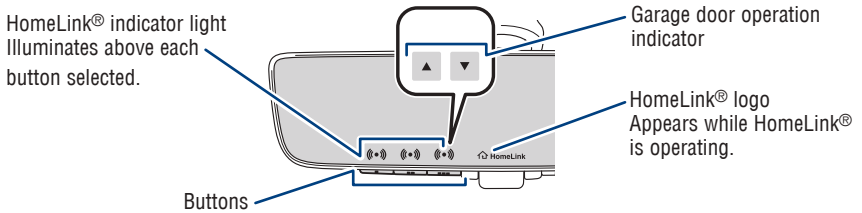

Garage door openers manufactured under license from HomeLink®* can be programmed to operate garage doors, estate gates, security lighting, etc.

Refer to "Garage door opener," Section 5-5 in the Owner's Manual, for more details.

For programming assistance, contact HomeLink® at 1-800-355-3515, or visit <http://www.homelink.com/toyota>.

* HomeLink® is a registered trademark of Gentex Corporation.





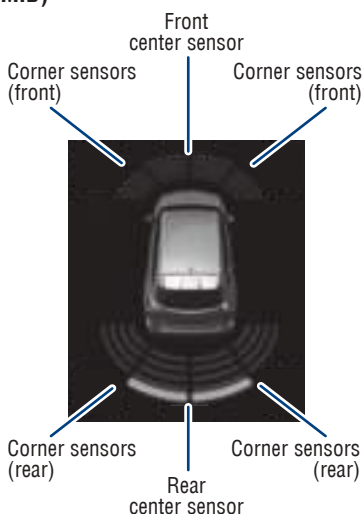

Intuitive parking assist (if equipped)

Multi-Information Display (MID)



If the sensors detect an obstacle, the buzzer and MID or navigation system display informs the driver of the approximate position and distance of the obstacle by illuminating continuously (far) or blinking (near). Depending on your Audio Multimedia system, you can adjust settings.

To turn system ON/OFF:

- 1) Press “” of the meter control switches and select “” from the Multi-Information Display (MID).
- 2) Press “” and select “” and then press “”. The system displays “” when the system is operational.

Always check the surrounding area when using this system.





Refer to the Owner's Manual for limitations and more details.

FEATURES & OPERATIONS

Front and Rear Parking Assist with Automated Braking (if equipped)

The Front and Rear Parking Assist with Automated Braking consists of the following functions that operate when driving at a low speed or backing up, such as when parking. When the system determines that the possibility of a collision with a detected object is high, a warning operates to urge the driver to take evasive action. If the system determines that the possibility of a collision with a detected object is extremely high, the brakes are automatically applied to help avoid the collision or help reduce the impact of the collision.

CHANGE SETTINGS

Use “” or “” and “” of the meter control switches to select “” and “” in the Multi-Information Display (MID) to change settings. The system will continue in the last state it was in (ON or OFF) when the engine is started again.

Refer to section PKSB (Parking Support Brake function) in the Owner's Manual for limitations and more details.

Rear view monitor system (if equipped)

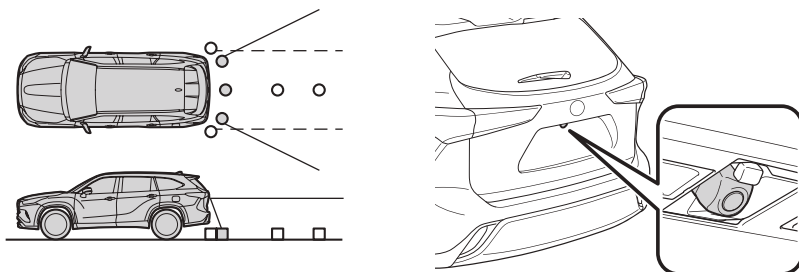

The rear view monitor system displays an image of the view from the bumper of the rear area of the vehicle. The camera for the rear view monitor system is located above the license plate.

To adjust the image on the rear view monitor screen, press the “MENU” button and select “Display”. Select “Camera” to adjust the screen contrast and brightness.

Refer to the Navigation and Multimedia System Owner's Manual for limitations and more details on this system.

Blind Spot Monitor (BSM) and Rear Cross Traffic Alert (RCTA) (if equipped)

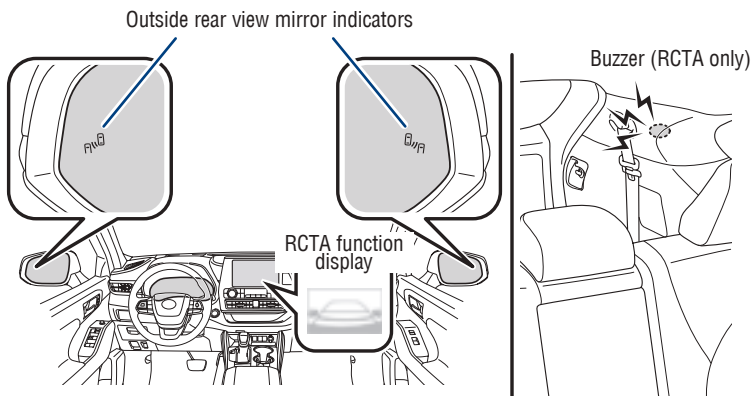

BLIND SPOT MONITOR (BSM)

The system is designed to use radar sensors to detect vehicles traveling in the Highlander's blind spot when to change lanes. If a vehicle is detected, the driver will be alerted via the outside rear view side mirror indicators.

REAR CROSS TRAFFIC ALERT (RCTA)

While in reverse, when a vehicle approaching from the right or left rear of the Highlander is detected, the outside rear view mirror indicators flash.

Refer to the Toyota Owner's Manual for limitations and more details on this system before attempting to use it.

Vehicle Stability Control (VSC)/ TRAC /Trailer Sway Control OFF switch

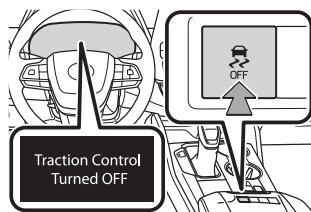

The VSC OFF switch can be used to help free a stuck vehicle in surroundings like mud, dirt or snow. While the vehicle is stopped, press switch to disable the TRAC system.

To disable VSC/TRAC/Trailer Sway Control systems, press and hold the switch for at least 3 seconds.

Refer to the Owner's Manual for limitations and more details.

FEATURES & OPERATIONS

Bird's Eye View Camera with Perimeter Scan Function (if equipped)

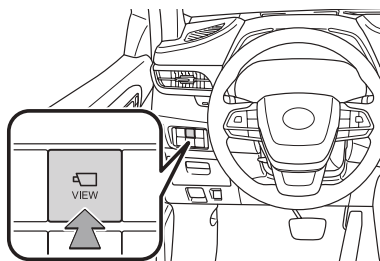

Moving view

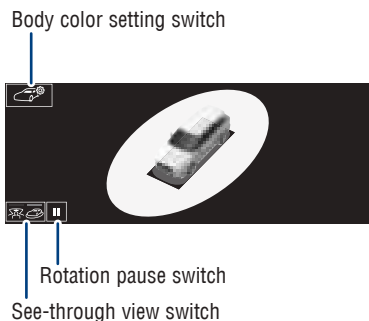

See through view

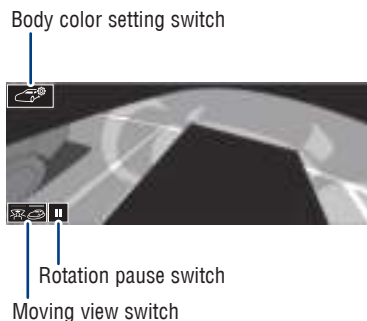

The Bird's Eye View Camera with Perimeter Scan function assists the driver in viewing the surroundings, when operating at low speeds or parking, by combining front, side and rear cameras and displaying an overhead image on the Audio Multimedia System screen.

To view or turn OFF the screen, press the camera switch when the shift lever is in the "P" position. It will display two angles, the Moving view and the See Through view.

For limitations and more details, refer to the "Navigation and Multimedia System Owner's Manual."

Stop & Start Engine System (if equipped)

The Stop & Start Engine System stops and restarts the engine according to the brake pedal operation and other operations when the vehicle is stopped.

Stopping and restarting the engine

While driving with the shift lever in D, depress the brake pedal, and stop the vehicle. The engine will stop automatically.

To restart the engine, release the brake pedal. The engine will start automatically.

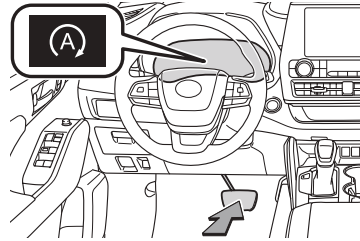

Disabling the Stop & Start Engine System

Press the Stop & Start Engine System cancel switch to disable the system.

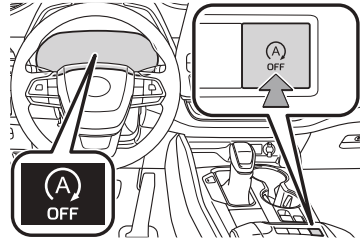

HILL-START ASSIST CONTROL (HAC)

If the engine is stopped by the Stop & Start Engine System when the vehicle is on an incline, brake force is temporarily maintained to prevent rolling backwards until the engine is restarted and drive force is generated.

When drive force is generated, the maintained brake force is automatically canceled.

Refer to the Owner's Manual for limitations and more details on this system before attempting to use it.

FEATURES & OPERATIONS

Multi-terrain Select (AWD vehicles)

DYNAMIC TORQUE CONTROL AWD VEHICLES

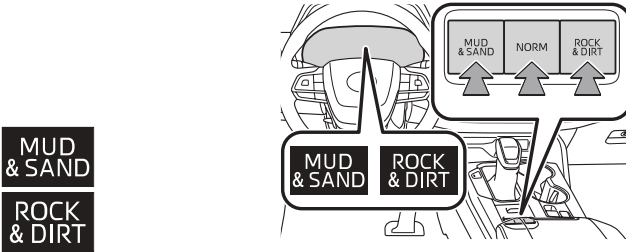

DYNAMIC TORQUE VECTORING AWD VEHICLES

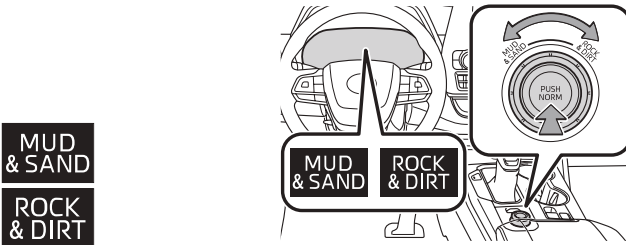

Multi-terrain Select is a system that helps drivability in off-road situations. When driving over muddy, sandy or rough road surfaces, the system selects a suitable driving mode to switch AWD, brake and drive force control to perform control suitable for the road condition.

MUD & SAND - Muddy roads, sandy roads, muddy road or dirty conditions.

ROCK & DIRT - Very bumpy road conditions, such as unpaved forest roads.

Refer to the Owner's Manual for limitations and more details on this system before attempting to use it.

Snow mode button

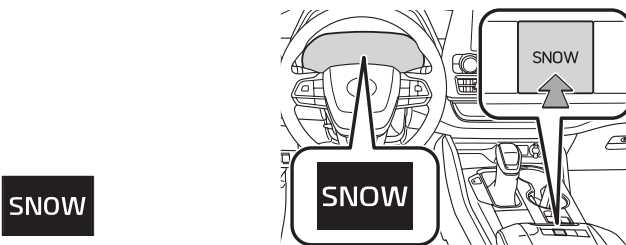

Use snow mode for accelerating and driving on slippery road surfaces, such as on snow.

Refer to the Owner's Manual for more details.

Downhill Assist Control system (DAC) (if equipped)

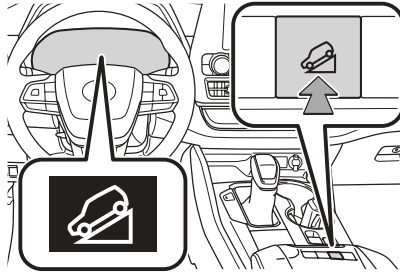

With the downhill assist control system, the vehicle is able to descend a steep hill, maintaining a constant low speed of about 18 mph (30 km/h) without brake pedal operation.

Press the “DAC” button to activate the system. The slip indicator will flash to indicate that the downhill assist control system is operating.

Refer to the Owner’s Manual for more details.

Driving mode select switch

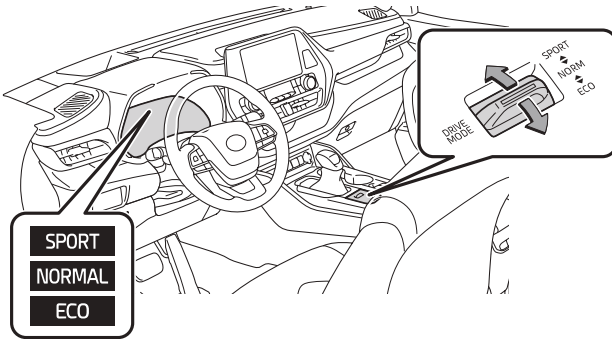

Normal - Suitable for normal driving.

SPORT mode - Use when a higher level of response is desired, such as when driving in mountainous regions.

ECO MODE - Helps achieve lower fuel consumption during trips that involve frequent accelerating and braking.

Refer to the Owner’s Manual for more details.

Quick overview-Toyota Safety Sense™ 2.0

Toyota Safety Sense™ 2.0 (TSS 2.0) is a set of active safety technologies designed to help mitigate or prevent collisions across a wide range of traffic situations, in certain conditions. TSS 2.0 is designed to help support the driver's awareness, decision making and vehicle operation contributing to a safe driving experience.

Refer to the Owner's Manual for operation, setting adjustments, limitations and more details to understand these functions and complete safety precautions. For more information, please go to <http://www.toyota.com/safety-sense>



Pre-Collision System with Pedestrian Detection (PCS w/PD)

PCS w/PD is designed to provide alert, mitigation, and/or avoidance support in certain conditions, when the system detects a potential collision with a preceding vehicle is likely to occur.

The advanced millimeter-wave radar sensor system is designed to work with the camera sensor to help recognize a preceding pedestrian or bicyclist, and provide an alert, mitigation and/or avoidance support in certain conditions.



Lane Departure Alert with Steering Assist (LDA w/SA)

LDA w/SA is designed to provide notification when the system detects an unintended lane departure.

The Steering Assist function is designed to provide small corrective steering inputs to the steering wheel for a short period of time to help keep the vehicle in its lane.

The Sway Warning function is designed to detect vehicle swaying (based on the vehicle location and steering wheel operation) and alert the driver with an audio and visual alert, urging them to take a break.



Lane Tracing Assist (LTA)

LTA contains all the features of LDA described above and additionally is designed to help keep the vehicle in the center of a lane by assisting the driver in steering control when using Full-Speed Range DRCC.



Full-Speed Range Dynamic Radar Cruise Control (DRCC)

Full-Speed Range DRCC is designed to help maintain a pre-set distance to a preceding vehicle when the preceding vehicle is traveling at a lower speed. The minimum set speed is approximately 20 MPH, but once activated, the operating speed range is 0-110 MPH.



Automatic High Beams (AHB)

AHB is designed to detect the headlights of oncoming vehicles and the tail lights of preceding vehicles and switch between high beams and low beams as appropriate.



Road Sign Assist (RSA)

RSA is designed to recognize specific road signs using the forward facing camera to provide information to the driver via the display.

Sensors

TSS 2.0 combines an in-vehicle camera mounted in front of the inside rear view mirror and a radar mounted in the front grille. These sensors support the driver assist systems.

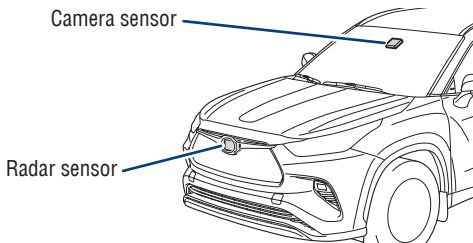

Pre-Collision System with Pedestrian Detection (PCS w/PD)

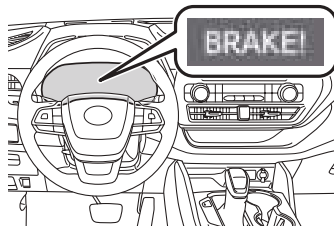

The Pre-Collision System uses a radar sensor and camera sensor to help detect a vehicle or pedestrian or bicyclist in front of your vehicle.

As there is a limit to the degree of recognition accuracy and control performance that this system can provide, do not overly rely on this system. This system will not prevent collisions or lessen collision damage or injury in every situation. Do not use PCS instead of normal braking operations under any circumstances. Do not attempt to test the operation of the Pre-Collision System yourself, as the system may not operate or engage, possibly leading to an accident. In some situations, such as when driving in inclement weather such as heavy rain, fog, snow or a sandstorm or while driving on a curve and for a few seconds after driving on a curve, a vehicle or pedestrian or bicyclist may not be detected by the radar and camera sensors, preventing the system from operating or engaging properly.

Refer to the Toyota Owner's Manual for a list of additional situations in which the system may not operate properly.

Pre-Collision Warning

When the system determines that the possibility of a frontal collision is high, a buzzer will sound and a warning message will be displayed on the Multi-Information Display (MID) to urge the driver to take evasive action.

Pre-Collision Brake Assist

If the driver notices the hazard and brakes, the system may provide additional braking force using Brake Assist. This system may prime the brakes and may apply greater braking force in relation to how strongly the brake pedal is depressed.

Pre-Collision Braking

If the driver does not brake in a set time and the system determines that the possibility of a frontal collision with a preceding vehicle is extremely high, the system may automatically apply the brakes, reducing speed in order to help the driver reduce the impact and in certain cases avoid the collision.

Refer to the Toyota Owner's Manual for additional information on PCS operation, settings adjustments, limitations, and precautions before attempting to use it.

PCS PEDESTRIAN DETECTION

Under certain conditions, the PCS system included with the TSS 2.0 package may also help to detect a pedestrian or bicyclist in front of your vehicle using the in-vehicle camera and front grille-mounted radar. The in-vehicle camera of PCS detects a potential pedestrian or bicyclist based on size, profile, and motion of the detected pedestrian or bicyclist. However, a pedestrian or bicyclist may not be detected depending on the conditions, including the surrounding brightness and the motion, posture, size, and angle of the potential detected pedestrian or bicyclist, preventing the system from operating or engaging.

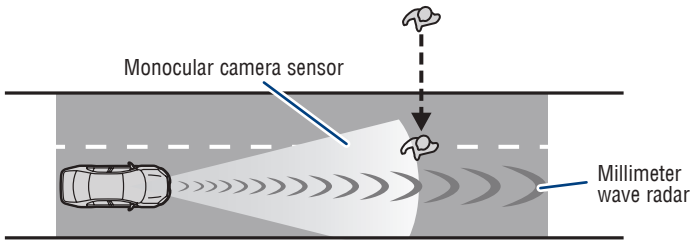

As part of the Pre-Collision System, this function is also designed to first provide an alert and then automatic braking if needed.

Refer to the Toyota Owner's Manual for additional limitations and information.

CHANGING PRE-COLLISION ALERT TIMING

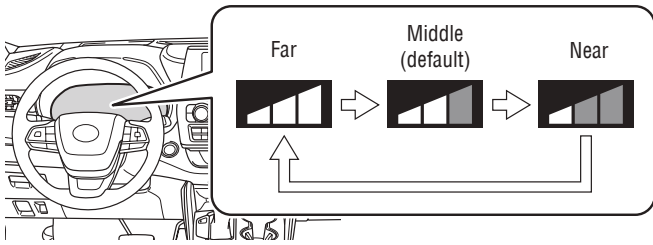

- (1) Press “<>” or “⬇” switches and select “⚙️” from the Multi-Information Display (MID).
- (2) Press “<>” or “⬇” switches and select “🚗 PCS” and then press and hold “OK”.
- (3) Press “<>” or “⬇” switches and select “Sensitivity” and then press and hold “OK” to select the desired setting. Each time it is pressed, the response to the PCS alert timing changes as shown above.
- (4) Press “⬅” to go back to the menu.

Note: PCS is enabled each time the engine switch is turned to Ignition On. The system can be disabled/enabled and the alert timing of the system can be changed. (Alert timing only, brake operation remains the same).

DISABLING PRE-COLLISION SYSTEM (PCS)

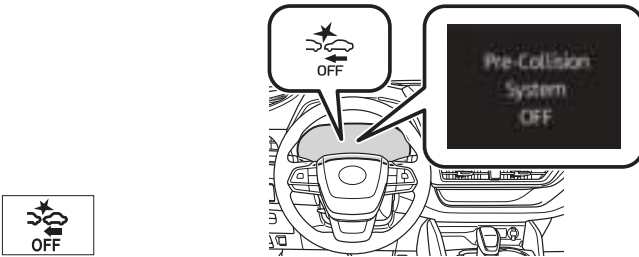

- (1) Press “<>” or “⬇” switches and select “⚙️” from the Multi-Information Display (MID).
- (2) Press “<>” or “⬇” switches and select “🚗 PCS” and then press and hold “OK”.
- (3) Press “<>” or “⬇” switches and select “PCS on/off” and then press “OK” to select the desired setting.
- (4) Press “⬅” to go back to the menu.

Note: The system is enabled each time the power switch is turned to ON mode.

Refer to the Toyota Owner's Manual for additional information on PCS operation, settings adjustments, limitations, and precautions before attempting to use it.

Lane Departure Alert with Steering Assist (LDA w/SA)

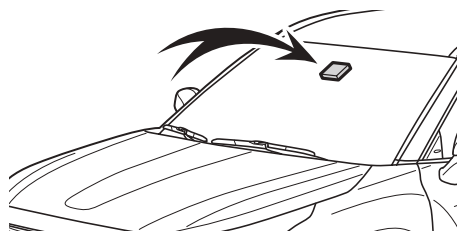

LDA in TSS 2.0 uses an in-vehicle camera designed to detect visible white and yellow lane markers or road edge in front of the vehicle and the vehicle's position on the road. If the system determines that the vehicle is starting to unintentionally deviate from its lane, the system alerts the driver with an audio and visual alert. When the alerts occur, the driver must check the surrounding road situation and carefully operate the steering wheel to move the vehicle back to the center part of their lane.

LDA is designed to function at speeds of approximately 32 mph (50 km/h) or higher on relatively straight roadways.

In addition to the alert function, LDA w/SA also features a steering assist function. When enabled, if the system determines that the vehicle is on a path to unintentionally depart from its lane, the system may provide small corrective steering inputs to the steering wheel for a short period of time to help keep the vehicle in its lane.

If the vehicle repeatedly deviates from the lane, the vehicle drifts within the lane due to inattention, or the driver abruptly operates the steering wheel after an inattentive period, when enabled, the vehicle sway warning function alerts the driver with an audio and visual alert, urging them to take a break.

TURNING THE LDA SYSTEM ON/OFF

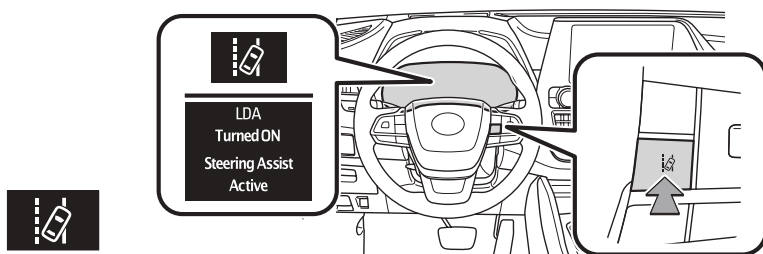

Press the LDA switch to turn the LDA system on. Depress again to turn it off.

Note: Operation of the LDA system and setting adjustments continues in the same condition regardless of ignition cycle until changed by the driver or the system is reset.

LDA function display

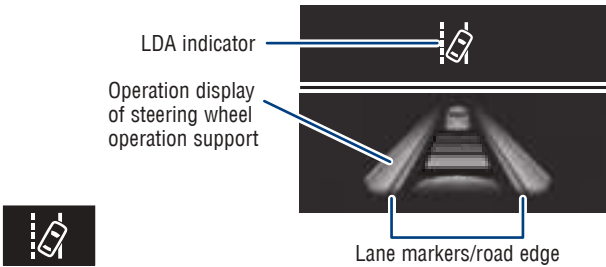

Lane Departure Alert (LDA) indicator flashes orange when operating.



(1)



(2)





The LDA function  displays when the Multi-Information Display (MID) is switched to the driving assist system information screen.

(1) The system displays solid white lines on the LDA indicator when visible lane markers or the road are detected. A side flashes orange to alert the driver when the vehicle deviates from its lane.

(2) The system displays outlines on the LDA indicator when lane markers or the road are not detected or the function is temporarily cancelled.

Note: When operation conditions are no longer met, a function may be temporarily canceled. However, when the operation conditions are met again, operation of the function is automatically restored. For example, LDA may not function on the side(s) where white/yellow lines are not detectable.

DISABLING STEERING ASSIST

- (1) Press “<>” or “◇” switches and select “” from the Multi-Information Display (MID).
- (2) Press “<>” or “◇” switches and select “ LDA” and then press and hold “.
- (3) Press “<>” or “◇” switches and select “Steering Assist” and then press and hold “” to select the desired setting.
- (4) Press “” to go back to the menu.





Note: Operation of the LDA system and setting adjustments continues in the same condition regardless of ignition cycle until changed by the driver or the system is reset.

ADJUSTING LDA ALERT SENSITIVITY

The driver can adjust the sensitivity of the LDA (warning) function from the Multi-Information Display (MID) customization screen.

High - Is designed to warn approximately before the front tire crosses the lane marker.

Normal - Is designed to warn approximately when the front tire crosses the lane marker.

- (1) Press “<>” or “◇” switches and select “” from the Multi-Information Display (MID).
- (2) Press “<>” or “◇” switches and select “ LDA” and then press and hold “.
- (3) Press “<>” or “◇” switches and select “Sensitivity” and then press and hold “” to select the desired setting.
- (4) Press “” to go back to the menu.

SWAY WARNING SYSTEM



Continuous lane deviations from swaying.







Gentle swaying from driver's inattentiveness.



Acute steering wheel operation after the number of operations decrease due to driver's inattentiveness.





SWS is a function of LDA and is designed to detect swaying based on the vehicle location in the lane and the driver's steering wheel operation. To help prevent swaying, the system alerts the driver using a buzzer sound and a warning displays in the MID.

DISABLING LDA SWAY WARNING ALERT

- (1) Press “<>” or “◇” switches and select “” from the Multi-Information Display (MID).
- (2) Press “<>” or “◇” switches and select “ LDA” and then press and hold “”.
- (3) Press “<>” or “◇” switches and select “Sway Warning” and then press and hold “” to select the desired setting.
- (4) Press “” to go back to the menu.

Note: Operation of the LDA system and setting adjustments continues in the same condition regardless of ignition cycle until changed by the driver or the system is reset.

ADJUSTING SWAY ALERT SENSITIVITY

- (1) Press “<>” or “◇” switches and select “” from the Multi-Information Display (MID).
- (2) Press “<>” or “◇” switches and select “ LDA” and then press and hold “”.
- (3) Press “<>” or “◇” switches and select “Sway Sensitivity” and then press and hold “” to select the desired setting.
- (4) Press “” to go back to the menu.

Refer to the Toyota Owner's Manual for additional information on LDA operation, settings adjustments, limitations, and precautions before attempting to use it.

Lane Tracing Assist (LTA)

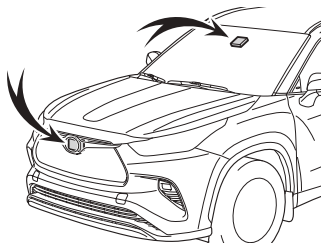

When enabled, the LTA system's lane centering function is designed to automatically provide assistance to help keep the vehicle in the center of the lane with Full-Speed Range DRCC set.

TURNING THE LTA SYSTEM ON/OFF

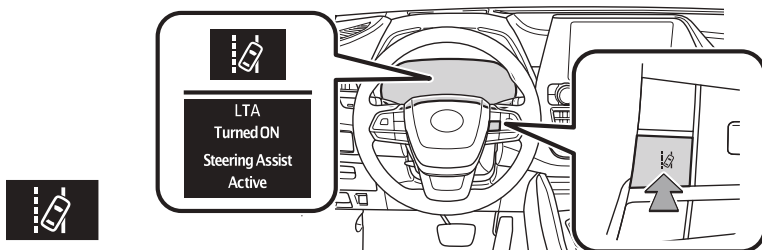

Press the LTA switch to turn the LTA system on. Depress again to turn it off.

Note: Operation of the LTA system and setting adjustments continues in the same condition regardless of Ignition cycle until changed by the driver or the system is reset.

Refer to the Toyota Owner's Manual for additional information on LTA operation, settings adjustments, limitations, and precautions before attempting to use it.

LTA function display

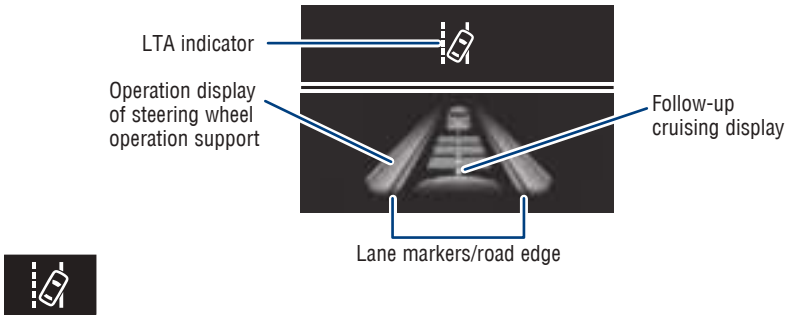

Lane Tracing Assist (LTA) indicator flashes orange when operating.



(1)



(2)

The LTA function  displays when the Multi-Information Display (MID) is switched to the driving assist system information screen.





(1) The system displays solid white lines on the LTA indicator when visible lane markers on the road are detected. A side flashes orange to alert the driver when the vehicle deviates from its lane.

(2) The system displays outlines on the LTA indicator when lane markers on the road are not detected or the function is temporarily cancelled.

Note: When operation conditions are no longer met, a function may be temporarily canceled. However, when the operation conditions are met again, operation of the function is automatically restored. For example, LTA may not function on the side(s) where white/yellow lines are not detectable.

Refer to the Toyota Owner's Manual for additional information on LTA operation, settings adjustments, limitations, and precautions before attempting to use it.

DISABLING STEERING ASSIST

- (1) Press “<>” or “◇” switches and select “” from the Multi-Information Display (MID).
- (2) Press “<>” or “◇” switches and select “ LTA” and then press and hold “.
- (3) Press “<>” or “◇” switches and select “Steering Assist” and then press and hold “” to select the desired setting.
- (4) Press “” to go back to the menu.





Note: Operation of the LTA system and setting adjustments continues in the same condition regardless of ignition cycle until changed by the driver or the system is reset.

ADJUSTING LTA ALERT SENSITIVITY

The driver can adjust the sensitivity of the LTA (warning) function from the Multi-Information Display (MID) customization screen.

High - Is designed to warn approximately before the front tire crosses the lane marker.

Normal - Is designed to warn approximately when the front tire crosses the lane marker.

- (1) Press “<>” or “◇” switches and select “” from the Multi-Information Display (MID).
- (2) Press “<>” or “◇” switches and select “ LTA” and then press and hold “.
- (3) Press “<>” or “◇” switches and select “Sensitivity” and then press and hold “” to select the desired setting.
- (4) Press “” to go back to the menu.



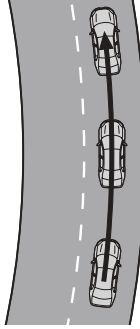

LANE CENTERING



The lane centering function is linked with Full-Speed Range Dynamic Radar Cruise Control (DRCC) and provides the required assistance by operating the steering wheel to keep the vehicle in its current lane.

When dynamic radar cruise control with full-speed range is not operating, the lane centering function does not operate.

DISABLING LANE CENTERING FUNCTION

- (1) Press “<>” or “◇” switches and select “” from the Multi-Information Display (MID).
- (2) Press “<>” or “◇” switches and select “ LTA” and then press and hold “.
- (3) Press “<>” or “◇” switches and select “Lane center” and then press and hold “.
- (4) Press “.

Note: Operation of the LTA system and setting adjustments continues in the same condition regardless of Ignition cycle until changed by the driver or the system is reset.

Full-Speed Range Dynamic Radar Cruise Control (DRCC)

Full-Speed Range DRCC helps maintain a pre-set distance to a preceding vehicle when the preceding vehicle is traveling at a lower speed. This mode is always selected first when the cruise control button is depressed. Constant speed cruise control mode is also available. Full-Speed Range DRCC is designed to function at speeds between 0 to approximately 110 MPH and is intended for highway use.

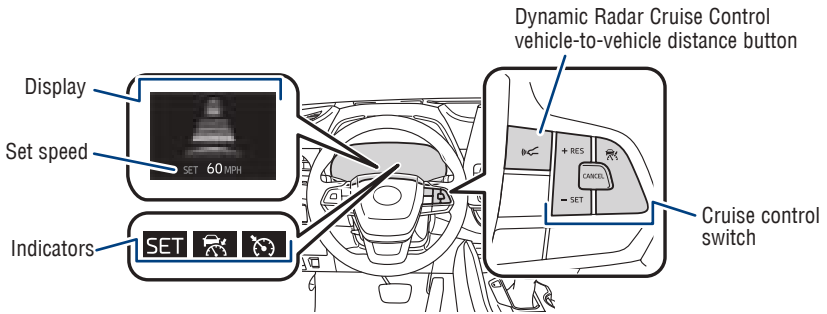

TURNING SYSTEM ON/OFF

(1)



Push once: On
Push twice: Off

Refer to page 56 for switching to Constant Speed (Cruise) Control Mode.

ADJUSTING SET SPEED

(2) Increase speed/Resume

(3)

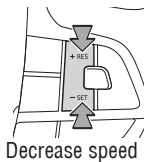



Decrease speed



Cancel¹

Vehicle will cruise at a set speed, decelerate to maintain selected distance from a slower vehicle traveling in front and accelerate back up to the selected speed if the vehicle in front changes lanes or speeds up.

- (1) Push  to turn DRCC system ON. The “RADAR READY” and  indicator will come on.
- (2) Use the steering wheel controls to increase speed by pushing “+RES” or decrease the speed by pushing “-SET”. Push and hold to make a large adjustment or push each time to make fine adjustments (1 mph [1.6 km/h] or 1 km/h [0.6 mph] increments).
- (3) Push “Cancel” to cancel the speed control operation.

¹ The speed control may also be cancelled by depressing the brake pedal.

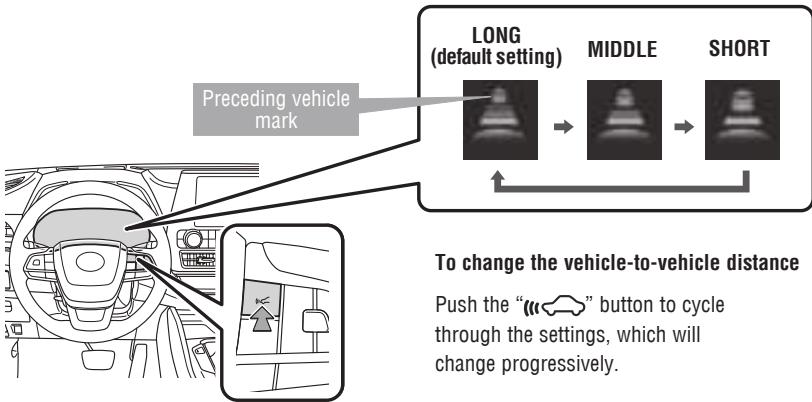

This mode employs a radar sensor to detect the presence of a preceding vehicle up to approximately 328 ft (100 m) ahead, determines the current vehicle-to-vehicle following distance and operates to maintain a preset following distance from the vehicle ahead. These distances vary based on vehicle speed.

Note: Vehicle-to-vehicle distance will close in when traveling on long downhill slopes.

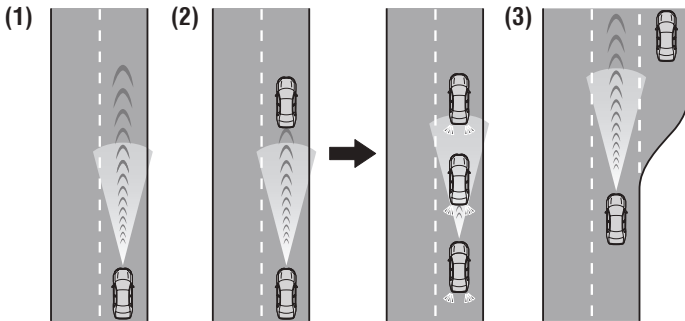

(1) Constant speed cruising when there are no vehicles ahead

The vehicle travels at the speed set by the driver. The desired vehicle-to-vehicle distance can also be set by operating the vehicle-to-vehicle distance control.

(2) Deceleration cruising and follow-up cruising when a preceding vehicle driving slower than the set speed appears

When a vehicle is detected running ahead of you, the system automatically decelerates your vehicle. When a greater reduction in vehicle speed is necessary, the system applies the brakes (the brake lights will come on at this time). The system will respond to changes in the speed of the vehicle ahead in order to maintain the vehicle-to-vehicle distance set by the driver. A warning tone warns you when the system cannot decelerate sufficiently to prevent your vehicle from closing in on the vehicle ahead.

ADJUSTING DISTANCE (CONTINUED)

(3) Acceleration when there are no longer any preceding vehicles driving slower than the set speed

The system accelerates until the set speed is reached. The system then returns to constant speed cruising.

Note: When your vehicle is too close to a vehicle ahead, and sufficient automatic deceleration via the cruise control is not possible, the display will flash and the buzzer will sound to alert the driver. An example of this would be if another driver cuts in front of you while you are following a vehicle. Depress the brake pedal to ensure an appropriate vehicle-to-vehicle distance.

SWITCHING TO CONSTANT SPEED (CRUISE) CONTROL MODE

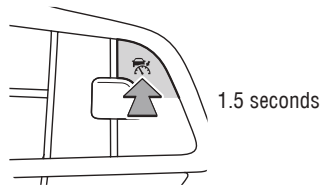

If you are already using DRCC “”, push ON-OFF button to turn the system off first, then push and hold ON-OFF button for at least 1.5 seconds to switch.

Note: When the engine is turned off, it will automatically default to DRCC.

SETTING CONSTANT SPEED (CRUISE) CONTROL

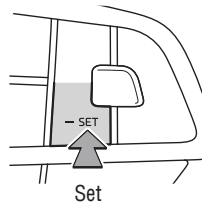

To adjust speed or cancel, see steps (2) and (3) of ADJUSTING SET SPEED on page 54.

Refer to the Toyota Owner's Manual for additional information on DRCC operation, settings adjustments, limitations, and precautions before attempting to use it.

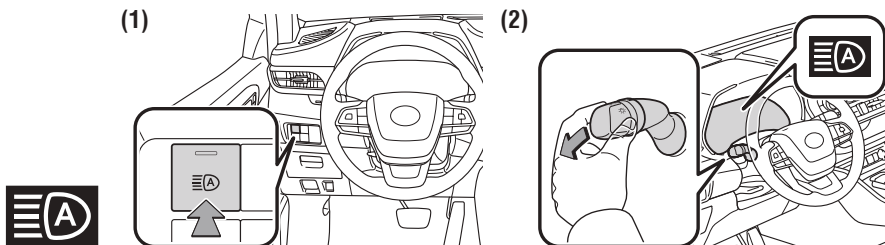

Automatic High Beams (AHB)



AHB is a safety system designed to help drivers see more of what's ahead at nighttime while reducing glare for oncoming drivers. AHB uses an in-vehicle camera to help detect the headlights of oncoming vehicles and tail lights of preceding vehicles, then automatically switches between high and low beams as appropriate to provide the most light possible and enhance forward visibility. By using high beams more frequently, the system may allow earlier detection of pedestrians and obstacles.



Refer to the *Toyota Owner's Manual* for additional information on AHB operation, settings adjustments, limitations, and precautions before attempting to use it.

ACTIVATING THE AHB SYSTEM

- (1) Press the “” switch.
- (2) Push lever away from you with the headlight switch is in the “” or “AUTO” position.

The AHB indicator will come on when the headlights are turned on automatically to indicate that the system is active.

Note: Pull the lever back toward you or press the AHB switch to turn the AHB system off.

The AHB indicator will turn off. To turn switch to “” position and the manual high beam indicator “” turns on.

CONDITIONS WHERE AHB WILL TURN ON/OFF AUTOMATICALLY

When all of these conditions are met, high beams will be automatically turned on (after approximately 1 second):

- Vehicle speed is above approximately 21 mph (34 km/h).
- The area ahead of the vehicle is dark.
- There are no oncoming or preceding vehicles with headlights or tail lights turned on.
- There are few streetlights on the road ahead.

If any of these conditions occur, high beams will be automatically turned off:

- Vehicle speed drops below approximately 17 mph (27 km/h).
- The area ahead of the vehicle is not dark.
- Oncoming or preceding vehicles have headlights or tail lights turned on.
- There are many streetlights on the road ahead.

Road Sign Assist (RSA)

Road Sign Assist is designed to help ensure drivers are kept informed. The RSA system recognizes specific road signs using a forward-facing intelligent camera to provide information to the driver via a Multi-information Display (MID). If the system judges that the vehicle is being driven over the speed limit, or performing actions prohibited by other support types of road signs, it alerts the driver using a warning display and may sound a warning buzzer.

RSA DISPLAY

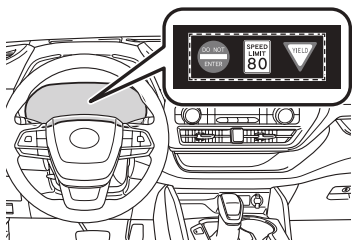

When the driving assist system information is selected, a maximum of 3 signs can be displayed.

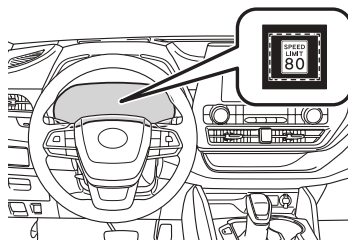

When a tab other than the driving assist system information is selected, only a recognized speed limit sign or do not enter sign (when notification is necessary) will be displayed.

SUPPORTED TYPES OF ROAD SIGNS



Speed limit



Stop







Do Not Enter



Yield

SETTING RSA

- (1) Press “◀▶” or “⬢” switches and select “” from the Multi-Information Display (MID).
- (2) Press “◀▶” or “⬢” switches and select “ RSA” and then press and hold “.”
- (3) Press “⬢” switches and select the “Road Sign Assist on/off” setting function and then press “.”
- (4) Press “” to go back to the menu.

Note: If the engine switch was last turned off while a speed limit sign was displayed on the multi-information display, the same sign displays again when the engine switch is turned to ON.

Refer to the Toyota Owner’s Manual for additional information on RSA operation, settings adjustments, limitations, and precautions before attempting to use it.

Seat belts

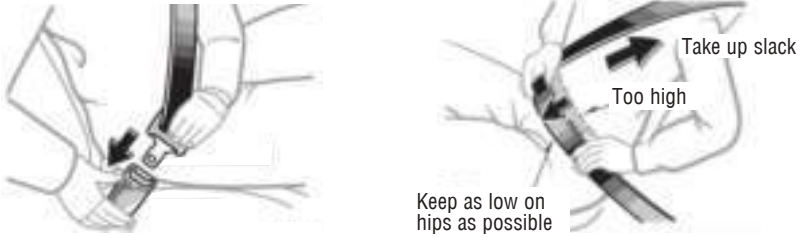

NOTE: If a passenger's seat belt is fully extended, then retracted even slightly, the Automatic locking retractor (ALR) will prevent it from being re-extended beyond that point, unless fully retracted again. This feature is used to help hold child restraint systems securely.

To find more information about seat belts, and how to install a child restraint system, refer to the Owner's Manual.

Seat belts-Shoulder belt anchor

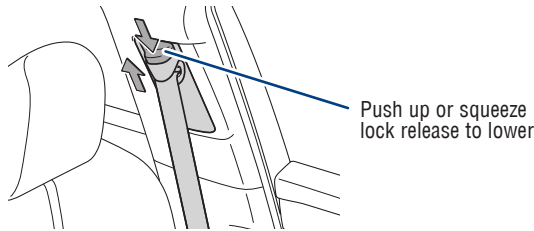

Seat belts-3rd row center

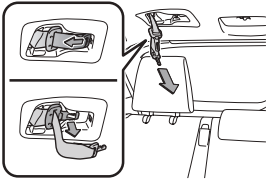

Take the plate out of the holder, and then pull down the seat belt

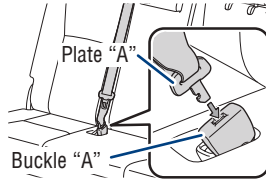

Push plate "A" into buckle "A" until a click sound is heard.

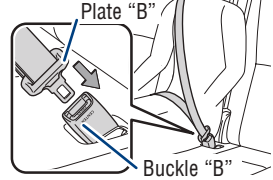

Push plate "B" into buckle "B" until a click sound is heard.

SAFETY AND EMERGENCY FEATURES

Rear door child safety locks

Rear door

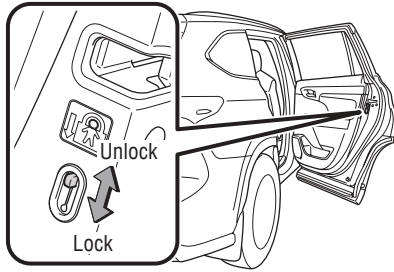

Moving the lever to the lock position will allow the door to be opened only from the outside.

Tire Pressure Monitoring (warning) System (TPMS)

4.2-inch display







7-inch display



Park the vehicle in a safe place and turn the engine switch off. (Initialization cannot be performed while the vehicle is moving.) Adjust the tire inflation pressure to the specified cold tire inflation pressure level then turn the engine switch to ON.

System rest initialization

- (1) Press “<>” or “◇” switches and select “” from the Multi-information Display (MID).
- (2) Press “<>” or “◇” switches and select “” and then press and hold “”.
- (3) Select “TPWS” and then push “”.
- (4) Select “Set Pressure” and then push and hold “”.

“Setting Tire Pressure Warning System” will be displayed on the multi-information display (MID) and the tire pressure warning light will blink 3 times.

When the message disappears, initialization is complete.

Refer to the load label on the door jamb or the Owner’s Manual for tire inflation specifications.

If the tire pressure indicator flashes for more than 60 seconds and then remains on, take the vehicle to your local Toyota dealer.

NOTE: The warning light may come on due to temperature changes or changes in tire pressure from natural air leakage. If the system has not been initialized recently, setting the tire pressures to factory specifications should turn off the light.

Spare tire & tools

SPARE TIRE, JACK AND TOOL LOCATION

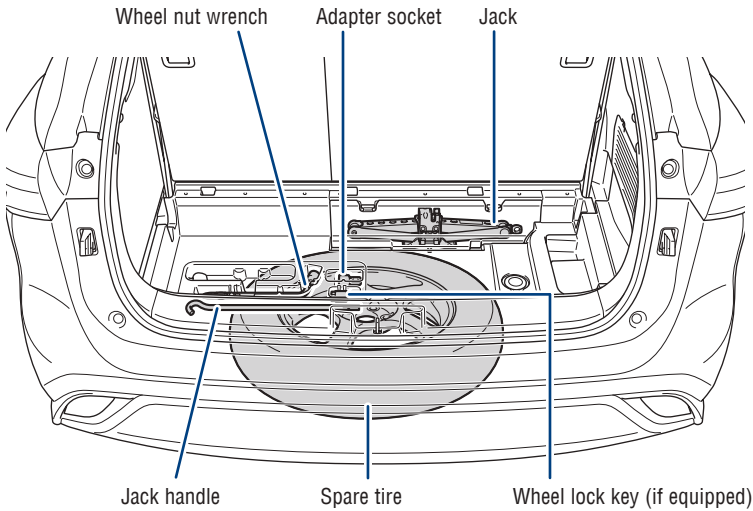

REMOVING THE SPARE TIRE

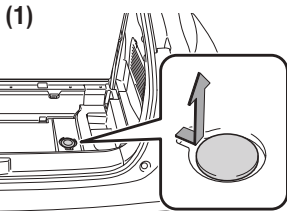

Remove the cover under the center deck board to find the spare tire clamp bolt.

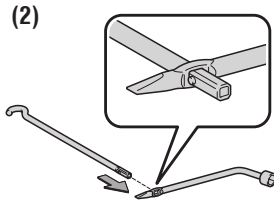

Assemble the jack handle.

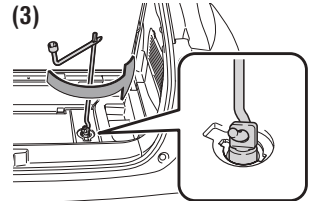

Put the socket adapter on the spare tire clamp bolt. Loosen the bolt by turning it counterclockwise with the jack handle.

Refer to the Owner's Manual for tire changing and jack positioning procedures.

SAFETY AND EMERGENCY FEATURES

Safety Connect® (if equipped)

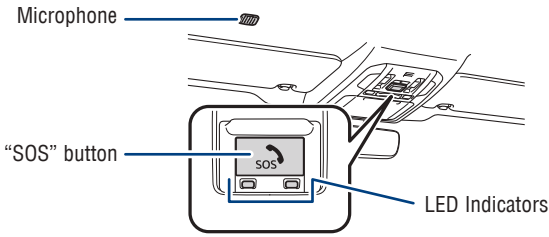

Safety Connect is a subscription-based telematics service that uses Global Positioning System (GPS) data and embedded cellular technology to provide safety and security features to subscribers. Safety Connect is staffed with live agents at the Toyota response center, which operates 24 hours per day, 7 days per week.

Services for subscribers include:

- Automatic collision notification
- Stolen vehicle locator
- Emergency assistance ("SOS" button)
- Enhanced roadside assistance

For additional information, refer to the "Owner's Manual" or visit www.Toyota.com/connected-services.

Star Safety System™

Your vehicle comes standard with the Star Safety System™, which combines Anti-lock Brake System (ABS), Brake Assist (BA), Electronic Brake-force Distribution (EBD), Smart Stop Technology (SST), Traction Control (TRAC) and Vehicle Stability Control (VSC).

Refer to the Owner's Manual for more details and important information on limitations to these systems.

ANTI-LOCK BRAKE SYSTEM (ABS)

Toyota's ABS sensors detect which wheels are locking up and limits wheel lockup by "pulsing" each wheel's brakes independently. Pulsing releases brake pressure repeatedly for fractions of a second. This helps the tires attain the traction that current road conditions will allow, helping you to stay in directional control.

BRAKE ASSIST (BA)

Brake Assist is designed to detect sudden or "panic" braking, and then add braking pressure to help decrease the vehicle's stopping distance. When there's only a split second to react, Brake Assist can add additional brake pressure more quickly than just the driver alone can.

ELECTRONIC BRAKE FORCE DISTRIBUTION (EBD)

Toyota's ABS technology has Electronic Brake-force Distribution (EBD) to help maintain control and balance when braking. EBD responds to sudden stops by redistributing brake force to enhance the braking effectiveness of all four wheels.

SMART STOP TECHNOLOGY (SST)

Smart Stop Technology automatically reduces engine power when the accelerator and brake pedals are pressed simultaneously under certain conditions.

SST engages when the accelerator is depressed first and the brakes are applied firmly for longer than one-half second at speeds greater than five miles per hour.

SST doesn't engage if the brake pedal is depressed before the accelerator pedal, allowing vehicles to start on a steep hill and safely accelerate without rolling backward.

ENHANCED VEHICLE STABILITY CONTROL (VSC)

Enhanced Vehicle Stability Control provides cooperative control of the ABS, TRAC, VSC and EPS.

Enhanced VSC helps to maintain directional stability when loss of traction occurs during a turn.

SAFETY AND EMERGENCY FEATURES

TRACTION CONTROL (TRAC)

VSC helps prevent loss of traction during cornering by reducing engine power, and Traction Control helps maintain traction on loose gravel and wet, icy, or uneven surfaces by applying brake force to the spinning wheel(s).

Toyota's TRAC sensors are activated when one of the drive wheels starts to slip. TRAC limits engine output and applies the brakes to the spinning wheel. This transfers power to the wheels that still have traction to help keep you on track.

Floor mat installation

There are two types of Toyota floor mats: carpeted and all-weather. Each vehicle has model-specific floor mats. Installation is easy.

To keep your floor mat properly positioned, follow these steps:

- Only use Toyota floor mats designed for your specific model.
- Use only one floor mat at a time, using the retaining hooks to keep the mat in place.
- Install floor mats right side up.

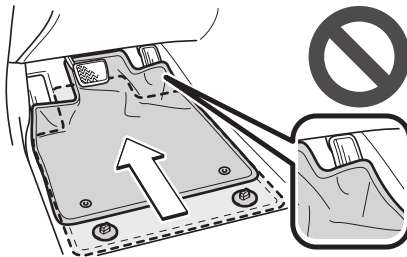
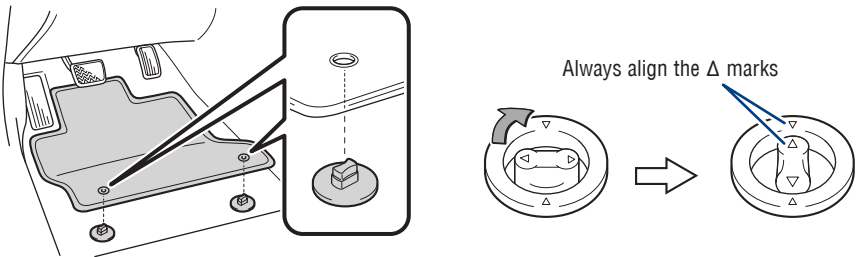

BLUETOOTH® DEVICE PAIRING SECTION

Do not attempt the Bluetooth® Pairing process while driving.

To begin the Bluetooth® Pairing process, press the HOME button on the faceplate of your multimedia system.

Bluetooth® Pairing for your phone

Pairing your phone is the first step in connecting with your Toyota. This pairing process is quick and easy. All you have to do is setup the phone and multimedia system to form a connection.¹



Audio / Audio Plus / Premium Audio

STEP 1 Press [MENU] on the audio system faceplate, then select "Setup" on display screen.



iPhone bluetooth Menu



Android bluetooth Menu



STEP 2 Ensure Bluetooth is turned on for your device.

STEP 3 Select "Bluetooth", then select "Add New Device" on display screen.



STEP 4 Select "Device Name".



STEP 5 Check the display on your smart phone. Does the PIN XXXX match the PIN displayed? If it does select "Pair".

¹ Some Android devices may have slightly different SETTINGS screen layout depending on manufacturer of device and Android OS version.

Bluetooth® Pairing for your phone (cont.)



STEP 6 "Connecting" displays while device is forming the connection to your multimedia system.



STEP 7 Enable Notifications (text message). While pairing your phone a message will be displayed: **"You may need to allow message access on your phone"**.

Note: You may also select "Skip" on display screen to skip enabling notifications. If skipped proceed to **Step 8**.

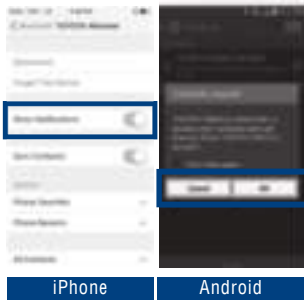

STEP 8 Turn on "Show Notifications" for iPhone or "ON" for Android.



STEP 9 A confirmation will appear once your phone has been paired and connected.



Highlander

Quick Reference Guide 2020



00505QRG20HIG

toyota.com



Printed in U.S.A. 11/19
19-MKG-14039