

QUICK REFERENCE GUIDE



2020

2020

C-HR

This Quick Reference Guide is a summary of basic vehicle operations. It contains brief descriptions of fundamental operations so you can locate and use the vehicle's main equipment quickly and easily.

The Quick Reference Guide is not intended as a substitute for the Owner's Manual located in your vehicle's glove box. We strongly encourage you to review the Owner's Manual and supplementary manuals so you will have a better understanding of your vehicle's capabilities and limitations.

Your dealership and the entire staff of Toyota Motor North America, Inc. wish you many years of satisfied driving in your new C-HR.

A word about safe vehicle operations

This Quick Reference Guide is not a full description of C-HR operations. Every C-HR owner should review the Owner's Manual that accompanies this vehicle.

Pay special attention to the boxed information highlighted in color throughout the Owner's Manual. Each box contains safe operating instructions to help you avoid injury or equipment malfunction.

All information in this Quick Reference Guide is current at the time of printing. Toyota reserves the right to make changes at any time without notice.

INDEX

OVERVIEW

Engine maintenance	9
Fuel tank door release & cap	8
Hood release	8
Indicator symbols	4-5
Instrument cluster	4
Instrument panel	2-3
Instrument panel light control	9
Keyless entry ^{1,2}	6
Smart Key system ^{1,2}	7

FEATURES & OPERATIONS

Air conditioning/heating	18
Audio	20
Auxiliary storage	17
Blind Spot Monitor (BSM) and Rear Cross Traffic Alert (RCTA)	22
Clock	19
Continuously variable transmission	10
Cup holders	17
Door locks	16
Driving mode select	10
Electric parking brake	11
Lights ¹ & turn signals	12
Multi-Information Display (MID) ¹	15
Power outlet-12V DC	20
Rear view monitor system	23
Seat adjustments-Front	14
Seat heaters	19
Seats-Folding rear	14
Seats-Head restraints	14
Steering lock release	16
Steering wheel switches & telephone controls (Bluetooth®)	21
Tilt & telescopic steering wheel	16
Vehicle Stability Control (VSC)/ TRAC OFF switch	23
USB media port	21
Windows-Power	17
Windshield wipers & washers	13

TOYOTA SAFETY SENSE™ P (TSS-P)

Automatic High Beams (AHB)	34
Full-Speed Range Dynamic Radar Cruise Control (DRCC)	31-33
Lane Departure Alert with Steering Assist (LDA w/SA)	27-30
Pre-Collision System with Pedestrian Detection (PCS w/PD)	25-27
Quick overview- Toyota Safety Sense™ P (TSS-P)	24
Sensors	24

SAFETY & EMERGENCY FEATURES

Floor mat installation	40
Rear door child safety locks	35
Safety Connect	37
Seat belts	35
Seat belts-Shoulder belt anchor	35
Spare tire & tools	38
Star Safety System™	39-40
Tire Pressure Monitoring (warning) System (TPMS)	36

BLUETOOTH® DEVICE PAIRING SECTION

42-44

¹ Visit your Toyota dealer for information on customizing this feature.

² Programmable by customer. Refer to the Owner's Manual for instructions and more information.

Instrument panel

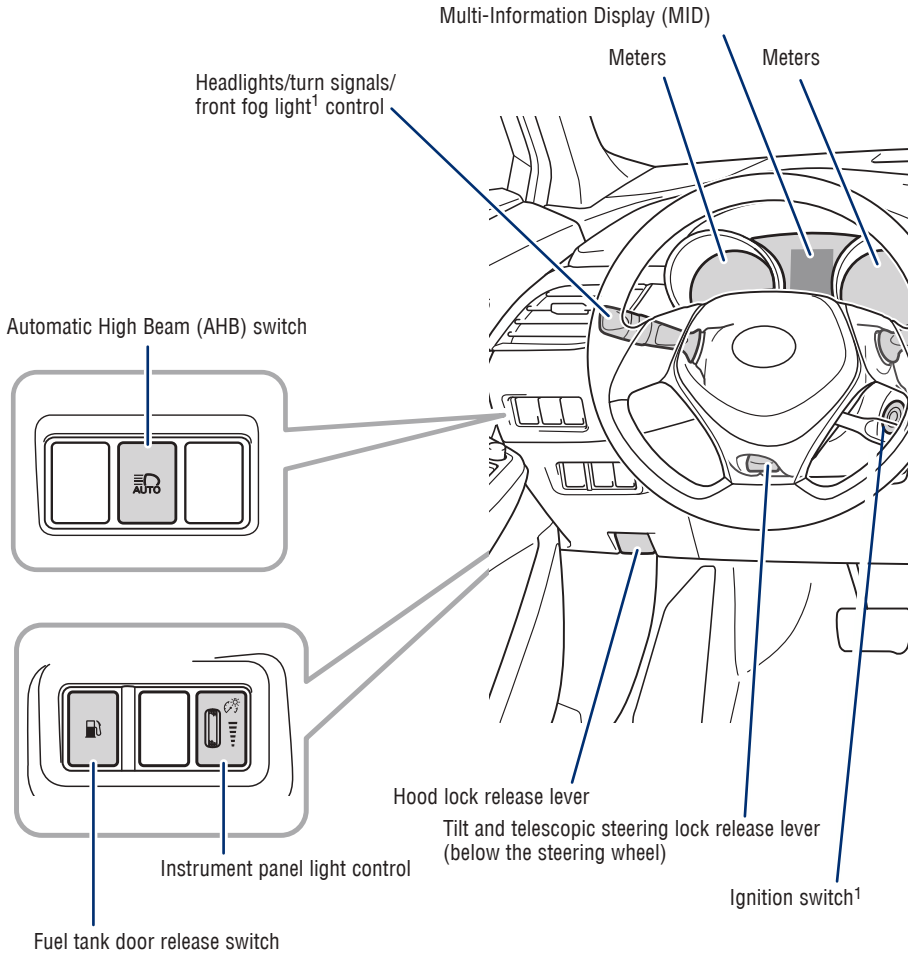
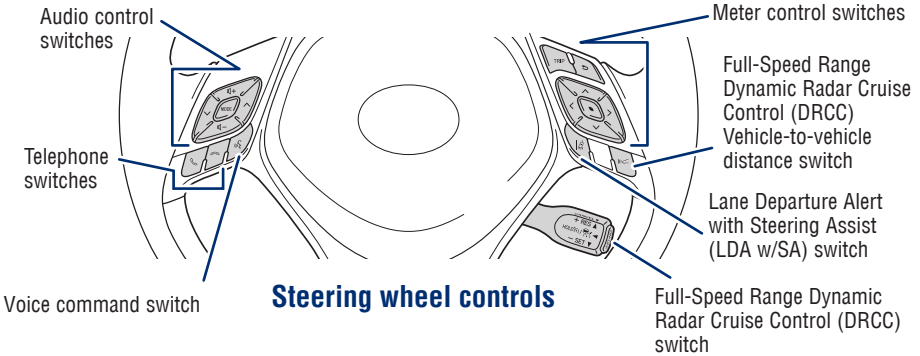

¹ If equipped.

² For details, refer to the “Navigation and Multimedia System Owner’s Manual” or visit www.toyota.com/audio-multimedia for additional resources.

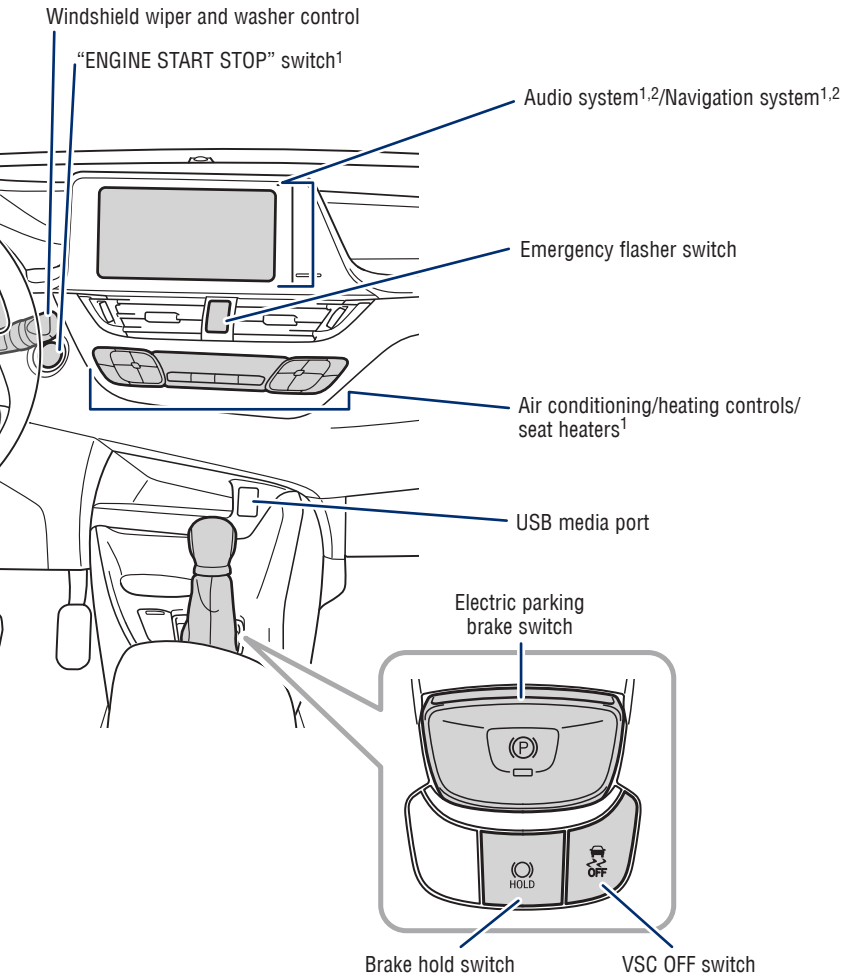



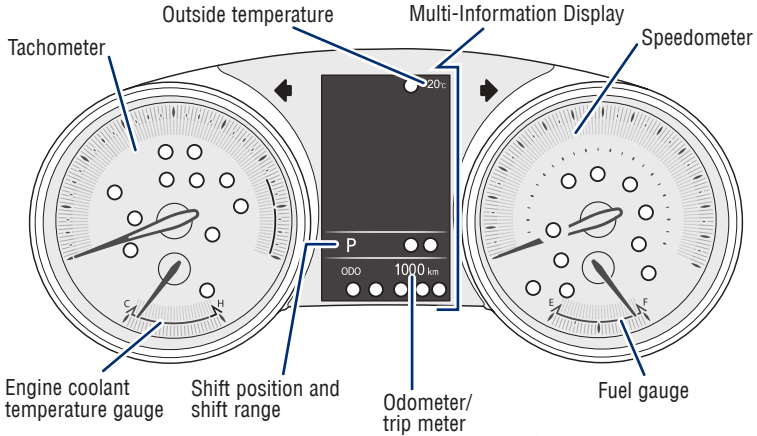















Instrument cluster



Indicator symbols

For details, refer to “Indicators and warning lights,” Section 2, 2020 Owner’s Manual.

	“AIRBAG ON/OFF” indicator ¹		Brake system warning ¹
	AIRBAG SRS warning ¹		Brake system warning (yellow) ¹
	Anti-lock Brake System (ABS) warning ¹		Charging system warning
	Arrow direction indicates fuel tank door position		Constant speed cruise control indicator/Constant speed cruise control SET indicator
	Automatic High Beam (AHB) indicator		Full-Speed Dynamic Radar Cruise Control (DRCC) indicator/DRCC SET indicator
	Blind Spot Monitor (BSM) OFF indicator ^{1,4}		Driver’s and front passenger’s seat belt reminder (alarm will sound when the engine switch is IGNITION ON mode)
	BSM outside rear view mirror indicators ^{1,4}		ECO MODE indicator
	“RCTA OFF” indicator ^{2,4}		Eco Driving Indicator
	Brake hold operated indicator ^{1,2}		Electric power steering system warning (red/yellow) ¹
	Brake hold standby indicator ¹		
	Brake Override System/ Drive-Start Control		

	Front fog light indicator ⁴
	Headlight low/high beam indicators
	High engine coolant temperature warning
	Lane Departure Alert (LDA) with steering assist indicator
	Low engine oil pressure warning
	Low fuel level warning
	Low outside temperature indicator
	Low Tire Pressure Warning ¹
	Malfunction/Check Engine indicator ¹
	Parking brake indicator ²
	Pre-Collision System (PCS) warning light ^{1,2}
	Rear passengers' seat belt reminder indicator
	Security indicator
	Slip indicator ^{1,3}
	Smart Key system ⁴
	SPORT mode indicator
	Turn signal indicator
	Vehicle Stability Control (VSC) OFF indicator ¹

¹ If the indicator does not turn off within a few seconds of starting the engine, there may be a malfunction. Have the vehicle inspected by your Toyota dealer.

² If the indicator flashes, there may be a malfunction. Refer to the Owner's Manual.

³ If the indicator flashes, it indicates that the system is operating.

⁴ If equipped.

OVERVIEW

Keyless entry

UNLOCKING OPERATION

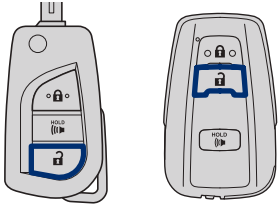

Push

ONCE: Driver door
TWICE: All doors

Carry Smart
Key remote
Front door unlock*

Grasp

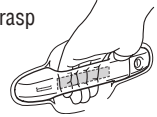

NOTE: If a door is not opened within 60 seconds of unlocking, all doors will relock for safety.

LOCKING OPERATION

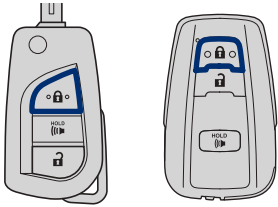

Push

Carry Smart
Key remote
All-door lock

Touch



PANIC BUTTON

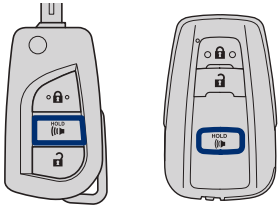

HOLD



Push and hold



BACK DOOR LOCKING/UNLOCKING



Carry Smart
Key remote

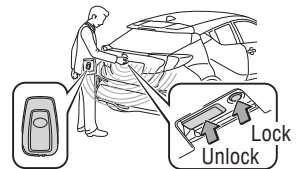

* Driver door unlocking function can be programmed to unlock driver door only, or all doors. In some models, grasping front passenger door handle will unlock all doors. *Please refer to the Owner's Manual for more details on how to program the doors.*

NOTE: Doors may also be locked/unlocked using remote.

Smart Key system (if equipped)

START FUNCTION

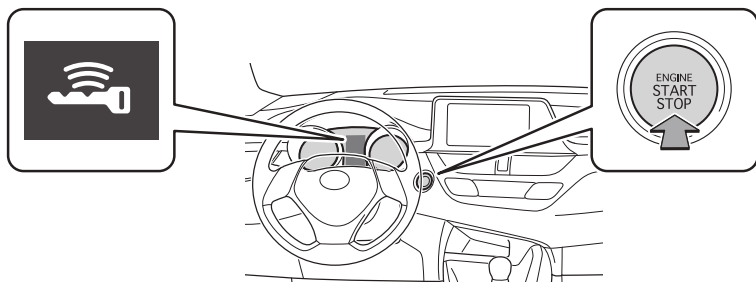

NOTE: The Smart Key must be carried to enable the start function. With the gear shift lever in Park and the brake pedal depressed, push the “ENGINE START STOP” button.

POWER (WITHOUT STARTING ENGINE)

Without depressing the brake pedal, pressing the engine switch will change the operation mode in succession from:

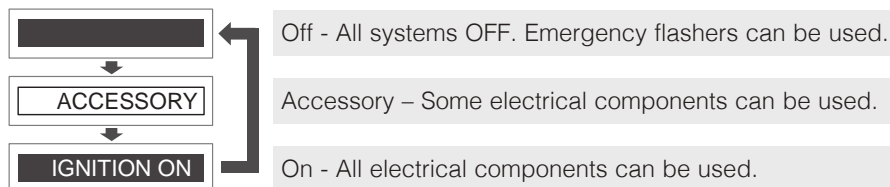

Fuel tank door release & cap

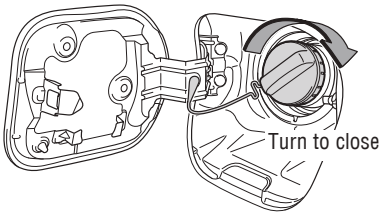
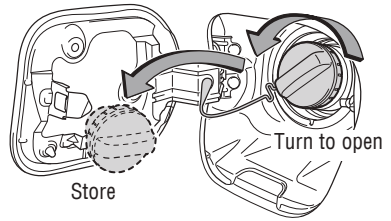
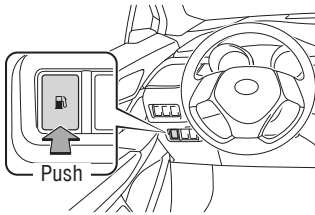

NOTE: Tighten until one click is heard. If the cap is not locked or tightened, Check Engine "H" CHECK indicator may illuminate.

Hood release

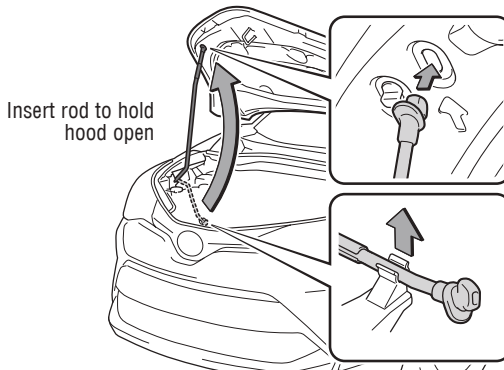
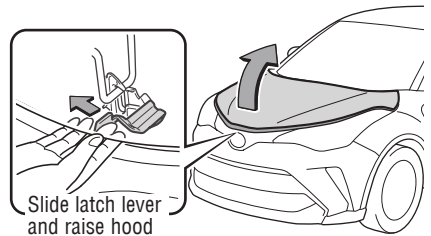
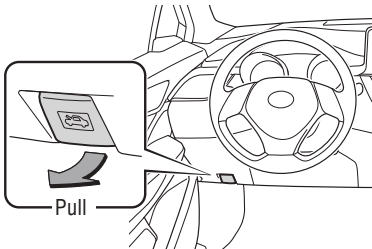

Instrument panel light control

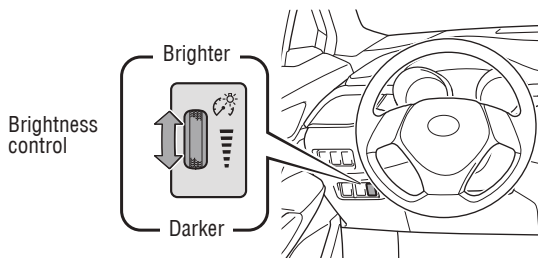

Engine maintenance

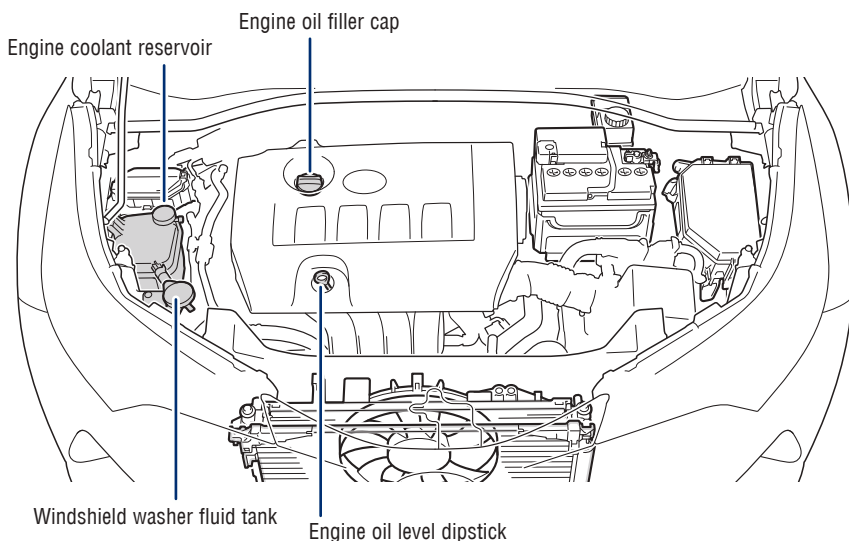

NOTE: Regularly scheduled maintenance, including oil changes, will help extend the life of your vehicle and maintain performance. Please refer to the "Warranty & Maintenance Guide."

Continuously variable transmission

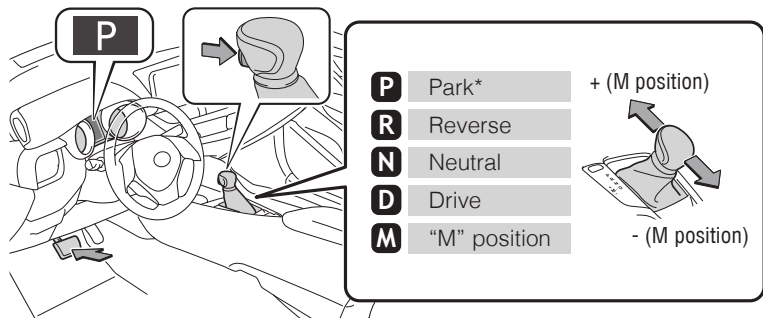

* The engine switch must be in the “ON” position (without Smart Key) / “IGNITION ON” mode (with Smart Key) and the brake pedal depressed to shift from Park.

7-SPEED SPORT SEQUENTIAL SHIFTMATIC MODE (M POSITION)

Shift the shift lever to “M” position from “D” position.

- + : Upshifting (push and release)
- : Downshifting (pull and release)

Downshifting increases power going uphill, or provides engine braking downhill. For best fuel economy during normal driving conditions, always drive with the shift lever in the “D” position.

Refer to the Owner’s Manual for more details.

Driving mode select

Use the steering wheel meter control switches to operate the MID. See above.

“**NORMAL**” - Suitable for city driving.

“**SPORT**” - Suitable for roads with many curves needing improved driving response.

“**ECO**” - Suitable for improved fuel economy and energy saving controlled air/heating.

- (1) Press steering wheel switches “<>” to find and select  in the MID.
- (2) Press steering wheel switches “<” switches and select “Drive Mode” in the MID.
- (3) Select a driving mode:

The “SPORT” and “ECO” indicators display in the Multi-Information Display (MID).

Note: Operation of the LDA system and setting adjustments continues in the same condition regardless of Ignition cycle until changed by the driver or the system is reset.

Electric parking brake

PARKING BRAKE

Automatic mode



Manual mode

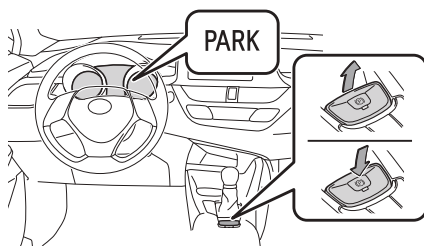

Automatic

To turn automatic mode ON, while vehicle is stopped, pull and hold switch until “EPB Shift Interlock Function Activated” displays in Multi-Information Display (MID). While depressing brake, shifting into P position will automatically set the brake and turn the parking brake indicator and parking brake light on. To release brake, depress brake and shift out of P. The indicator light and the light on the switch turn off.

To turn automatic mode OFF, push and hold parking brake switch until “EPB Shift Interlock Function Deactivated” displays on the MID.

Manual

While vehicle is stopped and brake pedal is depressed, pull to set parking brake and turn the parking brake indicator and parking brake light on. To release, press the brake pedal and push switch. The indicator light turns off.

BRAKE HOLD

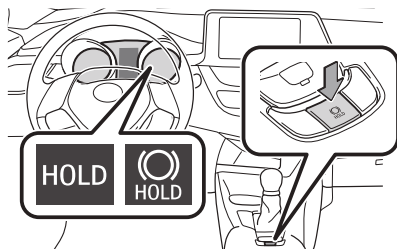

The brake hold system keeps the brake applied when the shift lever is in any position other than P or R with the system on and the brake pedal has been depressed to stop the vehicle (yellow indicator light.) The system releases the brake when the accelerator pedal is depressed with the shift lever in any position other than P or N to allow smooth start off (green indicator light.)

Refer to the Owner's Manual for limitations and more details.

FEATURES & OPERATIONS

Lights & turn signals

HEADLIGHTS

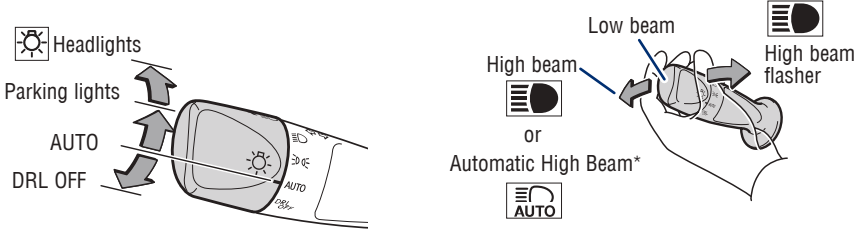

Daytime Running Light system (DRL)

Automatically turns on under certain conditions to make vehicle more visible to other drivers. Not for use at night.

Automatic light cut off system

Automatically turns lights off after 30 second delay, or lock switch on remote is pushed after locking.

Automatic High Beam (AHB) system Automatically switches between high and low beams as appropriate to enhance vision at night.

Refer to *Toyota Safety Sense™ P (TSS-P)* in this guide or the *Owner's Manual* for more details on the Automatic High Beam feature.

* Operating conditions must be met. Refer to the *Owner's Manual* for details.

FRONT FOG LIGHTS (IF EQUIPPED)

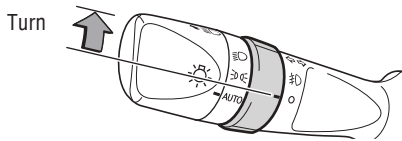

Front fog lights come on only when the headlights are on low beam.

TURN SIGNALS

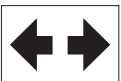
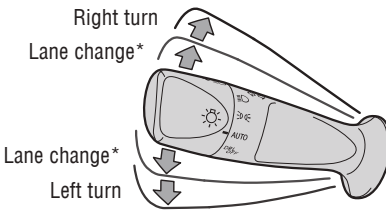

* Move lever partway and release; signal will flash three times.

Windshield wipers & washers

WITH INTERMITTENT WIPER (IF EQUIPPED)

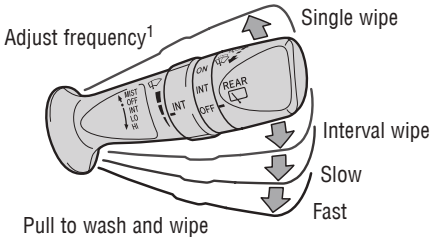

¹ **Intermittent windshield wiper frequency adjustment**
Rotate to increase/decrease wipe frequency.

REAR

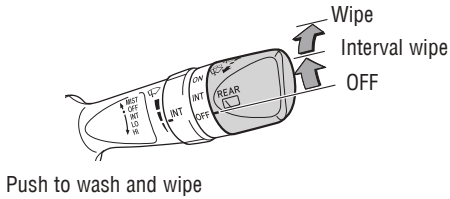

Refer to the Owner's Manual for more information.

FEATURES & OPERATIONS

Seat adjustments-Front

MANUAL SEAT

POWER SEAT (DRIVER SIDE ONLY)

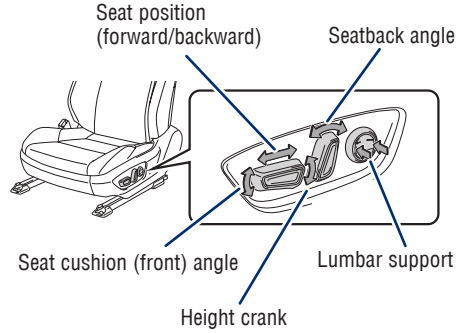
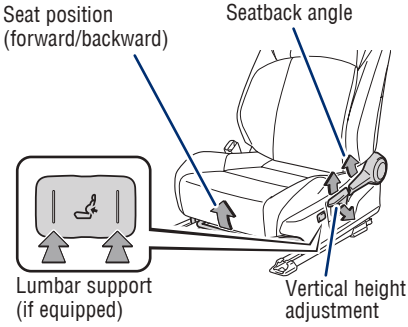

Seats-Folding rear

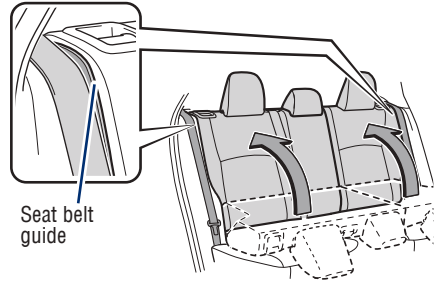
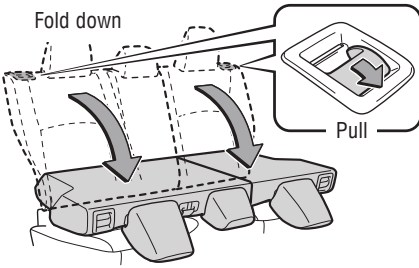

Seats-Head restraints

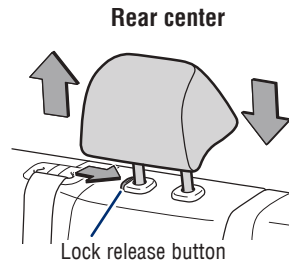
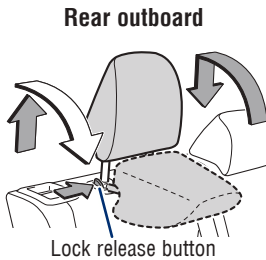
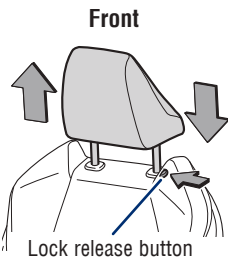

Multi-Information Display (MID)



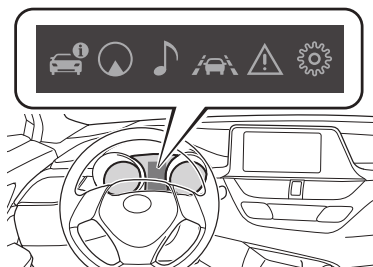

Multi-Information Display (MID)

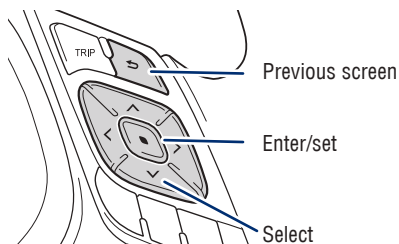

Steering wheel switches



Push MID control switches to view or change information in the following:

-  Drive information
-  Audio system-linked display
-  Driving assist system information
-  Warning message display
-  Settings display

Refer to the Owner's Manual for more settings and customizable features.

Steering lock release

Without Smart Key system

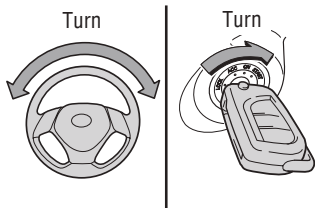

When starting the engine, the engine switch may seem stuck in the "LOCK" position. To free it, turn the key while turning the steering wheel slightly left and right.

With Smart Key system

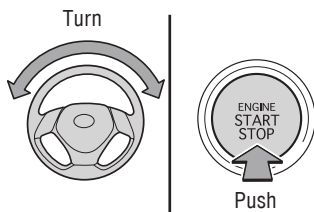

"Push ENGINE START STOP button while turning the steering wheel in either direction." will be displayed on the multi-information display. Check that the shift lever is set in P. Press the engine switch while turning the steering wheel left and right.

Tilt & telescopic steering wheel

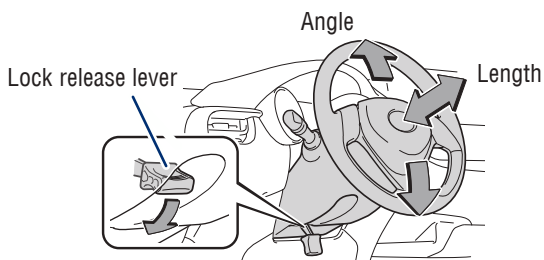

Hold wheel, push lever down, set angle and length, and return lever.

NOTE: Do not attempt to adjust while the vehicle is in motion.

Door locks

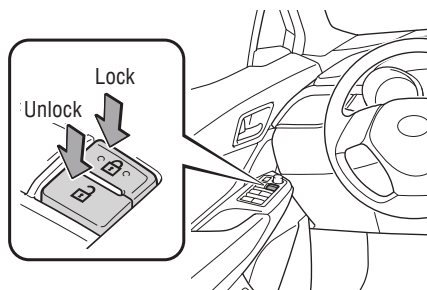

Cup holders

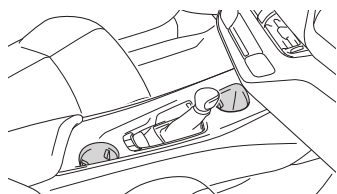

Adjust size

Change depth

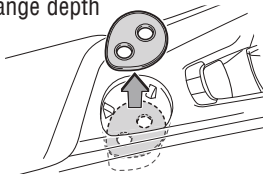

Auxiliary storage

Console box

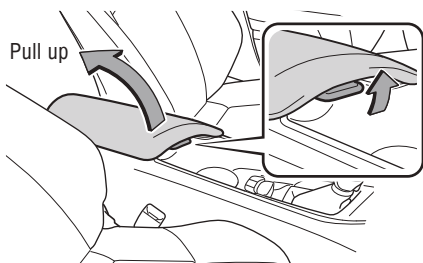

Luggage compartment auxiliary boxes

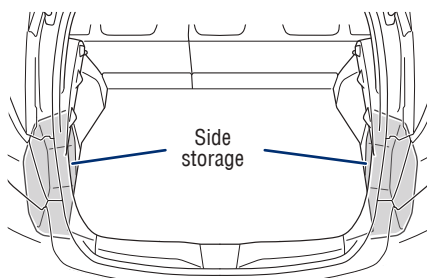

Windows-Power

Driver side

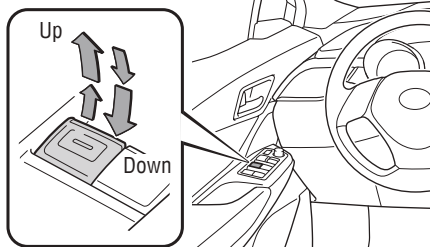

Window lock switch

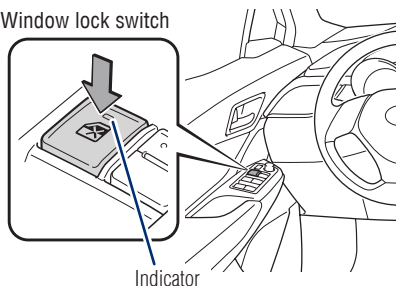

All window auto up/down

Push the switch completely down or pull it completely up and release to fully open or close. To stop the window partway, operate the switch in the opposite direction.

Window lock switch

Deactivates all passenger windows. Driver's window remains operable.

Air conditioning/heating

Automatic climate control ON

Adjusting the temperature setting will cause the airflow vents, air intake and fan to adjust automatically to set temperature.

Airflow vent

In “” or “” mode, use outside air (“” indicator OFF) to reduce window fogging.

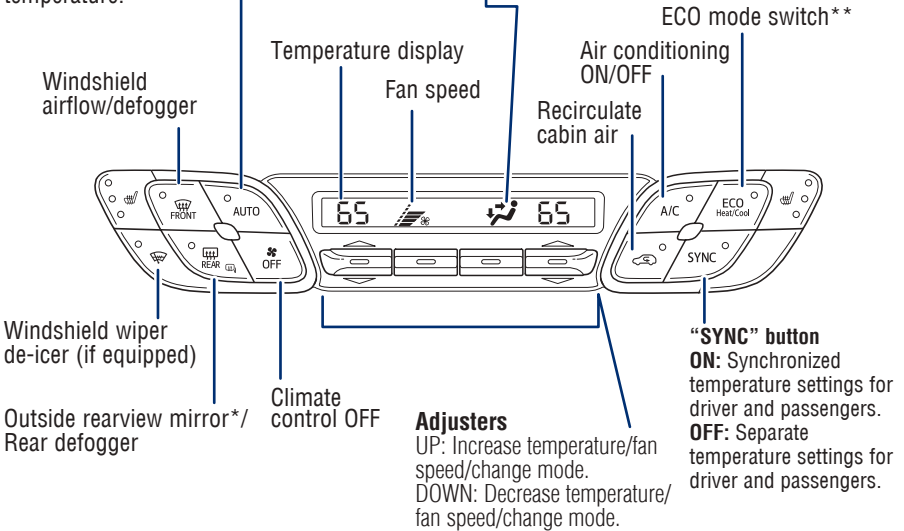

* Defoggers automatically turn off after a period of time.

** Air conditioning feature that helps lower fuel consumption by controlling and prioritizing functions like reducing fan speed, etc.

Seat heaters (if equipped)

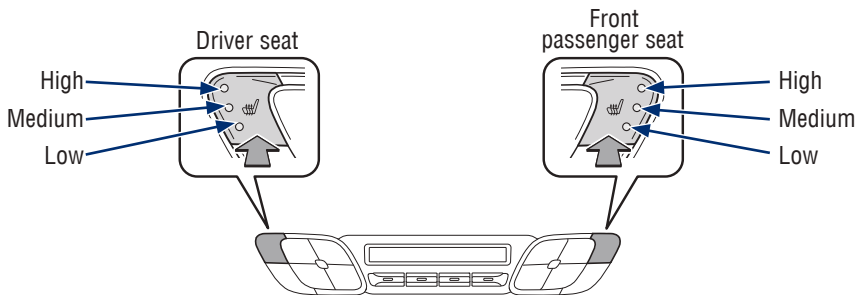

The engine switch must be in the "ON" position (without Smart Key) / "IGNITION ON" mode (with Smart Key) for use.

Clock

Select to change time zone

Select to daylight savings time ON/OFF.

Select to set to automatic GPS adjustment of clock.

Select to set hour display to 12 or 24 hour time.



- 1) Push "**MENU**" button next to the screen.
- 2) Select "**Setup**" or "**General**" in the touch screen to access the general settings screen.
- 3) Select "**Clock.**"
- 4) Then select desired items to be reset.

Refer to the "Navigation and Multimedia System Owner's Manual" for more details.

FEATURES & OPERATIONS

Audio

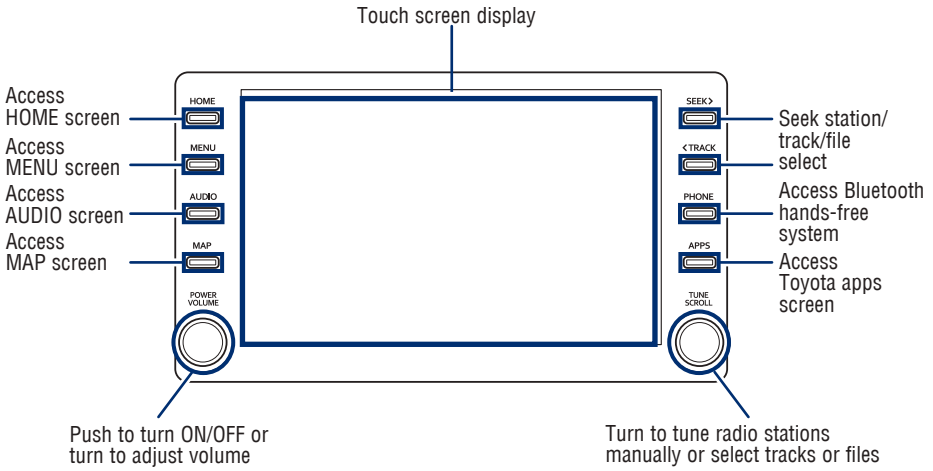

Refer to the "Navigation and Multimedia System Owner's Manual" or visit www.toyota.com/audio-multimedia for additional resources.

NOTE: Concentrating on the road should always be your first priority while driving. Do not use the Audio Multimedia System if it will distract you.

Power outlet-12V DC

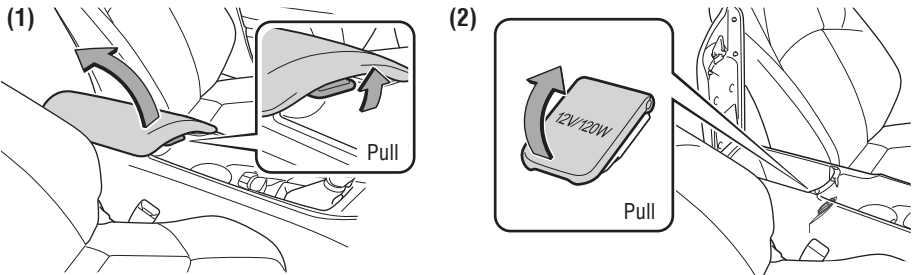

The engine switch must be in the "ACC" or "ON" position (without Smart Key) / "ACCESSORY" or "IGNITION ON" mode (with Smart Key) for use.

Steering wheel switches & telephone controls (Bluetooth®)

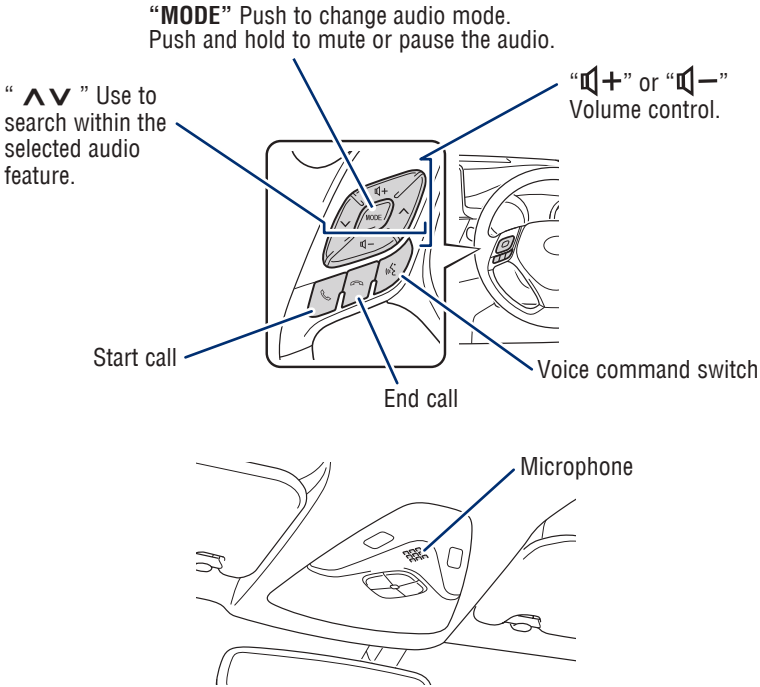

Bluetooth® technology allows dialing or receipt of calls without removing your hands from the steering wheel.

Refer to the Bluetooth® device pairing in this guide or the Navigation and Multimedia System Owner's Manual for additional user instructions.

NOTE: Concentrating on the road should always be your first priority while driving. Do not use the Audio Multimedia System if it will distract you.

USB media port

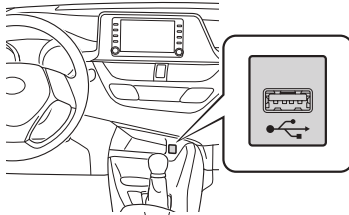

Connecting a compatible device and cable into the USB media port will support charging and music playback through the audio multimedia system.

FEATURES & OPERATIONS

Blind Spot Monitor (BSM)* and Rear Cross Traffic Alert (RCTA)*

* If equipped

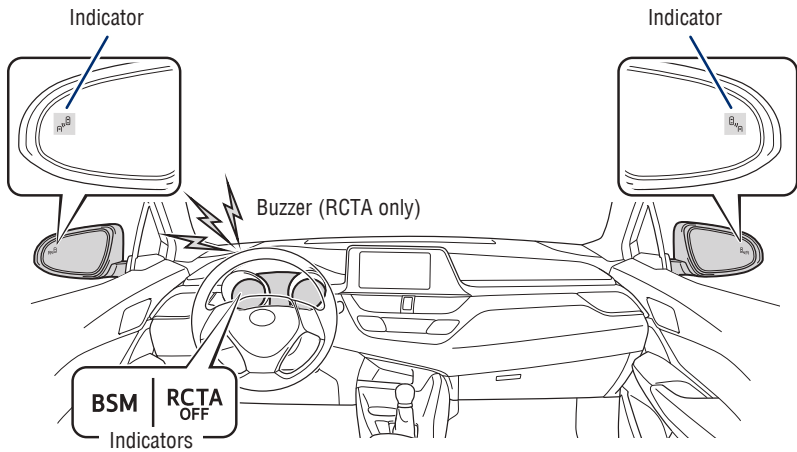

BLIND SPOT MONITOR (BSM)

The system is designed to use radar sensors to detect vehicles traveling in the C-HR's blind spot when to change lanes. If a vehicle is detected, the driver will be alerted via the outside rear view side mirror indicators.

REAR CROSS TRAFFIC ALERT (RCTA)

While in reverse, when a vehicle approaching from the right or left rear of the vehicle is detected, the outside rear view mirror indicators flash.

Refer to the Toyota Owner's Manual for limitations and more details on this system before attempting to use it.

Rear view monitor system

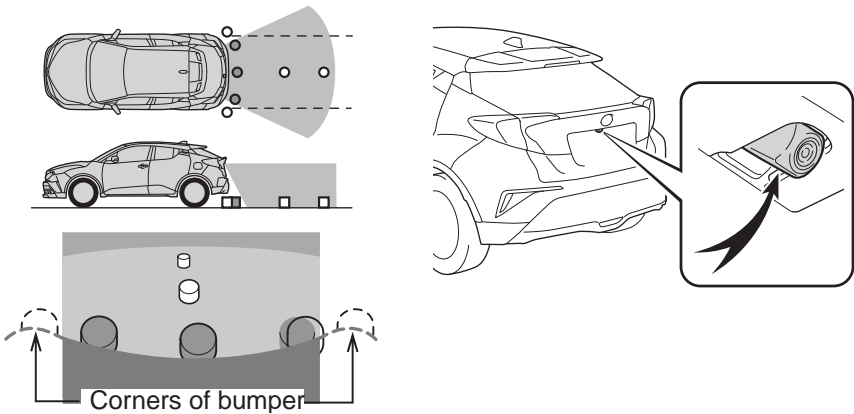

The rear view monitor system displays an image of the view from the bumper of the rear area of the vehicle. The camera for the rear view monitor system is located above the license plate.

To adjust the image on the rear view monitor screen, press the “MENU” button and select “Display”. Select “Camera” to adjust the screen contrast and brightness.

Refer to the *Navigation and Multimedia System Owner's Manual* for limitations and more details on this system.

Vehicle Stability Control (VSC)/ TRAC OFF switch

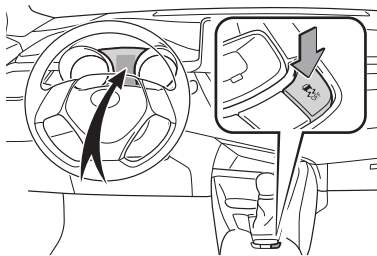

The VSC OFF switch can be used to help free a stuck vehicle in surroundings like mud, dirt or snow. While the vehicle is stopped, press switch to disable the TRAC system.

To disable both VSC and TRAC systems, press and hold the switch for at least 3 seconds.

Refer to the *Owner's Manual* for limitations and more details.

Quick overview-Toyota Safety Sense™ P (TSS-P)

Toyota Safety Sense™ P (TSS-P) is a set of active safety technologies designed to help mitigate or prevent collisions across a wide range of traffic situations, in certain conditions. TSS-P is designed to help support the driver's awareness, decision making and vehicle operation contributing to a safe driving experience.

Refer to the Owner's Manual for operation, setting adjustments, limitations and more details to understand these functions and complete safety precautions. For more information, please go to <http://www.toyota.com/safety-sense>



Pre-Collision System with Pedestrian Detection (PCS w/PD)

PCS w/PD is designed to provide alert, mitigation, and/or avoidance support in certain conditions, when the system detects a potential collision with a preceding vehicle is likely to occur.

The advanced millimeter-wave radar sensor system is designed to work with the camera sensor to help recognize a preceding pedestrian, and provide an alert, mitigation and/or avoidance support in certain conditions.



Lane Departure Alert with Steering Assist (LDA w/SA)

LDA w/SA is designed to provide notification when the system detects an unintended lane departure.

The Steering Assist function is designed to provide small corrective steering inputs to the steering wheel for a short period of time to help keep the vehicle in its lane.



Full-Speed Range Dynamic Radar Cruise Control (DRCC)

DRCC is designed to help maintain a pre-set distance to a preceding vehicle when the preceding vehicle is traveling at a lower speed.



Automatic High Beams (AHB)

AHB is designed to detect the headlights of oncoming vehicles and the tail lights of preceding vehicles and switch between high beams and low beams as appropriate.

Sensors

TSS-P combines an in-vehicle camera mounted in front of the inside rear view mirror and a millimeter-wave radar mounted in the front grille. These sensors support the driver assist systems.

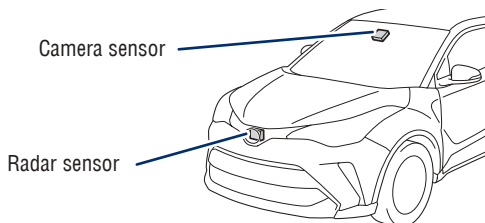

Pre-Collision System with Pedestrian Detection (PCS w/PD)

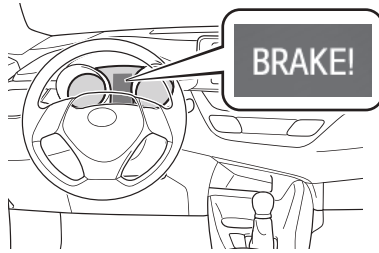

The Pre-Collision System with Pedestrian Detection uses a radar sensor and camera sensor to help detect a vehicle or pedestrian in front of your vehicle.

As there is a limit to the degree of recognition accuracy and control performance that this system can provide, do not overly rely on this system. This system will not prevent collisions or lessen collision damage or injury in every situation. Do not use PCS w/PD instead of normal braking operations under any circumstances. Do not attempt to test the operation of the pre-collision system yourself, as the system may not operate or engage, possibly leading to an accident. In some situations, such as when driving in inclement weather such as heavy rain, fog, snow or a sandstorm or while driving on a curve and for a few seconds after driving on a curve, a vehicle or pedestrian may not be detected by the radar and camera sensors, preventing the system from operating or engaging properly.

Refer to the Toyota Owner's Manual for a list of additional situations in which the system may not operate properly.

Pre-Collision Warning

When the system determines that the possibility of a frontal collision is high, a buzzer will sound and a warning message will be displayed on the Multi-Information Display (MID) to urge the driver to take evasive action.

Pre-Collision Brake Assist

If the driver notices the hazard and brakes, the system may provide additional braking force using Brake Assist. This system may prime the brakes and may apply greater braking force in relation to how strongly the brake pedal is depressed.

Pre-Collision Braking

If the driver does not brake in a set time and the system determines that the possibility of a frontal collision with a preceding vehicle is extremely high, the system may automatically apply the brakes, reducing speed in order to help the driver reduce the impact and in certain cases avoid the collision.

Refer to the Toyota Owner's Manual for additional information on PCS w/PD operation, settings adjustments, limitations, and precautions before attempting to use it.

PCS PEDESTRIAN DETECTION

Under certain conditions, the PCS system included with the TSS-P package may also help to detect a pedestrian in front of your vehicle using the in-vehicle camera and front grille-mounted radar. The in-vehicle camera of PCS detects a potential pedestrian based on size, profile, and motion of the detected pedestrian. However, a pedestrian may not be detected depending on the conditions, including the surrounding brightness and the motion, posture, size, and angle of the potential detected pedestrian, preventing the system from operating or engaging.

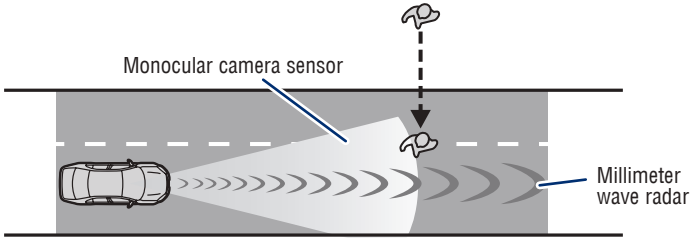



As part of the Pre-Collision System, this function is also designed to first provide an alert and then automatic braking if needed.

Refer to the *Toyota Owner's Manual* for additional limitations and information.

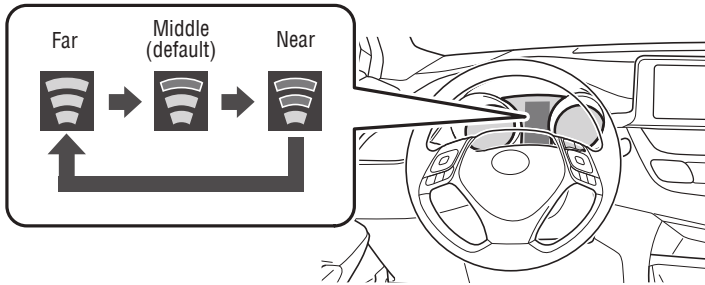

CHANGING PCS ALERT TIMING

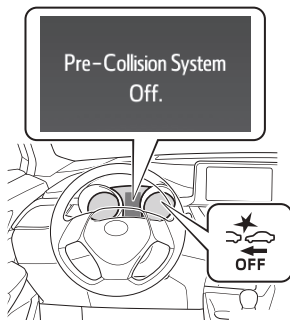

- (1) Press “<>” switches and select  from the Multi-Information Display (MID).
- (2) Press “<” switches and select the  setting function and then press “<>”.
- The setting screen is displayed.
- (3) Press “<” switches and select “ Sensitivity” from the MID and then press “<>” to select the desired setting. You can press “<>” to go back to the menu.

Note: PCS is enabled each time the engine switch is turned to Ignition On. The system can be disabled/enabled and the alert timing of the system can be changed. (Alert timing only, brake operation remains the same).



- (1) Press “<>” switches and select  from the Multi-Information Display (MID).
- (2) Press “◇” switches and select  and then press “Ⓜ” to select ON or OFF setting.
- (3) Press “←” to go back to the menu.

Note: The system is enabled each time the power switch is turned to ON mode.

Refer to the Toyota Owner’s Manual for additional information on PCS operation, settings adjustments, limitations, and precautions before attempting to use it.

Lane Departure Alert with Steering Assist (LDA w/SA)



LDA w/SA in TSS-P uses an in-vehicle camera designed to detect visible white and yellow lane markers in front of the vehicle and the vehicle’s position on the road. If the system determines that the vehicle is starting to unintentionally deviate from its lane, the system alerts the driver with an audio and visual alert. When the alerts occur, the driver must check the surrounding road situation and carefully operate the steering wheel to move the vehicle back to the center part of their lane.

LDA is designed to function at speeds of approximately 32 MPH or higher on relatively straight roadways.

In addition to the alert function, LDA w/SA also features a steering assist function. When enabled, if the system determines that the vehicle is on a path to unintentionally depart from its lane, the system may provide small corrective steering inputs to the steering wheel for a short period of time to help keep the vehicle in its lane.

TOYOTA SAFETY SENSE™

TURNING THE LDA SYSTEM ON/OFF

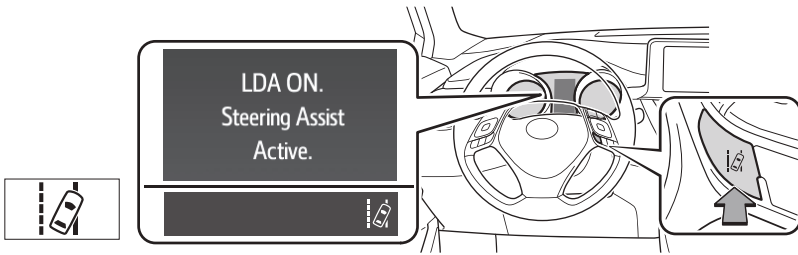

Press the LDA switch to turn the LDA system on. Depress again to turn it off.

Note: The system will continue in the last state it was in (ON or OFF) when the engine is started again.

Refer to the Toyota Owner's Manual for additional information on LDA operation, settings adjustments, limitations, and precautions before attempting to use it.

LANE DEPARTURE ALERT

LDA function display

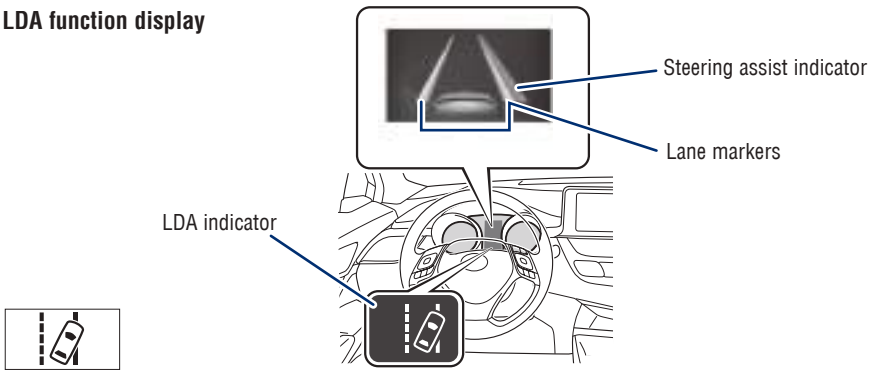

Lane Departure Alert (LDA w/SA) indicator flashes amber when operating



LANE DEPARTURE ALERT (CONTINUED)

The LDA w/SA function  displays when the Multi-Information Display (MID) is switched to the driving assist system information screen.

(1) The system displays solid white lines on the LDA indicator when visible lane markers on the road are detected. A side flashes orange to alert the driver when the vehicle deviates from its lane.

(2) The system displays outlines on the LDA indicator when lane markers on the road are not detected or the function is temporarily cancelled.

Note: When operational conditions are no longer met, the function may be temporarily canceled. However, when the operational conditions are met again, operation of the function is automatically restored. For example, LDA w/SA may not function on the side(s) where white/yellow lines are not detectable.

Refer to the Toyota Owner's Manual for additional information on LDA operation, settings adjustments, limitations, and precautions before attempting to use it.

DISABLING STEERING ASSIST

(1) Press “<>” switches and select  from the Multi-Information Display (MID).

(2) Press “<” switches and select the “ Steering Assist” and then press “”.

(3) Press “” each time to change the setting.

(4) Press “” to go back to the menu.

Note: Operation of the LDA w/SA system and setting adjustments continues in the same condition regardless of Ignition cycle until changed by the driver or the system is reset.

ADJUSTING LDA ALERT SENSITIVITY

The driver can adjust the sensitivity of the LDA (warning) function from the Multi-Information Display (MID) customization screen.

High - Is designed to warn approximately before the front tire crosses the lane marker.

Normal - Is designed to warn approximately when the front tire crosses the lane marker.

(1) Press “<>” switches and select  from the Multi-Information Display (MID).

(2) Press “<” switches and select the “ Alert sensitivity” and then press “” to set sensitivity to Normal or High.

(3) Press “” each time to change the setting.

(4) Press “” to go back to the menu.

SWAY WARNING SYSTEM



Continuous lane deviations from swaying.







Gentle swaying from driver's inattentiveness.



Acute steering wheel operation after the number of operations decrease due to driver's inattentiveness.





SWS is a function of LDA and is designed to detect swaying based on the vehicle location in the lane and the driver's steering wheel operation. To help prevent swaying, the system alerts the driver using a buzzer sound and a warning displays in the MID.

DISABLING LDA SWAY WARNING SYSTEM

- (1) Press “<>” switches to find and select .
- (2) Press “⏏” switches to find the “ Vehicle sway warning” and then press “.
- (3) Press “” each time to change the setting.
- (4) Press “” to go back to the menu.

Note: Operation of the LDA system and setting adjustments continues in the same condition regardless of Ignition cycle until changed by the driver or the system is reset.

ADJUSTING SWAY ALERT SENSITIVITY

- (1) Press “<>” switches to find and select .
- (2) Press “⏏” switches to find the “ Vehicle sway warning sensitivity” and then press “.
- (3) Press “” each time to change the setting.
- (4) Press “” to go back to the menu.

Full-Speed Range Dynamic Radar Cruise Control (DRCC)

DRCC helps maintain a pre-set distance to a preceding vehicle when the preceding vehicle is traveling at a lower speed. This mode is always selected first when the cruise control button is depressed. Constant speed cruise control mode is also available. DRCC is designed to function at speeds between approximately 30 to 110 MPH and is intended for highway use. Full-Speed Range DRCC is designed to function at speeds between 0 to approximately 110 MPH and is intended for highway use.

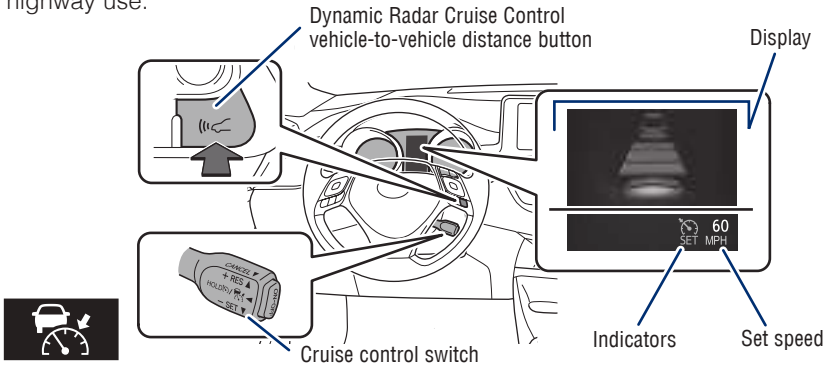

TURNING SYSTEM ON/OFF

(1)

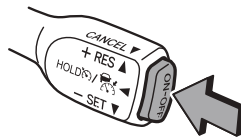

Push once: On
Push again: Off

Refer to page 33 for switching to Constant Speed (Cruise) Control Mode.

ADJUSTING SET SPEED

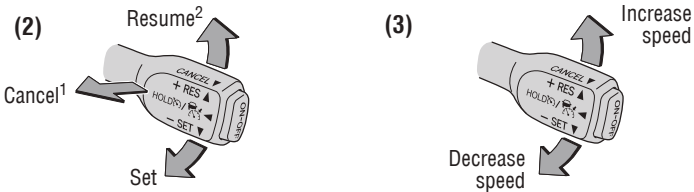

SET

Vehicle will cruise at a set speed, decelerate to maintain selected distance from a slower vehicle traveling in front and accelerate back up to the selected speed if the vehicle in front changes lanes or speeds up.

- (1) Push the ON-OFF button. The "RADAR READY" and  indicator will come on.
- (2) Push the lever down to SET speed, push it up to Resume and pull it or depress brake to Cancel.
- (3) Push up to increase the set speed, push down to decrease (1 mph [1.6 km/h] or 1 km/h [0.6 mph]).

¹ The set speed may also be cancelled by depressing the brake pedal.

² The set speed may be resumed once vehicle speed exceeds 25 mph.

ADJUSTING DISTANCE

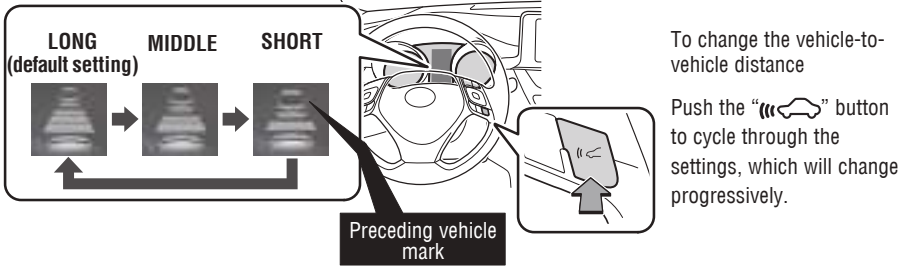

This mode employs a radar sensor to detect the presence of vehicles up to approximately 328 ft (100 m) ahead, determines the current vehicle-to-vehicle following distance and operates to maintain a preset following distance from the vehicle ahead. These distances vary based on vehicle speed.

Note: Vehicle-to-vehicle distance will close in when traveling on long downhill slopes.

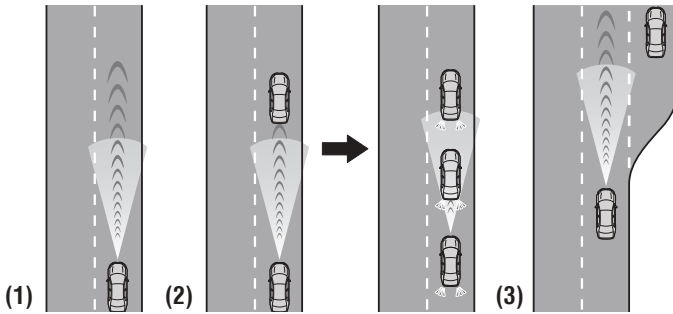

(1) Constant speed cruising when there are no vehicles ahead

The vehicle travels at the speed set by the driver. The desired vehicle-to-vehicle distance can also be set by operating the vehicle-to-vehicle distance control.

(2) Deceleration cruising and follow-up cruising when a preceding vehicle driving slower than the set speed appears

When a vehicle is detected running ahead of you, the system automatically decelerates your vehicle. When a greater reduction in vehicle speed is necessary, the system applies the brakes (the brake lights will come on at this time). The system will respond to changes in the speed of the vehicle ahead in order to maintain the vehicle-to-vehicle distance set by the driver. A warning tone warns you when the system cannot decelerate sufficiently to prevent your vehicle from closing in on the vehicle ahead.

ADJUSTING DISTANCE (CONTINUED)

(3) Acceleration when there are no longer any preceding vehicles driving slower than the set speed

The system accelerates until the set speed is reached. The system then returns to constant speed cruising.

Note: When your vehicle is too close to a vehicle ahead, and sufficient automatic deceleration via the cruise control is not possible, the display will flash and the buzzer will sound to alert the driver. An example of this would be if another driver cuts in front of you while you are following a vehicle. Depress the brake pedal to ensure an appropriate vehicle-to-vehicle distance.

SWITCHING TO CONSTANT SPEED (CRUISE) CONTROL MODE

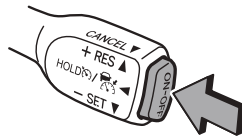

1.5 seconds

If you are already using DRCC “”, push ON-OFF button to turn the system off first, then push and hold ON-OFF button for at least 1.5 seconds to switch.

Note: When the engine is turned off, it will automatically default to DRCC.

Refer to the Toyota Owner's Manual for additional information on DRCC operation, settings adjustments, limitations, and precautions before attempting to use it.

SETTING CONSTANT SPEED (CRUISE) CONTROL

SET

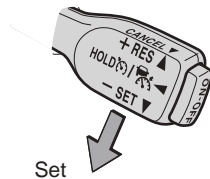

Set

To adjust speed or cancel, see steps (2) and (3) of ADJUSTING SET SPEED on page 31.

Refer to the Toyota Owner's Manual for additional information on DRCC operation, settings adjustments, limitations, and precautions before attempting to use it.

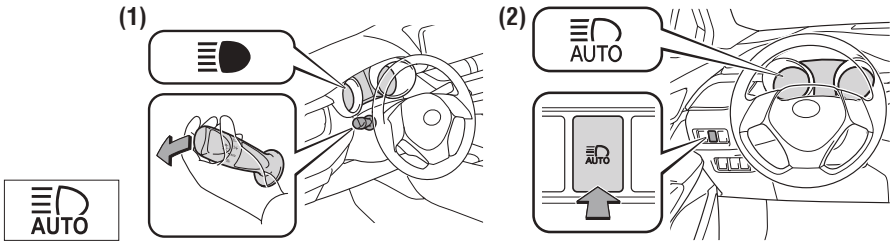

Automatic High Beams (AHB)



AHB is a safety system designed to help drivers see more of what's ahead at nighttime while reducing glare for oncoming drivers. When enabled, AHB uses an in-vehicle camera to help detect the headlights of oncoming vehicles and tail lights of preceding vehicles, then automatically switches between high and low beams as appropriate to provide the most light possible and enhance forward visibility. By using high beams more frequently, the system may allow earlier detection of pedestrians and obstacles.



Refer to the Toyota Owner's Manual for additional information on AHB operation, settings adjustments, limitations, and precautions before attempting to use it.

ACTIVATING THE AHB SYSTEM

- (1) With the engine switch in ON/IGNITION ON mode, turn the headlight switch to "  " or "AUTO" position, then push lever away from you.
- (2) Press the "  " switch.

The AHB indicator will come on when the headlights are turned on automatically to indicate that the system is active.

Note: Pull the lever back toward you to turn the AHB system off.

The AHB indicator will turn off. To turn switch to "  " position and the manual high beam indicator "  " turns on.

CONDITIONS WHERE AHB WILL TURN ON/OFF AUTOMATICALLY

When all of these conditions are met, high beams will be automatically turned on (after approximately 1 second):

- Vehicle speed is above approximately 21 mph (34 km/h).
- The area ahead of the vehicle is dark.
- There are no oncoming or preceding vehicles with headlights or tail lights turned on.
- There are few street lights on the road ahead.

If any of these conditions occur, the system is designed to automatically turn off high beams:

- Vehicle speed drops below approximately 17 mph (27 km/h).
- The area ahead of the vehicle is not dark.
- Oncoming or preceding vehicles have headlights or tail lights turned on.
- There are many streetlights on the road ahead.

SAFETY & EMERGENCY FEATURES

Seat belts

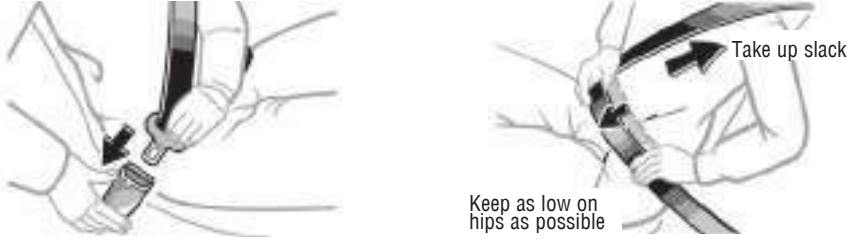

NOTE: If a passenger's seat belt is fully extended, then retracted even slightly, the Automatic locking retractor (ALR) will prevent it from being re-extended beyond that point, unless fully retracted again. This feature is used to help hold child restraint systems securely.

To find more information about seat belts, and how to install a child restraint system, refer to the Toyota Owner's Manual.

Seat belts-Shoulder belt anchor

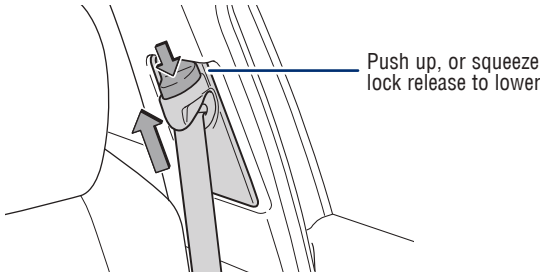

Rear door child safety locks

Rear door

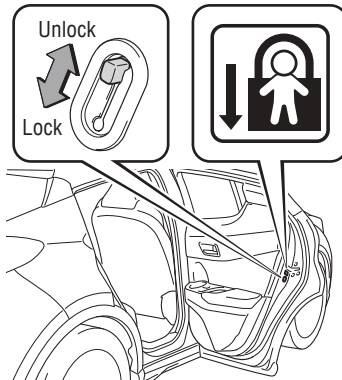



Moving the lever downward will allow the door to be opened only from the outside.

Tire Pressure Monitoring (warning) System (TPMS)



The tire pressure warning system can be selected on “” of the multi-information display (MID).

System rest initialization

- (1) Select “Vehicle Settings” and then push and hold “”.
- (2) Select “ Setup” then push and hold “”.

The tire pressure detected by the tire pressure warning system can be displayed on the multi-information display (MID).

Refer to the load label on the door jamb or the Owner’s Manual for tire inflation specifications.

If the tire pressure indicator flashes for more than 60 seconds and then remains on, take the vehicle to your local Toyota dealer.

NOTE: The warning light may come on due to temperature changes or changes in tire pressure from natural air leakage. If the system has not been initialized recently, setting the tire pressures to factory specifications should turn off the light.

Safety Connect (if equipped)

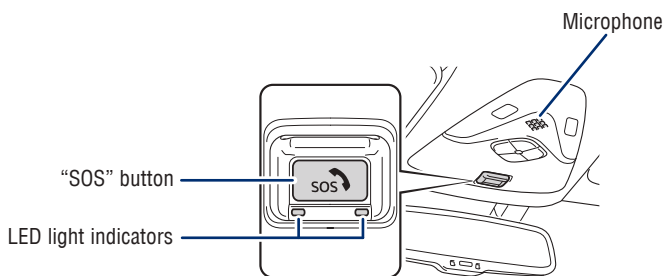

Safety Connect is a subscription-based telematics service that uses Global Positioning System (GPS) data and embedded cellular technology to provide safety and security features to subscribers. Safety Connect is staffed with live agents at the Toyota response center, which operates 24 hours per day, 7 days per week.

Services for subscribers include:

- Automatic collision notification
- Stolen vehicle locator
- Emergency assistance ("SOS" button)
- Enhanced roadside assistance

For additional information refer to the "Owner's Manual" or visit www.Toyota.com/connected-services.

SAFETY & EMERGENCY FEATURES

Spare tire & tools

TOOL LOCATION

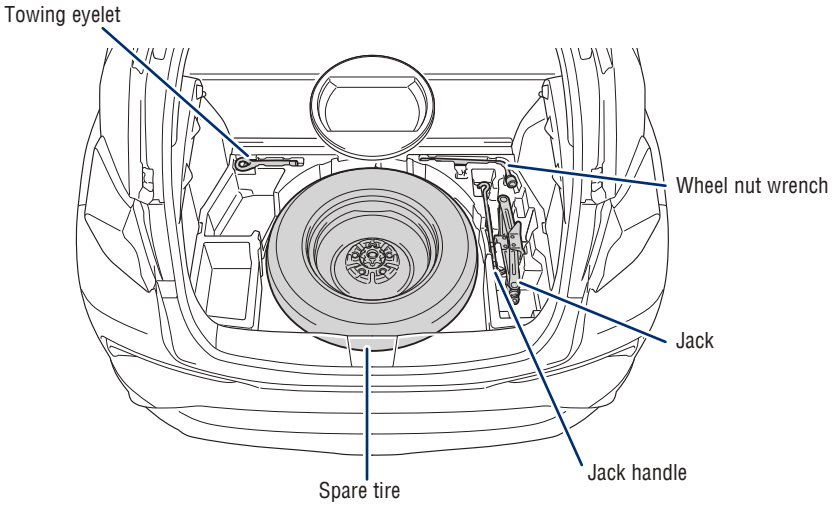

REMOVE THE SPARE TIRE

Remove the deck board and cushion.

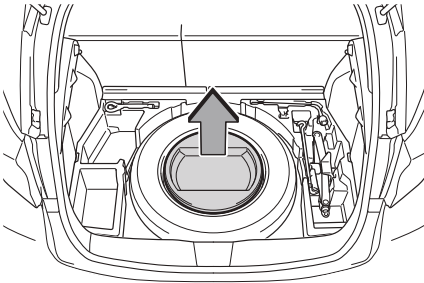

Loosen the center fastener that secures the spare tire.

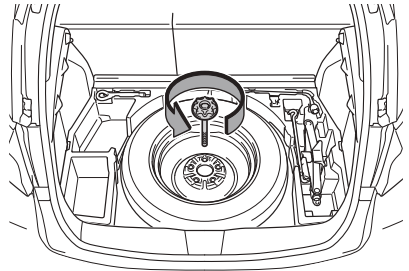

Take out jack.

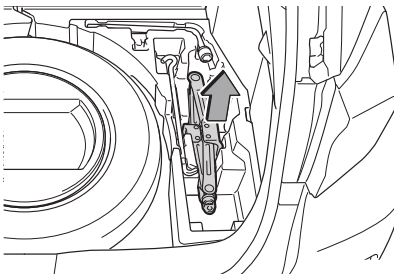

Refer to the *Toyota Owner's Manual* for tire changing and jack positioning procedures.

Star Safety System™

Your vehicle comes standard with the Star Safety System™, which combines Anti-lock Braking System (ABS), Brake Assist (BA), Electronic Brake-force Distribution (EBD), Smart Stop Technology (SST), Traction Control (TRAC) and Vehicle Stability Control (VSC).

Refer to the Owner's Manual for more details and important information on limitations to these systems.

ANTI-LOCK BRAKE SYSTEM (ABS)

Toyota's ABS sensors detect which wheels are locking up and limits wheel lockup by "pulsing" each wheel's brakes independently. Pulsing releases brake pressure repeatedly for fractions of a second. This helps the tires attain the traction that current road conditions will allow, helping you to stay in directional control.

BRAKE ASSIST (BA)

Brake Assist is designed to detect sudden or "panic" braking, and then add braking pressure to help decrease the vehicle's stopping distance. When there's only a split second to react, Brake Assist can add additional brake pressure more quickly than just the driver alone can.

ELECTRONIC BRAKE FORCE DISTRIBUTION (EBD)

Toyota's ABS technology has Electronic Brake-force Distribution (EBD) to help maintain control and balance when braking. EBD responds to sudden stops by redistributing brake force to enhance the braking effectiveness of all four wheels.

SMART STOP TECHNOLOGY (SST)

Smart Stop Technology automatically reduces engine power when the accelerator and brake pedals are pressed simultaneously under certain conditions.

SST engages when the accelerator is depressed first and the brakes are applied firmly for longer than one-half second at speeds greater than five miles per hour.

SST doesn't engage if the brake pedal is depressed before the accelerator pedal, allowing vehicles to start on a steep hill and safely accelerate without rolling backward.

ENHANCED VEHICLE STABILITY CONTROL (VSC)

Enhanced Vehicle Stability Control provides cooperative control of the ABS, TRAC, VSC and EPS.

Enhanced VSC helps to maintain directional stability when loss of traction occurs during a turn.

SAFETY & EMERGENCY FEATURES

TRACTION CONTROL (TRAC)

VSC helps prevent loss of traction during cornering by reducing engine power, and Traction Control helps maintain traction on loose gravel and wet, icy, or uneven surfaces by applying brake force to the spinning wheel(s).

Toyota's TRAC sensors are activated when one of the drive wheels starts to slip. TRAC limits engine output and applies the brakes to the spinning wheel. This transfers power to the wheels that still have traction to help keep you on track.

Floor mat installation

There are two types of Toyota floor mats: carpeted and all-weather. Each vehicle has model-specific floor mats. Installation is easy.

To keep your floor mat properly positioned, follow these steps:

- Only use Toyota floor mats designed for your specific model.
- Use only one floor mat at a time, using the retaining hooks to keep the mat in place.
- Install floor mats right side up.

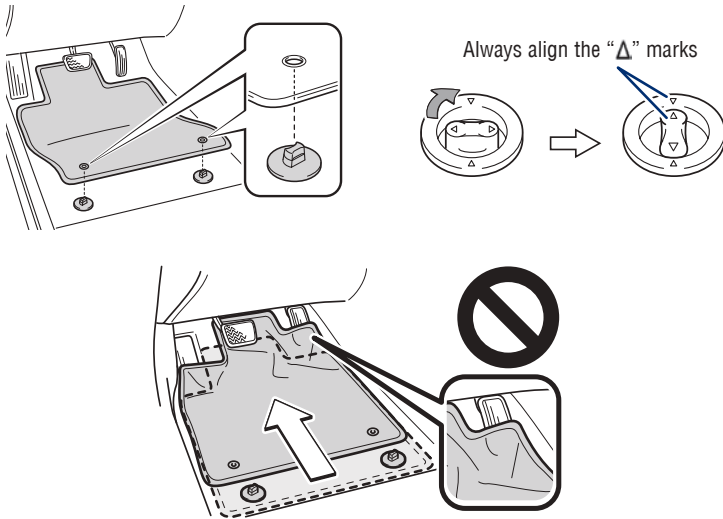

BLUETOOTH® DEVICE PAIRING SECTION

Do not attempt the Bluetooth® Pairing process while driving.

To begin the Bluetooth® Pairing process, press the HOME button on the faceplate of your multimedia system.

Bluetooth® Pairing for your phone

Pairing your phone is the first step in connecting with your Toyota. This pairing process is quick and easy. All you have to do is setup the phone and multimedia system to form a connection.¹



Audio / Audio Plus / Premium Audio

STEP 1 Press [MENU] on the audio system faceplate, then select "Setup" on display screen.

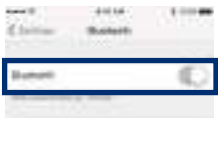

iPhone bluetooth Menu



Android bluetooth Menu



STEP 2 Ensure Bluetooth is turned on for your device.

STEP 3 Select "Bluetooth", then select "Add New Device" on display screen.



STEP 4 Select "Device Name".



STEP 5 Check the display on your smart phone. Does the PIN XXXX match the PIN displayed? If it does select "Pair".

¹ Some Android devices may have slightly different SETTINGS screen layout depending on manufacturer of device and Android OS version.

Bluetooth® Pairing for your phone (cont.)



STEP 6 "Connecting" displays while device is forming the connection to your multimedia system.



STEP 7 Enable Notifications (text message). While pairing your phone a message will be displayed: **"You may need to allow message access on your phone"**.

Note: You may also select "Skip" on display screen to skip enabling notifications. If skipped proceed to **Step 8**.

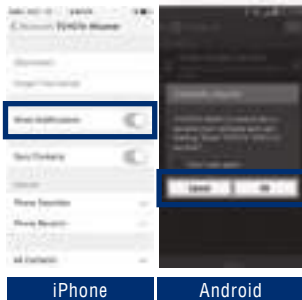

STEP 8 Turn on "Show Notifications" for iPhone or "ON" for Android.



STEP 9 A confirmation will appear once your phone has been paired and connected.



C-HR

Quick Reference Guide 2020



00505QRG20CHR

toyota.com



Printed in U.S.A. 9/19
19-MKG-13592