

Foreword

Welcome to the growing group of value-conscious people who drive Toyotas. We are proud of the advanced engineering and quality construction of each vehicle we build.

This Owner's Manual explains the operation of your new Toyota. Please read it thoroughly and have all the occupants follow the instructions carefully. Doing so will help you enjoy many years of safe and trouble-free motoring. For important information about this manual and your Toyota, read the following pages carefully.

When it comes to service, remember that your Toyota dealer knows your vehicle best and is interested in your complete satisfaction. He will provide quality maintenance and any other assistance you may require.

If there is not a Toyota dealer near you, or you need emergency assistance for any reason, please call the following number:

© U.S. OWNERS:	Toyota Customer Assistance Center	Toll-free:1-800-331-4331
© CANADIAN OWNERS:	Toyota Canada Customer Interaction Centre	Toll-free:1-888-TOYOTA-8 (1-888-869-6828)

Please leave this Owner's Manual in this vehicle at the time of resale. The next owner will need this information also.

All information and specifications in this manual are current at the time of printing. However, because of Toyota's policy of continual product improvement, we reserve the right to make changes at any time without notice.

Please note that this manual applies to all models and explains all equipment, including options. Therefore, you may find some explanations for equipment not installed on your vehicle.

TOYOTA MOTOR CORPORATION

© 2001 TOYOTA MOTOR CORPORATION

All rights reserved. This material may not be reproduced or copied, in whole or in part, without the written permission of Toyota Motor Corporation.

2002 MY CAMRY_U (OM33567U)

Important information about this manual

Safety and vehicle damage warnings

Throughout this manual, you will see safety and vehicle damage warnings. You must follow these warnings carefully to avoid possible injury or damage.

The types of warnings, what they look like, and how they are used in this manual are explained as follows:

 CAUTION
This is a warning against something which may cause injury to people if the warning is ignored. You are informed about what you must or must not do in order to avoid or reduce the risk to yourself and other people.

NOTICE
<i>This is a warning against something which may cause damage to the vehicle or its equipment if the warning is ignored. You are informed about what you must or must not do in order to avoid or reduce the risk of damage to your vehicle and its equipment.</i>

Safety symbol



When you see the safety symbol shown above, it means: “Do not...”; “Do not do this”; or “Do not let this happen”.

Important information about your Toyota

New vehicle warranty

Your new vehicle is covered by the following Toyota limited warranties:

- © New vehicle warranty
- © Emission control systems warranty
- © Others

For further information, please refer to the “Owner’s Warranty Information Booklet”, or “Owner’s Manual Supplement”.

Accessories, spare parts and modification of your Toyota

A wide variety of non-genuine spare parts and accessories for Toyota vehicles are currently available in the market. You should know that Toyota does not warrant these products and is not responsible for their performance, repair, or replacement, or for any damage they may cause to, or adverse effect they may have on, your Toyota vehicle.

This vehicle should not be modified with non-genuine Toyota products. Modification with non-genuine Toyota products could affect its performance, safety or durability, and may even violate governmental regulations. In addition, damage or performance problems resulting from the modification may not be covered under warranty.

Your responsibility for maintenance

It is the owner’s responsibility to make sure that the specified maintenance is performed. Section 6 gives details of these maintenance requirements. Also included in Section 6 is general maintenance. For scheduled maintenance information, please refer to the “Scheduled Maintenance Guide” or “Owner’s Manual Supplement”.

Spark ignition system of your Toyota

The spark ignition system in your Toyota meets all requirements of the Canadian Interference-Causing Equipment Standard.

Installation of a mobile two-way radio system

As the installation of a mobile two-way radio system in your vehicle could affect electronic systems such as multiport fuel injection system/sequential multiport fuel injection system, electronic throttle control system, cruise control system, anti-lock brake system, traction control system, vehicle skid control system, SRS airbag system and seat belt pretensioner system, be sure to check with your Toyota dealer for precautionary measures or special instructions regarding installation.

Scrapping of your Toyota

The SRS airbag and seat belt pretensioner devices in your Toyota contain explosive chemicals. If the vehicle is scrapped with the airbags and pretensioners left as they are, this may cause an accident such as fire. Be sure to have the systems of the SRS airbag and seat belt pretensioner removed and disposed of by the qualified service shop or by your Toyota dealer before you dispose of your vehicle.



Quick index

© If a service reminder indicator or warning buzzer comes on 99
© If your vehicle will not start 211
© If your engine stalls while driving 214
© If your vehicle overheats 215
© If you have a flat tire 216
© If your vehicle needs to be towed 224
© Tips for driving during break-in period 181
© How to start the engine 197
© General maintenance 238
© Complete index NO TAG

Gas station information

Fuel type:

2AZ-FE engine: UNLEADED gasoline, Octane Rating 87
(Research Octane Number 91) or higher
1MZ-FE engine: UNLEADED gasoline, Octane Rating 87
(Research Octane Number 91) or higher.
For improved vehicle performance, the use of premium unleaded
gasoline with an Octane Rating of 91 (Research Octane Number 96)
or higher is recommended.
See page 181 for detailed information.

Fuel tank capacity:

70 L (18.5 gal., 15.4 Imp. gal.)

Engine oil:

API grade SJ "Energy-Conserving", SL "Energy-Conserving" or ILSAC
multigrade engine oil is recommended.
See page 251 for detailed information.

Automatic transmission fluid:

Automatic transmission fluid Type T-IV

Tire information: See pages 255 through 260.



Tire pressure: See page 278.

2002 MY CAMRY_U (OM33567U)

Publication No. OM33567U

Part No. 01999-33567

Printed in Japan 01-0112-00 

 ()

You should know as much about the quality and importance of proper maintenance of your new vehicle as the people who built it.

The Toyota authorized Repair Manual tells you how to maintain your vehicle and enables you to correctly perform your own maintenance.



2002 MY CAMRY_U (OM33567U)

The best way to keep your new vehicle in top running order is to maintain it properly from the moment you drive it off the showroom floor.

The Toyota authorized Repair Manual is packed with literally everything you need to know to perform your own maintenance in virtually every area of your new vehicle.

Maintenance procedures for the engine, chassis, body, electrical system, and more, are clearly explained and illustrated.

Periodic maintenance and tune-up

Periodic maintenance and tune-up helps to prevent small problems from growing into larger ones later on. The repair manual outlines exactly what maintenance is required and clearly explains how to do the work yourself step-by-step.

Areas covered include such things as spark plug replacement, valve clearance adjustment and engine oil and filter replacement.

Where to obtain the Repair Manual

The repair manual for CAMRY, written in English, may be purchased as applicable from any Toyota dealer.

Pub. Name: 2002 CAMRY Repair Manual

Pub. No.: RM881U1 (Maintenance, Preparation, Service specifications and Diagnostics)

RM881U2 (Engine, Chassis and Body)

WE REALLY CARE ABOUT YOU — PLEASE BUCKLE UP

Toyota has made a special effort to encourage use of seat belts.

Toyota belts are:

- © **Comfortable**
- © **Easy to use**
- © **Convenient**

We encourage you to use your belts every time you drive.



2002 MY CAMRY_U (OM33567U)

SECTION 1-1

OPERATION OF INSTRUMENTS AND CONTROLS

Overview of instruments and controls

Instrument panel overview	2
Instrument cluster overview	6
Indicator symbols on the instrument panel	7

Instrument panel overview

© With lever type parking brake

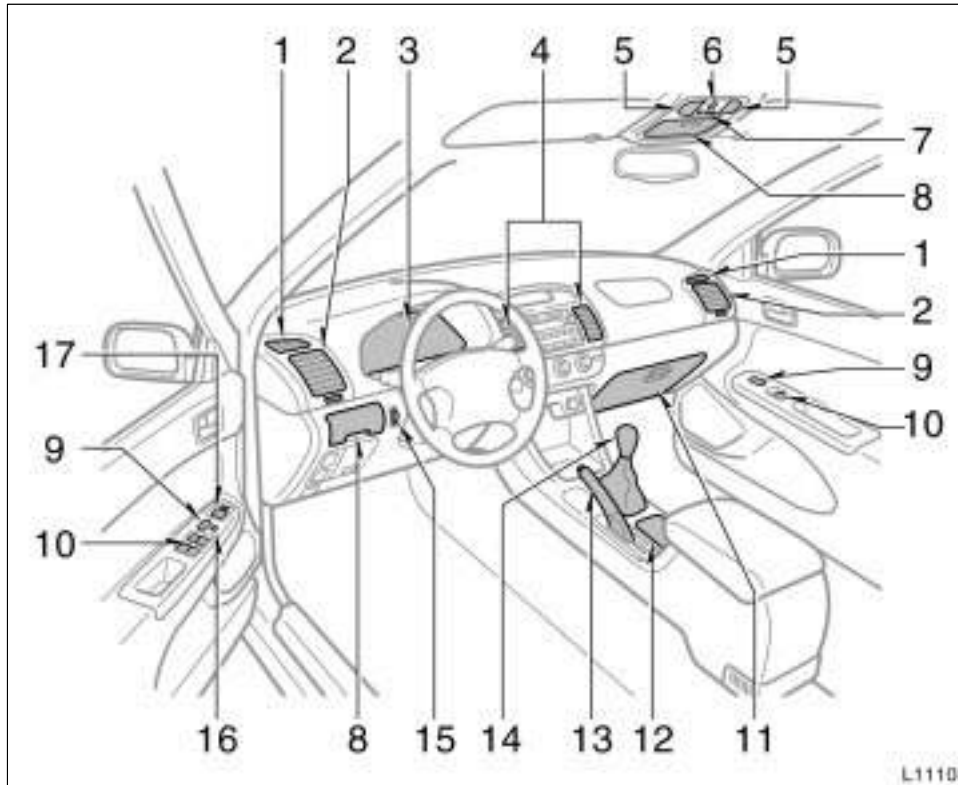

1. Side defroster outlets
2. Side vents
3. Instrument cluster
4. Center vents
5. Personal lights
6. Electric moon roof switch
7. Garage door opener
8. Auxiliary boxes
9. Power door lock switches
10. Power window switches
11. Glove box
12. Cup holder
13. Parking brake lever
14. Automatic transmission selector lever
or manual transmission gear shift lever
15. Instrument panel light control dial
16. Window lock switch
17. Power rear view mirror control switches

© With pedal type parking brake

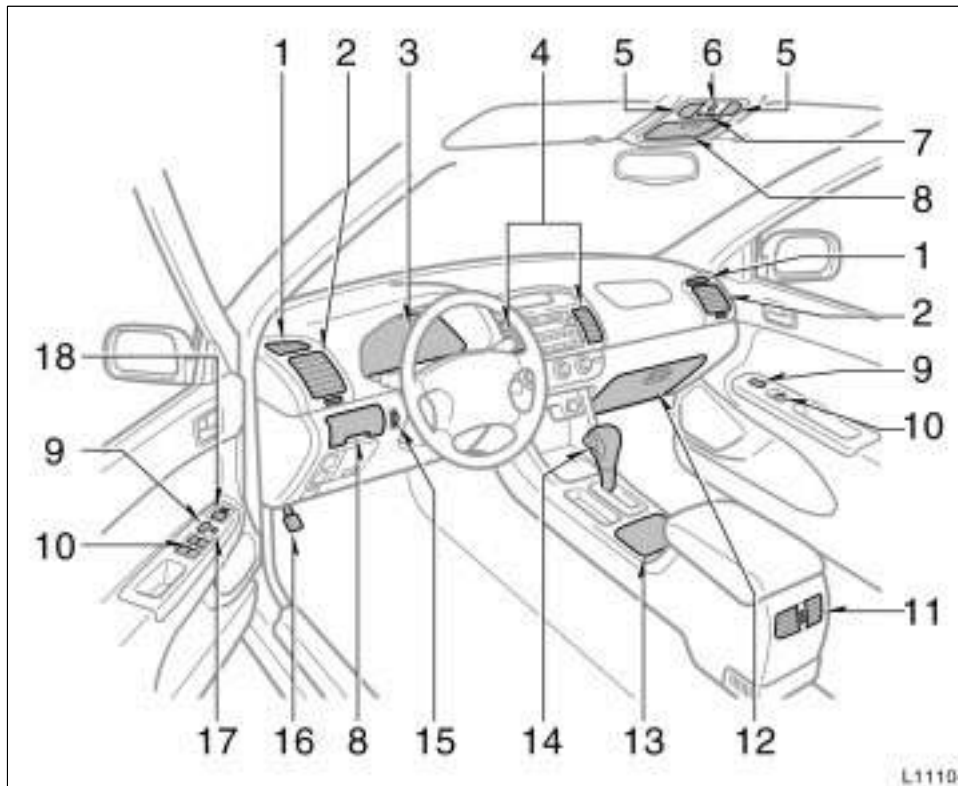

1. Side defroster outlets
2. Side vents
3. Instrument cluster
4. Center vents
5. Personal lights
6. Electric moon roof switch
7. Garage door opener
8. Auxiliary boxes
9. Power door lock switches
10. Power window switches
11. Rear vents
12. Glove box
13. Cup holder
14. Automatic transmission selector lever
15. Instrument panel light control dial
16. Parking brake pedal
17. Window lock switch
18. Power rear view mirror control switches

© With manual air conditioning controls

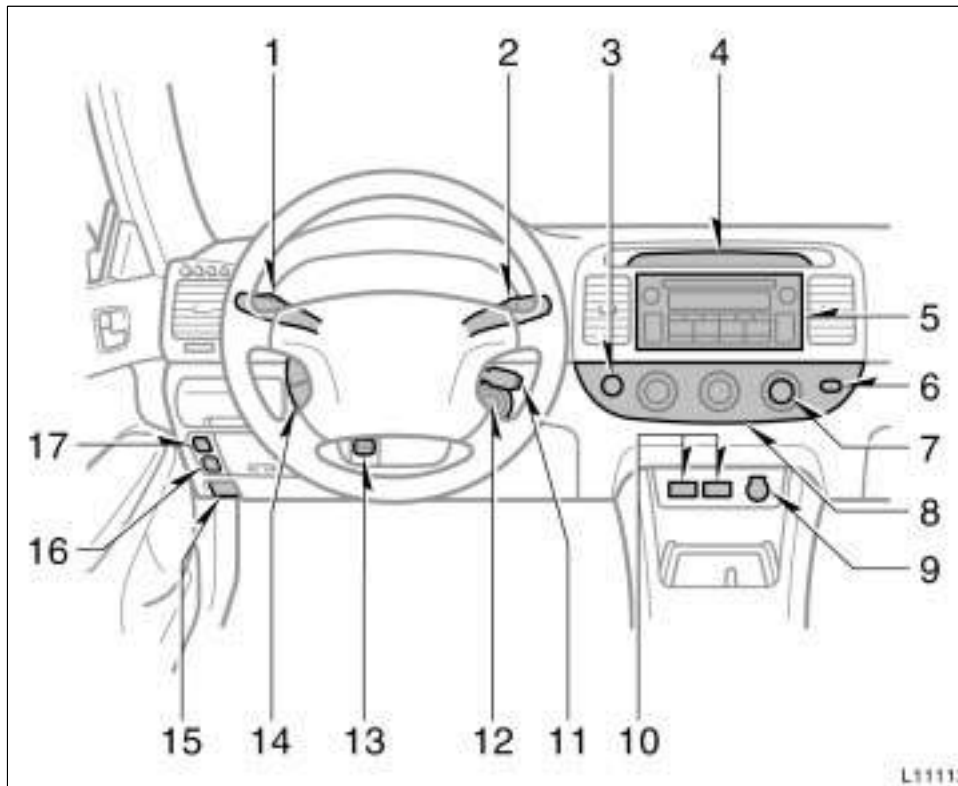

1. Headlight and turn signal switch and front fog light switch
2. Wiper and washer switches
3. Emergency flasher switch
4. Clock/outside temperature gauge and multi-information display
5. Car audio
6. Theft deterrent system/engine immobiliser system indicator light
7. Rear window and outside rear view mirror defogger switch
8. Air conditioning controls
9. Power outlet
10. Seat heater switches
11. Cruise control switch
12. Ignition switch
13. Tilt steering lock release lever
14. Multi-information display control switches
15. Hood lock release lever
16. Traction control system off switch
17. Power adjustable pedals switch

© With automatic air conditioning controls

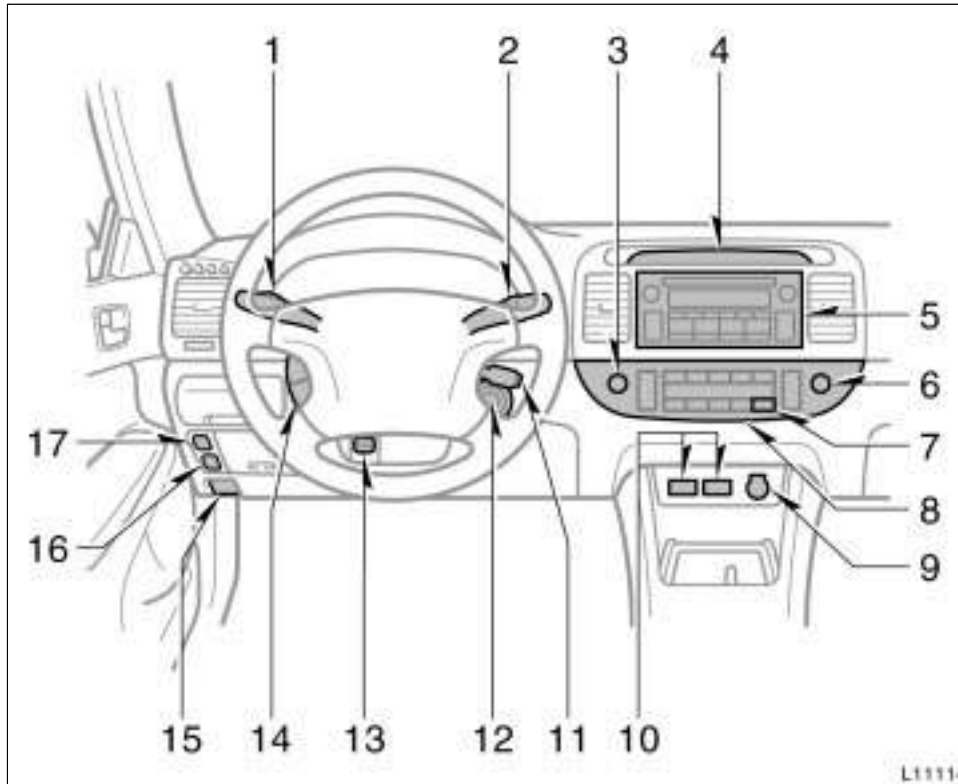





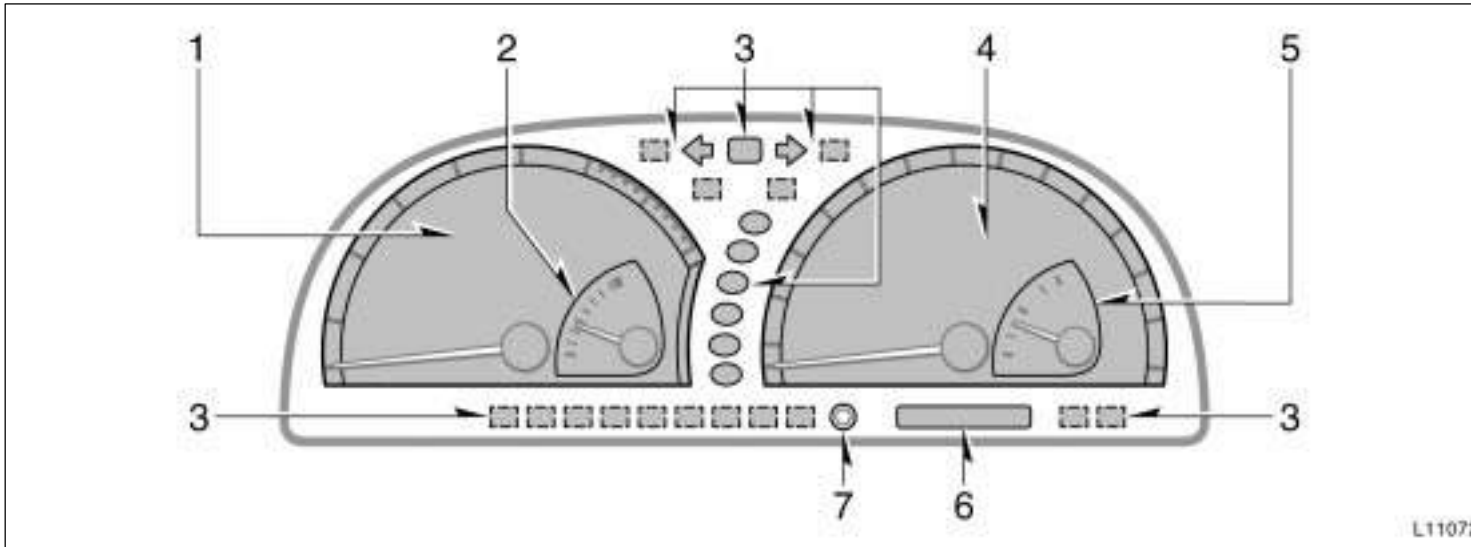







1. Headlight and turn signal switch and front fog light switch
2. Wiper and washer switches
3. Emergency flasher switch
4. Clock/outside temperature gauge and multi-information display
5. Car audio
6. Theft deterrent system/engine immobiliser system indicator light
7. Rear window and outside rear view mirror defogger switch
8. Air conditioning controls
9. Power outlet
10. Seat heater switches
11. Cruise control switch
12. Ignition switch
13. Tilt steering lock release lever
14. Multi-information display control switches
15. Hood lock release lever
16. Traction control system off switch
17. Power adjustable pedals switch

Instrument cluster overview



- | | | |
|---|----------------|---------------------------------|
| 1. Tachometer | 4. Speedometer | 6. Odometer and two trip meters |
| 2. Engine coolant temperature gauge | 5. Fuel gauge | 7. Trip meter reset knob |
| 3. Service reminder indicators and indicator lights | | |

Indicator symbols on the instrument panel

<p>BRAKE or </p>	Brake system warning light* ¹	<p>ABS or </p>	Anti-lock brake system warning light* ¹
	Driver's seat belt reminder light* ¹		Open door warning light* ¹
<p> PASSENGER</p>	Front passenger's seat belt reminder light* ¹		SRS warning light* ¹
	Discharge warning light* ¹		Low windshield washer fluid level warning light* ¹
 CHECK	Malfunction indicator lamp* ¹	VSC	Vehicle skid control system and traction control system warning light* ¹
	Low engine oil pressure warning light* ¹		Turn signal indicator lights
	Low fuel level warning light* ¹		Headlight high beam indicator light

PRN D 2 L	Automatic transmission indicator lights
O/D OFF	Overdrive-off indicator light
	Slip indicator light
TRAC OFF	Traction control system off indicator light
CRUISE	Cruise control indicator light* ²

*1: For details, see "Service reminder indicators and warning buzzers" on page 99 in Section 1-5.

*2: If this light flashes, see "Cruise control" on page 118 in Section 1-6.

SECTION 1-2

OPERATION OF INSTRUMENTS AND CONTROLS

Keys and Doors

Keys	10
Engine immobiliser system	13
Side doors	15
Power windows	23
Trunk lid	25
Hood	27
Theft deterrent system	28
Fuel tank cap	30
Electric moon roof	32

Keys (without engine immobiliser system)

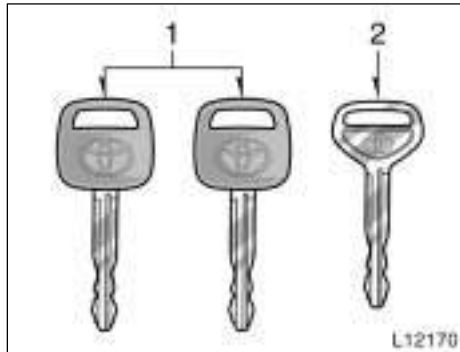

Your vehicle is supplied with two kinds of keys.

1. Master key—

This key works in every lock.

Since the doors and trunk lid can be locked without a key, you should always carry a spare master key in case you accidentally lock your keys inside the vehicle.

2. Sub key—

This key will not work in the glove box and trunk.

To protect things locked in the glove box or trunk when you have your vehicle at valet parking, leave the sub key with the attendant.

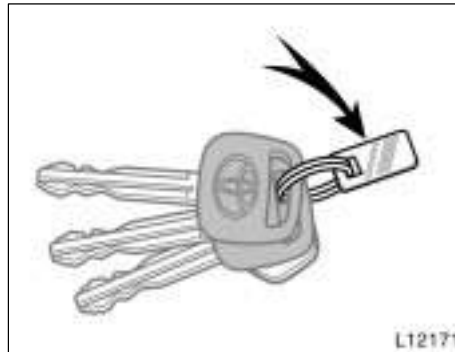

KEY NUMBER PLATE

Your key number is shown on the plate. **Keep the plate in a safe place such as your wallet, not in the vehicle.**

If you should lose your keys or if you need additional keys, duplicates can be made by a Toyota dealer using the key number.

We recommend you to write down the key number and keep it in safe place.

Keys (with engine immobiliser system)

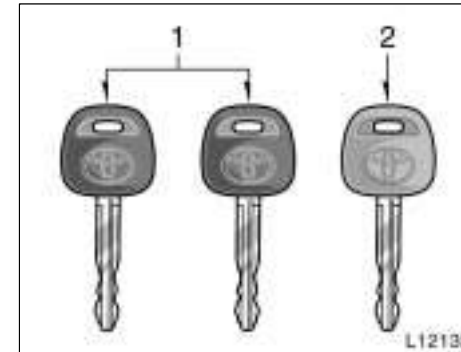

Your vehicle is supplied with two kinds of keys.

1. Master key (black)—

This key works in every lock. Your Toyota dealer will need it to make you a new key with built-in transponder chip.

Since the doors and trunk lid can be locked without a key, you should always carry a spare master key in case you accidentally lock your keys inside the vehicle.

2. Sub key (gray)—

This key will not work in the glove box and trunk.

To protect things locked in the glove box or trunk when you have your vehicle at valet parking, leave the sub key with the attendant.

A transponder chip for engine immobiliser system has been fitted in the head of the master and sub keys. These chips are needed to enable the system to function correctly, so be careful not to lose these keys. If you make your own duplicate key, you will not be able to cancel the system or start the engine.



NOTICE

When using a key containing a transponder chip, observe the following precautions:

◀ *When starting the engine, do not use the key with a key ring resting on the key grip and do not press the key ring against the key grip. Otherwise the engine may not start, or may stop soon after it starts.*

◀ *When starting the engine, do not use the key with other transponder keys around (including keys of other vehicles) and do not press other key plates against the key grip. Otherwise the engine may not start, or may stop soon after it starts. If this happens, remove the key once and then insert it again after taking off other transporter keys (including keys of other vehicles) from the ring or while gripping or covering them with your hand to start the engine.*



◀Do not bend the key grip.

- ◀Do not cover the key grip with any material that cuts off electromagnetic waves.
- ◀Do not knock the key hard against other objects.
- ◀Do not leave the key exposed to high temperatures for a long period, such as on the dashboard and hood under the direct sunlight.
- ◀Do not put the key in water or wash it in an ultrasonic washer.
- ◀Do not use the key with electromagnetic materials.

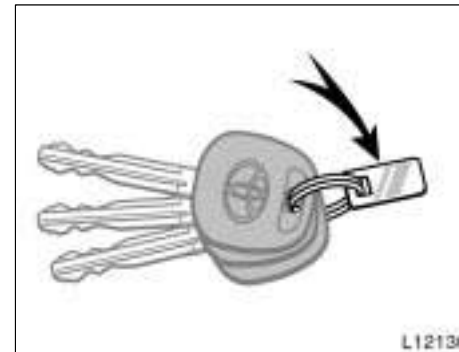

KEY NUMBER PLATE

Your key number is shown on the plate. Keep the plate in a safe place such as your wallet, not in the vehicle.

If you should lose your keys or if you need additional keys, duplicates can be made by a Toyota dealer using the key number.

We recommend you to write down the key number and keep it in safe place.

Engine immobiliser system

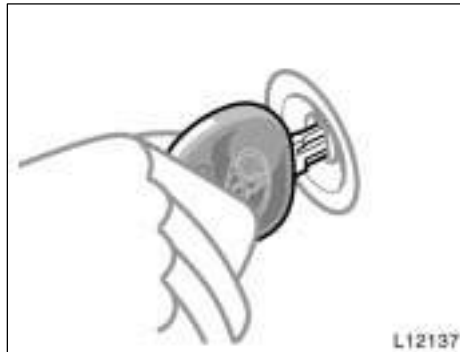

The engine immobiliser system is a theft prevention system. When you insert the key in the ignition switch, the transporter chip in the key's head transmits an electronic code to the vehicle. The engine will start, only when the electronic code in the chip corresponds to the registered ID code for the vehicle.

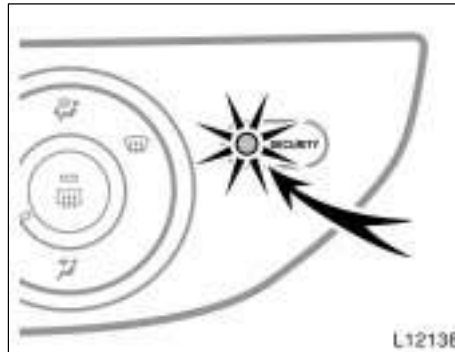

With manual air conditioning controls

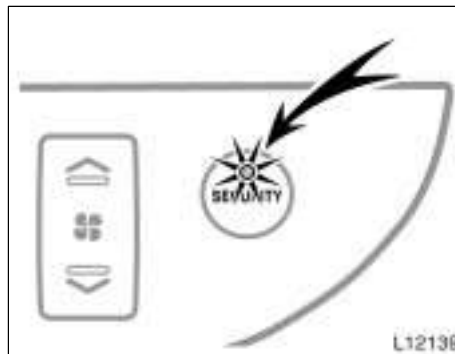

With automatic air conditioning controls

The system is automatically set when the key is removed from the ignition switch. The indicator light will start flashing to show the system is set.

If either of the following indicator conditions occurs, contact your Toyota dealer.

- Ⓒ The indicator light stays on except when the theft deterrent system is setting or activating. (See "Theft deterrent system" on page 28 in this section.)
- Ⓒ The indicator light does not start flashing when the key is removed from the ignition switch.
- Ⓒ The indicator light flashes unsteady.

Inserting the registered key in the ignition switch automatically cancels the system, which enables the engine to start. The indicator light will go off.

For your Toyota dealer to make you a new key with built-in transporter chip, your dealer will need your key number and master key. However, there is a limit to the number of additional keys your Toyota dealer can make for you.

If you make your own duplicate key, you will not be able to cancel the system or start the engine.

NOTICE

Do not modify, remove or disassemble the engine immobiliser system. If any unauthorized changes or modifications are made, the proper operation of the system cannot be guaranteed.

For vehicles sold in U.S.A.

**FCC ID: MOZRI-19BTY
MADE IN JAPAN**

This device complies with Part 15 of the FCC Rules. Operation is subject to the following two conditions:

(1) This device may not cause harmful interference, and (2) this device must accept any interference received, including interference that may cause undesired operation.

**FCC ID: NT8-156072FIFXCVR
CANADA: 3043104233 5 2**

This device complies with Part 15 of the FCC Rules. Operation is subject to the following two conditions:

(1) This device may not cause harmful interference, and (2) this device must accept any interference received, including interference that may cause undesired operation.

 **CAUTION**

Changes or modifications not expressly approved by the party responsible for compliance could void the user's authority to operate the equipment.

For vehicles sold in Canada

This device complies with RSS-210 of Industry Canada. Operation is subject to the following two conditions:

(1) This device may not cause interference, and (2) this device must accept any interference, including interference that may cause undesired operation of the device.

Side doors—

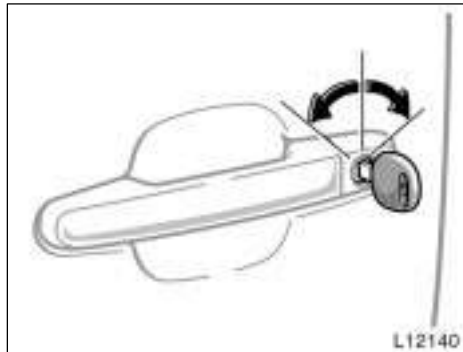

LOCKING AND UNLOCKING WITH KEY Insert the key into the keyhole and turn it.

To lock: Turn the key forward.

To unlock: Turn the key backward.

All the doors lock and unlock simultaneously with either front door. In the driver's door lock, turning the key once will unlock the driver's door and twice in succession will unlock all the doors simultaneously.

When all the doors are unlocked simultaneously with a key or wireless remote control transmitter, the interior light and ignition switch light come on for about 15 seconds and then fades out, even if the door is not opened. (For further information, see "Interior light" on page 92 and "Ignition switch light" on page 92 in Section 1-4.)

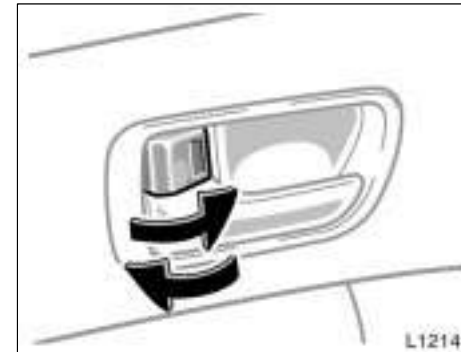

LOCKING AND UNLOCKING WITH INSIDE LOCK KNOB

Move the lock knob.

To lock: Push the knob forward.

To unlock: Pull the knob backward.

The front doors can be opened by pulling the inside handle even if the lock knobs are in the locked position.

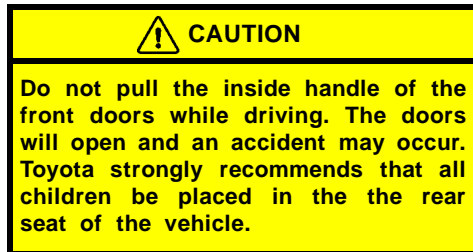

Closing the door with the lock knob in the lock position will also lock the door. Be careful not to lock your keys in the vehicle.

The door cannot be locked if you leave the key in the ignition switch with the door open.

If the vehicle is subjected to a severe impact from the front or rear, or from either side with the ignition switch at the "ON" position, all the doors will unlock automatically.

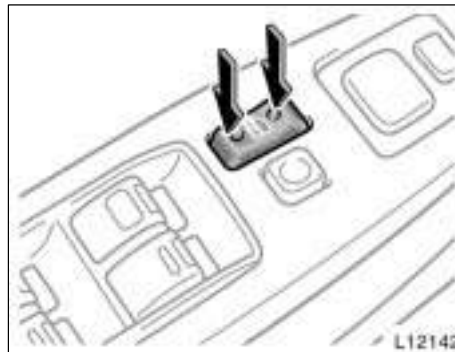

Driver's side

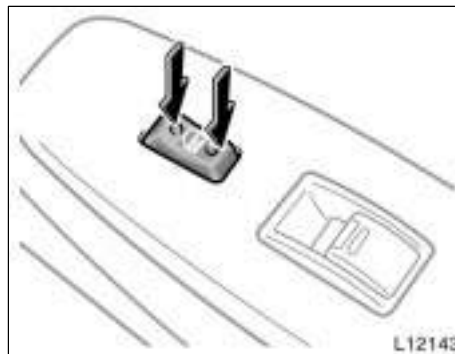

Passenger's side

LOCKING AND UNLOCKING WITH POWER DOOR LOCK SWITCH

Push the switch.

To lock: Push the switch on the front side.
To unlock: Push the switch on the rear side.

Operating the switch simultaneously locks or unlocks all the side doors.

If you do either of the following, no door can be unlocked with the power door lock switch.

- Ⓢ Lock all the side doors with the key or wireless remote control transmitter when the front doors are closed.
- Ⓢ Open the driver's door or front passenger's door and move the inside lock knobs of both front doors to the lock position, then close the front doors.

The power door lock switch can be reset in the following ways.

- Ⓢ Turn the ignition key to "ON".
- Ⓢ Unlock all the doors with the key or wireless remote control transmitter.
- Ⓢ Unlock the driver's door or front passenger's door with the inside lock knob, and then unlock all the doors with the power door lock switch.

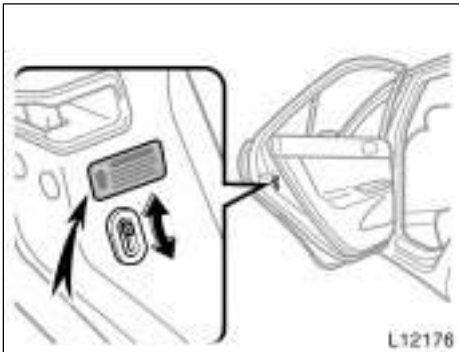

REAR DOOR CHILD-PROTECTORS

Move the lock lever to the “LOCK” position as shown on the label.

This feature allows you to lock a rear door so it can be opened from the outside only, not from inside. We recommend using this feature whenever small children are in the vehicle.

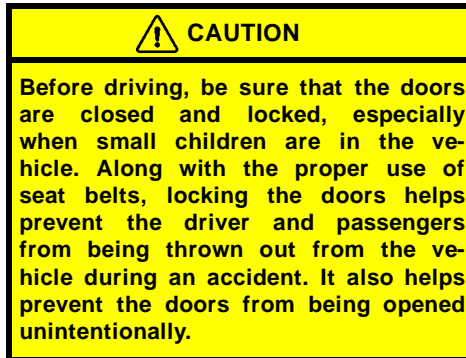

—Automatic door locking and unlocking functions (vehicles with automatic transmission)

You can select the following modes of the automatic locking and unlocking functions. The initial mode is mode 1.

© **Mode 1—Automatic locking linked with the shift position**

All doors are automatically locked when the shift lever is moved out of the “P” position with the ignition switch in the “ON” position and all the doors are closed.

© **Mode 2—Functions cancelled**

Automatic door locking and unlocking functions do not activate in this mode.

© **Mode 3—Automatic locking and unlocking linked with the shift position**

Locking function—All doors are automatically locked when the shift lever is moved out of the “P” position with the ignition switch in the “ON” position and all the doors are closed.

Unlocking function—All doors are automatically unlocked when the shift lever is moved to the “P” position with the ignition switch in the “ON” position.

© **Mode 4—Automatic locking and unlocking linked with the shift position and ignition switch**

Locking function—All doors are automatically locked when the shift lever is moved out of the “P” position with the ignition switch in the “ON” position and all the doors are closed.

Unlocking function—All doors are automatically unlocked when the ignition switch is turned from the “ON” position to the “ACC” or “LOCK” position.

CHANGING THE MODE

The mode toggles through from mode 1 to mode 4. To change the mode, do the following:

1. Shift the shift lever into the “P” position and close all doors.
2. Push the power door lock switch on the rear side to unlock the doors.
3. Turn the ignition switch to the “ON” position.

4. Within 5 seconds after the ignition switch is turned to the “ON” position, push and hold the power door lock switch on the front side for about 5 seconds.

5. Open door warning light will flash to indicate that the mode has been changed.

The flashing of the open door warning light indicates the mode which has been selected.

© Flashing once, the function has changed to mode 1.

© Flashing twice, the function has changed to mode 2.

© Flashing three times, the function has changed to mode 3.

© Flashing four times, the function has changed to mode 4.

—Wireless remote control

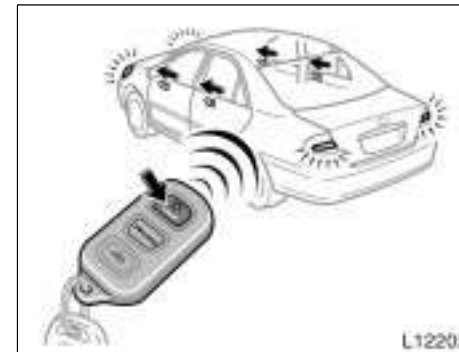

Locking operation



Unlocking operation

The wireless remote control system is designed to lock or unlock all the doors, open the trunk lid or activate the "PANIC" mode from a distance within approximately 1 m (3 ft.) of the vehicle.

LOCKING AND UNLOCKING THE DOORS

To lock and unlock all the doors, push the switches of the transmitter slowly and securely.

To lock: Push the "LOCK" switch. All the doors are locked simultaneously. At this time one beep will be heard, and the turn signal lights will flash once.

Check to see that the doors are securely locked.

If any door is not securely closed, locking cannot be performed by the "LOCK" switch and a beep will sound continuously for 10 seconds. However, if the key is in the ignition, a beep will not sound.

To stop the beep, close all the doors securely or push the "UNLOCK" switch.

To unlock: Push the "UNLOCK" switch once to unlock the driver's door alone. Pushing the switch twice within 3 seconds unlocks all the doors simultaneously. Each time the "UNLOCK" switch is pushed, two beeps will be heard, and the turn signal lights will flash twice.

When the "UNLOCK" switch is pressed, the interior light and ignition switch light come on. The lights remain on for about 15 seconds unless any door is opened and closed. (For further information, see "Interior light" on page 92 and "Ignition switch light" on page 92 in Section 1-4.)

You have 30 seconds to open a door after using the wireless remote unlock feature. If a door is not opened by then, all the doors will be automatically locked again and one beep will be heard.

If the "LOCK" or "UNLOCK" switch is kept pressed in, the locking or unlocking operation is not repeated. Release the button and then push again.

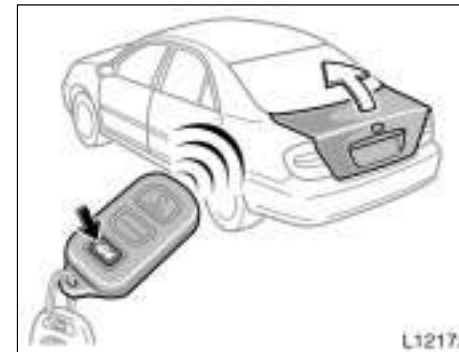

OPENING THE TRUNK LID

To open the trunk lid, push the trunk lid open switch of the transmitter for 1 second. A long beep will sound.

If the ignition key is in the "ON" position, the trunk lid cannot be opened by the trunk lid open switch.

To open the trunk lid with the master key, see "Trunk lid" on page 25 in this section.



“PANIC” SWITCH

Pushing the “PANIC” switch blows the horn intermittently and flashes the headlights, tail lights, turn signal lights and interior light.

The “PANIC” switch is used to deter vehicle theft when you witness anyone attempting to break into or damage your vehicle.

The alarm will last for one minute. To stop alarm midway, push the “PANIC” switch once again, unlock any door with the key or transmitter, or turn the ignition key from the “LOCK” to “ON” position.

The “PANIC” mode does not work when the ignition key is in the “ON” position.

SWITCHING BEEP SOUND ON AND OFF

You can switch the beep on and off. (The beep is on initially and after battery replacement.)

To switch the beep on and off:

With the driver’s door opened—

1. Insert the ignition key and remove it.
2. Within 5 seconds, insert the ignition key again and turn it to the “ON” position.
3. After 10 seconds, push the same “LOCK”, “UNLOCK”, “PANIC” or trunk lid open switch twice within 10 seconds.

Two beep sounds inform you that the program has been switched on or off.

If this procedure is not followed exactly, the beep will not operate as expected.

Check the beep ON/OFF operation by pushing the transmitter switch after you finish this procedure. If the beep does not operate as expected, repeat this procedure from step 1.

WIRELESS REMOTE CONTROL TRANSMITTER

The wireless remote control transmitter is an electronic component. Observe the following instructions in order not to cause damage to the transmitter.

- © Do not leave the transmitter on places where the temperature becomes high such as on the dashboard.
- © Do not disassemble it.
- © Avoid knocking it hard against other objects or dropping it.
- © Avoid putting it in water.

You can use up to 4 wireless remote control transmitters for the same vehicle. Contact your Toyota dealer for detailed information.

If the wireless remote control transmitter does not actuate the doors or alarm, or operate from a normal distance:

- © Check for closeness to a radio transmitter such as a radio station or an airport which can interfere with normal operation of the transmitter.
- © The battery may have been consumed. Check the battery in the transmitter. To replace the battery, see “REPLACING TRANSMITTER BATTERY”.

If you lose your transmitter, contact your Toyota dealer as soon as possible to avoid the possibility of theft, or an accident. (See "If you lose your wireless remote control transmitter" on page 229 in Section 4.)

MODEL/FCC ID: GQ43VT14T
CAN: 1470 102 849
MADE IN U.S.A.

This complies with Part 15 of the FCC rules. Operation is subject to the following two conditions:

(1) This device may not cause harmful interference, and (2) this device must accept any interference received, including interference that may cause undesired operation.

REPLACING TRANSMITTER BATTERY

For replacement, use CR2032 lithium battery or equivalent.

CAUTION

Special care should be taken that small children do not swallow the removed transmitter battery or components.

NOTICE

- ◀ *When replacing the transmitter battery, be careful not to lose the components.*
- ◀ *Replace only with the same or equivalent type recommended by the manufacturer.*
- ◀ *Dispose of used batteries according to the local laws.*

Replace the transmitter battery by the following procedures:



1. Using a coin or equivalent, open the transmitter case.



2. Remove the discharged transmitter battery.

NOTICE

Do not bend the terminals.

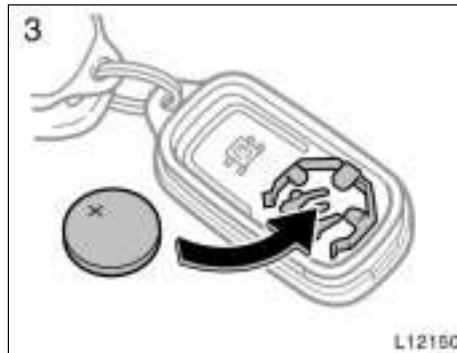

3. Put new transmitter battery with positive (+) side up.

Close the transmitter case securely.

NOTICE

- ◀ *Make sure the positive side and negative side of the transmitter battery should be faced correctly.*
- ◀ *Do not replace the battery with wet hands. Water may cause unexpected rust.*
- ◀ *Do not touch or move any components inside of the transmitter, or it may interfere with proper operation.*

◀ *Be careful not to bend the electrode of the transmitter battery insertion and that dust or oils do not adhere to the transmitter case.*

◀ *Close the transmitter case securely.*

After replacing battery, check that the transmitter operates properly. If the transmitter still does not operate properly, contact your Toyota dealer.

Power windows

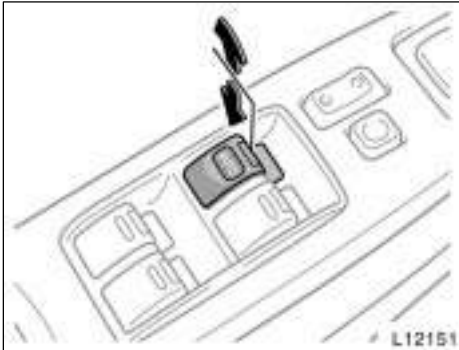

The windows can be operated with the switch on each door.

The power windows work when the ignition switch is in the "ON" position.

Key off operation: All windows work for 43 seconds even after the ignition switch is turned off. They stop working when either front door is opened.

OPERATING THE DRIVER'S WINDOW

Use the switch on the driver's door.

Normal operation: The window moves as long as you hold the switch.

To open: Lightly push down the switch.

To close: Lightly pull up the switch.

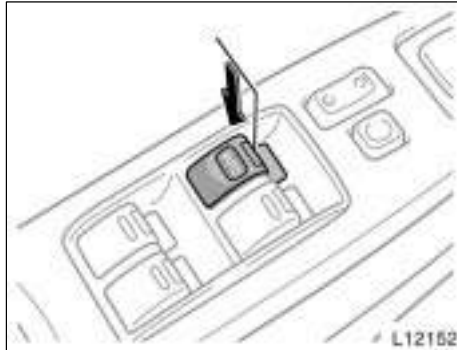

Type A (to open only)

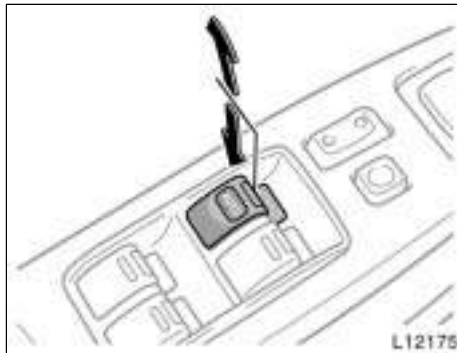

Type B (to open and close)

Automatic operation:

Type A (to open only)—Push the switch completely down and then release it. The window will fully open. To stop the window partway, lightly pull the switch up and then release it.

Type B (to open and close)—Push the switch completely down or pull it completely up, and then release it. The window will fully open or close. To stop the window partway, lightly move the switch in the opposite direction and then release it.

Jam protection function (type B only):

During automatic closing operation or key off closing operation, the window stops and opens half way if something gets caught between the window and window frame.

If the window receives a strong impact, this function may work even if nothing is caught.

⚠ CAUTION

©Never try jamming any part of your body to make the jam protection function work intentionally.

©The jam protection function may not work if something gets caught just before the window fully closed.

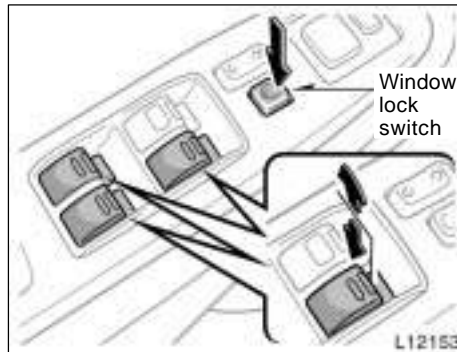

OPERATING THE PASSENGERS' WINDOWS

Use the switches on the passengers' doors. The driver's door also has switches that control the passengers' windows.

The window moves as long as you hold the switch.

To open: Push down the switch.

To close: Pull up the switch.

If you push in the window lock switch on the driver's door, the passengers' windows cannot be operated.

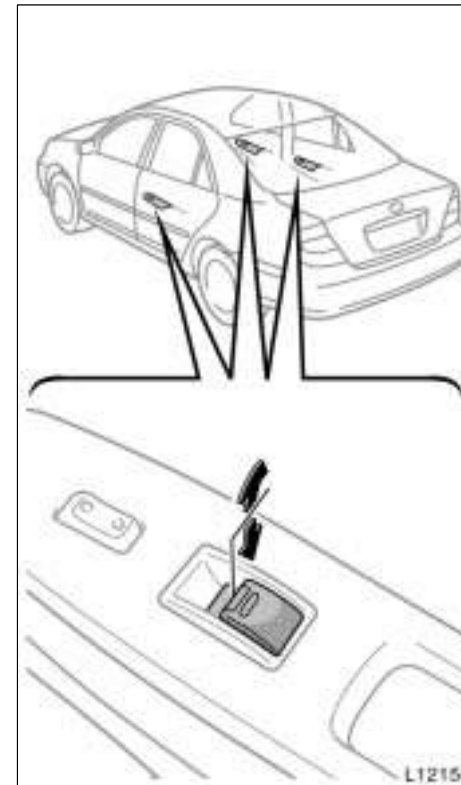

CAUTION

To avoid serious personal injury, you must do the following.

- © Always make sure the heads, hands and other parts of the bodies of all occupants are kept completely inside the vehicle before you close the power windows. If someone's neck, head or hands gets caught in a closing window, it could result in a serious injury. When anyone closes the power windows, make sure that he/she operates the windows safely.
- © When small children are in the vehicle, never let them use the power window switches without supervision. Use the window lock switch to prevent them from making unexpected use of the switches.
- © Never leave small children alone in the vehicle, especially with the ignition key still inserted. They could use the power window switches and get trapped in a window. Unattended children can be involved in serious accidents.

Trunk lid—

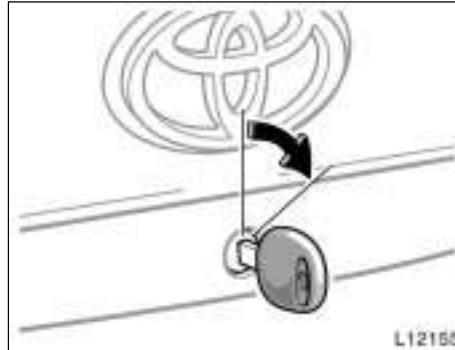

To open the trunk lid from the outside, insert the master key and turn it clockwise.

See "Luggage stowage precautions" on page 191 in Section 2 for precautions in loading luggage.

To close the trunk lid, lower it and press down on it. After closing the trunk lid, try pulling it up to make sure it is securely closed.

The trunk lid can be opened with the wireless remote control transmitter, see "—Wireless remote control" on page 18 in this section.

CAUTION

Keep the trunk lid closed while driving. This not only keeps the luggage from being thrown out but also prevents exhaust gases from entering the vehicle.

—Lock release lever



To open the trunk lid from the driver's seat, pull up on the lock release lever. To deactivate this lock release lever from opening the trunk lid, see "—Luggage security system" described below.

—Luggage security system

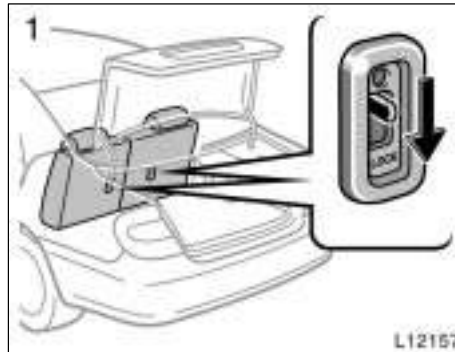

This system prevents someone (with the sub key) from gaining access to the trunk by folding down a rear seat or using the trunk lid lock release lever.

To protect valuables stored in the trunk, do the following procedure.

1. Open the trunk lid and push down the security lock levers to lock the rear seatbacks.

After locking the rear seatbacks, try folding them down to make sure they are securely locked, otherwise someone could get into the trunk by folding down a rear seat.

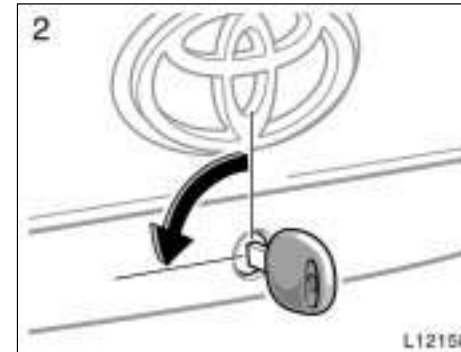

2. Close the trunk lid. Insert the master key and turn it counterclockwise to deactivate the trunk lid lock release lever.

After the operation, try pulling up the trunk lid lock release lever to make sure it is locked.

NOTICE

Implement the above steps to maximize security of the luggage in the trunk whenever the vehicle is unattended.

—Internal trunk release handle

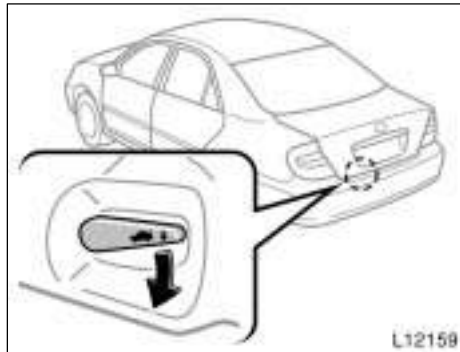

If a person is locked in the trunk, pull down the phosphorescent handle (illuminated for a while) on the inside of trunk lid in case of emergency to open the trunk lid.

The handle illuminating time depends on the intensity of the light thrown on the handle.

CAUTION

- ©Always lock the trunk lid and all doors, and keep away the vehicle keys out of children's reaches.
- ©Never leave children unattended in the vehicle. Unsupervised children may lock themselves in the vehicle or trunk and suffer serious injuries or death.

Hood

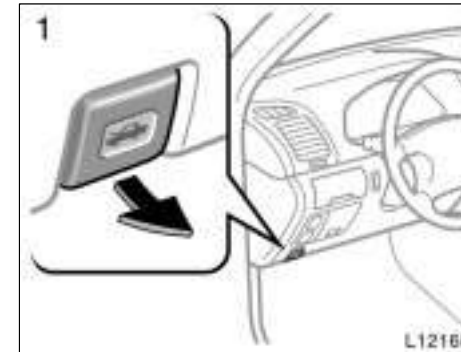

To open the hood:

1. Pull the hood lock release lever. The hood will spring up slightly.

CAUTION

Before driving, be sure that the hood is closed and securely locked. Otherwise, the hood may open unexpectedly while driving and an accident may occur.

Theft deterrent system

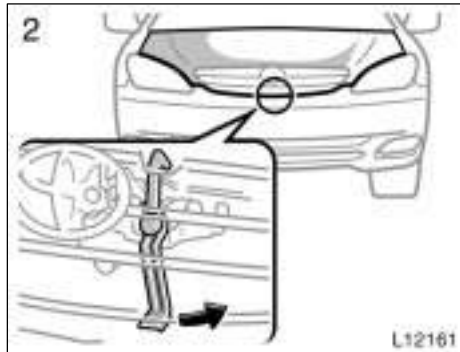

2. In front of the vehicle, pull up the auxiliary catch lever and lift the hood.

Before closing the hood, check to see that you have not forgotten any tools, rags, etc. Then lower the hood and make sure it locks into place. If necessary, press down gently on the front edge to lock it.



To deter the vehicle theft, the system is designed to give an alarm if any of the doors, trunk or hood is forcibly unlocked or the battery terminal is disconnected and then reconnected when the vehicle is locked.

The alarm blows the horn intermittently and flashes the headlights, tail lights, turn signal lights and interior light.

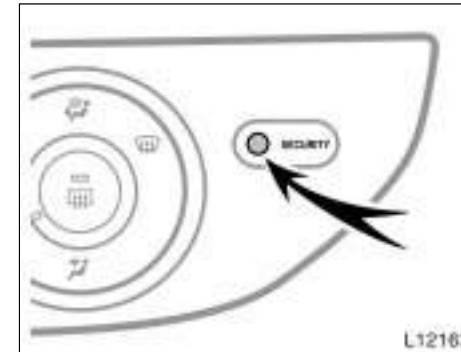

With manual air conditioning controls

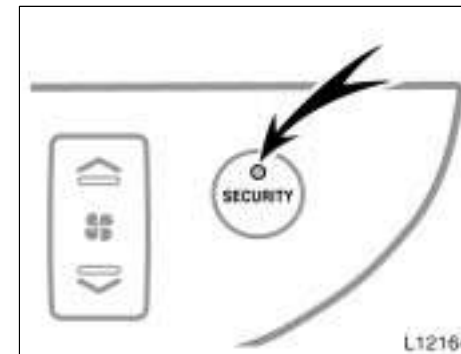

With automatic air conditioning controls

SETTING THE SYSTEM

1. Turn the ignition key to the "LOCK" position and remove it.

The indicator light will start flashing when the key is removed from the ignition switch. (See "Engine immobiliser system" on page 13 for details.)

2. Have all passengers get out of the vehicle.
3. Close and lock all the doors, trunk and hood.

The indicator light will come on when all the doors, trunk and hood are closed and locked.

The system will automatically be set after 30 seconds. When the system is set, the indicator light will start flashing again.

4. After making sure the indicator light starts flashing, you may leave the vehicle.

Never leave anyone in the vehicle when you set the system, because unlocking from the inside will activate the system.

WHEN THE SYSTEM IS SET

Activating the system

The system will give the alarm under the following conditions:

- © If any of the doors are unlocked or if the trunk or hood is forcibly opened without the key or wireless remote control transmitter
- © If the battery terminal is disconnected and then reconnected
- © Hotwire the ignition.

The indicator light will come on when the system is activating.

If any of the door is unlocked without the key or wireless remote control transmitter and the key is not in the ignition switch, all the doors will be automatically locked again.

After one minute, the alarm will automatically stop and the indicator light will start flashing again.

Reactivating the alarm

Once set, the system automatically resets the alarm after the alarm stops.

The alarm will activate again under the same circumstances described in "Activating the system".

Stopping the alarm

The alarm will be stopped by the following three ways:

- © Turn the ignition key from the "LOCK" to "ON" position.
- © Unlock any of the doors with the key or wireless remote control transmitter.
- © Open the trunk with the key or wireless remote control transmitter.

CANCELLING THE SYSTEM

The system will be cancelled by the above mentioned 3 ways.

If the tail lights come on for 2 seconds, the theft deterrent system has been alarmed. Check to see if there is any abnormality on your vehicle.

TESTING THE SYSTEM

1. Open all the windows.
2. Set the system as described above. The doors should be locked with the key or wireless remote control transmitter. Be sure to wait until the indicator light goes off or starts flashing.
3. Unlock any door from the inside. The system should activate the alarm.
4. Stopping the alarm as described above.

5. Repeat this operation for the other doors, trunk and hood. When testing on the hood, also check that the system is activated when the battery terminal is disconnected and then reconnected.
If the system does not work properly, have it checked by your Toyota dealer.

Fuel tank cap

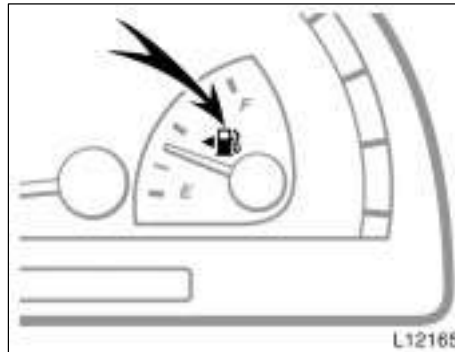

This indicates that the fuel filler door is on the left side of your vehicle.



1. To open the fuel filler door, pull the lever up.
When refueling, turn off the engine.

CAUTION

- © Do not smoke, cause sparks or allow open flames when refueling. The fumes are flammable.
- © When opening the cap, do not remove the cap quickly. In hot weather, fuel under pressure could cause injury by spraying out of the filler neck if the cap is suddenly removed.

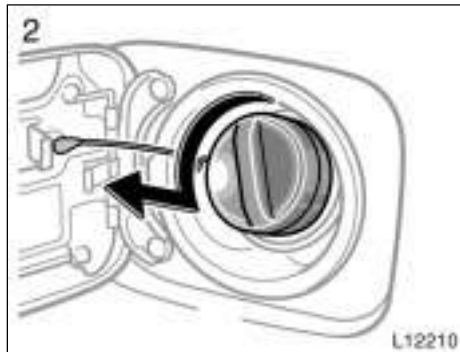

2. To remove the fuel tank cap, turn the cap slowly counterclockwise, then pause slightly before removing it.

It is not unusual to hear a slight swoosh when the cap is opened.

The cap can be removed in about 1/2 of a turn.

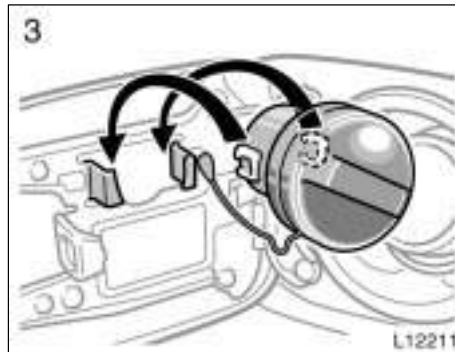

3. The removed cap can be stored on the back side of the fuel filler door.

Position the cap so that the hooks point to the left and right, and set it in the receptacle on the back side of the door.

When installing the cap, turn the cap clockwise until you hear one click. When you hear the click, the cap is fully closed.

If the cap is not installed securely, the malfunction indicator lamp comes on. Make sure the cap is tightened securely.

The indicator lamp goes off after driving several times. If the indicator lamp does not go off, contact your Toyota dealer as soon as possible.

CAUTION

Ⓢ Make sure the cap is tightened securely to prevent fuel spillage in case of an accident.

Ⓢ Use only a genuine Toyota fuel tank cap for replacement. It is designed to regulate fuel tank pressure.

NOTICE

Do not attempt to tighten the cap further, as the cap could be damaged or become difficult to open.

Electric moon roof



Sliding operation



Tilting operation

To operate the moon roof, use the switch beside the personal lights.

The moon roof works when the ignition switch is in the "ON" position. However, if both front doors are closed, it works for about 43 seconds even after the ignition switch is turned off. It stops working when either of the front doors are opened.

Sun shade operation—

The sun shade can be opened or closed by hand.

Sliding operation—

To open: Push and hold the switch for 1 second on the "SLIDE OPEN" side.

The roof will fully open automatically. To stop the roof partway, push the switch on either the "SLIDE OPEN" or "TILT UP" side briefly.

The sun shade will be opened together with the roof.

To close: Push and hold the switch for 1 second on the "TILT UP" side.

The roof will fully close automatically. To stop the roof partway, push the switch on either the "SLIDE OPEN" or "TILT UP" side briefly.

Tilting operation—

To tilt up: Push and hold the switch for 1 second on the "TILT UP" side.

The roof will fully tilt up automatically. To stop the roof partway, push the switch on either the "SLIDE OPEN" or "TILT UP" side briefly.

To tilt down: Push and hold the switch for 1 second on the "SLIDE OPEN" side.

The roof will fully tilt down automatically. To stop the roof partway, push the switch on either the "SLIDE OPEN" or "TILT UP" side briefly.

Jam protection function: During closing operation, the moon roof stops and opens half way if something gets caught between the moon roof and frame.

If the moon roof receives a strong impact, this function may work even if nothing is caught.

If the battery is disconnected or run down, the moon roof may not operate automatically and the jam protection function will not function correctly after you reconnect, replace or recharge the battery. In any of these cases, you should normalize the moon roof.

To normalize the moon roof, push and hold the switch on the "TILT UP" side until the moon roof tilts all the way up and then tilts down a little automatically.

Make sure that the moon roof opens and closes automatically. If the moon roof cannot be operated properly, have it checked by your Toyota dealer.



CAUTION

To avoid serious personal injury, you must do the following.

- ©While the vehicle is moving, always keep the heads, hands and other parts of the bodies of all occupants away from the roof opening. Otherwise, they could be seriously injured if the vehicle stops suddenly or if the vehicle is involved in an accident.
- ©Always make sure nobody places his/her head, hands and other parts of the body in the roof opening before you close the roof. If someone's neck, head or hands gets caught in the closing roof, it could result in a serious injury. When anyone closes the roof, first make sure it is safe to do so.

- ©Never leave small children alone in the vehicle, especially with the ignition key still inserted. They could use the moon roof switches and get trapped in the roof opening. Unattended children can be involved in serious accidents.
- ©Never sit on top of the vehicle around the roof opening.
- ©Never try jamming any part of your body to make the jam protection function work intentionally.
- ©The jam protection function may not work if something gets caught just before the moon roof is fully closed.

SECTION 1-3

OPERATION OF INSTRUMENTS AND CONTROLS

Seats, Seat belts, Steering wheel and Mirrors

Seats	35
Front seats	35
Fold-down rear seat	38
Seat heaters	39
Head restraints	40
Armrest	40
Seat belts	41
SRS driver airbag and front passenger airbag	50
SRS side airbags and curtain shield airbags	58
Child restraint	65
Tilt steering wheel	81
Outside rear view mirrors	82
Anti-glare inside rear view mirror	83
Auto anti-glare inside rear view mirror	84
Vanity mirrors	85

Seats

While the vehicle is being driven, all vehicle occupants should have the seatback upright, sit well back in the seat and properly wear the seat belts provided.

CAUTION

- © Do not drive the vehicle unless the occupants are properly seated. Do not allow sitting on top of a folded-down seatback, or in the luggage compartment or cargo area. Persons not properly seated and/or properly restrained by seat belts can be severely injured in the event of emergency braking or a collision.
- © During driving, do not allow passengers to stand up or move around between seats. Severe injuries can occur in the event of emergency braking or a collision.

Front seats— —Front seat precautions (on vehicles with SRS side airbags)

CAUTION

The SRS side airbags are installed in the driver and front passenger seats. Observe the following precautions.

- © Do not lean against the front door when the vehicle is in use. The side airbag inflates with considerable speed and force; you may be killed or seriously injured.
- © Do not use accessories for the seats which cover the parts where the side airbags inflate. Such accessories may prevent the side airbags from activating correctly, causing death or serious injury.
- © Do not modify or replace the seats or upholstery of the front seats with the side airbags. Such changes may disable the system or cause the side airbags to inflate accidentally, resulting in death or serious injury. Consult your Toyota dealer if you insist on modifications of this kind.

—Seat adjustment precautions

Adjust the driver's seat so that the foot pedals, steering wheel and instrument panel controls are within easy reach of the driver.

CAUTION

- © Adjustments should not be made while the vehicle is moving, as the seat may unexpectedly move and cause the driver to lose control of the vehicle.
- © When adjusting the seat, be careful that the seat does not hit a passenger or luggage.
- © After adjusting the seat position, try sliding it forward and backward to make sure it is locked in position.
- © After adjusting the seatback, push back your body to make sure it is locked in position.
- © Do not put objects under the seats. The objects may interfere with the seat-lock mechanism or unexpectedly push up the seat position adjusting lever; the seat may suddenly move, causing the driver to lose control of the vehicle.

—Adjusting front seats
(manual seat)

©While adjusting the seat, do not put your hands under the seat or near the moving parts. You may catch and injure your hands or fingers.



1. SEAT POSITION ADJUSTING LEVER

Hold the center of the lever and pull it up. Then slide the seat to the desired position with slight body pressure and release the lever.

2. SEAT CUSHION HEIGHT ADJUSTING KNOB

Turn the knob either way.

3. SEATBACK ANGLE ADJUSTING LEVER

Lean forward and pull the lever up. Then lean back to the desired angle and release the lever.

—Adjusting front seats (power seat)

CAUTION

To reduce the risk of sliding under the lap belt during a collision, avoid reclining the seatback any more than needed. The seat belts provide maximum protection in a frontal or rear collision when the driver and the passenger are sitting up straight and well back in the seats. If you are reclined, the lap belt may slide past your hips and apply restraint forces directly to the abdomen. Therefore, in the event of a frontal collision, the risk of personal injury may increase with increasing recline of the seatback.

4. SEAT LUMBAR SUPPORT ADJUSTING KNOB

Turn the knob either way.



1. SEAT POSITION AND SEAT CUSHION HEIGHT ADJUSTING SWITCH

Move the control switch in the desired direction.

Releasing the switch will stop the seat at that position.

Do not place anything under the front seats. It might interfere with the seat-lock mechanism.

2. SEATBACK ANGLE ADJUSTING SWITCH

Move the control switch in the desired direction.

Releasing the switch will stop the seatback at that position.

CAUTION

To reduce the risk of sliding under the lap belt during a collision, avoid reclining the seatback any more than needed. The seat belts provide maximum protection in a frontal or rear collision when the driver and the passenger are sitting up straight and well back in the seats. If you are reclined, the lap belt may slide past your hips and apply restraint forces directly to the abdomen. Therefore, in the event of a frontal collision, the risk of personal injury may increase with increasing recline of the seatback.

**3. SEAT LUMBAR SUPPORT
ADJUSTING KNOB**

Turn the knob either way.

Fold-down rear seat

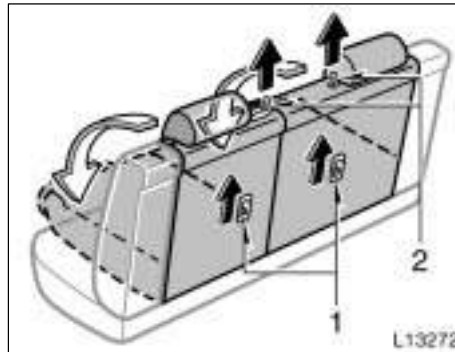

1. Pull up the seatback security lock lever 1 to the unlock position.
2. Pull up the lock release button 2.
3. Fold down the seatback.

Each seatback can be folded separately.



This will enlarge the trunk as far as the seatbacks. See "Luggage stowage precautions" on page 191 in Section 2 for precautions in loading luggage.

NOTICE

Make sure the luggage loaded in the enlarged trunk will not damage the webbing of the rear center seat belt when the left seatback is folded down.

Seat heaters

CAUTION

When returning the seatback to the upright position, observe the following precautions in order to prevent personal injury in a collision or sudden stop:

- ©Make sure the seatback is securely locked by pushing forward and rearward on the top of the seatback and that the red mark at the button on the top of the seatback cannot be seen. Failure to do so will prevent the seat belt from operating properly.
- ©Make sure the seat belts are not twisted or caught in the seatback and are arranged in the proper position and are ready to use.

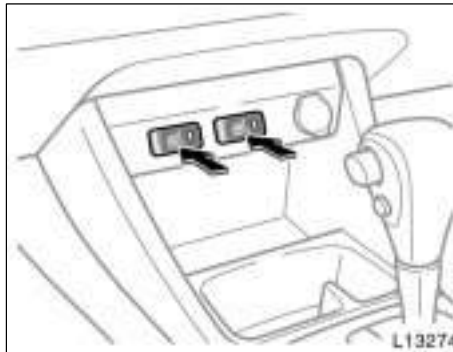

To turn on the seat heater, push the switch. To turn off the seat heater, push the switch once again.

The key must be in the "ON" position.

CAUTION

Occupants must use caution when operating the seat heater because it may make them feel too hot or cause burns at low temperatures (erythema, varicella). Use extra caution for;

- ©Babies, small children, elderly persons, sick persons or handicapped persons

- ©Persons who have delicate skin
- ©Persons who are exhausted
- ©Persons who have taken alcohol or drugs which induce sleep (sleeping drug, cold remedy, etc.)

To prevent the seat overheating, do not use the seat heater with a blanket, cushion, or other insulating objects which cover the seat.

NOTICE

- ◀Do not put unevenly weighed objects on the seat and do not stick sharp objects (needles, nails, etc.) into the seat.
- ◀When cleaning the seats, do not use organic substances (paint thinner, benzine, alcohol, gasoline, etc.). They may damage the heater and seat surface.
- ◀To prevent the battery from being discharged, turn the switch off when the engine is not running.

Head restraints

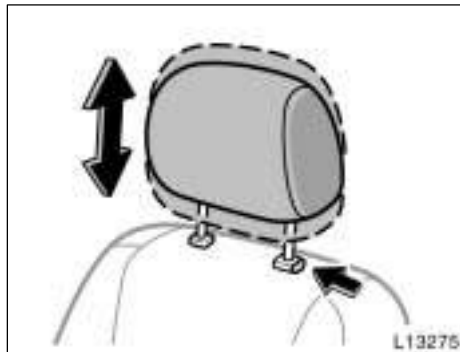

Front

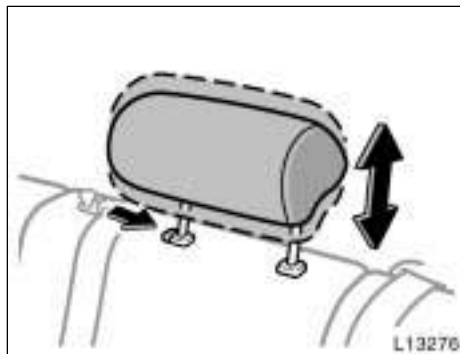

Rear

For your safety and comfort, adjust the head restraint before driving.

To raise: Pull it up.

To lower: Push it down while pressing the lock release button.

The head restraint is most effective when it is close to your head. Therefore, using a cushion on the seatback is not recommended.

⚠ CAUTION

- Ⓢ Adjust the center of the head restraint so that it is closest to the top of your ears.
- Ⓢ After adjusting the head restraint, make sure it is locked in position.
- Ⓢ Do not drive with the head restraints removed.

Armrest



To use the armrest, pull it out as shown above.

**Seat belts—
—Seat belt precautions**

Toyota strongly urges that the driver and passengers in the vehicle be properly restrained at all times with the seat belts provided. Failure to do so could increase the chance of injury and/or the severity of injury in accidents.

Child. Use a child restraint system appropriate for the child until the child becomes large enough to properly wear the vehicle's seat belts. See "Child restraint" on page 65 for details.

If a child is too large for a child restraint system, the child should sit in the rear seat and must be restrained using the vehicle's seat belt. According to accident statistics, the child is safer when properly restrained in the rear seat than in the front seat.

If a child must sit in the front seat, the seat belts should be worn properly. If an accident occurs and the seat belts are not worn properly, the force of the rapid inflation of the airbag may cause death or serious injury to the child.

Do not allow the child to stand up or kneel on either rear or front seats. An unrestrained child could suffer serious injury or death during emergency braking or a collision. Also, do not let the child sit on your lap. It does not provide sufficient restraint.

Pregnant woman. Toyota recommends the use of a seat belt. Ask your doctor for specific recommendations. The lap belt should be worn securely and as low as possible over the hips and not on the waist.

Injured person. Toyota recommends the use of a seat belt. Depending on the injury, first check with your doctor for specific recommendations.

 **CAUTION**

Persons should ride in their seats properly wearing their seat belts whenever the vehicle is moving. Otherwise, they are much more likely to suffer serious bodily injury or death in the event of sudden braking or a collision.

When using the seat belts, observe the following:

- Ⓢ **Use the belt for only one person at a time. Do not use a single belt for two or more people—even children.**
- Ⓢ **Avoid reclining the seatbacks too much. The seat belts provide maximum protection when the seatbacks are in the upright position. (Refer to the seat adjustment instructions.)**
- Ⓢ **Be careful not to damage the belt webbing or hardware. Take care that they do not get caught or pinched in the seat or doors.**
- Ⓢ **Inspect the belt system periodically. Check for cuts, fraying, and loose parts. Damaged parts should be replaced. Do not disassemble or modify the system.**

—Front and rear seat belts

- ©Keep the belts clean and dry. If they need cleaning, use a mild soap solution or lukewarm water. Never use bleach, dye, or abrasive cleaners—they may severely weaken the belts. (See “Cleaning the interior” on page 234 in Section 5.)
- ©Replace the belt assembly (including bolts) if it has been used in a severe impact. The entire assembly should be replaced even if damage is not obvious.



Adjust the seat as needed (front seats only) and sit up straight and well back in the seat. To fasten your belt, pull it out of the retractor and insert the tab into the buckle.

You will hear a click when the tab locks into the buckle.

The seat belt length automatically adjusts to your size and the seat position.

The retractor will lock the belt during a sudden stop or on impact. It also may lock if you lean forward too quickly. A slow, easy motion will allow the belt to extend, and you can move around freely.

If the seat belt cannot be pulled out of the retractor, firmly pull the belt and release it. You will then be able to smoothly pull the belt out of the retractor.

When a passenger's shoulder belt is completely extended and is then retracted even slightly, the belt is locked in that position and cannot be extended. This feature is used to hold the child restraint system securely. (For details, see “Child restraint” on page 65 in this section.) To free the belt again, fully retract the belt and then pull the belt out once more.

 CAUTION

- ©After inserting the tab, make sure the tab and buckle are locked and that the belt is not twisted.
- ©Do not insert coins, clips, etc. in the buckle as this may prevent you from properly latching the tab and buckle.
- ©If the seat belt does not function normally, immediately contact your Toyota dealer. Do not use the seat until the seat belt is fixed. It cannot protect an adult occupant or your child from injury.



Seat belts with an adjustable shoulder anchor—

Adjust the shoulder anchor position to your size.

To raise: Slide the anchor up.

To lower: Push in the lock release button and slide the anchor down.

After adjustment make sure the anchor is locked in position.

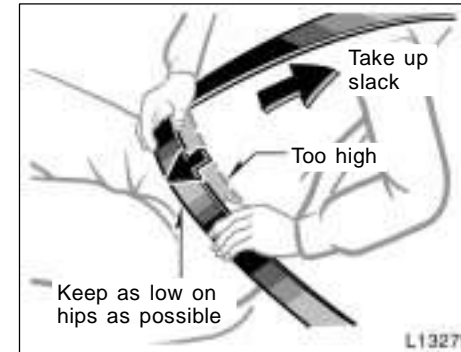
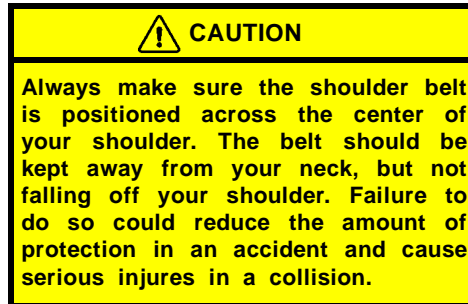

Adjust the position of the lap and shoulder belts.

Position the lap belt as low as possible on your hips—not on your waist, then adjust it to a snug fit by pulling the shoulder portion upward through the latch plate.

⚠ CAUTION

©Both high-positioned lap belts and loose-fitting belts could cause serious injuries due to sliding under the lap belt during a collision or other unintended result. Keep the lap belt positioned as low on hips as possible.

©For your safety, do not place the shoulder belt under your arm.



To release the belt, press the buckle-release button and allow the belt to retract.

If the belt does not retract smoothly, pull it out and check for kinks or twists. Then make sure it remains untwisted as it retracts.

—Seat belt extender

If your seat belt cannot be fastened securely because it is not long enough, a personalized seat belt extender is available from your Toyota dealer free of charge.

Please contact your local Toyota dealer so that the dealer can order the proper required length for the extender. Bring the heaviest coat you expect to wear for proper measurement and selection of length. Additional ordering information is available at your Toyota dealer.

⚠ CAUTION

When using the seat belt extender, observe the following precautions. Failure to follow these instructions could result in less effectiveness of the seat belt restraint system in case of vehicle accident, increasing the chance of personal injury.

©Never use the seat belt extender if you can fasten the seat belt without it.

©Remember that the extender provided for you may not be safe when used on a different vehicle, or for another person or at a different seating position than the one originally intended for.



To connect the extender to the seat belt, insert the tab into the seat belt buckle so that the “PRESS” signs on the buckle–release buttons of the extender and the seat belt are both facing outward as shown.

You will hear a click when the tab locks into the buckle.

When releasing the seat belt, press on the buckle–release button on the extender, not on the seat belt. This helps prevent damage to the vehicle interior and extender itself.

When not in use, remove the extender and store in the vehicle for future use.

CAUTION

- ©After inserting the tab, make sure the tab and buckle are locked and that the seat belt extender is not twisted.
- ©Do not insert coins, clips, etc. in the buckle as this may prevent you from properly latching the tab and buckle.
- ©If the seat belt does not function normally, immediately contact your Toyota dealer. Do not use the seat until the seat belt is fixed. It cannot protect an adult occupant or your child from injury.

—Seat belt comfort guides



The outside shoulder belt comfort guides for the rear seat outside positions will provide added seat belt comfort for children who have outgrown child restraints and for small adults. When the outside shoulder belt is inserted through the guide, the comfort guide pulls the belt away from the neck and head of an occupant.

To use the comfort guide, do as follows.

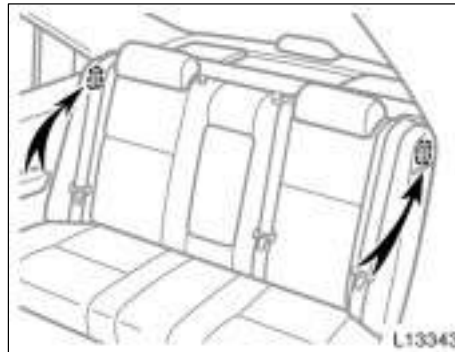

Seat belt comfort guides are stored in the both pockets on the sides of the rear seatback.

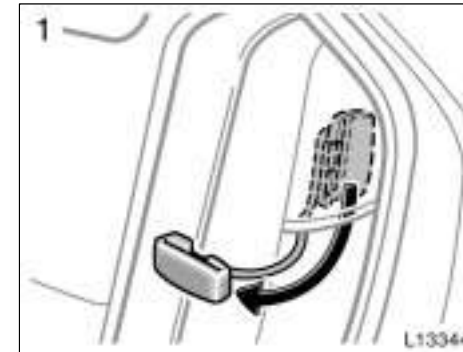

INSTALLING THE COMFORT GUIDE

1. Pull the comfort guide from the pocket.

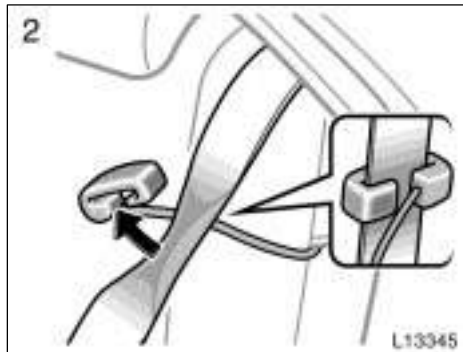

2. Pinch the two edges of the shoulder belt for the rear seat outside position with your fingers and slide the belt past the slot of the guide as shown above. At this time, the elastic cord must be behind the seat belt.

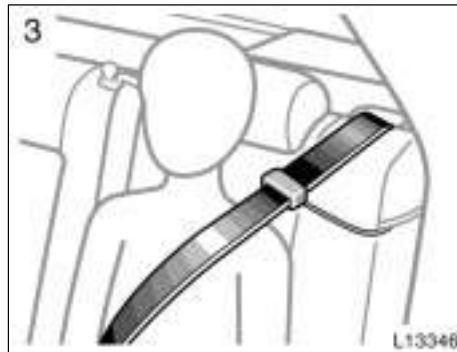

3. Buckle, position and release the seat belt. (For wearing the seat belt, see “—Front and rear seat belts” on page 42 in this section.) Make sure the shoulder belt crosses the shoulder.

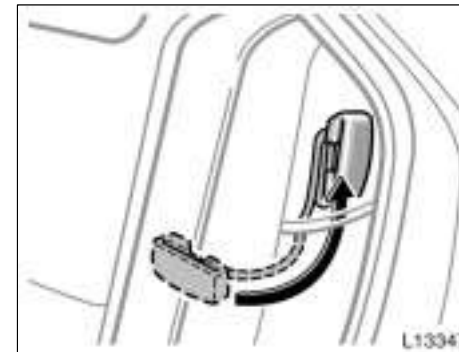

REMOVING AND STORING THE COMFORT GUIDE

Pinch the two edges of the seat belt together so that you can slide them out of the guide. Store the guide with the elastic cord into the pocket.

CAUTION

Make sure the belt is not twisted and that it lies flat. The elastic cord must be behind the belt and the guide must be on the front.

CAUTION

To reduce the chance of injury in case of an accident or a sudden stop while driving, remove and store the comfort guide in its pocket when it is not in use.

—Front seat belt pretensioners



The driver and front passenger's seat belt pretensioners are designed to be activated in response to a severe frontal impact.

When the airbag sensor detects the shock of a severe frontal impact, the front seat belts are quickly drawn back in by the retractors so that the belts snugly restrain the front seat occupants.

The front seat belt pretensioners are activated even with no passenger in the front seat.

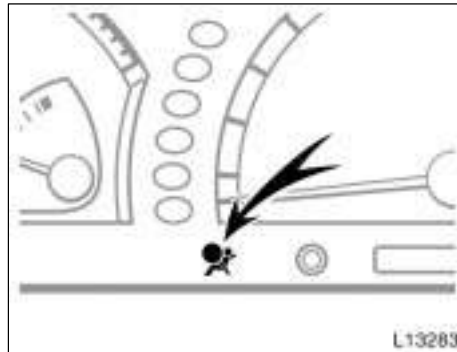

This indicator comes on when the ignition key is turned to the "ON" position. It goes off after about 6 seconds. This means the front seat belt pretensioners are operating properly.

This warning light system monitors the airbag sensor assembly, front airbag sensors, side and curtain shield airbag sensors, curtain shield airbag sensors, driver's seat position sensor, driver's seat belt buckle switch, front seat belt pretensioner assemblies, inflators, warning light, interconnecting wiring and power sources. (For details, see "Service reminder indicators and warning buzzers" on page 99 in Section 1-5.)

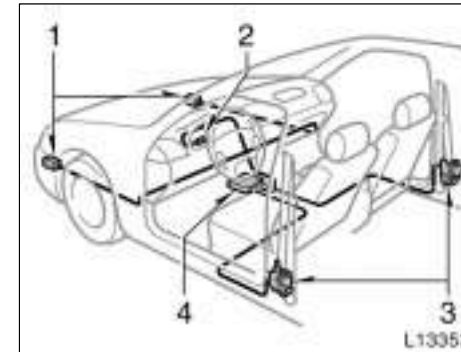

The front seat belt pretensioner system mainly consists of the following components and their locations are shown in the illustration.

1. Front airbag sensors
2. SRS warning light
3. Front seat belt pretensioner assemblies
4. Airbag sensor assembly

The front seat belt pretensioners are controlled by the airbag sensor assembly. The airbag sensor assembly consists of a safing sensor and airbag sensor.

When the front seat belt pretensioners are activated, an operating noise may be heard and a small amount of smoke-like gas may be released. This gas is harmless and does not indicate that a fire is occurring.

Once the front seat belt pretensioners have been activated, the seat belt retractors remain locked.

CAUTION

Do not modify, remove, strike or open the front seat belt pretensioner assemblies, airbag sensor or surrounding area or wiring. Doing so may cause sudden operation of the front seat belt pretensioners or disable the system, which could result in death or serious injury.

Failure to follow these instructions can result in death or serious injuries.

NOTICE

Do not perform any of the following changes without consulting your Toyota dealer. Such changes can interfere with proper operation of the front seat belt pretensioners in some cases.

- ◀ *Installation of electronic devices such as a mobile two-way radio, cassette tape player or compact disc player*
- ◀ *Repairs on or near the front seat belt retractor assemblies*
- ◀ *Modification of the suspension system*
- ◀ *Modification of the front end structure*
- ◀ *Attachment of a grille guard (bull bar, kangaroo bar, etc.), snowplow, winches or any other equipment to the front end*
- ◀ *Repairs made on or near the front fenders, front end structure or console*

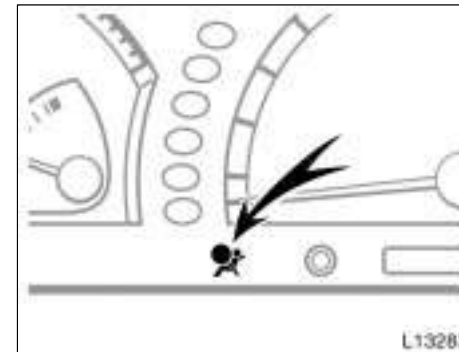

This front seat belt pretensioner system has a service reminder indicator to inform the driver of operating problems. If any of the following conditions occurs, this indicates a malfunction of the airbags or pretensioners. Contact your Toyota dealer as soon as possible to service the vehicle.

- Ⓢ The light does not come on when the ignition key is turned to the "ON" position, or the light remains on.
- Ⓢ The light comes on or flashes while driving.
- Ⓢ If either front seat belt does not retract or can not be pulled out due to a malfunction or activation of the relevant front seat belt pretensioner.

SRS driver airbag and front passenger airbag

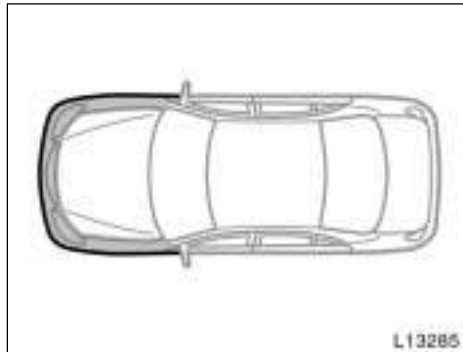

In the following cases, contact your Toyota dealer as soon as possible:

- © The front of the vehicle (shaded in the illustration) was involved in an accident that was not severe enough to cause the front seat belt pretensioners to operate.
- © Either front seat belt pretensioner assembly or surrounding area is scratched, cracked, or otherwise damaged.

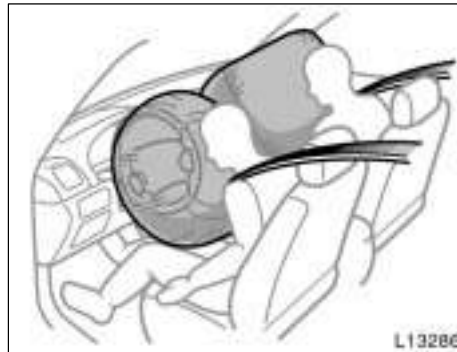

The SRS (Supplemental Restraint System) front airbags are designed to provide further protection for the driver and front passenger in addition to the primary safety protection provided by the seat belts.

In response to a severe frontal impact, the SRS front airbags work together with the seat belts to help reduce injury by inflating. The SRS front airbags help to reduce injuries mainly to the driver's or front passenger's head or chest caused by directly hitting the steering wheel or dashboard. The front passenger airbag is activated even with no passenger in the front seat.

Be sure to wear your seat belt properly.
2002 MY CAMRY_U (OM33567U)

Your vehicle is equipped with a crash sensing and diagnostic module, which will record the use of the seat belt restraint system by the driver when the SRS airbags are inflated.

CAUTION

The driver or front passenger who is too close to the steering wheel or dashboard during airbag deployment can be killed or seriously injured. Toyota strongly recommends that:

- ©The driver sit as far back as possible from the steering wheel while still maintaining control of the vehicle.
- ©The front passenger sit as far back as possible from the dashboard.
- ©All vehicle occupants be properly restrained using the available seat belts.

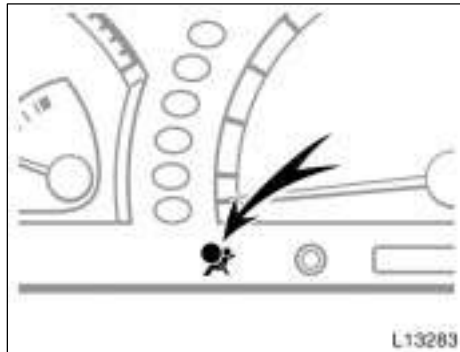

This indicator comes on when the ignition key is turned to the "ON" position. It goes off after about 6 seconds. This means the SRS front airbags are operating properly.

This warning light system monitors the airbag sensor assembly, front airbag sensors, side and curtain shield airbag sensors, curtain shield airbag sensors, driver's seat position sensor, driver's seat belt buckle switch, front seat belt pretensioner assemblies, inflators, warning light, interconnecting wiring and power sources. (For details, see "Service reminder indicators and warning buzzers" on page 99 in Section 1-5.)

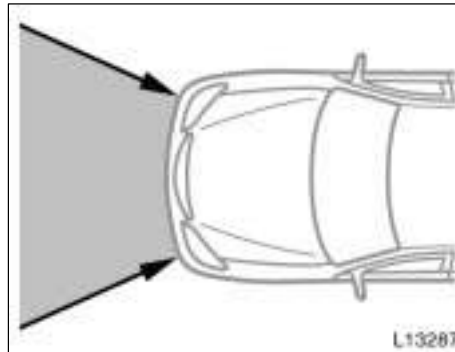

The SRS front airbag system is designed to activate in response to a severe frontal impact within the shaded area between the arrows in the illustration.

The SRS front airbags will deploy if the severity of the impact is above the designed threshold level, comparable to an approximate 25 km/h (15 mph) collision when impacting straight into a fixed barrier that does not move or deform.

If the severity of the impact is below the above threshold level, the SRS front airbags may not deploy.

However, this threshold velocity will be considerably higher if the vehicle strikes an object, such as a parked vehicle or sign pole, which can move or deform on impact, or if it is involved in an underride collision (e.g. a collision in which the nose of the vehicle "underrides", or goes under, the bed of a truck, etc.).

It is possible that in some collisions at the lower zone of airbag sensor detection and activation the SRS airbags and seat belt pretensioners will not operate all together.

For the safety of all occupants, always wear your seat belts properly.

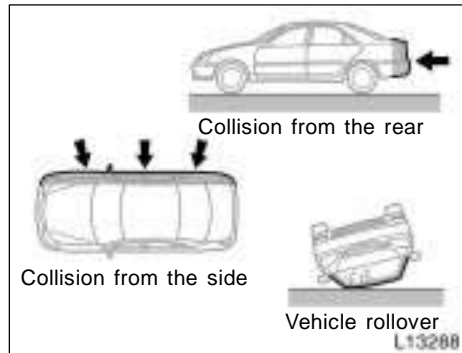

The SRS front airbags are not designed to inflate if the vehicle is involved in a side or rear collision, if it rolls over, or if it is involved in a low-speed frontal collision.

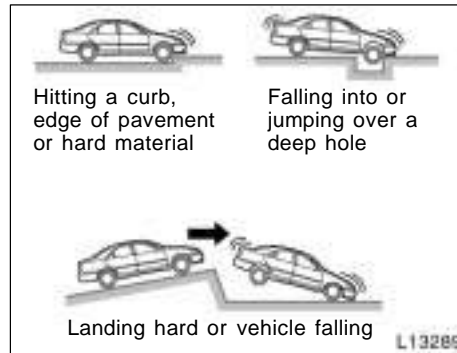

The front SRS airbags may deploy if a serious impact occurs to the underside of your vehicle. Some examples are shown in the illustration.

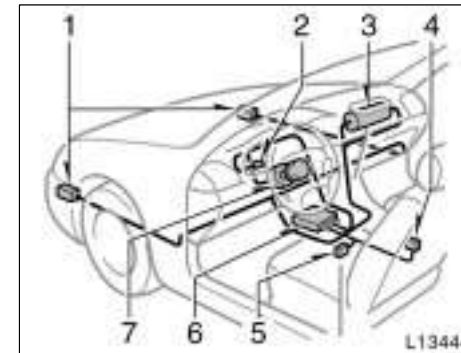

The SRS airbag system consists mainly of the following components, and their locations are shown in the illustration.

1. Front airbag sensors
2. SRS warning light
3. Airbag module for front passenger (airbag and inflator)
4. Driver's seat belt buckle switch
5. Driver's seat position sensor
6. Airbag sensor assembly
7. Airbag module for driver (airbag and inflator)

The airbag sensor assembly consists of a safing sensor and airbag sensor.

In a severe frontal impact, the sensors detect deceleration and the system triggers the airbag inflators. Then a chemical reaction in the inflators quickly fills the airbags with non-toxic gas to help restrain the forward motion of the occupants.

When the airbags inflate, they produce a fairly loud noise and release some smoke and residue along with non-toxic gas. This does not indicate a fire. This gas is normally harmless; however, for those who have delicate skin, it may cause a minor skin irritation. Be sure to wash off any residue as soon as possible to prevent any potential skin irritation.

Deployment of the airbags happens in a fraction of a second, so the airbags must inflate with considerable force. While the system is designed to reduce serious injuries, it may also cause minor burns or abrasions and swelling.

Parts of the airbag module (steering wheel hub, dashboard) may be hot for several minutes, but the airbags themselves will not be hot. The airbags are designed to inflate only once.

A crash severe enough to inflate the airbags may break the windshield as the vehicle buckles. In vehicles with a passenger airbag the windshield may also be damaged by absorbing some of the force of the inflating airbag.

 CAUTION

©The SRS airbag system is designed only as a supplement to the primary protection of the driver side and front passenger side seat belt systems. The front seat occupants can be killed or seriously injured by the inflating airbags if they do not wear the available seat belts properly. During sudden braking just before a collision, an unrestrained driver or front passenger can move forward into direct contact with or close proximity to the airbag which may then deploy during the collision. To ensure maximum protection in an accident, the driver and all passengers in the vehicle must wear their seat belts properly. Wearing a seat belt properly during an accident reduces the chances of death or serious injury or being thrown out of the vehicle. For instructions and precautions concerning the seat belt system, see "Seat belts" on page 41 in this section.

© Improperly seated and/or restrained infants and children can be killed or seriously injured by the deploying front airbags. An infant or child who is too small to use a seat belt should be properly secured using a child restraint system. Toyota strongly recommends that all infants and children be placed in the rear seat of the vehicle and properly restrained. The rear seat is the safest for infants and children. For instructions concerning the installation of a child restraint system, see "Child restraint" on page 65 in this section.



© Never install a rear-facing child restraint system on the front passenger seat because the force of the rapid inflation of the front passenger airbag can cause death or serious injury to the child.



© A forward-facing child restraint system should be allowed to be installed on the front passenger seat only when it is unavoidable. Always move the seat as far back as possible, because the force of the deploying front passenger airbag could cause death or serious injury to the child.

©On vehicles with side airbags and curtain shield airbags, do not allow the child to lean against the door or around the door even if the child is seated in the child restraint system. It is dangerous if the side airbag and curtain shield airbag inflate, and the impact could cause death or serious injury to the child.

©For instructions concerning the installation of a child restraint system, see "Child restraint" on page 65 in this section.



©Do not sit on the edge of the seat or lean over the dashboard when the vehicle is in use. The front airbags inflate with considerable speed and force; you may be killed or seriously injured. Sit up straight and well back in the seat, and always use your seat belt properly.



©Do not allow a child to stand up, or to kneel on the front passenger seat. The front airbag inflates with considerable speed and force; the child may be killed or seriously injured.

©Do not hold a child on your lap or in your arms. Use a child restraint system in the rear seat. For instructions concerning the installation of a child restraint system, see "Child restraint" on page 65 in this section.

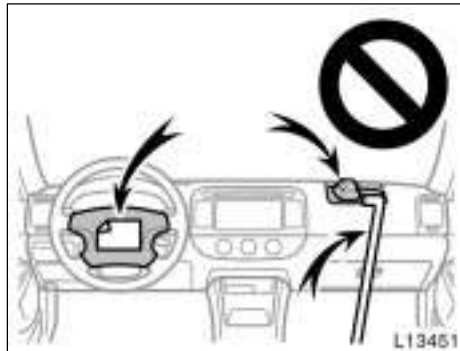

©Do not put objects or your pets on or in front of the dashboard or steering wheel pad that houses the front airbag system. They might restrict inflation or cause death or serious injury as they are projected rearward by the force of deploying airbags. Likewise, the driver and front passenger should not hold things in their arms or on their knees.

©Do not modify or remove any wiring. Do not modify, remove, strike or open any components such as the steering wheel pad, steering wheel, column cover or front passenger airbag cover, front passenger airbag, airbag sensor assembly. Doing so may cause sudden SRS front airbag inflation or disable the system, which could result in death or serious injury.

Failure to follow these instructions can result in death or serious injury. Consult your Toyota dealer about any repairs and modifications.

NOTICE

Do not perform any of the following changes without consulting your Toyota dealer. Such changes can interfere with proper operation of the SRS front airbag system in some cases.

- ◀ *Installation of electronic devices such as a mobile two-way radio, cassette tape player or compact disc player*
- ◀ *Modification of the suspension system*
- ◀ *Modification of the front end structure*
- ◀ *Attachment of a grille guard (bull bar, kangaroo bar, etc.), snowplow, winches or any other equipment to the front end*
- ◀ *Repairs made on or near the front fenders, front end structure, console, steering column, steering wheel or dashboard near the front passenger airbag*

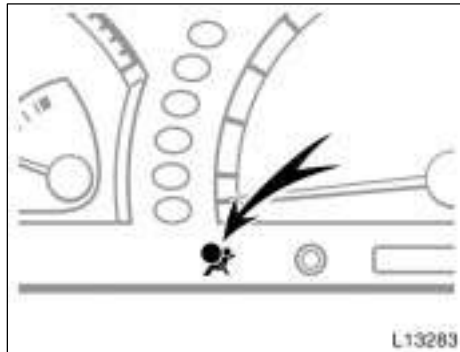

This SRS front airbag system has a service reminder indicator to inform the driver of operating problems. If either of the following conditions occurs, this indicates a malfunction of the airbags. Contact your Toyota dealer as soon as possible to service the vehicle.

- © The light does not come on when the ignition key is turned to the "ON" position, or the light remains on.
- © The light comes on while driving.

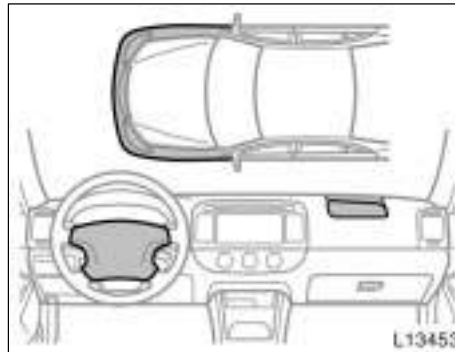

In the following cases, contact your Toyota dealer as soon as possible:

- © The SRS front airbags have been inflated.
- © The front of the vehicle (shaded in the illustration) was involved in an accident that was not severe enough to cause the SRS front airbags to inflate.
- © The pad section of the steering wheel or front passenger airbag cover (shaded in the illustration) is scratched, cracked, or otherwise damaged.

NOTICE

Do not disconnect the battery cables before contacting your Toyota dealer.

SRS side airbags and curtain shield airbags



The SRS (Supplemental Restraint System) side airbags and curtain shield airbags are designed to provide further protection for the driver, front passenger and rear outside passengers in addition to the primary safety protection provided by the seat belts.

In response to a severe side impact, the SRS side airbags and curtain shield airbags work with the seat belts to help reduce injury by inflating. The SRS side airbags help to reduce injuries mainly to the driver's or front passenger's chest and the SRS curtain shield airbags help to reduce injuries mainly to the driver's, front passenger's or rear outside passenger's head. The SRS side airbag and curtain shield airbag on the passenger side are activated even with no passenger in the front seat or rear seat.

The curtain shield airbags may activate even when the side airbags are not activated.

Be sure to wear your seat belt properly.

Your vehicle is equipped with a crash sensing and diagnostic module, which will record the use of the seat belt restraint system by the driver when the SRS side airbags and curtain shield airbags are inflated.

CAUTION

SRS side airbags and curtain shield airbags inflate with considerable force. To avoid potential death or serious injury when they inflate, the driver, front passenger and rear outside passengers must:

- ©Wear their seat belts properly.
- ©Remain properly seated with their back upright and against the seat at all times.

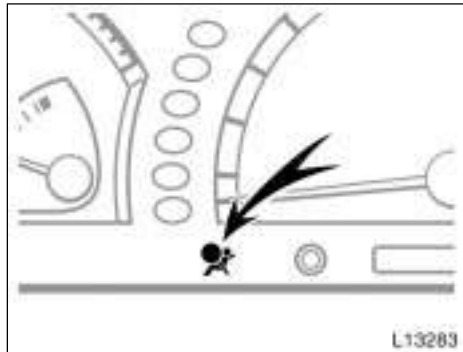

This indicator comes on when the ignition key is turned to the "ON" position. It goes off after about 6 seconds. This means the SRS side airbags and curtain shield airbags are operating properly.

This warning light system monitors the airbag sensor assembly, front airbag sensors, side and curtain shield airbag sensors, curtain shield airbag sensors, driver's seat position sensor, driver's seat belt buckle switch, front seat belt pretensioner assemblies, inflators, warning light, interconnecting wiring and power sources. (For details, see "Service reminder indicators and warning buzzers" on page 99 in Section 1-5.)

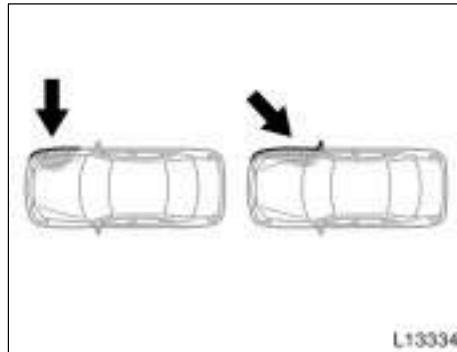

The SRS side airbag and curtain shield airbag system may not inflate if the vehicle is subjected to a collision from the side at certain angles, or a collision to the side of the vehicle body other than the passenger compartment as shown in the illustration.

The SRS side airbags and curtain shield airbags are designed to inflate when the passenger compartment area suffers a severe impact from the side.

For the safety of all occupants, always wear your seat belts properly.

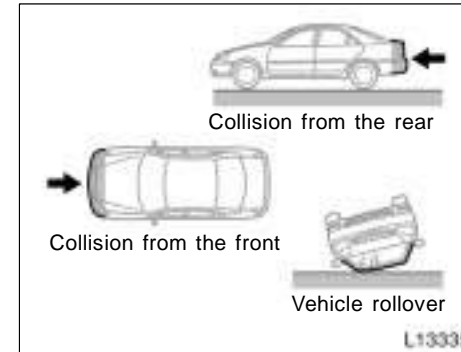

The SRS side airbags and curtain shield airbags are not designed to inflate if the vehicle is involved in a front or rear collision, if it rolls over, or if it is involved in a low-speed side collision.

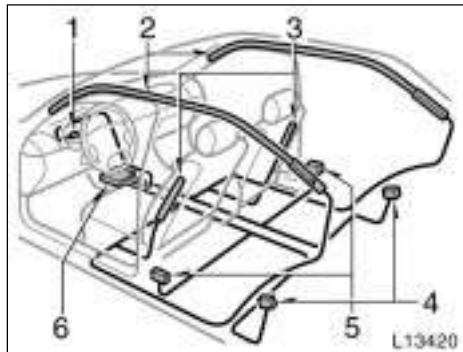

The SRS side airbag and curtain shield airbag system consists mainly of the following components, and their locations are shown in the illustration.

1. SRS warning light
2. Curtain shield airbag modules (airbag and inflator)
3. Side airbag modules (airbag and inflator)
4. Curtain shield airbag sensors
5. Side and curtain shield airbag sensors
6. Airbag sensor assembly

The SRS side airbag and curtain shield airbag system is controlled by the airbag sensor assembly. The airbag sensor assembly consists of a safing sensor and airbag sensor.

In a severe side impact, the side and curtain shield airbag sensor and/or the curtain shield airbag sensor trigger(s) the side airbag and curtain shield airbag inflators and/or the curtain shield airbag inflators. Then a chemical reaction in the inflators quickly fills the airbags with non-toxic gas to help restrain the lateral motion of the occupants.

When the airbags inflate, they produce a fairly loud noise and release some smoke and residue along with non-toxic gas. This does not indicate a fire. This gas is normally harmless; however, for those who have delicate skin, it may cause a minor skin irritation. Be sure to wash off any residue as soon as possible to prevent any potential skin irritation.

Deployment of the airbags happens in a fraction of a second, so the airbags must inflate with considerable force. While the system is designed to reduce serious injuries, it may also cause minor burns or abrasions and swelling.

Front seats as well as parts of the front and rear pillars, and roof side may be hot for several minutes, but the airbags themselves will not be hot. The airbags are designed to inflate only once.

⚠ CAUTION

©The SRS side airbag and curtain shield airbag system is designed only as a supplement to the primary protection of the driver side, and front and rear outside passenger side seat belt systems. To ensure maximum protection in an accident, the driver and all passengers in the vehicle must wear their seat belts. Wearing a seat belt during an accident reduces the chances of death or serious injury or being thrown out of the vehicle. For instructions and precautions concerning the seat belt system, see "Seat belts" on page 41 in this section.

©Improperly seated and/or restrained infants and children can be killed or seriously injured by a deploying airbag. An infant or child who is too small to use a seat belt should be properly secured using a child restraint system. Toyota strongly recommends that all infants and children be placed in the rear seat of the vehicle and properly restrained. The rear seat is the safest for infants and children. For instructions concerning the installation of a child restraint system, see "Child restraint" on page 65 in this section.

©Do not allow a child to lean his/her head or any part of his/her body against the front door or the area of the seat, front pillar, rear pillar or roof side from which the side airbag and curtain shield airbag deploy even if he/she is seated in the child restraint system. It is dangerous if the side airbag and curtain shield airbag inflate, and the impact could cause death or serious injury to the child. For instructions concerning the installation of a child restraint system, see "Child restraint" on page 65 in this section.



©Do not lean against the door when the vehicle is in use. Otherwise, the side airbag and curtain shield airbag inflate with considerable speed and force; you may be killed or seriously injured. Special care should be taken especially when you have a small child in the vehicle.

©Sit up straight and well back in the seat, distributing your weight evenly in the seat. Do not apply excessive weight to the outer side of the front seats with a side airbag, and to the front pillar, rear pillar and roof side rail with a curtain shield airbag.



©Do not get your head closer to the area where the side airbag and curtain shield airbag inflate. These airbags inflate with considerable speed and force; you may be killed or seriously injured. Special care should be taken especially when you have a small child in the vehicle.



©Do not allow a child to kneel on the passenger seat facing the passenger's side door. The side airbag and curtain shield airbag inflate with considerable speed and force; the child may be killed or seriously injured.

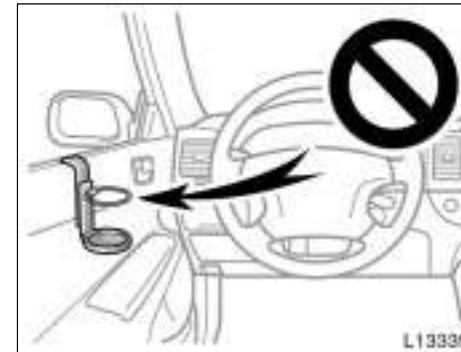

©Do not attach a cup holder or any other device or object on or around the door. When the side airbag inflates, the cup holder or any other device or object will be hurled with great force or the side airbag may not activate correctly, resulting in death or serious injury. Likewise, the driver and front passenger should not hold things in their arms or on their knees.



©Do not attach a microphone or any other device or object around the part where the curtain shield airbag activates such as on the windshield glass, side door glass, front and rear pillars, roof side and assist grips. When the curtain shield airbag inflates, the microphone or other device or object will be hurled with great force or the curtain shield airbag may not activate correctly, resulting in death or serious injury.

©Do not hook a hanger, heavy or sharp pointed objects on the coat hook. If the curtain shield airbag inflates, those items will be hurled away with great force or the curtain shield airbag may not activate correctly. When you hang clothes, hang them on the coat hook directly.

©Do not use seat accessories which cover the parts where the side airbags inflate. Such accessories may prevent the side airbags from activating correctly, causing death or serious injury.

©Do not modify or replace the seats or upholstery of front seats with side airbags. Such changes may disable the system or cause the side airbags to inflate accidentally, resulting in death or serious injury.

©Do not disassemble or repair the front pillar, rear pillar and roof side rail containing the curtain shield airbags. Such changes may disable the system or cause the curtain shield airbags to inflate accidentally, resulting in death or serious injury.

Failure to follow these instructions can result in death or serious injury.

NOTICE

Do not perform any of the following changes without consulting your Toyota dealer. Such changes can interfere with proper operation of the SRS side airbag and curtain shield airbag system in some cases.

◀*Installation of electronic devices such as a mobile two-way radio, cassette tape player or compact disc player*

◀*Modification of the suspension system*

- ◀ *Modification of the side structure of the passenger compartment*
- ◀ *Repairs made on or near the console*

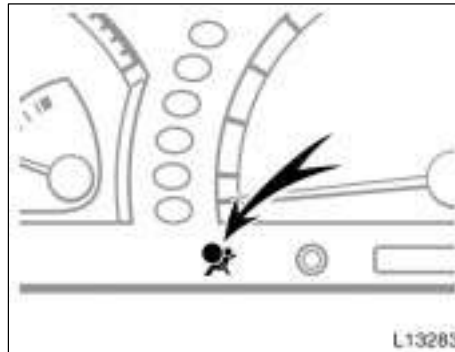

This SRS side airbag and curtain shield airbag system has a service reminder indicator to inform the driver of operating problems. If either of the following conditions occurs, this indicates a malfunction of the airbags. Contact your Toyota dealer as soon as possible to service the vehicle.

- © The light does not come on when the ignition key is turned to the "ON" position, or the light remains on.
- © The light comes on or flashes while driving.

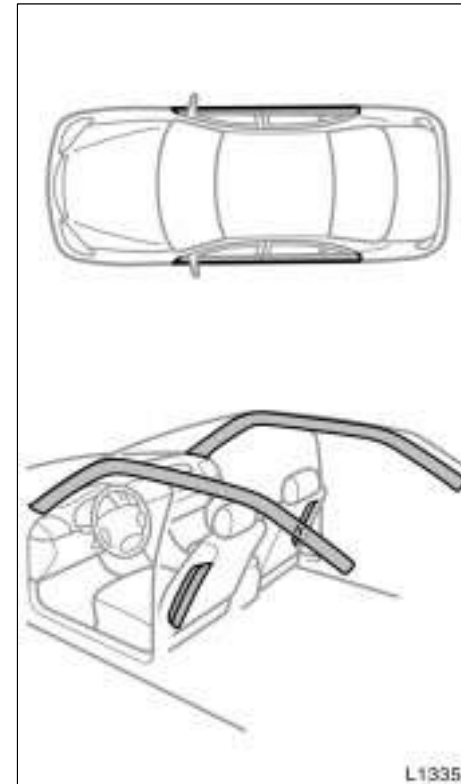

In the following cases, contact your Toyota dealer as soon as possible:

- © The SRS side airbags and curtain shield airbags have been inflated.
- © The portion of the doors (shaded in the illustration) was involved in an accident that was not severe enough to cause the SRS side airbags and curtain shield airbags to inflate.
- © The surface of the seats with the side airbag (shaded in the illustration) is scratched, cracked, or otherwise damaged.
- © The portion of the front pillars, rear pillars and roof side rail garnishes (padding) containing the curtain shield airbags inside (shaded in the illustration) is scratched, cracked, or otherwise damaged.

NOTICE

Do not disconnect the battery cables before contacting your Toyota dealer.

**Child restraint—
—Child restraint precautions**

Toyota strongly urges the use of child restraint systems for children small enough to use them.

The laws of all fifty states in the U.S.A. and Canada now require the use of a child restraint system.

Your vehicle conforms to SAEJ1819.

If a child is too large for a child restraint system, the child should sit in the rear seat and must be restrained using the vehicle's seat belt. See "Seat belts" on page 41 for details.

! CAUTION

© For effective protection in automobile accidents and sudden stops, a child must be properly restrained, using a seat belt or child restraint system depending on the age and size of the child. Holding a child in your arms is not a substitute for a child restraint system. In an accident, the child can be crushed against the windshield, or between you and the vehicle's interior.

© Toyota strongly urges use of a proper child restraint system which conforms to the size of the child, installed on the rear seat. According to accident statistics, the child is safer when properly restrained in the rear seat than in the front seat.

© Never install a rear-facing child restraint system on the front seat. In the event of an accident, the force of the rapid inflation of the airbag can cause death or serious injury if a rear-facing child restraint system is installed on the front seat.

© Unless it is unavoidable, do not install a child restraint system on the front seat.

—Child restraint system

©A forward-facing child restraint system should be allowed to be installed on the front passenger seat only when it is unavoidable. Always move the seat as far back as possible, because the force of the deploying front passenger airbag could cause death or serious injury to the child.

©On vehicles with side airbags and curtain shield airbags, do not allow the child to lean against the door or around the door even if the child is seated in the child restraint system. It is dangerous if the side airbag and curtain shield airbag inflate, and the impact could cause death or serious injury to the child.

©Make sure that you have complied with all installation instructions provided by the child restraint manufacturer and that the system is properly secured.

A child restraint system for a small child or baby must itself be properly restrained on the seat with the lap portion of the lap/shoulder belt. You must carefully consult the manufacturer's instructions which accompany the child restraint system.

To provide proper restraint, use a child restraint system following the manufacturer's instructions about the appropriate age and size of the child for the child restraint system.

Install the child restraint system correctly following the instructions provided by its manufacturer. General directions are also provided under the following illustrations.

The child restraint system should be installed on the rear seat. According to accident statistics, the child is safer when properly restrained in the rear seat than in the front seat.

CAUTION

©Never install a rear-facing child restraint system on the front seat. In the event of an accident, the force of the rapid inflation of the airbag can cause death or serious injury if a rear-facing child restraint system is installed on the front seat.

©Unless it is unavoidable, do not install a child restraint system on the front seat.

©A forward-facing child restraint system should be allowed to be installed on the front passenger seat only when it is unavoidable. Always move the seat as far back as possible, because the force of the deploying front passenger airbag could cause death or serious injury to the child.

©On vehicles with side airbags and curtain shield airbags, do not allow the child to lean against the door or around the door even if the child is seated in the child restraint system. It is dangerous if the side airbag and curtain shield airbag inflate, and the impact could cause death or serious injury to the child.

©After installing the child restraint system, make sure it is secured in place following the manufacturer's instructions. If it is not restrained securely, it may cause death or serious injury to the child in the event of a sudden stop or accident.

When not using the child restraint system, keep it secured with the seat belt or place it in the trunk or somewhere other than the passenger compartment. This will prevent it from injuring passengers in the event of a sudden stop or accident.

—Types of child restraint system

Child restraint systems are classified into the following 3 types depending on the child's age and size.

- (A) Infant seat
- (B) Convertible seat
- (C) Booster seat

Install the child restraint system following the instructions provided by its manufacturer.

Your vehicle has anchor brackets for securing the top strap of a child restraint system.

For instructions about how to use the anchor bracket, see “—Using a top strap” on page 77 in this section.

The child restraint lower anchorages approved for your vehicle may also be used. See “—Installation with child restraint lower anchorages” on page 79 in this section.



(A) Infant seat



(B) Convertible seat

—Installation with seat belt



(C) Booster seat



(A) INFANT SEAT INSTALLATION

An infant seat is used in rear-facing position only.



 CAUTION

©Never install a rear-facing child restraint system on the front passenger seat because the force of the rapid inflation of the front passenger airbag can cause death or serious injury to the child.



©Do not install a rear-facing child restraint system on the rear seat if it interferes with the lock mechanism of the front seats. This can cause death or serious injury to the child and front passenger in case of sudden braking or a collision.

©If the driver's seat position does not allow sufficient space for safe installation, install the child restraint system at another position.



1. Run the lap and shoulder belt through or around the infant seat following the instructions provided by its manufacturer and insert the tab into the buckle taking care not to twist the belt. Keep the lap portion of the belt tight.

CAUTION

©After inserting the tab, make sure the tab and buckle are locked and that the lap and shoulder portions of the belt are not twisted.

©Do not insert coins, clips, etc. in the buckle as this may prevent you from properly latching the tab and buckle.

©If the seat belt does not function normally, it cannot protect your child from injury. Contact your Toyota dealer immediately. Do not use the child restraint system until the seat belt is fixed.

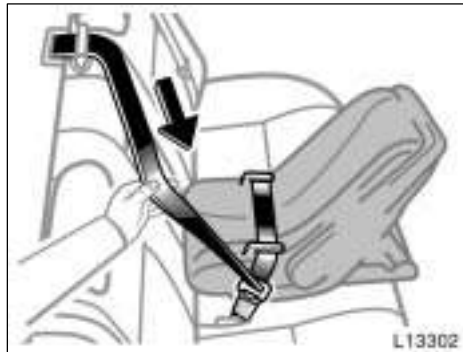

2. Fully extend the shoulder belt to put it in the lock mode. When the belt is then retracted even slightly, it cannot be extended.

To hold the infant seat securely, make sure the belt is in the lock mode before letting the belt retract.

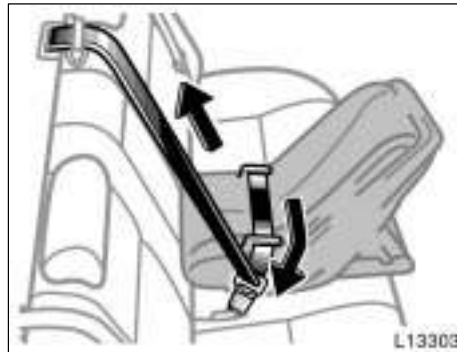

3. While pressing the infant seat firmly against the seat cushion and seatback, let the shoulder belt retract as far as it will go to hold the infant seat securely.



CAUTION

Push and pull the child restraint system in different directions to be sure it is secure. Follow all the installation instructions provided by its manufacturer.

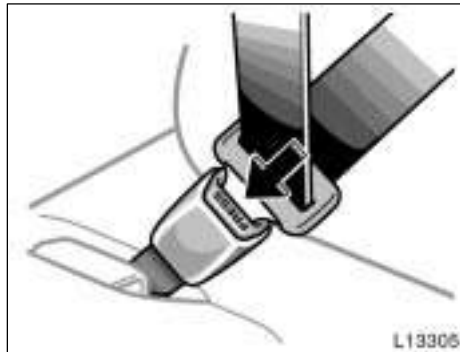

4. To remove the infant seat, press the buckle-release button and allow the belt to retract completely. The belt will move freely again and be ready to work for an adult or older child passenger.

(B) CONVERTIBLE SEAT INSTALLATION
A convertible seat is used in forward-facing or rear-facing position depending on the child's age and size. When installing, follow the manufacturer's instructions about the applicable child's age and size as well as directions for installing the child restraint system.

⚠ CAUTION

©Never install a rear-facing child restraint system on the front passenger seat because the force of the rapid inflation of the front passenger airbag can cause death or serious injury to the child.



©A forward-facing child restraint system should be allowed to be installed on the front passenger seat only when it is unavoidable. Always move the seat as far back as possible, because the force of the deploying front passenger airbag could cause death or serious injury to the child.

©On vehicles with side airbags and curtain shield airbags, do not allow the child to lean against the door or around the door even if the child is seated in the child restraint system. It is dangerous if the side airbag and curtain shield airbag inflate, and the impact could cause death or serious injury to the child.



©Do not install a rear-facing child restraint system on the rear seat if it interferes with the lock mechanism of the front seats. This can cause death or serious injury to the child and front passenger in case of sudden braking or a collision.

©If the driver's seat position does not allow sufficient space for safe installation, install the child restraint system at another position.



1. Run the lap and shoulder belt through or around the convertible seat following the instructions provided by its manufacturer and insert the tab into the buckle taking care not to twist the belt. Keep the lap portion of the belt tight.

CAUTION

- ©After inserting the tab, make sure the tab and buckle are locked and that the lap and shoulder portions of the belt are not twisted.
- ©Do not insert coins, clips, etc. in the buckle as this may prevent you from properly latching the tab and buckle.
- ©If the seat belt does not function normally, it cannot protect your child from injury. Contact your Toyota dealer immediately. Do not use the child restraint system until the seat belt is fixed.



2. Fully extend the shoulder belt to put it in the lock mode. When the belt is then retracted even slightly, it cannot be extended.

To hold the convertible seat securely, make sure the belt is in the lock mode before letting the belt retract.



3. While pressing the convertible seat firmly against the seat cushion and seatback, let the shoulder belt retract as far as it will go to hold the convertible seat securely.



⚠ CAUTION
Push and pull the child restraint system in different directions to be sure it is secure. Follow all the installation instructions provided by its manufacturer.

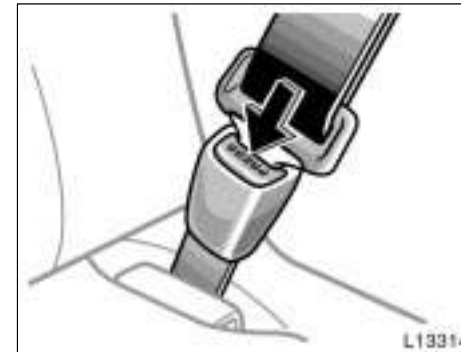

4. To remove the convertible seat, press the buckle-release button and allow the belt to retract completely. The belt will move freely again and be ready to work for an adult or older child passenger.

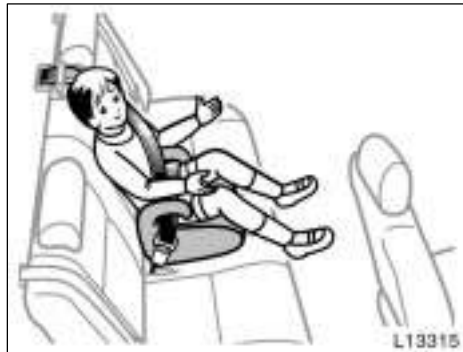

(C) BOOSTER SEAT INSTALLATION

A booster seat is used in forward-facing position only.



©On vehicles with side airbags and curtain shield airbags, do not allow the child to lean against the door or around the door even if the child is seated in the child restraint system. It is dangerous if the side airbag and curtain shield airbag inflate, and the impact could cause death or serious injury to the child.

⚠ CAUTION

©A forward-facing child restraint system should be allowed to be install on the front seat only when it is unavoidable. Always move the seat as far back as possible, because the force of the deploying airbag could cause death or serious injury to the child.



1. Sit the child on a booster seat. Run the lap and shoulder belt through or around the booster seat and child following the instructions provided by its manufacturer and insert the tab into the buckle taking care not to twist the belt.

Make sure the shoulder belt is correctly across the child's shoulder and that the lap belt is positioned as low as possible on child's hips. See "Seat belts" on page 41 for details.

⚠ CAUTION

- Ⓢ Always make sure the shoulder belt is positioned across the center of child's shoulder. The belt should be kept away from child's neck, but not falling off child's shoulder. Failure to do so could reduce the amount of protection in an accident and cause serious injuries in a collision.
- Ⓢ Both high-positioned lap belts and loose-fitting belts could cause serious injuries due to sliding under the lap belt during a collision or other unintended result. Keep the lap belt positioned as low on a child's hips as possible.
- Ⓢ For child's safety, do not place the shoulder belt under child's arm.
- Ⓢ After inserting the tab, make sure the tab and buckle are locked and that the lap and shoulder portions of the belt are not twisted.
- Ⓢ Do not insert coins, clips, etc. in the buckle as this may prevent your child from properly latching the tab and buckle.

Ⓢ If the seat belt does not function normally, it cannot protect your child from injury. Contact your Toyota dealer immediately. Do not use the child restraint system until the seat belt is fixed.

—Using a top strap



2. To remove the child restraint system, press the buckle-release button and allow the belt to retract.

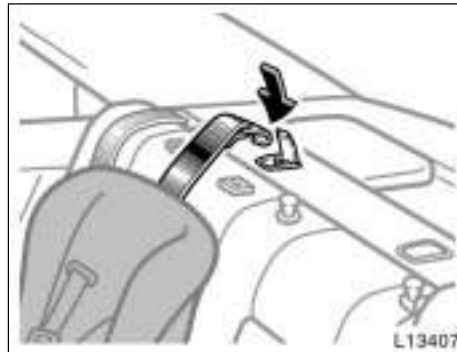

Follow the procedure below for a child restraint system that requires the use of a top strap.

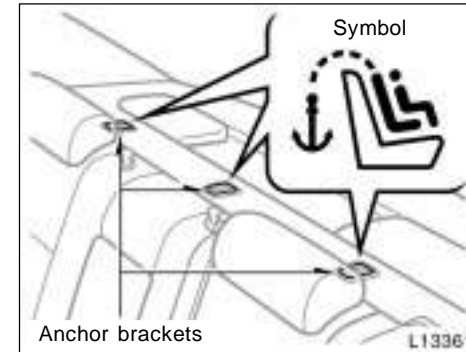

Use the anchor bracket on the package tray behind the rear seat to attach the top strap.

Anchor brackets are installed for each rear seating position.

This symbol indicates the location of the anchor brackets.

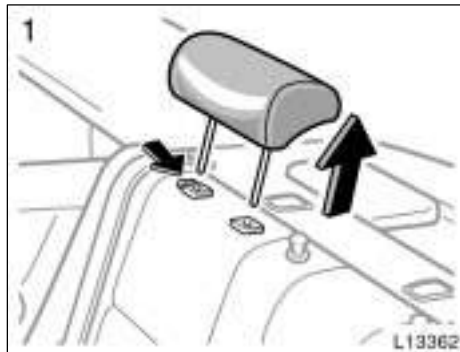

TO USE THE ANCHOR BRACKET:
1. Outside anchor brackets only—
Remove the head restraint.

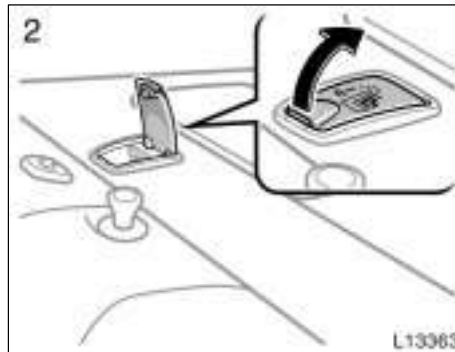

2. Open the lid of the anchor bracket
to open.



3. Securely fasten the child restraint
system with the seat belt.

Latch the hook onto the anchor
bracket and tighten the top strap.

For instructions to install the child re-
straint system, see "Child restraint" on
page 65 in this section.

⚠ CAUTION

Make sure the top strap is securely
latched, and check that the child re-
straint system is secure by pushing
and pulling it in different directions.
Follow all the installation instructions
provided by its manufacturer.

—Installation with child restraint lower anchorages



4. Outside anchor brackets only—
Replace the head restraint.

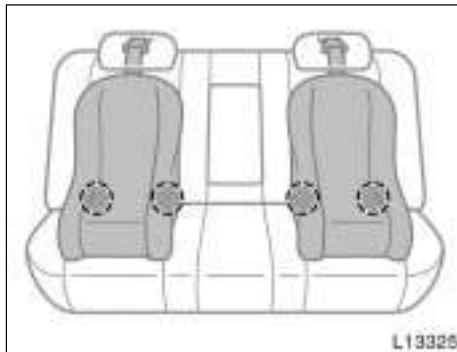

The lower anchorages for the child restraint system interfaced with the FMVSS225 specification are installed in the rear seat.

The anchorages are installed in the clearance between the seat cushion and seat-back of both outside rear seats.

Child restraint system interfaced with the FMVSS225 specification can be fixed with these anchorages. In this case, it is not necessary to fix the child restraint system with a seat belt on the vehicle.

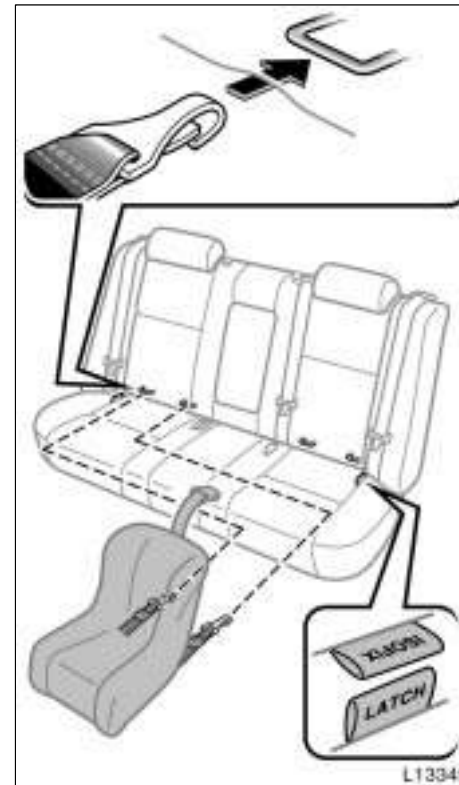

Type A

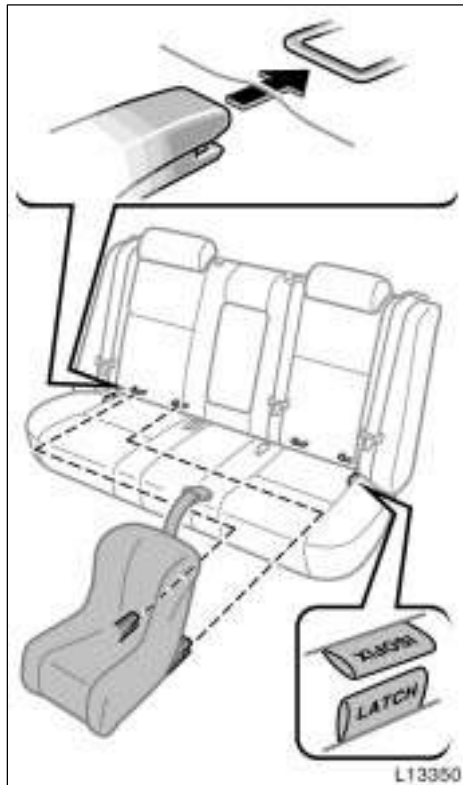

Type B

CHILD RESTRAINT SYSTEM INSTALLATION

Type A—

1. Widen the clearance between the seat cushion and seatback a little and confirm the position of the lower anchorages around the tag on the seat cushion.
2. Latch the hooks of lower straps onto the anchorages and tighten the lower straps.

Type B—

1. Widen the clearance between the seat cushion and seatback a little and confirm the position of the lower anchorages around the tag on the seat cushion.
2. Latch the buckles onto the anchorages.

If your child restraint system has a top strap, it should be anchored. (For the installation of the top strap, see “—Using a top strap” on page 77 in this section.)

For the installation details, refer to the instruction manual equipped with each product.

⚠ CAUTION

- Ⓢ When using the lower anchorages for the child restraint system, be sure that there are no irregular objects around the anchorages or that the seat belt is not caught.
- Ⓢ Push and pull the child restraint system in different directions to be sure it is secure. Follow all the installation instructions provided by its manufacturer.
- Ⓢ Do not install a child restraint system on the rear seat if it interferes with the lock mechanism of the front seats. This can cause death or serious injury to the child and front passenger in case of sudden braking or a collision.

Tilt steering wheel

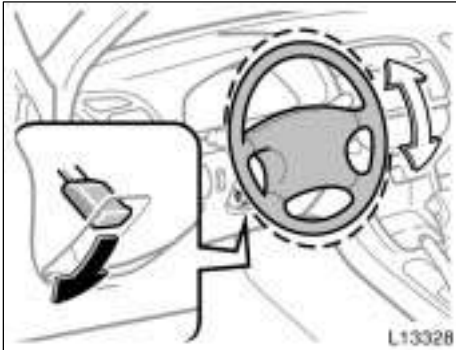

To change the steering wheel angle, hold the steering wheel, push down the lock release lever, tilt the steering wheel to the desired angle and return the lever to its original position.

⚠ CAUTION

- ©Do not adjust the steering wheel while the vehicle is moving. It may cause the driver to mishandle the vehicle and an accident may occur resulting in death or serious injuries.
- ©After adjusting the steering wheel, try moving it up and down to make sure it is locked in position.

Outside rear view mirrors—



Adjust the mirror so that you can just see the side of your vehicle in the mirror.

Be careful when judging the size or distance of any object seen in the outside rear view mirror on the passenger's side. It is a convex mirror with a curved surface. Any object seen in a convex mirror will look smaller and farther away than when seen in a flat mirror.

On some models, when you push the rear window defogger switch, the heater panels in the outside rear view mirrors will quickly clear the mirror surface. (See "Rear window and outside rear view mirror defoggers" on page 94 in Section 1-4.)

⚠ CAUTION

©Do not adjust the mirror while the vehicle is moving. It may cause the driver to mishandle the vehicle and an accident may occur resulting in death or serious injuries.

©Since the mirror surfaces can get hot, keep your hands off them when the defogger switch is on.

NOTICE

The outside rear view mirrors are fixed in place. Do not try to fold the mirrors. It may damage the mirrors.

—Power rear view mirror control

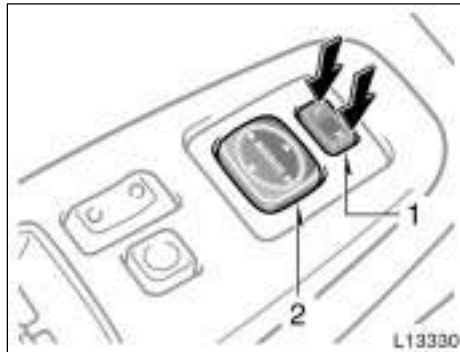

To adjust a mirror, use the switches.

1. Master switch—To select the mirror to be adjusted
Push the “L” (left) or “R” (right) side of the switch.
2. Control switch—To move the mirror
Push the switch in the desired direction.

Mirrors can be adjusted when the key is in the “ACC” or “ON” position.

NOTICE

If ice should jam the mirror, do not operate the control or scrape the mirror face. Use a spray de-icer to free the mirror.

Anti-glare inside rear view mirror

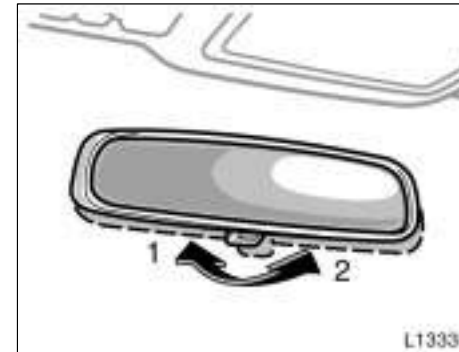

Adjust the mirror so that you can just see the rear of your vehicle in the mirror.

To reduce glare from the headlights of the vehicle behind you during night driving, operate the lever on the lower edge of the mirror.

Daylight driving—Lever at position 1

The reflection in the mirror has greater clarity at this position.

Night driving—Lever at position 2

Remember that by reducing glare you also lose some rear view clarity.

Auto anti-glare inside rear view mirror

CAUTION

Do not adjust the mirror while the vehicle is moving. It may cause the driver to mishandle the vehicle and an accident may occur resulting in death or serious injuries.

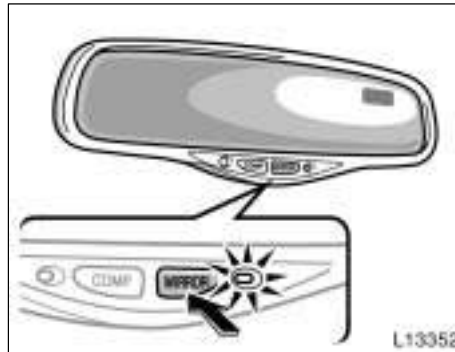

Adjust the mirror so that you can just see the rear of your vehicle in the mirror.

This mirror is equipped with auto anti-glare function. The function is designed to reduce glare from the headlights of the vehicle behind you during night driving.

When the ignition key is inserted and turned on, the inside rear view mirror always turns on in the automatic function mode.

The indicator illuminates to show you that the function is on.

In automatic function mode, if the mirror detects light from the headlights of the vehicle behind you, the mirror surface darkens slightly to reduce the reflected light.

To turn off the automatic function, push the "MIRROR" switch.

To turn on the automatic function again, push the "MIRROR" switch.

Adjust it before driving so that the rear view is in the best condition.

When the inside air temperature is low, it may take little longer for the mirror to darken in response to the detection of headlights.

CAUTION

Do not adjust the mirror while the vehicle is moving. It may cause the driver to mishandle the vehicle and an accident may occur resulting in death or serious injuries.

Vanity mirrors

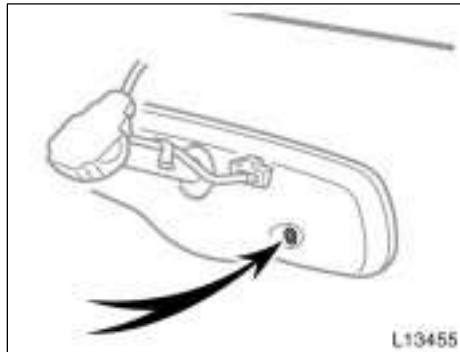

An anti-glare mirror sensor is located on the back side of the mirror. In order not to disturb correct functioning of the mirror, do not touch or cover the sensor with your finger or a piece of cloth, etc.

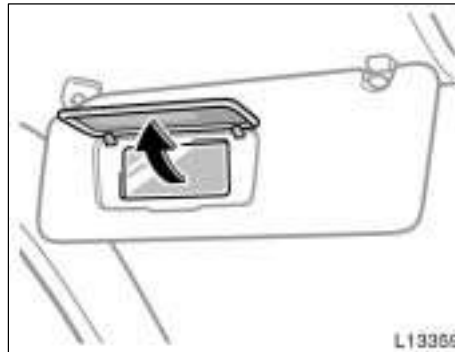

Type A

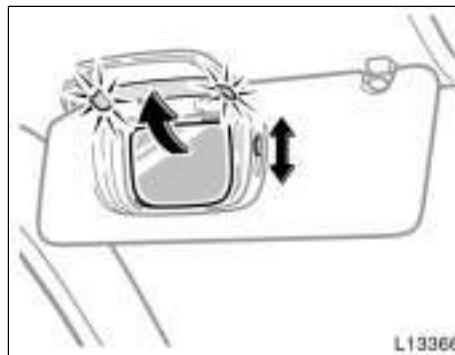

Type B

To use the vanity mirror, swing down the sun visor and open the cover.

Vanity lights (type B only)—

The lights come on when you open the cover.

To adjust the brightness of the lights, slide the switch.

SECTION 1-4

OPERATION OF INSTRUMENTS AND CONTROLS

Lights, Wipers and Defogger

Headlights and turn signals	87
Emergency flashers	90
Instrument panel light control	91
Front fog lights	91
Interior light	92
Ignition switch light	92
Personal lights	93
Windshield wipers and washer	93
Rear window and outside rear view mirror defoggers	94

Headlights and turn signals (without automatic light control system)

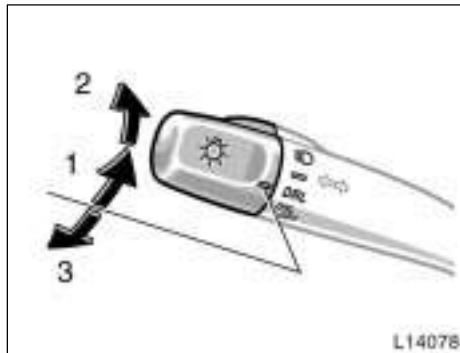

HEADLIGHTS

To turn on the following lights: Twist the headlight/turn signal lever knob.

Position 1—Parking, tail, license plate, side marker and instrument panel lights

Position 2—Headlights and all of the above

Automatic light cut off system

Position 1—

The lights automatically turn off when the driver's door is opened with the ignition key in the "ACC" or "LOCK" position.

Position 2—

The lights automatically turn off after 30 seconds in the following conditions:

- © When the ignition key is turned to the "ACC" or "LOCK" position with all the doors and trunk lid closed
- © When any of the door or trunk lid is opened and closed with the ignition key in the "ACC" or "LOCK" position

The lights can be turned off immediately by pushing the "LOCK" switch on the wireless remote control transmitter with all the doors locked and the trunk lid closed.

If any of the door or trunk lid is kept opened, the lights automatically turn off after 20 minutes.

To turn on the lights again, turn the ignition key to the "ON" position or actuate the headlight switch. If you are going to park for over one week, make sure the headlight switch is off.

NOTICE

To prevent the battery from being discharged, do not leave the lights on for a long period when the engine is not running.

Daytime running light (DRL) system

Daytime Running Light (DRL) system can make it easier for others to see the front of your vehicle during the day. The DRL system can be helpful in many different driving conditions, but they can be especially helpful in the short periods after dawn and before sunset.

The DRL system will make your headlights come on at a reduced brightness when:

- © The light switch is in "DRL" position.
- © The ignition is on with the engine running.
- © The headlight switch is off.
- © The parking brake is released.

To turn on the other exterior lights and instrument panel lights, twist the knob to the position 1.

Twist the knob to the position 2 to turn the headlights to full intensity for night driving.

To turn off the DRL system, twist the knob to the position 3 ("DRL OFF") or turn the ignition switch off.

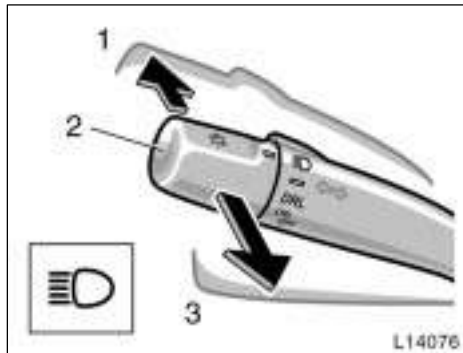

High-Low beams—For high beams, turn the headlights on and push the lever away from you (position 1). Pull the lever toward you (position 2) for low beams.

The headlight high beam indicator light (blue light) on the instrument panel will tell you that the high beams are on.

Flashing the high beam headlights (position 3)—Pull the lever all the way back. The high beam headlights turn off when you release the lever.

You can flash the high beam headlights with the knob turned to “DRL” or “DRL OFF”.

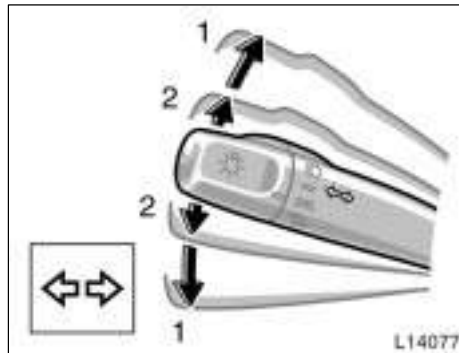

TURN SIGNALS

To signal a turn, push the headlight/turn signal lever up or down to position 1.

The key must be in the “ON” position.

The lever automatically returns after you make a turn, but you may have to return it by hand after you change lanes.

To signal a lane change, move the lever up or down to the pressure point (position 2) and hold it.

If the turn signal indicator lights (green lights) on the instrument panel flash faster than normal, a front or rear turn signal bulb is burned out. See “Replacing light bulbs” on page 266 in Section 7-3.

Headlights and turn signals (with automatic light control system)

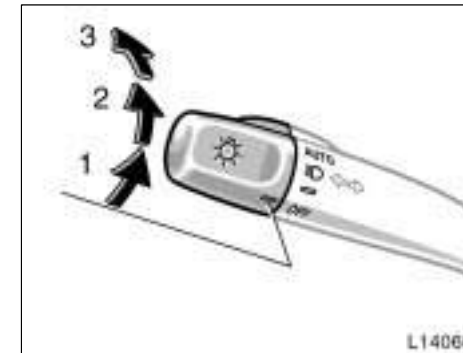

HEADLIGHTS

To turn on the following lights: Twist the headlight/turn signal lever knob.

Position 1—Parking, tail, license plate, side marker and instrument panel lights

Position 2—Headlights and all of the above

Position 3 (“AUTO”)—Headlights and/or all of the lights in position 1

They automatically turn on or off depending on the darkness of the surroundings.

Manually twist the knob to the position 2 to turn on the headlights if they are needed immediately when entering a dark tunnel, parking structure, etc.

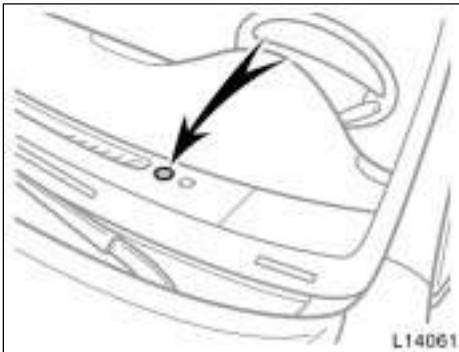

The automatic light control sensor is on the top of the driver's side instrument panel.

Do not place anything on the instrument panel, and/or do not affix anything on the windshield to block this sensor.

If you feel that the automatic light control comes into operation too early or too late, have the sensor adjusted by your Toyota dealer.

Automatic light cut off system

Position 1 or position 3 with the tail lights on—

The lights automatically turn off when the driver's door is opened with the ignition key in the "ACC" or "LOCK" position.

Position 2 or position 3 with the headlights on—

The lights automatically turn off after 30 seconds in the following conditions:

- © When the ignition key is turned to the "ACC" or "LOCK" position with all the doors and trunk lid closed
- © When any of the door or trunk lid is opened and closed with the ignition key in the "ACC" or "LOCK" position

When the doors are locked by wireless remote control transmitter, the lights automatically turn off immediately.

If any of the door or trunk lid is kept opened, the lights automatically turn off after 20 minutes.

To turn on the lights again, turn the ignition key to the "ON" position or actuate the headlight switch. If you are going to park for over one week, make sure the headlight switch is off.

NOTICE

To prevent the battery from being discharged, do not leave the lights on for a long period when the engine is not running.

Daytime running light (DRL) system

Daytime Running Light (DRL) system can make it easier for others to see the front of your vehicle during the day. The DRL system can be helpful in many different driving conditions, but they can be especially helpful in the short periods after dawn and before sunset.

The DRL system will make your headlights come on at a reduced brightness when:

- © The ignition is on with the engine running.
- © The headlight switch is off.
- © The parking brake is released.

To turn on the other exterior lights and instrument panel lights, twist the knob to the position 1.

Twist the knob to the position 2 to turn the headlights to full intensity for night driving.

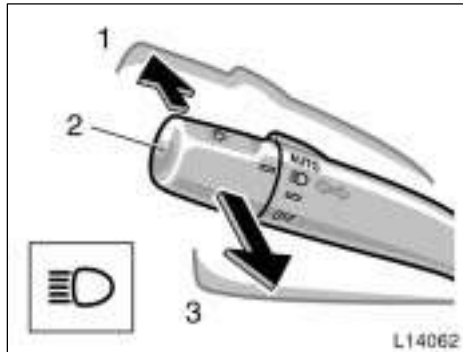

High-Low beams—For high beams, turn the headlights on and push the lever away from you (position 1). Pull the lever toward you (position 2) for low beams.

The headlight high beam indicator light (blue light) on the instrument panel will tell you that the high beams are on.

Flashing the high beam headlights (position 3)—Pull the lever all the way back. The high beam headlights turn off when you release the lever.

You can flash the high beam headlights with the knob turned to “OFF”.

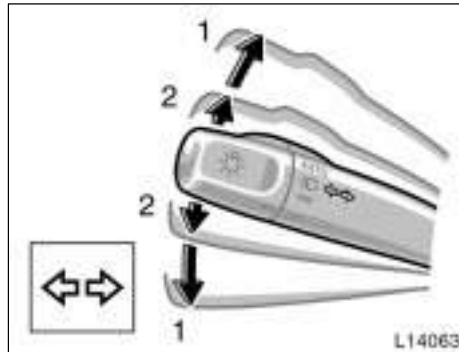

TURN SIGNALS

To signal a turn, push the headlight/turn signal lever up or down to position 1.

The key must be in the “ON” position.

The lever automatically returns after you make a turn, but you may have to return it by hand after you change lanes.

To signal a lane change, move the lever up or down to the pressure point (position 2) and hold it.

If the turn signal indicator lights (green lights) on the instrument panel flash faster than normal, a front or rear turn signal bulb is burned out. See “Replacing light bulbs” on page 266 in Section 7-3.

Emergency flashers

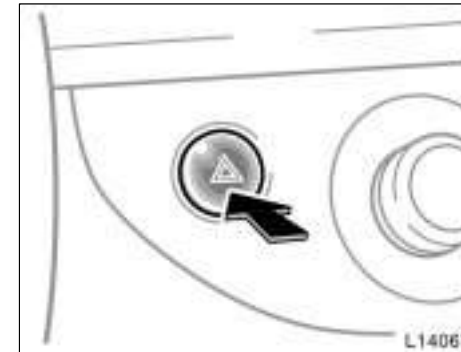

To turn on the emergency flashers, push the switch.

All the turn signal lights will flash. To turn them off, push the switch once again.

Turn on the emergency flashers to warn other drivers if your vehicle must be stopped where it might be a traffic hazard. Always pull as far off the road as possible.

The turn signal light switch will not work when the emergency flashers are operating.

NOTICE

To prevent the battery from being discharged, do not leave the switch on longer than necessary when the engine is not running.

Instrument panel light control

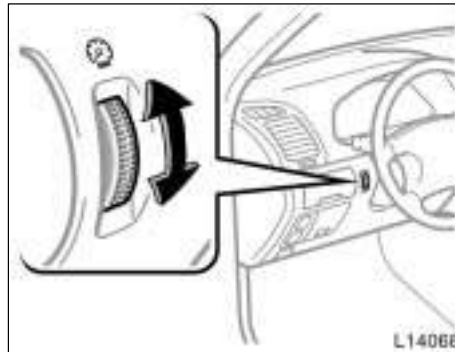

To adjust the brightness of the instrument panel lights, turn the dial.

Front fog lights



To turn on the front fog lights, twist the band of the headlight and turn signal switch lever. They will come on only when the headlights are on low beam.

Interior light

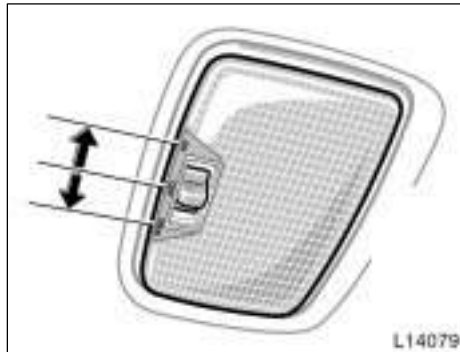

To turn on the interior light, slide the switch.

The interior light switch has the following positions:

“ON”—Keeps the light on all the time.

“OFF”—Turns the light off.

“DOOR”—Turns the light on when any of the doors is opened. The light goes off when all the doors are closed.

ILLUMINATED ENTRY SYSTEM

With the switch in the “DOOR” position, the light comes on when any door is opened. After all the doors are closed, the light remains on for about 15 seconds and then goes out.

However, in the following cases, the light go off immediately.

- © All the doors are closed when the ignition key is in the “ACC” or “ON” position.
- © The ignition key is turned to the “ACC”, “ON”, or “START” after all the side doors are closed.
- © All the doors are closed and locked.

When all the doors are unlocked with the key or wireless remote control transmitter simultaneously, the ignition switch light comes on for about 15 seconds and then fade out, even if the door is not opened.

To prevent the battery being discharged, the lights will automatically turn off when the key is removed and the door is left opened with the switch at “DOOR” position for 20 minutes or more.

Ignition switch light

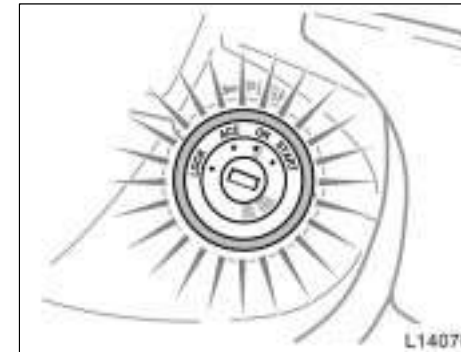

For easy access to the ignition switch, the ignition switch light comes on when any of the doors are opened.

The light remains on for about 15 seconds after all the doors are closed.

However, in the following cases, the light go off immediately.

- © All the doors are closed when the ignition key is in the “ACC” or “ON” position.
- © The ignition key is turned to the “ACC”, “ON”, or “START” after all the side doors are closed.
- © All the doors are closed and locked.

When all the doors are unlocked with the key or wireless remote control transmitter simultaneously, the ignition switch light comes on for about 15 seconds and then fade out, even if the door is not opened.

To prevent the battery being discharged, the light will automatically turn off when the key is removed and the door is left opened for 20 minutes or more.

Personal lights



To turn on the front personal lights, push the lens. To turn the lights off, push the lens once again.

Windshield wipers and washer

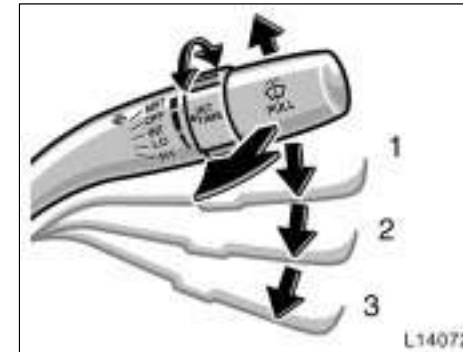

To turn on the windshield wipers, move the lever to the desired setting.

The key must be in the "ON" position.

Lever position	Speed setting
Position 1	Intermittent
Position 2	Slow
Position 3	Fast

For a single sweep of the windshield, push the lever up and release it.

With interval adjuster: The "INT TIME" band lets you adjust the wiping time interval when the wiper lever is in the intermittent position (position 1). Twist the band upward to increase the time between sweeps, and downward to decrease it.

To squirt washer fluid, pull the lever toward you.

If the windshield wipers are off, they will operate a couple of times after the washer squirts.

For instructions on adding washer fluid, see "Adding washer fluid" on page 266 in Section 7-3.

In freezing weather, warm the windshield with the defroster before using the washer. This will help prevent the washer fluid from freezing on your windshield, which can block your vision.

NOTICE

Do not operate the wipers if the windshield is dry. It may scratch the glass.

When waxing your vehicle, make sure that the washer nozzles do not become blocked. If a nozzle becomes blocked, contact your Toyota dealer to have the vehicle serviced.

NOTICE

If a nozzle becomes blocked, do not try to clear it with a pin or other object. The nozzle will be damaged.

Rear window and outside rear view mirror defoggers

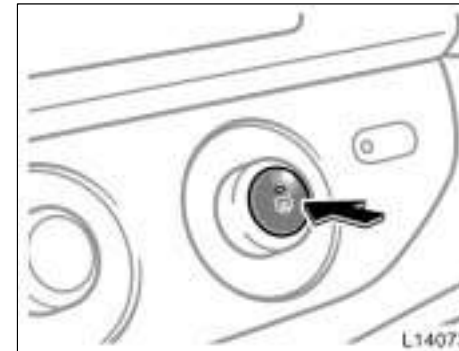

With manual air conditioning system

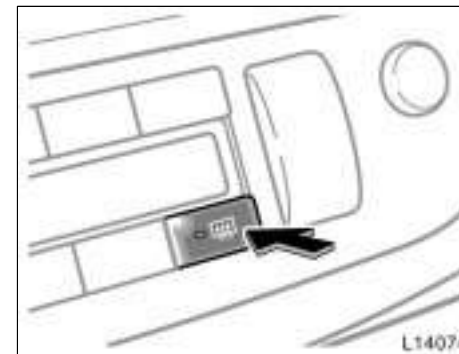

With automatic air conditioning system

To defog or defrost the rear window, push the switch.

The key must be in the "ON" position.

The thin heater wires on the inside of the rear window will quickly clear the surfaces. An indicator light will illuminate to indicate the defogger is operating.

On some models, heater panels in the outside rear view mirrors will also quickly clear the surfaces.

Push the switch once again to turn the defogger off.

The system will automatically shut off after the defogger has operated about 15 minutes.

 CAUTION
Since the mirror surfaces can get hot keep your hands off them when the defogger switch is on.

Make sure you turn the defoggers off when the surfaces are clear. Leaving the defoggers on for a long time could cause the battery to discharge, especially during stop-and-go driving. The defoggers are not designed for drying rain water or for melting snow.

If the outside rear view mirrors are heavily coated with ice, use a spray de-icer before operating the switch.

NOTICE
<i>When cleaning the inside of the rear window, be careful not to scratch or damage the heater wires or connectors.</i>

SECTION 1-5

OPERATION OF INSTRUMENTS AND CONTROLS

Gauges, Meters and Service reminder indicators

Fuel gauge	97
Engine coolant temperature gauge	97
Tachometer	98
Odometer and two trip meters	98
Service reminder indicators and warning buzzers	99

Fuel gauge

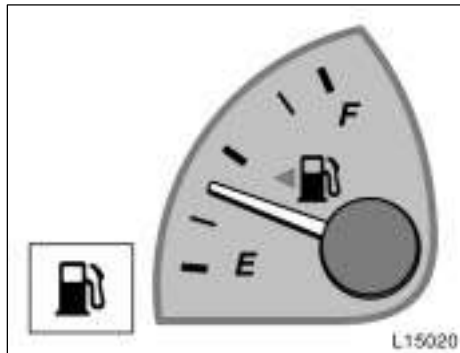

The gauge indicates the approximate quantity of the fuel remaining in the tank when the ignition switch is on.

Nearly full—Needle at “F”
Nearly empty—Needle at “E”

It is a good idea to keep the tank over 1/4 full.

The gauge remains on for about 10 minutes after the ignition switch is off.

If the fuel level approaches “E” or the low fuel level warning light comes on, fill the fuel tank as soon as possible.

On inclines or curves, due to the movement of fuel in the tank, the fuel gauge needle may fluctuate or the low fuel level warning light may come on earlier than usual.

If the fuel tank is completely empty, the malfunction indicator lamp comes on. Fill the fuel tank immediately.

The indicator lamp goes off after driving several times. If the indicator lamp does not go off, contact your Toyota dealer as soon as possible.

Engine coolant temperature gauge

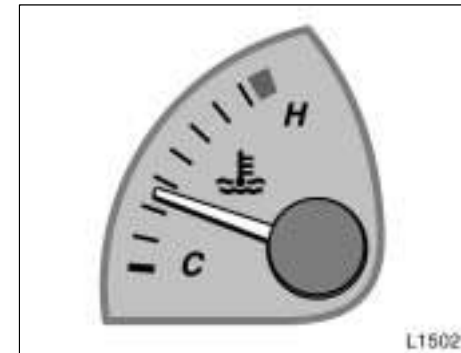

The gauge indicates the engine coolant temperature when the ignition switch is on. The engine operating temperature will vary with changes in weather and engine load.

If the needle moves into the red zone, your engine is too hot. If your vehicle overheats, stop your vehicle and allow the engine to cool.

Your vehicle may overheat during severe operating conditions, such as:

- © Driving up a long hill on a hot day.
- © Reducing speed or stopping after high speed driving.

- © Idling for a long period with the air conditioning on in stop-and-go traffic.
- © Towing a trailer.

NOTICE

◀ **Do not remove the thermostat in the engine cooling system as this may cause the engine to overheat. The thermostat is designed to control the flow of coolant to keep the temperature of the engine within the specified operating range.**

◀ **Do not continue driving with an overheated engine. See "If your vehicle overheats" on page 215 in Section 4.**

Tachometer

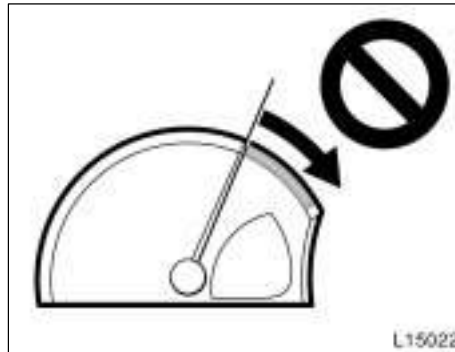

The tachometer indicates engine speed in thousands of rpm (revolutions per minute). Use it while driving to select correct shift points and to prevent engine lugging and over-revving.

Driving with the engine running too fast causes excessive engine wear and poor fuel economy. Remember, in most cases the slower the engine speed, the greater the fuel economy.

NOTICE

Do not let the indicator needle get into the red zone. This may cause severe engine damage.

Odometer and two trip meters

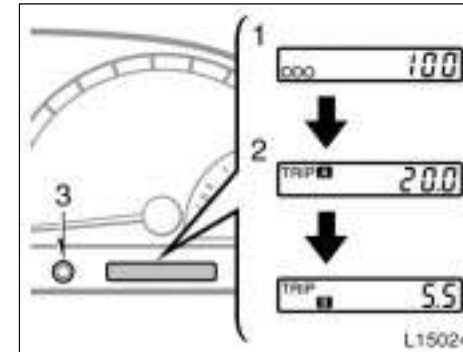

This meter displays the odometer and two trip meters when the ignition switch is on.

1. Odometer—Shows the total distance the vehicle has been driven.
2. Two trip meters—Show two different distances independently driven since the last time each trip meter was set to zero.

You can use one trip meter to calculate the fuel economy and the other to measure the distance on each trip. All trip meter data is cancelled if the electrical power source is disconnected.









3. Trip meter reset knob—Resets the two trip meters to zero, and also change the meter display.



To change the meter display, quickly push and release the knob. The meter display changes in the order from the odometer to trip meter A to trip meter B, then back to the odometer each time you push.

To reset the trip meter A to zero, display the meter A reading, then push and hold the knob until the meter is set to zero. The same process can be applied for resetting the trip meter B.

This display remains on for about 10 minutes after the ignition switch is off.

Service reminder indicators and warning buzzers

	If the indicator or buzzer comes on...	Do this.
(a)	BRAKE or 	If parking brake is off, stop immediately and contact Toyota dealer.
(b)	 (indicator and buzzer)	Fasten driver's seat belt.
(c)	 PASSENGER	Fasten front passenger's seat belt.
(d)		Stop and check.
(e)	 CHECK	Take vehicle to Toyota dealer.
(f)		Stop and check.
(g)		Fill up tank.
(h)	ABS or 	Take vehicle to Toyota dealer. If brake system warning light is also on, stop immediately and contact Toyota dealer.
(i)		Close all doors.

If the indicator or buzzer comes on...	Do this.
(j) 	Take vehicle to Toyota dealer immediately.
(k) 	Add washer fluid.
(l) VSC	Take vehicle to Toyota dealer.
(m) Key reminder buzzer	Remove key.

(a) Brake System Warning Light

This light comes on in the following cases when the ignition key is in the "ON" position.

© **When the parking brake is applied...**

Vehicles with anti-lock brake system—
 This light comes on for a few seconds when the ignition key is turned to the "ON" position even after the parking brake is released.

© **When the brake fluid level is low...**

 **CAUTION**

It is dangerous to continue driving normally when the brake fluid level is low.

Have your vehicle checked at your Toyota dealer in the following cases:

© The light does not come on even if the parking brake is applied when the ignition key is in the "ON" position.

Vehicles with anti-lock brake system—

© The light does not come on even if the ignition key is turned on with the parking brake released.

A warning light turning on briefly during operation does not indicate a problem.

 **CAUTION**

If either of the following conditions occurs, immediately stop your vehicle at a safe place and contact your Toyota dealer.

© **The light does not turn off even after the parking brake is released while the engine is running.**

In this case, the brakes may not work properly and your stopping distance will become longer. Depress the brake pedal firmly and bring the vehicle to an immediate stop.

Vehicles with anti-lock brake system—

© **The brake system warning light remains on together with the "ABS" warning light.**

In this case, not only the anti-lock brake system will fail but also the vehicle will become extremely unstable during braking.

(b) Driver's Seat Belt Reminder Light and Buzzer

This light and buzzer remind you to buckle up the driver's seat belt.

Once the ignition key is turned to "ON", the reminder light flashes and buzzer sounds if the driver's seat belt is not fastened. Unless the driver fastens the belt, the light keeps flashing and the buzzer stops after about 4 to 8 seconds.

(c) Front Passenger's Seat Belt Reminder Light

This light reminds you to buckle up the front passenger's seat belt.

Once the ignition key is turned to "ON", the reminder light flashes if a passenger sits in the front passenger seat and does not fastened. However, if a front passenger uses an additional seat cushion, the light may not flash even when the seat belt is not buckled up.

If luggage load is placed on the front outside passenger seat, depending on its weight and how it is placed on the seat, built-in sensors in the seat cushion may detect the pressure, causing the reminder light to come on.

(d) Discharge Warning Light

This light warns that the battery is being discharged.

If it comes on while you are driving, there is a problem somewhere in the charging system.

The engine ignition will continue to operate, however, until the battery is discharged. Turn off the air conditioning, blower, radio, etc., and drive directly to the nearest Toyota dealer or repair shop.

NOTICE

Do not continue driving if the engine drive belt is broken or loose.

(e) Malfunction Indicator Lamp

This lamp comes on when the ignition key is turned to the "ON" position and goes off after the engine starts. This means that the warning light system is operating properly.

If the lamp remains on, or the lamp comes on while driving, first check the followings.

© Empty fuel tank

If the fuel tank is empty, refuel immediately.

© Loose fuel tank cap

If the fuel tank cap is loose, securely tighten it.

These cases are temporary malfunctions. The malfunction indicator lamp will go off after taking several driving trips.

If the lamp will not go off even after the several trips, contact your Toyota dealer as soon as possible.

If the fuel tank is not empty or the fuel tank cap is not loose...

© There is a problem somewhere in the engine, emission control system, electronic throttle control system, automatic transmission electrical system or warning light system itself.

Contact your Toyota dealer as soon as possible to service the vehicle.

If the engine speed does not increase with the accelerator pedal depressed down, there may be a problem somewhere in your electronic throttle control system.

At this time, vibration may occur. However, if you depress the accelerator pedal more firmly and slowly, you can drive your vehicle at low speeds. Have your vehicle checked by your Toyota dealer as soon as possible.

Even if the abnormality of the electronic throttle control system is corrected during low speed driving, the system may not be recovered until the engine is stopped and the ignition key is turned to "ACC" or "LOCK" position.



Emissions inspection and maintenance (I/M) programs

Your vehicle may not pass a state emission inspection if the malfunction indicator lamp remains on. Contact your Toyota dealer to check your vehicle's emission control system and OBD (On-Board Diagnostics) system before taking your vehicle for the inspection.

For details, see "Emissions Inspection and Maintenance (I/M) programs" on page 241 in Section 6.

(f) Low Engine Oil Pressure Warning Light

This light warns that the engine oil pressure is too low.

If it flickers or stays on while you are driving, pull off the road to a safe place and stop the engine immediately. Call a Toyota dealer or qualified repair shop for assistance.

The light may occasionally flicker when the engine is idling or it may come on briefly after a hard stop. There is no cause for concern if it then goes out when the engine is accelerated slightly.

The light may come on when the oil level is extremely low. It is not designed to indicate low oil level, and the oil level must be checked using the level dipstick.

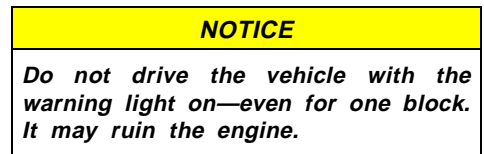

(g) Low Fuel Level Warning Light

This light comes on when the fuel level in the tank becomes nearly empty. Fill up the tank as soon as possible.

On inclines or curves, due to the movement of fuel in the tank, the low fuel level warning light may come on earlier than usual.

(h) "ABS" Warning Light

Vehicles without vehicle skid control system—

The light comes on with the ignition key turned to the "ON" position. If the anti-lock brake system works properly, the light turns off after a few seconds. Thereafter, if the system malfunctions, the light comes on again.

When the "ABS" warning light is on (and the brake system warning light is off), the anti-lock brake system does not operate, but the brake system still operates conventionally.

When the "ABS" warning light is on (and the brake system warning light is off), the anti-lock brake system does not operate so that the wheels could lock up during a sudden braking or braking on slippery road surfaces.

If either of the following conditions occurs, this indicates a malfunction somewhere in the parts monitored by the warning light. Contact your Toyota dealer as soon as possible to service the vehicle.

- © The light does not come on when the ignition key is turned to the "ON" position, or remains on.
- © The light comes on while you are driving.

A warning light turning on briefly during operation does not indicate a problem.



CAUTION

If the "ABS" warning light remains on together with the brake system warning light, immediately stop your vehicle at a safe place and contact your Toyota dealer.

In this case, not only the anti-lock brake system will fail but also the vehicle will become extremely unstable during braking.

Vehicles with vehicle skid control system—

The light comes on when the ignition key is turned to the "ON" position. If the anti-lock brake system and the brake assist system work properly, the light turns off after a few seconds. Thereafter, if either of the systems malfunctions, the light comes on again.

When the "ABS" warning light is on (and the brake system warning light is off), the anti-lock brake system, the brake assist system, traction control system and the vehicle skid control system do not operate, but the brake system still operates conventionally.

When the "ABS" warning light is on (and the brake system warning light is off), the anti-lock brake system does not operate so that the wheels could lock up during a sudden brake or braking on slippery road surfaces.

If either of the following conditions occurs, this indicates a malfunction somewhere in the parts monitored by the warning light. Contact your Toyota dealer as soon as possible to service the vehicle.

- © The light does not come on when the ignition key is turned to the "ON" position, or remains on.
- © The light comes on while you are driving.

A warning light turning on briefly during operation does not indicate a problem.



CAUTION

If the "ABS" warning light remains on together with the brake system warning light, immediately stop your vehicle at a safe place and contact your Toyota dealer.

In this case, not only the anti-lock brake system will fail but also the vehicle will become extremely unstable during braking.

(i) Open Door Warning Light

This light remains on until all the doors are completely closed.

(j) SRS Warning Light

This light will come on when the ignition key is turned to the "ON" position. After about 6 seconds, the light will go off. This means the systems of the airbag and front seat belt pretensioner are operating properly.

This warning light system monitors the airbag sensor assembly, front airbag sensors, side and curtain shield airbag sensors, curtain shield airbag sensors, driver's seat position sensor, driver's seat belt buckle switch, front seat belt pretensioner assemblies, inflators, warning light, interconnecting wiring and power sources.

If either of the following conditions occurs, this indicates a malfunction somewhere in the parts monitored by the warning light system. Contact your Toyota dealer as soon as possible to service the vehicle.

- © The light does not come on when the ignition key is turned to the "ON" position or remains on.
- © The light comes on or flashes while driving.

(k) Low Windshield Washer Fluid Level Warning Light

The light warns that the windshield washer fluid level is too low. Add washer fluid at your earliest opportunity. (For instructions, see "Adding washer fluid" on page 266 in Section 7-3.)

(l) "VSC" Warning Light

The light warns that there is a problem somewhere in the vehicle skid control system or traction control system.

The light will come on when the ignition key is turned to "ON", and will go off after about a few seconds.

If the light comes on, the vehicle skid control system and traction control system do not work. However, as conventional braking operates when applied, there is no problem to continue your driving.

In the following cases, contact your Toyota dealer:

- © The light does not come on after the ignition is turned to on.
- © The light is left on after the ignition is turned to on.
- © The light comes on while driving.

The "TRAC OFF" indicator light will come on when the "VSC" warning light comes on even if the "TRAC OFF" switch is not pushed.

(m) Key Reminder Buzzer

This buzzer reminds you to remove the key when you open the driver's door with the ignition key in the "ACC" or "LOCK" position.

CHECKING SERVICE REMINDER INDICATORS (except the low fuel level warning light and low windshield washer fluid level warning light)

1. Apply the parking brake.
2. Open one of the doors.
The open door warning light should come on.
3. Close the door.
The open door warning light should go off.
4. Turn the ignition key to "ON", but do not start the engine.
All the service reminder indicators except the open door warning light should come on. The "ABS" and "VSC" warning lights, "TRAC OFF" and slip indicator lights go off after a few seconds. The SRS warning light goes off after about 6 seconds.

If any service reminder indicator or warning buzzer does not function as described above, have it checked by your Toyota dealer as soon as possible.

SECTION 1-6

OPERATION OF INSTRUMENTS AND CONTROLS

Ignition switch, Transmission and Parking brake

Ignition switch with steering lock	107
Automatic transmission	108
Manual transmission	112
Traction control system	113
Vehicle skid control system	115
Parking brake	117
Cruise control	118

Ignition switch with steering lock

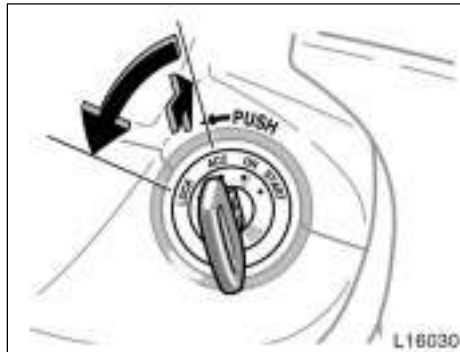

“START”—Starter motor on. The key will return to the “ON” position when released.

For starting tips, see page 196 in Section 3.

“ON”—Engine on and all accessories on.

This is the normal driving position.

“ACC”—Accessories such as the radio operate, but the engine is off.

If you leave the key in the “ACC” or “LOCK” position and open the driver’s door, a buzzer will remind you to remove the key.

“LOCK”—Engine is off and the steering wheel is locked. The key can be removed only at this position.

You must push in the key to turn the key from “ACC” to the “LOCK” position. On vehicles with an automatic transmission, the selector lever must be put in the “P” position before pushing the key.

Vehicles with engine immobiliser system—Once you remove the key, the engine immobiliser system is automatically set. (See “Engine immobiliser system” on page 13 in Section 1–2.)

When starting the engine, the key may seem stuck at the “LOCK” position. To free it, first be sure the key is pushed all the way in, and then rock the steering wheel slightly while turning the key gently.

If the automatic unlocking operation linked with the ignition switch is set, all doors are automatically unlocked when the ignition switch is turned from the “ON” position to the “ACC” or “LOCK” position. For details, see “—Automatic door locking and unlocking functions” on page 17 in Section 1–2.

CAUTION

For manual transmission:

Never remove the key when the vehicle is moving, as this will lock the steering wheel and result in loss of steering control.

NOTICE

Do not leave the key in the “ON” position if the engine is not running. The battery will discharge and the ignition could be damaged.

Automatic transmission

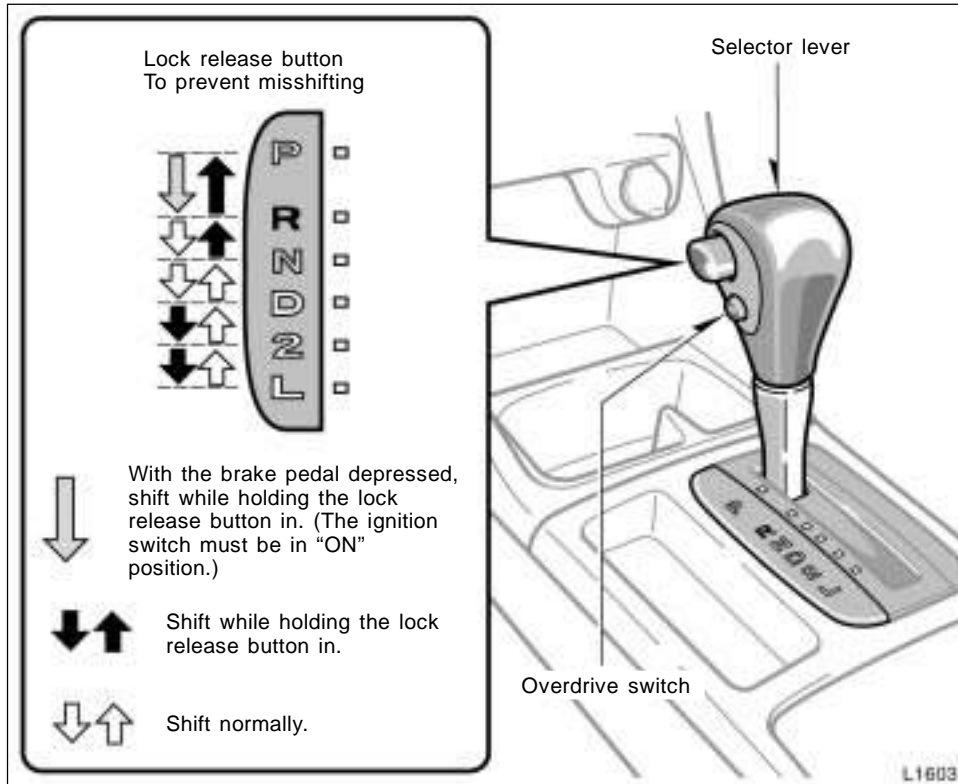

Your automatic transmission has a shift lock system to minimize the possibility of incorrect operation. This means you can only shift out of "P" position when the brake pedal is depressed (with the ignition switch in "ON" position and the lock release button depressed).

(a) Selector lever

The shift position is also displayed on the instrument cluster.

P: Parking, engine starting and key removal

R: Reverse

N: Neutral

D: Normal driving (with overdrive on)

2: Stronger engine braking

L: Maximum engine braking

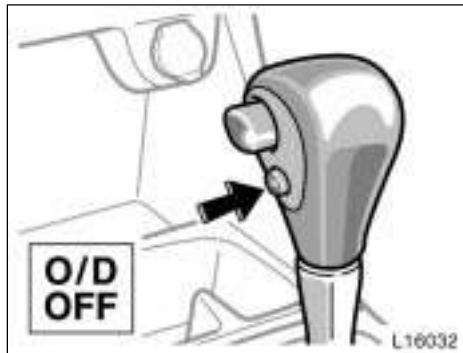

(b) Overdrive switch

You can select either third gear (with overdrive off) or fourth gear (with overdrive on) by pushing this switch.

To turn the overdrive off, push the switch. The “O/D OFF” indicator light should come on. To turn the overdrive on again, push the switch again. The “O/D OFF” indicator light should go off.

Always drive your vehicle with the overdrive on for better fuel economy and quieter driving.

If the engine is turned off when the overdrive is off and restarted, the overdrive will be on automatically.

Vehicles with cruise control—When the cruise control is being used, even if you downshift the transmission by pushing and releasing the overdrive switch, engine braking will not be enabled because the cruise control is not cancelled.

For ways to decrease the vehicle speed, see “Cruise control” on page 118 in this section.

(c) Normal driving

1. Start the engine as instructed in “How to start the engine” on page 197 in Section 3. The transmission must be in “P” or “N”.
2. With your foot holding down the brake pedal, shift the selector lever to “D”.

When the lever is in the “D” position, the automatic transmission system will select the most suitable gear for running conditions such as normal cruising, hill climbing, hard towing, etc.

Always turn the overdrive on for better fuel economy and quieter driving. If the engine coolant temperature is low, the transmission will not shift into overdrive gear even with the overdrive on.

⚠ CAUTION

Never put your foot on the accelerator pedal while shifting.

3. Release the parking brake and brake pedal. Depress the accelerator pedal slowly for smooth starting.

If the automatic locking operation linked with the shift position is set, all doors are automatically locked when the shift lever is moved out of the “P” position with the ignition switch is in the “ON” position and all the doors are closed. For details, see “—Automatic door locking and unlocking functions” on page 17 in Section 1–2.

(d) Using engine braking

To use engine braking, you can downshift the transmission as follows:

- © Push the overdrive switch. The “O/D OFF” indicator light will come on and the transmission will downshift to third gear.

© Shift into the “2” position. The transmission will downshift to second gear when the vehicle speed drops down to or lower than 106 km/h (66 mph), and stronger engine braking will be enabled.

© Shift into the “L” position. The transmission will downshift to first gear when the vehicle speed drops down to or lower than 50 km/h (31 mph), and maximum engine braking will be enabled.

Vehicles with cruise control—When the cruise control is being used, even if you downshift the transmission by pushing and releasing the overdrive switch, engine braking will not be enabled because the cruise control is not cancelled.

For ways to decrease the vehicle speed, see “Cruise control” on page 118 in this section.

 **CAUTION**

Be careful when downshifting on a slippery surface. Abrupt shifting could cause the vehicle to spin or skid.

(e) Using “2” and “L” positions

The “2” and “L” positions are used for strong engine braking as described previously.

With the selector lever in “2” or “L”, you can start the vehicle in motion as with the lever in “D”.

With the selector lever in “2”, the vehicle will start in first gear and automatically shift to second gear.

With the selector lever in “L”, the transmission is engaged in first gear.

NOTICE

◀ **Be careful not to over-rev the engine. Watch the tachometer to keep engine rpm from going into the red zone. The approximate maximum allowable speed for each position is given below for your reference:**

“2” 115 km/h (71 mph)
“L” 64 km/h (40 mph)

◀ **Do not continue hill climbing or hard towing for a long time in the “2” or “L” position. This may cause severe automatic transmission damage from overheating. To prevent such damage, “D” position should be used in hill climbing or hard towing.**

(f) Backing up

1. Bring the vehicle to a complete stop.
2. With the brake pedal held down with your foot, shift the selector lever to the “R” position.

NOTICE

Never shift into reverse while the vehicle is moving.

(g) Parking

1. Bring the vehicle to a complete stop.
2. Pull the parking brake lever up fully to securely apply the parking brake.
3. With the brake pedal pressed down, shift the selector lever to the “P” position.

 **CAUTION**

Never attempt to move the selector lever into "P" position under any circumstances while the vehicle is moving. Serious mechanical damage and loss of vehicle control may result.

If the automatic unlocking operation linked with the shift position is set, all doors are automatically unlocked when the selector lever is moved to the "P" position with the ignition switch is in the "ON" position. For details, see "—Automatic door locking and unlocking functions" on page 17 in Section 1–2.

(h) Good driving practice

- © If the transmission repeatedly shifts up and down between third gear and overdrive when climbing a gentle slope, the overdrive should be turned off. Be sure to turn the switch on immediately afterward.
- © When towing a trailer, in order to maintain engine braking efficiency, do not use overdrive.

 **CAUTION**

Always keep your foot on the brake pedal while stopped with the engine running. This prevents the vehicle from creeping.

NOTICE

Do not hold the vehicle on an up-grade with the accelerator pedal. It can cause the transmission to over-heat. Always use the brake pedal or parking brake.

(i) Rocking your vehicle if stuck

 **CAUTION**

If your vehicle becomes stuck in snow, mud, sand, etc., then you may attempt to rock your vehicle free by moving it forward and backward. Do not attempt this procedure if people or objects are anywhere near the vehicle. During the rocking operation the vehicle may suddenly move forward or backward as it becomes unstuck, causing injury or damage to nearby people or objects.

NOTICE

If you rock your vehicle, observe the following precautions to prevent damage to the transmission and other parts.

- ◀ *Do not depress the accelerator pedal while shifting the selector lever or before the transmission is completely shifted to forward or reverse gear.*
- ◀ *Do not race the engine and avoid spinning the wheels.*

◀ **If your vehicle remains stuck after rocking the vehicle several times, consider other ways such as towing.**

(j) If you cannot shift the selector lever out of “P” position

If you cannot shift the selector lever from “P” position even though the brake pedal is depressed, use the shift lock override button. For instructions, see “If you cannot shift automatic transmission selector lever” on page 228 in Section 4.

Manual transmission

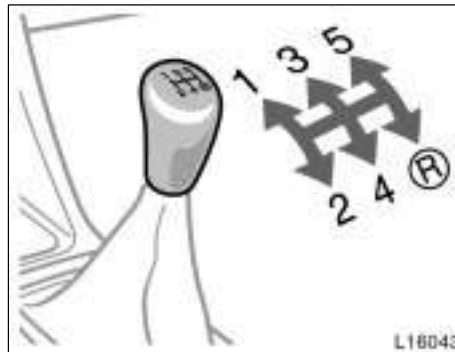

The shift pattern is conventional as shown above.

Press the clutch pedal down fully while shifting, and then release it slowly. Do not rest your foot on the pedal while driving, because it will cause clutch trouble. And do not use the clutch to hold the vehicle when stopped on an uphill grade—use the parking brake.

Recommended shifting speeds

The transmission is fully synchronized and upshifting or downshifting is easy.

For the best compromise between fuel economy and vehicle performance, you should upshift or downshift at the following speeds:

gear	km/h (mph)
1 to 2 or 2 to 1	24 (15)
2 to 3 or 3 to 2	40 (25)
3 to 4 or 4 to 3	64 (40)
4 to 5 or 5 to 4	72 (45)

Downshift to the appropriate gear if acceleration is needed when you are cruising below the above downshifting speeds.

Upshifting too soon or downshifting too late will cause lugging, and possibly ping-pong. Regularly revving the engine to maximum speed in each gear will cause excessive engine wear and high fuel consumption.

Maximum allowable speeds

To get on a highway or to pass slower traffic, maximum acceleration may be necessary. Make sure you observe the following maximum allowable speeds in each gear:

gear	km/h (mph)
1	52 (32)
2	89 (55)
3	137 (85)
4	189 (117)

NOTICE

Do not downshift if you are going faster than the maximum allowable speed for the next lower gear.

Good driving practice

- © If it is difficult to shift into reverse, put the transmission in neutral, release the clutch pedal momentarily, and then try again.
- © When towing a trailer, in order to maintain engine braking efficiency, do not use fifth gear.



CAUTION

Be careful when downshifting on a slippery surface. Abrupt shifting could cause the vehicle to spin or skid.

NOTICE

Make sure the vehicle is completely stopped before shifting into reverse.

Traction control system

The traction control system automatically helps prevent the spinning of front wheels when the vehicle is started or accelerated on slippery road surfaces.

When the ignition key is turned to "ON", the system automatically turns on.



CAUTION

Under certain slippery road conditions, full traction of the vehicle and power against front wheels cannot be maintained, even though the traction control system is in operation. Do not drive the vehicle under any speed or maneuvering conditions which may cause the vehicle to lose traction control. In situations where the road surface is covered with ice or snow, your vehicle should be fitted with snow tires or tire chains. Always drive at an appropriate and cautious speed for the present road conditions.

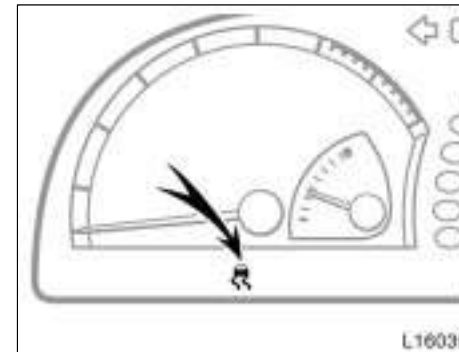

NORMAL DRIVING MODE

Leave the system on during the ordinary driving so that it can operate when needed.

You may hear a sound in the engine compartment for a few seconds when the engine is started or just after the vehicle is started. This means that the traction control system is in the self-check mode, but does not indicate a malfunction.

When the traction control system is operating, the following conditions occur:

- © The system controls the spinning of the front wheels. At this time, the slip indicator light blinks.
- © You may feel vibration or noise in your vehicle, caused by operation of the brakes. This indicates the system is functioning properly.

The slip indicator light comes on for a few seconds when the ignition key is turned to "ON". If the indicator light does not come on when the ignition is turned on, contact your Toyota dealer.



TRACTION CONTROL OFF MODE

When getting the vehicle out of mud or new fallen snow, etc., turn off the traction control system. This system that controls engine performance interferes with the process of freeing front wheels.

To turn off: Push "TRAC OFF" switch.

The "TRAC OFF" indicator light will come on.

The vehicle skid control system is always activated, even if the traction control system is turned off.

To turn on: Push "TRAC OFF" switch once again.

The "TRAC OFF" indicator light will go off.
2002 MY CAMRY_U (OM33567U)

"TRAC OFF" indicator light comes on for a few seconds when the ignition key is turned to "ON". It will come on again when you push the "TRAC OFF" switch to turn off the system.

In the following cases, contact your Toyota dealer:

- © The indicator light does not come on when the ignition key is turned "ON".
- © The indicator light remains on after the ignition is turned on.
- © The indicator light comes on with the normal driving mode while driving.

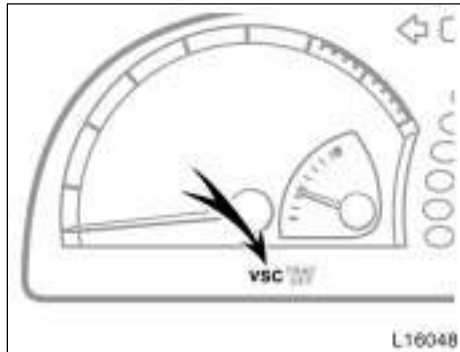

“VSC” warning light

This light warns that there is a problem somewhere in the traction control system or the vehicle skid control system.

The light will come on when the ignition key is turned to “ON” and will go off after a few seconds.

If the light comes on while driving, the system does not work. However, as conventional braking operates when applied, there is no problem to continue your driving.

In the following cases, contact your Toyota dealer:

- © The warning light does not come on after the ignition key is turned to “ON”.
- © The warning light remains on after the ignition key is turned to “ON”.
- © The warning light comes on while driving.

The “TRAC OFF” indicator light will come on when the “VSC” warning light comes on even if the “TRAC OFF” switch is not pushed.

Vehicle skid control system

The vehicle skid control system helps provide integrated control of the systems such as anti-lock brake system, traction control, engine control, etc. This system automatically controls the brakes and engine to help prevent the vehicle from skidding when cornering on a slippery road surface or operating steering wheel abruptly.

This system will activate when your vehicle speed reaches or exceeds 15 km/h (9 mph), and will deactivate when the vehicle speed reduced to below 15 km/h (9 mph).

You may hear a sound in the engine compartment for a few seconds when the engine is started or just after the vehicle is started. This means that the system is in the self-check mode but does not indicate a malfunction.

CAUTION

©Do not rely excessively on the vehicle skid control system. Even if the vehicle skid control system is operating, you must always drive carefully and attentively to avoid serious injury. Reckless driving will result in an unexpected accident. If the slip indicator light flashes, an alarm sounds, and special care should be taken while driving.

©Only use tires of specified size. The size, manufacture, brand and tread pattern for all 4 tires should be the same. If you use the tires other than specified, or different type or size, the vehicle skid control system may not function correctly. When replacing the tires or wheels, contact your Toyota dealer. (See “Checking and replacing tires” on page 256 in Section 7-2.)

©In situations where the road surface is covered with ice or snow, your vehicle should be fitted with snow tires or tire chains.

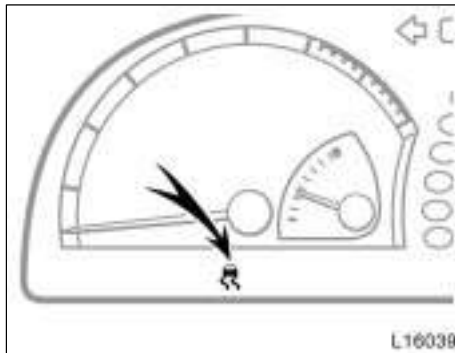

If the vehicle is going to skid during driving, the slip indicator light blinks and an alarm sounds intermittently. Special care should be taken while driving.

The slip indicator light comes on for a few seconds when the ignition key is turned to “ON”. If the indicator light does not come on when the ignition is turned on, contact your Toyota dealer.

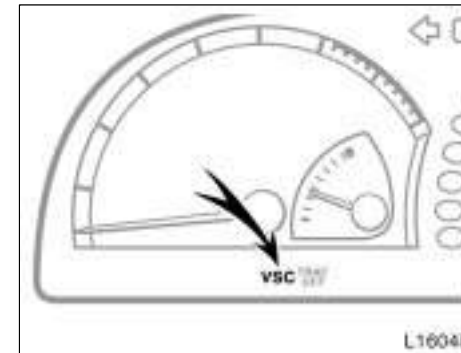

“VSC” warning light

This light warns that there is a problem somewhere in the vehicle skid control system or the traction control system.

The light will come on when the ignition key is turned to “ON” and will go off after a few seconds.

If the light comes on while driving, the system does not work. However, as conventional braking operates when applied, there is no problem to continue your driving.

Parking brake

In the following cases, contact your Toyota dealer:

- © The warning light does not come on after the ignition key is turned to "ON".
- © The warning light remains on after the ignition key is turned to "ON".
- © The warning light comes on while driving.

The "TRAC OFF" indicator light will come on when the "VSC" warning light comes on even if the "TRAC OFF" switch is not pushed.

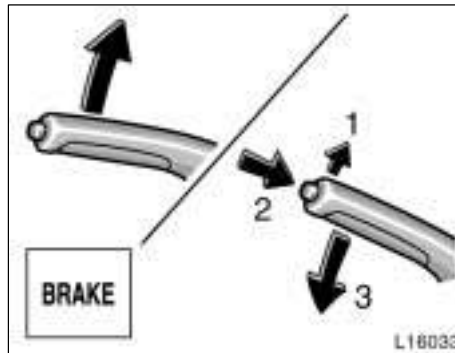

Lever type (type A)

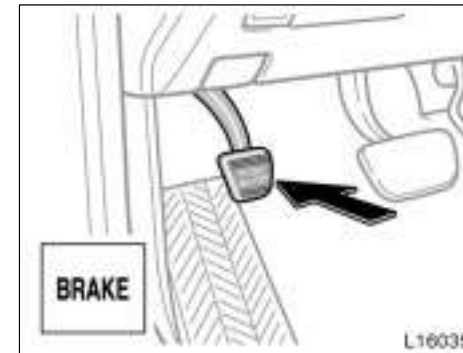

Pedal type (type A)

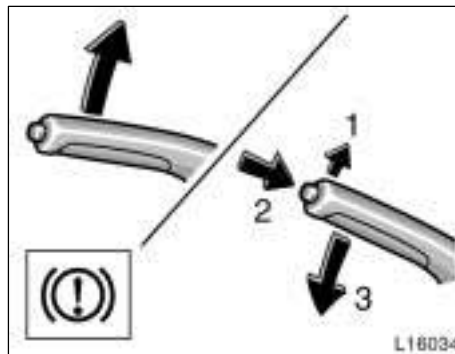

Lever type (type B)

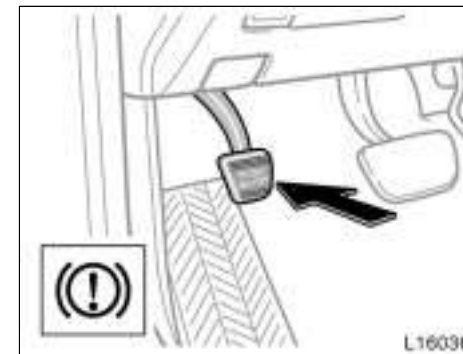

Pedal type (type B)

When parking, firmly apply the parking brake to avoid inadvertent creeping.

Lever type—

To set: Pull up the lever. For better holding power, first depress the brake pedal and hold it while setting the parking brake.

To release: Pull up the lever slightly (1), press the lock release button (2), and lower (3).

Pedal type—

To set: Fully depress the parking brake pedal. For better holding power, first depress the brake pedal and hold it while setting the parking brake.

To release: Depress the parking brake pedal while depressing the brake pedal.

To remind you that the parking brake is set, the parking brake reminder light in the instrument panel remains on until you release the parking brake.

CAUTION
Before driving, be sure the parking brake is fully released and the parking brake reminder light is off.

Cruise control

The cruise control allows you to cruise the vehicle at a desired speed over 40 km/h (25 mph) even with your foot off the accelerator pedal.

Your cruising speed can be maintained up or down grades within the limits of engine performance, although a slight speed change may occur when driving up or down the grades. On steeper hills, a greater speed change will occur so it is better to drive without the cruise control.

CAUTION

- ©To help maintain maximum control of your vehicle, do not use the cruise control when driving in heavy or varying traffic, or on slippery (rainy, icy or snow-covered) or winding roads.
- ©Avoid vehicle speed increases when driving downhill. If the vehicle speed is too fast in relation to the cruise control set speed, cancel the cruise control then downshift the transmission to use engine braking to slow down.

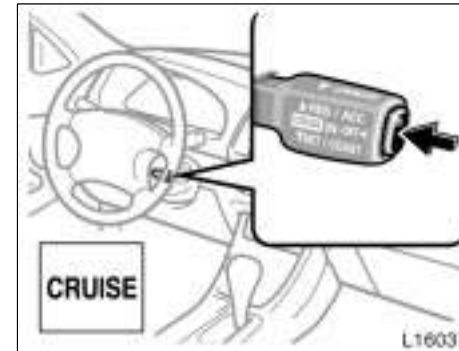

TURNING ON THE SYSTEM

To operate the cruise control, press the "CRUISE ON-OFF" button. This turns the system on. The indicator light in the instrument panel shows that you can now set the vehicle at a desired cruising speed. Another press will turn the system completely off.

CAUTION
To avoid accidental cruise control engagement, keep the "CRUISE ON-OFF" switch off when not using the cruise control.

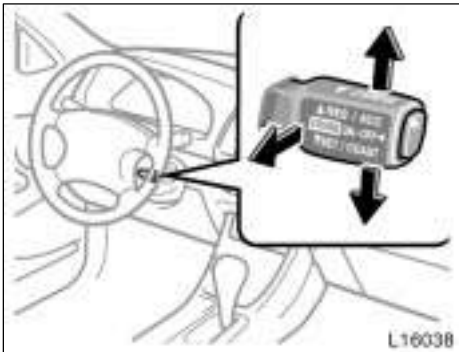

SETTING AT A DESIRED SPEED

On vehicles with automatic transmission, the transmission must be in "D" before you set the cruise control speed.

Bring your vehicle to the desired speed, push the lever down in the "SET/COAST" direction and release it. This sets the vehicle at that speed. If the speed is not satisfactory, tap the lever up for a faster speed, or tap it down for a slower speed. Each tap changes the set speed by 1.6 km/h (1.0 mph). You can now take your foot off the accelerator pedal.

If you need acceleration—for example, when passing—depress the accelerator pedal enough for the vehicle to exceed the set speed. When you release it, the vehicle will return to the speed set prior to the acceleration.

CAUTION

For manual transmission:

While driving with the cruise control on, do not shift to neutral without depressing the clutch pedal, as this may cause engine racing or overrevving.

CANCELLING THE PRESET SPEED

You can cancel the preset speed by:

- Pulling the lever in the "CANCEL" direction and releasing it.
- Depressing the brake pedal.
- Depressing the clutch pedal (manual transmission).

If the vehicle speed falls below about 40 km/h (25 mph), the preset speed will automatically cancel out.

If the vehicle speed drops 16 km/h (10 mph) below the preset speed, the preset speed will also automatically cancel out.

2002 MY CAMRY_U (OM33567U)

If the preset speed automatically cancels out other than for the above cases, have your vehicle checked by your Toyota dealer at the earliest opportunity.

RESETTING TO A FASTER SPEED

Push the lever up in the "RES/ACC" direction and hold it. Release the lever when the desired speed is attained. While the lever is held up, the vehicle will gradually gain speed.

However, a faster way to reset is to accelerate the vehicle and then push the lever down in the "SET/COAST" direction.

RESETTING TO A SLOWER SPEED

Push the lever down in the "SET/COAST" direction and hold it. Release the lever when the desired speed is attained. While the lever is held down, the vehicle speed will gradually decrease.

However, a faster way to reset is to depress the brake pedal and then push the lever down in the "SET/COAST" direction.

On vehicles with automatic transmission, even if you turn off the overdrive switch, with the cruise control on, engine braking will not be applied because the cruise control is not cancelled. To decrease the vehicle speed, reset to a slower speed with the cruise control lever or depress the brake pedal. If you use the brake pedal, cruise control is cancelled.

RESUMING THE PRESET SPEED

If the preset speed is cancelled by pulling the control lever or by depressing the brake pedal or clutch pedal, pushing the lever up in the "RES/ACC" direction will restore the speed set prior to cancellation.

However, once the vehicle speed falls below about 40 km/h (25 mph), the preset speed will not be resumed.

CRUISE CONTROL FAILURE WARNING

If the "CRUISE" indicator light in the instrument cluster flashes when using the cruise control, press the "CRUISE ON-OFF" button to turn the system off and then press it again to turn it on.

If any of the following conditions then occurs, there is some trouble in the cruise control system.

- Ⓢ The indicator light does not come on.
- Ⓢ The indicator light flashes again.
- Ⓢ The indicator light goes out after it comes on.

If this is the case, contact your Toyota dealer and have your vehicle inspected.

SECTION 1-7

OPERATION OF INSTRUMENTS AND CONTROLS

Car audio system

Reference	123
Using your audio system	123
Car audio system operating hints	139

For vehicle equipped with Navigation system, please refer to the separate "Owner's Manual for Navigation System".

Reference



Type 1: AM-FM ETR radio/cassette player/
compact disc player



Type 2: AM-FM ETR radio/cassette player/
compact disc auto changer

Using your audio system— —Some basics

This section describes some of the basic features on Toyota audio systems. Some information may not pertain to your system.

Your audio system works when the ignition key is in the “ACC” or “ON” position.

TURNING THE SYSTEM ON AND OFF

Push “PWR·VOL” to turn the audio system on and off.

Push “AM”, “FM1·2”, “FM”, “TAPE” or “CD” to turn on that function without pushing “PWR·VOL”.

You can turn on each player by inserting a cassette tape or compact disc.

You can turn off each player by ejecting the cassette tape or compact disc. If the audio system was previously off, then the entire audio system will be turned off when you eject the cassette tape or compact disc. If the another function was previously playing, it will come on again.

SWITCHING BETWEEN FUNCTIONS

Push “AM”, “FM1·2”, “FM”, “TAPE” or “CD” if the system is already on but you want to switch from one function to another.

TONE AND BALANCE

For details about your system's tone and balance controls, see the description of your own system.

Tone

How good an audio program sounds to you is largely determined by the mix of the treble, midrange (type 2 and on some models of type 1), and bass levels. In fact, different kinds of music and vocal programs usually sound better with different mixes of treble, midrange, and bass.

Balance

A good balance of the left and right stereo channels and of the front and rear sound levels is also important.

Keep in mind that if you are listening to a stereo recording or broadcast, changing the right/left balance will increase the volume of one group of sounds while decreasing the volume of another.

YOUR RADIO ANTENNA

Your vehicle has an antenna printed on the inside of the rear window.

NOTICE

Attaching the film (especially conductive or metallic type) on the rear glass will noticeably reduce the sensitivity of the radio.

YOUR CASSETTE PLAYER

When you insert a cassette, the exposed tape should be to the right.

NOTICE

Do not oil any part of the player and do not insert anything other than cassette tapes into the slot, or the tape player may be damaged.

YOUR COMPACT DISC PLAYER (type 1)

When you insert a disc, gently push it in with the label side up. (The player will automatically eject a disc if the label side is down.) The compact disc player will play from track 1 through the end of the disc. Then it will play from track 1 again.

NOTICE

Never try to disassemble or oil any part of the compact disc player. Do not insert anything except a compact disc into the slot.

8 cm (3 in.) compact disc singles

Your compact disc player does not need an adaptor to play compact disc singles. Compact disc singles are about 8 cm (3 in.) in diameter—smaller than standard discs.

After you eject a compact disc single, do not insert a standard 12 cm (4.7 in.) disc until "DISC" disappears from the display.

NOTICE

Do not use an adaptor for compact disc singles—it could cause tracking errors or interfere with the ejection of compact discs.

**YOUR COMPACT DISC AUTO CHANGER
(type 2)**

When you insert a disc, push the "LOAD" button and gently push the disc in with the label side up. (The player will automatically eject a disc if the label side is down.) The compact disc auto changer will play from track 1 through the end of the disc. Then it will play from track 1 of the next disc.

The changer is intended for use with 12 cm (4.7 in.) discs only.



NOTICE

- *Do not stack up two discs for insertion, or it will cause damage to the compact disc auto changer. Insert only one compact disc into slot at a time.*
- *Never try to disassemble or oil any part of the compact disc player. Do not insert anything except a compact disc into the slot.*

—Controls and features

© Type 1



Details of specific buttons, controls and features are described in the alphabetical listing that follows.

1 2 3 4 5 6 (Preset buttons)

These buttons are used to preset and tune in radio stations.

To preset a station to a button: Tune in the desired station (see "TUNE" or "SEEK" button). Push and hold down the button until you hear a beep—this will set the station to the button. The button number will appear on the display.

To tune in to a preset station: Push the button for the station you want. The button number and station frequency will appear on the display.

These systems can store one AM and two FM stations for each button (The display will show "AM", "FM1" or "FM2" when you push "AM" "FM1.2").

▲ (Eject button)

Push the cassette tape eject button to eject a cassette. Push the compact disc eject button to eject a compact disc.

After you turn the ignition to "LOCK", you will be able to eject a cassette or disc but you will not be able to reinsert it.

◀▶ (Program)

Push "◀▶" to select the other side of a cassette tape. The display indicates which side is currently selected ("▲" indicates top side, "▼" indicates bottom side).

Auto-reverse feature: After the cassette player reaches the end of a tape side, it automatically reverses and begins to play the other side. This is true whether the cassette was playing or fast forwarding.

◀◀/▶▶ (Reverse/Fast forward buttons)

Cassette player

Push the fast forward button to fast forward a cassette tape. "FF" will appear on the display. Push the reverse button to rewind a tape. "REW" will appear on the display.

To stop the tape while it is fast forwarding, push the fast forward button or "TAPE"; to stop the tape while it is rewinding, push the reverse button or "TAPE".

If a tape side rewinds completely, the cassette player will stop and then play that same side. If a tape fast forwards completely, the cassette player will play the other side of the tape, using the auto-reverse feature.

Compact disc player

If you want to fast forward or reverse through a compact disc track, push and hold in the fast forward or reverse button. When you release the button, the compact disc player will resume playing.

AM

Push "AM" to turn on the radio and select the AM band. "AM" will appear on the display.

If the audio system is off, you can turn on the radio by pushing "AM". Also, push "AM" to switch from cassette or compact disc operation to radio operation.

CD (Compact disc player)

Push "CD" to switch from radio or cassette operation to compact disc player operation. If the audio system is off, you can turn on the compact disc player by pushing "CD". In both cases, a disc must already be loaded in the player.

When the audio is set into compact disc operation, the display shows the track currently being played.

If the player malfunctions, your audio system will display one of the four following error messages.

Error codes

“WAIT”: The compact disc player unit may be too hot due to temperature. Allow the player to cool down.





“Err 1”: The disc may be dirty, damaged or inserted incorrectly (up-side down). Clean disc and re-insert.

“Err 3”: There is trouble inside the system. Eject the disc. Set the disc again.

“Err 4”: **Over-current**. Ask your Toyota dealer to inspect.

If the malfunction still exists, take your vehicle to your Toyota dealer.

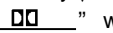
Dolby B NR*

If you are listening to a tape that was recorded with Dolby  B Noise Reduction, push .  will appear on the display. Push the button again to turn off Dolby  B NR.

The Dolby NR mode reduces tape noise by about 10 dB. For best sound reproduction, play your tapes with this button on or off according to the mode used for recording the tape.

*: Dolby noise reduction manufactured under license from Dolby Laboratories Licensing Corporation. “DOLBY” and the double D symbol  are trademarks of Dolby Laboratories Licensing Corporation.

FM1-2

Push “FM1-2” to turn on the radio and select the FM band. “FM1” or “FM2” will appear on the display. This system allows you to set twelve FM stations, two for each button.

If the audio system is off, you can turn on the radio by pushing “FM1-2”. Also, push “FM1-2” to switch from cassette or compact disc operation to radio operation.

MODE (manual tone and sound balance adjustment function)

Each time you push the “MODE” knob, the mode changes. To adjust the tone and balance, turn the knob.

BASS: Adjusts low-pitched tones. The display ranges from -5 to 5.

MID (on some models): Adjusts mid-pitched tones. The display ranges from -5 to 5.

TREBLE: Adjusts high-pitched tones. The display ranges from -5 to 5.

BALANCE: Adjusts the sound balance between the right and left speakers. The display ranges from L7 to R7.

FADER: Adjusts the sound balance between the front and rear speakers. The display ranges from F7 to R7.

PWR-VOL (Power and Volume)

Push “PWR-VOL” to turn the audio system on and off. Turn “PWR-VOL” to adjust the volume.

RAND (Random)

Push “RAND” to listen the tracks on the disc in random order. “RAND” will appear on the display. The disc you are listening to will play in random order. To turn off the random feature, push this button again.

RPT (Repeat)

Cassette player

Push “RPT” while the track is playing. “RPT” will appear on the display. When the track ends, it will automatically be rewound and replayed. This process will be continued until you push the button again to turn off the repeat feature.

There must be at least 3 seconds of blank space between tracks in order for the repeat feature to work correctly.

Compact disc player

Push "RPT" while the track is playing. "RPT" will appear on the display. When the track ends, it will automatically be replayed. This process will be continued until you push the button again to turn off the repeat feature.

SCAN

Radio

You can either scan all the frequencies on a band or scan only the preset stations for that band.

To scan the preset stations:

Push and hold "SCAN" until you hear a beep. The radio will tune in the next preset station up the band, stay there for 5 seconds, and then move to the next preset station. To select a station, push "SCAN" again.

To scan all the frequencies:

Quickly push and release "SCAN". If you hear a beep, you held the button too long, and the radio will scan the preset stations. The radio will find the next station up the station band, stay there for 5 seconds, and then scan again. To select a station, push "SCAN" again.

Compact disc player

Push "SCAN" to scan the tracks on a specific disc. "SCAN" will appear on the display and the player will scan all the tracks on the disc you are listening to. To select a track, push "SCAN" again. If the player scanned all the tracks on the disc, it will stop scanning.

SEEK (Seeking)

Radio

In the seek mode, the radio finds and plays the next station up or down the station band.

To seek a station, quickly push and release the "×" or "±" under the "SEEK". Do this again to find another station.

Cassette player

By using this button, you can skip up or down to a different track.

You can skip up to nine tracks at a time.

Push the up or down side of the button. "FF 1" or "REW 1" will appear on the display.

Next, push either side of the track button until the number on the display reaches the number of tracks you want to skip. If you push the button ten times, the skip feature will be turned off.

When counting the number of tracks you want to rewind, remember to count the current track as well. For example, if you want to rewind to a song that is two before the song you are listening to, push on the down side of the button until "REW 3" appears on the display.

If you have pushed the track button more than you wanted to, push the other side of the button. The track number will be reduced.

The track number you select is not valid if it is higher than the number of tracks remaining on the current cassette side.

◀ After the beginning of the tape is reached, the player will automatically start playing the same side.

◀ After the end of the tape is reached, the player will automatically reverse sides and start playing the other side.

There must be at least 3 seconds of blank space between tracks for the track button to work correctly. In addition, the feature may not work well with some spoken word, live, or classical recordings.

ST (Stereo reception) display

Your radio automatically changes to stereo reception when a stereo broadcast is received. "ST" appears on the display. If the signal becomes weak, the radio reduces the amount of channel separation to prevent the weak signal from creating noise. If the signal becomes extremely weak, the radio switches from stereo to mono reception.

TAPE

Push "TAPE" to switch from radio or compact disc operation to cassette operation. If the audio system is off, you can turn on the cassette player by pushing "TAPE". In both cases, a cassette must already be loaded in the player.

**TRACK (Track up/down button):
Compact disc player**

By using this button, you can skip up or down to a different track.

Push either side of the track button until the number of the track you want to listen to appears on the display. If you want to return to the beginning of the current track, push the down side of the button one time, quickly.

TUNE (Tuning)

Your Toyota has an electronic tuning radio (ETR). Push and release the "×" or "±" side of "TUNE" to step up or down the station band. Do this again to find another frequency.

If you push and hold the "×" or "±" side of "TUNE", the radio will continue seeking up or down for frequencies and will stop at the next frequency that it finds after the button is released. Press the button again to resume the search.

© Type 2



Details of specific buttons, controls and features are described in the alphabetical listing that follows.

1 2 3 4 5 6 (Preset buttons)

These buttons are used to preset and tune in radio stations.

To preset a station to a button: Tune in the desired station (see "TUNE" knob or "SEEK" button). Push and hold down the button until you hear a beep—this will set the station to the button. The preset button number will appear on the display.

RDS stations will be preset to the buttons when you turn on the RDS (see "RDS" button).

To tune in to a preset station: Push the button for the station you want. The preset button number and station frequency will appear on the display.

This radio can store one AM, two FM and RDS stations for each button (The display will show "AM", "FM1", "FM2" or "FM TYPE" when you push "AM" "FM").

▲ (Eject button)

Cassette tape

This button is used to eject a cassette.

While the ignition is in "LOCK", you can eject a cassette but you cannot reinsert it.

Compact disc

This button is used to eject one or all compact discs. To eject the current compact disc, push and release the compact disc eject button. To eject all specific discs, push either side of the "DISC" button until the number of the disc you want to eject is displayed. Push and release the eject button. To eject all discs, press and hold the eject button until you hear a beep. The last compact disc played before pushing the button will be ejected first. If the ejected disc is not removed for a long time, the eject function will be cancelled.

While the ignition is in "LOCK", you can eject one or all discs but you cannot reinsert them.

◀▶ (Program)

Push "◀▶" to select the other side of a cassette tape. The display indicates which side is currently selected ("▲" indicates top side, "▼" indicates bottom side).

Auto-reverse feature: After the cassette player reaches the end of a tape side, it automatically reverses and begins to play the other side. This is true whether the cassette was playing or fast forwarding.

◀◀/▶▶ (Reverse/Fast-forward button)

Cassette player

Push the fast-forward button to fast-forward a cassette tape. "FF" will appear on the display. Push the reverse button to rewind a tape. "REW" will appear on the display.

To stop the tape while it is fast-forwarding, push the fast-forward button or "TAPE"; to stop the tape while it is rewinding, push the reverse button or "TAPE".

If a tape rewinds completely, the cassette player will stop and then play that same side. If a tape fast-forwards completely, the cassette will play the other side of the tape using the auto-reverse feature.

Compact disc auto changer

If you want to fast-forward or reverse a compact disc track, push and hold the fast-forward or reverse button. When you release the button, the compact disc auto changer will resume playing.

AM

Push "AM" to turn on the radio and select the AM band. "AM" will appear on the display.

If the audio system is off, you can turn on the radio by pushing "AM". Also, push "AM" to switch from cassette or compact disc operation to AM.

MODE (manual tone and sound balance adjustment function)

Each time you push the MODE knob, the mode changes. To adjust the tone and balance, turn the knob.

BASS: Adjusts low-pitched tones. The display ranges from -5 to 5.

MID: Adjusts mid-pitched tones. The display ranges from -5 to 5.

TREBLE: Adjusts high-pitched tones. The display ranges from -5 to 5.

BALANCE: Adjusts the sound balance between the right and left speakers. The display ranges from L7 to R7.

FADER: Adjusts the sound balance between the front and rear speakers. The display ranges from F7 to R7.

CD (Compact disc)

Push "CD" to switch from radio or cassette operation to compact disc auto changer operation. If the audio system is off, you can turn on the compact disc auto changer by pushing "CD". In both cases, a disc must already be loaded in the auto changer.

When the audio is set into compact disc operation, the display shows the track or track and disc number currently being played.

If the auto changer or another unit equipped with the player malfunctions, your audio system will display one of the six following error messages.

Error codes

"WAIT": The compact disc auto changer unit may be too hot due to temperature. Allow the auto changer to cool down.

"Err 1": The disc may be dirty, damaged or inserted incorrectly (up-side down). Clean disc and re-insert.

"Err 2": The compact disc auto changer is empty. Insert a disc.

"Err 3": There is trouble inside the system. Eject the disc or magazine. Set the disc or magazine again.

"Err 4": Over-current. Ask your Toyota dealer to inspect.

"OPEN": The compact disc auto changer lid of another unit is open. Close the compact disc auto changer lid.

If the malfunction still exists, take your vehicle to your Toyota dealer.

DISC ± ×

By using this button, you can select a disc you wish to listen to.

Push either side of the button until the number of the disc you want to listen appears on the display.

Dolby ▼ B NR*

If you are listening to a tape that was recorded with Dolby ▼ B Noise Reduction, push "" will appear on the display. Push the button again to turn off Dolby ▼ B NR.

The Dolby NR mode reduces tape noise by about 10 dB. For best sound reproduction, play your tapes with this button on or off according to the mode used for recording the tape.

*: Dolby noise reduction manufactured under license from Dolby Laboratories Licensing Corporation. "DOLBY" and the double D symbol  are trademarks of Dolby Laboratories Licensing Corporation.

FM

Push "FM" to turn on the radio to FM band. "FM1", "FM2" or "FM TYPE" will appear on the display. This system allows you to set twelve FM stations, two for each of the six preset button. If the RDS is off or RDS stations are not preset to the preset buttons, "FM TYPE" will not appear on the display.

If the audio system is off, you can turn on the radio by pushing "FM". Also, push "FM" to switch from cassette or compact disc operation to FM.

LOAD

This button is used to load the compact discs in the compact disc auto changer which is integrated with the radio and cassette player. This compact disc auto changer can store up to 6 discs.

The key must be in the "ACC" or "ON" position for the load function.

Loading one compact disc only—

To load one compact disc only, quickly push and release the button. If you hold the button too long (if the audio system is on at this time, you hear a beep.), the mechanism will change to the mode for loading multiple compact discs. After pushing the button, insert a compact disc. After the disc is loaded, the shutter of the slot will close.

If no compact disc is inserted, the shutter will close after 15 seconds.

Loading multiple compact discs—

To load multiple compact discs, push and hold (until you hear a beep when the audio system is on). After pushing the button, insert the first compact disc. After the disc is loaded, the shutter of the slot will close. After a few seconds, the shutter will automatically open again so the next disc can be inserted. The same process can be applied for loading the rest of the discs.

If no compact disc is inserted, the shutter will close after 15 seconds.

MSG (Message)

This button is operational only in RDS mode.

When an RDS radio station transmits a text message, "MSG" will be displayed. At this time, push "MSG" button to view the text message. The message display will be canceled if any button that affects the display is pushed. To view the message again, push the "MSG" button again. After the entire message has been displayed, the message will disappear.

The RDS audio system has memory to store three 64-character messages. To store a message in memory, push and hold the "MSG" button until you hear a beep.

If 3 messages are already stored in memory, the oldest message will be overwritten by the new message.

To recall a radio text message, push the "MSG" button momentarily. This will display the most recent message. A second push of the "MSG" button while the most stored message(s) are displayed begins with the newest one.

If no messages have been stored, or if there are no more messages to be recalled, "NO MSG STORED" will appear on the display, and the message display will be canceled. The display then returns to show the program service name. The message display will be canceled if you activate any function that affects the display.

Message display can be canceled by pressing any of the following buttons: "AM", "FM", "CD", "TAPE", "SEEK", any preset, "SCAN", any audio control, "RDS", or "TYPE". If the current station is not a traffic program and traffic announcements is off, pushing "TRAF" will cancel the display. The message will be canceled after the entire message has been displayed.

PWR·VOL (Power and Volume)

Push "PWR·VOL" to turn the audio system on and off. Turn "PWR·VOL" to adjust the volume.

RDS (Radio Data System)

Your audio system is equipped with Radio Data Systems (RDS). RDS station providing good reception is automatically selected if current reception worsens.

To turn on the RDS, push and hold this button until you hear a beep, the RDS turns on and "RDS" will appear on the display. At this time, the radio starts to search the RDS stations and "RDS SEARCH" will flash on the display.

Quickly push and release this button when the RDS turns on, the radio starts to search the RDS stations and "RDS SEARCH" will appear on the display.

When the RDS stations are found, "FOUND" and the number of the RDS stations will appear on the display, and you will hear two beeps. The stations will be preset to the preset buttons.

If the RDS stations can not be found, "NOTHING" will appear on the display and you will hear a beep, and the display returns to previous mode.

To turn the RDS off, push the button until you hear a beep again.

If the FM radio, cassette player or compact disc auto changer is on, pushing this button will turn RDS on or off.

RAND (Random)

There are two random features—you can either listen to the tracks on all the compact discs in the magazine in random order, or only listen to the tracks on a specific compact disc in random order.

To randomly play the tracks on a disc: Quickly push and release “RAND”. “RAND” will appear on the display. The disc you are listening to will play in random order. If you hear a beep, the auto changer will play all the tracks in the magazine in random order. To turn off the random feature, push this button again.

To randomly play all the tracks in the magazine:

Push and hold “RAND” until you hear a beep. “RAND” will appear on the display and the auto changer will perform all the tracks on all the discs in the magazine in random order. To turn off the random feature, push this button again.

RPT (Repeat)

Cassette Player

Push “RPT” while the track is playing. “RPT” will appear on the display. When the track ends, it will automatically rewind and replay. To turn off the repeat feature, push this button again.

There must be at least 3 seconds of blank space between tracks in order for the repeat feature to work correctly.

Compact disc auto changer

There are two repeat features—You can either replay a disc track or a whole compact disc.

Repeating a track:

Quickly push and release “RPT” while the track is playing. “RPT” will appear on the display. If you hear a beep, the auto changer will repeat the whole disc. When the track ends, it will automatically replay. To turn off the repeat feature, push this button again.

Repeating a disc:

Push and hold “RPT” until you hear a beep. “RPT” will appear on the display. The auto changer will repeat all the tracks on the disc you are listening to. When the disc ends, the auto changer will automatically go back to the top track of the disc and replay. To turn off the repeat feature, push this button again.

SCAN

Radio

You can either scan all the frequencies on a band or scan only the preset stations for that band.

To scan the preset stations:

Push and hold “SCAN” until you hear a beep. The radio will tune in the next preset station up the band, stay there for 5 seconds, and then move to the next preset station. To select a station, push “SCAN” again.

To scan all the frequencies:

Quickly push and release “SCAN”. The radio will find the next station up the station band, stay there for 5 seconds, and then scan again to the next preset. To select a station, push “SCAN” again. If you hear a beep, the radio will scan the preset stations.

Compact disc auto changer

There are two scan features—you can either scan the tracks on a specific disc or scan the first tracks of all the discs in the magazine.

Scanning the tracks on a disc:
Quickly push and release “SCAN”. “SCAN” will appear on the display and the auto changer will scan all the tracks on the disc you are listening to. If you hear a beep, the auto changer will scan the first track of all the discs in the magazine. To select a track, push “SCAN” again. If the auto changer scanned all the tracks on the disc, it will stop scanning.

Scanning the first track of all the discs in the magazine:

Push “SCAN” until you hear a beep. “SCAN” will appear on the display and the auto changer will scan the first track of the next disc. To select a disc, push the “SCAN” again. If the auto changer has scanned all the discs, it will stop scanning.

SEEK (Seeking)

Radio

In the seek mode, the radio finds and plays the next station up or down the station band.

To seek the next station, quickly push and release the “x” or “±” side of “SEEK”. Do this again to find the station after that.

Cassette Player

By using this button you can skip up or down to locate a song or recording.

You can select up to 9 recordings (including current one).

A blank space of at least 3 seconds is considered to be a start of a recording.

When a beginning of a tape is reached, the player automatically resumes play.

When the end of the tape is reached, the player automatically reverses sides and resumes normal play.

In addition, the feature may not work well with some spoken word, live, or classical recordings.

ST (Stereo reception) display

Your radio automatically changes to stereo reception when a stereo broadcast is received. “ST” appears on the display. If the signal becomes weak, the radio reduces the amount of channel separation to prevent the weak signal from creating noise. If the signal becomes extremely weak, the radio switches from stereo to mono reception.

TAPE

Push “TAPE” to switch from radio or compact disc operation to cassette operation. If the audio system is off, you can turn on the cassette player by pushing “TAPE”. In both cases, a cassette must already be loaded in the player.

**TRACK (Track up/down button):
compact disc auto changer**

By using this button, you can skip up or down to a different track.

Push either side of the track button until the number of the track you want to listen to appears on the display. If you want to return to the beginning of the current track, quickly push the down side of the button one time.

TRAF (Traffic)

This button turns the traffic announcement (TA) feature on and off.

By pushing "TRAF" button, "TRAF SEEK" appears on the display and the radio will start seeking any traffic program station.

When a traffic program station is found, "< >" will be displayed (<TRAF>) and you will hear a beep.

After the traffic announcement program is over, a beep sounds and the display returns to the previous mode.

If no traffic program station is found, "NO TRAF INFO" appears on the display for a few seconds and the display returns to the previous mode. However, if the "TRAF" button is pushed when the cassette player or compact disc player is on, the radio will start seeking traffic program stations.

TA volume memory function—The volume level when receiving the traffic announcement is memorized.

When "TA" is received next time, the system compares the volume before "TA" is received and the memorized TA volume and automatically selects the louder volume. However, the range of volume memory is limited: if the volume received previously is less than the minimum, this volume will be used.

You can adjust the volume independently from the memorized TA volume range while receiving a TA station.

Traffic announcement can be canceled by turning RDS off, or pressing the "TRAF" button again.

TUNE (Tuning)

Your Toyota has an electronic tuning radio (ETR). Turn the knob clockwise to step up the frequency. Turn the knob counterclockwise to step down the frequency.

TYPE (Program Types)

When you push the "TYPE" button while receiving an RDS station, the current program type appears on the display.

Each time you push the "TYPE" button, the program type changes as in the following:

- ◀ROCK
- ◀EASY LIS (Easy listening)
- ◀CLS/JAZZ (Classical music and Jazz)
- ◀R&B (Rhythm and Blues)
- ◀INFORM (Information)
- ◀RELIGION
- ◀MISC
- ◀ALERT (Emergency message)

ALERT: If an emergency broadcast is received during reception of anything other than AM broadcasting, you will hear a beep and "ALERT" appears on the display.

Car audio system operating hints

NOTICE

To ensure the correct audio system operation:

- **Be careful not to spill beverages over the audio system.**
- **Do not put anything other than a cassette tape or Compact Disc into the slot.**
- **The use of cellular phone inside or near the vehicle may cause a noise from the speakers of the audio system which you are listening to. However, this does not indicate a malfunction.**

RADIO RECEPTION

Usually, a problem with radio reception does not mean there is a problem with your radio—it is just the normal result of conditions outside the vehicle.

For example, nearby buildings and terrain can interfere with FM reception. Power lines or telephone wires can interfere with AM signals. And of course, radio signals have a limited range. The farther you are from a station, the weaker its signal will be. In addition, reception conditions change constantly as your vehicle moves.

Here are some common reception problems that probably do not indicate a problem with your radio:

FM

Fading and drifting stations—Generally, the effective range of FM is about 40 km (25 miles). Once outside this range, you may notice fading and drifting, which increase with the distance from the radio transmitter. They are often accompanied by distortion.

Multi-path—FM signals are reflective, making it possible for two signals to reach your antenna at the same time. If this happens, the signals will cancel each other out, causing a momentary flutter or loss of reception.

Static and fluttering—These occur when signals are blocked by buildings, trees, or other large objects. Increasing the bass level may reduce static and fluttering.

Station swapping—If the FM signal you are listening to is interrupted or weakened, and there is another strong station nearby on the FM band, your radio may tune in the second station until the original signal can be picked up again.

AM

Fading—AM broadcasts are reflected by the upper atmosphere—especially at night. These reflected signals can interfere with those received directly from the radio station, causing the radio station to sound alternately strong and weak.

Station interference—When a reflected signal and a signal received directly from a radio station are very nearly the same frequency, they can interfere with each other, making it difficult to hear the broadcast.

Static—AM is easily affected by external sources of electrical noise, such as high tension power lines, lightening, or electrical motors. This results in static.

CARING FOR YOUR CASSETTE PLAYER AND TAPES

For the best performance for your cassette player and tapes:

Clean the tape head and other parts regularly.

- ◀ A dirty tape head or tape path can decrease sound quality and tangle your cassette tapes. The easiest way to clean them is by using a cleaning tape. (A wet type is recommended.)

Use high-quality cassettes.

- ◀ Low-quality cassette tapes can cause many problems, including poor sound, inconsistent playing speed, and constant auto-reversing. They can also get stuck or tangled in the cassette player.
- ◀ Do not use a cassette if it has been damaged or tangled or if its label is peeling off.
- ◀ Do not leave a cassette in the player if you are not listening to it, especially if it is hot outside.
- ◀ Store cassettes in their cases and out of direct sunlight.
- ◀ Avoid using cassettes with a total playing time longer than 100 minutes (50 minutes per side). The tape used in these cassettes is thin and could get stuck or tangled in the cassette player.



CARING FOR YOUR COMPACT DISC PLAYER AND DISCS

- ◀ Bumpy roads or other vibrations may make your compact disc player skip.
- ◀ If moisture gets into your compact disc player, you may not hear any sound even though your compact disc player appears to be working. Remove the disc from the player and wait until it dries.
- ◀ Use only compact discs labeled as shown above. CD-R (CD-Recordable), CD-RW (CD-Re-writable) and personal computer use CD-ROMs may not be playable on your compact disc player.
- ◀ Type 2 only—Your compact disc auto changer is intended for use with 12 cm (4.7 in.) discs only.
- ◀ Extremely high temperatures can keep your compact disc player from working. On hot days, use the air conditioning to cool the vehicle interior before you listen to a disc.

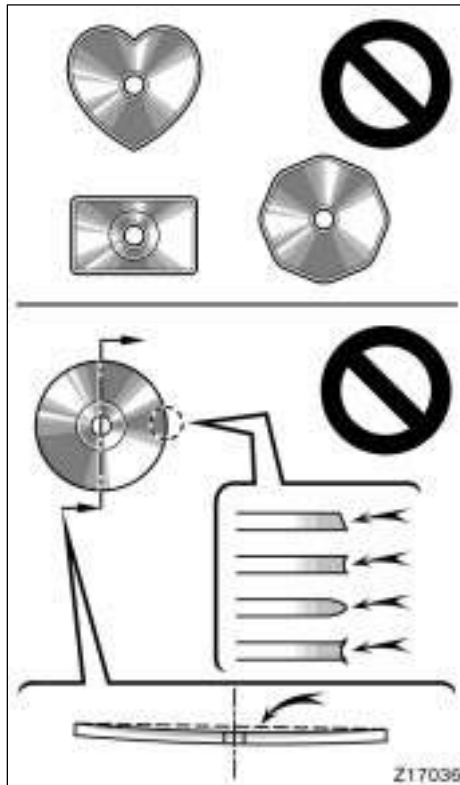

◀ Your automatic changer or compact disc player cannot play special shaped or low-quality compact discs such as those shown here. Do not use them as the changer or player could be damaged.

◀ Handle compact discs carefully, especially when you are inserting them. Hold them on the edge and do not bend them. Avoid getting fingerprints on them, particularly on the shiny side.

◀ Dirt, scrapes, warping, pin holes, or other disc damage could cause the player to skip or to repeat a section of a track. (To see a pin hole, hold the disc up to the light.)

◀ Remove discs from the compact disc player when you are not listening to them. Store them in their plastic cases away from moisture, heat, and direct sunlight.

To clean a compact disc: Wipe it with a soft, lint-free cloth that has been dampened with water. Wipe in a straight line from the center to the edge of the disc (not in circles). Dry it with another soft, lint-free cloth. Do not use a conventional record cleaner or anti-static device.

⚠ CAUTION

Compact disc players use an invisible laser beam which could cause hazardous radiation exposure if directed outside the unit. Be sure to operate the player correctly.

SECTION 1-8

OPERATION OF INSTRUMENTS AND CONTROLS

Air conditioning system

Manual air conditioning system

Controls	143
Air flow selector settings	146
Operating tips	146

Automatic air conditioning system

Controls	149
Air flow selector settings	153
Operating tips	153
Side and rear vents	156
Checking and replacing the air conditioning filter	157

**Manual air conditioning system—
—Controls**

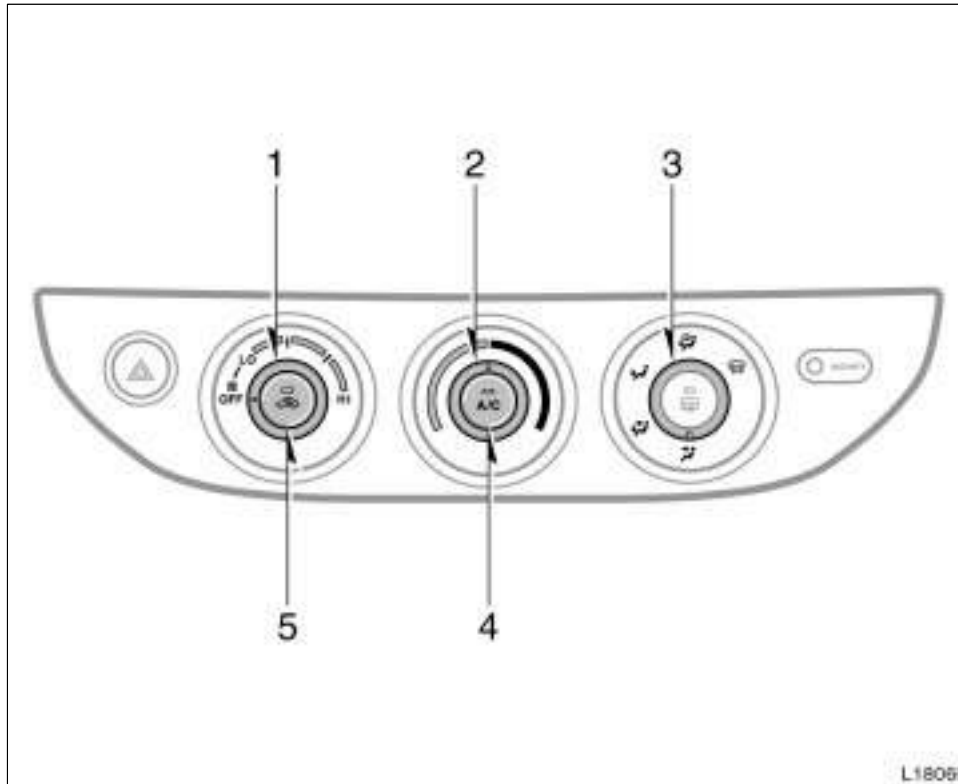

1. Fan speed selector
2. Temperature selector
3. Air flow selector
4. "A/C" button
5. Air intake selector

Fan speed selector

Turn the knob to adjust the fan speed—to the right to increase, to the left to decrease.

Temperature selector

Turn the knob to adjust the temperature—to the right to warm, to the left to cool.

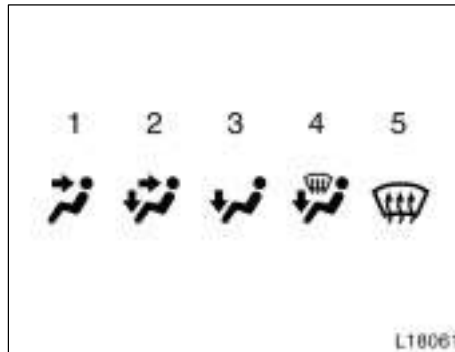

Air flow selector

Turn the knob to select the vents used for air flow.

- 1. Panel**—Air flows mainly from the instrument panel vents.
- 2. Bi-level**—Air flows from both the floor vents and the instrument panel vents.
- 3. Floor**—Air flows mainly from the floor vents.
- 4. Floor/Windshield**—Air flows mainly from the floor vents and windshield vents.

This position allows the air intake to select FRESH automatically. This is to clean up the front view more quickly.

If you want to return the setting to RECIRCULATE mode, press the air intake selector button once again.

Press the “A/C” button for dehumidified heating or cooling. This setting clears the front view more quickly.

- 5. Windshield**—Air flows mainly from the windshield vents.

Turning the air flow selector to the windshield position turns on the defogging function with the purpose of clearing the front view.

This position allows the air intake to select FRESH automatically. This is to clean up the front view more quickly.

If you want to return the setting to RECIRCULATE mode, press the air intake selector button once again.

Press the “A/C” button for dehumidified heating or cooling. This setting clears the front view more quickly.

For details about air flow selector settings, see the illustration after “A/C” button.

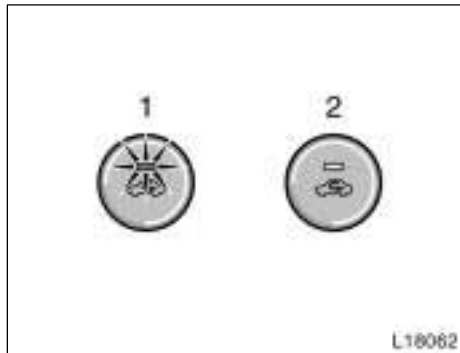

Air intake selector

Press the button to select the air source.

1. **Recirculate** (indicator light is on)—Recirculates the air inside the vehicle.
2. **Fresh** (indicator light is off)—Draws outside air into the system.

To prevent fogging up of the windshield, the air intake mode may change automatically to FRESH depending on the condition of the air conditioning system.

“A/C” button

To turn on the air conditioning, press the “A/C” button. The “A/C” button indicator will come on. To turn the air conditioning off, press the button again.

If the “A/C” button indicator flashes, there is a problem in the air conditioning system and the air conditioning automatically shuts off. If this happens, take your vehicle to a Toyota dealer for service.

—Air flow selector settings

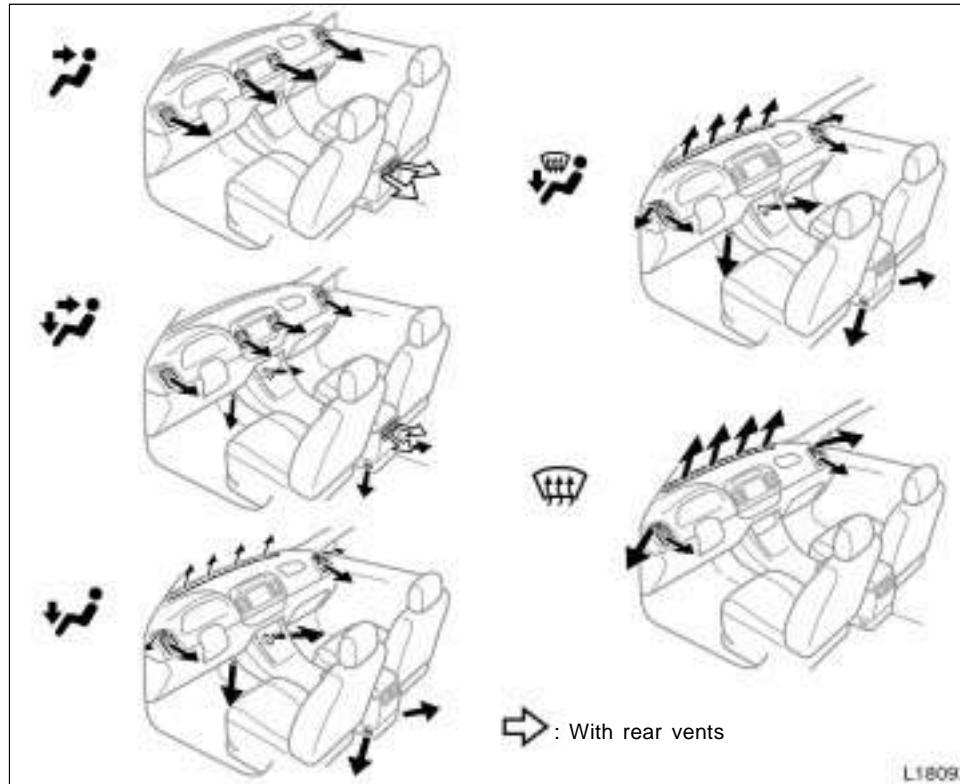

—Operating tips

- © To cool off your Toyota after it has been parked in the hot sun, drive with the windows open for a few minutes. This vents the hot air, allowing the air conditioning to cool the interior more quickly.
- © Make sure the air intake grilles in front of the windshield are not blocked (by leaves or snow, for example).
- © On humid days, do not blow cold air on the windshield. The windshield could fog up because of the difference in air temperature on the inside and outside of the windshield.
- © Keep the area under the front seats clear to allow air to circulate throughout the vehicle.
- © On cold days, set the fan speed to high for a minute to help clear the intake ducts of snow or moisture. This can reduce the amount of fogging on the windows.
- © When driving on dusty roads, close all windows. If dust thrown up by the vehicle is still drawn into the vehicle after closing the windows, it is recommended that the air intake selector be set to FRESH and the fan speed selector to any setting except "OFF".

© If following another vehicle on a dusty road, or driving in windy and dusty conditions, it is recommended that the air intake selector be temporarily set to RECIRCULATE, which will close off the outside passage and prevent outside air and dust from entering the vehicle interior.

Heating

For best results, set controls as follows:

Fan speed—Any setting except "OFF"
Temperature—Towards **WARM**
(red zone)
Air intake—**FRESH** (outside air)
Air flow—**FLOOR**
Air conditioning—**OFF**

© For quick heating, select recirculated air for a few minutes. To keep the windows from fogging, select fresh after the vehicle interior has been warmed.

© Press the "A/C" button on for dehumidified heating.

© Choose floor/windshield air flow to heat the vehicle interior while defrosting or defogging the windshield.

Air conditioning

For best results, set controls as follows:

Fan speed—Any setting except "OFF"
Temperature—Towards **COLD**
(blue zone)
Air intake—**FRESH** (outside air)
Air flow—**PANEL**
Air conditioning—**ON**

© For quick cooling, select recirculated air for a few minutes.

Ventilation

For best results, set controls as follows:

Fan speed—Any setting except "OFF"
Temperature—Towards **COLD**
(blue zone)
Air intake—**FRESH** (outside air)
Air flow—**PANEL**
Air conditioning—**OFF**

Defogging

The inside of the windshield

For best results, set controls as follows:

Fan speed—Any setting except “OFF”
Temperature—Towards **WARM**
(red zone) to heat;
COLD (blue zone) to
cool
Air intake—**FRESH** (outside air)
Air flow—**WINDSHIELD**

Turning the air flow selector to the windshield position turns on the defogging function with the purpose of clearing the front view.

When turning the air flow selector to windshield position, the air intake selects FRESH automatically. This is to clean up the front view more quickly.

If you want to return the setting to RECIRCULATE mode, press the air intake selector button once again.

Press the “A/C” button for dehumidified heating or cooling. This setting clears the front view more quickly.

- © On humid days, do not blow cold air on the windshield—the difference between the outside and inside temperatures could make the fogging worse.

Defrosting

The outside of the windshield

For best results, set controls as follows:

Fan speed—Any setting except “OFF”
Temperature—Towards **WARM**
(red zone)
Air intake—**FRESH** (outside air)
Air flow—**WINDSHIELD**

Turning the air flow selector to the windshield position turns on the defrosting function with the purpose of clearing the front view.

When turning the air flow selector to windshield position, the air intake selects FRESH automatically. This is to clean up the front view more quickly.

If you want to return the setting to RECIRCULATE mode, press the air intake selector button once again.

Press the “A/C” button for dehumidified heating. This setting clears the front view more quickly.

- © To heat the vehicle interior while defrosting the windshield, choose floor/windshield air flow.

**Automatic air conditioning system—
—Controls**

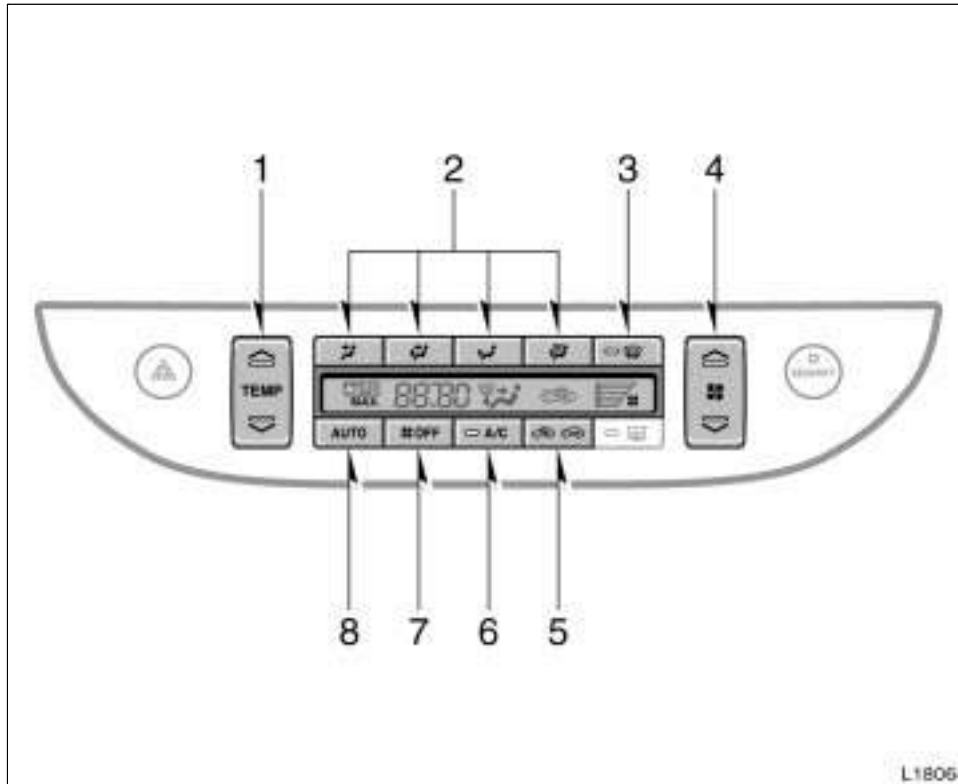

1. Temperature selector
2. Air flow selector
3. Windshield air flow button
4. Fan speed selector
5. Air intake selector
6. "A/C" button
7. "OFF" button
8. "AUTO" button

“AUTO” button

For automatic operation of the air conditioning, press the “AUTO” button. “AUTO” will appear on the display to show that the automatic operation mode has been selected.

In the automatic operation mode, the air conditioning selects the most suitable fan speed, air flow, air intake and on-off of the air conditioning according to the temperature.

When you press the “AUTO” button with the air intake mode at FRESH, internal circulation may be applied for maximum cooling.

You may use manual controls if you want to select your own settings.

To turn off the automatic operation, press the “OFF” button.

Fan speed selector

Push the “×” (increase) or “±” (decrease) side of the button to adjust the fan speed.

In automatic operation, you do not have to adjust the fan speed unless you desire another fan speed mode.

Temperature selector

To increase the temperature, press the “×” side, to decrease it, press the “±” side.

“MAX. COLD” appears when you adjust to maximum cooling, and “MAX. HOT” when you adjust to maximum warming.

“OFF” button

Push the button to turn off the air conditioning system.

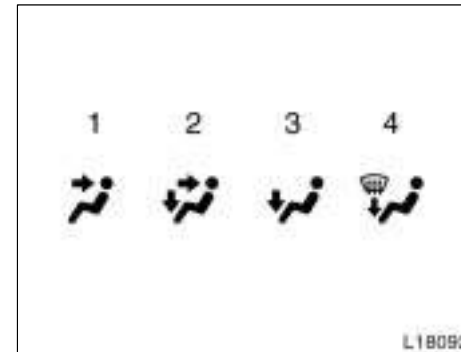

Air flow selector

Push the buttons to select the vents used for air flow.

In automatic operation, you do not have to select the air flow unless you desire another air flow mode.

- 1. Panel**—Air flows mainly from the instrument panel vents.
- 2. Bi-level**—Air flows from both the floor vents and the instrument panel vents.
- 3. Floor**—Air flows mainly from the floor vents.
- 4. Floor/Windshield**—Air flows mainly from the floor vents and windshield vents.



Windshield air flow button

When this button is pressed, air flows mainly from the windshield vents and turns on the defogging function with the purpose of clearing the front view.

Pressing this button once again returns the air flow mode to the last one used.

This button allows the air intake to select FRESH automatically. This is to clean up the front view more quickly. If you want to return the setting to RECIRCULATE mode, press the air intake selector button once again.

Press the "A/C" button for dehumidified heating or cooling. This setting clears the front view more quickly.

For details about air flow selector settings, see the illustration after "A/C" button.

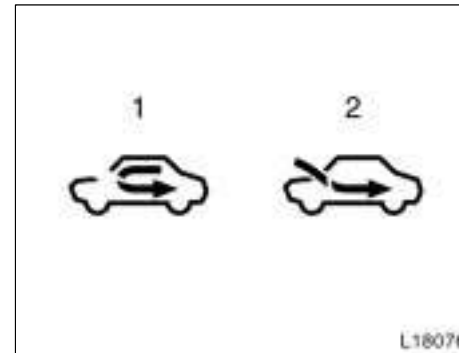

Air intake selector

Press the button to select the air source.

- 1. **Recirculate**—Recirculates the air inside the vehicle.
- 2. **Fresh**—Draws outside air into the system.

To prevent fogging up of the windshield, the air intake mode may change automatically to FRESH depending on the condition of the air conditioning system.

“A/C” button

To turn on the air conditioning, press the “A/C” button. The “A/C” button indicator will come on. To turn the air conditioning off, press the button again.

If the “A/C” button indicator flashes, there is a problem in the air conditioning system and the air conditioning automatically shuts off. If this happens, take your vehicle to a Toyota dealer for service.

—Air flow selector settings

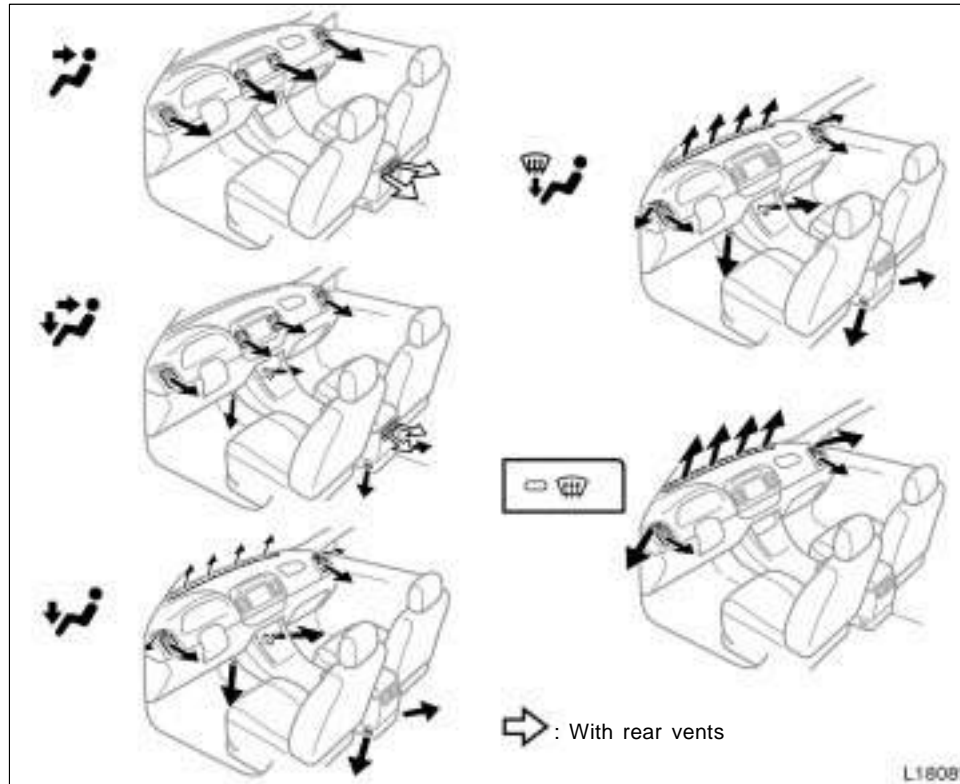

—Operating tips

- © To cool off your Toyota after it has been parked in the hot sun, drive with the windows open for a few minutes. This vents the hot air, allowing the air conditioning to cool the interior more quickly.
- © Make sure the air intake grilles in front of the windshield are not blocked (by leaves or snow, for example).
- © On humid days, do not blow cold air on the windshield. The windshield could fog up because of the difference in air temperature on the inside and outside of the windshield.
- © Keep the area under the front seats clear to allow air to circulate throughout the vehicle.
- © On cold days, set the fan speed to high for a minute to help clear the intake ducts of snow or moisture. This can reduce the amount of fogging on the windows.
- © When driving on dusty roads, close all windows. If dust thrown up by the vehicle is still drawn into the vehicle after closing the windows, it is recommended that the air intake selector be set to FRESH and the fan speed selector to any setting except "OFF".

© If following another vehicle on a dusty road, or driving in windy and dusty conditions, it is recommended that the air intake selector be temporarily set to RECIRCULATE, which will close off the outside passage and prevent outside air and dust from entering the vehicle interior.

Heating

For best results, set controls as follows:

For automatic operation—

Press in the “AUTO” button.
Temperature—To the desired temperature
Air intake—FRESH (outside air)
Air conditioning—OFF

For manual operation—

Fan speed—To the desired fan speed
Temperature—Towards **WARM**
Air intake—FRESH (outside air)
Air flow—FLOOR
Air conditioning—OFF

© For quick heating, select recirculated air for a few minutes. To keep the windows from fogging, select fresh after the vehicle interior has been warmed.

© Press the “A/C” button on for dehumidified heating.

© Choose floor/windshield air flow to heat the vehicle interior while defrosting or defogging the windshield.

Air conditioning

For best results, set controls as follows:

For automatic operation—

Press in the “AUTO” button.
Temperature—To the desired temperature
Air intake—FRESH (outside air)
Air conditioning—ON

For manual operation—

Fan speed—To the desired fan speed
Temperature—Towards **COLD**
Air intake—FRESH (outside air)
Air flow—PANEL
Air conditioning—ON

© For quick cooling, select recirculated air for a few minutes.

Ventilation

For best results, set controls as follows:

For automatic operation—

Press in the “AUTO” button.
Temperature—Towards low temperature
Air intake—FRESH (outside air)
Air conditioning—OFF

For manual operation—

Fan speed—To the desired fan speed
Temperature—Towards **COLD**
Air intake—FRESH (outside air)
Air flow—PANEL
Air conditioning—OFF

Defogging and defrosting

—**The inside of the windshield**

For best results, set controls as follows:

—For automatic operation

Temperature—Towards high temperature to heat; low temperature to cool
Air intake—FRESH (outside air)
Air flow—WINDSHIELD

—For manual operation

Fan speed—To the desired fan speed
Temperature—Towards high temperature to heat; low temperature to cool
Air intake—FRESH (outside air)
Air flow—WINDSHIELD

Pressing the windshield air flow button turns on the defogging function with the purpose of clearing the front view.

When pressing the windshield air flow button, the air intake selects FRESH automatically. This is to clean up the front view more quickly.

If you want to return the setting to RE-CIRCULATE mode, press the air intake selector button once again.

Press the “A/C” button for dehumidified heating or cooling. This setting clears the front view more quickly.

© On humid days, do not blow cold air on the windshield—the difference between the outside and inside temperatures could make the fogging worse.

—**The outside of the windshield**

For best results, set controls as follows:

—For automatic operation

Temperature—Towards high temperature
Air intake—FRESH (outside air)
Air flow—WINDSHIELD

—For manual operation

Fan speed—To the desired fan speed
Temperature—Towards high temperature
Air intake—FRESH (outside air)
Air flow—WINDSHIELD

Pressing the windshield air flow button turns on the defrosting function with the purpose of clearing the front view.

When pressing the windshield air flow button, the air intake selects FRESH automatically. This is to clean up the front view more quickly.

If you want to return the setting to RE-CIRCULATE mode, press the air intake selector button once again.

Press the "A/C" button for dehumidified heating or cooling. This setting clears the front view more quickly.

© To heat the vehicle interior while defrosting the windshield, choose floor/windshield air flow.

Side and rear vents

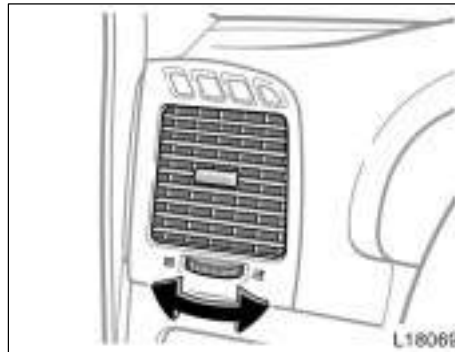

Side vents

If air flow control is not satisfactory, check the side and rear vents. The side and rear vents may be opened or closed as shown.

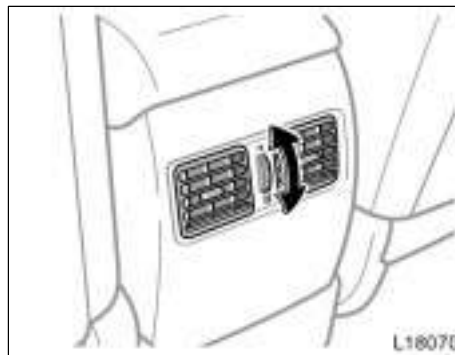

Rear vents

Checking and replacing the air conditioning filter

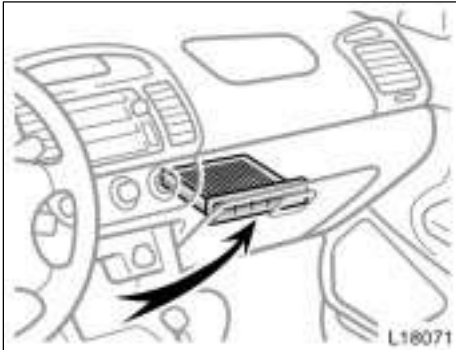

The air conditioning filter is behind the glove box.

The air conditioning filter may clog after long use. The filter may need to be replaced if the air flow of the air conditioning and heater experiences extreme reductions in operating efficiency, or if the windows begin to fog up easily in FRESH mode.

To maintain the air conditioning efficiency, inspect and replace the air conditioning filter according to the maintenance schedule. (For scheduled maintenance information, please refer to the "Scheduled Maintenance Guide" or "Owner's Manual Supplement".)

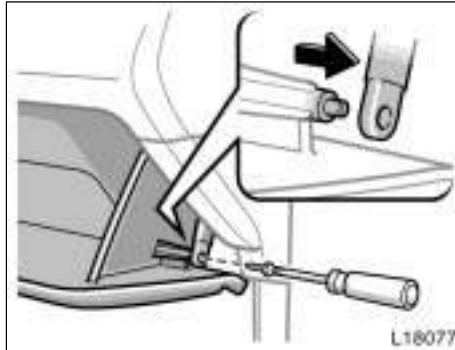

1. Open the glove box. Remove the screw with a Phillips-head screwdriver and slide the hook as shown.

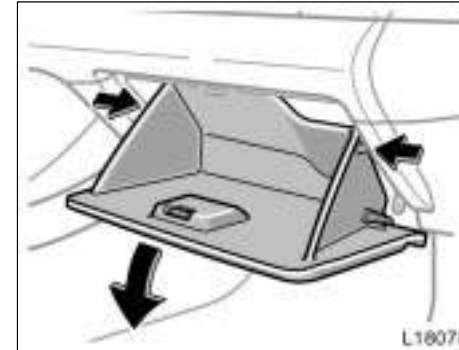

2. Push each side of the glove box to disconnect the claws.

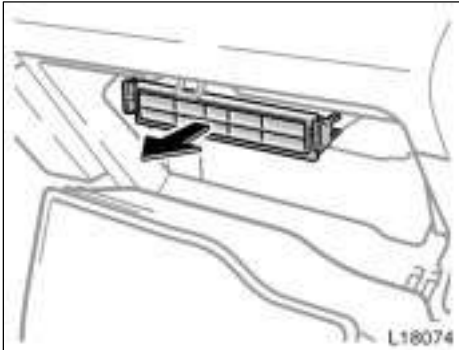

3. Remove the filter case from the filter outlet as shown in the illustration.

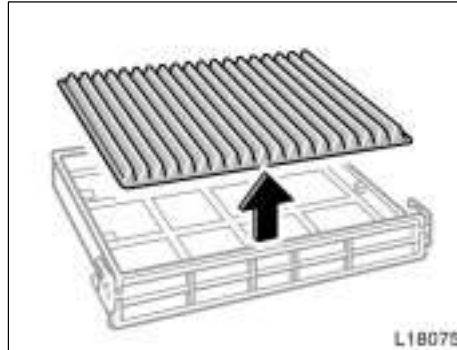

4. Remove the filter from the filter case.

5. Inspect the filter on the surface.

If it is dirty, it should be replaced.

INFORMATION

The air filter should be installed properly in position. The use of air conditioning with the air filter removed may cause deteriorated dustproof performance and then affect air conditioning performance.

SECTION 1-9

OPERATION OF INSTRUMENTS AND CONTROLS

Other equipment

Clock	161
Outside temperature gauge	161
Multi-information display	162
Compass	164
Power outlets	169
Garage door opener	170
Glove box	173
Auxiliary boxes	173
Rear console box	174
Front cup holder	175
Rear cup holder	175
Storage box	176
Grocery bag hooks	176
Luggage net	177
Rear sunshade	177
Floor mat	177

Clock

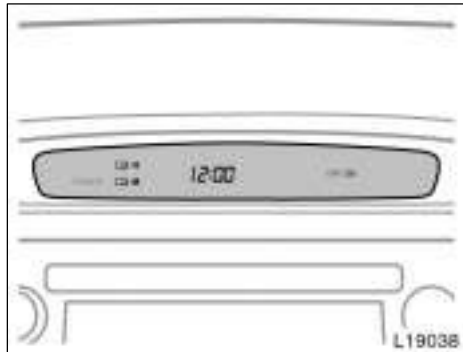

The digital clock indicates the time.

The key must be in the "ACC" or "ON" position.

To reset the hour: Push the "H" button.
To reset the minutes: Push the "M" button.

If the electrical power source has been disconnected from the clock, the time display will automatically be set to 1:00 (one o'clock).

When the instrument panel lights are turned on, the brightness of the time indicator will be reduced.

Outside temperature gauge

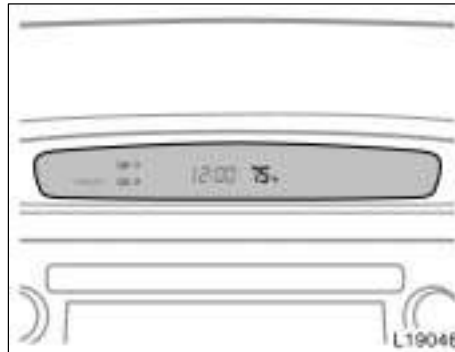

With multi-information display

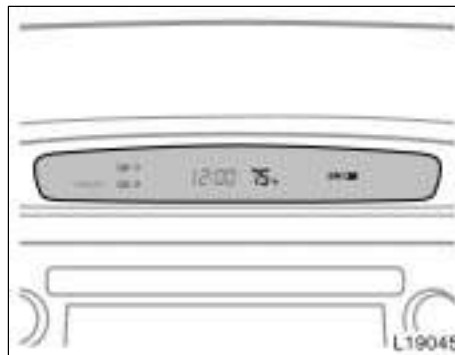

Without multi-information display

The outside temperature gauge indicates outside air temperatures when the ignition switch is on.

Without multi-information display—To select "°C" or "°F", push the "E/M" button.

The displayed temperature ranges from -30°C (-22°F) up to 50°C (122°F).

If there is some abnormality in the connection of the outside air temperature sensor, "—" will appear on the display. If "—" appears on the display, contact your Toyota dealer.

There may be a case that "—" appears momentarily when the ignition is quickly turned to "ON". It is normal if it goes out soon.

Multi-information display

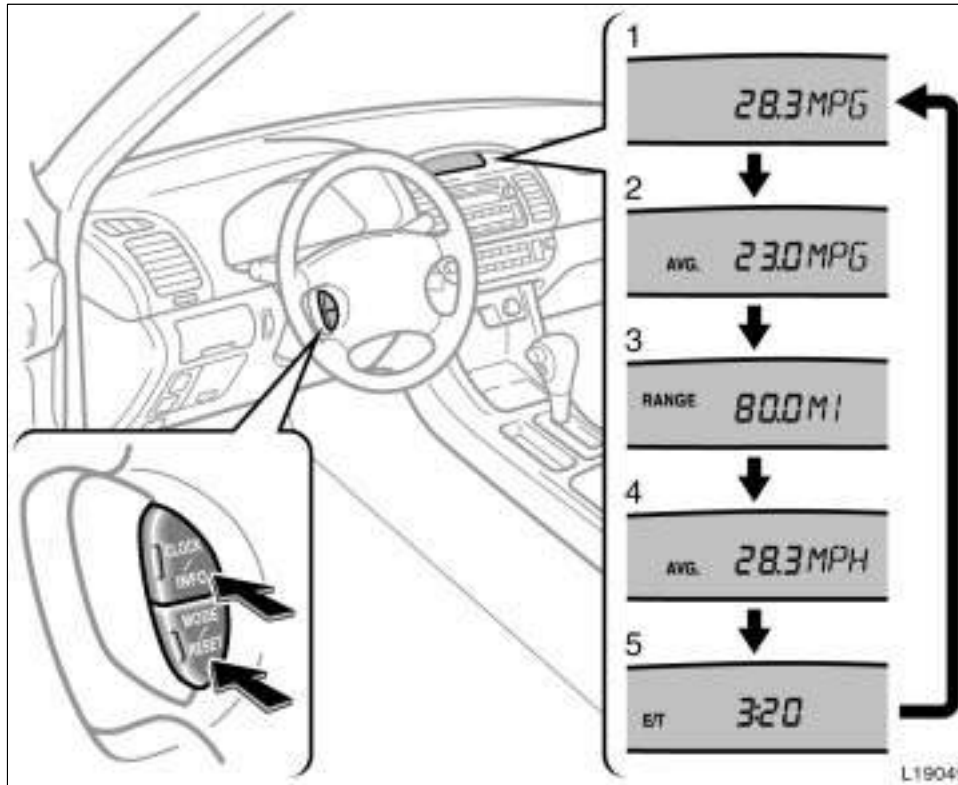

The following information is displayed on the clock/outside temperature gauge when you push the “CLOCK/INFO” button with the ignition switch turned on.

Each time you push the “MODE/RESET” button, the display toggles through this information.

1. Instantaneous fuel consumption
2. Average fuel consumption
3. Driving range
4. Average vehicle speed
5. Driving time

The displayed values in the multi-information display indicate general driving conditions. Accuracy varies with driving habits and road conditions.

Push the “CLOCK/INFO” button once again, the display will return to the clock and outside temperature gauge.

When the ignition switch is on, the last previously used mode displayed just before the ignition switch is off will appear.

If the electrical power source has been disconnected from the multi-information display, the display will automatically be set to the initial mode.

When the instrument panel lights are turned on, the brightness of the display will be reduced.

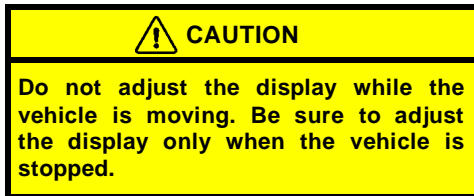

1. Instantaneous fuel consumption ("MPG" or "L/100 km")

The instantaneous fuel consumption is calculated and displayed based on distance and fuel consumption for 2 seconds with the engine running.

The displayed value is updated every 2 seconds.

Note that an accurate figure may not be shown in the following cases.

- ◀ When the vehicle is stopped with the engine running, the display will indicate the extremely high fuel consumption.
- ◀ When the vehicle is driving down a long slope, applying the engine brake, the display will indicate the extremely low fuel consumption.

The calculation is reset when the ignition switch is turned off.

2. Average fuel consumption ("AVG. MPG" or "AVG. L/100 km")

Average fuel consumption is calculated and displayed based on total driving distance and total fuel consumption with the engine running.

The displayed value is updated every 10 seconds.

To reset the calculations, push and hold the "MODE/RESET" button for more than 1 second.

3. Driving range ("RANGE MI" or "RANGE KM")

The distance the vehicle can travel with the remaining fuel is calculated and displayed based on the quantity of remaining fuel and past fuel consumption.

The driving range display indicates the approximate distance that you can drive until the fuel gauge reaches "E". It is different from the actual distance traveled.

The displayed value is updated every time the fuel equivalent for 1 mile or 1 km is consumed.

Every time you refuel the vehicle, the calculation is reset.

The actual driving range varies with driving habits and road conditions. If fuel consumption is good, the driving range will be longer. If fuel consumption is poor, the driving range will be shorter.

If the low fuel level warning light comes on, refuel even if the display indicates that the vehicle can be driven further.

4. Average vehicle speed ("AVG. MPH" or "AVG. KM/h")

Average vehicle speed is calculated and displayed based on total driving distance and total driving time with the engine running.

The displayed value is updated every 10 seconds.

To reset the calculations, push and hold the "MODE/RESET" button for more than 1 second.

5. Driving time ("E/T")

The elapsed time after the engine starts is displayed.

When the engine is started, driving time is counted from 0:00. Up to 99:59 (99 hours, 59 minutes) can be displayed. When the driving time exceeds 99:59, the counter returns to 0:00.

To reset the calculations, push and hold the "MODE/RESET" button for more than 1 second.

Compass

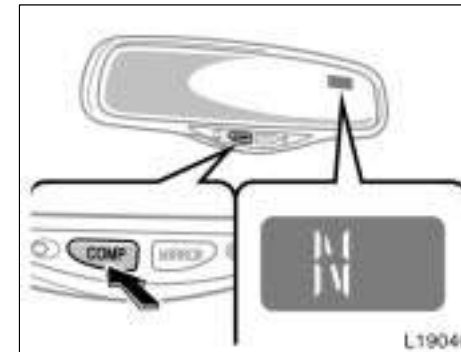

The direction is indicated on the inside rear view mirror.

If the ignition switch was turned off with the system on, the system will automatically turn back on when the ignition switch is turned on.

Push the "COMP" switch to turn the compass system on and off.

The compass indicates the direction that the vehicle is heading. In the above case, it shows that the vehicle is heading north.

Displays	Directions
N	North
NE	Northeast
E	East
SE	Southeast
S	South
SW	Southwest
W	West
NW	Northwest

The compass may not show the correct direction in the following conditions:

- ◀ The vehicle is stopped immediately after turning.
- ◀ The compass does not adjust while the vehicle is stopped.
- ◀ The ignition switch is turned off immediately after turning.
- ◀ The vehicle is on an inclined surface.

◀ The vehicle is in a place where the earth's magnetic field is subject to interference by artificial magnetic fields (underground parking, under a steel tower, between buildings, roof parking, near a crossing, near a large vehicle, etc.).

◀ The vehicle is magnetized. (There is a magnet or a metal object on or near the inside rear view mirror.)

◀ The battery has been disconnected.

Your vehicle is out of the set zone. Refer to the "CALIBRATING THE COMPASS" below to set the zone number.

The compass works to calibrate the direction automatically while the vehicle is in motion, if deviation is small.

For additional precision or for complete calibrating, see "CALIBRATING THE COMPASS" below.

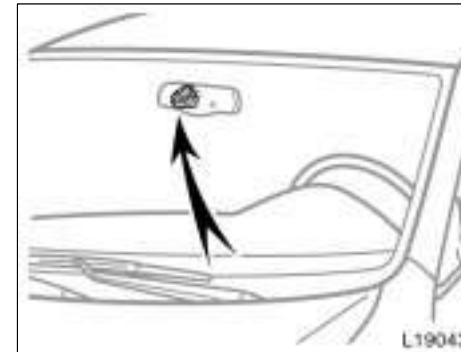

Compass sensor

The compass sensor is in the inside rear view mirror.

NOTICE

Do not put magnets or a metal object on or near the inside rear view mirror of the vehicle. Doing this may cause malfunction of the compass sensor.

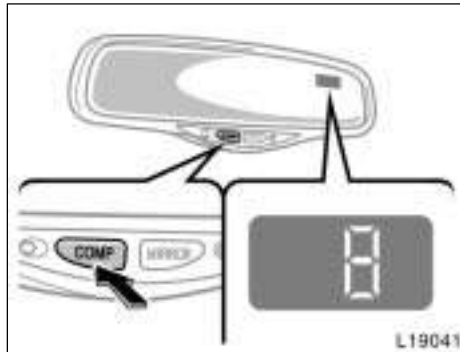

CALIBRATING THE COMPASS (deviation calibration)

The direction display on the compass deviates from the true direction determined by the earth's magnetic field. The angle of deviation varies according to the geographic position of the vehicle.

To adjust this deviation, stop the vehicle, then push and hold the "COMP" switch until the zone number appears on the display. Then push the "COMP" switch, referring to the following map to select the number of the zone where the vehicle is.

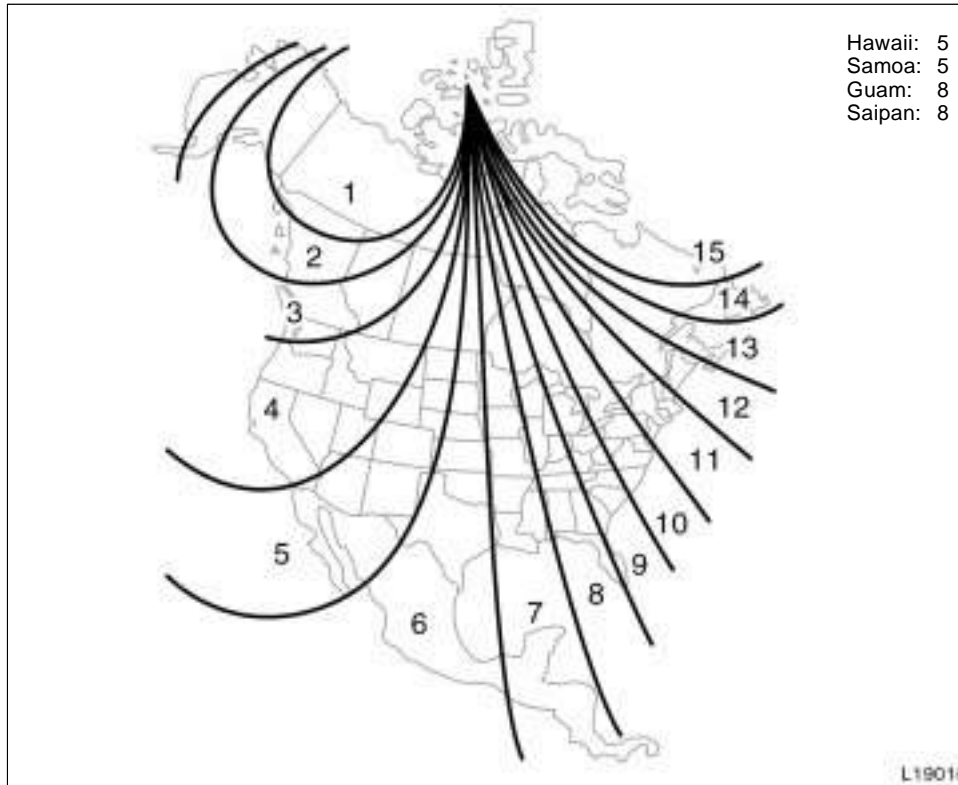

Zone number

After calibration, leaving the system for several seconds returns it to the compass mode.

⚠ CAUTION

Do not adjust the display while the vehicle is moving. Be sure to adjust the display only when the vehicle is stopped.

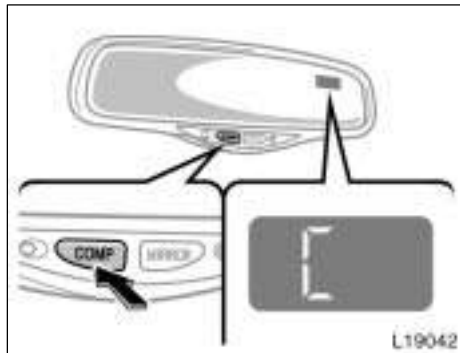

CALIBRATING THE COMPASS (circling calibration)

Sometimes the direction display on the compass may not change after a turn. To rectify this, stop the vehicle and push and hold the "COMP" switch until "C" appears on the display.

If "C" appears on the display because of the drastic change of the magnetic field, perform circling calibration.

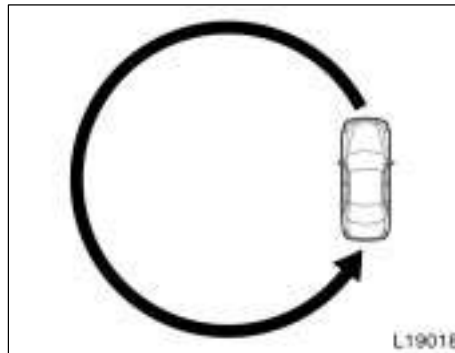

Drive the vehicle in a circle at 8 km/h (5 mph) or less. If there is not enough space to drive in a circle, drive around the block.

After driving 1 to 3 circles in the above method, calibration is completed when the direction is shown on the display.

If calibration cannot be performed because of the magnetized vehicle etc., take your vehicle to Toyota dealer.

Perform circling calibration just after you have purchased your Toyota. And then always perform circling calibration after the battery has been removed, replaced or disconnected.

◀ Do not perform circling calibration of the compass in a place where the earth's magnetic field is subject to interference by artificial magnetic fields (underground parking, under a steel tower, between buildings, roof parking, near a crossing, near a large vehicle, etc.).

◀ During calibration, do not operate electric systems (moon roof, power windows, etc.) as they may interfere with the calibration.

CAUTION

- ◀ When doing the circling calibration, be sure to secure a wide space, and pay attention to people and vehicles in the neighborhood. Do not violate any local traffic rules while performing circling calibration.
- ◀ Do not adjust the display while the vehicle is moving. Be sure to adjust the display only when the vehicle is stopped.

Power outlets

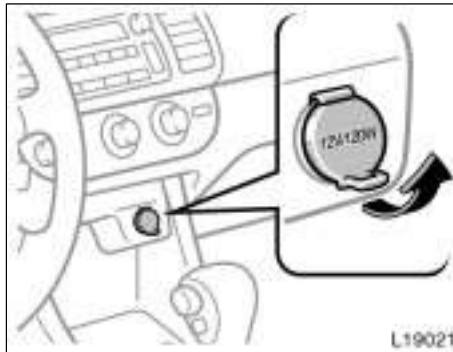

Instrument panel



Rear console box

The power outlets are designed for power supply for car accessories.

The key must be in the "ACC" or "ON" position for the power outlet to be used.

NOTICE

- ▲ To prevent the fuse from being blown, do not use the electricity over the total vehicle capacity of 12V/120W.
- ▲ To prevent the battery from being discharged, do not use the power outlets longer than necessary when the engine is not running.
- ▲ Close the power outlet lid when the power outlets are not in use. Inserting a foreign object other than the appropriate plug that fits the outlet, or allowing any liquid into the outlet may cause electrical failure or short circuits.

Garage door opener

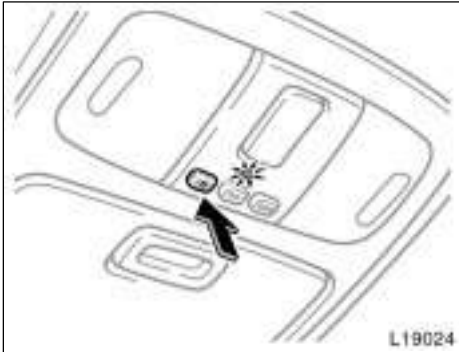

The garage door opener (HomeLink Universal Transceiver) is manufactured under license from HomeLink and can be programmed to operate garage doors, gates, entry doors, door locks, home lighting systems, and security systems, etc.

(a) Programming the HomeLink

The HomeLink in your vehicle has 3 buttons and you can store one program for each button.

To ensure correct programming into the HomeLink, install a new battery in the hand-held transmitter prior to programming.

The battery side of the hand-held transmitter must be pointed away from the HomeLink during the programming process.

For Canadian users, follow the procedure in "Programming an entrance gate/Programming all devices in the Canadian market".

1. Decide which of 3 HomeLink buttons you want to program.
2. Place your hand-held garage transmitter 25 to 75 mm (1 to 3 in.) away from the surface of the HomeLink.

Keep the indicator light on the HomeLink in view while programming.

3. Simultaneously press and hold the hand-held garage transmitter button along with the selected HomeLink button.
4. When the indicator light on the HomeLink changes from a slow to a rapid flash after 20 seconds, you can release both buttons.
5. Test the operation of the HomeLink by pressing the newly programmed button. If programming a garage door opener, check to see if the garage door opens and closes.

If the garage door does not operate, identify if your garage transmitter is of the "Rolling Code" type. Press and hold the programmed HomeLink button. The garage door has the rolling code feature if the indicator light (on the HomeLink) flashes rapidly and then remains lit after 2 seconds. If your garage transmitter is the "Rolling Code" type, proceed to the heading "Programming a rolling code system".

6. Repeat steps 2 through 5 for each remaining HomeLink button to program another device.

Programming a rolling code system

If your device is “Rolling Code” equipped, it is necessary to follow steps 1 through 4 under the heading “Programming the HomeLink▼” before proceeding with the steps listed below.

1. Locate the “training” button on the ceiling mounted garage door opener motor. The exact location and color of the button may vary by brand of garage door opener. Refer to the owner’s guide supplied by the garage door opener manufacturer for the location of this “training” button.
2. Press the “training” button on the ceiling mounted garage door opener motor.

Following this step, you have 30 seconds in which to initiate step 3 below.

3. Press and release the vehicle’s programmed HomeLink▼ button twice. The garage door may open. If the door does open, the programming process is complete. If the door does not open, press and release the button a third time. This third press and release will complete the programming process by opening the garage door.

The ceiling mounted garage door opener motor should now recognize the HomeLink▼ unit and be able activate the garage door up/down.

4. Repeat steps 1 through 3 for each remaining HomeLink▼ button to program another rolling code system.

Programming an entrance gate/Programming all devices in the Canadian market

1. Decide which of the 3 HomeLink▼ buttons you want to program.
2. Place your hand-held gate/device transmitter 25 to 75 mm (1 to 3 in.) away from the surface of the HomeLink▼.

Keep the indicator light on the HomeLink▼ in view while programming.

3. Press and hold the selected HomeLink▼ button.
4. Continuously press and release (cycle) the hand-held gate/device transmitter button every two seconds until step 5 is complete.
5. When the indicator light on the HomeLink▼ changes from a slow to a rapid flash after 20 seconds, you can release both buttons.

6. Test the operation of the HomeLink▼ by pressing the newly programmed button. Check to see if the gate/device operates correctly.
7. Repeat steps 1 through 6 for each remaining HomeLink▼ button to program another device.

Programming other devices

To program other devices such as home security systems, home door locks or lighting, contact your authorized Toyota dealer for assistance.

Reprogramming a button

Individual HomeLink▼ buttons cannot be erased, however, to reprogram a single button, follow the procedure “Programming the HomeLink▼”.

(b) Operating the HomeLink▼

To operate the HomeLink▼, press the appropriate HomeLink▼ button to activate the programmed device. The HomeLink▼ indicator light should come on. The HomeLink▼ continues to send the signal for up to 20 seconds as long as the button is pressed.

(c) Erasing the entire HomeLink▼ memory (all three programs)

To erase all previously programmed codes at one time, press and hold down the 2 outside buttons for 20 seconds until the indicator light flashes.

If you sell your vehicle, be sure to erase the programs stored in the HomeLink▼ memory.

 **CAUTION**

◀ **When programming the HomeLink▼ Universal Transceiver, you may be operating a garage door or other device. Make sure people and objects are out of the way of the garage door or other device to prevent potential harm or damage.**

◀ **Do not use this HomeLink▼ Universal Transceiver with any garage door opener that lacks the safety stop and reverse feature as required by federal safety standards. (This includes any garage door opener model manufactured before April 1, 1982.) A garage door opener which cannot detect an object (signaling the door to stop and reverse), does not meet current federal safety standards. Using a garage door opener without these features increases risk of serious injury or death.**

**FCC ID: CB2300NHL3
CANADA: 2791032088**

This device complies with FCC Rules Part 15. Operation is subject to the following two conditions: (1) This device may not cause harmful interference, and (2) this device must accept any interference that may be received, including interference that may cause undesired operation.

WARNING: This transmitter has been tested and complies with FCC and DOC/MPAC rules. Changes or modifications not expressly approved by the partly responsible for compliance could void the user's authority to operate the device.

Glove box

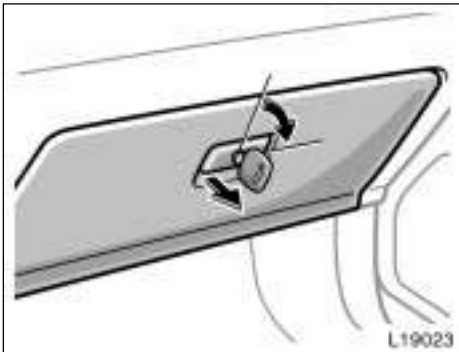

To use the glove box, do this.

To open: Pull the lever.

With the instrument panel lights on, the glove box light will come on when the glove box is open.

To lock: Insert the master key and turn it clockwise.

CAUTION

To reduce the chance of injury in case of an accident or a sudden stop, always keep the glove box door closed while driving.

Auxiliary boxes

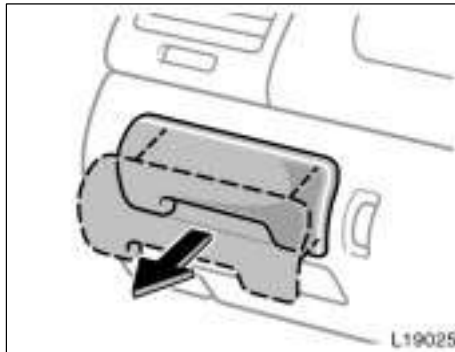

Instrument panel

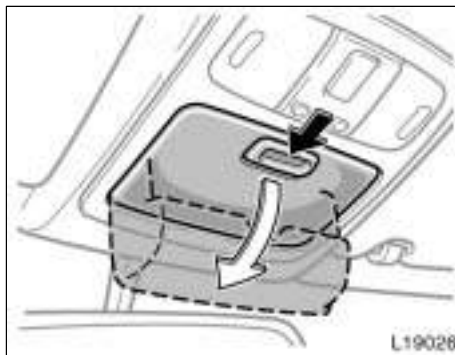

Over head console

To use the box, open it as shown above.

CAUTION

To reduce the chance of injury in case of an accident or a sudden stop, always keep the auxiliary box closed while driving.

NOTICE

Over head console box—During hot weather, the interior of the vehicle becomes very hot. Do not leave anything flammable or deformable such as a lighter, glasses, etc. inside.

Rear console box



UPPER TRAY

To access the upper tray, raise the console box lid while pushing the lock release button.

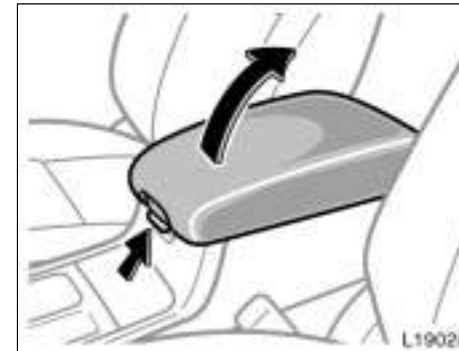

CONSOLE BOX

To access the rear console box, pull up the lock release lever while raising the rear console box lid.

⚠ CAUTION

To reduce the chance of injury in case of an accident or a sudden stop, always keep the console box closed while driving.

Front cup holder

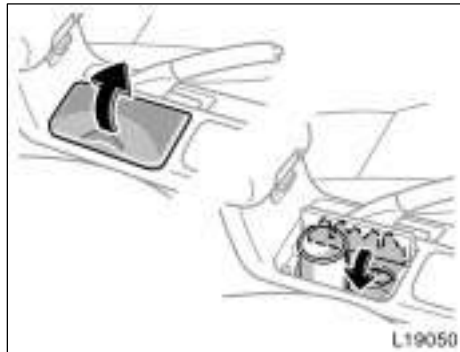

With lever type parking brake

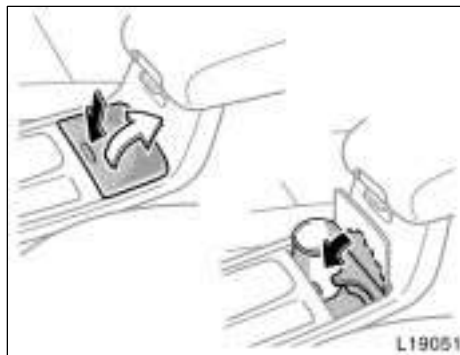

With pedal type parking brake

The cup holder is designed for holding cups or drink-cans securely.

With lever type parking brake: To use the cup holder, open the lid.

With pedal type parking brake: To use the cup holder, push the lid.

To hold the cups or drink-cans securely, adjust the size with the adapter.

CAUTION

Do not place anything else other than cups or drink-cans in the cup holder, as such items may be thrown about in the compartment and possibly injure people in the vehicle during sudden braking or in an accident.

To reduce the chance of injury in case of an accident or sudden stop while driving, keep the cup holder closed when it is not in use.

Rear cup holder



The cup holder is designed for holding cups or drink-cans securely.

To use the cup holder, pull down the arm-rest.

CAUTION

◀ Do not place anything else other than cups or drink-cans in the cup holder, as such items may be thrown about in the compartment and possibly injure people in the vehicle during sudden braking or in an accident.

◀ Do not lift the armrest upright when the cup holder is in use.

Storage box



This box is designed to hold things like bottles.

Grocery bag hooks



This hook is designed to hang things like grocery bags.

NOTICE

To prevent damage to the hook, avoid hanging heavy loads on it.

Luggage net

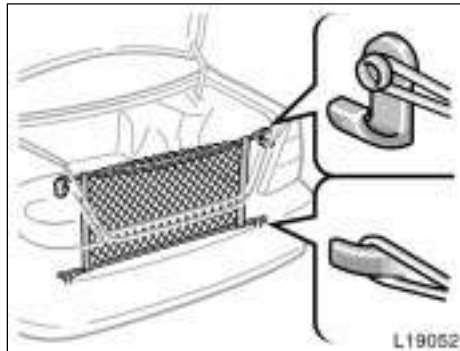

To secure your luggage, hang the luggage net on the hooks.

NOTICE

- ▲ Do not use the net to secure sharp or heavy object. The net will tear off.
- ▲ Be sure not to twist the net when hooking.

Rear sunshade

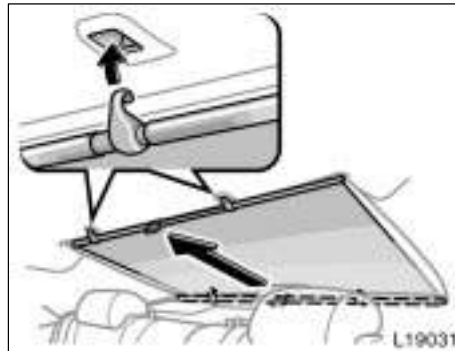

To raise the rear sunshade, pull the tab of the sunshade and hook it on the anchors. To lower the rear sunshade, pull the tab slightly to unhook the sunshade, and lower it slowly.

NOTICE

- Observe the following, otherwise damage and/or failure may result:
- ▲ Do not place anything where they may hinder the opening/closing of the shade.
 - ▲ Do not place things on shade.

Floor mat

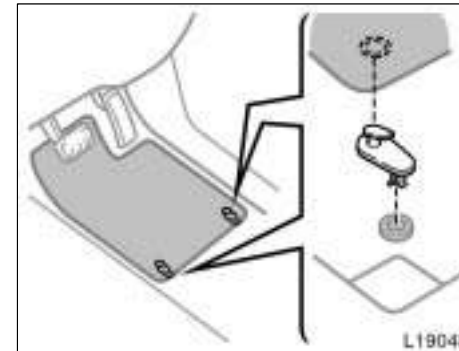

Use a floor mat of the correct size.

If the floor carpet and floor mat have 2 holes, then they are designed for use with locking clips. Fix the floor mat with locking clips into the holes in the floor carpet.



CAUTION

Make sure the floor mat is properly placed on the floor carpet. If the floor mat slips and interferes with the movement of the pedals during driving, it may cause an accident.

SECTION 2

INFORMATION BEFORE DRIVING YOUR TOYOTA

Break-in period	181
Fuel	181
Operation in foreign countries	183
Three-way catalytic converters	183
Engine exhaust cautions	185
Facts about engine oil consumption	185
Iridium-tipped spark plugs	186
Brake system	187
Brake pad wear limit indicators	191
Luggage stowage precautions	191
Your Toyota's identification	192
Theft prevention labels	193
Suspension and chassis	193
Types of tires	194

Break-in period

Drive gently and avoid high speeds.

Your vehicle does not need an elaborate break-in. But following a few simple tips for the first 1600 km (1000 miles) can add to the future economy and long life of your vehicle:

- © Do not drive over 88 km/h (55 mph).
- © Run the engine at moderate speed between 2000 and 4000 rpm.
- © Avoid full-throttle starts.
- © Try to avoid hard stops during the first 300 km (200 miles).
- © Do not drive slowly with the manual transmission in a high gear.
- © Do not drive for a long time at any single speed, either fast or slow.
- © Do not tow a trailer during the first 800 km (500 miles).

Fuel

FUEL TYPE

Your new vehicle must use only unleaded gasoline.

To help prevent gas station mix-ups, your Toyota has a smaller fuel tank opening. The special nozzle on pumps with unleaded fuel will fit it, but the larger standard nozzle on pumps with leaded gas will not.

At a minimum, the gasoline you use should meet the specifications of ASTM D4814 in the U.S.A. and CGSB 3.5-M93 in Canada.

NOTICE

Do not use leaded gasoline. Use of leaded gasoline will cause the three-way catalytic converter to lose its effectiveness and the emission control system to function improperly. Also, this can increase maintenance costs.

OCTANE RATING

2AZ-FE engine: Select Octane Rating 87 (Research Octane Number 91) or higher.

1MZ-FE engine: Select Octane Rating 87 (Research Octane Number 91) or higher. For improved vehicle performance, the use of premium unleaded gasoline with an Octane Rating 91 (Research Octane Number of 96) or higher is recommended.

Use of unleaded gasoline with an octane rating or research octane number lower than stated above will cause persistent heavy knocking. If it is severe, this will lead to engine damage.

If your engine knocks...

If you detect heavy knocking even when using the recommended fuel, or if you hear steady knocking while holding a steady speed on level roads, consult your Toyota dealer.

However, now and then, you may notice light knocking for a short time while accelerating or driving up hills. This is no cause for concern.

GASOLINE CONTAINING DETERGENT ADDITIVES

Toyota recommends the use of gasoline that contains detergent additives to avoid build-up of engine deposits.

However, all gasoline sold in the U.S. contains detergent additives to keep clean and/or clean intake systems.

QUALITY GASOLINE

Automotive manufacturers in the U.S., Europe and Japan have developed a specification for quality fuel named World-Wide Fuel Charter (WWFC) that is expected to be applied world wide. The WWFC consists of three categories that depend on required emission levels. In the U.S., category 3 has been adopted. The WWFC improves air quality by providing for better emissions in vehicle fleets, and customer satisfaction through better vehicle performance.

CLEANER BURNING GASOLINE

Cleaner burning gasoline, including reformulated gasoline that contains oxygenates such as ethanol or MTBE is available in many areas.

Toyota recommends the use of cleaner burning gasoline and appropriately blended reformulated gasoline. These types of gasoline provide excellent vehicle performance, reduce vehicle emissions, and improve air quality.

OXYGENATES IN GASOLINE

Toyota allows the use of oxygenate blended gasoline where the oxygenate content is up to 10% ethanol or 15% MTBE. If you use gasohol in your Toyota, be sure that it has an octane rating no lower than 87.

Toyota does not recommend the use of gasoline containing methanol.

GASOLINE CONTAINING MMT

Some gasoline contain an octane enhancing additive called MMT (Methylcyclopentadienyl Manganese Tricarbonyl).

Toyota does not recommend the use of gasoline that contains MMT. If fuel containing MMT is used, your emission control system may be adversely affected. The Malfunction Indicator Lamp on the instrument cluster may come on. If this happens, contact your Toyota dealer for service.

GASOLINE QUALITY

In a very few cases, you may experience driveability problems caused by the particular gasoline that you are using. If you continue to have unacceptable driveability, try changing gasoline brands. If this does not rectify your problem, then consult your Toyota dealer.

NOTICE

- ◀ *Do not use gasohol other than stated above. It will cause fuel system damage or vehicle performance problems.*
- ◀ *If driveability problems are encountered (poor hot starting, vaporizing, engine knock, etc.), discontinue the use.*
- ◀ *Take care not to spill gasohol during refueling. Gasohol may cause paint damage.*

FUEL TANK CAPACITY

70 L (18.5 gal., 15.4 Imp. gal.)

Operation in foreign countries

If you plan to drive your Toyota in another country...

First, comply with the vehicle registration laws.

Second, confirm the availability of the correct fuel (unleaded and minimum octane number).

Three-way catalytic converters

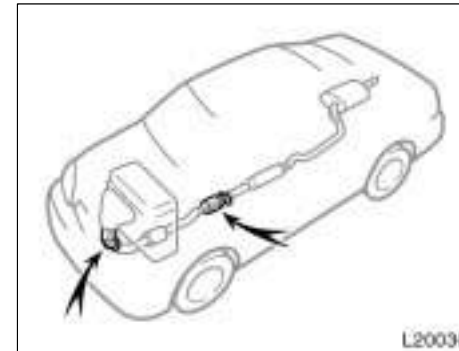

2AZ-FE engine

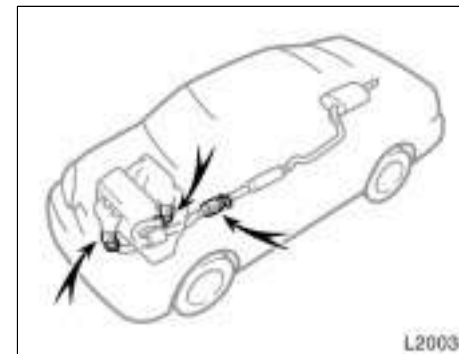

1MZ-FE engine

The three-way catalytic converter is an emission control device installed in the exhaust system.

The purpose is to reduce pollutants in the exhaust gas.

 CAUTION

- ©Keep people and combustible materials away from the exhaust pipe while the engine is running. The exhaust gas is very hot.
- ©Do not drive, idle or park your vehicle over anything that might burn easily such as grass, leaves, paper or rags.

NOTICE

A large amount of unburned gases flowing into the three-way catalytic converter may cause it to overheat and create a fire hazard. To prevent this and other damage, observe the following precautions:

- ◀Use only unleaded gasoline.
- ◀Do not drive with an extremely low fuel level; running out of fuel could cause the engine to misfire, creating an excessive load on the three-way catalytic converter.
- ◀Do not allow the engine to run at idle speed for more than 20 minutes.
- ◀Avoid racing the engine.
- ◀Do not push-start or pull-start your vehicle.
- ◀Do not turn off the ignition while the vehicle is moving.

◀Keep your engine in good running order. Malfunctions in the engine electrical system, electronic ignition system/distributor ignition system or fuel system could cause an extremely high three-way catalytic converter temperature.

◀If the engine becomes difficult to start or stalls frequently, take your vehicle in for a check-up as soon as possible. Remember, your Toyota dealer knows your vehicle and its three-way catalytic converter system best.

◀To ensure that the three-way catalytic converter and the entire emission control system operate properly, your vehicle must receive the periodic inspections required by the Toyota Maintenance Schedule. For scheduled maintenance information, refer to the "Scheduled Maintenance Guide" or "Owner's Manual Supplement".

Engine exhaust cautions

 **CAUTION**

- © Avoid inhaling the engine exhaust. It contains carbon monoxide, which is a colorless and odorless gas. It can cause unconsciousness or even death.
- © Make sure the exhaust system has no holes or loose connections. The system should be checked from time to time. If you hit something, or notice a change in the sound of the exhaust, have the system checked immediately.
- © Do not run the engine in a garage or enclosed area except for the time needed to drive the vehicle in or out. The exhaust gases cannot escape, making this a particularly dangerous situation.
- © Do not remain for a long time in a parked vehicle with the engine running. If it is unavoidable, however, do so only in an unconfined area and adjust the heating or cooling system to force outside air into the vehicle.

- © Keep the trunk lid closed while driving. An open or unsealed trunk lid may cause exhaust gases to be drawn into the vehicle.
- © To allow proper operation of your vehicle's ventilation system, keep the inlet grilles in front of the windshield clear of snow, leaves, or other obstructions.
- © If you smell exhaust fumes in the vehicle, drive with the windows open and the trunk lid closed. Have the cause immediately located and corrected.

Facts about engine oil consumption

FUNCTIONS OF ENGINE OIL

Engine oil has the primary functions of lubricating and cooling the inside of the engine, and plays a major role in maintaining the engine in proper working order.

ENGINE OIL CONSUMPTION

It is normal that an engine should consume some engine oil during normal engine operation. The causes of oil consumption in a normal engine are as follows.

- © Oil is used to lubricate pistons, piston rings and cylinders. A thin film of oil is left on the cylinder wall when a piston moves downwards in the cylinder. High negative pressure generated when the vehicle is decelerating sucks some of this oil into the combustion chamber. This oil as well as some part of the oil film left on the cylinder wall is burned by the high temperature combustion gases during the combustion process.

© Oil is also used to lubricate the stems of the intake valves. Some of this oil is sucked into the combustion chamber together with the intake air and is burned along with the fuel. High temperature exhaust gases also burn the oil used to lubricate the exhaust valve stems.

The amount of engine oil consumed depends on the viscosity of the oil, the quality of the oil and the conditions the vehicle is driven under.

More oil is consumed by high-speed driving and frequent acceleration and deceleration.

A new engine consumes more oil, since its pistons, piston rings and cylinder walls have not become conditioned.

When judging the amount of oil consumption, note that the oil may become diluted and make it difficult to judge the true level accurately.

As an example, if a vehicle is used for repeated short trips, and consumes a normal amount of oil, the dipstick may not show any drop in the oil level at all, even after 1000 km (600 miles) or more. This is because the oil is gradually becoming diluted with fuel or moisture, making it appear that the oil level has not changed.

The diluting ingredients evaporate out when the vehicle is then driven at high speeds, as on an express way, making it appear that oil is excessively consumed after driving at high speeds.

IMPORTANCE OF ENGINE OIL LEVEL CHECK

One of the most important points in proper vehicle maintenance is to keep the engine oil at the optimum level so that oil function will not be impaired. Therefore, it is essential that the oil level be checked regularly. Toyota recommends that the oil level be checked every time you refuel the vehicle.

NOTICE

Failure to check the oil level regularly could lead to serious engine trouble due to insufficient oil.

For detailed information on oil level check, see "Checking the engine oil level" on page 251 in Section 7-2.

Iridium-tipped spark plugs

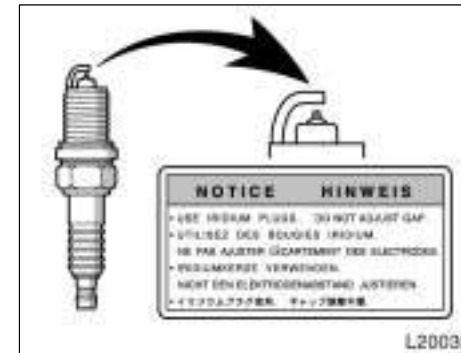

Your engine is fitted with iridium-tipped spark plugs.

NOTICE

Use only iridium-tipped spark plugs and do not adjust gaps for your engine performance and smooth drive-ability.

Brake system

The tandem master cylinder brake system is a hydraulic system with two separate sub-systems. If either sub-system should fail, the other will still work. However, the pedal will be harder to press, and your stopping distance will be longer. Also, the brake system warning light may come on.



BRAKE BOOSTER

The brake booster uses engine vacuum to power-assist the brakes. If the engine should quit while you are driving, you can bring the vehicle to a stop with normal pedal pressure. There is enough reserved vacuum for one or two stops—but no more!

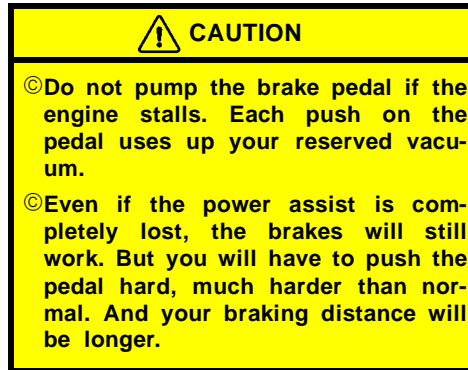

ANTI-LOCK BRAKE SYSTEM (with "ABS" warning light)

The anti-lock brake system is designed to help prevent lock-up of the wheels during a sudden braking or braking on slippery road surfaces. This assists in providing directional stability and steering performance of the vehicle under these circumstances.

Effective way to press the ABS brake pedal: When the anti-lock brake system function is in action, you may feel the brake pedal pulsating and hear a noise. In this situation, to let the anti-lock brake system work for you, just hold the brake pedal down more firmly. Do not pump the brake in a panic stop. This will result in reduced braking performance.

The anti-lock brake system becomes operative after the vehicle has accelerated to a speed in excess of approximately 10 km/h (6 mph). It stops operating when the vehicle decelerates to a speed below approximately 5 km/h (3 mph).

Depressing the brake pedal on slippery road surfaces such as on the manhole cover, the steel plate under the construction, joints in the bridge, etc. on a rainy day tends to activate the anti-lock brake system.

You may hear a click or motor sound in the engine compartment for a few seconds when the engine is started or just after the vehicle is started. This means that the anti-lock brake system is in the self-check mode, and does not indicate a malfunction.

When the anti-lock brake system is activated, the following conditions may occur. They do not indicate a malfunction of the system:

- © You may hear the anti-lock brake system operating and feel the brake pedal pulsating and the vibrations of the vehicle body and steering wheel. You may also hear the motor sound in the engine compartment even after the vehicle is stopped.
- © At the end of the anti-lock brake system activation, the brake pedal may move a little forward.

 CAUTION

Do not overestimate the anti-lock brake system: Although the anti-lock brake system assists in providing vehicle control, it is still important to drive with all due care and maintain a moderate speed and safe distance from the vehicle in front of you, because there are limits to the vehicle stability and effectiveness of steering wheel operation even with the anti-lock brake system on.

If tires grip performance exceeds its capability, or if hydroplaning occurs during high speed driving in the rain, the anti-lock brake system does not provide vehicle control.

Anti-lock brake system is not designed to shorten the stopping distance: Always drive at the moderate speed and maintain a safe distance from the vehicle in front of you. Compared with vehicles without an anti-lock brake system, your vehicle may require a longer stopping distance in the following cases:

- © Driving on rough, gravel or snow-covered roads.
- © Driving with tire chains installed.
- © Driving over the steps such as the joints on the road.
- © Driving on roads where the road surface is pitted or has other differences in surface height.

Install all 4 tires of specified size at appropriate pressure: The anti-lock brake system detects vehicle speeds using the speed sensors for respective wheels' turning speeds. The use of tires other than specified may fail to detect the accurate turning speed resulting in a longer stopping distance.

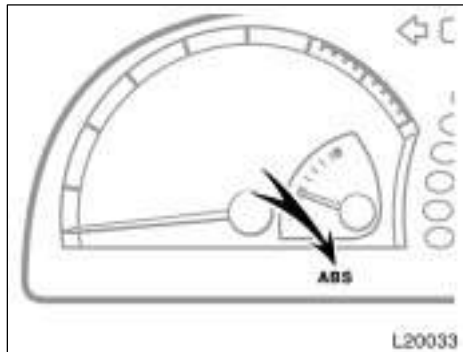

Type A

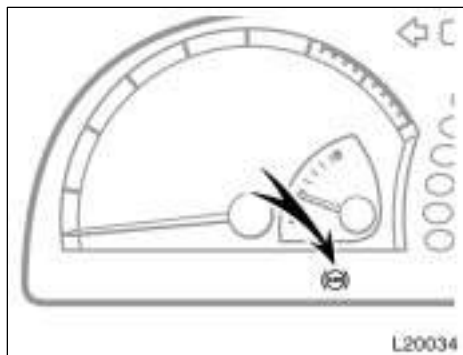

Type B

“ABS” warning light (without vehicle skid control system)

The light comes on when the ignition key is turned to the “ON” position. If the anti-lock brake system works properly, the light turns off after a few seconds. Thereafter, if the system malfunctions, the light comes on again.

When the “ABS” warning light is on (and the brake system warning light is off), the anti-lock brake system does not operate, but the brake system still operates conventionally.

When the “ABS” warning light is on (and the brake system warning light is off), the anti-lock brake system does not operate so that the wheels could lock up during a sudden braking or braking on slippery road surfaces.

If either of the following conditions occurs, this indicates a malfunction somewhere in the parts monitored by the warning light. Contact your Toyota dealer as soon as possible to service the vehicle.

- © The light does not come on when the ignition key is turned to the “ON” position, or remains on.
- © The light comes on while you are driving.

2002 MY CAMRY_U (OM33567U)

A warning light turning on briefly during operation does not indicate a problem.

“ABS” warning light (with vehicle skid control system)

The light comes on when the ignition key is turned to the “ON” position. If the anti-lock brake system and the brake assist system work properly, the light turns off after a few seconds. Thereafter, if the system malfunctions, the light comes on again.

When the “ABS” warning light is on (and the brake system warning light is off), the anti-lock brake system, the brake assist system, the traction control system and the vehicle skid control system do not operate, but the brake system still operates conventionally.

When the “ABS” warning light is on (and the brake system warning light is off), the anti-lock brake system does not operate so that the wheels could lock up during a sudden braking or braking on slippery road surfaces.

If either of the following conditions occurs, this indicates a malfunction somewhere in the parts monitored by the warning light. Contact your Toyota dealer as soon as possible to service the vehicle.

- © The light does not come on when the ignition key is turned to the "ON" position, or remains on.
- © The light comes on while you are driving.

A warning light turning on briefly during operation does not indicate a problem.

 **CAUTION**

If the "ABS" warning light remains on together with the brake system warning light, immediately stop your vehicle at a safe place and contact your Toyota dealer.

In this case, not only the anti-lock brake system will fail but also the vehicle will become extremely unstable during braking.

DRUM-IN-DISC TYPE PARKING BRAKE SYSTEM (on some models)

Your vehicle has a drum-in-disc type parking brake system. This type of brake system needs bedding-down of the brake shoes periodically or whenever the parking brake shoes and/or drums are replaced.

Have your Toyota dealer perform the bedding-down.

BRAKE ASSIST SYSTEM (with vehicle skid control system)

When you slam the brakes on, the brake assist system judges as an emergency stop and provides more powerful braking for a driver who cannot hold down the brake pedal firmly.

When you slam the brakes on, more powerful braking will be applied. At this time, you may hear a sound in the engine compartment and feel the vibrations of the brake pedal. This does not indicate a malfunction.

The brake assist system becomes operative after the vehicle has accelerated to a speed in excess of approximately 10 km/h (6 mph). It stops operating when the vehicle decelerates to a speed below approximately 5 km/h (3 mph).

For an explanation of this system's warning light, see "Service reminder indicators and warning buzzers" on page 99 in Section 1-5.

Brake pad wear limit indicators

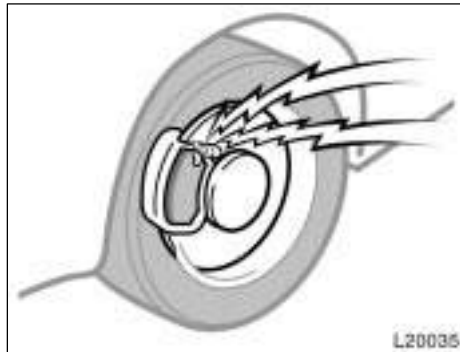

The brake pad wear limit indicators on your disc brakes give a warning noise when the brake pads are worn to where replacement is required.

If you hear a squealing or scraping noise while driving, have the brake pads checked and replaced by your Toyota dealer as soon as possible. Expensive rotor damage can result if the pads are not replaced when necessary.

Luggage stowage precautions

When stowing luggage or cargo in the vehicle, observe the following:

- © Put luggage or cargo in the trunk when at all possible. Be sure all items are secured in place.
- © Be careful to keep the vehicle balanced. Locating the weight as far forward as possible helps maintain balance.
- © For better fuel economy, do not carry unneeded weight.

⚠ CAUTION

- © To prevent luggage or packages from sliding forward during braking, do not stack anything in the enlarged trunk. Keep luggage or packages low, as close to the floor as possible.
- © Never allow anyone to ride in the enlarged trunk. It is not designed for passengers. They should ride in their seats with their seat belts properly fastened. Otherwise, they are much more likely to suffer serious bodily injury, in the event of sudden braking or a collision.

- © Do not place anything on the package tray behind the rear seatback. Such items may be thrown about and possibly injure people in the vehicle during sudden braking or an accident.
- © Do not drive with objects left on top of the instrument panel. They may interfere with the driver's field of view. Or they may move during sharp vehicle acceleration or turning, and impair the driver's control of the vehicle. In an accident they may injure the vehicle occupants.

NOTICE

Do not load the vehicle beyond the vehicle capacity weight specified on page 274 in Section 8.

**Your Toyota's identification—
—Vehicle identification
number**

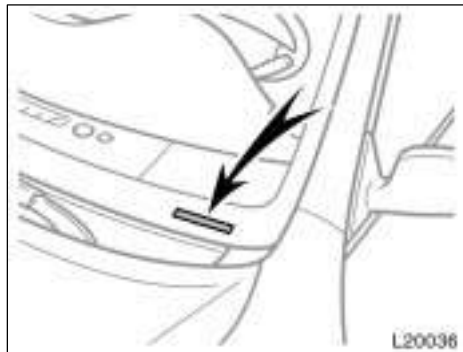

The vehicle identification number (VIN) is the legal identifier for your vehicle. This number is on the left top of the instrument panel, and can be seen through the windshield from outside.

This is the primary identification number for your Toyota. It is used in registering the ownership of your vehicle.

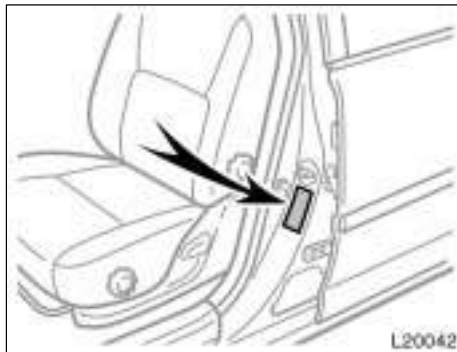

The vehicle identification number (VIN) is also on the Certification Label.

—Engine number



2AZ-FE engine

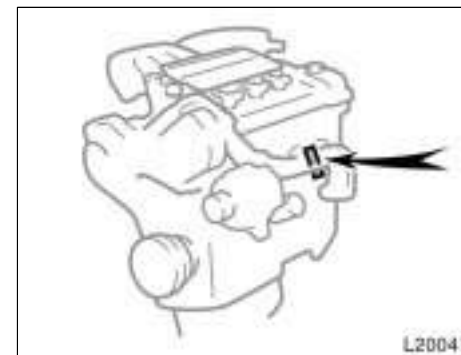

1MZ-FE engine

The engine number is stamped on the engine block as shown.

Theft prevention labels

Your new vehicle carries theft prevention labels which are approximately 56 mm (2.20 in.) by 16 mm (0.63 in.).

The purpose of these labels is to reduce the incidence of vehicle thefts by facilitating the tracing and recovery of parts from stolen vehicles. The label is designed so that once it is applied to a surface, any attempt to remove it will result in destroying the integrity of the label. Transferring these labels intact from one part to another, will be impossible.

NOTICE

You should not attempt to remove the theft prevention labels as it may violate certain state or federal laws.

Suspension and chassis

CAUTION

Do not modify the suspension/chassis with lift kits, spacers, springs, etc. It can cause dangerous vehicle handling characteristics, resulting in loss of control.

Types of tires

Determine what kind of tires your vehicle is originally equipped with.

1. Summer tires

Summer tires are high-speed capability tires best suited to highway driving under dry conditions.

Since summer tires do not have the same traction performance as snow tires, summer tires are inadequate for driving on snow-covered or icy roads. For driving on snow-covered or icy roads, we recommend using snow tires. If installing snow tires, be sure to replace all four tires.

2. All season tires

All season tires are designed to provide better traction in snow and to be adequate for driving in most winter conditions, as well as for use all year round.

All season tires, however, do not have adequate traction performance compared with snow tires in heavy or loose snow. Also, all season tires fall short in acceleration and handling performance compared with summer tires in highway driving.



SECTION 3

STARTING AND DRIVING

Before starting the engine	197
How to start the engine	197
Tips for driving in various conditions	198
Winter driving tips	199
Dinghy towing	200
Trailer towing	201
How to save fuel and make your vehicle last longer	207



Before starting the engine

1. Check the area around the vehicle before entering it.
2. Adjust seat position, seatback angle, seat cushion height, head restraint height and steering wheel angle.
3. Vehicles with the power adjustable pedals—Adjust the position of the accelerator and brake pedals.
4. Adjust the inside and outside rear view mirrors.
5. Lock all doors.
6. Fasten seat belts.

How to start the engine—

(a) Before cranking

1. Apply the parking brake firmly.
2. Turn off unnecessary lights and accessories.
3. **Manual transmission:** Press the clutch pedal to the floor and shift the transmission into neutral. Hold the clutch pedal to the floor until the engine is started. A starter safety device will prevent the starter from operating if the clutch pedal is not fully depressed.
Automatic transmission: Put the selector lever in “P”. If you need to restart the engine while the vehicle is moving, put the selector lever in “N”. A starter safety device will prevent the starter from operating if the selector lever is in any drive position.
4. **Automatic transmission only:** Depress the brake pedal and hold it to the floor until driving off.

(b) Starting the engine

Before starting the engine, be sure to follow the instructions in “(a) Before cranking”.

Normal starting procedure

The multiport fuel injection system/sequential multiport fuel injection system in your engine automatically controls the proper air–fuel mixture for starting. You can start a cold or hot engine as follows:

1. With your foot off the accelerator pedal, crank the engine by turning the key to “START”. Release it when the engine starts.
2. After the engine runs for about 10 seconds, you are ready to drive.

If the weather is below freezing, let the engine warm up for a few minutes before driving.

If the engine stalls...

Simply restart it, using the correct procedure given in normal starting.

If the engine will not start...

See “If your vehicle will not start” on page 211 in Section 4.

NOTICE

- ▼ **Do not crank for more than 30 seconds at a time. This may overheat the starter and wiring systems.**
- ▼ **Do not race a cold engine.**
- ▼ **If the engine becomes difficult to start or stalls frequently, have the engine checked immediately.**

Tips for driving in various conditions

- © Always slow down in gusty crosswinds. This will allow you much better control.
- © Drive slowly onto curbs and, if possible, at a right angle. Avoid driving onto high, sharp-edged objects and other road hazards. Failure to do so can lead to severe tire damage resulting in tire bursts.

Drive slowly when passing over bumps or travelling on a bumpy road. Otherwise, the impact could cause severe damage to the tires and/or wheels.
- © When parking on a hill, turn the front wheels until they touch the curb so that the vehicle will not roll. Apply the parking brake, and place the transmission in "P" (automatic) or in first or reverse (manual). If necessary, block the wheels.

- © Washing your vehicle or driving through deep water may get the brakes wet. To see whether they are wet, check that there is no traffic near you, and then press the pedal lightly. If you do not feel a normal braking force, the brakes are probably wet. To dry them, drive the vehicle cautiously while lightly pressing the brake pedal with the parking brake applied. If they still do not work safely, pull to the side of the road and call a Toyota dealer for assistance.

CAUTION

- © **Before driving off, make sure that the parking brake is fully released and the parking brake reminder light is off.**
- © **Do not leave your vehicle unattended while the engine is running.**
- © **Do not rest your foot on the brake pedal while driving. It can cause dangerous overheating, needless wear, and poor fuel economy.**
- © **To drive down a long or steep hill, reduce your speed and downshift. Remember, if you ride the brakes excessively, they may overheat and not work properly.**

- ©Be careful when accelerating, upshifting, downshifting or braking on a slippery surface. Sudden acceleration or engine braking could cause the vehicle to spin or skid.
- ©Do not drive in excess of the speed limit. Even if the legal speed limit permits it, do not drive over 140 km/h (85 mph) unless your vehicle has high-speed capability tires. Driving over 140 km/h (85 mph) may result in tire failure, loss of control and possible injury. Be sure to consult a tire dealer to determine whether the tires on your vehicle are high-speed capability tires or not before driving at such speeds.
- ©Do not continue normal driving when the brakes are wet. If they are wet, your vehicle will require a longer stopping distance, and it may pull to one side when the brakes are applied. Also, the parking brake will not hold the vehicle securely.

Winter driving tips

Make sure you have a proper freeze protection of engine coolant.

Your coolant must contain ethylene-glycol type coolant for a proper corrosion protection of aluminum components. Use "TOYOTA Long Life Coolant" or equivalent.

See page 252 in Section 7-2 for details about coolant type selection.

NOTICE

Do not use alcohol type antifreeze or plain water alone.

When it is extremely cold, we recommend to use 60% solution for your Toyota, to provide protection down to about -50◄ (-58◄). Do not use more than 70% solution for better coolant performance.

Check the condition of the battery and cables.

Cold temperatures reduce the capacity of any battery, so it must be in top shape to provide enough power for winter starting. Section 7-3 tells you how to visually inspect the battery. Your Toyota dealer and most service stations will be pleased to check the level of charge.

Make sure the engine oil viscosity is suitable for the cold weather.

See page 251 in Section 7-2 for recommended viscosity. Leaving a heavy summer oil in your vehicle during winter months may cause harder starting. If you are not sure about which oil to use, call your Toyota dealer—he will be pleased to help.

Keep the door locks from freezing.

Squirt lock de-icer or glycerine into the locks to keep them from freezing.

Use a washer fluid containing an anti-freeze solution.

This product is available at your Toyota dealer and most auto parts stores. Follow the manufacturer's directions for how much to mix with water.

NOTICE

Do not use engine antifreeze or any other substitute because it may damage your vehicle's paint.

Do not use your parking brake when there is a possibility it could freeze.

When parking, put the transmission into "P" (automatic) or into first or reverse (manual) and block the rear wheels. Do not use the parking brake, or snow or water accumulated in and around the parking brake mechanism may freeze, making it hard to release.

Keep ice and snow from accumulating under the fenders.

Ice and snow built up under your fenders can make steering difficult. During bad winter driving, stop and check under the fenders occasionally.

Depending on where you are driving, we recommend you carry some emergency equipment.

Some of the things you might put in the vehicle are tire chains, window scraper, bag of sand or salt, flares, small shovel, jumper cables, etc.

**Dinghy towing
(with automatic transmission)**

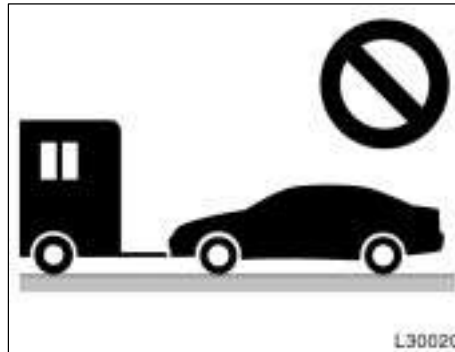

Your vehicle is not designed to be dinghy towed (with four wheels on the ground) behind a motorhome.

NOTICE

Do not tow your vehicle with four wheels on the ground. This may cause serious damage to your vehicle.

**Dinghy towing
(with manual transmission)**

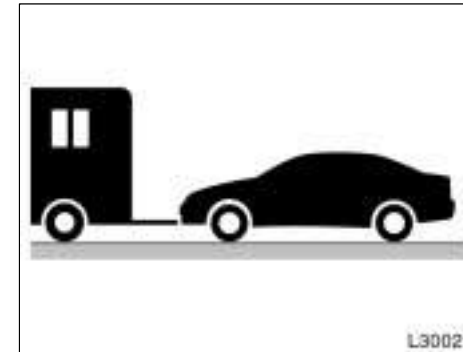

Your vehicle can be dinghy towed (with four wheels on the ground) from the front behind a motorhome.

CAUTION

Dinghy towing requires special equipment and accessories. Please refer to your service outlet of the motorhome manufacture for the recommended equipment.

NOTICE

Dinghy towing does not eliminate the possibility of damage to your vehicle.

DINGHY TOWING TIPS

Before dinghy towing, be sure to observe the following in order to reduce the damage to your vehicle.

1. Put the shift lever in neutral.
2. Turn the ignition switch to the "ACC" position. Make sure the audio is turned off and any item is not plugged into the power outlet.

NOTICE

To avoid the locking of the steering wheel, turn the ignition switch to the "ACC" position.

3. Release the parking brake.

After dinghy towing, let the engine idle for more than 3 minutes before driving the vehicle.

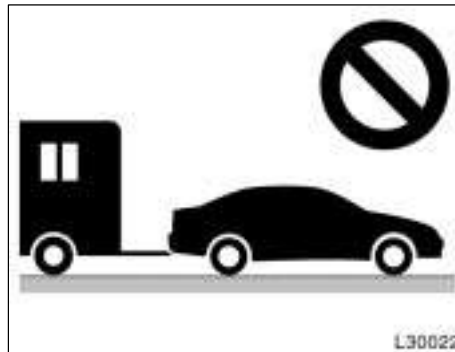

NOTICE

Do not tow your vehicle from the rear. This may cause serious damage to your vehicle.

Trailer towing

Your vehicle is designed primarily as a passenger-carrying vehicle. Towing a trailer will have an adverse effect on handling, performance, braking, durability and driving economy (fuel consumption, etc.). Your safety and satisfaction depend on the proper use of correct equipment and cautious driving habits. For your safety and the safety of others, you must not overload your vehicle or trailer. Toyota warranties do not apply to damage or malfunction caused by towing a trailer for commercial purposes. Ask your local Toyota dealer for further details before towing.

NOTICE

When towing a trailer, be sure to consult your Toyota dealer for further information on additional requirements such as a towing kit, etc.

WEIGHT LIMITS

Before towing, make sure the total trailer weight, gross vehicle weight, gross axle weight and trailer tongue load are all within the limits.

The total trailer weight and tongue load can be measured with platform scales found at a highway weighing station, building supply company, trucking company, junk yard, etc.

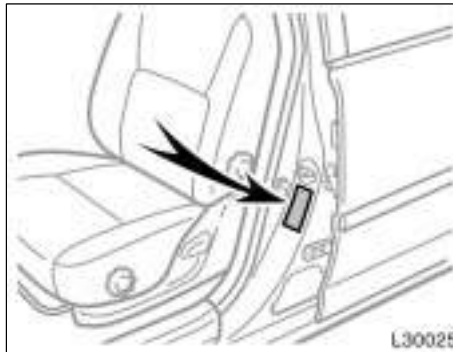

⚠ CAUTION

©The total trailer weight (trailer weight plus its cargo load) must not exceed 907 kg (2000 lb.). Exceeding this weight is dangerous.

©Trailer hitch assemblies have different weight capacities established by the hitch manufacturer. Even though the vehicle may be physically capable of towing a higher weight, the operator must determine the maximum weight rating of the particular hitch assembly and never exceed the maximum weight rating specified for the trailer-hitch. Exceeding the maximum weight rating set by the trailer hitch manufacturer can cause an accident resulting in serious personal injuries.

©The gross vehicle weight must not exceed the Gross Vehicle Weight Rating (GVWR) indicated on the Certification Label. The gross vehicle weight is the sum of weights of the unloaded vehicle, driver, passengers, luggage, hitch and trailer tongue load. It also includes the weight of any special equipment installed on your vehicle.

©The load on either the front or rear axle resulting from distribution of the gross vehicle weight on both axles must not exceed the Gross Axle Weight Rating (GAWR) listed on the Certification Label.

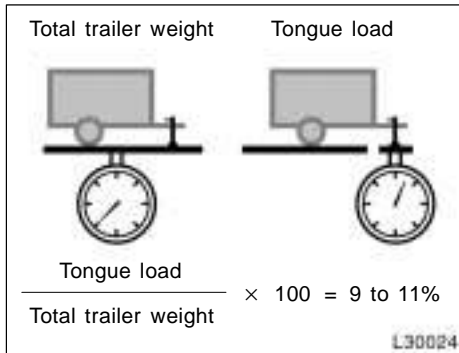

©The trailer cargo load should be distributed so that the tongue load is 9 to 11% of the total trailer weight, not exceeding the maximum of 90 kg (200 lb.). Never load the trailer with more weight in the back than in the front. About 60% of the trailer load should be in the front half of the trailer and the remaining 40% in the rear.

HITCHES

- ©Use only a hitch which is recommended by the hitch manufacturer and conforms to the total trailer weight requirement.
- ©Follow the directions supplied by the hitch manufacturer. Lubricate the hitch ball with a light coat of grease.
- ©Toyota recommends removing the trailer hitch whenever you are not towing a trailer to reduce the possibility of additional damage caused by the hitch if your vehicle is struck from behind.

NOTICE

Do not use axle-mounted hitches as they can cause damage to the axle housing, wheel bearings, wheels or tires. Also, never install a hitch which may interfere with the normal function of an Energy Absorbing Bumper, if so equipped.

BRAKES AND SAFETY CHAINS

- ©Toyota recommends trailers with brakes that conform to any applicable federal and state/provincial regulations.

- © A safety chain must always be used between the towing vehicle and the trailer. Leave sufficient slack in the chain for turns. The chain should cross under the trailer tongue to prevent the tongue from dropping to the ground in case it becomes damaged or separated. For correct safety chain procedures, follow the hitch or trailer manufacturer's recommendations.

 **CAUTION**

- © If the total trailer weight exceeds 453 kg (1000 lb.), trailer brakes are required.
- © Never tap into your vehicle's hydraulic system as it would lower its braking effectiveness.
- © Never tow a trailer without using a safety chain securely attached to both the trailer and the vehicle. If damage occurs to the coupling unit or hitch ball, there is danger of the trailer wandering over into another lane.

TIRES

- © Ensure that your vehicle's tires are properly inflated. Adjust the tire pressure to the recommended cold tire pressure indicated below (see page 255 in Section 7-2 for instructions.):

Tire pressure, kPa (kgf/cm ² or bar, psi)	
P205/65R15 92T or P205/65R15 92H	
Front	220 (2.2, 32)
Rear	220 (2.2, 32)
P215/60R16 94V	
Front	200 (2.0, 29)
Rear	200 (2.0, 29)

- © The trailer tires should be inflated to the pressure recommended by the trailer manufacturer in respect to the total trailer weight.

TRAILER LIGHTS

- © Trailer lights must comply with federal, state/provincial and local regulations. See your local recreational vehicle dealer or rental agency for the correct type of wiring and relays for your trailer. Check for correct operation of the turn signals and stop lights each time you hitch up. Direct splicing may damage your vehicle's electrical system and cause a malfunction of your lights.

BREAK-IN SCHEDULE

- © Toyota recommends that you do not tow a trailer with a new vehicle or a vehicle with any new power train component (engine, transmission, differential, wheel bearing, etc.) for the first 800 km (500 miles) of driving.

MAINTENANCE

- © If you tow a trailer, your vehicle will require more frequent maintenance due to the additional load. For this information, please refer to the scheduled maintenance information in the "Scheduled Maintenance Guide" or "Owner's Manual Supplement".
- © Retighten all fixing bolts of the towing ball and bracket after approximately 1000 km (600 miles) of trailer driving.

PRE-TOWING SAFETY CHECK

- © Check that your vehicle remains level when a loaded or unloaded trailer is hitched. Do not drive if the vehicle has an abnormal nose-up or nose-down condition, and check for improper tongue load, overload, worn suspension or other possible causes.
- © Make sure the trailer cargo is securely loaded so that it can not shift.
- © Check that your rear view mirrors conform to any applicable federal, state/provincial or local regulations. If not, install the rear view mirrors required for towing purpose.

TRAILER TOWING TIPS

When towing a trailer, your vehicle will handle differently than when not towing. The three main causes of vehicle-trailer accidents are driver error, excessive speed and improper trailer loading. Keep these in mind when towing:

- © Before starting out, check operation of the lights and all vehicle-trailer connections. After driving a short distance, stop and recheck the lights and connections. Before actually towing a trailer, practice turning, stopping and backing with a trailer in an area away from traffic until you learn the feel.

- © Backing with a trailer is difficult and requires practice. Grip the bottom of the steering wheel and move your hand to the left to move the trailer to the left. Move your hand to the right to move the trailer to the right. (This procedure is generally opposite to that when backing without a trailer.) Also, just turn the steering wheel a little at a time, avoiding sharp or prolonged turning. Have someone guide you when backing to reduce the risk of an accident.
- © Because stopping distance may be increased, vehicle-to-vehicle distance should be increased when towing a trailer. For each 16 km/h (10 mph) of speed, allow at least one vehicle and trailer length between you and the vehicle ahead. Avoid sudden braking as you may skid, resulting in jackknifing and loss of control. This is especially true on wet or slippery surfaces.
- © Avoid jerky starts or sudden acceleration. If your vehicle has a manual transmission, prevent excessive clutch slippage by keeping engine rpm low and not racing the engine. Always start out in first gear.
- © Avoid jerky steering and sharp turns. The trailer could hit your vehicle in a tight turn. Slow down before making a turn to avoid the necessity of sudden braking.
- © Remember that when making a turn, the trailer wheels will be closer than the vehicle wheels to the inside of the turn. Therefore, compensate for this by making a larger than normal turning radius with your vehicle.
- © Crosswinds and rough roads will adversely affect handling of your vehicle and trailer, causing sway. Pay attention to the rear from time to time to prepare yourself for being passed by large trucks or buses, which may cause your vehicle and trailer to sway. If swaying happens, firmly grip the steering wheel and reduce speed immediately but gradually. Never increase speed. Steer straight ahead. If you make no extreme correction with the steering or brakes, the vehicle and trailer will stabilize.
- © Be careful when passing other vehicles. Passing requires considerable distance. After passing a vehicle, do not forget the length of your trailer and be sure you have plenty of room before changing lanes.

© In order to maintain engine braking efficiency do not use fifth gear (manual transmission) or overdrive (automatic transmission).

© Because of the added load of the trailer, your vehicle's engine may overheat on hot days (at temperatures over 30°C [85°F]) when going up a long or steep grade with a trailer. If the engine coolant temperature gauge indicates overheating, immediately turn off the air conditioning (if in use), pull off the road and stop in a safe spot. Refer to "If your vehicle overheats" on page 215 in Section 4.

© Always place wheel blocks under both the vehicle and trailer wheels when parking. Apply the parking brake firmly. Put the transmission in "P" (automatic) or in first or reverse (manual). Avoid parking on a slope with a trailer, but if it cannot be avoided, do so only after performing the following:

1. Apply the brakes and hold.
2. Have someone place wheel blocks under both the vehicle and trailer wheels.
3. When the wheel blocks are in place, release your brakes slowly until the blocks absorb the load.
4. Apply the parking brake firmly.
5. Shift into first or reverse (manual) or "P" (automatic) and turn off the engine.

When restarting out after parking on a slope:

1. With the transmission in "P" position (automatic) or the clutch pedal depressed (manual), start the engine. (With an automatic transmission, be sure to keep the brake pedal depressed.)
2. Shift into gear.
3. Release the parking brake (also foot brake on automatic transmission vehicles) and slowly pull or back away from the wheel blocks. Stop and apply your brakes.
4. Have someone retrieve the blocks.

 CAUTION

© Do not exceed 72 km/h (45 mph) or the posted towing speed limit, whichever is lower. Because instability (swaying) of a towing vehicle-trailer combination usually increases as the speed increases, exceeding 72 km/h (45 mph) may cause loss of control.

© Slow down and downshift before descending steep or long downhill grades. Do not make sudden downshifts.

© Avoid holding the brake pedal down too long or too frequently. This could cause the brakes to overheat and result in reduced braking efficiency.

How to save fuel and make your vehicle last longer

Improving fuel economy is easy—just take it easy. It will help make your vehicle last longer, too. Here are some specific tips on how to save money on both fuel and repairs:

- © **Keep your tires inflated at the correct pressure.** Underinflation causes tire wear and wastes fuel. See page 255 in Section 7–2 for instructions.
- © **Do not carry unneeded weight in your vehicle.** Excess weight puts a heavier load on the engine, causing greater fuel consumption.
- © **Avoid lengthy warm-up idling.** Once the engine is running smoothly, begin driving—but gently. Remember, however, that on cold winter days this may take a little longer.
- © **Keep the automatic transmission overdrive turned on when engine braking is not required.** Driving with the overdrive off will reduce the fuel economy. (For details, see “Automatic transmission” on page 108 in Section 1–6.)
- © **Accelerate slowly and smoothly.** Avoid jackrabbit starts. Get into high gear as quickly as possible.
- © **Avoid long engine idling.** If you have a long wait and you are not in traffic, it is better to turn off the engine and start again later.
- © **Avoid engine lugging or over-revving.** Use a gear position suitable for the road on which you are travelling.
- © **Avoid continuous speeding up and slowing down.** Stop-and-go driving wastes fuel.
- © **Avoid unnecessary stopping and braking.** Maintain a steady pace. Try to time the traffic signals so you only need to stop as little as possible or take advantage of through streets to avoid traffic lights. Keep a proper distance from other vehicles to avoid sudden braking. This will also reduce wear on your brakes.
- © **Avoid heavy traffic or traffic jams whenever possible.**
- © **Do not rest your foot on the clutch or brake pedal.** This causes premature wear, overheating and poor fuel economy.
- © **Maintain a moderate speed on highways.** The faster you drive, the greater the fuel consumption. By reducing your speed, you will cut down on fuel consumption.
- © **Keep the front wheels in proper alignment.** Avoid hitting the curb and slow down on rough roads. Improper alignment not only causes faster tire wear but also puts an extra load on the engine, which, in turn, wastes fuel.
- © **Keep the bottom of your vehicle free from mud, etc.** This not only lessens weight but also helps prevent corrosion.
- © **Keep your vehicle tuned-up and in top shape.** A dirty air cleaner, improper valve clearance, dirty plugs, dirty oil and grease, brakes not adjusted, etc. all lower engine performance and contribute to poor fuel economy. For longer life of all parts and lower operating costs, keep all maintenance work on schedule, and if you often drive under severe conditions, see that your vehicle receives more frequent maintenance (For scheduled maintenance information, please refer to the “Scheduled Maintenance Guide” or “Owner’s Manual Supplement”).

2002 MY CAMRY_U (OM33567U)



CAUTION

Never turn off the engine to coast down hills. Your power steering and brake booster will not function without the engine running. Also, the emission control system operates properly only when the engine is running.

SECTION 4

IN CASE OF AN EMERGENCY

If your vehicle will not start	211
If your engine stalls while driving	214
If you cannot increase the engine speed	214
If your vehicle overheats	215
If you have a flat tire	216
If your vehicle needs to be towed	224
If you cannot shift automatic transmission selector lever	228
If you lose your keys	229
If you lose your wireless remote control transmitter	229

**If your vehicle will not start—
(a) Simple checks**

Before making these checks, make sure you have followed the correct starting procedure given in “How to start the engine” on page 197 in Section 3 and that you have sufficient fuel. If your vehicle is equipped with the engine immobiliser system, also check whether the other keys will start the engine. If they work, your key may be broken. Have the key checked at your Toyota dealer. If none of your keys work, the system is possibly broken. Call your Toyota dealer. (See “Keys (with engine immobiliser system)” on page 10 in Section 1–2.)

If the engine is not turning over or is turning over too slowly—

1. Check that the battery terminals are tight and clean.
2. If the battery terminals are O.K., switch on the interior light.
3. If the light is out, dim or goes out when the starter is cranked, the battery is discharged. You may try jump starting. See “(c) Jump starting” on page 212 for further instructions.

If the light is O.K., but the engine still will not start, it needs adjustment or repair. Call a Toyota dealer or qualified repair shop.

NOTICE

Do not pull– or push–start the vehicle. It may damage the vehicle or cause a collision when the engine starts. Also the three–way catalytic converter may overheat and become a fire hazard.

If the engine turns over at its normal speed but will not start—

1. The engine may be flooded because of repeated cranking. See “(b) Starting a flooded engine” on page 211 for further instructions.
2. If the engine still will not start, it needs adjustment or repair. Call a Toyota dealer or qualified repair shop.

(b) Starting a flooded engine

If the engine will not start, your engine may be flooded because of repeated cranking.

If this happens, turn the key to “START” with the accelerator pedal held down. Keep the key and accelerator pedal in these positions for 15 seconds and release them. Then try starting the engine with your foot off the accelerator pedal.

If the engine does not start after 15 seconds of cranking, release the key, wait a few minutes and try again.

If the engine still will not start, it needs adjustment or repair. Call a Toyota dealer or qualified repair shop for assistance.

NOTICE

Do not crank for more than 30 seconds at a time. This may overheat the starter and wiring systems.

(c) Jump starting

To avoid serious personal injury and damage to your vehicle which might result from battery explosion, acid burns, electrical burns, or damaged electronic components, these instructions must be followed precisely.

If you are unsure about how to follow this procedure, we strongly recommend that you seek the help of a competent mechanic or towing service.

 CAUTION
©Batteries contain sulfuric acid which is poisonous and corrosive. Wear protective safety glasses when jump starting, and avoid spilling acid on your skin, clothing, or vehicle.
©If you should accidentally get acid on yourself or in your eyes, remove any contaminated clothing and flush the affected area with water immediately. Then get immediate medical attention. If possible, continue to apply water with a sponge or cloth while enroute to the medical office.

©The gas normally produced by a battery will explode if a flame or spark is brought near. Use only standardized jumper cables and do not smoke or light a match while jump starting.
©Warning: Battery posts, terminals and related accessories contain lead and lead compounds, chemicals known to the State of California to cause cancer and reproductive harm. Wash hands after handling.

NOTICE
<i>The battery used for boosting must be 12 V. Do not jump start unless you are sure that the booster battery is correct.</i>

JUMP STARTING PROCEDURE

1. If the booster battery is installed in another vehicle, make sure the vehicles are not touching. Turn off all unnecessary lights and accessories.
2. If required, remove all the vent plugs from the booster and discharged batteries. Lay a cloth over the open vents on the batteries. (This helps reduce the explosion hazard, personal injuries and burns.)
3. If the engine in the vehicle with the booster battery is not running, start it and let it run for a few minutes. During jump starting run the engine at about 2000 rpm with the accelerator pedal lightly depressed.

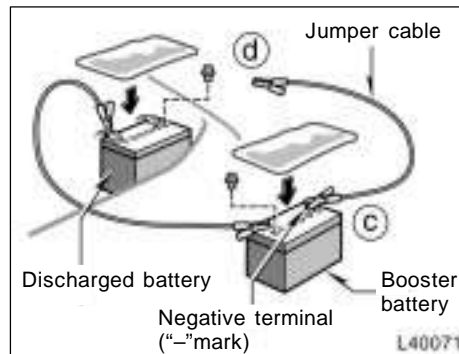
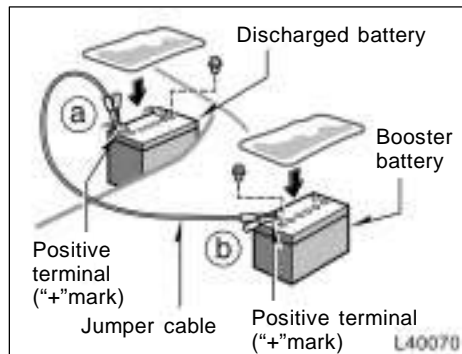

4. Make the cable connections in the order a, b, c, d.
- a. Connect the clamp of the positive (red) jumper cable to the positive (+) terminal on the discharged battery.
 - b. Connect the clamp at the other end of the positive (red) jumper cable to the positive (+) terminal on the booster battery.

- c. Connect the clamp of the negative (black) jumper cable to the negative (-) terminal on the booster battery.
 - d. Connect the clamp at the other end of the negative (black) jumper cable to a solid, stationary, unpainted, metallic point of the vehicle with the discharged battery.
- The recommended connecting points are shown in the following illustrations:

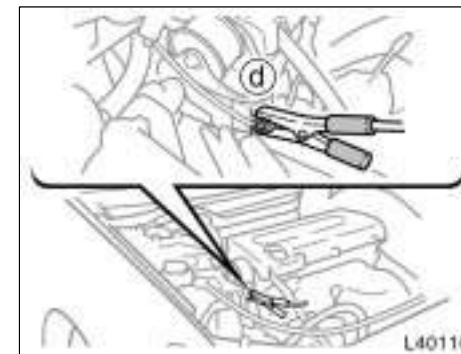

Connecting point for 2AZ-FE engine

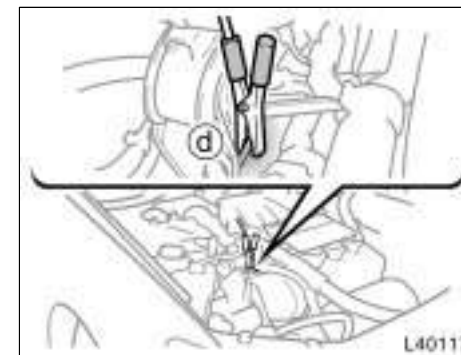

Connecting point for 1MZ-FE engine

Do not connect it to or near any part that moves when the engine is cranked.

 **CAUTION**

When making the connections, to avoid serious injury, do not lean over the battery or accidentally let the jumper cables or clamps touch anything except the correct battery terminals or the ground.

5. Start your engine in the normal way. After starting, run it at about 2000 rpm for several minutes with the accelerator pedal lightly depressed.
6. Carefully disconnect the cables in the exact reverse order: the negative cable and then the positive cable.
7. Carefully dispose of the battery cover cloths—they may now contain sulfuric acid.
8. If removed, replace all the battery vent plugs.

If the cause of your battery discharging is not apparent (for example, lights left on), you should have it checked.

If your engine stalls while driving

If your engine stalls while driving...

1. Reduce your speed gradually, keeping a straight line. Move cautiously off the road to a safe place.
2. Turn on your emergency flashers.
3. Try starting the engine again.

If the engine will not start, see “If your vehicle will not start” on page 211 in this section.

 **CAUTION**

If the engine is not running, the power assist for the brakes and steering will not work so steering and braking will be much harder than usual.

If you cannot increase the engine speed

If the engine speed does not increase when the accelerator pedal is depressed, there may be a problem somewhere in your electronic throttle control system.

At this time, vibration may occur. However, if you depress the accelerator pedal more firmly and slowly, you can drive your vehicle at low speeds. Have your vehicle checked by your Toyota dealer as soon as possible.

Even if the abnormality of the electronic throttle control system is corrected during low speed driving, the system may not be recovered until the engine is stopped and the ignition key is turned to “ACC” or “LOCK” position.

 **CAUTION**

Be especially careful to prevent erroneous pedal operation.

If your vehicle overheats

If your engine coolant temperature gauge indicates overheating, if you experience a loss of power, or if you hear a loud knocking or pinging noise, the engine has probably overheated. You should follow this procedure...

1. Pull safely off the road, stop the vehicle and turn on your emergency flashers. Put the transmission in "P" (automatic) or neutral (manual) and apply the parking brake. Turn off the air conditioning if it is being used.
2. If coolant or steam is boiling out of the radiator or reservoir, stop the engine. Wait until the steam subsides before opening the hood. If there is no coolant boiling over or steam, leave the engine running and make sure the electric cooling fan is operating. If it is not, turn the ignition off.

CAUTION
To help avoid personal injury, keep the hood closed until there is no steam. Escaping steam or coolant is a sign of very high pressure.

3. Look for obvious coolant leaks from the radiator, hoses, and under the vehicle. However, note that water draining from the air conditioning is normal if it has been used.

CAUTION
When the engine is running, keep hands and clothing away from the moving fan and engine drive belts.

4. If the coolant is leaking, stop the engine immediately. Call a Toyota dealer for assistance.
5. If there are no obvious leaks, check the coolant reservoir. If it is dry, add coolant to the reservoir while the engine is running. Fill it about half full.

CAUTION
Do not attempt to remove the radiator cap when the engine and radiator are hot. Serious injury could result from scalding hot fluid and steam blown out under pressure.

6. After the engine coolant temperature has cooled to normal, again check the coolant level in the reservoir. If necessary, bring it up to half full again. Serious coolant loss indicates a leak in the system. You should have it checked as soon as possible at your Toyota dealer.

If you have a flat tire—

1. Reduce your speed gradually, keeping a straight line. Move cautiously off the road to a safe place well away from the traffic. Avoid stopping on the center divider of a highway. Park on a level spot with firm ground.
2. Stop the engine and turn on your emergency flashers.
3. Firmly set the parking brake and put the transmission in "P" (automatic) or reverse (manual).
4. Have everyone get out of the vehicle on the side away from traffic.
5. Read the following instructions thoroughly.



CAUTION

When jacking, be sure to observe the following to reduce the possibility of personal injury:

- ©Follow jacking instructions.
- ©Do not put any part of your body under the vehicle supported by the jack. Personal injury may occur.

- ©Do not start or run the engine while your vehicle is supported by the jack.
- ©Stop the vehicle on a level firm ground, firmly set the parking brake and put the transmission in "P" (automatic) or reverse (manual). Block the wheel diagonally opposite to the one being changed if necessary.
- ©Make sure to set the jack properly in the jack point. Raising the vehicle with jack improperly positioned will damage the vehicle or may allow the vehicle to fall off the jack and cause personal injury.
- ©Never get under the vehicle when the vehicle is supported by the jack alone.
- ©Use the jack only for lifting your vehicle during wheel changing.
- ©Do not raise the vehicle with someone in the vehicle.
- ©When raising the vehicle, do not put an object on or under the jack.

- ©Raise the vehicle only high enough to remove and change the tire.

NOTICE

Do not continue driving with a deflated tire. Driving even a short distance can damage a tire and wheel beyond repair.

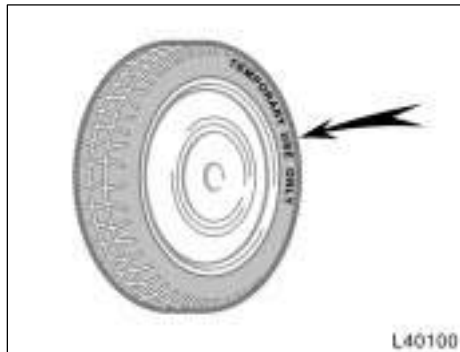

Compact spare tire (on some models)
The compact spare tire is designed for temporary emergency use only.

The compact spare tire is identified by the distinctive wording "TEMPORARY USE ONLY" molded into the side wall of the tire.

The standard tire should be repaired and replaced as soon as possible.

The compact spare tire saves space in your luggage compartment, and its lighter weight helps to improve fuel economy and permits easier installation in case of a flat tire.

The compact spare tire can be used many times, if necessary. It has tread life of up to 4800 km (3000 miles) depending on road conditions and your driving habits. When tread wear indicators appear on the tire, replace the tire.

See also the tire section on page 255 in Section 7-2 for details on the tread wear indicators and other service information.

! CAUTION

- Ⓢ The compact spare tire was designed especially for your Toyota. Do not use it on any other vehicle.
- Ⓢ Do not exceed 80 km/h (50 mph) when driving with the compact spare tire.
- Ⓢ Avoid sudden acceleration, sudden deceleration and sharp turns with the compact spare tire.

NOTICE

Your ground clearance is reduced when the compact spare tire is installed so avoid driving over obstacles and drive slowly on rough, unpaved roads and speed bumps. Also, do not attempt to go through an automatic car wash as the vehicle may get caught, resulting in damage.

—Required tools and spare tire

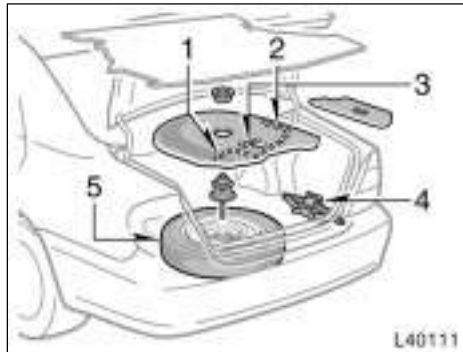

With a compact spare tire

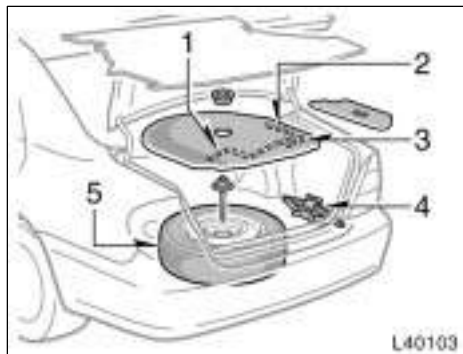

Without a compact spare tire

1. Get the required tools and spare tire.

1. Jack handle
2. Wheel nut wrench
3. Front towing eyelet (on some models)
4. Jack
5. Spare tire

To prepare yourself for an emergency, you should familiarize yourself with the use of the jack, each of the tools and their storage locations.

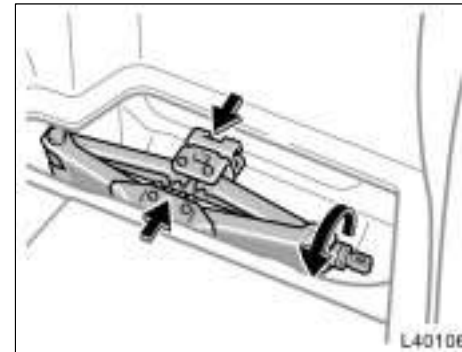

To remove the jack, turn the jack joint by hand until the jack becomes free.

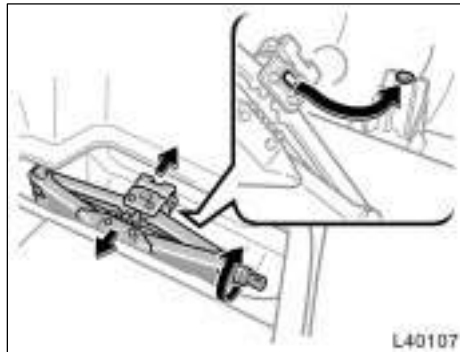

To store the jack, align the hole of the jack head with the vehicle hook. Turn the jack joint until the jack base fits securely with the vehicle body.

This prevents the jack from flying forward during a collision or sudden stop.

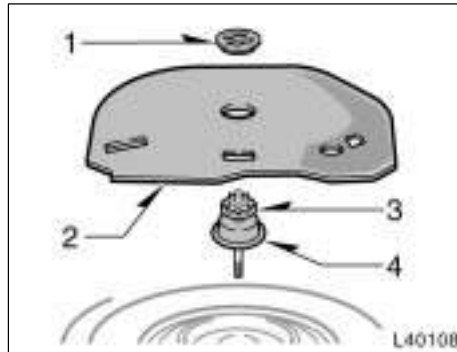

To remove the spare tire:

1. Loosen the nut and remove it.
2. Remove the spare tire cover.
3. Loosen the bolt and remove it.
4. Remove the spacer. (compact spare tire only)

Then take the spare tire out of the vehicle.

When storing the spare tire, put it in place with the outer side of the wheel facing up. Then secure the tire by repeating the above removal steps in reverse order to prevent it from flying forward during a collision or sudden braking.

—Blocking the wheel

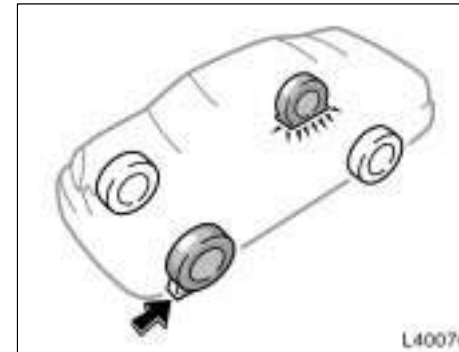

2. **Block the wheel diagonally opposite the flat tire to keep the vehicle from rolling when it is jacked up.**

When blocking the wheel, place a wheel block from the front for the front wheels or from the rear for the rear wheels.

—Removing wheel ornament
(steel wheels only)

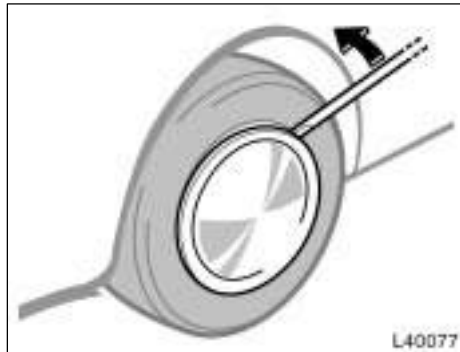

3. Remove the wheel ornament.

Pry off the wheel ornament, using the beveled end of the wheel nut wrench as shown.



Do not try to pull off the ornament by hand. Take due care in handling the ornament to avoid unexpected personal injury.

—Loosening wheel nuts

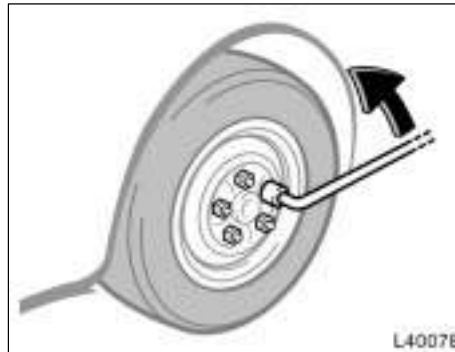

4. Loosen all the wheel nuts.

Always loosen the wheel nuts before raising the vehicle.

Turn the wheel nuts counterclockwise to loosen. To get maximum leverage, fit the wrench to the nut so that the handle is on the right side, as shown above. Grab the wrench near the end of the handle and pull up on the handle. Be careful that the wrench does not slip off the nut.

Do not remove the nuts yet—just unscrew them about one-half turn.

—Positioning the jack

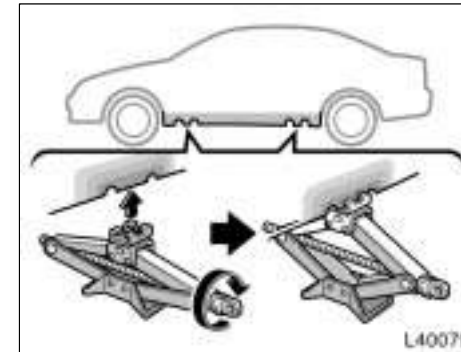

5. Position the jack at the correct jack point as shown. Rotate the load rest 90° from storage position to lifting position.

Make sure the jack is positioned on a level and solid place.

—Raising your vehicle

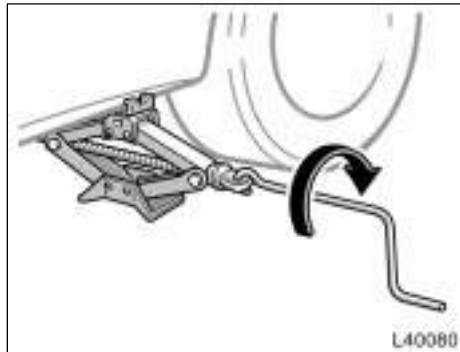

6. After making sure that no one is in the vehicle, raise it high enough so that the spare tire can be installed.

Remember you will need more ground clearance when putting on the spare tire than when removing the flat tire.

To raise the vehicle, insert the jack handle into the jack (it is a loose fit) and turn it clockwise. As the jack touches the vehicle and begins to lift, double-check that it is properly positioned.



—Changing wheels



7. Remove the wheel nuts and change tires.

Lift the flat tire straight off and put it aside.

Roll the spare wheel into position and align the holes in the wheel with the bolts. Then lift up the wheel and get at least the top bolt started through its hole. Wiggle the tire and press it back over the other bolts.

—Reinstalling wheel nuts



Before putting on wheels, remove any corrosion on the mounting surfaces with a wire brush or such. Installation of wheels without good metal-to-metal contact at the mounting surface can cause wheel nuts to loosen and eventually cause a wheel to come off while driving. Therefore after the first 1600 km (1000 miles), check to see that the wheel nuts are tight.

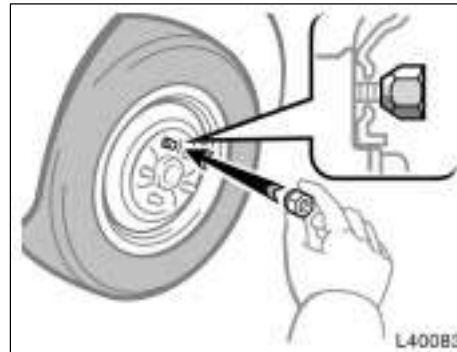

8. Reinstall all the wheel nuts finger tight.

Reinstall the wheel nuts (tapered end inward) and tighten them as much as you can by hand. Press back on the tire and see if you can tighten them more.

—Lowering your vehicle

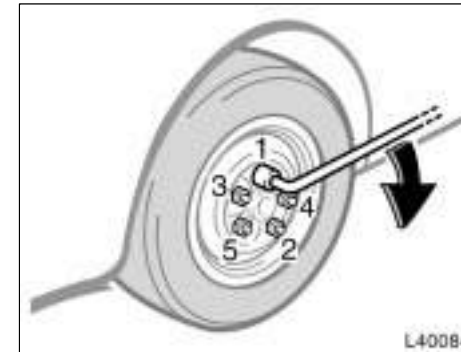

9. Lower the vehicle completely and tighten the wheel nuts.

Turn the jack handle counterclockwise to lower the vehicle.

Use only the wheel nut wrench to tighten the nuts. Do not use other tools or any additional leverage other than your hands, such as a hammer, pipe or your foot. Make sure the wrench is securely engaged over the nut.

Tighten each nut a little at a time in the order shown. Repeat the process until all the nuts are tight.

CAUTION

When lowering the vehicle, make sure all portions of your body and all other persons around will not be injured as the vehicle is lowered to the ground.

—Reinstalling wheel ornament (steel wheels only)

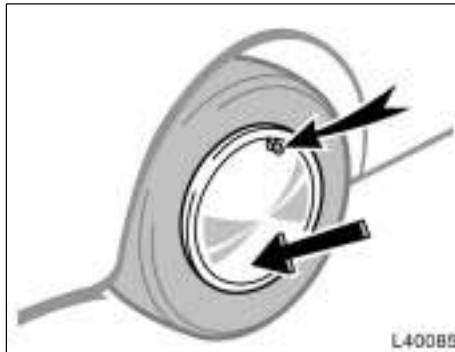

10. Reinstall the wheel ornament.

1. Put the wheel ornament into position. Align the cutout of the wheel ornament with the valve stem as shown.
2. Tap it firmly with the side or heel of your hand to snap it into place.

CAUTION

Take due care in handling the ornament to avoid unexpected personal injury.

—After changing wheels

11. Check the air pressure of the replaced tire.

Adjust the air pressure to the specification designed on page 278 in Section 8. If the pressure is lower, drive slowly to the nearest service station and fill to the correct pressure.

Do not forget to reinstall the tire inflation valve cap as dirt and moisture could get into the valve core and possibly cause air leakage. If the cap is missing, have a new one put on as soon as possible.

12. Restow all the tools, jack and flat tire securely.

As soon after changing wheels as possible, tighten the wheel nuts to the torque specified on page 278 in Section 8 with a torque wrench. Have a technician repair the flat tire and replace the spare tire with it.

CAUTION

Before driving, make sure all the tools, jack and flat tire are securely in place in their storage location to reduce the possibility of personal injury during a collision or sudden braking.

If your vehicle needs to be towed—

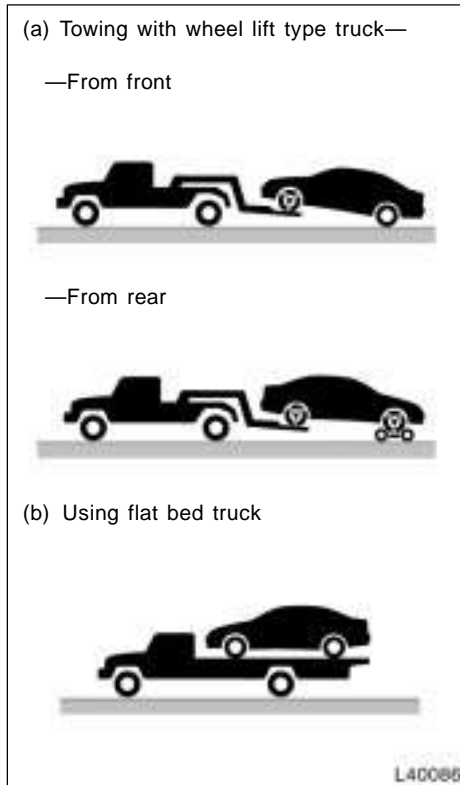

If towing is necessary, we recommend you to have it done by your Toyota dealer or a commercial tow truck service. In consultation with them, have your vehicle towed using either (a) or (b).

Only when you cannot receive a towing service from a Toyota dealer or commercial tow truck service, tow your vehicle carefully in accordance with the instructions given in “—Emergency towing” on page 225 in this section.

Proper equipment will help ensure that your vehicle is not damaged while being towed. Commercial operators are generally aware of the state/provincial and local laws pertaining to towing.

Your vehicle can be damaged if it is towed incorrectly. Although most operators know the correct procedure, it is possible to make a mistake. To avoid damage to your vehicle, make sure the following precautions are observed. If necessary, show this page to the tow truck driver.

TOWING PRECAUTIONS:

Use a safety chain system for all towing, and abide by the state/provincial and local laws. The wheels and axle on the ground must be in good condition. If they are damaged, use a towing dolly.

(a) Towing with wheel lift type truck

NOTICE

When lifting wheels, take care to ensure adequate ground clearance for towing at the opposite end of the raised vehicle. Otherwise, the bumper and/or underbody of the towed vehicle will be damaged during towing.

From front—Release the parking brake.

From rear—

© Manual transmission:

We recommend using a towing dolly under the front wheels. If you do not use a towing dolly, place the ignition key in the “ACC” position and put the transmission in neutral.

NOTICE

Do not tow with the key removed or in the “LOCK” position when towing from the rear without a towing dolly. The steering lock mechanism is not strong enough to hold the front wheels straight.

© Automatic transmission:
Use a towing dolly under the front
wheels.

NOTICE
Never tow a vehicle with an automatic transmission from the rear with the front wheels on the ground, as this may cause serious damage to the transmission.

(b) Using flat bed truck

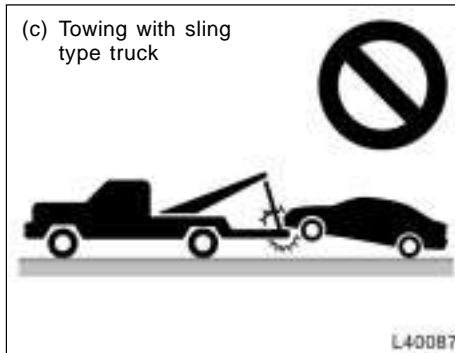

(c) Towing with sling type truck

NOTICE
Do not tow with sling type truck, either from the front or rear. This may cause body damage.

—Emergency towing

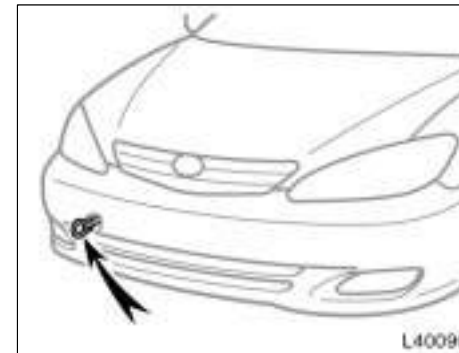

Front (type A)

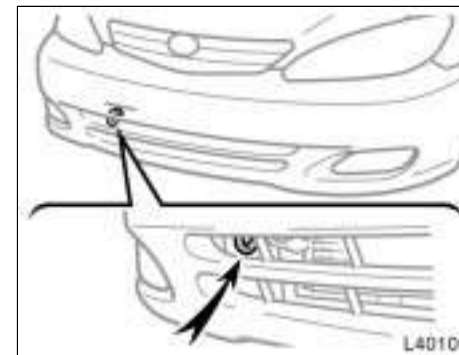

Front (type B)

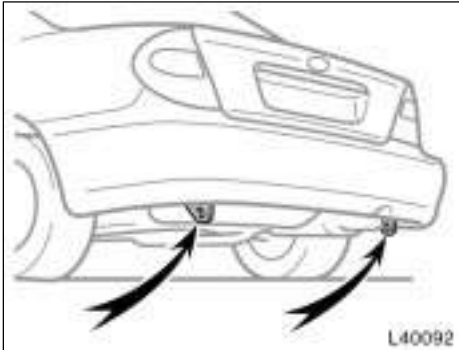

Rear (on some models)

If towing is necessary, we recommend you to have it done by your Toyota dealer or a commercial tow truck service.

If towing service is not available in an emergency, your vehicle may be temporarily towed by a cable or chain secured to one of the emergency towing eyelets under the vehicle. Use extreme caution when towing vehicles.

Front towing eyelet (type A)—To install the front towing eyelet, see “—Installing front towing eyelet” on page 227 in this section.

NOTICE

Only use specified towing eyelet; otherwise your vehicle may be damaged.

A driver must be in the vehicle to steer it and operate the brakes.

Towing in this manner may be done only on hard-surfaced roads for a short distance and at low speeds. Also, the wheels, axles, drive train, steering and brakes must all be in good condition.

CAUTION

Use extreme caution when towing vehicles. Avoid sudden starts or erratic driving maneuvers which would place excessive stress on the emergency towing eyelets and towing cable or chain. The eyelets and towing cable or chain may break and cause serious injury or damage.

NOTICE

Use only a cable or chain specifically intended for use in towing vehicles. Securely fasten the cable or chain to the towing eyelets provided.

Before towing, release the parking brake and put the transmission in neutral (manual) or “N” (automatic). The key must be in “ACC” (engine off) or “ON” (engine running).

CAUTION

If the engine is not running, the power assist for the brakes and steering will not work so steering and braking will be much harder than usual.

—Installing front towing eyelet



With a compact spare tire

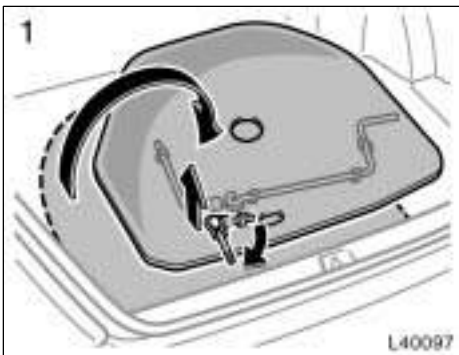

Without a compact spare tire

1. Remove and turn over the spare tire cover. Remove the front towing eyelet by turning it as shown in the illustrations.

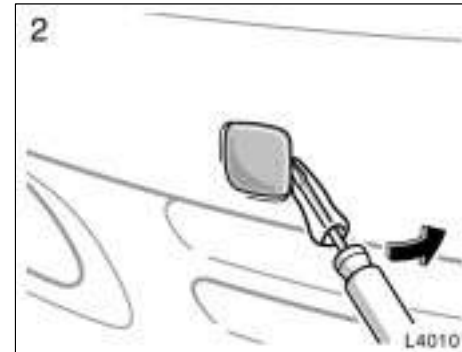

2. Remove the front towing eyelet cover on the front bumper, using a flat-bladed screwdriver which is wrapped with a cloth.

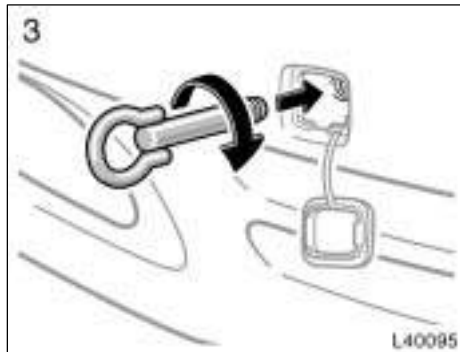

3. Secure the front towing eyelet to the hole on the bumper by turning clockwise.

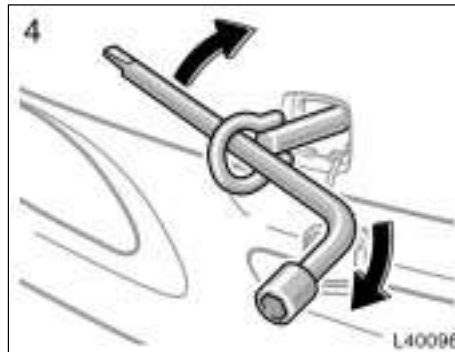

4. Tighten the front towing eyelet securely by a wheel nut wrench.

NOTICE

Make sure that the front towing eyelet is tightened securely, or it may be loosened or removed when towing the vehicle.

If you cannot shift automatic transmission selector lever

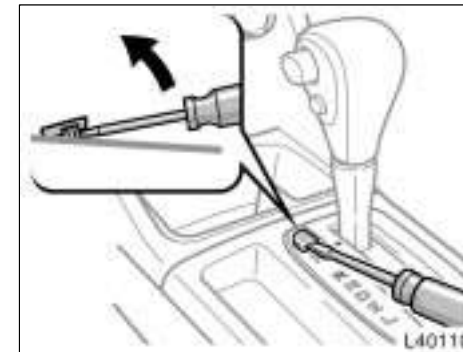

If you cannot shift the selector lever out of "P" position to other positions even though the brake pedal is depressed, use the shift lock override button as follows:

1. Turn the ignition key to "LOCK" position. Make sure the parking brake is on.
2. Pry up the cover with a flat-bladed screwdriver or equivalent.

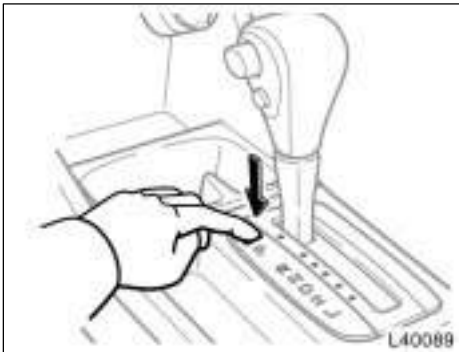

3. **Insert your finger into the hole to push down the shift lock override button. You can shift out of "P" position only while pushing the button.**
4. **Shift into "N" position.**
5. **Insert the cover.**
6. **Start the engine. For your safety, keep the brake pedal depressed.**

Be sure to have the system checked by your Toyota dealer as soon as possible.

If you lose your keys

You can purchase a new key at your Toyota dealer if you can give them the key number. If your vehicle is equipped with the engine immobiliser system, the dealer will also need your master key.

Vehicles with engine immobiliser system— Even if you lose only one key, contact your Toyota dealer to make a new key. If you lose all your master keys, you cannot make new keys; the whole engine immobiliser system must be replaced.

See the suggestion given in "Keys" on page 10 in Section 1–2.

If your keys are locked in the vehicle and you cannot get a duplicate, many Toyota dealers can still open the door for you, using their special tools. If you must break a window to get in, we suggest breaking the smallest side window because it is the least expensive to replace. Be extremely cautious to avoid cuts from the glass.

If you lose your wireless remote control transmitter

You can purchase a new wireless remote control transmitter at your Toyota dealer.

Have the registered identification numbers of your transmitters deleted from your vehicle by your Toyota dealer as soon as possible to avoid the possibility of theft or an accident. Then, have the identification number of your new transmitter registered. At the same time, you must bring all of the remaining transmitters to have them registered again as well.

You can use the wireless remote control system with the new transmitter. Contact your Toyota dealer for detailed information.

SECTION 5

CORROSION PREVENTION AND APPEARANCE CARE

Protecting your Toyota from corrosion	231
Washing and waxing your Toyota	232
Cleaning the interior	234

Protecting your Toyota from corrosion

Toyota, through its diligent research, design and use of the most advanced technology available, has done its part to help prevent corrosion and has provided you with the finest quality vehicle construction. Now, it is up to you. Proper care of your Toyota can help ensure long-term corrosion prevention.

The most common causes of corrosion to your vehicle are:

- © The accumulation of road salt, dirt and moisture in hard-to-reach areas under the vehicle.
- © Chipping of paint, or undercoating caused by minor accidents or by stones and gravel.

Care is especially important if you live in particular areas or operate your vehicle under certain environmental conditions:

- © Road salt or dust control chemicals will accelerate corrosion, as will the presence of salt in the air near the sea-coast or in areas of industrial pollution.
- © High humidity accelerates corrosion especially when temperatures range just above the freezing point.

- © Wetness or dampness to certain parts of your vehicle for an extended period of time, may cause corrosion even though other parts of the vehicle may be dry.
- © High ambient temperatures can cause corrosion to those components of the vehicle which are prevented from quick-drying due to lack of proper ventilation.

The above signifies the necessity to keep your vehicle, particularly the underside, as clean as possible and to repair any damage to paint or protective coatings as soon as possible.

To help prevent corrosion on your Toyota, follow these guidelines:

Wash your vehicle frequently. It is, of course, necessary to keep your vehicle clean by regular washing, but to prevent corrosion, the following points should be observed:

- © If you drive on salted roads in the winter or if you live near the ocean, you should hose off the undercarriage at least once a month to minimize corrosion.

- © High pressure water or steam is effective for cleaning the vehicle's underside and wheel housings. Pay particular attention to these areas as it is difficult to see all the mud and dirt. It will do more harm than good to simply wet the mud and debris without removing them. The lower edge of doors, rocker panels and frame members have drain holes which should not be allowed to clog with dirt as trapped water in these areas can cause corrosion.

- © Wash the underside of the vehicle thoroughly when winter is over.

See "Washing and waxing your Toyota" on page 232 for more tips.

Check the condition of your vehicle's paint and trim. If you find any chips or scratches in the paint, touch them up immediately to prevent corrosion from starting. If the chips or scratches have gone through the bare metal, have a qualified body shop make the repair.

Check the interior of your vehicle. Water and dirt can accumulate under the floor mats and could cause corrosion. Occasionally check under the mats to make sure the area is dry. Be particularly careful when transporting chemicals, cleansers, fertilizers, salt, etc.; these should be transported in proper containers. If a spill or leak should occur, immediately clean and dry the area.

Use mud shields on your wheels. If you drive on salted or gravel roads, mud shields help protect your vehicle. Full-size shields, which come as near to the ground as possible, are the best. We recommend that the fittings and the area where the shields are installed be treated to resist corrosion. Your Toyota dealer will be happy to assist in supplying and installing the shields if they are recommended for your area.

Keep your vehicle in a well ventilated garage or a roofed place. Do not park your vehicle in a damp, poorly ventilated garage. If you wash your vehicle in the garage, or if you drive it in covered with water or snow, your garage may be so damp it will cause corrosion. Even if your garage is heated, a wet vehicle can corrode if the ventilation is poor.

Washing and waxing your Toyota

Washing your Toyota

Keep your vehicle clean by regular washing.

The following cases may cause weakness to the paint or corrosion to the body and parts. Wash your vehicle as soon as possible.

- Ⓢ When driving in a coastal area
- Ⓢ When driving on a road sprinkled with antifreeze
- Ⓢ When having coal tar, tree sap, bird droppings and carcass of an insect
- Ⓢ When driving in the areas where there is a lot of smoke, soot, dust, iron dust and chemical substance
- Ⓢ When the vehicle becomes remarkably dirty with dust and mud

Hand-washing your Toyota

Work in the shade and wait until the vehicle body is not hot to the touch.



When cleaning under floor or chassis, be careful not to injure your hands.

1. Rinse off loose dirt with a hose. Remove any mud or road salt from the underside of the vehicle or in the wheel wells.
2. Wash with a mild car-wash soap, mixed according to the manufacturer's instructions. Use a soft cotton mitt and keep it wet by dipping it frequently into the wash water. Do not rub hard—let the soap and water remove the dirt.

Plastic wheel ornaments: The plastic wheel ornaments are damaged easily by organic substances. If any organic substances splashes an ornament, be sure to wash it off with water and check if the ornament is damaged.



Do not attach the heavily damaged plastic wheel ornament. It may fly off the wheel and cause accidents while the vehicle is moving.

Aluminum wheels: Use only a mild soap or neutral detergent.

Plastic bumpers: Wash carefully. Do not scrub with abrasive cleaners. The bumper faces are soft.

Road tar: Remove with turpentine or cleaners that are marked safe for painted surfaces.

NOTICE

Do not use organic substances (gasoline, kerosene, benzine or strong solvents), which may be toxic or cause damage.

3. Rinse thoroughly—dried soap can cause streaking. In hot weather you may need to rinse each section right after you wash it.
4. To prevent water spots, dry the vehicle using a clean soft cotton towel. Do not rub or press hard—you might scratch the paint.

Automatic car wash

Your vehicle may be washed in an automatic car wash, but remember that the paint can be scratched by some type of brushes, unfiltered washing water, or the washing process itself. Scratching reduces paint durability and gloss, especially on darker colors. The manager of the car wash should be able to advise you whether the process is safe for the paint on your vehicle.

Waxing your Toyota

Polishing and waxing is recommended to maintain the original beauty of your Toyota's finish.

Once a month or if the vehicle surface does not repel water well, apply wax.

1. Always wash and dry the vehicle before you begin waxing, even if you are using a combined cleaner and wax.
2. Use a good quality polish and wax. If the finish has become extremely weathered, use a car-cleaning polish, followed by a separate wax. Carefully follow the manufacturer's instructions and precautions. Be sure to polish and wax the chrome trim as well as the paint.

Windshield washer nozzles: Make sure that the nozzles do not become blocked when waxing. If a nozzle becomes blocked, contact your Toyota dealer to have the vehicle serviced.

NOTICE

If a nozzle becomes blocked, do not try to clear it with a pin or other object. The nozzle will be damaged.

3. Wax the vehicle again when water does not bead but remains on the surface in large patches.

NOTICE

Always remove the plastic bumpers if your vehicle is re-painted and placed in a high heat paint waxing booth. High temperatures could damage the bumpers.

Cleaning the interior

CAUTION

©Vehicles with side airbags and curtain shield airbags:
Be careful not to splash water or spill liquid on the floor. This may prevent the side airbags from activating correctly, resulting in serious injury.

©Do not wash the vehicle floor with water, or allow water to get onto the floor when cleaning the vehicle interior or exterior. Water may get into audio components or other electrical components above or under the floor carpet (or mat) and cause a malfunction; and it may cause body corrosion.

Vinyl interior

The vinyl upholstery may be easily cleaned with a mild soap or detergent and water.

First vacuum over the upholstery to remove loose dirt. Then, using a sponge or soft cloth, apply the soap solution to the vinyl. After allowing it to soak in for a few minutes to loosen the dirt, remove the dirt and wipe off the soap with a clean damp cloth. If all the dirt do not come off, repeat the procedure. Commercial foaming-type vinyl cleaners are also available which work well. Follow the manufacturer's instructions.

NOTICE

Do not use solvent, thinner, gasoline or window cleaner on the interior.

Carpets

Use a good foam-type shampoo to clean the carpets.

Begin by vacuuming thoroughly to remove as much dirt as possible. Several types of foam cleaners are available; some are in aerosol cans and others are powders or liquids which you mix with water to produce a foam. To shampoo the carpets, use a sponge or brush to apply the foam. Rub in overlapping circles.

Do not apply water—the best results are obtained by keeping the carpet as dry as possible. Read the shampoo instructions and follow them closely.

Seat belts

The seat belts may be cleaned with mild soap and water or with lukewarm water.

Use a cloth or sponge. As you are cleaning, check the belts for excessive wear, fraying, or cuts.

NOTICE

◀Do not use dye or bleach on the belts—it may weaken them.
◀Do not use the belts until they become dry.

Windows

The windows may be cleaned with any household window cleaner.

NOTICE

When cleaning the inside of the rear window, be careful not to scratch or damage the heater wires or connectors.

Air conditioning control panel, car audio, instrument panel, console panel, and switches

Use a soft damp cloth for cleaning.

Soak a clean soft cloth in water or lukewarm water then lightly wipe off dirt.

NOTICE

- ◀ **Do not use organic substances (solvents, kerosene, alcohol, gasoline, etc.) or alkaline or acidic solutions. These chemicals can cause discoloring, staining or peeling of the surface.**
- ◀ **If you use cleaners or polishing agents, make sure their ingredients do not include the substances mentioned above.**
- ◀ **If you use a liquid car freshener, do not spill the liquid onto the vehicle's interior surfaces. It may contain the ingredients mentioned above. Immediately clean any spill using the method mentioned above.**

Leather Interior

The leather upholstery may be cleaned with neutral detergent for wool.

Remove dirt using a soft cloth dampened with 5% solution of neutral detergent for wool. Then thoroughly wipe off all traces of detergent with a clean damp cloth.

After cleaning or whenever any part of the leather gets wet, dry with a soft clean cloth. Allow the leather to dry in a ventilated shaded area.

NOTICE

- ◀ **If a stain should fail to come out with a neutral detergent, apply a cleaner that does not contain an organic solvent.**
- ◀ **Never use organic substances such as benzene, alcohol or gasoline, or alkaline or acid solutions for cleaning the leather as these could cause discoloring.**
- ◀ **Use of a nylon brush or synthetic fiber cloth, etc. may scratch the fine grained surface of the leather.**

◀ **Mildew may develop on soiled leather upholstery. Be especially careful to avoid oil spots. Try to keep your upholstery always clean.**

◀ **Long exposure to direct sunlight may cause the leather surface to harden and shrink. Keep your vehicle in a shaded area, especially in the summer.**

◀ **The interior of your vehicle is apt to heat up on hot summer days, so avoid placing on the upholstery items made of vinyl or plastic or containing wax as these tend to stick to leather when warm.**

◀ **Improper cleaning of the leather upholstery could result in discoloration or staining.**

If you have any questions about the cleaning of your Toyota, your local Toyota dealer will be pleased to answer them.

SECTION 6

VEHICLE MAINTENANCE AND CARE

Maintenance requirements	237
General maintenance	238
Does your vehicle need repairing?	240
Emissions Inspection and Maintenance (I/M) programs	241

For scheduled maintenance information, please refer to the "Scheduled Maintenance Guide" or "Owner's Manual Supplement".



Maintenance requirements

Your Toyota vehicle has been designed for fewer maintenance requirements with longer service intervals to save both your time and money. However, each regular maintenance, as well as day-to-day care, is more important than ever before to ensure smooth, trouble-free, safe, and economical drivings.

It is the owner's responsibility to make sure the specified maintenance, including general maintenance service, is performed. Note that both the new vehicle and emission control system warranties specify that proper maintenance and care must be performed. See "Owner's Warranty Information Booklet" or "Owner's Manual Supplement" for complete warranty information.

General maintenance

General maintenance items are those day-to-day care practices that are important to your vehicle for proper operation. It is the owner's responsibility to insure that the general maintenance items are performed regularly.

These checks or inspections can be done either by yourself or a qualified technician, or if you prefer, your Toyota dealer will be pleased to do them at a nominal cost.

Scheduled maintenance

The scheduled maintenance items listed in the "Scheduled Maintenance Guide" or "Owner's Manual Supplement" are those required to be serviced at regular intervals.

For details of your maintenance schedule, read the "Scheduled Maintenance Guide" or "Owner's Manual Supplement".

It is recommended that any replacement parts used for maintenance or for the repair of the emission control system be Toyota supplied.

The owner may elect to use non-Toyota supplied parts for replacement purposes without invalidating the emission control system warranty. However, use of replacement parts which are not of equivalent quality may impair the effectiveness of the emission control systems.

You may also elect to have maintenance, replacement, or repair of the emission control devices and system performed by any automotive repair establishment or individual without invalidating this warranty. See "Owner's Warranty Information Booklet" or "Owner's Manual Supplement" for complete warranty information.

Where to go for service?

Toyota technicians are well-trained specialists and are kept up to date with the latest service information through technical bulletins, service tips, and in-dealership training programs. They learn to work on Toyotas before they work on your vehicle, rather than while they are working on it.

You can be confident that your Toyota dealer's service department performs the best job to meet the maintenance requirements on your vehicle—reliably and economically.

Your copy of the repair order is proof that all required maintenance has been performed for warranty coverage. And if any problems should arise with your vehicle while under warranty, your Toyota dealer will promptly take care of it. Again, be sure to keep a copy of the repair order for any service performed on your Toyota.

What about do-it-yourself maintenance?

Many of the maintenance items are easy to do yourself if you have a little mechanical ability and a few basic automotive tools. Simple instructions for how to perform them are presented on page 242 in Section 7.

If you are a skilled do-it-yourself mechanic, the Toyota service manuals are recommended. Please be aware that do-it-yourself maintenance can affect your warranty coverage. See "Owner's Warranty Information Booklet" or "Owner's Manual Supplement" for the details.

General maintenance

Listed below are the general maintenance items that should be performed as frequently as specified. In addition to checking the items listed, if you notice any unusual noise, smell or vibration, you should investigate the cause or take your vehicle to your Toyota dealer or a qualified service shop immediately. It is recommended that any problem you notice be brought to the attention of your dealer or the qualified service shop for their advice.



OUTSIDE THE VEHICLE

Items listed below should be performed from time to time, unless otherwise specified.

Tire pressure

Check the pressure with a gauge every two weeks, or at least once a month. See page 255 in Section 7-2 for additional information.

Tire surface and wheel nuts

Check the tires carefully for cuts, damage or excessive wear. See page 256 in Section 7-2 for additional information. When checking the tires, make sure no nuts are missing, and check the nuts for looseness. Tighten them if necessary.

Tire rotation

Rotate the tires according to the maintenance schedule. (For scheduled maintenance information, please refer to the "Scheduled Maintenance Guide" or "Owner's Manual Supplement".) See page 257 in Section 7-2 for additional information.

Fluid leaks

Check underneath for leaking fuel, oil, water or other fluid after the vehicle has been parked for a while. If you smell fuel fumes or notice any leak, have the cause found and corrected immediately.

Doors and engine hood

Check that all doors including trunk lid operate smoothly and all latches lock securely. Make sure the engine hood secondary latch secures the hood from opening when the primary latch is released.

INSIDE THE VEHICLE

Items listed below should be checked regularly, e.g. while performing periodic services, cleaning the vehicle, etc.

Lights

Make sure the headlights, stop lights, tail lights, turn signal lights, and other lights are all working. Check headlight aim.

Service reminder indicators and warning buzzers

Check that all service reminder indicators and warning buzzers function properly.

Steering wheel

Be alert for changes in steering condition, such as hard steering or strange noise.

Seats

Check that all front seat controls such as seat adjusters, seatback recliner, etc. operate smoothly and that all latches lock securely in any position. Check that the head restraints move up and down smoothly and that the locks hold securely in any latched position. For folding-down rear seatbacks, check that the latches lock securely.

Seat belts

Check that the seat belt system such as buckles, retractors and anchors operate properly and smoothly. Make sure that the belt webbings not cut, frayed, worn or damaged.

Accelerator pedal

Check the pedal for smooth operation and uneven pedal effort or catching.

Clutch pedal

Check the pedal for smooth operation.

Brake pedal

Check the pedal for smooth operation and that the pedal has the proper clearance. Check the brake booster function.

Brakes

At a safe place, check that the brakes do not pull to one side when applied.

Parking brake

Check that the lever has the proper travel and that, on a safe incline, your vehicle is held securely with only the parking brake applied.

Automatic transmission "Park" mechanism

Check the lock release button of the selector lever for proper and smooth operation. On a safe incline, check that your vehicle is held securely with the selector lever in "P" position and all brakes released.

IN THE ENGINE COMPARTMENT

Items listed below should be checked from time to time, e.g. each time when refueling.

Washer fluid

Make sure there is sufficient fluid in the tank. See page 266 in Section 7-3 for additional information.

Engine coolant level

Make sure the coolant level is between the "F" and "L" lines on the see-through reservoir when the engine is cold. See page 252 in Section 7-2 for additional information.

Radiator, condenser and hoses

Check that the front of the radiator and condenser are clean and not blocked with leaves, dirt, or insects. See page 253 in Section 7-2 for additional information.

Battery condition

Check the battery condition by the indicator color. See page 263 in Section 7-3 for additional information.

Brake fluid level

Make sure the brake fluid level is correct. See page 254 in Section 7-2 for additional information.

Engine oil level

Check the level on the dipstick with the engine turned off and the vehicle parked on a level spot. See page 251 in Section 7-2 for additional information.

Power steering fluid level

Check the level through the reservoir. The level should be in the "HOT" or "COLD" range depending on the fluid temperature. See page 254 in Section 7-2 for additional information.

Exhaust system

If you notice any change in the sound of the exhaust or smell exhaust fumes, have the cause located and corrected immediately. (See "Engine exhaust cautions" on page 185 in Section 2.)

Does your vehicle need repairing?

Be on the alert for changes in performance, sounds, and visual tip-offs that indicate service is needed. Some important clues are as follows:

- Ⓢ Engine missing, stumbling, or pinging
- Ⓢ Appreciable loss of power
- Ⓢ Strange engine noises
- Ⓢ A leak under the vehicle (however, water dripping from the air conditioning after use is normal.)
- Ⓢ Change in exhaust sound (This may indicate a dangerous carbon monoxide leak. Drive with the windows open and have the exhaust system checked immediately.)
- Ⓢ Flat-looking tire; excessive tire squeal when cornering; uneven tire wear
- Ⓢ Vehicle pulls to one side when driving straight on a level road
- Ⓢ Strange noises related to suspension movement
- Ⓢ Loss of brake effectiveness; spongy feeling brake or clutch pedal; pedal almost touches floor; vehicle pulls to one side when braking
- Ⓢ Engine coolant temperature continually higher than normal

If you notice any of these clues, take your vehicle to your Toyota dealer as soon as possible. It probably needs adjustment or repair.



Do not continue driving with the vehicle unchecked. It could result in serious vehicle damage and possibly personal injury.

Emissions Inspection and Maintenance (I/M) programs

Some states have vehicle emission inspection programs which include OBD (On-Board Diagnostics) checks.

The OBD system monitors the operation of the emission control system. When the OBD system determines that a problem exists somewhere in the emission control system, the malfunction indicator lamp comes on. In this case, your vehicle may not pass the I/M test and need to be repaired. Contact your Toyota dealer to service the vehicle.

Even if the malfunction indicator lamp does not come on, your vehicle may not pass the I/M test as readiness codes have not been set in the OBD system.

Readiness codes are automatically set during ordinary driving. However, when the battery is disconnected or run down, the codes are erased. Also, depending on your driving habits, the codes may not be completely set.

Also, if the malfunction indicator lamp had come on recently due to temporary malfunction such as a loose fuel tank cap, your vehicle may not pass the I/M test.

The malfunction indicator lamp will go off after taking several driving trips, but the error code in the OBD system will not be cleared unless about 40 trips or more are taken.

If your vehicle does not pass the I/M test even the malfunction indicator lamp does not come on, contact your Toyota dealer to prepare the vehicle for re-testing.

SECTION 7-1

DO-IT-YOURSELF MAINTENANCE

Introduction

Engine compartment overview	243
Fuse locations	245
Do-it-yourself service precautions	246
Positioning the jack	247
Parts and tools	248

Engine compartment overview

© 2AZ-FE engine

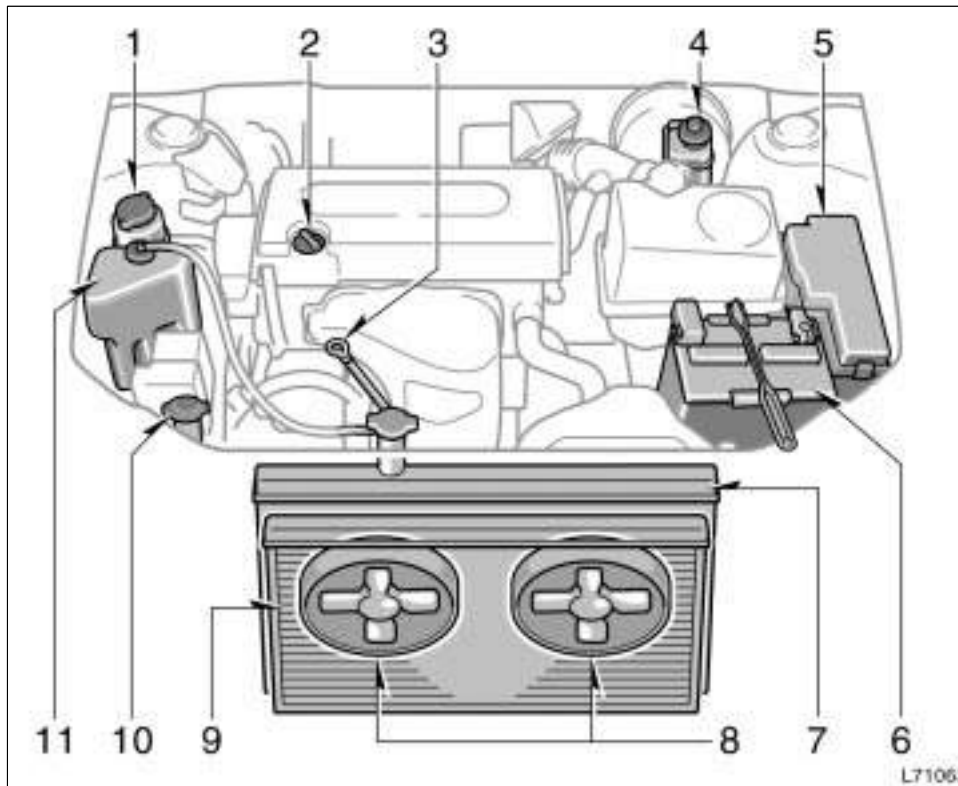

1. Power steering fluid reservoir
2. Engine oil filler cap
3. Engine oil level dipstick
4. Brake fluid reservoir
5. Fuse block
6. Battery
7. Radiator
8. Electric cooling fans
9. Condenser
10. Windshield washer fluid tank
11. Engine coolant reservoir

© 1MZ-FE engine

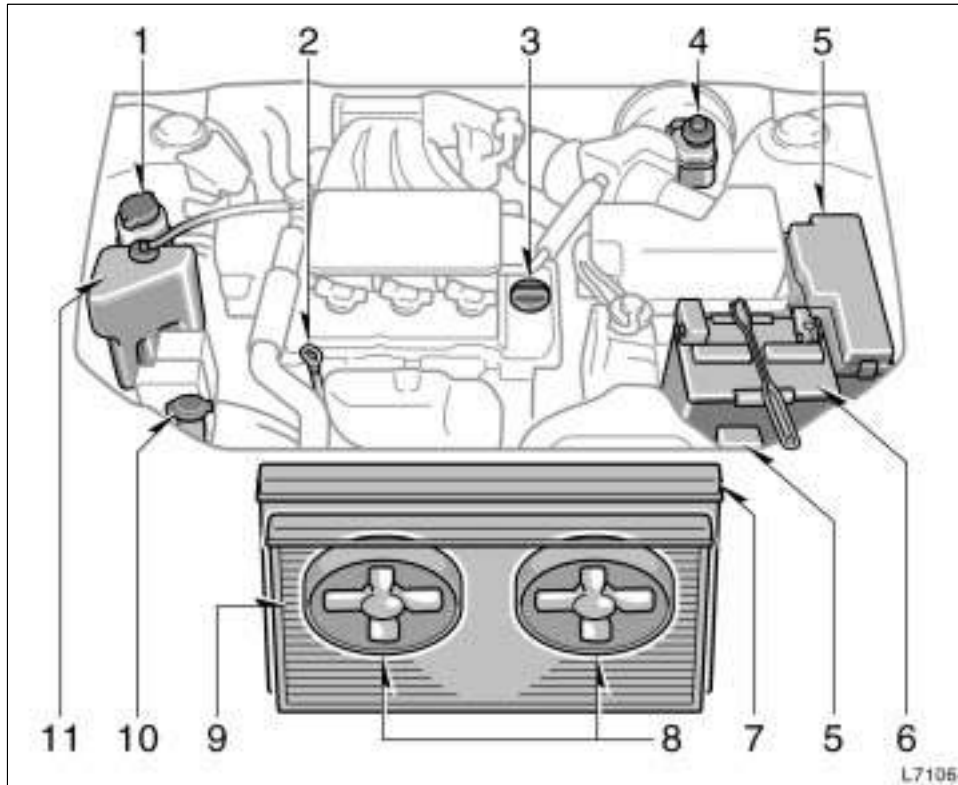

1. Power steering fluid reservoir
2. Engine oil level dipstick
3. Engine oil filler cap
4. Brake fluid reservoir
5. Fuse blocks
6. Battery
7. Radiator
8. Electric cooling fans
9. Condenser
10. Windshield washer fluid tank
11. Engine coolant reservoir

Fuse locations

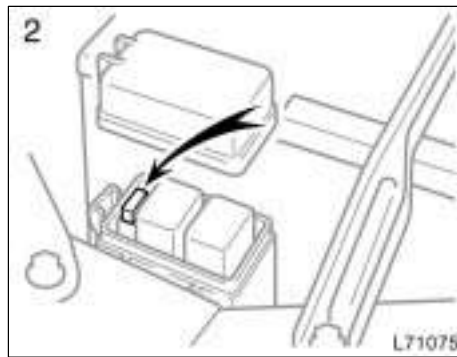
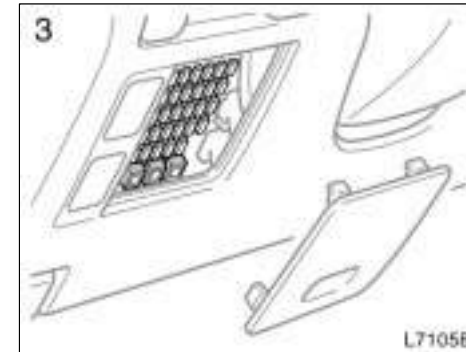
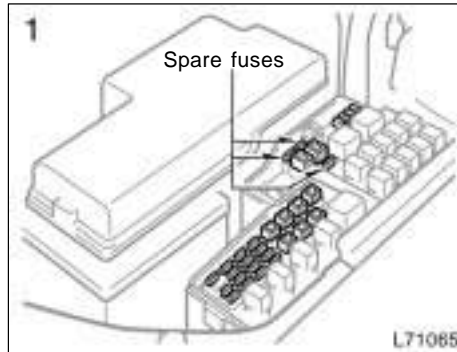
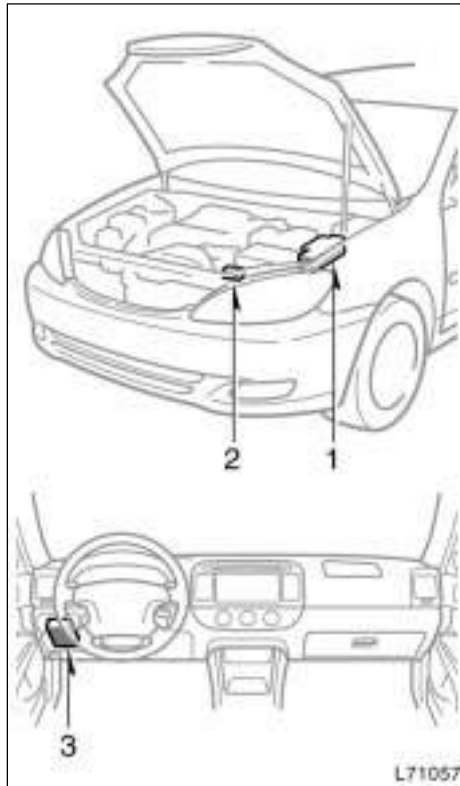

With vehicle skid control system

Do-it-yourself service precautions

If you perform maintenance by yourself, be sure to follow the correct procedure given in this section.

You should be aware that improper or incomplete servicing may result in operating problems.

Performing do-it-yourself maintenance during the warranty period may affect your warranty coverage. Read the separate Toyota Warranty statement for details and suggestions.

This section gives instructions only for those items that are relatively easy for an owner to perform. As explained in Section 6, there are still a number of items that must be done by a qualified technician with special tools.

For information on tools and parts for do-it-yourself maintenance, see "Parts and tools" on page 248 in this section.

Utmost care should be taken when working on your vehicle to prevent accidental injury. Here are a few precautions that you should be especially careful to observe:

 **CAUTION**

- ◀ When the engine is running, keep hands, clothing, and tools away from the moving fan and engine drive belts. (Removing rings, watches, and ties is advisable.)
- ◀ Right after driving, the engine compartment—the engine, radiator, exhaust manifold and spark plug boots, etc.—will be hot. So be careful not to touch them. Oil, fluids and spark plugs may also be hot.
- ◀ If the engine is hot, do not remove the radiator cap or loosen the drain plugs to prevent burning yourself.
- ◀ Do not smoke, cause sparks or allow open flames around fuel or the battery. Their fumes are flammable.
- ◀ Do not get under your vehicle with just the body jack supporting it. Always use automotive jack stands or other solid supports.

- ◀ Be sure that the ignition is off if you work near the electric cooling fans or radiator grille. With the ignition on, the electric cooling fans will automatically start to run if the engine coolant temperature is high and/or the air conditioning is on.
- ◀ Use eye protection whenever you work on or under your vehicle where you may be exposed to flying or falling material, fluid spray, etc.
- ◀ Used engine oil contains potentially harmful contaminants which may cause skin disorders such as inflammation or skin cancer, so care should be taken to avoid prolonged and repeated contact with it. To remove used engine oil from your skin, wash thoroughly with soap and water.
- ◀ Do not leave used oil within the reach of children.
- ◀ Be extremely cautious when working on the battery. It contains poisonous and corrosive sulfuric acid.

◀ **Warning:** Battery posts, terminals and related accessories contain lead and lead compounds, chemicals known to the State of California to cause cancer and reproductive harm. Wash hands after handling.

◀ **Dispose of used oil and filter only in a safe and acceptable manner. Do not dispose of used oil and filter in household trash, in sewers or onto the ground. Call your dealer or a service station for information concerning recycling or disposal.**

NOTICE

- Remember that battery and ignition cables carry high currents or voltages. Be careful of accidentally causing a short circuit.
- Add only demineralized or distilled water to fill the radiator. And if you spill some of the coolant, be sure to wash off with water to prevent it from damaging the parts or paint.
- Do not allow dirt or anything else to fall through the spark plugholes.

- Use only spark plugs of the specified type. Using other types will cause engine damage, loss of performance or radio noise.
- Do not reuse iridium-tipped spark plugs by cleaning or regapping.
- Do not overfill automatic transmission fluid, or the transmission could be damaged.
- Do not drive with the air cleaner filter removed, or excessive engine wear could result. Also backfiring could cause a fire in the engine compartment.
- Be careful not to scratch the glass surface with the wiper frame.
- When closing the engine hood, check to see that you have not forgotten any tools, rags, etc.

Positioning the jack

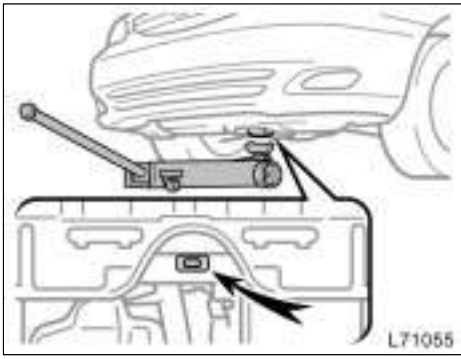

Front

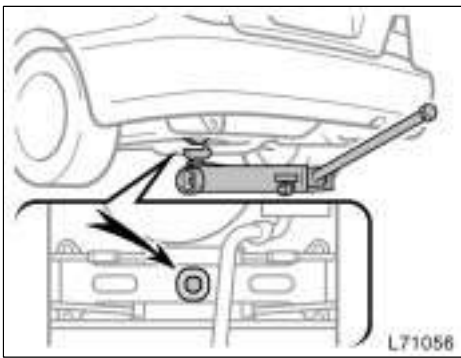

Rear

When jacking up your vehicle with the jack, position the jack correctly as shown in the illustrations.

CAUTION

When jacking, be sure to observe the following to reduce the possibility of personal injury:

- ◀ Follow jacking instructions.
- ◀ Do not put any part of your body under the vehicle supported by the jack. Personal injury may occur.
- ◀ Do not start or run the engine while your vehicle is supported by the jack.
- ◀ Stop the vehicle on a level firm ground, firmly set the parking brake and put the transmission in "P" (automatic) or reverse (manual). Block the wheels on the opposite side of the jack up point if necessary.
- ◀ Make sure to set the jack properly in the jack point. Raising the vehicle with jack improperly positioned will damage the vehicle or may allow the vehicle to fall off the jack and cause personal injury.

- ◀ Never get under the vehicle when the vehicle is supported by the jack alone; use vehicle support stands.
- ◀ Do not raise the vehicle with someone in the vehicle.
- ◀ When raising the vehicle, do not put an object on or under the jack.

NOTICE

Make sure to place the jack correctly, or your vehicle may be damaged.

Parts and tools

Here is a list of parts and tools you will need on performing do-it-yourself maintenance. Remember all Toyota parts are designed in metric sizes, so your tools must be metric.

CHECKING THE ENGINE OIL LEVEL

Parts (if level is low):

- ◀ Engine oil API grade SJ "Energy-Conserving", SL "Energy-Conserving" or ILSAC multigrade having viscosity proper for your climate

Tools:

- ◀ Rag or paper towel
- ◀ Funnel (only for adding oil)

CHECKING THE ENGINE COOLANT LEVEL

Parts (if level is low):

- ◀ "TOYOTA Long Life Coolant" or equivalent
See page 252 in Section 7-2 for details about coolant type selection.
- ◀ Demineralized or distilled water

Tools:

- ◀ Funnel (only for adding coolant)

CHECKING BRAKE FLUID

Parts (if level is low):

- ◀SAE J1703 or FMVSS No.116 DOT 3 brake fluid

Tools:

- ◀Rag or paper towel
- ◀Funnel (only for adding fluid)

CHECKING POWER STEERING FLUID

Parts (if level is low):

- ◀Automatic transmission fluid DEXRON[®]VI or III

Tools:

- ◀Rag or paper towel
- ◀Funnel (only for adding fluid)

CHECKING BATTERY CONDITION

Tools:

- ◀Warm water
- ◀Baking soda
- ◀Grease
- ◀Conventional wrench (for terminal clamp bolts)

CHECKING AND REPLACING FUSES

Parts (if replacement is necessary):

- ◀Genuine Toyota fuse or equivalent with same amperage rating as original

ADDING WASHER FLUID

Parts:

- ◀Water
- ◀Washer fluid containing antifreeze (for winter use)

Tools:

- ◀Funnel

REPLACING LIGHT BULBS

Parts:

- ◀Bulb with same number and wattage rating as original (See charts in "Replacing light bulbs" on page 266 in Section 7-3.)

Tools:

- ◀Screwdriver
- ◀Flat-bladed screwdriver

SECTION 7-2

DO-IT-YOURSELF MAINTENANCE

Engine and Chassis

Checking the engine oil level	251
Checking the engine coolant level	252
Checking the radiator and condenser	253
Checking brake fluid	254
Checking power steering fluid	254
Checking tire pressure	255
Checking and replacing tires	256
Rotating tires	257
Installing snow tires and chains	258
Replacing wheels	259
Aluminum wheel precautions	260

Checking the engine oil level

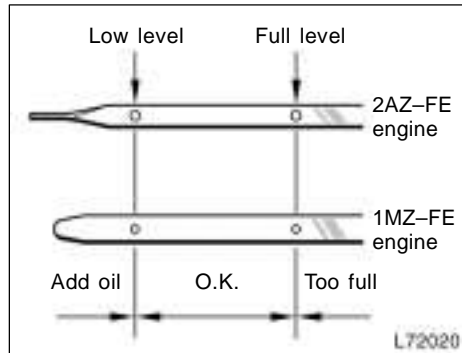

With the engine at operating temperature and turned off, check the oil level on the dipstick.

1. To get a true reading, the vehicle should be on a level spot. After turning off the engine, wait a few minutes for the oil to drain back into the bottom of the engine.
2. Pull out the dipstick, and wipe it clean with a rag.
3. Reinsert the dipstick—push it in as far as it will go, or the reading will not be correct.
4. Pull the dipstick out and look at the oil level on the end.

CAUTION

Be careful not to touch the hot exhaust manifold.

If the oil level is below or only slightly above the low level line, add engine oil of the same type as already in the engine.

Remove the oil filler cap and add engine oil in small quantities at a time, checking the dipstick.

The approximate quantity of oil needed to fill between the low level and the full level on the dipstick is indicated below for reference.

When the level reaches within the correct range, install the filler cap hand-tight.

Oil quantity, L (qt., Imp. qt.):

2AZ-FE engine	1.0 (1.1, 0.9)
1MZ-FE engine	1.5 (1.6, 1.3)

NOTICE

- Avoid overfilling, or the engine could be damaged.
- Check the oil level on the dipstick once again after adding the oil.

ENGINE OIL SELECTION

Use API grade SJ “Energy-Conserving”, SL “Energy-Conserving” or ILSAC multi-grade engine oil.

Recommended viscosity (SAE):

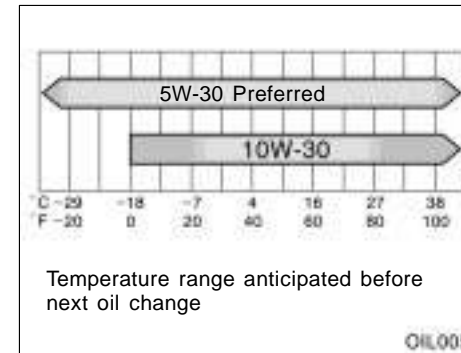

SAE 5W-30 is the best choice for your vehicle, for good fuel economy, and good starting in cold weather.

If you use SAE 10W-30 engine oil in extremely low temperatures, the engine may become difficult to start, so SAE 5W-30 engine oil is recommended.

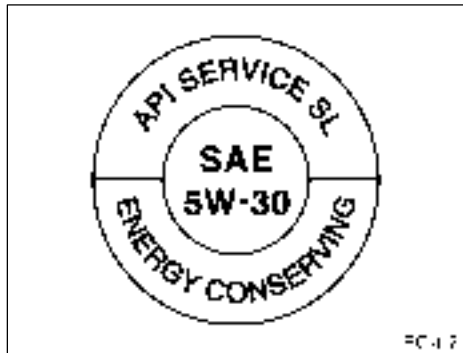

API service symbol



ILSAC certification mark

Oil identification marks

Either or both API registered marks are added to some oil containers to help you select the oil you should use.

The API Service Symbol is located anywhere on the outside of the container.

The top portion of the label shows the oil quality by API (American Petroleum Institute) designations such as SL. The center portion of the label shows the SAE viscosity grade such as SAE 5W-30. "Energy-Conserving" shown in the lower portion, indicates that the oil has fuel-saving capabilities.

The ILSAC (International Lubricant Standardization and Approval Committee) Certification Mark is displayed on the front of the container.

Checking the engine coolant level

Look at the see-through coolant reservoir when the engine is cold. The coolant level is satisfactory if it is between the "F" and "L" lines on the reservoir. If the level is low, add ethylene-glycol type coolant for a proper corrosion protection of aluminum components.

The coolant level in the reservoir will vary with engine temperature. However, if the level is on or below the "L" line, add coolant. Bring the level up to the "F" line.

Always use ethylene-glycol type coolant for a proper corrosion protection of aluminum components. See information in the next column.

If the coolant level drops within a short time after replenishing, there may be a leak in the system. Visually check the radiator, hoses, engine coolant filler cap, radiator cap and drain cock and water pump.

If you can find no leak, have your Toyota dealer test the cap pressure and check for leaks in the cooling system.



CAUTION

To prevent burning yourself, do not remove the radiator cap when the engine is hot.

Coolant type selection

Use of improper coolants may damage your engine cooling system. Your coolant must contain ethylene-glycol type coolant for a proper corrosion protection of your engine that contains aluminum components. Use "TOYOTA Long Life Coolant" or equivalent.

In addition to preventing freezing and subsequent damage to the engine, this type of coolant will also prevent corrosion. Further supplemental inhibitors or additives are neither needed nor recommended.

Read the coolant container for information on freeze protection. Follow the manufacturer's directions for how much to mix with plain water (preferably demineralized water or distilled water). The total capacity of the cooling system is given on page 275 in Section 8.

We recommend to use 50% solution for your Toyota, to provide protection down to about -35°C (-31°F). When it is extremely cold, to provide protection down to about -50°C (-58°F), 60% solution is recommended. Do not use more than 70% solution for better coolant performance.

NOTICE

Do not use alcohol type antifreeze or plain water alone.

Checking the radiator and condenser

If any of the above parts are extremely dirty or you are not sure of their condition, take your vehicle to Toyota dealer.



CAUTION

To prevent yourself from burning, be careful not to touch the radiator or condenser when the engine is hot.

NOTICE

To prevent damage to the radiator and condenser, do not perform the work by yourself.

Checking brake fluid

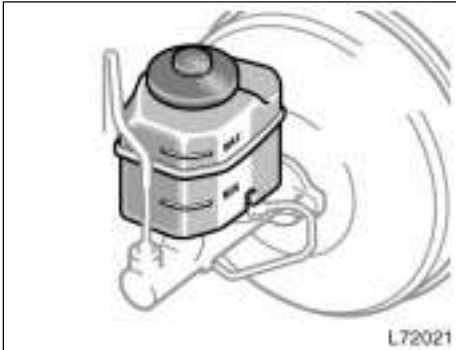

To check the fluid level, simply look at the see-through reservoir. The level should be between the "MAX" and "MIN" lines on the reservoir.

It is normal for the brake fluid level to go down slightly as the brake pads wear. So be sure to keep the reservoir filled.

If the reservoir needs frequent refilling, it may indicate a serious mechanical problem.

If the level is low, add SAE J1703 or FMVSS No.116 DOT 3 brake fluid to the brake reservoir.

Remove and replace the reservoir cap by hand. Fill the brake fluid to the dotted line. This brings the fluid to the correct level when you put the cap back on.

Use only newly opened brake fluid. Once opened, brake fluid absorbs moisture from the air, and excess moisture can cause a dangerous loss of braking.

CAUTION

Take care when filling the reservoir because brake fluid can harm your eyes and damage painted surfaces. If fluid gets in your eyes, flush your eyes with clean water immediately. If you still feel uncomfortable with your eyes, go to the doctor.

NOTICE

If you spill some of the fluid, be sure to wash it off with water to prevent it from damaging the parts or paint.

Checking power steering fluid

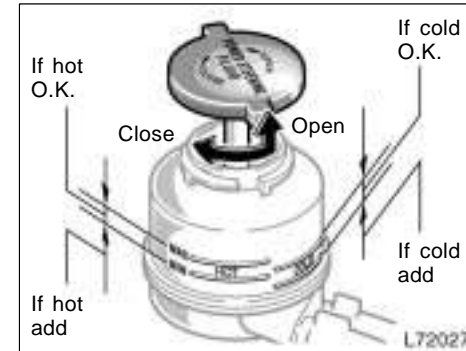

Check the fluid level through the reservoir. If necessary, add automatic transmission fluid DEXRON^{III} or III.

If the vehicle has been driven around 80 km/h (50 mph) for 20 minutes (a little more in frigid temperatures), the fluid is hot (60°C—80°C or 140°F—175°F). You may also check the level when the fluid is cold (about room temperature, 10°C—30°C or 50°F—85°F) if the engine has not been run for about five hours.

Clean all dirt from outside of the reservoir tank and look at the fluid level. If the fluid is cold, the level should be in the "COLD" range. Similarly, if it is hot, the fluid level should be in the "HOT" range. If the level is at the low side of either range, add automatic transmission fluid DEXRON ∇ I or III to bring the level within the range.

To remove the reservoir cap, turn it counterclockwise and lift up. To reinstall it, turn it clockwise. After replacing the reservoir cap, visually check the steering box case, vane pump and hose connections for leaks or damage.

CAUTION
 The reservoir tank may be hot so be careful not to burn yourself.

NOTICE
 Avoid overfilling, or the power steering could be damaged.

Checking tire pressure

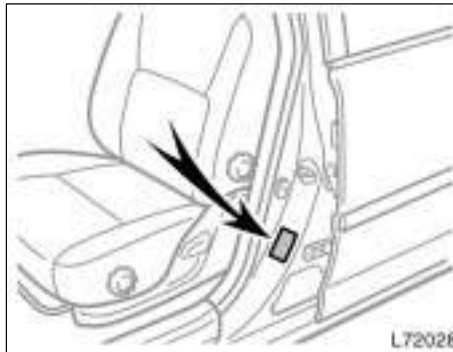

Keep your tire pressures at the proper level.

The recommended cold tire pressures, tire size and the vehicle capacity weight are given on page 273 in Section 8. They are also on the tire pressure label as shown.

You should check the tire pressures every two weeks, or at least once a month. And don't forget the spare!

Incorrect tire pressure can reduce tire life and make your vehicle less safe to drive.

Low tire pressure results in excessive wear, poor handling, reduced fuel economy, and the possibility of blowouts from overheated tires. Also, low tire pressure can cause poor sealing of the tire bead. If the tire pressure is excessively low, there is the possibility of wheel deformation and/or tire separation.

High tire pressure produces a harsh ride, handling problems, excessive wear at the center of the tire tread, and a greater possibility of tire damage from road hazards.

If a tire frequently needs refilling, have it checked by your Toyota dealer.

The following instructions for checking tire pressure should be observed:

- © **The pressure should be checked only when the tires are cold.** If your vehicle has been parked for at least 3 hours and has not been driven for more than 1.5 km or 1 mile since, you will get an accurate cold tire pressure reading.
- © **Always use a tire pressure gauge.** The appearance of a tire can be misleading. Besides, tire pressures that are even just a few pounds off can degrade ride and handling.

- © **Do not bleed or reduce tire pressure after driving.** It is normal for the tire pressure to be higher after driving.
- © **Never exceed the vehicle capacity weight.** The passenger and luggage weight should be located so that the vehicle is balanced.
- © **Be sure to reinstall the tire inflation valve caps.** Without the valve caps, dirt or moisture could get into the valve core and cause air leakage. If the caps have been lost, have new ones put on as soon as possible.

Checking and replacing tires

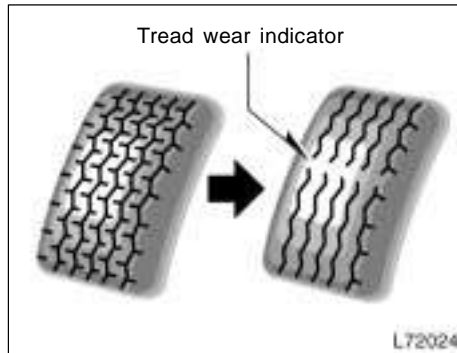

CHECKING YOUR TIRES

Check the tires tread for the tread wear indicators. If the indicators show, replace the tires.

The tires on your Toyota have built-in tread wear indicators to help you know when the tires need replacement. When the tread depth wears to 1.6 mm (0.06 in.) or less, the indicators will appear. If you can see the indicators in two or more adjacent grooves, the tire should be replaced. The lower the tread, the higher the risk of skidding.

The effectiveness of snow tires is lost if the tread wears down below 4 mm (0.16 in.).

Check the tires regularly for damage such as cuts, splits and cracks. If any damage is found, consult with a technician and have the tire repaired or replaced.

Even if the damage does not appear serious, a qualified technician should examine the damage. Objects which have penetrated the tire may have caused internal damage.

Any tires which are over 6 years old must be checked by a qualified technician even if damage is not obvious.

Tires deteriorate with age even if they have never or seldom been used.

This applies also to the spare tire and tires stored for future use.

REPLACING YOUR TIRES

When replacing a tire, use only the same size and construction as originally installed and with the same or greater load capacity.

Using any other size or type of tire may seriously affect handling, ride, speedometer/odometer calibration, ground clearance, and clearance between the body and tires or snow chains.

CAUTION

- Do not mix radial, bias belted, or bias-ply tires on your vehicle. It can cause dangerous handling characteristics, resulting in loss of control.
- Do not use tires or wheels other than the manufacturer's recommended size.

Toyota recommends all four tires, or at least both front or rear tires be replaced as a set.

See "If you have a flat tire" on page 216 in Section 4 for tire change procedure.

When a tire is replaced, the wheel should always be balanced.

An unbalanced wheel may affect vehicle handling and tire life. Wheels can get out of balance with regular use and should therefore be balanced occasionally.

When replacing a tubeless tire, the air valve should also be replaced with a new one.

Rotating tires

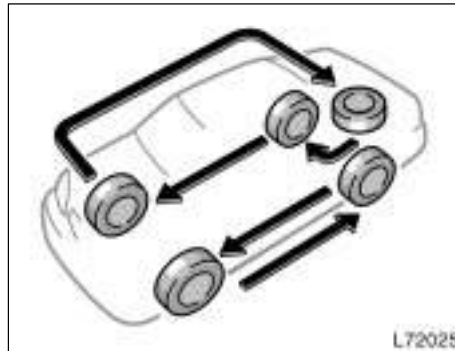

With a spare tire of the same wheel type as the installed tires

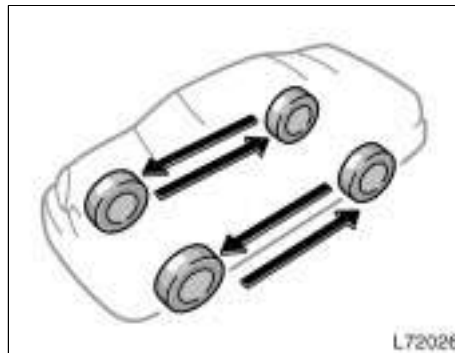

With a spare tire of different wheel type from the installed tires

To equalize the wear and help extend tire life, Toyota recommends that you rotate your tires according to the maintenance schedule. (For scheduled maintenance information, please refer to the "Scheduled Maintenance Guide" or "Owner's Manual Supplement".) However, the most appropriate timing for tire rotation may vary according to your driving habits and road surface conditions.

See "If you have a flat tire" on page 216 in Section 4 for tire change procedure.

When rotating tires, check for uneven wear and damage. Abnormal wear is usually caused by incorrect tire pressure, improper wheel alignment, out-of-balance wheels, or severe braking.

CAUTION

Do not include a compact spare tire when rotating the tires. It is designed for temporary use only.

Installing snow tires and chains

WHEN TO USE SNOW TIRES OR CHAINS

Snow tires or chains are recommended when driving on snow or ice.

On wet or dry roads, conventional tires provide better traction than snow tires.

SNOW TIRE SELECTION

If you need snow tires, select the same size, construction and load capacity as the original tires on your Toyota.

Do not use tires other than those mentioned above. Do not install studded tires without first checking local regulations for possible restrictions.

SNOW TIRE INSTALLATION

Snow tires should be installed on all wheels.

Installing snow tires on the front wheels only can lead to an excessive difference in road grip capability between the front and rear tires which could cause loss of vehicle control.

When storing removed tires you should store them in a cool dry place. Mark the direction of rotation and be sure to install them in the same direction when replacing.

 **CAUTION**

©Do not drive with the snow tires incorrectly inflated.

©Never drive over 120 km/h (75 mph) with any type of snow tires.

TIRE CHAIN SELECTION

Use the tire chains of correct size and type.

Use SAE Class "S" type radial tire chains except radial cable chains or V-bar type chains.

Regulations regarding the use of tire chains vary according to location or type of road, so always check them before installing chains.

CHAIN INSTALLATION

Install the chains on the front tires as tightly as possible. Do not use tire chains on the rear tires. Retighten chains after driving 0.5—1.0 km (1/4—1/2 mile).

When installing chains on your tires, carefully follow the instructions of the chain manufacturer.

If wheel covers are used, they will be scratched by the chain band, so remove the covers before putting on the chains.

 **CAUTION**

©Do not exceed 50 km/h (30 mph) or the chain manufacturer's recommended speed limit, whichever is lower.

©Drive carefully avoiding bumps, holes, and sharp turns, which may cause the vehicle to bounce.

©Avoid sharp turns or locked-wheel braking, as use of chains may adversely affect vehicle handling.

©When driving with chains installed, be sure to drive carefully. Slow down before entering the curves to avoid losing control of the vehicle. Otherwise an accident may occur.

NOTICE

Do not attempt to use a tire chain on the compact spare tire, as it may result in damage to the vehicle as well as the tire.

Replacing wheels

WHEN TO REPLACE YOUR WHEELS

If you have wheel damage such as bending, cracks or heavy corrosion, the wheel should be replaced.

If you fail to replace damaged wheels, the tire may slip off the wheel or cause loss of handling control.

WHEEL SELECTION

When replacing wheels, care should be taken to ensure that the wheels are replaced by ones with the same load capacity, diameter, rim width, and offset.

Correct replacement wheels are available at your Toyota dealer.

A wheel of a different size or type may adversely affect handling, wheel and bearing life, brake cooling, speedometer/odometer calibration, stopping ability, headlight aim, bumper height, vehicle ground clearance, and tire or snow chain clearance to the body and chassis.

Replacement with used wheels is not recommended as they may have been subjected to rough treatment or high mileage and could fail without warning. Also, bent wheels which have been straightened may have structural damage and therefore should not be used. Never use an inner tube in a leaking wheel which is designed for a tubeless tire.

Aluminum wheel precautions

- © When installing aluminum wheels, check that the wheel nuts are tight after driving your vehicle the first 1600 km (1000 miles).
- © If you have rotated, repaired, or changed your tires, check that the wheel nuts are still tight after driving 1600 km (1000 miles).
- © When using tire chains, be careful not to damage the aluminum wheels.
- © Use only the Toyota wheel nuts and wrench designed for your aluminum wheels.
- © When balancing your wheels, use only Toyota balance weights or equivalent and a plastic or rubber hammer.
- © As with any wheel, periodically check your aluminum wheels for damage. If damaged, replace immediately.

SECTION 7-3

DO-IT-YOURSELF MAINTENANCE

Electrical components

Checking battery condition	263
Battery recharging precautions	264
Checking and replacing fuses	265
Adding washer fluid	266
Replacing light bulbs	266

Checking battery condition—
—Precautions

⚠ CAUTION

BATTERY PRECAUTIONS

The battery produces flammable and explosive hydrogen gas.

- Ⓢ Do not cause a spark from the battery with tools.
- Ⓢ Do not smoke or light a match near the battery.

The electrolyte contains poisonous and corrosive sulfuric acid.

- Ⓢ Avoid contact with eyes, skin or clothes.
- Ⓢ Never ingest electrolyte.
- Ⓢ Wear protective safety glasses when working near the battery.
- Ⓢ Keep children away from the battery.

EMERGENCY MEASURES

- Ⓢ If electrolyte gets in your eyes, flush your eyes with clean water immediately and get immediate medical attention. If possible, continue to apply water with a sponge or cloth while en route to the medical office.

- Ⓢ If electrolyte gets on your skin, thoroughly wash the contact area. If you feel pain or burning, get medical attention immediately.
- Ⓢ If electrolyte gets on your clothes, there is a possibility of its soaking through to your skin, so immediately take off the exposed clothing and follow the procedure above, if necessary.
- Ⓢ If you accidentally swallow electrolyte, drink a large quantity of water or milk. Follow with milk of magnesia, beaten raw egg or vegetable oil. Then go immediately for emergency help.
- Ⓢ **Warning:** Battery posts, terminals and related accessories contain lead and lead compounds, chemicals known to the State of California to cause cancer and reproductive harm. Wash hands after handling.

—Checking battery exterior

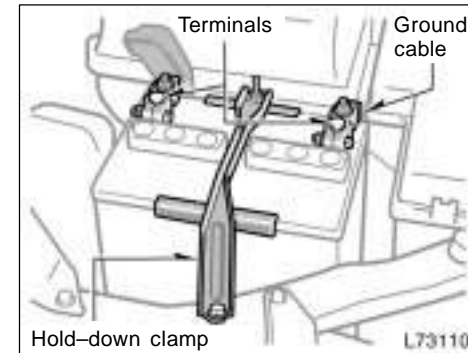

Check the battery for corroded or loose terminal connections, cracks, or loose hold-down clamp.

- If the battery is corroded, wash it off with a solution of warm water and baking soda. Coat the outside of the terminals with grease to prevent further corrosion.
- If the terminal connections are loose, tighten their clamp nuts—but do not overtighten.
- Tighten the hold-down clamp only enough to keep the battery firmly in place. Overtightening may damage the battery case.

NOTICE

- ◀ **Be sure the engine and all accessories are off before performing maintenance.**
- ◀ **When checking the battery, remove the ground cable from the negative terminal (“-” mark) first and reinstall it last.**
- ◀ **Be careful not to cause a short circuit with tools.**
- ◀ **Take care no solution gets into the battery when washing it.**

If the battery is disconnected or run down, the moon roof may not operate automatically and the jam protection function will not function correctly after you reconnect, replace or recharge the battery. In any of these cases, you should normalize the moon roof. To normalize the moon roof, see “Electric moon roof” on page 32 in Section 1-2.

—Checking battery condition

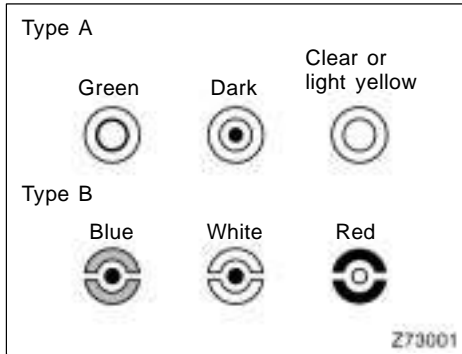

CHECKING BY INDICATOR

Check the battery condition by the indicator color.

Indicator color		Condition
Type A	Type B	
Green	Blue	Good
Dark	White	Charging necessary. Have battery checked by your Toyota dealer.
Clear or light yellow	Red	Have battery checked by your Toyota dealer.

Battery recharging precautions

During recharging, the battery is producing hydrogen gas.

- Therefore, before recharging:
1. If recharging with the battery installed on the vehicle, be sure to disconnect the ground cable.
 2. Be sure the power switch on the recharger is off when connecting the charger cables to the battery and when disconnecting them.

CAUTION

- © **Always charge the battery in an unconfined area. Do not charge the battery in a garage or closed room where there is not sufficient ventilation.**
- © **Only do a slow charge (5 A or less). Charging at a quicker rate is dangerous. The battery may explode, causing personal injuries.**

NOTICE

Never recharge the battery while the engine is running. Also, be sure all accessories are turned off.

Checking and replacing fuses

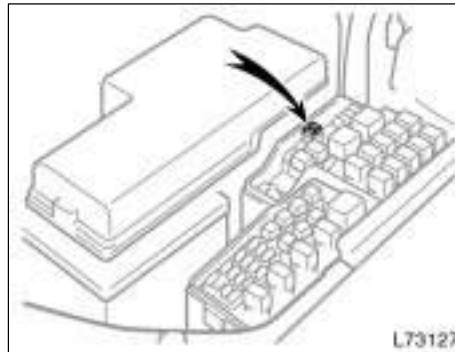
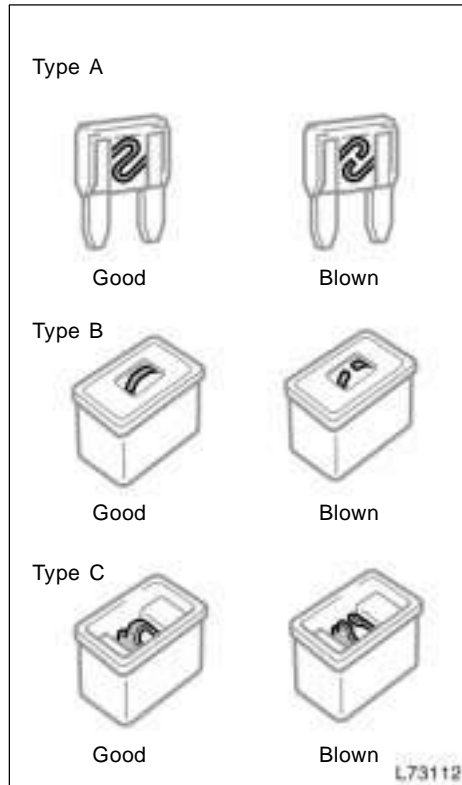

If the headlights or other electrical components do not work, check the fuses. If any of the fuses are blown, they must be replaced.

See "Fuse locations" on page 245 in Section 7-1 for locations of the fuses.

Turn the ignition switch and inoperative component off. Pull a suspected fuse straight out and check it.

Determine which fuse may be causing the problem. The lid of the fuse box shows the name of the circuit for each fuse. See page 278 in Section 8 of this manual for the functions controlled by each circuit.

Type A fuses can be pulled out by the pull-out tool. The location of the pull-out tool is shown in the illustration.

If you are not sure whether the fuse has blown, try replacing the suspected fuse with one that you know is good.

If the fuse has blown, push a new fuse into the clip.

Only install a fuse with the amperage rating designated on the fuse box lid.

If you do not have a spare fuse, in an emergency you can pull out the "MIR-HTR", "CIG" or "POWER POINT" fuse, which may be dispensable for normal driving, and use it if its amperage rating is the same.

If you cannot use one of the same amperage, use one that is lower, but as close as possible to the rating. If the amperage is lower than that specified, the fuse might blow out again but this does not indicate anything wrong. Be sure to get the correct fuse as soon as possible and return the substitute to its original clip.

It is a good idea to purchase a set of spare fuses and keep them in your vehicle for emergencies.

If the new fuse immediately blows out, there is a problem with the electrical system. Have your Toyota dealer correct it as soon as possible.

 CAUTION
Never use a fuse with a higher amperage rating, or any other object, in place of a fuse. This may cause extensive damage and possibly a fire.

Adding washer fluid

If any washer does not work or low windshield washer fluid level warning light comes on, the washer tank may be empty. Add washer fluid.

You may use plain water as washer fluid. However, in cold areas where temperatures range below freezing point, use washer fluid containing antifreeze. This product is available at your Toyota dealer and most auto parts stores. Follow the manufacturer's directions for how much to mix with water.

NOTICE
<i>Do not use engine antifreeze or any other substitute because it may damage your vehicle's paint.</i>

Replacing light bulbs—

The following illustrations show how to gain access to the bulbs. When replacing a bulb, make sure the ignition switch and light switch are off. Use bulbs with the wattage ratings given in the table.

 CAUTION
©To prevent yourself from burning, do not replace the light bulbs while they are hot.
©Halogen bulbs have pressurized gas inside and require special handling. They can burst or shatter if scratched or dropped. Hold a bulb only by its plastic or metal case. Do not touch the glass part of a bulb with bare hands.

NOTICE
<i>Only use a bulb of the listed type.</i>

The inside of the lens of exterior lights such as headlights may temporarily fog up when the lens becomes wet in the rain or in a car wash. This is not a problem because the fogging is caused by the temperature difference between the outside and inside of the lens, just like the windshield fogged up in the rain. However, if there is a large drop of water on the inside of the lens, or if there is water pooled inside the light, contact your Toyota dealer.

Light bulbs	Bulb No.	W	Type
Headlights (high)	9005	60	A
Headlights (low)	9006	51	B
Front fog lights	9006	51	B
Parking, front side marker and front turn signal lights	3457	30/8	C
Tail and rear side marker lights	194	3.8	C
Rear turn signal lights	921	18	C
Stop/tail lights	3057	27/7	C
Back-up lights	921	18	C
License plate lights	—	5	C
High mounted stoplight	921	18	C
Personal lights	—	4.9	C
Interior light (type A)	—	8	D
Interior light (type B)	—	5	D
Vanity lights	—	1.4	D
Glove box light	—	5	C

Light bulbs	Bulb No.	W	Type
Trunk light (type A)	—	5	C
Trunk light (type B)	—	3	D

A: HB3 halogen bulbs
 B: HB4 halogen bulbs
 C: Wedge base bulbs
 D: Double end bulbs

—Headlights

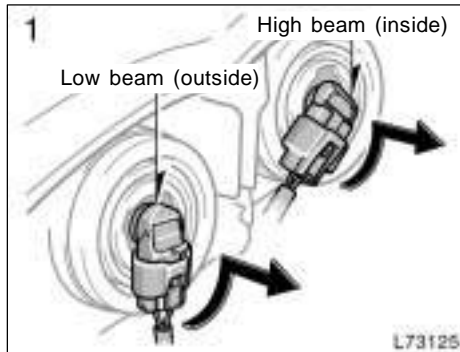

1. Open the hood. Turn the bulb base counterclockwise to the front of the vehicle as shown.

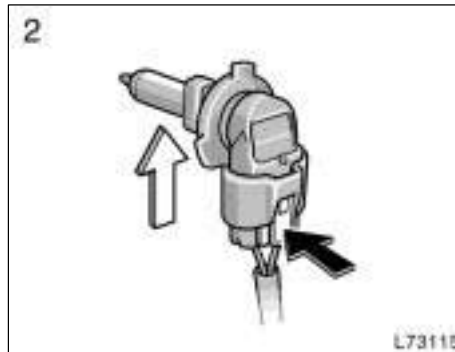

2. Unplug the connector while depressing the lock release.
If the connector is tight, wiggle it.



3. Plug in a new bulb into the connector and install it into the mounting hole.

Aiming is not necessary after replacing the bulb. When aiming adjustment is necessary, contact your Toyota dealer.

—Parking, front side marker and front turn signal lights

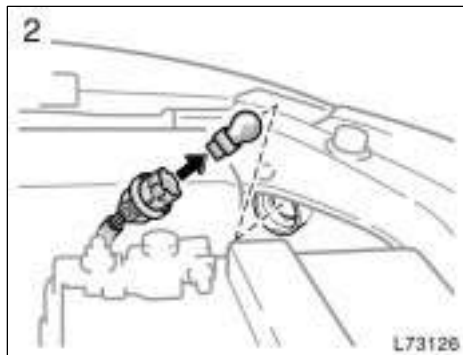
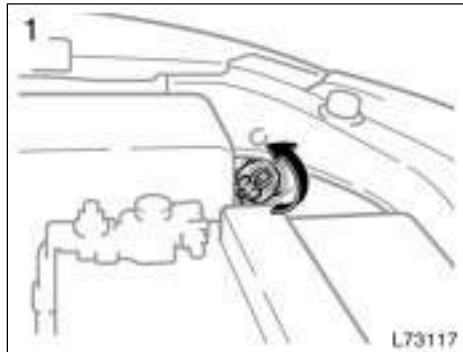

—Tail, rear side maker, rear turn signal, back-up and stop/tail lights (type A)

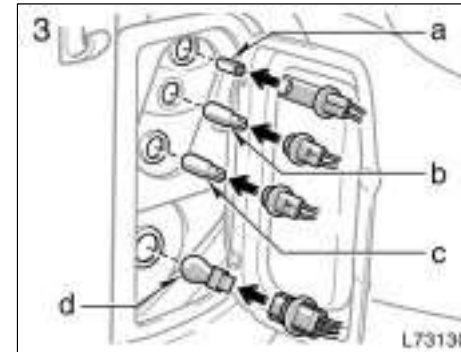
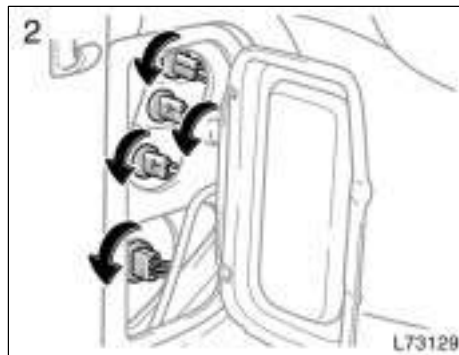

- a: Tail and rear side marker light
- b: Rear turn signal light
- c: Back-up light
- d: Stop/tail light

—Tail, rear side maker, rear turn signal, back-up and stop/tail lights (type B)

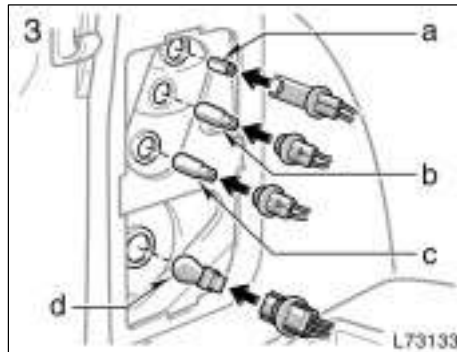
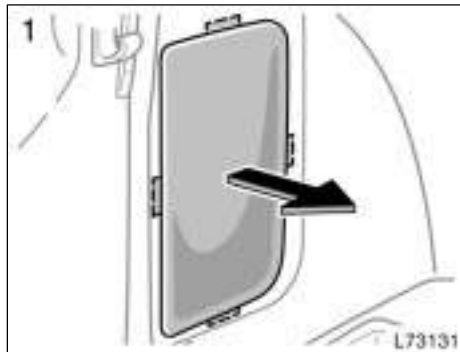

- a: Tail and rear side marker light
- b: Rear turn signal light
- c: Back-up light
- d: Stop/tail light

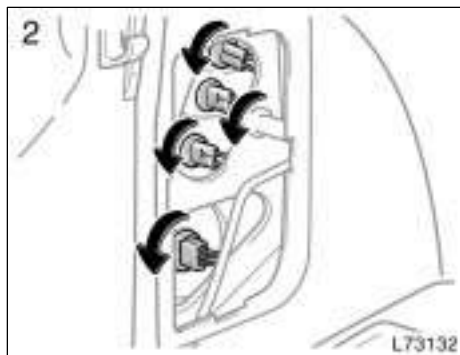

—High mounted stoplight

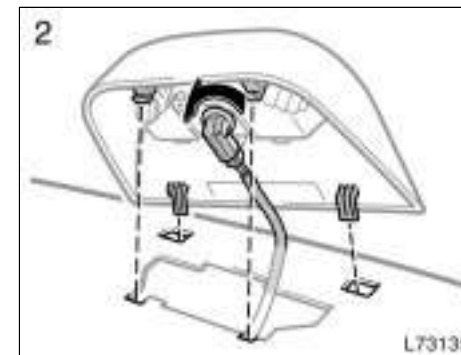
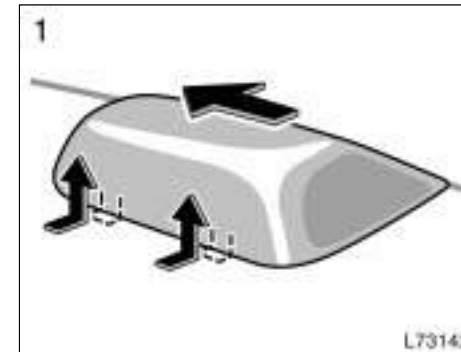

—Front fog and license plate lights

If either the left or right front fog or license plate lights burns out, contact your Toyota dealer.

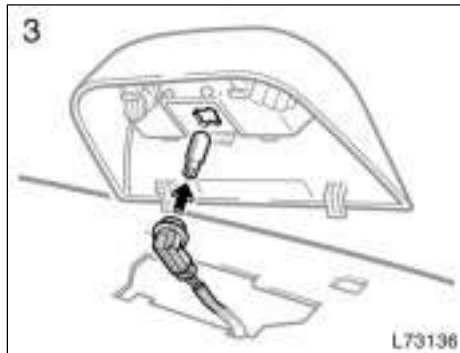

NOTICE

Do not try to replace the front fog or license plate light bulbs by yourself. You may damage the vehicle.

SECTION 8

SPECIFICATIONS

Dimensions and weight	274
Engine	274
Fuel	275
Service specifications	275
Tires	278
Fuses	278

Dimensions and weight

Overall length	mm (in.)	4805 (189.2)
Overall width	mm (in.)	1795 (70.7)
Overall height*1	mm (in.)	1490 (58.7)*2 1500 (59.1)*3
Wheelbase	mm (in.)	2720 (107.1)
Front tread	mm (in.)	1545 (60.8)
Rear tread	mm (in.)	1535 (60.4)
Vehicle capacity weight (occupants + luggage)	kg (lb.)	410 (900)

*1: Unladen vehicle

*2: With 205/65R15 tires

*3: With 215/60R16 tires

Engine

Model:

2AZ-FE and 1MZ-FE

Type:

2AZ-FE engine
 4 cylinder in line, 4 cycle, gasoline

1MZ-FE engine
 6 cylinder V type 4 cycle, gasoline

Bore and stroke, mm (in.):

2AZ-FE engine
 88.5 × 96.0 (3.48 × 3.78)

1MZ-FE engine
 87.5 × 83.0 (3.44 × 3.27)

Displacement, cm³ (cu. in.):

2AZ-FE engine 2362 (144.1)

1MZ-FE engine 2995 (182.8)

Fuel

Fuel type:

2AZ-FE engine

Unleaded gasoline, Octane Rating 87 (Research Octane Number 91) or higher

1MZ-FE engine

Unleaded gasoline, Octane Rating 87 (Research Octane Number 91) or higher. For improved vehicle performance, the use of premium unleaded gasoline with an Octane Rating of 91 (Research Octane Number 96) or higher is recommended.

Fuel tank capacity, L (gal., Imp. gal.):

70 (18.5, 15.4)

Service specifications

ENGINE

Valve clearance (engine cold), mm (in.):

2AZ-FE engine

Intake 0.19—0.29 (0.007—0.011)

Exhaust 0.30—0.40 (0.012—0.016)

1MZ-FE engine

Intake 0.15—0.25 (0.006—0.010)

Exhaust 0.25—0.35 (0.010—0.014)

Spark plug type:

DENSO SK20R11

NGK IFR6A11

Spark plug gap, mm(in.):

1.1 (0.043)

Drive belt tension measured with Borroughs drive belt tension gauge No.BT-33-73F (used belt), lbf:

1MZ-FE engine 115 ± 20

ENGINE LUBRICATION

Oil capacity (drain and refill), L (qt., Imp. qt.):

2AZ-FE engine

With filter 3.8 (4.0, 3.3)

Without filter 3.6 (3.8, 3.2)

1MZ-FE engine

With filter 4.7 (5.0, 4.1)

Without filter 4.5 (4.8, 4.0)

Oil grade:

API grade SJ "Energy-Conserving", SL "Energy-Conserving" or ILSAC multigrade engine oil is recommended.

Recommended oil viscosity (SAE):

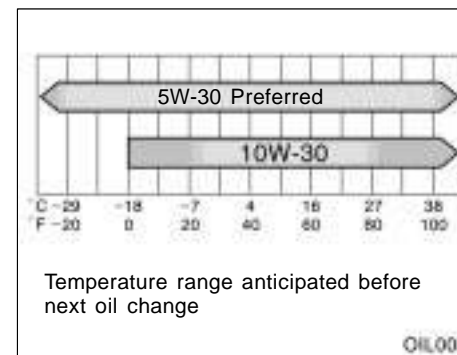

COOLING SYSTEM

Total capacity, L (qt., Imp. qt.):
 2AZ-FE engine 6.2 (6.6, 5.4)
 1MZ-FE engine 9.2 (9.8, 8.1)

Coolant type:
 "TOYOTA Long Life Coolant" or equivalent
 With ethylene-glycol type coolant for a proper corrosion protection of aluminum components
 Do not use alcohol type antifreeze or plain water alone.

BATTERY

Open voltage* at 20°C (68°F):
 12.6—12.8V Fully charged
 12.2—12.4V Half charged
 11.8—12.0V Discharged

*: Voltage that is checked 20 minutes after the key is removed with all the lights turned off

Charging rates:
 5 A max.

Note: If replacement is necessary, make sure to do so with a battery that meets the same standard as the original.

CLUTCH

Pedal free play, mm (in.):
 5—15 (0.2—0.6)
 Fluid type:
 SAE J1703 or FMVSS No.116 DOT 3

MANUAL TRANSAXLE

Oil capacity, L (qt., Imp. qt.):
 2.5 (2.6, 2.2)
 Oil type:
 Gear oil API GL-4 or GL-5
 Recommended oil viscosity:
 SAE 75W-90

AUTOMATIC TRANSAXLE

Fluid capacity (drain and refill), L (qt., Imp. qt.):
 2AZ-FE engine 3.9 (4.1, 3.4)
 1MZ-FE engine 3.5 (3.7, 3.1)

Fluid type:
 Automatic transmission fluid Type T-IV
 Change automatic transmission fluid only as necessary.

Generally, it is necessary to change automatic transmission fluid only if your vehicle is driven under one of the Special Operating Conditions listed in your "Scheduled Maintenance Guide" or "Owner's Manual Supplement". When changing the automatic transmission fluid, use only Toyota Genuine ATF Type T-IV (ATF JWS3309 or NWS6500) to aid in assuring optimum transaxle performance.

Notice: Using automatic transmission fluid other than Toyota Genuine ATF Type T-IV may cause deterioration in shift quality, locking up of your transmission accompanied by vibration, and ultimately damage the automatic transmission of your vehicle.

BRAKES

Minimum pedal clearance when depressed with the force of 490 N (50 kgf, 110 lbf) with the engine running, mm (in.):

Fixed type 63 (2.5)
Adjustable type (in frontmost position) 59 (2.3)

Pedal free play, mm (in.):

Fixed type 1—6 (0.04—0.24)
Adjustable type (in frontmost position) 1—8 (0.04—0.31)

Pad wear limit, mm (in.):

1.0 (0.04)

Lining wear limit, mm (in.):

1.0 (0.04)

Lever type parking brake

Parking brake adjustment when pulled with the force of 196 N (20 kgf, 44 lbf):
6—9 clicks

Pedal type parking brake

Parking brake adjustment when depressed with the force of 300 N (31 kgf, 67 lbf):
3—6 clicks

Fluid type:

SAE J1703 or FMVSS No.116 DOT 3

STEERING

Wheel free play:

Less than 30 mm (1.2 in.)

Power steering fluid type:

Automatic transmission fluid DEXRON◀
or III

Tires

Tire size and pressure:

Normal driving

kPa (kgf/cm² or bar, psi)

Tire size	Front	Rear	Wheel size
P205/65R15 92T	200 (2.0, 29)	200 (2.0, 29)	15 × 6 1/2 JJ
P205/65R15 92H	200 (2.0, 29)	200 (2.0, 29)	15 × 6 1/2 JJ
P215/60R16 94V	200 (2.0, 29)	200 (2.0, 29)	16 × 6 1/2 JJ

When driving under the above vehicle conditions at sustained high speeds above 160 km/h (100 mph), in countries where such speeds are permitted by-law, inflate the front and rear tires to 240 kPa (2.4 kgf/cm² or bar, 35 psi) provided that it does not exceed the maximum cold tire pressure molded on the tire sidewall.

Compact spare tire
 T145/80R16 105M

kPa (kgf/cm² or bar, psi)
 450 (45, 65)

Wheel size
 16 × 4T

Trailer driving

kPa (kgf/cm² or bar, psi)

Tire size	Front	Rear
P205/65R15 92T	220 (2.2, 32)	220 (2.2, 32)
P205/65R15 92H	220 (2.2, 32)	220 (2.2, 32)
P215/60R16 94V	200 (2.0, 29)	200 (2.0, 29)

Wheel nut torque, N-m (kgf-m, ft-lbf):

104 (10.5, 77)

NOTE: For a complete information on tires (e.g. replacing tires or replacing wheels), see "Checking tire pressure" through "Aluminum wheel precautions", pages 255 through 260, in Section 7-2.

Fuses

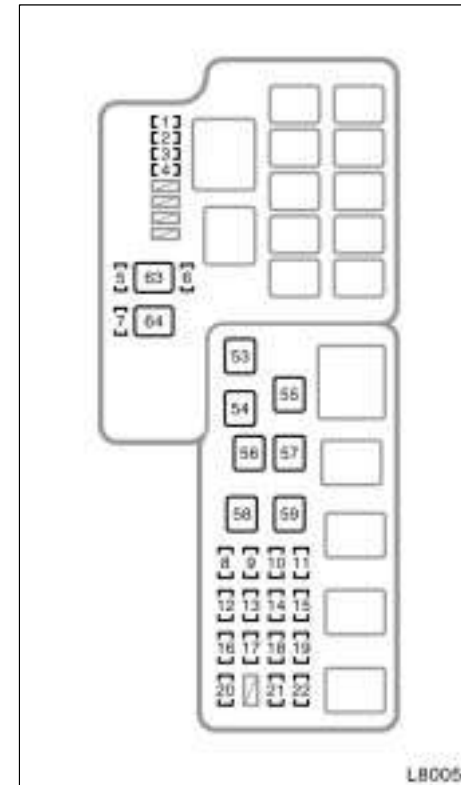

Engine compartment

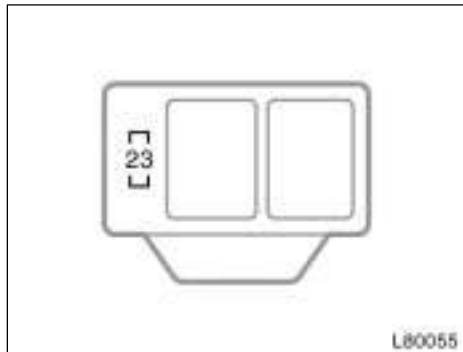

Engine compartment
(with vehicle skid control system)

Fuses (type A)

1. **HEAD LH LWR 15 A:** Left-hand headlight (low beam)
2. **HEAD RH LWR 15 A:** Right-hand headlight (low beam)
3. **DRL 5 A:** Daytime running light system
4. **A/C 10 A:** Air conditioning system
5. **SPARE 10 A:** Spare fuse
6. **SPARE 15 A:** Spare fuse
7. **SPARE 5 A:** Spare fuse
8. **AM2 30 A:** Starting system, "IGN" and "IG2" fuses

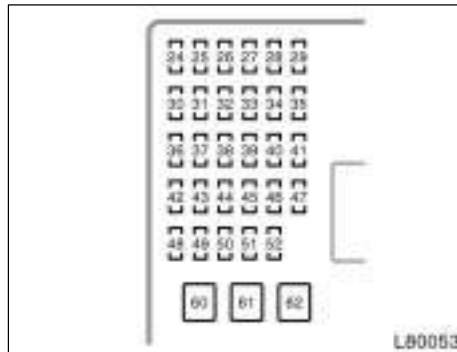

Instrument panel

9. **HEAD LH UPR 10 A:** Left-hand headlight (high beam)
10. **HEAD RH UPR 10 A:** Right-hand headlight (high beam)
11. **ST 5 A:** Multiport fuel injection system/sequential multiport fuel injection system
12. **TEL 5 A:** No circuit
13. **ALT-S 5 A:** Charging system
14. **IGN 15 A:** Starting system

15. **IG2 10 A:** Multiport fuel injection system/sequential multiport fuel injection system, SRS airbag system, front seat belt pretensioners, cruise control system
16. **DOOR1 25 A:** Multiplex communication system (power door lock system, auto-door locking system, wireless remote control system)
17. **EFI 20 A:** Multiport fuel injection system/sequential multiport fuel injection system
18. **HORN 10 A:** Horns
19. **D.C.C 30 A:** "ECU-B", "RAD NO.1" and "DOME" fuses
20. **A/F 25 A:** Multiport fuel injection system/sequential multiport fuel injection system
21. **ETCS 10 A:** Multiport fuel injection system/sequential multiport fuel injection system
22. **HAZ 15 A:** Emergency flashers
23. **ABS NO.4 7.5 A:** Anti-lock brake system, vehicle skid control system, traction control system, brake assist system

- 24. ECU-B 10 A:** Multiplex communication system (power door lock system, security system, auto-door locking system, automatic light control system, headlight delay off system, tail light auto cut system, illuminated entry system, daytime running light system, wireless remote control system), air conditioning system
 - 25. DOME 7.5 A:** Ignition switch light, interior light, personal lights, trunk light, vanity lights, garage door opener, clock, outside temperature gauge, multi-information display
 - 26. CIG 15 A:** Cigarette lighter
 - 27. ECU-ACC 5 A:** Power rear view mirrors, clock, multi-information display
 - 28. RAD NO.2 10 A:** Car audio system, navigation system
 - 29. POWER POINT 15 A:** Power outlets
 - 30. RAD NO.1 20 A:** Car audio system, navigation system
 - 31. GAUGE1 10 A:** Gauges and meters, clock, outside temperature gauge, multi-information display, shift lock system, seat belt reminder lights
 - 32. ECU-IG 10 A:** SRS airbag system, power windows, anti-lock brake system
 - 33. WIPER 25 A:** Windshield wipers
 - 34. HTR 10 A:** Air conditioning systems
 - 35. MIR HTR 10 A:** Outside rear view mirror heaters
 - 36. AM1 5 A:** Starting system
 - 37. FOG 15 A:** Front fog lights
 - 38. SUN-SHADE 15 A:** No circuit
 - 39. GAUGE2 10 A:** Auto anti-glare inside rear view mirror, compass, electric moon roof, back-up lights, automatic transmission indicator lights, automatic light control system, cruise control system
 - 40. PANEL 10 A:** Glove box light, clock, outside temperature gauge, multi-information display, instrument cluster lights, instrument panel lights, overdrive-off indicator light
 - 41. TAIL 10 A:** Tail lights, parking lights, license plate lights
 - 42. PWR NO.4 20 A:** Rear passenger's power window (left side)
 - 43. PWR NO.2 20 A:** Front passenger's door lock system, front passenger's power window
 - 44. OBD 7.5 A:** On-board diagnosis system
 - 45. SEAT HTR 20 A:** Seat heaters
 - 46. WASHER 15 A:** Windshield washer
2002 MY CAMRY_U (OM33567U)
 - 47. FAN RLY 10 A:** Electric cooling fans
 - 48. STOP 15 A:** Stop lights, high mounted stoplight, anti-lock brake system, cruise control system
 - 49. FUEL OPEN 5 A:** No circuit
 - 50. DOOR NO.2 25 A:** Multiplex communication system (power door lock system, auto-door locking system, wireless remote control system)
 - 51. AMP 25 A:** No circuit
 - 52. PWR NO.3 20 A:** Rear passenger's power window (right side)
- Fuses (type B)**
- 53. MAIN 40 A:** "HEAD LH LWR", "HEAD RH LWR", "HEAD LH UPR", "HEAD LH UPR" and "DRL" fuses
 - 54. ABS NO.2 40 A:** Anti-lock brake system, vehicle skid control system, traction control system, brake assist system
 - 55. RDI 30 A:** Electric cooling fan
 - 56. CDS 30 A:** Electric cooling fan
 - 57. HTR 50 A:** Air conditioning system
 - 58. ADJ PDL 30 A:** Power adjustable pedals

- 59. **ABS NO.3 40 A:** Anti-lock brake system, vehicle skid control system, traction control system, brake assist system
- 60. **PWR SEAT 30 A:** Power seats
- 61. **PWR NO.1 30 A:** Driver's door lock system, driver's power window, electric moon roof
- 62. **DEF 40 A:** Rear window defogger

Fuses (type C)

- 63. **ALT 100 A (with 2AZ-FE engine) or ALT 120 A (with 1MZ-FE engine):**
"DEF", "PWR NO.1", "PWR NO.2",
"PWR NO.3", "PWR NO.4", "STOP",
"DOOR NO.2", "OBD", "PWR SEAT",
"FUEL OPEN", "FOG", "AMP", "PANEL",
"TAIL", "AM1", "CIG", "POWER POINT",
"RAD NO.2", "ECU-ACC", "GAUGE1",
"GAUGE2", "ECU-IG", "WIPER",
"WASHER", "HTR (10 A)", "SEAT HTR",
and "SUN-SHADE" fuses
- 64. **ABS NO.1 60 A:** Anti-lock brake system, vehicle skid control system, traction control system, brake assist system

SECTION 9

REPORTING SAFETY DEFECTS FOR U.S. OWNERS AND UNIFORM TIRE QUALITY GRADING

Reporting safety defects for U.S. owners	284
Uniform tire quality grading	284

Reporting safety defects for U.S. owners

If you believe that your vehicle has a defect which could cause a crash or could cause injury or death, you should immediately inform the National Highway Traffic Safety Administration (NHTSA) in addition to notifying Toyota Motor Sales, U.S.A., Inc. (Toll-free: 1-800-331-4331).

If NHTSA receives similar complaints, it may open an investigation, and if it finds that a safety defect exists in a group of vehicles, it may order a recall and remedy campaign. However, NHTSA cannot become involved in individual problems between you, your dealer, or Toyota Motor Sales, U.S.A., Inc.

To contact NHTSA, you may either call the Auto Safety Hotline toll-free at 1-800-424-9393 (or 366-0123 in Washington, D.C. area) or write to: NHTSA, U.S. Department of Transportation, Washington, D.C. 20590. You can also obtain other information about motor vehicle safety from the Hotline.

Uniform tire quality grading

This information has been prepared in accordance with regulations issued by the National Highway Traffic Safety Administration of the U.S. Department of Transportation. It provides the purchasers and/or prospective purchasers of Toyota vehicles with information on uniform tire quality grading.

Your Toyota dealer will help answer any questions you may have as you read this information.

DOT quality grades—All passenger car tires must conform to Federal Safety Requirements in addition to these grades. Quality grades can be found where applicable on the tire sidewall between tread shoulder and maximum section width. For example: Treadwear 200 Traction AA Temperature A

Treadwear—The treadwear grade is a comparative rating based on the wear rate of the tire when tested under controlled conditions on a specified government test course. For example, a tire graded 150 would wear one and a half (1-1/2) times as well on the government course as a tire graded 100. The relative performance of tires depends upon the actual conditions of their use, however, and may depart significantly from the norm due to variations in driving habits, service practices and differences in road characteristics and climate.

Traction AA, A, B, C—The traction grades, from highest to lowest, are AA, A, B, and C, and they represent the tire's ability to stop on wet pavement as measured under controlled conditions on specified government test surfaces of asphalt and concrete. A tire marked C may have poor traction performance.

Warning: The traction grade assigned to this tire is based on braking (straight ahead) traction tests and does not include cornering (turning) traction.

Temperature A, B, C—The temperature grades are A (the highest), B, and C, representing the tire's resistance to the generation of heat and its ability to dissipate heat when tested under controlled conditions on a specified indoor laboratory test wheel. Sustained high temperature can cause the material of the tire to degenerate and reduce tire life, and excessive temperature can lead to sudden tire failure. The grade C corresponds to a level of performance which all passenger car tires must meet under the Federal Motor Vehicle Safety Standard No.109. Grades B and A represent higher levels of performance on the laboratory test wheel than the minimum required by law.

Warning: The temperature grades for this tire are established for a tire that is properly inflated and not overloaded. Excessive speed, underinflation, or excessive loading, either separately or in combination, can cause heat buildup and possible tire failure.

Foreword

Thank you for your purchase of the Navigation System. Please read this manual carefully to ensure proper use. Keep this manual stored in your vehicle at all times.

The Toyota Navigation System is one of the most technologically advanced vehicle accessories ever developed. The system receives satellite signals from the Global Positioning System (GPS) operated by the U.S. Department of Defense. Using these signals and other vehicle sensors, the system can show you where you are and assist you in locating a desired destination.

The navigation system is designed to select efficient routes from your present starting location to your destination. The system is designed to direct you to a destination that is unfamiliar to you in efficient manners. The routes are generated from a large database that includes all roads contained in AAA state maps along with detailed street coverage for many major metropolitan areas. The calculated routes are neither the shortest routes nor routes without traffic congestion. Your own personal local knowledge or "short cut" may at times be faster than the calculated routes.

The navigation system's database includes more than 50 point of interest categories to allow you to easily select destinations such as restaurants and banks. If a destination is not in the database, you can enter the street address or a major intersection close to it and the system will route you there. The system will provide both a visual map and audio instructions. The audio instructions will announce the distance and direction to go when you are approaching a fork or intersection. These voice instructions will help you keep your eyes on the road and are timed to provide enough time to allow you to maneuver, change lanes or slow down.

Please be aware that all current vehicle navigation systems have certain limitations that may affect their ability to perform properly. The accuracy of the vehicle's position depends on the satellite condition, road configuration, vehicle condition or other circumstances. For more information on the limitations of the system, refer to pages 59 through 61.

TOYOTA MOTOR CORPORATION

© 2001 TOYOTA MOTOR CORPORATION

All rights reserved. This material may not be reproduced or copied, in whole or in part, without the written permission of Toyota Motor Corporation.

Important information about this manual

For safety reasons, this manual indicates items requiring particular attention with the following marks.

! CAUTION

This is a warning against something that may cause injury to people if the warning is ignored. You are informed about what you must or must not do in order to avoid or reduce the risk to yourself and other people.

NOTICE

This is a warning against something which may cause damage to the vehicle or its equipment if the warning is ignored. You are informed about what you must or must not do in order to avoid or reduce the risk of damage to your vehicle and its equipment.

INFORMATION

This provides additional information.

Initial screen



When you start the engine or turn the ignition switch to "ACC", the initial "TOYOTA" screen appears and the system begins operating.

! CAUTION

When the vehicle is stopped with the engine running, always apply the parking brake for safety.

After a few seconds, the "CAUTION" screen appears.



Touch either "English" or "French" to select a language. Read and follow the instructions.

When you touch the "I agree" switch on the screen, the "map" screen appears.

You can access this screen when you push the "INFO" button and touch the "Language" switch. Then you can select a language.

Safety Instruction



To use your system as safely as possible, follow all the safety tips shown below.

This system is intended to assist you in reaching your destination and, if used properly, can do so. You, as the driver, are solely responsible for the safe operation of your vehicle and the safety of your passengers.

Do not use any feature of this system to the extent it distracts you from safe driving. Your first priority while you are driving should always be the safe operation of your vehicle. While you are driving, be sure to observe all traffic regulations.

Before attempting to use this system while you are driving, learn how to use it and become thoroughly familiar with it. Read the entire Navigation System Manual to make sure you understand the system. Do not allow others to use this system until they have read and understood these and other instructions in this manual.

For your safety, some functions may become inoperable when you start driving. Unavailable switches are dimmed. You can input your destination and select your route only when the vehicle is not moving.

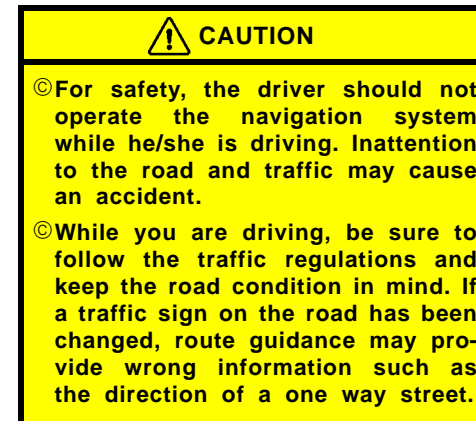

While you are driving, listen to the voice instructions as much as possible and glance at the screen briefly and only when it is safe. However, do not totally rely on voice guidance. Use it just for your information. If the system cannot determine your current position correctly, there is a possibility of incorrect, late or non-voice guidance.

The data in the system may occasionally be incomplete. Road conditions, including driving restrictions (no left turns, street closures, etc.) frequently change. Therefore, before you follow any instruction from the system, look to see whether you can comply with the instruction safely and legally.

This system cannot warn you about such things as the quality of a neighborhood, condition of streets, and availability of emergency services. If you are unsure about the safety of an area, don't drive into it. **Under no circumstances is this system a substitute for the driver's personal judgement.**

We recommend that you obtain updated map data, when it becomes available, in order to help use the system as effectively and safely as possible.

Use this system only in locations where it is legal to do so. Some states/provinces may have laws prohibiting video screens within sight of the driver.

Overview of Touch Screen and Switches



Switch operation

This system is operated mainly by the switches on the screen. To prevent damage to the screen, lightly touch switches on the screen with your finger. When you touch a switch on the screen or push a button, a beep sounds.

INFORMATION

- © *If the system does not respond to a touch of a switch, move your finger away from the screen and then touch it again.*
- © *You cannot operate dimmed switches.*
- © *Wipe off fingerprints on the surface of the display using a glass cleaning cloth.*

Symbols, Switches and Buttons

GPS mark (Global Positioning System)

Whenever your vehicle is receiving signals from the GPS, this mark is displayed. For details, see page 59.

Map/Guidance

Push this switch to change the screen mode. For details, see page 34.

Distance and time to destination

Displays the distance and the estimated travel time to the destination. If you input more than two destinations, it displays the distance and time to the next destination. Touching this indication will change it to the distance and time to the other destinations. The direction will be indicated when your vehicle is off the route.

INFO button

Push this button to display the "Information Menu" screen. For details, see pages 1, 107, 114 and 122.

NAVI button

Push this button to turn the navigation screen on.

North-up or heading-up symbol and scale of map

Indicates a map view with north up or heading up. Touching this symbol changes the map orientation. The figure also indicates the map scale. For details, see page 59.

Current vehicle position mark

Indicates the current position. For details, see page 37.

MAP/VOICE tab

Touch this tab to repeat voice guidance, cancel one touch scroll and start guidance. For details, see page 38.

DEST tab

Touch this tab to display the Destination screen. For details, see page 6.

MENU tab

Touch this tab to display the "Menu" screen. This screen allows you to make adjustments or correct settings of various options and functions.

TILT button

Push this button to tilt the display. For details, see page 2.

DISPLAY button

Push this button to display the "Display" screen. For details, see page 121.

Current street name

Turn on this function to indicate the current street name. For details, see page 106.

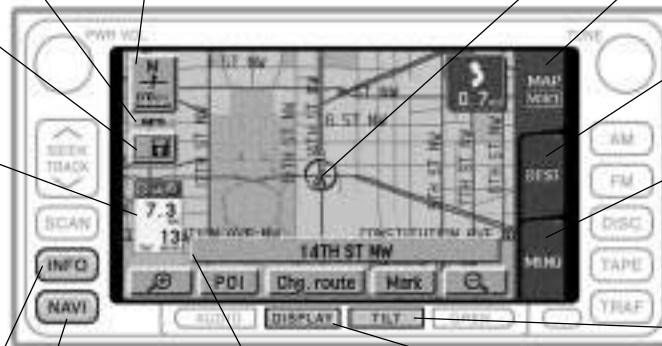

L00003



Changing the route guidance

When you touch this switch, the "Change route" screen will appear. For details, see page 49.



One-touch registration of marked point

To register the current vehicle position as a marked point. For details, see page 82.



Display of point of interest

Symbols such as restaurants and hotels, etc. can be displayed on the screen. For details, see page 51.



Zoom in/zoom out

These switches magnify or reduce the map scale. For details, see page 57.

SECTION I

BASIC FUNCTIONS

Descriptions of basic operations in frequent use

Your navigation system	2
Inputting letters and numbers	2
How to move the cursor	4
Destination input Explains 11 ways to input your destination	6
<i>Explains 11 ways to input your destination</i>	
Setting and deleting destination	25
Setting and deleting preferred road	31
Search condition	33
Route guidance screen	34
Route overview	36
Route preview	36
Current position display	37
Voice guidance	38
Typical voice guidance prompts	38
Registering your home	40
Registering preset destinations	44
Detour setting	49
Displaying POI	51
Turn list	52
Map appearance	55
Map scale	57
Screen scrolling	58
Orientation of the map	59
Limitations of the navigation system	59
Map database information and updates	62

Your navigation system

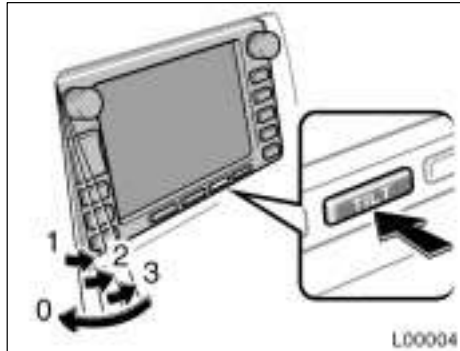

You can adjust the angle of the display by pushing the “TILT” button. Each push of the “TILT” button will tilt the display to position 1, 2, 3 and then back to 0 in that order.

If you turn the ignition switch off, the display will automatically move back to position 0. The display will automatically resume the previous position you used when the ignition switch is turned to the “ACC” or “ON” position.

CAUTION

Take care not to jam your fingers while the display is moving. Otherwise, you could be injured.



NOTICE

Do not obstruct the display while it is tilting. It could damage your navigation system.

Inputting letters and numbers

The navigation system is operated by switches on the screen and the buttons located on the front face around the screen. When you touch a switch or push a button, a beep sounds. When using the switches on the touch screen, please use only light pressure with your finger to protect the screen from damage. Do not use objects other than your finger to touch the screen.



To type in an address etc., directly touch alphabet keys on the screen. If you touch a wrong letter, delete it using the  switch. Touching the  switch erases one letter.

Touching the **“List”** switch will change the screen to a display of the database items that match the name or address that you have entered on the screen. The number of matching items is shown to the right side of the screen. If the matching item is more than 9,999, the system displays **“▼▼▼▼”** on the screen.

To input numerals, touch the **“0-9”** switch and the display will change the screen to number input display.



Touching the **“A-Z”** switch changes the screen back to the previous name input display.



When a list is displayed, you can scroll or page through the list by using the appropriate switch.



To shift to the next or previous page.





To scroll up or down one item at a time.



This expresses a displayed screen position.



If  appears to the right of the item name, the complete name is too long for the display.

Touch , and the name will scroll to the end of the name.

Touching  will scroll the name to the beginning of the name.

How to move the cursor



1. Touch the **“Adjust”** switch to move the cursor .

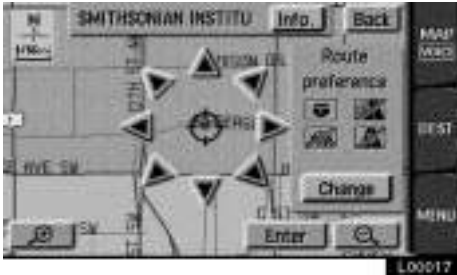

◀ *Position locating screen on the map*

2. When you touch an arrow facing your desired point, the map scrolls in that direction. When you release your finger, scrolling stops.
3. If you touch the “Enter” switch, the position of cursor  is set.

Destination input

Touch the **“DEST”** tab on the screen and the “Destination” screen appears.



The “Destination” screen allows you to select the area to search for your destination.

Touch the **“Change”** switch on the “Destination” screen to display a map of the United States and Canada divided into 11 areas. See page 62 for map database information and updates.



Touch one of the **“US1”** through **“CAN”** switches to select a search area. Touch the **“OK”** switch and the “Destination” screen returns.

Once you choose the area to search, you can use one of 11 different methods to enter your destination.

USA	
Switch	States included in the search area
US1	Idaho Oregon Washington
US2	California Nevada
US3	Arizona Colorado Montana New Mexico Utah Wyoming
US4	Iowa Kansas Minnesota Missouri Nebraska North Dakota South Dakota
US5	Oklahoma Texas
US6	Illinois Indiana Kentucky Michigan Ohio Wisconsin

US7	Alabama Arkansas Louisiana Mississippi Tennessee
US8	Connecticut Maine Massachusetts New Hampshire New Jersey New York Rhode Island Vermont
US9	Delaware Maryland New Jersey Pennsylvania Virginia West Virginia
US10	Florida Georgia North Carolina South Carolina

Canada	
Switch	Provinces and regions included in the search area
CAN	Alberta British Columbia Manitoba New Brunswick Newfoundland and Labrac Nova Scotia Ontario Prince Edward Island Québec Saskatchewan

You can find your destination using various methods. See page 10 through 24 for the detailed steps.

- 1. By Home (🏠 switch on the “Destination” screen):** You can select your own home without entering the address each time. In this case, it is necessary to register your home beforehand. See page 10 for the detailed steps.
- 2. By Preset Destination (1 — 5 switches on the “Destination” screen):** You can select one of 5 preset destinations directly. In this case, it is necessary to register the destinations beforehand. See page 11 for the detailed steps.
- 3. By Address:** You can input the house number and the street address by using the input keys. See page 11 for the detailed steps.

2002 MY CAMRY NAVI_U (OM33559U7)

- 4. By POI:** You can select one of the many points of interest that have been already stored in the system's database. There are more than 50 categories to choose from, including restaurants, banks and automotive locations. See page 14 for the detailed steps.

5. **By Marked Point:** You can register your own favorite destinations as a "Marked Point". The system allows you to store up to 100 marked points. See page 19 for the detailed steps.
6. **By Previous Destination:** You can select a destination from any of the last 20 previously set destinations. See page 20 for the detailed steps.
7. **By Emergency:** You can select one of the three points of emergency service points that have been already stored in the system's database. See page 21 for the detailed steps.
8. **By Intersection:** You can enter the names of two intersecting streets. This is helpful if you do not know the specific street address of your destination but know the general vicinity. See page 22 for the detailed steps.
9. **By Freeway Entrance/Exit:** You can enter the name of the freeway (interstate) entrance or exit. See page 23 for the detailed steps.
10. **By Previous Starting Point:** You can enter a point where the system has started to guide last time. See page 24 for the detailed steps.

Destination input by HOME

11. **By Map Selection:** You can select a destination simply by touching the location on the displayed map. See page 24 for the detailed steps.

INFORMATION

When inputting the destination, the response to the switch may be slow.

“Point of Interest” are mainly registered in “Detailed map coverage areas”. The registration is made based on the NavTech “Standard POI Inclusion List”.

If there is no point registered, switches such as “Marked Point”, “Previous Destination” or “Previous Starting Point” are dimmed and not available.

The route for returning may not be the same as that for going.

The route guidance to the destination may not be the shortest route or a route without traffic congestion.

Route guidance may not be available if there is no road data for the specified location.

When setting the destination, you should use the map on a scale of one half mile or smaller.

To select an “Address”, “Point of Interest”, “Freeway Entrance/Exit” or “Intersection” in a different area, it is necessary to change the search area.

CAUTION

While you are driving, be sure to follow traffic regulations and keep the road condition in mind. If a traffic sign on the road has been changed, the route guidance may provide wrong information.

Touch the  switch on the Destination input screen.

The screen changes and displays the map location of your home.

Guidance starts from your current position to your home immediately after you touch the  switch during driving.

For the steps to register your home, see “Registering your home” on page 40.

Destination input by PRESET DESTINATION

Touch any of **1** — **5** (preset destination) switches on the “Destination” screen.

The screen changes and displays the map location of the preset destination.

Guidance starts from your current position to the preset destination immediately after you touch the preset destination switch.

For the steps to register a preset destination, see “Registering preset destination” on page 44.

Destination input by ADDRESS



There are 2 ways to input a destination by address.

(a) Inputting a house number and a street name

Touch the “Address” switch on the destination screen. The “Address” screen appears, and then you can input a house number.

Touch letters directly on the screen to input a house number.



After inputting a house number, touch the “Enter” switch to display the screen which you can input a street name.

It is possible to input a street name first. Touch the “Street” switch to display the screen which you can input a street name.



After each letter is input, the system searches the database for street names that match. Alphabet keys are dimmed if the database does not have a match for the next letter in the remaining list of matching street names.

When you input numerals, touch the “0-9” switch to display the screen for numeral input.

Based on your input, the number of matching sites appears at the top right of the screen. After the number decreases to some extent, touch the “List” switch to display the street selection list. If the number of matches decreases to 4 or less, the screen changes automatically to the selection list.



When you find your desired street name, touch [] of the item. The screen changes and displays the map location of the selected destination and the route preference. (See “(a) Entering Destination” on page 25.)

If the same address exists in more than one city, the current screen changes to the “City Select” screen. Select or enter your desired city.

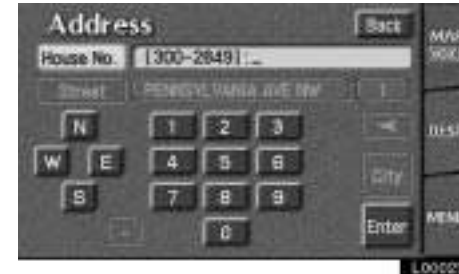

If you input a street name first, the screen changes. You can then input the house number.



If the above screen appears, you can select an address range on that screen.

(b) Selecting a city to search

The screen for selecting last 5 cities appears if you touch the **“City”** switch on the **“Address”** screen on page 11.



5 cities are displayed on the screen.
 Touch the of the desired city name. The current screen changes to the screen which is for inputting a street name.
All cities: All cities are selected.
Near 5 cities: Near 5 cities are displayed. Selecting a city in the list changes to the display to input a street name.
Input city name: The screen for inputting the city name appears.

The screen for inputting a city name appears if you touch the **“Input city name”** switch on the **“Address”** screen.



Input the city name.
 After the number decreases to some extent, touch the **“List”** switch to display the city selection list. If the number of matches decreases to 4 or less, the screen changes automatically to the selection list.
 Touch the of the desired city name.
 The current screen changes to the screen which is for inputting a street name. After inputting a street name, the screen may change to the screen which is for inputting a house number. Input a house number. Then touch the **“Enter”** switch to display the map screen.

The screen changes and displays the map location of the selected destination and the road preference. (See **“(a) Entering destination”** on page 25.)

Destination input by POI

There are 3 ways to select a point of interest location.

- (a) Input the name directly
- (b) Selecting a city to search
- (c) Selecting from the categories

It will not take a long time for you to find your destination if you use a combination of the searching ways of (a), (b) and (c).

(a) Input the name directly

Touch the “POI” switch on the “Destination” screen.



The “POI” screen appears, and then you can input the name of the point of interest.

Touch letters directly on the screen to input a name. When you input numerals, touch the “0-9” switch to display the screen for numeral input.

If the number of sites becomes 4 or less, or if you touch the “List” switch at the bottom right of the screen, the screen changes and displays a list of sites.

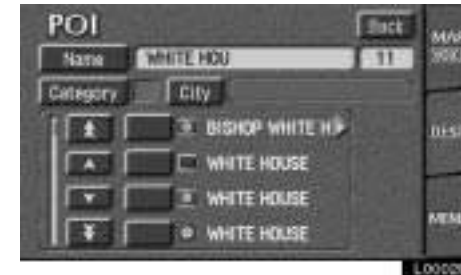

Touch the of your desired destination. The screen changes and displays the map location of the selected destination and the route preference. (See “(a) Entering Destination” on page 25.)

If the same name exists in more than one city, you can search it more easily with the “City” and “Category” switch. (See (b) Selecting a city to search and (c) Selecting from the categories.)

(b) Selecting a city to search

Touch the “City” switch on the “POI” screen.



5 cities are displayed on the screen. Touch the of the desired city name. The current screen changes to the screen which is for inputting a name of POI.

All cities: All cities are selected.

Near 5 cities: Near 5 cities are displayed. Selecting a city in the list changes to the display to input the name of the POI.

Input city name: The screen for inputting the city name appears.



Input the city name.

If the number of sites becomes 4 or less, or if you touch the “List” switch on the screen, the screen changes and displays the selection list.

Touch the of the desired city name.

After entering the city name, input the name of the POI.

(c) Selecting from the categories

Touch the “Category” switch on the “POI” screen.



The categories are shown on the screen. When you touch the symbol switch of your desired category, more detailed categories are shown.



When you touch the of your desired category, the screen changes and displays the menu to input a name.



Once you have selected a category, you can touch letters directly on the screen to input a name. To input numerals, touch the “0-9” switch to display the screen for numeral input.

If the number of sites becomes 4 or less, or if you touch the “List” switch at the bottom right of the screen, the screen changes and displays a list of sites.



If you input the name of a specific point of interest and there are more than two sites with the same name, the “Dist Sort” switch will be shown. Touch the “Dist Sort” switch on the screen to display a listing of all items based on the distance from your current location.

When you touch the of your desired item, the screen changes and displays the map location of the selected destination and the route preference. (See “(a) Entering Destination” on page 25.)

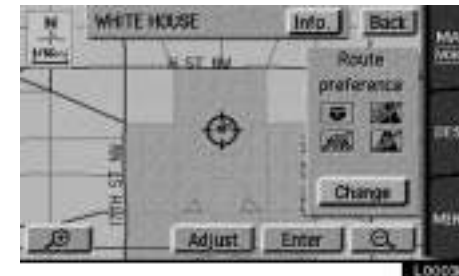

Touch the “Info.” switch on the screen to display the selected destination name, address and telephone number.

INFORMATION

The desired point of interest can be displayed on the map screen. (For details, see page 51.)

POI (Points of Interest) icons



RESTAURANT



JAPANESE



CHINESE



FRENCH



ITALIAN



OTHER



AMERICAN



CONTINENTAL



MEXICAN



SEAFOOD



SHOPPING



GROCERY STORE



GAS STATION



PARKING GARAGE/HOUSE



PARKING LOT



RENTAL CAR AGENCY



TOYOTA DEALERSHIPS
(all search areas)



LEXUS DEALERSHIPS
(all search areas)























AUTOMOBILE CLUB















AUTO SERVICE &
MAINTENANCE



HOTEL

	GOLF COURSE		WINERY		CONVENTION/EXHIBITION CENTER
	SKI RESORT		CITY HALL		COURT HOUSE
	AMUSEMENT PARK (all search areas)		POLICE STATION		TRAIN STATION
	SPORTS COMPLEX		LIBRARY		AIRPORT (all search areas)
	CASINO		HOSPITAL		BUS STATION
	MARINA		PARK/RECREATION (all search areas)		COMMUTER RAIL STATION
	TOURIST ATTRACTION (all search areas)		CIVIC/COMMUNITY CENTER		FERRY TERMINAL

	PARK AND RIDE		SCHOOL
	REST AREA		ATM
	TOURIST INFORMATION		HIGHER EDUCATION
	HISTORICAL MONUMENTS		BUSINESS FACILITY
	PERFORMING ARTS		CITY CENTER/NAMED PLACE
	MUSEUM		
	BANK		

Destination input by MARKED POINTS

Touching the “Marked points” switch on the “Destination” screen displays your list of registered marked points. See page 75 on registering and editing marked points.

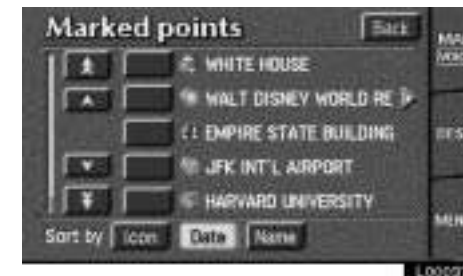

When you touch the of your desired item, the screen changes and displays the map location of the selected destination and the route preference. (See “(a) Entering destination” on page 25.)

There are 3 ways to list the marked point by touching switches on bottom of the screen.

Sort by Icon: Touch this switch to list the marked points by the registered icon. There are 46 different normal purpose icons and 3 sound icons. (For details, see page 76.)

Sort by Date: Touch this switch to list the marked points in order of registered date.

Sort by Name: Touch this switch to list the marked points in alphabetical order. While driving, only special purpose icons will be shown on the screen.

Destination input by PREVIOUS DESTINATION

Touch the “Prev. dest” switch on the “Destination” screen.

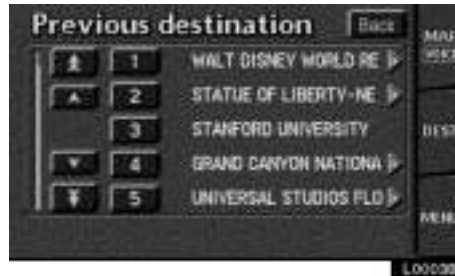

The screen lists up to 20 previously set destinations. During driving, you will not be able to perform this operation.

Select your desired destination. The screen changes and displays the map location of the selected destination and the route preference. (See “(a) Entering destination” on page 25.)

You can delete the list of previous destinations while you stop your car, if you no longer need them.



Touch the “Menu” tab on the screen to display the menu screen and touch the “Marked points” switch. Touch the “Del. prev. dest.” switch.

When you touch the switch for each previous destination or the “Delete all” switch, a message appears to confirm your request. If you are sure, touch the “Yes” switch. If not, touch the “No” switch.

Destination input by EMERGENCY

By touching the “Emergency” switch on the “Destination” screen, the display changes to a screen to select dealers, hospitals or police stations. During driving, only nearby police stations, hospitals or dealers are shown. The current position is shown with an address, the latitude and the longitude at the top of the screen.

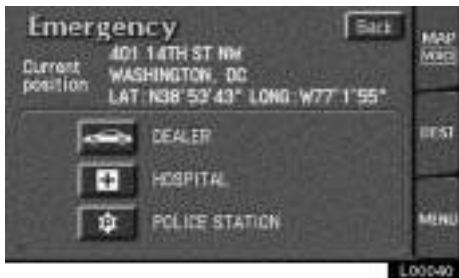

When you touch your desired emergency category, the selected emergency category list is displayed.

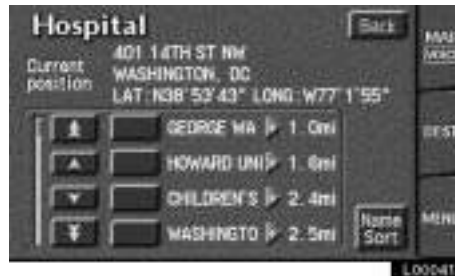

The distance from your current position up to the destination is displayed on the right of the name.

You can see the names of the emergency destinations in alphabetical order by touching the “Name Sort” switch on the screen.

Touch the of your desired item. The screen changes and displays the map location of the selected destination and the route preference. (See “(a) Entering destination” on page 25.)

Touch the “Info.” switch on the screen to display the selected emergency destination name, address and telephone number.

INFORMATION

The navigation system does not guide in areas where route guidance is unavailable. (See page 62.)

Destination input by INTERSECTION

Touch the “Intersection” switch on the “Destination” screen.



Input the name of the two intersecting streets which are located near the destination to be set.

When you touch the “List” switch or the number of sites becomes 4 or less, the list of matching street names appears.



Touch the of your desired item. After inputting the two intersecting streets, the screen changes and displays the map location of the selected destination and the route preference. (See “(a) Entering destination” on page 25.)

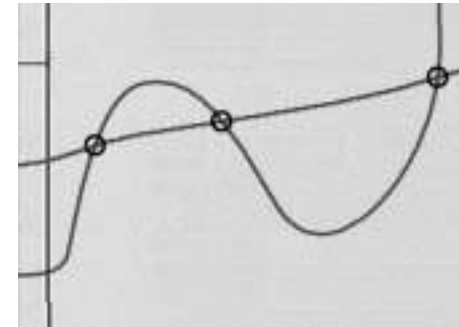

If the same two streets cross at more than one intersection, the screen changes and displays the menu to select the city name where the streets intersect. Select the city, and the map location of the selected destination and the route preference. (See “(a) Entering destination” on page 25.)

**Destination input by
FREEWAY ENTRANCE or EXIT**

To input a freeway entrance or exit, touch the “FWY Ent./Exit” switch on the “Destination” screen.



Be sure to use the complete name of the freeway or highway, including the hyphen, when entering the destination. Freeways and interstates use an “I” (I-405). US highways use the state designation before the number (CA-118).

As the number of matching freeways decreases, you can touch the “List” switch to display the list. When the number of sites becomes 4 or less, the list screen appears automatically.



Select the desired freeway by touching the .



You can then select either a freeway “Entrance” or “Exit”.



Touch the of the desired entrance or exit name. The screen changes and displays the map location of the selected destination and the route preference. (See “(a) Entering destination” on page 25.)

There are 2 ways to list the freeway entrance or exit.

Dist. Sort: Touch this switch to list the entrances or exits in order of distance from your current location.



Name sort: Touch this switch to list the entrances or exits in alphabetical order.

Destination input by PREVIOUS STARTING POINT

Touch the “Previous starting point” switch on the “Destination” screen.

The screen changes and displays the map location of the previous starting point and the route preference. (See “(a) Entering destination” on page 25.)

If you have not used the navigation yet, the “Previous Starting Point” switch is dimmed.

Destination input by MAP

Touch the “Map” switch on the “Destination” screen.





The screen changes and displays the map location that was previously displayed just before the destination input operation and the route preference. (See “(a) Entering destination” on page 25.)

Setting and deleting destination

(a) Entering destination

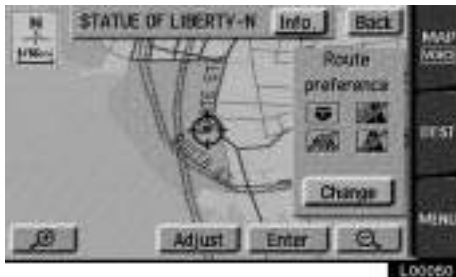
After you input the destination, the screen changes and displays the map location of the selected destination and the route preference.



You can move and set the cursor  at a desired point. (For the method of how to move the cursor, see page 4.)

When you touch the **“Enter”** switch, the system starts searching for a route to your destination using the conditions entered.

Route preference

Touch the **“Change”** switch to change the conditions which are to determine the route to your destination.

You are given a number of choices on the conditions which the system uses to determine the route to your destination.



Touch the **“Detour”** switch of **“Freeway”** to search for a route that includes freeways as little as possible. (In some cases, the route cannot avoid including a freeway.)

Touch the **“Detour”** switch of **“Toll road”** to search for a route that includes toll roads as little as possible.

Touch the **“Detour”** switch of **“Ferry”** to search for a route includes ferries as little as possible.

Touch the **“Detour”** switch of **“Restricted road”** to search for a route that does not utilize restricted road.

Touching the **“Allow”** switch on each item allows its use.

The switches you select are highlighted in green. After choosing conditions, touch the **“OK”** switch.

(b) Adding destinations



During the route search, “Searching route...” appears on the screen. When the search is completed, 3 types of routes are displayed on the screen.



If you want to see the other routes and make a comparison, touch the “3routes” switch. 3 types of the routes are displayed on the screen.

1. Touch the “MENU” tab on the screen to display the “Menu” screen.

Quick: A route by which you can reach the destination in the shortest time. This route is indicated by an orange line.

Short: A route by which you can reach the destination in the shortest distance. This route is indicated by a purple line.

Alternative: Other route. This route is indicated by a green line. Touch the switch to select the route.

If you want to add a destination, see the following “(b) Adding destinations”.

After selecting one, you can start the route guidance by touching the “Start” switch or starting to move your vehicle.

If you want to change the search condition, touch the “Chg. route” switch. The screen changes and displays the change route menu. (For details, see page 49.)

When you keep touching the “Start” switch until you hear a beep, Demo mode will start.



2. Touch the “Edit route” switch.

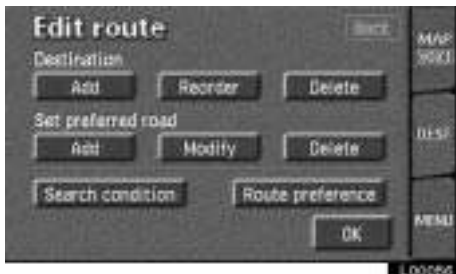

3. Touch the “Add” switch of Destination.

4. Input an additional destination in the same way as the destination input. (See page 25.)

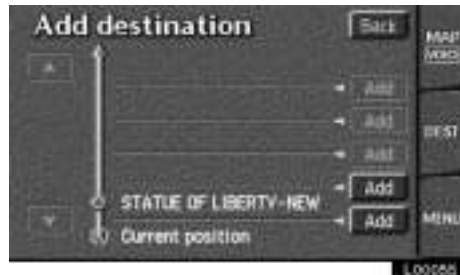

5. The add destination screen appears. Touch the “Add” switch that you want to add a destination.

(c) Relocating destinations

1. Touch the **"MENU"** tab on the screen to display the **"Menu"** screen and touch the **"Edit route"** switch.

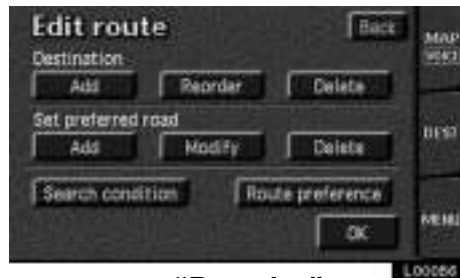

2. Touch the **"Reorder"** switch under **"Destination"**.

(d) Deleting destination

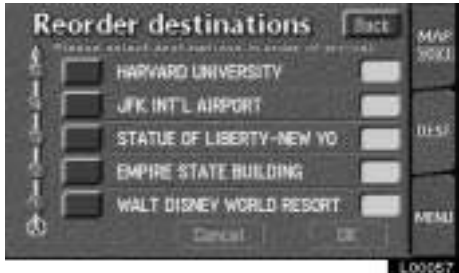

3. Select the destinations in the order of arrival by touching the switch.

After you finished selecting the destinations, touch the **“OK”** switch. The previous screen returns.

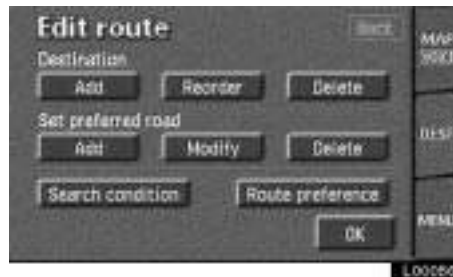

1. Touch the **“Delete”** switch under **“Destination”**.



2. Touch the switch next to the destination where you want to delete. Touch the **“Delete all”** switch if you want to delete all destinations.

2002 MY CAMRY NAVI_U (OM33559U)

Setting and deleting preferred road

(a) Adding preferred road

3. A message appears to confirm your request to delete. To delete the destination(s), touch the “Yes” switch.

If you touch the “Yes” switch, the data cannot be recovered.

If you touch the “No” switch, the previous screen will return.



Touch the “Edit route” switch on the “Menu” screen.

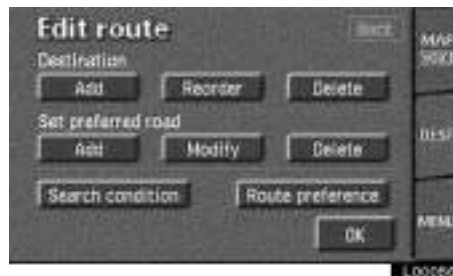

Touch the “Add” switch under “Set preferred road”. The following screen appears.



Move the cursor  to your desired location and touch the “Preferred road” switch.

Messages appear to confirm your request on the screen. Touch the “Enter” switch to register the road.

Touch the “Next” switch to change the road type.

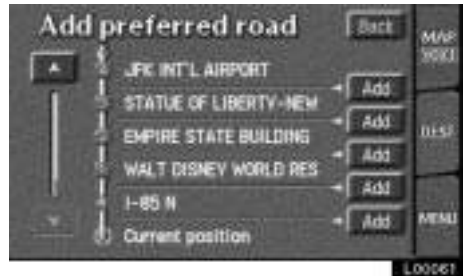

The “Add preferred road” screen appears. Touch the “Add” switch where you want to add a preferred road.

(b) Modifying preferred road

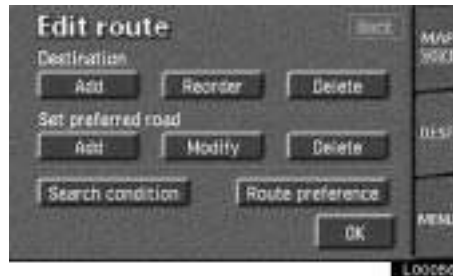

Touch the “Modify” switch under “Set preferred road”. The modify preferred road screen appears.

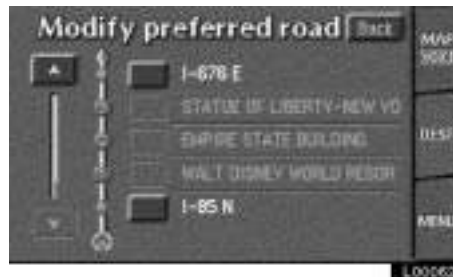

Select the preferred road which you want to modify and touch the switch.

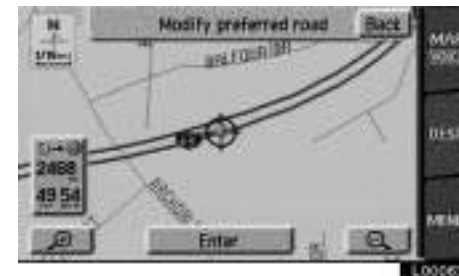

Follow the same procedure as when adding a preferred road (see page 31).

(c) Deleting preferred road Search condition

1. Touch the **“Delete”** switch under **“Set preferred road”**. The **“Delete preferred road”** screen appears.



2. Select the preferred road which you want to delete. Touch the **“Delete all”** switch if you want to delete all preferred roads.

3. Messages appear to confirm your request to delete the preferred road. To delete the road(s), touch the **“Yes”** switch.

If you touch the **“Yes”** switch, the data cannot be recovered.

If you want to try again or cancel deletion, touch the **“No”** switch. The previous screen will return.

Touch the “Search Condition” switch on the “Edit route” screen. The “Search condition” screen appears.

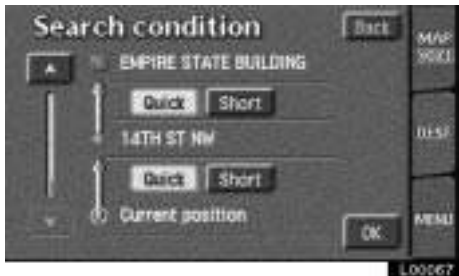

Touch the “Quick”, “Short” or “Alternative” switch and touch the “OK” switch.

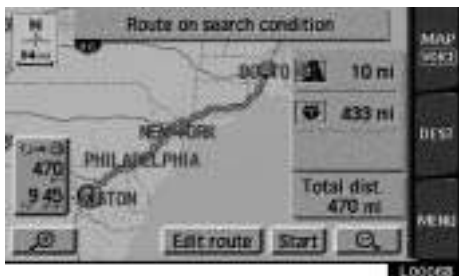

Route guidance screen

The route guidance system has two different screen modes.



Single map: Map is shown in a screen.

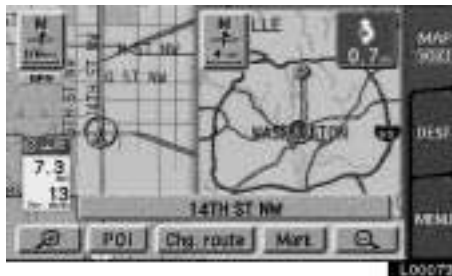

Dual map: Two different maps are shown in a screen.



Split screen: Map and guidance screen are shown in a screen mode. (For detail about Guidance screen, see page 55.)

The two route guidance screens have a number of indicators and switches with which you should be familiar.



Map/guidance:
Changes the screen mode.

GPS Upon reception of signals from the GPS (Global Positioning System), this mark appears. (For details, see page 59.)

Map Magnifies or reduces the map scale. (For details, see page 57.)

POI Touch this switch, and symbols of points of interest are shown on the screen. (For details, see page 51.)

Mark Touch this switch for one-touch registration of the marked point. (For details, see page 82.)

INFORMATION

The distance up to your destination appears at the left of the screen.

The time to your destination can also be displayed. (For the setting steps, see page 96.)

Chg. route The "Change Route" screen appears and the following settings are available.



Search condition: To change the condition for Reroute.

Detour: To change the condition for Detour. (For details, see page 49.)

Del. next dest.: To delete and skip the next destination.

INFORMATION

If the calculated route includes a trip by ferry, the route guidance shows a sea route. After you travel by ferry, the current vehicle position may be incorrect. Upon reception of GPS signals, it is automatically corrected.

Route overview



Touch the “Route overview” on the “Menu” screen.

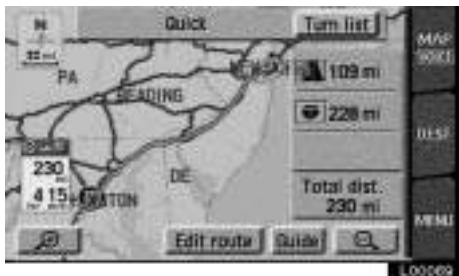

The entire route from the starting point to the destination is displayed.

Route preview

Touch the “Route preview” switch on the “Menu” screen. The “Route preview” screen appears.



To indicate the next destination or selected POI



To preview the route to the next destination or selected POI



To preview the route to the next destination in fast-forward mode



To stop the preview



To review the route to the previous starting point in fast-forward mode



To review the route to the previous starting point



To indicate the previous starting point



Touch the **“Edit”** switch to display the **“Edit route preview”** screen.

To next POI: Preview the next POI.

To next : Preview the next destination.

Delete: Delete the POI icon.

Select POI: Select the POI icon.

Touch the **“OK”** switch after selection.

Current position display



The current vehicle position mark appears in the center of the map screen. You can return to this map screen showing your current position at any time from any screen by touching the **“MAP/VOICE”** tab on the screen.

During driving, the current vehicle position mark is fixed in the center of the screen and the map moves.

If you move the map with a **“one-touch”** scroll (see page 58 for details), the current vehicle position mark continues to track your current location.

INFORMATION

*When you use the **“one-touch”** scroll feature, the current vehicle position mark may disappear from the screen. Move the map with a **“one-touch”** scroll again or touch the **“MAP/VOICE”** tab on the screen to return to the current vehicle position map location display.*

The current position is automatically set as your vehicle receives signals from the GPS (Global Positioning System). If your current position is not correct, it is automatically corrected after your vehicle receives signals from the GPS.

INFORMATION

After the battery disconnection, or on a new vehicle, the current position may not be correct. As soon as the system receives signals from the GPS, the correct current position is displayed.

If you must correct the current position manually, follow the steps on page 88.

Voice guidance

Voice guidance to the destination during route guidance. Use voice guidance just for your reference.

You can adjust the volume of the voice or turn off voice guidance.



Touch the “MENU” tab on the screen to display the “Menu” screen. Then touch the “Volume” switch on the “Menu” screen.



Touch any number to select the desired volume. Touching the “Off” switch turns the voice route guidance off. If you turn the “Adaptive volume control” on, the volume is turned up automatically when the vehicle speed exceeds 80 km/h (50 mph).

INFORMATION

During route guidance, the voice guidance continues even if the navigation screen is changed to the other screens, such as the audio screen.

Typical voice guidance prompts

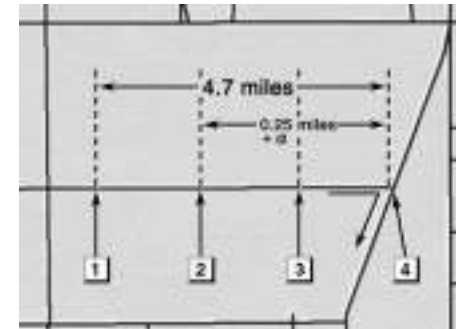

The voice guidance provides various messages as you approach an intersection, or other point where you need to maneuver the vehicle.

- 1 “Proceed about 5 miles.”
- 2 “In a quarter of a mile, right turn.”
- 3 “Right turn.”
- 4 (Beep sound only)

INFORMATION

On freeways, interstates or other highways with higher speed limits, the voice guidance will be made at earlier points than on city streets in order to allow time to maneuver.

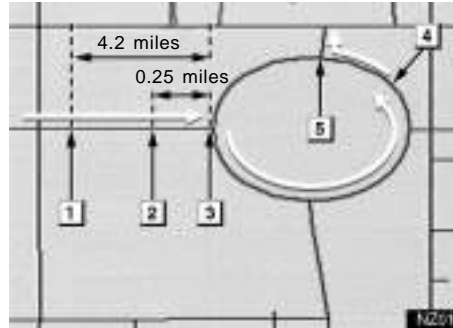

- 1 "Proceed about 4 miles to the traffic circle."
- 2 "In a quarter of a mile, traffic circle ahead, and then 3rd exit ahead."
- 3 "The 3rd exit ahead."
- 4 "The exit ahead."
- 5 (Beep sound only)

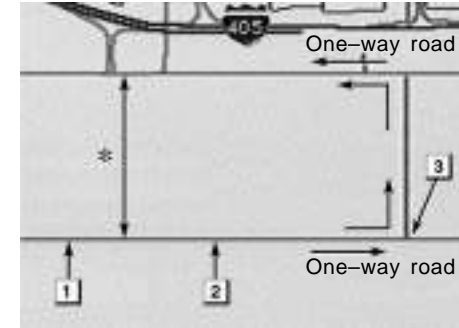

*: The system indicates a U-turn if the distance between two one-way roads (of opposite directions) is less than 15 m (50 ft.) in residential areas or 50 m (164 ft.) in non-residential areas.

- 1 "In half of a mile, make a legal U-turn."
- 2 "Make a legal U-turn ahead."
- 3 (Beep sound only)

Registering your home

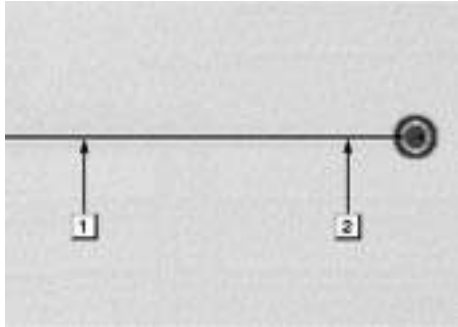



INFORMATION

If the system cannot determine the current vehicle position correctly (in cases of poor GPS signal reception), the voice guidance may be made early or delayed.

If you did not hear the voice guidance command, touch the "MAP/VOICE" tab on the screen to hear it again.

The system announces your approach to the final destination.

- 1  "Your destination is ahead."
- 2  "You have arrived at your destination. The route guidance is now finished."

If you register your home address beforehand, you can easily set the route back to your home.



1. Touch the **“MENU”** tab on the screen to display the **“Menu”** screen and touch the **“Marked points”** switch.



2. Touch the **“Reg. home”** switch on the **“Marked points”** screen to register your home.

If your home already is registered, the **“Delete home”** switch will appear.



You may register the location of your home by ten different methods: address, POI, marked points, previous destination, intersection, freeway entrance/exit, map, current position or preset destinations. Touch the screen to select your desired method from the menu.

Input your home in the same way as the destination input. (See page 25.)

Deleting your home



1. Touch the **“MENU”** tab on the screen to display the **“Menu”** screen and touch the **“Marked points”** switch.



2. Touch the **“Delete home”** switch on the **“Marked points”** screen.

Registering preset destinations

You can register up to 5 preset destinations.



The screen changes and displays the map location of home and a message. If you are sure that you want to delete, touch the **“Yes”** switch. If not, touch the **“No”** switch.

1. Touch the **“MENU”** tab on the screen to display the **“Menu”** screen and touch the **“Marked points”** switch.



2. Touch the **“Register”** switch under **“Preset destinations ①~⑤”**.



If you have already registered a preset destination, you can overwrite it.



3. Touch any of the **1** — **5** switches for which you want to register the preset destination. Input the preset destination in the same way as the destination input. (See page 25.)

EDITING PRESET DESTINATIONS

1. Touch the **"MENU"** tab on the screen to display the "Menu" screen and touch the **"Marked points"** switch.



2. Touch the **"Edit"** switch of preset destinations ①~⑤.



3. Select the destination that you want to edit and touch the switch.



DELETING THE PRESET DESTINATIONS

You can change the name, location and phone number of the preset destination in the same way as editing marked points.

Touch the **“Change”** switch. (See page 76.)

1. Touch the **“MENU”** tab on the screen to display the **“Menu”** screen and touch the **“Marked points”** switch.



2. Touch the **“Delete”** switch of preset destinations ①-⑤.



Detour setting

3. Select the destination that you want to delete and touch the switch.

If you want to delete all the preset destinations, touch the "Delete all" switch.

Messages appear depending on the type of deletion. If you want to delete, touch the "Yes" switch. To cancel the deletion, touch the "No" switch.

When you are driving while the route guidance is operating, you can change the route to detour around a section of the route where a delay is caused by road repairs, an accident, etc.

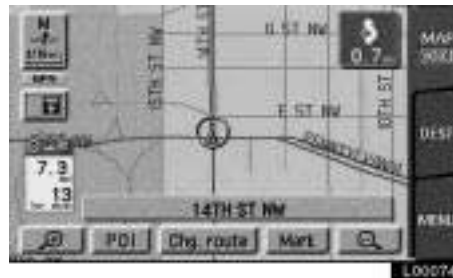

Touch the "Chg. Route" switch if you encounter a reason to divert from the selected route.

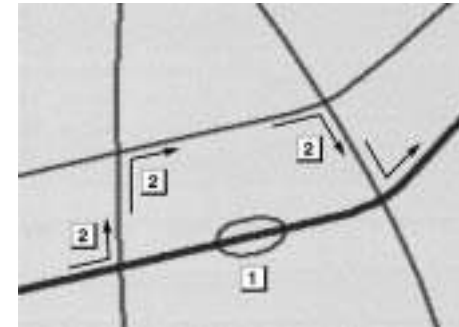

This picture shows an example of how the system would route you around a delay caused by a traffic jam.

1 This part indicates the location where traffic jam is occurring due to road repairs or an accident.

2002 MY CAMRY NAVI_U (OM3355949)

- 2 Detour route suggested by the system



When you touch the “Chg. route” switch, the screen changes to a “Change route” screen that allows you to select the distance you want to detour. Touch one of the numeral keys to start the detour process. After detouring, the system returns to the original guidance route.

Whole route: If you touch this switch, the system will calculate an entire new route to the destination.

INFORMATION

When your vehicle is on a freeway, the detour distance selections are 5, 15, and 25 miles.

The system may not be able to calculate a detour route depending on the selected distance and surrounding road conditions.

Displaying POI

Points of interest such as gas stations and restaurants can be displayed on the map screen. You can also set their location as a destination and use them for route guidance.



To display a particular type of point of interest on the screen, touch the “POI” switch on the map screen.



A window with a limited choice of points of interest will be displayed. When you touch your desired type of point of interest, symbols will appear on the map screen indicating where the POI addresses are located.

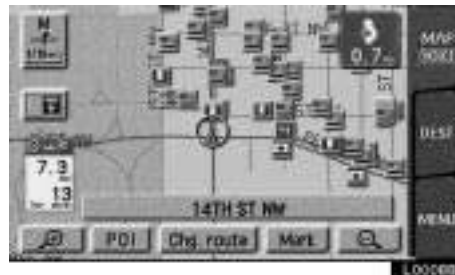

More: If you cannot find your desired point of interest on the limited choice screen, touch this switch. The screen then displays the complete POI listing screen.

You can display up to 5 categories of icons on the screen.



When you select a point of interest type from either the limited list or the complete list, the screen will display symbols at those locations on the map screen.

Touching the “Delete” switch will delete the last selected icon.

Local POI list: If you want to search the nearest point of interest, touch this switch. Then choose one of the categories. The system will list the points within 20 miles.

You can sort the local POI list three different ways as follows.

Icon: In the order of the POI icons

Dist: In the order of distance from your current location.

Name: In alphabetical order by name

By turning the **“Route”** switch on, you can search for POIs on the route when in the route guidance mode.

Touch the  of your desired point of interest. Points of interest which you chose are displayed on the map screen.

To turn off the symbols of the points of interest on the map screen, touch the “POI off” switch.

Setting a POI as a destination

You can select one of the points of interest symbols on the map screen as a destination and use it for a route guidance.

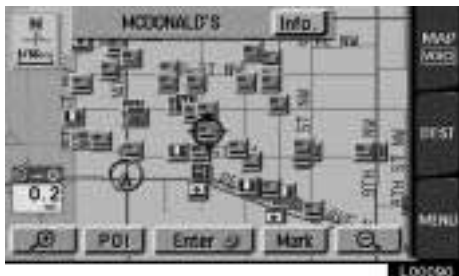

Directly touch the symbol of the point of interest that you want to set as a destination.

1. Touch the **“MENU”** tab on the screen to display the **“Menu”** screen and touch the **“Route overview”** switch.

The map will shift so that the symbol is centered on the screen and overlaps with the cursor . At this time, the distance from your current position will be displayed on the screen. The distance shown is as measured in a straight line from the current vehicle position to the POI.

The name of the point of interest and the **“Info.”** switch on the screen are displayed at the top of the screen. When you touch the **“Info.”** switch on the screen, the information such as the name and address, etc. are displayed.

When your desired point of interest overlaps with the cursor, touch the **“Enter”** switch. The screen changes and displays the map location of the selected destination and route preference. (See **“(a) Entering destination”** on page 25.)

Turn list

You can change from the map screen to a **“Turn List”** screen that displays the list of the roads up to your destination. This list can be used for a route guidance.



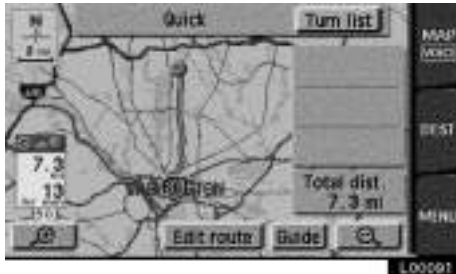

2. The screen will change to the entire route map screen where you can touch the “Turn list” switch.



You can scroll through the list of roads by touching **▲** **▼**. However, not all road names in the route may appear on the list. If a road changes its name without requiring a turn (such as on a street that runs through two or more cities), the name change will not appear on the list. The street name closest to the starting point will be displayed with a mileage to the next turn.



These marks indicate the direction which you should turn at an intersection.



Touch the **“Map”** switch of your desired point. The point which you choose is displayed on the map screen.



INFORMATION

The current vehicle position mark appears at the bottom of the screen next to the name of the street you are driving on. The mark does not move.

If you leave the guidance route, the name of the street you are on is not shown on the list next to the current vehicle position mark.

If the road type you are on changes between a highway, a main street or a residential street (at an interchange or fork), it will appear on the turn list.

If a long route has been selected, it may take a long time to display the turn list.

*Touch the **“MAP/VOICE”** tab on the screen to return to the map display with a route guidance.*

Map appearance

You can select the single screen map or the dual screen map. You can also change the half of the screen to the guidance screen by touching the map/guidance switch while the map screen is displayed. You can choose one of two types of guidance screens.



1. Touch the “MENU” tab on the screen to display the “Menu” screen and touch the “Map appearance” switch.



2. The screen will change to the “Map appearance” screen and you can select the map mode and the guidance mode.

Map mode



To display single map screen



To display dual map screen

Guidance mode



To display arrow screen



To display turn list screen



To turn off guidance screen

Single map



This screen shows the single map.

Dual map

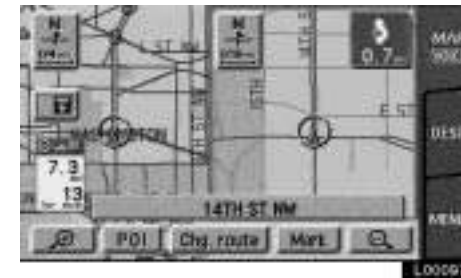

The screen shows the dual map. The map on the left is the main map. You can change the scale of the right side map by touching it. The screen turns into edit mode. You can also choose to display POI icons on the right side map.

Arrow screen

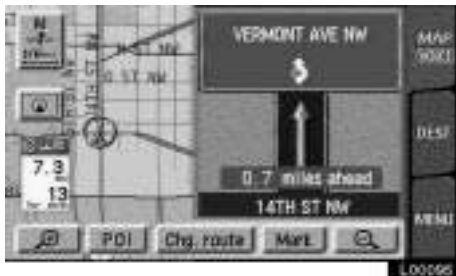

This screen shows the current road name and the distance to the next corner.

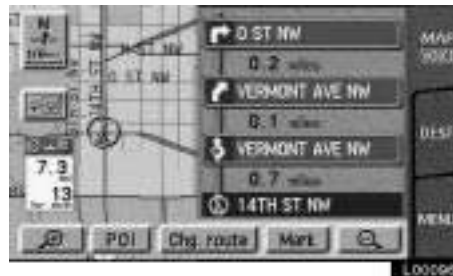

Turn list screen





The screen shows the Turn List. You cannot scroll through the list of roads.

Map scale





Touch  or  to change the scale of the map display. The scale bar and indicator at the bottom of the screen indicates the map scale menu. The scale runs from 1/32nd of a mile to 128 miles.

Touch  or  until the scale bar changes normally. If you continue to touch on the switch, the scale bar changes smoothly.

You can change the scale of the map display by touching the scale bar directly. It is not available during driving.

The map scale is displayed under the north-up symbol or heading-up symbol at the top left of the screen.

INFORMATION

When the map scale is at the maximum range of 128 miles,  is dimmed. When the map scale is at the minimum range of 1/32nd mile,  is dimmed.

Screen scrolling



If you wish to look at a different point on the map other than your current vehicle position, you can bring the desired point to the center of the screen by using the scroll feature.

Touch any point on the screen, and that point moves to the center of the screen and is shown by the cursor mark . You can then set this place as a destination. Touch the **“Enter”**  switch on the screen.

If a destination is already registered, you can add the new location as another destination.

If you continue to hold your finger on the screen, the map will continue scrolling in that direction until you lift your finger.

If you touch switches such as **“Mark”**, **“POI”**, etc., the screen does not scroll and the selected function operates.

After you scroll the screen, the map remains centered at the selected location until you activate another function. The current vehicle position mark will continue to move along your actual route and may move off the screen. When you touch the **“MAP/VOICE”** tab on the screen, the current vehicle position mark returns to the center of the screen and the map moves as you proceed on your route.

INFORMATION

If you enter a destination using the screen scrolling function, the road nearest to the point you touched is set as the destination.

Orientation of the map

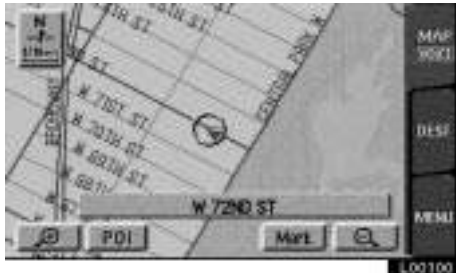

You can change the orientation of the map from the north-up to the heading up by touching the orientation symbol at the top left of the screen.



North-up symbol

Regardless of the direction of vehicle travel, North is always up.



Heading-up symbol

The direction of the vehicle travel is always up. A red arrow indicates North.

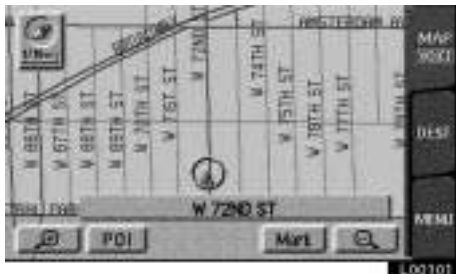

Limitations of the navigation system

This navigation system calculates the current vehicle position using satellite signals, various vehicle signals, map data, etc. However, the accurate position may not be shown depending on the satellite condition, road configuration, vehicle condition or other circumstances.

The Global Positioning System (GPS) developed and operated by the U.S. Department of Defense provides an accurate current vehicle position using 3 to 4 satellites. The GPS system has a certain level of inaccuracy. While the navigation system will compensate for this most of the time, occasional positioning errors up to 300 feet can and should be expected. Generally, position errors will be corrected within a few seconds.



When your vehicle is receiving signals from the satellites, the "GPS" mark appears at the top left of the screen.

The GPS signal may be physically obstructed, leading to inaccurate vehicle position on the map display. Tunnels, tall buildings, trucks, or even the placement of objects on the instrument panel may obstruct the GPS signals.

The installation of window tinting may also obstruct the GPS signals. Most window tinting contains some metallic content that will interfere with the GPS signal reception. We recommend not to use the window tinting on vehicles equipped with navigation systems.

The GPS satellites may not send signals due to repairs or improvements being made to them.

Even when the navigation system is receiving good GPS signals, the vehicle position may not be shown accurately or inappropriate route guidance may occur in some cases.

(a) Accurate current vehicle position may not be shown in the following cases:

- When driving on a small angled Y-shaped road.
- When driving on a spiral road.
- When driving on a slippery road such as in sand, gravel, snow, etc.
- When driving on a long straight road.
- When freeway and surface streets run in parallel.
- After moving by ferry or vehicle carrier.
- When a long route is searched during high speed driving.
- When driving without setting the current position calibration correctly.
- After repeating a change of directions by going forward and backward, or turning on a turntable in the parking lot.
- When leaving a covered parking lot or parking garage.
- When a roof carrier is installed.
- When driving with the tire chains installed.
- When the tires are worn.
- After replacing a tire or tires.
- When using tires that are smaller or larger than the factory specifications.

2002 MY CAMRY NAVI_U (OM33559U)

- When the tire pressure in any of the four tires is not correct.

INFORMATION

If your vehicle cannot receive GPS signals, you can correct the current position manually. For the information on setting the current position calibration, see page 88.

(b) Inappropriate route guidance may occur in the following cases:

- When turning at a wrong intersection off the designated route guidance
- If you set more than one destination but skip any of them, auto reroute will display a route returning to the destination on the previous route when you try to skip any of the destinations.
- When turning at an intersection, there is no route guidance.
- When passing through the intersection, there is no route guidance.
- During automatic rerouting, the route guidance may not be available for the next turn to the right or left.
- It may take a long time to operate auto reroute during high speed driving. In auto reroute, a detour route may be shown.
- After auto reroute, the route may not be changed.
- An unnecessary U-turn may be shown or announced.
- A location may have multiple names and the system will announce one or more.
- Some routes may not be searched.
- If the route to your destination includes gravel, unpaved roads or alleys, the route guidance may not be shown.
- Your destination point might be shown on the opposite side of the street.
- When a portion of the route has regulations prohibiting the entry of the vehicle that vary by time or season or other reason.
- The road and map data stored in your navigation system may not be complete or may not be the latest release.

When replacing the tire(s), perform calibration. See page 88 for detailed information.

Map database information and updates

Map database is made based on the maps, 2000 edition of DENSO, whose information source comes from Nav-Tech maps and GDT maps.

▲2000 Navigation Technologies. All rights reserved.

▲GDT, Geographic Data Technology, Inc.

This product contains proprietary and confidential property of Geographic Data Technology, Inc. Unauthorized use, including duplication of this product is expressly prohibited.

There are two types of areas available for route guidance. (See the following pages.) In one type of area, primarily around metropolitan centers, detailed route guidance is available for the entire area. In the other type of area, all roads are displayed on the map but route guidance is limited. The navigation route might lack precision because the data (no right turns, one-way traffic, etc.) is not complete. It is still possible to reach the destination by following the arrow direction and distance as shown on the bottom left of the screen. The arrow points in the direction of the destination. The distance shown is as measured in a straight line from the current vehicle position to the destination area.



In order to provide you with accurate map information as much as possible, we are always gathering information such as road repairs and doing site investigation. However, the names of roads, streets, facilities, and their locations are often changed. In some places, construction on roads may be in progress. For that reason, information on some areas in this system might be different from the actual location.

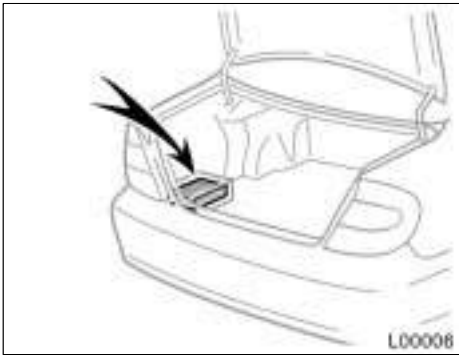

The map database is normally updated once a year. Contact your dealer for updating a map database.

INFORMATION

For the up-dated map DVD-ROM, contact your Toyota dealer.





DVD: To determine which version of the database is currently in your vehicle, touch the “**DVD**” switch on the “Menu” screen. The “DVD information” screen appears and the map database version date is displayed. Contact your dealer to find out if a more recent update has been released.

Route guidance availability





© 2000 by NavTech

-  Route guidance available areas
-  Route guidance available for main roads only

Route guidance availability



© 2000 by NavTech



-  Route guidance available areas
-  Route guidance available for main roads only

2002 MY CAMRY NAVI_U (OM3355905)

Route guidance availability





2000 by NavTech

-  Route guidance available areas
-  Route guidance available for main roads only

Route guidance availability



2000 by NavTech



-  Route guidance available areas
-  Route guidance available for main roads only

2002 MY CAMRY NAVI_U (OM3355907)

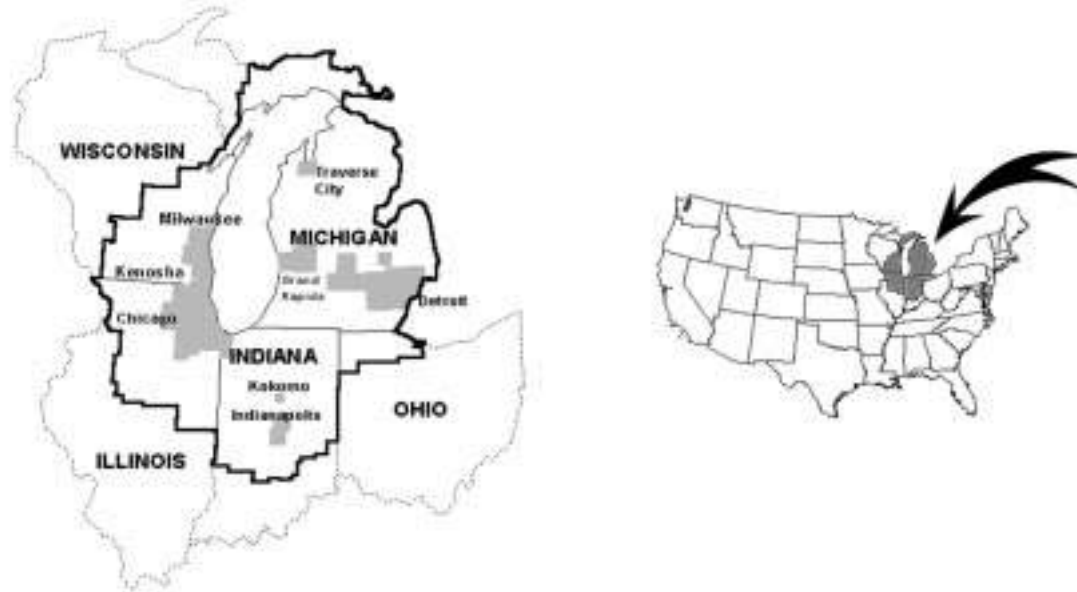
Route guidance availability





© 2000 by NavTech

-  Route guidance available areas
-  Route guidance available for main roads only

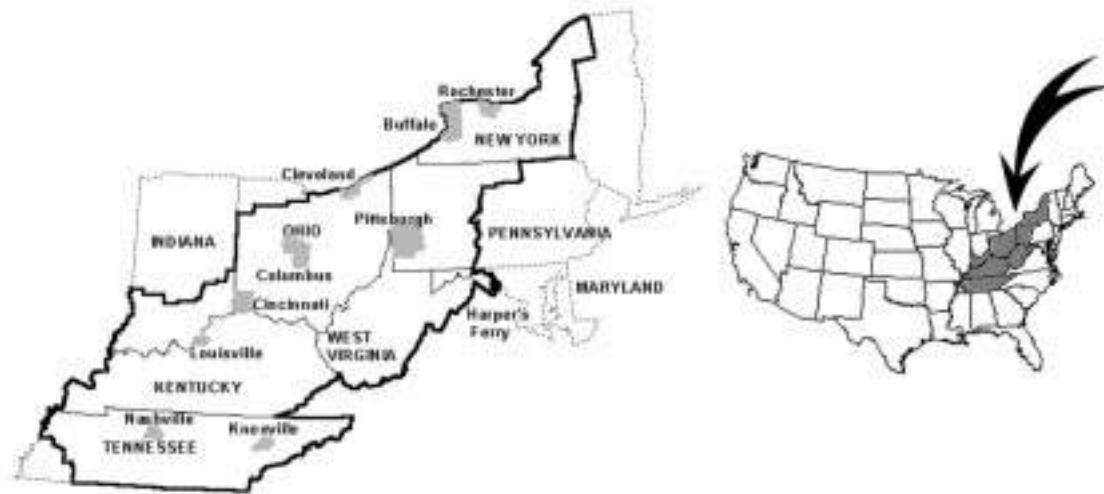
Route guidance availability



2000 by NavTech



-  Route guidance available areas
-  Route guidance available for main roads only

2002 MY CAMRY NAVI_U (OM3355909)

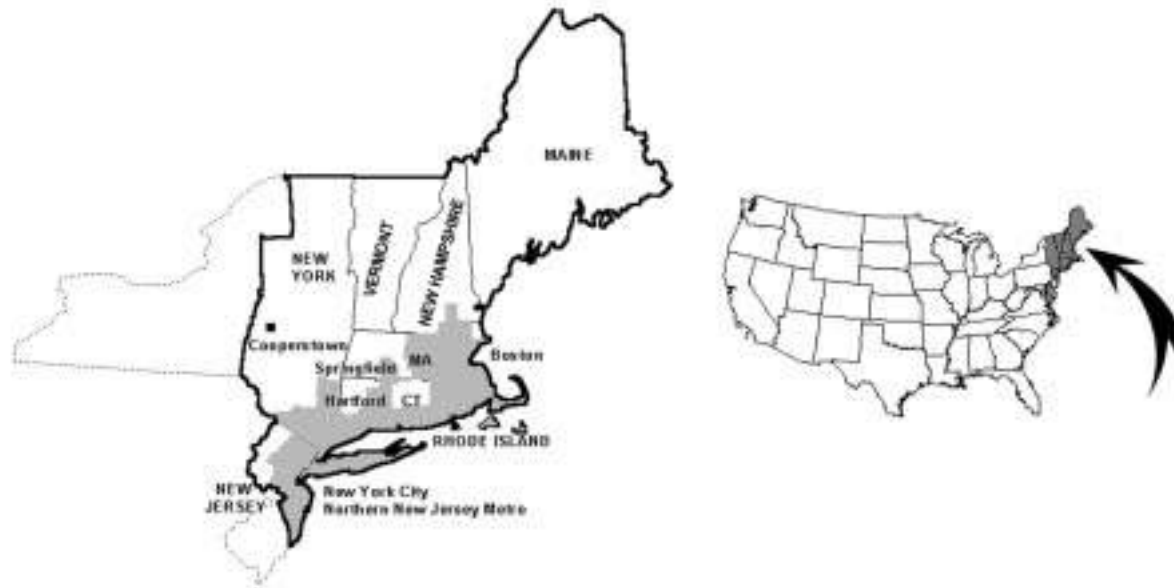
Route guidance availability





2000 by NavTech

-  Route guidance available areas
-  Route guidance available for main roads only

Route guidance availability



© 2000 by NavTech



-  Route guidance available areas
-  Route guidance available for main roads only

2002 MY CAMRY NAVI_U (OM335590)

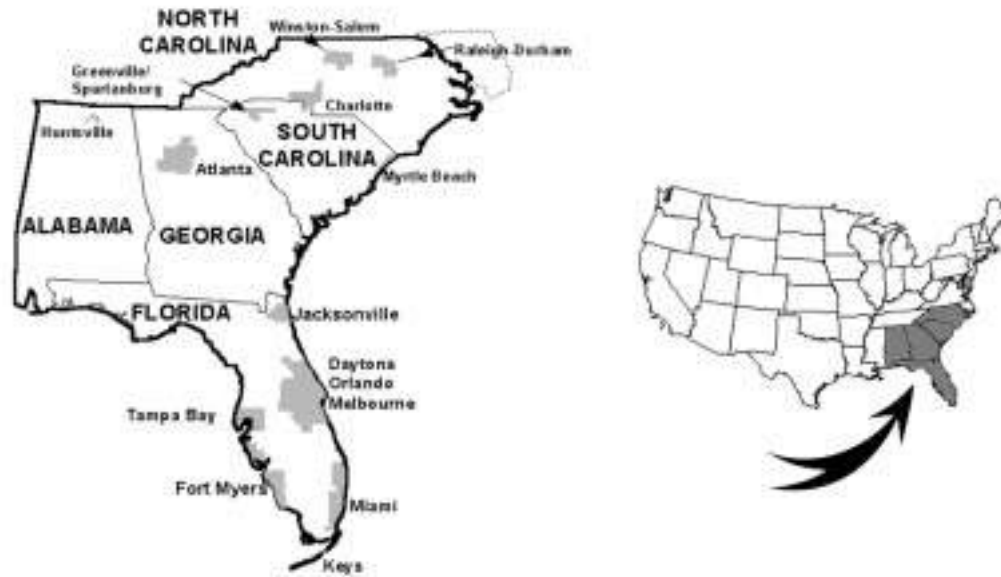
Route guidance availability





© 2000 by NavTech

-  Route guidance available areas
-  Route guidance available for main roads only

Route guidance availability



© 2000 by NavTech

-  Route guidance available areas
-  Route guidance available for main roads only

2002 MY CAMRY NAVI_U (OM335597)

SECTION II

ADVANCED FUNCTIONS

Descriptions of operations for more effective use

Marked points	75
Area to avoid	83
Current position calibration	88



Marked points

You can register and keep your own marked points of interest list (like restaurants, sports facilities, etc.) and use the marked points to input a destination.

(a) Registering marked points



1. Touch the **“MENU”** tab on the screen to display the **“Menu”** screen and touch the **“Marked points”** switch.



2. Touch the **“Register”** switch under **“Marked points”**.

(b) Editing marked points



A screen similar to that for destination input appears. Input the address of the marked point in the same way as any destination input. See pages 10 through 24.

3. After you finish registering the marked point, touch the “Back” switch.

INFORMATION

Up to 100 marked points can be registered.

Once a marked point is registered, you can edit the icon, name or telephone number.

1. Touch the **"MENU"** tab on the screen to display the "Menu" screen and touch the **"Marked points"** switch.



2. Touch the **"Edit"** switch under "Marked points".



The screen lists the marked points.

Sort by Icon: Touch this switch to list the marked points in order of the type of symbol.

Sort by Date: Touch this switch to list the marked points in order of the registered date.

Sort by Name: Touch this switch to list the marked points in alphabetical order.

Touch of the desired marked point to display the edit marked point screen.



Touch the “Change” switch to edit the each item.

CHANGING THE ICON



Touch your desired icon.

Page 1 and page 2: You can select one of 46 icons.

When you touch the desired icon or “Back”, or complete the direction setting, the previous screen is displayed.

With sound: When you set “With sound” for these icons, a buzzer sounds as your vehicle approaches them.

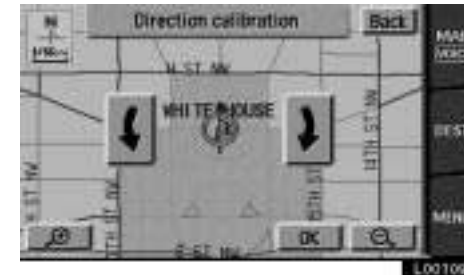

Touch the direction switches and adjust the direction. Touch the “OK” switch. The buzzer sounds when your vehicle approaches this icon in the direction that you set.

When you touch the desired icon or “Back”, or complete the direction setting, the previous screen is displayed.

CHANGING THE NAME



Touch alphabet or numeral keys directly to input the name.

After you finish your entry, touch the **“OK”** switch.

The previous screen will be displayed. If you touch the **“Off”** switch of “Show name”, the name of the marked point will not be shown on the map.

CHANGING THE PHONE NUMBER



Touch numeral keys directly.

After you finish your entry, touch the **“OK”** switch.

The previous screen will be displayed.

CHANGING THE POSITION

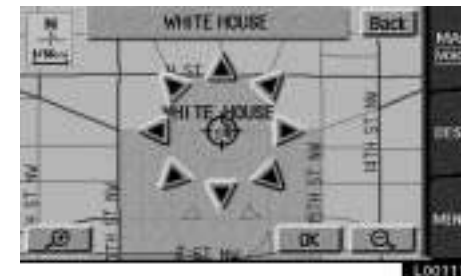

Touch the arrows to scroll to your desired point on the map screen.

Touch the **“OK”** switch when the cursor  moves to your desired point.

The previous screen will return.

After you finish any editing, touch the **“Back”** switch on the first screen of **“Edit marked points”**.

(c) Deleting marked points

You can register up to 100 marked points. If you attempt to register more than 100, a message appears for confirmation.

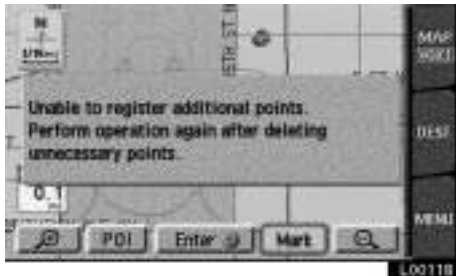

If you want to register a new point, delete one of the marked points. See "(c) Deleting marked points".

1. Touch the **"MENU"** tab on the screen to display the "Menu" screen and touch the **"Marked points"** switch.



2. Touch the **"Delete"** switch of the marked point.

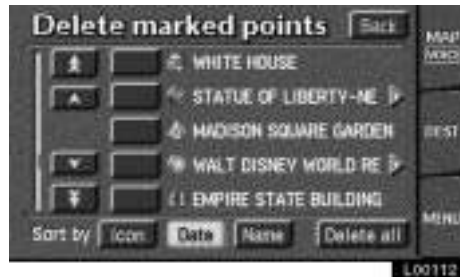

3. Touch of the marked point to delete.

A screen for confirmation will appear with the map of the marked point. If you want to delete it, touch **“Yes”**. Touching **“No”** or **“Back”** will return to the previous screen.

If you want to delete all of the marked points, touch the **“Delete all”** switch. A screen for confirmation will appear. Touching **“Yes”** will delete all of the marked points. Touching **“No”** or **“Back”** will return to the previous screen.

To delete only specified marked points, use the **“Icon”**, **“Date”** or **“Name”** switch to display the screen, so that you can easily find the marked points.

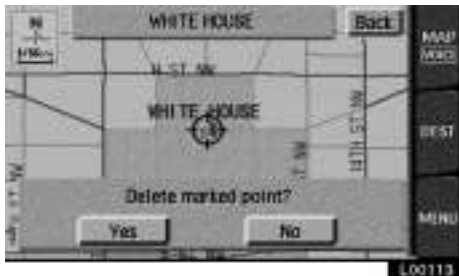

Either of the above messages appears depending on the type of deletion. If you want to delete, touch the **“Yes”** switch. To cancel the deletion, touch the **“No”** or **“Back”** switch.

(d) One-touch marked point registration



You can register your current position or any points (See **“Screen scrolling”** on page 58.) from the map screen by touching the **“Mark”** switch.



When you touch the **“Mark”** switch, the above screen appears for a few seconds, and then the map screen returns.



The registered point is shown by  on the map.

To change the icon or name, etc., see “(b) Editing marked points”.

You can register up to 100 marked points. If you attempt to register more than 100, a message appears for confirmation.

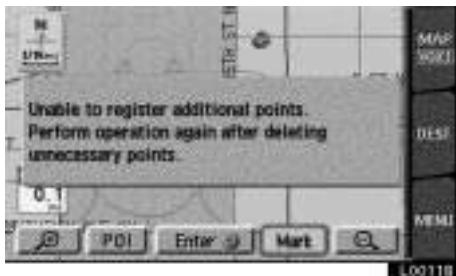

If you want to register a new point, delete one of the marked points. See “(c) Deleting marked points”.

Area to avoid

Any areas you want to avoid due to traffic jams, construction work or other reasons can be registered as areas to avoid.

Touch the “MENU” tab on the screen to display “Menu” screen and touch the “Marked points” switch. Touch the “Area to avoid” switch to display the following screen.



(a) Registering area to avoid

INFORMATION
© <i>Some areas and freeways may not be able to be set as an avoid point.</i>
© <i>If a destination is input in the avoid area or the route calculation cannot be made without running through the avoid area, a route passing through the avoid area may be shown.</i>

1. Touch the “Register” switch of “Area to avoid”.



2. Find the area to avoid in the same way as you find any destination. (See page 10 through 24.)



2002 MY CAMRY NAVI_U (OM33559U)

3. Touch the “OK” switch when the cursor is at the center of the area that you want to edit. (b) Editing area to avoid



4. Depending on the contents to be edited, touch either  or  switch.

When you touch the “OK” switch, the following message appears.



After a few seconds, the avoid area screen returns.

1. Touch the **“Edit”** switch under **“Area to avoid”** to display the **“Edit area to avoid”** screen.

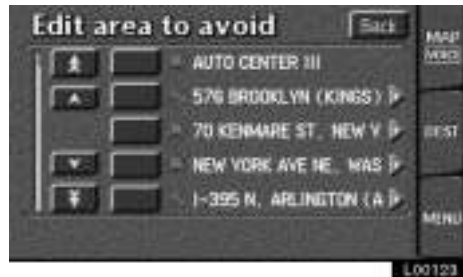

2. Touch the point you want to edit from the list.



You can edit the name, location and size of the area to avoid. Touch the change switch of any item that you want to edit.

3. **Edit the name, location or size of the area to avoid.**

When editing is completed, touch the **“OK”** switch.

INFORMATION

- © *If you try to change the map to an inappropriate scale, a message appears.*
- © *For magnification or reduction of the map scale, see page 57.*

(c) Deleting area to avoid

1. Touch the **"Delete"** switch to display the "Delete area to avoid" screen.

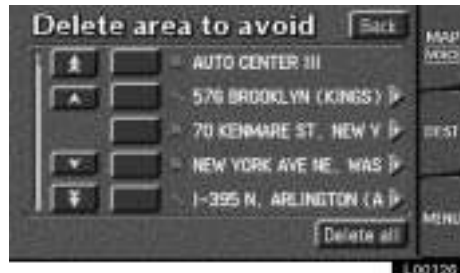

2. Select the area you want to delete.

Delete all: All the areas to avoid registered in the system are deleted.



Current position calibration

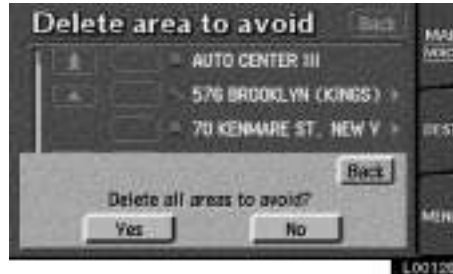

3. Either of the above messages appears.

To delete the area(s), touch the **“Yes”** switch.

If you want to try again or cancel the deletion, touch the **“No”** switch. The previous screen will return.

The current vehicle position mark will be automatically corrected during driving on reception of GPS signals. If your vehicle cannot receive GPS signals, you can correct the current position mark manually.



1. Touch the “MENU” tab on the screen to display the “Menu” screen, and touch the “Setup” switch.



2. Touch the “**Calibration**” switch.

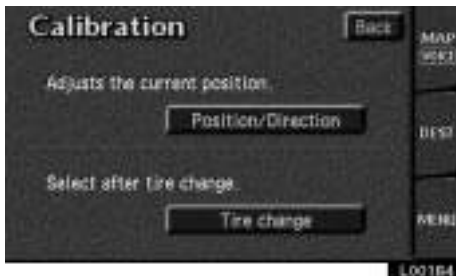

3. Touch the “**Position/Direction**” switch.

INFORMATION

For additional information on current position accuracy, see “Limitations of the navigation system” on page 59.

POSITION/DIRECTION CALIBRATION



1. Touch the scroll arrows to move the cursor  to your desired location.
Touch the “OK” switch.



2. Touch either the left or right arrow to correct the direction of the current vehicle position mark.
Touch the “OK” switch on the screen and the map screen returns.

TIRE CHANGE CALIBRATION

The tire change calibration function should be used when the tires are replaced. This will adjust for any possible change in tire circumference from the old tires to the new ones. If this procedure is not performed when tires are replaced, the current vehicle position mark may become incorrect.

To execute the fast distance tire calibration procedure, touch the “**Tire change**” switch on the “Calibration” screen.

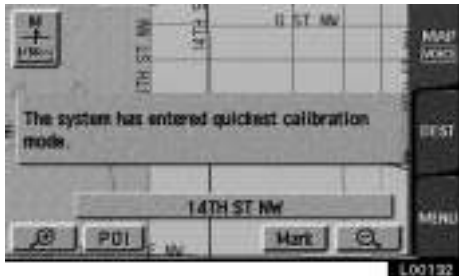

The above message appears and the fast distance calibration is automatically started. A few seconds later, the map screen returns.

SECTION III

MORE ADVANCED FUNCTIONS

Convenient features

Setup	93
Map color	94
Auto reroute	95
Estimated travel time	96
Adjusting time zone	100
Distance indication	102
Notification of seasonal restrictions	103
Voice guidance in all modes	105
Current street name	106
Maintenance information	107
Dealer setting	110
Calendar with memo	114



Setup

You can set the values shown on the Setup screen.

1. Touch the “MENU” tab on the screen.



2. Touch the “Setup” switch to display the “Setup” screen. Select your desired items you want to set. Selected items will be highlighted in green.



3. Touch the “OK” switch on the screen and the previous screen returns.

To default: Touch the “Default” switch on the screen. All of the settings can be defaulted.

Map colour (day or night): You can select your desired map color.

Auto reroute: You can set the system will or will not automatically search for a new route to the destination.

Estimated travel time: You can set to display the time required to reach the destination on the road guidance screen.

Adjust time zone: You can select your desired time zone.

2002 MY CAMRY NAVI_U (OM3355993)

Distance: You can change “km” or “miles” to display your desired units.

Notify seasonal restrict: You can select to notify or not to notify a seasonal restriction.

Voice guide in all mode: You can set the voice guide in all mode or not.

Current street name: You can select to show or not to show a current street name on the map screen.

Map color

1. Touch the **“MENU”** tab on the screen.
2. Touch the **“Setup”** switch.

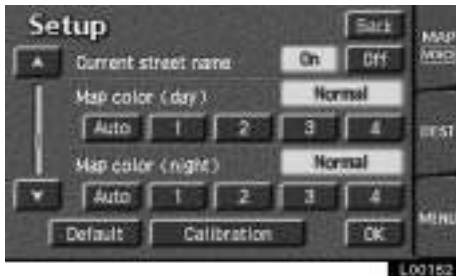

3. Select your desired day and/or night map color and then touch the **“OK”** switch to return to the map screen. See **“Map color list”** below for details.

Touch the **“Normal”** switch to select the default the map color.

Touch the **“Auto”** switch to have the map color selected automatically. The map color changes every three months.

Map color list

Switch NO.	Map color	“Auto” mode
1	Green	Mar.–May

2	Blue	Jun.–Aug.
3	Gray	Sep.–Nov.
4	Beige	Dec.–Feb.

Auto reroute

When the auto reroute feature is turned on, the system will automatically search for a new route to the destination if you leave the guidance route. This feature does not operate while you are driving on roads where the guidance is not available.

1. Touch the **"MENU"** tab on the screen, touch the **"Setup"** switch.



2. Touch the **"On"** switch of **"Auto reroute"**. If you can not find the item on the list, touch  or  to scroll up or down the list.

INFORMATION

If your vehicle leaves the guidance route, the system searches for a new route to the destination. The new route may or may not take you back to the previous route depending on how far you are off the original guidance route.



When the **"Estimated travel time"** feature is turned on, the time required to reach the destination is displayed on the route guidance screen.



To turn the **"Estimated travel time"** on:



1. Touch the **“MENU”** tab on the screen to display the **“Menu”** screen, and touch the **“Setup”** switch.



2. Touch the “On” switch of the Estimated travel time. If you cannot find the item on the list, touch  or  to scroll up or down the list.



To set average speeds:

1. Touch the **“Change speed”** switch of **“Estimated travel time”**.
2. Touch  or  to set average vehicle speeds for driving on a freeway, main street and residential road.

If you touch the **“Default”** switch, the default speed is set at each item.

3. After you finish setting the desired speeds, touch the **“OK”** switch. The **“Setup”** screen returns.

Adjusting time zone

INFORMATION
<p>© <i>The displayed time to the destination is the approximate driving time calculated based on the speeds you selected and your actual position along the guidance route.</i></p> <p>© <i>The time shown may vary greatly depending on your progress along the route (which may be affected by road conditions such as traffic jams, construction work, etc.)</i></p> <p>© <i>Up to 99 hours 59 minutes can be displayed.</i></p>

1. Touch the **"MENU"** tab on the screen.



2. Touch the **"Setup"** switch.



3. Touch the “Adjust” switch. The “Adjust time zone” screen appears on the display.



4. Select your desired time zone. The selected switch is highlighted in green.

Touch the “On” switch and then touch

◀ or ▶ to set daylight saving time.

5. Touch the “OK” switch on the screen. The “Setup” screen returns.

Distance indication

1. Touch the “MENU” tab on the screen.



2. Touch the “Setup” switch.



3. Touch “km” or “mile” to select your desired units.

4. Touch the “OK” switch.

Notification seasonal restrictions

1. Touch the “MENU” tab on the screen.



2. Touch the “Setup” switch.



3. Touch the “On” switch of the “Notify seasonal restrict”. Touch the “OK” switch. The screen return to the previous map.

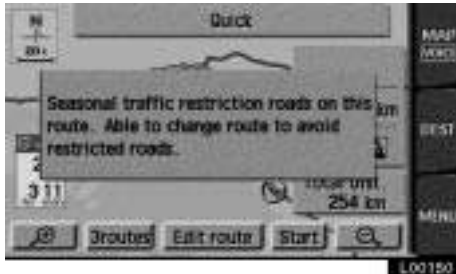

4. The restricted road icon and message will appear on the screen.

Voice guidance in all modes

1. Touch the “MENU” tab on the screen.



2. Touch the “Setup” switch.



3. Touch the “On” switch on the right of “Voice guide in all mode”.

Current street name

1. Touch the **"MENU"** tab on the screen.



2. Touch the **"Setup"** switch.



3. Touch the **"On"** switch on the right of **"Current street name"**.

The current street name appears on the map screen.

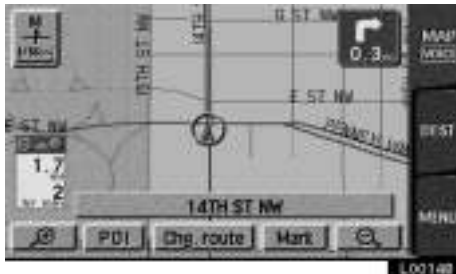

Maintenance information

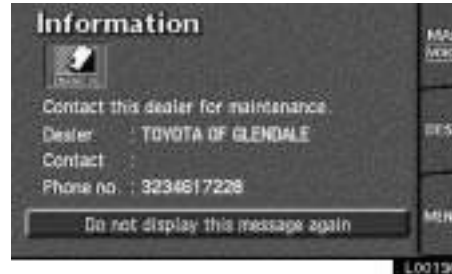

This system has a function which informs you of the time to replace certain parts or components as well as other information shown on the screen. (See "INFORMATION ITEMS" on page 109.) When the system begins operating after reaching either the Information Item's date or driving distance, the "Information" screen will be displayed.

To avoid seeing the "Information" screen again, touch the **"Do not display this message again"** switch.



1. Push the **“INFO”** button to display the **“Information Menu”** screen, and then touch the **“Maintenance”** switch.



2. Touch your desired icon and input the conditions.



Date: Input the next maintenance date.

Distance: Input the driving distance until the next maintenance check. You can input up to five digits for the driving distance.

When you touch the “!” switch on the screen, the screen changes to display the “Change name” screen. Touch the keys to input your desired name and then input the conditions.

After you input the information, touch the “OK” switch. The screen returns to the “Maintenance” screen. The icon color will change to green after the date and driving distance are input. The icon color will change to orange when your vehicle needs to be serviced. The following switches appear on the “Maintenance” screen.

Delete all: Cancel all conditions which have been input.

Reset all: Reset all items which satisfy either condition.

Touch the “Off” switch on the “Maintenance” screen, and the “Information” screen will no longer be displayed.

INFORMATION

- © *For scheduled maintenance information, please refer to the “Scheduled Maintenance Guide” or “Owner’s Manual Supplement”.*
- © *Depending on your driving or the road conditions, the system may have a time-lag between the data which has been input and the actual date and driving distance.*

INFORMATION ITEMS



Oil change



Replace oil filter



Rotate tires



Replace tires



Replace battery







Replace brake linings



Replace wiper blades



Replace engine coolant

-  Replace brake fluid
-  Replace ATF
-  Scheduled maintenance
-  Replace air filter
-  Personal

Dealer setting



You can register your dealer's name and address. Touch the "Set dealer" switch on the Maintenance screen.

(a) Registering dealer



1. Enter your dealer's location address in the same way as you input any destination. (See page 10 through 24.)

(b) Editing dealer

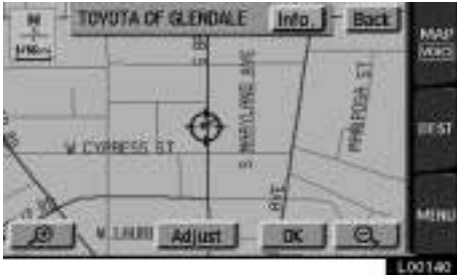

2. After you enter your dealer, the screen changes and displays the map location of the dealer. If it is OK, touch the “Enter” switch.

The current screen changes to the screen where you can edit the data of your dealer. (See (b) Editing dealer.)

Touch the “View map” switch of “Edit dealer” to see the location of the dealer and route preferences. (See “(a) Entering destination” on page 25.)



1. Touch the “Set dealer” switch and touch the “Change” switch of the item to be edited.

EDITING THE NAME OF THE DEALER OR CONTACT



Touch alphabet or numeral keys directly to input the name.

After you finish your entry, touch the “OK” switch. The previous screen will be displayed.

EDITING THE LOCATION

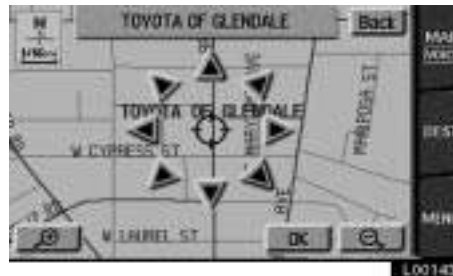

Touch the arrows to scroll to your desired point on the map screen.

Touch the “OK” switch when the cursor  moves to your desired point.

The previous screen will be displayed.

EDITING THE PHONE NUMBER



Touch numeral keys directly.

After you finish your entry, touch the “OK” switch.

The previous screen will be displayed.

After you finish any editing, touch the “Back” switch.

(c) Deleting dealer



1. Touch the “Set dealer” switch and then touch the “Delete dealer” switch.

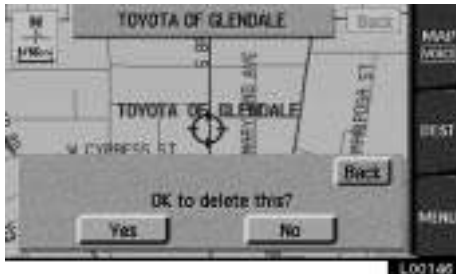

2. A selected point will appear. Also, a message will appear at the bottom of the screen. To delete, touch the “Yes” switch. To cancel the deletion, touch the “No” switch.

Calendar with memo



This system has a function which informs you the memo you entered. When the system begins operating after reaching the memo's date, the Information screen will be displayed.

The Information screen will not be displayed again by touching the **“Do not display this message again”** switch.



Push the **“INFO”** button to display the **“Information Menu”** screen. Touch the **“Calendar”** switch to display the **“Calendar”** screen.

Today's date is circled in green. If today's date is not displayed on the screen, touch **“Today”** switch to display a calendar of this month.

(a) Inputting a memo



1. Touch directly on the day you want to input a memo.



2. Touch the **“Memo”** switch to display the **“Memo”** screen.



3. Touch keys directly to input a memo. You can input up to 24 letters.

After you input the memo, touch the **“OK”** switch at the bottom right of the screen. The previous screen will appear. You can input a memo until December 31, 2020.



The date for which a memo is set is displayed with a mark as in the above illustration. The default color of the mark is light blue.



You can select your desired date and/or mark color. Touch the **“Chg. mark”** switch.

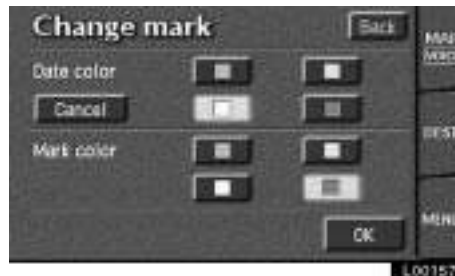

Select your desired date or mark color. If you want to default the date color you chose, touch the **“Cancel”** switch. After you select the date and/or mark color, touch the **“OK”** switch to display the previous screen.

(b) Adding a Memo



When you want to add a memo, touch directly on the date you want to add the memo.

The **“Memo”** screen appears on the display. If touching **“Memo”** switch, the memo input screen is displayed. (See page 114 for inputting a memo.)

You can input up to three memos a day.

(c) Deleting a memo



Touch the date you already input the memo. Displaying the memo you want to delete and then touch the “Delete” switch. A message appears on the display. To delete, touch the “Yes” switch. If not, touch the “No” switch.

(d) Editing a memo



If you want to edit the memo, touch the date. Touching the “Edit” switch will display the “Memo edit” screen. (See page 114 for the details.)

(e) Memo list



If you want to look at the memo you input, touch the “List” switch to display the “Memo list”.



Touch your desired search condition to list the memo. The memo list is displayed on the screen.



Touch the “**Period**” switch to display the “**Memo list**” as long as you desired. Touch numeral keys to input your desired search period. After inputting a search period, touch the “**OK**” switch. The “**Memo list**” screen will be displayed.

You can input a search period from January 1, 2000 through December 31, 2020.



If you want to delete and/or edit the memo, touch the switch of the memo.

If you want to delete all of the memo, touch the “**Delete all**” switch. A message appears on the display. To delete, touch the “**Yes**” switch. If not, touch the “**No**” switch.

If you want to remove all of the date colors of date you input, touch the “**Remove color of date**” switch. A message appears on the display. To remove the colors, touch the “**Yes**” switch. To allow the colors to remain, touch the “**No**” switch.



To edit: Touch the “**Edit**” switch. (See page 118 for details.)

To delete: Touch the “**Delete**” switch. (See page 118 for details.)

SECTION IV

OTHER FUNCTIONS

Screen adjustment	121
Screen transition	122



Screen adjustment

You can adjust the brightness or contrast of the screen depending on the brightness of your surroundings. You also can turn the screen off.

1. Push the “DISPLAY” button. The following adjustment screen appears.

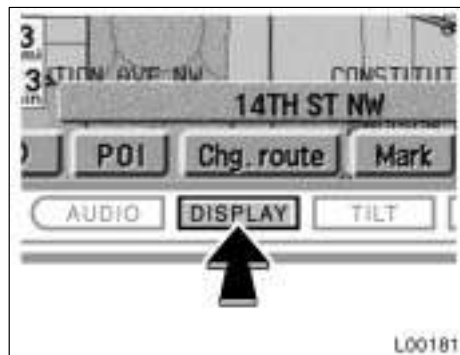

BRIGHTNESS: Adjusts the brightness of the screen.

CONTRAST: Adjusts the contrast of the screen.

2. Touch “+” or “-” for adjustment.

“-”: The screen becomes dark or its contrast becomes weak.

“+”: The screen becomes bright or its contrast becomes strong.

You can adjust the brightness and contrast with exterior light on or off individually.

3. After adjusting the brightness and contrast, touch the “OK” switch.

Touching the “SCREEN OFF” switch turns the screen off.

Screen transition



You can select a function that enables automatic return to the previous screen from the audio screen.

1. Push the **“INFO”** button to display the “Information Menu” screen. Touch **“Screen Transition”**.



2. Select **“ON”** or **“OFF”** and then touch **“OK”**.

ON: The previous screen automatically returns from the audio screen 20 seconds after the end of audio operation.

OFF: The audio screen remains on.

SECTION V

AUDIO SYSTEM

Quick reference for your audio system	126
Your audio system	127
Using your audio system	128
Car audio system operating hints	142



Quick reference for your audio system

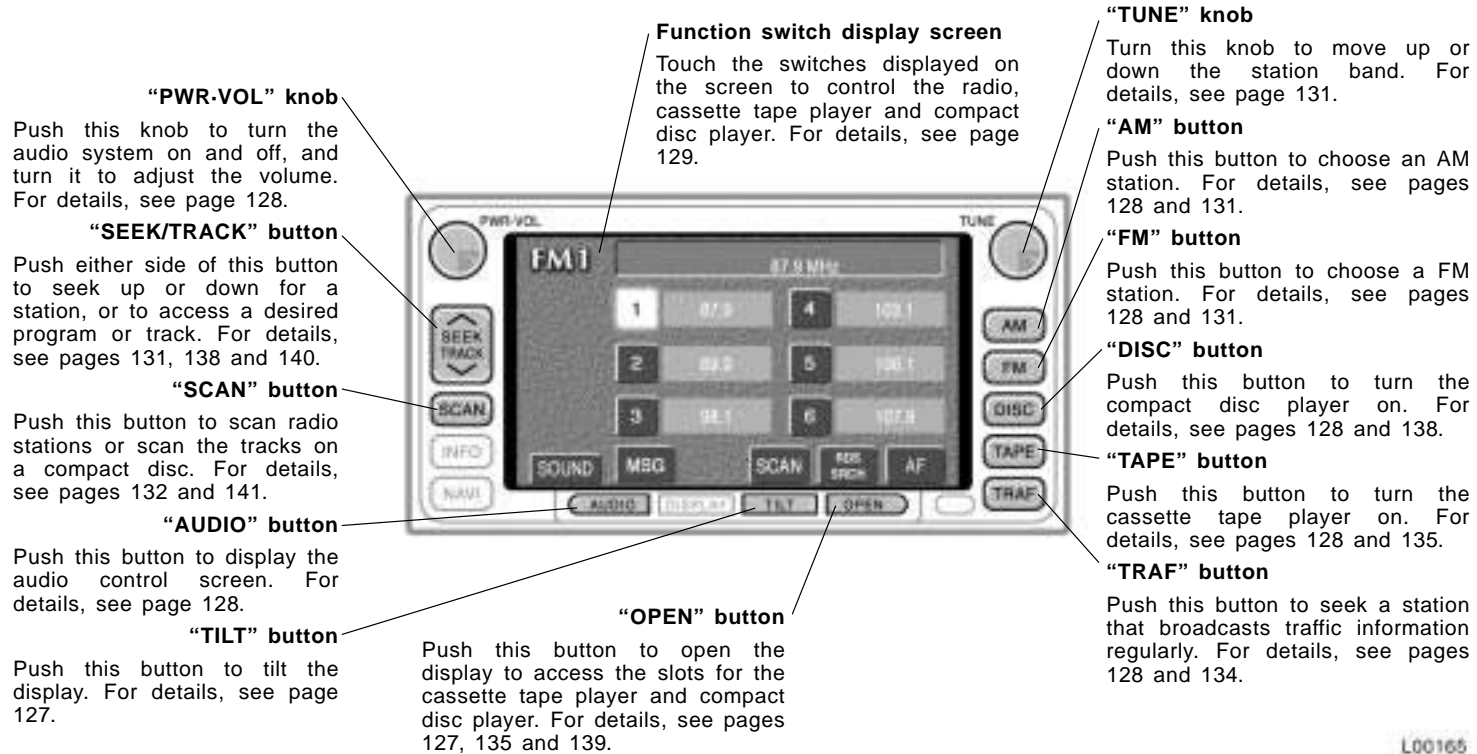

L00165

Your audio system

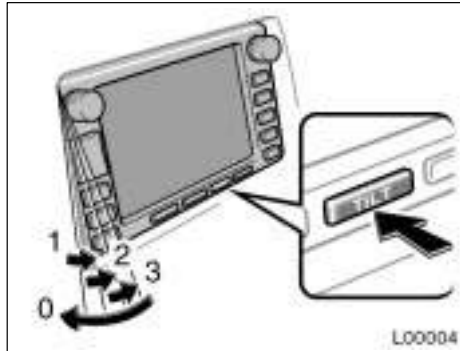

You can adjust the angle of the display by pushing the “TILT” button. Each push of the “TILT” button will tilt the display to position 1, 2, 3 and then back to 0 in that order.

If you turn the ignition switch off, the display will automatically move back to position 0. The display will automatically resume the previous position you used when the ignition switch is turned to the “ACC” or “ON” position.

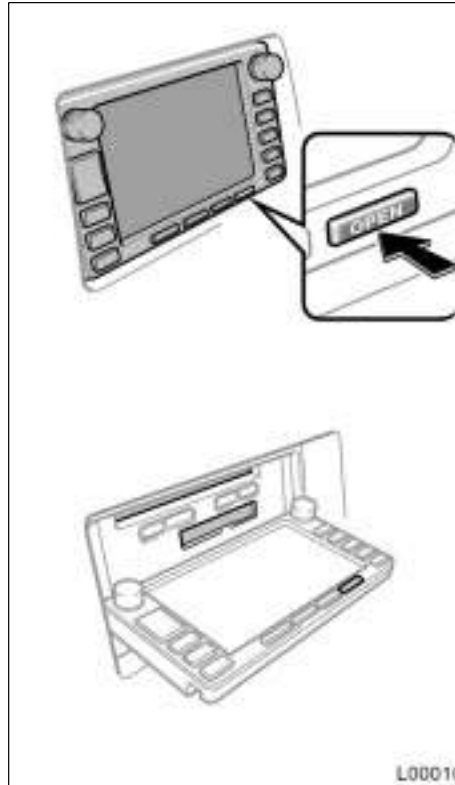

The slots for the cassette tape player and compact disc player are behind the display.

To lower the display, push the “OPEN” button. After you inserting the cassette tape or compact disc, push the button again to close the display.

CAUTION

- Do not place anything on the opened display, as such items may be thrown about in the compartment and possibly injure people in the vehicle during sudden braking or in an accident.
- To reduce the chance of injury in case of an accident or sudden stop while driving, keep the display closed.
- Take care not to jam your fingers while the display is moving. Otherwise, you could be injured.

NOTICE

Do not obstruct the display while it is moving. It could damage your audio system.

Using your audio system— —Some basics

This section describes some of the basic features of the Toyota audio system. Some information may not pertain to your system.

Your audio system works when the ignition switch is in the “ACC” or “ON” position.

NOTICE

To prevent the battery from being discharged, do not leave the car audio on longer than necessary when the engine is not running.

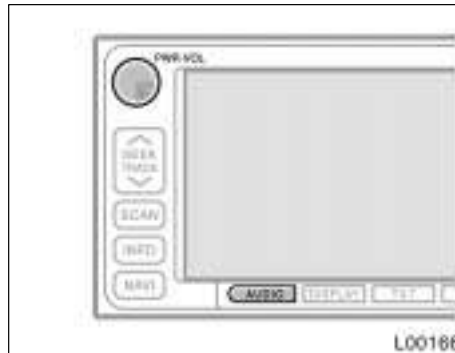

(a) Turning the system on and off

POWER-VOL: Push this knob to turn the audio system on and off. Turn this knob to adjust the volume. The system turns on in the last mode used.

AUDIO: Push this button to display switches for audio system (audio control mode).

You can select the function that enables automatic return to the previous screen from the audio screen. See page 122 for details.

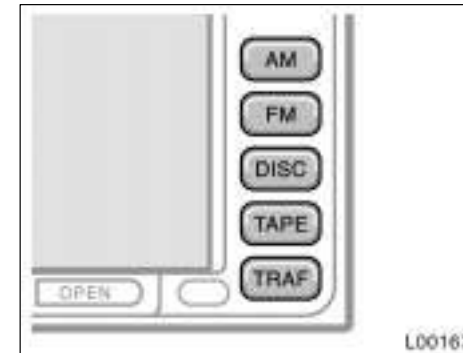

Push “AM”, “FM”, “DISC”, “TAPE” or “TRAF” button to turn on the desired mode. The selected mode turns on immediately.

Push these buttons if you want to switch from one mode to another.

If the tape or disc is not set, the cassette player or compact disc player does not turn on.

You can turn off the cassette player or compact disc player by ejecting the cassette tape or compact disc. If the audio system was previously off, then the entire audio system will be turned off when you eject the cassette tape. If another function was previously playing, it will come on again.

2002 MY CAMRY NAVI_U (OM33559U)

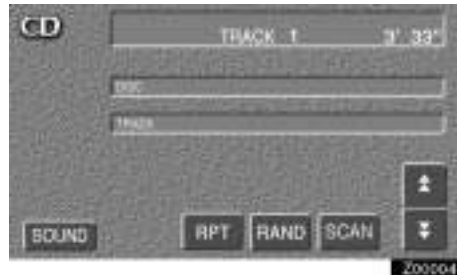
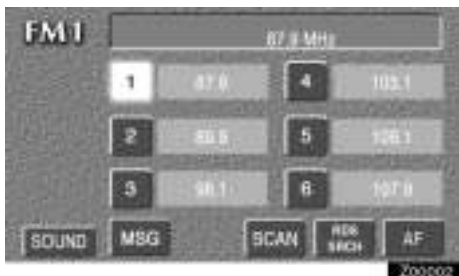
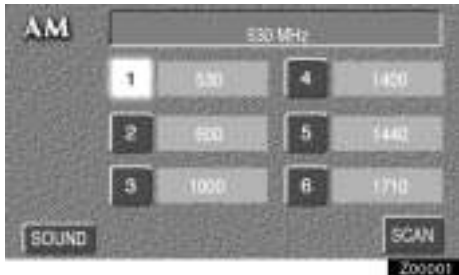

The switches for radio, cassette tape and compact disc player operation are displayed on the function switch display screen when the audio control mode is selected. Touch them lightly and directly on the screen.

The selected switch is highlighted in green.

INFORMATION

If the system does not respond to a touch of a switch, move your finger away from the screen and then touch it again.

You cannot operate dimmed switches.

Wipe off fingerprints on the surface of the display using a glass cleaning cloth.

(b) Tone and balance

How good an audio program sounds to you is largely determined by the mix of the treble, midrange, and bass levels. In fact, different kinds of music and vocal programs usually sound better with different mixes of treble, mid-range, and bass.

A good balance of the left and right stereo channels and of the front and rear sound levels is also important.

Keep in mind that if you are listening to a stereo recording or broadcast, changing the right/left balance will increase the volume of one group of sounds while decreasing the volume of another.

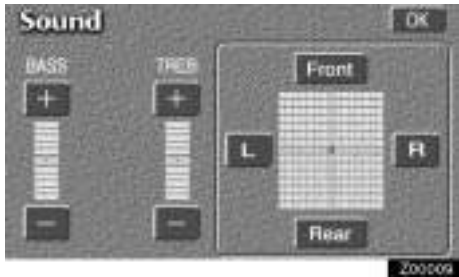

Except JBL

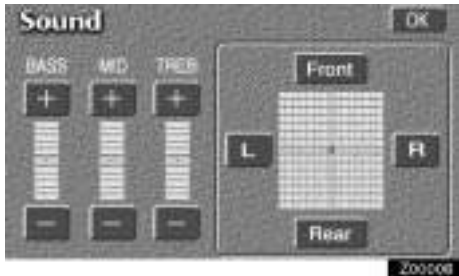

JBL

Touching the “SOUND” switch displayed on the screen at the audio control mode will display the sound control mode. Adjust the tone and balance as follows.

To adjust the tone, touch the “+” or “-” switches on the screen. To adjust the balance between the front and rear speakers, touch the “Front” or “Rear” switch on the screen, and to adjust the balance between the left and right, touch the “L” or “R” switch on the screen.

BASS: Adjusts low-pitched tones.

MID: Adjusts mid-pitched tones (JBL only).

TREB: Adjusts high-pitched tones.

As the orange display goes up, each tone is more emphasized.

(c) Your radio antenna

Your vehicle has an antenna printed on the inside of the rear window.

NOTICE

Attaching the film (especially conductive or metallic type) on the rear window will noticeably reduce the sensitivity of the radio.

(d) Your cassette player

When you insert a cassette, insert it with the exposed tape side to the right.

NOTICE

Do not oil any part of the cassette player, and do not insert anything except a cassette tape into the slot.

(e) Your compact disc player

When you insert a compact disc, insert it with the label side up. The compact disc player will play from track 1 through the end of the disc. Then it will play from track 1 again.

NOTICE

Never try to disassemble or oil any part of the compact disc player. Do not insert anything except a compact disc into the slot.

The player is intended for use with 12 cm (4.7 in.) discs only.

—Radio operation

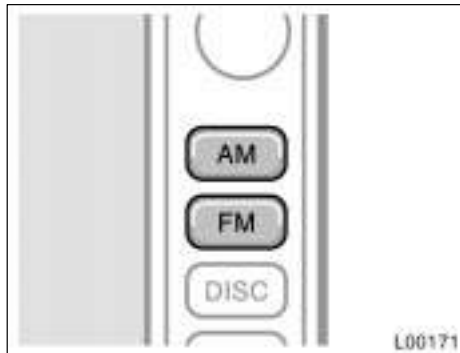

(a) Listening to the radio

Push these buttons to choose either an AM or FM station.

“AM”, “FM1” or “FM2” appears on the screen.

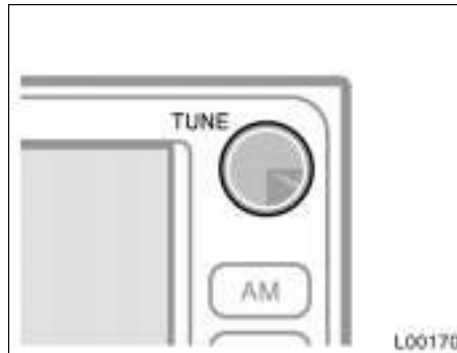

Turn the knob clockwise to step up the station band or counterclockwise to step down.

Your radio automatically changes to stereo reception when a stereo broadcast is received. “ST” appears on the screen. If the signal becomes weak, the radio reduces the amount of channel separation to prevent the weak signal from creating noise. If the signal becomes extremely weak, the radio switches from stereo to mono reception. In this case, “ST” disappears from the screen.

1. Tune in the desired station.

2. Touch one of the station selector switches (1–6) and hold it until a beep is heard. This sets the station to the switch and the frequency appears on the switch

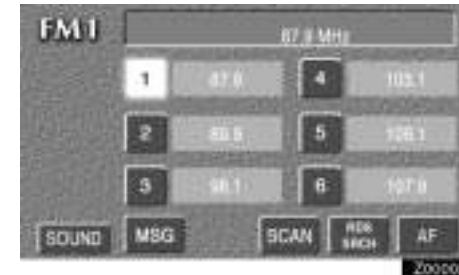

(b) Presetting a station

Each radio mode (AM, FM1 or FM2) can store up to 6 stations. To change the preset station to a different one, follow the same procedure.

The preset station memory is cancelled when the power source is interrupted by battery disconnection or a blown fuse.

(c) Selecting a station

Your vehicle has an electronic tuning radio (ETR). Tune in the desired station using one of the following methods.

Preset tuning: Touch the switch (1–6) for the station you want. The switch is highlighted in green and the station frequency appears on the screen.

Seek tuning: Push the “SEEK/TRACK” button on either side. The radio will begin seeking up or down for a station of the nearest frequency and will stop on reception. Each time you push the button, the stations will be searched out one after another.

To scan all the frequencies: Touch the “SCAN” switch on the screen or push the “SCAN” button briefly. “SCAN” appears on the screen. The radio will find the next station and stay there for a few seconds, and then scan again. To select a station, touch the “SCAN” switch or push the “SCAN” button again.

To scan the preset stations: Touch the “SCAN” switch on the screen or push the “SCAN” button for longer than 2 seconds. “P. SCAN” appears on the screen. The radio will tune in the next preset station, stay there for a few seconds, and then move to the next preset station. To select a station, touch the “SCAN” switch or push the “SCAN” button again.

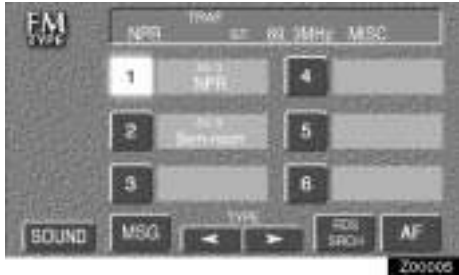

(d) Radio Data System

Your audio system is equipped with Radio Data Systems (RDS). RDS mode provides you to receive text messages from radio stations that utilize RDS transmitters.

- When RDS is on, the radio can
- only select stations of a particular program type,
 - display messages from radio stations,
 - search for a stronger signal station,
 - search for local stations broadcasting the same network as the vehicle travels,
 - receive announcements concerning local and national emergencies (even if RDS function is turned off).

RDS features are available for the use only on FM stations which broadcast RDS information.

“RDS SRCH” switch

This switch allows you to search all available RDS stations out of the entire FM band and sort them by program type (See following “TYPE” switch for details on program types).

By touching this button at the FM mode, RDS is turned on and the radio is switched to FM type mode. During the program type search, “RDS SEARCH” will be shown on the screen. Also at this time, “FM TYPE” will appear on the screen to indicate that the station selector switches are for program type.

After searching for all the available RDS stations, the radio will activate the previously used program type. If the previously used program type is not available, or if the radio has not yet performed a program type search, the radio will activate the first available program type that has stations in memory. The radio will preset the stations of the current program type into the preset buttons.

These are accessible through the “TYPE” switch. If more than 6 stations are found, the radio will load the 6 strongest stations signal of the program type into the presets.

If no RDS stations are found, “No RDS Stations Found” will be displayed and the beep sounds. Then the radio will return to the previous FM mode and frequency. “Alert”

This type of announcement warns of national or local emergencies. You will not be able to turn off alert announcements. Alert announcements will come on even if RDS mode is turned off. “Alert” appears on the screen when an alert announcement plays. The radio uses TA volume during these announcements. When an alert announcement comes on the tuned radio station or a related network station, you will hear it even if the volume is muted or a cassette tape or compact disc is playing. If the radio tunes to a related network station for an alert announcement, it will return to the original station when the announcement is finished. If the cassette tape or compact disc player is playing, play will stop for the announcement and resume when the announcement is finished.



“MSG” (Message)

When an RDS radio station transmits a text message, “MSG” will be displayed. At this time, touch the “MSG” switch to view the text message. The message display will be canceled if any button that affects the display is pushed. To view the message again, touch the “MSG” switch again. After the entire message has been displayed, the message will disappear.

The RDS audio system has memory to store three 64 character messages. To store a message in memory, touch and hold the “STORE” switch until you hear a beep.

If 3 messages are already stored in memory, the oldest message will be overwritten by the new message.

To recall a radio text messages stored in memory, touch the “RECALL” switch. Touching the “LATEST MESSAGE” will display the most recent message.

If no messages have been stored, or if there are no more messages to be recalled, “RECALL” switch is dimmed. The message display will be canceled if you activate any function that affects the display.

“TYPE” switch

This switch is used for changing the program type (PTY) of RDS stations in all RDS mode. 8 program types are available as listed here.

The following program type names are available.

- ROCK
- EASY LIS
- CLS/JAZZ
- R & B
- INFORM
- RELIGION
- MISC
- ALERT (Emergency message)

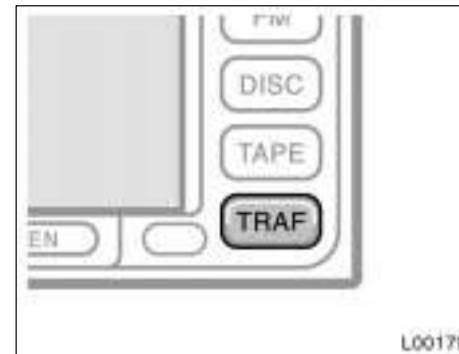
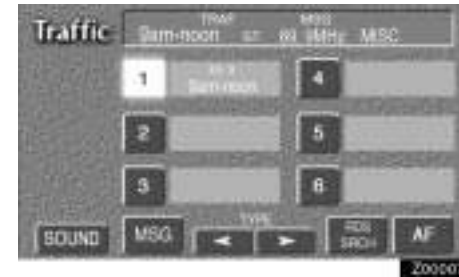

(e) Traffic announcement

“TRAF” button

This button turns the traffic announcement (TA) feature on and off.

Pushing this button turns on, RDS if it was off, and the traffic announcement feature will come on ("TRAF" will appear and start blinking). When the radio is tuned to a traffic station, "TRAF" will stop blinking.

If the current station is not a traffic station, the radio will start a traffic program search in increasing frequency order. During a traffic program search, "TRAF SEEK" will display. If no traffic programs are found, "NOTHING" will display.

If the radio receives a traffic announcement, it will interrupt the cassette player or compact disc mode (if either one is on), adjust the volume to Traffic Announcement level, and broadcast the traffic announcement. During a traffic announcement, "Traffic" will appear on the screen. After traffic announcement is finished, it will return to the previous mode and volume level.

TA volume memory function—The volume level when receiving the traffic announcement is memorized.

When "TA" is received next time, the system compares the volume before "TA" is received and the memorized TA volume and automatically selects the louder volume. However, the range of volume memory is limited: if the volume received previously is less than the minimum, this volume will be used.

You can adjust the volume independently from the memorized TA volume range while receiving a TA station.

Traffic announcement can be canceled by turning RDS off, or pressing the "TRAF" button again.

—Cassette tape player operation

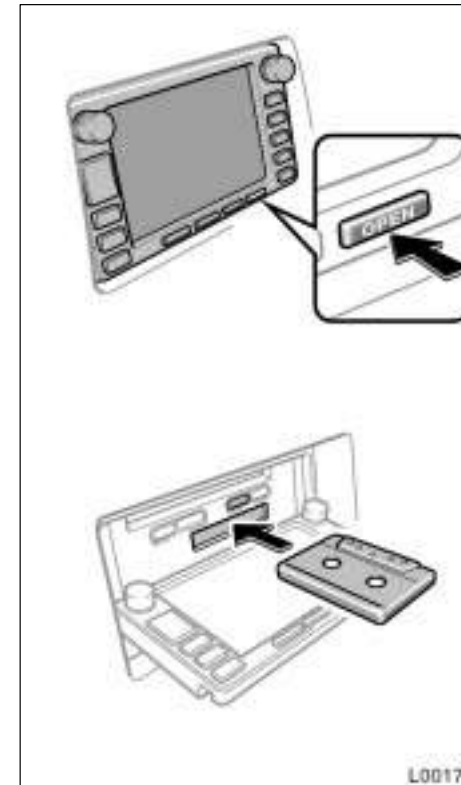

(a) Playing a cassette tape

To insert a cassette tape, push the “OPEN” button to lower the display. Put the cassette tape in the slot with the exposed tape side to the right and lightly push it in.

The player will automatically start when you insert the cassette tape. At this time, “Tape” appears on the screen.

If a metal or chrome equivalent cassette tape is put in the cassette player, the player will automatically adapt to it and “MTL” appears on the screen.

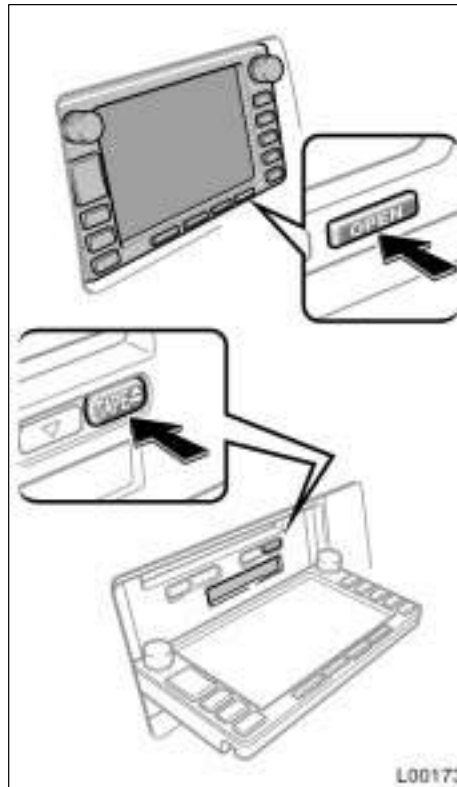

To stop and eject the cassette tape, push the “OPEN” button to lower the display. Push the “TAPE ▲” button.

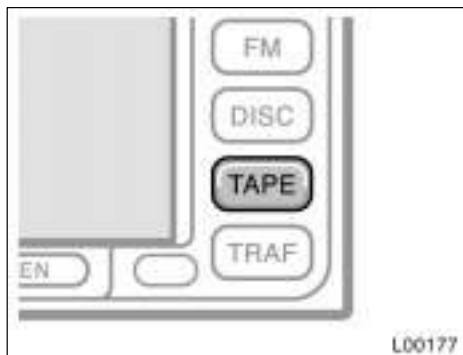

Push the “TAPE” button if a cassette tape is already in the slot.

Dolby Noise Reduction* feature: If you are listening to a tape that was recorded with Dolby* Noise Reduction, touch the  switch on the screen. The symbol is highlighted in green.

The Dolby NR mode reduces tape noise by about 10 dB. For best sound reproduction, play your tapes with the Dolby NR on or off according to the mode used for recording the tape.

To play a tape recorded without Dolby NR, touch the switch once again.

* Dolby noise reduction manufactured under license from Dolby Laboratories Licensing Corporation. “DOLBY” and the double-D symbol  are trademarks of Dolby Laboratories Licensing Corporation.

(b) Manual program selection

Program switch: Touch the “◀|©” switch on the screen to select the other side of a cassette tape. The display indicates which side is currently selected (▲ indicates top side, ▼ indicates bottom side).

Fast forward switch: Touch the “©©” switch on the screen to fast forward a cassette tape. “FF” appears on the screen.

To stop fast forwarding, touch the same switch or push the “TAPE” button.

Rewind switch: Touch the “◀◀” switch on the lower side to rewind a tape. “REW” appears on the screen.

To stop rewinding, touch the same switch or push the “TAPE” button.

Auto-reverse feature: After the cassette player reaches the end of a tape, it automatically reverses and begins to play the other side, regardless of whether the cassette was playing or fast forwarding.

(c) Automatic program selection

“RPT” switch: The repeat feature automatically replays the current program.

Touch the “RPT” switch while the program is playing. When the program ends, it will automatically be rewound and re-played. Touch the switch again to turn off the repeat feature.

There must be at least 5 seconds of blank space between programs for the repeat feature to work correctly.

“SKIP” switch: The skip feature allows you to fast forward past long stretches of blank tape. This is especially useful at the end of cassettes.

Touch the “SKIP” switch. The player will automatically skip any blank portions of 15 seconds or more and play the next program. To cancel it, touch the switch once again.



“SEEK/TRACK” button: The automatic program selection feature allows you to program your cassette player to skip forward or backward to locate the track you want to listen to. You can skip up to 9 programs at a time.

Push the upper side of this button to skip forward. “FF” and the number will appear on the screen. Push the button until the number of programs you want to skip appears on the screen. After that, the player will automatically skip forward.

When the end of the tape is reached, the player automatically reverses sides and resumes normal play.

Push the lower side of this button to skip backward. Push the button until “REW” and the number of programs you want to skip appears on the screen.

- If you set “REW 1”, the player will rewind to the beginning of the current program.
- When counting the number of programs you want to rewind, remember to count the current program as well. For example, if you want to rewind to a program that is two before the program you are listening to, push this button until “REW 3” appears on the screen.

When the beginning of the tape is reached, the player automatically resumes normal play.

There must be at least 5 seconds of blank space between programs for this feature to work correctly.

“RPT”, “SKIP” or Automatic program selection features: These features may not work well with some spoken word, live or classical recordings.

—Compact disc player operation

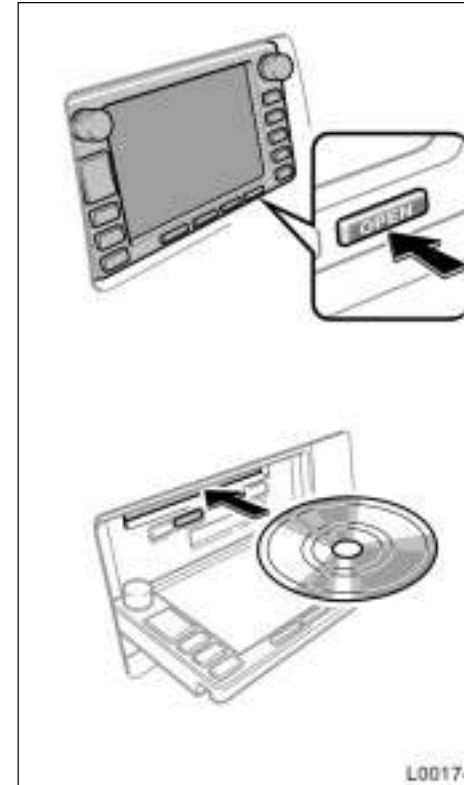

(a) Playing a compact disc

To insert a compact disc, push the “OPEN” button to lower the display. Put the compact disc in the slot with the label side up.

The player will automatically start when you insert the compact disc. At this time, “CD” appears on the screen.

If the label faces down, the disc cannot be played. In this case, “CD ERROR” appears on the screen.

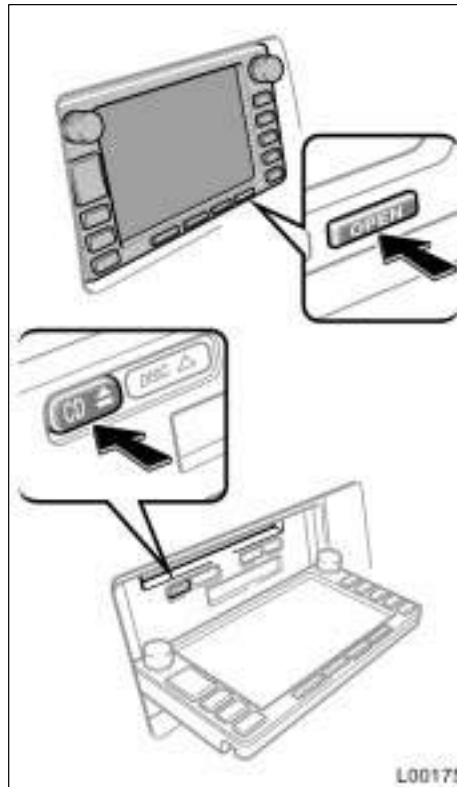

To stop and eject the compact disc, push the “OPEN” button to lower the display. Push the “CD ▲” button.

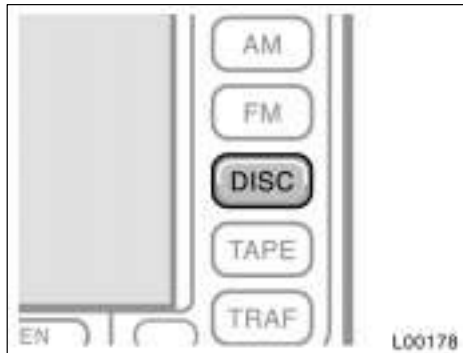

Push the “DISC” button if a compact disc is already loaded in the slot. “CD” appears on the screen.



(b) Selecting a desired track

“SEEK/TRACK” button: Use for a direct access to a desired track.

Push either side of the “SEEK/TRACK” button and hold it until the desired track number appears on the screen. As you release the button, the player will start playing the selected track from the beginning.

Fast forward: Touch the “⏭” switch and hold it to fast forward the disc. When you release the switch, the compact disc player will resume playing from that position.

Reverse: Touch the “⏮” switch and hold it to reverse the disc. When you release the switch, the compact disc player will resume playing.

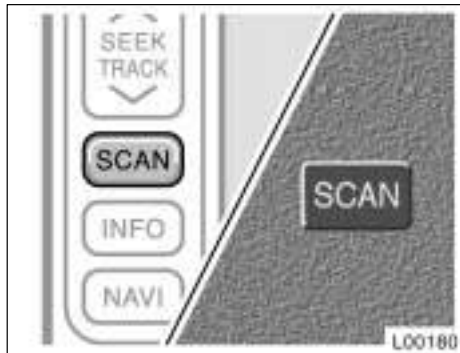

(c) Searching for a desired track

Touch the "SCAN" switch on the screen or push the "SCAN" button.

The compact disc player will play the next track for 10 seconds, then scan again. To select a track, touch the "SCAN" switch on the screen or push the "SCAN" button a second time. If the player reaches the end of the disc, it will continue scanning at track 1.

After all the tracks are scanned in one pass, normal play resumes.

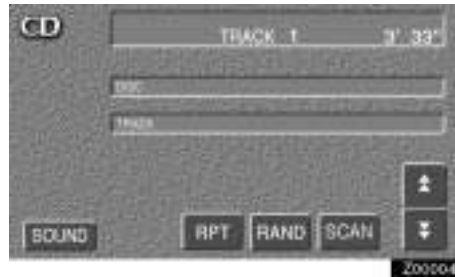

(d) Other compact disc player functions

"RPT" switch: Use it for automatic repeat of the track you are currently listening to.

Touch the switch while the track is playing. When the track is finished, the player will automatically go back to the beginning of the track and play the track again. To cancel it, touch the switch once again.

"RAND" switch: Use it for automatic and random selection.

When the switch is touched, the system selects a track in the disc. To cancel it, touch the switch once again.

(e) If the player malfunctions

If "WAIT" appears on the screen, audio signals of the disc cannot be read or the system has trouble. Push the "CD" button once again.

If the player does not operate, check that the disc surface is not soiled or damaged. If the disc is O.K., the temperature of the player's internal mechanism may be raised because of high external temperature. Remove the disc from the player to cool it.

If the player still does not operate, have it checked by your Toyota dealer.

Car audio system operating hints

NOTICE

To ensure the correct audio system operation:

Be careful not to spill beverages over the audio system.

Do not put anything other than a cassette tape or Compact Disc into the slot.

The use of cellular phone inside or near the vehicle may cause a noise from the speakers of the audio system which you are listening to. However, this does not indicate a malfunction.

RADIO RECEPTION

Usually, a problem with radio reception does not mean there is a problem with your radio—it is just the normal result of conditions outside the vehicle.

For example, nearby buildings and terrain can interfere with FM reception. Power lines or telephone wires can interfere with AM signals. And of course, radio signals have a limited range. The farther you are from a station, the weaker its signal will be. In addition, reception conditions change constantly as your vehicle moves.

Here are some common reception problems that probably do not indicate a problem with your radio:

FM

Fading and drifting stations—Generally, the effective range of FM is about 40 km (25 miles). Once outside this range, you may notice fading and drifting, which increase with the distance from the radio transmitter. They are often accompanied by distortion.

Multi-path—FM signals are reflective, making it possible for two signals to reach your antenna at the same time. If this happens, the signals will cancel each other out, causing a momentary flutter or loss of reception.

Static and fluttering—These occur when signals are blocked by buildings, trees, or other large objects. Increasing the bass level may reduce static and fluttering.

Station swapping—If the FM signal you are listening to is interrupted or weakened, and there is another strong station nearby on the FM band, your radio may tune in the second station until the original signal can be picked up again.

AM

Fading—AM broadcasts are reflected by the upper atmosphere—especially at night. These reflected signals can interfere with those received directly from the radio station, causing the radio station to sound alternately strong and weak.

Station interference—When a reflected signal and a signal received directly from a radio station are very nearly the same frequency, they can interfere with each other, making it difficult to hear the broadcast.

Static—AM is easily affected by external sources of electrical noise, such as high tension power lines, lightning, or electrical motors. This results in static.

CARING FOR YOUR CASSETTE PLAYER AND TAPES

For the best performance for your cassette player and tapes:

Clean the tape head and other parts regularly.

- A dirty tape head or tape path can decrease sound quality and tangle your cassette tapes. The easiest way to clean them is by using a cleaning tape. (A wet type is recommended.)

Use high-quality cassettes.

- Low-quality cassette tapes can cause many problems, including poor sound, inconsistent playing speed, and constant auto-reversing. They can also get stuck or tangled in the cassette player.
- Do not use a cassette if it has been damaged or tangled or if its label is peeling off.
- Do not leave a cassette in the player if you are not listening to it, especially if it is hot outside.
- Store cassettes in their cases and out of direct sunlight.
- Avoid using cassettes with a total playing time longer than 100 minutes (50 minutes per side). The tape used in these cassettes is thin and could get stuck or tangled in the cassette player.



CARING FOR YOUR COMPACT DISC PLAYER AND DISCS

- Use only compact discs labeled as shown above. CD-R (CD-Recordable), CD-RW (CD-Re-writable) and personal computer use CD-ROMs may not be playable on your compact disc player.
 - Your compact disc player is intended for use with 12 cm (4.7 in.) discs only.
 - Extremely high temperatures can keep your compact disc player from working. On hot days, use the air conditioning to cool the vehicle interior before you listen to a disc.
- Bumpy roads or other vibrations may make your compact disc player skip.
 - If moisture gets into your compact disc player, you may not hear any sound even though your compact disc player appears to be working. Remove the disc from the player and wait until it dries.

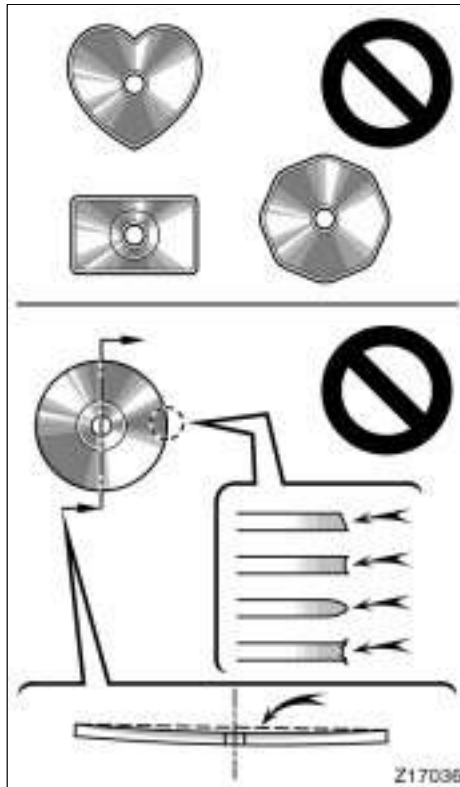

- Your automatic changer or compact disc player cannot play special shaped or low-quality compact discs such as those shown here. Do not use them as the changer or player could be damaged.
- Handle compact discs carefully, especially when you are inserting them. Hold them on the edge and do not bend them. Avoid getting fingerprints on them, particularly on the shiny side.
- Dirt, scrapes, warping, pin holes, or other disc damage could cause the player to skip or to repeat a section of a track. (To see a pin hole, hold the disc up to the light.)
- Remove discs from the compact disc player when you are not listening to them. Store them in their plastic cases away from moisture, heat, and direct sunlight.

To clean a compact disc: Wipe it with a soft, lint-free cloth that has been dampened with water. Wipe in a straight line from the center to the edge of the disc (not in circles). Dry it with another soft, lint-free cloth. Do not use a conventional record cleaner or anti-static device.

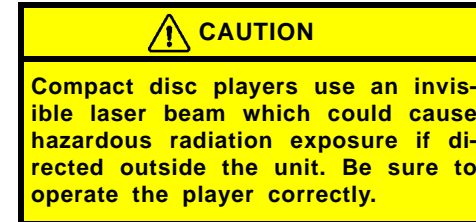

PASSPORT

TO PERFORMANCE



2002

Scheduled Maintenance Guide

Regular maintenance is essential to obtaining the highest level of performance from your Toyota. It can also enhance your vehicle's resale value. This booklet is designed to help you make sure your vehicle receives proper and timely maintenance. It includes factory-recommended maintenance guidelines along with information on the extensive maintenance and repair support available through Toyota and your dealership.

With proper maintenance and care, your vehicle will run better, last longer and deliver more economical performance. Follow the recommendations in this *Scheduled Maintenance Guide* and you'll enjoy reliability and peace of mind from your Toyota for many years to come.

Documenting Your Investment

To help you verify that you've invested in proper maintenance, each maintenance log in this booklet includes space for your Toyota dealership to certify that you obtained Genuine Toyota Service for your vehicle. The dealership will mark the dealer service verification area with the following stamp (which may be customized with the dealership's name):



Additional Maintenance

In addition to scheduled maintenance, your Toyota requires ongoing general maintenance such as fluid checks and visual inspections. These procedures are explained in the "Vehicle Maintenance and Care" section of the *Owner's Manual*. Be sure to perform these procedures regularly to ensure the most trouble-free operation of your vehicle.

Maintenance Records

Maintaining your vehicle according to the recommendations in this booklet is required to ensure that your warranty coverage remains intact. You should keep detailed records of vehicle maintenance, including date of service, mileage at time of service and a description of service and/or parts installation performed. The scheduled maintenance log in this booklet can help you document this information. If you sell your vehicle, be sure to give your maintenance records to the new owner.

Toyota will not deny a warranty claim solely because you do not have records to show that you maintained your vehicle. However, damage or failures caused by lack of proper maintenance are not covered under warranty.

Maintenance Providers

Maintenance and repair services may be performed by you or by any automotive service provider you choose. Toyota will not deny a warranty claim solely because you used a service provider other than a Toyota dealership for maintenance and repairs. However, damage or failures caused by improper maintenance or repairs are not covered under warranty.

Dealer-Recommended Maintenance

Your dealer may recommend more frequent maintenance intervals or more maintenance services than those listed in the scheduled maintenance log. These additional services are not required to maintain your warranty coverage. Ask your dealer for an explanation of any recommended maintenance not included in the scheduled maintenance log.

For a complete description of Toyota warranty coverages, see the booklet entitled *2002 Owner's Warranty Information* located in your vehicle's glove box.

TABLE OF CONTENTS

TOYOTA MAINTENANCE AND REPAIR SUPPORT

Toyota Dealership Service	2
Toyota Express Lube	3
Genuine Toyota Parts and Accessories	4
Lifetime Guarantee Replacement Parts	6
TrueStart™ Batteries	7
Collision Repair Parts	8
Do-It-Yourself Products	10
Toyota Parts Centers	12
Toyota Service Manuals	13
Service Agreements and Pre-Paid Maintenance	14

GENERAL MAINTENANCE INFORMATION

Determining Your Vehicle's Maintenance Needs	16
Explanation of Maintenance Items	20
Vehicle Identification	23

SCHEDULED MAINTENANCE LOGS

Cars and Sienna	24
SUVs and Trucks	40

WWW.MANUALS.WS



To ensure that your vehicle receives first-quality service and factory-authorized parts, Toyota recommends having maintenance performed by an authorized Toyota dealership.

Toyota dealership technicians are experts in the maintenance and repair of Toyota vehicles. They stay current on the latest service information through Toyota technical bulletins, service publications and training courses. Many are also certified through the Toyota Certification Program, which requires completion of Toyota's specialized, state-of-the-art training as well as rigorous exams through both Toyota and the National Institute for Automotive Service Excellence (ASE). Feel free to ask any Toyota dealership to show you its technicians' credentials.

You can be confident you're getting the best possible service for your vehicle when you take it to a Toyota dealership. Why trust your investment to anything but a team of highly qualified Toyota specialists?



WWW.MANUALS.WS

With Toyota Express Lube, you get the convenience of a quick-lube shop and the quality and expertise you count on when you go to a Toyota dealership. You also get the Express Lube guarantee: in 29 minutes or less from the time of write-up, a complete oil-and-filter change using Genuine Toyota Parts along with a multi-point inspection, or the next one is free.



You never need an appointment to use Express Lube at a Toyota dealership. You'll be waited on promptly and your oil-and-filter change will be done while you wait. Express Lube also delivers outstanding value, since the service is priced very competitively with franchised quick-lube centers.

More than 625 Toyota dealerships now offer Express Lube service. Call (800)331-4331 for the Express Lube location nearest you.



WWW.MANUALS.WS

Genuine Toyota Parts

To safeguard the quality, reliability and value of your vehicle, Toyota recommends using only Genuine Toyota Parts for maintenance and repairs. Like all Toyota products, Genuine Toyota Parts are built to the highest standards of quality and performance. They are also designed to fit your vehicle's exact specifications.

Your Toyota dealership maintains an extensive inventory of Genuine Toyota Parts to meet your vehicle service needs. And because it is linked electronically to Toyota's Parts Distribution Centers, the dealership has quick access to any parts it may not have in stock.



When installed by a Toyota dealership, Genuine Toyota Parts (with the exception of batteries) are warranted for 12 months from date of installation, regardless of mileage, or the remainder of any applicable New Vehicle Limited Warranty, whichever provides greater coverage. Selected Toyota replacement parts are covered by a lifetime warranty (see page 6). Non-Genuine Toyota Parts – and any damage or failures resulting from their use – are not covered by any Toyota warranty.

Genuine Toyota Remanufactured Parts

Toyota also offers the highest level of quality, fit and performance in selected remanufactured parts. These parts enable you to economically maintain and repair your vehicle with Genuine Toyota quality. They also feature the same warranty coverage as new Genuine Toyota Parts. Available parts range from alternators to water pumps; ask your Toyota dealership for a complete list of remanufactured product offerings.

For all your maintenance and repair needs, insist on the quality and peace of mind you only get with Genuine Toyota Parts.



Genuine Toyota Accessories

When you want to personalize your Toyota vehicle, be sure to do it without sacrificing Toyota quality and performance. How? By choosing Genuine Toyota Accessories.

Only Genuine Toyota Accessories are designed and manufactured specifically for Toyota vehicles. In addition, they undergo rigorous testing to ensure first-rate quality, precise fit and long-term durability. Aftermarket accessories don't always meet these same high standards.

The quality of Genuine Toyota Accessories is also backed by the integrity of a Toyota warranty. Coverage is for 12 months from date of purchase, regardless of mileage. If an accessory is installed during the New Vehicle Limited Warranty period (36 months/36,000 miles), coverage is for the remainder of that period. See your dealer for details. And remember that Genuine Toyota Accessories can only be purchased from an authorized Toyota dealership.

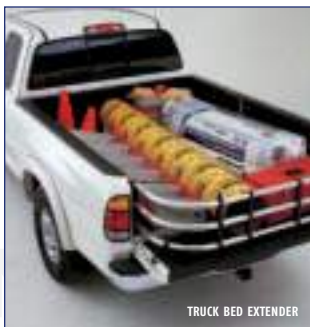

Toyota's confidence in its products and commitment to customer satisfaction are demonstrated by outstanding warranty coverage – including a lifetime guarantee on replacement mufflers, exhaust pipes, shock absorbers, struts and strut cartridges. When purchased at and installed by a Toyota dealership, these Genuine Toyota Parts are guaranteed to the original purchaser for the life of the vehicle. This includes coverage for parts and labor.

Compare the guarantees offered on these parts by aftermarket repair shops; many don't offer the extensive coverage Toyota does. And remember that only Genuine Toyota Parts are manufactured to your vehicle's exact specifications. So don't compromise: When replacement time comes, count on your Toyota dealer for quality, performance and the peace of mind that comes with a factory-backed lifetime guarantee.

Compare Lifetime Guarantee Coverage

Toyota vs. Others		
	Toyota	Others*
• Muffler	Yes	Yes
- Labor to replace	Yes	Yes
• Tail Pipe	Yes	No
- Labor to replace	Yes	No
• Exhaust Pipes	Yes	No
- Labor to replace	Yes	No



Theirs

**We Cover
The Muffler,
Pipes And
Labor Too!**



Ours

* Some muffler shops—read their fine print and compare.

WWW.MANUALS.WS

For complete details of the Toyota Lifetime Guarantee, see an authorized Toyota dealer.

The reputation for quality and reliability was likely a key reason behind your decision to buy a Toyota. That overall quality is present in each of the components of your car or truck, including the battery. When it's time for a replacement, your Toyota dealer is the only place to find a battery with the power to start and operate your vehicle like new.

To maintain the original performance designed into your Toyota, a replacement battery must meet Toyota's specifications for Cold Cranking Amps (CCA) and Reserve Capacity (RC). RC, a specification often not met by aftermarket brands, supplies the power you need during high-demand conditions such as driving in heavy traffic. RC is also what gives you the power to operate electronic accessories with the engine off. By choosing a TrueStart™ you can be confident your battery will meet your needs, every day.

Warranty coverage is another important consideration when selecting a battery. TrueStart™ batteries feature a free replacement period of 24 months or the remainder of the Toyota New Vehicle Limited Warranty, whichever is longer. Following the free replacement period, warranty coverage is prorated from months 25–84 in two simple tiers. See your Toyota dealer for more details.

Don't entrust your Toyota's performance to anything less than the best: Genuine Toyota TrueStart™ Batteries.

WARNING: Battery posts, terminals and related accessories contain lead and lead compounds, chemicals known to the State of California to cause cancer and reproductive harm. *Wash hands after handling.*



Insist on Genuine Toyota Quality

If you're involved in a collision, you want your vehicle to be returned to its pre-accident condition when repaired. To maintain your Toyota's value, it's important to make sure it is repaired with Genuine Toyota Parts. Some repair shops and insurance companies may suggest using imitation or used salvage parts to save money. However, these parts do not meet Toyota's high standards for quality, fit and corrosion resistance. In addition, imitation and used salvage parts are not covered by any Toyota warranty (see box below).

To maintain the appearance, performance and safety of your Toyota, make sure only Genuine Toyota Parts are used for collision repairs. Protect your investment – insist on Genuine Toyota quality.

Toyota warranty coverage remains intact when vehicle repairs are completed with Genuine Toyota Parts. Toyota warranties do not cover imitation or used salvage parts or any damage or failures caused by the use of such parts.

In Case of Accident, Be an Informed Owner

Toyota believes customers have the right to choose the types of parts used in the repair of their vehicles. That's why Toyota supports full disclosure by repair shops and insurance companies regarding parts used for collision repair. The following information is provided to help you understand the differences in the types of parts that could be used in the repair of your vehicle.

General Information

"Collision repair parts" or "replacement crash parts" are the parts typically replaced during the repair of a vehicle that has been damaged in a collision. These parts include exterior sheet metal such as fenders, hoods, doors and related components; and plastic components such as bumper covers and lamp assemblies.

Warranty Coverage

Warranties for collision repair parts are provided by the manufacturer or distributor of the parts. Warranty coverage varies. Your insurance company or collision repair facility should provide you with written warranty statements for all parts used in the repair of your vehicle.

Types of Collision Repair Parts

New original-equipment manufacturer (OEM): Parts that are made by the vehicle manufacturer or one of its licensees and distributed through its normal channels. These parts maintain the manufacturer's vehicle warranty.

Aftermarket or imitation: Parts that are made by companies other than the vehicle manufacturer or its licensees.

Recycled or used salvage: Used parts and assemblies that have been removed from another vehicle. There are no systems in place to regulate the quality or safety of these parts.

Remanufactured: Parts that have been returned to like-new condition through repair, refurbishing or rebuilding.

Due to the critical nature of Supplemental Restraint Systems (also known as air bags), Toyota does not support the use of imitation or used parts for their repair. Only new Genuine Toyota Parts should be used to repair or replace Supplemental Restraint Systems.

When it's time to replace key wear items on your vehicle, don't settle for less than Genuine Toyota Parts. Available exclusively through Toyota dealerships, Genuine Toyota Parts meet the highest standards of quality and performance and are built to exact factory specifications. Here are a few of your vehicle's components that are particularly subject to wear and some benefits of replacing them with Genuine Toyota Parts.

Genuine Toyota Platinum and Iridium Spark Plugs*

- Designed to last at least 60,000 miles.
- Provide the maximum spark required by Toyota's high-compression engines.
- Resist fouling and misfires for more efficient combustion and better fuel economy.

Genuine Toyota Brake Pads

- Friction materials selected for optimum performance when matched with Toyota brake drums or rotors.
- Precision-machined backing plates allow pads to move freely within the calipers for smooth, efficient braking.

Genuine Toyota Wiper Inserts

- Cut to match the exact length and shape of your vehicle's wiper blades for a proper and secure fit.
- Constructed of compression-molded natural rubber – not synthetic – for superior wiping performance.



* Always use the right spark plugs for your engine. The wrong plugs can have a negative impact on fuel economy and overall engine performance.

Genuine Toyota Chemicals

Toyota offers a complete line of products to help you keep your Toyota looking and running like new. To safeguard your vehicle's appearance, you'll find everything from fabric spot remover and glass cleaner to liquid car wash and touch-up paint. When it's time to get under the hood (or under the car), products such as fuel injector cleaner, brake fluid and silicone spray will help you get the job done. All of these products are formulated specifically for use with Toyota vehicles, so you can be confident you're giving your vehicle the best care possible, inside and out.

Genuine Toyota Antifreeze Coolant

Genuine Toyota Long Life Antifreeze Coolant is the same high-quality, factory-fill product found in all new Toyotas. You'll know it by its distinctive red color. It provides maximum protection and durability without the use of harmful silicates. And because it's compatible with non-metallic materials, it helps extend the life of water-pump seals. Don't trust your engine to anything less than the best: Genuine Toyota Long Life Antifreeze Coolant.

Genuine Toyota Motor Oil

Your Toyota's engine features highly advanced technology to ensure superior performance, reliability and fuel economy. Genuine Toyota Motor Oil is formulated with a special combination of lube-base stocks and an additive blend to maximize the benefits of this technology. Make sure you're getting the most out of your engine by always putting the best into it: Genuine Toyota Motor Oil.



WWW.MANUALS.WS

If you plan to perform your own maintenance or repairs on your Toyota, be sure to check out your nearby Toyota Parts Center (TPC). More than 535 Toyota dealerships now have a TPC, which is an in-dealership parts store offering a wide selection of automotive products. All TPCs feature a complete line of Genuine Toyota maintenance parts and car-care products for do-it-yourselfers.

In addition to Toyota maintenance and repair products, TPCs offer free technical advice to Toyota owners who want to service their own vehicles. You'll also find model-specific parts application guides and how-to brochures covering most common maintenance jobs. Both are provided to customers free of charge.

Toyota Parts Centers are open during regular dealership hours; many also have extended evening and weekend hours. If you're a do-it-yourselfer, stop by and experience the service, selection and value offered by your local TPC.



WWW.MANUALS.WS

If you'll be doing some of your own maintenance and repair work on your vehicle, a Toyota service manual will be one of your most valuable tools. Toyota offers three types of manuals to assist do-it-yourselfers. To order any of the following manuals, call Toyota's service publications department at (800)622-2033.

Vehicle Repair Manual

This is the same manual used by professional technicians in Toyota dealerships throughout the United States. It is fully illustrated and includes maintenance and repair procedures for all vehicle mechanical systems. It also includes instructions for vehicle tune-ups.

Electrical Systems Manual

This manual provides detailed wiring diagrams for each electrical system in your vehicle, along with troubleshooting tips and repair procedures.

Automatic Transmission/Transaxle Repair Manual

This manual includes complete procedures for overhauling the automatic transmission/transaxle of your vehicle.

For information on basic do-it-yourself maintenance items, see the "Vehicle Maintenance and Care" and "Do-It-Yourself Maintenance" sections of your *Owner's Manual*.

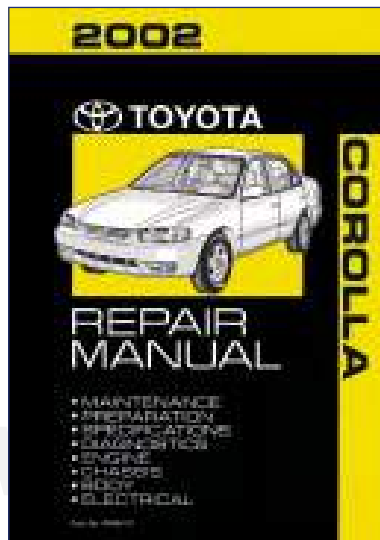

Extended Service Coverage

Toyota vehicle service agreements provide protection against unexpected repairs for mechanical breakdown of covered components beyond the factory warranty.* They also protect you from increases in the cost of covered repairs. In addition, many plans include benefits such as towing, substitute transportation and travel protection with lodging and meals.

Because they are factory-backed, Toyota service agreements are accepted at all Toyota dealerships in the United States and Canada. That means repairs are made only by factory-trained technicians using Genuine Toyota Parts.

Toyota Financial Services offers several levels of service agreement coverage, each with a variety of time and mileage options.** Your Toyota dealer can help you select the coverage that best meets your needs.

Pre-Paid Maintenance

An excellent way to make sure your Toyota receives the recommended maintenance – and to protect yourself from increases in vehicle service costs – is to pay for maintenance services in advance.

Toyota Auto Care pre-paid maintenance plans are available for both new and used vehicles. Benefits include oil-and-filter changes, lubrication of key chassis parts and a 19-point vehicle inspection at each service interval. In addition, you receive 24-hour roadside assistance, timed service reminders and a computerized history of each service visit. The Premium Plan (available for new vehicles) also includes tire rotations and factory-recommended maintenance at service intervals of 15,000, 30,000 and 45,000 miles.

Toyota Auto Care plans offer two coverage levels as well as several options for service intervals, time and mileage. Ask your Toyota dealer to help you select the options that are best for you.



* Vehicle service agreements are offered by Toyota Motor Insurance Services, Inc., dba Toyota Motor Services Company in certain states. In Florida, offered by Toyota Motor Insurance Company.

** Toyota Financial Services is a service mark of Toyota Motor Insurance Services, Inc.

Determining the Proper Maintenance Interval

Depending on your circumstances, you should obtain maintenance for your Toyota every 5,000 miles or every 7,500 miles. Follow these guidelines to determine which interval to use.

5,000-Mile Intervals

Use 5,000-mile intervals if you primarily operate your vehicle under any of the following conditions:

- Driving on unpaved or dusty roads.
- Towing a trailer or using a car-top carrier.
- Repeated trips of less than five miles in temperatures below freezing.

7,500-Mile Intervals

Use 7,500-mile intervals if you primarily operate your vehicle under conditions other than those listed above.

Following the Maintenance Log Charts

The scheduled maintenance log identifies the maintenance required at each mileage interval and corresponding time interval based on mileage of 1,250 miles per month. If you drive more than 1,250 miles per month, you should obtain maintenance at the indicated mileage interval rather than the indicated time interval.

The maintenance log charts are colored differently for Cars/Sienna and SUVs/Trucks. Be sure to follow the appropriate charts for your vehicle.

Cars and Sienna

If you choose 5,000-mile intervals, follow the instructions below the light blue bars in the "Cars and Sienna" charts, such as this one:

5,000 Miles or 4 Months

If you choose 7,500-mile intervals, follow the instructions below the dark blue bars in the "Cars and Sienna" charts, such as this one:

7,500 Miles or 6 Months

At 15,000-mile increments, the 5,000-mile and 7,500-mile intervals coincide. Therefore, the colored bars appear together, as in this example:

15,000 Miles or 12 Months

15,000 Miles or 12 Months

SUVs and Trucks

If you choose 5,000-mile intervals, follow the instructions below the gold bars in the "SUVs and Trucks" charts, such as this one:

5,000 Miles or 4 Months

If you choose 7,500-mile intervals, follow the instructions below the dark blue bars in the "SUVs and Trucks" charts, such as this one:

7,500 Miles or 6 Months

At 15,000 miles, the 5,000-mile and 7,500-mile intervals coincide. Therefore, the colored bars appear together, as in this example:

15,000 Miles or 12 Months

15,000 Miles or 12 Months

Special Operating Conditions

In addition to standard maintenance items, the scheduled maintenance log indicates services that should be performed on vehicles that are driven under especially demanding conditions. Specific conditions require specific services, as indicated below. The scheduled maintenance log indicates at which mileage/time intervals each service should be performed.

You should perform these additional maintenance services if you drive primarily under any of the conditions noted. If you drive only occasionally under these conditions, it is not necessary to perform the additional services.

Driving on Rough, Muddy or Snow-Melted Roads

- Inspect ball joints and dust cover
- Inspect brake linings/drums and brake pads/discs
- Inspect drive shaft boots
- Inspect nuts and bolts on chassis and body
- Inspect steering linkage and boots
- Lubricate propeller shaft and re-torque bolt*
- Re-torque drive shaft bolt*
- Rotate tires

Driving on Salt-Covered Roads

- Lubricate propeller shaft and re-torque bolt*

Driving on Unpaved or Dusty Roads

- Inspect brake linings/drums and brake pads/discs
- Inspect or change engine air filter
- Lubricate propeller shaft and re-torque bolt*
- Replace air conditioning filter*

Extensive Idling or Low-Speed Driving for Long Distances

- Inspect brake linings/drums and brake pads/discs

Towing a Trailer or Using a Camper or Car-Top Carrier

- Inspect brake linings/drums and brake pads/discs
- Inspect nuts and bolts on chassis and body
- Lubricate propeller shaft and re-torque bolt*
- Replace differential oil
- Replace transfer case oil*
- Replace transmission fluid or oil

For Sequoia Only

Replace the rear differential oil every 5,000 miles on vehicles used for extended-duration trailer towing.

Off-Road Maintenance

If you own a Land Cruiser or a four-wheel-drive RAV4, Sequoia, Tacoma, Tundra or 4Runner, you should check the following items daily whenever you drive off-road through deep sand, mud or water:

- Brake lines and hoses
- Brake linings/drums and brake pads/discs
- Differential oil
- Drive shaft bearings (Land Cruiser)
- Engine air filter
- Steering linkage and boots
- Transfer case oil
- Transmission fluid or oil
- Wheel bearings (Land Cruiser)

For all four-wheel drive vehicles except RAV4, you should also lubricate the propeller shafts daily.

* Applies to selected models. See the scheduled maintenance log for details.

The following descriptions are provided to give you a better understanding of the maintenance items that should be performed on your vehicle. The scheduled maintenance log indicates at which mileage/time intervals each item should be performed. Please note that many maintenance items should be performed only by a qualified technician.

For further information on maintenance items you can perform yourself, see the "Vehicle Maintenance and Care" and "Do-It-Yourself Maintenance" sections of your *Owner's Manual*.

Air Conditioning Filter

Replace at specified intervals.

Automatic Transmission Fluid or Manual Transmission Oil

Replace at specified intervals. When performing inspections, check each component for signs of leakage. If you discover any leakage, have it repaired by a qualified technician immediately.

Ball Joints and Dust Covers

Check the suspension and steering linkage ball joints for looseness and damage. Check all dust covers for deterioration and damage. Replace any deteriorated or damaged parts. A qualified technician should perform these operations.

Brake Lines and Hoses

Visually inspect for proper installation. Check for chafing, cracks, deterioration and signs of leakage. Replace any deteriorated or damaged parts. A qualified technician should perform these operations.

Brake Linings/Drums and Brake Pads/Disks

Check the brake linings (shoes) and drums for scoring, burning, fluid leakage, broken parts and excessive wear. Check the pads for excessive wear and the discs for runout, excessive wear and fluid leakage. Replace any deteriorated or damaged parts. A qualified technician should perform these operations.

Charcoal Canister (CA, MA and NY vehicles)

Check for internal damage and clogging. If necessary, clean with compressed air or replace. A qualified technician should perform these operations.

Differential Oil

Replace at specified intervals. When performing inspections, check each component for signs of leakage. If you discover any leakage, have it repaired by a qualified technician immediately.

Drive Belts

Inspect for cracks, excessive wear and oiliness. Check the belt tension and adjust if necessary. Replace the belts if they are damaged.

Drive Shaft Boots

Check the drive shaft boots and clamps for cracks, deterioration and damage. Replace any deteriorated or damaged parts and, if necessary, repack the grease. Selected models also require periodic inspection of the drive shaft bolt for proper torque. A qualified technician should perform these operations.

Engine Air Filter

Replace at specified intervals. When performing inspections, check for damage, excessive wear and oiliness, and replace if necessary.

Engine Coolant

Drain and flush the cooling system and refill with an ethylene-glycol type coolant. A qualified technician should perform this operation.

Engine Oil and Oil Filter

Replace the oil filter and drain and refill the engine oil at specified intervals. For recommended oil grade and viscosity, refer to the *Owner's Manual*.

Engine Valve Clearance

Inspect for excessive lifter noise and engine vibration and adjust if necessary. A qualified technician should perform this operation.

Exhaust Pipes and Mountings

Visually inspect the exhaust pipes, muffler and hangers for cracks, deterioration and damage. Start the engine and listen carefully for any exhaust gas leakage. Tighten connections or replace parts as necessary.

Fuel Lines and Connections, Fuel Tank Band and Fuel Tank Vapor Vent System Hoses

Visually inspect for corrosion, damage, cracks and loose or leaking connections. Tighten connections or replace parts as necessary.

Fuel Tank Cap Gasket

Visually inspect for cracks, deterioration and damage and replace if necessary.

Nuts and Bolts on Chassis and Body

Re-tighten the seat-mounting bolts and front/rear suspension member retaining bolts to specified torque.

Propeller Shaft

Lubricate the propeller shaft spiders and slide yokes with lithium-base chassis grease and the double cardan joint with molybdenum-disulfide lithium-base chassis grease, and re-torque the bolt. Only a qualified technician should re-torque the bolt.

Spark Plugs

Replace at specified intervals. Install new plugs of the same type as originally equipped. A qualified technician should perform this operation.

Steering Gear Box

Inspect for signs of leakage. If you discover any leakage, have it repaired immediately by a qualified technician.

Steering Linkage and Boots

With the vehicle stopped, check for excessive freeplay in the steering wheel. Inspect the linkage for bending and damage and the dust boots for deterioration, cracks and damage. Replace any damaged parts. A qualified technician should perform these operations.

Timing Belt

Replace every 90,000 miles. A qualified technician should perform this operation.

Tire Rotation

Tires should be rotated according to the instructions in the *Owner's Manual*. When rotating tires, check for damage and uneven wear. Replace if necessary.

Transfer Case Oil

Replace at specified intervals. When performing inspections, check for signs of leakage. If you discover any leakage, have it repaired by a qualified technician immediately.

Wheel Bearing and Drive Shaft Bearing Grease

Repack the wheel bearings with wheel bearing grease and the front drive shaft bearings with molybdenum-disulfide lithium-base chassis grease. A qualified technician should perform these operations.

WWW.MANUALS.WS

Model _____

In-service date _____

Selling dealership _____

Key number _____

Body style _____

Mileage at delivery _____

Selling dealership phone number _____

Vehicle Identification Number _____

WWW.MANUALS.WS

5,000-Mile Maintenance Intervals

7,500-Mile Maintenance Intervals

To determine the appropriate maintenance interval for your vehicle, see page 16.

5,000 Miles or 4 Months

- Replace engine oil and oil filter

Additional Maintenance Items for Special Operating Conditions:¹

- Inspect the following:
 - ___ Ball joints and dust covers
 - ___ Brake linings/drums and brake pads/discs
 - ___ Drive shaft boots
 - ___ Engine air filter
 - ___ Nuts and bolts on chassis and body
 - ___ Steering linkage and boots
- Rotate tires (except MR2 Spyder)

DEALER SERVICE VERIFICATION:

DATE:

MILEAGE:

10,000 Miles or 8 Months

- Replace engine oil and oil filter

Additional Maintenance Items for Special Operating Conditions:¹

- Inspect the following:
 - ___ Ball joints and dust covers
 - ___ Brake linings/drums and brake pads/discs
 - ___ Drive shaft boots
 - ___ Engine air filter
 - ___ Nuts and bolts on chassis and body
 - ___ Steering linkage and boots
- Replace air conditioning filter (Avalon, Camry)
- Rotate tires (except MR2 Spyder)

DEALER SERVICE VERIFICATION:

DATE:

MILEAGE:

7,500 Miles or 6 Months

- Replace engine oil and oil filter
- Rotate tires (except MR2 Spyder)

DEALER SERVICE VERIFICATION:

DATE:

MILEAGE:

15,000 Miles or 12 Months

15,000 Miles or 12 Months

- Replace engine oil and oil filter
- Replace air conditioning filter (Avalon, Camry)²
- Rotate tires (except MR2 Spyder)
- Inspect the following:

<input type="checkbox"/> Ball joints and dust covers	<input type="checkbox"/> Exhaust pipes and mountings
<input type="checkbox"/> Brake lines and hoses	<input type="checkbox"/> Steering gear box
<input type="checkbox"/> Brake linings/drums and brake pads/discs	<input type="checkbox"/> Steering linkage and boots
<input type="checkbox"/> Differential oil ³	
<input type="checkbox"/> Drive shaft boots	

Additional Maintenance Items for Special Operating Conditions:¹

- Inspect automatic transmission fluid (Avalon, Camry, Camry Solara, Corolla, Sienna)
- Inspect differential oil⁴
- Inspect engine air filter
- Inspect nuts and bolts on chassis and body

DEALER SERVICE VERIFICATION:

DATE:

MILEAGE:

¹ Specific services apply to specific operating conditions. See pages 18–19 for details.

² Do not replace if replaced at 10,000 miles/8 months.

³ Applies to Corolla with A131L automatic transmission.

⁴ Applies to Avalon, Corolla and Sienna models with automatic transmission.

5,000-Mile Maintenance Intervals

7,500-Mile Maintenance Intervals

To determine the appropriate maintenance interval for your vehicle, see page 16.

20,000 Miles or 16 Months

- Replace engine oil and oil filter

Additional Maintenance Items for Special Operating Conditions:¹

- Inspect the following:
 - ___ Ball joints and dust covers
 - ___ Brake linings/drums and brake pads/discs
 - ___ Drive shaft boots
 - ___ Engine air filter
 - ___ Nuts and bolts on chassis and body
 - ___ Steering linkage and boots
- Replace air conditioning filter (Avalon, Camry)
- Rotate tires (except MR2 Spyder)

DEALER SERVICE VERIFICATION:

DATE:

MILEAGE:

25,000 Miles or 20 Months

- Replace engine oil and oil filter

Additional Maintenance Items for Special Operating Conditions:¹

- Inspect the following:
 - ___ Ball joints and dust covers
 - ___ Brake linings/drums and brake pads/discs
 - ___ Drive shaft boots
 - ___ Engine air filter
 - ___ Nuts and bolts on chassis and body
 - ___ Steering linkage and boots
- Rotate tires (except MR2 Spyder)

DEALER SERVICE VERIFICATION:

DATE:

MILEAGE:

22,500 Miles or 18 Months

- Replace engine oil and oil filter
- Rotate tires (except MR2 Spyder)

DEALER SERVICE VERIFICATION:

DATE:

MILEAGE:

30,000 Miles or 24 Months

30,000 Miles or 24 Months

- Replace engine air filter
- Replace engine coolant
- Replace engine oil and oil filter
- Replace air conditioning filter (Avalon, Camry)
- Replace spark plugs (ECHO)²
- Rotate tires (except MR2 Spyder)
- Inspect the following:
 - Ball joints and dust covers
 - Brake lines and hoses
 - Brake linings/drums and brake pads/discs
 - Differential oil
 - Drive shaft boots
 - Exhaust pipes and mountings
 - Fuel lines and connections, fuel tank band and fuel tank vapor vent system hoses
 - Fuel tank cap gasket
 - Steering gear box
 - Steering linkage and boots
 - Transmission fluid or oil

Additional Maintenance Items for Special Operating Conditions:¹

- Inspect nuts and bolts on chassis and body
- Replace automatic transmission fluid (Avalon, Camry, Camry Solara, Corolla, Sienna)
- Replace differential oil³
- Replace manual transmission oil

DEALER SERVICE VERIFICATION:

DATE:

MILEAGE:

¹ Specific services apply to specific operating conditions. See pages 18–19 for details.

² Required under the terms of the Emission Control Warranty.

³ Applies to all models with manual transmission and Avalon, Corolla and Sienna models with automatic transmission.

5,000-Mile Maintenance Intervals

7,500-Mile Maintenance Intervals

To determine the appropriate maintenance interval for your vehicle, see page 16.

35,000 Miles or 28 Months

- Replace engine oil and oil filter

Additional Maintenance Items for Special Operating Conditions:¹

- Inspect the following:
 - ___ Ball joints and dust covers
 - ___ Brake linings/drums and brake pads/discs
 - ___ Drive shaft boots
 - ___ Engine air filter
 - ___ Nuts and bolts on chassis and body
 - ___ Steering linkage and boots
- Rotate tires (except MR2 Spyder)

DEALER SERVICE VERIFICATION:

DATE:

MILEAGE:

40,000 Miles or 32 Months

- Replace engine oil and oil filter

Additional Maintenance Items for Special Operating Conditions:¹

- Inspect the following:
 - ___ Ball joints and dust covers
 - ___ Brake linings/drums and brake pads/discs
 - ___ Drive shaft boots
 - ___ Engine air filter
 - ___ Nuts and bolts on chassis and body
 - ___ Steering linkage and boots
- Replace air conditioning filter (Avalon, Camry)
- Rotate tires (except MR2 Spyder)

DEALER SERVICE VERIFICATION:

DATE:

MILEAGE:

37,500 Miles or 30 Months

- Replace engine oil and oil filter
- Rotate tires (except MR2 Spyder)

DEALER SERVICE VERIFICATION:

DATE:

MILEAGE:

45,000 Miles or 36 Months

45,000 Miles or 36 Months

- Replace engine oil and oil filter
- Replace air conditioning filter (Avalon, Camry)²
- Rotate tires (except MR2 Spyder)
- Inspect the following:

<input type="checkbox"/> Ball joints and dust covers	<input type="checkbox"/> Exhaust pipes and mountings
<input type="checkbox"/> Brake lines and hoses	<input type="checkbox"/> Steering gear box
<input type="checkbox"/> Brake linings/drums and brake pads/discs	<input type="checkbox"/> Steering linkage and boots
<input type="checkbox"/> Differential oil ³	
<input type="checkbox"/> Drive shaft boots	

Additional Maintenance Items for Special Operating Conditions:¹

- Inspect automatic transmission fluid (Avalon, Camry, Camry Solara, Corolla, Sienna)
- Inspect differential oil⁴
- Inspect engine air filter
- Inspect nuts and bolts on chassis and body

DEALER SERVICE VERIFICATION:

DATE:

MILEAGE:

¹ Specific services apply to specific operating conditions. See pages 18–19 for details.

² Do not replace if replaced at 40,000 miles/32 months.

³ Applies to Corolla with A131L automatic transmission.

⁴ Applies to Avalon, Corolla and Sienna models with automatic transmission.

5,000-Mile Maintenance Intervals

7,500-Mile Maintenance Intervals

To determine the appropriate maintenance interval for your vehicle, see page 16.

50,000 Miles or 40 Months

- Replace engine oil and oil filter

Additional Maintenance Items for Special Operating Conditions:¹

- Inspect the following:
 - ___ Ball joints and dust covers
 - ___ Brake linings/drums and brake pads/discs
 - ___ Drive shaft boots
 - ___ Engine air filter
 - ___ Nuts and bolts on chassis and body
 - ___ Steering linkage and boots
- Replace air conditioning filter (Avalon, Camry)
- Rotate tires (except MR2 Spyder)

DEALER SERVICE VERIFICATION:

DATE:

MILEAGE:

55,000 Miles or 44 Months

- Replace engine oil and oil filter

Additional Maintenance Items for Special Operating Conditions:¹

- Inspect the following:
 - ___ Ball joints and dust covers
 - ___ Brake linings/drums and brake pads/discs
 - ___ Drive shaft boots
 - ___ Engine air filter
 - ___ Nuts and bolts on chassis and body
 - ___ Steering linkage and boots
- Rotate tires (except MR2 Spyder)

DEALER SERVICE VERIFICATION:

DATE:

MILEAGE:

52,500 Miles or 42 Months

- Replace engine oil and oil filter
- Rotate tires (except MR2 Spyder)

DEALER SERVICE VERIFICATION:

DATE:

MILEAGE:

60,000 Miles or 48 Months

60,000 Miles or 48 Months

- Replace engine air filter
- Replace engine coolant
- Replace engine oil and oil filter
- Replace air conditioning filter (Avalon, Camry)
- Replace spark plugs (Camry Solara with 1MZ-FE engine, ECHO, Sienna)²
- Rotate tires (except MR2 Spyder)
- Inspect the following:

<input type="checkbox"/> Ball joints and dust covers	<input type="checkbox"/> Exhaust pipes and mountings
<input type="checkbox"/> Brake lines and hoses	<input type="checkbox"/> Fuel lines and connections, fuel tank band and fuel tank vapor vent system hoses
<input type="checkbox"/> Brake linings/drums and brake pads/discs	<input type="checkbox"/> Fuel tank cap gasket
<input type="checkbox"/> Charcoal canister (Sienna) ³	<input type="checkbox"/> Steering gear box
<input type="checkbox"/> Differential oil	<input type="checkbox"/> Steering linkage and boots
<input type="checkbox"/> Drive belts ⁴	<input type="checkbox"/> Transmission fluid or oil
<input type="checkbox"/> Drive shaft boots	
<input type="checkbox"/> Engine valve clearance	

Additional Maintenance Items for Special Operating Conditions:¹

- Inspect nuts and bolts on chassis and body
- Replace automatic transmission fluid
- Replace differential oil
- Replace manual transmission oil

DEALER SERVICE VERIFICATION:

DATE:

MILEAGE:

¹ Specific services apply to specific operating conditions. See pages 18–19 for details.

² Required under the terms of the Emission Control Warranty.

³ Inspect at 60,000 miles or 72 months, whichever comes first. Required only for vehicles in California, Massachusetts and New York.

⁴ Initial inspection at 60,000 miles. Inspect every 15,000 miles thereafter.

5,000-Mile Maintenance Intervals

7,500-Mile Maintenance Intervals

To determine the appropriate maintenance interval for your vehicle, see page 16.

65,000 Miles or 52 Months

- Replace engine oil and oil filter

Additional Maintenance Items for Special Operating Conditions:¹

- Inspect the following:
 - ___ Ball joints and dust covers
 - ___ Brake linings/drums and brake pads/discs
 - ___ Drive shaft boots
 - ___ Engine air filter
 - ___ Nuts and bolts on chassis and body
 - ___ Steering linkage and boots
- Rotate tires (except MR2 Spyder)

DEALER SERVICE VERIFICATION:

DATE:

MILEAGE:

70,000 Miles or 56 Months

- Replace engine oil and oil filter

Additional Maintenance Items for Special Operating Conditions:¹

- Inspect the following:
 - ___ Ball joints and dust covers
 - ___ Brake linings/drums and brake pads/discs
 - ___ Drive shaft boots
 - ___ Engine air filter
 - ___ Nuts and bolts on chassis and body
 - ___ Steering linkage and boots
- Replace air conditioning filter (Avalon, Camry)
- Rotate tires (except MR2 Spyder)

DEALER SERVICE VERIFICATION:

DATE:

MILEAGE:

67,500 Miles or 54 Months

- Replace engine oil and oil filter
- Rotate tires (except MR2 Spyder)

DEALER SERVICE VERIFICATION:

DATE:

MILEAGE:

75,000 Miles or 60 Months

75,000 Miles or 60 Months

- Replace engine oil and oil filter
- Replace air conditioning filter (Avalon, Camry)²
- Rotate tires (except MR2 Spyder)
- Inspect the following:

<input type="checkbox"/> Ball joints and dust covers	<input type="checkbox"/> Drive shaft boots
<input type="checkbox"/> Brake lines and hoses	<input type="checkbox"/> Exhaust pipes and mountings
<input type="checkbox"/> Brake linings/drums and brake pads/discs	<input type="checkbox"/> Steering gear box
<input type="checkbox"/> Differential oil ³	<input type="checkbox"/> Steering linkage and boots
<input type="checkbox"/> Drive belts	

Additional Maintenance Items for Special Operating Conditions:¹

- Inspect automatic transmission fluid (Avalon, Camry, Camry Solara, Corolla, Sienna)
- Inspect differential oil⁴
- Inspect engine air filter
- Inspect nuts and bolts on chassis and body

DEALER SERVICE VERIFICATION:

DATE:

MILEAGE:

¹ Specific services apply to specific operating conditions. See pages 18–19 for details.

² Do not replace if replaced at 70,000 miles/56 months.

³ Applies to Corolla with A131L automatic transmission.

⁴ Applies to Avalon, Corolla and Sienna models with automatic transmission.

5,000-Mile Maintenance Intervals

7,500-Mile Maintenance Intervals

To determine the appropriate maintenance interval for your vehicle, see page 16.

80,000 Miles or 64 Months

- Replace engine oil and oil filter

Additional Maintenance Items for Special Operating Conditions:¹

- Inspect the following:
 - Ball joints and dust covers
 - Brake linings/drums and brake pads/discs
 - Drive shaft boots
 - Engine air filter
 - Nuts and bolts on chassis and body
 - Steering linkage and boots
- Replace air conditioning filter (Avalon, Camry)
- Rotate tires (except MR2 Spyder)

DEALER SERVICE VERIFICATION:

DATE:

MILEAGE:

85,000 Miles or 68 Months

- Replace engine oil and oil filter

Additional Maintenance Items for Special Operating Conditions:¹

- Inspect the following:
 - Ball joints and dust covers
 - Brake linings/drums and brake pads/discs
 - Drive shaft boots
 - Engine air filter
 - Nuts and bolts on chassis and body
 - Steering linkage and boots
- Rotate tires (except MR2 Spyder)

DEALER SERVICE VERIFICATION:

DATE:

MILEAGE:

82,500 Miles or 66 Months

- Replace engine oil and oil filter
- Rotate tires (except MR2 Spyder)

DEALER SERVICE VERIFICATION:

DATE:

MILEAGE:

90,000 Miles or 72 Months

90,000 Miles or 72 Months

- Replace engine air filter
- Replace engine coolant
- Replace engine oil and oil filter
- Replace air conditioning filter (Avalon, Camry)
- Replace spark plugs (ECHO)²
- Replace timing belt (Avalon, Camry with 1MZ-FE, Camry Solara with 1MZ-FE, Sienna)
- Rotate tires (except MR2 Spyder)
- Inspect the following:
 - Ball joints and dust covers
 - Brake lines and hoses
 - Brake linings/drums and brake pads/discs
 - Differential oil
 - Drive belts
 - Drive shaft boots
 - Exhaust pipes and mountings
 - Fuel lines and connections, fuel tank band and fuel tank vapor vent system hoses
 - Fuel tank cap gasket
 - Steering gear box
 - Steering linkage and boots
 - Transmission fluid or oil

Additional Maintenance Items for Special Operating Conditions:¹

- Inspect nuts and bolts on chassis and body
- Replace automatic transmission fluid (Avalon, Camry, Camry Solara, Corolla, Sienna)
- Replace differential oil³
- Replace manual transmission oil

DEALER SERVICE VERIFICATION:

DATE:

MILEAGE:

¹ Specific services apply to specific operating conditions. See pages 18–19 for details.

² Required under the terms of the Emission Control Warranty.

³ Applies to all models with manual transmission and Avalon, Corolla and Sienna models with automatic transmission.

5,000-Mile Maintenance Intervals

7,500-Mile Maintenance Intervals

To determine the appropriate maintenance interval for your vehicle, see page 16.

95,000 Miles or 76 Months

- Replace engine oil and oil filter

Additional Maintenance Items for Special Operating Conditions:¹

- Inspect the following:
 - ___ Ball joints and dust covers
 - ___ Brake linings/drums and brake pads/discs
 - ___ Drive shaft boots
 - ___ Engine air filter
 - ___ Nuts and bolts on chassis and body
 - ___ Steering linkage and boots
- Rotate tires (except MR2 Spyder)

DEALER SERVICE VERIFICATION:

DATE:

MILEAGE:

100,000 Miles or 80 Months

- Replace engine oil and oil filter

Additional Maintenance Items for Special Operating Conditions:¹

- Inspect the following:
 - ___ Ball joints and dust covers
 - ___ Brake linings/drums and brake pads/discs
 - ___ Drive shaft boots
 - ___ Engine air filter
 - ___ Nuts and bolts on chassis and body
 - ___ Steering linkage and boots
- Replace air conditioning filter (Avalon, Camry)
- Rotate tires (except MR2 Spyder)

DEALER SERVICE VERIFICATION:

DATE:

MILEAGE:

97,500 Miles or 78 Months

- Replace engine oil and oil filter
- Rotate tires (except MR2 Spyder)

DEALER SERVICE VERIFICATION:

DATE:

MILEAGE:

105,000 Miles or 84 Months

105,000 Miles or 84 Months

- Replace engine oil and oil filter
- Replace air conditioning filter (Avalon, Camry)²
- Rotate tires (except MR2 Spyder)
- Inspect the following:

<input type="checkbox"/> Ball joints and dust covers	<input type="checkbox"/> Drive shaft boots
<input type="checkbox"/> Brake lines and hoses	<input type="checkbox"/> Exhaust pipes and mountings
<input type="checkbox"/> Brake linings/drums and brake pads/discs	<input type="checkbox"/> Steering gear box
<input type="checkbox"/> Differential oil ³	<input type="checkbox"/> Steering linkage and boots
<input type="checkbox"/> Drive belts	

Additional Maintenance Items for Special Operating Conditions:¹

- Inspect automatic transmission fluid (Avalon, Camry, Camry Solara, Corolla, Sienna)
- Inspect differential oil⁴
- Inspect engine air filter
- Inspect nuts and bolts on chassis and body

DEALER SERVICE VERIFICATION:

DATE:

MILEAGE:

¹ Specific services apply to specific operating conditions. See pages 18–19 for details.

² Do not replace if replaced at 100,000 miles/80 months.

³ Applies to Corolla with A131L automatic transmission.

⁴ Applies to Avalon, Corolla and Sienna models with automatic transmission.

5,000-Mile Maintenance Intervals

7,500-Mile Maintenance Intervals

To determine the appropriate maintenance interval for your vehicle, see page 16.

110,000 Miles or 88 Months

- Replace engine oil and oil filter

Additional Maintenance Items for Special Operating Conditions:¹

- Inspect the following:
 - ___ Ball joints and dust covers
 - ___ Brake linings/drums and brake pads/discs
 - ___ Drive shaft boots
 - ___ Engine air filter
 - ___ Nuts and bolts on chassis and body
 - ___ Steering linkage and boots
- Replace air conditioning filter (Avalon, Camry)
- Rotate tires (except MR2 Spyder)

DEALER SERVICE VERIFICATION:

DATE:

MILEAGE:

115,000 Miles or 92 Months

- Replace engine oil and oil filter

Additional Maintenance Items for Special Operating Conditions:¹

- Inspect the following:
 - ___ Ball joints and dust covers
 - ___ Brake linings/drums and brake pads/discs
 - ___ Drive shaft boots
 - ___ Engine air filter
 - ___ Nuts and bolts on chassis and body
 - ___ Steering linkage and boots
- Rotate tires (except MR2 Spyder)

DEALER SERVICE VERIFICATION:

DATE:

MILEAGE:

112,500 Miles or 90 Months

- Replace engine oil and oil filter
- Rotate tires (except MR2 Spyder)

DEALER SERVICE VERIFICATION:

DATE:

MILEAGE:

120,000 Miles or 96 Months

120,000 Miles or 96 Months

- Replace engine air filter
- Replace engine coolant
- Replace engine oil and oil filter
- Replace air conditioning filter (Avalon, Camry)
- Replace spark plugs (all models)²
- Rotate tires (except MR2 Spyder)
- Inspect the following:
 - Ball joints and dust covers
 - Brake lines and hoses
 - Brake linings/drums and brake pads/discs
 - Charcoal canister (Sienna)³
 - Differential oil
 - Drive belts
 - Drive shaft boots
 - Engine valve clearance
 - Exhaust pipes and mountings
 - Fuel lines and connections, fuel tank band and fuel tank vapor vent system hoses
 - Fuel tank cap gasket
 - Steering gear box
 - Steering linkage and boots
 - Transmission fluid or oil

Additional Maintenance Items for Special Operating Conditions:¹

- Inspect nuts and bolts on chassis and body
- Replace automatic transmission fluid
- Replace differential oil
- Replace manual transmission oil

DEALER SERVICE VERIFICATION:

DATE:

MILEAGE:

¹ Specific services apply to specific operating conditions. See pages 18–19 for details.

² Required under the terms of the Emission Control Warranty.

³ Inspect at 120,000 miles or 144 months, whichever comes first. Required only for vehicles in California, Massachusetts and New York.

5,000-Mile Maintenance Intervals

7,500-Mile Maintenance Intervals

To determine the appropriate maintenance interval for your vehicle, see page 16.

5,000 Miles or 4 Months

- Replace engine oil and oil filter
- Additional Maintenance Items for Special Operating Conditions:¹**
- Inspect the following:
 - ___ Ball joints and dust covers
 - ___ Brake linings/drums and brake pads/discs
 - ___ Drive shaft boots (Highlander; Land Cruiser; RAV4; 4WD Sequoia, Tacoma, Tundra and 4Runner)
 - ___ Engine air filter
 - ___ Nuts and bolts on chassis and body
 - ___ Steering linkage and boots
- Lubricate propeller shaft (all 4WD except Highlander and RAV4)
- Replace rear differential oil (Sequoia)
- Re-torque drive shaft bolt (Highlander, 4WD RAV4)
- Re-torque propeller shaft bolt (all models except Highlander and RAV4)
- Rotate tires

DEALER SERVICE VERIFICATION:

DATE:

MILEAGE:

10,000 Miles or 8 Months

- Replace engine oil and oil filter
- Additional Maintenance Items for Special Operating Conditions:¹**
- Inspect the following:
 - ___ Ball joints and dust covers
 - ___ Brake linings/drums and brake pads/discs
 - ___ Drive shaft boots (Highlander; Land Cruiser; RAV4; 4WD Sequoia, Tacoma, Tundra and 4Runner)
 - ___ Engine air filter
 - ___ Nuts and bolts on chassis and body
 - ___ Steering linkage and boots
- Lubricate propeller shaft (all 4WD except Highlander and RAV4)
- Replace air conditioning filter (Highlander, RAV4)
- Replace rear differential oil (Sequoia)
- Re-torque drive shaft bolt (Highlander, 4WD RAV4)
- Re-torque propeller shaft bolt (all models except Highlander and RAV4)
- Rotate tires

DEALER SERVICE VERIFICATION:

DATE:

MILEAGE:

7,500 Miles or 6 Months

- Replace engine oil and oil filter
- Rotate tires

DEALER SERVICE VERIFICATION:

DATE:

MILEAGE:

15,000 Miles or 12 Months

15,000 Miles or 12 Months

- Replace engine oil and oil filter
- Lubricate propeller shaft (all 4WD except Highlander and RAV4)
- Re-torque drive shaft bolt (Highlander, 4WD RAV4)
- Re-torque propeller shaft bolt (all models except Highlander and RAV4)
- Rotate tires
- Inspect the following:
 - Ball joints and dust covers
 - Brake lines and hoses
 - Brake linings/drums and brake pads/discs
 - Drive shaft boots (Highlander; Land Cruiser; RAV4; 4WD Sequoia, Tacoma, Tundra and 4Runner)
 - Exhaust pipes and mountings
 - Front differential oil (all 4WD except Highlander and RAV4)
 - Limited-slip differential oil (Land Cruiser, 4WD Highlander and 4WD RAV4)²
 - Rear differential oil (all models except 2WD Highlander and 2WD RAV4)
 - Steering gear box
 - Steering linkage and boots
 - Transfer case oil (4WD Highlander, 4WD RAV4)

Additional Maintenance Items for Special Operating Conditions:¹

- Inspect automatic transmission fluid (Land Cruiser, Sequoia, Tacoma, Tundra, 4Runner)
- Inspect engine air filter
- Inspect front differential oil (all 4WD except Highlander and RAV4)
- Inspect nuts and bolts on chassis and body
- Replace rear differential oil (including limited-slip)
- Replace transfer case oil (4WD Highlander, 4WD RAV4)

DEALER SERVICE VERIFICATION:

DATE:

MILEAGE:

¹ Specific services apply to specific operating conditions. See pages 18–19 for details.

² If vehicle is equipped with limited-slip differential.

5,000-Mile Maintenance Intervals

7,500-Mile Maintenance Intervals

To determine the appropriate maintenance interval for your vehicle, see page 16.

20,000 Miles or 16 Months

- Replace engine oil and oil filter

Additional Maintenance Items for Special Operating Conditions:¹

- Inspect the following:
 - ___ Ball joints and dust covers
 - ___ Brake linings/drums and brake pads/discs
 - ___ Drive shaft boots (Highlander; Land Cruiser; RAV4; 4WD Sequoia, Tacoma, Tundra and 4Runner)
 - ___ Engine air filter
 - ___ Nuts and bolts on chassis and body
 - ___ Steering linkage and boots
- Lubricate propeller shaft (all 4WD except Highlander and RAV4)
- Replace air conditioning filter (Highlander, RAV4)
- Replace rear differential oil (Sequoia)
- Re-torque drive shaft bolt (Highlander, 4WD RAV4)
- Re-torque propeller shaft bolt (all models except Highlander and RAV4)
- Rotate tires

DEALER SERVICE VERIFICATION:

DATE:

MILEAGE:

25,000 Miles or 20 Months

- Replace engine oil and oil filter

Additional Maintenance Items for Special Operating Conditions:¹

- Inspect the following:
 - ___ Ball joints and dust covers
 - ___ Brake linings/drums and brake pads/discs
 - ___ Drive shaft boots (Highlander; Land Cruiser; RAV4; 4WD Sequoia, Tacoma, Tundra and 4Runner)
 - ___ Engine air filter
 - ___ Nuts and bolts on chassis and body
 - ___ Steering linkage and boots
- Lubricate propeller shaft (all 4WD except Highlander and RAV4)
- Replace rear differential oil (Sequoia)
- Re-torque drive shaft bolt (Highlander, 4WD RAV4)
- Re-torque propeller shaft bolt (all models except Highlander and RAV4)
- Rotate tires

DEALER SERVICE VERIFICATION:

DATE:

MILEAGE:

22,500 Miles or 18 Months

- Replace air conditioning filter (Highlander, RAV4)²
- Replace engine oil and oil filter
- Rotate tires

DEALER SERVICE VERIFICATION:

DATE:

MILEAGE:

30,000 Miles or 24 Months

30,000 Miles or 24 Months

- | | |
|---|---|
| <input type="checkbox"/> Replace engine air filter | <input type="checkbox"/> Replace engine oil and oil filter |
| <input type="checkbox"/> Replace engine coolant | <input type="checkbox"/> Rotate tires |
| <input type="checkbox"/> Lubricate propeller shaft (all 4WD except Highlander and RAV4) | |
| <input type="checkbox"/> Lubricate wheel bearings and drive shaft bearings (Land Cruiser) | |
| <input type="checkbox"/> Replace limited-slip differential oil (Land Cruiser) ³ | |
| <input type="checkbox"/> Replace non-platinum spark plugs (Sequoia, Tacoma, Tundra, 4Runner) ⁴ | |
| <input type="checkbox"/> Re-torque drive shaft bolt (Highlander, 4WD RAV4) | |
| <input type="checkbox"/> Re-torque propeller shaft bolt (all models except Highlander and RAV4) | |
| <input type="checkbox"/> Inspect the following: | |
| ___ Automatic transmission fluid | ___ Fuel tank cap gasket |
| ___ Ball joints and dust covers | ___ Limited-slip differential oil (4WD Highlander, 4WD RAV4) ³ |
| ___ Brake lines and hoses | ___ Manual transmission oil (Tacoma, Tundra) |
| ___ Brake linings/drums and brake pads/discs | ___ Rear differential oil (all models except 2WD Highlander and 2WD RAV4) |
| ___ Drive shaft boots (Highlander; Land Cruiser; RAV4; 4WD Sequoia, Tacoma, Tundra and 4Runner) | ___ Steering gear box |
| ___ Exhaust pipes and mountings | ___ Steering linkage and boots |
| ___ Front differential oil (4WD models, Highlander and RAV4) | ___ Transfer case oil (4WD models) |
| ___ Fuel lines and connections, fuel tank band and fuel tank vapor vent system hoses | |

Additional Maintenance Items for Special Operating Conditions:¹

- Inspect nuts and bolts on chassis and body
- Replace air conditioning filter (Highlander, RAV4)
- Replace automatic transmission fluid (all models except Highlander and RAV4)
- Replace front differential oil (2WD RAV4 w/ manual transmission; all 4WD except RAV4 w/ automatic transmission and Highlander)
- Replace manual transmission oil
- Replace rear differential oil (including limited-slip)
- Replace transfer case oil (4WD models)

DEALER SERVICE VERIFICATION:

DATE:

MILEAGE:

¹ Specific services apply to specific operating conditions. See pages 18–19 for details.

² Do not replace if replaced at 20,000 miles/16 months.

³ If vehicle is equipped with limited-slip differential.

⁴ Required under the terms of the Emission Control Warranty.

5,000-Mile Maintenance Intervals

7,500-Mile Maintenance Intervals

To determine the appropriate maintenance interval for your vehicle, see page 16.

35,000 Miles or 28 Months

- Replace engine oil and oil filter
- Additional Maintenance Items for Special Operating Conditions:¹**
- Inspect the following:
 - ___ Ball joints and dust covers
 - ___ Brake linings/drums and brake pads/discs
 - ___ Drive shaft boots (Highlander; Land Cruiser; RAV4; 4WD Sequoia, Tacoma, Tundra and 4Runner)
 - ___ Engine air filter
 - ___ Nuts and bolts on chassis and body
 - ___ Steering linkage and boots
- Lubricate propeller shaft (all 4WD except Highlander and RAV4)
- Replace rear differential oil (Sequoia)
- Re-torque drive shaft bolt (Highlander, 4WD RAV4)
- Re-torque propeller shaft bolt (all models except Highlander and RAV4)
- Rotate tires

DEALER SERVICE VERIFICATION:

DATE:

MILEAGE:

40,000 Miles or 32 Months

- Replace engine oil and oil filter
- Additional Maintenance Items for Special Operating Conditions:¹**
- Inspect the following:
 - ___ Ball joints and dust covers
 - ___ Brake linings/drums and brake pads/discs
 - ___ Drive shaft boots (Highlander; Land Cruiser; RAV4; 4WD Sequoia, Tacoma, Tundra and 4Runner)
 - ___ Engine air filter
 - ___ Nuts and bolts on chassis and body
 - ___ Steering linkage and boots
- Lubricate propeller shaft (all 4WD except Highlander and RAV4)
- Replace air conditioning filter (Highlander, RAV4)
- Replace rear differential oil (Sequoia)
- Re-torque drive shaft bolt (Highlander, 4WD RAV4)
- Re-torque propeller shaft bolt (all models except Highlander and RAV4)
- Rotate tires

DEALER SERVICE VERIFICATION:

DATE:

MILEAGE:

37,500 Miles or 30 Months

- Replace engine oil and oil filter
- Rotate tires

DEALER SERVICE VERIFICATION:

DATE:

MILEAGE:

45,000 Miles or 36 Months

45,000 Miles or 36 Months

- Replace engine oil and oil filter
- Lubricate propeller shaft (all 4WD except Highlander and RAV4)
- Replace air conditioning filter (Highlander, RAV4)²
- Re-torque drive shaft bolt (Highlander, 4WD RAV4)
- Re-torque propeller shaft bolt (all models except Highlander and RAV4)
- Rotate tires
- Inspect the following:
 - Ball joints and dust covers
 - Brake lines and hoses
 - Brake linings/drums and brake pads/discs
 - Drive shaft boots (Highlander, Land Cruiser; RAV4; 4WD Sequoia, Tacoma, Tundra and 4Runner)
 - Exhaust pipes and mountings
 - Front differential oil (all 4WD except Highlander and RAV4)
 - Limited-slip differential oil (Land Cruiser, 4WD Highlander, 4WD RAV4)³
 - Rear differential oil (all models except 2WD Highlander and 2WD RAV4)
 - Steering gear box
 - Steering linkage and boots
 - Transfer case oil (4WD Highlander, 4WD RAV4)

Additional Maintenance Items for Special Operating Conditions:¹

- Inspect automatic transmission fluid (Land Cruiser, Sequoia, Tacoma, Tundra, 4Runner)
- Inspect engine air filter
- Inspect nuts and bolts on chassis and body
- Replace front differential oil (all 4WD except Highlander and RAV4)
- Replace rear differential oil (including limited-slip)
- Replace transfer case oil (4WD Highlander, 4WD RAV4)

DEALER SERVICE VERIFICATION:

DATE:

MILEAGE:

¹ Specific services apply to specific operating conditions. See pages 18–19 for details.

² Do not replace if replaced at 40,000 miles/32 months.

³ If vehicle is equipped with limited-slip differential.

5,000-Mile Maintenance Intervals

7,500-Mile Maintenance Intervals

To determine the appropriate maintenance interval for your vehicle, see page 16.

50,000 Miles or 40 Months

- Replace engine oil and oil filter

Additional Maintenance Items for Special Operating Conditions:¹

- Inspect the following:
 - ___ Ball joints and dust covers
 - ___ Brake linings/drums and brake pads/discs
 - ___ Drive shaft boots (Highlander; Land Cruiser; RAV4; 4WD Sequoia, Tacoma, Tundra and 4Runner)
 - ___ Engine air filter
 - ___ Nuts and bolts on chassis and body
 - ___ Steering linkage and boots
- Lubricate propeller shaft (all 4WD except Highlander and RAV4)
- Replace air conditioning filter (Highlander, RAV4)
- Replace rear differential oil (Sequoia)
- Re-torque drive shaft bolt (Highlander, 4WD RAV4)
- Re-torque propeller shaft bolt (all models except Highlander and RAV4)
- Rotate tires

DEALER SERVICE VERIFICATION:

DATE:

MILEAGE:

55,000 Miles or 44 Months

- Replace engine oil and oil filter

Additional Maintenance Items for Special Operating Conditions:¹

- Inspect the following:
 - ___ Ball joints and dust covers
 - ___ Brake linings/drums and brake pads/discs
 - ___ Drive shaft boots (Highlander; Land Cruiser; RAV4; 4WD Sequoia, Tacoma, Tundra and 4Runner)
 - ___ Engine air filter
 - ___ Nuts and bolts on chassis and body
 - ___ Steering linkage and boots
- Lubricate propeller shaft (all 4WD except Highlander and RAV4)
- Replace rear differential oil (Sequoia)
- Re-torque drive shaft bolt (Highlander, 4WD RAV4)
- Re-torque propeller shaft bolt (all models except Highlander and RAV4)
- Rotate tires

DEALER SERVICE VERIFICATION:

DATE:

MILEAGE:

52,500 Miles or 42 Months

- Replace engine oil and oil filter
- Rotate tires

DEALER SERVICE VERIFICATION:

DATE:

MILEAGE:

60,000 Miles or 48 Months

60,000 Miles or 48 Months

- | | |
|--|--|
| <input type="checkbox"/> Replace engine air filter | <input type="checkbox"/> Replace engine oil and oil filter |
| <input type="checkbox"/> Replace engine coolant | <input type="checkbox"/> Rotate tires |
| <input type="checkbox"/> Lubricate propeller shaft (all 4WD except Highlander and RAV4) | |
| <input type="checkbox"/> Lubricate wheel bearings and drive shaft bearings (Land Cruiser) | |
| <input type="checkbox"/> Replace limited-slip differential oil (Highlander, Land Cruiser, RAV4) ² | |
| <input type="checkbox"/> Replace non-platinum spark plugs (Sequoia, Tacoma, Tundra, 4Runner) ³ | |
| <input type="checkbox"/> Re-torque drive shaft bolt (Highlander, 4WD RAV4) | |
| <input type="checkbox"/> Re-torque propeller shaft bolt (all models except Highlander and RAV4) | |
| <input type="checkbox"/> Inspect the following: | |
| ___ Automatic transmission fluid | ___ Fuel lines and connections, fuel tank band and fuel tank vapor vent system hoses |
| ___ Ball joints and dust covers | ___ Fuel tank cap gasket |
| ___ Brake lines and hoses | ___ Manual transmission oil (Tacoma, Tundra) |
| ___ Brake linings/drums and brake pads/discs | ___ Rear differential oil (all models except 2WD Highlander and 2WD RAV4) |
| ___ Drive belts ⁴ | ___ Steering gear box |
| ___ Drive shaft boots (Highlander; Land Cruiser; RAV4; 4WD Sequoia, Tacoma, Tundra and 4Runner) | ___ Steering linkage and boots |
| ___ Engine valve clearance | ___ Transfer case oil (4WD models) |
| ___ Exhaust pipes and mountings | |
| ___ Front differential oil (4WD models, Highlander, RAV4) | |

Additional Maintenance Items for Special Operating Conditions:¹

- Inspect nuts and bolts on chassis and body
- Replace air conditioning filter (Highlander, RAV4)
- Replace front differential oil
- Replace rear differential oil (including limited-slip)
- Replace transfer case oil (4WD models)
- Replace transmission fluid or oil

DEALER SERVICE VERIFICATION:

DATE:

MILEAGE:

¹ Specific services apply to specific operating conditions. See pages 18–19 for details.

² If vehicle is equipped with limited-slip differential.

³ Required under the terms of the Emission Control Warranty.

⁴ Initial inspection at 60,000 miles. Inspect every 15,000 miles thereafter.

5,000-Mile Maintenance Intervals

7,500-Mile Maintenance Intervals

To determine the appropriate maintenance interval for your vehicle, see page 16.

65,000 Miles or 52 Months

- Replace engine oil and oil filter

Additional Maintenance Items for Special Operating Conditions:¹

- Inspect the following:
 - ___ Ball joints and dust covers
 - ___ Brake linings/drums and brake pads/discs
 - ___ Drive shaft boots (Highlander; Land Cruiser; RAV4; 4WD Sequoia, Tacoma, Tundra and 4Runner)
 - ___ Engine air filter
 - ___ Nuts and bolts on chassis and body
 - ___ Steering linkage and boots
- Lubricate propeller shaft (all 4WD except Highlander and RAV4)
- Replace rear differential oil (Sequoia)
- Re-torque drive shaft bolt (Highlander, 4WD RAV4)
- Re-torque propeller shaft bolt (all models except Highlander and RAV4)
- Rotate tires

DEALER SERVICE VERIFICATION:

DATE:

MILEAGE:

70,000 Miles or 56 Months

- Replace engine oil and oil filter

Additional Maintenance Items for Special Operating Conditions:¹

- Inspect the following:
 - ___ Ball joints and dust covers
 - ___ Brake linings/drums and brake pads/discs
 - ___ Drive shaft boots (Highlander; Land Cruiser; RAV4; 4WD Sequoia, Tacoma, Tundra and 4Runner)
 - ___ Engine air filter
 - ___ Nuts and bolts on chassis and body
 - ___ Steering linkage and boots
- Lubricate propeller shaft (all 4WD except Highlander and RAV4)
- Replace air conditioning filter (Highlander, RAV4)
- Replace rear differential oil (Sequoia)
- Re-torque drive shaft bolt (Highlander, 4WD RAV4)
- Re-torque propeller shaft bolt (all models except Highlander and RAV4)
- Rotate tires

DEALER SERVICE VERIFICATION:

DATE:

MILEAGE:

67,500 Miles or 54 Months

- Replace air conditioning filter (Highlander, RAV4)²
- Replace engine oil and oil filter
- Rotate tires

DEALER SERVICE VERIFICATION:

DATE:

MILEAGE:

75,000 Miles or 60 Months

75,000 Miles or 60 Months

- Replace engine oil and oil filter
- Lubricate propeller shaft (all 4WD except Highlander and RAV4)
- Re-torque drive shaft bolt (Highlander, 4WD RAV4)
- Re-torque propeller shaft bolt (all models except Highlander and RAV4)
- Rotate tires
- Inspect the following:
 - Ball joints and dust covers
 - Brake lines and hoses
 - Brake linings/drums and brake pads/discs
 - Drive belts
 - Drive shaft boots (Highlander; Land Cruiser; RAV4; 4WD Sequoia, Tacoma, Tundra and 4Runner)
 - Exhaust pipes and mountings
 - Front differential oil (all 4WD except Highlander and RAV4)
 - Limited-slip differential oil (Land Cruiser, 4WD Highlander, 4WD RAV4)³
 - Rear differential oil (all models except 2WD Highlander and 2WD RAV4)
 - Steering gear box
 - Steering linkage and boots
 - Transfer case oil (4WD Highlander, 4WD RAV4)

Additional Maintenance Items for Special Operating Conditions:¹

- Inspect automatic transmission fluid (Land Cruiser, Sequoia, Tacoma, Tundra, 4Runner)
- Inspect engine air filter
- Inspect nuts and bolts on chassis and body
- Replace front differential oil (all 4WD except Highlander and RAV4)
- Replace rear differential oil (including limited-slip)
- Replace transfer case oil (4WD Highlander, 4WD RAV4)

DEALER SERVICE VERIFICATION:

DATE:

MILEAGE:

¹ Specific services apply to specific operating conditions. See pages 18–19 for details.

² Do not replace if replaced at 60,000 miles/48 months.

³ If vehicle is equipped with limited-slip differential.

5,000-Mile Maintenance Intervals

7,500-Mile Maintenance Intervals

To determine the appropriate maintenance interval for your vehicle, see page 16.

80,000 Miles or 64 Months

- Replace engine oil and oil filter

Additional Maintenance Items for Special Operating Conditions:¹

- Inspect the following:
 - Ball joints and dust covers
 - Brake linings/drums and brake pads/discs
 - Drive shaft boots (Highlander; Land Cruiser; RAV4; 4WD Sequoia, Tacoma, Tundra and 4Runner)
 - Engine air filter
 - Nuts and bolts on chassis and body
 - Steering linkage and boots
- Lubricate propeller shaft (all 4WD except Highlander and RAV4)
- Replace air conditioning filter (Highlander, RAV4)
- Replace rear differential oil (Sequoia)
- Re-torque drive shaft bolt (Highlander, 4WD RAV4)
- Re-torque propeller shaft bolt (all models except Highlander and RAV4)
- Rotate tires

DEALER SERVICE VERIFICATION:

DATE:

MILEAGE:

85,000 Miles or 68 Months

- Replace engine oil and oil filter

Additional Maintenance Items for Special Operating Conditions:¹

- Inspect the following:
 - Ball joints and dust covers
 - Brake linings/drums and brake pads/discs
 - Drive shaft boots (Highlander; Land Cruiser; RAV4; 4WD Sequoia, Tacoma, Tundra and 4Runner)
 - Engine air filter
 - Nuts and bolts on chassis and body
 - Steering linkage and boots
- Lubricate propeller shaft (all 4WD except Highlander and RAV4)
- Replace rear differential oil (Sequoia)
- Re-torque drive shaft bolt (Highlander, 4WD RAV4)
- Re-torque propeller shaft bolt (all models except Highlander and RAV4)
- Rotate tires

DEALER SERVICE VERIFICATION:

DATE:

MILEAGE:

82,500 Miles or 66 Months

- Replace engine oil and oil filter
- Rotate tires

DEALER SERVICE VERIFICATION:

DATE:

MILEAGE:

90,000 Miles or 72 Months

90,000 Miles or 72 Months

- | | |
|--|---|
| <ul style="list-style-type: none"> <input type="checkbox"/> Replace engine air filter <input type="checkbox"/> Replace engine coolant <input type="checkbox"/> Lubricate propeller shaft (all 4WD except Highlander and RAV4) <input type="checkbox"/> Lubricate wheel bearings and drive shaft bearings (Land Cruiser) <input type="checkbox"/> Replace air conditioning filter (Highlander, RAV4) <input type="checkbox"/> Replace limited-slip differential oil (Land Cruiser)² <input type="checkbox"/> Replace non-platinum spark plugs (Sequoia, Tacoma, Tundra, 4Runner)³ <input type="checkbox"/> Replace timing belt (except RAV4, Highlander with 2AZ-FE and Tacoma with 2RZ-FE or 3RZ-FE) <input type="checkbox"/> Re-torque drive shaft bolt (Highlander, 4WD RAV4) <input type="checkbox"/> Re-torque propeller shaft bolt (all models except Highlander and RAV4) <input type="checkbox"/> Inspect the following: <ul style="list-style-type: none"> ___ Automatic transmission fluid ___ Ball joints and dust covers ___ Brake lines and hoses ___ Brake linings/drums and brake pads/discs ___ Drive belts ___ Drive shaft boots (Highlander; Land Cruiser; RAV4; 4WD Sequoia, Tacoma, Tundra and 4Runner) ___ Exhaust pipes and mountings ___ Front differential oil (4WD models, Highlander, RAV4) | <ul style="list-style-type: none"> <input type="checkbox"/> Replace engine oil and oil filter <input type="checkbox"/> Rotate tires ___ Fuel lines and connections, fuel tank band and fuel tank vapor vent system hoses ___ Fuel tank cap gasket ___ Limited-slip differential oil (4WD Highlander, 4WD RAV4)² ___ Manual transmission oil (Tacoma, Tundra) ___ Rear differential oil (all models except 2WD Highlander and 2WD RAV4) ___ Steering gear box ___ Steering linkage and boots ___ Transfer case oil (4WD models) |
|--|---|

Additional Maintenance Items for Special Operating Conditions:¹

- Inspect nuts and bolts on chassis and body
- Replace automatic transmission fluid (all models except Highlander and RAV4)
- Replace front differential oil (2WD RAV4 w/ manual transmission; all 4WD except RAV4 w/ automatic transmission and Highlander)
- Replace manual transmission oil
- Replace rear differential oil (including limited-slip)
- Replace transfer case oil (4WD models)

DEALER SERVICE VERIFICATION:

DATE:

MILEAGE:

¹ Specific services apply to specific operating conditions. See pages 18–19 for details.

² If vehicle is equipped with limited-slip differential.

³ Required under the terms of the Emission Control Warranty.

5,000-Mile Maintenance Intervals

7,500-Mile Maintenance Intervals

To determine the appropriate maintenance interval for your vehicle, see page 16.

95,000 Miles or 76 Months

- Replace engine oil and oil filter
- Additional Maintenance Items for Special Operating Conditions:¹**
- Inspect the following:
 - ___ Ball joints and dust covers
 - ___ Brake linings/drums and brake pads/discs
 - ___ Drive shaft boots (Highlander; Land Cruiser; RAV4; 4WD Sequoia, Tacoma, Tundra and 4Runner)
 - ___ Engine air filter
 - ___ Nuts and bolts on chassis and body
 - ___ Steering linkage and boots
- Lubricate propeller shaft (all 4WD except Highlander and RAV4)
- Replace rear differential oil (Sequoia)
- Re-torque drive shaft bolt (Highlander, 4WD RAV4)
- Re-torque propeller shaft bolt (all models except Highlander and RAV4)
- Rotate tires

DEALER SERVICE VERIFICATION:

DATE:

MILEAGE:

100,000 Miles or 80 Months

- Replace engine oil and oil filter
- Additional Maintenance Items for Special Operating Conditions:¹**
- Inspect the following:
 - ___ Ball joints and dust covers
 - ___ Brake linings/drums and brake pads/discs
 - ___ Drive shaft boots (Highlander; Land Cruiser; RAV4; 4WD Sequoia, Tacoma, Tundra and 4Runner)
 - ___ Engine air filter
 - ___ Nuts and bolts on chassis and body
 - ___ Steering linkage and boots
- Lubricate propeller shaft (all 4WD except Highlander and RAV4)
- Replace air conditioning filter (Highlander, RAV4)
- Replace rear differential oil (Sequoia)
- Re-torque drive shaft bolt (Highlander, 4WD RAV4)
- Re-torque propeller shaft bolt (all models except Highlander and RAV4)
- Rotate tires

DEALER SERVICE VERIFICATION:

DATE:

MILEAGE:

97,500 Miles or 78 Months

- Replace engine oil and oil filter
- Rotate tires

DEALER SERVICE VERIFICATION:

DATE:

MILEAGE:

105,000 Miles or 84 Months

105,000 Miles or 84 Months

- Replace engine oil and oil filter
- Lubricate propeller shaft (all 4WD except Highlander and RAV4)
- Re-torque drive shaft bolt (Highlander, 4WD RAV4)
- Re-torque propeller shaft bolt (all models except Highlander and RAV4)
- Rotate tires
- Inspect the following:
 - Ball joints and dust covers
 - Brake lines and hoses
 - Brake linings/drums and brake pads/discs
 - Drive belts
 - Drive shaft boots
 - Drive shaft boots (Highlander; Land Cruiser; RAV4; 4WD Sequoia, Tacoma, Tundra and 4Runner)
 - Exhaust pipes and mountings
 - Front differential oil (all 4WD except Highlander and RAV4)
 - Limited-slip differential oil (Land Cruiser, 4WD Highlander, 4WD RAV4)²
 - Rear differential oil (all models except 2WD Highlander and 2WD RAV4)
 - Steering gear box
 - Steering linkage and boots
 - Transfer case oil (4WD Highlander, 4WD RAV4)

Additional Maintenance Items for Special Operating Conditions:¹

- Inspect automatic transmission fluid (Land Cruiser, Sequoia, Tacoma, Tundra, 4Runner)
- Inspect engine air filter
- Inspect nuts and bolts on chassis and body
- Replace front differential oil (all 4WD except Highlander and RAV4)
- Replace rear differential oil (including limited-slip)
- Replace transfer case oil (4WD Highlander, 4WD RAV4)

DEALER SERVICE VERIFICATION:

DATE:

MILEAGE:

¹ Specific services apply to specific operating conditions. See pages 18–19 for details.

² If vehicle is equipped with limited-slip differential.

5,000-Mile Maintenance Intervals

7,500-Mile Maintenance Intervals

To determine the appropriate maintenance interval for your vehicle, see page 16.

110,000 Miles or 88 Months

- Replace engine oil and oil filter

Additional Maintenance Items for Special Operating Conditions:¹

- Inspect the following:
 - ___ Ball joints and dust covers
 - ___ Brake linings/drums and brake pads/discs
 - ___ Drive shaft boots (Highlander; Land Cruiser; RAV4; 4WD Sequoia, Tacoma, Tundra and 4Runner)
 - ___ Engine air filter
 - ___ Nuts and bolts on chassis and body
 - ___ Steering linkage and boots
- Lubricate propeller shaft (all 4WD except Highlander and RAV4)
- Replace air conditioning filter (Highlander, RAV4)
- Replace rear differential oil (Sequoia)
- Re-torque drive shaft bolt (Highlander, 4WD RAV4)
- Re-torque propeller shaft bolt (all models except Highlander and RAV4)
- Rotate tires

DEALER SERVICE VERIFICATION:

DATE:

MILEAGE:

115,000 Miles or 92 Months

- Replace engine oil and oil filter

Additional Maintenance Items for Special Operating Conditions:¹

- Inspect the following:
 - ___ Ball joints and dust covers
 - ___ Brake linings/drums and brake pads/discs
 - ___ Drive shaft boots (Highlander; Land Cruiser; RAV4; 4WD Sequoia, Tacoma, Tundra and 4Runner)
 - ___ Engine air filter
 - ___ Nuts and bolts on chassis and body
 - ___ Steering linkage and boots
- Lubricate propeller shaft (all 4WD except Highlander and RAV4)
- Replace rear differential oil (Sequoia)
- Re-torque drive shaft bolt (Highlander, 4WD RAV4)
- Re-torque propeller shaft bolt (all models except Highlander and RAV4)
- Rotate tires

DEALER SERVICE VERIFICATION:

DATE:

MILEAGE:

112,500 Miles or 90 Months

- Replace air conditioning filter (Highlander, RAV4)²
- Replace engine oil and oil filter
- Rotate tires

DEALER SERVICE VERIFICATION:

DATE:

MILEAGE:

120,000 Miles or 96 Months

120,000 Miles or 96 Months

- | | |
|---|---|
| <ul style="list-style-type: none"> <input type="checkbox"/> Replace engine air filter <input type="checkbox"/> Replace engine coolant <input type="checkbox"/> Lubricate propeller shaft (all 4WD except Highlander and RAV4) <input type="checkbox"/> Lubricate wheel bearings and drive shaft bearings (Land Cruiser) <input type="checkbox"/> Replace limited-slip differential oil (Highlander, Land Cruiser, RAV4)³ <input type="checkbox"/> Replace spark plugs (all models)⁴ <input type="checkbox"/> Re-torque drive shaft bolt (Highlander, 4WD RAV4) <input type="checkbox"/> Re-torque propeller shaft bolt (all models except Highlander and RAV4) <input type="checkbox"/> Inspect the following: <ul style="list-style-type: none"> ___ Automatic transmission fluid ___ Ball joints and dust covers ___ Brake lines and hoses ___ Brake linings/drums and brake pads/discs ___ Drive belts ___ Drive shaft boots (Highlander; Land Cruiser; RAV4; 4WD Sequoia, Tacoma, Tundra and 4Runner) ___ Engine valve clearance ___ Exhaust pipes and mountings ___ Front differential oil (4WD models, Highlander, RAV4) | <ul style="list-style-type: none"> <input type="checkbox"/> Replace engine oil and oil filter <input type="checkbox"/> Rotate tires ___ Fuel lines and connections, fuel tank band and fuel tank vapor vent system hoses ___ Fuel tank cap gasket ___ Manual transmission oil (Tacoma, Tundra) ___ Rear differential oil (all models except 2WD Highlander and 2WD RAV4) ___ Steering gear box ___ Steering linkage and boots ___ Transfer case oil (4WD models) |
|---|---|

Additional Maintenance Items for Special Operating Conditions:¹

- Inspect nuts and bolts on chassis and body
- Replace air conditioning filter (Highlander, RAV4)
- Replace front differential oil
- Replace rear differential oil (including limited-slip)
- Replace transmission fluid or oil
- Replace transfer case oil (4WD models)

DEALER SERVICE VERIFICATION:

DATE:

MILEAGE:

¹ Specific services apply to specific operating conditions. See pages 18–19 for details.

² Do not replace if replaced at 110,000 miles/88 months.

³ If vehicle is equipped with limited-slip differential.

⁴ Required under the terms of the Emission Control Warranty.

