

HANDBOOK



PEUGEOT ION



On-line handbook

Select one of the following means of access to view your handbook on-line...

Find your handbook on the PEUGEOT website, under "MyPEUGEOT".

This personal space offers advice and other useful information for the care and maintenance of your vehicle.

Referring to the handbook on-line also gives you access to the latest information available, easily identified by the bookmark, associated with this symbol:



Scan this code for direct access to your handbook.



 If the "MyPEUGEOT" function is not available on the PEUGEOT public website for your country, you can find your handbook at the following address:
<http://public.servicebox.peugeot.com/ddb/>

Select:

- > the language,
- > the vehicle, its body style,
- > the print edition of your handbook appropriate for the date of registration of your vehicle.

Welcome

This handbook describes all of the equipment available in the whole range.

Your vehicle will be fitted with some of the equipment described in this document, depending on its trim level, version and the specification for the country in which it is sold.

The descriptions and illustrations are given without any obligation. Automobiles PEUGEOT reserves the right to modify the technical specifications, equipment and accessories without having to update this edition of the handbook.

This document is an integral part of your vehicle. It should be passed on to the new user in the event of sale or transfer.

Thank you for choosing an ION, a symbol of confidence, passion and inspiration.

ION is the first 100% electric vehicle for PEUGEOT, with 0% pollutant emissions when driving and particularly quiet. This handbook has been designed to enable you to make the most of your ION in all circumstances.

Key

 safety warning

 additional information

 contributes to the protection of the environment

<hr style="border: 1px solid #808080;"/> <p>Overview ■</p>	<hr style="border: 1px solid #808080;"/> <p>Access 2</p>	<hr style="border: 1px solid #808080;"/> <p>Lighting and visibility 4</p>
	<p>Remote control key 25</p> <p>Doors 28</p> <p>Boot 29</p> <p>Electric windows 30</p> <p>Charging flaps 31</p>	<p>Lighting controls 53</p> <p>Automatic illumination of headlamps 55</p> <p>Headlamp adjustment 56</p> <p>Wiper control 56</p> <p>Courtesy lamp 57</p>
<hr style="border: 1px solid #808080;"/> <p>Eco-driving ■</p>		
<hr style="border: 1px solid #008080;"/> <p>Instruments 1</p>	<hr style="border: 1px solid #008080;"/> <p>Ease of use and comfort 3</p>	<hr style="border: 1px solid #808080;"/> <p>Safety 5</p>
<p>Instrument panel 10</p> <p>Indicator and warning lamps 11</p> <p>Operation indicator lamps 12</p> <p>Main battery state of charge indicator 19</p> <p>Energy consumption / generation indicator 20</p> <p>Distance recorder 21</p> <p>Trip distance recorder 21</p> <p>Lighting dimmer 22</p> <p>Service indicator 22</p> <p>Range indicator 24</p>	<p>Front seats 32</p> <p>Rear seats 34</p> <p>Mirrors 36</p> <p>Interior fittings 38</p> <p>Ventilation 41</p> <p>Heating 43</p> <p>Air conditioning 43</p> <p>Front demist - defrost 46</p> <p>Rear screen demist - defrost 46</p> <p>Remote control 47</p>	<p>General safety recommendations 58</p> <p>Hazard warning lamps 59</p> <p>Automatic operation of brake lamps 59</p> <p>Horn 59</p> <p>Pedestrian horn 60</p> <p>Emergency or assistance 61</p> <p>Braking assistance systems 63</p> <p>Trajectory control systems 65</p> <p>Engine brake reduction indicator lamp 66</p> <p>Front seat belts 67</p> <p>Airbags 70</p> <p>Child seats 74</p> <p>Deactivating the passenger front airbag 77</p> <p>ISOFIX child seats 83</p> <p>Child lock 86</p>

Driving

6

Driving recommendations	87
Starting - stopping the vehicle	88
Parking brake	89
Drive selector	90
Under-inflation detection	92

In the event of a breakdown

8

Ancillaries battery	113
Temporary puncture repair kit	117
Spare wheel	121
Snow chains	125
Changing a bulb	126
Changing a fuse	134
Towing the vehicle	139

Audio equipment and telematics

Audio system / Bluetooth	145
KENWOOD - KDC-X7000DAB	163

Practical information

7

Charging the main battery	97
Bonnet	106
Front compartment	107
Rear compartment	108
Checking levels	109
Checks	111
Changing a wiper blade	112
Precautions for washing	112

Technical data

9

Motor and main battery	140
Weights	141
Dimensions	142
Identification markings	143

Alphabetical index

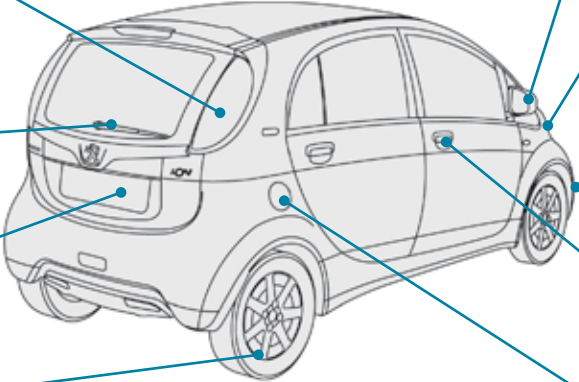
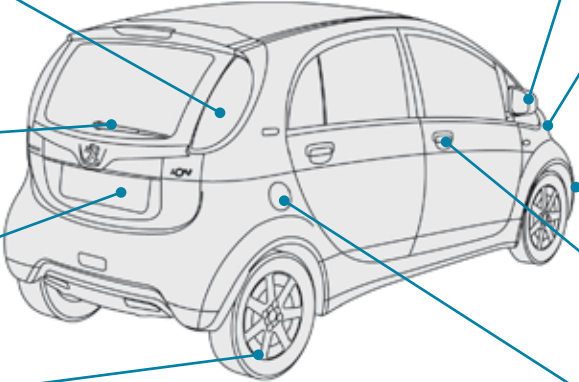
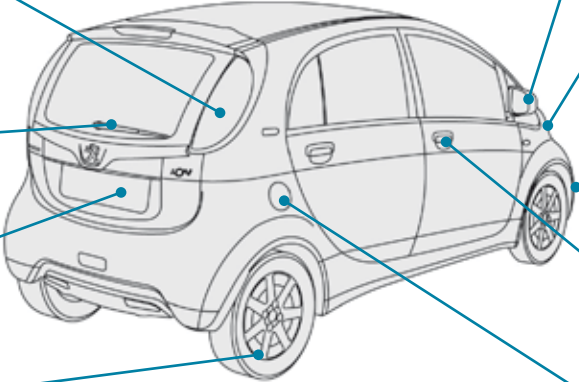
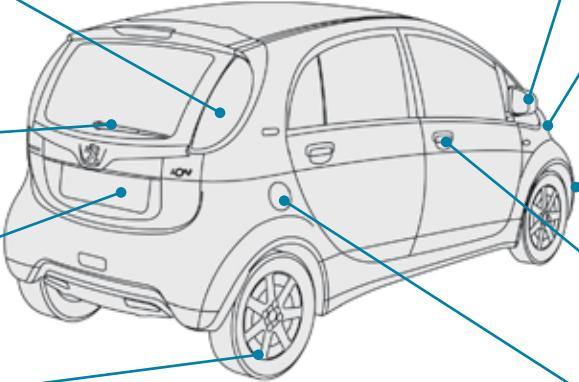

Exterior

<p>Remote control key 25-27</p> <ul style="list-style-type: none"> - unfolding / folding the key - unlocking / locking the vehicle - anti-theft protection <p>Starting - Stopping the vehicle 88</p>		<p>Remote control 47-52</p>
<p>Changing bulbs 131-133</p> <ul style="list-style-type: none"> - rear lamps - 3rd brake lamp - number plate lamps - foglamp 		<p>Door mirrors 36</p> <p>Lighting 53-55</p> <p>Headlamp height adjustment 56</p> <p>Changing bulbs 126-131</p> <ul style="list-style-type: none"> - front lamps - foglamps - daytime running lamps - direction indicator repeaters
<p>Wipers 56-57</p> <p>Changing a wiper blade 112</p>		<p>Towing 139</p>
<p>Boot 29</p> <ul style="list-style-type: none"> - opening / closing 		<p>Doors 28</p> <ul style="list-style-type: none"> - opening / closing <p>Electric windows 30</p>
<p>ABS, EBF, EBA, ASR, ESP 63-65</p> <p>Tyre pressures 143</p> <p>Under-inflation detection 92-95</p> <p>Changing a wheel 121-124</p> <p>Snow chains 125</p>		<p>Charging flaps 31</p> <p>Charging the main battery 97-105</p> <ul style="list-style-type: none"> - normal - fast

Interior

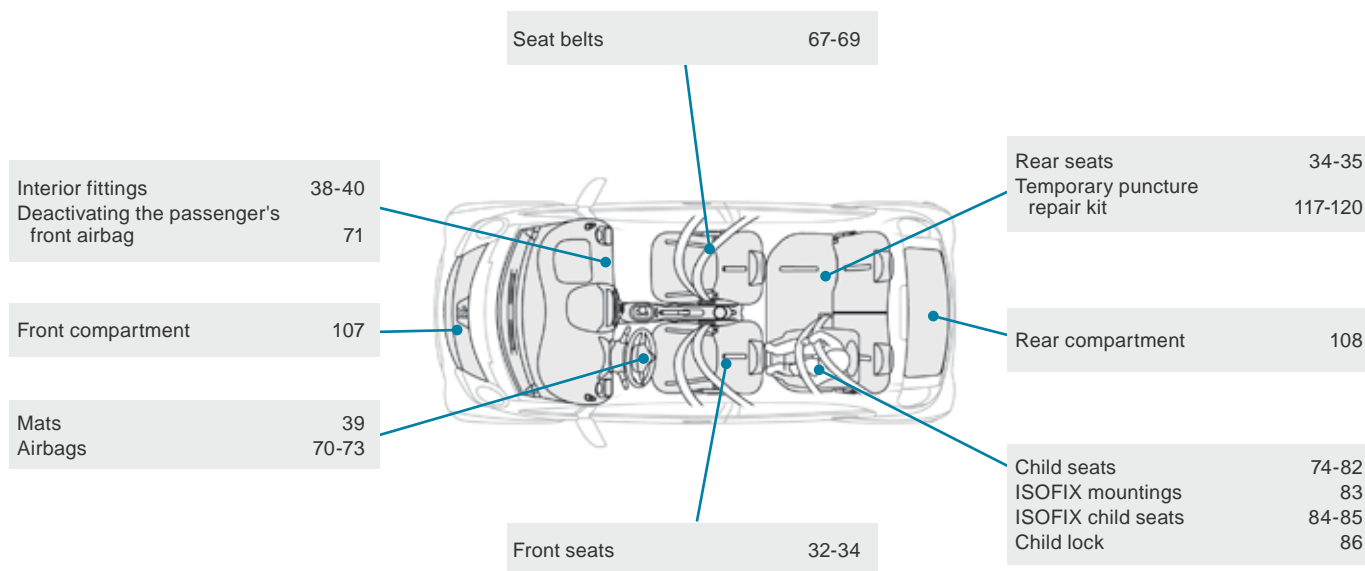

Instruments and controls

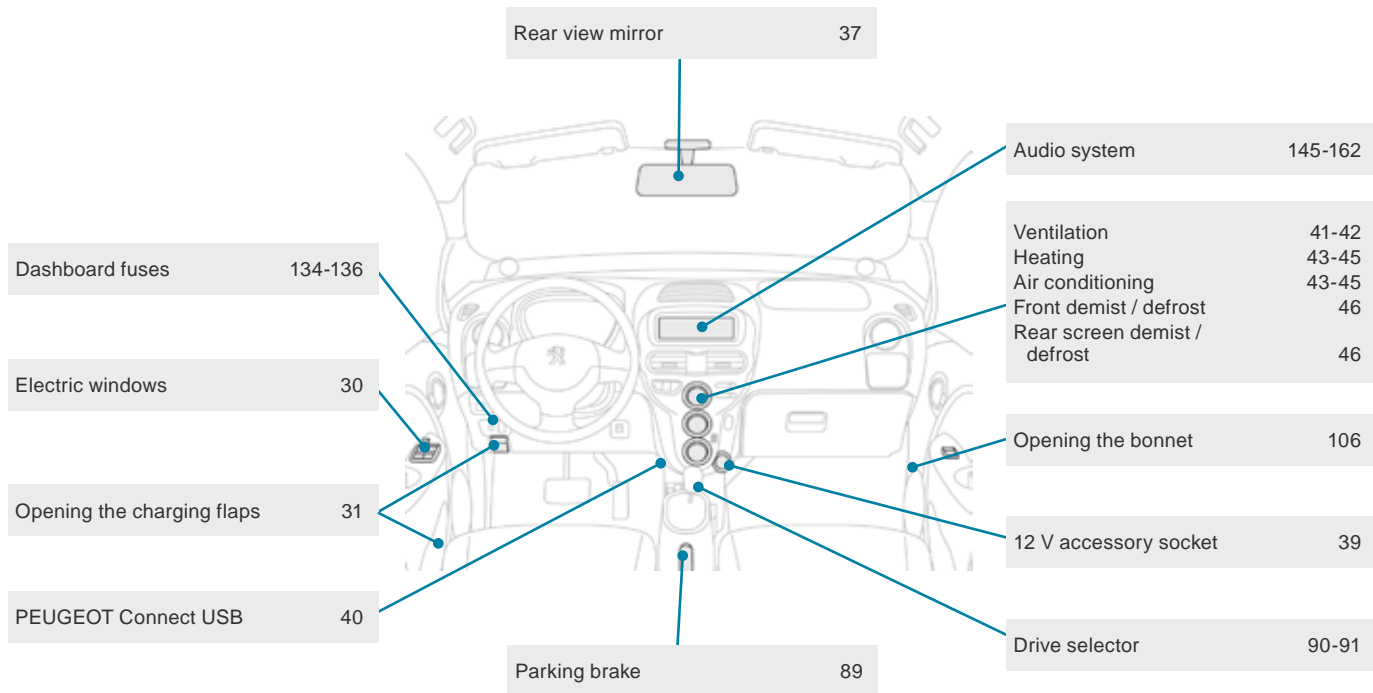

Instruments and controls (continued)

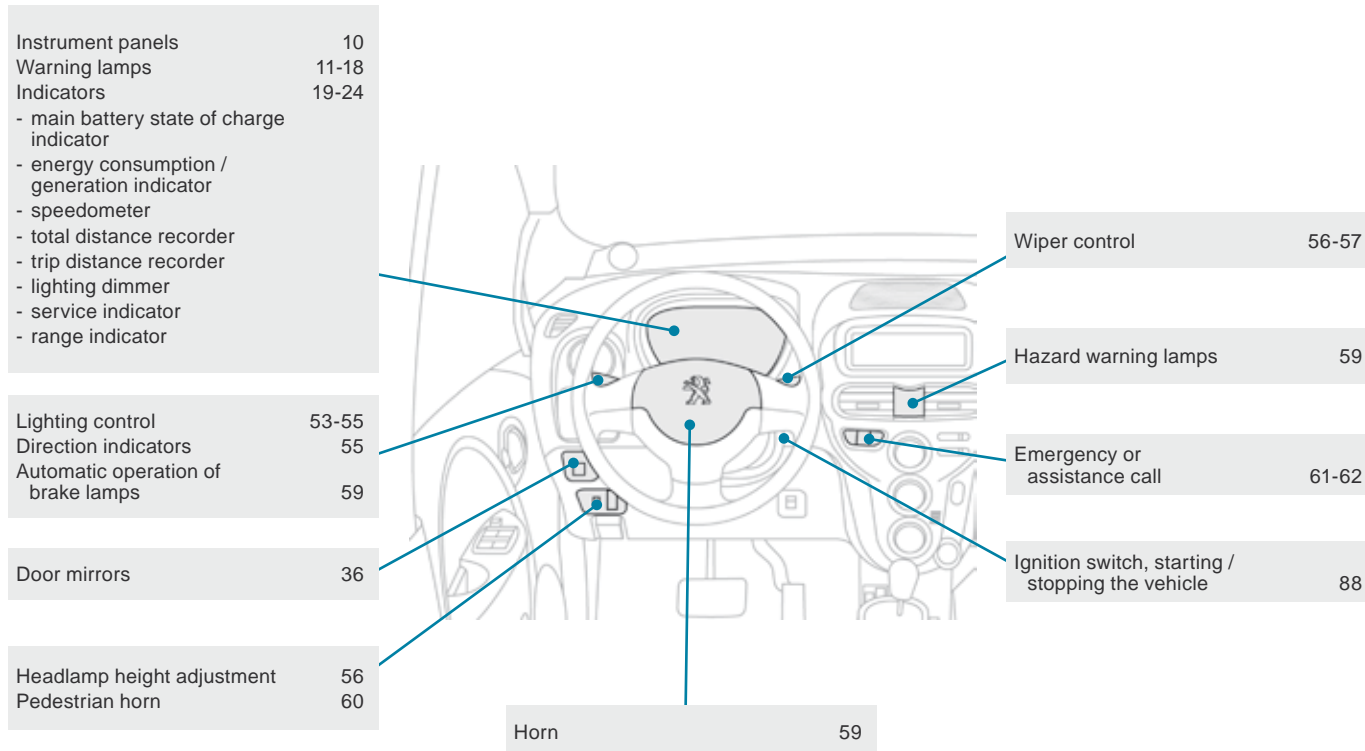

Technical data - Maintenance

Front compartment	107
Checking levels	109-110
- 12 V battery electrolyte	
- brake fluid	
- heating system fluid	
- screenwash fluid	
Checking components	111

Changing front bulbs 126-131

12 V battery 113-116

Front compartment fuses 134, 137-138

Opening the bonnet 106
Electric motor 140

Rear compartment 108
Checking the coolant level 110

Weights 141

Dimensions 142
Identification markings 143

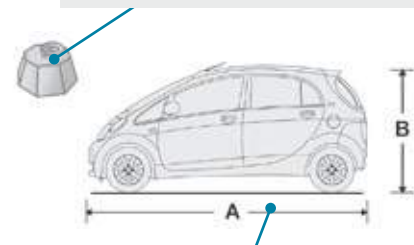
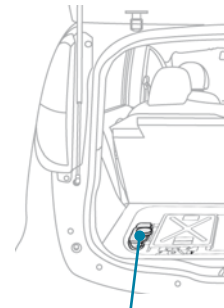
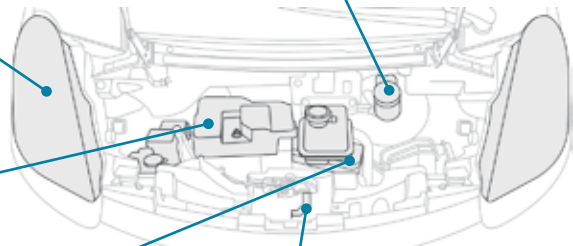

For more economical driving, and increased range

Practical advice for everyday use to optimise the range of your vehicle by conserving battery power.

Adopt a smooth driving style

The electrical consumption of your vehicle depends greatly on your journey, your driving style and your speed.

In all cases, adopt a smooth driving style.



Stay in the "Eco" zone indicated in the energy consumption / generation meter: depress the accelerator pedal progressively, without sudden movement, and if the conditions permit, drive at steady and moderate speed.

Recover energy

Anticipating the driving conditions allows you to recover energy and increase the range of your vehicle.

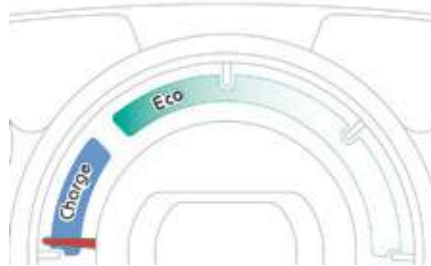

Use the "Charge" zone of the energy consumption / generation meter whenever possible: anticipate the traffic slowing down and if the conditions permit, use deceleration rather than the brakes.

Control the use of your electrical equipment

The heating and air conditioning systems operate on energy from the main battery. Excessive use of these systems greatly reduces the range of your vehicle. Remember to switch them off once the desired level of comfort is reached and check their settings every time you set off.

Control also the use of demisting / defrosting and the heated seat.

Limit the causes of excess consumption

As with any vehicle, limit the loads carried in the vehicle and reduce wind resistance (windows open above 30 mph (50 km/h), roof bars, roof box, etc.).

Observe the recommendations on maintenance

Check the tyre pressures regularly and follow the schedule for routine servicing recommended by PEUGEOT.

Instrument panel

Panel bringing together the various gauges and indicators for the operation of the vehicle.

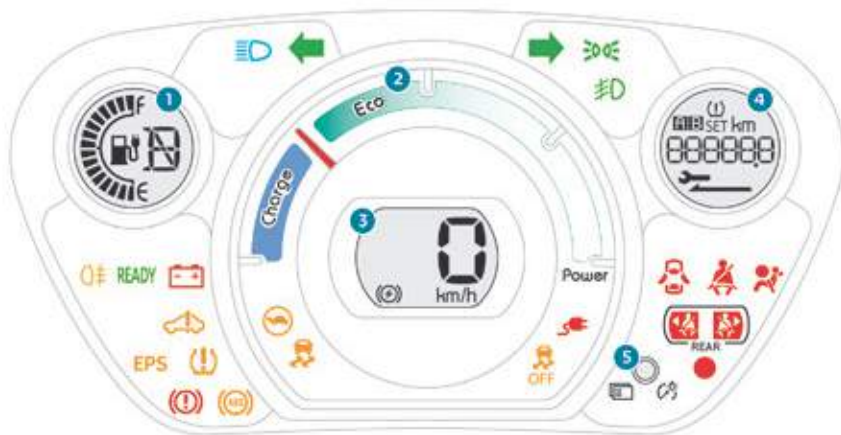

Gauges and indicators

- State of charge indicator for the main battery.**
Drive selector position indicator.
- Energy consumption / generation indicator.**
- Speedometer.**
Temporary engine brake reduction indicator.
- Screen.**
Display the various functions in turn.
Reset the function selected (trip recorder or service indicator).
Adjust the level of the lighting dimmer.
- Screen control button.**
Reset the function selected (trip recorder or service indicator).
Adjust the level of the lighting dimmer.

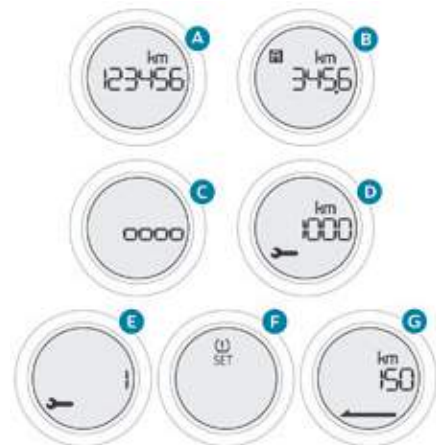

Screen

- Total distance recorder.
- Trip distance recorder (Trip A or B).
- Instrument panel lighting dimmer.
- Distance remaining to the next service.
- Time remaining to the next service.
- Under-inflation detection.
- Remaining range.

Indicator and warning lamps

Visual indicators informing the driver that a system is in operation, is deactivated or has a fault.

When the ignition is switched on

Certain warning lamps come on for a few seconds when the vehicle's ignition is switched on.

These same warning lamps go off after a few seconds.

If you notice one of these warning lamps remaining on, refer to the information on the warning lamp in question.

Associated warnings

The illumination of certain warning lamps may be accompanied by an audible signal.







The warning lamps may come on continuously (fixed) or flash.





Certain warning lamps may come on in one of two modes. Only by relating the type of lighting to the operating status of the vehicle can it be ascertained whether the situation is normal or whether a fault has occurred.

Operation indicator lamps



If one of the following indicator lamps comes on in the instrument panel, this confirms that the corresponding system has come into operation.

Warning / indicator lamp		State	Cause	Action / Observations
	Left-hand direction indicator	Flashing with audible signal.	The lighting stalk is pushed down.	
	Right-hand direction indicator	Flashing with audible signal.	The lighting stalk is pushed up.	
	Hazard warning lamps	Flashing with audible signal.	The hazard warning lamps switch, located on the dashboard, has been operated.	The left-hand and right-hand direction indicators and their associated indicator lamps flash simultaneously.
	Sidelamps and/or dipped beam headlamps	On fixed.	The sidelamps and/or dipped beam headlamps are on.	
	Main beam headlamps	On fixed.	The lighting stalk is pulled towards you.	Pull the stalk to return to dipped beam headlamps.
	Front foglamps	On fixed.	The front foglamps are switched on.	Turn the ring on the stalk rearwards twice to switch off the front foglamps.
	Rear foglamp	On fixed.	The rear foglamp is switched on.	Turn the ring on the stalk rearwards to switch off the rear foglamp.

Warning / indicator lamp		State	Cause	Action / Observations
	Ready (ready to move off)	On fixed, accompanied by an audible signal when it comes on.	The vehicle is ready to move off and you can press the accelerator.	The illumination period corresponds to the powering-up of the vehicle.
	Parking brake	On fixed.	The parking brake is applied or not properly released.	Release the parking brake to switch off the warning lamp, keeping your foot on the brake pedal. Observe the safety recommendations. For more information on the Parking brake , refer to the corresponding section.
	Main battery charge (normal or fast)	On fixed.	The main battery is on charge.	On completion of the charge, the lamp goes off.
		Flashing.	The charging cable is connected to the vehicle but the main battery is not yet charging.	Check the connection of the charging cable.

Deactivation indicator lamps

If one of the following indicator lamps comes on, this confirms that the corresponding system has been switched off intentionally. This may be accompanied by an audible signal.



Warning / indicator lamp		State	Cause	Action / Observations
	Passenger's airbag system	On fixed, on the centre console.	The control switch, located in the glove box, is set to the OFF position. The passenger's front airbag is deactivated.	Set the control switch to the ON position to activate the passenger's front airbag. In this case, do not fit a child seat in the rear-facing position. Remember to check the state of the control switch before starting your vehicle.
	ESP/ASR	On fixed.	The ESP/ASR off switch, located at the bottom of the dashboard (driver's side) is activated. The ESP/ASR is deactivated. ESP: electronic stability programme ASR: anti-slip regulation.	Press the button to activate the ESP/ASR. The ESP/ASR system is automatically activated on starting the vehicle.





Warning lamps





When the engine is running or the vehicle is being driven, illumination of one of the following warning lamps indicates a fault which requires action on the part of the driver.





Any fault resulting in the illumination of a warning lamp must be investigated further.

If you encounter any problems, do not hesitate to contact a PEUGEOT dealer or a qualified workshop.

Warning / indicator lamp		State	Cause	Action / Observations
	Braking	On fixed.	The braking system fluid level has dropped significantly. or Braking assistance system fault.	You must stop as soon as it is safe to do so. Top up with brake fluid listed by PEUGEOT. If the problem persists, have the system checked by a PEUGEOT dealer or qualified workshop.
+ 		On fixed, associated with the ABS warning lamp.	The electronic brake force distribution (EBFD) system has a fault.	You must stop as soon as it is safe to do so. Have it checked by a PEUGEOT dealer or a qualified workshop.
	Anti-lock Braking System (ABS)	On fixed.	The anti-lock braking system has a fault.	The vehicle retains conventional braking. Drive carefully at reduced speed and contact a PEUGEOT dealer or a qualified workshop without delay.

Warning / indicator lamp		State	Cause	Action / Observations
	Electronic stability programme and anti-slip regulation (ESP/ASR)	Flashing.	Activation of the ESP/ASR systems.	The systems optimise traction and improve the directional stability of the vehicle. Adapt your driving and moderate your speed.
		On fixed.	Fault in the ESP/ASR systems.	Have it checked by a PEUGEOT dealer or a qualified workshop.
+ 				
EPS	Electric power steering	On fixed.	The electric power steering has a fault.	Drive carefully at reduced speed. Have it checked by a PEUGEOT dealer or a qualified workshop.
	12 V battery charge	On fixed.	The 12 V battery charging circuit has a fault (dirty or loose terminals, slack, transformer fault, etc.).	The warning lamp should go off when the motor is started. If it does not go off, contact a PEUGEOT dealer or qualified workshop.
	Door(s) open	On fixed, accompanied by an audible signal.	A door or the boot is still open.	Close the door or boot.

Warning / indicator lamp	State	Cause	Action / Observations	
	Under-inflation	On fixed.	Check the tyre pressures as soon as possible. This check should preferably be done with the tyres cold. You must reinitialise the system after every adjustment of one or more tyre pressures and after replacing one or more wheels. For more information on the Under-inflation detection , refer to the corresponding section.	
		Flashing then fixed.	The system has a fault and/or one or more wheels does not have a detected sensor.	The tyre pressures are no longer monitored. Have the system checked by a PEUGEOT dealer or a qualified workshop.
	Front seat belt not fastened / unfastened	On fixed, then flashing, accompanied by an audible signal.	The driver and/or the front passenger has not fastened or has unfastened their seat belt.	Pull the strap, then insert the tongue in the buckle.
	Right-hand rear seat belt unfastened	On fixed.	The right-hand rear passenger has unfastened their seat belt.	Pull the strap then insert the tongue in the buckle.
	Left-hand rear seat belt unfastened	On fixed.	The left-hand rear passenger has unfastened their seat belt.	

Warning / indicator lamp		State	Cause	Action / Observations
	Airbags	On temporarily.	When you switch on the ignition, this warning lamp comes on for a few seconds, then goes off.	If it does not go off, contact a PEUGEOT dealer or a qualified workshop.
		On fixed.	Fault with one of the airbag or seat belt pretensioner systems.	Have it checked by a PEUGEOT dealer or a qualified workshop.
	Protection system for the main battery	On fixed.	The state of charge of the main battery is too low or the temperature of the main battery is too low...	The power from the motor is limited. Charge the main battery as soon as possible. If the warning lamp does not go off, contact a PEUGEOT dealer or qualified workshop.
	Self-diagnosis system of the main electrical circuit	On fixed.	Fault in the main electrical circuit.	You must stop as soon as it is safe to do so. Have it checked by a PEUGEOT dealer or a qualified workshop.
	Reduction of the engine brake	Flashing.	The main battery is fully charged, the engine brake is reduced temporarily.	Anticipate your braking as much as possible: use the brake pedal to slow down or stop the vehicle.

Main battery state of charge indicator

Display



The state of charge of the main battery is displayed continuously in the instrument panel.

Low energy alerts

Four successive alerts indicate that the energy available in the main battery is dropping to a low level:

- 2 bars of the state of charge gauge in the instrument panel, on and flashing: starting to use the reserve.
- The last bar in the state of charge gauge flashing.
- The last bar disappears: display of the range disappears; the heating and air conditioning are switched off.
-  Display of this warning lamp in the instrument panel: progressive reduction in the power available from the motor.

Energy consumption / generation indicator

A system that informs the driver of the level of energy consumption or generation of the main battery.

"Neutral" position

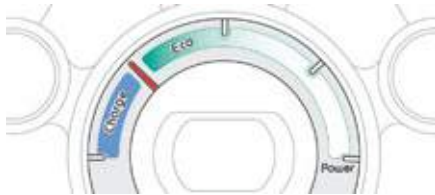

On switching on the ignition, your vehicle neither consumes nor generates energy in its electric traction system: the needle is in the "neutral" position (provided that the heating and air conditioning are off).

Energy consumption

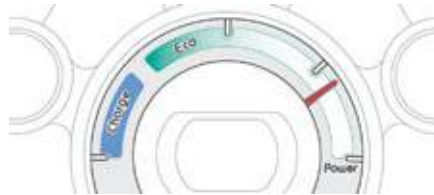

The needle moves to the right in proportion to the energy consumption by the vehicle.

"Charge" zone

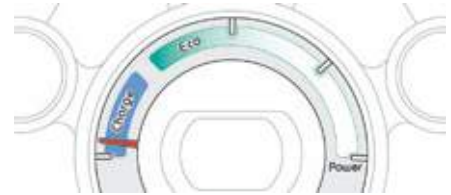

The needle moves to the left in proportion to the level of charge sent to the main battery, during periods of deceleration and braking.

"Eco" zone



The needle is in this zone when the vehicle is used so as to moderate electric consumption and optimise its range.

i In cold weather, the capacity for regeneration via braking is reduced.

Instrument panel screen

When the ignition switch is in the "ON" position, press button **A** repeatedly to display the following information in turn.

Distance recorder



System for measuring the total distance travelled by the vehicle during its life.

Press button **A**.

The total distance appears in the screen.

Trip distance recorder (Trip A or B)



Each of these trip recorders indicates the distance travelled since the last reset.

Press button **A** to display the desired trip.

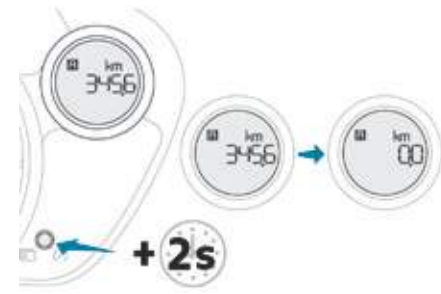

Reset to zero

With the ignition on and either trip **A** or **B** displayed, press the button for more than 2 seconds.

Lighting dimmer

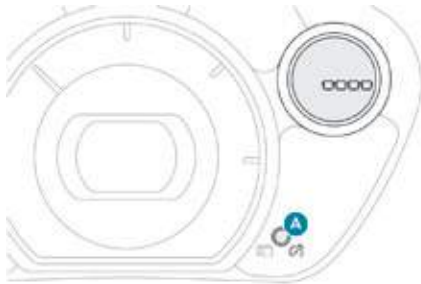

System for manual adjustment of the brightness of the instruments and controls in relation to the exterior brightness.

With the lighting on or off, press button **A** to select the function, then hold down to change the intensity of the lighting of the instruments and controls in "day" or "night" mode.

The intensity of the lighting increases each time button **A** is pressed.

When the lighting reaches the maximum setting, press again to change to the minimum setting.

When the lighting reaches the required intensity, release button **A**.

The setting is saved when you release button **A** and retained when the ignition switch is turned to OFF.

Service indicator

System which informs the driver when the next service is due in accordance with the manufacturer's servicing schedule.

The point at which the next service is due is calculated from the last service indicator zero reset.

This point can be indicated in one of two ways:

- the miles (km) remaining,
- the time remaining to the next service.

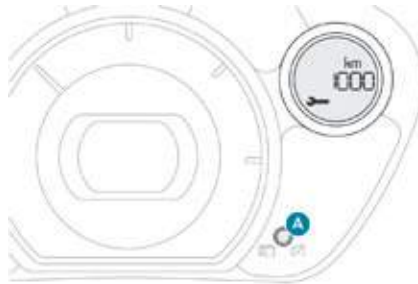

When the ignition is switched on, press button **A** several times in succession until the service indicator is displayed in the desired units.

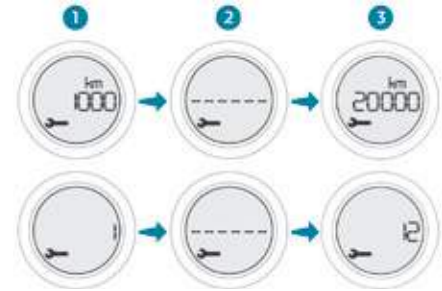

Operation

1. The screen indicates that 620 miles (1000 km) or 1 month remain before the next service.
2. The screen indicates that the date for the service has been exceeded. Every time the ignition is switched on, the service spanner is displayed for a few seconds to remind you that a service should be carried out as soon as possible.
3. Once the service has been carried out, the distance or the number of months to the next service is displayed again.

Resetting the service indicator to zero



After each service, the service indicator should be reset to zero.

The procedure is as follows:

- ☞ Switch off the ignition (switch in the LOCK or ACC position).
- ☞ Press the reset button **A** several times in succession until the service indicator is displayed.
- ☞ Press and hold the reset button for a few seconds until the **spanner flashes**.
- ☞ Press the reset button while the spanner is flashing to change the display from "---" to "**CLEAR**".

The distance (or time) remaining before the next service is due is displayed.

i The display of "---", indicating that the service date has arrived, comes on automatically after a certain time and distance travelled. The screen then indicates the time remaining before the next service is due.

Under-inflation detection



You have to reinitialise the under-inflation detection system after adjusting one or more tyre pressures or after changing one or more wheels.

Carry out the following procedure to do this.

- ☞ Press button **A** to select the system.
- ☞ Press and hold button **A** for **at least 3 seconds**.

There is an audible signal and the under-inflation warning lamp flashes slowly until the initialisation is complete.

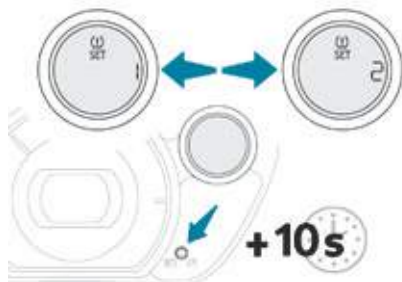

Selecting the set of wheels and tyres fitted

If you have previously registered a second set of wheels and tyres with sensor, you have to select the corresponding set in the instrument panel screen after fitting them.

Carry out the following procedure to do this.

- ☞ Press button **A** to select the system.
- ☞ Press and hold button **A** for **more than 10 seconds**, to change from set of tyres and wheels 1 to set 2 or the other way round.

Range indicator

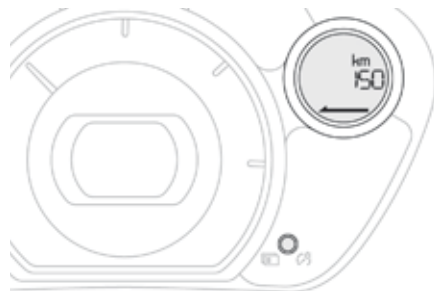

This function gives an estimate of the number of miles (km) that your vehicle can still cover, based on the recent conditions of use (driving style, use of heating, air conditioning...).

i When the remaining range falls to a low level, "--" is displayed in the instrument panel.

Remote control key

System used for centralised locking or unlocking of the vehicle using the door lock barrel or from a distance. It is also used to start the vehicle, as well as providing protection against theft.

Unfolding / Folding the key

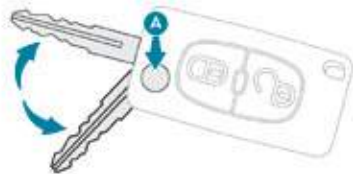

☞ Press button **A** to unfold or fold the key.

Unlocking the vehicle

Unlocking using the remote control



☞ Press the open padlock to unlock the vehicle.

Unlocking is confirmed by the interior lighting which comes on for approximately 15 seconds and the direction indicators which flash **twice**. Depending on version, the door mirrors unfold at the same time.

Unlocking using the key

☞ Turn the key to the right in the **driver's door** lock to unlock the vehicle. Locking is confirmed by the interior lighting which comes on for about 15 seconds and the direction indicators which flash **twice**. On the other hand, the door mirrors do not unfold.



The passenger's door lock barrel does not lock or unlock the other doors and/or the boot.

Locking the vehicle

Normal locking using the remote control



☞ Press the closed padlock to lock the vehicle.

Locking is confirmed by the direction indicators which come on **once**. Depending on version, the door mirrors fold at the same time.

Normal locking using the key

☞ Turn the key to the left in the **driver's door** lock to lock the vehicle. Locking is confirmed by the direction indicators, which flash **once**. On the other hand, the door mirrors do not fold.



The vehicle will lock itself again automatically after thirty seconds unless a door or the boot is opened. This function avoids inadvertent unlocking.

Anti-theft protection

Electronic immobiliser

The key contains an electronic chip which has a special code. When the ignition is switched on, this code must be recognised to permit starting.

This electronic immobiliser locks the control system a few moments after the ignition is switched off and prevents starting by anyone who does not have the key.

In the event of a malfunction and if your vehicle does not start, contact a PEUGEOT dealer as soon as possible.

Remote control problem

In the event of a remote control malfunction, you can neither unlock nor lock your vehicle.

- ☞ First of all, use the key in the driver's door lock to unlock or lock your vehicle.
- ☞ Then, contact a PEUGEOT dealer to check the operation of the remote control and replace the battery if necessary.

! Lost keys

Visit a PEUGEOT dealer with the vehicle's V5 registration document and your personal identification documents.

The PEUGEOT dealer will be able to retrieve the key code and the transponder code required to order a replacement key.

Remote control

The high frequency remote control is a sensitive system; do not operate it while it is in your pocket as there is a possibility that it may unlock the vehicle, without you being aware of it. Do not repeatedly press the buttons of your remote control out of range and out of sight of your vehicle. You run the risk of stopping it from working.

The remote control does not operate when the key is in the ignition, even when the ignition is switched off.

Locking the vehicle

Driving with the doors locked may make access to the passenger compartment by the emergency services more difficult in an emergency.

As a safety precaution (with children on board), remove the key from the ignition when you leave the vehicle, even for a short time.

Anti-theft protection

Do not make any modifications to the electronic immobiliser system; this could cause malfunctions.

When purchasing a second-hand vehicle

Have the key codes memorised by a PEUGEOT dealer, to ensure that the keys in your possession are the only ones which can start the vehicle.

Doors Opening

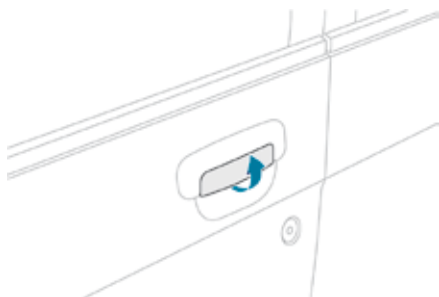

From outside

- ☞ After unlocking the vehicle using the remote control or the key, pull the door handle.

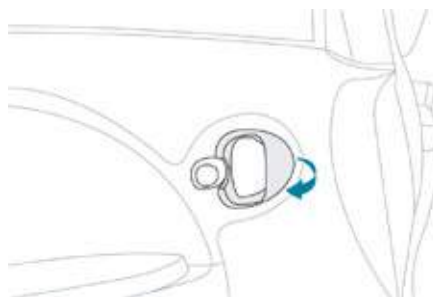

From inside

- ☞ Pull the front or rear door control to open the door.
- If the doors are locked:
- opening the driver's door unlocks the other doors,
 - the front passenger or rear doors must then be unlocked manually using the front locking control before they can be opened.

Locking/ unlocking from the inside

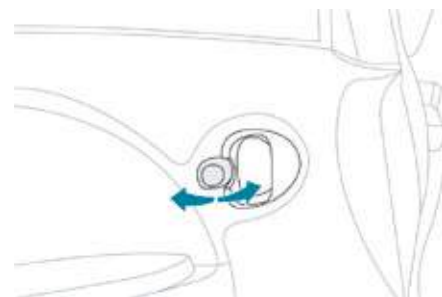

- ☞ Press the button on the driver's door towards the front to lock and towards the rear to unlock the vehicle completely.

! The buttons on the front and rear passenger doors only lock / unlock the door in question.

Closing



If a door or the boot is not closed correctly, this warning lamp comes on in the instrument panel until the door in question or the boot is closed.

Boot Opening



- ☞ After unlocking the vehicle using the remote control or the key, press the handle **A** and open the tailgate.

Closing



- ☞ Pull the handle **B** downwards to guide the tailgate down,
- ☞ release the handle and press the exterior surface of the tailgate gently to close it.

Electric windows

System which opens or closes a window manually or automatically. It is fitted with a deactivation system to prevent misuse of the rear controls.

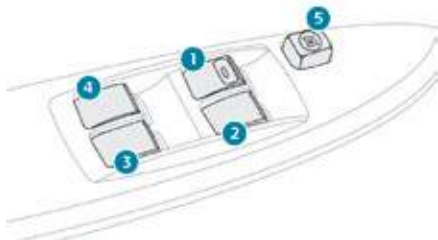

1. Driver's electric window.
2. Passenger's electric window.
3. Rear right electric window.
4. Rear left electric window.
5. Deactivating the passenger and rear electric window switches.

Operation

With the ignition on:

- ☞ Press the switch gently to open or pull it gently to close. The window stops as soon as the switch is released.

Automatic one-touch mode (driver's side)

- ☞ Press the switch fully to open. The driver's window opens completely when the switch is released.
- ☞ Pressing the switch again stops the movement of the window.

i The electric window switches remain operational for approximately 30 seconds after the ignition is switched off. The windows can no longer be opened or closed after the driver's door is closed.

Deactivating the passenger and rear electric window switches

- ☞ For the safety of your children, press switch 5 to prevent operation of the passenger and rear electric windows irrespective of their position.

When the button is pressed down, the switches are deactivated.

When the button is raised, the switches are activated.

! Always remove the key from the ignition when leaving the vehicle, even for a short time. In the event of contact during operation of the windows, you must reverse the movement of the window. To do this, press the switch concerned. When the driver operates the passenger electric window switches, they must ensure that no one is preventing correct closing of the windows. The driver must ensure that passengers use the electric windows correctly. Be aware of children when operating the windows.

Charging flaps

Normal charging

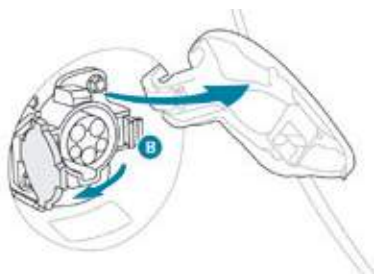
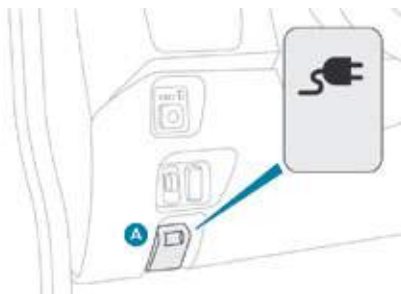

- ☞ Pull control **A** located at the bottom of the dashboard, driver's side, to release the charging flap.
- ☞ Open the access flap on the right of the vehicle.
- ☞ Press latch **B** to open the socket cover.

Fast charging*

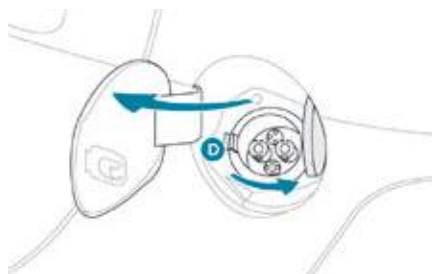
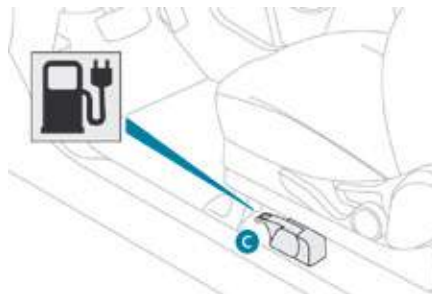

- ☞ Pull control **C** located under the driver's seat, on the door side, to release the flap.
- ☞ Open the flap on the left of the vehicle.
- ☞ Press latch **D** to open the socket cover.

i For more information on **Charging the main battery**, refer to the corresponding section.

2

* Depending on equipment.

Front seats

Manual adjustments

- 1. Adjustable head restraint**
- 2. Adjustment of the backrest angle**
Operate the control lever and adjust the position of the backrest to the front or to the rear.
- 3. Adjustment of the driver's seat height**
Raise or lower the control lever the number of times required to obtain the desired position.
- 4. Forwards-backwards adjustment of the seat position**
Lift the control bar and slide the seat forwards or backwards.



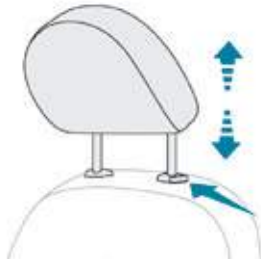

Head restraint height adjustment

- ☞ To raise it, pull upwards.
- ☞ To lower it, push it downwards, pressing the height adjustment button at the same time.
- ☞ To remove it, raise it to the high position, then remove it pressing the height adjustment button at the same time.
- ☞ To refit it, engage the rods of the head restraint in the apertures, pressing the height adjustment button at the same time.



Never drive with the removed head restraints in the vehicle as they could be thrown around the vehicle on sharp braking. They must always be in place and adjusted correctly.

After installing the head restraint, check that the height adjustment button has engaged correctly.

The adjustment is correct when the top of the head restraint is aligned with the top of the head of the seated person.

Heated seat control

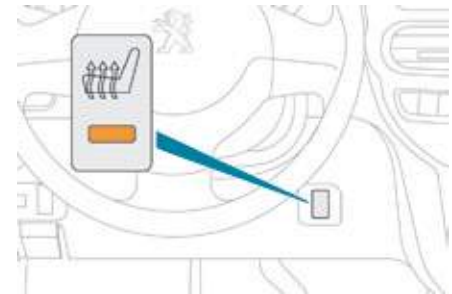

Press the control switch, located on the dashboard, to switch on the driver's seat heating.

The warning lamp in the switch comes on. The temperature is controlled automatically. Pressing a second time stops operation.

- ! Do not use the function if the seat is not occupied.
Reduce the level of heating as soon as possible.
Once the seat and passenger compartment are at a comfortable temperature, you can switch off the function; reducing electric current consumption also reduces fuel consumption.

Prolonged use at the highest setting is not recommended for those with sensitive skin. There is a risk of burns for those that do not have normal perception of heat (illness, taking medicines, etc.).

There is a risk of overheating the system if material with insulating properties is used, such as cushions or seat covers.

Do not use the system:

- if wearing damp clothing,
- if child seats are fitted.

To avoid breaking the heating element in the seat:

- do not place heavy objects on the seat,
- do not kneel or stand on the seat,
- do not place sharp objects on the seat,
- do not spill liquids onto the seat.

To avoid the risk of short-circuit:

- do not use liquid products for cleaning the seat,
- never use the heating function when the seat is damp.

Rear seats

Rear seat comprising two adjustable, foldable backrests and a fixed cushion.

Rear head restraints

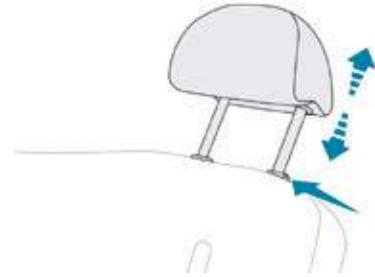

These have a high position (comfort and best safety) and a low position (best rear vision for the driver).

They can also be removed.

To remove a head restraint:

- ☞ pull the head restraint fully upwards,
- ☞ then, press the lug.

- ! When carrying rear passengers, never drive with their head restraints removed; ensure that they are in place and in the high position.

Adjusting the backrest angle



To adjust the backrest:

- ☞ pull the control forwards to release the backrest,
- ☞ adjust the backrest then release the control.

The backrest can be adjusted to one of seven positions.

! Always ensure that the backrest has engaged correctly.

Folding the backrest

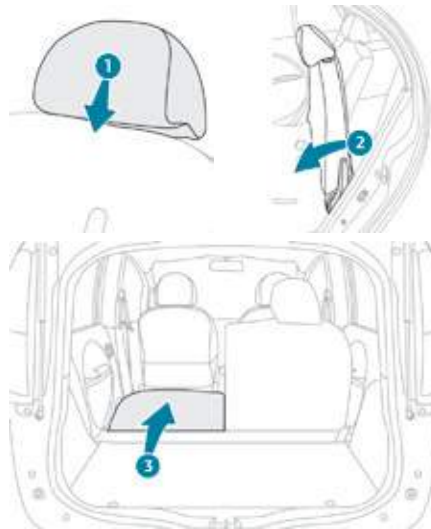

1. place the head restraints in the low position or remove them if necessary,
2. pull the control forwards to release backrest,
3. fold the backrest forward.

Returning the seat backrest to its original position

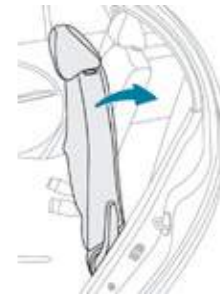

- ☞ push the seat backrest in position and secure it,
- ☞ refit the head restraints or put them back in place.

! When returning the backrest to its original position, take care not to trap the seat belts.

Mirrors

Door mirrors

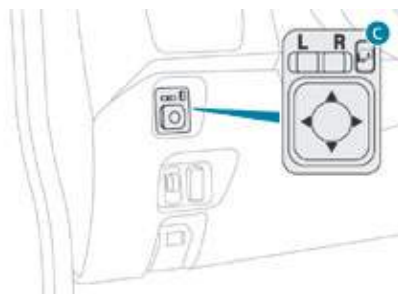
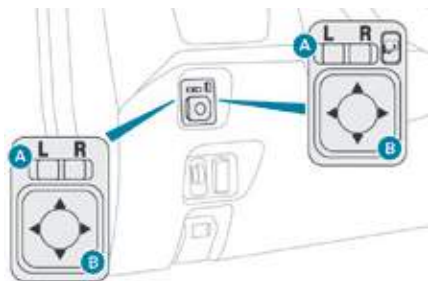

! The mirrors can also be folded manually. However, you must **never unfold them manually**, otherwise the mirrors may not remain in place correctly when driving. Always use control **C** to unfold them.

Adjustment

The mirrors can be adjusted when the ignition switch is in the "ON" or "ACC" position.

- ☞ Move control **A** to the right or to the left to select the corresponding mirror.
- ☞ Direct control **B** in all four directions to adjust the mirror.

When adjustment is complete, return control **A** to the central position.

Electric folding / unfolding*

- ☞ With the ignition switch in the "ON" or "ACC" position: press control **C** to unfold them.
- ☞ With the ignition switch in the "LOCK" position: press control **C** **within 30 seconds** to fold them.

* Depending on version.

Rear view mirror

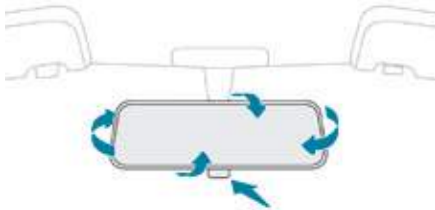

Adjust the mirror by moving it up or down and/or to the left or right.

The rear view mirror has two positions:

- day (normal),
- night (anti-dazzle).

To change from one to the other, push or pull the lever on the lower edge of the mirror.

Interior fittings

1. **Glove box**
2. **Retractable cup holder**
Press the cover to open the cup holder
3. **12 V accessory socket (120 W)**
Observe the maximum power rating to avoid damaging your accessory
4. **Open storage**
5. **PEUGEOT Connect USB**
6. **Door pocket**

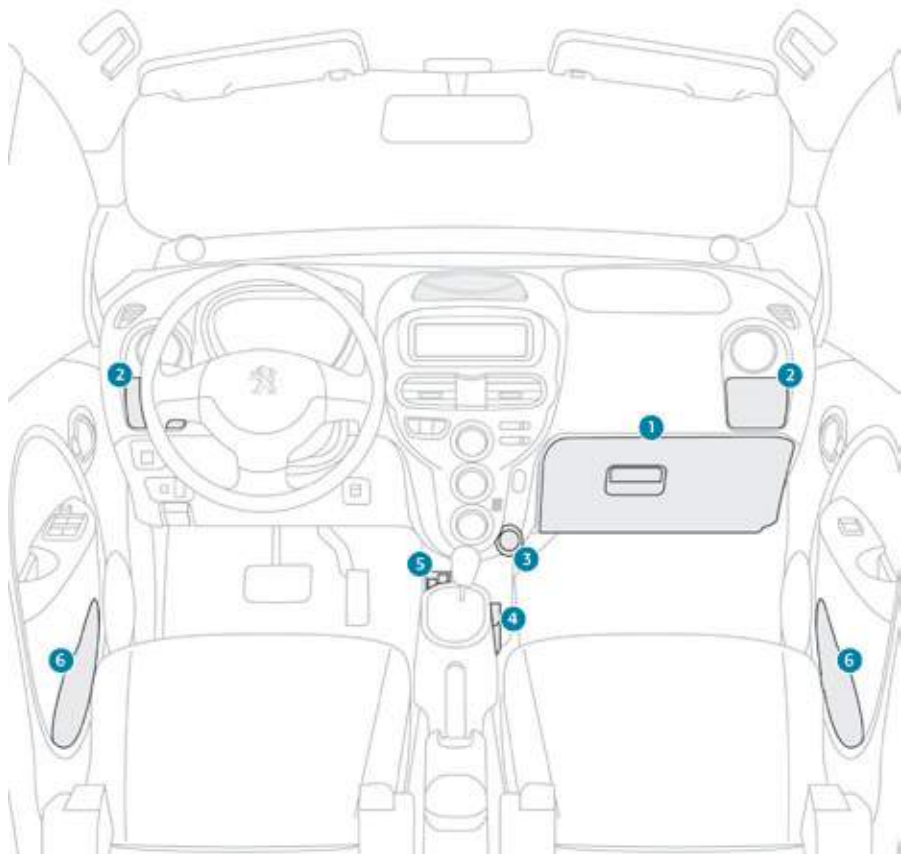

Sun visor

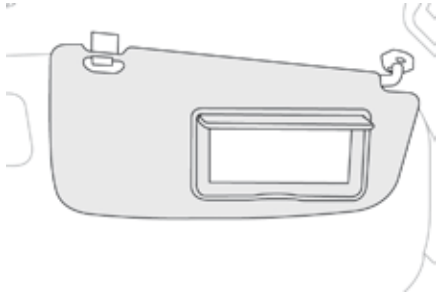

The sun visors fold forwards, and to the side when they are unhooked. They are fitted with a vanity mirror and a ticket holder.

12 V accessory socket

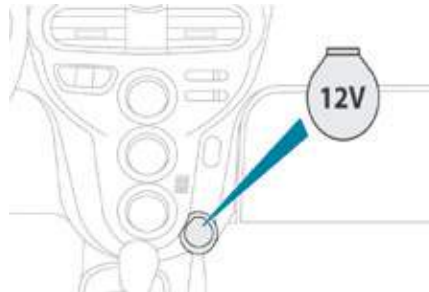

- ☞ To connect a 12 V accessory (max power: 120 W), lift the cover and connect a suitable adaptor.

i The connection of an electrical device not approved by PEUGEOT, such as a USB charger, may adversely affect the operation of vehicle electrical systems, causing faults such as poor telephone reception or interference with displays in the screens.

Mats

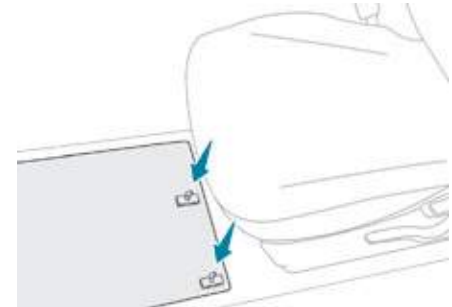

When removing the mat on the driver's side, move back the seat as far as possible and remove the fixings.

When refitting, position the mat correctly on the pins and clip the fixings. Check that the mat is secured firmly.

- !** To prevent any risk of jamming under the pedals:
- only use mats suited to the fixings already present in the vehicle; it is imperative that these fixings are used.
 - never fit one mat on top of another.

PEUGEOT Connect USB



This USB port is located at the bottom of the centre console.

It allows the connection of portable devices, such as a digital audio player of the iPod® type or a USB memory stick.

It reads the audio files which are transmitted to your audio system and played via the vehicle's speakers.

You can manage these files using the audio system controls.

When connected to the USB port, the portable device charges automatically.

i For more information on the use of this system, refer to the **Audio and Telematics** section.

Ventilation

System which creates and maintains good conditions of comfort and visibility in the vehicle's passenger compartment.

Air intake

The air circulating in the passenger compartment is filtered and originates either from the outside via the grille located at the base of the windscreen or from the inside in air recirculation mode.

Controls

The incoming air follows various routes depending on the controls selected.

The temperature control enables you to obtain the level of comfort required by mixing the air of the various circuits.

The air distribution control enables you to select the air vents used in the passenger compartment.

The air flow control enables you to increase or reduce the speed of the ventilation fan.

These controls are grouped together on control panel **A** on the centre console.

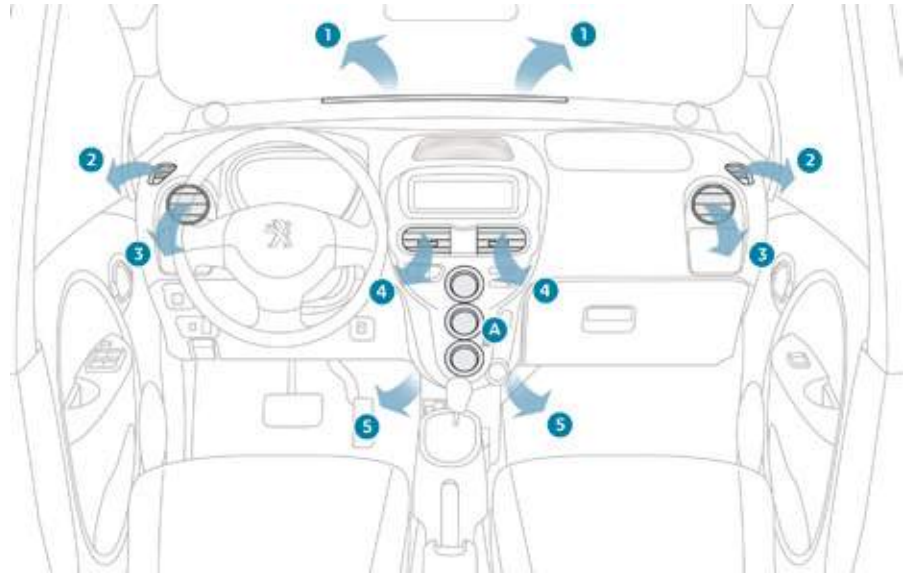

Air distribution

1. Windscreen demisting/defrosting vents.
2. Front side window demisting/defrosting vents.
3. Side adjustable air vents.
4. Central adjustable air vents.
5. Air outlets to the front footwells.

Recommendations for ventilation and air conditioning

- i** In order for these systems to be fully effective, follow the operation and maintenance guidelines below:
- ☞ If the interior temperature remains very high after the vehicle has been parked in the sun for a considerable time, first ventilate the passenger compartment for a few moments by opening the windows.
Place the air flow control at a sufficient level to provide an adequate renewal of air in the passenger compartment.
 - ☞ Condensation created by the air conditioning results in a discharge of water under the vehicle when stationary, which is perfectly normal.
 - ☞ To obtain an even air distribution, take care not to obstruct the exterior air intake grilles located at the base of the windscreen, the nozzles, the vents and the air outlets, as well as the air extractor located in the boot.
 - ☞ Favour the intake of exterior air as prolonged use of the air recirculation may cause misting of the windscreen and the side windows.
 - ☞ Operate the air conditioning system for 5 to 10 minutes, once or twice a month to keep it in good working order.
 - ☞ Ensure that the passenger compartment filter is in good condition and have the filter elements replaced regularly.
 - ☞ To ensure correct operation of the air conditioning system, you are also advised to have it checked regularly.
 - ☞ If the system does not produce cold air, do not use it and contact a PEUGEOT dealer or a qualified workshop.



The heating and air conditioning use energy from the main battery. Their use increases electrical consumption and reduces the range of the vehicle. Remember to switch off the heating or air conditioning as soon as they are no longer needed.



During **normal charging** of the vehicle, the ventilation, heating and air conditioning can be activated from the **ACC** position of the switch. During **fast charging** of the vehicle, the ventilation, heating and air conditioning cannot be activated.

Heating / Ventilation Air conditioning

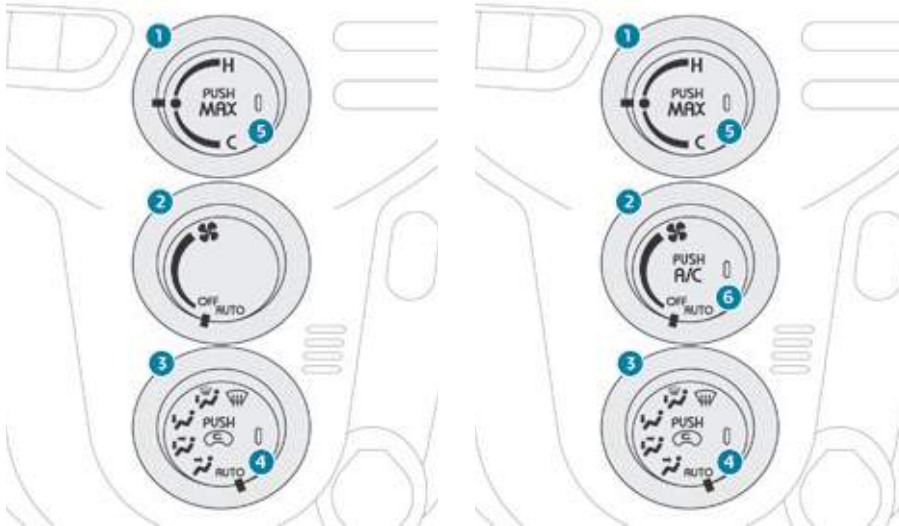

Adjustments can be made manually or automatically.

1. Temperature
2. Air flow
3. Air distribution
4. Exterior air intake / Interior air recirculation
5. "Max" button
6. Air conditioning On / Off

1. Temperature adjustment



☞ Turn the dial from blue (cold) to red (hot) to adjust the temperature to your requirements.

i When the dial is placed on "●", the fan air will be at the exterior temperature. If you move the dial to "●" while using the heating or air conditioning, these will stop immediately.

2. Air flow adjustment



☞ Turn the dial to the right to increase air flow and to the left to reduce it.

i With the dial in the "AUTO" position, the air flow is adjusted automatically, according to the interior temperature.

3. Air distribution adjustment



Place the dial in the desired position to distribute air to:



central and side vents,



central, side and footwell vents,



footwells,



windscreen, side windows and footwells,



windscreen and side windows.

The air distribution can be adapted by placing the dial in an intermediate position.

i With the dial in the "AUTO" position, air distribution is adjusted automatically, according to the temperature selected.

4. Air intake / Air recirculation

The intake of exterior air prevents the formation of mist on the windscreen and side windows. The recirculation of interior air isolates the passenger compartment from exterior odours and smoke.

Return to exterior air intake as soon as possible to prevent deterioration of the air quality and the formation of mist.



☞ Press this button to recirculate the interior air. The indicator lamp comes on to confirm this.

☞ Press the button again to permit the intake of exterior air. The indicator lamp switches off to confirm this.

5. "MAX" button

This button allows the passenger compartment to be quickly heated or cooled. It only works when the air flow control is not in the "OFF" position.



Press this button. The corresponding indicator lamp comes on.

The place the temperature control in the desired position:

- on "●" for maximum ventilation,
- between "●" and "H" for maximum heating,
- between "C" and "●" for maximum air conditioning.

6. Air conditioning On / Off



The air conditioning is designed to operate effectively in all seasons, with the windows closed.

It enables you to:

- lower the temperature, in summer,
- increase the effectiveness of the demisting in winter, above 3 °C.

Switching on

- ☞ Press the "A/C" button, the associated indicator lamp comes on.

The air conditioning does not operate when the air flow adjustment is set to off.

i To obtain cool air sooner, you can use air recirculation for a few moments. Then return to the intake of exterior air.

Switching off

- ☞ Press the "A/C" button again, the associated indicator lamp goes off.

Switching off may result in some discomfort (humidity, misting).

Front demist - defrost



Place the air distribution control in this position.

The intake of exterior air is selected (indicator lamp off) and depending on equipment, the air conditioning starts running (indicator lamp on).



Place the temperature control between "●" and "H".



Place the air flow control in the desired position.

i For rapid demisting - defrosting, you can also press the "**MAX**" button.

Rear screen demist - defrost

The control button is located on the right of the centre console.



Switching on



☞ Press this button to demist/defrost the rear screen and, depending on version, the door mirrors. The indicator lamp associated with the button comes on.

Switching off

The demisting/defrosting switches off automatically to prevent excessive electric consumption.

☞ It is possible to stop the demisting/defrosting operation before it is switched off automatically by pressing the button again. The indicator lamp associated with the button goes off.



Switch off the demisting/defrosting of the rear screen and the door mirrors as soon as appropriate, so as to limit electrical consumption and optimise the range of the vehicle.

Remote control*

This is used for remote control of the following functions:

- Check of the vehicle charge status.
- Programming of charging: start time and duration of charging.
- Activation of the climate control functions (heating, air conditioning, demisting).

i In order to programme charging, the following conditions must be met.

- Place the drive selector in position **P**.
- Place the switch on **LOCK**.
- Connect the vehicle using the normal charging cable.

i The remote control has a range of approximately 100 metres.

Buttons



1. On/Off, transmission of data.
2. MODE: used to scroll through the various functions available (start of charging, duration of charging, interior temperature).
3. Immediate charging of the vehicle (resetting of the programming values to zero).
4. Settings.

Display



1. Data transmission status indicator lamp.
2. Charging indicator lamp.
3. Fault warning lamp.
4. Battery charge status warning lamp.
5. Charging programming functions status indicator lamp.
6. Charging time remaining indicator.
7. Interior temperature function status indicator lamp.

* Depending on equipment.

On / Off



Extend the aerial.

Press and hold this button to switch the remote control on or off.

i If there is no action on the remote control within 30 seconds, it will switch off automatically.

Programming the start of charging

This function is used to set the time remaining before starting the charging of your vehicle. (e.g. it is 19:00 at the time of programming, the programmed charging start time is 2:00 hours: charging will begin at 21:00). Switch on the remote control.



This symbol is displayed on the screen.

Use the arrows to set the charging start time: each press changes the time in steps of half an hour.

Press the on/off button briefly to transmit the data to the vehicle.

i If the start of charging is programmed without programming the duration of charging, the battery will be charged fully.

Programming the duration of charging

This function is used to programme the duration of charging of your vehicle. Switch on the remote control. Press the MODE button to select the programming of the duration of charging.



This symbol is displayed on the screen.

Use the arrows to set the charging time: each press changes the time in steps of half an hour. Press the on/off button briefly to transmit the data to the vehicle.

i The duration of charging can be programmed between 0.5 and 19.5 hours. However, you can also select the duration "-h": in this case, charging will stop when the battery is fully charged. This duration is the default value.

i If the duration of charging is programmed without programming the start time, the battery will be charged immediately for the duration programmed.

Cancelling the programmed settings

Using the remote control



Press the immediate charging button, then press the on/off button briefly to transmit the data to the vehicle.

Using the switch

Place the vehicle's switch in the **ON** position then return it to the **LOCK** position.

- The programmed values set using the remote control are cancelled automatically each time the vehicle is started.

Programming the interior temperature

This function is used to programme the switching on of:

- the heating.
- the air conditioning.
- the demisting.

- In order to programme the heating, air conditioning or demisting functions, the following conditions must be met.
 - The drive selector is in position **P**.
 - The switch is on **LOCK**.
 - The vehicle is connected using the normal charging cable.
 - All of the doors are closed correctly.
 - The battery charge level is sufficient (one bar minimum).

- For maximum effectiveness of the programming of the interior temperature, ensure that all of the vehicle's windows are closed.

Activation of the functions

Switch on the remote control. Press the MODE button to select the interior temperature programming.

COOL **HEAT**  **A/C OFF**

One of these symbols is displayed on the screen. It indicates the current status of the interior temperature.

Use the arrows to select the function required. Press the on/off button briefly to transmit the data to the vehicle.

Functions available

COOL

Cooling: Switching on of the air conditioning and ventilation in the passenger compartment, via the central vents.

HEAT

Heating: Switching on of the heating in the passenger compartment and of the ventilation via the lower vents. The heating of the driver's seat will also be activated, if the function was activated previously.



Demisting: Switching on of the de-icing of the rear screen and exterior mirrors (depending on version), of the ventilation and heating in the passenger compartment, via the side vents, of the heating of the driver's seat, if the function was activated previously.

A/C OFF

Deactivation of the interior temperature programming function and cancellation of the programmed settings.

Battery charge level indicator

You can check the charge status of the main battery using the remote control.



Battery fully charged.



Battery at half charge.



Battery charge low.



Battery flat.

Changing the batteries

Battery type: CR2032



Unclip the housing then replace the 2 batteries.



Do not discard the old batteries, take them to an approved collection point.

Operating faults



Remote control

Indicator lamps	Status	Causes	Actions / Observations
ERROR	Flashes within approximately 10 seconds after the remote control is switched on.	A fault has occurred.	Switch the remote control off, then on again.
ERROR 	Flashes within approximately 1 second after the remote control is switched on.	Electrical interference is preventing the operation of the remote control or the transmission of data.	Move away from the sources of interference.
ERROR 	Flashes within approximately 10 seconds after the remote control is switched on.	The aerial has not been extended.	Extend the aerial.
		The range of the remote control has been exceeded.	Move closer to the vehicle.
		The switch is not in the LOCK position.	Place the switch in the LOCK position.

Programming the charging

Indicator lamps	Status	Causes	Actions / Observations
ERROR 	Flashes for a few seconds.	The charging cable is not connected correctly.	Check the cable.
		There is a problem with your electrical installation.	Have your electrical installation checked by a professional.
ERROR	Flashes for a few seconds.	The drive selector is not in position P .	Place the drive selector in position P .

Programming the interior temperature

Indicator lamps	Status	Causes	Actions / Observations
ERROR 	Flashes for a few seconds.	The charging cable is not connected correctly.	Check the cable.
		There is a problem with your electrical installation.	Have your electrical installation checked by a professional.
ERROR 	Flashes for a few seconds.	The charge of the main battery is not sufficient.	Charge the battery then start the programming again.
ERROR	Flashes for a few seconds.	One of the vehicle's doors is open.	Close all of the doors then start the programming again.
		The drive selector is not in position P .	Place the drive selector in position P .

Lighting controls

Main lighting

The various front and rear lamps of the vehicle are designed to adapt the lighting progressively in relation to the climatic conditions and so ensure the best visibility for the driver:

- sidelamps, to be seen,
- dipped beam headlamps to see without dazzling other drivers,
- main beam headlamps to see clearly when the road is clear.

Additional lighting



Other lamps are provided to fulfil the requirements of particular driving conditions:

- a rear foglamp to be seen from a distance,
- front foglamps for even better visibility,
- daytime running lamps to be seen during the day.

Selection ring for main lighting mode

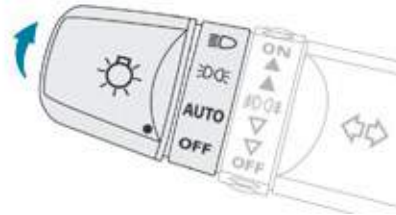
Turn the ring to position the symbol required facing the mark.



-  Dipped or main beam headlamps.
-  Sidelamps only.
- AUTO** Automatic illumination of headlamps.
- OFF** Lighting off.

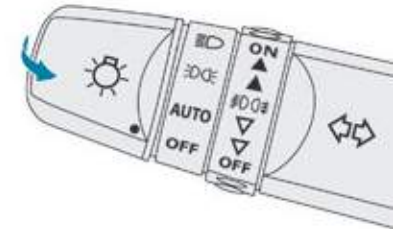

Stalk for switching headlamp beam

Pull the stalk to switch the lighting between dipped / main beam headlamps.

In the lighting off and sidelamps modes, the driver can switch on the main beam headlamps temporarily ("headlamp flash") by maintaining a pull on the stalk.

Displays

Illumination of the corresponding indicator lamp in the instrument panel confirms the lighting switched on.

Front and rear foglamps

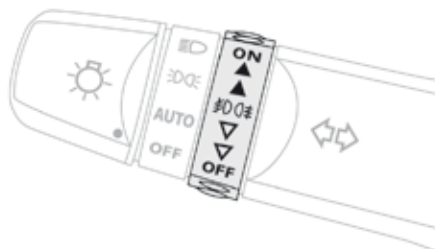

Foglamps selection ring.
The foglamps operate with the sidelamps and dipped and main beam headlamps.



Front and rear foglamps.

- ☞ To switch on the front foglamps, turn the ring forwards once.
- ☞ To switch on the rear foglamp, turn the ring forwards twice.
- ☞ To switch off the rear foglamp, turn the ring rearwards twice.
- ☞ To switch off the front foglamps, turn the ring rearwards once.

The ring returns to its initial position automatically.

The rear foglamp is switched off automatically when you switch off the sidelamps, or the dipped or main beam headlamps.

! In good or rainy weather, both day and night, the front foglamps and the rear foglamp is prohibited. In these situations, the power of its beam may dazzle other drivers. Do not forget to switch off the front foglamps and the rear foglamp when they are no longer necessary.

i Lighting on reminder

There is an audible signal when the driver's door is opened, to warn the driver if the vehicle lighting is on, with the ignition off. Switching off the lighting stops the audible signal.

Direction indicators

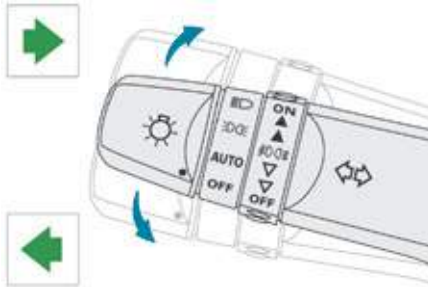

- ☞ Left: lower the lighting stalk, passing the point of resistance.
- ☞ Right: raise the lighting stalk, passing the point of resistance.

Daytime running lamps

Special daytime lighting so that the vehicle can be seen more easily.

The daytime running lamps come on automatically when starting the motor, if no other lighting is on. They cannot be deactivated.

i Although these lamps are located in the same unit as the front foglamp, they operate with a specific bulb. Their use is covered by road vehicle lighting regulations.

Automatic illumination of headlamps

With the main lighting control ring in the **AUTO** position, the sidelamps and dipped beam headlamps come on automatically, without any action by the driver, when a low level of ambient light is detected. When the light returns to a sufficient level or the wipers are switched off, the lighting is switched off automatically.

The sensor is located at the base of the windscreen.

i In foggy weather or in snow, the sunshine sensor may detect sufficient light. The lighting will not come on automatically. Do not cover the sunshine sensor, the associated functions will no longer be controlled.

Automatic lighting off

When the lighting stalk is in the "AUTO" position, if the ignition switch is in the "LOCK" or "ACC" position or if the key has been removed, the lighting switches off automatically **when the driver's door is opened**.

Headlamp adjustment

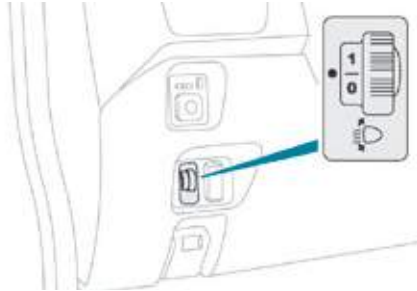

To avoid causing a nuisance to other road users, the height of the halogen headlamps should be adjusted according to the load in the vehicle.

0. Driver only or driver + 1 front passenger.
- 1 or 2. 4 people (including the driver).
3. 4 people (including the driver) + maximum authorised load.
4. Driver + maximum authorised load.

i The initial setting is position "0".

Wiper control

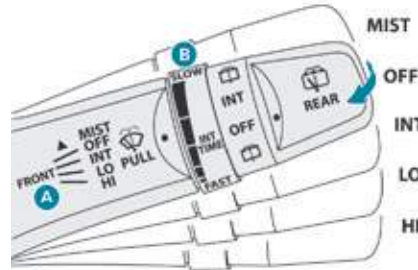

The wipers are controlled directly by the driver by means of the stalk **A** and its ring **B**.

i In wintry conditions, remove snow, ice or frost present on the windscreen, around the wiper arms and blades and the windscreen seal, before operating the wipers.

! Do not operate the wipers on a dry windscreen. Under extremely hot or cold conditions, ensure that the wiper blades are not stuck to the windscreen before operating the wipers.

Windscreen wipers

A. Wiping speed selection stalk: raise or lower the stalk to the desired position.

MIST

Single wipe.

OFF

Park.

INT

Intermittent (the speed can be set manually),

LO

Slow.

HI

Fast.

B. Intermittent operation adjustment ring.

☞ Turn this ring to increase or reduce the wiping frequency in intermittent mode.

Windscreen wash

Pull the wiper stalk towards you. The windscreen wash, then the windscreen wipers, operate for a pre-determined time.

Rear wiper

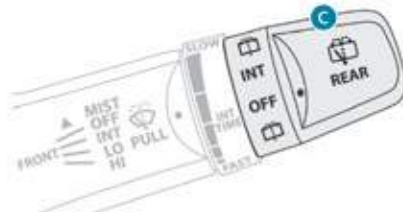

C. Rear wiper selection ring.



Park.



Intermittent wipe.

The wiper wipes twice then switches to intermittent mode with an interval of a few seconds.



Wipe with screenwash.

Keep the ring in this position to operate the screenwash with several wipes of the wiper.

Courtesy lamp

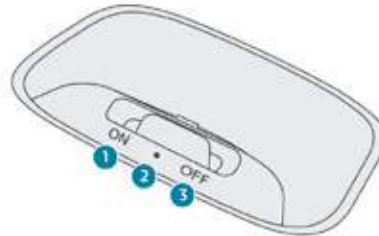

Position 1 "ON"

The courtesy lamp is permanently on.

Position 2 "•"

The courtesy lamp comes on when opening a door or the boot; when the door or boot is closed again, the lighting gradually dims for a few seconds before going off.

However, the courtesy lamp is switched off immediately when the doors and boot are closed and you lock the vehicle from the inside or using the remote control.

Position 3 "OFF"

The courtesy lamp is permanently off.



Before leaving the vehicle, ensure that the courtesy lamp is not on. If left on, it discharges the 12 V battery, even if the main battery is charged or on charge. Starting your vehicle will then no longer be possible.

General safety recommendations

! Labels are applied at various points on your vehicle. They carry safety warnings as well as vehicle identification information. Do not remove them: they form an integral part of your vehicle.

! For any work on your vehicle, use a qualified workshop that has the technical information, skills and equipment required, all of which a PEUGEOT dealer is able to provide.

! We draw your attention to the following points:

- The fitting of electrical equipment or accessories not listed by PEUGEOT may cause excessive current consumption and faults and failures with the electrical system of your vehicle. Contact a PEUGEOT dealer for information on the range of recommended accessories.
- As a safety measure, access to the diagnostic socket, used for the vehicle's electronic systems, is reserved strictly for PEUGEOT dealers or qualified workshops, equipped with the special tools required (risk of malfunctions of the vehicle's electronic systems that could cause breakdowns or serious accidents). The manufacturer cannot be held responsible if this advice is not followed.
- Any modification or adaptation not intended or authorised by Automobiles PEUGEOT or carried out without meeting the technical requirements defined by the manufacturer would lead to the suspension of the legal and contractual warranties.

! Installation of accessory radio communication transmitters

Before installing a radio communication transmitter, you must contact a PEUGEOT dealer for the specification of transmitters which can be fitted (frequency, maximum power, aerial position, specific installation requirements), in line with the Vehicle Electromagnetic Compatibility Directive (2004/104/EC).

! Depending on the legislation in force in the country, certain safety equipment may be compulsory: high visibility safety vests, warning triangles, breathalysers, spare bulbs, spare fuses, fire extinguisher, first aid kit, mud flaps at the rear of the vehicle...

Hazard warning lamps



Visual warning with all of the direction indicators flashing to alert other road users to a vehicle breakdown, towing or accident.

- ☞ Press this button, all of the direction indicators flash.

They can operate with the ignition off.

Automatic operation of brake lamps

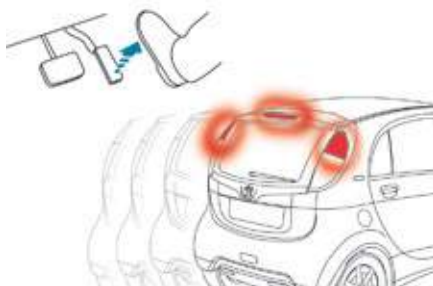

The brake lamps come on automatically when you release the accelerator pedal. This does not happen in all cases and depends on the rate of deceleration.

Horn

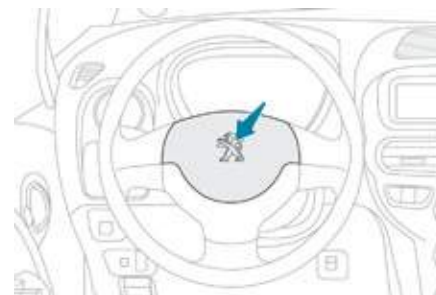

- ☞ Press the central part of the steering wheel.

Pedestrian horn*

System used to warn pedestrians of the presence of the vehicle.

Operation

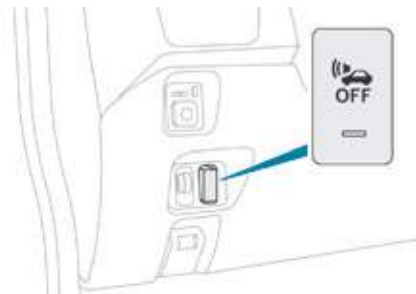

When the vehicle is started, lighting of the indicator lamp on the button for a few seconds indicates the activation of the system. The warning is heard when the vehicle speed is between 0 and 22 mph (0 and 35 km/h).

Deactivation

In certain driving conditions, you can deactivate the system.



Press this button.

The indicator lamp on the button comes on and the audible warning stops.

Pressing the button again reactivates the system. The indicator lamp on the button switches off.

i Before deactivating the system, ensure that you are not driving in an area frequented by pedestrians.

i The system is reactivated automatically each time the vehicle is started.

Operating fault

If a system fault occurs, the indicator lamp on the button flashes. Contact a PEUGEOT dealer or a qualified workshop to have the system checked.

* Depending on equipment.

Emergency or assistance call

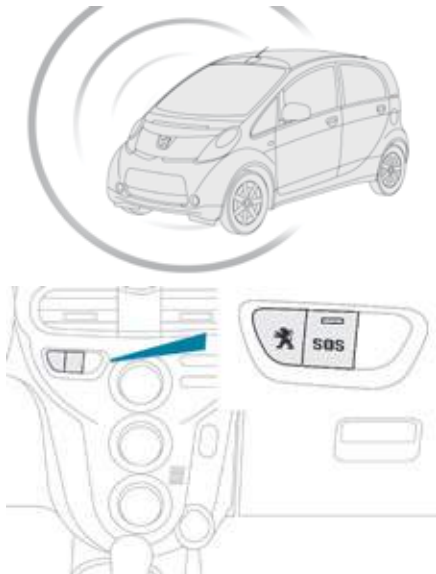

PEUGEOT Connect SOS



In an emergency, press this button for more than 2 seconds. Flashing of the green indicator lamp and a voice message confirm that the call has been made to the "PEUGEOT Connect SOS"* centre.

Pressing this button again immediately cancels the call.

The green indicator lamp goes off.

The green indicator lamp remains on (without flashing) when communication is established. It goes off at the end of the call.

PEUGEOT Connect SOS immediately locates your vehicle, makes contact with you in your language** and - if necessary - organises sending of the appropriate emergency services**. In countries where the service is not operational, or if the locating service has been expressly declined, the call is directed straight to the emergency services (112) without location.

! If an impact is detected by the airbag control unit, and independently of the deployment of any airbags, an emergency call is made automatically.

i If you benefit from the PEUGEOT Connect Packs offer with the SOS and assistance pack included, there are additional services available to you in your personal space, via your country's website.

* Depending on the terms and conditions for the service, available from dealers, and technological and technical limits.

** Depending on the geographic cover for "PEUGEOT Connect SOS", "PEUGEOT Connect Assistance" and the official national language selected by the owner of the vehicle.

The list of countries covered by PEUGEOT CONNECT services is available at dealers or on the website in your country.

Operation of the system



When the ignition is switched on, the green indicator lamp comes on for 3 seconds indicating that the system is operating correctly.



If the orange indicator lamp flashes then goes off: the system has a fault.

If the orange indicator lamp is on fixed: the back-up battery should be replaced.

In both cases, the emergency and assistance calls service may not work.

Contact a qualified repairer as soon as possible.

i The fault with the system does not prevent the vehicle being driven.

PEUGEOT Connect Assistance



Press this button for more than 2 seconds to request assistance if the vehicle breaks down.

A voice message confirms that the call has been made**.

Pressing this button again immediately cancels the request.

The cancellation is confirmed by a voice message.

Geo-location



You can deactivate geo-location by simultaneously pressing the "PEUGEOT Connect SOS" and "PEUGEOT Connect Assistance" buttons, followed by a press on "PEUGEOT Connect Assistance" to confirm.

To reactivate geo-location, simultaneously press the "PEUGEOT Connect SOS" and "PEUGEOT Connect Assistance" buttons again, followed by a press on "PEUGEOT Connect Assistance" to confirm.

i If you purchased your vehicle outside the Brand's dealer network, we suggest that you have a dealer check and, if desired, modify the configuration of these services.

In a multi-lingual country, configuration is possible in the official national language of your choice.

i For technical reasons, particularly to improve the quality of PEUGEOT CONNECT services to customers, the manufacturer reserves the right to carry out updates to the vehicle's on-board telematic system.

** Depending on the geographic cover for "PEUGEOT Connect SOS", "PEUGEOT Connect Assistance" and the official national language selected by the owner of the vehicle.

The list of countries covered by PEUGEOT CONNECT services is available at dealers or on your country's website.

Braking assistance systems

Group of supplementary systems which help you to obtain optimum braking in complete safety in emergency situations:

- anti-lock braking system (ABS),
- electronic brake force distribution (EBFD),
- emergency braking assistance (EBA).

Anti-lock braking system and electronic brake force distribution

Linked systems which improve the stability and manoeuvrability of your vehicle when braking, in particular on poor or slippery surfaces.

Activation

The anti-lock braking system comes into operation automatically when there is a risk of wheel lock.

Normal operation of the ABS may make itself felt by slight vibration of the brake pedal.



When braking in an emergency, press very firmly without releasing the pressure.

Operating fault

Vehicle stationary



Illumination of this warning lamp indicates a malfunction of the anti-lock braking system, which could result in a loss of control of the vehicle when braking.

Contact a PEUGEOT dealer or a qualified workshop.

i The warning lamp comes on for a few seconds when the ignition is switched on (ON position). If it does not go off or does not come on, contact a PEUGEOT dealer or a qualified workshop.

Vehicle moving



Fixed illumination of this warning lamp indicates a malfunction of the anti-lock braking system which could result in a loss of control of the vehicle on braking.

You must stop as soon as it is safe to do so.

Contact a PEUGEOT dealer or a qualified workshop.



Illumination of these two warning lamps indicates a malfunction of the electronic brake force distribution

which could result in a loss of control of the vehicle on braking.

You MUST stop as soon as it is safe to do so.

Contact a PEUGEOT dealer or a qualified workshop.

When replacing wheels (tyres and rims), ensure that they conform to the manufacturer's recommendations.

Emergency braking assistance

System which, in an emergency, enables you to obtain the optimum braking pressure more quickly, thus reducing the stopping distance.

Activation

It is triggered by the speed at which the brake pedal is pressed.

The effect of this is a reduction in the resistance of the pedal and an increase in braking efficiency.



When braking in an emergency, press firmly without releasing the pressure.

Trajectory control systems

Anti-slip regulation (ASR) and electronic stability programme (ESP)

The anti-slip regulation (also known as Traction Control) optimises traction to limit wheel spin, by acting on the brakes of the driving wheels and on the engine.

The electronic stability programme acts on the brake of one or more wheels and on the engine to keep the vehicle on the trajectory required by the driver, within the limits of the laws of physics.

Activation

These systems are activated automatically each time the vehicle is started. They come into operation in the event of a grip or trajectory problem.



This is indicated by flashing of this symbol in the instrument panel.



Deactivation

In exceptional conditions (starting a vehicle which is bogged down, stuck in snow, on soft ground, etc.), it may be advisable to deactivate the ASR and ESP systems to regain grip.

☞ Press this button, located on the dashboard (driver's side), until the corresponding symbol appears in the instrument panel screen.



The display of this symbol indicates that the ASR and ESP systems are deactivated.



Excessive wheel spin may cause damage to the differential of your vehicle.

Reactivation

These systems are not reactivated automatically.

☞ Press this button again to reactivate them manually.

The symbol going off in the instrument panel indicates the reactivation of the ASR and ESP systems.

Operating fault



The display of this message in the instrument panel indicates a malfunction of these systems.

Contact a PEUGEOT dealer or a qualified workshop to have the ASR/ESP systems checked.



The ASR/ESP systems should not encourage the driver to take extra risks or drive at high speed.

The correct functioning of these systems depends on observation of the manufacturer's recommendations regarding the wheels (tyres and rims), the braking components, the electronic components and the assembly and repair procedures used by the PEUGEOT dealer network. After an impact, have these systems checked by a PEUGEOT dealer or a qualified workshop.

Engine brake reduction indicator lamp



Your vehicle is equipped with a system for the recovery of energy during deceleration which uses the engine brake.

It recovers into the traction battery some of the energy generated when the vehicle slows down (e.g. on a long descent) to improve the range of the battery and so the distance that can be travelled between charges.

When the traction battery has been charged fully and for the first few miles (or kilometres) of use of the vehicle, the engine brake is reduced temporarily.

We therefore recommend that you anticipate your braking as much as possible: use the brake pedal to slow down or stop the vehicle.

i The braking power is never reduced while the indicator lamp is flashing.



This indicator lamp flashes on the instrument panel, inviting you to adapt your driving accordingly.

Seat belts

Front seat belts

The front seat belts are fitted with a pretensioning and force limiting system. This system improves safety in the front seats in the event of a front or side impact. Depending on the severity of the impact, the pretensioning system instantly tightens the seat belts against the body of the occupants. The pretensioning seat belts are active when the ignition is on. The force limiter reduces the pressure of the seat belt on the chest of the occupant, so improving their protection.



Fastening

- ☞ Pull the strap, then insert the tongue in the buckle **A**.
- ☞ Check that the seat belt is fastened correctly by pulling the strap.

Unfastening

- ☞ Press the red button on the buckle **A**.

Front seat belt not fastened / unfastened warning lamp



When the ignition is switched on, this warning lamp comes on accompanied by an audible signal for a few seconds if the driver and/or passenger has not fastened their seat belt.

If the driver does not fasten their seat belt within one minute after switching on the ignition, the warning lamp flashes accompanied by an intermittent audible signal. After about 90 seconds, the warning lamp, the audible signal and the display stop, and then return until the driver fastens their seat belt. If the seat belt is unfastened **while the vehicle is moving**, you are warned by the same alerts.

Rear seat belts

Each rear seat is fitted with a three-point inertia reel seat belt.



Fastening

- ☞ Pull the strap, then insert the tongue in the buckle.
- ☞ Check that the seat belt is fastened correctly by pulling the strap.

Unfastening

- ☞ Press the red button in the buckle.

Seat belt unfastened warning lamps



Right-hand rear seat belt warning lamp.



Left-hand rear seat belt warning lamp.

Illumination of one of these warning lamps in the instrument panel indicates that one of the rear passengers has unbuckled their seat belt.

i Advice

The driver must ensure that passengers use the seat belts correctly and that they are all fastened before setting off.

Wherever you are seated in the vehicle, always fasten your seat belt, even for short journeys.

Do not interchange the seat belt buckles as they will not fulfill their role fully.

The seat belts are fitted with an inertia reel permitting automatic adjustment of the length of the strap to your size. The seat belt is stowed automatically when not in use.

Before and after use, ensure that the seat belt is reeled in correctly.

The lower part of the strap must be positioned as low as possible on the pelvis. The upper part must be positioned in the hollow of the shoulder.

The inertia reels are fitted with an automatic locking device which comes into operation in the event of a collision, emergency braking or if the vehicle rolls over. You can release the device by pulling the strap firmly and then releasing it so that it reels in slightly.

In order to be effective, a seat belt must:

- be tightened as close to the body as possible,
- be pulled in front of you with a smooth movement, checking that it does not twist,
- be used to restrain only one person,
- not bear any trace of cuts or fraying,
- not be converted or modified to avoid affecting its performance.

In accordance with current safety regulations, for all repairs on your vehicle's seat belts, go to a qualified workshop with the skills and equipment needed, which a PEUGEOT dealer is able to provide.

Have your seat belts checked regularly by a PEUGEOT dealer or a qualified workshop, particularly if the straps show signs of damage.

Clean the seat belt straps with soapy water or a textile cleaning product, sold by PEUGEOT dealers.

After folding or moving a seat or rear bench seat, ensure that the seat belt is positioned and reeled in correctly.

Recommendations for children

Use a suitable child seat if the passenger is less than 12 years old or shorter than one and a half metres.

Never use the same seat belt to secure more than one person.

Never allow a child to travel on your lap.

For more information on **Child seats**, refer to the corresponding section.

In the event of an impact

Depending on the nature and seriousness of the impact, the pretensioning device may be deployed before and independently of the airbags. Deployment of the pretensioners is accompanied by a slight discharge of harmless smoke and a noise, due to the activation of the pyrotechnic cartridge incorporated in the system.

In all cases, the airbag warning lamp comes on.

Following an impact, have the seat belts system checked, and if necessary replaced, by a PEUGEOT dealer or a qualified workshop.

Airbags

The airbags have been designed to contribute towards improving the safety of the occupants in the event of violent collisions. They supplement the action of the force-limiting seat belts.

In this case, the electronic detectors record and analyse the front and side impacts suffered in the impact detection zones:

- in the event of a serious impact, the airbags are deployed instantaneously and contribute towards protecting the occupants of the vehicle; immediately after the impact, the airbags deflate rapidly so that they do not hinder the visibility of the occupants or their possible exit from the vehicle,
- in the event of a minor impact or rear impact and in certain roll-over conditions, the airbags may not be deployed; the seat belt alone contributes towards providing your protection in these situations.

! **The airbags do not operate when the ignition is off.**

This equipment only operates once. If a second impact occurs (during the same or a subsequent accident), the airbag will not be deployed again.

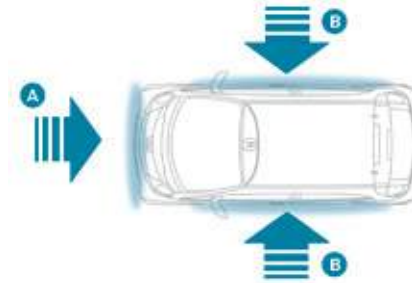

Impact detection zones

- A. Front impact zone.
- B. Side impact zone.

i The deployment of one or more airbags is accompanied by a slight discharge of smoke and a noise, due to the activation of the pyrotechnic cartridge incorporated in the system. This smoke is not harmful, but sensitive individuals may experience some irritation. The noise of the detonation related to the deployment of one or more airbags may result in a slight loss of hearing for a short time.

Front airbags

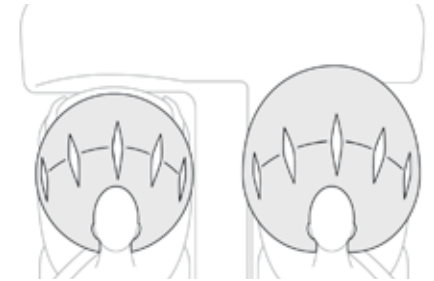

System which protects the head and chest of the driver and front passenger in the event of a front impact.

The driver's airbag is fitted in the centre of the steering wheel; the front passenger's airbag is fitted in the dashboard above the glove box.

Deployment

The airbags are deployed, except the passenger's front airbag if it is deactivated, in the event of a serious front impact applied to all or part of the front impact zone **A**, in the longitudinal centreline of the vehicle on a horizontal plane and directed from the front to the rear of the vehicle.

The front airbag inflates between the front occupant of the vehicle and the dashboard to cushion their forward movement.

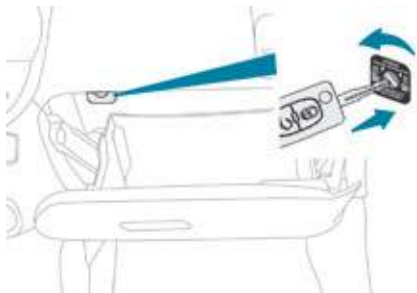

Deactivation

Only the front passenger's airbag can be deactivated:

- ☞ **with the ignition off**, insert the key in the passenger airbag deactivation switch **A**,
- ☞ turn it to the **"OFF"** position,
- ☞ remove the key.

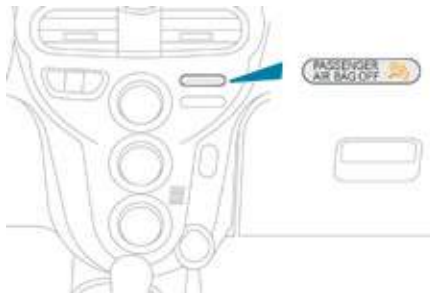

This warning lamp comes on in the centre console when the ignition is on and until the airbag is reactivated.



To ensure the safety of your child, the passenger airbag must be deactivated when you install a rearward facing child seat on the front passenger seat. Otherwise, the child would risk being seriously injured or killed if the airbag were deployed.

Reactivation

When you remove the child seat, turn switch **A** to the **"ON"** position to reactivate the airbag and so ensure the safety of your front passenger in the event of an impact. The associated warning lamp goes off.



Operating fault

If this warning lamp comes on in the instrument panel, contact a PEUGEOT dealer or a qualified workshop without delay to have the system checked. The airbags may no longer be deployed in the event of a serious impact. In this case, do not install a child seat or seat an adult on the front passenger seat.

Lateral airbags



System which protects the driver and front passenger in the event of a serious side impact in order to limit the risk of injury to the chest, between the hip and the shoulder. Each lateral airbag is fitted in the seat backrest frame, door side.

Deployment

A lateral airbag is deployed unilaterally in the event of a serious side impact applied to all or part of the side impact zone **B**, perpendicular to the longitudinal centreline of the vehicle on a horizontal plane and directed from the outside towards the inside of the vehicle.

The lateral airbag inflates between the hip and shoulder of the front occupant of the vehicle and the corresponding door trim panel.

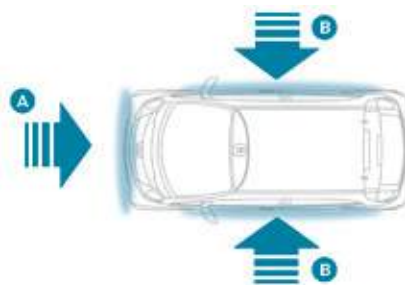

Impact detection zones

- A. Front impact zone.
- B. Side impact zone.

Curtain airbags

System which protects the driver and passengers in the event of a serious side impact in order to limit the risk of injury to the head.

Each curtain airbag is fitted in the pillars and the upper section of the passenger compartment.

Deployment

Each curtain airbag is deployed at the same time as the corresponding lateral airbag in the event of a serious side impact applied to all or part of the side impact zone **B**, perpendicular to the longitudinal centreline of the vehicle on a horizontal plane and directed from the outside towards the inside of the vehicle.

The curtain airbag inflates between the front or rear occupant of the vehicle and the windows.

Operating fault



If this warning lamp comes on in the instrument panel, contact a PEUGEOT dealer or a qualified workshop to have the system checked. The airbags may no longer be deployed in the event of a serious impact.

! In the event of a minor impact or bump on the side of the vehicle or if the vehicle rolls over, the airbag may not be triggered. In the event of a rear or front collision, the airbag is not triggered.

! Advice

For the airbags to be fully effective, observe the safety recommendations below:

Sit in a normal upright position.

Wear a correctly adjusted seat belt.

Do not leave anything between the occupants and the airbags (a child, pet, object...), nor fix or attach anything close to the inflation trajectory of the airbags; this could cause injuries during their deployment. Never modify the original definition of your vehicle, particularly in the area directly around the airbags.

After an accident or if the vehicle has been stolen or broken into, have the airbag systems checked.

All work on the airbag system must be carried out by a PEUGEOT dealer or a qualified workshop.

Even if all of the precautions mentioned are observed, a risk of injury or of minor burns to the head, chest or arms when an airbag is deployed cannot be ruled out.

The bag inflates almost instantly (within a few milliseconds) then deflates within the same time discharging the hot gas via openings provided for this purpose.

Front airbags

Do not drive holding the steering wheel by its spokes or resting your hands on the centre part of the wheel.

Passengers must not place their feet on the dashboard.

Do not smoke as deployment of the airbags can cause burns or the risk of injury from a cigarette or pipe.

Never remove or pierce the steering wheel or hit it violently.

Do not fit or attach anything to the steering wheel or dashboard, this could cause injuries with deployment of the airbags.

Lateral airbags

Use only approved covers on the seats, compatible with the deployment the lateral airbags. For information on the range of seat covers suitable for your vehicle, you can contact a PEUGEOT dealer.

Do not fix or attach anything to the seat backs (clothing...). This could cause injury to the chest or arms if the lateral airbag is deployed.

Do not sit with the upper part of the body any nearer to the door than necessary.

Curtain airbags

Do not fix or attach anything to the roof. This could cause injury to the head if the curtain airbag is deployed.

If fitted on your vehicle, do not remove the grab handles installed on the roof, they play a part in securing the curtain airbags.

General points relating to child seats

Although one of PEUGEOT's main criteria when designing your vehicle, the safety of your children also depends on you.

For maximum safety, please observe the following recommendations:

- in accordance with European regulations, **all children under the age of 12 or less than one and a half metres tall must travel in approved child seats suited to their weight**, on seats fitted with a seat belt or ISOFIX mountings*,
- **statistically, the safest seats in your vehicle for carrying children are the rear seats,**
- **a child weighing less than 9 kg must travel in the rearward facing position both in the front and in the rear.**

- i** **PEUGEOT recommends** that children should travel in the **outer rear seats** of your vehicle:
- **rearward facing** up to the age of 3,
 - **forward facing** over the age of 3.

* The regulations on carrying children are specific to each country. Refer to the legislation in force in your country.

Child seat at the rear



Rearward facing

When a rearward facing child seat is installed **on a rear passenger seat**, move the vehicle's front seat forwards and straighten the backrest so that the rearward facing child seat does not touch the vehicle's front seat.

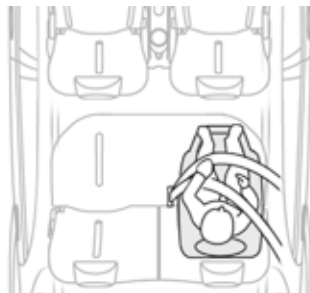

Forward facing

When a forward facing child seat is installed **on a rear passenger seat**, move the vehicle's front seat forwards and straighten the backrest so that the legs of the child in the forward facing child seat do not touch the vehicle's front seat.

! Ensure that the seat belt is correctly tightened. For child seats with a support leg, ensure that the support leg is in stable contact with the floor.

Child seat in the front*



Rearward facing

When a rearward facing child seat is installed on the **front passenger seat**, adjust the seat to the intermediate longitudinal position, with the backrest straightened.

The passenger's front airbag must be deactivated. Otherwise, **the child would risk being seriously injured or killed if the airbag were to inflate.**



Forward facing

When a forward facing child seat is installed on the **front passenger seat**, adjust the vehicle's seat to the intermediate longitudinal position with seat backrest straightened and leave the passenger's front airbag activated.

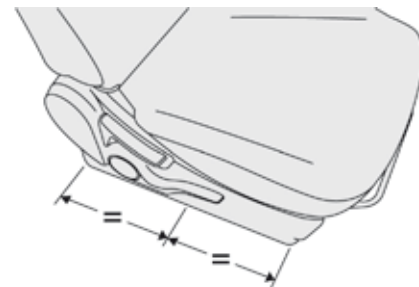

Passenger seat adjusted to the intermediate longitudinal position.

- !** Ensure that the seat belt is correctly tensioned.
For child seats with a support leg, ensure that the support leg is in stable contact with the floor. If necessary, adjust the passenger seat.

* Refer to the current legislation in your country before installing your child on the front seat.

Deactivating the passenger front airbag

! Never install a rearward facing child restraint system on a seat protected by an active front airbag. This could cause the death of the child or serious injury.

The warning label present on both sides of the passenger sun visor repeats this advice. In line with current legislation, the following tables contain this warning in all of the languages required.

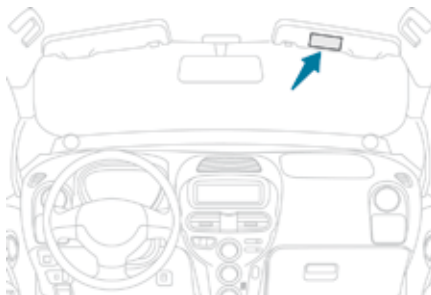

Passenger airbag OFF

This label is located on the middle door pillar, passenger side.

! For more information on the **Airbags**, refer to the corresponding section.

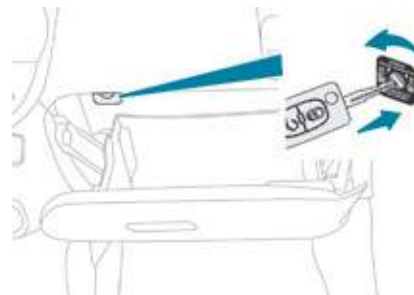

AR	لا يجب أبدا تركيب نظام لإجلاس الطفل الوجه باتجاه الورااء على مقعد سيارة مجهز بوسادة امان هوائية امامية مغلقة، فقد يؤدي هذا إلى التسبب بموت الطفل أو بإصابات خطيرة لديه.
BG	НИКОГА НЕ инсталирайте детско столче на седалка с АКТИВИРАНА предна ВЪЗДУШНА ВЪЗГЛАВНИЦА. Това може да причини СМЪРТ или СЕРИОЗНО НАРАНЯВАНЕ на детето.
CS	NIKDY neumistujte dětské zádržné zařízení orientované směrem dozadu na sedadlo chráněné AKTIVOVANÝM čelním AIRBAGEM. Hrozí nebezpečí SMRTI DÍTĚTE nebo VÁŽNĚHO ZRANĚNÍ.
DA	Brug ALDRIG en bagudvendt barnestol på et sæde, der er beskyttet af en AKTIV AIRBAG. BARNET risikerer at blive ALVORLIGT KVÆSTET eller DRÆBT.
DE	Montieren Sie auf einem Sitz mit AKTIVIERTEM Front-Airbag NIEMALS einen Kindersitz oder eine Babyschale entgegen der Fahrtrichtung, das Kind könnte schwere oder sogar tödliche Verletzungen erleiden.
EL	Μη χρησιμοποιείτε ΠΟΤΕ παιδικό κάθισμα με την πλάτη του προς το εμπρός μέρος του αυτοκινήτου, σε μια θέση που προστατεύεται από ΜΕΤΩΠΙΚΟ αερόσακο που είναι ΕΝΕΡΓΟΣ. Αυτό μπορεί να έχει σαν συνέπεια το ΘΑΝΑΤΟ ή το ΣΟΒΑΡΟ ΤΡΑΥΜΑΤΙΣΜΟ του ΠΑΙΔΙΟΥ
EN	NEVER use a rearward facing child restraint on a seat protected by an ACTIVE AIRBAG in front of it, DEATH or SERIOUS INJURY to the CHILD can occur
ES	NO INSTALAR NUNCA un sistema de retención para niños de espaldas al sentido de la marcha en un asiento protegido mediante un AIRBAG frontal ACTIVADO, ya que podría causar lesiones GRAVES o incluso la MUERTE del niño.
ET	Ärge MITTE KUNAGI paigaldage "seljaga sõidusuunas" lapseistet juhi kõrvalistmele, mille ESITURVAPADI on AKTIVEERITUD. Turvapadja avanemine võib last TÕSISELT või ELUOHTLIKULT vigastada.
FI	ÄLÄ KOSKAAN aseta lapsen turvaistuinta selkää ajosuuntaan istuimelle, jonka edessä suojana on käyttöön aktivoitu TURVATYYNYY. Sen laukeaminen voi aiheuttaa LAPSEN KUOLEMAN tai VAKAVAN LOUKKAANTUMISEN.
FR	NE JAMAIS installer de système de retenue pour enfants faisant face vers l'arrière sur un siège protégé par un COUSSIN GONFLABLE frontal ACTIVE. Cela peut provoquer la MORT de l'ENFANT ou le BLESSER GRAVEMENT
HR	NIKADA ne postavljati dječju sjedalicu leđima u smjeru vožnje na sjedalo zaštićeno UKLJUČENIM prednjim ZRAČNIM JASTUKOM. To bi moglo uzrokovati SMRT ili TEŠKU OZLJEDU djeteta.
HU	SOHA ne használnjok menetirányinak háttal beszerelt gyermekülést AKTIVÁLT (BEKAPCSOLT) FRONTLÉGSZÁKKAL védett ülésen. Ez a gyermek HALÁLÁT vagy SÜLYÖS SÉRÜLÉSÉT okozhatja.
IT	NON installare MAI seggiolini per bambini posizionati in senso contrario a quello di marcia su un sedile protetto da un AIRBAG frontale ATTIVATO. Ciò potrebbe provocare la MORTE o FERITE GRAVI al bambino.
LT	NIKADA neįrengkite vaiko prilaikymo priemonės su atgal atgretžtu vaiku ant sėdynės, kuri saugoma VEIKIANČIOS priekinės ORO PAGALVĖS. Išsiskleidus oro pagalvei vaikas gali būti MIRTINAI arba SUNKIAI TRAUMUOTAS.
LV	NEKAD NEuzstādiet uz aizmuguri vērstu bērnu sēdekli priekšējā pasažiera sēdvietā, kurā ir AKTIVIZĒTS priekšējais DROŠĪBAS GAISA SPILVENS. Tas var izraisīt BĒRNA NĀVI vai radīt NOPIETNUS IEVAINOJUMUS.

MT	Qatt m'għandek thalli tifel/tifla marbut f'siggu dahru lejn l-Airbag attiva, għaliex tista' tikkawza korriment serju jew anke mewt lit-tifel/tifla
NL	Plaats NOOIT een kinderzitje met de rug in de rijrichting op een zitplaats waarvan de AIRBAG is INGESCHAKELD. Bij het afgaan van de airbag kan het KIND LEVENSGEVAARLIJK GEWOND RAKEN
NO	Installer ALDRI et barnesete med ryggen mot kjøretretningen i et sete som er beskyttet med en frontal AKTIVERT KOLLISJONSPUTE, BARNET risikerer å bli DREPT eller HARDT SKADET.
PL	NIGDY nie instalować fotelika dziecięcego w pozycji "tyłem do kierunku jazdy" na siedzeniu wyposażonym w CZŁOWA PODUSZKĘ POWIETRZNA w stanie AKTYWNYM. Może to doprowadzić do ŚMIERCI DZIECKA lub spowodować u niego POWAŻNE OBRAŻENIA CIAŁA.
PT	NUNCA instale um sistema de retenção para crianças de costas para a estrada num banco protegido por um AIRBAG frontal ACTIVADO. Esta instalação poderá provocar FERIMENTOS GRAVES ou a MORTE da CRIANÇA.
RO	Nu instalati NICIODATA un sistem de retenere pentru copii, dispus cu spatele in directia de mers, pe un loc din vehicul protejat cu AIRBAG frontal ACTIVAT. Aceasta ar putea provoca MOARTEA COPILULUI sau RANIREA lui GRAVA.
RU	ВО ВСЕХ СЛУЧАЯХ ЗАПРЕЩАЕТСЯ использовать обращенное назад детское удерживающее устройство на сиденье, защищенном ФУНКЦИОНИРУЮЩЕЙ ПОДУШКОЙ БЕЗОПАСНОСТИ, установленной перед этим сиденьем. Это может привести к ГИБЕЛИ РЕБЕНКА или НАНЕСЕНИЮ ЕМУ СЕРЬЕЗНЫХ ТЕЛЕСНЫХ ПОВРЕЖДЕНИЙ
SK	NIKDY neinštalujte detské zádržné zariadenie orientované smerom dozadu na sedadlo chránené AKTIVOVANÝM čelným AIRBAGOM. Mohlo by dôjsť k SMRTEĽNÉMU alebo VÁŽNEMU PORANENIU DIEŤAŤA.
SL	NIKOLI ne nameščajte otroškega sedeža s hrbtom v smeri vožnje, če je VARNOSTNA BLAZINA pred sprednjim sopotnikovim sedežem AKTIVIRANA. Takšna namestitve lahko povzroči SMRT OTROKA ali HUDE POŠKODBE.
SR	NIKADA ne koristite dečje sedište koje se okreće unazad na sedištu zaštićenim AKTIVNIM VAZDUŠNIM JASTUKOM ispred njega, jer mogu nastupiti SMRT ili OZBILJNA POVREDA DETETA.
SV	Passagerarkrockkudden fram MÅSTE vara avaktiverad om en bakåtvänd bilbarnstol installeras på denna plats. Annars riskerar barnet att DÖDAS eller SKADAS ALLVARLIGT.
TR	KESİNLKLE HAVA YASTIĞI AKTİF olan ön koltuğa yüzü arkaya dönük bir çocuk koltuğu yerleştirmeyiniz. Bu ÇOCUĞUN ÖLMESİNE veya ÇOK AĞIR YARALANMASINA sebep olabilir.

Child seats recommended by PEUGEOT

PEUGEOT offers a range of recommended child seats which are secured using a **three point seat belt**.

Group 0+: from birth to 13 kg



L1
"RÖMER Baby-Safe Plus"
Installed in the rearward facing position.

Groups 2 and 3: from 15 to 36 kg





L4
"KLIPPAN Optima"
From 22 kg (approximately 6 years), the booster is used on its own.



L5
"RÖMER KIDFIX"
Can be fitted to the vehicle's ISOFIX mountings.
The child is restrained by the seat belt.

Installing child seats using the seat belt

In accordance with European regulations, this table indicates the options for installing child seats secured using a seat belt and universally approved (a) in accordance with the weight of the child and the seat in the vehicle.

Weight of the child and indicative age				
Seat	Under 13 kg (groups 0 (b) and 0+) Up to approx 1 year	From 9 to 18 kg (group 1) 1 to 3 years approx	From 15 to 25 kg (group 2) 3 to 6 years approx	From 22 to 36 kg (group 3) 6 to 10 years approx
Front passenger seat (c) (e) 	L1	ISOFIX ROMER Duo Plus (secured with the seat belt)	X	X
Outer rear seats (d) 	U	U	U	U

- (a) Universal child seat: child seat that can be installed in all vehicles using a seat belt.
- (b) Group 0: from birth to 10 kg. Shells seats and baby carriers cannot be installed in the front passenger seat.
- (c) Consult the legislation in force in your country before installing your child on this seat.
- (d) To install a child seat on a rear seat, rearward or forward facing, move the front seat forward, then straighten the backrest to allow enough room for the child seat and the child's legs.
- (e) When a rearward facing child seat is installed on the **front passenger seat**, the passenger's airbag must be deactivated. Otherwise, **the child risks being seriously injured or killed if the airbag is deployed**. When a forward facing child seat is installed on the **front passenger seat**, the passenger's airbag must remain active.

- U: Seat suitable for the installation of a child seat secured using a seat belt and universally approved, rearward facing and/or forward facing.
- X: Seat not suitable for the installation of a child seat of the weight group indicated.

! Remove and stow the head restraint before installing a child seat with a backrest on a passenger seat. Refit the head restraint once the child seat has been removed.

Advice on child seats

! The incorrect installation of a child seat in a vehicle compromises the child's protection in the event of an accident.

Check that there is no seat belt or seat belt buckle under the child seat as this could destabilise it.

Remember to fasten the seat belts or the child seat harnesses keeping the slack in relation to the child's body to a minimum, even for short journeys.

When installing a child seat using the seat belt, check that the seat belt is tightened correctly on the child seat and that it secures the child seat firmly on the seat of your vehicle. If your passenger seat is adjustable, move it forward if necessary. At the rear seats, always leave sufficient space between the front seat and:

- a rearward facing child seat,
- the feet of a child seated in a forward facing child seat.

For this, move the front seat forward and if necessary straighten its backrest.

For optimum installation of a forward facing child seat, ensure that the back of the child seat is as close as possible to the backrest of the vehicle's seat, or in contact if possible.

The head restraint must be removed before installing a child seat with a backrest on the passenger seat. Ensure that the head restraint is stowed or attached securely so that it is not thrown around the vehicle in the event of sharp braking.

Refit the head restraint as soon as the child seat is removed.

Children at the front

The legislation on carrying a child on the front passenger seat is specific to each country.

Refer to the legislation in force in your country.

Deactivate the passenger's airbag when a rearward facing child seat is installed on the front seat.

Otherwise, the child would risk being seriously injured or killed if the airbag were deployed.

Installing a booster seat

The chest part of the seat belt must be positioned on the child's shoulder without touching the neck.

Ensure that the lap part of the seat belt passes correctly over the child's thighs. PEUGEOT recommends the use of a booster seat which has a back, fitted with a seat belt guide at shoulder level.

As a safety precaution, do not leave:

- one or more children alone and unsupervised in a vehicle,
- a child or an animal in a vehicle which is exposed to the sun, with the windows closed,
- the keys within reach of children inside the vehicle.

To prevent accidental opening of the doors, use the "Child lock".

Take care not to open the rear windows by more than one third.

To protect young children from the rays of the sun, fit side blinds on the rear windows.

"ISOFIX" mountings

Your vehicle has been approved in accordance with the **latest ISOFIX regulation**.

The seats, represented below, are fitted with regulation ISOFIX mountings:

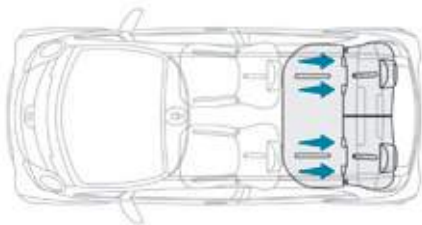

There are three rings for each seat:

- two rings **A** located in the angle between the vehicle seat's cushion and backrest, indicated by a marking



- a ring **B** for securing the upper strap called the **TOP TETHER**, located in the boot. It is indicated by a marking.

The TOP TETHER is used to secure the upper strap of child seats that have one. This arrangement limits the forward tipping of the child seat in the event of a front impact.

This ISOFIX mounting system provides fast, reliable and safe fitting of the child seat in your vehicle.

The **ISOFIX child seats** are fitted with two latches which are secured on the two rings **A**. Some seats also have an **upper strap** which is secured to the ring **B**.

To secure the child seat to the TOP TETHER:

- pass the top strap of the child seat centrally over the top of the vehicle seat backrest,
- raise the TOP TETHER cover,
- secure the hook on the upper strap to the ring **B**,
- tighten the upper strap.

i The incorrect installation of a child seat in a vehicle compromises the child's protection in the event of an accident.

! Follow precisely the fitting instructions in the installation guide provided with the child seat

For information on the possibilities for installing ISOFIX child seats in your vehicle, refer to the summary table.

ISOFIX child seats recommended by PEUGEOT and approved for your vehicle

RÖMER BabySafe Plus ISOFIX (size category E)

Group 0+: up to 13 kg

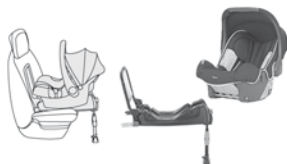

It is installed in the rearward facing position using an ISOFIX base which attaches to the rings **A**. The base has a support leg, adjustable for height, that sits on the vehicle floor. This child seat can also be secured using a child seat. In this case, only the shell is used and is secured to the vehicle's seat using the three-point seat belt.

RÖMER Duo Plus ISOFIX (size class B1)

Group 1: from 9 to 18 kg



It is installed only in the forward facing position. Secured to the rings **A**, as well as ring **B**, called the Top Tether, using an upper strap. Three angles for the shell: sitting, inclined and lying positions. This child seat can also be used on seats which are not fitted with ISOFIX mountings. In this case, it must be attached to the vehicle seat using the three point seat belt.



Follow the instructions for fitting the child seat given in their manufacturer's installation guide.

Installing ISOFIX child seats

In accordance with European regulations, this table indicates the options for the installation of ISOFIX child seats on the vehicle seats fitted with ISOFIX mountings.

In the case of the universal and semi-universal ISOFIX child seats, the child seat's ISOFIX size category, determined by a letter between **A** and **G**, is indicated on the child seat next to the ISOFIX logo.

	Weight of the child / indicative age									
	Less than 10 kg (group 0) Up to 6 months approx		Less than 10 kg (group 0) Less than 13 kg (group 0+) Up to 1 year approx			From 9 to 18 kg (group 1) From 1 to 3 years approx				
Type of ISOFIX child seat	Infant car seat*		rearward facing			rearward facing		forward facing		
ISOFIX size category	F	G	C	D	E	C	D	A	B	B1
Universal and semi-universal ISOFIX child seats which can be installed on the outer rear seats	X		X	X	RÖMER BabySafe Plus ISOFIX	X	X	IUF		

IUF: seat suitable for the installation of an Isofix Universal seat, Forward facing and secured using the "Top Tether" upper strap.

X: seat which is not suitable for the installation of an ISOFIX seat of the size category indicated.

* Infant car seats and "car cots" cannot be installed on the front passenger seat.

! Remove and stow the head restraint before installing a child seat with a backrest on a passenger seat. Refit the head restraint once the child seat has been removed.

Child lock

Mechanical system to prevent opening of the rear doors using their interior controls.

The control is located on the edge of each rear door.



Child lock on

☞ Lower the control **A** to position **1**.

Child lock off

☞ Raise the control **A** to position **2**.

A few driving recommendations

Observe the driving regulations at all times and remain vigilant whatever the traffic conditions. Pay close attention to the traffic and keep your hands on the wheel so that you are ready to react at any time to any eventuality. In difficult weather, drive smoothly, anticipate the need to brake and increase the distance from other vehicles.

If you are obliged to drive through water:



- check that the depth of water does not exceed 15 cm, taking account of waves that might be generated by other users.
- drive as slowly as possible; do not exceed 6 mph (10 km/h).

On leaving the flooded road, as soon as circumstances allow, make several light brake applications to dry the brake discs and pads. If in doubt on the state of your vehicle, contact a PEUGEOT dealer or a qualified workshop.

Driving on flooded roads

We strongly advise against driving on flooded roads, as this could cause serious damage to the motor and the gearbox as well as the electrical systems of your vehicle.

Important!

! Never drive with the parking brake applied - Risk of overheating and damage to the braking system!

! Never leave a vehicle unsupervised with the motor switched on. If you have to leave your vehicle with the motor switched on, apply the parking brake and place the drive selector in position **N** or **P**.

Starting - stopping the vehicle

Ignition switch

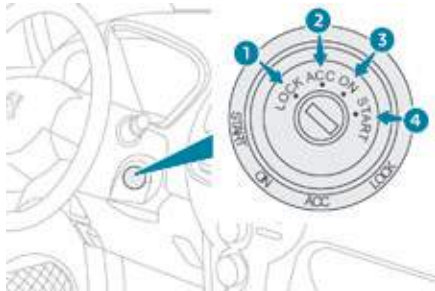

- Position 1: **LOCK**
The steering is locked.
- Position 2 : **ACC**
The ancillaries (radio, 12 V socket, etc.) can be used.
- Position 3: **ON**
Ignition on.
- Position 4: **START**
"Ready" lamp on.
Motor ready to drive the vehicle.

! If you use the ancillaries for a prolonged period (with the key in the **ACC** position), you risk discharging the 12 V battery. Starting your vehicle will then no longer be possible. **Be aware.**

Starting

- ☞ Check that the drive selector is in position **P**.
- ☞ Insert the key in the ignition switch.
- ☞ Turn the key to position **4 (START)**.

READY

- ☞ Hold it in this position for a few seconds until the "**READY**" lamp comes on accompanied by an audible signal.
- ☞ Release the key.
The key returns automatically to position **3 (ON)**.

Stopping

- ☞ Stop the vehicle.
- ☞ Keep your foot on the brake pedal.
- ☞ Place the drive selector in position **P**.
- ☞ Apply the parking brake.
- ☞ Turn the key to position **1 (LOCK)**.
- ☞ Remove the key from the ignition switch.

i Do not attach any heavy objects to the key as this could weigh down on it when in the ignition switch and cause a fault.

Parking brake

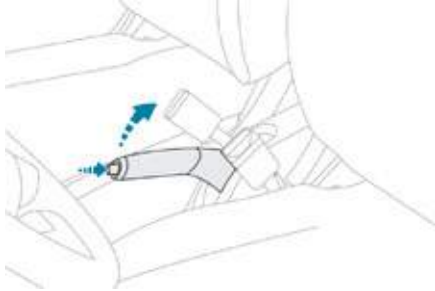

Applying

- ☞ Pull the parking brake lever fully up to immobilise your vehicle.

Releasing

- ☞ Pull the parking brake lever up slightly, press the release button then lower the lever fully.



When the vehicle is being driven, if the parking brake is still on or has not been fully released, this warning lamp comes on.



When parking on a slope, direct your wheels against the kerb, apply the parking brake, place the drive selector in position **P** and switch off the ignition.

Drive selector

Selector positions



P. Park.

This position is used for starting the vehicle. To come out of the **P** position, you must have your foot on the brake.

R. Reverse.

N. Neutral.

D. Drive (Forward).

Displays in the instrument panel



When you move the drive selector through the grille to select a position, the corresponding indicator is displayed in the instrument panel.

Moving off



With the motor running, **P** appears in the instrument panel screen.

- ☞ Press the brake pedal to come out of position **P**.
- ☞ Select forward (**D**) or reverse (**R**) gear.
- ☞ Release the parking brake.
- ☞ Take your foot off the brake pedal, the vehicle then moves off slowly to facilitate manoeuvring.
- ☞ Accelerate to go forwards or backwards.
- ☞ "**D**" or "**R**" appears in the instrument panel screen.

Parking the vehicle

To stop the motor, you must select position **P**. You must apply the parking brake to immobilise the vehicle.

To remove the key from the ignition switch, the drive selector must be in position **P**.

! To tow your vehicle, the drive selector must be in position **N**. For more information on **Towing the vehicle**, refer to the corresponding section.

Under-inflation detection

System which continuously and automatically checks the pressures of the four tyres after switching on the ignition.

A pressure sensor is located in the valve of each tyre.

The system triggers an alert if a drop in pressure is detected in one or more tyres, compared to the reference pressure registered in the system. This reference pressure must be reinitialised every time the tyre pressures are adjusted or a wheel changed.

The system operates on condition that sensor identifiers have first been memorised in the system by a PEUGEOT dealer or a qualified workshop.

You can memorise two sets of tyres (for example: wheels with "standard" tyres and wheels with "winter" tyres).

 The tyre under-inflation detection system is an aid to driving which does not replace the need for vigilance on the part of the driver.

 This system does not avoid the need to check the tyre pressures monthly and before a long journey. Driving with under-inflated tyres adversely affects road holding, extends braking distances and causes premature tyre wear, particularly under arduous conditions (vehicle loaded, high speed, long journey).

 Driving with under-inflated tyres increases fuel consumption.

 The tyre pressures for your vehicle can be found on the tyre pressure label. For more information on the **Identification markings**, refer to the corresponding section. The tyre pressures must be checked with the tyres "cold" (vehicle stopped for 1 hour or after driving for less than 6 miles (10 km) at moderate speed). Otherwise, add 0.3 bar to the values indicated on the label.

Under-inflation alert



The alert is given by the fixed illumination of this warning lamp.

- ☞ Reduce speed, avoid sudden steering movements or harsh brake applications.
- ☞ Stop as soon as it is safe to do so.



The loss of pressure detected does not always lead to visible deformation of the tyre. Do not rely on just a visual check.

- ☞ Check the four tyre pressures when "cold", using the compressor from the temporary puncture repair kit.
If it is not possible to check the tyre pressures at the time, drive carefully at reduced speed.
- or
- ☞ In the event of a puncture, use the temporary puncture repair kit.



The alert is maintained until the reference pressure is reinitialised after the reinflation, repair or replacement of the tyres concerned. In the event of the repair or replacement of tyres, the sensor identifiers must be registered in the system by a PEUGEOT dealer or a qualified workshop.

Reinitialising the reference pressure

The system must be reinitialised after any adjustment of tyre pressures and after changing one or more wheels.



Before reinitialising the system, ensure that the pressures in the four tyres are suitable for the conditions of use of the vehicle and as specified on the tyre pressure label.

The under-inflation detection system cannot warn of an incorrect pressure at the time of reinitialisation.



The reinitialisation instruction is entered in the instrument panel screen screen, with the ignition on and the vehicle stationary.

☞ Press button **A** to select the function.

☞ Press and hold button **A** for **at least 3 seconds** to reinitialise the under-inflation detection system.

Reinitialisation of the system is confirmed by the flashing of the warning lamp in the instrument panel.

You then have to drive about 100 metres before the warning lamp goes off.

! The under-inflation alert is only reliable if the system has been reinitialised with the four tyre pressures correctly adjusted.

Operating fault



The flashing and then fixed illumination of the under-inflation warning lamp indicates a fault with the system.

In this case, monitoring of the tyre pressures is not assured.

This alert is also displayed if:

- one or more wheels is not fitted with a sensor.
- a wireless device operating on the same frequency is close to the vehicle.
- there are accumulations of snow or ice in the wings or in the wheel rims.
- the state of charge of the tyre pressure monitoring system battery is too low.
- the wheel sensor identifiers have not been memorised in the system by a PEUGEOT dealer or a qualified workshop.

i Go to a PEUGEOT dealer or a qualified workshop to have the system checked or, following the repair of a puncture, to have the original wheel, equipped with a sensor, refitted.

! Any tyre repair or replacement on a wheel fitted with this system must be carried out by a PEUGEOT dealer or a qualified workshop. If you fit the second set of tyres memorised in the system, a fault will be signalled until the second set is selected in the configuration menu.

Managing sets of wheels and tyres

If you have had a second set of wheels and tyres registered by a PEUGEOT dealer or a qualified workshop, every time you change the set of wheels (fitting a set of winter tyres, for example), you must select the set you have just fitted in the configuration menu.



After fitting the new set of wheels and tyres, you should check and adjust the tyre pressures to the values specified on the tyre pressure label. For more information on the **Identification markings**, refer to the corresponding section.

Selection of the other set of wheels and tyres is done via the instrument panel screen, with the ignition on and the vehicle stationary.

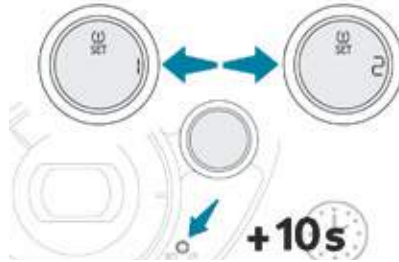

- ☞ Press button **A** to select the function.
- ☞ Press and hold button **A** button for **more than 10 seconds** to change successively from set of wheels and tyres **1** to set of wheels and tyres **2** or the other way round.



The system automatically reinitialises the reference pressure based on the pressure in the new set (the under-inflation detection warning lamp flashes during the operation).

PEUGEOT & TOTAL PARTNERS IN THE FUTURE OF THE AUTOMOBILE

PEUGEOT and TOTAL personnel combine their talents to optimise the efficient use of energy and reduce the impact on the environment.

The partnership between our two groups, which is on an international scale, does not merely amount to the supply and maintenance of vehicles to the public: our positions as industrial leaders allow us to meet the environmental challenges of today and of tomorrow.

To provide ecologically responsible mobility to everyone is more than our driving force, it is our passion.

Innovation is underway, the future of the automobile depends on it; we will meet the challenges together.



PEUGEOT RECOMMENDS TOTAL



OFFICIAL PARTNERS

Charging the main battery

There are two types of charging you can use: normal or fast.

Normal charging should be favoured; it is done from a domestic mains power point.

Fast charging is done at a compatible fast charging station.

Normal charging



During charging, if you wear a pacemaker or other electrical medical device, you

must not stay inside the vehicle or near the vehicle, charging cable, charging unit or charging point, even for a short time.

It is also important that you take advice from your doctor on the precautions to take and observe.



Before connecting, check that the electrical installation you want to use meets standards* and is compatible with the rating of your charging unit. If in doubt, call upon a professional installer.

There are sockets available that are specially designed for charging electric vehicles.

For sockets dedicated to charging an electric vehicle, refer to the installation instructions for the socket.

In all cases, it is recommended that you first have an initial check and then regular checks carried out on your installation by a qualified electrician.



In most European countries, PEUGEOT has established a partnership with a specialist company that can check and bring your electrical installation up to standard. For more information, contact a PEUGEOT dealer.



You must always use only a genuine PEUGEOT charging cable.

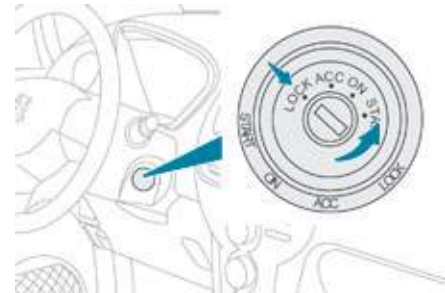

- ☞ Apply the parking brake and put the drive selector in position **P**.
- ☞ Switch off all electrical consumers and turn the ignition switch to the "**LOCK**" position.



In the event of damage to or deterioration of the charging cable or control unit, do not use it. Contact a PEUGEOT dealer if in doubt or for a replacement.

* For example, in France the standard is NF C 15-100.

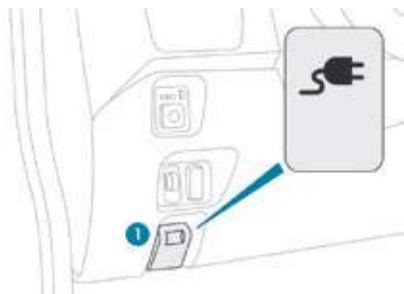

- ☞ Pull lever **1**, located at the bottom of the dashboard, driver's side, to open the access flap for the normal charging socket (right-hand side of the vehicle).
- ☞ Take the charging cable from the storage bag provided. This cable has a control unit.
- ☞ Connect the charging cable to a compatible standard power socket. On connecting the cable, the three **POWER**, **FAULT** and **CHARGING** lamps all come on temporarily, then only the green **POWER** lamp stays on.

! If the exterior temperature is lower than -25°C , charging may not be possible.



! Do not use an electrical extension, multi-gang socket, adaptor or timer.

i Use the cord supplied to hook the control unit, so that it does not weigh down on the power point (risk of damage to the charging cable or electric power point).

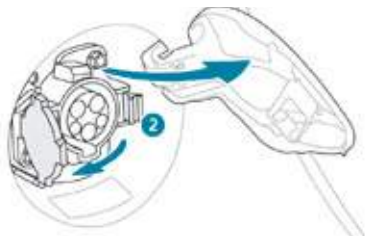

- ☞ Press the latch **2** to open the socket cover.

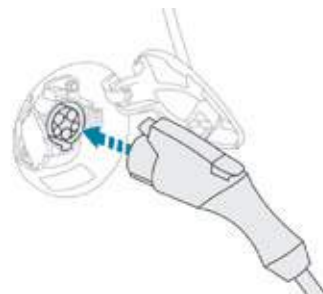

- ☞ Ensure that there is no foreign object on the vehicle's socket.
- ☞ Remove the protective cover from the charging cable.
- ☞ Insert the charging plug into the socket without pressing the button, until it **clicks into place**.

! Do not touch the metal end of the normal charging socket or of the charging cable (risk of electrocution and/or faults).

! Never connect or disconnect the cable or charging plug with **wet hands** (risk of electrocution).



- ☞ Check that the charging lamp in the instrument panel and the green **CHARGING** lamp of the control unit are on fixed.

If this is not the case, charging has not started; repeat the procedure, ensuring that all connections are correct.

The state of charge indicator for the main battery is displayed in the instrument panel and the number of bars illuminated increases as the battery is charged.

i The start of charging may be accompanied by the noise of a fan running. This noise is perfectly normal.

i The charge may be interrupted at any time by withdrawing the charging plug.

! If exceptionally you have to interrupt the charge by disconnecting the charging cable from the power point, it is essential to first press the **Manual Stop** button on the control unit.

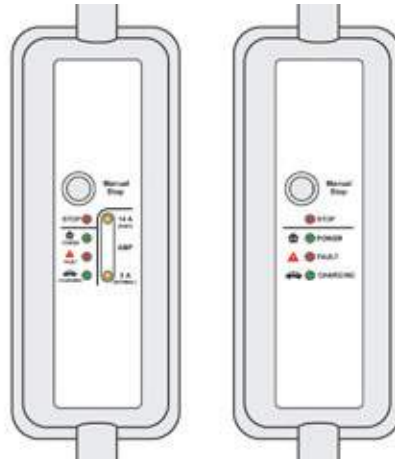

Control unit

There are four indicator lamps:

- **STOP:** on red.
It indicates that charging has been interrupted by a press on the **Manual Stop button**. This action is essential before disconnecting the charging cable from the power point when charging.
- **POWER:** on green.
It indicates that the electric connection has been established. If it does not come on, check that the connections are correct. If the problem persists, contact a PEUGEOT dealer or a qualified workshop.
- **FAULT:** on red.
It indicates the presence of a fault. Check that the connections are correct. If this warning lamp does not go off, contact a PEUGEOT dealer or a qualified workshop.
- **CHARGING:** on green.
It indicates that charging is in progress. If it does not come on, check that the connections are correct. If the problem persists, contact a PEUGEOT dealer or a qualified workshop.

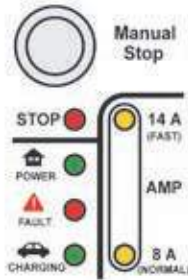

This type of control unit that has a system for recognising the type of power point (depending on country). It detects the power rating of your domestic power point and is able to support and select the best current rating to ensure safe charging:

- **14 A (FAST)**: if your electrical installation supports it.
- **8 A (NORMAL)**: if your electrical installation is standard.

The charge lamp in the instrument panel going off and flashing of the green **CHARGING** lamp indicate that charging is complete.

- ☞ Press the button to remove the charging plug.
- ☞ Refit the protective cover to the charging cable.
- ☞ Close the charging socket cover, then the flap.
- ☞ Disconnect the charging cable from the power point.
- ☞ Stow the charging cable in the bag provided.

i As a safety measure, the motor will not start when the charging cable is connected to the vehicle's socket. Also, any attempt to start the motor interrupts the charging procedure. It will then be necessary to disconnect and reconnect the charging cable plug to continue charging.

! If the 12 V battery is discharged, it is not possible to charge the main battery.

! While charging, do not do anything under the bonnet, even with the ignition off, as the cooling fan may start at any time (risk of injury). You must wait for at least one hour after the end of the charging procedure before doing anything under the bonnet, as some areas may be extremely hot (risk of burns).

! After charging, close the charging socket cover and flap. Take care to avoid the ingress of water or dust to the socket and its cover or the charging plug (risk of fire or electrocution).

! After removing the charging plug from the vehicle's socket, do not leave the cable connected to the electric power point (risk of short circuit or electrocution if there is contact or immersion in water).

! In the event of an accident or an impact to the underbody of the vehicle (contact with a raised kerb, a bollard, street furniture, etc.), the electric circuit or the main battery may be damaged. Have your vehicle checked by a PEUGEOT dealer or a qualified workshop. Never touch the 300 V components, nor the orange cables.

! In the event of serious damage to the main battery, never touch liquids coming from this component. In the event of contact with your body, wash abundantly with water and contact a doctor without delay.

! **To optimise the service life of the main battery, recharge it completely every 2 weeks.**



For a complete charge, follow the normal charging procedure (domestic power point) without interruption, until it stops automatically (charging warning lamp goes off in the instrument panel). In addition, **every 3 months, carry out this complete recharge of the main battery from a state of charge of 2 bars or less.**



i **Vehicle out of use for a long period**

When your vehicle is going to be out of use for a long period, charge the main battery completely every three months (following the normal charging procedure).































Before charging, check that the 12 V battery is not disconnected or discharged. If this is the case, refer to the "12 V battery" section for reconnecting or charging the battery.

Control unit statuses

  Lit in the corresponding indicator lamp colour.

  Flashing in the corresponding indicator lamp colour.





 Off.

POWER 	FAULT 	CHARGING 	
			Normal operation
			As soon as the charging cable is connected to a socket, all of the indicator lamps come on for approximately 0.5 second.
			Once the initialisation process is complete: <ul style="list-style-type: none"> • if the charging cable is not connected to the vehicle's socket. • if the charging cable is connected to the vehicle's socket, but the vehicle is not charging.
			When the traction battery is being charged.
			When charging is complete.
POWER 	FAULT 	CHARGING 	Operating faults and solutions
			If a current leak is detected or the charging cable is faulty. <ul style="list-style-type: none"> - Stop the charging procedure immediately and contact a PEUGEOT dealer or a qualified workshop.
			If the charging cable is faulty. <ul style="list-style-type: none"> - Stop the charging procedure immediately and contact a PEUGEOT dealer or a qualified workshop.
			If the indicator lamp on the control unit does not come on when the charging cable is connected to the socket, check the socket's circuit breaker: <ul style="list-style-type: none"> • if the circuit breaker has cut out, your electrical installation may not be compatible with the use of the charging cable: <ul style="list-style-type: none"> - contact a professional to have your electrical installation checked and repaired. • if the circuit breaker has not cut out: <ul style="list-style-type: none"> - do not use the charging cable and contact a PEUGEOT dealer or a qualified workshop.

Using a public charging point for normal charging

Several types of electrical socket may be available for charging your vehicle.

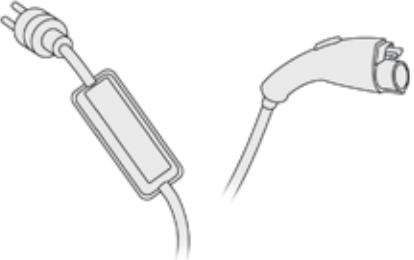
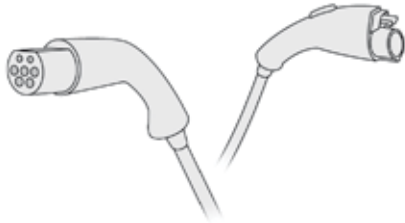
Before starting the charging procedure, use the table below to identify the correct type of socket and use the corresponding charging cable.

<p>Domestic power point</p> 	<p>"Mode 3 - Type 2" socket</p> 	<p>"Mode 3 - Type 3" socket</p> 
<p>"Mode 2" cable (supplied with your vehicle)</p> 	<p>"Mode 3 - Type 2" cable (available as an accessory)</p> 	<p>"Mode 3 - Type 3" cable (available as an accessory)</p> 

i Some public charging points include a charging cable.

In this case, use the cable provided.

In Mode 3, regardless of the power of the charging point, charging will be limited to 16 A maximum. For more information on the charging times, refer to the **Motor and main battery** section.

Fast charging*



If you wear a pacemaker or other electrical medical device, you must not use fast charging.

Avoid going near a fast charging point.

However, should this occur, leave the area as quickly as possible.

If necessary, ask someone else to charge your vehicle.



Check the compatibility of the charging station and its charging cable with your vehicle.

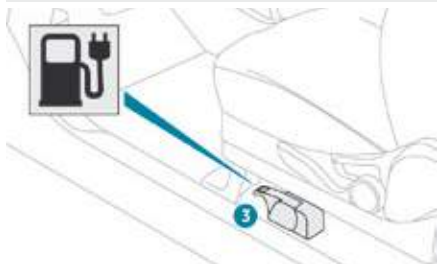

- ☞ Apply the parking brake and put the drive selector in position **P**.
- ☞ Switch off all electrical consumers and turn the ignition switch to the "**LOCK**" position.
- ☞ Pull lever **3**, located alongside the driver's seat, door side, to open the access flap for the fast charging socket (left-hand side of the vehicle).

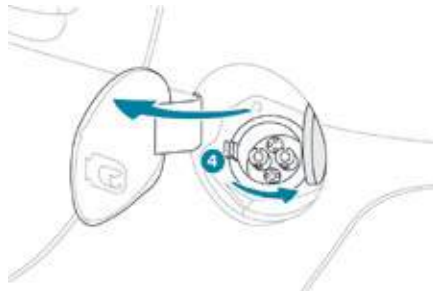

- ☞ Press latch **4** to open the socket cover.
- ☞ Ensure that there is no foreign body on the vehicle's charging socket.



Do not touch the metal end of the fast charging socket or of the charging cable.
Risk of electrocution and/or faults.



- ☞ Connect the charging cable of the charging station to the vehicle following the instructions on use of the station.

* Depending on equipment.



- ☞ Check that the charging warning lamp in the instrument panel is on fixed.

If this is not the case, charging has not started; check the operating instructions for the charging station.

The charging warning lamp in the instrument panel goes off when charging is complete.

- ☞ Disconnect the charging cable following the instructions for the charging terminal.
- ☞ Close the charging socket cover and the flap.

- i If the exterior temperature is below 0 °C, the charging time may be longer. If the exterior temperature is below -25 °C, charging may not be possible.

- i During fast charging, the vehicle's air conditioning may start automatically, if needed to cool the main battery. It is therefore perfectly normal to hear the noise of a fan running from outside the vehicle and to see a puddle of water form under the vehicle.

- i As a safety measure, the motor will not start when the charging cable is connected to the vehicle's socket. Also, any attempt to start the motor interrupts the charging procedure. It will then be necessary to disconnect and reconnect the charging cable to the vehicle's socket, then to restart the charging following the instructions for using the charging station.

i **Vehicle out of use for a long period**

When your vehicle is going to be out of use for a long period, charge the main battery completely every three months (following the normal charging procedure).

Before charging, check that the 12 V battery is not disconnected or discharged. If this is the case, refer to the "12 V battery" section for reconnecting or charging the battery.

- i Fast charging stops automatically when the main battery is around 80% charged. It is possible to attain a charge of 100% by restarting the procedure. However, the time taken by this additional charge will be relatively long, as the charging rate is reduced.

- ! After charging, close the charging socket cover and flap. Take care to avoid the ingress of water or dust into the socket, under its cover or into the charging plug. Risk of fire or electrocution.

Bonnet

Protects the components in the front compartment and provides access for checking levels, charging the 12 V battery, changing fuses, etc.

Opening



- ☞ Open the front right door.
- ☞ Pull the interior release lever **A**, located at the bottom of the door aperture.

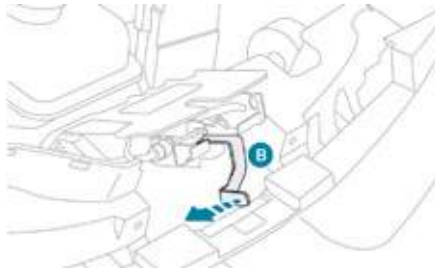

- ☞ Push the exterior safety catch **B** to the left and raise the bonnet.

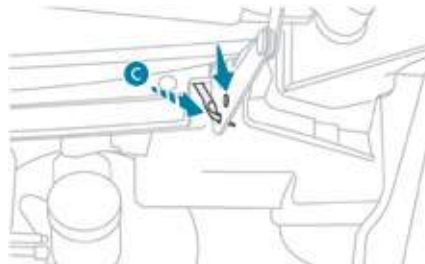

- ☞ Open the bonnet fully and on the right, unclip the stay **C** from its holder.
- ☞ Fit the stay **C** in one of the two notches to hold the bonnet open.

i The location of the interior release lever prevents opening of the bonnet while the front right door is closed.

Closing

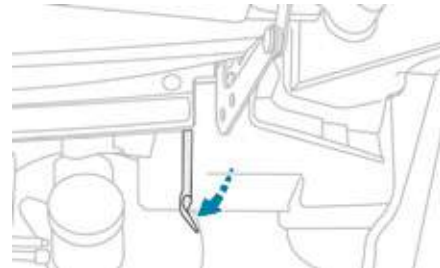

- ☞ Take the stay out of the support notch.
- ☞ Clip the stay in its housing.
- ☞ Lower the bonnet and release it at the end of its travel.
- ☞ Pull on the bonnet to check that it is fully latched.

! Do not press down on the middle of the bonnet if it does not fully close, as there is a risk of deforming it. Open the bonnet fully and close it again.

Front compartment

1. Screenwash fluid reservoir.
2. Heater fluid reservoir.
3. Brake fluid reservoir.
4. 12 V battery.
5. Fusebox.

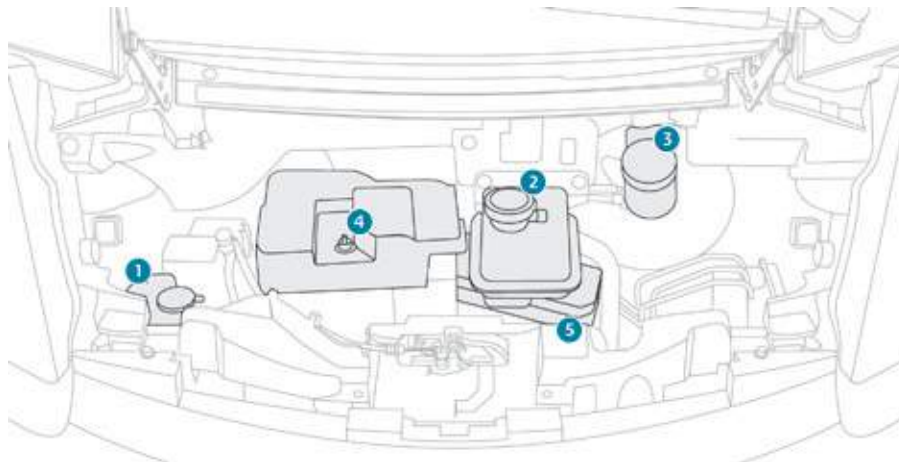

! To avoid damaging electrical components, the use of a high pressure jet washer in the front compartment is strictly prohibited.

Rear compartment

Located under the boot floor, this compartment gives access to the cooling system reservoir.

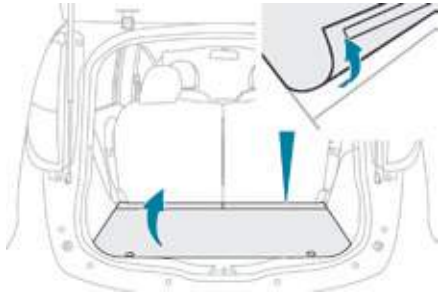

- ☞ Open the boot.
- ☞ Detach the carpet retaining adhesive strip.
- ☞ Remove the boot carpet.

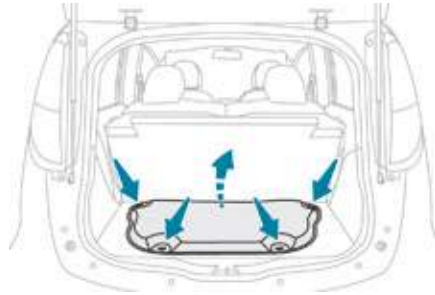

- ☞ Remove the four "butterfly" screws.
- ☞ Remove the protective cover.

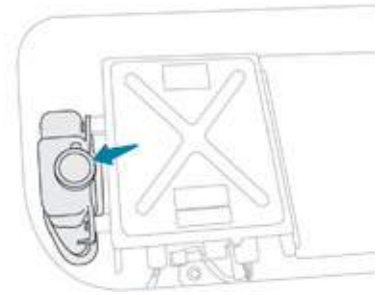

- ☞ Check the coolant level and top up if necessary.

! For more information on **Checking levels**, refer to the corresponding section.
When working in this compartment, you must observe the safety recommendations on the labels.

Checking levels

Check all of these levels regularly and top them up if necessary, unless otherwise indicated.

If a level drops significantly, have the corresponding system checked by a PEUGEOT dealer or a qualified workshop.

! Never do anything in the compartments when the "Ready" lamp is on or when your vehicle is being charged. Take care when carrying out checks in the front and rear compartments as some parts of the compartments can be very hot (risk of burns): wait at least one hour after stopping the motor or the end of the charging procedure before carrying out any work.

Front compartment

Brake fluid level



The brake fluid level should be between the "MIN" and "MAX" marks. If it is not, check the brake pad wear.

Changing the fluid

Refer to the manufacturer's service schedule for details of the interval for this operation.

Fluid specification

The brake fluid must conform to the manufacturer's recommendations.

Heating system fluid level

The level of this fluid should be between the "L" MIN and "F" MAX marks.

Changing the fluid

This fluid does not have to be changed.

Fluid specification

The fluid must conform to the manufacturer's recommendations.

Screenwash fluid level



Top up the level when necessary.

Fluid specification

For optimum cleaning and to avoid freezing, this fluid must not be topped up or replaced with plain water.

12 V battery electrolyte level

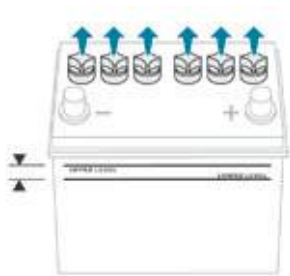

Remove the battery protective cover to check this level.

For more information on the **12 V battery**, refer to the corresponding section.

The level of this fluid should be between the MIN "LOWER LEVEL" and MAX "UPPER LEVEL" marks.

If necessary, top up using distilled water by removing the caps of the different battery compartments.

i Check the electrolyte level at least once per month.

Rear compartment

Coolant level



The coolant level should be between the MIN "L" and MAX "F" marks.

As the cooling system is pressurised, wait at least one hour after switching off the motor and/or the end of the charging cycle before carrying out any work.

To avoid any risk of scalding, unscrew the cap by two turns to allow the pressure to drop. When the pressure has dropped, remove the cap and top up the level.

Changing the coolant

The coolant does not have to be changed.

Coolant specification

The coolant must conform to the manufacturer's recommendations.

Used products

! Avoid prolonged contact of used fluids with the skin. Most of these fluids are harmful to health and some are very corrosive.

♻️ Do not discard used fluids into sewers or onto the ground. Take used fluids to a PEUGEOT dealer or a qualified workshop (France) or to an authorised waste disposal site.

Checking components

Unless otherwise indicated, check these components in accordance with the manufacturer's service schedule. Otherwise, have them checked by a PEUGEOT dealer or a qualified workshop.

Passenger compartment filter



Refer to the manufacturer's service schedule for details of the replacement intervals for this filter.

Depending on the environment (e.g. dusty atmosphere) and the use of the vehicle (e.g. city driving), **replace it twice as often if necessary**. A dirty passenger compartment filter may have an adverse effect on the performance of the air conditioning system and generate undesirable odours.

Brake pads



Brake wear depends on the style of driving, particularly in the case of vehicles used in town, over short distances. It may be necessary to have the condition of the brakes checked, even between vehicle services.

Unless there is a leak in the circuit, a drop in the brake fluid level indicates that the brake pads are worn.

Brake disc / drum wear



For information on checking the brake disc or drum wear, contact a PEUGEOT dealer or a qualified workshop.

Parking brake



If a loss of effectiveness of this system is noticed, the parking brake must be checked, even between two services.

This system must be checked by a PEUGEOT dealer or a qualified workshop.

i Only use products recommended by PEUGEOT or products of equivalent quality and specifications. In order to optimise the operation of units as important as the braking system, PEUGEOT selects and offers very specific products.

Changing a wiper blade

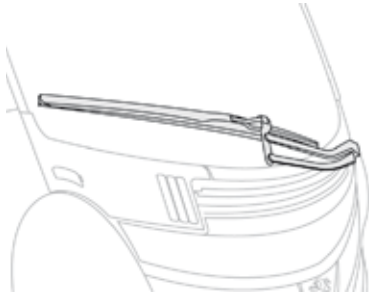

Removing a front or rear wiper blade

- ☞ Raise the corresponding wiper arm.
- ☞ Remove the wiper blade, sliding it towards the outside.

Fitting a front or rear wiper blade

- ☞ Put the new wiper blade in place and secure it.
- ☞ Fold down the wiper arm carefully.

Precautions for washing

! Do not wash the vehicle while the battery is being recharged.

! Check - before washing the vehicle - that the charging flaps and the charging socket covers (normal and fast charge) are properly closed.

! To avoid damaging the electrical components, the use of a high pressure jet wash is strictly prohibited:

- in the front compartment (under the bonnet).
- under the body.

i For washing the bodywork, do not use a pressure greater than 80 bars.

12 V battery

All of the electrical components of your vehicle (other than the electric motor, the heating and the air conditioning) are powered by this 12 V ancillaries battery.

It is located in the front compartment and is recharged by the main battery, during phases of operation ("Ready" lamp on in the instrument panel) and charging.

! If the 12 V battery is discharged, it will not be possible to start the motor and the main battery cannot be charged.

i Disconnecting the battery is not recommended. However, if the vehicle is not to be used for a prolonged period of more than a month, it may be necessary, in winter, to disconnect and store the battery to avoid the electrolyte freezing.

! After prolonged disconnection of the battery, you must contact a PEUGEOT dealer or a qualified workshop to have the electronic control unit reinitialised.

Access to the battery

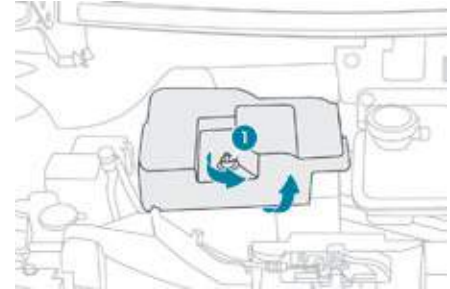

- ☞ Open the front bonnet using the interior release lever, then the exterior safety catch.
- ☞ Secure the bonnet stay.
- ☞ Slacken the nut 1.
- ☞ Remove the battery protective cover for access to the two terminals.

Starting using a battery on another vehicle

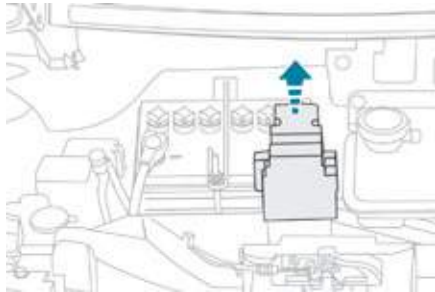

! Ensure that the electrolyte is not frozen. Check the electrolyte level and top up with distilled water if necessary. For more information on **Checking levels**, refer to the corresponding section.

☞ Lift the protective cover on the (+) terminal.

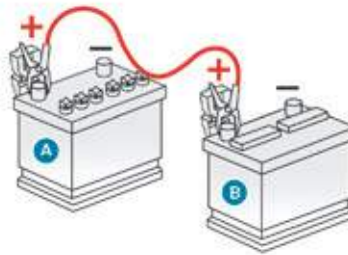

! Check that the battery on the other vehicle is a 12 V battery.

☞ Connect one end of the red cable to the (+) terminal of your discharged battery **A**, then the other end to the (+) terminal of the battery on the other vehicle **B**.

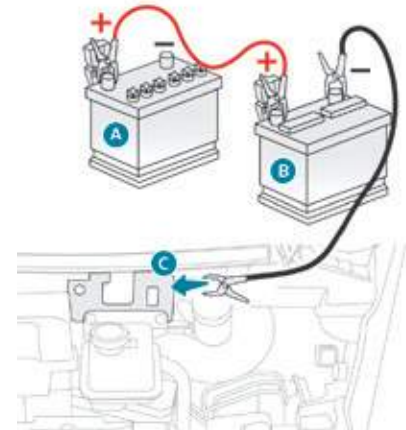

☞ Connect one end of the green or black cable to the (-) terminal of the battery on the other vehicle **B**.

☞ Connect the other end the green or black cable to the earth point **C** of your vehicle.

Charging the battery using a battery charger

- ☞ Start the other vehicle and wait a few minutes.
- ☞ Turn the ignition key on your vehicle, until the "Ready" lamp comes on.
- ☞ Disconnect the cables in the reverse order.
- ☞ Refit the battery protective cover and tighten the fixing screw.

If the "Ready" lamp does not come on, proceed as follows:

- ☞ Leave the cables connected.
- ☞ Return the ignition switch on your vehicle to the "**LOCK**" position.
- ☞ Put the main battery on charge, following the procedure for normal charging.
- ☞ When the charging warning lamp in the instrument panel comes on fixed, disconnect the cables.
- ☞ Leave the battery on charge for at least one hour.
- ☞ Turn the ignition key on your vehicle, until the "Ready" lamp comes on.

If the problem persists, contact a PEUGEOT dealer or a qualified workshop.

- ☞ Remove the protective cover from the battery.

! Ensure that the electrolyte is not frozen. Check the electrolyte level and top up with distilled water if necessary. For more information on **Checking levels**, refer to the corresponding section.

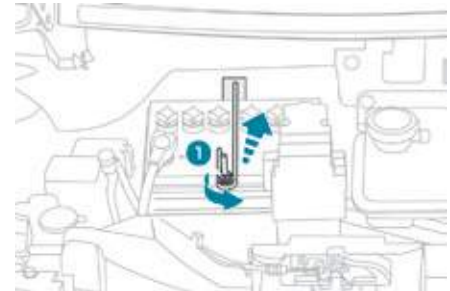

- ☞ Slacken the nut 1 and lift off the retaining bar.

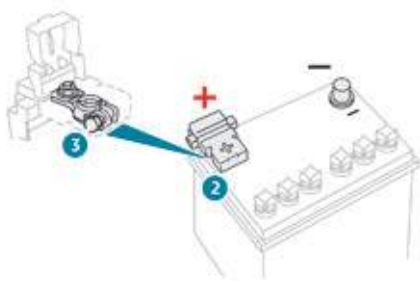

- 🔧 Disconnect the (-) terminal cable.
- 🔧 Lift the protective cover on the (+) terminal **2**.
- 🔧 Slacken the nut **3**.
- 🔧 Disconnect the positive (+) terminal cable.
- 🔧 Remove the battery.
- 🔧 Charge the battery following the instructions given by the manufacturer of the battery charger.
- 🔧 Reconnect the battery starting with the (+) cable.

i Ensure that the battery terminals are clean. If they are covered with sulphates (whitish or greenish deposit), disconnect and clean them.

! Never charge the battery without first disconnecting the terminals and removing it from the vehicle. Do not disconnect the terminals when the "Ready" lamp is on, nor when the vehicle is being charged.

Before disconnecting

You must wait 2 minutes after switching off the ignition before disconnecting the battery.

After reconnecting

After reconnecting the battery, switch on the ignition and wait 1 minute before starting, to allow initialisation of the electronic systems. However, if minor problems persist after doing this, contact a PEUGEOT dealer or a qualified workshop. Remember to reinitialise the audio system yourself.

🍀 Batteries contain harmful substances such as sulphuric acid and lead. They must be disposed of in line with legal requirements and never put out with household waste. Take used batteries to an authorised collection point.

Temporary puncture repair kit

Complete system consisting of a compressor and a sealant cartridge which permits the **temporary repair** of a tyre so that you can drive to the nearest garage.

It is designed to repair most punctures which could affect the tyre, located on the tyre tread or shoulder.

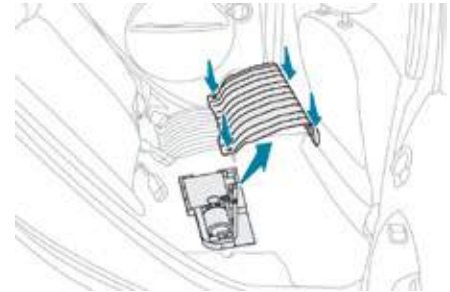

Access to the kit

This kit is installed in the storage box, under the rear seat, right-hand side.

You must therefore remove the rear seat cushion for access to the kit.

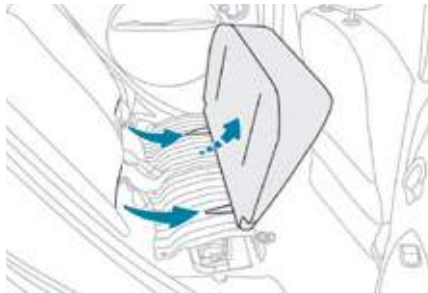

Removing the metal cover

- ☞ Remove the four "butterfly" screws.
- ☞ Remove the metal cover.

You now have access to the repair kit.

Removing the rear seat cushion

- ☞ Pull the controls **A** forwards to release the two rear seat cushion locks.
- ☞ Lift the front of the cushion and tip it upwards to remove it.

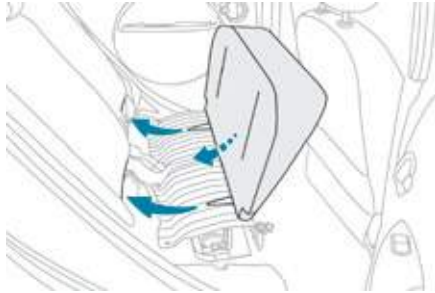

Refitting the rear seat cushion

- ☞ Put the metal cover back into place.
- ☞ Refit the four "butterfly" screws.
- ☞ Insert the metal hooks into the seat backrest.
- ☞ Fold the seat cushion down and press to secure the two locks.
- ☞ Check that the seat cushion is locked securely.

! When refitting the cushion, take care not to trap the seat belt buckles.

Composition of the kit

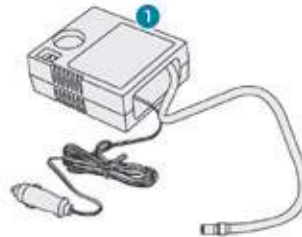

1. 12 V compressor with integral pressure gauge, to measure and adjust the tyre pressure.

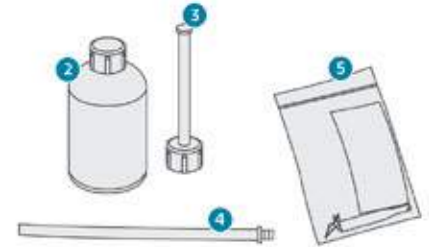

2. Sealant cartridge for the temporary repair of a tyre.
3. Injection pipe.
4. Suction pipe, to remove the sealant product if necessary.
5. Sachet containing a replacement valve core, a tool for removing/refitting the valve core and a speed restriction sticker.

i The speed restriction sticker must be affixed to the vehicle's steering wheel to remind you that a wheel is in temporary use.
Do not exceed a speed of 50 mph (80 km/h) when driving with a tyre repaired using this type of kit.

Repair procedure

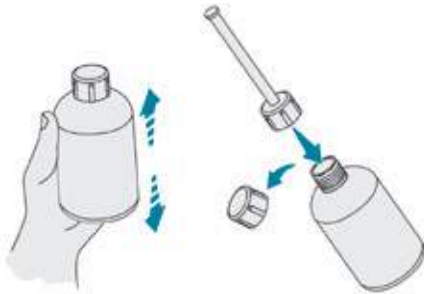

1. Sealing

- ☞ Switch off the ignition.
- ☞ Indicate, on the speed restriction sticker provided, the wheel to be repaired, then fix it to the steering wheel as a reminder that a wheel is in temporary use.
- ☞ Shake the sealant cartridge, remove the cap and screw on the injection pipe.



- ☞ Remove the valve cap for the tyre to be repaired.
- ☞ Remove the valve core using the tool provided, and store it in a clean place.
- ☞ Connect the injection pipe to the valve of the tyre to be repaired.

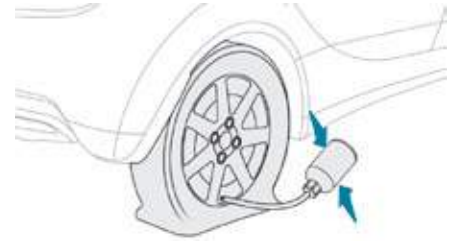

- ☞ Tap the sealant cartridge (top down) several times with your hand, so as to inject **all of the product** into the tyre.
- ☞ Remove the injection pipe.
- ☞ Refit the valve core and tighten it using the tool provided.

i Avoid removing any foreign bodies which have penetrated into the tyre.

! Take care, this product is harmful if swallowed and causes irritation to the eyes. Keep it out of reach of children. The use-by date of the sealant is marked on the cartridge. After use, do not discard the empty cartridge but take it to a PEUGEOT dealer or to an authorised waste disposal site. Do not forget to obtain a replacement cartridge; they are available from a PEUGEOT dealer or a qualified workshop.

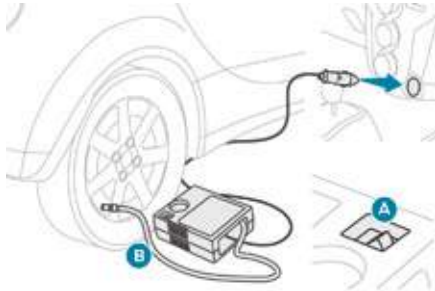

2. Inflation

- ☞ Check that the compressor switch **A** is in the "OFF" position.
- ☞ Fully uncoil the compressor pipe **B**.

- ☞ Connect this pipe to the valve of the repaired wheel.
- ☞ Connect the compressor's electric plug to the vehicle's 12 V socket (ignition switch in position "ON" or "ACC").
- ☞ Start the compressor by turning the switch **A** to the "ON" position.
- ☞ Using the compressor, adjust the pressure in accordance with the vehicle's tyre pressure label (located in the driver's door aperture).
A loss of pressure indicates that the puncture has not been fully plugged; contact a PEUGEOT dealer or a qualified workshop for assistance.
- ☞ Remove the compressor and stow the kit.
- ☞ Drive off straight away at reduced speed (50 mph [80 km/h] max) limiting the distance travelled to approximately 120 miles (200 km).

i If after around 5 to 7 minutes the required pressure is not attained, this indicates that the tyre is not repairable; contact a PEUGEOT dealer or a qualified workshop for assistance.

! As soon as possible, go to a PEUGEOT dealer or a qualified workshop. You must tell the technician that you have used the kit. After checking, the technician will advise you whether the tyre can be repaired or must be replaced.

Spare wheel

i Parking the vehicle

Immobilise the vehicle where it does not block traffic: the ground must be level, stable and not slippery.

Apply the parking brake, switch off the ignition and put the drive selector in position **P** to lock the wheels.

If necessary, place a chock under the wheel diagonally opposite the wheel to be changed.

You must ensure that the occupants get out of the vehicle and wait where they are safe.

Never go underneath a vehicle raised using a jack; use an axle stand.

Tools required

- A jack: for lifting the vehicle.
 - A wheelbrace: for removing and refitting the wheel bolts.
 - A handle: for operating the jack.
- These tools are not supplied with your vehicle.

i Wheel with wheel trim

When removing the wheel, first remove the wheel trim using the wheelbrace, by pulling at the valve hole.

When refitting the wheel, refit the wheel trim starting by aligning the valve hole with the valve, and then press on the edge of the trim with the palm of your hand.

Removing a wheel

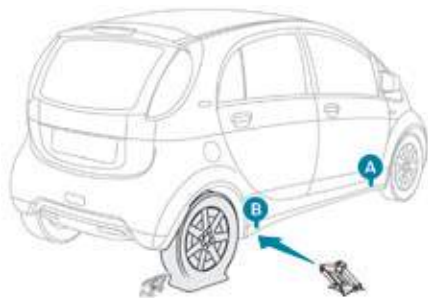

- ☞ Slacken the bolts using the wheelbrace.
- ☞ Position the foot of the jack on the ground and ensure that it is directly below the front **A** or rear **B** jacking point provided on the underbody, whichever is closest to the wheel to be changed.

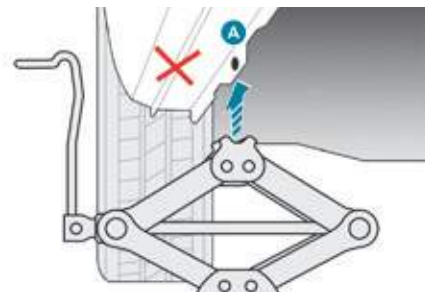
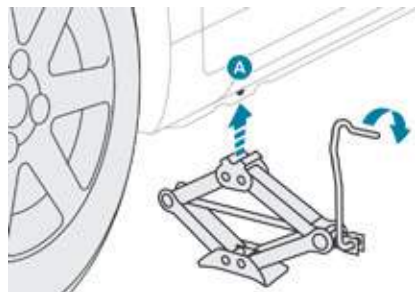

- ☞ Extend the jack until its head comes into contact with the jacking point **A** or **B** used. The vehicle's contact surface **A** or **B** must be engaged with the central part of the head of the jack.
- ☞ Raise the vehicle until there is sufficient space between the wheel and the ground.

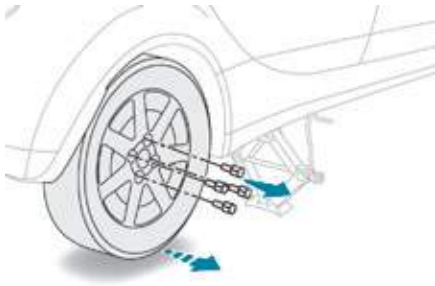

- ☞ Remove the bolts and store them in a clean place.
- ☞ Remove the wheel.

! Ensure that the jack is stable. If the ground is slippery or loose, the jack might slip or drop - Risk of injury!
Take care to position the jack only at one of the vehicle's jacking points **A** or **B** under the vehicle, ensuring that the contact surface of the vehicle's jacking point is centred on the head of the jack. Otherwise there is a risk of damage to the vehicle and/or that the jack might drop - Risk of injury!

Fitting a wheel

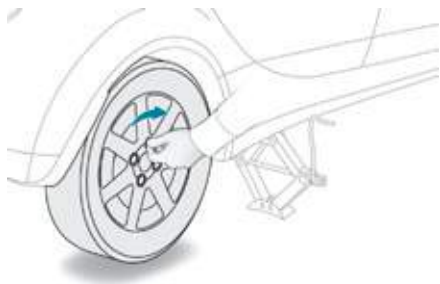

- ☞ Put the wheel in place on the hub.
- ☞ Screw in the bolts by hand.
- ☞ Pre-tighten the bolts using the wheelbrace.

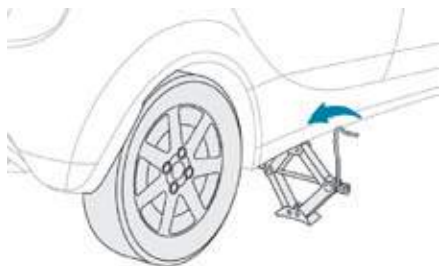

- ☞ Lower the vehicle fully.
- ☞ Fold the jack and detach it.

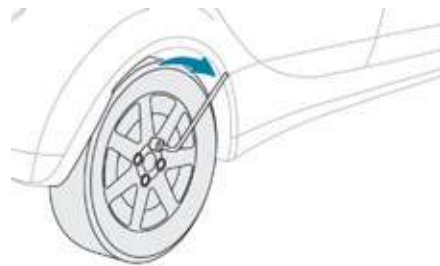

- ☞ Tighten the bolts using the wheelbrace.

i After changing a wheel

Have the tightening of the bolts and the tyre pressure of the new wheel checked by a PEUGEOT dealer or a qualified workshop without delay.

Snow chains

The snow chains must be fitted only to the rear wheels (vehicle with rear wheel drive).

i Take account of the legislation in force in your country on the use of snow chains and the maximum running speed authorised.

Use only the chains designed to be fitted to the type of wheel fitted to your vehicle:

Original tyre size	Maximum link size.
175/55 R15	9 mm
145/65 R15	cannot be fitted with chains

! It is strongly recommended that before you leave, you practise fitting the snow chains on a level and dry surface.

i For more information on snow chains, contact a PEUGEOT dealer or a qualified workshop.

Advice on installation

- ☞** If you have to fit the chains during a journey, stop the vehicle on a flat surface on the side of the road.
- ☞** Apply the parking brake and position any wheel chocks to prevent movement of your vehicle.
- ☞** Fit the chains following the instructions provided by the manufacturer.
- ☞** Move off gently and drive for a few moments, without exceeding 30 mph (50 km/h).
- ☞** Stop your vehicle and check that the snow chains are correctly tightened.

i Avoid driving with snow chains on roads that have been cleared of snow, to avoid damaging your vehicle's tyres and the road surface. If your vehicle is fitted with alloy wheels, check that no part of the chain or its fixings is in contact with the wheel rim.

Changing a bulb

- !** The headlamps have polycarbonate lenses with a protective coating:
- ☞ **do not clean them using a dry or abrasive cloth, nor with a detergent or solvent product,**
 - ☞ use a sponge and soapy water or a pH neutral product,
 - ☞ when using a high pressure washer on persistent marks, do not keep the lance directed towards the lamps or their edges for too long, so as not to damage their protective coating and seals.

Changing a bulb should only be done after the headlamp has been switched off for several minutes (risk of serious burns).

- ☞ Do not touch the bulb directly with your fingers, use a lint-free cloth.

It is imperative to use only anti-ultraviolet (UV) type bulbs to avoid damaging the headlamp.

Always replace a failed bulb with a new bulb with the same type and specification.

Front lamps

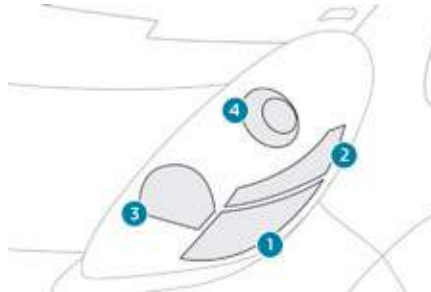

1. Direction indicators (W21W - 21 W).
2. Sidelamps (W5W - 5 W).
3. Main beam headlamps (HB3 - 60 W).
4. Dipped beam headlamps (H11 - 55 W).

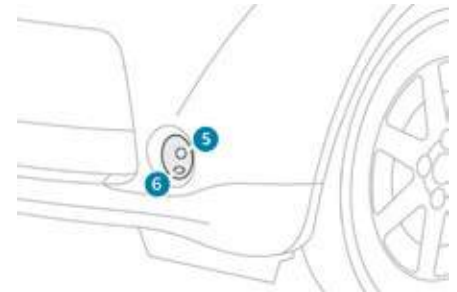

5. Front foglamps (H8 - 35 W).
6. Daytime running lamps (P13W - 13 W).

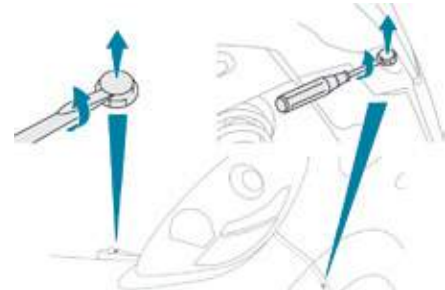
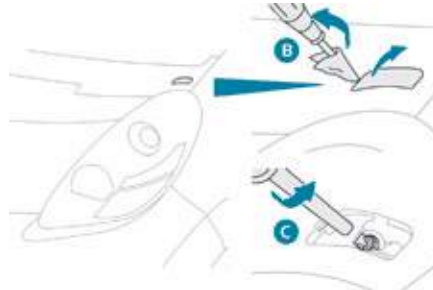
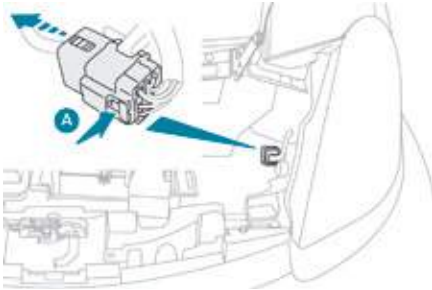

Access to bulbs

To replace a failed bulb, you must first remove the lamp.

To remove the lamp:

- ☞ Open the bonnet.
- ☞ Press tab **A** to release the connector.

- ☞ Lift the cover **B**, using a screwdriver protected by a cloth.
- ☞ Slacken fixing screw **C** until the head of the screw touches the trim.

- ☞ Remove the bumper retaining clips, using a screwdriver.
- ☞ Carefully lift the bumper.

In the event of a breakdown

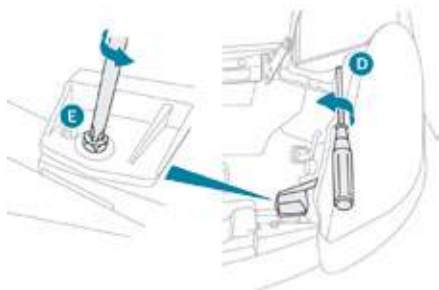

- ☞ Slacken fixing screw **D**, while holding the bumper away.
- ☞ Slacken fixing screw **E**.

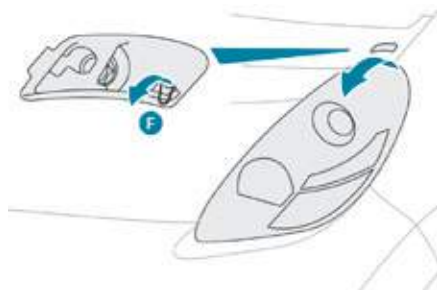

- ☞ Pull the lamp towards you, and disengage the tab **F** to remove it completely.

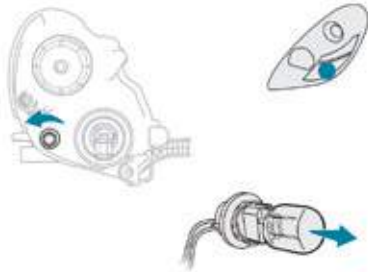

Changing direction indicator bulbs

- ☞ Turn the bulb holder to the left and pull it out.
- ☞ Pull the bulb out and change it.

To refit, carry out these operations in reverse order.

i Amber coloured bulbs must be replaced with bulbs of identical specifications and colour.

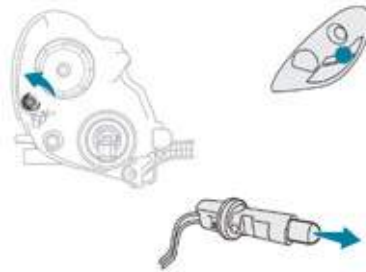

Changing sidelamp bulbs

- ☞ Turn the bulb holder to the left and pull it out.
 - ☞ Pull the bulb out and change it.
- To reassemble, carry out these operations in reverse order.

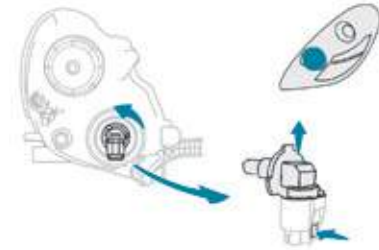

Changing main beam headlamp bulbs

- ☞ Turn the bulb holder to the left and pull it out.
- ☞ Remove the bulb by pressing on the tongue.
- ☞ Change the bulb.

For reassembly, carry out these operations in reverse order.

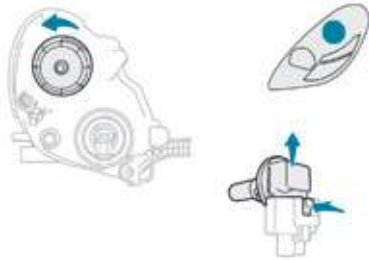

Changing dipped beam headlamp bulbs

- ☞ Turn the bulb holder to the left and pull it out.
- ☞ Remove the bulb by pressing on the tongue.
- ☞ Change the bulb.

To refit, carry out these operations in reverse order.

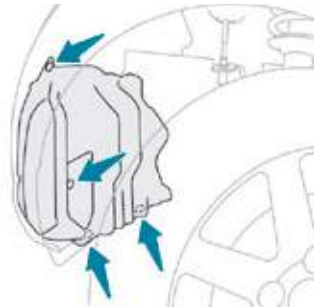

Changing front foglamp bulbs / daytime running lamp bulbs

- ☞ Put the front wheels onto full lock, to facilitate access.
- ☞ Remove the clips securing the protective covers on the bulb holders.
- ☞ Move the cover aside.

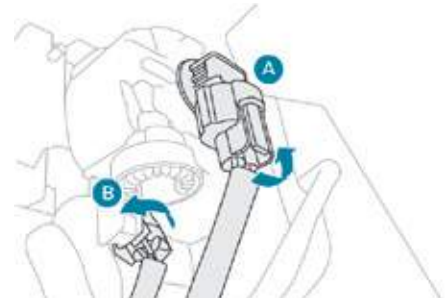

- ☞ Turn the bulb holder (A for the front fog lamp, B for the daytime running lamp) to the left and pull it out.
- ☞ Pull the bulb out and change it.

To reassemble, carry out these operations in reverse order.

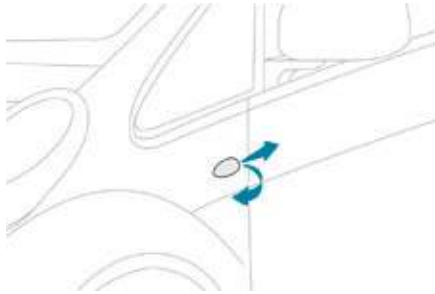

Changing integrated direction indicator side repeater bulbs (WY5W - 5 W)

- ☞ Push the repeater towards the rear and disengage it.
- ☞ Turn the bulb holder to the left and pull it out.
- ☞ Pull the bulb out and change it.

To reassemble, carry out these operations in reverse order.

Rear lamps

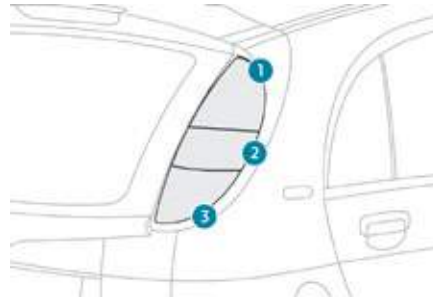

1. Brake lamps / Sidelamps (21 W / 15 W or LEDs).
2. Direction indicators (WY21W - 21 W).
3. Reversing lamps (W21W - 21 W).

i In some weather conditions (e.g. low temperature or humidity), the presence of misting on the internal surface of the glass of the headlamps and rear lamps is normal; it disappears after the lamps have been on for a few minutes.

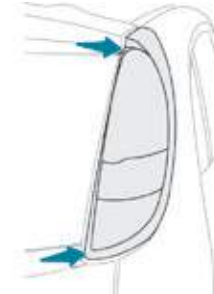

Access to bulbs

- ☞ Remove the two screws.
- ☞ Disengage the lamp unit by pulling it towards you.

i Amber coloured bulbs, such as the direction indicators, must be replaced with bulbs of identical specification and colour.

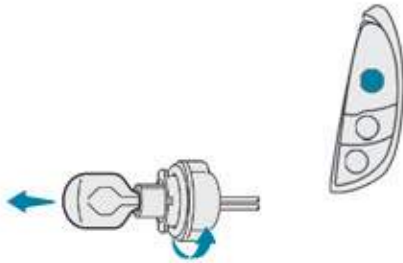

Changing brake lamp / sidelamp bulbs (21 W / 15 W)

- ☞ Turn the bulb holder to the left and pull it out.
- ☞ Pull out the bulb and change it.

To refit, carry out these operations in reverse order.

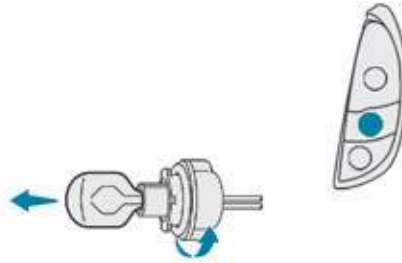

Changing a direction indicator bulb

- ☞ Turn the bulb holder to the left and pull it out.
- ☞ Pull the bulb out and replace it.

To refit, carry out these operations in reverse order.

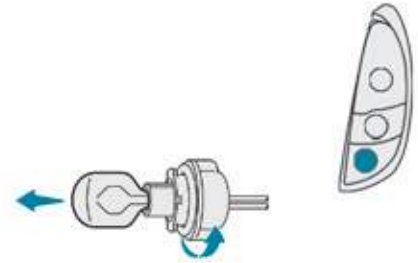

Changing a reversing lamp bulb

- ☞ Turn the bulb holder to the left and pull it out.
- ☞ Pull the bulb out and replace it.

To refit, carry out these operations in reverse order.

Changing brake lamp / sidelamp LEDs

All work on the LED lamps must be carried out by a PEUGEOT dealer or qualified workshop.

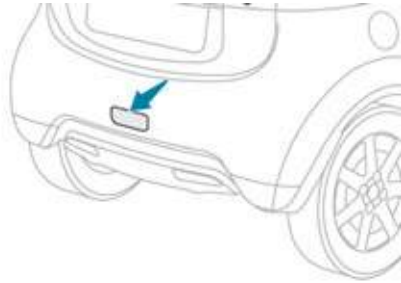

Changing a foglamp bulb (W21W - 21W)

- ☞ Remove the cover.
- ☞ Turn the bulb holder to the left and pull it out.
- ☞ Pull the bulb out and change it.

To refit, carry out these operations in reverse order.

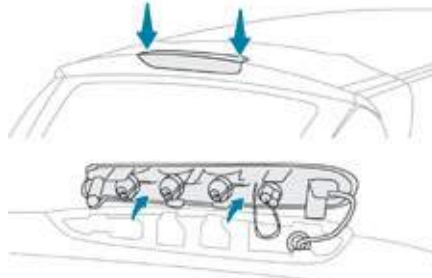

Third brake lamp (W5W - 5W)

- ☞ Remove the two screws.
- ☞ Pull out the bulb-holder.
- ☞ Pull out the bulb and change it.

To refit, carry out these operations in reverse order.

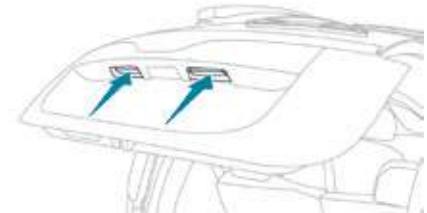

Changing number plate lamp bulbs (W5W - 5W)

- ☞ Push the cover inwards.
- ☞ Turn the bulb holder and pull it out.
- ☞ Remove the bulb and change it.

To refit, carry out these operations in reverse order.

Changing a fuse

Access to tools



The extraction tweezers are fitted to the back of the fusebox cover in the dashboard (left-hand side).

To gain access to it:

- ☞ Unclip the cover and remove it completely by pulling it towards you.
- ☞ Remove the tweezers.

Changing a fuse



Good



Failed

Before changing a fuse, the cause of the failure must be identified and rectified.

- ☞ Check that the ignition switch is in the "LOCK" position.
- ☞ Identify the faulty fuse by checking the condition of its filament.
- ☞ Use the special tweezers to extract the fuse from its location.
- ☞ Always replace the faulty fuse with a fuse of the same rating.
- ☞ Check that the number etched on the box, the rating etched on the top and the tables below all agree.

i Your vehicle's electrical system is designed to operate with standard or optional equipment. Before installing other electrical equipment or accessories in your vehicle, contact a PEUGEOT dealer or a qualified workshop.

! PEUGEOT will not accept responsibility for the cost incurred in repairing your vehicle or for rectifying the malfunctions resulting from the installation of accessories not supplied and not recommended by PEUGEOT and not installed in accordance with its instructions, in particular when the consumption of all of the additional equipment connected exceeds 10 milliamperes.

Dashboard fuses



The fusebox is placed in the lower dashboard (left-hand side).

Fuse N°	Rating	Functions
1	7.5 A	Left-hand front and rear sidelamps.
2	15 A	Accessory socket.
3	-	Not used.
4	7.5 A	Starter.
5	20 A	Audio system.
6	-	Not used.
7	7.5 A	Vehicle equipment, right-hand front and rear sidelamps.
8	7.5 A	Electric door mirrors.
9	7.5 A	Supervisory controller.
10	7.5 A	Air conditioning.
11	10 A	Rear foglamp.
12	15 A	Door locking.
13	10 A	Courtesy lamp.

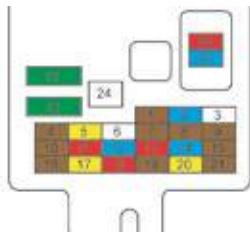

To gain access to it:

- ☞ Unclip the cover and remove it completely by pulling towards you.

Fuse N°	Rating	Functions
14	15 A	Rear wiper.
15	7.5 A	Instrument panel.
16	7.5 A	Heating.
17	20 A	Heated seat.
18	10 A	Option.
19	7.5 A	Door mirror de-icing.
20	20 A	Windscreen wiper.
21	7.5 A	Airbags.
22	30 A	Rear de-icing.
23	30 A	Heating.
24	-	Non used.
25	10 A	Radio.
26	15 A	Passenger compartment fuse.

Front compartment fuses

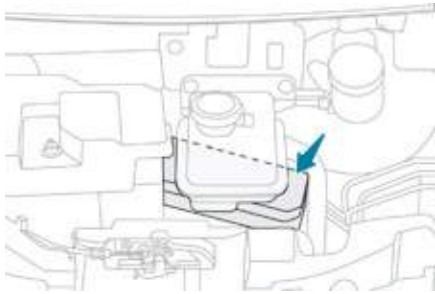

The fusebox is placed in the front compartment under the heating system fluid reservoir. Only these fuses can be replaced.

i The replacement of fuses for other units (vacuum pump and 12 V battery) requires the involvement of a PEUGEOT dealer or a qualified workshop.

Fuse N°	Rating	Functions
1	-	Not used.
2	30 A	Internal fuse.
3	40 A	Electric motor.
4	40 A	Radiator fan.
5	40 A	Electric windows.
6	30 A	Vacuum pump.
7	15 A	Main battery ECU.
8	15 A	Third brake lamp.
9	15 A	Front foglamps.
10	15 A	Water pump.

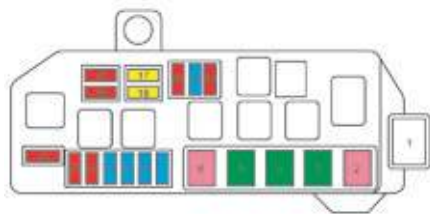

Access to the fuses

- ☞ Open the bonnet.
- ☞ Unclip the cover and remove it completely by pulling towards you.
- ☞ Change the fuse.
- ☞ When you have finished, close the cover carefully to ensure sealing of the fusebox.

Fuse N°	Rating	Functions
11	10 A	On-board charger.
12	10 A	Direction indicators.
13	10 A	Horn.
14	10 A	Daytime running lamps.
15	15 A	Battery fan.
16	10 A	Air conditioning compressor.
17	20 A	Right-hand dipped beam.
18	20 A	Left-hand dipped beam, headlamp adjusters.
19	10 A	Right-hand main beam.
20	10 A	Left-hand main beam.

Towing the vehicle

Procedure for having your vehicle towed using fixed mechanical equipment.

Towing your vehicle

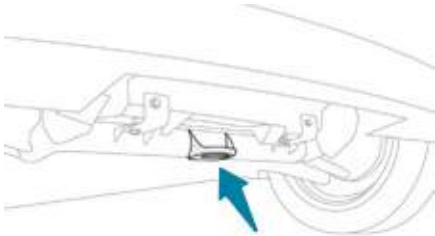

The towing eye is welded to the body below the front bumper.

- ☞ Install the towing bar.
- ☞ Start your vehicle ("Ready" lamp on).
- ☞ Put the drive selector in position **N**.
- ☞ Release the parking brake.
- ☞ Switch on the hazard warning lamps on your vehicle.
- ☞ Have your vehicle towed **for no more than 20 miles (30 km) without exceeding a speed of 20 mph (30 km/h)**.

! When towing the vehicle with the four wheels on the ground, always use a towing bar.
When towing with only two wheels on the ground, use professional lifting equipment.

i Failure to follow these instructions may cause damage to braking components and the electric motor.

! **Towing another vehicle**
Your vehicle cannot be used in any circumstances to tow another vehicle.

Motor and main battery

Model type code:	1 N ZKY Z
Electric motor	Y51
Technology	Synchronous with neodymium permanent magnets
Max. power: EU standard (kW)	49
Max. power speed (rpm)	4,000 to 8,800
Max. torque: EU standard (Nm)	196
Max. torque speed (rpm)	0 to 300
Main battery	Lithium-Ion
Energy when new (kWh)	14.5
Normal charge	
Voltage (V) AC	230
Charging time (*) (**):	
- 16 A	Approximately 6 hours
- 14 A	6 hours
- 10 A	8 hours
- 8 A	11 hours
Fast charge	
Voltage (V) DC	300
Charging time (80% charge)**	30 minutes

* Depending on the power supply in the country.

** Time measured for exterior temperatures between 20 and 25° C. Depending on the use of the audio system and/or the air conditioning, charging may take longer.

Range varies according to the exterior climatic conditions, the driver's style of driving, the use of electrical equipment, the frequency of normal or fast charges and ageing of the main battery.

Weights (in kg)

Electric motor	Y51
Main battery	Lithium-Ion
Model type code:	1 N ZKY Z
Unladen weight	1 065
Kerb weight	1 140
Gross vehicle weight (GVW)	1 450
Gross train weight (GTW)	1 450
Maximum load on the roof (including the roof bars)	43

! Your vehicle cannot be fitted with a towbar. It cannot tow a trailer.

Dimensions (in mm)

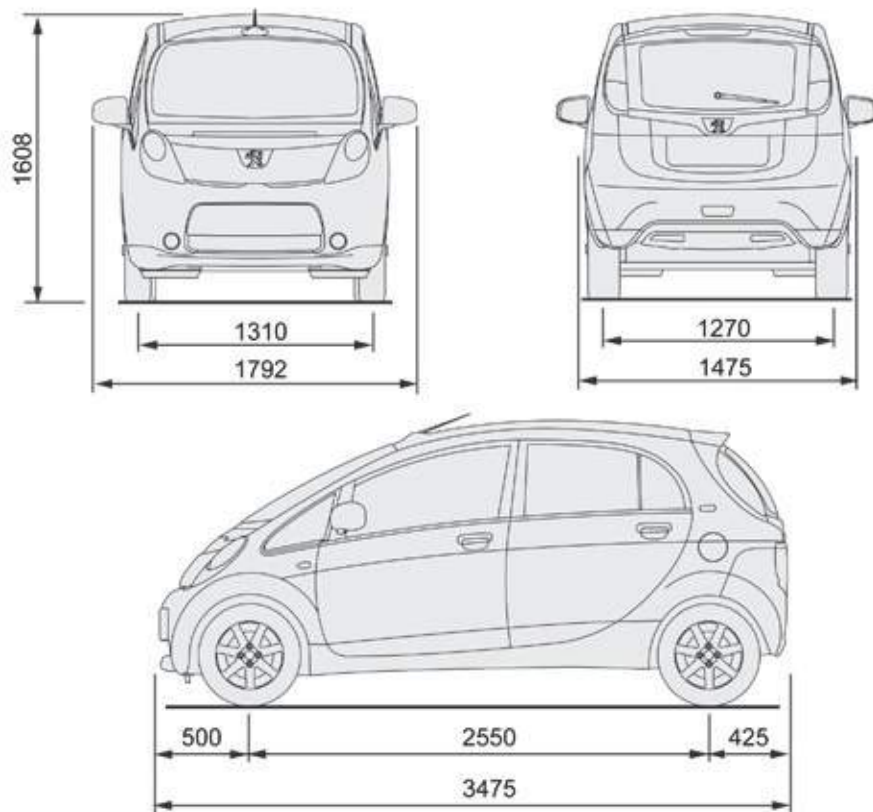

Identification markings

Various visible markings for the identification of your vehicle.

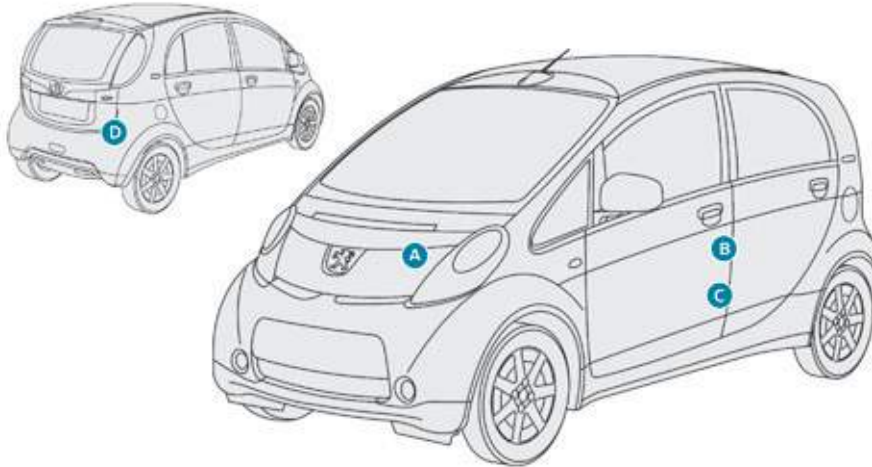

A. Service - Replacement Parts identification plate.

This plate is riveted to the underside of the bonnet.

It bears in particular the following information:

- the vehicle model.
- the paint code.
- the type, variant, version, etc.

B. Tyre identification label.

This label is affixed to the driver's centre pillar.

It bears the following information:

- the tyre pressures (in bars).
- the tyre specification.
- the type of tyre.

C. Manufacturer's plate.

This plate is riveted to the left-hand centre pillar.

D. Vehicle identification number (VIN).

This number is engraved on the inner wheel arch, inside the boot, right-hand side.

i For information on fitting snow chains, contact a PEUGEOT dealer or a qualified workshop.

i The original tyres fitted to the vehicle may have a load index or speed rating higher than those given on the label; this has no effect on the inflation pressures.

Checking tyre pressures

The tyre pressures should be checked when cold at least monthly.

The pressures given on the label are valid for cold tyres. If you have driven for more than 10 minutes or for more than 6 miles (10 kilometres) at more than 30 mph (50 km/h), the tyres will be warm; in this case 0.3 bar (30 kPa) should be added to the pressures given on the label.



Never reduce the pressure of a warm tyre.



Low tyre pressures increase your vehicle's power consumption, therefore reducing its range.

Audio system / Bluetooth®



	Contents
First steps	146
Radio	147
Media	149
Telephone	152
Audio settings	155
Configuration	156
Screen menu map(s)	157
Frequently asked questions	158

! After a battery disconnection, a code has to be entered for operation of the audio system. A maximum of five attempts are possible. For the last two attempts, a 15 minutes wait is imposed between each attempt. Refer to the end of this document to find the label indicating this code:



! As a safety measure, the driver must only carry out operations which require prolonged attention while the vehicle is stationary. When the engine is switched off and to prevent discharging of the battery, the system switches off after activation of energy economy mode.

First steps



On / Off, volume adjustment.



Selection of the source:

Radio (FM1, FM2), CD, USB, AUX, Streaming.

Telephone: accept an incoming call.

Telephone, continuous press: end a call, access the calls log of the telephone connected.



Adjust audio settings: sound ambience, treble, bass, loudness, distribution, left/right balance, front/rear balance, automatic volume.



Automatic search for a lower radio frequency.
Select the previous track for the CD or USB source.
Navigation in a list.
Press and hold: rewind.



Display the list of stations received, the CD/USB tracks or folders.
Press and hold: update the list of stations received.



Abandon the current operation.
Go up one level (menu or folder).



Automatic search for a higher radio frequency.
Select the next track for the CD or USB source.
Navigation in a list.
Press and hold: fast forward.



Open the main menu.



Select one of the preset radio stations.
Radio, press and hold: preset a radio station.
Other than radio: see the corresponding sections.



Eject CD.

Radio

Presetting a station

 Press **SRC/TEL** several times in succession to select the FM1 or FM2 radio band.

 A continuous press on one of the buttons presets the station being listened to. The name of the station is displayed accompanied by an audible signal to confirm the preset.

i The exterior environment (hills, buildings, tunnel, car park, below ground, etc.) may prevent reception, even in RDS station tracking mode. This phenomenon is normal in the propagation of radio waves and is in no way indicative of a fault with the audio system.

Selecting a station

 Press a button to listen to the corresponding preset station.

Managing a list

LIST Press **LIST** to display the list of stations received in alphabetical order.

 Select the desired radio station by pressing one of the buttons.

OK Confirm by pressing "**OK**".

 Press one of the buttons briefly to change to the next or previous letter.

LIST A continuous press on **LIST** builds or updates the list of stations; audio reception is cut momentarily.

Entering a frequency

MENU Press on **MENU**.

 Select "**Radio**".

 Select "**Write freq.**".

+ Press **+**.

or

- press **-** to select the desired frequency.

OK Confirm with "**OK**".

RDS

i RDS, if activated, enables you to continue listening to the same station by automatic retuning to alternative frequencies. However, in certain conditions, coverage of an RDS station may not be assured throughout the country as radio stations do not cover 100 % of the territory. This explains the loss of reception of the station during a journey.

MENU With source FM1 or FM2, press **MENU**.

Select "**Radio**".



Select or deselect "**RDS**" to switch RDS on or off.



OK Confirm with "**OK**" to save the setting.



Receiving TA messages

i The TA (Traffic Announcement) function gives priority to TA alert messages. To operate, this function needs good reception of a radio station transmitting this type of message. When a traffic report is transmitted, the current audio source (Radio, CD, USB, etc.) is interrupted automatically to play the TA message. Normal playback of the audio source resumes at the end of the transmission of the message.

MENU Press **MENU**.



Select "**Radio**".



Select or deselect "**TA**" to activate or deactivate the reception of traffic messages.



OK Confirm with "**OK**" to save the setting.



Displaying "RADIO TEXT"

i "RADIO TEXT" is information transmitted by the radio station related to the current programme or song.

MENU With the radio displayed on the screen, press **MENU**.

Select "**Radio**".



Select or deselect "**TEXT**" to activate or deactivate the display of "RADIO TEXT".



OK Confirm with "**OK**" to save the setting.



Media

USB port



This unit comprises a USB port and a Jack auxiliary socket, depending on model.

! The system constitutes playlists (in temporary memory), whose creation time can be from a few seconds to several minutes at the first connection. Limiting the number of non-music files and the number of folders reduces this waiting time. The playlists are updated every time the ignition is switched off or a USB memory stick is connected. The lists are memorised: if there is no change in the lists, the next loading time will be shorter.

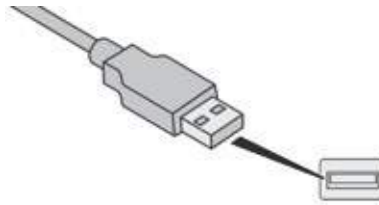

Connect a USB memory stick to the USB port or connect a USB device to the USB port using a suitable cable (not supplied).

i To protect the system, do not use a USB hub.

SRC /

Press **SRC/TEL** repeatedly to select "**USB**".



Press one of these buttons to select the next or previous track in the list.



Press one of these buttons to select the next or previous folder in the order chosen.



Press and hold one of these buttons for fast forward or rewind.

LIST

Press **LIST** to display the structure of the folders in the compilation.



Select a line in the list.

OK

Confirm with "**OK**".



Up a level in the menu.

MENU

Press **MENU**.



Select "**Media**".



Select or deselect "**TA**" to switch traffic announcements on or off.



Select the play mode: "**Normal**", "**Random**", "**Random all**" or "**Repeat**".

CD player

Insert a CD into the player, play starts automatically.

Insert an MP3 compilation CD into the CD player.

The audio system searches for audio tracks, which can take from a few to several dozen seconds before play starts.

 Press the **SRC/TEL** button repeatedly to select "**CD**".

 Press one of these buttons to go to the previous or next track in the list.

 Press one of these buttons to select the previous or next folder according to the category chosen.

 Press and hold one of these buttons for fast forward or back.

 Press **LIST** to display the folder structure of the compilation.

 Select a line in the list.

 Confirm with "**OK**".

Return to the top level of the folder structure to select the type of tracks.

- By **Folders** (CD or USB): all folders containing audio files recognised on the peripheral device, in alphabetical order without following the folder structure.
- By **Artist** (USB only): all of the artist names defined in the ID3 Tags, in alphabetical order.
- By **Genre** (USB only): all of the genres defined in the ID3 Tags.
- By **Playlist** (CD or USB): if playlists have been saved.

Information and advice

The audio system will only play files with ".mp3", ".wma" and ".wav" on a CD and can also play files with ".ogg" extension only on USB.

It is recommended that file names be of no more than 20 characters and avoiding special characters (e.g. " ? ; ù) so as to avoid any problem reading or displaying the files.

In order to be able to play a recorded CDR or CDRW, when recording it is preferable to select standards ISO 9660 level 1.2 or Joliet.

If the disc is recorded in another format, it may not be played correctly.

It is recommended that the same recording standard is always used for an individual disc, with as low a speed as possible (4x maximum) for optimum sound quality.

In the particular case of a multi-session CD, the Joliet standard is recommended.

The playlists accepted on CD, MP3, iPod and USB connection are types ".m3u" and ".wpl". The number of files recognised is limited to 5,000 in 500 folders on a maximum of 8 levels.

On a single disc, the CD player can read up to 255 MP3 files spread over 8 folder levels with a maximum of 192 folders. However, it is recommended that this be kept to 2 levels so as to limit the time taken to access and play the CD.

During play, the folder structure is not observed.

Do not connect a hard disk or USB device other than audio players to the USB port. This may cause damage to your installation.

Use only USB memory sticks formatted to FAT32 (File Allocation Table).

! To protect the system, do not use a USB hub.

i The use of genuine Apple® USB cables is recommended to ensure correct operation.

Bluetooth® audio streaming

Streaming allows music files on a telephone to be heard via the vehicle's speakers.

Connect the telephone: see the "**Telephone**" section.

In the "**Bluetooth: Audio**" menu, select the telephone to connect.

The audio system connects automatically to a newly paired telephone.

SRC / Activate the streaming source by pressing the **SRC/TEL*** button.

The control of common tracks is possible via the audio system control buttons and the steering mounted controls**. Contextual information can be displayed in the screen.

The audio quality depends on the quality of the transmission from the telephone.

* In certain cases, the playing of audio files must be initiated from the telephone.

** If the telephone supports the function.

Connecting Apple® players

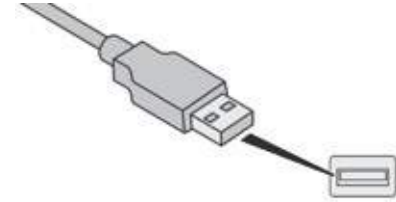

Connect the Apple® player to the USB port using a suitable cable (not supplied). Play starts automatically.

Management of the device is via the audio system controls.

The classifications available are those on the portable player connected (artists / albums / genres / playlists / audiobooks / podcasts).

The software version of the audio system may not be compatible with the generation of your Apple® player.

Telephone

Pairing a Bluetooth® telephone

! For safety reasons and because they require prolonged attention on the part of the driver, the operations for pairing of the Bluetooth mobile telephone with the Bluetooth hands-free system of your audio system must be carried out with the vehicle stationary and the ignition on.

Visit www.peugeot.co.uk for more information (compatibility, more help, etc.).

Activate the telephone's Bluetooth function and ensure that it is set as visible to all (refer to the telephone instructions).



MENU

Press the **MENU** button.



Select **"Bluetooth"**.



Select **"Search"**.

A window is displayed with **"Searching device"**.

i The services available depend on the network, the SIM card and the compatibility of the Bluetooth telephone used. Consult your telephone's manual and your operator to find out which services are available to you.



Select the telephone to be paired from the list.



OK

Confirm with **"OK"**.

Only one telephone can be paired at a time.

In some cases, the Bluetooth address of the telephone may appear instead of the name of the telephone.



A virtual keypad is displayed on the screen: choose a 4 digit code.



OK

Confirm with **"OK"**.

A message is displayed on the screen of the telephone: enter the same code and confirm.

If pairing fails, try again; the number of attempts is not limited.

A message appears on the screen to confirm the result of the connection.

i Pairing can also be initiated from the telephone by searching for detected Bluetooth devices.

i The directory and the calls list can be accessed after the synchronisation period (if the telephone is compatible). Automatic connection must be configured in the telephone to allow the connection each time the vehicle is started.

Managing connections

 Press the **MENU** button.

 Select "**Bluetooth**".

 Select "**BT management**" and confirm. The list of paired telephones is displayed.

 Indicates connection of the audio profile.

 Indicates connection of the hands-free profile.

 In the list, select a telephone to pair.

 Confirm with "**OK**".

 Select or deselect:

- "**Tel.**": hands-free connection
- "**Audio**": play audio files

 "**OK**" to confirm the choice.

 "**Delete**" to delete the pairing.

i It is not possible to pair more than 5 telephones. Press **MENU** and select "**Bluetooth**". Select "**BT management**". If 5 telephones are already paired, select the telephone to delete by pressing "**OK**" and selecting "**Delete**".

Making a call

From the directory

 Press the **MENU** button.

 Select "**Telephone**".

 Select "**Call**".

 Select "**Directory**".

 Select the desired number.

 Confirm with "**OK**" to start the call.

Making a call

Recently called numbers*

 Press and hold **SRC/TEL** to display the calls list.

i For access to the calls list, it is also possible to press **MENU**, select **"Telephone"**, then select **"Call"**, and finally select **"Calls list"**.

 In the list of calls, select the number and choose **"Missed calls"**, **"Dialed calls"** or **"Answered calls"**.

 Scroll through the calls list.

 Confirm with **"OK"**.

 Press one of these buttons to go to the previous or next page in the list.

 **"OK"** starts the call.

i The calls list includes the calls sent from and by from the vehicle via the connected telephone. It is possible to make a call directly from the telephone; stop the vehicle as a safety measure.

Receiving a call

An incoming call is announced by a ring and a superimposed display in the screen.

Press **SRC/TEL**.

or

 select **"YES"** to accept the call,

or

 select **"NO"** to reject the call.

 Pressing and holding the back button,

or

 on **SRC/TEL** also rejects an incoming call.

* Depending on the compatibility of the telephone.

Managing calls

Hang up



In the contextual menu, select "**Hang up**" to end the call.

SRC / TEL

Pressing and holding on **SRC/TEL** also ends the call.

Secret - Mute

(so that the caller cannot hear)

In the contextual menu:



Select "**Micro OFF**" to switch off the microphone.



Select "**Micro OFF**" to switch the microphone on again.

Combined mode

(to leave the vehicle without ending the call)

From the contextual menu:



Select "**Combined mode**" to transfer the call to the telephone.



Select "**Combined mode**" to transfer the call to the vehicle.

i In certain cases, the combined mode has to be activated from the telephone. The Bluetooth connection will be restored automatically if the ignition has been switched off, then on again (depending on the compatibility of the telephone).

Audio settings



Press **⌘** to display the audio settings menu.

Press **⌘** to go to the next setting.

The settings available are:

- AMBIANCE: BASS, TREBLE and LOUDNESS.
- BALANCE (left/right balance), FADER (front/rear balance)
- SOUND DIST. (driver or passenger).
- AUTO VOLUME.

i The distribution, or spatialisation of sound, is an audio process which allows the sound quality to be improved according to the setting chosen, corresponding to the position of the listeners in the vehicle.

i The AMBIANCE, TREBLE and BASS audio settings are different and independent for each sound source.

Configuration

Display and language settings

MENU

Press the **MENU** button.



Select "**Config.**".



Select "**Displaying**" to activate or deactivate scrolling text.



Select "**Language**" to modify the display language.



Select "**Version**" for information on the software.



Select "**System**" when you want to install an update. Information can be obtained from a PEUGEOT dealer.



Select "**Unit**" to modify the units for temperature (Celsius, Fahrenheit).

Screen menu map(s)

MENU

1 Radio

- 2 TA
- 2 RDS
- 2 TXT
- 2 Write freq.

1 Media

- 2 Normal
- 2 Random
- 2 Random all
- 2 Repeat
- 2 TA

1 Telephone

- 2 Call
- 3 Directory
- 3 Calls list
- 4 Missed calls
- 4 Dialed calls
- 4 Answered calls

2 Phone status

1 Bluetooth

2 BT management

2 Search

1 Config.

- 2 Displaying
- 3 Scrolling text

2 Language

- 3 Deutsch
- 3 English
- 3 Español
- 3 Français
- 3 Italiano
- 3 Nederlands
- 3 Português
- 3 Português-Brasil
- 3 Русский
- 3 Türkçe

2 Version

2 System

- 2 Unit
- 3 Celsius
- 3 Fahrenheit

Frequently asked questions

The following tables contain answers to the most frequently asked questions.

QUESTION	ANSWER	SOLUTION
<p>There is a difference in sound quality between the different audio sources (radio, CD...).</p>	<p>For optimum sound quality, the audio settings (volume, bass, treble, ambience, loudness) can be adapted to the different sound sources, which may result in audible differences when changing source (radio, CD...).</p>	<p>Check that the audio settings (volume, bass, treble, ambience, loudness) are adapted to the sources listened to. It is advisable to adjust audio settings (bass, treble, Front-Rear balance, Left-Right balance) to the middle position, select the musical ambience and set the loudness correction to the "Active" position in CD mode or to the "Inactive" position in radio mode.</p>
<p>When changing the settings for treble and bass, the ambience setting is deselected. When changing the ambience setting, treble and bass are reset to zero.</p>	<p>Choosing an ambience imposes settings for treble and bass. Modifying one without the other is only possible with a personalised ambience.</p>	<p>Modify the treble and bass settings or the ambience setting to obtain the desired sound quality.</p>
<p>When changing the balance setting, distribution is deselected.</p>	<p>Choosing the "driver" distribution setting imposes a balance setting.</p>	<p>Modify the balance setting or the distribution setting to obtain the desired sound quality.</p>

QUESTION	ANSWER	SOLUTION
The quality of reception of the radio station listened to gradually deteriorates or the stored stations do not function (no sound, 87.5 MHz is displayed...).	The vehicle is too far from the transmitter used by the station listened to or there is no transmitter in the geographical area through which the vehicle is travelling.	Activate the RDS function to enable the system to check whether there is a more powerful transmitter in the geographical area.
	The environment (hills, buildings, tunnels, basement car parks...) block reception, including in RDS mode.	This phenomenon is normal and does not indicate a failure of the audio equipment.
	The aerial is absent or has been damaged (for example when going through a car wash or into an underground car park).	Have the aerial checked by a PEUGEOT dealer.
Sound cut-outs of 1 to 2 seconds in radio mode.	During this brief sound cut-out, the RDS searches for any frequency permitting better reception of the station.	Deactivate the RDS function if the phenomenon is too frequent and always on the same route.
Traffic announcement TA is displayed. I do not receive any traffic information.	The radio station does not broadcast traffic information.	Tune to a radio station which broadcasts traffic information.
The stored stations are not found (no sound, 87.5 MHz is displayed...).	An incorrect waveband is selected.	Press the SRC/TEL button to return to the waveband (FM1 or FM2) on which the stations are stored.

QUESTION	ANSWER	SOLUTION
The CD is ejected automatically or is not played by the player.	The CD is inserted upside down, is unplayable, does not contain any audio data or contains an audio format which the player cannot play. The CD is protected by an anti-pirating protection system which is not recognised by the audio equipment.	<ul style="list-style-type: none"> - Check that the CD is inserted in the player the right way up. - Check the condition of the CD: the CD cannot be played if it is too damaged. - Check the content in the case of a recorded CD: consult the advice in the "Audio" section. - The audio equipment's CD player does not play DVDs. - Due to their quality level, certain writeable CDs will not be played by the audio system.
The CD player sound is poor.	The CD used is scratched or of poor quality.	Insert good quality CDs and store them in suitable conditions.
	The audio settings (bass, treble, ambience) are unsuitable.	Set the treble or bass level to 0, without selecting an ambience.
The Bluetooth connection is cut.	The battery of the peripheral may not be sufficiently charged.	Recharge the battery of the peripheral device.
The message "USB device error" is displayed on the screen.	The USB memory stick is not recognised.	Use only USB memory sticks formatted to FAT 32 (28-bit file allocation table).
A telephone connects automatically, disconnecting another telephone.	Automatic connection overrides manual connection.	Modify the telephone settings to remove automatic connection.

QUESTION	ANSWER	SOLUTION
An iPod is not recognised when connecting to the USB port.	The iPod is of a generation that is not compatible with the USB connection.	
The hard disk or device is not recognised when connecting to the USB port.	Some hard disks and devices need a power supply greater than is provided by the audio system.	Connect the device to the 230 V socket, the 12 V socket or an external power supply. Caution: ensure that the device does not transmit a voltage greater than 5 V (risk of destruction of the system).
When streaming, the sound cuts momentarily.	Some telephones prioritise connection of the "hands-free" profile.	Delete the "hands-free" connection profile to improve streaming.
In "Random all" play, not all of the tracks are played.	In "Random all" play, the system can only take into account up to 999 tracks.	
With the engine off, the audio system switches off after a few minutes of use.	When the engine is switched off, the audio system operating time depends on the battery charge. The switch-off is normal: the audio system switches to economy mode and switches off to prevent discharging the vehicle's battery.	Start the vehicle's engine to increase the battery charge.
The message "the audio system is overheated" appears on the display.	In order to protect the installation if the surrounding temperature is too high, the audio system switches to an automatic thermal protection mode leading to a reduction of the volume or stopping of the playing of the CD.	Switch the audio system off for a few minutes to allow the system to cool.

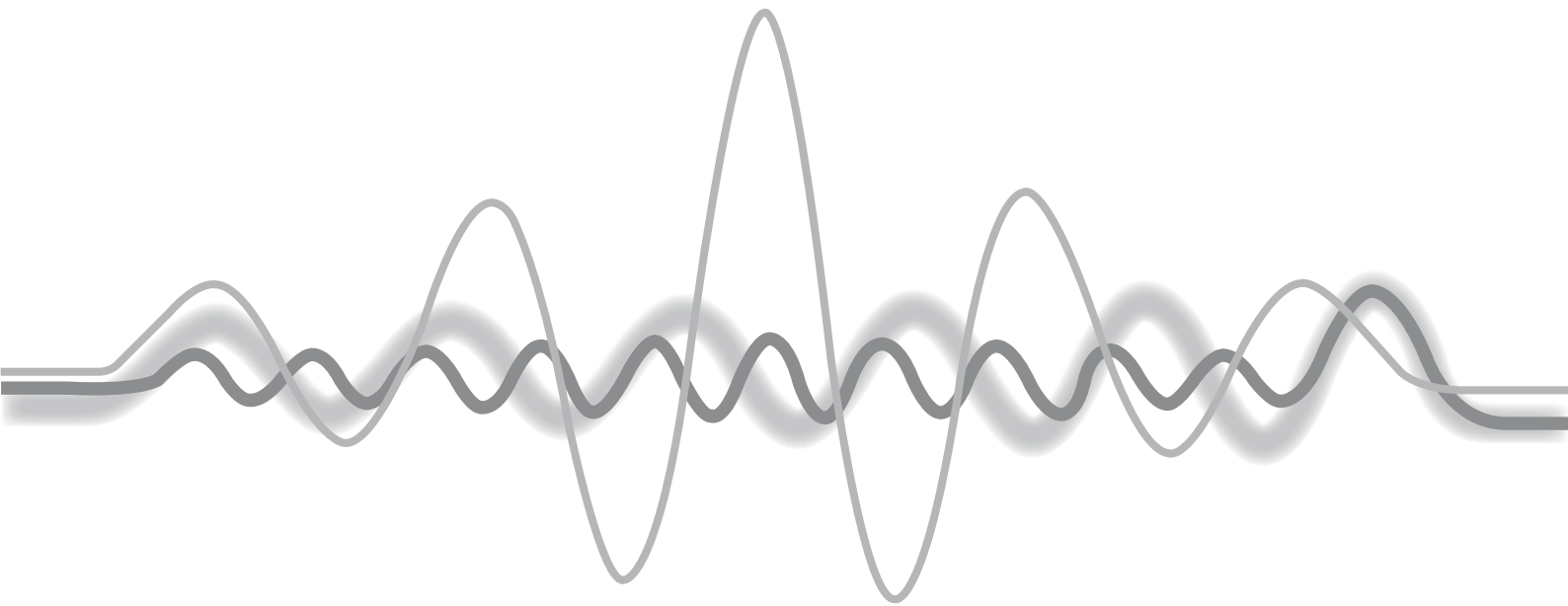

KENWOOD - KDC-X7000DAB



! For obvious safety reasons, the vehicle must be stationary when the driver carries out operations which require sustained attention.

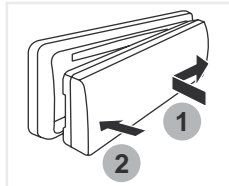

Fitting the control panel.

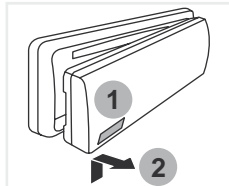

Removing the control panel.



Short press: on.
Long press: off.



Rotation: adjust the volume, navigate in a list.
Press: confirm.

SRC

Change audio source.



Short press: accept an incoming call, switch between two calls, enter Bluetooth mode.
Long press: smartphone voice commands via the system.



Short press: search for a service.
Long press: updating of the list of stations available.



Abandon the current operation.
Go up one level.
Reject or end a call.

BAND

Select an analogue waveband FM1 / FM2 / FM3 / MW / LW.
Select a digital waveband DB1 / DB2 / DB3.



Navigate in a list.



SEEK

Change of search method (automatic or manual).



Short press: search for a radio station, a frequency or a service, search for a previous/next track or file, navigate in a list.



Long press: Rewind / fast forward.

1

Short press: select a stored radio station.
Long press: store a radio station.

For more information, consult the KENWOOD user guide provided with the system.

A

Accessories	58
Access to bulbs.....	127, 131
Adjusting headlamps	56
Adjusting head restraints	32
Adjusting seat	32, 34
Advice on driving	87
Airbags.....	70, 77
Airbags, curtain.....	72, 73
Airbags, front.....	70, 73
Airbags, lateral.....	72, 73
Air conditioning	42, 43, 45
Air vents	41
Anti-lock braking system (ABS).....	63
Anti-slip regulation (ASR)	65
Assistance call.....	61
Audio streaming (Bluetooth)	151

B

Battery, 12 V.....	109, 113
Battery, main.....	97, 140
Bluetooth (hands-free).....	152
Bonnet.....	106
Bonnet stay	106
Brake discs.....	111
Brake lamps	59, 132
Brake lamps, automatic operation.....	59
Brakes	111
Braking assistance system	63
Bulbs (changing)	126, 131

C

CD, MP3.....	149, 150
Changing a bulb.....	126, 131
Changing a fuse	134
Changing a wheel	121
Changing a wiper blade	112
Charging, fast.....	104
Charging, normal	97
Charging time.....	140
Checking components	107, 111
Checking the levels.....	109, 110
Checking tyre pressures (using the kit)	117
Child lock.....	85, 86
Children.....	81, 83, 85
Child seats	69, 74-76, 80, 81
Child seats, conventional.....	80
Child seats, ISOFIX	83-85
Closing the boot.....	29
Compartment, front.....	107
Compartment, rear	108
Control, heated seats.....	34
Control stalk, lighting	53
Control stalk, wipers	56
Control unit.....	99
Courtesy lamp.....	57
Cup holder.....	38

D

Daytime running lamps.....	55, 130
Deactivating the passenger airbag.....	70, 77
Deactivating the passenger and rear window control switches.....	30

Defrosting / demisting, front	46
Dimensions	142
Direction indicators	55, 129, 132
Display screen	21, 22
Door pockets.....	38
Doors.....	28
Drive selector	90

E

Electric motor	140
Electronic brake force distribution (EBFD)	63
Electronic stability programme (ESP)	65
Emergency braking assistance (EBA).....	63, 64
Emergency call	61
Emergency warning lamps	59
Engine brake	66
Engine brake reduction indicator lamp... ..	10, 66
Environment	9

F

Filter, passenger compartment.....	111
Fitting a wheel.....	121
Fittings, interior	38
Fitting the mat	39
Flaps, charging	31
Flashing indicators.....	55, 129, 131, 132
Foglamp, rear.....	54, 133

Foglamps, front54, 130
 Folding the rear seat backrest34
 Folding / unfolding the door
 mirrors.....36
 Fuses.....134

H

Hazard warning lamps59
 Headlamp adjustment.....56
 Headlamps, automatic illumination55
 Headlamps, dipped beam.....130
 Headlamps, main beam.....129
 Head restraints.....32-34
 Heating.....43
 Horn.....59

I

Immobiliser, electronic.....26, 27
 Indicator, energy consumption /
 generation20
 Indicator lamps, operation11
 Indicators, direction55
 Inflating tyres117, 144
 Instrument panel10
 Isofix mountings.....83-85

J

Jack121

K

Key with remote control25, 27
 Kit, hands-free152
 Kit, temporary puncture
 repair.....117

L

Labels, identification143
 Lamps, front126
 Lamps, rear131
 Level, brake fluid.....109
 Level, engine coolant.....109
 Level, heating system fluid109
 Levels and checks107, 109, 110
 Level, screenwash fluid109
 Lighting, automatic off55
 Lighting dimmer21, 22
 Locking from the inside.....28

M

Markings, identification.....143
 Mat39

Mirror, rear view37
 Mirrors, door.....36
 Mountings, Isofix.....83-85
 MP3, CD.....149, 150

N

Number plate lamps.....133

O

Opening the boot29
 Opening the front compartment106

P

Pads, brake111
 Parking brake89, 111
 Pedestrian horn60
 PEUGEOT Connect Assistance61
 PEUGEOT Connect Packs61
 PEUGEOT Connect SOS61
 Player, MP3 CD.....149, 150
 Port, USB40, 150
 Pressures, tyre.....92, 143, 144
 Pre-tensioning seat belts69

Protecting children 74-76, 81, 83-86
 Puncture 117

R

Radio 147
 Range 21, 24
 Rear screen, demisting 46
 Recharging the main battery 97
 Recirculation / exterior air intake 43
 Reminder, lighting on 54
 Remote control 27, 47
 Removing a wheel 121
 Removing the mat 39
 Replacing bulbs 126, 131
 Replacing fuses 134
 Replacing the passenger compartment
 filter 111
 Reservoir, screenwash 109
 Reversing lamps 132

S

Safety, children 74-76, 81, 83, 84
 Screen menu map 157
 Screenwash 56
 Seat belts 67-69, 80
 Seats, front 32
 Seats, heated 34
 Seats, rear 34

Selector, drive 90
 Serial number, vehicle 143
 Service indicator 22
 Sidelamps 129, 132
 Side repeater 131
 Snow chains 125
 Socket, 12 V accessory 38, 39
 Speedometer 10
 Stability control (ESP) 65
 Starting the vehicle 88, 90
 Stopping the vehicle 88, 90
 Storage 38
 Sun visor 39

T

Technical data 140, 141
 Third brake lamp 133
 Total distance recorder 21
 Towing another vehicle 139
 Traction control (ASR) 65
 Traffic information (TA) 148
 Tyres 92, 144
 Tyre under-inflation detection 17, 24, 92

U

Under-inflation detection, tyre 17, 24, 92
 Unlocking from the inside 28
 USB (PEUGEOT Connect) 38, 40

V

Ventilation 41-43

W

Warning and indicator lamps 11, 14, 15
 Warning lamp, seat belts 67
 Weights 141
 Wheel, spare 144
 Window controls 30
 Wiper blades (changing) 112
 Wiper, rear 57
 Wipers 56

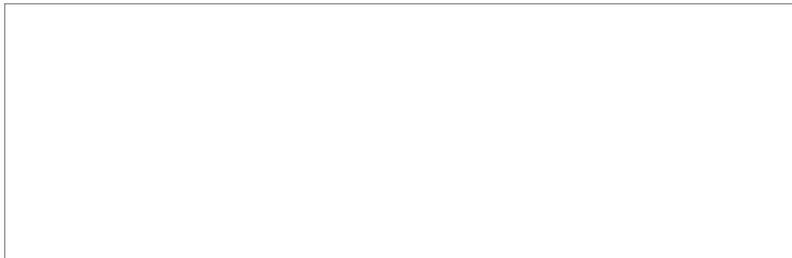

AUDIO SYSTEM CODE



After a battery disconnection, a code must be entered for operation of the audio system. A maximum of 5 attempts are possible. For the last two attempts, a wait of around 15 minutes is imposed.

Keep your code in a safe place, never inside the vehicle.

When undertaking a long trip or journey, however, it is advisable to take the code with you along with your personal papers.



Reproduction or translation of all or part of this document is prohibited without written authorisation from Automobiles PEUGEOT.

Automobiles PEUGEOT declares, by application of the provisions of the European legislation (Directive 2000/53) relating to End of Life Vehicles, that it achieves the objectives set by this legislation and that recycled materials are used in the manufacture of the products that it sells.

Printed in the EU
Anglais

08-16



PEUGEOT

AUTOMOBILES PEUGEOT - Siège Social : 75, avenue de la Grande-Armée 75016 Paris - France

Tél. : +33 (0)1 40 66 55 11 - Fax : +33 (0)1 40 66 54 14 - Téléc. : 645 700 F

<http://www.peugeot.com>

Société anonyme au capital de 172.711.770 € - R.C.S. : 552 144 503 R.C.S. Paris - SIRET : 552 144 503 00018 - APE : 2910Z

