

HANDBOOK



PEUGEOT 2008





On-line handbook

Select one of the following means of access to view your handbook on-line...

Find your handbook on the PEUGEOT website, under "MyPEUGEOT".

This personal space offers advice and other useful information for the care and maintenance of your vehicle.

Flash this code for direct access to your handbook.



If the "MyPEUGEOT" function is not available on the PEUGEOT public website for your country, you can find your handbook at the following address:

<http://public.servicebox.peugeot.com/ddb/>

Select:

- > the language,
- > the vehicle, its body style,
- > the print edition of your handbook appropriate for the date of registration of your vehicle.

Referring to the handbook on-line also gives you access to the latest information available, easily identified by the bookmark, associated with this symbol:



Welcome

Within the model range, an item of equipment may be not available, an option or fitted as standard.

When an option, the customer has the choice of adding to the vehicle's equipment at extra cost when ordering and before the vehicle is produced.

Any equipment fitted after the vehicle leaves the production line becomes an aftermarket accessory. The instructions for the user are supplied by the manufacturer of the accessory, it is not covered in this edition of the handbook.

! Please note the following point:

The fitting of electrical equipment or accessories which are not recommended by PEUGEOT may result in a failure of your vehicle's electronic system. Please note this specific warning. It is advisable to contact a PEUGEOT dealer to be shown the recommended equipment and accessories.

Thank you for choosing a 2008.

This handbook has been designed to help you make the most of using your vehicle in all circumstances.

Key

! Warning

This symbol marks warnings which it is essential to observe for your own safety, for the safety of others or to avoid any risk of damaging your vehicle.

i Information

This symbol draws your attention to additional information for better use of your vehicle.

☘ Protection of the environment

This symbol accompanies advice relating to protection of the environment.

<p>Overview</p>	<p>Access</p> <p>Remote control key 43</p> <p>Alarm 50</p> <p>Electric windows 52</p> <p>Boot 54</p> <p>Panoramic sunroof 55</p>	<p>Driving</p> <p>Starting - Stopping the engine 79</p> <p>Manual parking brake 80</p> <p>Manual gearbox 81</p> <p>5-speed electronic gearbox 82</p> <p>6-speed electronic gearbox 85</p> <p>Automatic gearbox 89</p> <p>Gear shift indicator 93</p> <p>Stop & Start 94</p> <p>Hill start assist 97</p> <p>Speed limiter 98</p> <p>Cruise control 100</p> <p>Parking sensors 104</p> <p>Park Assist 106</p>
<p>Eco-driving</p>		
<p>Monitoring</p> <p>Instrument panels 14</p> <p>Indicator and warning lamps 16</p> <p>Touch screen 28</p> <p>Gauges and indicators 32</p> <p>Trip computer 38</p> <p>Trip computer with touch screen 40</p> <p>Setting the date and time 42</p>	<p>Comfort</p> <p>Front seats 56</p> <p>Rear seats 58</p> <p>Steering wheel adjustment 59</p> <p>Mirrors 60</p> <p>Ventilation 62</p> <p>Heating 65</p> <p>Manual air conditioning 65</p> <p>Dual-zone digital air conditioning 67</p> <p>Front demist - defrost 70</p> <p>Rear screen demist - defrost 70</p> <p>Interior fittings 71</p> <p>Boot fittings 75</p>	<p>Visibility</p> <p>Lighting controls 110</p> <p>LED lamps 114</p> <p>Daytime running lamps 114</p> <p>Automatic illumination of headlamps 116</p> <p>Headlamp adjustment 117</p> <p>Cornering lighting 118</p> <p>Wiper controls 119</p> <p>Automatic rain sensitive wipers 121</p> <p>Courtesy lamps 123</p> <p>Interior mood lighting 124</p>

Safety

6

Direction indicators	125
Hazard warning lamps	125
Emergency or assistance call	126
Horn	126
Tyre under-inflation detection	127
ESC system	130
Grip control	133
Front seat belts	135
Airbags	138
Child seats	142
Deactivating the passenger's front airbag	144
ISOFIX child seats	151
Child lock	155

Practical information

7

Temporary puncture repair kit	156
Changing a wheel	161
Snow chains	168
Changing a bulb	169
Changing a fuse	176
Battery	182
Electrical energy economy mode	185
Changing a wiper blade	186
Towing the vehicle	187
Towing a trailer	189
Fitting roof bars	191
Advice on care and maintenance	191
Accessories	192

Checks

8

Bonnet	195
Petrol engines	196
Diesel engines	197
Fuel tank	198
Misfuel prevention (Diesel)	200
Running out of fuel (Diesel)	202
AdBlue [®] additive and SCR system (Blue HDi Diesel)	203
Checking levels	211
Checks	214

Technical data

9

General information	216
Petrol engines / weights	217
Diesel engines / weights	218
Dimensions	219
Identification markings	220

Audio equipment and telematics

Emergency or assistance	221
7-inch Touch screen	223
Audio system / Bluetooth	295
Audio system	321

Alphabetical index

Exterior

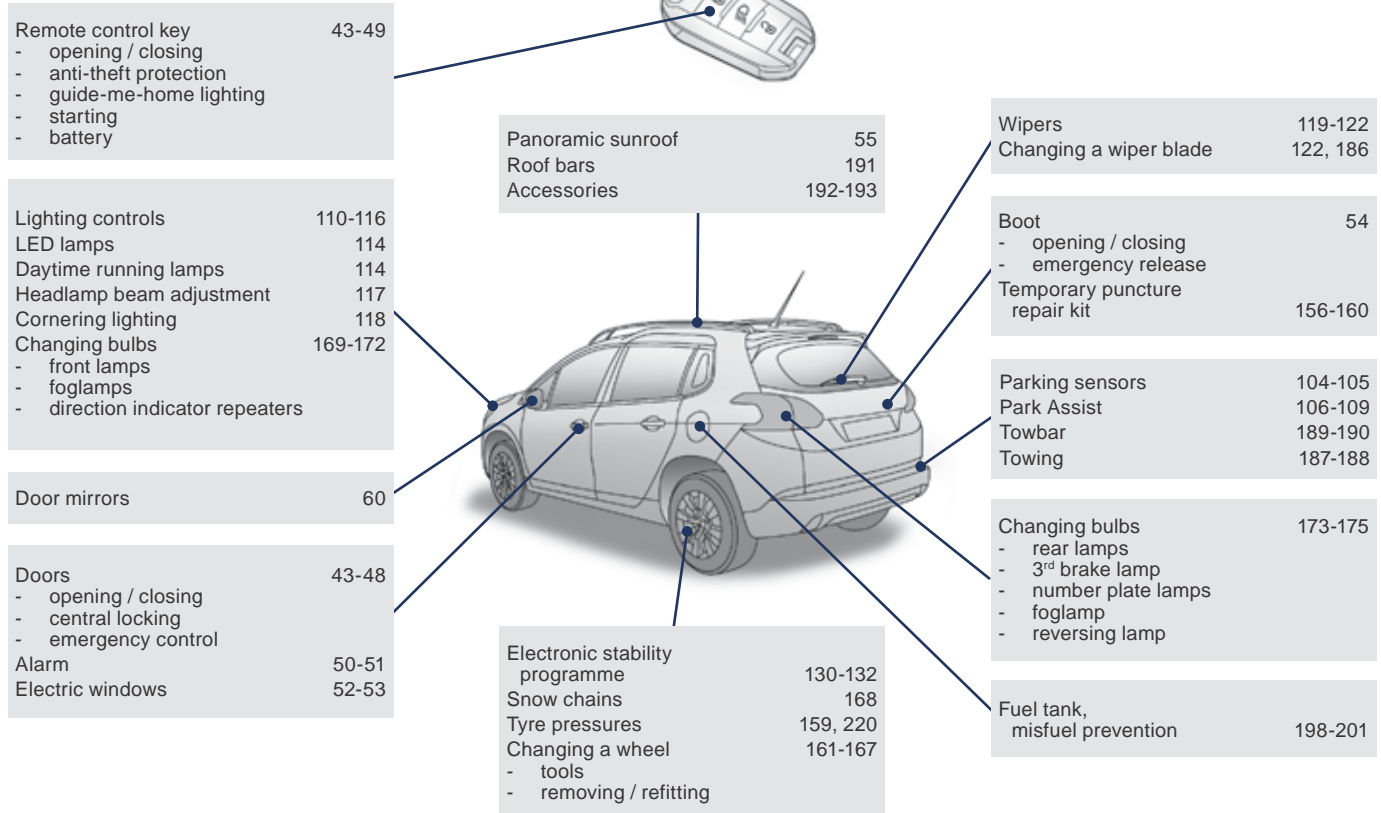

Interior

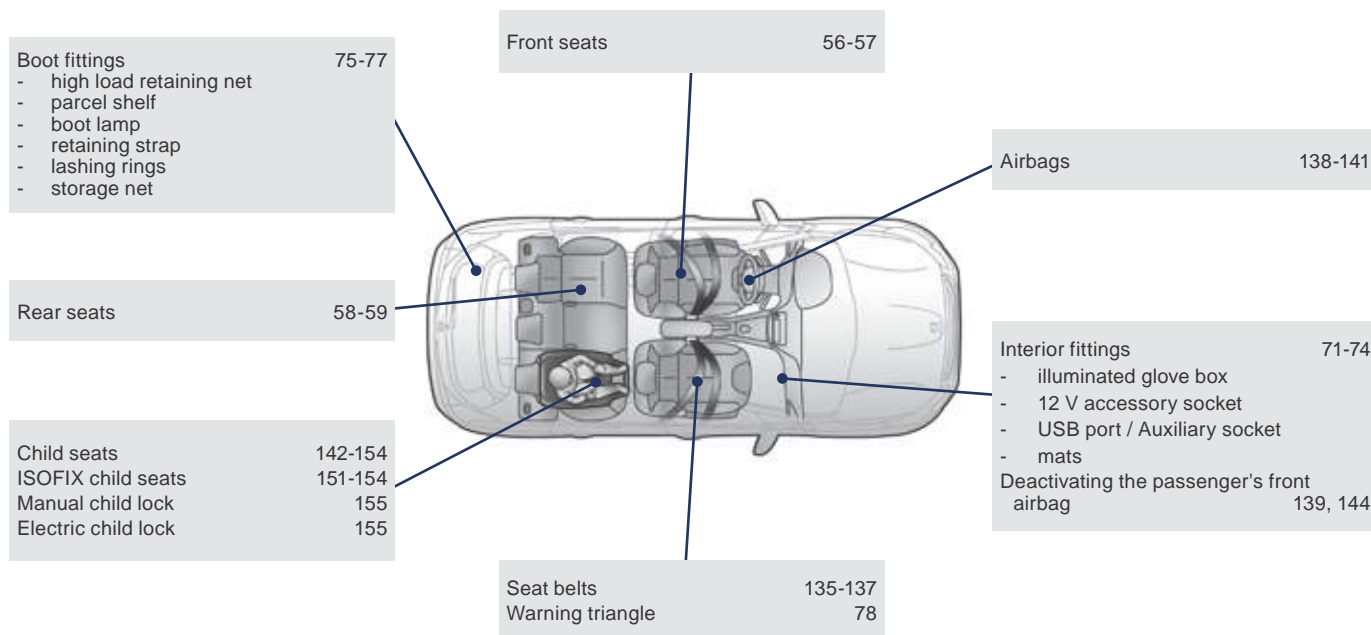

Instruments and controls

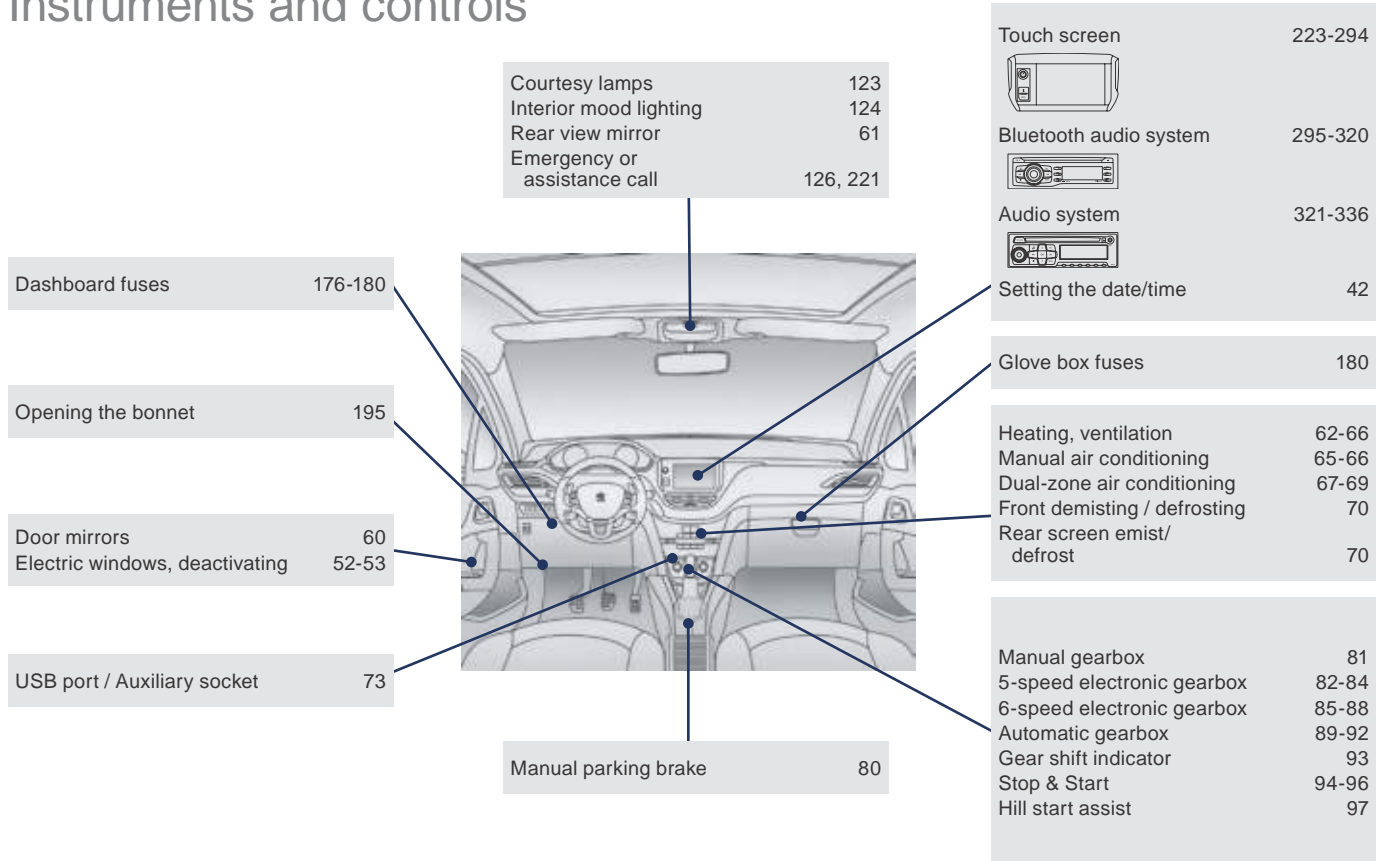

Instruments and controls (cont.)

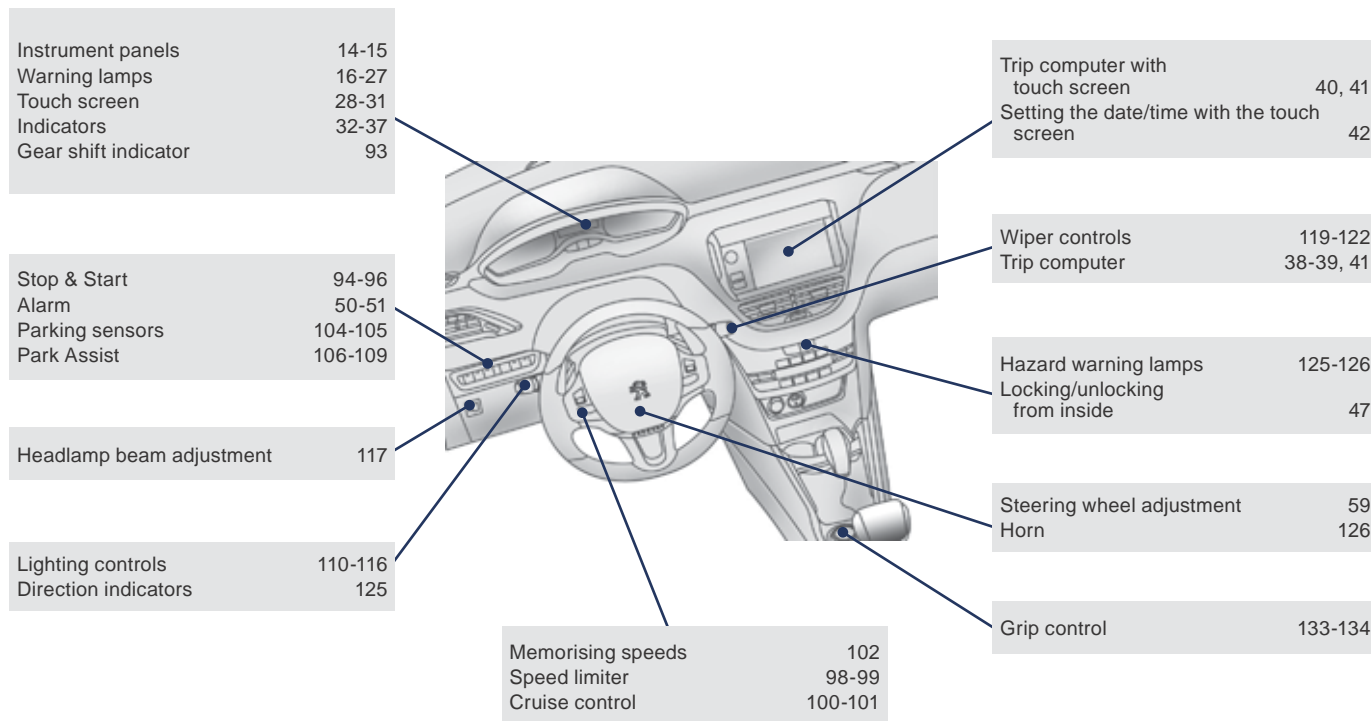

Maintenance - Technical data

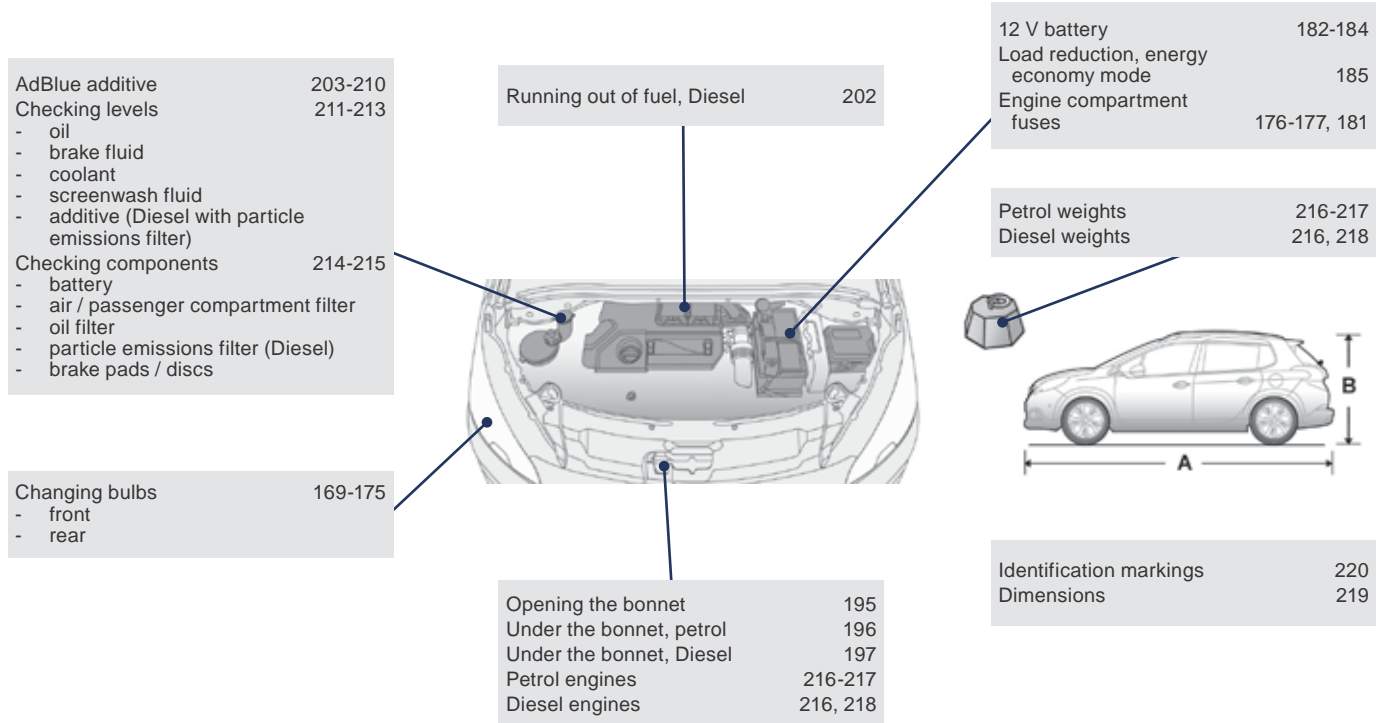



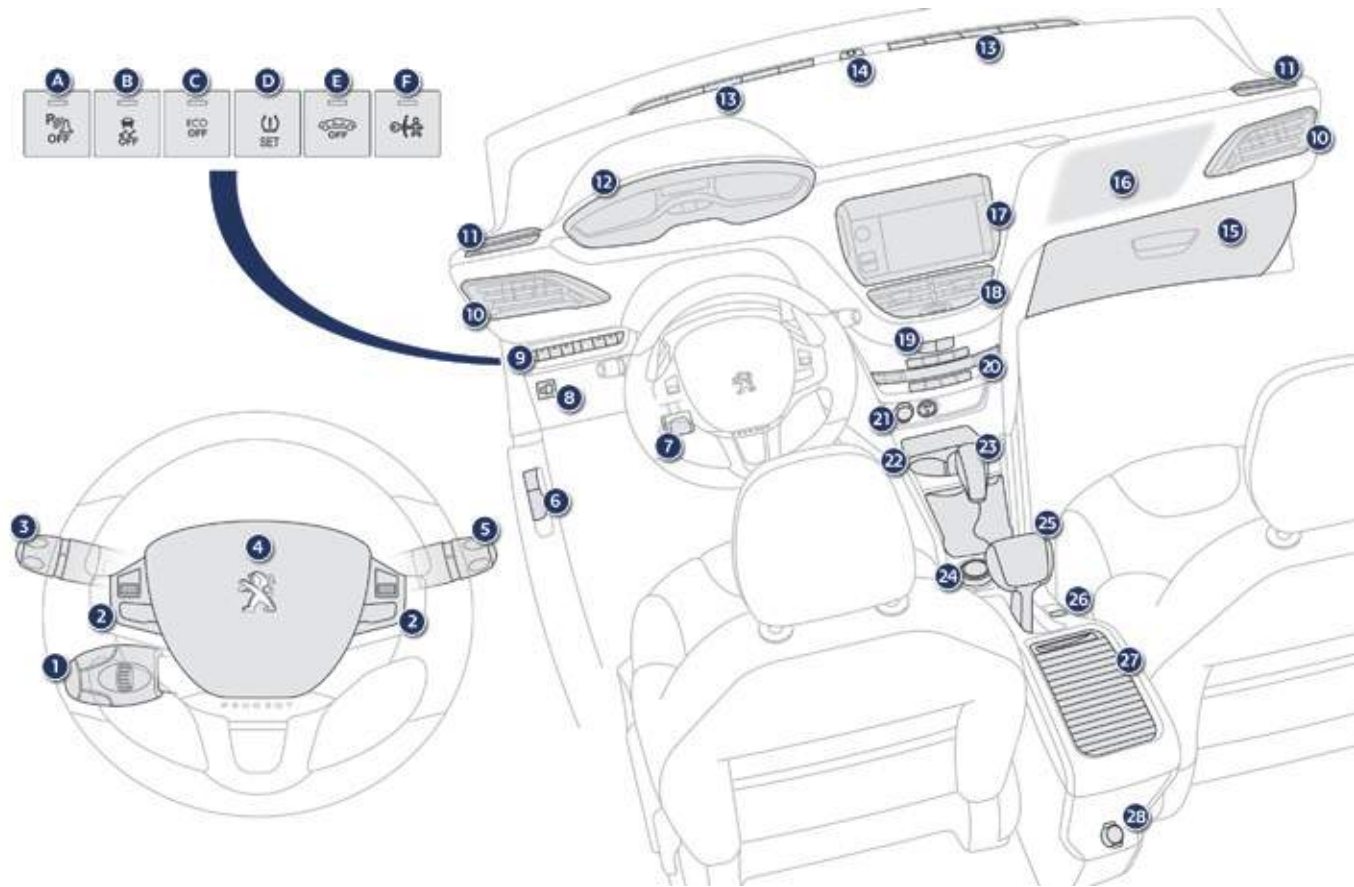

Dashboard / centre console

1. Cruise control / speed limiter controls.
2. Steering mounted controls for the touch screen.
3. Lighting and direction indicator stalk
4. Driver's front airbag.
5. Wiper / screenwash / trip computer stalk.
6. Bonnet release lever.
7. Steering wheel adjustment control.
8. Headlamp height adjustment.
9. Switch panel:
 - A. Deactivation of rear parking sensors or
Activation of Park Assist.
 - B. Deactivation of the DSC/ASR system.
 - C. Deactivation of Stop & Start.
 - D. Reinitialisation of the under-inflation detection system.
 - E. Deactivation of volumetric monitoring.
 - F. Activation of the electric child lock.
10. Side adjustable air vents.
11. Front side window demisting/defrosting vent.
12. Instrument panel.
13. Windscreen demisting/defrosting vent.
14. Sunshine sensor.
15. Glove box / Passenger's front airbag deactivation.
16. Passenger's front airbag.
17. Multifunction screen / Audio system.
18. Central adjustable air vents.
19. Central locking and hazard warning buttons.
20. Heating / air conditioning controls.
21. 12 V accessory socket.
USB port / auxiliary socket.
22. Open storage.
Cup holder.
23. Gear lever.
24. Grip control switch.
25. Parking brake.
26. Panoramic sunroof blind opening and closing control.
27. Closed storage compartment.
28. Rear 12 V socket.

Eco-driving

Eco-driving is a range of everyday practices that allow the motorist to optimise their fuel consumption and CO₂ emissions.

Optimise the use of your gearbox

With a manual gearbox, move off gently and change up without waiting. During acceleration change up early.

With an automatic or electronic gearbox, give preference to automatic mode and avoid pressing the accelerator pedal heavily or suddenly.

The gear shift indicator invites you engage the most suitable gear: as soon as the indication is displayed in the instrument panel, follow it straight away.

For vehicles fitted with an electronic or automatic gearbox, this indicator appears only in manual mode.

Drive smoothly

Maintain a safe distance between vehicles, use engine braking rather than the brake pedal, and press the accelerator progressively. These practices contribute towards a reduction in fuel consumption and CO₂ emissions and also helps reduce the background traffic noise.

If your vehicle has cruise control, make use of the system at speeds above 25 mph (40 km/h) when the traffic is flowing well.

Control the use of your electrical equipment

Before moving off, if the passenger compartment is too warm, ventilate it by opening the windows and air vents before using the air conditioning. Above 30 mph (50 km/h), close the windows and leave the air vents open.

Remember to make use of equipment that can help keep the temperature in the passenger compartment down (sunroof and window blinds...).

Switch off the air conditioning, unless it has automatic regulation, as soon as the desired temperature is attained.

Switch off the demisting and defrosting controls, if not automatic.

Switch off the heated seat as soon as possible.

Switch off the headlamps and front foglamps when the level of light does not require their use.

Avoid running the engine before moving off, particularly in winter; your vehicle will warm up much faster while driving.

As a passenger, if you avoid connecting your multimedia devices (film, music, video game...), you will contribute towards limiting the consumption of electrical energy, and so of fuel.

Disconnect your portable devices before leaving the vehicle.

Limit the causes of excess consumption

Spread loads throughout the vehicle; place the heaviest items in the bottom of the boot, as close as possible to the rear seats.

Limit the loads carried in the vehicle and reduce wind resistance (roof bars, roof rack, bicycle carrier, trailer...). Use a roof box in preference. Remove roof bars and roof racks after use.

At the end of winter, remove snow tyres and refit your summer tyres.

Observe the recommendations on maintenance

Check the tyre pressures regularly, when cold, referring to the label in the door aperture, driver's side.

Carry out this check in particular:

- before a long journey,
- at each change of season,
- after a long period out of use.

Don't forget the spare wheel and the tyres on any trailer or caravan.

Have your vehicle serviced regularly (engine oil, oil filter, air filter, passenger compartment filter...) and observe the schedule of operations recommended in the warranty and maintenance record.

With a Blue HDi Diesel engine, if the SCR system is faulty your vehicle becomes polluting; go to a PEUGEOT dealer or a qualified workshop without delay to have the emissions of nitrous oxides brought back to the legal level.

When refuelling, do not continue after the third cut-off of the nozzle to avoid any overflow.

At the wheel of your new vehicle, it is only after the first 1 800 miles (3 000 kilometres) that you will see the fuel consumption settle down to a consistent average.

LCD instrument panel



Dials and screens

1. Engine coolant temperature gauge.
2. Rev counter (x 1 000 rpm or tr/min), graduation according to engine (petrol or Diesel).
3. Engine oil level indicator*.
4. Gear shift indicator for a manual gearbox or gear lever position and gear for an electronic or automatic gearbox.
5. Digital speedometer (mph or km/h)
This can be switched off with a long press on **B**.

6. Cruise control or speed limiter settings.
7. Service indicator, then total distance recorder (miles or km).
These functions are displayed successively on switching on the ignition.
8. Trip distance recorder (miles or km).
9. Analogue speedometer (mph or km/h).
10. Fuel gauge.

Control buttons

- A.** General lighting dimmer.
- B.** Recalling the service information.
Resetting the function selected (service indicator or trip distance recorder).
Setting the time.
Switching the digital speedometer on and off.

* Depending on version.

Active matrix instrument panel

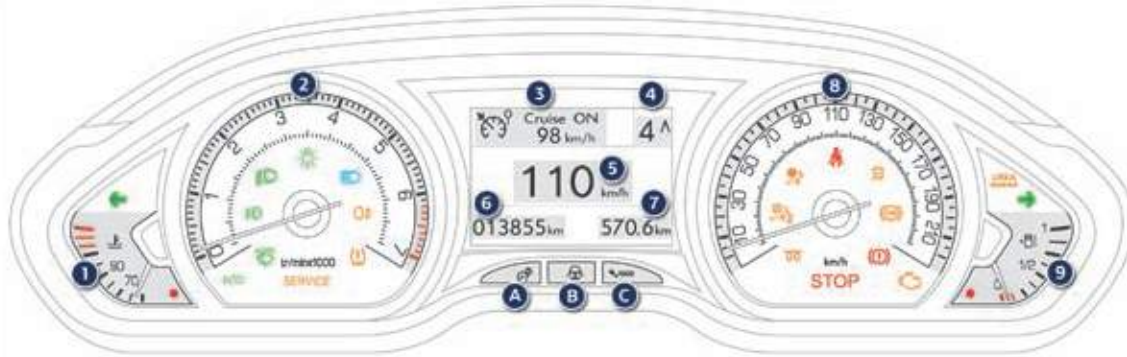

Dials and screens

1. Engine coolant temperature gauge.
2. Rev counter (x 1 000 rpm or tr/min), graduation according to engine (petrol or Diesel).
3. Cruise control or speed limiter settings.
4. Gear shift indicator for a manual gearbox or gear lever position and gear for an electronic or automatic gearbox.
5. Speedometer (mph or km/h).
6. Service indicator, then total distance recorder (miles or km). These functions are displayed successively on switching on the ignition.
7. Trip distance recorder (miles or km).
8. Analogue speedometer (mph or km/h).
9. Fuel gauge.

Control buttons

- A. Main lighting dimmer.
- B. Instrument panel mood lighting.
- C. Recall of the service information. Reset the selected function (service indicator or trip distance recorder).

Indicator and warning lamps

Visual indicators informing the driver that a system is switched on (indicator or deactivation lamp) or has a fault (warning lamp).



When the ignition is switched on

Certain warning lamps come on for a few seconds in the instrument panel and/or instrument panel screen when the vehicle's ignition is switched on.

When the engine is started, these same warning lamps should go off.

If they remain on, before moving off, refer to the information on the warning lamp concerned.

Associated warnings







The switching on of certain warning lamps may be accompanied by an audible signal and a message in the instrument panel or multifunction screen.

The warning lamps may come on continuously (fixed) or flash.

! Certain warning lamps may come on in one of two modes. Only by relating the type of lighting to the operating status of the vehicle can it be ascertained whether the situation is normal or whether a fault has occurred.



Operation indicator lamps



If one of the following indicator lamps comes on in the instrument panel and/or instrument panel screen, this confirms that the corresponding system has come into operation.

Warning / indicator lamp	State	Cause	Action / Observations
 Left-hand direction indicator	flashing with buzzer.	The lighting stalk is pushed down.	
 Right-hand direction indicator	flashing with buzzer.	The lighting stalk is pushed up.	
 Sidelamps	fixed.	The lighting stalk is in the "Sidelamps" position.	
 Dipped beam headlamps	fixed.	The lighting stalk is in the "Dipped beam headlamps" position.	
 Main beam headlamps	fixed.	The lighting stalk is pulled towards you.	Pull the stalk to return to dipped beam headlamps.
 Front foglamps	fixed.	The front foglamps are switched on using the ring on the lighting control stalk.	Turn the ring on the lighting control stalk rearwards twice to switch off the front foglamps.
 Rear foglamp	fixed.	The rear foglamp is switched on using the ring on the lighting control stalk.	Turn the ring on the lighting control stalk rearwards to switch off the rear foglamp.



For more information on the lighting controls, refer to the corresponding section.

Warning / indicator lamp		State	Cause	Action / Observations
	Diesel engine pre-heating	fixed.	The ignition switch is at the 2nd position (ignition on).	Wait until the warning lamp goes off before starting. The period of illumination of the warning lamp is determined by the climatic conditions (up to about thirty seconds in extreme climatic conditions). If the engine does not start, switch the ignition off and then on, wait until the warning lamp goes off again, then start the engine.
	Parking brake	fixed.	The parking brake is applied or not properly released.	Release the parking brake to switch off the warning lamp, keeping your foot on the brake pedal. Observe the safety recommendations. For more information on the parking brake, refer to the corresponding section.
	Foot on the brake pedal	fixed.	The brake pedal must be pressed.	With an electronic gearbox, press the brake pedal to start the engine (lever in position N). With an automatic gearbox, with the engine running, press the brake pedal before releasing the parking brake, to unlock the lever and come out of position P . If you wish to release the parking brake without pressing the brake pedal, this warning lamp will remain on.
		flashing.	With an electronic gearbox, if you hold the vehicle on an incline using the accelerator for too long, the clutch overheats.	Use the brake pedal and/or the parking brake.

Warning / indicator lamp	State	Cause	Action / Observations
 Foot on the clutch*	fixed.	In the STOP mode of Stop & Start, changing to START mode is refused because the clutch pedal is not fully down.	You must declutch fully to allow the change to engine START mode.
 Automatic wiping	fixed.	The wiper control is pushed downwards.	Automatic front wiping is activated. To deactivate automatic wiping, operate the control stalk downwards or put the stalk into another position.
 Stop & Start	fixed.	When the vehicle stops (red lights, traffic jams, ...) the Stop & Start system has put the engine into STOP mode.	The warning lamp goes off and the engine restarts automatically in START mode, as soon as you want to move off.
	flashes for a few seconds, then goes off.	STOP mode is temporarily unavailable. or START mode is invoked automatically.	For more information on special cases with STOP mode and START mode, refer to the "Stop & Start" section.

* Except for the active matrix instrument panel.

Deactivation indicator lamps

If one of the following indicator lamps comes on, this confirms that the corresponding system has been switched off intentionally. This is may be accompanied by an audible signal and a message in the screen.

Warning / indicator lamp		State	Cause	Action / Observations
	Passenger's airbag system	fixed.	The control, located in the glove box, is set to the OFF position. The passenger's front airbag is deactivated. In this case you can install a "rear facing" child seat.	Set the control to the ON position to activate the passenger's front airbag. In this case, do not fit a child seat in the rear-facing position.





Warning lamps





When the engine is running or the vehicle is being driven, illumination of one of the following warning lamps indicates a fault which requires action on the part of the driver.

Any fault resulting in the illumination of a warning lamp must be investigated further by reading the associated message in the screen.



If you encounter any problems, contact a PEUGEOT dealer or a qualified workshop.





Warning / indicator lamp		State	Cause	Action / Observations
STOP	STOP	fixed, associated with another warning lamp.	Major faults have occurred.	Stop as soon as it is safe to do so. Park, switch off the ignition and call a PEUGEOT dealer or qualified workshop.
SERVICE	Service	fixed, associated with another warning lamp.	Major faults have occurred.	Refer to the section on this warning lamp and you must then contact a PEUGEOT dealer or qualified workshop.
		fixed associated with a message (if a display screen is fitted).	Faults have occurred for which there is no specific warning lamp.	Identify the fault by reading the message shown in the screen (if a display screen is fitted) and refer to the corresponding section: <ul style="list-style-type: none"> - engine oil level alert, - risk of blockage of the particle emissions filter (Diesel). - Diesel fuel additive level (Diesel with particle emissions filter), You must contact a PEUGEOT dealer or a qualified workshop.



Warning / indicator lamp	State	Cause	Action / Observations
	Braking	fixed. The braking system fluid level has dropped significantly.	You must stop as soon as it is safe to do so. Top up with brake fluid listed by PEUGEOT. If the problem persists, have the system checked by a PEUGEOT dealer or a qualified workshop.
	Braking	fixed, associated with the ABS warning lamp. The electronic brake force distribution (EBFD) system has a fault.	You must stop as soon as it is safe to do so. Have it checked by a PEUGEOT dealer or a qualified workshop.
	Maximum coolant temperature	fixed with the needle in the red zone. The temperature of the cooling system is too high.	Stop as soon as it is safe to do so. Wait until the engine has cooled down before topping up the level, if necessary. If the problem persists, contact a PEUGEOT dealer or a qualified workshop.
	Anti-lock Braking System (ABS)	fixed. The anti-lock braking system has a fault.	The vehicle retains conventional braking. Drive carefully at reduced speed and contact a PEUGEOT dealer or a qualified workshop without delay.

Warning / indicator lamp		State	Cause	Action / Observations
	Dynamic stability control (DSC/ASR)	flashing.	The DSC/ASR regulation is operating.	The system optimises traction and improves the directional stability of the vehicle in the event of loss of grip or trajectory.
		fixed.	The DSC/ASR system has a fault.	Have it checked by a PEUGEOT dealer or a qualified workshop.
	Power steering	fixed.	The power steering has a fault.	Drive carefully at reduced speed. Have it checked by a PEUGEOT dealer or a qualified workshop.
	Engine autodiagnosis system	fixed.	The emission control system has a fault.	The warning lamp should go off when the engine is started. If it does not go off, contact a PEUGEOT dealer or qualified workshop without delay.
		flashing.	The engine management system has a fault.	Risk of destruction of the catalytic converter. Have it checked by a PEUGEOT dealer or a qualified workshop.
		fixed, associated with the SERVICE warning lamp.	A minor engine fault has been detected.	Have it checked by a PEUGEOT dealer or a qualified workshop.
			fixed, associated with the STOP warning lamp.	A major engine fault has been detected.

Warning / indicator lamp		State	Cause	Action / Observations
UREA  + SERVICE	AdBlue[®] additive (BlueHDi Diesel)	fixed, on switching on the ignition, accompanied by an audible signal and a message indicating the remaining driving range.	The remaining driving range is between 350 miles (600 km) and 1500 miles (2400 km).	Have the AdBlue [®] additive tank topped up as soon as possible: go to a dealer PEUGEOT or a qualified workshop, or carry out this operation yourself by referring to the corresponding section.
		flashing associated with the SERVICE warning lamp, accompanied by an audible signal and a message indicating the remaining driving range.	The remaining driving range is between 0 and 375 miles (600 km).	You must top-up the AdBlue[®] additive tank to avoid a breakdown : go to a dealer PEUGEOT or a qualified workshop, or carry out this operation yourself by referring to the corresponding section.
		flashing, associated with the SERVICE warning lamp, accompanied by an audible signal and a message indicating that starting is prevented.	The AdBlue [®] tank is empty: the starting inhibition system required by legislation prevents starting of the engine.	To be able to start the engine, you must top-up the AdBlue[®] additive tank : go to a dealer PEUGEOT or a qualified workshop, or carry out this operation yourself by referring to the corresponding section. It is essential to add at least 3.8 litres of AdBlue [®] to the tank.

Warning / indicator lamp	State	Cause	Action / Observations
 +  + 	SCR emissions control system (Blue HDi Diesel)	<p>A fault with the SCR emissions control system has been detected.</p>	<p>This alert disappears once the exhaust emissions return to normal levels.</p>
	<p>flashing, on switching on the ignition, associated with the SERVICE and engine diagnostic warning lamps, accompanied by an audible signal and a message indicating the remaining driving range.</p>	<p>The remaining driving range is between 0 and 650 miles (1 100 km).</p>	<p>Contact a PEUGEOT dealer or a qualified workshop without delay.</p>
	<p>flashing, on switching on the ignition, associated with the SERVICE and engine diagnostic warning lamps, accompanied by an audible signal and a message indicating that starting is prevented.</p>	<p>You have exceeded the authorised driving limit: the starting inhibition system prevents starting of the engine.</p>	<p>To be able to start the engine, you must call on a PEUGEOT dealer or a qualified workshop.</p>

Warning / indicator lamp	State	Cause	Action / Observations
	Low fuel level fixed with the needle in the red zone.	There remains approximately 5 litres of fuel in the tank. At this point, you begin to use the fuel reserve.	Refuel as soon as possible to avoid running out of fuel. This warning lamp will come on every time the ignition is switched on, until a sufficient addition of fuel is made.
	flashing with the needle in the red zone.	There remains very little fuel in the tank.	Fuel tank capacity: approximately 50 litres . Never continue to drive until you run out of fuel, as this could damage the emission control and injection systems.
	Engine oil pressure fixed.	There is a fault with the engine lubrication system.	You must stop as soon it is safe to do so. Park, switch off the ignition and contact a PEUGEOT dealer or a qualified workshop.
	Battery charge fixed.	The battery charging circuit has a fault (dirty or loose terminals, slack or cut alternator belt, ...).	The warning lamp should go off when the engine is started. If it does not go off, contact a PEUGEOT dealer or a qualified workshop.
 + SERVICE	Under-inflation fixed.	The pressure in one or more wheels is too low.	Check the pressure of the tyres as soon as possible. This check should preferably be carried out when the tyres are cold.
	flashing then fixed, accompanied by the Service warning lamp.	The tyre pressure monitoring system has a fault or no sensor is detected on one of the wheels.	Under-inflation detection is not assured. Have the system checked by a PEUGEOT dealer or a qualified workshop.

Warning / indicator lamp	State	Cause	Action / Observations
	Door(s) open	A door or the boot is still open.	Close the door or boot.
	fixed, associated with a message identifying the door, if the speed is below 6 mph (10 km/h).	fixed, associated with a message identifying the door, and accompanied by an audible signal if the speed is above 6 mph (10 km/h).	
	Seat belt(s) not fastened / unfastened	A seat belt has not been fastened or has been unfastened.	Pull the strap then insert the tongue in the buckle.
	Airbags	on temporarily.	This lamp should go off when the engine is started. If it does not go off, contact a PEUGEOT dealer or a qualified workshop.
	fixed.	One of the airbag or seat belt pretensioner systems has a fault.	Have it checked by a PEUGEOT dealer or a qualified workshop.

Touch screen

It gives access to:

- menus for adjusting settings for vehicle functions and systems,
- audio and display configuration menus,
- audio system and telephone controls and the display of associated information.

And, depending on equipment, it allows:

- the display of alert messages and the visual parking sensors information,
- access to the controls for the navigation system and Internet services, and the display of associated information.

! For reasons of safety, the driver should only carry out operations that require close attention, with the vehicle stationary.

Some functions are not accessible when driving.

General operation

Recommendations

It is necessary to press firmly, particularly for "flick" gestures (scrolling through lists, moving the map...).

A light wipe is not enough.

The screen does not recognise pressing with more than one finger.

This technology allows use at all temperatures and when wearing gloves.

Do not use pointed objects on the touch screen.

Do not touch the touch screen with wet hands. Uses a soft clean cloth to clean the touch screen.

State of indicator lamps

Some buttons contain an indicator lamp that gives the state of the corresponding function.

Green indicator: you have switched on the corresponding function.

Orange indicator: you have switched off the corresponding function.

Principles

Press the "MENU" button for access to the different menus, then press the virtual buttons in the touch screen.

Each menu is displayed over one or two pages (primary page and secondary page).



Use this button to go to the secondary page.



Use this button to return to the primary page.



After a few moments with no action on the secondary page, the primary page is displayed automatically.



Use this button for access to additional information and to the settings for certain functions.



Use this button to confirm.



Use this button to quit.

Menus

MENU

Press this button.



Navigation.

Depending on trim level, navigation can be not available, an option or standard. See the "Audio equipment and telematics" section.



Radio Media.

See the "Audio equipment and telematics" section.



Settings.

Allows configuration of the display and the system.



Internet.

These services can be not available, an option or standard. See the "Audio equipment and telematics" section.



Telephone.

See the "Audio equipment and telematics" section.



Driving.

Allows access to the trip computer and, depending on version, the adjustment of settings for certain functions. See the corresponding section.













1. Volume / mute.

See the "Audio equipment and telematics" section.



"Settings" menu

The functions available through this menu are detailed in the table below.

Button	Corresponding function	Comments
	Audio settings	Adjustment of volume, balance...
	Turn off screen	Turns the screen off.
	Color schemes	Choice of a color scheme.
	Interactive help	Access to the interactive user guide.
	System Settings	Choice of units: <ul style="list-style-type: none"> - temperature (°Celsius or °Fahrenheit) - distance and fuel consumption (l/100 km, mpg or km/l).
	Time/Date	Setting the date and time.
	Languages	Choice of language used.
	Screen settings	Adjustment of the screen (brightness) and display settings (scrolling of text, animations...)
	Calculator	
	Calendar	

"Driving" menu

The functions accessible from this menu are detailed in the table below.

Button	Corresponding function	Comments
	Vehicle settings	<p>The functions with settings that can be adjusted are grouped together under these tabs:</p> <ul style="list-style-type: none"> - "Driving assistance" <ul style="list-style-type: none"> ● "Automatic rear wiper in reverse" (Activation of rear wiper coupled to reverse gear; see the "Visibility" section) - "[Lighting]" <ul style="list-style-type: none"> ● "Guide-me-home lighting" (Automatic guide me home lighting; see the "Visibility" section), ● "LED daytime running lamps" (Exterior welcome lighting; see the "Visibility" section), ● "Mood lighting" (Interior mood lighting; see the "Visibility" section). <p>Select or deselect the tabs at the bottom of the screen to display the functions required.</p>
	Speed settings	<p>Memorisation of speeds for use with the speed limiter or cruise control.</p>

Gauges and indicators

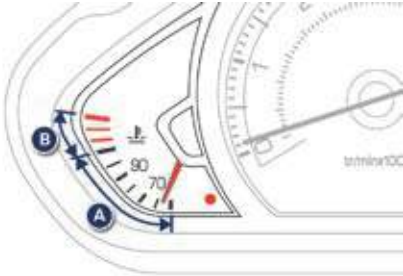

After driving for a few minutes, the temperature and pressure in the cooling system increase.

To top up the level:

- ☞ wait for the engine to cool,
- ☞ unscrew the cap slightly to allow the pressure to drop,
- ☞ when the pressure has dropped, remove the cap,
- ☞ top up the level to the "MAX" mark.

Coolant temperature gauge

With the engine running, when the needle is:

- in zone **A**, the temperature is correct,
- in zone **B**, the temperature is too high; the maximum temperature and the central **STOP** warning lamps come on, accompanied by an audible signal and a warning message in the screen.

You MUST stop as soon as it is safe to do so.

Wait a few minutes before switching off the engine.

Contact a PEUGEOT dealer or a qualified workshop.

! Be aware of the risk of burns when topping up the cooling system. Do not fill above the maximum level (indicated on the header tank).

Lighting dimmer control

System for the manual adjustment of the brightness of the instrument panel and the touch screen to suit the ambient light level.

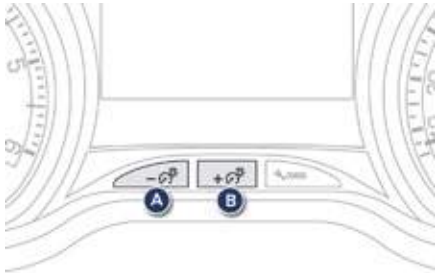

Two buttons

With the headlamps on, press button **B** to increase the brightness of the instruments and controls and the interior mood lighting or button **A** to reduce it.

As soon as the lighting reaches the required level of brightness, release the button.



One button

Activation

- ☞ press the button to adjust the brightness of the instruments and controls,
- ☞ release the button when the desired level is attained.

Switching off

When the vehicle lighting is off or in day mode (daytime running lamps on), pressing the button has no effect.

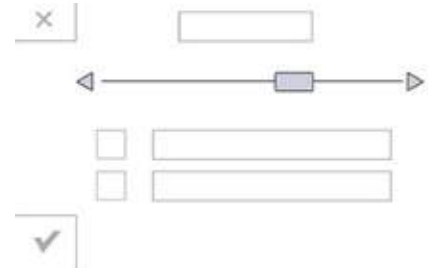

Touch screen

- ☞ Press **MENU** to display the "**MAIN MENU**" then select "**Preferences**".
- ☞ From the secondary page, select "**Screen preferences**".
- ☞ Adjust the brightness by moving the cursor.

You can also switch off the screen. To do this:

- ☞ Press **MENU** to display the "**MAIN MENU**" then select "**Preferences**".
 - ☞ Press "**Turn off screen**". The screen goes off completely.
- Press the screen again (anywhere on its surface) to activate it.

Service indicator

System which informs the driver when the next service is due, in accordance with the manufacturer's servicing schedule.

The point at which the service is due is calculated from the last reset of the indicator, according to the mileage covered and the time elapsed since the last service. For Blue HDi Diesel versions, the degree of deterioration of the engine oil is also taken into account.

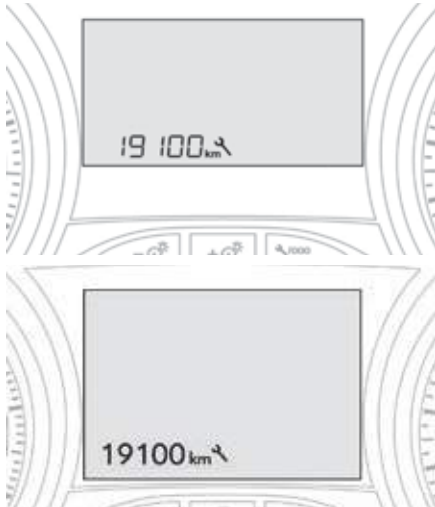

More than 1 800 miles (3 000 km) remain before the next service is due

When the ignition is switched on, no service information appears in the screen.

Between 600 miles (1 000 km) and 1 800 miles (3 000 km) remain before the next service is due

For 7 seconds after the ignition is switched on, the spanner symbolising the service operations comes on. The distance recorder display line indicates the distance remaining before the next service is due.

Example: 1 700 miles (2 800 km) remain before the next service is due.

For 7 seconds after the ignition is switched on, the screen indicates:



7 seconds after the ignition is switched on, **the spanner goes off**; the distance recorder resumes its normal operation. The screen then indicates the total and trip distances.



Less than 600 miles (1 000 km) remain before the next service is due

Example: 560 miles (900 km) remain before the next service is due.

For 7 seconds after the ignition is switched on, the screen indicates:



7 seconds after the ignition is switched on, the distance recorder resumes its normal operation. **The spanner remains on** to indicate that a service must be carried out soon.



Service overdue

For 7 seconds after the ignition is switched on, **the spanner flashes** to indicate that the service must be carried out as soon as possible.

Example: the service is overdue by 186 miles (300 km).

For 7 seconds after the ignition is switched on, the screen indicates:

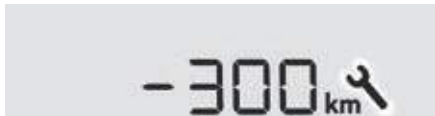

7 seconds after the ignition is switched on, the distance recorder resumes its normal operation. **The spanner remains on.**



i For Blue HDi Diesel versions, this alert is also accompanied by the fixed illumination of the Service warning lamp, when the ignition is switched on. The distance remaining may be weighted by the time factor, depending on the driving conditions. Therefore, the spanner may also come on if you have exceeded the period since the last service, indicated in the warranty and maintenance record. For Blue HDi Diesel versions, the spanner can also come on early, according to the degree of deterioration of the engine oil. The deterioration of the engine oil depends on the conditions in which the vehicle is used.

Service indicator zero reset

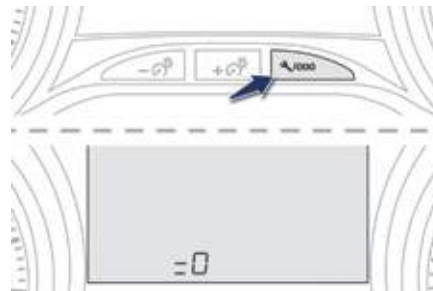

After each service, the service indicator must be reset to zero.

If you have carried out the service on your vehicle yourself:

- ☞ switch off the ignition,
- ☞ press and hold the trip distance recorder zero reset button,
- ☞ switch on the ignition; the distance recorder display begins a countdown,
- ☞ when the display indicates "**=0**", release the button; the spanner disappears.

i Following this operation, if you wish to disconnect the battery, lock the vehicle and wait at least five minutes for the zero reset to be registered.

Retrieving the service information

You can access the service information at any time.

- ☞ Press the trip distance recorder zero reset button.

The service information is displayed for a few seconds, then disappears.

Mileage recorder



The total mileage is displayed in zone **A** of the screen and the trip mileage in zone **B**.

Trip recorder zero reset



With the trip mileage displayed, press the button for a few seconds.

Engine oil level indicator*

System which informs the driver whether the engine oil level is correct or not. This information is indicated for a few seconds when the ignition is switched on, after the service information.

i The level read will only be correct if the vehicle is on level ground and the engine has been off for more than 30 minutes.

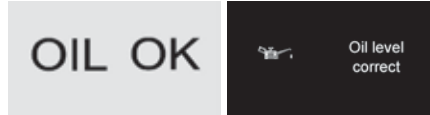

Oil level correct

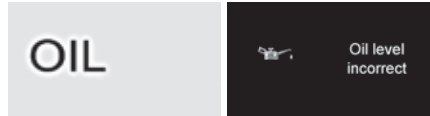

Oil level incorrect

This is indicated by the flashing of "OIL" or by the display of a dedicated message in the instrument panel.

If the low oil level is confirmed by a check using the dipstick, the level must be topped up to avoid damage to the engine.

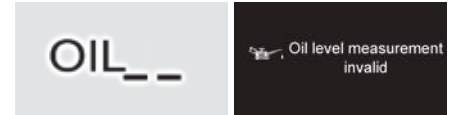

Oil level indicator fault

This is indicated by the flashing of "OIL__" or by the display of a dedicated message in the instrument panel. Contact a PEUGEOT dealer or a qualified workshop.

Dipstick

Refer to the "Checks" section to locate the dipstick and the oil filler cap on your engine. There are 2 marks on the dipstick:



- **A** = max; never exceed this level,
- **B** = min; top up the level via the oil filler cap, using the grade of oil suited to your engine.

* Depending on version.

Trip computer

System that gives you information on the current journey (range, fuel consumption...).

Instrument panel screen



Information display

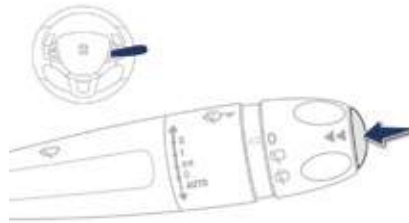

☞ Press the button on the end of the **wiper control stalk** to display the various tabs in succession.

1

- The current information tab with:
 - the range,
 - the current fuel consumption,
 - the Stop & Start time counter.

2

- Trip "1" with:
 - the average speed,
 - the average fuel consumption,
 - the distance travelled, for the first trip.
- Trip "2" with:
 - the average speed,
 - the average fuel consumption,
 - the distance travelled, for the second trip.

Trip reset

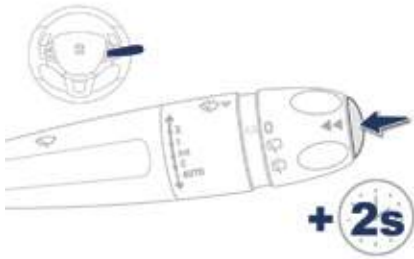

- ☞ When the trip required is displayed, press the control for more than two seconds or use the left hand thumb wheel of the steering mounted controls.

Trips "1" and "2" are independent but their use is identical.

For example, trip "1" can be used for daily figures, and trip "2" for monthly figures.

Trip computer with touch screen

System which provides current information concerning the trip (range, fuel consumption...).

Information display

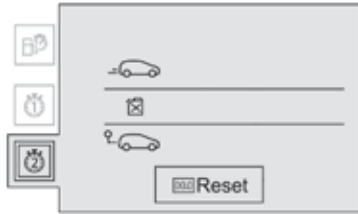

MENU

- ☞ Press **MENU** button, then select "**Driving**", to display the various tabs.
- ☞ Select the desired tab using your finger.



- The current fuel consumption tab with:
 - the range,
 - the current fuel consumption,
 - the Stop & Start time counter.



- The trip "1" tab with:
 - the distance travelled,
 - the average fuel consumption,
 - the average speed, for the first trip.



- The trip "2" tab with:
 - the distance travelled,
 - the average fuel consumption,
 - the average speed, for the second trip.

Trip reset

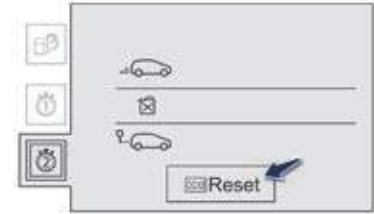

000

- ☞ When the desired trip is displayed, press the reset button.

Trips "1" and "2" are independent but their use is identical.
For example, trip "1" can be used for daily figures, and trip "2" for monthly figures.

Trip computer, a few definitions



Range

(miles or km)

The distance which can still be travelled with the fuel remaining in the tank (related to the average fuel consumption over the last few miles (kilometres) travelled).

i This value may vary following a change in the style of driving or the relief, resulting in a significant change in the current fuel consumption.

When the range falls below 20 miles (30 km), dashes are displayed. After filling with at least 5 litres of fuel, the range is recalculated and is displayed when it exceeds 60 miles (100 km).

i If dashes are displayed continuously while driving in place of the digits, contact a PEUGEOT dealer or a qualified workshop.



Current fuel consumption

(mpg or l/100 km or km/l)

Calculated over the last few seconds.

i This function is only displayed from 20 mph (30 km/h).



Average fuel consumption

(mpg or l/100 km or km/l)

Calculated since the last trip computer reset.



Average speed

(mph or km/h)

Calculated since the last trip computer reset.



Distance travelled

(miles or km)

Calculated since the last trip computer reset.



Stop & Start time counter

(minutes / seconds or hours / minutes)

If your vehicle is fitted with Stop & Start, a time counter calculates the time spent in STOP mode during a journey.

It resets to zero every time the ignition is switched on with the key.

Setting the date and time

Touch screen



MENU Press **MENU** to display the "MAIN MENU".

 Select "**Settings**".

 In the secondary page, select "**Time/Date**".

Select "**Adjust time**" or "**Adjust date**" and modify the setting using the virtual keypad then confirm.

✓ Press "**Confirm**" to quit.

LCD instrument panel



☞ Press this button to display the following settings successively:

- hours,
- minutes,
- 12 or 24 hour format.

Remote control key

System which permits central unlocking or locking of the vehicle using the lock or from a distance. It is also used to locate and start the vehicle, as well as providing protection against theft.

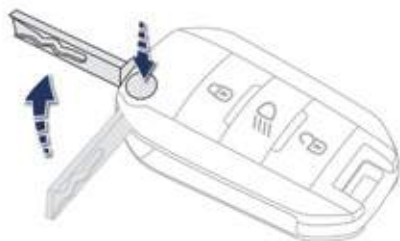

Unfolding the key

- ☞ First press this button to unfold the key.

Unlocking the vehicle

Complete unlocking

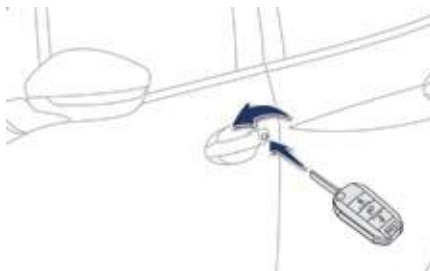

Using the key

- ☞ Turn the key to the front of the vehicle to unlock the vehicle.

Using the remote control



- ☞ Press the open padlock to unlock the vehicle.

i Unlocking is confirmed by rapid flashing of the direction indicators for approximately two seconds. According to version, the door mirrors unfold at the same time. Unlocking with the key does not deactivate the alarm.

Locking the vehicle

Normal locking

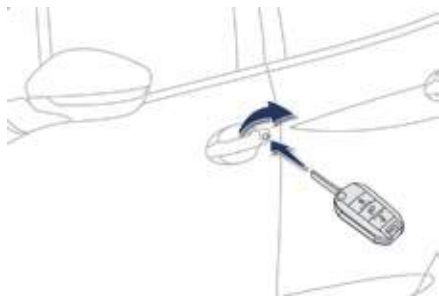

Using the key

- ☞ Turn the key towards the rear of the vehicle to lock the vehicle completely.

Using the remote control



- ☞ Press the closed padlock to lock the vehicle completely.

Maintaining the locking action (key or remote control) automatically closes the windows.

i Locking is confirmed by fixed lighting of the direction indicators for approximately two seconds. According to version, the door mirrors fold at the same time.

! As a safety measure (children on board), never leave the vehicle without taking your key, even for a short period.

i If one of the doors or the boot is still open or if an electronic key has been left inside the vehicle, the central locking does not take place. When the vehicle is locked, if it is unlocked inadvertently, it will relock automatically after about thirty seconds unless a door is opened.

When the key is in the ignition switch, its locking/unlocking functions are deactivated. The folding and unfolding of the door mirrors by the remote control can be deactivated by a PEUGEOT dealer or a qualified workshop.

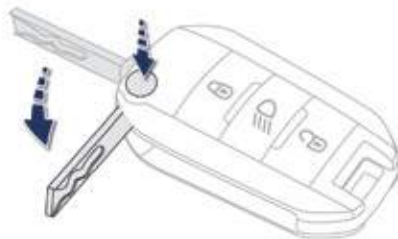

Locating your vehicle



- ☞ Press the closed padlock to locate your locked vehicle in a car park.

This is indicated by lighting of the courtesy lamps and flashing of the direction indicators for a few seconds.

Folding the key

- ☞ First press this button to fold the key.

! If you do not press the button when folding the key, there is a risk of damage to the mechanism.

Guide-me-home lighting



Make a long press this button to operate the guide-me-home lighting (switching on the sidelamps, dipped beams and number plate lamps).

A second press before the end of the timed period cancels the guide-me-home lighting.

Anti-theft protection

Electronic engine immobiliser

The key contains an electronic chip which has a special code. When the ignition is switched on, this code must be recognised in order for starting to be possible.

This electronic engine immobiliser locks the engine management system a few minutes after the ignition is switched off and prevents starting of the engine by anyone who does not have the key.

SERVICE In the event of a fault, you are informed by illumination of this warning lamp, an audible signal and a message in the screen.

In this case, your vehicle will not start; contact a PEUGEOT dealer as soon as possible.

i Keep safely, away from your vehicle, the label attached to the keys given to you on acquisition of the vehicle.

Locking / unlocking from the inside

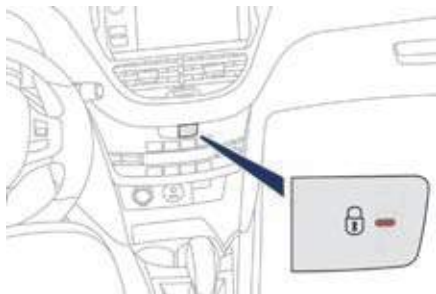

☞ Press the switch.

This allows the doors and the boot to be locked or unlocked.

When one of the doors is not properly closed:



- **with the engine running**, this warning lamp comes on, accompanied by the display of an alert message for a few seconds,
- **when driving** (speed above 6 mph (10 km/h)), this warning lamp comes on, accompanied by an audible signal and the display of an alert message for a few seconds.

i If one of the doors is open, the doors are not locked.

! When locking / deadlocking from outside

When the vehicle is locked or deadlocked from outside, the switch does not operate.

- ☞ After normal locking, pull the interior door lever to unlock the vehicle.
- ☞ After deadlocking, you have to use the remote control or the key to unlock the vehicle.

Automatic central locking of the doors

The doors can lock automatically while driving (speed above 6 mph [10 km/h]).

To turn this function on or off (on by default).

- ☞ press and hold the button until there is an audible signal and/or a message in the screen.

! Driving with the doors locked may make access to the passenger compartment by the emergency services more difficult in an emergency.

Secondary control

For mechanically locking and unlocking the doors in the event of a fault with the central locking system or a battery failure.

Driver's door

Insert the key in the lock to lock or unlock the door.

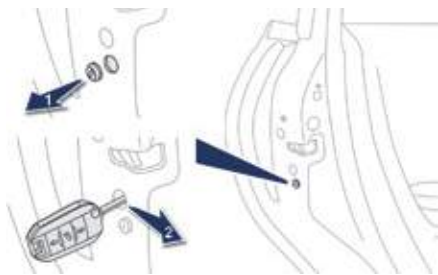

Passenger doors

- ☞ On the rear doors, check that the child lock is not on.
- ☞ Remove the black cap located on the edge of the door, using the key.
- ☞ Insert the key into the aperture without forcing, then without turning, move the latch sideways towards the inside of the door.
- ☞ Remove the key and refit the cap.

Remote control problem

Following disconnection of the vehicle battery, replacement of the remote control battery or in the event of a remote control malfunction, you can no longer unlock, lock or locate your vehicle.

- ☞ First of all, use the key in the lock to unlock or lock your vehicle.
- ☞ Then, reinitialise the remote control.

If the problem persists, contact a PEUGEOT dealer as soon as possible.



Reinitialisation

- ☞ Switch off the ignition.
- ☞ Turn the key to position **2 (Ignition)**.
- ☞ Press the closed padlock immediately for a few seconds.
- ☞ Switch off the ignition and remove the key from the ignition switch.

The remote control is fully operational again.

Changing the battery



Battery ref.: CR1620 / 3 volts.

SERVICE If the battery is flat, you are informed by lighting of this warning lamp in the instrument panel, an audible signal and a message in the screen.

- ☞ Unclip the cover using a screwdriver in the cutout.
- ☞ Remove the cover.
- ☞ Extract the flat battery from its location.
- ☞ Place the new battery into its location observing the original direction.
- ☞ Clip the cover in place.



Do not throw the remote control batteries away, they contain metals which are harmful to the environment. Take them to an approved collection point.

! Lost keys

Go to a PEUGEOT dealer with the vehicle's registration document, your personal identification documents and if possible the key code label. The PEUGEOT dealer will be able to look up the key code and the transponder code required to order a new key.

Remote control

The high frequency remote control is a sensitive system; do not operate it while it is in your pocket as there is a possibility that it may unlock the vehicle, without you being aware of it.

Do not repeatedly press the buttons of your remote control out of range and out of sight of your vehicle. You run the risk of stopping it from working and the remote control would have to be reinitialised.

No remote control can operate when the key is in the ignition switch, even when the ignition is switched off, except for reinitialisation.

Locking the vehicle

Driving with the doors locked may make access to the passenger compartment by the emergency services more difficult in an emergency.

As a safety precaution, never leave children alone in the vehicle, except for a very short period.

In all cases, it is essential to remove the key from the ignition switch when leaving the vehicle.

Anti-theft protection

Do not make any modifications to the electronic engine immobiliser system; this could cause malfunctions.

When purchasing a second-hand vehicle

Have the pairing of all of the keys in your possession checked by a PEUGEOT dealer, to ensure that only your keys can be used to open and start the vehicle.

Alarm

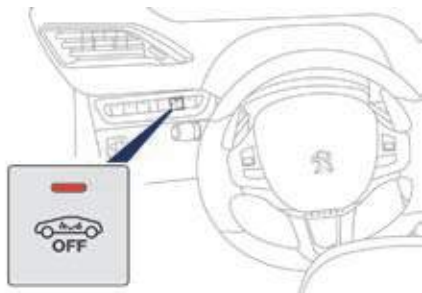

System which protects and provides a deterrent against theft and break-ins. It provides the following types of monitoring:

- Exterior perimeter

The system checks for opening of the vehicle. The alarm is triggered if anyone tries to open a door, the boot, the bonnet...

- Interior volumetric

The system checks for any variation in the volume in the passenger compartment. The alarm is triggered if anyone breaks a window, enters the passenger compartment or moves inside the vehicle.

! Self-protection function

The system checks for the putting out of service of its components. The alarm is triggered if the battery, the central control or the wires of the siren are put out of service or damaged.

For all work on the alarm system, contact a PEUGEOT dealer or a qualified workshop.

Locking the vehicle with full alarm system

Activation

☞ Switch off the ignition and get out of the vehicle.



☞ Press the locking button on the remote control.



The monitoring system is active: the indicator lamp in the button flashes once per second.

After the locking button on the remote control is pressed, the exterior perimeter monitoring is activated after a delay of 5 seconds and the interior volumetric monitoring after a delay of 45 seconds.

If an opening (door, boot...) is not closed fully, the vehicle is not locked but the exterior perimeter monitoring will be activated after a delay of 45 seconds at the same time as the interior volumetric monitoring.

Deactivation



☞ Press the unlocking button on the remote control.



The alarm system is deactivated: the indicator lamp in the button goes off.

Locking the vehicle with exterior perimeter monitoring only

Deactivate the interior volumetric monitoring to avoid unwanted triggering of the alarm in certain cases such as:

- leaving a pet in the vehicle,
- leaving a window partially open,
- washing your vehicle.

Deactivation of the interior volumetric monitoring



- ☞ Switch off the ignition.
- ☞ Within ten seconds, press the button until the indicator lamp is on continuously.
- ☞ Get out of the vehicle.
- ☞ Press the locking button on the remote control immediately.



The exterior perimeter monitoring alone is activated: the indicator lamp in the button flashes once per second.

i To be effective, this deactivation must be carried out each time the ignition is switched off.

Reactivation of the interior volumetric monitoring



- ☞ Press the unlocking button on the remote control to deactivate the exterior perimeter monitoring.



- ☞ Press the locking button on the remote control to activate all the monitoring functions.



The indicator lamp in the button again flashes once per second.

Triggering of the alarm

This is indicated by sounding of the siren and flashing of the direction indicators for thirty seconds.

The monitoring functions remain active until the alarm has been triggered eleven times in succession.



When the vehicle is unlocked using the remote control, rapid flashing of the indicator lamp in the button informs you that the alarm was triggered during your absence. When the ignition is switched on, this flashing stops immediately.

Failure of the remote control

To deactivate the monitoring functions:

- ☞ Unlock the vehicle using the key in the driver's door lock.
- ☞ Open the door; the alarm is triggered.
- ☞ Switch on the ignition; the alarm stops. The indicator lamp in the button goes off.

Locking the vehicle without activating the alarm

- ☞ Lock or deadlock the vehicle using the key in the driver's door lock.

Malfunction

When the ignition is switched on, fixed illumination of the indicator lamp in the button indicates a malfunction of the system. Have it checked by a PEUGEOT dealer or a qualified workshop.

Automatic activation*

2 minutes after the last door or the boot is closed, the system is activated automatically.

- ☞ To avoid triggering the alarm on entering the vehicle, first press the unlocking button on the remote control.

* According to country.

Electric windows



1. **Left hand front electric window.**
2. **Right hand front electric window.**
3. **Right hand rear electric window.**
4. **Left hand rear electric window.**
5. **Deactivating the rear electric window switches.**

Manual operation

To open or close the window, press or pull the switch gently. The window stops as soon as the switch is released.

Automatic one-touch operation (depending on version)

To open or close the window, press or pull the switch fully: the window opens or closes completely when the switch is released. Pressing the switch again stops the movement of the window.

The electric window switches remain operational for approximately one minute after the key has been removed.

Once this time has elapsed, the electric windows will not operate. To reactivate them, switch the ignition on again.

Safety anti-pinch (depending on version)

When the window rises and meets an obstacle, it stops and immediately partially lowers again. In the event of unwanted opening of the window when closing automatically, press the switch until the window opens completely, then pull the switch immediately until the window closes. Continue to hold the switch for approximately one second after the window has closed. The safety anti-pinch function is not active during this operation.

Deactivating the rear window controls



For the safety of your children, press switch 5 to prevent operation of the windows of the rear doors, irrespective of their position.

With the warning lamp on, the rear switches are deactivated. With the warning lamp off, the switches are active.

Reinitialising the electric windows

Following reconnection of the battery, the safety anti-pinch function must be reinitialised. The safety anti-pinch is not active during these operations:

- lower the window completely, then raise it, it will rise in steps of a few centimetres each time the switch is pressed. Repeat the operation until the window closes completely,
- press and hold the switch upwards for at least one second after reaching this position, window closed.

! Always remove the key when leaving the vehicle, even for a short time.

In the event of contact during operation of the windows, you must reverse the movement of the window. To do this, press the switch concerned.

When operating the passenger electric window switches, the driver must ensure that no one is preventing correct closing of the windows.

The driver must ensure that the passengers use the electric windows correctly.

Be aware of children when operating the windows.

Boot Opening

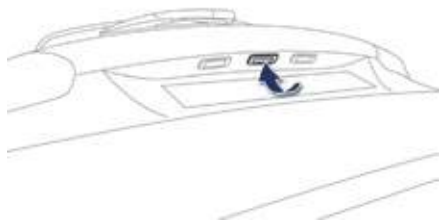

- ☞ After unlocking the boot or the vehicle using the remote control or the key, press the opening control, then raise the tailgate.

Closing

- ☞ Lower the tailgate using the interior grab handle.
- ☞ If necessary, press down on the tailgate to fully close it.

If the tailgate is not closed correctly:



- **when the engine is running,** this warning lamp comes on, accompanied by the display of an alert message for a few seconds,
- **when the vehicle is moving** (speed above 6 mph (10 km/h)), this warning lamp comes on, accompanied by an audible signal and the display of an alert message for a few seconds.

Tailgate release

System for mechanical unlocking of the boot in the event of a central locking malfunction.

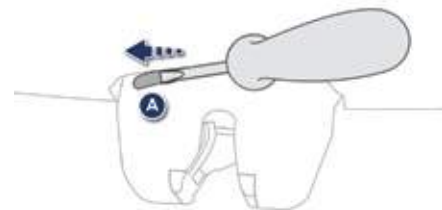

Unlocking

- ☞ Fold back the rear seats to gain access to the lock from inside the boot.
- ☞ Insert a small screwdriver into hole **A** of the lock to unlock the tailgate.

Panoramic sunroof

System which comprises configurable light guides and a panoramic tinted glass area to increase the light and visibility in the passenger compartment.

It is fitted with an electric blind to improve temperature and acoustic comfort.

Electric blind

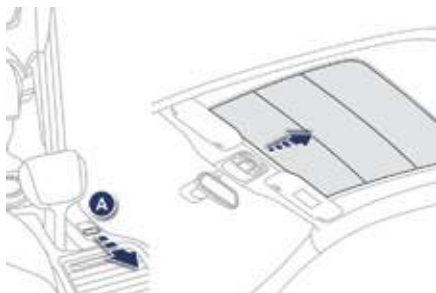

Opening

- ☞ Lift the control **A** towards the rear. The blind stops when you release the control.



Closing

- ☞ Lift the control **A** towards the front. The blind stops when you release the control.

I If something is trapped when operating the blind, you should reverse the movement of the blind. To do this press the control in question. When the driver operates the blind, they should ensure that nobody prevents its correct closing. The driver should ensure that passengers use the blind correctly. Be aware of children when operating the blind.

Front seats with manual adjustments

As a safety measure, seat adjustments should only be carried out when stationary.

Forwards-backwards



- ☞ Raise the control and slide the seat forwards or backwards.

Height



- ☞ Pull the control upwards to raise or push it downwards to lower, as many times as required, to obtain the position required.

Seat backrest angle



- ☞ Push the control rearwards.

! Before moving the seat backwards, ensure that there is nothing that might prevent the full travel of the seat, so as to avoid the risk of jamming the seat caused by the presence of objects on the floor behind the seat or rear passengers. If the seat jams, stop the movement immediately.

Head restraint height



- ☞ To raise the head restraint, pull it upwards.
- ☞ To remove the head restraint, press the lug **A** and pull the head restraint upwards.
- ☞ To put the head restraint back in place, engage the head restraint stems in the openings keeping them in line with the seat back.
- ☞ To lower the head restraint, press the lug **A** and the head restraint at the same time.

! The head restraint is fitted with a frame with notches which prevents it from lowering; this is a safety device in case of impact.

The adjustment is correct when the upper edge of the head restraint is level with the top of the head.

Never drive with the head restraints removed; they must be in place and adjusted correctly.

Heated seats control



With the engine running, the front seats can be heated separately.

- ☞ Use the adjustment dial, placed on the side of each front seat, to switch on and select the level of heating required:

- 0:** Off.
- 1:** Low.
- 2:** Medium.
- 3:** High.

Rear seats

Bench seat with fixed one-piece cushion and split backrest (left hand 2/3, right hand 1/3) which can be folded individually to adapt the load space in the boot.

Folding the backrest

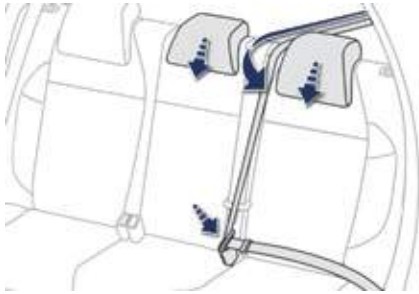

- ☞ Move the corresponding front seat forward if necessary.
- ☞ Check that the corresponding outer seat belt is positioned correctly against the backrest and buckle it.
- ☞ Place the head restraints in the low position.

! When folding the seat, the centre seat belt should not be fastened, but laid out flat on the seat

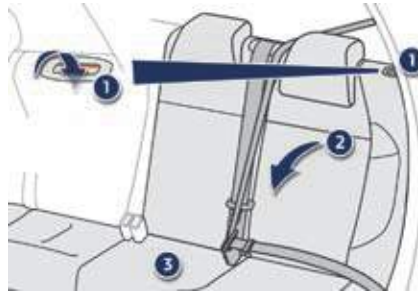

- ☞ Press control 1 to release the seat backrest 2.
- ☞ Fold the seat backrest 2 on to the cushion 3.

i The rear seat cushion does not fold, just the seat backrest can be folded to increase the boot loading space.

Repositioning the seat backrest



- ☞ Straighten the seat backrest 2 and secure it.
- ☞ Check that the red indicator, located next to the control 1, is no longer visible.
- ☞ Unbuckle and reposition the outer seat belt on the side of the backrest.

! When repositioning the seat backrest, take care not to trap the seat belts.

PEUGEOT i-Cockpit Steering wheel adjustment

Rear head restraints



These have one position for use (up) and a stowed position (down).

They can be removed and are interchangeable side to side.

To remove a head restraint:

- ☞ pull the head restraint upwards to the stop,
- ☞ then, press the lug **A**.



Never drive with the head restraints removed; they must be in place and correctly adjusted.



Before taking to the road and to make the most of the special ergonomics of the PEUGEOT i-Cockpit, carry out these adjustments in the following order:

- height of the head restraint,
- backrest angle,
- cushion height,
- longitudinal position of the seat,
- reach and then height of the steering wheel,
- the interior and door mirrors.



Once these adjustments have been made, ensure that from your driving position you can see the "head-up" instrument panel clearly, over the reduced diameter steering wheel.

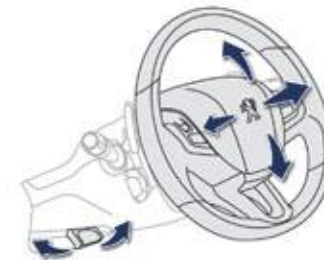

- ☞ **When stationary**, pull the control lever to release the adjustment mechanism.
- ☞ Adjust the height and reach to suit your driving position.
- ☞ Push the control lever to lock the adjustment mechanism.



As a safety precaution, these operations should only be carried out with the vehicle stationary.

Mirrors

Door mirrors

Each fitted with an adjustable mirror glass providing the lateral rearward vision necessary for overtaking or parking. They can also be folded for parking in confined spaces.

! As a safety measure, the mirrors should be adjusted to reduce the "blind spots".

Demisting - Defrosting



Demisting-defrosting of the door mirrors operates with the engine running, by switching on the heated rear screen.

For more information on demisting and defrosting the rear screen, refer to the corresponding section.

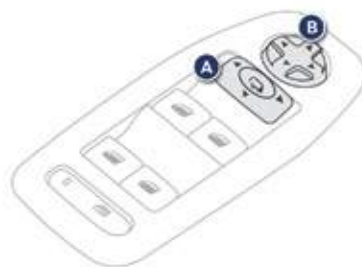

Adjustment

- ☞ Move control **A** to the right or to the left to select the corresponding mirror.
- ☞ Move control **B** in all four directions to adjust.
- ☞ Return control **A** to the central position.

i The objects observed are, in reality, closer than they appear. Take this into account in order to correctly judge the distance of vehicles approaching from behind.

Folding

- Automatic: lock the vehicle using the remote control or the key.
- Manual: with the ignition on, pull control **A** rearwards.

i If the mirrors are folded using control **A**, they will not unfold when the vehicle is unlocked. Pull again on control **A**.

Unfolding

- Automatic: unlock the vehicle using the remote control or the key.
- Manual: with the ignition on, pull control **A** rearwards.

i The folding and unfolding of the door mirrors using the remote control can be deactivated by a PEUGEOT dealer or a qualified workshop. Fold the mirrors when putting your vehicle through an automatic car wash.

If necessary, it is possible to fold the mirrors manually.

Rear view mirror

Adjustable mirror providing a central rearward view.

Equipped with an anti-dazzle system, which darkens the mirror glass and reduces the nuisance to the driver caused by the sun, headlamps from other vehicles...



Manual day/night model

Adjustment

- ☞ Adjust the mirror so that the glass is directed correctly in the "day" position.

Day / night position

- ☞ Pull the lever to change to the "night" anti-dazzle position.
- ☞ Push the lever to change to the normal "day" position.

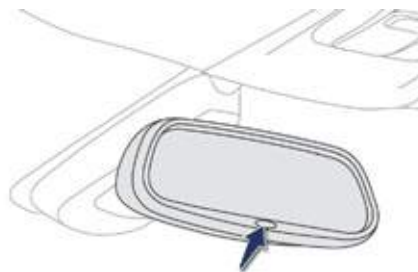

Automatic day/night model

By means of a sensor, which measures the light from the rear of the vehicle, this system automatically and progressively changes between the day and night uses.

i In order to ensure optimum visibility during your manoeuvres, the mirror lightens automatically when reverse gear is engaged.

Ventilation

Air intake

The air circulating in the passenger compartment is filtered and originates either from the outside via the grille located at the base of the windscreen or from the inside in air recirculation mode.

Air intake flow

The incoming air follows various paths depending on the controls selected by the driver:

- direct arrival in the passenger compartment (air intake),
- passage through a heating circuit (heating),
- passage through a cooling circuit (air conditioning).

Control panel

The controls of this system are grouped together on control panel **A** on the centre console.

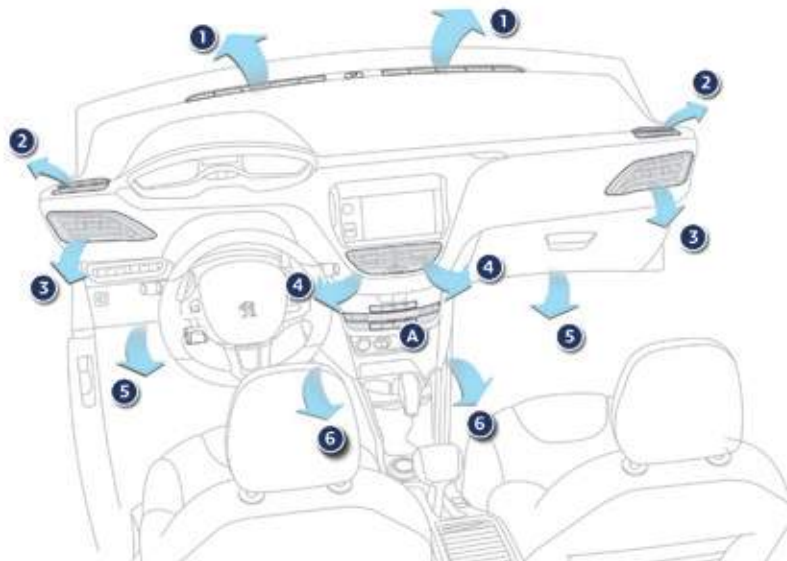

Air distribution

1. Windscreen demisting-defrosting vents.
2. Front side window demisting-defrosting vents.
3. Side adjustable air vents.
4. Central adjustable air vents.
5. Air outlets to the front footwells.
6. Air outlets to the rear footwells.

Recommendations for ventilation and air conditioning

- i** In order for these systems to be fully effective, follow the operation and maintenance guidelines below:
- ☞ To obtain an even air distribution, take care not to obstruct the exterior air intake grilles located at the base of the windscreen, the nozzles, the vents and the air outlets, as well as the air extractor located in the boot.
 - ☞ Do not cover the sunshine sensor, located on the dashboard; this is used for regulation of the air conditioning system.
 - ☞ Operate the air conditioning system for at least 5 to 10 minutes, once or twice a month to keep it in perfect working order.
 - ☞ Ensure that the passenger compartment filter is in good condition and have the filter elements replaced regularly.
- We recommend the use of a combined passenger compartment filter. Thanks to its special active additive, it contributes to the purification of the air breathed by the occupants and the cleanliness of the passenger compartment (reduction of allergic symptoms, bad odours and greasy deposits).
- ☞ To ensure correct operation of the air conditioning system, you are also advised to have it checked regularly as recommended in the warranty and maintenance record.
 - ☞ If the system does not produce cold air, switch it off and contact a PEUGEOT dealer or a qualified workshop.

When towing the maximum load on a steep gradient in high temperatures, switching off the air conditioning increases the available engine power and so improves the towing ability.

i Stop & Start

The heating and air conditioning systems only work when the engine is running. To maintain a comfortable temperature in the passenger compartment, you can temporarily deactivate the Stop & Start system (see the corresponding section).



If after an extended stop in sunshine, the interior temperature is very high, first ventilate the passenger compartment for a few moments.







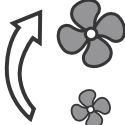
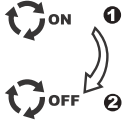

Put the air flow control at a setting high enough to quickly change the air in the passenger compartment.

The air conditioning system does not contain chlorine and does not present any danger to the ozone layer.

- i** The condensation created by the air conditioning results in a discharge of water under the vehicle which is perfectly normal.

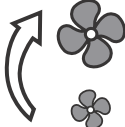
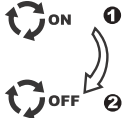
Ventilation

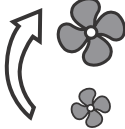
Recommended interior settings

I require...	Heating or Manual air conditioning				
	Air distribution	Air flow	Air recirculation/Intake of exterior air	Temperature	Manual AC
HOT					
COLD					ON
DEMISTING DEFROSTING					ON

Digital air conditioning: use the automatic mode in preference by pressing the "AUTO" button.

Heating / Ventilation

Manual air conditioning

The air conditioning system only operates with the engine running.



1. Temperature adjustment.
2. Air flow adjustment.
3. Air distribution adjustment.
4. Air intake/ air recirculation.
5. Air conditioning On / Off.

Temperature adjustment



- ☞ Turn the dial from blue (cold) to red (hot) to adjust the temperature to your requirements.

Air flow adjustment



- ☞ Turn the dial from position 1 to position 6 to obtain a comfortable air flow.

i If you put the air flow control in position 0 (system off), the temperature is no longer controlled. However, a slight flow of air can still be felt, resulting from the movement of the vehicle.

Air distribution adjustment



Windscreen and side windows.



Windscreen, side windows and footwells.



Footwells.



Central and side vents.



The air distribution can be adapted by placing the dial in an intermediate position.

Air intake / Air recirculation

The recirculation of interior air insulates the passenger compartment from exterior odours and smoke.

Return to exterior air intake as soon as possible to prevent deterioration of the air quality and the formation of mist.



☞ Press the button to recirculate the interior air. The indicator lamp comes on to confirm this.

☞ Press the button again to allow fresh air into the passenger compartment. The indicator lamp goes off to confirm this.

Air conditioning On / Off



The air conditioning is designed to operate effectively in all seasons, with the windows closed.

It enables you to:

- lower the temperature, in summer,
- increase the effectiveness of the demisting in winter, above 3 °C.

Switching on

☞ Press the "A/C" button, the button's indicator lamp comes on.

i The air conditioning does not operate when the air flow adjustment control **2** is in position "0".

To obtain cooled air more quickly, you can use recirculation of interior air for a few moments. Then return to fresh air intake.

Switching off

☞ Press the "A/C" button again, the button's indicator lamp goes off.

Switching off may affect comfort levels (humidity, condensation).

Dual-zone digital air conditioning

The air conditioning can only operate with the engine running.

Automatic operation

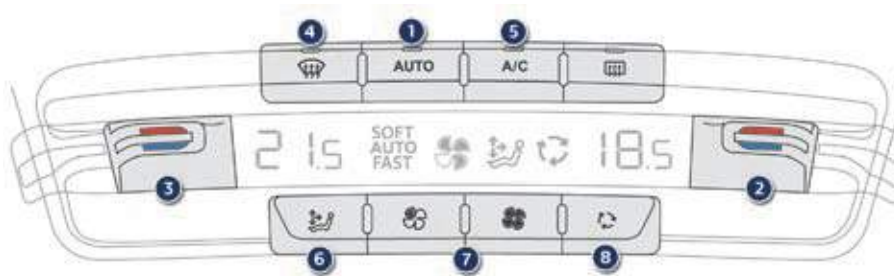

1. Automatic comfort programme.
2. Temperature adjustment on driver's side.
3. Temperature adjustment on passenger's side.
4. Automatic visibility programme.
5. Air conditioning On/Off.
6. Air distribution adjustment.
7. Air flow adjustment.
8. Air intake/ Air recirculation.

Automatic comfort programme

Three modes are provided for the driver and for the front passenger to select their desired level of comfort in the passenger compartment.

AUTO

- ☞ Press the "AUTO" button repeatedly. The indicator lamp comes on at the first press; the mode activated appears in the digital air conditioning screen:

**SOFT
AUTO**

Provides soft and quiet operation by limiting air flow.

AUTO

Offers the best compromise between a comfortable temperature and quiet operation.

**AUTO
FAST**

Provides strong and effective air flow.

i When the engine is cold, to prevent too great a distribution of cold air, the air flow will only reach its optimum level gradually. In cold weather, it favours the distribution of warm air to the windscreen, the side windows and the footwells only.

3

Temperature adjustment

The driver and front passenger can each set the temperature to suit their requirements. The value indicated in the screen corresponds to a level of comfort and not to a temperature in degrees Celsius or Fahrenheit.



- ☞ Press the button **2** or **3** down (blue) reduce the value or up (red) to increase it.

A setting around 21 enables you to obtain an optimum level of comfort. Depending on your requirements, a setting between 18 and 24 is usual. In addition, it is recommended that you avoid a left/right setting difference of more than 3.

- i** On entering the vehicle, if the interior temperature is much colder or warmer than the comfort value, there is no need to alter the value displayed in order to obtain the required level of comfort. The system corrects the temperature difference automatically and as quickly as possible.

Automatic visibility programme



See the "Front demisting-defrosting" section.

Resuming manual control

Depending on your requirements, you can make a different selection from that offered by the system by changing a setting. The other functions will still be controlled automatically.



When you modify a setting, the indicator lamp in the "**AUTO**" button goes off.

- ☞ Press the "**AUTO**" button again to return to the automatic comfort programme.

- i** For maximum cooling or heating of the passenger compartment, you can exceed the minimum value of 14 or the maximum value of 28.

- ☞ Push the switch **2** or **3** down until "**LO**" is displayed or up until "**HI**" is displayed.

Air conditioning On/Off



The air conditioning is designed to operate efficiently in all seasons, with the windows closed.

It allows you:

- in summer, to lower the temperature,
- in winter, above 3 °C, to improve demisting.

Switching on

- ☞ Press the "**A/C**" button, the associated indicator lamp comes on.

The air conditioning cannot operate when the air flow is set to off.

Switching off

- ☞ Press the "**A/C**" button again; the associated indicator lamp goes off. Switching off may cause some problems (humidity, misting).

Air distribution adjustment



☞ Press this button several times in succession to direct the air flow in turn towards:

- the windscreen, the side windows and the footwells,
- the windscreen and side windows (demisting or defrosting),
- the central and side vents,
- the central vents, the side vents and the footwells,
- the footwells.

Air flow adjustment



☞ Press this **"full fan"** button to increase the air flow.

The air flow symbol (a fan) appears in the screen. It is filled in progressively in relation to the value required.



☞ Press this **"empty fan"** button to reduce the air flow.

Air intake/Air recirculation



☞ Press this button to recirculate the interior air. The indicator lamp in the button comes on and the air recirculation symbol is displayed.

Air recirculation prevents exterior odours and fumes from entering the passenger compartment. It is activated automatically when operating the screen wash.

☞ As soon as possible, press this button again to permit the intake of exterior air and prevent misting. The indicator lamp in the button goes off.

! Avoid prolonged operation in interior air recirculation mode (risk of misting and of deterioration of the air quality).

Switching the system off



☞ Press the **"empty fan"** air flow button until the fan symbol disappears and "---" appears.

This action switches off all of the functions of the air conditioning system.

The temperature is no longer maintained at a comfortable level. However, a slight flow of air, due to the movement of the vehicle, can still be felt.

! Avoid driving for too long with the system switched off (risk of misting and of deterioration of the air quality). Pressing the **"full fan"** button reactivates the system with the settings prior to deactivation.

Front demist - defrost



These markings on the control panel indicate the control positions for rapid demisting or defrosting of the windscreen and side windows.

With manual air conditioning

- ☞ Put the air flow, temperature and distribution controls to the dedicated marked position.
- ☞ Press the **"A/C"** button for air conditioning; the indicator lamp in the button comes on.

With dual-zone digital air conditioning

Automatic visibility programme

- ☞ Select this programme to demist or defrost the windscreen and side windows as quickly as possible.

The system automatically manages the air conditioning, air flow and air intake, and provides optimum distribution towards the windscreen and side windows.

- ☞ To stop the programme, press either the **"visibility"** button again or **"AUTO"**, the warning lamp on the button goes off and the warning lamp in the **"AUTO"** button comes on.

The system reverts to the previous settings.

i With Stop & Start, when demisting has been activated, the STOP mode is not available.

Rear screen demist - defrost



The control button is located on the air conditioning system control panel.

Switching on

The rear screen demisting/defrosting can only operate when the engine is running.

- ☞ Press this button to demist/defrost the rear screen and (depending on version) the door mirrors. The indicator lamp associated with the button comes on.

Switching off

The demisting/defrosting switches off automatically to prevent an excessive consumption of current.

- ☞ It is possible to stop the demisting/defrosting operation before it is switched off automatically by pressing the button again. The indicator lamp associated with the button goes off.



- ☞ Switch off the demisting/defrosting of the rear screen and door mirrors as soon as appropriate, as lower current consumption results in reduced fuel consumption.

Interior fittings

1. **Illuminated glove box**
(see details on the following page)
2. **Open storage compartment (depending on equipment)**
3. **12 V accessory socket (120 W)**
Observe the maximum power rating to avoid damaging your accessory.
4. **USB port / Auxiliary socket**
(see details on following pages)
5. **Open storage compartments**
6. **Cup holder**
7. **Closed storage compartment**
8. **Door pockets**

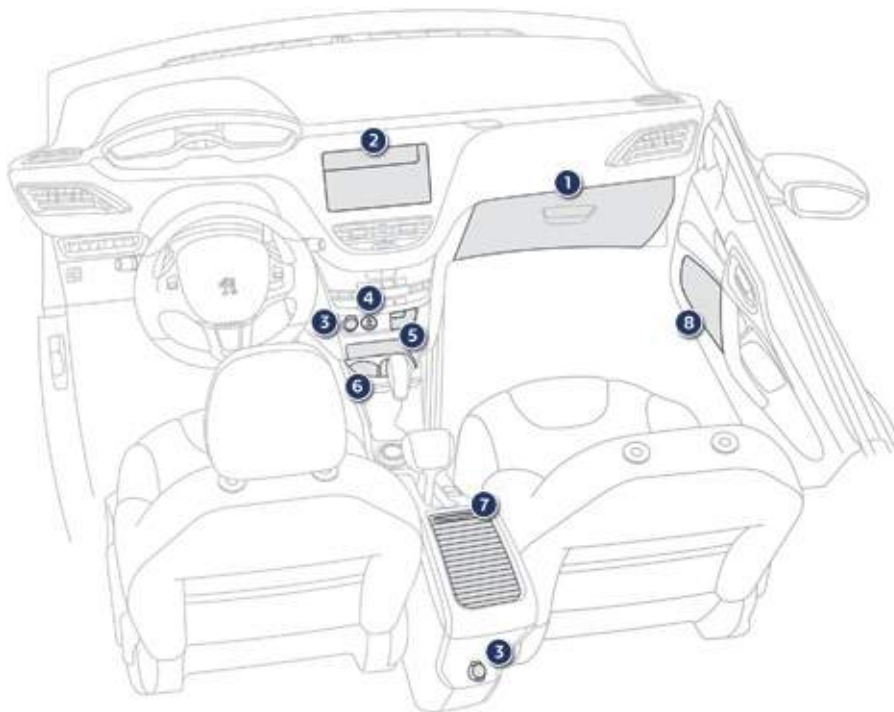

Illuminated glove box

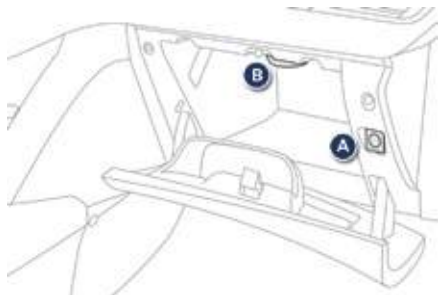

It has dedicated locations for storing a water bottle, the vehicle's handbook pack...

Its lid has locations for a pair of glasses...

☞ To open the glove box, raise the handle.

It is illuminated when the lid is opened (depending on version).

It houses the front passenger airbag deactivation switch **A**.

If the vehicle is fitted with air conditioning, it provides access to the ventilation nozzle **B**, distributing the same conditioned air as the vents in the passenger compartment.

12 V accessory socket



☞ To connect a 12 V accessory (maximum power: 120 Watts), lift the cover and connect a suitable adaptor.

USB port / Jack auxiliary socket



This connection box, consisting of a JACK auxiliary socket and a USB port, is located on the centre console.

It allows the connection of portable device, such as a digital audio player of the iPod® type or a USB memory stick.

It reads the audio files which are transmitted to your audio system and played via the vehicle's speakers.

You can manage these files using the steering mounted controls or the audio system control panel and display them in the instrument panel screen.

When the USB port is used, the portable device charges automatically.

i For more information on the use of this system, refer to the "Audio equipment and telematics" section.

Mats

Removable carpet protection.

Removal



To remove the mat on the driver's side:

- ☞ move the seat as far back as possible,
- ☞ unclip the fixings,
- ☞ remove the mat.

Refitting

To refit the mat on the driver's side:

- ☞ position the mat correctly,
- ☞ refit the fixings by pressing,
- ☞ check that the mat is secured correctly.

! To avoid any risk of jamming of the pedals:

- only use mats which are suited to the fixings already present in the vehicle; these fixings must be used,
- never fit one mat on top of another.

The use of mats not approved by PEUGEOT may interfere with access to the pedals and hinder the operation of the cruise control / speed limiter.

Boot fittings

1. **High load retaining net (depending on version)**
(see following page for details)
2. **Luggage cover**
(see following page for details)
3. **Boot lamp**
4. **Retaining strap**
5. **Stowing rings (depending on version)**
6. **Retaining net**



Rear parcel shelf

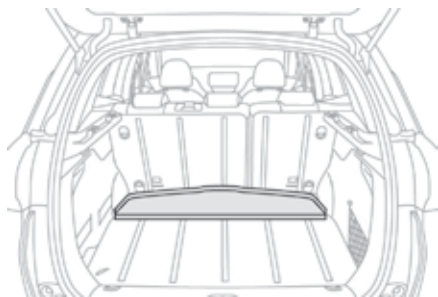

This consists of two sections which can be folded back on each other.
To store it, fold it on itself and place it at the bottom of the boot.

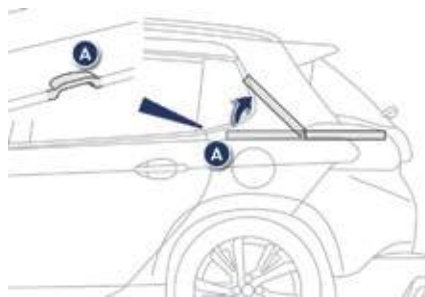

To gain access to the boot from the rear seats:
☞ raise the front section of the rear parcel shelf using the grip **A**.

High load retaining net



Hooked onto the upper fixings and onto the lower rings or the lugs, this permits use of the entire loading volume up to the roof:

- behind the rear seats (row 2),
- behind the front seats (row 1) when the rear seats are folded.

i When positioning the net, check that the strap loops are visible from the boot; this will make slackening or tightening easier.



To use it in row 1:

- ☞ open the covers of the upper fixings 1,
- ☞ unroll the high load retaining net,
- ☞ position one of the ends of the net's metal bar in the corresponding upper fixing 1, then do the same with the other end,
- ☞ slacken the straps fully,
- ☞ fix the snap hook of each of the straps on the corresponding lug 3, located under the bench seat cushion,
- ☞ fold the rear seats,
- ☞ tighten the straps without raising the bench seat,
- ☞ check that the net is hooked and tightened correctly.

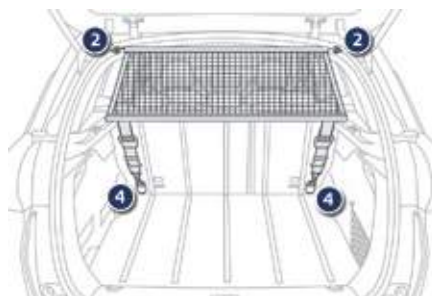

To use it in row 2:

- ☞ fold or remove the load space cover,
- ☞ open the covers of the upper fixings 2,
- ☞ unroll the high load retaining net,
- ☞ position one of the ends of the net's metal bar in the corresponding upper fixing 2, then do the same with the other end,
- ☞ attach the hook of each of the net's straps in the corresponding lower ring 4,
- ☞ tighten the straps,
- ☞ check that the net is hooked and tightened correctly.

! Never use the ISOFIX ring intended for fixing the upper strap of child seat to the Top Tether.

Warning triangle (stowing)

The location for stowing a folded triangle or its box is under the front seat or under the boot carpet (depending on version).

- !** Before leaving your vehicle to set up and install the triangle, put on your high visibility vest.

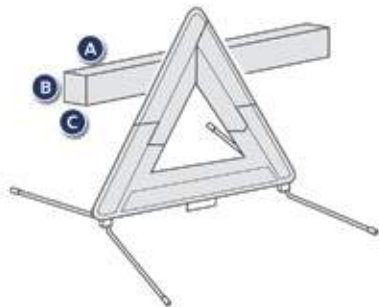

The dimensions of the triangle (once folded) or its storage box must be:

- **A:** length = **438** mm,
- **B:** height = **56** mm,
- **C:** width = **38** mm.

To use the triangle, refer to the manufacturer's instructions.

Placing the triangle in the road

- ☞ Place the triangle at a distance behind the vehicle, as shown in the table below, according to the type of road and the level of ambient light.

i These are the internationally recognised values. Use the triangle in line with local driving regulations.

Distance from your vehicle (in metres)		
Road		Motorway
Day	Night	
50 m	80 m	150 m

The triangle is available as an accessory, contact a PEUGEOT dealer or a qualified workshop.

Starting - Stopping the engine

With a **manual gearbox**, put the gear lever in neutral.

With an **electronic gearbox**, put the gear lever at **N**.

With an **automatic gearbox**, put the gear lever at **P** or **N**.

Starting the engine

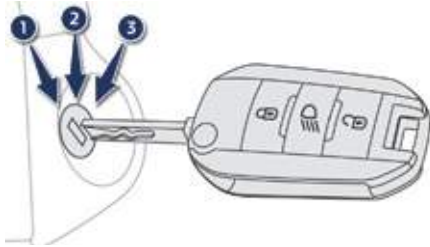

- ☞ Insert the key in the ignition switch. The system recognises the starting code.
- ☞ Turn the key fully towards the dashboard to position **3 (Starting)**.
- ☞ When the engine starts, release the key.

Switching the engine off

- ☞ Immobilise the vehicle.
- ☞ Turn the key fully towards you to position **1 (Stop)**.
- ☞ Remove the key from the ignition switch.

! Free-wheeling

For safety reasons, do not free-wheel. When free-wheeling, some vehicle functions will no longer be active.

! Switching off the engine leads to a loss of braking assistance.

i Avoid attaching heavy objects to the key, which would weigh down on its blade in the ignition switch and could cause a malfunction.

i Key left in the "Ignition on" position

On opening the driver's door, an alert message is displayed, accompanied by an audible signal, to remind you that the key is still in the ignition switch at position **1 (Stop)**.

If the key has been left in the ignition switch at position **2 (Ignition on)**, the ignition will be switched off automatically after one hour. To switch the ignition back on, turn the key to position **1 (Stop)**, then back to position **2 (Ignition on)**.

Manual parking brake



Application

- ☞ Pull the parking brake lever up to immobilise your vehicle.

i On level ground, it is not necessary to make a maximum pull on the parking brake lever.

Release

- ☞ **With the foot brake applied**, pull the parking brake lever up gently, press the trigger, then lower the lever fully.



When the vehicle is being driven, if this warning lamp and the **STOP** warning lamp come on, accompanied by an audible signal and a message in the screen, indicating that the parking brake is still on or has not been fully released.

! When parking on a slope, direct your wheels against the kerb, apply the parking brake, engage a gear and switch off the ignition.

5-speed manual gearbox

Engaging reverse gear



- ☞ Push the gear lever to the right then backwards.

! Only engage reverse gear when the vehicle is stationary with the engine at idle.

- i** As a safety precaution and to facilitate starting of the engine:
 - always select neutral,
 - press the clutch pedal.

6-speed manual gearbox

Engaging 5th or 6th gear

- ☞ Move the lever fully to the right to engage 5th or 6th gear.

Engaging reverse gear



- ☞ Raise the ring under the knob and move the gear lever to the left then forwards.

! Only engage reverse gear when the vehicle is stationary with the engine at idle.

- i** As a safety precaution and to facilitate starting of the engine:
 - always select neutral,
 - press the clutch pedal.

5-speed electronic gearbox

Five-speed electronically controlled gearbox which offers a choice between the comfort of automatic operation or the pleasure of manual gear changing.

Three driving modes are offered:

- **automated** mode for automatic control of the gears by the gearbox, without any action by the driver.
- **manual** mode for sequential changing of the gears by the driver, using the gear lever or the steering mounted control paddles
- **auto sequential** mode for overtaking, for example, remaining in the automated mode while using the functions of the sequential mode.

! Do not drive with your hand resting on the gear lever, as there is a risk of damaging the gearbox.

Gear lever



- R.** Reverse
 - ☞ With your foot on the brake, move the lever forwards to select this position.
- N.** Neutral.
 - ☞ With your foot on the brake, select this position to start the engine.
- A.** Automated mode.
 - ☞ Move the lever backwards to select this mode.
- M. + / -** Manual mode with sequential gear changing.
 - ☞ Move the lever backwards, then to the left to select this mode:
 - push forwards to change up a gear,
 - or push backwards to change down a gear.

Steering mounted controls



- +** Change up paddle.
 - ☞ Press the back of the steering wheel "+" paddle to change up a gear.
- Change down paddle.
 - ☞ Press the back of the steering wheel "-" paddle to change down a gear.

i The steering mounted paddles do not permit the selection of neutral or the engaging and disengaging of reverse gear.

Display in the instrument panel



Gear lever positions

N. Neutral
R. Reverse

1 2 3 4 5. Gears in manual mode

AUTO. This comes on when the automated mode is selected. It switches off on changing to manual mode.



- ☞ Place your **foot on the brake** when this warning lamp flashes (e.g.: starting the engine).

i There is an audible signal on engagement of reverse.

Moving off

- ☞ To start the engine, place the lever in position **N**.
- ☞ Press the brake pedal fully.
- ☞ Start the engine.

i If the engine does not start:



- if **N** is flashing in the instrument panel, move the lever to position **A**, then to position **N**,
- if the "**Foot on the brake**" warning is flashing in the instrument panel, press the brake pedal firmly.

- ☞ Select a mode (position **M** or **A**) or reverse (position **R**)
- ☞ Release the parking brake.
- ☞ Progressively take your foot off the brake pedal, then move off.



AUTO and **1** or **R** appear in the instrument panel.

Stopping - Moving off on a slope

When stopping on a slope, do not use the accelerator to immobilise the vehicle; apply the parking brake.

i When moving off on a slope, accelerate gradually while releasing the parking brake.

Manual mode

- ☞ After starting the vehicle, select position **M** to change to manual mode.



AUTO disappears and the gears engaged appear in succession in the instrument panel.

The gear change commands are only carried out if the engine speed permits.

When driving at low speed, on approaching a stop sign or traffic lights for example, the gearbox changes down to first gear automatically.

Automated mode

- ☞ Following use of the sequential mode, select position **A** to return to the automated mode.



AUTO and the gear engaged appear in the instrument panel.

The gearbox then operates in auto-adaptive mode, without any action on the part of the driver. It continuously selects the most suitable gear for:

- optimisation of fuel consumption,
- the driving style,
- the road conditions,
- the vehicle load.

i For best acceleration, when overtaking another vehicle for example, press the accelerator pedal firmly to pass the point of resistance.

"Auto sequential" mode

In the automated mode, you can resume control temporarily at any time using the steering mounted control paddles.

The use of these paddles permits manual selection of the gears in situations which require a more rapid change-down than in the automated mode (arrival at a roundabout, leaving a car park with a steep gradient, overtaking...).

The gearbox engages the required gear if the engine speed permits. **AUTO** remains displayed on the instrument panel.

After a few moments, the gearbox resumes automatic control of the gears.

Stopping the vehicle

Before switching off the engine, you can change to position **N** to be in neutral.

In this case, you must **apply the parking brake** to immobilise the vehicle.

Reinitialisation

Following disconnection of the battery, the gearbox must be reinitialised.

☞ Switch on the ignition.



AUTO and - appear in the instrument panel.

- ☞ Select position **N**.
- ☞ Press the brake pedal.
- ☞ Wait approximately 30 seconds until **N** or a gear appears in the instrument panel.
- ☞ Release the brake pedal.

The gearbox is operational again.

Operating fault

SERVICE

With the ignition on, if this warning lamp comes on and **AUTO** flashes, accompanied by an audible signal and a message in the screen, this indicates a gearbox fault.

Have it checked by a PEUGEOT dealer or a qualified workshop.



You must press the brake pedal firmly while starting the engine.

Never select neutral **N** while the vehicle is moving.

Only engage reverse gear **R** when the vehicle is immobilised, with your foot on the brake pedal.

In all cases, you must apply the parking brake to immobilise the vehicle.

6-speed electronic gearbox

Six-speed electronically controlled gearbox which offers a choice between the comfort of fully automatic operation or the pleasure of manual gear changing.

There are two driving modes:

- **automated** mode for automatic control of the gears by the gearbox,
- **manual** mode for sequential gear changing by the driver.

In automated mode, it remains possible to change gear manually by using the steering mounted control paddles when required, when overtaking, for example.



Do not drive with your hand resting on the gear lever as there is a risk of damaging the gearbox.

Gear lever



- R. Reverse**
 - ☞ With your foot on the brake, lift the lever and push forwards.
- N. Neutral.**
 - ☞ With your foot on the brake, select this position to start.
- A. Automated mode.**
 - ☞ Move the lever backwards to select this mode.
- M. + / - . Manual mode with sequential gear changing.**
 - ☞ Move the lever to the left to select this mode, then:
 - push it forwards to change up,
 - or pull it backwards to change down.

Steering mounted control paddles



4

- + . Change up paddle.**
 - ☞ Press the back of the "+" steering mounted paddle to change up a gear.
- . Change down paddle.**
 - ☞ Press the back of the "-" steering mounted paddle to change down a gear.



The steering mounted paddles cannot be used to select neutral, or to engage or disengage reverse gear.

Display in the instrument panel



Gear lever positions

N. Neutral

R. Reverse

1 2 3 4 5 6. Gears in manual mode

AUTO. This comes on when the automated mode is selected. It switches off on changing to manual mode.



- ☞ Place your **foot on the brake** when this warning lamp is flashing (for example, when starting the engine).

i Engagement of reverse gear is accompanied by an audible signal.

Moving off

- ☞ To start the engine, place the lever in position **N**.
- ☞ Press the brake pedal down fully.
- ☞ Start the engine.

i If the engine does not start:



- if **N** is flashing in the instrument panel, move the lever to position **A**, then to position **N**,
- if the message "**Foot on the brake**" is displayed, press the brake pedal firmly.

- ☞ Select a mode (position **A** - automated or **M** - manual) or reverse (position **R**).
- ☞ Release the parking brake.
- ☞ Take your foot off the brake pedal, then accelerate.

AUTO and **1**, **1** or **R** appears in the instrument panel screen.

Automated mode

- ☞ After starting the vehicle, select position **A** for enter automated mode.



AUTO and the gear engaged appear in the instrument panel screen.

The gearbox is then operating in auto-active mode, without any action on the part of the driver. It continuously selects the most suitable gear, depending on the:

- style of driving,
- profile of the road.

i For optimum acceleration, for example when overtaking another vehicle, press the accelerator pedal firmly past the point of resistance.

Manual gear changing



This selective gear change mode enables you to overtake, for example, while still remaining in automatic mode.

☞ Operate the **+** or **-** steering mounted control paddle.

The gearbox engages the gear requested if the engine speed permits. **AUTO** is still displayed in the instrument panel.

After a few moments without any action on the controls, the gearbox resumes automatic control of the gears.

Manual mode

- ☞ When the vehicle has moved off, select position **M** to change to manual mode.
- ☞ Pull the lever towards the **+** sign to change up a gear.
- ☞ Push the lever towards the **-** sign to change down a gear.



The gears engaged appear successively in the instrument panel screen.

The gear change requests are only carried out if the engine speed permits.

It is not necessary to release the accelerator during gear changes.

When braking or slowing down, the gearbox changes down automatically to permit acceleration in the correct gear.

i At very low speed, if reverse gear is requested, this will only be taken into account when the vehicle is immobilised. A warning lamp appears in the instrument panel screen.

! On sharp acceleration, the gearbox will not change up unless the driver acts on the gear lever or the steering mounted paddles. Never select neutral **N** while the vehicle is moving. Only engage reverse gear **R** when the vehicle is immobilised with the brake pedal pressed.

Stopping the vehicle

Before switching off the engine, you can choose to:

- move to position **N** to engage neutral,
- leave the gear engaged; in this case, it will not be possible to move the vehicle.

In both cases, you must apply the parking brake to immobilise the vehicle.

! When immobilising the vehicle, with the engine running, you must place the gear lever in neutral **N**.
Before carrying out any work in the engine compartment, check that the gear lever is in neutral **N** and that the parking brake is applied.

Operating fault

SERVICE

With the ignition on, the flashing of this warning lamp and the flashing of **AUTO**, accompanied by an audible signal and a message in the instrument panel screen, indicates a malfunction of the gearbox.
Have it checked by PEUGEOT or a qualified workshop.

! You must press the brake pedal firmly when starting the engine.
Whatever the circumstances, you must manually apply the parking brake to immobilise the vehicle.

Automatic gearbox

Four-speed automatic gearbox which offers a choice between the comfort of fully automatic operation, enhanced by sport and snow programmes, or manual gear changing. There are therefore four driving modes:

- **automatic** operation for electronic management of the gears by the gearbox,
- **sport** programme for a more dynamic style of driving,
- **snow** programme to improve driving when traction is poor,
- **sequential** operation for manual changing of the gears by the driver.

Gear selection gate



1. Gear lever.
2. Button "S" (sport).
3. Button "*" (snow).

Gear lever



- P.** Park.
- Immobilisation of the vehicle, parking brake on or off.
 - Starting the engine.
- R.** Reverse.
- Reversing manoeuvres, vehicle stationary, engine at idle.
- N.** Neutral.
- Immobilisation of the vehicle, parking brake on.
 - Starting the engine.
- D.** Automatic operation.
- M + / -.** Manual operation with sequential changing of the four gears.
- ☞ Push forwards to change up through the gears.
 - or
 - ☞ Pull backwards to change down through the gears.

Displays in the instrument panel



4

When you move the lever in the gate to select a position, the corresponding indicator is displayed in the instrument panel.

- P.** Park
R. Reverse
N. Neutral
D. Drive (Automatic driving)
S. Sport programme
 * **Snow** programme
1 2 3 4. Gears engaged during manual operation
 - Invalid value during manual operation

Foot on brake



- ☞ Press the brake pedal when this indicator lamp is displayed in the instrument panel (e.g.: starting the engine).

Moving off

- ☞ Apply the parking brake.
- ☞ Select position **P** or **N**.
- ☞ Start the engine.

If this procedure is not followed, there is an audible signal, accompanied by the display of an warning message.

- ☞ With the engine running, press the brake pedal.
- ☞ Release the parking brake.
- ☞ Select position **R**, **D** or **M**.
- ☞ Gradually release the brake pedal.

The vehicle moves off immediately.

I If position **N** is selected inadvertently while driving, allow the engine to return to idle then select position **D** to accelerate.

If the ambient temperature is below -23°C, the engine should be left at idle for four minutes, to ensure the correct operation and life of the engine and gearbox.

! When the engine is running at idle, with the brakes released, if position **R**, **D** or **M** is selected, the vehicle moves even without the accelerator being pressed.

When the engine is running, never leave children in the vehicle without supervision.

When carrying out maintenance with the engine running, apply the parking brake and select position **P**.

Automatic operation

- ☞ Select position **D** for **automatic** changing of the four gears.

The gearbox then operates in auto-adaptive mode, without any intervention on the part of the driver. It continuously selects the most suitable gear according to the style of driving, the profile of the road and the load in the vehicle.

For maximum acceleration without touching the gear lever, press the accelerator pedal down fully (kick down). The gearbox changes down automatically or maintains the gear selected until the maximum engine speed is reached. On braking, the gearbox changes down automatically to provide efficient engine braking.

If you release the accelerator sharply, the gearbox will not change to a higher gear for safety reasons.

! Never select position **N** while the vehicle is moving.
Never select positions **P** or **R** unless the vehicle is completely stationary.

Sport and snow programmes

These two special programmes supplement the automatic operation in very specific conditions of use.

Sport programme "S"

☞ Press button "S", after starting the engine. The gearbox automatically favours a dynamic style of driving.



S appears in the instrument panel.

Snow programme "❄"

☞ Press button "❄", after starting the engine.

The gearbox adapts to driving on slippery roads.

This programme improves starting and drive when traction is poor.



❄ appears in the instrument panel.

Return to automatic operation

☞ At any time, press the button selected again to quit the programme engaged and return to auto-adaptive mode.

Manual operation

- ☞ Select position **M** for **sequential** changing of the four gears.
- ☞ Push the lever towards the + sign to change up a gear.
- ☞ Pull the lever towards the - sign to change down a gear.

It is only possible to change from one gear to another if the vehicle speed and engine speed permit; otherwise, the gearbox will operate temporarily in automatic mode.



D disappears and the gears engaged appear in succession in the instrument panel.

If the engine speed is too low or too high, the gear selected flashes for a few seconds, then the actual gear engaged is displayed.

It is possible to change from position **D** (automatic) to position **M** (manual) at any time. When the vehicle is stationary or moving very slowly, the gearbox selects gear **M1** automatically.

The sport and snow programmes do not operate in manual mode.

Invalid value during manual operation



This symbol is displayed if a gear is not engaged correctly (selector between two positions).

Stopping the vehicle

Before switching off the engine, you can engage position **P** or **N** to place the gearbox in neutral.

In both cases, apply the parking brake to immobilise the vehicle.

i If the lever is not in position **P**, when the driver's door is opened or approximately 45 seconds after the ignition is switched off, a warning message appears in the screen.

 Return the lever to position **P**; the message disappears.

When driving on flooded roads or when crossing a ford, proceed at walking pace.

Operating fault

SERVICE When the ignition is on, the lighting of this warning lamp, accompanied by an audible signal and a message in the multifunction screen, indicates a gearbox fault.

In this case, the gearbox switches to back-up mode and is locked in 3rd gear. You may feel a substantial knock when changing from **P** to **R** and from **N** to **R**. This will not cause any damage to the gearbox.

Do not exceed 60 mph (100 km/h), local speed restrictions permitting.

Contact a PEUGEOT dealer or a qualified workshop as soon as possible.

! There is a risk of damage to the gearbox:

- if you press the accelerator and brake pedals at the same time,
- if you force the movement of the gear lever from the **P** position to another position when the battery is flat.

To reduce fuel consumption when at a prolonged standstill with the engine running (traffic jam...), put the gear lever in the **N** position and apply the parking brake.

Gear shift indicator

System which reduces fuel consumption by advising the driver to change up.

Operation

Depending on the driving situation and your vehicle's equipment, the system may advise you to skip one (or more) gear(s). You can follow this instruction without engaging the intermediate gears.

The gear engagement recommendations must not be considered compulsory. In fact, the configuration of the road, the amount of traffic and safety remain determining factors when choosing the best gear. Therefore, the driver remains responsible for deciding whether or not to follow the advice given by the system. This function cannot be deactivated.

i With an electronic or automatic gearbox, the system is only active in manual mode.

Example:



- You are in third gear.

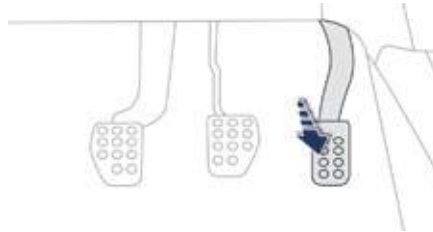

- You press the accelerator pedal.



- The system may suggest that you engage a higher gear.

The information appears in the instrument panel in the form of an arrow.

i On vehicle fitted with a manual gearbox, the arrow may be accompanied by the gear recommended.

i The system adapts its gear change recommendation according to the driving conditions (slope, load, ...) and the demands of the driver (power, acceleration, braking, ...).

The system never suggests:

- engaging first gear,
- engaging reverse gear,
- engaging a lower gear.

Stop & Start

The Stop & Start system puts the engine temporarily into standby - STOP mode - during stops in the traffic (red lights, traffic jams, or other...). The engine restarts automatically - START mode - as soon as you want to move off. The restart takes place instantly, quickly and silently.

Perfect for urban use, the Stop & Start system reduces fuel consumption and exhaust emissions as well as the noise level when stationary.

Operation

Going into engine STOP mode

-  The "ECO" warning lamp comes on in the instrument panel and the engine goes into standby:
- for **e-HDi Diesel engines**:
 - **with a manual gearbox**, at speeds below 12 mph (20 km/h), when you place the gear lever into neutral, and you release the clutch pedal,
 - **with an electronic gearbox**, at speeds below 5 mph (8 km/h), when you press the brake pedal or place the gear lever into position **N**,
 - for **e-VTI and e-THP petrol engines** and **Blue Hdi Diesel engines**, with the vehicle stationary.

 A time counter calculates the sum of the periods in STOP mode during a journey. It rests itself to zero every time the ignition is switched on with the key.

 For your comfort, during parking manoeuvres, STOP mode is not available for a few seconds after coming out of reverse gear. STOP mode does not affect the functionality of the vehicle, such as for example, braking, power steering...

 Never refuel with the engine in STOP mode; you must switch off the ignition with the key.

Special cases: STOP mode not available

STOP mode is not invoked when:

- the driver's door is open,
- the driver's seat belt is not fastened,
- the vehicle has not exceeded 6 mph (10 km/h) since the last engine start using the key,
- the engine is needed to maintain a comfortable temperature in the passenger compartment,
- demisting is active,
- some special conditions (battery charge, engine temperature, braking assistance, ambient temperature...) where the engine is needed to assure control of a system.

 The "ECO" warning lamp flashes for a few seconds then goes off.

This operation is perfectly normal.

Going into engine START mode



The "ECO" warning lamp goes off and the engine starts:

- **with a manual gearbox**, when you depress the clutch pedal,
- **with an electronic gearbox**:
 - gear lever in position **A** or **M**, when you release the brake pedal,
 - or gear lever in position **N** and the brake pedal released, when you place the gear lever into position **A** or **M**,
 - or when you engage reverse gear.

Special cases: START invoked automatically

For reasons of safety and for your comfort, START mode is invoked automatically when:

- you open the driver's door,
- you unfasten the driver's seat belt,
- some special conditions (battery charge, engine temperature, braking assistance, ambient temperature...) where the engine is needed for control of a system.



The "ECO" warning lamp flashes for a few seconds, then goes off.

This operation is perfectly normal.

Deactivation



4

At any time, press the "ECO OFF" switch to deactivate the system.

This is confirmed by the switch warning lamp coming on accompanied by a message in the screen.



If the system has been deactivated in STOP mode, the engine restarts immediately.

Reactivation

Press the "ECO OFF" switch again. The system is active again; this is confirmed by the switch warning lamp going off, accompanied by a message in the screen.

i The system is reactivated automatically at every new start using the key.

Operating fault



In the event of a fault with the system, the "ECO OFF" switch warning lamp flashes then comes on continuously. Have it checked by a PEUGEOT dealer or a qualified workshop. In the event of a fault in STOP mode, the vehicle may stall. All of the warning lamps come on. It is then necessary to switch off the ignition and start the engine again using the key.

Maintenance

! Before doing anything under the bonnet, deactivate the Stop & Start system to avoid any risk of injury resulting from automatic operation of START mode.

This system requires a battery with a special specification and technology (reference numbers available from a PEUGEOT dealer or a qualified workshop). Fitting a battery not listed by PEUGEOT introduces the risk of malfunction of the system.



! The Stop & Start system makes use of advanced technology. All work on this type of battery must be done by a PEUGEOT dealer or a qualified workshop.

Hill start assist

System which keeps your vehicle immobilised temporarily (approximately 2 seconds) when starting on a gradient, the time it takes to move your foot from the brake pedal to the accelerator pedal.

This function is only active when:

- the vehicle is completely stationary, with your foot on the brake pedal,
- when certain conditions of gradient are met,
- with the driver's door closed.

The hill start assist function cannot be deactivated.

Operation

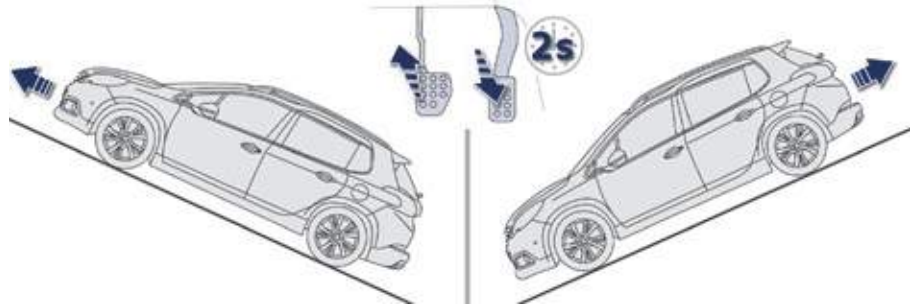

On an ascending slope, the vehicle is held for a brief moment when you release the brake pedal:

- if you are in first gear or neutral with a manual gearbox*,
- if you are in position **A** or **M** with an electronic gearbox,
- if you are in position **D** or **M** with an automatic gearbox.

On a descending slope, with the vehicle stationary and reverse gear engaged, the vehicle is held for a brief moment when you release the brake pedal.

Operating fault



SERVICE

If a fault occurs with the system, these warning lamps come on. Contact a PEUGEOT dealer or a qualified workshop to have the system checked.

! Do not leave the vehicle while it is being held in the hill start assist phase. If you need to leave the vehicle while the engine is running, apply the parking brake manually then ensure that the parking brake warning lamp is on (not flashing) in the instrument panel.

* Depending on version.

Speed limiter

System which prevents the vehicle from exceeding the speed programmed by the driver. When the programmed speed limit is reached, pressing the accelerator pedal in the normal manner no longer has any effect.

The speed limiter is **switched on** manually: the programmed speed must be at least 20 mph (30 km/h).

The speed limiter is **switched off** by manual operation of the control.

The programmed speed can be exceeded temporarily by pressing the accelerator firmly. To return to the programmed speed, simply slow down to a speed below the programmed speed.

The programmed speed remains in the memory when the ignition is switched off.

i The speed limiter cannot, in any circumstances, replace the need to respect speed limits, nor can it replace the need for vigilance on the part of the driver.

Steering mounted controls

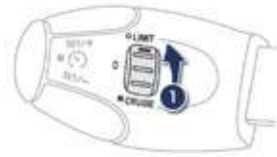

1. Selection of speed limiter mode.

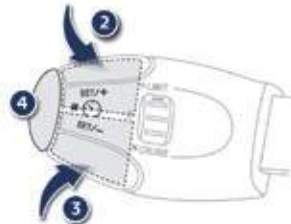

2. Increase the programmed value.
3. Decrease the programmed value.
4. Speed limiter On / Off.

Displays in the instrument panel



The programmed information is grouped together in the instrument panel screen.

5. Speed limiter on/off indication.
6. Speed limiter mode selection indication.
7. Programmed speed value.
8. Selection of a memorised speed setting.

Programming



- ☞ Turn thumb wheel **1** to the "**LIMIT**" position: the speed limiter mode is selected but is not switched on (PAUSE).

You do not have to switch the speed limiter on in order to set the speed.

- ☞ Set the speed value by pressing button **2** or **3**.

You can then change the programmed speed using buttons **2** and **3**:

- by + or - 1 mph (km/h) = short press,
- by + or - 5 mph (km/h) = long press,
- in steps of + or - 5 mph (km/h) = maintained press.

- ☞ Switch the speed limiter on by pressing button **4**.
- ☞ Switch the speed limiter off by pressing button **4**: the display confirms that it has been switched off (PAUSE).
- ☞ Switch the speed limiter back on by pressing button **4** again.

Exceeding the programmed speed

Pressing the accelerator pedal to exceed the programmed speed will not have any effect unless you press the pedal **firmly** past the **point of resistance**.

The speed limiter is deactivated temporarily and the programmed speed, which is still displayed, flashes.

Returning to the programmed speed, by means of intentional or unintentional deceleration of the vehicle, automatically cancels the flashing of the programmed speed.



Leaving limiter mode

- ☞ Turn thumb wheel **1** to the "**0**" position: the speed limiter mode is deselected. The display returns to the distance recorder.

Operating fault



In the event of a speed limiter fault, the speed is cleared resulting in flashing of the dashes. Have it checked by a PEUGEOT dealer or a qualified workshop.

! On a steep descent or in the event of sharp acceleration, the speed limiter will not be able to prevent the vehicle from exceeding the programmed speed.

To avoid any risk of jamming of the pedals:

- ensure that the mat is positioned correctly,
- do not fit one mat on top of another.

Cruise control

System which automatically maintains the speed of the vehicle at the value programmed by the driver, without any action on the accelerator pedal.

The cruise control is **switched on** manually: it requires a minimum vehicle speed of 25 mph (40 km/h), as well as the engagement of:

- fourth gear on a manual gearbox,
- second gear on an electronic or automatic gearbox, in manual sequential mode,
- position **A** on an electronic gearbox or position **D** on an automatic gearbox.

The cruise control is **switched off** manually or by pressing the brake or clutch pedal or on triggering of the electronic stability system for safety reasons.

It is possible to exceed the programmed speed temporarily by pressing the accelerator pedal.

To return to the programmed speed, simply release the accelerator pedal.

Switching off the ignition cancels any programmed speed value.

Steering mounted controls

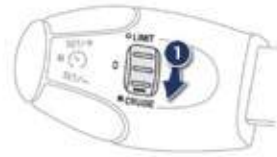

1. Selection of cruise control mode.



2. Increase the programmed value.
3. Decrease the programmed value.
4. Cruise control Off / Resume.

Displays in the instrument panel

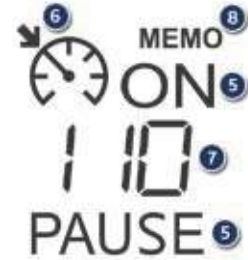

The programmed information is grouped together in the instrument panel screen.

5. Cruise control stopped/resumed indication.
6. Cruise control mode selection indication.
7. Programmed speed value.
8. Selection of a memorised speed setting.

i The cruise control cannot, in any circumstances, replace the need to observe speed limits, nor can it replace the need for vigilance on the part of the driver.

Programming



- ☞ Turn thumb wheel **1** to the "CRUISE" position: the cruise control mode is selected but is not switched on (PAUSE).
- ☞ Set the programmed speed by accelerating to the required speed, then press button **2** or **3**.

You can then change the programmed speed using buttons **2** and **3**:

- by + or - 1 mph (km/h) = short press,
- by + or - 5 mph (km/h) = long press,
- in steps of + or - 5 mph (km/h) = maintained press.

- ☞ Switch off the cruise control by pressing button **4**: the screen confirms that it has been switched off (PAUSE).
- ☞ Switch the cruise control back on by pressing button **4** again.

Exceeding the programmed speed

Intentional or unintentional exceeding of the programmed speed results in flashing of this speed in the screen.

Return to the programmed speed, by means of intentional or unintentional deceleration of the vehicle, automatically cancels the flashing of the speed.

Leaving cruise control mode

- ☞ Turn thumb wheel **1** to the "0" position: the cruise control mode is deselected. The display returns to the distance recorder.



In the event of a cruise control malfunction, the speed is cleared resulting in flashing of the dashes. Have it checked by a PEUGEOT dealer or a qualified workshop.

- !** When the cruise control is switched on, be careful if you maintain the pressure on one of the programmed speed changing buttons: this may result in a very rapid change in the speed of your vehicle.

Do not use the cruise control on slippery roads or in heavy traffic. On a steep descent, the cruise control will not be able to prevent the vehicle from exceeding the programmed speed. To avoid any risk of jamming of the pedals:

- ensure that the mat is positioned correctly,
- never fit one mat on top of another.

4

Memorising speeds

This memorisation of speeds applies to both the speed limiter (speed limit) and the cruise control (running speed).

You can memorise up to 5 speed settings in the system. By default, a few speeds are already memorised.

Memorisation



MENU



- ☞ Go to the main menu by pressing the **"MENU"** button.
- ☞ Select the **"Driving"** menu.
- ☞ In the secondary page, select **"Speed settings"**.
- ☞ Choose the speed you want to modify, then press **"Modify"**.



- ☞ Enter the new value using the virtual key pad and confirm.
- ☞ Confirm to save the modifications and quit the menu.

! For safety reasons, the driver must carry out these operations when stationary.



Use this button to select all speeds.



Use this button to deselect all speeds.



This button restores the factory settings.

Selection

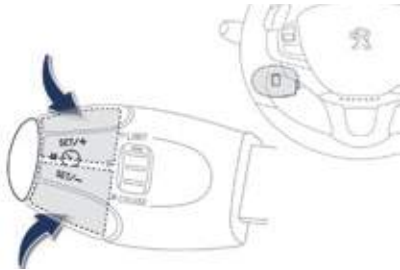

To select a memorised speed:

- ☞ press and hold button "+" or "-"; the system stops at the closest memorised speed,
- ☞ press and hold button "+" or "-" again to select another memorised speed.

A reminder of the speed and the state of the system (on / off) is displayed in the instrument panel.

Parking sensors



This system indicates the proximity of an obstacle (person, vehicle, tree, gate, etc.) which comes within the field of detection of sensors located in the bumper. Certain types of obstacle (stake, roadworks cone, etc.) detected initially will no longer be detected at the end of the manoeuvre due to the presence of blind spots.

! This function cannot, in any circumstances, take the place of the vigilance of the driver.

Rear parking sensors

The system is switched on by engaging reverse gear. This is accompanied by an audible signal. The system is switched off when you come out of reverse gear.



Audible assistance

The proximity information is given by an intermittent audible signal, the frequency of which increases as the vehicle approaches the obstacle. The sound emitted by the speaker (right or left) indicates the side on which the obstacle is located. When the distance between the vehicle and the obstacle becomes less than approximately thirty centimetres, the audible signal becomes continuous.



Visual assistance

This supplements the audible signal by displaying bars in the multifunction screen which move progressively nearer to the vehicle. When the obstacle is near, the "Danger" symbol is displayed in the screen.

Front parking sensors*

In addition to the rear parking sensors, the front parking sensors are triggered when an obstacle is detected in front and the speed of the vehicle is still below 6 mph (10 km/h).

The front parking sensors are interrupted if the vehicle stops for more than three seconds in forward gear, if no further obstacles are detected or when the speed of the vehicle exceeds 6 mph (10 km/h).

The sound emitted by the speaker (front or rear) indicates whether the obstacle is in front or behind.



Deactivation / Activation of the front and rear parking sensors

The function is deactivated by pressing this button. The indicator lamp in the button comes on.

Pressing this button again reactivates the function. The indicator lamp in the button goes off.

i The function will be deactivated automatically if a trailer is being towed or a bicycle carrier is fitted (vehicle fitted with a towbar or bicycle carrier recommended by PEUGEOT).

* Available only with the Park Assist system.

Operating fault

SERVICE

In the event of a malfunction of the system, when reverse gear is engaged this warning lamp is displayed in the instrument panel and/or a message appears in the screen, accompanied by an audible signal (short beep). Contact a PEUGEOT dealer or a qualified workshop.

i In bad weather or in winter, ensure that the sensors are not covered with mud, ice or snow. When reverse gear is engaged, an audible signal (long beep) indicates that the sensors may be dirty. Certain sound sources (motorcycle, lorry, pneumatic drill, etc.) may trigger the audible signals of the parking sensor system.

4

Park Assist

This system provides active assistance with parking, detecting a parking space then controlling the steering to park in the space.

It controls the steering while the driver manages the accelerator, brakes, gears and clutch (manual gearbox). During phases of entry into and exit from a parking space, the system provides visual and audible information to the driver in order to make the manoeuvre safe. It may be necessary to move forwards and backwards more than once.

! The Park Assist system cannot in any circumstances replace the care and responsibility of the driver. The driver must remain in control of their vehicle ensuring that the space remains clear during the manoeuvre. In some circumstances, the sensors may not detect small obstacles located in their blind spots.

! During a manoeuvre the steering wheel turns quickly: do not hold the steering wheel, do not place your hand between the spokes of the steering wheel and take care with loose and bulky clothing, scarves, handbags... There is a risk of injury.

i For entry into a parking space (parallel parking) the system does not detect spaces which are clearly much smaller or larger than the size of the vehicle. This "parking assistance" system is activated automatically during manoeuvres; it is therefore possible that a symbol comes on in the screen, accompanied by an audible signal, without affecting the manoeuvre.

i Changing tyre sizes (out-size tyres, winter tyres, ...) can interfere with the correct operation of the parking assistance system.

i The selection of the type of manoeuvre (entering or exiting a parallel parking space) prevents a change to STOP mode of Stop & Start. In STOP mode, this selection restarts the engine.

The driver can take control at any time by gripping the steering wheel.



The system provides assistance in entering and exiting a parking space when parallel parking.

Entering a parallel parking space

- When you have identified a free space, reduce the speed of the vehicle to a maximum of 12 mph (20 km/h).

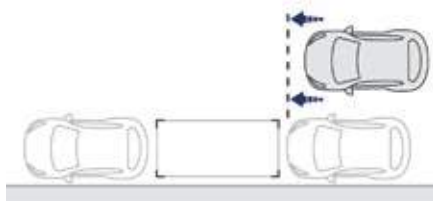

- Position your vehicle before this space.

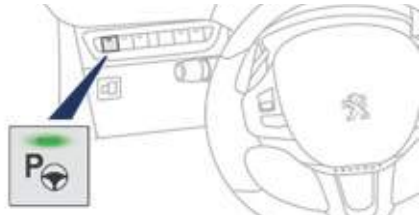

To activate the Park Assist system:

- Press this control to activate the system. The indicator lamp in the control remains off.
- A message is displayed in the screen.
- Select the enter parking space manoeuvre. The indicator lamp in the control comes on.



- Operate the direction indicator on the parking side.



- Move forwards alongside the parking space at a speed below 12 mph (20 km/h) to measure it, keeping at a distance of between 0.5 and 1.5 metres from the row of parked vehicles.

Once measurement is complete, if the space is large enough a message indicates that parking is possible.



- Move your vehicle forward until a new message is displayed.



- Select reverse and release the steering wheel.



The assisted parking manoeuvre is in progress. Without exceeding 5 mph (8 km/h), continue the manoeuvres following the information given by the "parking assistance" system, until the end of manoeuvre message is displayed. The indicator lamp in the control goes off, accompanied by an audible signal.



The driver takes back control of the vehicle's steering.

Exit from a parallel parking space

- When you want to exit from a parallel parking space, start the engine.



With the vehicle stationary, to activate the Park Assist system:

- Press this control.

The indicator lamp in the control remains off.

A message is displayed in the screen.

- Select the exit parking space manoeuvre. The indicator lamp in the control comes on.
- Operate the direction indicator on the exit from parking side. The direction indicator warning lamp flashes in the instrument panel throughout the manoeuvre, whatever the position of the stalk.
- Select a forward or reverse gear then release the steering wheel.



The assisted exit from parking manoeuvre is in progress. Without exceeding 5 mph (8 km/h), continue the manoeuvres following the information given by the "parking assistance" system, until the end of manoeuvre message is displayed. The manoeuvre is complete once the front wheels of the vehicle are out of the parking space. The indicator lamp in the control goes off, accompanied by an audible signal.



The driver takes back control of the vehicle's steering.

Deactivation

The system is deactivated automatically:

- on switching off the ignition,
- if the engine stalls,
- if no manoeuvre is started within 5 minutes of selection of the type of manoeuvre,
- after a prolonged stop of the vehicle during a manoeuvre,
- if the road wheel anti-spin regulation (ASR) is triggered,
- if the speed of the vehicle exceeds the stated limit,
- when the driver interrupts movement of the steering wheel,
- if the driver presses the Park Assist control,
- if correct positioning of the vehicle is not possible (too many manoeuvres needed to insert or extract the vehicle),
- if the driver's door is open,
- if one of the front wheels encounters an obstacle.

! If the system is deactivated during a manoeuvre, the drive should reactivate it manually to repeat the measurement.

A message is displayed in the screen.



The driver then takes back control of the vehicle's steering.

Switching off

The system is switched off automatically:

- when towing a trailer,
- if the driver's door is opened,
- if the speed of the vehicle is above 42 mph (70 km/h).

To switch the system of for a prolonged period, contact a PEUGEOT dealer or a qualified workshop.

Operating faults

SERVICE In the event of a fault with the system, this warning lamp is displayed in the instrument panel and/or a message appears in the screen, accompanied by an audible signal (short beep). The indicator lamp in the control flashes for a few seconds. If the problem occurs while using the system, the indicator lamp goes off.

STOP  In the event of a fault with the power steering, these warning lamps come on in the instrument panel. Contact a PEUGEOT dealer or a qualified workshop.

! If the lateral distance between your vehicle and the space is too great, the system may not be able to measure the space. Anything projecting beyond the envelope of the vehicle (long or wide load) is not taken into account by the Park Assist system during a manoeuvre.

i In bad weather and in winter, ensure that the sensors are not covered by road dirt, ice or snow. In the event of a fault, have the system checked by a PEUGEOT dealer or a qualified workshop.

Lighting controls

System for selection and control of the various front and rear lamps providing the vehicle's lighting and signalling.

Main lighting

The vehicle has various lamps:

- sidelamps, to be seen,
- dipped beam headlamps to see without dazzling other drivers,
- main beam headlamps to see clearly when the road is clear,
- directional headlamps for improved visibility when cornering.

Additional lighting

Other lamps are installed to fulfil the requirements of particular driving conditions:

- a rear foglamp to better signal the presence of the vehicle in foggy conditions,
- front foglamps with cornering lighting,
- daytime running lamps to be seen during the day,
- guide-me-home and welcome lighting for leaving and entering to the vehicle.

Automatic lighting functions

Various automatic lighting functions are also available depending on options:

- guide-me-home lighting,
- cornering lighting,
- welcome lighting,
- daytime running lamps,
- automatic illumination of headlamps.

i In some weather conditions (e.g. low temperature or humidity), the presence of misting on the internal surface of the glass of the headlamps and rear lamps is normal; it disappears after the lamps have been on for a few minutes.

Selection ring for main lighting mode



Turn the ring to position the symbol required facing the mark.

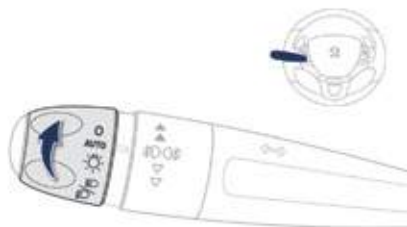

Model without AUTO lighting



Model with AUTO lighting

- O** Lighting off.
- AUTO** Automatic illumination of headlamps.
-  Sidelamps only.
-  Dipped or main beam headlamps.

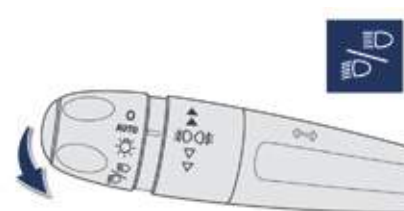

Dipping the headlamps

Pull the stalk to switch the lighting between dipped / main beam headlamps.

In the lighting off and sidelamps modes, the driver can switch on the main beam headlamps temporarily ("headlamp flash") by maintaining a pull on the stalk.

Displays

Illumination of the corresponding indicator lamp in the instrument panel confirms the lighting switched on.

Foglamps selection ring

The foglamps operate with dipped and main beam headlamps.

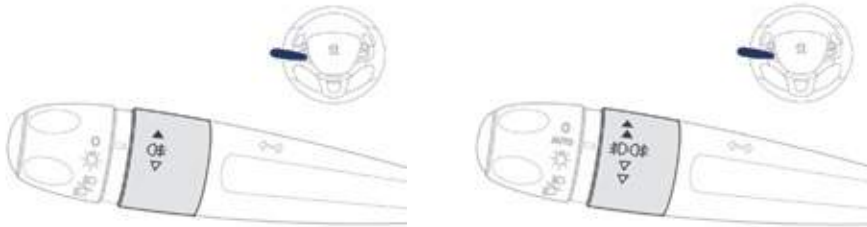

Rear foglamp only

- ☞ To switch it on, turn the ring forwards. When the lighting is switched off automatically (with AUTO model), the foglamp and the dipped beam headlamps will remain on.
- ☞ To switch it off, turn the ring rearwards.

Front foglamps and rear foglamp

- Rotate and release the ring:
- ☞ forwards a first time to switch on the front foglamps,
 - ☞ forwards a second time to switch on the rear foglamp,
 - ☞ rearwards a first time to switch off the rear foglamp,
 - ☞ rearwards a second time to switch of the front fog lamps.

- When the headlamps switch off with automatic illumination of headlamps (AUTO model) or when the dipped beam headlamps are switched off manually, the foglamps and sidelamps remain on.
- ☞ Turn the ring rearwards to switch off the foglamps, the sidelamps will then switch off.

! In good or rainy weather, both day and night, the front foglamps and the rear foglamp are prohibited. In these situations, the power of their beams may dazzle other drivers. They should only be used in fog or snow. In these weather conditions, it is your responsibility to switch on the foglamps and dipped beam headlamps manually as the sunshine sensor may detect sufficient light. Do not forget to switch off the front foglamps and the rear foglamp when they are no longer necessary.

i **Switching off the lamps when the ignition is switched off**

On switching off the ignition, all of the lamps turn off immediately, except for dipped beam if guide-me-home lighting is activated.

i **Switching on the lamps after the ignition is switched off**

To reactivate the lighting control, rotate the ring to the "0" position - lamps off, then to the desired position. On opening the driver's door a temporary audible signal warns the driver that the lighting is on. The lamps, with the exception of the sidelamps, switch off automatically after a maximum duration of thirty minutes to prevent discharging of the battery.

LED lamps

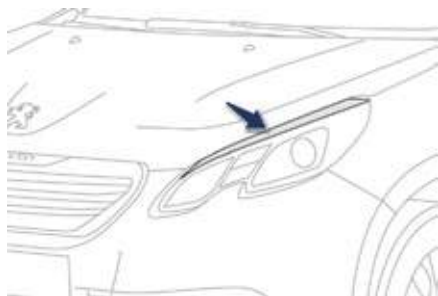

They come on when the engine is started. Depending on the country of sale, they are used for:

- daytime running lamps* in day mode and sidelamps in night mode (they are brighter when daytime running lamps),
- or
- sidelamps in day and night mode.

* Function that can be set in the vehicle configuration menu.

Daytime running lamps

Daytime lighting, compulsory in certain countries, which comes on automatically when the engine is started making the vehicle more visible to other users.

This function is assured:

- in countries where it is imposed by regulations, by illumination of the dipped beam headlamps with the sidelamps and number plate lamps; this function cannot be deactivated.
- for other countries where it is provided, by the use of dedicated lamps (LEDs); this function can be activated or deactivated via the vehicle configuration menu.

The lighting control stalk must be placed in the "0" or "AUTO" (day mode) position.

Deactivation of the daytime running lamps is effective after operation of the lighting control stalk or after the next engine start; activation is effective immediately.

The instruments and controls (instrument panel, multifunction screen, air conditioning control panel, ...) are not illuminated, except in night mode with manual or automatic illumination of headlamps.

Manual guide-me-home lighting

Temporarily keeping the dipped beam headlamps on after the vehicle's ignition has been switched off makes the driver's exit easier when the light is poor.



Switching on

- ☞ With the ignition off, "flash" the headlamps using the lighting stalk.
- ☞ A further "headlamp flash" switches the function off.



Manual guide-me-home lighting is also available from the remote control lighting button (see the "Remote control" section).

Switching off

The manual guide-me-home lighting switches off automatically after a set time.

Parking lamps



5

Side markers for the vehicle by illumination of the sidelamps on the traffic side only.

- ☞ Within one minute of switching off the ignition, operate the lighting control stalk up or down depending on the traffic side (for example: when parking on the left; lighting control stalk upwards; the right hand sidelamps are on).

This is confirmed by an audible signal and illumination of the corresponding direction indicator warning lamp in the instrument panel. To switch off the parking lamps, return the lighting control stalk to the middle position or switch on the ignition.

Automatic illumination of headlamps

The sidelamps and dipped beam headlamps are switched on automatically, without any action on the part of the driver, when a low level of external light is detected or in certain cases of activation of the windscreen wipers.

As soon as the brightness returns to a sufficient level or after the windscreen wipers are switched off, the lamps are switched off automatically.

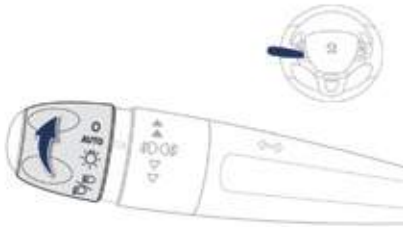

Switching on

- ☞ Turn the ring to the "AUTO" position. Activation of the function is accompanied by a message in the screen.

Switching off

- ☞ Turn the ring to another position. Deactivation of the function is accompanied by a message in the screen.

Automatic guide-me-home lighting

Association with the automatic lighting provides the guide-me-home lighting with the following additional options:

- selection of the lighting duration of 15, 30 or 60 seconds,
- automatic activation of guide-me-home lighting when the automatic illumination of headlamps is in operation.

Programming



The duration of the guide-me-home lighting can be set in the vehicle configuration menu.

Operating fault

SERVICE

In the event of a fault with the sunshine sensor, the lighting comes on, this warning lamp is displayed in the instrument panel and/or a message appears in the screen, accompanied by an audible signal. Contact a PEUGEOT dealer or a qualified workshop.



In fog or snow, the sunshine sensor may detect sufficient light. In this case, the lighting will not come on automatically.

Do not cover the sunshine sensor, coupled with the rain sensor and located in the centre of the windscreen behind the rear view mirror; the associated functions would no longer be controlled.

Headlamp adjustment

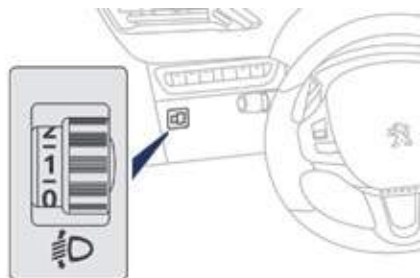

To avoid causing a nuisance to other road users, the headlamp beams should be adjusted according to the load in the vehicle.

- 0.** 1 or 2 people in the front seats.
- Intermediate setting
- 1.** 5 people.
- 5 people + maximum authorised load.
- 2.** Driver + maximum authorised load.

i The initial setting is position "0".

i Travelling abroad

If using your vehicle in a country that drives on the other side of the road, the headlamps must be adjusted to avoid dazzling on-coming drivers. Contact a PEUGEOT dealer or a qualified workshop.

Cornering lighting

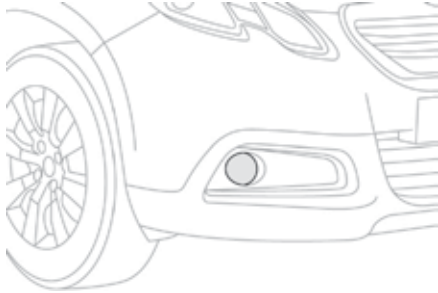

With dipped or main beams, this function makes use of the beam from a front foglamp to illuminate the inside of a bend, when the vehicle speed is below 25 mph (approximately 40 km/h) (urban driving, winding road, intersections, parking manoeuvres...).

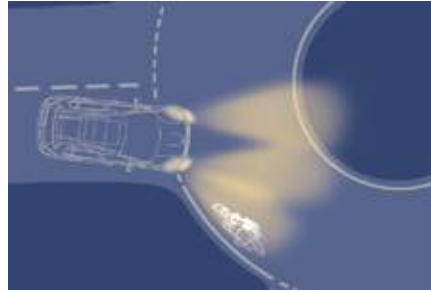

with cornering lighting

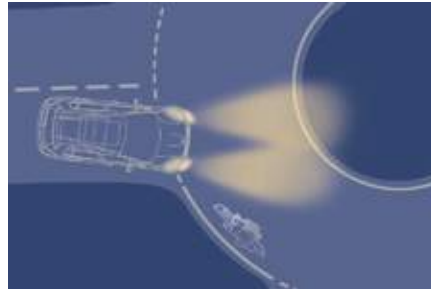

without cornering lighting

Switching on

This function starts:

- when the corresponding direction indicator is switched on,
- or
- from a certain angle of rotation of the steering wheel.

Switching off

The system does not operate:

- below a certain angle of rotation of the steering wheel,
- above 25 mph (40 km/h),
- when reverse gear is engaged.

Wiper controls

The vehicle's front and rear wipers are designed to improve the driver's visibility progressively according to the climatic conditions.

Programming

Various automatic wiper control modes are also available according to the following options:

- automatic rain sensitive windscreen wipers,
- rear wiping on engaging reverse gear.

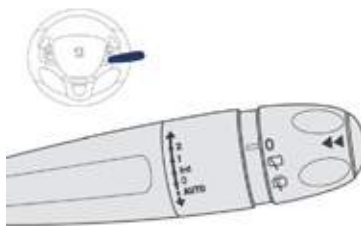

Model with AUTO wiping

Manual controls

The wipers are controlled directly by the driver.

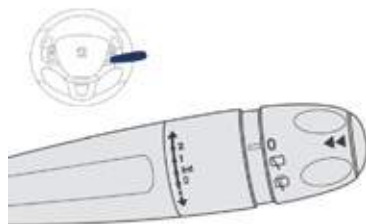

Model without AUTO wiping

Windscreen wipers

Wiping speed:

- 2** fast (heavy rain),
- 1** normal (moderate rain),
- Int** intermittent (proportional to the speed of the vehicle),
- 0** park,
- ↓** single wipe (press down and release),
- AUTO ↓** automatic (press down and release),
single wipe (pull the stalk briefly towards you).

5

Windscreen wash

Pull the wiper stalk towards you. The windscreen wash, then the windscreen wipers, operate for a pre-determined time.

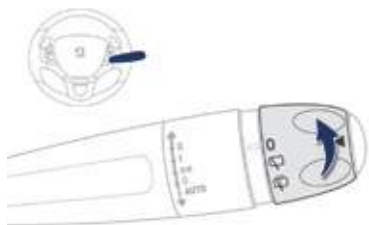

! If a significant accumulation of snow or ice is present, or when using a bicycle carrier on the boot, deactivate the automatic rear wiper via the vehicle configuration menu.

Rear wiper

Rear wiper selection ring:



park,



intermittent wipe,



wash-wipe (set duration).

Reverse gear

When reverse gear is engaged, the rear wiper will come into operation if the windscreen wipers are operating.

Programming



The function is activated or deactivated via the vehicle configuration menu.

This function is activated by default.

Automatic rain sensitive windscreen wipers

The windscreen wipers operate automatically, without any action on the part of the driver, if rain is detected (sensor behind the rear view mirror), adapting their speed to the intensity of the rainfall.

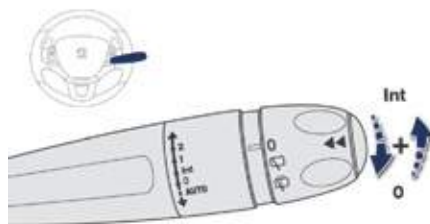
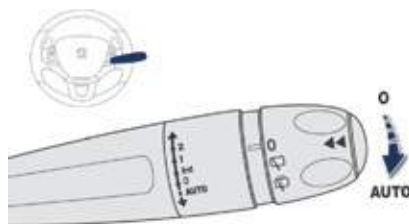

Switching on



Briefly push the control stalk downwards.

This warning lamp comes on in the instrument panel and a message is displayed.

Switching off



Briefly push the control stalk downwards again, or place the control stalk in another position (Int, 1 or 2).

This warning lamp goes off in the instrument panel and a message is displayed.

i The automatic rain sensitive windscreen wipers must be reactivated by pushing the control stalk downwards, if the ignition has been off for more than one minute.

Operating fault

If a fault occurs with the automatic rain sensitive wipers, the wipers will operate in intermittent mode.

Have it checked by PEUGEOT dealer or a qualified workshop.

! Do not cover the rain sensor, linked with the sunshine sensor and located in the centre of the windscreen behind the rear view mirror.

Switch off the automatic rain sensitive wipers when using an automatic car wash. In winter, it is advisable to wait until the windscreen is completely clear of ice before activating the automatic rain sensitive wipers.

Special position of the windscreen wipers



This position permits release of the windscreen wiper blades.

It is used for cleaning or replacement of the blades. It can also be useful, in winter, to detach the blades from the windscreen.

- ☞ Any action on the wiper stalk in the minute after switching off the ignition places the blades vertically on the screen.
- ☞ To park the blades again, switch on the ignition and operate the wiper stalk.

i To maintain the effectiveness of the "flat-blade" type of wiper blades, it is advisable to:

- handle them with care,
- clean them regularly using soapy water,
- avoid using them to retain cardboard on the windscreen,
- replace them at the first signs of wear.

Courtesy lamps



1. Front / rear courtesy lamps
2. Map reading lamps



In this position, the courtesy lamp comes on gradually:

- when the vehicle is unlocked,
- when the key is removed from the ignition,
- when opening a door,
- when the remote control locking button is pressed, in order to locate your vehicle.

It switches off gradually:

- when the vehicle is locked,
- when the ignition is switched on,
- 30 seconds after the last door is closed.



Permanently off.



Permanent lighting.

- i** With the "permanent lighting" mode, the lighting time varies according to the circumstances:
- with the ignition off, approximately ten minutes,
 - in energy economy mode, approximately thirty seconds,
 - with the engine running, unlimited.

Map reading lamps



With the ignition on, press the corresponding switch.



Take care to avoid leaving anything in contact with the courtesy lamp.

Interior mood lighting

The dimmed passenger compartment lighting improves visibility in the vehicle when the light is poor.



Switching on

At night, interior mood light emitting diodes - LEDs (courtesy lamp, instrument panel, footwells, back-lit roof lining, panoramic sunroof*...) come on automatically when the sidelamps are switched on.

Switching off

The interior mood lighting switches off automatically when the sidelamps are switched off.



Settings

The illumination of the back-lit roof lining and panoramic sunroof can be set from the audio system.

* Depending on version.

Direction indicators

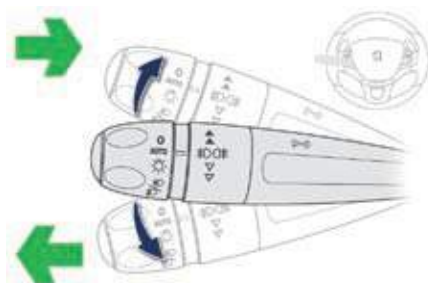

- ☞ Lower the lighting control stalk fully when moving to the left.
- ☞ Raise the lighting control stalk fully when moving to the right.

i If you forget to cancel the direction indicators for more than twenty seconds, the volume of the audible signal will increase if the speed is above 40 mph (60 km/h).

Three flashes

Move the stalk briefly upwards or downwards, without going beyond the point of resistance; the corresponding direction indicators will flash 3 times.

i This function can be used at any speed, but it is particularly useful for changing lane on fast roads.

Hazard warning lamps

A visual warning by means of the direction indicators to alert other road users to a vehicle breakdown, towing or accident.



- ☞ Press this button, the direction indicators flash.
- They can operate with the ignition off.

Automatic operation of hazard warning lamps

When braking in an emergency, depending on the deceleration, the hazard warning lamps come on automatically.

They switch off automatically the first time you accelerate.

- ☞ You can also switch them off by pressing the button.

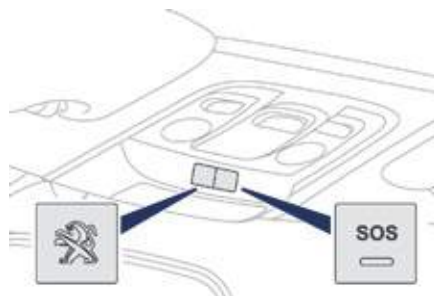

This system allows you to make an emergency or assistance call to the emergency services or to the dedicated PEUGEOT service.

For more information on the use of this function, refer to the "Audio equipment and telematics" section.

Horn

Audible warning system to alert other road users to an imminent danger.

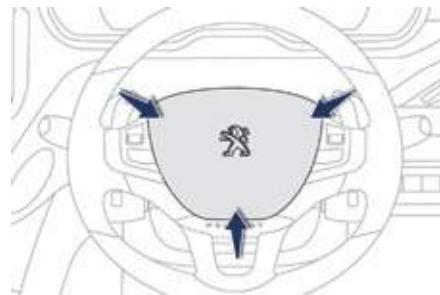

- ☞ Press the central part of the multifunction steering wheel.

i Use the horn moderately and only in situations allowed by the motoring regulations in the country you are driving in.

Tyre under-inflation detection

System which automatically checks the pressure of the tyres while driving.

The system monitors the pressures on the four tyres, once the vehicle is moving.

It compares the information given by the four wheel speed sensors with **reference values, which must be reinitialised every time the tyre pressures are adjusted or a wheel changed.**

The system triggers an alert as soon as it detects a drop in the inflation pressure of one or more tyres.



The under-inflation detection system does not replace the vigilance or the responsibility of the driver.

This system does not avoid the need to check the tyre pressures (including the spare wheel) every month as well as before a long journey.

Driving with under-inflated tyres impairs road holding, extends braking distances and causes premature tyre wear, particularly under arduous condition (high loading, high speed, long journey).



Driving with under-inflated tyres increases fuel consumption.



The inflation pressures defined for your vehicle can be found on the tyre pressure label.

See the "Identification markings" section.

Tyre pressures should be checked when the tyres are "cold" (vehicle stopped for 1 hour or after a journey of less than 6 miles (10 km) at moderate speeds).

Otherwise (when hot), add 0.3 bar to the pressures shown on the label.

Under-inflation alert



This is given by fixed illumination of this warning lamp, accompanied by an audible signal and, depending on equipment, the display of a message.

- ☞ Reduce speed immediately, avoid excessive steering movements and sudden braking
- ☞ Stop the vehicle as soon as it is safe to do so.

! The loss of pressure detected does not always cause visible bulging of the tyre. Do not satisfy yourself with just a visual check.

- ☞ In the event of a puncture, use the temporary puncture repair kit or the spare wheel (depending on equipment),
- or
- ☞ if you have a compressor, such as the one in the temporary puncture repair kit, check the pressures of the four tyres when cold,
- or
- ☞ if it is not possible to make this check immediately, drive carefully at reduced speed.

i The alert is maintained until the system is reinitialised.

Reinitialisation



It is necessary to reinitialise the system every time one or more tyre pressure is adjusted, and after changing one or more wheels. A label attached to the middle pillar, driver's side, gives a reminder of this.

! Before reinitialising the system, ensure that the pressures of the four tyres are correct for the use of the vehicle and in line with the recommendations on the tyre pressure label. The under-inflation detection system does not give a warning if a pressure is incorrect at the time of reinitialisation.

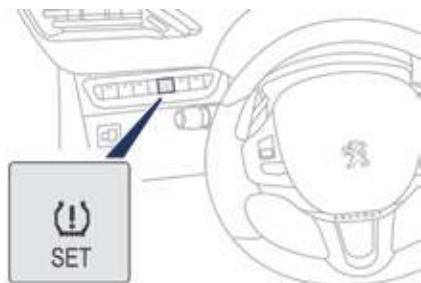

With the ignition on and the vehicle stationary, press this button for about 3 seconds then release it, an audible signal confirms the reinitialisation.

! The under-inflation alert is only dependable if the system has been reinitialised with all four tyres inflated to the correct pressures.

i Snow chains

The system does not have to be reinitialised after fitting or removing snow chains.

Operating fault



The flashing and then fixed illumination of the under-inflation warning lamp accompanied by illumination of the Service warning lamp indicates a fault with the system.

In this case, under-inflation monitoring of the tyres is no longer assured.

Have the system checked by a PEUGEOT dealer or a qualified workshop.

i Before doing anything to the system, the pressures of the four tyres must be checked and the system reinitialised.

Electronic stability control (ESC)

A set of the following Electronic Stability systems:

- anti-lock braking system (ABS) and electronic brake force distribution (EBFD),
- emergency braking assistance,
- wheel anti-slip regulation (ASR) or traction control,
- dynamic stability control (DSC).

Definitions

Anti-lock braking system (ABS) and electronic brake force distribution (EBFD)

These systems improve the stability and manoeuvrability of your vehicle when braking and contribute towards improved control in corners, in particular on poor or slippery road surfaces.

The ABS prevents wheel lock in the event of emergency braking.

The electronic brake force distribution system manages the braking pressure wheel by wheel.

Emergency braking assistance

In an emergency, this system enables you to reach the optimum braking pressure more quickly and therefore reduce the stopping distance.

It is triggered in relation to the speed at which the brake pedal is pressed. This is felt by a reduction in the resistance of the pedal and an increase in the effectiveness of the braking.

Anti-slip regulation (ASR)

This system (also known as Traction Control) optimises traction in order to avoid wheel slip by acting on the brakes of the driving wheels and on the engine. It also improves the directional stability of the vehicle on acceleration.

Dynamic stability control (DSC)

If there is a difference between the path followed by the vehicle and that required by the driver, this system monitors each wheel and automatically acts on the brake of one or more wheels and on the engine to return the vehicle to the required path, within the limits of the laws of physics.

Operation

Anti-lock braking system (ABS) and electronic brake force distribution (EBFD)



When this warning lamp comes on, accompanied by an audible signal and a message, it indicates that there is a fault with the ABS, which could cause loss of control of the vehicle when braking.



When this warning lamp comes on, coupled with the **STOP** warning lamp, accompanied by an audible signal and a message, it indicates that there is a fault with the electronic brake force distribution (EBFD), which could cause loss of control of the vehicle when braking.
You must stop as soon as it is safe to do so. In both cases, contact a PEUGEOT dealer or a qualified workshop.

i When changing wheels (tyres and rims), make sure that these are approved for your vehicle.
Normal operation of the ABS may make itself felt by slight vibrations of the brake pedal.

! **In emergency braking, press very firmly without releasing the pressure.**

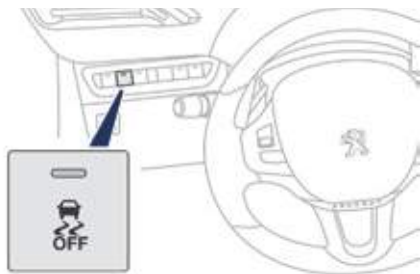

Dynamic stability control (DSC) and anti-slip regulation (ASR)

Activation

These systems are activated automatically each time the vehicle is started. As soon as they detect a problem of grip or trajectory, these systems act on the operation of the engine and brakes.



This is indicated by flashing of this warning lamp in the instrument panel.

Deactivation

In exceptional conditions (starting a vehicle which is bogged down, stuck in snow, on soft ground...), it may be advisable to deactivate the DSC system, so that the wheels can move freely and regain grip.



But it is recommended that the system be reactivated as soon as possible.



☞ Press the button or, depending on version, turn the knob to this position.

The indicator lamp in the button or the knob comes on: the DSC system no longer acts on the operation of the engine.

Reactivation

The system is reactivated automatically each time the ignition is switched back on or from 30 mph (50 km/h).



☞ Press the button again to reactivate it manually.

Operating fault



If this warning lamp comes on, accompanied by an audible signal and a message in the screen, this indicates a fault with the system.

Contact a PEUGEOT dealer or a qualified workshop to have the system checked.

! The DSC system offers exceptional safety in normal driving, but this should not encourage the driver to take extra risks or drive at high speed. The correct operation of the system depends on observation of the manufacturer's recommendations regarding the wheels (tyres and rims), the braking components, the electronic components and the PEUGEOT assembly and operation procedures. After an impact, have the system checked by a PEUGEOT dealer or a qualified workshop.

Grip control

Special patented traction control system which improves traction on snow, mud and sand.

This system, the operation of which has been optimised for each situation, allows you to manoeuvre in most conditions of poor grip (encountered during touring use).

Associated with all-seasons Peak Mountain Snow Flake tyres, this system offers a compromise between safety, adhesion and traction. These tyres work equally well in winter and summer.

The accelerator pedal should be pressed sufficiently to allow the system to use the power of the engine. Operation at high engine speeds is completely normal.

A five-position selector allows you to choose the setting best suited to the driving conditions encountered.

An indicator lamp associated with each mode comes on to confirm your choice.

A specific and additional display appears temporarily in the touch screen to confirm the selection made with the knob.



Standard mode (ESC)

Mode calibrated for a low level of wheel spin, based on the different levels of grip normally encountered on the road.



☞ Place the dial in this position.



Snow mode

Mode which adapts its strategy to the conditions of grip encountered for each of the two front wheels on moving off. (mode active up to 30 mph (50 km/h))



☞ Place the dial in this position.

i Every time the ignition is switched off, the system automatically resets to this mode.



Mud mode

Mode which, when moving off allows considerable spin on the wheel with the least grip to optimise clearing of the mud and regain grip. At the same time, the wheel with the most grip is controlled in such a way as to pass as much torque as possible.

When moving, the system optimises wheel spin to respond to the driver's requirements as fully as possible.

(mode active up to 50 mph (80 km/h))



☞ Place the dial in this position.



Sand mode

Mode which allows little spin on the two driving wheels at the same time to allow the vehicle to move forward and limit the risks of getting stuck in the sand.

(mode active up to 75 mph (120 km/h))



☞ Place the dial in this position.

Do not use the other modes on sand as the vehicle may become stuck.

You can deactivate certain functions of the ESC (ASR and DSC) by turning the dial to the "OFF" position.

These functions are reactivated automatically from 30 mph (50 km/h) or every time the ignition is switched back on.

i Driving advice

Your vehicle is designed principally to drive on tarmac roads but it allows you to drive on other less passable terrain occasionally.

However, it does not permit off-road driving such as:

- crossing and driving on terrain which could damage the underbody or strip away components (fuel pipe, fuel cooler, ...) due to obstacles or stones in particular,
- driving on terrain with steep gradients and poor grip,
- crossing a stream.

Seat belts

Front seat belts



The front seat belts are fitted with a pretensioning and force limiting system. This system improves safety in the front seats in the event of a front or side impact. Depending on the severity of the impact, the pretensioning system instantly tightens the seat belts against the body of the occupants. The pretensioning seat belts are active when the ignition is on. The force limiter reduces the pressure of the seat belt on the chest of the occupant, so improving their protection.



Fastening

- ☞ Pull the strap, then insert the tongue in the buckle.
- ☞ Check that the seat belt is fastened correctly by pulling the strap.

Unfastening

- ☞ Press the red button on the buckle.
- ☞ Guide the seat belt as it reels in.

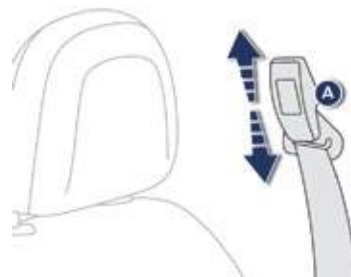

Height adjustment

- ☞ To lower the attachment point, squeeze the control **A** and slide it downwards.
- ☞ To raise the attachment point, slide the control **A** upwards.

Seat belt not fastened / unfastened warning lamp in the instrument panel



When the ignition is switched on, this warning lamp comes on in the instrument panel.

It remains on for a certain time if the front passenger has not fastened their seat belt. After this time, the warning lamp goes off if the driver's seat belt is fastened.

From approximately 12 mph (20 km/h) this warning lamp flashes for two minutes if the driver and/or front passenger has not fastened their seat belt, accompanied by an audible signal of increasing volume. Once these two minutes have elapsed, this warning lamp remains on until the driver and/or the front passenger fastens their seat belt.

Rear seat belts

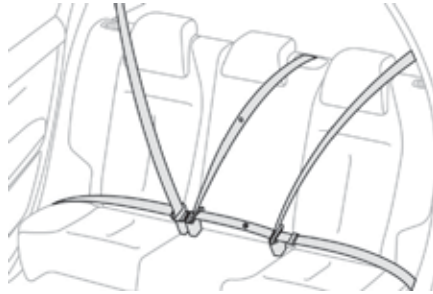

The rear seats are each fitted with a three-point seat belt.

Fastening

- ☞ Pull the strap, then insert the tongue in the buckle.
- ☞ Check that the seat belt is fastened correctly by pulling the strap.

Unfastening

- ☞ Press the red button on the buckle.
- ☞ Guide the seat belt as it reels in.

i The driver must ensure that passengers use the seat belts correctly and that they are all restrained securely before setting off. Wherever you are seated in the vehicle, always fasten your seat belt, even for short journeys.

Do not interchange the seat belt buckles as they will not fulfil their role fully.

The seat belts are fitted with an inertia reel permitting automatic adjustment of the length of the strap to your size. The seat belt is stowed automatically when not in use. Before and after use, ensure that the seat belt is reeled in correctly.

The lower part of the strap must be positioned as low as possible on the pelvis. The upper part must be positioned in the hollow of the shoulder.

The inertia reels are fitted with an automatic locking device which comes into operation in the event of a collision, emergency braking or if the vehicle rolls over. You can release the device by pulling the strap firmly and then releasing it so that it reels in slightly.

In order to be effective, a seat belt must:

- be tightened as close to the body as possible,
- be pulled in front of you with a smooth movement, checking that it does not twist,
- be used to restrain only one person,
- not bear any trace of cuts or fraying,
- not be converted or modified to avoid affecting its performance.

In accordance with current safety regulations, for all repairs on your vehicle's seat belts, go to a qualified workshop with the skills and equipment needed, which a PEUGEOT dealer is able to provide. Have your seat belts checked regularly by a PEUGEOT dealer or a qualified workshop, particularly if the straps show signs of damage.

Clean the seat belt straps with soapy water or a textile cleaning product, sold by PEUGEOT dealers.

After folding or moving a seat or rear bench seat, ensure that the seat belt is positioned and reeled in correctly.

Recommendations for children

Use a suitable child seat if the passenger is less than 12 years old or shorter than one and a half metres.

Never use the same seat belt to secure more than one person.

Never allow a child to travel on your lap.

For more information, refer to the "Child seats" section.

In the event of an impact

Depending on the nature and seriousness of the impact, the pretensioning device may be deployed before and independently of the airbags. Deployment of the pretensioners is accompanied by a slight discharge of harmless smoke and a noise, due to the activation of the pyrotechnic cartridge incorporated in the system.

In all cases, the airbag warning lamp comes on.

Following an impact, have the seat belts system checked, and if necessary replaced, by a PEUGEOT dealer or a qualified workshop.

Airbags

System designed to contribute towards improving the safety of the occupants (with the exception of the rear centre passenger) in the event of violent collisions. The airbags supplement the action of the force-limiting seat belts (with the exception of the centre rear passenger).

If a collision occurs, the electronic detectors record and analyse the front and side impacts sustained in the impact detection zones:

- in the case of a serious impact, the airbags are deployed instantly and contribute towards better protection of the occupants of the vehicle (with the exception of the rear centre passenger); immediately after the impact, the airbags deflate rapidly so that they do not hinder visibility or the exit of the occupants,
- in the case of a minor or rear impact or in certain roll-over conditions, the airbags may not be deployed; the seat belt alone contributes towards ensuring your protection in these situations.

! **The airbags do not operate when the ignition is switched off.**

This equipment will only deploy once. If a second impact occurs (during the same or a subsequent accident), the airbag will not be deployed again.

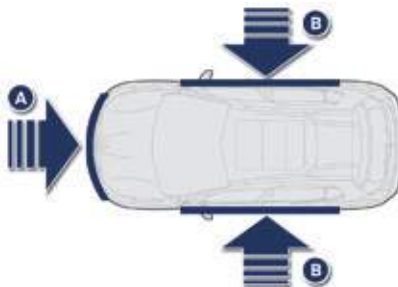

Impact detection zones

- A. Front impact zone.
- B. Side impact zone.

i Deployment of one or more of the airbags is accompanied by a slight emission of smoke and a noise, due to the activation of the pyrotechnic cartridge incorporated in the system. This smoke is not harmful, but sensitive individuals may experience slight irritation. The noise of detonation related to the deployment of one or more airbags may result in a slight loss of hearing for a short time.

Front airbags

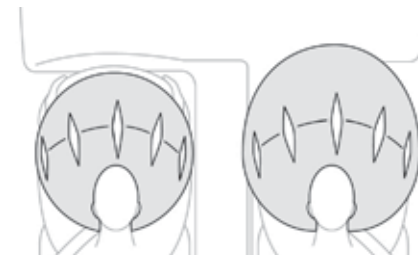

System which protects the driver and front passenger in the event of a serious front impact in order to limit the risk of injury to the head and thorax.

The driver's airbag is fitted in the centre of the steering wheel; the front passenger's airbag is fitted in the dashboard above the glove box.

Deployment

The airbags are deployed, except the passenger's front airbag if it has been deactivated, in the event of a serious front impact to all or part of the front impact zone **A**, in the longitudinal centreline of the vehicle on a horizontal plane and directed from the front to the rear of the vehicle.

The front airbag inflates between the thorax and head of the front occupant of the vehicle and the steering wheel, driver's side, and the dashboard, passenger's side to cushion their forward movement.



Deactivation

Only the passenger's front airbag can be deactivated:

- ☞ **with the ignition off**, insert the key into the passenger airbag deactivation switch,
- ☞ turn it to the **"OFF"** position,
- ☞ then, remove the key keeping the switch in the new position.



This warning lamp comes on in the instrument panel when the ignition is on and until the airbag is reactivated.



To assure the safety of your child, the passenger's front airbag must be deactivated when you install a "rear facing" child seat on the front passenger seat. Otherwise, the child would risk being seriously injured or killed if the airbag were deployed.

Reactivation

When you remove the child seat, **with the ignition on**, turn the switch to the **"ON"** position to reactivate the airbag and so assure the safety of your front passenger in the event of an impact.

Operating fault



If this warning lamp comes on in the instrument panel, accompanied by an audible warning and a message in the screen, contact a PEUGEOT dealer or a qualified workshop to have the system checked. The airbags may no longer be deployed in the event of a serious impact.



If this warning lamp flashes, contact a PEUGEOT dealer or a qualified workshop. The passenger's front airbag may no longer be deployed in the event of a serious impact.



In the event of a fault, identified by the illumination of at least one of the two airbag warning lamps, do not install a passenger (adult or child) at the front. Have it checked by a PEUGEOT dealer or qualified workshop.

Lateral airbags

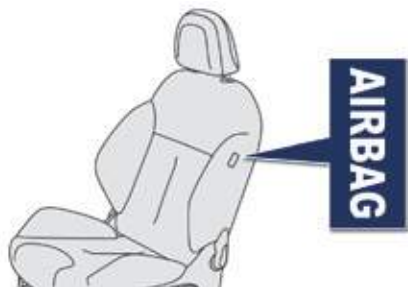

System which protects the driver and front passenger in the event of a serious side impact in order to limit the risk of injury to the chest, between the hip and the shoulder. Each lateral airbag is fitted in the seat backrest frame, door side.

Deployment

A lateral airbag is deployed unilaterally in the event of a serious side impact applied to all or part of the side impact zone **B**, perpendicular to the longitudinal centreline of the vehicle on a horizontal plane and directed from the outside towards the inside of the vehicle.

The lateral airbag inflates between the hip and shoulder of the front occupant of the vehicle and the corresponding door trim panel.

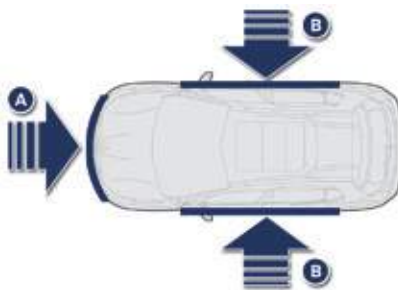

Impact detection zones

- A. Front impact zone.
- B. Side impact zone.

Curtain airbags

System which protects the driver and passengers (with the exception of the rear centre passenger) in the event of a serious side impact in order to limit the risk of injury to the side of the head.

Each curtain airbag is built into the pillars and the upper passenger compartment area.

Deployment

The curtain airbag is deployed at the same time as the corresponding lateral airbag in the event of a serious side impact applied to all or part of the side impact zone **B**, perpendicular to the longitudinal centreline of the vehicle on a horizontal plane and directed from the outside towards the inside of the vehicle.

The curtain airbag inflates between the front or rear occupant of the vehicle and the windows.

Operating fault



If this warning lamp comes on in the instrument panel, accompanied by an audible signal and a message in the screen, contact a PEUGEOT dealer or a qualified workshop to have the system checked. The airbags may no longer be deployed in the event of a serious impact.



In the event of a minor impact or bump on the side of the vehicle or if the vehicle rolls over, the airbag may not be deployed.

In the event of a rear or front collision, the airbag is not deployed.

! For the airbags to be fully effective, observe the following safety rules:

Sit in a normal upright position.

Wear a correctly adjusted seat belt.

Do not leave anything between the occupants and the airbags (a child, pet, object...). This could hamper the operation of the airbags or injure the occupants.

After an accident or if the vehicle has been stolen or broken into, have the airbag systems checked.

All work on the airbag system must be carried out by a PEUGEOT dealer or a qualified workshop.

Even if all of the precautions mentioned are observed, a risk of injury or of minor burns to the head, chest or arms when an airbag is deployed cannot be ruled out. The bag inflates almost instantly (within a few milliseconds) then deflates within the same time discharging the hot gas via openings provided for this purpose.

Front airbags

Do not drive holding the steering wheel by its spokes or resting your hands on the centre part of the wheel.

Passengers must not place their feet on the dashboard.

Do not smoke as deployment of the airbags can cause burns or the risk of injury from a cigarette or pipe.

Never remove or pierce the steering wheel or hit it violently.

Do not fit or attach anything to the steering wheel or dashboard, this could cause injuries with deployment of the airbags.

Lateral airbags

Use only approved covers on the seats, compatible with the deployment the lateral airbags. For information on the range of seat covers suitable for your vehicle, you can contact a PEUGEOT dealer.

Refer to the "Accessories" section.

Do not fix or attach anything to the seat backs (clothing...). This could cause injury to the chest or arms if the lateral airbag is deployed.

Do not sit with the upper part of the body any nearer to the door than necessary.

Curtain airbags

Do not fix or attach anything to the roof. This could cause injury to the head if the curtain airbag is deployed.

If fitted on your vehicle, do not remove the grab handles installed on the roof, they play a part in securing the curtain airbags.

General points relating to child seats

Although one of PEUGEOT main criteria when designing your vehicle, the safety of your children also depends on you.

For maximum safety, please observe the following recommendations:

- in accordance with European regulations, **all children under the age of 12 or less than one and a half metres tall must travel in approved child seats suited to their weight**, on seats fitted with a seat belt or ISOFIX mountings*,
- **statistically, the safest seats in your vehicle for carrying children are the rear seats**,
- **a child weighing less than 9 kg must travel in the "rearward facing" position both in the front and in the rear.**

i PEUGEOT recommends that children should travel in the **outer rear seats** of your vehicle:

- "rearward facing" up to the age of 3,
- "forward facing" over the age of 3.

* The regulations on carrying children are specific to each country. Refer to the legislation in force in your country.

Child seat at the rear

"Rearward facing"

When a "rearward facing" child seat is installed **on a rear passenger seat**, move the vehicle's front seat forwards and straighten the backrest so that the "rearward facing" child seat does not touch the vehicle's front seat.

"Forward facing"

When a "forward facing" child seat is installed **on a rear passenger seat**, move the vehicle's front seat forwards and straighten the backrest so that the legs of the child in the "forward facing" child seat do not touch the vehicle's front seat.

! Ensure that the seat belt is correctly tensioned.
For child seats with a support leg, ensure that this is in firm contact with the floor. If necessary, adjust the front seat of the vehicle.

Child seat in the front*



"Rearward facing"

When a "rearward-facing" child seat is installed on the **front passenger seat**, adjust the seat to:

- the intermediate longitudinal position, with the backrest straightened for a seat without height adjuster,
- the intermediate longitudinal position and highest position, with the backrest straightened for a seat with height adjuster.

The passenger airbag must be deactivated.

Otherwise, **the child would risk being seriously injured or killed if the airbag were to inflate.**



"Forward facing"

When a "forward-facing" child seat is installed on the **front passenger seat**, adjust the vehicle's seat to:

- the intermediate longitudinal position, with the backrest straightened for a seat without height adjuster,
- the intermediate longitudinal position and highest position, with the backrest straightened for a seat with height adjuster.

The passenger's airbag must remain activated.



Passenger seat adjusted to the intermediate longitudinal and highest position.



Ensure that the seat belt is correctly tensioned.

For child seats with a support leg, ensure that this is in steady contact with the floor. If not, adjust the passenger seat.

* Refer to the legislation in your country before installing your child in this seating position.

Deactivating the passenger's front airbag

! Never install a rearward facing child restraint system on a seat protected by an active front airbag. This could cause the death of the child or serious injury.

The warning label present on both sides of the passenger's sun visor repeats this advice. In line with current legislation, the following tables contain this warning in all of the languages required.



Passenger airbag OFF



▶ For information on deactivating the passenger's front airbag, refer to the "Airbags" section.

AR	لا يجب أبداً تركيب نظام لإجلائ الطفل الوجه باتجاه الراء على مقعد سيارة مجهز بوسادة امان هوائية امنية مغلقة، فقد يؤدي هذا إلى التسبب بموت الطفل أو بإصابات خطيرة لديه.
BG	НИКОГА НЕ инсталирайте детско столче на седалка с АКТИВИРАНА предна ВЪЗДУШНА ВЪЗГЛАВНИЦА. Това може да причини СМЪРТ или СЕРИОЗНО НАРАНЯВАНЕ на детето.
CS	NIKDY neumistujte dětské zadržné zařízení orientované směrem dozadu na sedadlo chráněné AKTIVOVANÝM čelním AIRBAGEM. Hrozí nebezpečí SMRTI DÍTĚTE nebo VÁŽNĚHO ZRANĚNÍ.
DA	Brug ALDRIG en bagudvendt barnestol på et sæde, der er beskyttet af en AKTIV AIRBAG. BARNET risikerer at blive ALVORLIGT KVÆSTET eller DRÆBT.
DE	Montieren Sie auf einem Sitz mit AKTIVIERTEM Front-Airbag NIEMALS einen Kindersitz oder eine Babyschale entgegen der Fahrtrichtung, das Kind könnte schwere oder sogar tödliche Verletzungen erleiden.
EL	Μη χρησιμοποιείτε ΠΟΤΕ παιδικό κάθισμα με την πλάτη του προς το εμπρός μέρος του αυτοκινήτου, σε μια θέση που προστατεύεται από ΜΕΤΩΠΙΚΟ αερόσακο που είναι ΕΝΕΡΓΟΣ. Αυτό μπορεί να έχει σαν συνέπεια το ΘΑΝΑΤΟ ή το ΣΟΒΑΡΟ ΤΡΑΥΜΑΤΙΣΜΟ του ΠΑΙΔΙΟΥ
EN	NEVER use a rearward facing child restraint on a seat protected by an ACTIVE AIRBAG in front of it, DEATH or SERIOUS INJURY to the CHILD can occur
ES	NO INSTALAR NUNCA un sistema de retención para niños de espaldas al sentido de la marcha en un asiento protegido mediante un AIRBAG frontal ACTIVADO, ya que podría causar lesiones GRAVES o incluso la MUERTE del niño.
ET	Ärge MITTE KUNAGI paigaldage "seljaga sõidusuunas" lapseistet juhi kõrvalistmele, mille ESITURVAPADI on AKTIVEERITUD. Turvapadja avanemine võib last TÕSISELT või ELUOHTLIKULT vigastada.
FI	ÄLÄ KOSKAAN aseta lapsen turvaistuinta selkää ajosuuntaan istuimelle, jonka edessä suojana on käyttöön aktivoitu TURVATYYNY. Sen laukeaminen voi aiheuttaa LAPSEN KUOLEMAN tai VAKAVAN LOUKKAANTUMISEN.
FR	NE JAMAIS installer de système de retenue pour enfants faisant face vers l'arrière sur un siège protégé par un COUSSIN GONFLABLE frontal ACTIVÉ. Cela peut provoquer la MORT de l'ENFANT ou le BLESSER GRAVEMENT
HR	NIKADA ne postavljati dječju sjedalicu leđima u smjeru vožnje na sjedalo zaštićeno UKLJUČENIM prednjim ZRAČNIM JASTUKOM. To bi moglo uzrokovati SMRT ili TEŠKU OZLJEDU djeteta.
HU	SOHA ne használjon menetiránynak háttal beszerelt gyermekülést AKTIVÁLT (BEKAPCSOLT) FRONTLÉGZSÁKKAL védett ülésen. Ez a gyermek HALÁLÁT vagy SÜLYÖS SÉRÜLÉSÉT okozhatja.
IT	NON installare MAI seggiolini per bambini posizionati in senso contrario a quello di marcia su un sedile protetto da un AIRBAG frontale ATTIVATO. Ciò potrebbe provocare la MORTE o FERITE GRAVI al bambino.
LT	NIEKADA neįrengkite vaiko prilaikymo priemonės su atgal atgrežtu vaiku ant sėdynės, kuri saugoma VEIKIANČIOS priekinės ORO PAGALVĖS. Išsiskleidus oro pagalvei vaikas gali būti MIRTINAI arba SUNKIAI TRAUMUOTAS.
LV	NEKAD NEuzstādiēt uz aizmuguri vērstu bērnu sēdekļi priekšējā pasažiera sēdvietā, kurā ir AKTIVIZĒTS priekšējais DROŠĪBAS GAISA SPILVENS. Tas var izraisīt BĒRNA NĀVI vai radīt NOPIETNUS IEVAINOJUMUS.

MT	Qatt m'ghandek thalli tifel/tifla marbut f'siggu dahru lejn l-Airbag attiva, ghaliex tista' tikkawza korrimment serju jew anke mewt lit-tifel/tifla
NL	Plaats NOOIT een kinderzitje met de rug in de rijrichting op een zitplaats waarvan de AIRBAG is INGESCHAKELD. Bij het afgaan van de airbag kan het KIND LEVENSGEVAARLIJK GEWOND RAKEN
NO	Installer ALDRI et barnesete med ryggen mot kjøretretningen i et sete som er beskyttet med en frontal AKTIVERT KOLLISJONSPUTE, BARNET risikerer å bli DREPT eller HARDT SKADET.
PL	NIGDY nie instalować fotelika dziecięcego w pozycji "tyłem do kierunku jazdy" na siedzeniu wyposażonym w CZOŁOWĄ PODUSZKĘ POWIETRZNA w stanie AKTYWNYM. Może to doprowadzić do ŚMIERCI DZIECKA lub spowodować u niego POWAŻNE OBRAŻENIA CIAŁA.
PT	NUNCA instale um sistema de retenção para crianças de costas para a estrada num banco protegido por um AIRBAG frontal ACTIVADO. Esta instalação poderá provocar FERIMENTOS GRAVES ou a MORTE da CRIANÇA.
RO	Nu instalati NICIODATA un sistem de retinere pentru copii, dispus cu spatele in directia de mers, pe un loc din vehicul protejat cu AIRBAG frontal ACTIVAT. Aceasta ar putea provoca MOARTEA COPILULUI sau RANIREA lui GRAVA.
RU	ВО ВСЕХ СЛУЧАЯХ ЗАПРЕЩАЕТСЯ использовать обращенное назад детское удерживающее устройство на сиденье, защищенном ФУНКЦИОНИРУЮЩЕЙ ПОДУШКОЙ БЕЗОПАСНОСТИ, установленной перед этим сиденьем. Это может привести к ГИБЕЛИ РЕБЕНКА или НАНЕСЕНИЮ ЕМУ СЕРЬЕЗНЫХ ТЕЛЕСНЫХ ПОВРЕЖДЕНИЙ
SK	NIKDY neinštalujte detské zadržné zariadenie orientované smerom dozadu na sedadlo chránené AKTIVOVANÝM čelným AIRBAGOM. Mohlo by dôjsť k SMRTEĽNÉMU alebo VÁŽNEMU PORANENIU DIEŤAŤA.
SL	NIKOLI ne nameščajte otroškega sedeža s hrbtom v smeri vožnje, če je VARNOSTNA BLAZINA pred sprednjim sopotnikovim sedežem AKTIVIRANA. Takšna namestitvev lahko povzroči SMRT OTROKA ali HUDE POŠKODBE.
SR	NIKADA ne koristite dečje sedište koje se okreće unazad na sedištu zaštićenim AKTIVNIM VAZDUŠNIM JASTUKOM ispred njega, jer mogu nastupiti SMRT ili OZBILJNA POVREDA DETETA.
SV	Passagerarkrockkudden fram MÅSTE vara avaktiverad om en bakåtvänd bilbarnstol installerad på denna plats. Annars riskerar barnet att DÖDAS eller SKADAS ALLVARLIGT.
TR	KESİNLİKLE HAVA YASTIĞI AKTİF olan ön koltuğa yüzü arkaya dönük bir çocuk koltuğu yerleştirmeyiniz. Bu ÇOCUĞUN ÖLMESİNE veya ÇOK AĞIR YARALANMASINA sebep olabilir.

Child seats recommended by PEUGEOT

PEUGEOT offers a range of recommended child seats which are secured using a **three point seat belt**.

Group 0+: from birth to 13 kg



L1

"RÖMER Baby-Safe Plus"

Installed in the rearward facing position.

Groups 2 and 3: from 15 to 36 kg



L4

"KLIPPAN Optima"

From 22 kg (approximately 6 years), the booster is used on its own.





L5

"RÖMER KIDFIX"

Can be fitted to the vehicle's ISOFIX mountings.
The child is restrained by the seat belt.

Locations for child seats secured with the seat belt

In accordance with the European regulation, this table indicates the options for the installation of child seats secured using the seat belt and universally approved (a) in relation to the weight of the child and the seat in the vehicle.

Weight of the child / indicative age				
Seat	Less than 13 kg (groups 0 (b) and 0+) Up to 1 year approx	From 9 to 18 kg (group 1) From 1 to 3 years approx	From 15 to 25 kg (group 2) From 3 to 6 years approx	From 22 to 36 kg (group 3) From 6 to 10 years approx
Front passenger seat (c) - with height adjustment  - without height adjustment	U(R) U	U(R) U	U(R) U	U(R) U
Outer rear seats (d) 	U	U	U	U
Centre rear seat 	X	X	X	X

- (a) Universal child seat: child seat which can be installed in all vehicles using the seat belt.
 - (b) Group 0: from birth to 10 kg. Infant car seats and "car cots" cannot be installed on the front passenger seat.
 - (c) Consult the legislation in force in your country before installing your child on this seat.
 - (d) To install a child seat on a rear seat, "rearward facing" or "forward facing", move the front seat forward, then straighten the backrest to allow enough space for the child seat and the child's legs.
- U:** seat suitable for the installation of a child seat secured using the seat belt and universally approved "rearward facing" and/or "forward facing".
- U(R):** as for **U**, the vehicle seat must be adjusted to the highest position and the intermediate longitudinal position.
- X:** seating position not suitable for the installation of a child seat of the weight group indicated.



Remove and stow the head restraint before installing a child seat on a passenger seat.
Refit the head restraint once the child seat has been removed.

Advice on child seats

! The incorrect installation of a child seat in a vehicle compromises the child's protection in the event of an accident.

Ensure that there is no seat belt or seat belt buckle under the child seat, as this could destabilise it.

Remember to fasten the seat belts or the child seat harnesses keeping the slack relative to the child's body to a minimum, even for short journeys.

When installing a child seat using the seat belt, ensure that the seat belt is tightened correctly on the child seat and that it secures the child seat firmly on the seat of your vehicle. If your passenger seat is adjustable, move it forwards if necessary.

At rear seating positions, always leave sufficient space between the front seat and:

- a "rearward facing" child seat,
- the child's feet for a child seat fitted "forward facing".

To do this, move the front seat forwards and, if necessary, move its backrest into the upright position.

For optimum installation of the "forward-facing" child seat, ensure that the back of the child seat is as close as possible to the backrest of the vehicle's seat, in contact if possible.

You must remove the head restraint before installing a child seat with backrest to a passenger seat.

Ensure that the head restraint is stored or attached securely to prevent it from being thrown around the vehicle in the event of sharp braking. Refit the head restraint when the child seat is removed.

Children at the front

The legislation on carrying children on the front passenger seat is specific to each country. Refer to the legislation in force in your country.

Deactivate the passenger airbag when a "rearward-facing" child seat is installed on the front seat.

Otherwise, the child would risk being seriously injured or killed if the airbag were to inflate.

Installing a booster seat

The chest part of the seat belt must be positioned on the child's shoulder without touching the neck.

Ensure that the lap part of the seat belt passes correctly over the child's thighs. PEUGEOT recommends the use of a booster seat which has a back, fitted with a seat belt guide at shoulder level.

As a safety precaution, do not leave:

- a child or children alone and unsupervised in a vehicle,
- a child or an animal in a vehicle which is exposed to the sun, with the windows closed,
- the keys within reach of children inside the vehicle.

To prevent accidental opening of the doors and rear windows, use the "Child lock".

Take care not to open the rear windows by more than one third.

To protect young children from the rays of the sun, fit side blinds on the rear windows.

"ISOFIX" mountings

Your vehicle has been approved in accordance with the **latest ISOFIX regulation**.

The seats, represented below, are fitted with regulation ISOFIX mountings:

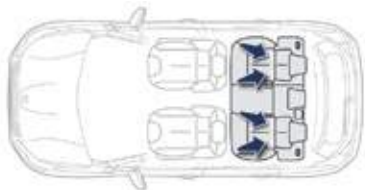

There are three rings for each seat:

- two rings **A**, located between the vehicle seat back and cushion, indicated by a marking,

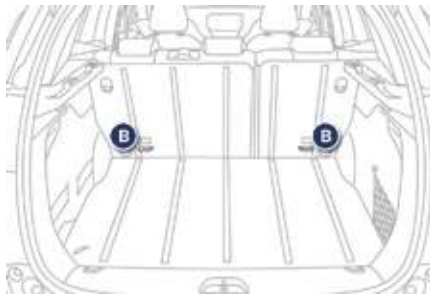

- a ring **B** behind the seat for fixing the upper strap, referred to as the **TOP TETHER**.

The TOP TETHER is used to secure the upper strap of child seats that have one. This arrangement limits the forward tipping of the child seat in the event of a front impact. This ISOFIX mounting system provides fast, reliable and safe fitting of the child seat in your vehicle.

When fitting an ISOFIX child seat to the left hand rear seat, before fitting the seat, first move the centre rear seat belt towards the middle of the vehicle, so as to avoid the seat interfering with the operation of the seat belt.

The **ISOFIX child seats** are fitted with two latches which are secured on the two rings **A**. Some seats also have an **upper strap**, known as the TOP TETHER, which is attached to ring **B**.

To secure the child seat to the TOP TETHER:

- remove and stow the head restraint before installing the child seat in this seating position (refit it once the child seat has been removed),
- pass the strap of the child seat over the top of the seat backrest, centred between the apertures for the head restraint rods,
- fix the hook of the upper strap to the ring **B**,
- tighten the upper strap.

i The incorrect installation of a child seat in a vehicle compromises the child's protection in the event of an accident. Follow the instructions for fitting child seats contained in the seat manufacturer's installation guide.

! For information on the possibilities for installing ISOFIX child seats in your vehicle, refer to the summary table.

ISOFIX child seats recommended by PEUGEOT

"RÖMER Baby-Safe Plus and its Baby-Safe Plus ISOFIX base" (size category: E)

Group 0+: from birth to 13 kg



Installed "rearward facing" using an ISOFIX base which is attached to the rings **A**. The base has a support leg, adjustable for height, which sits on the vehicle's floor. This seat can be secured with a seat belt. In this case, only the shell is used and attached to the vehicle's seat by the three-point seat belt.

Baby P2C Midi and its ISOFIX base (size categories: D, C, A, B, B1)

Group 1: from 9 to 18 kg



Installed "rearward facing" using an ISOFIX base which is attached to the rings **A**. The base has a support leg, adjustable for height, which sits on the vehicle's floor. This child seat can also be used "forward facing". This seat can **not** be secured with a seat belt. We recommend that you use the seat in the "rearward facing" position up to the age of 3 years.

i Follow the instructions for fitting child seats contained in the seat manufacturer's installation guide.

"RÖMER Duo Plus ISOFIX" (size category: **B1**)**Group 1: from 9 to 18 kg**

Installed forward facing

Attached to the rings **A** and the upper ring **B**, referred to as the TOP TETHER, using an upper strap.

Three seat body angles: sitting, reclining, lying down.

This child seat can also be used on seats not equipped with ISOFIX mountings.

In this case, it must be secured to the seat using the three-point seat belt.

FAIR G 0/1 S and its RWF A ISOFIX base (size category **C**)**Group 0+ and 1: from birth to 18 kg**

Installed in the rearward facing position using its ISOFIX base, which is attached to the rings **A**.

6 positions of inclination of the shell.

Use the **RWF** type **A** ISOFIX base.

This child seat can also be used in a forward facing position on seating positions not equipped with ISOFIX mountings.



In this case the shell of the child seat must be attached to the vehicle seat using the three-point seat belt.

i Follow the instructions for fitting child seats contained in the seat manufacturer's installation guide.

Locations for ISOFIX child seats

In accordance with European Regulations, this table indicates the options for installing ISOFIX child seats on seats in the vehicle fitted with ISOFIX mountings.

In the case of universal and semi-universal ISOFIX child seats, the ISOFIX size category, determined by a letter from **A** to **G**, is indicated on the child seat next to the ISOFIX logo.

	Weight of the child / indicative age									
	Less than 10 kg (group 0) Up to approx. 6 months		Less than 10 kg (group 0) Less than 13 kg (group 0+) Up to approx. 1 year			From 9 to 18 kg (group 1) From approx. 1 to 3 years				
Type of ISOFIX child seat	Infant car seat		"rearward facing"			"rearward facing"		"forward facing"		
ISOFIX size category	F	G	C	D	E	C	D	A	B	B1
Front passenger seat 	Not ISOFIX									
Outer rear seats 	X		IL-SU*	IL-SU	IL-SU*	IL-SU	IUF IL-SU			
Centre rear seat 	Not ISOFIX									

IUF: seat suitable for the installation of an Isofix **U**niversal seat, "Forward facing" secured using the upper strap.

IL-SU: seat suitable for the installation of an Isofix **S**emi-**U**niversal seat either:

- "rear facing" fitted with an upper strap or a support leg,
- "forward facing" fitted with a support leg,
- an infant car seat fitted with an upper strap or a support leg.

For advice on securing of the upper strap, refer to the paragraph "ISOFIX mountings".

X: seat not suitable for the installation of a child seat for the weight group indicated.

* Vehicle seat in a particular position: move the passenger seat forward.

! Remove and stow the head restraint before installing a child seat on a passenger seat. Refit the head restraint once the child seat has been removed.

Manual child lock

Mechanical system to prevent opening of the rear door using its interior lever.

The control is located on the edge of each rear door.

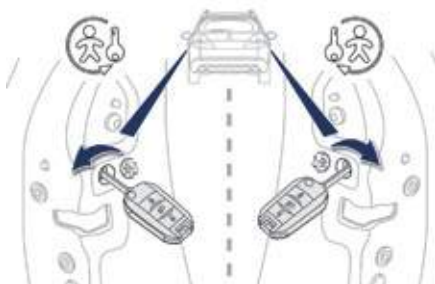

Locking

- ☞ Using the ignition key, turn the red control as far as it will go:
 - to the left on the left-hand rear door,
 - to the right on the right-hand rear door.

Unlocking

- ☞ Using the ignition key, turn the red control as far as it will go:
 - to the right on the left-hand rear door,
 - to the left on the right-hand rear door.

Electric child lock

Remote control system to prevent opening of the rear doors using their interior controls.



Switching on

- ☞ With the ignition on, press this button. The indicator lamp in the button comes on, accompanied by a message to confirm that the child lock is on. This indicator lamp remains on until the child lock is switched off. It is still possible to open the doors from the outside and operate the rear electric windows from the driver's control panel.

Switching off

- ☞ With the ignition on, press this button again. The indicator lamp in the button goes off, accompanied by a message to confirm that the child lock is off. This indicator lamp remains off while the child lock is switched off.

! Any other status of the indicator lamp indicates a fault with the electric child lock. Have it checked by a PEUGEOT dealer or a qualified workshop.

! This system is independent and in no circumstances does it take the place of the central locking control. Check the status of the child lock each time you switch on the ignition. Always remove the key from the ignition when leaving the vehicle, even for a short time.

Temporary puncture repair kit

Complete system consisting of a compressor and a sealant cartridge which permits **temporary repair** of a tyre so that you can drive to the nearest garage.

It is designed to repair most punctures which could affect the tyre, located on the tyre tread or shoulder.

Access to the kit

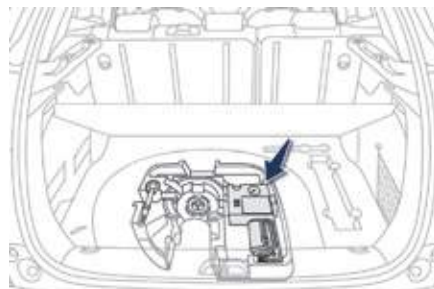

This kit is installed in the storage box, under the boot floor.

i The vehicle's electric system allows the connection of a compressor for long enough to inflate a tyre after a puncture repair or for inflating a small inflatable accessory.

Composition of the kit

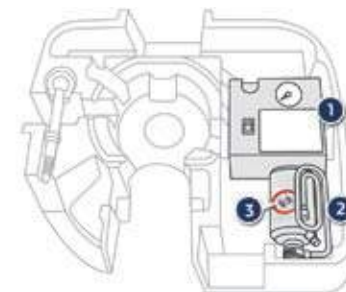

1. 12 V compressor, with integral pressure gauge.
2. Sealant cartridge, with integral hose.
3. Speed limit sticker.

i The speed limit sticker must be secured to the interior of the vehicle in the driver's field of vision, to remind you that a wheel is in temporary use.

! Do not exceed a speed of 50 mph (80 km/h) when driving with a tyre repaired using this type of kit.

Repair procedure



- ☞ Switch off the ignition.
- ☞ Secure the speed limit sticker inside the vehicle.

i Avoid removing any foreign bodies which have penetrated into the tyre.



- ☞ Uncoil the pipe stowed under the compressor.
- ☞ Connect the pipe from the compressor to the sealant cartridge.
- ☞ Turn the the sealant cartridge and secure it in the cut-out provided on the compressor.

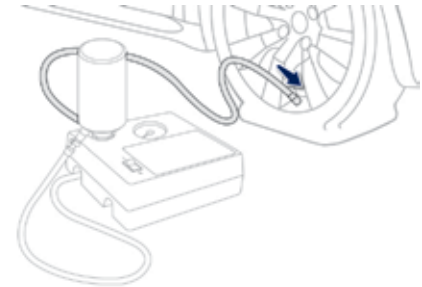

- ☞ Remove the valve cap from the tyre to be repaired, and place it in a clean area.
- ☞ Connect the hose from the sealant cartridge to the valve of the tyre to be repaired and tighten firmly.

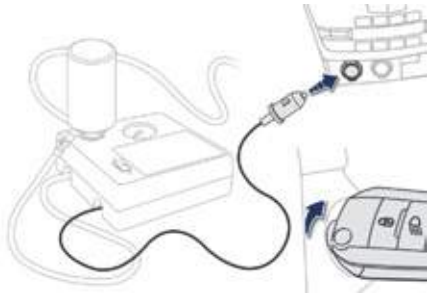

- ☞ Check that the compressor switch is at the "0" position).
- ☞ Uncoil fully the electric cable, stowed under the compressor.
- ☞ Connect compressor's plug to the vehicle's 12 V socket.
- ☞ Switch on the ignition.

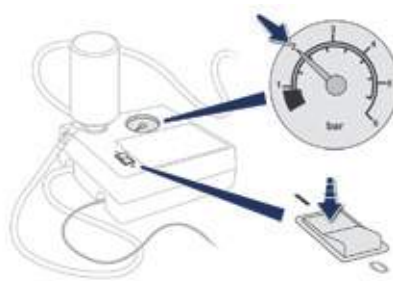

- ☞ Start the compressor by placing the switch at the "I" position and leave it running until the tyre pressure reaches 2.0 bar. The sealant product is injected into the tyre under pressure; do not disconnect the pipe from the valve during this operation (risk of splashing and stains).

i If after around 5 to 7 minutes the pressure is not attained, this indicates that the tyre is not repairable; contact a PEUGEOT dealer or a qualified workshop for assistance.

! Take care, the sealant product is harmful (e.g. ethylene-glycol, colophony...) if swallowed and causes irritation to the eyes. Keep this product out of the reach of children. The use-by date is marked on the cartridge. After use, do not discard the cartridge by the roadside, take it to a PEUGEOT dealer or an authorised waste disposal site. Don't forget to obtain a new sealant cartridge, available from a PEUGEOT dealer or a qualified workshop.

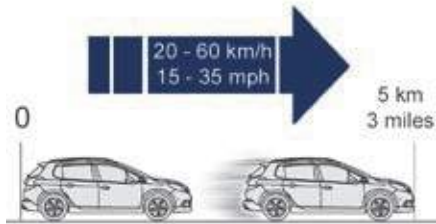

- ☞ Place the switch in the "O" position.
- ☞ Remove the kit.
- ☞ Drive immediately for approximately three miles (five kilometres), at reduced speed (between 15 and 35 mph (20 and 60 km/h)), to plug the puncture.
- ☞ Stop to check the repair and the tyre pressure using the kit.

Checking / adjusting tyre pressures

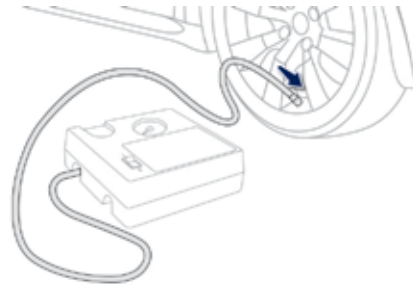

You can also use the compressor, without injecting sealant, to check and if necessary adjust the tyre pressures

- ☞ Remove the valve cap from the tyre and place it in a clean area.
- ☞ Uncoil the pipe stowed under the compressor.
- ☞ Screw the pipe onto the valve and tighten firmly.

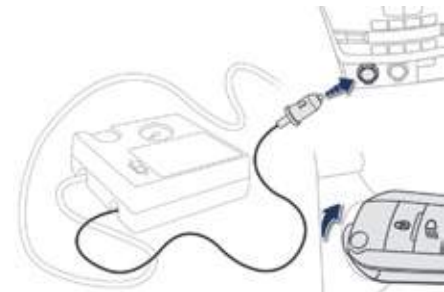

- ☞ Check that the compressor switch is at the "O" position.
- ☞ Uncoil fully the electric cable, stowed under the compressor.
- ☞ Connect compressor's plug to the vehicle's 12 V socket.
- ☞ Switch on the ignition.

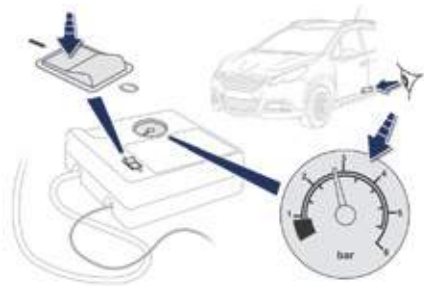

- ☞ Start the compressor by placing the switch at the "I" position and adjust the pressure to the value shown on the vehicle's tyre pressure label.
To deflate: press the black button on the compressor pipe, at the valve connector.
- ☞ Once the correct pressure is reached, put the switch to the "O" position.
- ☞ Remove the kit then stow it.

i Tyre under-inflation detection

After repair of the tyre, the warning lamp will remain on until the system is reinitialised.

For more information, refer to the "Under-inflation detection" section.

- !** Should the pressure of one or more tyres be adjusted, it is necessary to reinitialise the under-inflation detection system.
Refer to the "Under-inflation detection" section.

Changing a wheel

Procedure for changing a faulty wheel for the spare wheel using the tools provided with the vehicle.

Access to the tools

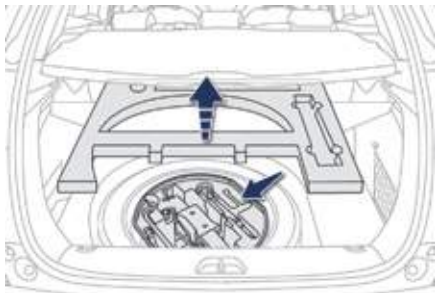

The tools are installed in the boot under the floor.

To gain access to them:

- ☞ open the boot,
- ☞ lift the floor and remove it.
- ☞ remove the polystyrene spacer,
- ☞ remove the carrier box containing the tools.

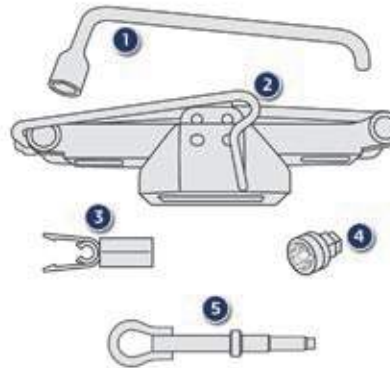

List of tools*

All of these tools are specific to your vehicle and can vary according to the level of equipment. Do not use them for other purposes.

1. Wheelbrace.
For removing the wheel trim and removing the wheel bolts.
2. Jack with integral handle.
For raising the vehicle.

3. "Bolt cover" tool.
For removing the bolt protectors (covers) on alloy wheels.
4. Socket for the security bolts (located in the glove box).
For adapting the wheelbrace to the special "security" bolts.
5. Removable towing eye.

For more information on the removable towing eye, refer to the "Towing the vehicle" section.

* Depending on country of sale.

i Wheel with trim

When refitting the wheel, refit the trim starting by placing its notch facing the valve and press around its edge with the palm of your hand.

Access to the spare wheel*

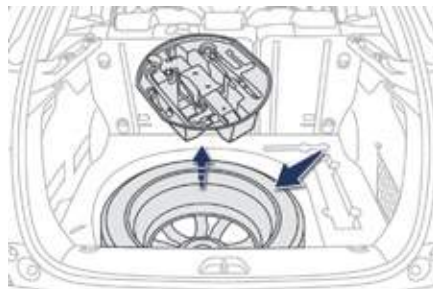

The spare wheel is installed in the boot under the floor.

It is the "space-saver" type.

To gain access to it, refer to the paragraph "Access to the tools" on the previous page.



Taking out the wheel

- ⌘ Unscrew the yellow central bolt.
- ⌘ Raise the spare wheel towards you from the rear.
- ⌘ Take the wheel out of the boot.

* Depending on country of sale.

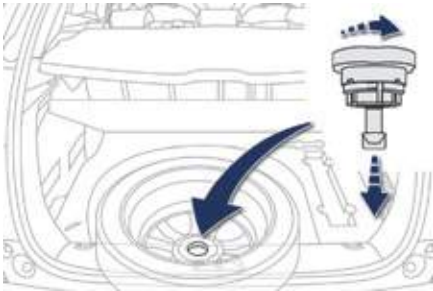

Putting the wheel back in place

- ☞ Put the wheel back in its housing.
- ☞ Unscrew the yellow central bolt by a few turns then put it in place in the centre of the wheel.
- ☞ Tighten fully until the central bolt clicks to retain the wheel correctly.

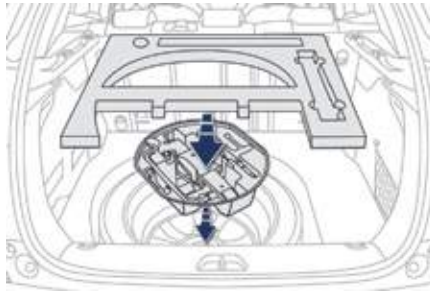

- ☞ Put the box back in the centre of the wheel and clip it in place.
- ☞ Refit the polystyrene spacer to restrain the housing.

Removing a wheel

i Parking the vehicle

Immobilise the vehicle where it does not block traffic: the ground must be level, stable and not slippery.

Apply the parking brake, switch off the ignition and engage first gear* to block the wheels.

Check that the parking brake warning lamps in the instrument panel come on.

The occupants must get out of the vehicle and wait where they are safe.

Never go underneath a vehicle raised using a jack; use an axle stand.

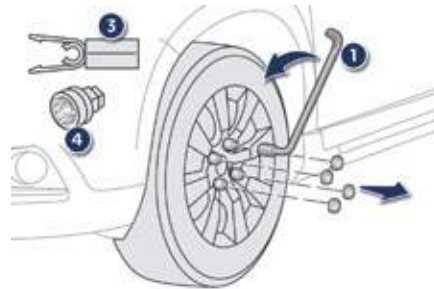

List of operations

- ☞ Remove the bolt cover from each of the bolts using the tool 3 (according to equipment).
- ☞ Fit the security socket 4 on the wheelbrace 1 to slacken the security bolt (if fitted).
- ☞ Slacken the other bolts using the wheelbrace 1 only.



- ☞ Place the foot of the jack 2 on the ground and ensure that it is directly below the front **A** or rear **B** location provided on the underbody, whichever is closest to the wheel to be changed.

* position **R** for an electronic gearbox; **P** for an automatic gearbox.

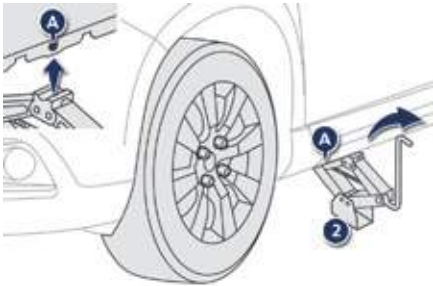

- ☞ Extend the jack **2** until it comes into contact with the location **A** or **B** used; the contact surface **A** or **B** on the vehicle must be inserted into the central part of the head of the jack.
- ☞ Raise the vehicle until there is sufficient space between the wheel and the ground to admit the spare (not punctured) wheel easily.

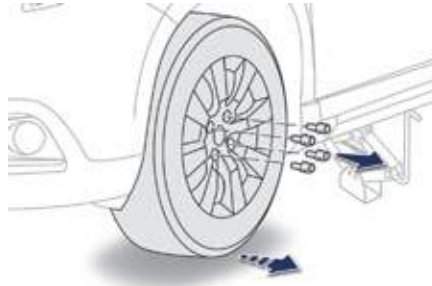

- ☞ Remove the bolts and store them in a clean place.
- ☞ Remove the wheel.

! Ensure that the jack is stable. If the surface is slippery or loose, the jack may slip or drop - Risk of injury!
 Take care to position the jack only at the location **A** or **B** under the vehicle, ensuring that the contact surface on the vehicle is well centred on the head of the jack. Otherwise there is a risk of damage to the vehicle and/or of the jack dropping - Risk of injury!

Fitting a wheel



i Fitting the "space-saver" spare wheel

If your vehicle is fitted with alloy wheels, when tightening the bolts on fitting, it is normal to notice that the washers do not come into contact with the "space-saver" spare wheel. The wheel is secured by the conical surface of each bolt.

After changing a wheel

To store the punctured wheel in the boot correctly, first remove the central cover.

When using the "space-saver" type spare wheel, do not exceed 50 mph (80 km/h).

Have the tightening of the bolts and the pressure of the spare wheel checked by a PEUGEOT dealer or a qualified workshop without delay.

Have the punctured wheel repaired and refitted to the vehicle as soon as possible.

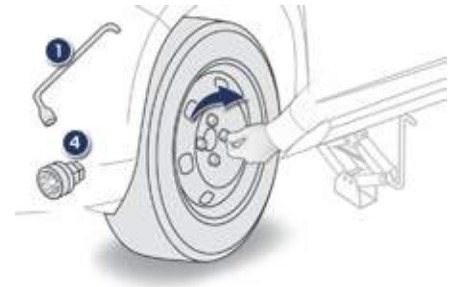

List of operations

- ☞ Put the wheel in place on the hub.
- ☞ Screw in the bolts fully by hand.
- ☞ Pre-tighten the security bolt using the wheelbrace **1** fitted with the security socket **4** (if your vehicle has them).
- ☞ Pre-tighten the other bolts using the wheelbrace **1** only.



- ☞ Lower the vehicle fully.
- ☞ Fold the jack **2** and detach it.

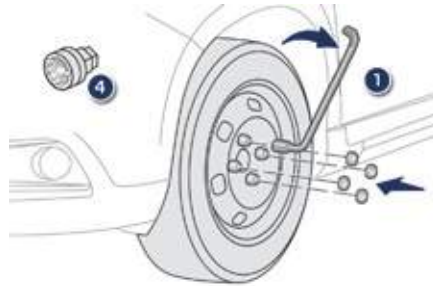

- ☞ Tighten the security bolt using the wheelbrace **1** fitted with the security socket **4** (if your vehicle has them).
- ☞ Tighten the other bolts using the wheelbrace **1** only.
- ☞ Refit the bolt covers on each of the bolts (according to equipment).
- ☞ Store the tools in the box.

Snow chains

In wintry conditions, snow chains improve traction as well as the behaviour of the vehicle when braking.

i The snow chains must be fitted only to the front wheels. They must never be fitted to "space-saver" type spare wheels.





Use only the chains designed to be fitted to the type of wheel fitted to your vehicle:

Original tyre size	Maximum link size.
195/65 R15	9 mm
195/60 R16	
205/55 R16	
205/50 R17	

For more information on snow chains, contact a PEUGEOT dealer or a qualified workshop.

i Take account of the legislation in force in your country on the use of snow chains and the maximum running speed authorised.

Advice on installation

-  If you have to fit the chains during a journey, stop the vehicle on a flat surface on the side of the road.
-  Apply the parking brake and position any wheel chocks to prevent movement of your vehicle.
-  Fit the chains following the instructions provided by the manufacturer.
-  Move off gently and drive for a few moments, without exceeding 30 mph (50 km/h).
-  Stop your vehicle and check that the snow chains are correctly tightened.

i Avoid driving with snow chains on roads that have been cleared of snow, to avoid damaging your vehicle's tyres and the road surface. It is recommended that before you leave, you practise fitting the snow chains on a level and dry surface. If your vehicle is fitted with alloy wheels, check that no part of the chain or its fixings is in contact with the wheel rim.

Changing a bulb

- !** The headlamps are fitted with polycarbonate glass with a protective coating:
- ☞ **do not clean them using a dry or abrasive cloth, nor with a detergent or solvent product,**
 - ☞ use a sponge and soapy water or a pH neutral product,
 - ☞ when using a high pressure washer on persistent marks, do not keep the lance directed towards the lamps or their edges for too long, so as not to damage their protective coating and seals.

- i** Changing a bulb should only be done after the headlamp has been switched off for several minutes (risk of serious burns).
- ☞ Do not touch the bulb directly with your fingers, use a lint-free cloth.
- It is imperative to use only anti-ultraviolet (UV) type bulbs to avoid damaging the headlamp.
- Always replace a failed bulb with a new bulb with the same type and specification.

Front lamps

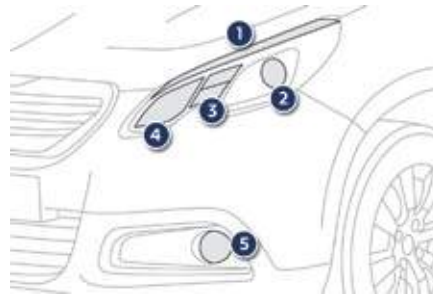

1. **Daytime running lamps / sidelamps (light emitting diodes - LEDs).**
2. **Dipped beam headlamps (H7-55W).**
3. **Direction indicators (PWY-24W).**
4. **Main beam headlamps (H7-55W).**
5. **Front foglamps (with "cornering lighting" function according to version) (PSX-24W).**

- i** In some weather conditions (e.g. low temperature or humidity), the presence of misting on the internal surface of the glass of the headlamps and rear lamps is normal; it disappears after the lamps have been on for a few minutes.

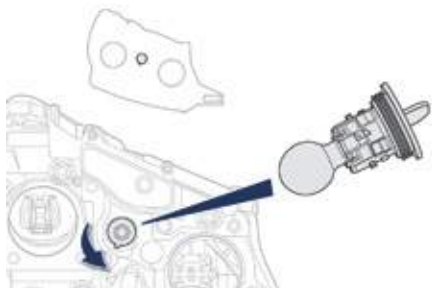

Changing direction indicator bulbs

i Rapid flashing of the direction indicator warning lamp (right or left) indicates the failure of a bulb on that side.

- ☞ Turn the bulb holder an eighth of a turn anti-clockwise and extract it.
- ☞ Remove the bulb and change it.

To reassemble, carry out these operations in reverse order.

i Amber coloured bulbs, such as the direction indicators, must be replaced with bulbs of identical specifications and colour.

When refitting, close the protective cover carefully to preserve the sealing of the headlamp.



Changing dipped beam headlamp bulbs

- ☞ Remove the protective cover by pulling on the tab.
- ☞ Disconnect the bulb connector.
- ☞ Spread the spring to release the bulb.
- ☞ Extract the bulb and change it.



To reassemble, carry out these operations in reverse order, positioning the alignment lug at the bottom.



Changing main beam headlamp bulbs

- ☞ Remove the protective cover by pulling on the tab.
- ☞ Disconnect the bulb connector.
- ☞ Pull out the bulb and replace it.



To reassemble, carry out these operations in reverse order, positioning the alignment lug at the bottom.

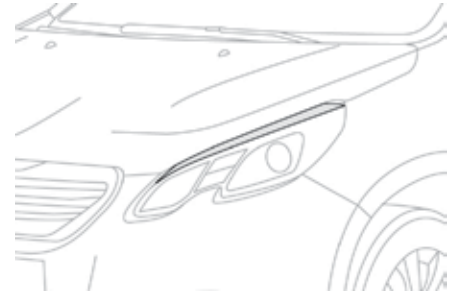

Daytime running lamps / sidelamps (light-emitting diodes - LEDs)

For the replacement of this type of LED lamp, contact a PEUGEOT dealer or a qualified workshop.

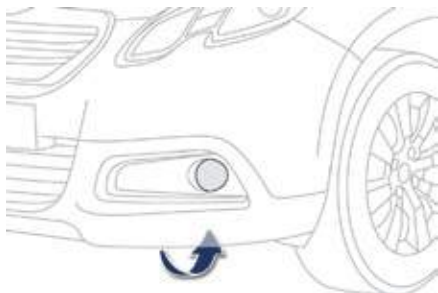

Changing front foglamp / directional lamps

- ☞ Access to the front foglamp is through the orifice below the bumper.
- ☞ Disconnect the bulb holder connector by pressing on the top of the tongue.
- ☞ Extract the bulb holder by pressing on the two clips (top and bottom).
- ☞ Replace the module.

To reassemble, carry out these operations in reverse order.

i To obtain this module, contact a PEUGEOT dealer or a qualified workshop. You can also contact a PEUGEOT dealer or a qualified workshop for this replacement.

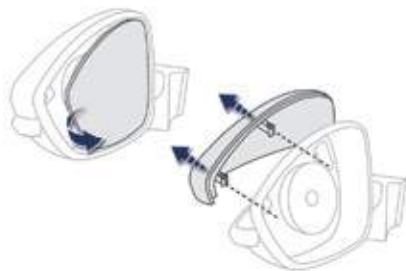

Changing integrated direction indicator side repeater bulbs

- ☞ Insert a flat screwdriver between the mirror glass and its base.
- ☞ Use the screwdriver as a lever to extract the mirror glass.
- ☞ Unclip the mirror shell by pressing on the two retaining clips.

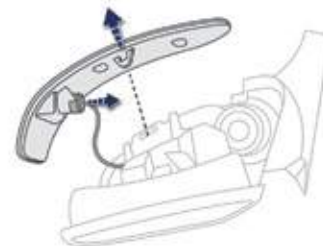

- ☞ Press the central tongue and remove the side repeater.
- ☞ Pull the bulb holder out and replace the failed bulb.

To reassemble, carry out these operations in reverse order.

You should contact a PEUGEOT dealer or a qualified workshop for the replacement of these bulbs.

Rear lamps

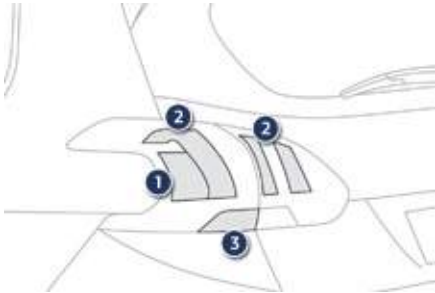

1. Brake lamps (P21W).
2. Sidelamps (light emitting diodes - LEDs).
3. Direction indicators (PY21W amber).

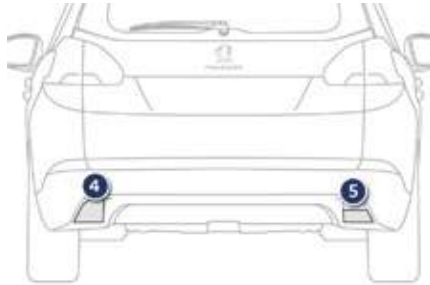

4. Foglamp (P21W).
5. Reversing lamp (P21W).

i Light emitting diodes-LEDs

For replacement, contact a PEUGEOT dealer or qualified workshop.

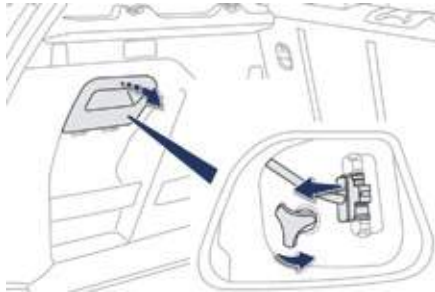

Changing brake lamp and direction indicator bulbs

These bulbs are changed from inside the boot:

- ☞ open the boot,
- ☞ remove the access grille from the corresponding side trim panel,
- ☞ slacken and remove the nut,
- ☞ disconnect the lamp unit connector,
- ☞ remove the lamp unit carefully by it pulling in line towards the outside,
- ☞ press the retaining tabs and remove the bulb holder,
- ☞ turn the bulb a quarter of a turn and change it.

To reassemble, carry out these operations in reverse order.

Take care to engage the lamp unit in its guides, while keeping it in line with the vehicle.

Tighten sufficiently to ensure sealing, but without damaging the lamp.



Changing the third brake lamp (light emitting diodes - LEDs)

Contact a PEUGEOT dealer or a qualified workshop.

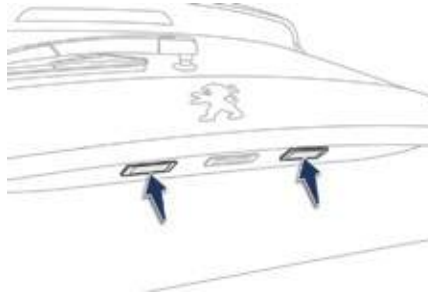

Number plate lamps

To facilitate the removal of the lamp, carry out this operation with the tailgate half open.

- ☞ Insert a thin screwdriver into the lens cutout.
- ☞ Push it outwards.
- ☞ Remove the lens.
- ☞ Change the faulty bulb.

To refit, press on the lens to clip it in place.

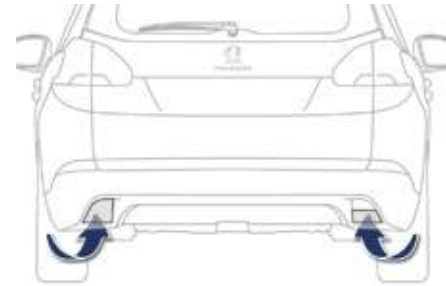

Changing a foglamp or reversing lamp bulb

Access is by passing a hand under the bumper.

- ☞ Turn the bulb holder an eighth of a turn and pull it out.
- ☞ Change the failed bulb.

To refit, carry out these operations in reverse order.

! On the left hand side, take care to not touch the exhaust silencer; risk of burns if changing a bulb after stopping the engine.

Changing a fuse

Access to the tools

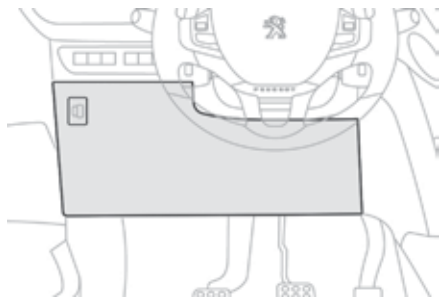

The extraction tweezers is fitted to the back of the dashboard fusebox cover.

- ☞ unclip the cover by pulling at the top left, then right,
- ☞ disengage the cover completely and turn it over,



- ☞ remove the carrier on which the tweezers is fitted.

Changing a fuse

Before changing a fuse:

- ☞ the cause of the failure must be identified and rectified,
- ☞ all electrical consumers must be switched off,
- ☞ the vehicle must be immobilised with the ignition off,
- ☞ identify the failed fuse using the tables and layout drawings in the following pages.

To replace a fuse, you must:

- ☞ use the special tweezers to extract the fuse from its housing and check the condition of its filament.
- ☞ always replace the failed fuse with a fuse of the same rating (same colour); using a different rating could cause faults (risk of fire).

If the fuse fails again soon after replacement, have the vehicle's electrical system checked by a PEUGEOT dealer or a qualified workshop.

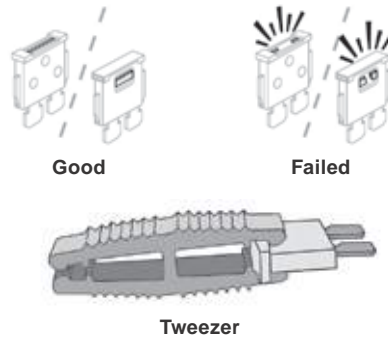

! The replacement of a fuse not shown in the tables below may cause a serious malfunction of your vehicle. Contact a PEUGEOT dealer or a qualified workshop.

i Installing electrical accessories

Your vehicle's electrical system is designed to operate with standard or optional equipment. Before installing other electrical equipment or accessories on your vehicle, contact a PEUGEOT dealer or a qualified workshop.

! PEUGEOT will not accept responsibility for the cost incurred in repairing your vehicle or for rectifying malfunctions resulting from the installation of accessories not supplied and not recommended by PEUGEOT and not installed in accordance with its instructions, in particular when the combined consumption of all of the additional equipment connected exceeds 10 milliamperes.

Dashboard fuses

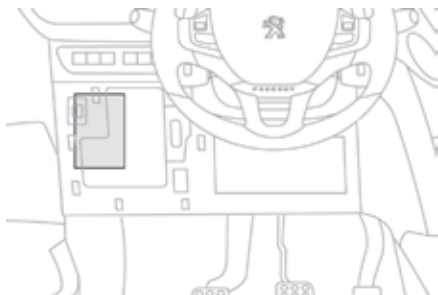

The fusebox is placed in the lower dashboard (left-hand side).

Access to the fuses

☞ Refer to the paragraph "Access to the tools".

Fuse tables

Fuse N°	Rating	Functions
F2	5 A	Door mirrors, headlamps, diagnostic socket.
F9	5 A	Alarm.
F10	5 A	Independent telematic unit, trailer interface.
F11	5 A	Electrochrome rear view mirror, additional heating.
F13	5 A	Hi-Fi amplifier, parking sensors
F16	15 A	Front 12 V socket.
F17	15 A	Audio system, audio system (accessory).
F18	20 A	Touch screen.

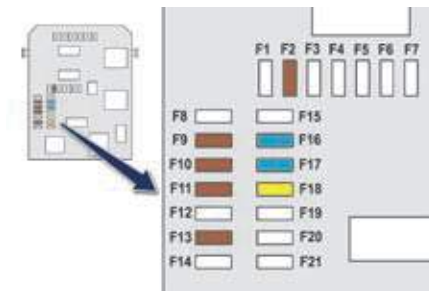

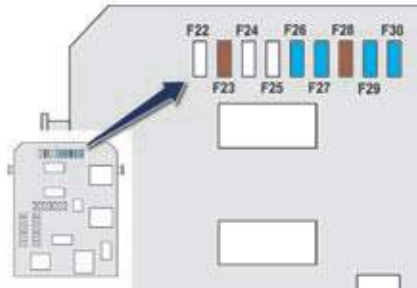

Fuse N°	Rating	Functions
F23	5 A	Glove box lamp, courtesy mirror, map reading lamps.
F26	15 A	Horn.
F27	15 A	Screenwash pump.
F28	5 A	Anti-theft.
F29	15 A	Air conditioning compressor.
F30	15 A	Rear wiper.

Fuses behind the glove box

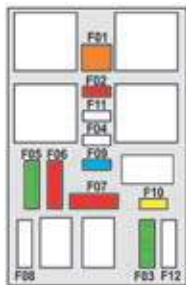
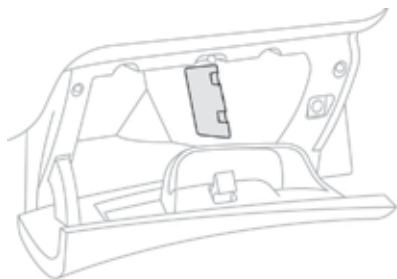

Fuse N°	Rating	Functions
F01	40 A	Heated rear window.
F02	10 A	Heated door mirrors.
F03	30 A	Front one-touch windows.
F04	-	Not used.
F05	30 A	Rear one-touch windows.
F06	10 A	Folding door mirrors.
F07	10 A	Folding door mirrors.
F08	-	Not used.
F09	15 A	Front heated seats.
F10	20 A	Hi-Fi amplifier.
F11	-	Not used.
F12	-	Not used.

Engine compartment fuses

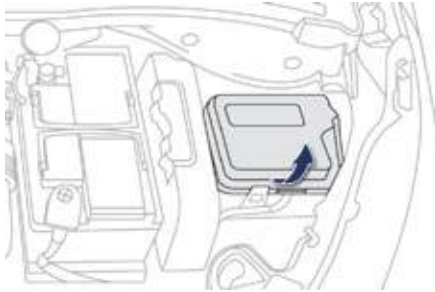

The fusebox is placed in the engine compartment near the battery (left-hand side).

Access to the fuses

- ☞ Unclip the cover.
- ☞ Change the fuse (see corresponding paragraph).
- ☞ When you have finished, close the cover carefully to ensure correct sealing of the fusebox.

Fuse table

Fuse N°	Rating	Functions
F16	15 A	Front foglamps.
F18	10 A	Right hand main beam headlamp.
F19	10 A	Left hand main beam headlamp.
F25	30 A	Headlamp wash relay (accessory).
F29	40 A	Front wiper motor.
F30	80 A	Pre-heater plugs (Diesel).

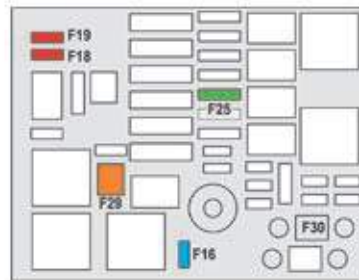

Battery

Procedure for charging your battery when it is flat or for starting the engine using another battery.



! The presence of this label indicates the use of a 12 V lead-acid battery with special technology and specification, for which the involvement of a PEUGEOT dealer or qualified workshop is required when replacing or disconnecting the battery. Failure to observe this recommendation may cause premature wear of the battery.

i After refitting the battery, the Stop & Start system will only be active after several hours depending on the climatic conditions and the state of charge of the battery (up to about 8 hours).

Access to the battery

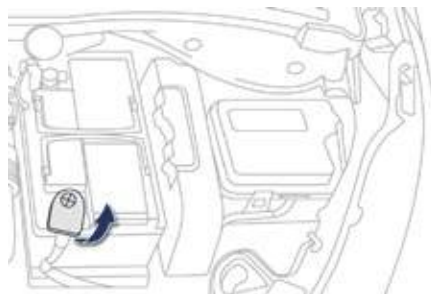

The battery is located under the bonnet.

To gain access to it:

- ☞ open the bonnet using the interior release lever, then the exterior safety catch,
- ☞ secure the bonnet stay,
- ☞ remove the plastic cover on the (+) terminal.

Disconnecting the (+) cable

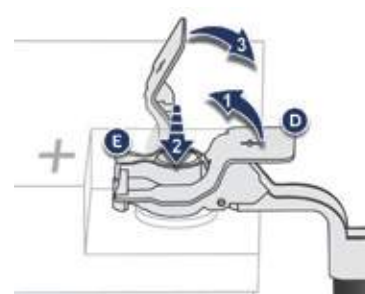

- ☞ Raise the locking tab **D** fully to release the cable terminal clamp **E**.

Reconnecting the (+) cable

- ☞ Position the open clamp **E** of the cable on the positive post (+) of the battery.
- ☞ Press vertically on the clamp **E** to position it correctly on the battery.
- ☞ Lock the clamp by spreading the positioning lug and then lowering the tab **D**.

! Do not apply excessive force on the tab as locking will not be possible if the clamp is not positioned correctly; start the procedure again.

Starting using another battery

When your vehicle's battery is discharged, the engine can be started using a slave battery (external or on another vehicle) and jump lead cables.

i First check that the slave battery has a nominal voltage of 12 V and a capacity at least equal to that of the discharged battery.

! Do not try to start the engine by connecting a battery charger. Do not disconnect the (+) terminal when the engine is running.

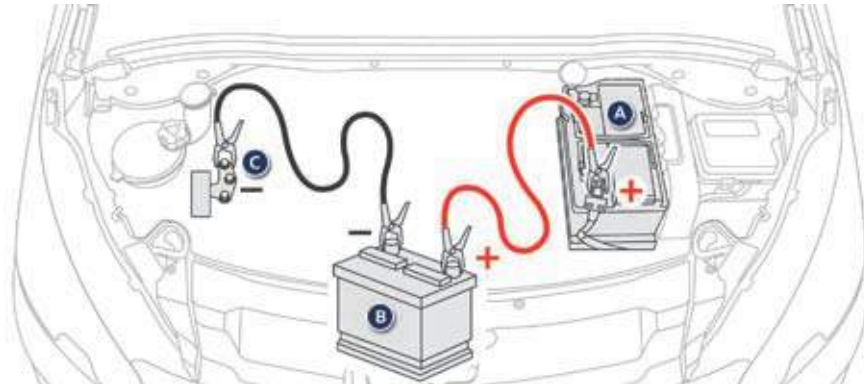

- ☞ Connect the red cable to the positive terminal (+) of the flat battery **A**, then to the positive terminal (+) of the slave battery **B**.
- ☞ Connect one end of the green or black cable to the negative terminal (-) of the slave battery **B** (or earth point on the other vehicle).
- ☞ Connect the other end of the green or black cable to the earth point **C** on the broken down vehicle (or on the engine mounting).
- ☞ Start the engine of the vehicle with the good battery and leave it running for a few minutes.
- ☞ Operate the starter on the broken down vehicle and let the engine run. If the engine does not start straight away, switch off the ignition and wait a few moments before trying again.
- ☞ Wait until the engine returns to idle then disconnect the jump lead cables in the reverse order.

Charging the battery using a battery charger

- ☞ Disconnect the battery from the vehicle.
- ☞ Follow the instructions for use provided by the manufacturer of the charger.
- ☞ Connect the battery starting with the negative terminal (-).
- ☞ Check that the terminals and connectors are clean. If they are covered with sulphate (whitish or greenish deposit), remove them and clean them.

i The Stop & Start battery does not have to be disconnected for charging.



The batteries contain harmful substances such as sulphuric acid and lead. They must be disposed of in accordance with regulations and must not, in any circumstances, be discarded with household waste.
Take used remote control batteries and vehicle batteries to a special collection point.

i It is advisable to disconnect the battery if the vehicle is to be left unused for more than one month.



Protect your eyes and face before handling the battery.

All operations on the battery must be carried out in a well ventilated area and away from naked flames and sources of sparks, so as to avoid the risk of explosion or fire.

Do not try to charge a frozen battery; the battery must first be thawed out to avoid the risk of explosion. If the battery has been frozen, before charging have it checked by a PEUGEOT dealer or a qualified workshop who will check that the internal components have not been damaged and the casing is not cracked, which could cause a leak of toxic and corrosive acid.

Do not reverse the polarity and use only a 12 V charger.

Do not disconnect the terminals while the engine is running.

Do not charge the batteries without disconnecting the terminals first.

Wash your hands afterwards.

Do not push the vehicle to start the engine if you have an electronic or automatic gearbox.

Before disconnecting the battery

Wait 2 minutes after switching off the ignition before disconnecting the battery.

Close the windows and the doors before disconnecting the battery.

Following reconnection of the battery

Following reconnection of the battery, switch on the ignition and wait 1 minute before starting to permit initialisation of the electronic systems.

However, if problems remain following this operation, contact a PEUGEOT dealer or a qualified workshop.

Referring to the corresponding section, you must yourself reinitialise:

- the remote control key,
- the on-board satellite navigation system.

Load reduction mode

System which manages the use of certain functions according to the level of charge remaining in the battery.

When the vehicle is being driven, the load reduction function temporarily deactivates certain functions, such as the air conditioning, the heated rear screen...

The deactivated functions are reactivated automatically as soon as conditions permit.

Electrical energy economy mode

System which manages the duration of use of certain functions to retain a sufficient level of charge in the battery.

After the engine has stopped, you can still use functions such as the audio and telematics system, windscreen wipers, dipped beam headlamps, courtesy lamps, etc. for a maximum combined duration of about thirty minutes.

Switching to economy mode

Once this time has elapsed, a message appears in the screen indicating that the vehicle has switched to economy mode and the active functions are put on standby.

If a telephone call is being made at this time, it will be maintained for around 10 minutes with the Bluetooth hands-free system of your audio system.

Exiting economy mode

These functions are reactivated automatically next time the vehicle is driven.

- ☞ To restore these functions immediately, start the engine and let it run for at least five minutes.

! A flat battery prevents the engine from starting (refer to the corresponding section).

Changing a wiper blade

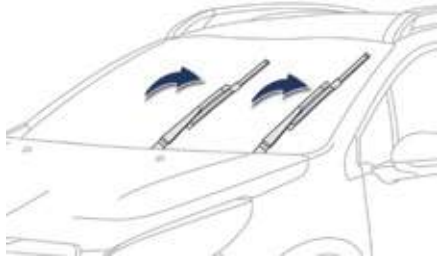

Before removing a front wiper blade

- ☞ Within one minute after switching off the ignition, operate the wiper stalk to position the wiper blades vertically on the windscreen.

Removing

- ☞ Raise the corresponding wiper arm.
- ☞ Unclip the wiper blade and remove it.

Fitting

- ☞ Put the corresponding new wiper blade in place and clip it.
- ☞ Fold down the wiper arm carefully.

After fitting a front wiper blade

- ☞ Switch on the ignition.
- ☞ Operate the wiper stalk again to park the wiper blades.

Towing the vehicle

Procedure for having your vehicle towed or for towing another vehicle using a removable towing eye.

Access to the tools

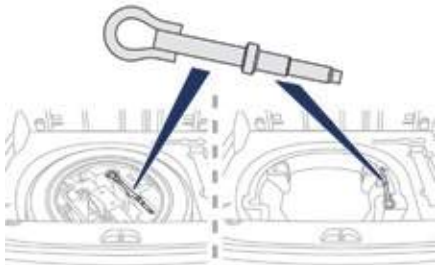

The towing eye is installed in the boot under the floor.

To gain access to it:

- ☞ open the boot,
- ☞ lift the floor and remove it,
- ☞ remove the towing eye from the holder.

! General recommendations

Observe the legislation in force in your country.

Ensure that the weight of the towing vehicle is higher than that of the towed vehicle.

The driver must remain at the wheel of the towed vehicle and must have a valid driving licence.

When towing a vehicle with all four wheels on the ground, always use an approved towing bar; rope and straps are prohibited.

The towing vehicle must move off gently.

When towing a vehicle with the engine off, there is no longer any power assistance for braking or steering.

In the following cases, you must always call on a professional recovery service:

- vehicle broken down on a motorway or fast road,
- four-wheel drive vehicle,
- when it is not possible to put the gearbox into neutral, unlock the steering, or release the parking brake,
- towing with only two wheels on the ground,
- where there is no approved towing bar available...

Towing your vehicle



- ☞ On the front bumper, unclip the cover by inserting the flat end of the towing eye in the bottom of the cover.
- ☞ Screw the towing eye in fully.
- ☞ Install the towing bar.

i ☞ Place the gear lever in neutral (position **N** on an electronic or automatic gearbox). Failure to observe this instruction could result in damage to certain components (braking, transmission...) and the absence of braking assistance the next time the engine is started.

- ☞ Unlock the steering by turning the key in the ignition one notch and release the parking brake.
- ☞ Switch on the hazard warning lamps on both vehicles.
- ☞ Move off gently, drive slowly and for a short distance.

Towing another vehicle

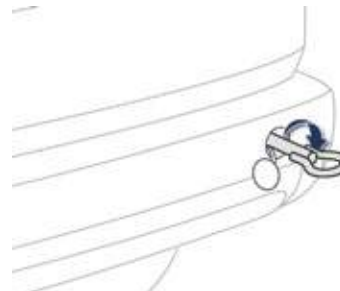

- ☞ On the rear bumper, unclip the cover by pressing at the bottom.
- ☞ Screw the towing eye in fully.
- ☞ Install the towing bar.
- ☞ Switch on the hazard warning lamps on both vehicles.
- ☞ Move off gently, drive slowly and for a short distance.

Towing a trailer



Towbar suitable for the attachment of a trailer or installation of a bicycle carrier, with additional lighting and signalling.

Your vehicle is primarily designed for transporting people and luggage, but it may also be used for towing a trailer.

i We recommend the use of genuine PEUGEOT towbars and their harnesses that have been tested and approved from the design stage of your vehicle, and that the fitting of the towbar is entrusted to a PEUGEOT dealer or a qualified workshop.
If the towbar is not fitted by a PEUGEOT dealer, it is imperative that it is fitted in accordance with the vehicle manufacturer's instructions.

i Driving with a trailer places greater demands on the towing vehicle and the driver must take particular care.

Driving advice

Distribution of loads

- ☞ Distribute the load in the trailer so that the heaviest items are as close as possible to the axle and the nose weight approaches the maximum permitted without exceeding it.

Air density decreases with altitude, thus reducing engine performance. Above 1 000 metres, the maximum towed load must be reduced by 10 % for every 1 000 metres of altitude.

Refer to the "Technical data" section for details of the weights and towed loads which apply to your vehicle.

Side wind

- ☞ Take into account the increased sensitivity to side wind.

Cooling

Towing a trailer on a slope increases the temperature of the coolant.

As the fan is electrically controlled, its cooling capacity is not dependent on the engine speed.

- ☞ To lower the engine speed, reduce your speed.

The maximum towed load on a long incline depends on the gradient and the ambient temperature.

In all cases, keep a check on the coolant temperature.



- ☞ If the warning lamp and the **STOP** warning lamp come on, stop the vehicle and switch off the engine as soon as possible.

Braking

Towing a trailer increases the braking distance. To avoid overheating of the brakes on a long mountain type of descent, the use of engine braking is recommended.

Tyres

- ☞ Check the tyre pressures of the towing vehicle and of the trailer, observing the recommended pressures.

Lighting

- ☞ Check the electrical lighting and signalling on the trailer.

i The rear parking sensors will be deactivated automatically if a genuine PEUGEOT towbar is used.

Fitting roof bars

Contact a PEUGEOT dealer or a qualified workshop for the installation of longitudinal bars. To install transverse roof bars, observe the fitting positions indicated by markings on the longitudinal roof bars.

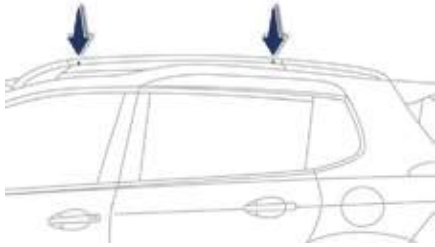

! Use accessories recommended by PEUGEOT, observing the manufacturer's recommendations and fitting instructions so as to avoid the risk of damaging the body (deformation, scratches, ...). To place a load on the roof, it is necessary to mount the load on the transverse roof bars. The longitudinal roof bars are not removable.

i Maximum authorised weight on the roof bars, for a loading height not exceeding 40 cm (with the exception of bicycle carriers): refer to the instructions provided with the roof bars. If the height exceeds 40 cm, adapt the speed of the vehicle to the profile of the road to avoid damaging the roof bars and the fixings on the roof. Be sure to refer to national legislation in order to comply with the regulations for transporting objects which are longer than the vehicle.

Advice on care and maintenance

Recommendations on the care and maintenance your vehicle are given in the warranty and maintenance record.

Accessories

A wide range of accessories and genuine parts is available from the PEUGEOT dealer network. These accessories and parts are all adapted to your vehicle and benefit from PEUGEOT's recommendation and warranty.

Conversion kits

You can obtain an "Enterprise" kit to convert a private car into a trade vehicle.

"Comfort":

door deflectors, side blinds and rear blind, cigarette lighter, boot dividers, coat hanger fixed to head restraint, front and rear parking sensors...

"Transport solutions":

boot liner, luggage net, roof bars, bicycle carrier on roof bars, ski carrier, roof box, towbars....

 The towbar must be fitted by a PEUGEOT dealer or a qualified workshop.

"Styling":

gear lever knob, spoiler, styling strips, alloy wheels, trims, chromed mirror shells...

"Security":

anti-theft alarm, window engraving, wheel security bolts, child seats and booster cushions, breathalyzer, first aid kit, warning triangle, high visibility jacket, stolen vehicle tracking system, temporary puncture repair kit, snow chains, non-slip covers, front foglamps kit, dog guard...

"Protection":

mats*, seat covers compatible with lateral airbags, mud flaps, door sill protectors, stainless steel boot sill protector, bumper protection strips, aluminium foot rest...

- * To avoid any risk of jamming of the pedals:
- ensure that the mat is positioned and secured correctly,
 - never fit one mat on top of another.

"Multimedia":

audio systems, portable satellite navigation systems, semi-integral support for portable satellite navigation system, hands-free kit, speakers, DVD player, connection kit for MP3 or CD player, Wi-Fi on-board, CD player for touch screen...

By visiting a PEUGEOT dealer, you can also obtain products for cleaning and maintenance (exterior and interior) - including ecological products in the "TECHNATURE" range, topping up products (screenwash...), touch-up pens and paint aerosols for the exact colour of your vehicle, refills (cartridge for the temporary puncture repair kit...), ...

i Depending on the legislation in force in the country, certain safety equipment may be compulsory: high visibility safety vests, warning triangles, breathalyzers, spare bulbs, spare fuses, fire extinguisher, first aid kit, mud flaps at the rear of the vehicle.

! The fitting of electrical equipment or accessories which are not recommended by PEUGEOT may result in a failure of your vehicle's electronic system and excessive electrical consumption. Contact a PEUGEOT dealer for information on the range of recommended equipment and accessories.

i Installation of radio communication transmitters

Before installing any after-market radio communication transmitter, you can contact a PEUGEOT dealer for the specification of transmitters which can be fitted (frequency, maximum power, aerial position, specific installation requirements), in line with the Vehicle Electromagnetic Compatibility Directive (2004/104/EC).



- ▶ 208 HYbrid FE, a technology demonstrator with exceptional characteristics: 1.9 l/100 km (148.7 mpg) and 0 to 100 km/h (0 to 62 mph) in 8 seconds.

PEUGEOT & TOTAL, A PARTNERSHIP TO DELIVER BETTER PERFORMANCE!

Innovation, the key to success

The TOTAL Research and Development and PEUGEOT teams work together to develop high quality lubricants that meet the requirements of PEUGEOT vehicles. For you, this is the assurance that the performance of your engine is optimised while also ensuring its durability. The 208 HYbrid FE demonstrates the ability of PEUGEOT and TOTAL to develop innovative technologies and provide other ways of moving towards the future.

Reduced exhaust emissions, a true reality

TOTAL lubricants are formulated to optimise the efficiency of engines and the protection of the emissions post-treatment systems. It is important to observe the servicing recommendations made by PEUGEOT to assure correct operation.

PEUGEOT RECOMMENDS TOTAL



OFFICIAL PARTNERS

Bonnet

- ! Before doing anything under the bonnet, switch off the Stop & Start system to avoid any risk of injury resulting from an automatic change to START mode.

Opening

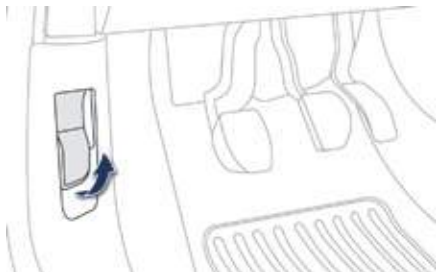

- i The location of the interior release lever prevents opening of the bonnet when the left hand front door is closed.

- ☞ Open the left hand front door.
- ☞ Pull the release lever, located at the bottom of the door aperture, towards you.

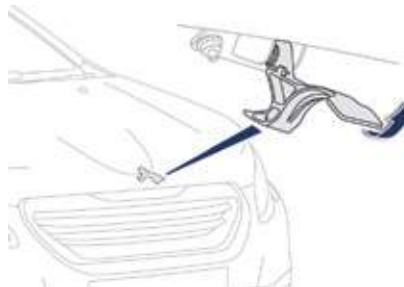

- ☞ Lift the safety catch and raise the bonnet.

- ! Do not open the bonnet under very windy conditions. When the engine is hot, handle the exterior safety catch and the stay with care (risk of burns).

- ! Because of the presence of electrical equipment under the bonnet, it is recommended that exposure to water (rain, washing, ...) be limited.



- ☞ Unclip the stay from its housing and place it in the support slot to hold the bonnet open.

Closing

- ☞ Take the stay out of its support slot.
- ☞ Clip the stay back into its housing.
- ☞ Lower the bonnet and release it at the end of its travel.
- ☞ Pull the bonnet to check that it has latched correctly.

Petrol engines

The various caps and covers allow access for checking the levels of the various fluids and for replacing certain components.

1. Screenwash reservoir.
2. Coolant reservoir.
3. Brake fluid reservoir.
4. Battery / Fuses.
5. Fusebox.
6. Air filter.
7. Engine oil dipstick.
8. Engine oil filler cap.

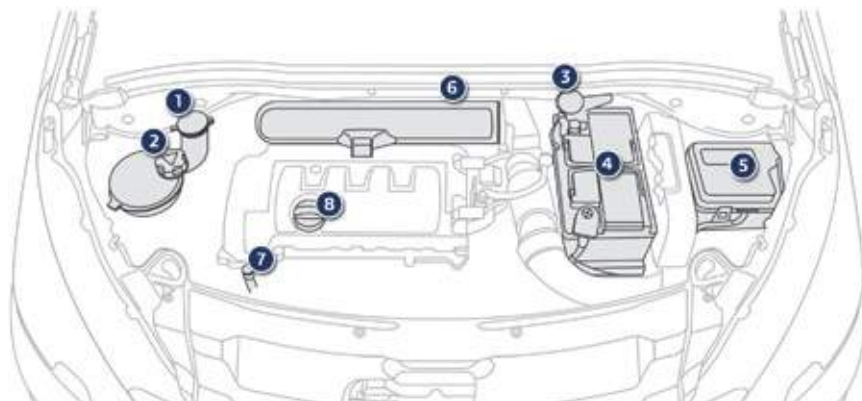

Diesel engines

The various caps and covers allow access for checking the levels of the various fluids, for replacing certain components and for priming the fuel system.

1. Screenwash reservoir.
2. Coolant reservoir.
3. Brake fluid reservoir.
4. Battery / Fuses.
5. Fusebox.
6. Air filter.
7. Engine oil dipstick.
8. Engine oil filler cap.

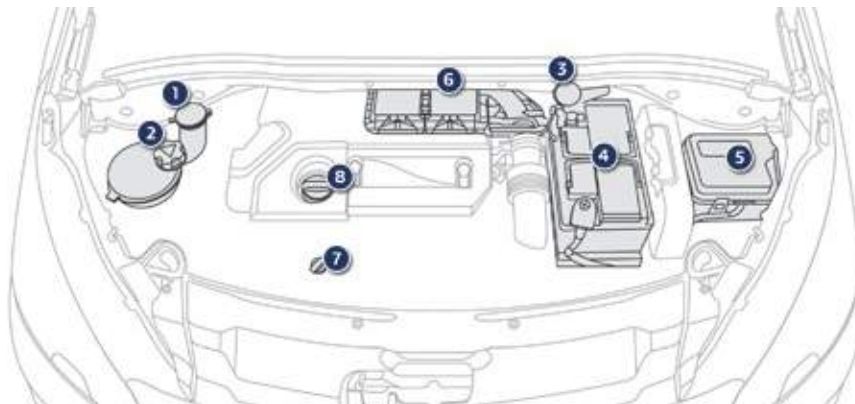

Fuel tank

Fuel tank capacity: approximately 50 litres.

Low fuel level



When the fuel tank minimum level is reached this warning lamp comes on in the instrument panel. There remains **approximately 5 litres** of fuel in the tank. When the warning lamp flashes there is **very little fuel** remaining in the tank.

You must refuel as soon as possible to avoid running out of fuel.

If you run out of fuel (Diesel), refer to the "Running out of fuel - Diesel" section.



With Stop & Start, never refuel with the system in STOP mode; you must switch off the ignition with the key.

Filling



A self-adhesive label on the inner face of the filler flap reminds you of the type of fuel to use depending on your engine. Additions of fuel must be of at least 5 litres to be registered by the fuel gauge.

i The key cannot be removed from the lock until the cap is refitted. Removing the filler cap may cause an inrush of air. This vacuum is perfectly normal and results from the sealing of the system.

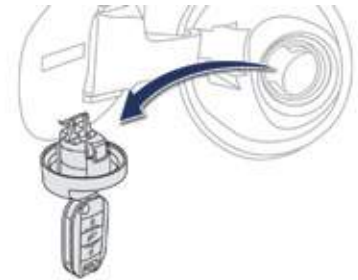

To fill the tank safely:

- f** **the engine must be switched off,**
- f** open the fuel filler flap by pressing at its rear,
- f** insert the key in the cap, then turn it to the left,
- f** remove the cap and hook it onto the clip located on the inside of the flap,
- f** fill the tank, **but do not continue after the 3rd cut-off of the pump;** this could cause malfunctions.

When you have filled the tank:

- ☞ put the cap back in place,
- ☞ turn the key to the right, then remove it from the cap,
- ☞ close the flap.

Fuel supply cut-off

Your vehicle is fitted with a safety system that cuts off the supply of fuel in the event of an impact.

! If you have put in the wrong fuel for the engine of your vehicle, you must have the fuel tank drained and filled with the correct fuel before starting the engine.

Misfuel prevention (Diesel)*

Mechanical device which prevents filling the tank of a Diesel vehicle with petrol. It avoids the risk of engine damage that can result from filling with the wrong fuel.

Located in the filler neck, the misfuel prevention device appears when the filler cap is removed.

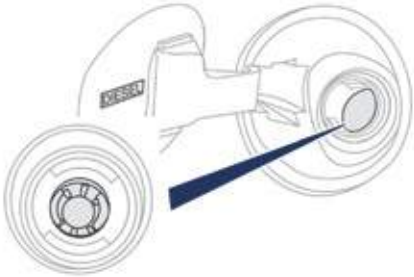

Operation

When a petrol filler nozzle is introduced into the fuel filler neck of your Diesel vehicle, it comes into contact with the flap. The system remains closed and prevents filling.

Do not persist but introduce a Diesel type filler nozzle.

i It remains possible to use a fuel can to fill the tank.
In order to ensure a good flow of fuel, do not place the nozzle of the fuel can in direct contact with the flap of the misfuel prevention device and pour slowly.

i Travelling abroad

As Diesel fuel pump nozzles may be different in other countries, the presence of the misfuel prevention device may make refuelling impossible. Before travelling abroad, we recommend that you check with the PEUGEOT dealer network, whether your vehicle is suitable for the fuel pumps in the country in which you want to travel.

* According to country of sale.

Fuel used for petrol engines

The petrol engines are compatible with E10 bio-petrol (containing 10 % ethanol), conforming to European standards EN 228 and EN 15376.

E85 type fuels (containing up to 85 % ethanol) are reserved exclusively for vehicles marketed for the use of this type of fuel (BioFlex vehicles). The quality of the ethanol must comply with European standard EN 15293.



Fuel used for Diesel engines

The Diesel engines are perfectly with biofuels which conform to current and future European standards (Diesel fuel which complies with standard EN 590 mixed with a biofuel which complies with standard EN 14214) available at the pumps (containing up to 7 % Fatty Acid Methyl Ester).

The B30 biofuel can be used in certain Diesel engines; however, this use is subject to strict application of the special servicing conditions indicated in the warranty and maintenance record. Contact a PEUGEOT dealer or a qualified workshop.

The use of any other type of (bio)fuel (vegetable or animal oils, pure or diluted, domestic fuel...) is strictly prohibited (risk of damage to the engine and fuel system).



Running out of fuel (Diesel)

On vehicle fitted with HDi engines, the fuel system must be primed if you run out of fuel; refer to the engine compartment view on the "Diesel engine" section.

If the tank on your vehicle is fitted with a misfuel prevention device, refer to the corresponding section.

i If the engine does not start first time, don't keep trying. Start the procedure again from the beginning.

1.4 HDi engine

- ☞ Fill the fuel tank with at least five litres of diesel.
- ☞ Open the bonnet.
- ☞ Press and release the priming pump until resistance is felt (there may be resistance on the first press).
- ☞ Operate the starter until the engine starts.
- ☞ Close the bonnet.

1.6 HDi engine

- ☞ Fill the fuel tank with at least five litres of diesel.
- ☞ Open the bonnet.
- ☞ If necessary, unclip the styling cover for access to the priming pump.
- ☞ Squeeze and release the priming pump repeatedly until resistance is felt (there may be resistance at the first press).
- ☞ Operate the starter until the engine starts (if the engine does not start at the first attempt, wait around 15 seconds before trying again).
- ☞ If the engine does not start after a few attempts, operate the priming pump again then start the engine.
- ☞ Refit the styling cover and clip it in place.
- ☞ Close the bonnet.

AdBlue® additive and SCR system for Blue HDi Diesel engines

To assure respect for the environment and conformity with the new Euro 6 emissions standard, without adversely affecting the performance or fuel consumption of Diesel engines, PEUGEOT has taken the decision to equip its vehicles with an effective system that associates SCR (Selective Catalytic Reduction) with a particle emissions filter (PEF) for the treatment of exhaust gases.

Presentation of the SCR system

Using an additive called AdBlue® containing urea, a catalytic converter turns up to 85% of nitrous oxides (NOx) into nitrogen and water, which are harmless to health and the environment.

The AdBlue® additive is held in a special tank located under the boot at the rear of the vehicle. It has a capacity of 17 litres: this provides a driving range of about 12 500 miles (20 000 km), after which an alert is triggered warning you when the reserve remaining is enough for just 1 500 miles (2 400 km).

During each scheduled service of your vehicle by a PEUGEOT dealer or a qualified workshop, the AdBlue® additive tank is refilled in order to allow normal operation of the SCR system.

If the estimated mileage between two services is greater than 12 500 miles (20 000 km), we recommend that you go to a PEUGEOT dealer or a qualified workshop to have the necessary top-up carried out.

! Once the AdBlue® tank is empty, a system required by regulations prevents starting of the engine. If the SCR is faulty, the level of emissions from your vehicle will longer meet the Euro 6 standard: your vehicle becomes polluting. In the event of a confirmed fault with the SCR system, you must go to a PEUGEOT dealer or a qualified workshop as soon as possible: after a running distance of 650 miles (1 100 km), a system will be triggered automatically to prevent engine starting.

Range indicators

When switching on the ignition, an indicator gives an estimate of the distance that can be travelled with your vehicle before engine starting is automatically prevented, once the vehicle starts using the reserve of AdBlue® or after a fault is detected with the SCR system. In the event of simultaneous system fault and low AdBlue® level, the shortest range is the one displayed.

In the event of the risk of non-starting related to a lack of AdBlue®

! The engine start prevention system required by regulations is activated automatically once the AdBlue® tank is empty.

Range greater than 1 500 miles (2 400 km)

When the ignition is switched on, no information on range is displayed automatically in the instrument panel.



Pressing this button displays the driving range temporarily.

Above 3 000 miles (5 000 km), the value is not specified.

Remaining range between 350 and 1500 miles (600 and 2 400 km)



When switching on the ignition, the UREA warning lamp comes on, accompanied by an audible signal and the display of a message (e.g.: "Top up emissions additive: Starting prevented in 900 miles") indicating the remaining range expressed in miles or kilometres.

When driving, the message is displayed every 150 miles (300 km) until the additive tank has been topped-up.

Go to a PEUGEOT dealer or a qualified workshop to have the AdBlue® tank topped-up. You can also top-up the tank yourself. Refer to the "Topping-up" section.

Remaining range between 0 and 350 miles (0 and 600 km)



When switching on the ignition, the SERVICE warning lamp comes on and the UREA warning lamp flashes, accompanied by an audible signal and the display of a message (e.g. "Top up emissions additive: Starting prevented in 350 miles") indicating the remaining range expressed in miles or kilometres.

When driving, the message is displayed every 30 seconds until the additive tank has been topped-up.

Go to a PEUGEOT dealer or a qualified workshop to have the AdBlue® tank topped-up. You can also top-up the tank yourself. Refer to the "Topping-up" section. Otherwise you will not be able to restart your engine.

Breakdown related to a lack of AdBlue® additive



When switching on the ignition, the SERVICE warning lamp comes on and the UREA warning lamp flashes, accompanied by an audible signal and the display of the message "Top up emissions additive: Starting prevented". The AdBlue® tank is empty: the system required by regulations prevents engine starting.

! To be able to start the engine, we recommend that you call on a PEUGEOT dealer or a qualified workshop for the top-up required. If you carry out the top-up yourself, it is essential to add at least 3.8 litres of AdBlue® to the tank. Refer to the "Topping-up" section.

In the event of a fault with the the SCR emissions control system

! A system that prevents engine starting is activated automatically from 650 miles (1 100 km) after confirmation of a fault with the SCR emissions control system. Have the system checked by a PEUGEOT dealer or a qualified workshop as soon as possible.

In the event of the detection of a fault



When switching on the ignition, the UREA, SERVICE and diagnostic warning lamps come on, accompanied by an audible signal and the display of a message "Emissions fault" to signal a fault with the emissions control system.

i If it is a temporary fault, the alert disappears once the exhaust gas emissions return to normal.

During an authorised driving phase (between 650 miles and 0 miles) (1 100 km and 0 km)



If a fault with the SCR system is confirmed (after 30 miles (50 km) covered with the permanent display of the message signalling a fault), when switching on the ignition, the SERVICE and engine diagnostic warning lamps come on and the UREA warning lamp flashes, accompanied by an audible signal and the display of a message (e.g.: "Emissions fault: Starting prevented in 150 miles") indicating the remaining range express in miles or kilometres. While driving, the message is displayed every 30 seconds while the fault with the SCR system persists.

You should go to a PEUGEOT dealer or a qualified workshop as soon as possible. Otherwise, you will not be able to restart your engine.

Starting prevented



Every time the ignition is switched on, the SERVICE and engine diagnostic warning lamps come on and the UREA warning lamp flashes, accompanied by an audible signal and the display of the message "Emissions fault: Starting prevented".

! You have exceeded the authorised driving limit: the starting prevention system inhibits engine starting.

To be able to start the engine, you must call on a PEUGEOT dealer or a qualified workshop.

i Freezing of the AdBlue® additive

The AdBlue® additive freezes at temperatures below around -11°C. The SCR system includes a heater for the AdBlue® tank.

In exceptional circumstances (vehicle kept for a long period at temperatures that are constantly below -15°C), an emissions control system fault alert may be related to freezing of the AdBlue® in your vehicle.

Park your vehicle in a warmer area for a few hours until the additive becomes liquid again.

The emissions alert does not go off immediately, it will occur after several mile of running.

Topping-up the AdBlue® additive

Filling the AdBlue® tank is an operation included in every routine service on your vehicle by a PEUGEOT dealer or a qualified workshop.

Nevertheless, given the capacity of the tank, it may be necessary to top-up the additive between services, more particularly if an alert (warning lamps and a message) signals the requirement.

You can go to a PEUGEOT dealer or a qualified workshop.

If you envisage topping-up yourself, please read the following warnings carefully.

Precautions in use

The AdBlue® additive is an urea-based solution. This liquid is non-flammable, colourless and odourless (kept in a cool area). In the event of contact with the skin, wash the affected area with soap and water. In the event of contact with the eyes, wash (irrigate) the eyes with large amounts of water or with an eye wash solution for at least 15 minutes. If a burning sensation or irritation persists, get medical attention.

If swallowed, immediately wash out the mouth with clean water and then drink plenty of water. In certain conditions (high ambient temperature, for example), the risk of release of ammonia cannot be excluded: do not inhale the product. Ammonia vapour has an irritant effect on mucous membranes (eyes, nose and throat).

Use only AdBlue® additive that meets the ISO 22241 standard.

! Never dilute the additive with water.
Never pour the additive into the Diesel fuel tank.



AdBlue®

The supply in a non-drip bottle simplifies topping-up. You can obtain 1.89 litre (half a US gallon) bottles from a PEUGEOT dealer or a qualified workshop.

! Keep AdBlue® out of the reach of children, in its original bottle.
Never transfer AdBlue® to another container: it would lose its purity.

! Never top-up from an AdBlue® dispenser reserved for heavy goods vehicles.

Recommendations on storage

AdBlue® freezes at about -11°C and deteriorates above 25°C. It is recommended that bottles be stored in a cool area and protected from direct sunlight.

Under these conditions, the additive can be kept for at least a year.

If the additive has frozen, can be used once it has completely thawed out.

! Never store bottles of AdBlue® in your vehicle.

Procedure

Before topping-up, ensure that the vehicle is parked on a flat and level surface. In wintry conditions, ensure that the temperature of the vehicle is above -11°C. Otherwise, by freezing, the AdBlue® cannot be poured into its tank. Park your vehicle in a warmer area for a few hours to allow the top-up to be carried out.

☞ Switch off the ignition and remove the key.

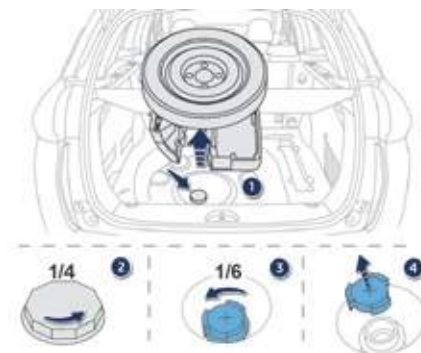

☞ For access to the AdBlue® tank, raise the boot carpet then, depending on equipment, lift out the spare wheel and/or the storage box.

☞ Without pressing, turn the black cap a quarter turn anti-clockwise and lift it off.

☞ Turn the blue cap a 6th of a turn anti-clockwise.

☞ Lift off the cap.



- ☞ Obtain a bottle of AdBlue®. After first checking the use-by date, read carefully the instructions on use on the label before pouring the contents of the bottle into your vehicle's AdBlue® tank.

! **Important:** if your vehicle's AdBlue® tank is completely empty - which is confirmed by the alert messages and the impossibility of starting the engine, you must add at least 3.8 litres (so two 1.89 litre bottles).

- ☞ After emptying the bottle, wipe away any spillage around the tank filler using a damp cloth.

! If any additive is split or splashed, wash immediately with cold water or wipe with a damp cloth.
If the additive has crystallised, clean it off using a sponge and hot water.

- ☞ Refit the blue cap to the tank and turn it a 6th of a turn clockwise, to its stop.
- ☞ Refit the black cap and turn it a quarter of a turn clockwise without pressing. Ensure that the indicator on the cap lines up with the indicator on the support.
- ☞ Depending on equipment, return the spare wheel and/or the storage box to the bottom of the boot.
- ☞ Refit the boot carpet and close the tailgate.

! Important: **in the event of a top-up after a breakdown because of a lack of additive**, signalled by the message "Top up emissions additive: Starting prevented", you must wait around 5 minutes before switching on the ignition, **without opening the driver's door, locking the vehicle or introducing the key into the ignition switch.**

Switch on the ignition, then, after 10 seconds, start the engine.

♻️ Never dispose of AdBlue® additive bottles in the household waste. Place them in a special container provided this purpose or take them to your dealer.

Checking levels

Check all of these levels regularly, in line with the warranty and maintenance record. Top them up if necessary, unless otherwise indicated. If a level drops significantly, have the corresponding system checked by a PEUGEOT dealer or a qualified workshop.

! Take care when working under the bonnet, as certain areas of the engine may be extremely hot (risk of burns) and the cooling fan could start at any time (even with the ignition off).

Oil level



The check is carried out either when the ignition is switched on using the oil level indicator in the instrument panel (depending on version), or using the dipstick.

It will only be correct if the vehicle is on level ground and the engine has been off for more than 30 minutes.

i It is normal to top up the oil level between two services (or oil changes). PEUGEOT recommends that you check the level, and top up if necessary, every 3 000 miles (5 000 kms).

Engine oil change

Refer to the warranty and maintenance record for details of the interval for this operation.

In order to maintain the reliability of the engine and emission control system, never use additives in the engine oil.

Oil specification

The oil must be the correct grade for your engine and conform to the manufacturer's recommendations.

Brake fluid level



The brake fluid level should be close to the "MAX" mark. If it is not, check the brake pad wear.

Changing the fluid

Refer to the warranty and maintenance record for details of the interval for this operation.

Fluid specification

The brake fluid must conform to the manufacturer's recommendations.

Coolant level



The coolant level should be close to the "MAX" mark but should never exceed it.

When the engine is warm, the temperature of the coolant is regulated by the fan.

The cooling fan may start after switching off the engine: take care with articles and clothing that might be caught by the fan blades.

In addition, as the cooling system is pressurised, wait at least one hour after switching off the engine before carrying out any work.

To avoid any risk of scalding, unscrew the cap by two turns to allow the pressure to drop. When the pressure has dropped, remove the cap and top up the level.

Changing the coolant

The coolant does not have to be replaced at routine services.

Fluid specification

The coolant must conform to the manufacturer's recommendations.

Screenwash fluid level



Top up the level when necessary.

Fluid specification

For optimum cleaning and to avoid freezing, this fluid must not be topped up or replaced with plain water.

In wintry conditions, it is recommended that you use an ethyl alcohol or methanol based fluid.

Diesel additive level (Diesel engine with particle emission filter)

SERVICE A low additive level is indicated by illumination of the service warning lamp, accompanied by an audible warning and a message in the screen (if a display screen is fitted).

Topping up

This additive must be topped up by a PEUGEOT dealer or a qualified workshop without delay.

Used products



Avoid prolonged contact of used oil or fluids with the skin.
Most of these fluids are harmful to health or indeed very corrosive.



Do not discard used oil or fluids into sewers or onto the ground.
Take used oil to a PEUGEOT dealer or a qualified workshop (France) or to an authorised waste disposal site.

Checks

Unless otherwise indicated, check these components in accordance with the warranty and maintenance record and according to your engine. Otherwise, have them checked by a PEUGEOT dealer or a qualified workshop.

12 V battery



The battery does not require any maintenance. However, check that the terminals are clean and correctly tightened, particularly in summer and winter.

When carrying out work on the battery, refer to the "12 V battery" section for details of the precautions to be taken before disconnecting the battery and following its reconnection.



The presence of this label, in particular with the Stop & Start system, indicates the use of a specific 12 V lead-acid battery with special technology and specification. The involvement of a PEUGEOT dealer or a qualified workshop is essential when replacing or disconnecting the battery.

Air filter and passenger compartment filter



Refer to the warranty and maintenance record for details of the replacement intervals for these components.

Depending on the environment (e.g. dusty atmosphere) and the use of the vehicle (e.g. city driving), **replace them twice as often if necessary**.

A clogged passenger compartment filter may have an adverse effect on the performance of the air conditioning system and generate undesirable odours.

Oil filter



Replace the oil filter each time the engine oil is changed. Refer to the warranty and maintenance record for details of the replacement interval for this component.

Particle emissions filter (Diesel)

SERVICE The start of saturation of the particle filter is indicated by the fixed illumination of this warning lamp accompanied by a warning message in the screen (if a display screen is fitted). As soon as the traffic conditions permit, regenerate the filter by driving at a speed of at least 40 mph (60 km/h) until the warning lamp goes off. If the warning lamp stays on, this indicates a low additive level.

i On a new vehicle, the first particle filter regeneration operations may be accompanied by a "burnt" smell, which is perfectly normal. Following prolonged operation of the vehicle at very low speed or at idle, you may, in exceptional circumstances, notice the emission of water vapour at the exhaust on acceleration. This does not affect the behaviour of the vehicle or the environment.

Manual gearbox



The gearbox does not require any maintenance (no oil change). Refer to the warranty and maintenance record for the checking interval for this component.

Electronic gearbox



The gearbox does not require any maintenance (no oil change). Refer to the warranty and maintenance record for details of the checking interval for this component.

Automatic gearbox



The gearbox does not require any maintenance (no oil change). Refer to the warranty and maintenance record for details of the level checking interval for this component.

Brake pads



Brake wear depends on the style of driving, particularly in the case of vehicles used in town, over short distances. It may be necessary to have the condition of the brakes checked, even between vehicle services.

Unless there is a leak in the circuit, a drop in the brake fluid level indicates that the brake pads are worn.

Brake disc wear



For information on checking brake disc wear, contact a PEUGEOT dealer or a qualified workshop.

Parking brake



If excessive travel or a loss of effectiveness of this system is noticed, the parking brake must be checked, even between two services.

Checking this system must be done by a PEUGEOT dealer or a qualified workshop.

! Only use products recommended by PEUGEOT or products of equivalent quality and specification. In order to optimise the operation of units as important as those in the braking system, PEUGEOT selects and offers very specific products. After washing the vehicle, dampness, or in wintry conditions, ice can form on the brake discs and pads: braking efficiency may be reduced. Make light brake applications to dry and defrost the brakes.

General information

Engine characteristics

The engine characteristics (capacity, maximum power, maximum power speed, fuel, CO₂ emissions...) for your vehicle are given in the registration document, as well as in sales brochures.

These characteristics correspond to the values type-approved on a test bed, under conditions defined in European legislation (Directive 1999/99/EC).

For more information, contact a PEUGEOT dealer or a qualified workshop.

Weights and towed loads

The maximum weights and towed loads for your vehicle are given in the registration document, as well as in sales brochures.

These values are also present on the manufacturer's plate or label (see the "Identification markings" section).

For more information, contact a PEUGEOT dealer or a qualified workshop.

The kerb weight is equal to the unladen weight + driver (75 kg).

The gross train weight and towed load values indicated apply up to a maximum altitude of 1 000 metres; the towed load mentioned must be reduced by 10 % for every additional 1 000 metres.

The weight of the braked trailer can be increased, within the GTW limit, on condition that the GVW of the towing vehicle is reduced by the same amount.

The recommended nose weight is the vertical load on the towbar ball (removable with or without tools).

GVW: gross vehicle weight, the maximum authorised vehicle weight.

GTW: gross train weight, the maximum authorised weight of vehicle plus trailer.

I High ambient temperatures may result in a reduction in the performance of the vehicle to protect the engine; when the ambient temperature is higher than 37 °C, limit the towed weight.

I Towing with a lightly loaded vehicle can adversely affect roadholding. Braking distances are increased when towing a trailer. The speed of a towing vehicle must not exceed 60 mph (100 km/h) (comply with the legislation in force in your country).

Petrol engines / weights

Engine	Gearbox	Speeds	Engine oil capacity* (litres)	Unbraked trailer (kg)	Recommended nose weight (kg)
1.2 VTi 82 hp	Manual	5	3,2	560	31
	Electronic	5	3,2	450	25
1.2 e-VTi 82 hp	Electronic	5	3,13	-	-
1.6 VTi 120 hp	Manual	5	4,25	570	39
	Automatic	4	4,25	600	38

* Capacity with oil filter replacement.

Diesel engines / weights

Engine	Gearbox	Speeds	Engine oil capacity* (litres)	Unbraked trailer (kg)	Recommended nose weight (kg)
1.4 HDi 68 hp	Manual	5	3,75	350	25
1.6 e-HDi 92 hp	Manual	5	3,75	610	38
	Electronic	6	3,75	500	25
1.6 e-HDi 115 hp	Manual	6	3,75	620	39
1.6 Blue HDi 120 hp	Manual	6	-	-	-

* Capacity with oil filter replacement.

Dimensions (in mm)

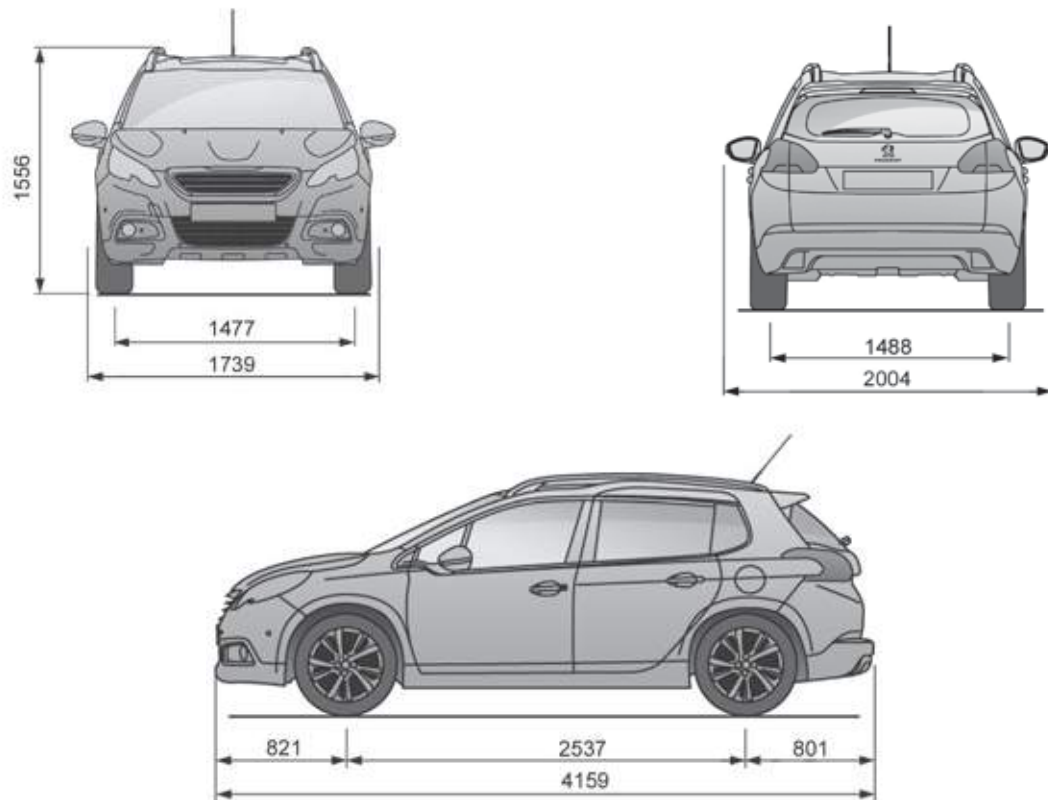

Identification markings

Various visible markings for the identification of your vehicle.



A. Vehicle Identification Number (VIN) under the bonnet.

This number is engraved on the bodywork near the damper support.

B. Vehicle identification Number (VIN) on the windscreen lower crossmember.

This number is indicated on a self-adhesive label which is visible through the windscreen.



C. Manufacturer's label.

The VIN is indicated on a self-destroying label affixed to the middle pillar, on the passenger's side.

D. Tyre/paint label.

This label is fitted to the middle pillar, on the driver's side.

It bears the following information:

- the tyre inflation pressures with and without load,
- the tyre sizes,
- the inflation pressure of the spare wheel,
- the paint colour code.

i The tyre pressures must be checked when the tyres are cold, at least once a month.

🍀 Low tyre pressures increase fuel consumption.

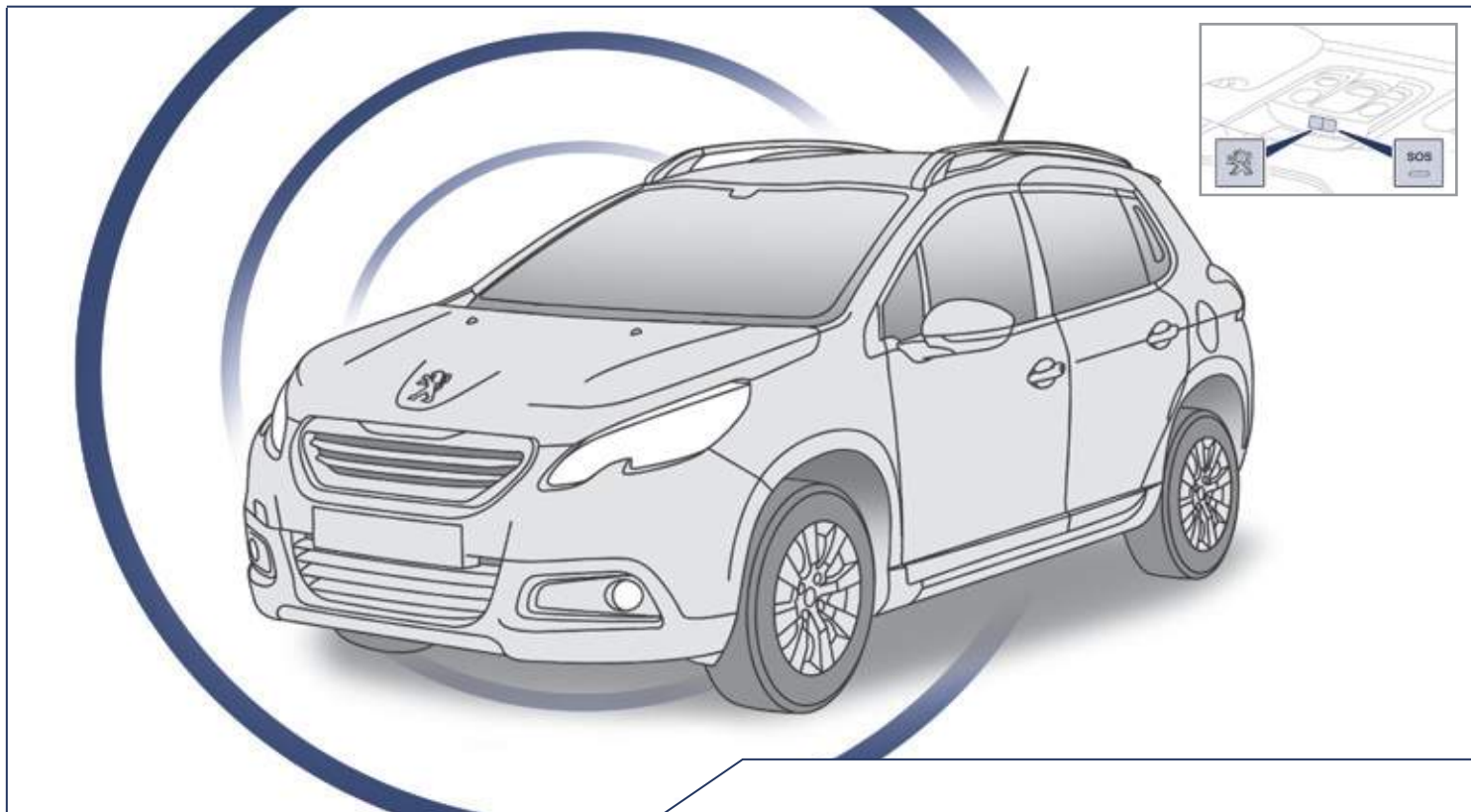

EMERGENCY OR ASSISTANCE CALL

EMERGENCY OR ASSISTANCE CALL

PEUGEOT Connect SOS



In an emergency, press this button for more than 2 seconds. Flashing of the green LED and a voice message confirm that the call has been made to the "PEUGEOT Connect SOS" centre*.

The green LED remains on (without flashing) when communication is established. It goes off at the end of communication.

Pressing this button again immediately cancels the request. The green LED goes off. Cancellation is confirmed by a voice message

To cancel a call, tell the "PEUGEOT Connect SOS" call centre that the call was a mistake.

"PEUGEOT Connect SOS" immediately locates your vehicle, starts communication with you in your language**, and where necessary sends the appropriate public emergency services**. In countries where the service is not available, or when the locating service has been expressly declined, the call sent directly to the emergency services (112) without the vehicle location .

 If an impact is detected by the airbag control unit, and independently of the deployment of any airbags, an emergency call is made automatically.

* Subject to the general conditions for the service available from dealers and to technological and technical limitations.

** Depending on the geographical cover of "PEUGEOT Connect SOS", "PEUGEOT Connect Assistance" and the official national language selected by the owner of the vehicle.

The list of countries covered and PEUGEOT CONNECT services is available from dealers or at www.peugeot.co.uk.

PEUGEOT Connect Assistance



Press this button for more than 2 seconds to request assistance if the vehicle breaks down. A voice message confirms that the call has been made**.

Pressing this button again immediately cancels the request. The cancellation is confirmed by a voice message.

Operation of the system



When the ignition is switched on, the green LED comes on for 3 seconds indicating that the system is operating correctly.



If the orange LED flashes: there is a system fault.

If the orange LED is on continuously: the backup battery must be replaced.

In either case, contact a PEUGEOT dealer.

If you purchased your vehicle outside the PEUGEOT dealer network, we invite you to have a dealer check the configuration of these services and, if desired, modified to suit your wishes. In a multi-lingual country, configuration is possible in the official national language of your choice.

For technical reasons and in particular to improve the quality of "PEUGEOT CONNECT services" services to customers, the manufacturer reserves the right to carry out updates to the vehicle's on-board telematic system.



7-inch Touch screen

GPS satellite navigation system

Multimedia audio system

Bluetooth® telephone



The system is protected in such a way that it will only operate in your vehicle.



For safety reasons, the driver must carry out operations which require prolonged attention while the vehicle is stationary.

When the engine is switched off and to prevent discharging of the battery, the system switches off following the activation of the energy economy mode.

CONTENTS

01	General operation	p. 224
02	First steps - Control panel	p. 226
03	Steering mounted controls	p. 227
04	Media	p. 228
05	Navigation	p. 246
06	Configuration	p. 266
07	Connected services	p. 276
08	Telephone	p. 278
	Frequently asked questions	p. 288

01 GENERAL OPERATION



"Navigation"

allows settings for navigation and the choice of a destination.



"Connected services"

allows connection to an applications portal to facilitate, make safe and personalise journeys by means of a connection key available on subscription from a PEUGEOT dealer.



"Media"

allows selection of a radio station, the various music sources and the display of photographs.



"Configuration"

allows sound settings, the color schemes and the brightness of instruments and controls to be adjusted and gives access to the interactive help for the main vehicle systems and warning lamps.



"Driving assistance"

allows access to the trip computer and certain vehicle functions to be activated, deactivated and adjusted.



"Telephone"

allows the connection of a mobile telephone via Bluetooth.

* Depending on equipment.

01 GENERAL OPERATION

Use the buttons to the left of the touch screen for access to the menu carousels, then press the virtual buttons in the touch screen.

Each menu is displayed in one or two pages (primary page and secondary page).

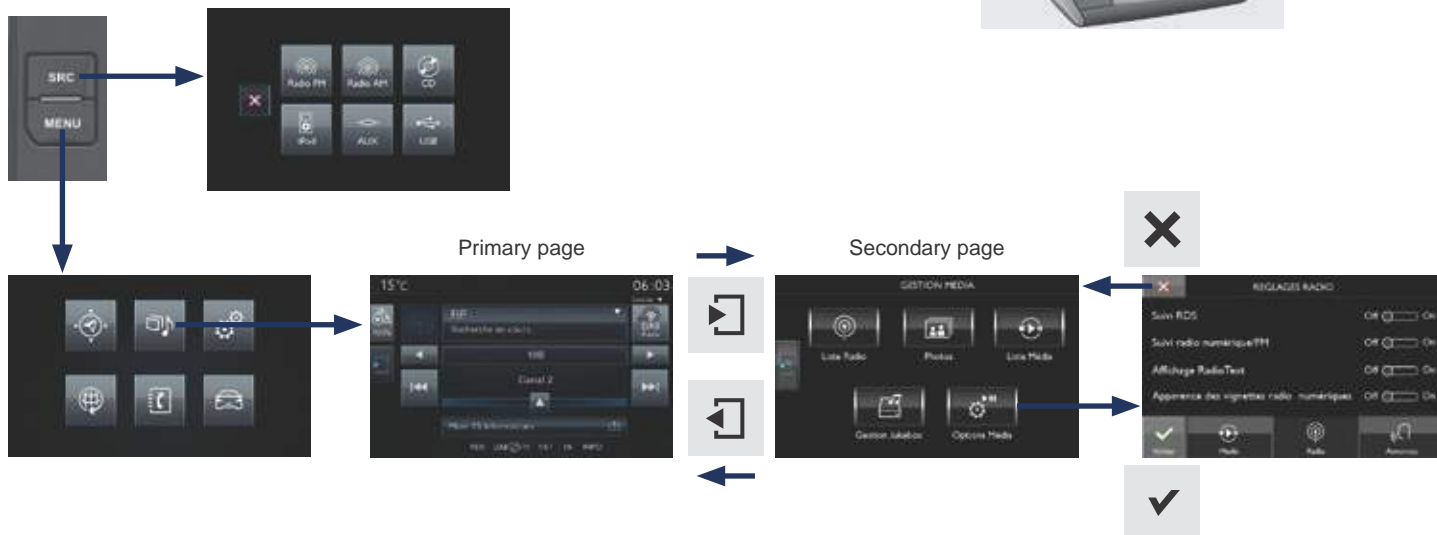

In very hot conditions, the system may go into stand-by (screen and sound completely off) for a minimum period of 5 minutes.

02 FIRST STEPS

With the engine running, press to mute the sound.

With the ignition off, press to switch the system on.

Volume adjustment (each source is independent, including Traffic announcements (TA) and navigation instructions).



Short-cuts: using the touch buttons in the upper band of the touch screen, it is possible to go directly to the selection of audio source, the list of stations (or titles, depending on the source).



Following prolonged operation in sunny conditions, the volume may be limited to protect the system. The return to normal takes place when the temperature in the passenger compartment drops.

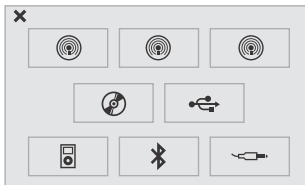

Selecting the audio source (depending on version):

- "FM" / "AM" / "DAB"* stations.
- "USB" memory stick.
- CD player (located in the glove box)*.
- Jukebox*, after first copying audio files to the internal memory of the touch screen tablet.
- Telephone connected by Bluetooth* and audio streaming Bluetooth* (streaming).
- Media player connected to the auxiliary socket (jack, cable not supplied).



The screen is of the "resistive" type, it is necessary to press firmly, particularly for "flick" gestures (scrolling through a list, moving the map...). A simple wipe will not be enough. Pressing with more than one finger is not recognised.

The screen can be used when wearing gloves. This technology allows use at all temperatures.



To clean the screen, use a soft non-abrasive cloth (spectacles cloth) without any additional product.

Do not use pointed objects on the screen.

Do not touch the screen with wet hands.

* Depending on equipment.

03 STEERING MOUNTED CONTROLS

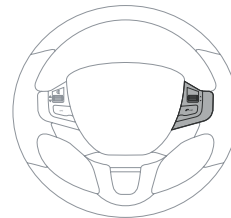
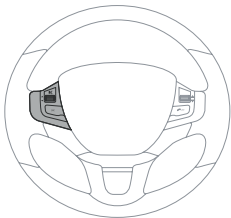

		- Press: mute / restore sound.
		- Increase volume.
		- Decrease volume.
		- Press: change the audio source: Radio, Media.

		- Rotation. Radio: automatic selection of next / previous frequency. Media: previous / next track. Menus: movement
		- Press. Radio: pre-set radio stations. Menus: confirm. Audio source: confirm selection
		- Incoming call: answer call. - Call in progress: Telephone menu (contacts, call log). End call.
		- Radio: display the list of stations. Media: display the list of albums / tracks.

04 MEDIA



Level 1

Level 2

Level 3

 **"Media"**
Primary page

















List of FM stations

<input type="checkbox"/>	<input type="text"/>
<input type="checkbox"/>	<input type="text"/>
<input type="checkbox"/>	<input type="text"/>
<input type="checkbox"/>	<input type="text"/>
<input type="checkbox"/>	<input type="text"/>
<input type="checkbox"/>	<input type="text"/>

Station Selection Panel









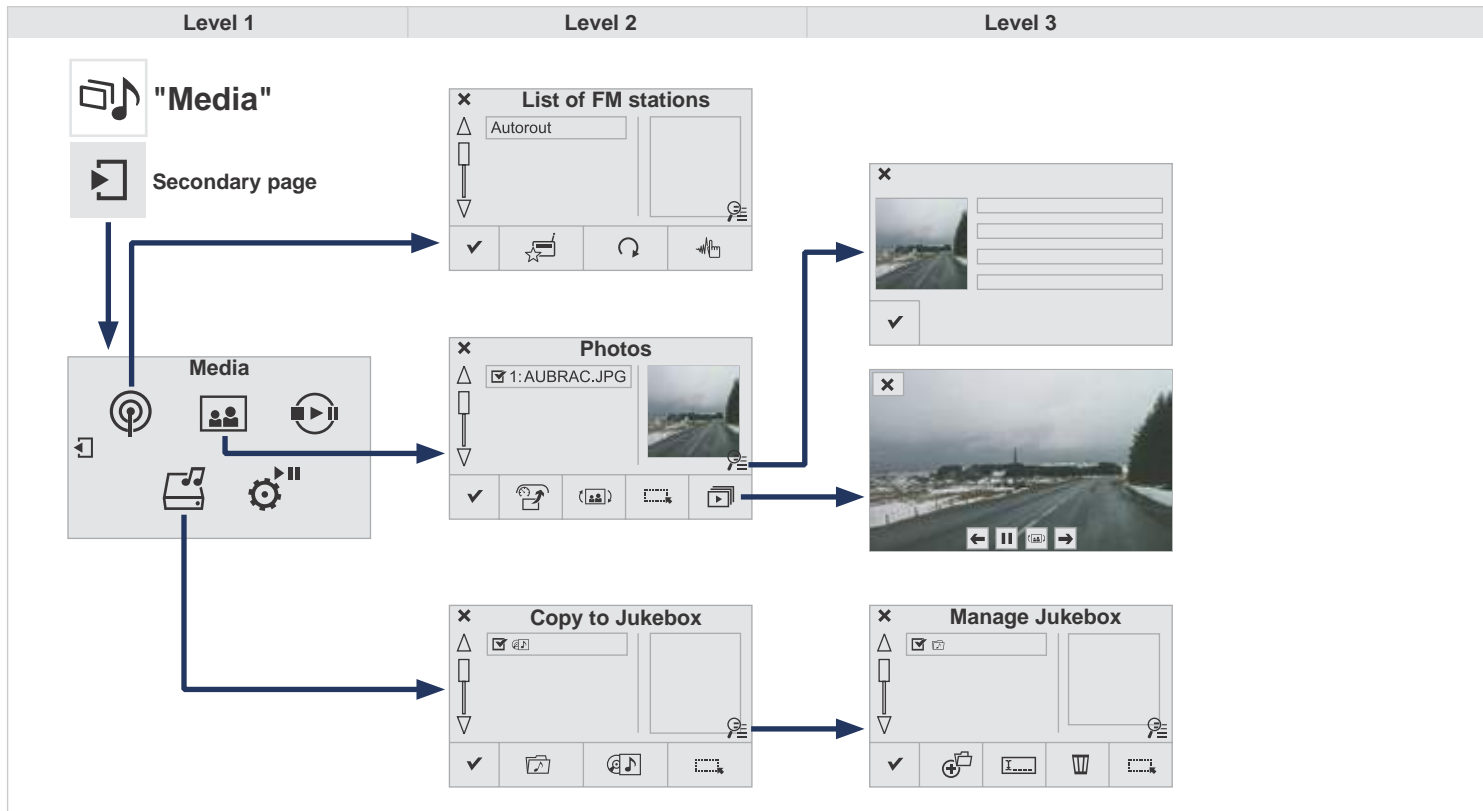





















Preset

<input type="checkbox"/>	<input type="checkbox"/>	<input type="checkbox"/>	
<input type="checkbox"/>	<input type="checkbox"/>	<input type="checkbox"/>	
<input type="checkbox"/>	<input type="checkbox"/>	<input type="checkbox"/>	
<input type="checkbox"/>	<input type="checkbox"/>	<input type="checkbox"/>	

Level 1		Level 2		Level 3	Comments
 	Media ↓ List →		List of FM stations		Press on a radio station to select it.
 	Media ↓ Source →	 <small>Radio FM</small>	FM Radio		Select change of source
		 <small>Radio DAB</small>	DAB Radio		
		 <small>Radio AM</small>	AM Radio		
			Jukebox		
			CD		
			USB		
			iPod		
			Bluetooth		
			AUX		
 	Media ↓ Preset →				Pres an empty location to Preset it.









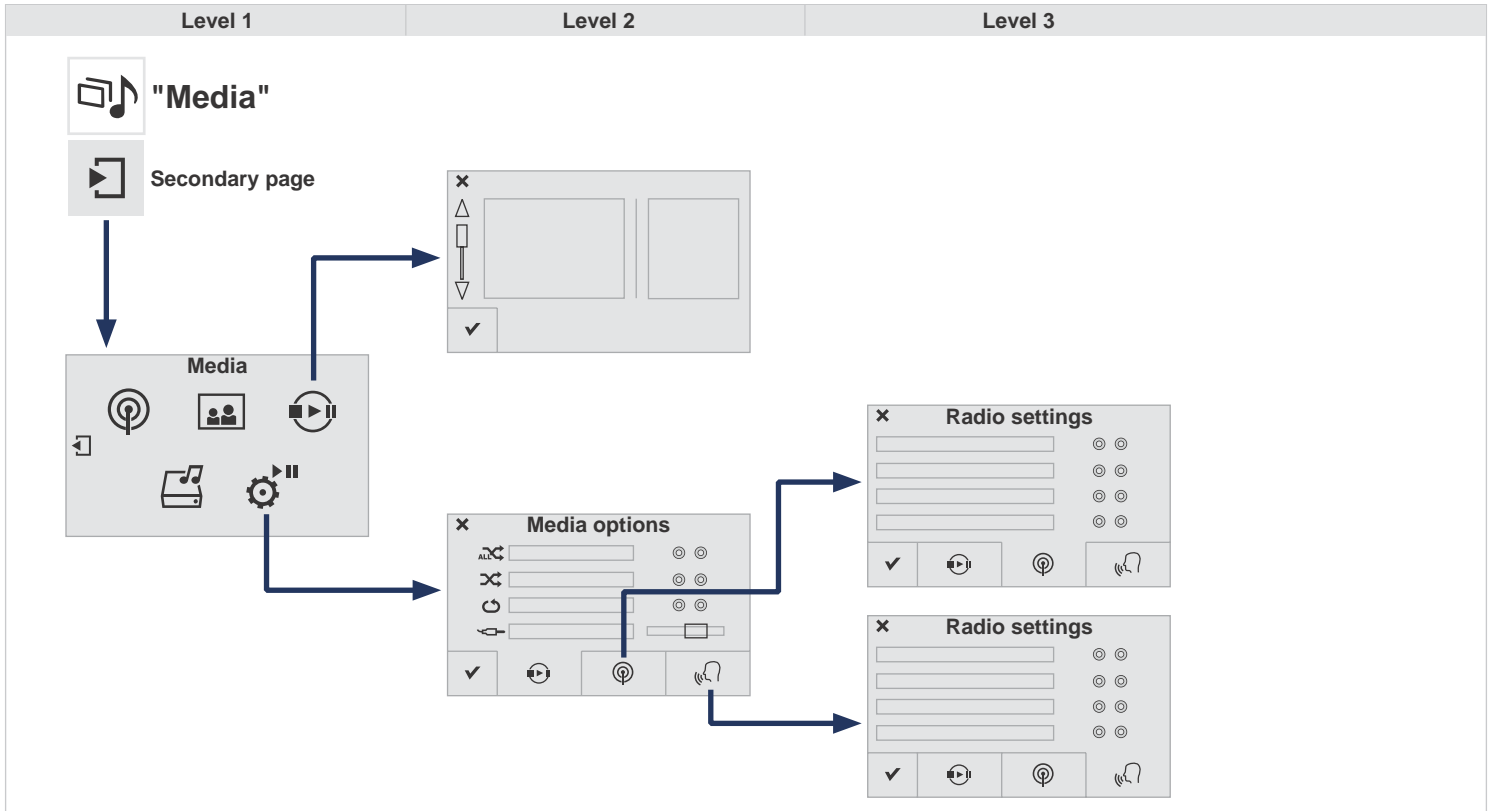





04 MEDIA



Level 1		Level 2		Level 3		Comments	
  	Media ↓ Secondary page ↓ Radio list →	 Preset				Press a radio station to select it.	
		 Update list				Update the list of stations received.	
		 Frequency				Enter the desired radio frequency.	
		 Confirm				Save the settings.	
  	Media ↓ Secondary page ↓ Photos →	 Page selection				Display the selected photo full screen.	
		 Rotate				Rotate the photo 90°.	
		 Select all				Select all the photos in the list. Press again to deselect.	
		 Slideshow	 Previous photo.	 Pause / Play.	 Next photo.		Display the photos in sequence, full screen.
		 Confirm					Save the settings.
  	Media ↓ Secondary page ↓ Manage Jukebox →	 Sort by folder					
		 Sort by album				Choose the selection mode.	
		 Select all					
		 Magnifying glass	 Create folder	 Rename	 Delete	 Select all	Choose the handling mode.
			 Confirm				Save the options.
		 Copy					Save the settings

04 MEDIA



Level 1		Level 2		Level 3		Comments
  	<p>Media</p> <p>↓</p> <p>Secondary page</p> <p>↓</p> <p>Media list</p> <p>→</p>					Presentation of the last media used.
  	<p>Media</p> <p>↓</p> <p>Secondary page</p> <p>↓</p> <p>Media options</p> <p>→</p>		<p>Media</p> <p>↓</p> <p>Media options</p> <p>→</p>	 Random (all tracks):		Choose the play settings.
				 Random (current album):		
				 Loop:		
				 Aux. amplification		
			<p>Radio</p> <p>↓</p> <p>Radio settings</p> <p>→</p>	<input type="checkbox"/> RDS options		Activate or deactivate the options.
				<input type="checkbox"/> DAB/FM options		
				<input type="checkbox"/> Display Radio Text		
				<input type="checkbox"/> DAB radio thumbnails		
				<input type="checkbox"/> Traffic announcements (TA)		
			<p>Announcements</p> <p>↓</p> <p>Radio settings</p> <p>→</p>	<input type="checkbox"/> Weather		Activate or deactivate the options.
				<input type="checkbox"/> Varied - Sport		
				<input type="checkbox"/> Alert settings		
			Confirm			

04 RADIO

Selecting a station

1a Press on **Media** to display the primary page.
or
Press on **Media** to display the primary page
then go to the secondary page.



2a Select "**List**" in the primary page.
or
Select "**Radio list**" in the secondary page.



3a Select a radio station from the list offered.

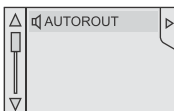

 Select "**Update list**" to refresh the list.



1b Press **Media** to display the primary
page then select "**Preset**".



OR

2b Select a preset radio station in the list.



1 If necessary, select change of source.



2 Select "**FM Radio**" or "**AM Radio**".



! The exterior environment (hills, buildings, tunnel, car park, below ground...) may prevent reception, even in RDS station tracking mode. This phenomenon is normal in the propagation of radio waves and is in no way indicative of a fault with the audio system.

04 RADIO

Changing a radio frequency

1a

Press on **Media** to display the primary page.



2a

By automatic frequency search

Press ◀ or ▶ to move the cursor for an automatic search down or up for a radio frequency.

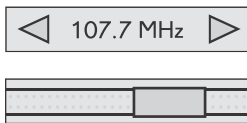

OR

1b

Press on **Media** to display the primary page then press on the secondary page.



2b

Press on "**Enter frequency**" to display the primary page then press on the secondary page.



THEN

3a

Select change source.



3b

Select "**FM Radio**" or "**AM Radio**".



OR

3c

Enter the frequency in full (e.g.: 92.10 MHz) using the keypad then "**Confirm**".



3d

By alphabetical list

Press the current radio band then choose the radio station from the list offered.



04 RADIO

Preset a station

1 Select a radio station or frequency
(refer to the corresponding section).

2 Press on "**Preset**".



3 Select a number in the list to preset the
previously chosen radio station.
A long press on a number presets (memorises)
the station.
Or
A press on this button presets all of the stations
one after the other.

Mémoire 1



Recall pre-set stations

Press on **Media** to display the primary page
then select "**Save**".



04 RADIO

Activate/ Deactivate RDS

1

Press on **Media** to display the primary page then go to the secondary page.



2

Select "**Settings**".



3

Select "**Radio**".



4

Activate/deactivate "**RDS options**".

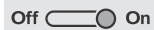

i

RDS, if activated, allows you to continue listening to the same station by automatic retuning to alternative frequencies. However, in certain conditions, coverage of an RDS station may not be assured throughout the entire country as radio stations do not cover 100 % of the territory. This explains the loss of reception of the station during a journey.

04 RADIO

Display of the name of the current station.

Short-cut: access to the choice of audio source and the list of stations (or titles, depending on the source).

Select the radio station.

Any thumbnail broadcast by the station.

Manage the Jukebox.
Display current action.

Secondary page.

Previous "Multiplex".
Previous radio station.

Display the name and number of the multiplex service being used.

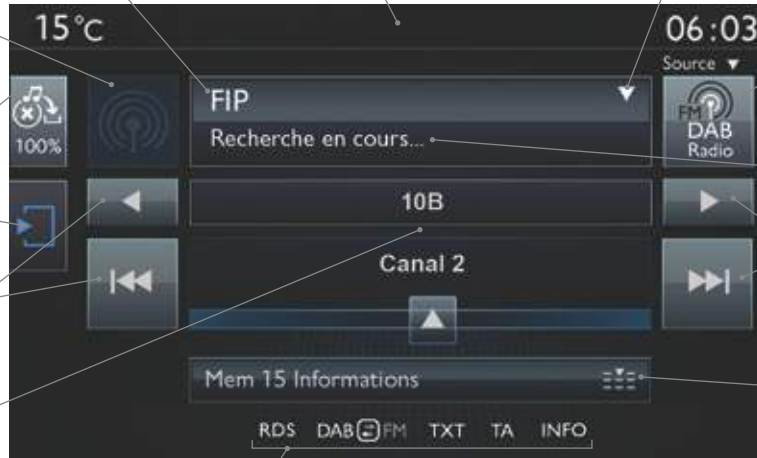

Select the audio source.
Display the "DAB" band.

Display of "Radiotext" for the current station.

Next "Multiplex".
Next radio station.

Preset stations, buttons 1 to 15
Short press: select the preset radio station.
Long press: preset a radio station.

Display of options:
if active but not available, the display will be greyed out,
if active and available, the display will be blank.

i If the "DAB" radio station being listened to is not available on "FM", the "DAB FM" option is greyed out.

04 RADIO

DAB (Digital Audio Broadcasting) Digital radio

- ! Digital radio provides higher quality reception and also the graphical display of current information on the radio station being listened to. Select "List" in the primary page.
The range of multiplexes available is displayed in alphabetical order.

1 Press on **Media** to display the primary page.



2 Select change of source.



3 Select "**DAB Radio**".



4 Select "**List**" in the primary page.
or
Select "**Radio list**" in the secondary page.



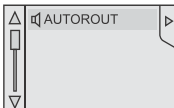

5 Select the radio station from the list offered.



Digital radio - DAB / FM auto tracking

- i "DAB" does not cover 100% of the territory.
When the digital radio signal is weak, "DAB / FM auto tracking" allows you to continue listening to the same station, by automatically switching to the corresponding "FM" analogue station (if there is one).

1 Press **Media** to display the primary page then press on the secondary page.



2 Select "**Settings**".



3 Select "**RADIO**".



4 Select "**Digital/FM auto tracking**" then "**Confirm**".



- i If "DAB / FM auto tracking" is activated, there is a difference of a few seconds when the system switches to "FM" analogue radio with sometimes a variation in volume.
When the digital signal is restored, the system automatically changes back to "DAB".

- ! If the "DAB" station being listened to is not available on "FM" ("**DAB/FM**" option greyed out), or "DAB / FM auto tracking" is not activated, the sound will cut out while the digital signal is too weak.

04 MUSIC

CD, MP3 CD, USB player, auxiliary input



Insert the CD in the player, insert the USB memory stick in the USB player or connect the USB peripheral to the USB port using a suitable cable (not supplied).

The system builds playlists (in temporary memory), an operation which can take from a few seconds to several minutes at the first connection.

Reduce the number of non-music files and the number of folders to reduce the waiting time.

The playlists are updated every time the ignition is switched off or connection of a USB memory stick. However, the system memorises these lists and if they are not modified, the loading time will be shorter.



Selection of source

- 1 Press on **Media** to display the primary page.
- 2 Select change of source then choose the source.



The steering mounted **SRC** (source) button can be used to go to the next media source, available if the source is active. Press **OK** to confirm the selection.

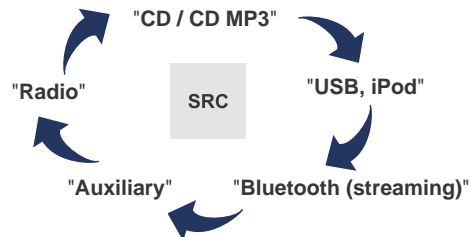

04 MUSIC

CD, MP3 CD / USB player

Information and advice



The audio equipment will only play audio files with ".wma, .aac, .flac, .ogg and .mp3" file extensions and with a bit rate of between 32 Kbps and 320 Kbps.

It also supports VBR (Variable Bit Rate) mode.

No other type of file (.mp4, ...) can be played.

WMA files must be of the standard wma 9 type.

The sampling rates supported are 11, 22, 44 and 48 KHz.



It is advisable to restrict file names to 20 characters, without using of special characters (e.g.: " " ? ; ù) to avoid any playing and displaying problems.



In order to be able to play a recorded CDR or CDRW, when recording it is preferable to select the ISO 9660 level 1, 2 or Joliet standard.

If the disc is recorded in another format it may not be played correctly.

It is recommended that the same recording standard is always used for an individual disc, with as low a speed as possible (4x maximum) for optimum sound quality.

In the particular case of a multi-session CD, the Joliet standard is recommended.



The system supports USB mass storage devices, BlackBerry® devices or Apple® players via USB ports. The adaptor cable not supplied.

Control of the peripheral device is with the audio system controls.

Other peripherals, not recognised on connection, must be connected to the auxiliary socket using a Jack cable (not supplied).



Use only USB memory sticks formatted FAT 32 (28-bit file allocation table).







The system does not support two identical devices connected at the same time (two memory sticks, two Apple® players) but it is possible to connect one memory stick and one Apple® player at the same time.







It is recommended that official Apple® USB cables are used to ensure correct operation.

04 MUSIC

Selecting a track to play

Previous track.	
Next track.	
Previous folder.	
Next folder.	
Pause.	

List of USB or CD tracks and folders.	
Up or down in the list.	
Confirm, next menu level.	
Up one menu level.	

04 MUSIC

Connecting APPLE® players

- 1 Connect the Apple® player to one of the USB ports using a suitable cable (not supplied).
Play starts automatically.



- 2 Control is via the audio system.

i The classifications available are those of the portable device connected (artists / albums / genres / playlists / audiobooks / podcasts).
The default classification used is by artist. To modify the classification used, return to the first level of the menu then select the desired classification (playlists for example) and confirm to go down through the menu to the desired track.

i Copies of photos and album artwork are not compatible with the audio system. These appear only with a USB memory stick.

! The version of software in the audio system may not be compatible with the generation of your Apple® player.

Audio streaming



Streaming allows audio files on your telephone to be played via the vehicle's speakers.

- 1 Connect the telephone: see the "**Telephone**" section, then "**Bluetooth**".
Choose the "**Audio**" or "**All**" profile.

- 2 If play does not start automatically, it may be necessary to start the audio playback from the telephone.
Control is from the peripheral device or by using the audio system buttons.

! Once connected in streaming mode, the telephone is considered to be a media source.
It is recommended that you activate "**Repeat**" on the Bluetooth peripheral.

04 MUSIC

Using the auxiliary input (AUX) (cable not supplied)

- 1 Connect the portable device (MP3 player...) to the auxiliary JACK socket using an audio cable.



- 2 Select **Media** to display the primary page.



- 3 Select change the source.



- 4 Select the **AUXILIARY** source.



- i** First adjust the volume of your portable device (to a high level). Then adjust the volume of your audio system. Display and management of the controls are via the portable device.

04 MUSIC

Managing the Jukebox

1

Connect the device (MP3 player...) to the USB port or auxiliary socket using a suitable audio cable.

i

When no audio file is copied to the system with a capacity of 8GB, all of the Jukebox function symbols are greyed and are not available.

2

Select "**Media list**".



3

Select copy "**Copy Jukebox**".



4

Select "**Sort by folder**" or "**Sort by album**".



5

Select the magnifying glass to enter the folder or album and select audio file by audio file.



6

Select "**Confirm**" then "**Copy**".



7

Select "**New folder**" to create a folder structure in the Jukebox or select "**Keep structure**" to retain the structure from the device.











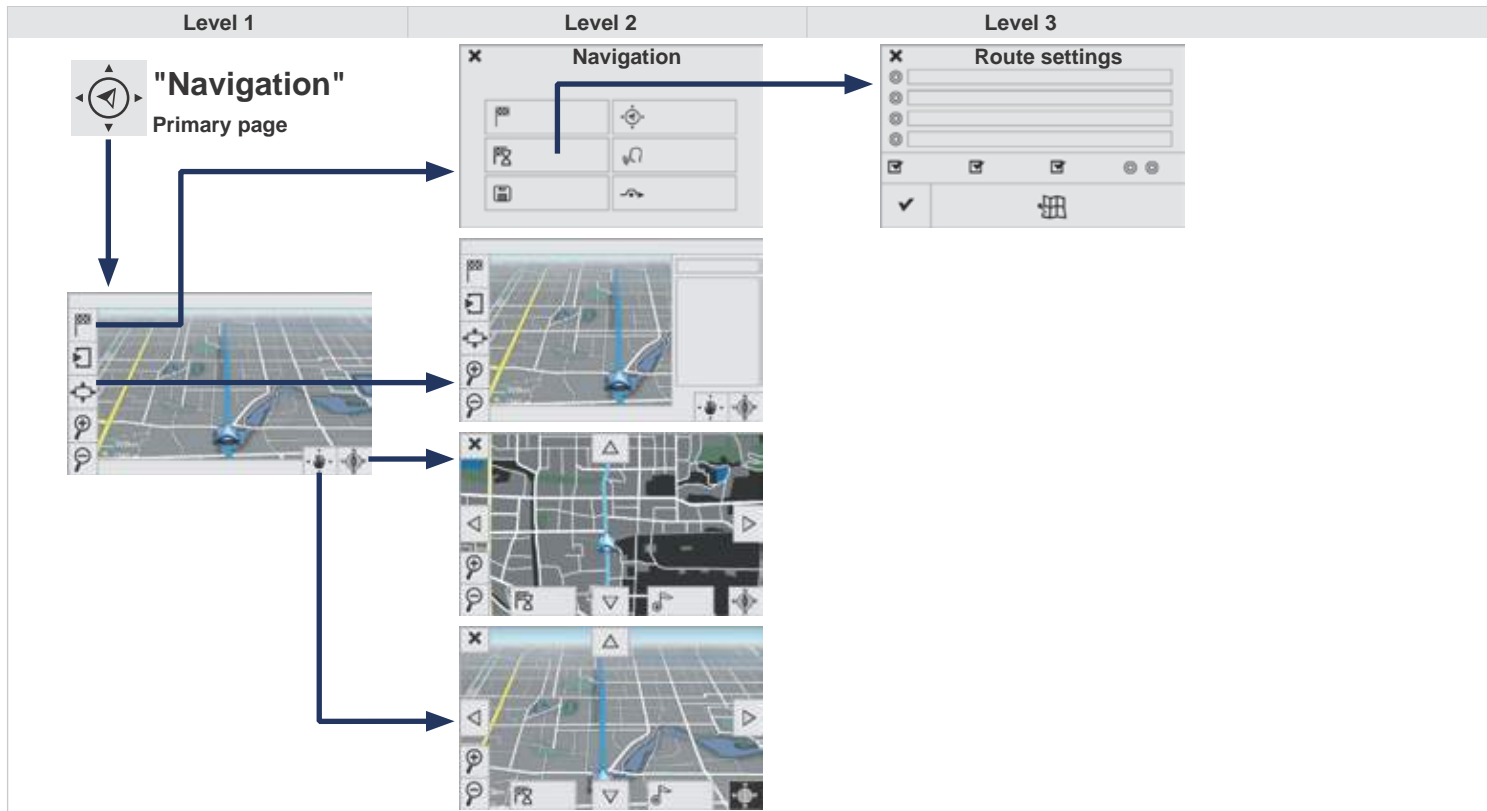







8

While copying the system returns to the primary page; you can go back to the copy view at any time by selecting this button.



05 NAVIGATION







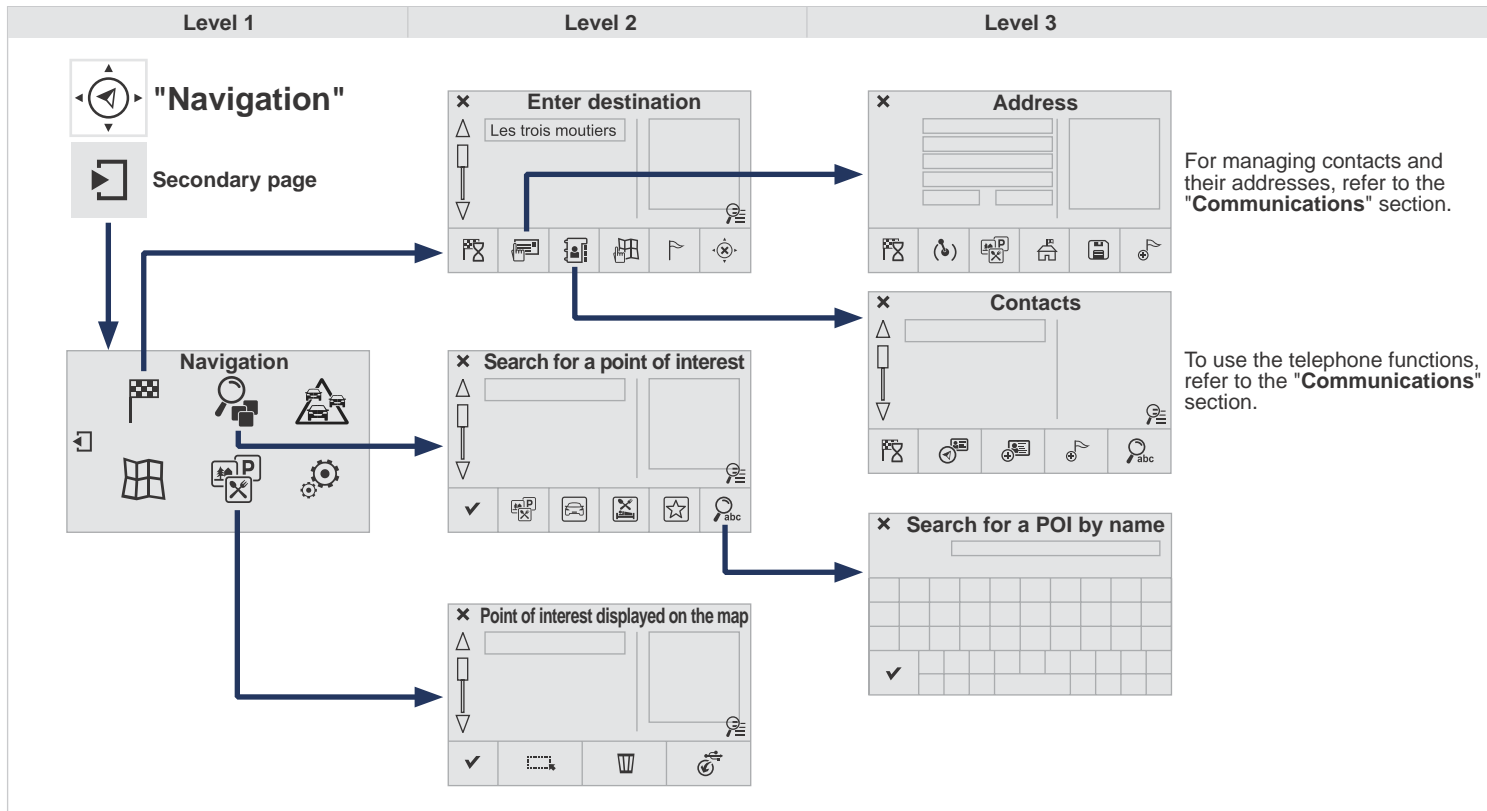































Level 1		Level 2		Level 3		Comments	
  <p style="text-align: center;"> Navigation ↓ Settings Navigation → </p>		Enter destination				Display recent destinations	
			Calculatory criteria		<input type="radio"/>	Fastest	Choose the navigation criteria. The map displays the route chosen according to these criteria.
					<input type="radio"/>	Shortest	
					<input type="radio"/>	Time/distance	
					<input type="radio"/>	Ecological	
					<input checked="" type="checkbox"/>	Tolls	
					<input checked="" type="checkbox"/>	Ferries	
					<input type="checkbox"/>	Strict - Close	
						Show route on map	
				<input checked="" type="checkbox"/>	Confirm	Save the options.	
			Save			Save the current address.	
			Stop navigation			Delete the navigation information.	
			Voice			Choose the volume for voice and announcement of street names.	
			Diversion			Detour from your initial route by a certain distance.	
	Navigation				Display in text mode		
					Zoom in.		
					Zoom out.		
						Display in full screen mode. Use the arrows to move the map.	
							Switch to 2D map.

05 NAVIGATION











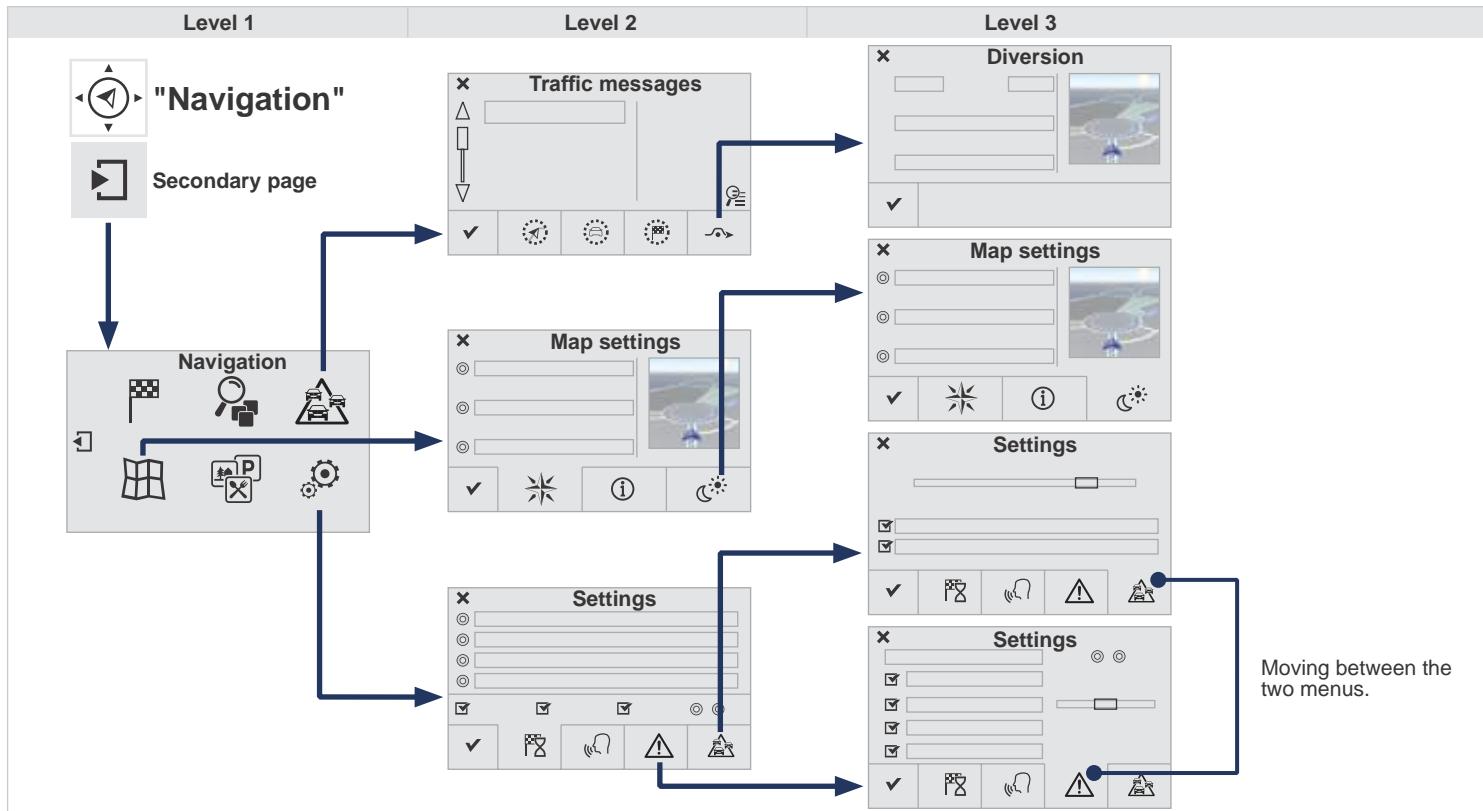











For managing contacts and their addresses, refer to the "Communications" section.

To use the telephone functions, refer to the "Communications" section.

Level 1		Level 2		Level 3		Comments	
  	<p>Navigation</p> <p>↓</p> <p>Secondary page</p> <p>↓</p> <p>Enter destination</p> <p>→</p>		Address		Curr. location	Address settings	
					Points of Interest		
					Town centre		
					Save		Save the current address.
					Add waypoint		Add a waypoint to the route.
			Navigate to	Press to calculate the route.			
			Contacts		Addresses	Select a contact then calculate the route.	
					Add contact		
					Add waypoint		
					Search for contact		
	Navigate to						
	From map		Display the map and zoom to view the roads.				
	Itinerary		Create, add or delete a waypoint or view the itinerary.				
	Stop		Delete navigation information.				
	Navigate to		Press to calculate the route.				
  	<p>Navigation</p> <p>↓</p> <p>Secondary page</p> <p>↓</p> <p>Search for a point of interest</p> <p>→</p>		All POIs	List of categories available. After choosing the category, select the points of interest.			
			Garage				
			Dining/hotels				
			Personal				
			By name				
			Search		Save the settings.		
  	<p>Navigation</p> <p>↓</p> <p>Secondary page</p> <p>↓</p> <p>Display point of interest</p> <p>→</p>		Select all	Choose the display settings for POIs.			
			Delete				
			Import POIs				
			Confirm		Save the options.		

05 NAVIGATION



Level 1		Level 2		Level 3		Comments	
  	<p>Navigation ↓ Secondary page ↓ Traffic messages →</p>	 On the route				Settings for the choice of messages and the filter radius.	
		 Around vehicle					
		 Near destination					
		 Detour	<input type="radio"/>	Detour over a distance			
		<input checked="" type="checkbox"/> Finish		<input type="radio"/>	Recalculate route		
  	<p>Navigation ↓ Secondary page ↓ Map settings →</p>	 Orientation	<input type="radio"/>	Flat view north heading		Choose the display and orientation of the map.	
			<input type="radio"/>	Flat view vehicle heading			
			<input type="radio"/>	Perspective view			
		 Maps					
		 Aspect	<input type="radio"/>	"Day" map colour			
			<input type="radio"/>	"Night" map colour			
	<input type="radio"/>	Automatic day/night					
<input checked="" type="checkbox"/> Confirm					Save the settings.		
  	<p>Navigation ↓ Secondary page ↓ Settings →</p>	 Route settings				Enter settings and choose the volume for the voice and announcement of street names.	
		 Voice					
		 Alert!					
		 Traffic options					
		<input checked="" type="checkbox"/> Confirm					Save the options.

05 NAVIGATION - GUIDANCE

Choosing a new destination

Towards a new destination

1

Press on **Navigation** to display the primary page then go to the secondary page.



2

Select **"Enter destination"**.



3

Select **"Address"**.



4

Select the **"Country:"** from the list offered then in the same way:
the **"City:"** or its post code, the **"Road:"**, the **"N°:"**. Confirm each time.

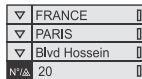



Select **"Save"** to save the address entered as a contact entry.
The system allows up to 200 entries.



5

Select **"Navigate to"**.



6

Choose the navigation criteria: **"Fastest"** or **"Shortest"** or **"Time/distance"** or **"Ecological"**.



7

Choose the restriction criteria: **"Include tollroads"**, **"Include ferries"**, **"Traffic"**, **"Strict"**, **"Close"**.



8

Select **"Confirm"** or press **"Show route on map"** to start navigation guidance.



i

To delete navigation information, press on **"Settings"** then **"Stop navigation"**.



To restore the navigation information press on **"Settings"** then **"Resume navigation"**.



05 NAVIGATION - GUIDANCE

Towards a recent destination

1

Press on **Navigation** to display the primary page then go to the secondary page.



2

Select "**Enter destination**".



3

Select an address from the list offered.

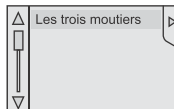

4

Select "**Navigate to**".
Select the criteria then "**Confirm**" or press "**Show route on map**" to start guidance.



Towards a contact

i

Navigation towards a contact imported from a telephone is only possible if the address entered is compatible with the system.

1

Press on **Navigation** to display the primary page then go to the secondary page.



2

Select "**Enter destination**".



3

Select "**Contacts**".



4

Select a destination from the contacts in the list offered.

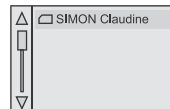

5

Select "**Navigate to**".
Select the criteria then "**Confirm**" to start guidance.



05 NAVIGATION - GUIDANCE

Towards GPS coordinates

1 Press on **Navigation** to display the primary page then go to the secondary page.



2 Select "**Enter destination**".



3 Select "**Address**".



4 Enter the "**Longitude:**" then the "**Latitude:**".

6°54'689"

5 Select "**Navigate to**".
Select the criteria then "**Confirm**" or press "**Show route on map**" to start guidance.



Towards a point on the map

1 Press on **Navigation** to display the primary page then go to the secondary page.



2 Select "**Enter destination**".



3 Select "**From map**".



4 Zoom in on the map then select the point.



 A long press displays the surrounding tourist attractions.

05 NAVIGATION - GUIDANCE

Towards points of interest (POI)

Points of Interest (POI) show all of the locations of services nearby (hotels, retail outlet, airports, ...).

1

Press on **Navigation** to display the primary page then go to the secondary page.



2

Select "**Search for a point of interest**".



3

Select "**All POIs**" or "**Garage**" or "**Dining/hotels**" or "**Personal**" or "**By name**".

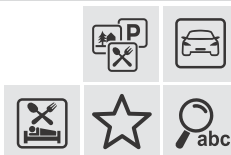

4

Select a category from the list offered.



5

Select "**Search**".



6

Select a point of interest from the list offered.

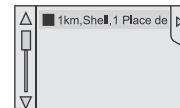

7

Select "**Navigate to**".



i

An annual mapping update allows new points of interest to be presented to you.
You can also update the Risk areas / Danger areas every month.
The detailed procedure is available on:
<http://peugeot.navigation.com>.

05 NAVIGATION - GUIDANCE

Towards points of interest (POI)

1

Press on **Navigation** to display the primary page then go to the secondary page.



2

Select "**Show POIs**".



3

Select a category from the list offered then "**Confirm**".



05 NAVIGATION - GUIDANCE

Risk area / Danger zone alert settings

1

Press on **Navigation** to display the primary page then go to the secondary page.



2

Select "**Settings**".



3

Select "**Alert config.**".



4

It is then possible to activate Risk Areas alerts then:

- "Audible warning"
- "Alert only when navigating"
- "Alert only for overspeed"
- "Display speed limits"
- Timing: the choice of timing allows the time before giving a Risk Area alert to be defined.

5

Select "**Confirm**".



!

These functions are only available if Risk Areas have been downloaded and installed on the system.

05 NAVIGATION - GUIDANCE

Adding a waypoint

- 1 Press on **Navigation** to display the primary page then go to the secondary page.



- 2 Select **"Enter destination"**.



- 3 Select **"Itinerary"**.



- 4 Select **"Add waypoint"** then **"Address"**.



- 5 The address of the waypoint is entered in the same way as a destination, so enter the **"City:"** or post code, the **"Road:"** and the **"N°:"**. Confirm each time. Then select **"Add waypoint"**.

▼	FRANCE	
▼	PARIS	
▼	Blvd Hossein	
N°/A	20	



- 6 Select **"Navigate to"**.
Select the criteria then **"Confirm"** to start guidance and give the general direction of the navigation route.



Organising waypoints

- 4 To organise waypoints, carry out the previous operations 1 to 3 again (Adding a waypoint).

- 5 Select the waypoint that you want to move in the order.

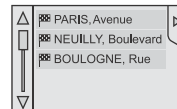

- 6a Select **"Up"**.



- 6b Select **"Down"**.



- 6c Select **"Delete"**.



- Select **"Road map"** to view the changes made to the route.



05 NAVIGATION - GUIDANCE

Route options

Calculation criteria

1

Press **Navigation** to display the primary page then go to the secondary page.



2

Select "**Settings**".



3

Select "**Criteria**".



4

It is then possible to choose:

- the navigation criteria: "**Fastest**", "**Shortest**", "**Time/distance**", "**Ecological**".
- the exclusion criteria: "**Include tollroads**", "**Include ferries**", "**Traffic**", "**Strict**", "**Close**".

5

Select "**Confirm**".



!

The ecological calculation is based on mapping data but this may not always be correct.

05 TRAFFIC

Traffic information

Display of messages

- 1 Press on **Navigation** to display the primary page then go to the secondary page.



- 2 Select "**Traffic messages**".



- 3 Set the "**On the route**", "**Around**", "**Near destination**" filters to fine-tune the list. Press again to remove the filter.



- 4 Select the message from the list offered. Select the magnifying glasses to have the information spoken.



- i TMC (Traffic Message Channel) messages on GPS-Navigation contain traffic information transmitted in real time.

Setting filters

- 1 Press on **Navigation** to display the primary page then go to the secondary page.



- 2 Select "**Settings**".



- 3 Select "**Info option**".



- 4 Select:
- "**Warn of new messages**",
- "**Speak messages**",
Then enter the filter radius.



- 5 Select "**Confirm**".



- i We recommend a filter radius of:
- 12 miles (20 km) in urban areas,
- 30 miles (50 km) on motorways.

05 TRAFFIC

Main traffic symbols

1 Red and yellow triangle: traffic information, for example:



2 Black and blue triangle: general information, for example:

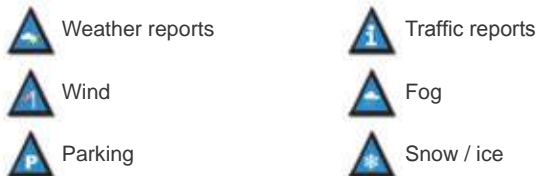

Receiving TA messages

1 Press on **Navigation** to display the primary page then go to the secondary page.



2 Select "**Settings**".



3 Select "**Voice**".



4 Activate / Deactivate "**Traffic (TA)**".



i The TA (Traffic Announcement) function gives priority to TA alert messages. To operate, this function needs good reception of a radio station transmitting this type of message. When a traffic report is transmitted, the current audio source (Radio, CD, USB, ...) is interrupted automatically to play the TA message. Normal playback of the audio source resumes at the end of the transmission of the message.

05 TRAFFIC

Diverting from a route

1

Press on **Navigation** to display the primary page then go to the secondary page.



2

Select "**Traffic messages**".



3

Select "**Diversion**".



4

Select the diversion distance by pressing **+** or **-**.



5

Select "**Recalculate route**". The route will be modified in time and distance.

+183 km +00:20

6

Select "**Confirm**".



The route may be diverted following the reception of a traffic information message.

05 MAP

Map settings

Map orientation

1

Press on **Navigation** to display the primary page then go to the secondary page.



2

Select "**Map settings**".



3

Select "**Orientation**".



4

Select:

- "**Flat view north heading**" to keep the map always North up,
- "**Flat view vehicle heading**" to have the map follow the direction of travel,
- "**Perspective view**" to display a perspective view.



5

Select "**Confirm**" to save the modifications.



05 MAP

Configure

1

Press on **Navigation** to display the primary page then go to the secondary page.



2

Select **"Map settings"**.



3

Select **"Aspect"**.



4

Select:

- **"Day" map colour** to have the map always in day mode.
- **"Night" map colour** to have the map always in night mode.
- **"Automatic day/night"** to have the brightness of the map adjusted automatically according to the ambient light level.



This mode makes use of the vehicle's sunshine sensor or by manual operation of the vehicle's lighting.

5

Then **"Confirm"** to save the modifications.



Street names are visible on the map from the 100 m scale.

05 SETTINGS

Navigation speech synthesis

Volume / Street names

1

Press on **Navigation** to display the primary page then go to the secondary page.



2

Select "**Settings**".



3

Select "**Voice**".



4

Select "**Voice synthesis**" and/or "**Male voice**" and/or "**Female voice**" and/or "**Speak road names**".











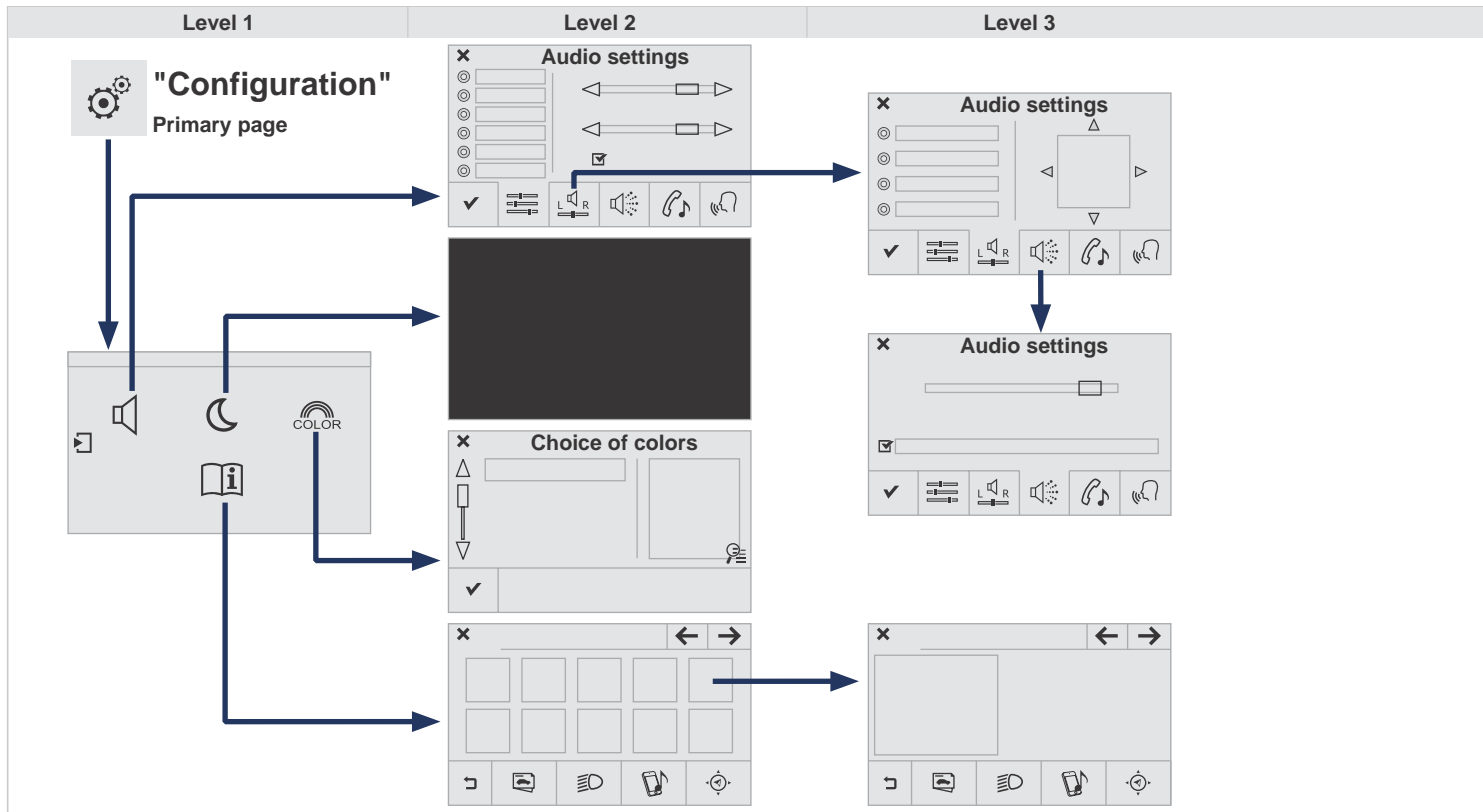















5

Select "**Confirm**" to save the modifications.











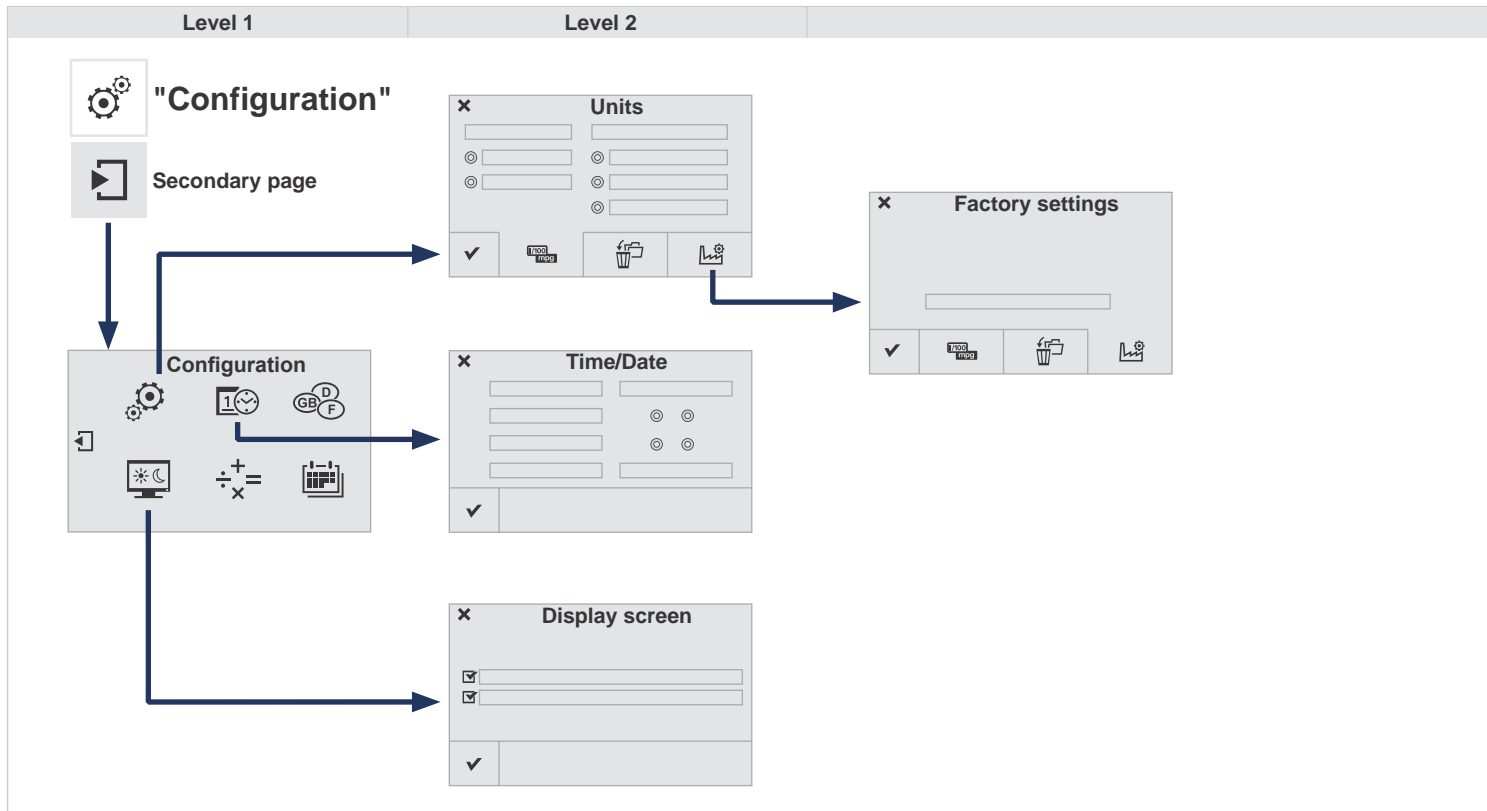



06 CONFIGURATION



Level 1		Level 2		Level 3	Comments
 	Configuration ↓ Audio settings ↓ Audio settings →		Ambience		Choose the sound ambience.
			Balance		Set the position of the sound in the vehicle using the Arkamys® system.
			Sound effects		Choose the volume or activate the link to vehicle speed.
			Ringtones		Choose the telephone ringtone and volume.
			Voice		Choose the volume for the voice and announcement of street names.
			Confirm		Save the settings.
 	Configuration ↓ Turn off screen →				Turns off the display (black screen). pressing the black screen restores the display.
 	Configuration ↓ Color ↓ Choice of color scheme →		Confirm		After choosing the color scheme, save the setting.
 	Configuration ↓ Interactive help →	      	Go back Driving assistance - Equipment Warning lamps Audio Communication Navigation GPS Previous page Next page		Consult the Interactive help.

06 CONFIGURATION



Level 1		Level 2		Comments
  	Configuration ↓ Secondary page ↓ System Settings →	 Units	Set the units used to display distance, fuel consumption and temperature.	
		 Erase data	Select the desired data in the list then press Delete.	
		 Factory settings	Return to factory settings.	
		<input checked="" type="checkbox"/> Confirm	Save the settings.	
  	Configuration ↓ Secondary page ↓ Time/Date →	<input checked="" type="checkbox"/> Confirm	Set the date and time then confirm.	
  	Configuration ↓ Secondary page ↓ Screen settings →	<input checked="" type="checkbox"/> Automatic text scrolling	Make the setting then confirm.	
		<input checked="" type="checkbox"/> Deactivate animations		
		<input checked="" type="checkbox"/> Confirm		







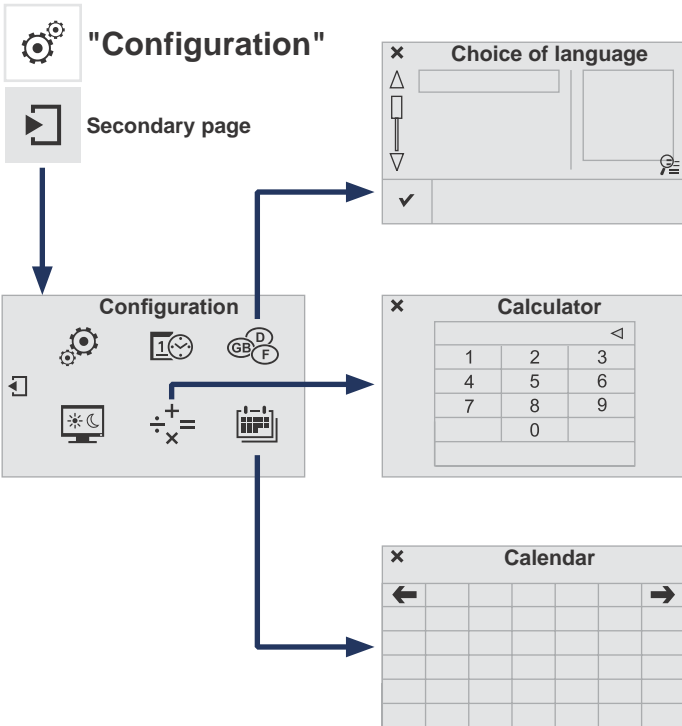

06 CONFIGURATION



Level 1

Level 2



Level 1		Level 2		Comments
  	<p>Configuration</p> <p>↓</p> <p>Secondary page</p> <p>↓</p> <p>Languages</p> <p>→</p>	✓	Confirm	Select the language then confirm.
  	<p>Configuration</p> <p>↓</p> <p>Secondary page</p> <p>↓</p> <p>Calculator</p> <p>→</p>			Select the calculator.
  	<p>Configuration</p> <p>↓</p> <p>Secondary page</p> <p>↓</p> <p>Calendar</p> <p>→</p>			Select the calendar.

06 CONFIGURATION

Audio settings

1 Press on **Configuration** to display the primary page.



2 Select "**Audio settings**".



3 Select "**Ambience**" or "**Balance**" or "**Sound effects**" or "**Ringtones**" or "**Voice**".

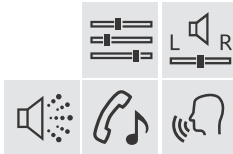

! The distribution (or spatialisation using the Arkamys® system) of sound is an audio process that allows the audio quality to be adapted to the number of listeners in the vehicle. Available only with the 6-speaker configuration.

! The audio settings (**Ambience**, **Bass**, **Treble** and **Loudness**) are different and independent for each sound source. The settings for distribution and balance are common to all sources.

- !
- "**Ambience**" (choice of 6 musical ambiances)
 - "**Bass** "
 - "**Treble** "
 - "**Loudness**" (Activate/Deactivate)
 - "**Balance**", "**Driver**", "**All passengers**", "**Front only** "
 - "**Audio setting on touch screen**"
 - "**Volume linked to vehicle speed:**" (Activate/Deactivate)

i

On-board audio: Arkamys® Sound Staging.

With Sound Staging, the driver and passengers are immersed in an "audio scene" recreating the natural atmosphere of an auditorium: truly a part of the scene and its surroundings.

This new sensation is made possible by software in the audio system which processes the digital signals from the media players (radio, CD, MP3...) without changing the audio settings. This processing takes account of the characteristics of the passenger compartment to produce optimum results.

The Arkamys® software installed in your audio system processes the digital signal from the media players (radio, CD, MP3, ...) and recreates a natural musical scene, with harmonious placement of instruments and voices in the space in front of passengers, level with the windscreen.

06 CONFIGURATION

Colour schemes

1

Press on **Configuration** to display the primary page.



2

Select "**Colour schemes**".



3

Select the colour scheme in the list then "**Confirm**".



i

At each change of colour scheme the touch screen tablet's system restarts, showing a black screen for a few moments.

!

For safety reasons, the procedure for changing the colour scheme is only possible with the vehicle stationary.

Interactive help

1

Press on **Configuration** to display the primary page.



2

Select "**Interactive help**".



i

The interactive version of your user guide available in this touch screen is not intended as a substitute for the more complete content of the printed document.

!

For safety reasons, consultation of your user guide is only possible with the vehicle stationary.

06 CONFIGURATION

System

Modify system settings

- 1 Press on **Configuration** to display the primary page then go to the secondary page.



- 2 Select "**System Settings**".



- 3 Select "**Units**" to change the units of distance, fuel consumption and temperature.



- 4 Select "**Delete data**" to delete the list of recent destinations, personal points of interest, contacts in the list.
Choose the item then select "**Delete**".



- 5 Select "**Factory settings**" to return to the original settings.



- 1 Press on **Configuration** to display the primary page then go to the secondary page.



- 2 Select "**Screen settings**".



- 3 Activate or deactivate "**Activate automatic text scrolling**" and "**Activate animations**".



06 CONFIGURATION

1

Press on **Configuration** to display the primary page then go to the secondary page.



2

Select:

- "**Time/Date**" to change the time zone, synchronisation with GPS, time and its format and then the date.
- "**Languages**" to change the language.
- "**Calculator**" to display a calculator
- "**Calendar**" to display a calendar.



07 CONNECTED SERVICES



Level 1

Level 2



"Connected services"

Primary page:
Driving assistance applications, see following page on "PEUGEOT CONNECT APPS" *.

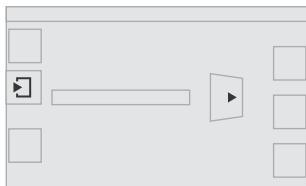

Secondary page:
Internet navigation via Bluetooth telephone Dial-Up Networking (DUN).

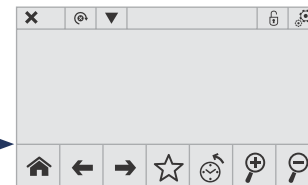
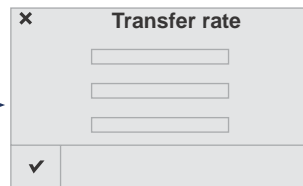
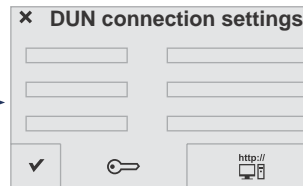
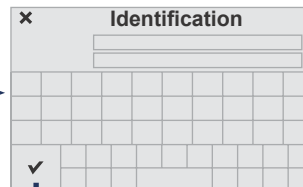

It may be that certain new generation smartphones are not compatible with this standard.

* Depending on country.

07 PEUGEOT CONNECT APPS

! "PEUGEOT CONNECT APPS" is a service providing driving aid applications in real time, that gives access to useful information such as the state of the traffic, danger zones, fuel prices, the availability of parking places, tourist sites, weather conditions, correct addresses...

It includes access to the mobile network associated with the use of these applications. "PEUGEOT CONNECT APPS" is a service available under subscription contract from PEUGEOT dealers, depending on country and the type of touch screen, both before and after delivery of a new vehicle.

1 Plug the "PEUGEOT CONNECT APPS" connection key into the USB port.



2 Press the "Connected services" menu to display the applications.

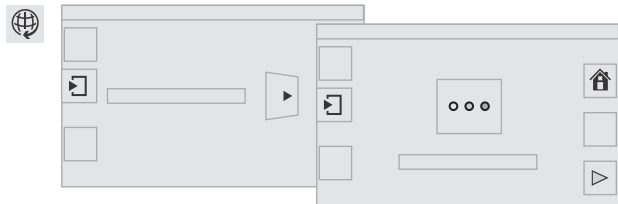

3



These applications use vehicle data such as the current speed, mileage, remaining fuel range or even GPS position to provide pertinent information.

!

For safety reasons, some functions can only be used when stationary.

⚙

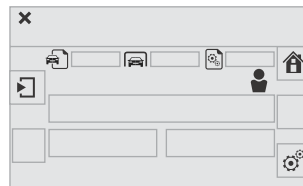









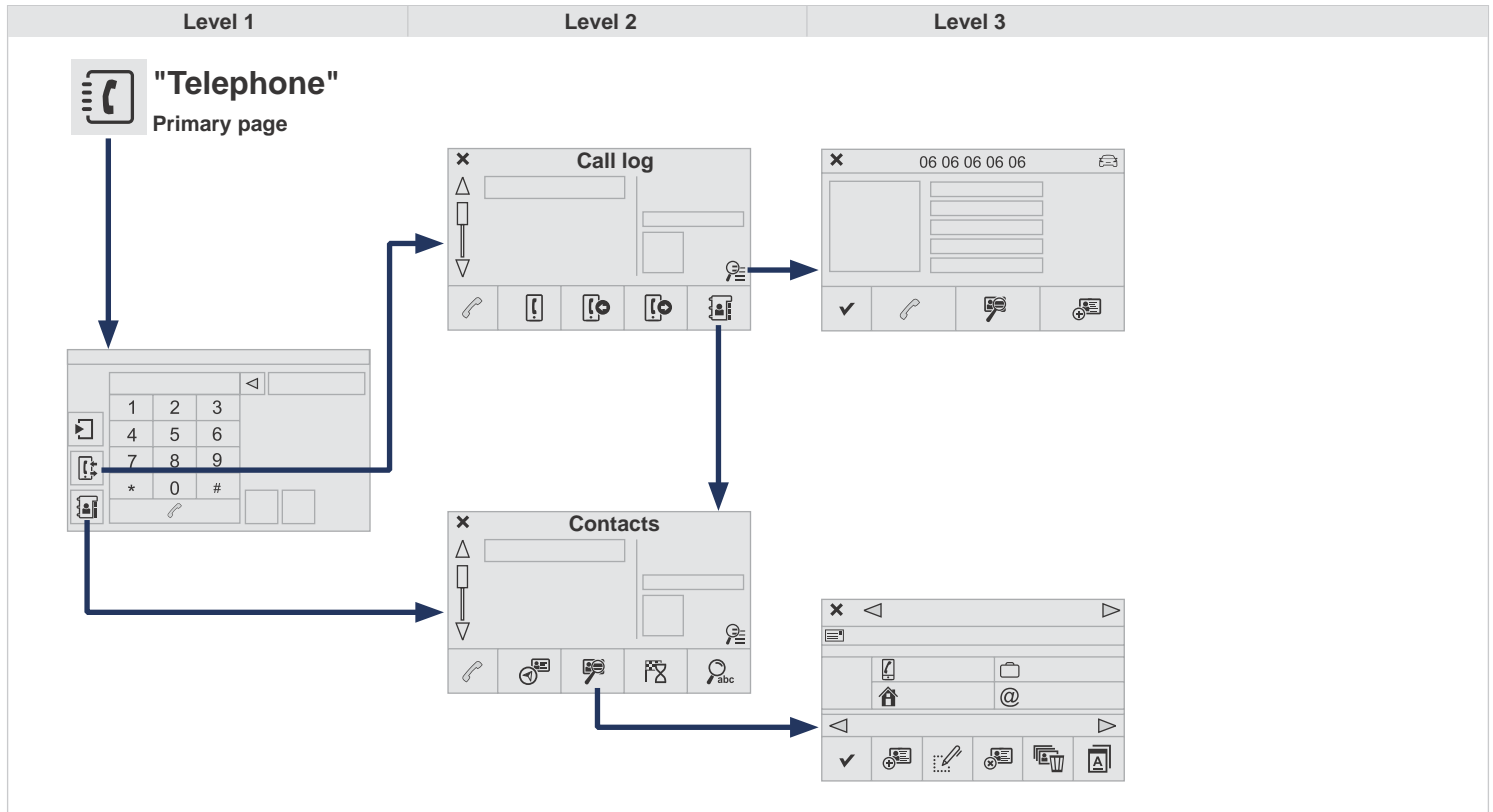















The "MyPEUGEOT" application is a link between the user, the manufacturer and its dealer network.

It allows the customer to know everything about their vehicle: servicing plan, accessory range, service contracts taken out, ...

It also makes possible the sending of the vehicle's mileage to the "MyPEUGEOT" site, or to identify a dealer.









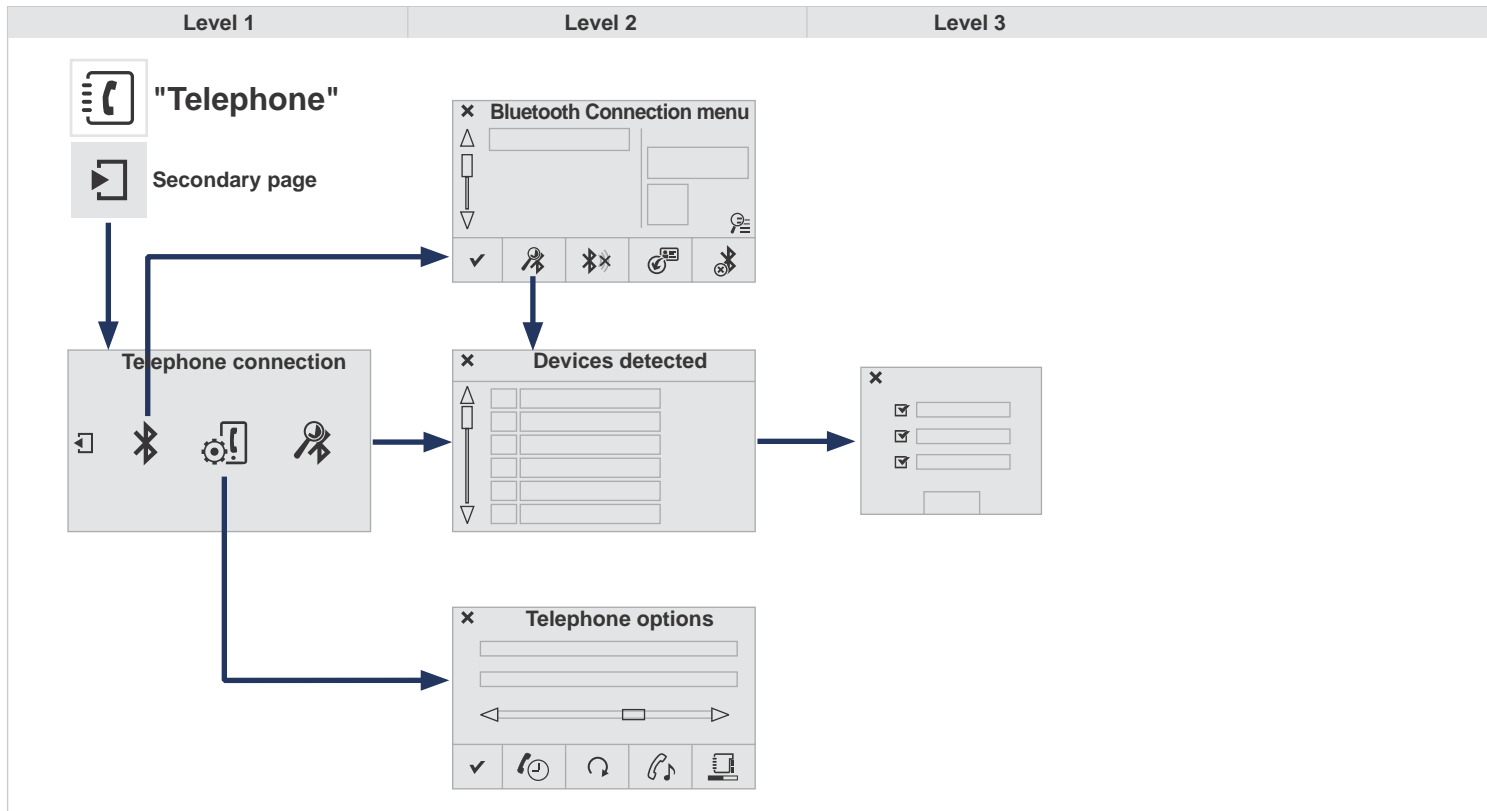









08 TELEPHONE



Level 1		Level 2		Level 3		Comments
 	Telephone ↓ Call log →	 All calls				After making choices, start the call.
		 Incoming calls				
		 Outgoing calls				
		 Contacts				
		 Magnifying glass	 View			
			 Create			
	 Call					
 	Telephone ↓ Contacts →	 Addresses				After making choices, start the call.
		 Add contact	 New			
			 Modify			
			 Delete			
			 Delete all			
			 Search for contact			
			 Confirm			
		 Navigate to				
		 Search for contact				
		 Call				

08 TELEPHONE



Level 1		Level 2		Level 3		Comments
  	Telephone connection ↓ Secondary page ↓ Bluetooth Connection →	 Search				Start the search for another peripheral device to connect.
		 Disconnect				Stop the Bluetooth connection to the selected peripheral device.
		 Update				Import the contacts from the selected telephone to store them in the audio system.
		 Delete				Delete the selected telephone.
		 Confirm				Save the settings.
  	Telephone connection ↓ Secondary page ↓ Search for devices →			<input checked="" type="checkbox"/> Telephone		Start the search for peripheral devices
		Devices detected		<input checked="" type="checkbox"/> Audio streaming		
				<input checked="" type="checkbox"/> Internet		
  	Telephone connection ↓ Secondary page ↓ Telephone Options →	 Put on hold				Cut the microphone temporarily so that the contact cannot hear your conversation with a passenger.
		 Update				Import the contacts from the selected telephone to save them in the audio system.
		 Ringtones				Choose the telephone ringtone and volume.
		 Memory info.				Contact records used and free, percentage of storage space used by internal contacts and Bluetooth contacts.
		 Confirm				Save the settings.

08 BLUETOOTH

Pairing a Bluetooth telephone First connection

Procedure (short) from the telephone

1 In the Bluetooth menu of your device, select the system name in the list of devices detected.



2 Enter a code of at least 4 figures in the device and confirm.



3 Enter this same code in the system, select "OK" and confirm.



Procedure from the system

1 Activate the telephone's Bluetooth function and ensure that it is "visible to all" (telephone configuration).



2 Press on **Telephone** to display the primary page then go to the secondary page.



3 Select "**Bluetooth Connection**".



! For reasons of safety and because they require prolonged attention on the part of the driver, the operations for pairing the Bluetooth mobile telephone to the hands-free system of the audio system must be carried out with the **vehicle stationary**.

4 Select **Search**.
The list of telephones detected is displayed.



i If the telephone is not detected, it is recommended that you switch the Bluetooth function on your telephone off and then on again.

5 Select the name of the desired peripheral from the list and **Confirm**.



6 Enter a code of at least 4 figures for the connection then "**Confirm**".



7 Enter this same code in the telephone then accept the connection.



8 The system offers to connect the telephone:

- in "**Telephone**" (hands-free kit, telephone only),
- in "**Audio streaming**" (streaming: wireless playing of audio files from the telephone),
- in "**Internet**" (internet browsing, only if your telephone is compatible with the "DUN" Dial-Up Networking Bluetooth standard).

Select one or more profiles and Confirm.

08 BLUETOOTH

! The services available depend on the network, the SIM card and the compatibility of the Bluetooth telephone used. Check the telephone manual and with your network provider for details of the services available to you.

! The ability of the system to connect with only one profile depends on the telephone. The two profiles may both connect by default.

☀ Visit www.peugeot.co.uk for more information (compatibility, additional help, ...).

9 The telephone is added to the list.



10 Depending on your telephone, you may be asked to accept automatic connection every time the ignition is switched on.

! Depending on the type of telephone, the system will ask you to accept or not the transfer of your contacts.



If not, select "**Update**".

☀ On return to the vehicle, the last telephone connected automatically reconnects, within around 30 seconds after switching on the ignition (Bluetooth activated).

To modify the automatic connection mode, select the telephone in the list then select the desired profile.

Connecting a Bluetooth peripheral

Automatic reconnection

- 1** On switching on the ignition, the telephone connected when the ignition was last switched off is automatically reconnected, if this connection mode had been activated during the pairing procedure (see previous pages).
- 2** The connection is confirmed by the display of a message and the name of the telephone.

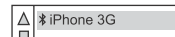

Manual connection

- 1** Press on **Telephone** to display the primary page then go to the secondary page.
- 2** Select "**Bluetooth**" to display the list of paired peripherals.
- 3** Select the peripheral to connect.

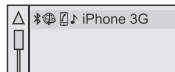

- 4** Press on "**Search**".



- 5** The connection is confirmed by the display of a message and the name of the telephone.



08 BLUETOOTH

Managing paired telephones

i This function allows the connection or disconnection of a peripheral device as well as the deletion of a pairing.

1 Press on **Telephone** to display the primary page then go to the secondary page.



2 Select "**Bluetooth**" to display the list of paired peripheral devices.



3 Select the peripheral in the list.

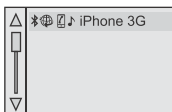

4 Select:

- "**Search**" or "**Disconnect**" to connect or disconnect the Bluetooth connection with the peripheral selected.
- "**Delete**" to remove the pairing.



Receiving a call

1 An incoming call is announced by a ring and a superimposed display in the screen.

2a Make a short press on the steering mounted **TEL** button to accept an incoming call.



2b Make a long press on the steering mounted **TEL** button to reject the call.
or
Select "**End call**".



08 CONTACTS

Making a call

Calling a new number

- 1 Press on **Telephone** to display the primary page.



- 2 Enter the phone number using the keypad then **Call** to start the call.



! Use of the telephone is not recommended while driving. We recommend that you park safely or make use of the steering mounted controls.

Calling a contact

- 1 Press on **Telephone** to display the primary page.



Or make a long press on the steering mounted **TEL** button.



- 2 Select **Contacts**.



- 3 Select the desired contact from the list offered.

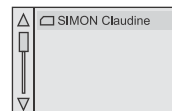

- 4 Select **Call**.



08 CALL LOG

Calling a recently used number

1

Press on **Telephone** to display the primary page.



2

Select "**Call log**".



3

Select the desired contact from the list offered.

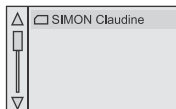

i

It is always possible to make a call directly from the telephone; park the vehicle first as a safety measure.

Ending a call

1a

Select "**End call**".



or

1b

Make a long press on the steering mounted **TEL** button.



08 SETTINGS

Ringtones

1

Press on **Telephone** to display the primary page then go to the secondary page.



2

Select "**Telephone Options**".



3

Select "**Ringtones**".



4

You can select the ringtone used and adjust its volume.

5

Select "**Confirm**".



Managing contacts / Entries

1

Press on **Telephone** to display the primary page.



2

Select "**Contacts**".



3

Select "**Add contact**".



4

Select:

- "**New**" to add a new contact.
- "**Modify**" to edit the selected contact.
- "**Delete**" to delete the selected contact.
- "**Delete all**" to delete all of the information for the selected contact.

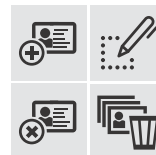

Select "**Directory information**" for the number of entries used, available, ...



FREQUENTLY ASKED QUESTIONS

The following table groups together the answers to the most frequently asked questions concerning your audio system.

QUESTION	ANSWER	SOLUTION
Navigation, guidance		
The route calculation is not successful.	The guidance criteria may conflict with the current location (exclusion of toll roads on a toll motorway).	Check the guidance criteria on the Navigation Menu, "Guidance options" \ "Define calculation criteria".
I am unable to enter my post code.	The system only accepts post codes of up to 5 characters.	
The POIs do not appear.	The POIs have not been selected.	Select the POIs in the list of POIs.
The risk areas audible warning does not work.	The audible warning is not active.	Activate audible warnings in the Guidance options menu, "Navigation - guidance", "Set parameters for risk areas".
The system does not suggest a detour around an incident on the route.	The guidance criteria do not take account of TMC messages.	Select the "Traffic info" function in the list of guidance criteria.
I receive a Risk area alert which is not on my route.	Other than guidance, the system announces all Risk areas positioned in a cone located in front of the vehicle. It may provide an alert for a Risk area located on nearby or parallel roads.	Zoom in on the map to view the exact position of the Risk area. Select "On the route" to no longer receive alerts other than guidance or to reduce the time for the announcement.

FREQUENTLY ASKED QUESTIONS

QUESTION	ANSWER	SOLUTION
Certain traffic jams along the route are not indicated in real time.	On starting, it is several minutes before the system begins to receive the traffic information.	Wait until the traffic information is being received correctly (display of the traffic information icons on the map).
	The filters are too restrictive.	Modify the "Geographic filter" settings.
	In certain countries, only major routes (motorways...) are listed for the traffic information.	This phenomenon is normal. The system is dependent on the traffic information available.
The altitude is not displayed.	On starting, the initialisation of the GPS may take up to 3 minutes to receive more than 4 satellites correctly.	Wait until the system has started up completely. Check that there is a GPS coverage of at least 4 satellites (long press on the SETUP button, then select "GPS coverage").
	Depending on the geographical environment (tunnel...) or the weather, the conditions of reception of the GPS signal may vary.	This phenomenon is normal. The system is dependent on the GPS signal reception conditions.
Telephone, Bluetooth		
I cannot connect my Bluetooth telephone.	The telephone's Bluetooth function may be switched off or the telephone may not be visible.	<ul style="list-style-type: none"> - Check that your telephone's Bluetooth function is switched on. - Check in the telephone settings that it is "visible to all".
	The Bluetooth telephone is not compatible with the system.	You can check the compatibility of your telephone at www.peugeot.co.uk (services).
The volume of the telephone connected in Bluetooth mode is inaudible.	The volume depends both on the system and on the telephone.	Increase the volume of the audio system, to maximum if required, and increase the volume of the telephone if necessary.
	The ambient noise level has an influence on the quality of telephone communication.	Reduce the ambient noise level (close the windows, reduce the booster fan speed, slow down, ...).

FREq UENTLY ASKED q UESTIONS

q UESTION	ANSWER	SOLUTION
Some contacts are duplicated in the list.	The options for synchronizing contacts are synchronizing the contacts on the SIM card, the contacts on the telephone, or both. When both synchronizations are selected, some contacts may be duplicated.	Select "Display SIM card contacts" or "Display telephone contacts".
Contacts are not shown in alphabetical order.	Some telephones offer display options. Depending on the settings chosen, contacts can be transferred in a specific order.	Modify the display setting in the telephone directory.
The system does not receive SMS text messages.	The Bluetooth mode does not permit sending SMS text messages to the system.	
CD, MP3		
The CD is ejected automatically or is not played by the player.	<p>The CD is inserted upside down, is unplayable, does not contain any audio data or contains an audio format which the player cannot play.</p> <p>The CD has been recorded in a format that is not compatible with the player (udf, ...).</p> <p>The CD is protected by an anti-pirating protection system which is not recognised by the audio system.</p>	<ul style="list-style-type: none"> - Check that the CD is inserted in the player the right way up. - Check the condition of the CD: the CD cannot be played if it is too damaged. - Check the content in the case of a recorded CD: refer to the advice in the "AUDIO" section. - The audio system's CD player does not play DVDs. - Some recorded CDs will not be played by the audio system because they are not of the correct quality.
There is a long waiting period following the insertion of a CD or connection of a USB memory stick.	When a new medium is inserted, the system reads a certain amount of data (directory, title, artist, etc.). This may take from a few seconds to a few minutes.	This phenomenon is normal.
The CD player sound is poor.	The CD used is scratched or of poor quality.	Insert good quality CDs and store them in suitable conditions.
	The audio equipment settings (bass, treble, ambiances) are unsuitable.	Set the treble or bass level to 0, without selecting an ambience.

FREQUENTLY ASKED QUESTIONS

QUESTION	ANSWER	SOLUTION
Some characters in the media information are not displayed correctly while playing.	The audio system does not display some types of characters.	Use standard characters to name tracks and folders.
Playing of streaming files does not start.	The peripheral device connected does not support automatic play.	Start the playback from the device.
The names of tracks and the track length are not displayed on the screen when streaming audio.	The Bluetooth profile does not allow the transfer of this information.	
Radio		
The quality of reception of the radio station listened to gradually deteriorates or the stored stations do not function (no sound, 87.5 Mhz is displayed...).	The vehicle is too far from the transmitter used by the station listened to or there is no transmitter in the geographical area through which the vehicle is travelling.	Activate the "RDS" function by means of the short-cut menu to enable the system to check whether there is a more powerful transmitter in the geographical area.
	The environment (hills, buildings, tunnels, basement car parks...) block reception, including in RDS mode.	This phenomenon is normal and does not indicate a fault with the audio system.
	The aerial is absent or has been damaged (for example when going through a car wash or into an underground car park).	Have the aerial checked by a PEUGEOT dealer.
I cannot find some radio stations in the list of stations received.	The station is not received or its name has changed in the list.	
	Some radio stations send other information in place of their name (the title of the song for example). The system interprets this information as the name of the station.	
The name of the radio station changes.		

FREQUENTLY ASKED QUESTIONS

QUESTION	ANSWER	SOLUTION
Settings, configuration		
In changing the setting of treble and bass the equalizer setting is deselected.	The selection of an equalizer setting imposes the balance settings. Modifying one without the other is not possible.	Modify the balance or equalizer settings to obtain the desired musical ambience.
In changing the equalizer setting, treble and bass return to zero.		
When changing the balance settings, the distribution setting is deselected.	The selection of a distribution setting imposes the balance settings. Modifying one without the other is not possible.	Modify the balance or distribution settings to obtain the desired musical ambience.
When changing an distribution setting, the balance setting is deselected.		
There is a difference in sound quality between the different audio sources (radio, CD...).	For optimum sound quality, the audio settings for Volume, Bass, Treble, Equalizer and Loudness can be adapted to the different sound sources, which may result in audible differences when changing source (radio, CD...).	Check that the audio settings for (Volume, Bass, Treble, Equalizer, Loudness) are adapted to the sources listened to. It is advisable to set the AUDIO functions (Bass, Treble, Fr-Re balance, Le-Ri balance) to the middle position, select the "None", musical ambience and set the loudness correction to the "Active" position in CD mode or to the "Inactive" position in radio mode.

FREq UENTLY ASKED q UESTIONS

q UESTION	ANSWER	SOLUTION
<p>With the engine off, the system switches off after a few minutes of use.</p>	<p>When the engine is switched off, the system's operating time depends on the battery charge. The switch-off is normal: the system switches to economy mode and switches off to prevent discharging of the vehicle's battery.</p>	<p>Start the vehicle's engine to increase the battery charge.</p>
USB, portable player, connection key		
<p>Playback of my USB memory stick starts only after a very long wait (around 2 to 3 minutes).</p>	<p>Some files supplied with the memory stick may greatly slow down access to reading the memory stick (multiplication by 10 of the catalogue time).</p>	<p>Delete the files supplied with the memory stick and limit the number of sub-folders in the file structure on the memory stick.</p>
<p>When I connect my iPhone as telephone and to the USB port at the same time, I am unable to play the music files.</p>	<p>When the iPhone connects automatically as a telephone, it forces the streaming function. The streaming function takes the place of the USB function which is then not useable, there is a period without sound of the track being played with Apple® players.</p>	<p>Disconnect and reconnect to the USB port (the USB function takes priority over streaming).</p>

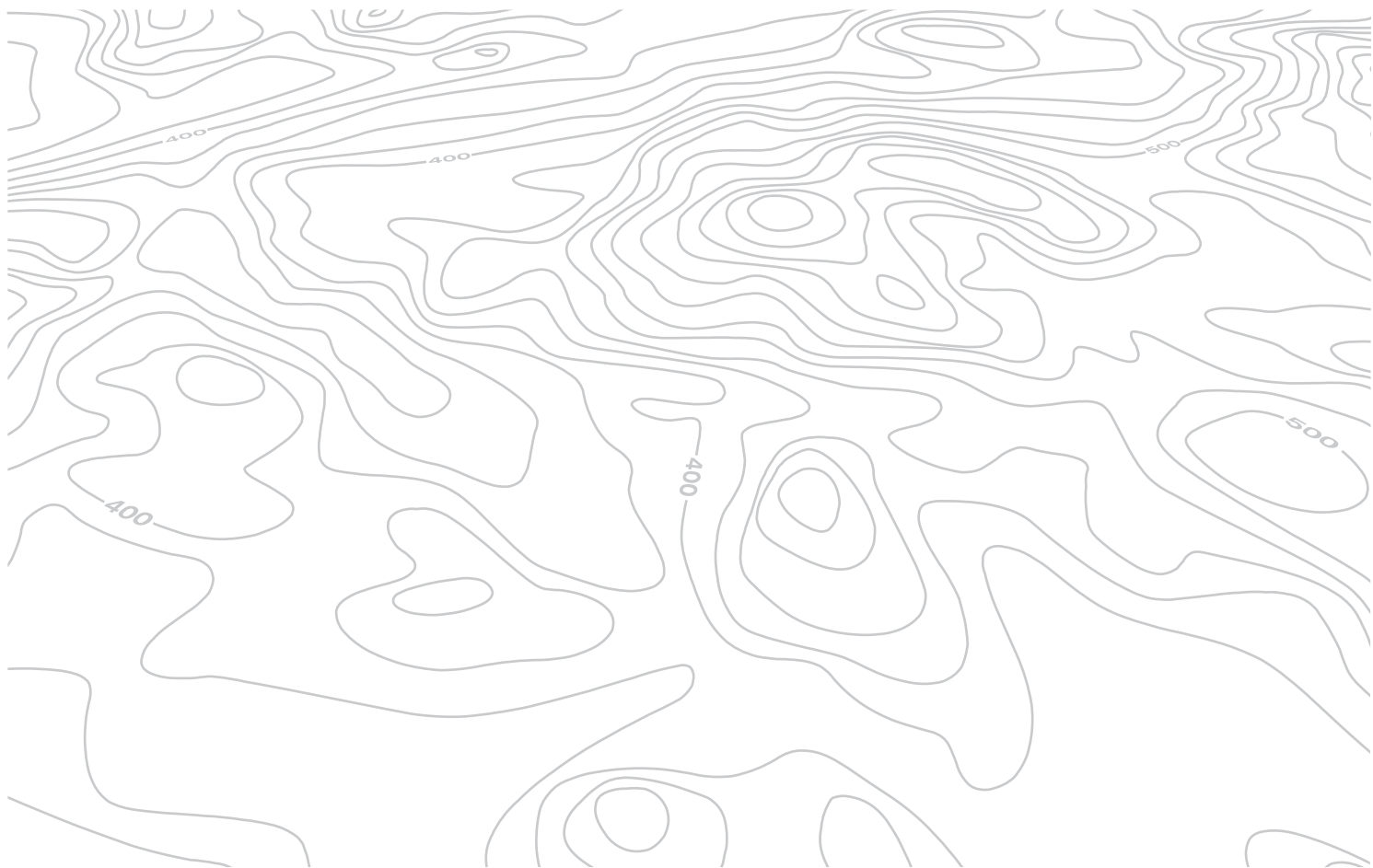



AUDIO SYSTEM / BLUETOOTH

CONTENTS

01 First steps	p.	296
02 Steering mounted controls	p.	297
03 Radio	p.	298
04 Audio	p.	301
05 Using the telephone	p.	307
06 Audio settings	p.	313
07 Configuration	p.	314
08 Screen menu map	p.	315
Frequently asked questions	p.	316



For safety reasons, the driver must only carry out operations which require prolonged attention while the vehicle is stationary.

When the engine is switched off and to prevent discharging of the battery, the system switches off after activation of energy economy mode.

01 FIRST STEPS

Select the source:

- FM1, FM2, AM, CD, USB, AUX, Streaming.
- accept an incoming call.

Long press:

- open the calls log for the telephone connected.
- or end a call if in progress.

Adjust audio settings:

sound ambience, treble, bass, loudness, distribution, left/right balance, front/rear balance, automatic volume.

On / Off and volume adjustment.

Abandon the current operation.

Go up one level (menu or folder).

Eject CD.



Display the list of stations received, the CD/USB tracks or folders.

Long press: update the list of stations received.

Open the main menu.

Automatic search for a lower / higher radio frequency.

Select previous / next CD, USB track.

Navigation in a list.

Press and hold: fast forwards or backwards.

Select a preset radio station.

Radio: long press: preset a radio station.

Other than radio: see the corresponding sections.

02 STEERING MOUNTED CONTROLS

RADIO: automatic search for a higher frequency.
CD / MP3 / USB: selection of the next track.
CD / USB: continuous press: fast forwards play.



Change of sound source.
Confirmation of a selection.
Start/End call with the telephone.
Press for more than 2 seconds: access to the call log.

RADIO: selection of the previous / next preset station.
CD / USB: selection of the previous genre / artist / folder / playlist from the list depending on classification.

RADIO: automatic search for a lower frequency.
CD / MP3 / USB: selection of the previous track.
CD / USB: continuous press: fast reverse.



Volume increase.

Volume decrease.

Mute the sound by pressing the volume increase and decrease buttons simultaneously.

Restore the sound: by pressing one of the two volume buttons.

03 RADIO

Radio

i The exterior environment (hills, buildings, tunnel, car park, below ground...) may prevent reception, even in RDS station tracking (alternative frequencies) mode. This phenomenon is normal in the propagation of radio waves and is in no way indicative of a fault with the audio system.

Presetting and selecting a station

1



Press **SRC/TEL** repeatedly and select the FM1, FM2 or AM waveband.



2



Make a long press on one of the buttons to preset the station being listened to. The name of the station is displayed and an audible signal confirms the preset.

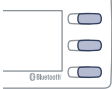

i



Press a button to listen to the corresponding preset station.



i When recalling a preset station, if the reception of the station is poor, the radio will try to find a frequency transmitting the same programme and a message appears in the screen.

Managing the list

i



A long press on **LIST** builds or updates the list of stations; audio reception is cut momentarily.



1



Press **LIST** to display the list of stations received in alphabetical order.



2



Select the desired radio station and confirm by pressing "**OK**".



3



A press changes to the next or previous letter (e.g. A, B, D, F, G, J, K, ...).

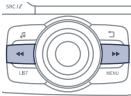

03 RADIO

RDS

Entering a frequency manually

1



Press **MENU**, select "Radio", then select "Write freq."



2



Press + or - to select the desired frequency and confirm with "OK".

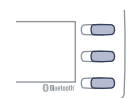

i

RDS, if displayed, enables you to continue listening to the same station by automatic retuning to alternative frequencies. However, in certain conditions, coverage of an RDS station may not be assured throughout the country as radio stations do not cover 100 % of the territory. This explains the loss of reception of the station during a journey.

1



With source FM1 or FM2, press **MENU** then select "Radio".



2



Select or deselect "RDS" to activate or deactivate RDS then confirm with "OK" to save the setting.



03 RADIO

Receiving TA messages

i

The TA (Traffic Announcement) function gives priority to TA alert messages. To operate, this function needs good reception of a radio station transmitting this type of message. When a traffic report is transmitted, the current audio source (Radio, CD, USB, ...) is interrupted automatically to play the TA message. Normal playback of the audio source resumes at the end of the transmission of the message.

1



Press **MENU**, select "Radio".



2



Select or deselect "**TA**" to activate or deactivate the reception of traffic messages.



Displaying RADIO TEXT

i

Radio text is information transmitted by the radio station related to the current programme or song.

1



With the radio displayed on the screen, press **MENU** then select "Radio".



2

Select or deselect "**TXT**" to activate or deactivate the display of Radio Text.

04 AUDIO

Audio CD

Playing a CD



Insert 12 cm diameter circular compact discs only.

Some anti-pirating systems, on original discs or CDs copied using a personal recorder, may cause faults which are no reflection on the quality of the original player.

Without pressing the **EJECT** button, insert a CD in the player, play begins automatically.

1



To play a disc which has already been inserted, press the **SRC/TEL** button several times until CD play is displayed.



2



Press one of the buttons to select a track on the CD.
Press and hold one of the buttons for fast forward or backward.



04 AUDIO

CD, USB

Information and advice



The audio system will only play files with ".mp3", ".wma" and ".wav" on a CD and can play files with ".ogg" extension only on USB.



A high compression rate can adversely affect sound quality.



The playlists accepted on CD, MP3, iPod and USB connection are types ".m3u" and ".wpl".
The number of files recognised is limited to 5 000 in 500 folders on a maximum of 8 levels.



On a single disc, the CD player can read up to 255 MP3 files spread over 8 folder levels with a maximum of 192 folders. However, it is recommended that this be kept to 2 levels so as to limit the time taken to access and play the CD.
During play, the folder structure is not observed.



In order to be able to play a recorded CDR or CDRW, when recording it is preferable to select standards ISO 9660 level 1.2 or Joliet.
If the disc is recorded in another format, it may not be played correctly. It is recommended that the same recording standard is always used for an individual disc, with as low a speed as possible (4x maximum) for optimum sound quality.
In the particular case of a multi-session CD, the Joliet standard is recommended.



Do not connect a hard disk or USB device other than audio players to the USB port. This may cause damage to your installation.

04 AUDIO

CD, USB

Playing a compilation

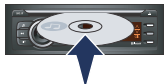

Insert an MP3 compilation in the CD player or connect a memory stick to the USB port.



The system creates playlists (temporary memory) the creation time for which can take from a few seconds to several minutes. The playlists are updated every time the ignition is switched off or a USB memory stick is connected. Play starts automatically after a period which depends on the capacity of the USB memory stick.



At a first connection, the order suggested is by folder. When connecting again, the order previously chosen is retained.

1



To play a disc or memory stick which has already been inserted, press **SRC/TEL** several times in succession and select "CD" or "USB".



2



Press one of the buttons to select the next or previous track.

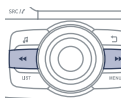

3



Press one of the buttons to select the next or previous folder in the order chosen.

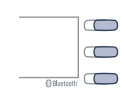







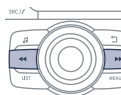



4

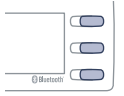
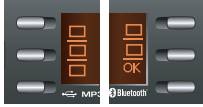
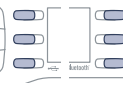

Press and hold one of the buttons for fast forwards or backwards.

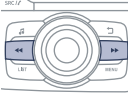

04 AUDIO

<p>5</p>  <p>Press LIST to display the structure of the folders in the compilation.</p>		<p>9</p>  <p>Press MENU, select "Media" then select or deselect "TA" to activate or deactivate reception of traffic messages.</p>	
<p>6</p>  <p>Select a line in the list.</p>		<p>10</p>  <p>Select the play mode: "Normal", "Random", "Random all" or "Repeat".</p>	
<p>7</p>  <p>Jump a page.</p>		<p> </p> <p>Return to the top level of the folder structure to select the type of tracks.</p> <ul style="list-style-type: none">- By Folders (CD or USB): all folders containing audio files recognised on the peripheral device, in alphabetical order without following the folder structure.- By Artist (USB only): all of the artist names defined in the ID3 Tags, in alphabetical order.- By Genre (USB only): all of the genres defined in the ID3 Tags.- By Playlist (CD or USB): if playlists have been saved.	
<p>8</p>  <p>Up a level in the menu.</p>			

04 AUDIO

APPLE® player or portable player



The audio files on a Mass Storage portable player* can be heard through the vehicle's speakers by connecting it to the USB port (cable not supplied).



Management of the device is via the audio system controls; refer to the "**CD, USB**" section.



The Apple® player must be updated regularly for the best connection.



The playlists are those defined in the Apple® player.



The Apple® player must be generation 3 or later.

* Check your player's manual.

04 AUDIO

Streaming - Playing audio files via Bluetooth



Depending on the compatibility of the phone



Streaming allows music files on a telephone to be heard via the vehicle's speakers.
The telephone must support the appropriate Bluetooth® profiles (profiles A2DP / AVRCP).

1



Connect the telephone: see the "USING THE TELEPHONE" section.

2



Activate the streaming source by pressing **SRC/TEL**. Control of playback is via the audio system. The contextual information can be displayed in the screen.



In certain cases, playing of the audio files must be initiated from the telephone.



The audio quality depends on the quality of the transmission from the telephone.

05 USING THE TELEPHONE

Pairing a Bluetooth telephone / First connection



The services offered depend on the network, the SIM card and the compatibility of the Bluetooth telephone used. Consult your telephone's manual and your operator to find out which services are available to you.



For safety reasons and because they require prolonged attention on the part of the driver, the operations for pairing of the Bluetooth mobile telephone with the Bluetooth hands-free system of your audio system must be carried out with the vehicle stationary and the ignition on.



Visit www.peugeot.co.uk for more information (compatibility, more help, ...).



It is not possible to pair more than 5 telephones. Press **MENU** and select "**Bluetooth**". Select "**BT management**". If 5 telephones are already paired, select the telephone to be deleted by pressing "**OK**" and select "**Delete**" (refer to "Managing connections").

1

Activate the telephone's Bluetooth function and ensure that it is set as visible to all (refer to the telephone instructions).



2



Press **MENU** then select "**Bluetooth**".



3

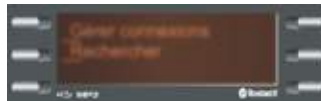

Select "**Search**".

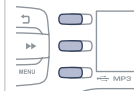

4

A window is displayed with "**Searching device**".

5



Select the telephone to be paired from the list and confirm with "**OK**". Only one telephone can be paired at a time.

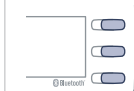

05 USING THE TELEPHONE



In some cases, the Bluetooth address of the telephone may appear instead of the name of the telephone.

6



A virtual keypad is displayed on the screen: choose a 4 digit code then confirm with **OK**.



7

A message is displayed on the screen of the telephone: enter the same code and confirm.



If pairing fails, try again; the number of attempts is not limited.

8

Accept the connection to the telephone.

9

A message appears in the screen to confirm the result of the connection.

!

Pairing can also be initiated from the telephone by searching for detected Bluetooth devices.

!

The directory and the calls list can be accessed after the synchronisation period (if the telephone is compatible). Automatic connection must be configured in the telephone to allow the connection each time the vehicle is started.

05 USING THE TELEPHONE

Managing connections

1



Press **MENU** then select **"Bluetooth"**.



3



Select a telephone and confirm **"OK"**.

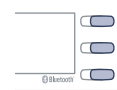

2

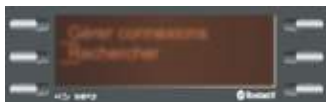

Select **"BT management"** and confirm. The list of paired telephones is displayed.



4



Then select or deselect:

- **"Tel."**: hands-free connection
- **"Audio"**: play audio files

"OK" to confirm the choice.
"Delete" to delete the pairing.

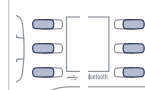

Indicates connection of the audio profile.



Indicates connection of the hands-free profile.

05 USING THE TELEPHONE

Making a call - Recently called numbers*

1



Make a long press on **SRC/TEL** to display the calls list.



i

For access to the calls list, it is also possible to press **MENU**, select **"Telephone"**, then select **"Call"**, and finally select **"Calls list"**.

2

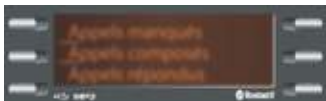

In the list of calls, select the number and choose **"Missed calls"**, **"Dialed calls"** or **"Answered calls"**.



3



Navigation in the calls list.

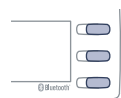

4



Previous or next page in the calls list.

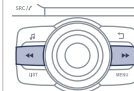

5



"OK" starts the call.

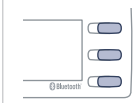

i

The calls list includes the calls sent from and by from the vehicle via the connected telephone.

It is possible to make a call directly from the telephone; stop the vehicle as a safety measure.

* Depending on the compatibility of the telephone.

05 USING THE TELEPHONE

Making a call - From the directory

1



Press **MENU**, select **"Telephone"**.



2

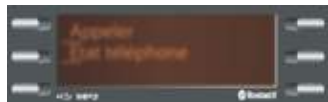

Select **Call** then **"Directory"**.

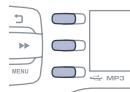

3



Select the desired number and confirm. **"OK"** to start the call.



Receiving a call

1

An incoming call is announced by a ring and a superimposed display in the screen.

2



Press **SRC/TEL** or select **"YES"** to accept the call,
or
select **"NO"** to reject the call.



A long press on **ESC** or on **SRC/TEL** also rejects an incoming call.



05 USING THE TELEPHONE

Managing calls

1a Hang up



In the contextual menu, select "**Hang up**" to end the call.

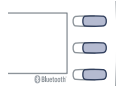

A long press on **SRC/TEL** also ends the call.



1b Secret - Mute (so that the caller cannot hear)



In the contextual menu:

- select "**Micro OFF**" to switch off the microphone.
- select "**Micro OFF**" to switch the microphone on again.

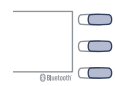

1c Combined mode (to leave the vehicle without ending the call)



In the contextual menu:

- select "**Combined mode**" to transfer the call to the telephone.
- select "**Combined mode**" to transfer the call to the vehicle.

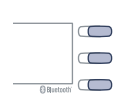



In certain cases, the combined mode has to be activated from the telephone.

The Bluetooth connection will be restored automatically if the ignition has been switched off, then on again (depending on the compatibility of the telephone).

06 AUDIO SETTINGS

1



Press  to display the audio settings menu.
Press  to go to the next setting.



2

The settings available are:

- AMBIANCE: BASS, TREBLE and LOUDNESS.
- BALANCE (left/right balance), FADER (front/rear balance)
- SOUND DIST. (driver or passenger).
- AUTO VOLUME.

!

The distribution, or spatialisation of sound, is an audio process which allows the sound quality to be improved according to the setting chosen, corresponding to the position of the listeners in the vehicle.

i

The AMBIANCE, TREBLE and BASS audio settings are different and independent for each sound source.

07 CONFIGURATION

Display and language settings

1



Press **MENU** then "**Config.**".



2a

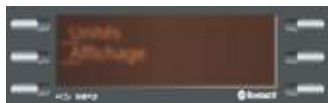

Select "**Displaying**" to activate or deactivate scrolling text.

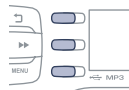

2b

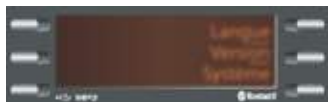

Select "**Language**" to modify the display language.

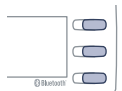

2c



Select "**Version**" for information on the software.

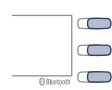

2d



Select "**System**" when you want to install an update. Information can be obtained from a PEUGEOT dealer.

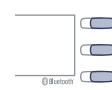

08 SCREEN MENU MAP(S)

MENU

1 Radio

2 TA

2 RDS

2 TXT

2 Write freq.

1 Media

2 Normal

2 Random

2 Random all

2 Repeat

2 TA

1 Telephone

2 Call

3 Directory

3 Calls list

4 Missed calls

4 Dialed calls

4 Answered calls

2 Phone status

1 Bluetooth

2 BT management

2 Search

1 Config.

2 Time

2 Displaying

3 Scrolling text

2 Language

3 Deutsch

3 English

3 Español

3 Français

3 Italiano

3 Nederlands

3 Português

3 Português-Brasil

3 Русский

3 Türkçe

2 Version

2 System

FREQUENTLY ASKED QUESTIONS

The following tables contain answers to the most frequently asked questions.

QUESTION	ANSWER	SOLUTION
<p>There is a difference in sound quality between the different audio sources (radio, CD...).</p>	<p>For optimum sound quality, the audio settings (volume, bass, treble, ambience, loudness) can be adapted to the different sound sources, which may result in audible differences when changing source (radio, CD...).</p>	<p>Check that the audio settings (volume, bass, treble, ambience, loudness) are adapted to the sources listened to. It is advisable to adjust audio settings (bass, treble, Front-Rear balance, Left-Right balance) to the middle position, select the musical ambience and set the loudness correction to the "Active" position in CD mode or to the "Inactive" position in radio mode.</p>
<p>When changing the settings for treble and bass, the ambience setting is deselected. When changing the ambience setting, treble and bass are reset to zero.</p>	<p>Choosing an ambience imposes settings for treble and bass. Modifying one without the other is only possible with a personalised ambience.</p>	<p>Modify the treble and bass settings or the ambience setting to obtain the desired sound quality.</p>
<p>When changing the balance setting, distribution is deselected.</p>	<p>Choosing the "driver" distribution setting imposes a balance setting.</p>	<p>Modify the balance setting or the distribution setting to obtain the desired sound quality.</p>

FREQUENTLY ASKED QUESTIONS

QUESTION	ANSWER	SOLUTION
<p>The quality of reception of the radio station listened to gradually deteriorates or the stored stations do not function (no sound, 87.5 MHz is displayed...).</p>	<p>The vehicle is too far from the transmitter used by the station listened to or there is no transmitter in the geographical area through which the vehicle is travelling.</p>	<p>Activate the RDS function to enable the system to check whether there is a more powerful transmitter in the geographical area.</p>
	<p>The environment (hills, buildings, tunnels, basement car parks...) block reception, including in RDS mode.</p>	<p>This phenomenon is normal and does not indicate a failure of the audio equipment.</p>
	<p>The aerial is absent or has been damaged (for example when going through a car wash or into an underground car park).</p>	<p>Have the aerial checked by a PEUGEOT dealer.</p>
<p>Sound cut-outs of 1 to 2 seconds in radio mode.</p>	<p>During this brief sound cut-out, the RDS searches for any frequency permitting better reception of the station.</p>	<p>Deactivate the RDS function if the phenomenon is too frequent and always on the same route.</p>
<p>Traffic announcement TA is displayed. I do not receive any traffic information.</p>	<p>The radio station does not broadcast traffic information.</p>	<p>Tune to a radio station which broadcasts traffic information.</p>
<p>The stored stations are not found (no sound, 87.5 MHz is displayed...).</p>	<p>An incorrect waveband is selected.</p>	<p>Press the SRC/TEL button to return to the waveband (FM1 or FM2) on which the stations are stored.</p>

FREq UENTLY ASKED q UESTIONS

q UESTION	ANSWER	SOLUTION
The CD is ejected automatically or is not played by the player.	The CD is inserted upside down, is unplayable, does not contain any audio data or contains an audio format which the player cannot play. The CD is protected by an anti-pirating protection system which is not recognised by the audio equipment.	<ul style="list-style-type: none"> - Check that the CD is inserted in the player the right way up. - Check the condition of the CD: the CD cannot be played if it is too damaged. - Check the content in the case of a recorded CD: consult the advice in the "Audio" section. - The audio equipment's CD player does not play DVDs. - Due to their quality level, certain writeable CDs will not be played by the audio system.
The CD player sound is poor.	The CD used is scratched or of poor quality.	Insert good quality CDs and store them in suitable conditions.
	The audio settings (bass, treble, ambience) are unsuitable.	Set the treble or bass level to 0, without selecting an ambience.
The Bluetooth connection is cut.	The battery of the peripheral may not be sufficiently charged.	Recharge the battery of the peripheral device.
The message "USB device error" is displayed on the screen.	The USB memory stick is not recognised.	Use only memory sticks formatted to FAT 32 (28-bit file allocation table).
A telephone connects automatically, disconnecting another telephone.	Automatic connection overrides manual connection.	Modify the telephone settings to remove automatic connection.

FREq UENTLY ASKED q UESTIONS

q UESTION	ANSWER	SOLUTION
An iPod is not recognised when connecting to the USB port.	The iPod is of a generation that is not compatible with the USB.	
The hard disk or device is not recognised when connecting to the USB port.	Some hard disks and devices need a power supply greater than is provided by the audio system.	Connect the device to the 230 V socket, the 12 V socket or an external power supply. Caution: ensure that the device does not transmit a voltage greater than 5 V (risk of destruction of the system).
When streaming, the sound cuts momentarily.	Some telephones prioritise connection of the "hands-free" profile.	Delete the "hands-free" connection profile to improve streaming.
In "Random all" play, not all of the tracks are played.	In "Random all" play, the system can only take into account up to 999 tracks.	
With the engine off, the audio system switches off after a few minutes of use.	When the engine is switched off, the audio system operating time depends on the battery charge. The switch-off is normal: the audio system switches to economy mode and switches off to prevent discharging the vehicle's battery.	Start the vehicle's engine to increase the battery charge.
The message "the audio system is overheated" appears on the display.	In order to protect the installation if the surrounding temperature is too high, the audio system switches to an automatic thermal protection mode leading to a reduction of the volume or stopping of the playing of the CD.	Switch the audio system off for a few minutes to allow the system to cool.

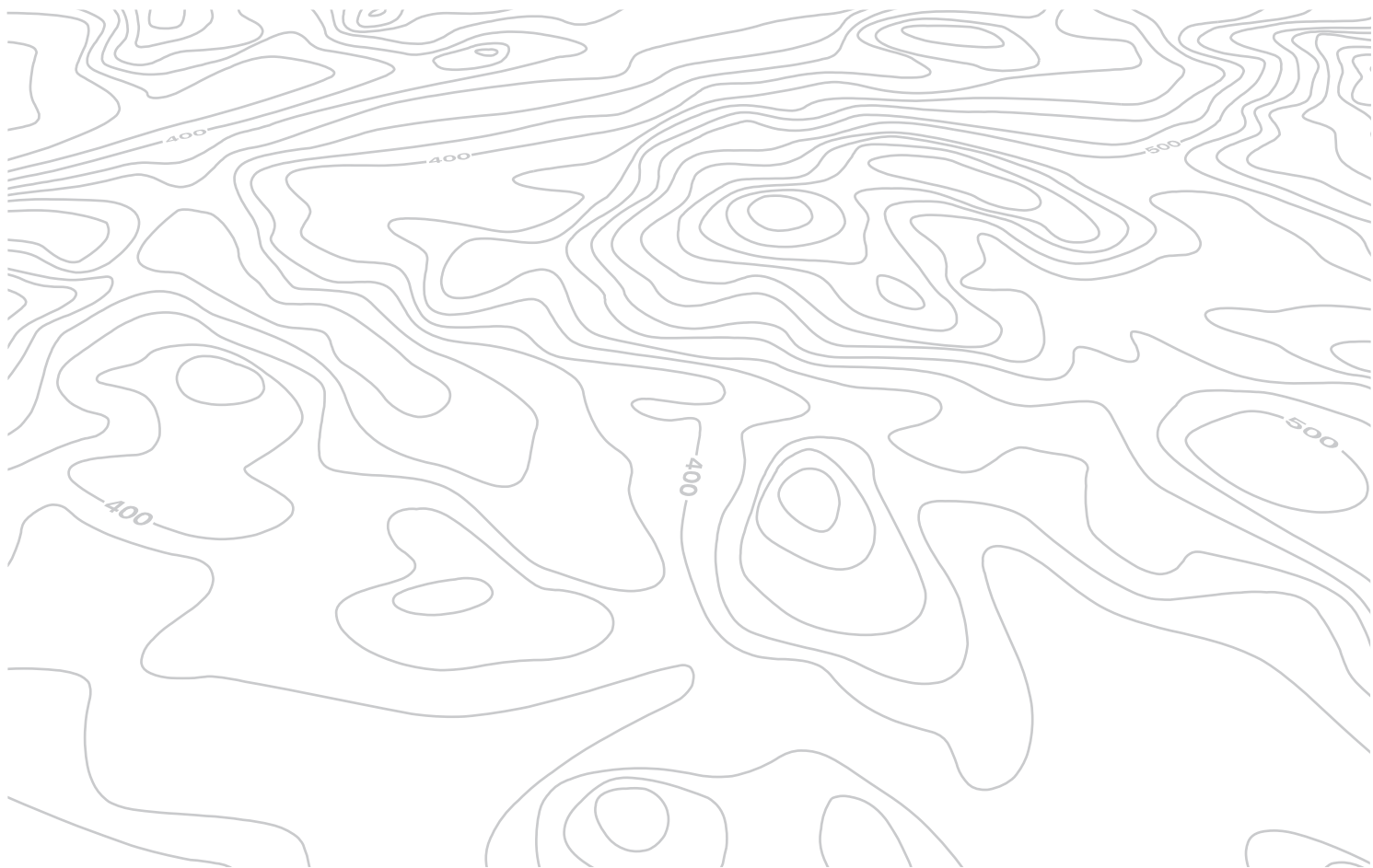



AUDIO SYSTEM



For safety reasons, the driver must only carry out operations which require prolonged attention while the vehicle is stationary.

When the engine is switched off and to prevent discharging of the battery, the system switches off after activation of economy mode.

CONTENTS

01 First steps	p.	322
02 Steering mounted controls	p.	323
03 Audio system	p.	324
04 Audio settings	p.	332
05 Screen menu map	p.	333
Frequently asked questions	p.	334

01 FIRST STEPS

Selection of source:
FM1, FM2, AM, CD, AUX.

Adjust audio settings:
sound ambience, treble, bass,
loudness, left/right balance,
automatic volume.

Abandon the current
operation.
Go up one level (menu or
folder).

Automatic search for a lower/
higher radio frequency.

Select the previous/next CD
track.

Navigation in a list.

Press and hold: fast forward
or backward.

Eject CD.



On / Off and
volume adjustment.

Display the list of stations received,
the CD/MP3 tracks or MP3 folders.
Long press: update the list of
stations received.

Manual search step by step
for a lower/higher radio
frequency.
Select the previous/next
MP3 track.
Navigation in a list.

Open the main
menu.

Select a preset radio station.
Radio: long press: preset a radio
station.

02 STEERING MOUNTED CONTROLS

RADIO: automatic search for next frequency.
CD / MP3: select the next track.
CD: press and hold: fast forward.



Change audio source.
Confirm a selection.

RADIO: automatic search for previous frequency.
CD / MP3: select the previous track.
CD: press and hold: fast backward.

RADIO: select previous / next preset station.
Select previous / next item in a menu.



Volume up.

Volume down.

Mute on; cuts the sound:
simultaneous press on
volume up and down buttons.
Mute off: press one of the
volume buttons.

03 AUDIO

Radio

Selecting a station



The external environment (hills, buildings, tunnels, basement car parks) may block reception, including in RDS mode. This is a normal effect of the way in which radio waves are transmitted and does not indicate any failure of the audio equipment.

1



Press the **SRC/BAND** button several times in succession and select the FM1, FM2 or AM waveband.



Selecting a preset station

1



Make a long press on a button to preset the station being listened to. The name of the station is displayed and an audible signal confirms that it has been preset.

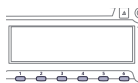

2



Press a button to listen to the corresponding preset station.

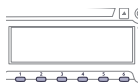

Press **LIST** to display the list of stations received, in alphabetical order.

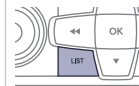

Select the desired radio station then confirm by pressing **OK**.



Press to change to the next or previous letter (e.g. A, B, D, F, G, J, K, ...).



1



Make a long press on **LIST** to construct or update the list of stations; the sound is interrupted temporarily.

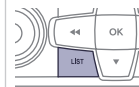

03 AUDIO

RDS

i RDS, if displayed, enables you to continue listening to the same station by automatic retuning to alternative frequencies. However, in certain conditions, coverage by an RDS station may not be assured throughout the country as radio stations do not cover 100 % of the territory. This explains the loss of reception of the station during a journey.

1



Press **MENU**.



2



Select "**Radio**" then confirm by pressing **OK**.
Select "**RDS**" then confirm by pressing **OK**.



3



Select "**On**" or "**Off**" to switch **RDS** on or off, then confirm with **OK** to save the selection.



Receiving TA messages

i The TA (Traffic Announcement) function gives priority to TA alert messages. To operate, this function needs good reception of a radio station transmitting this type of message. When a traffic report is transmitted, the current audio source (Radio, CD, ...) is interrupted automatically to play the TA message. Normal playback of the audio source resumes at the end of the transmission of the message.

1



Press **MENU** to switch on or off the reception of traffic announcements.



2



Select "**Radio**" then confirm by pressing **OK**.
Select "**Traffic TA**" then confirm by pressing **OK**.



3



Select "**On**" or "**Off**" to switch on or off the reception of traffic announcements then confirm by pressing **OK** to save the selection.



03 AUDIO

Display RADIO TEXT



Radio Text is information transmitted by the radio station on the station or on the song being played.

1



Press **MENU**.

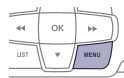

2



Select "**Radio**" or "**Media**" (depending on the current sound source) then confirm by pressing **OK**.
Select "**RADIO TEXT**" then confirm by pressing **OK**.



3



Select "**On**" or "**Off**" to switch radio text on or off, then confirm with **OK** to save the selection.



Audio CD

Playing a CD



Insert 12 cm diameter circular compact discs only.
Some anti-pirating systems, on original discs or CDs copied using a personal recorder, may cause faults which are no reflection on the quality of the original player.
Without pressing the **EJECT** button, insert a CD in the player, play begins automatically.

1



To play a disc which has already been inserted, press the **SRC/BAND** button several times in succession until "**CD**" is displayed.



2



Press one of the buttons to select a track on the CD.
Press and hold one of the buttons for fast forward or backward.



03 AUDIO

CD

Information and advice



The audio system can only play files with ".mp3", ".wma" or ".wav" extensions.



A high compression level can degrade the sound quality.



It is advisable to restrict file names to 20 characters without using special characters (e.g. " ? ; ù) to avoid any playing or displaying problems.



Playlists accepted are types .m3u and .pls.
The system can recognise up to 5 000 files in 500 folders on 8 levels.



On a given disc, the CD player can read up to 255 MP3 files spread over 8 levels. However, it is advisable to keep to a limit of two levels to reduce the access time before the CD is played.

The folder structure is not observed during playback.



In order to be able to play a recorded CDR or CDRW, when recording it is preferable to select standards ISO 9660 level 1.2 or Joliet.

If the disc is recorded in another format, it may not be played correctly.

It is recommended that the same recording standard is always used for a given disc, with as low a speed as possible (4x maximum) for optimum sound quality.

In the particular case of a multi-session CD, the Joliet standard is recommended.

03 AUDIO

CD

Playing a compilation

!



Insert an MP3 compilation on the CD player.

☀

The system constitutes playlists (in temporary memory) which may take between a few seconds to several minutes.

1



To play a disc already inserted, press **SRC/BAND** several times in succession until "CD" is displayed.



2



Press one of the buttons to select the previous or next track.



3



Press one of the buttons to select the previous or next folder depending on the classification selected.



4



Press and hold one of the buttons for fast forward or backward.



03 AUDIO

5



Press **LIST** to display the compilation folder structure.

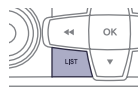

6



Select a line in the list.



7



Jump a page.



8



Select a folder /Playlist.
Start play of the track selected.



9



Go back one level.



Go back to the first level to select the track classification:

- By **Folders**: all folders containing audio files recognised on the peripheral, in alphabetical order, ignoring the folder structure.
- By **Playlist**: depending on the playlists saved.

03 AUDIO

Auxiliary socket (AUX)

Auxiliary JACK socket



The auxiliary Jack socket permits the connection of a portable device.

1

Connect the portable device to the auxiliary Jack socket using a suitable cable (not supplied).

2



Press the **SRC/BAND** button successively and select "**AUX**".



3

First adjust the volume on your portable device.



4



Then adjust the volume of the audio system.

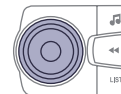

The display and management of controls is on the portable device.



03 AUDIO

Play mode

!

The play modes available are:

- Normal: the tracks are played in order, depending on the classification of the selected files.
- Random: the tracks in an album or folder are played in a random order.
- Random all: all of the tracks saved in the media are played in random order.
- Repeat: the tracks played are only those from the current album or folder.

1



Press **MENU**.

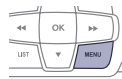

2



Select "**Media**" then confirm by pressing **OK**.



3



Select the desired play mode and confirm with **OK** to save the changes.



04 AUDIO SETTINGS

1



Press  to display the audio settings menu.



4



Adjust the setting then confirm by pressing **OK**.



2

The settings available are:

- AMBIANCE,
- BASS,
- TREBLE,
- LOUDNESS,
- BALANCE (L/R),
- AUTO VOLUME.

3



Select the settings to adjust.



!

The AMBIANCE, TREBLE and BASS settings are different and independent for each sound source.

05 SCREEN MENU MAP(S)



MAIN FUNCTION

- 1 **OPTION A**
- 2 Option A1
- 2 Option A2
- 1 **OPTION B...**

MENU

- 1 **Radio**
- 2 Traffic TA
- 2 RDS
- 2 Radio Text

- 1 **Media**
- 2 Play
- 3 Normal
- 3 Random
- 3 Random all
- 3 Repeat
- 2 Radio Text

1 **Displaying**

- 2 Scroll Text

1 **Unit**

- 2 Celsius
- 2 Fahrenheit

1 **Language**

FREQUENTLY ASKED QUESTIONS

The following tables contain answers to the most frequently asked questions.

QUESTION	ANSWER	SOLUTION
<p>There is a difference in sound quality between the different audio sources (radio, CD...).</p>	<p>For optimum sound quality, the audio settings (Volume, Bass, Treble, Ambiance, Loudness) can be adapted to the different sound sources, which may result in audible differences when changing source (radio, CD...).</p>	<p>Check that the audio settings (Volume, Bass, Treble, Ambiance, Loudness) are adapted to the sources listened to. It is advisable to set the AUDIO functions (Bass, Treble, Front-Rear Fader, Left-Right Balance) to the middle position, select the musical ambience "None" and set the loudness correction to the "Active" position in CD mode or to the "Inactive" position in radio mode.</p>
<p>When changing the settings for treble and bass, the ambience setting is deselected. When changing the ambience setting, treble and bass are reset to zero.</p>	<p>Choosing an ambience imposes settings for treble and bass. Modifying one without the other is not possible.</p>	<p>Modify the treble and bass settings or the ambience setting to obtain the desired sound quality.</p>

FREQUENTLY ASKED QUESTIONS

QUESTION	ANSWER	SOLUTION
<p>The quality of reception of the radio station listened to gradually deteriorates or the stored stations do not function (no sound, 87.5 MHz is displayed...).</p>	<p>The vehicle is too far from the transmitter used by the station listened to or there is no transmitter in the geographical area through which the vehicle is travelling.</p>	<p>Switch on the RDS function to enable the system to check whether there is a more powerful transmitter in the geographical area.</p>
	<p>The environment (hills, buildings, tunnels, basement car parks...) block reception, including in RDS mode.</p>	<p>This phenomenon is normal and does not indicate a failure of the audio equipment.</p>
	<p>The aerial is absent or has been damaged (for example when going through a car wash or into an underground car park).</p>	<p>Have the aerial checked by a PEUGEOT dealer.</p>
<p>Sound cut-outs of 1 to 2 seconds in radio mode.</p>	<p>During this brief sound cut-out, the RDS searches for any frequency permitting better reception of the station.</p>	<p>Switch off the RDS function if the phenomenon is too frequent and always on the same route.</p>
<p>The traffic announcement (TA) is displayed. I do not receive any traffic information.</p>	<p>The radio station does not broadcast traffic information.</p>	<p>Tune to a radio station which broadcasts traffic information.</p>
<p>The stored stations are not found (no sound, 87.5 MHz is displayed...).</p>	<p>An incorrect waveband is selected.</p>	<p>Press the SRC button to return to the waveband (AM, FM1, FM2) on which the stations are stored.</p>

FREq UENTLY ASKED q UESTIONS

q UESTION	ANSWER	SOLUTION
The CD is ejected automatically or is not played by the player.	The CD is inserted upside down, is unplayable, does not contain any audio data or contains an audio format which the player cannot play. The CD is protected by an anti-pirating protection system which is not recognised by the audio equipment.	<ul style="list-style-type: none"> - Check that the CD is inserted in the player the right way up. - Check the condition of the CD: the CD cannot be played if it is too damaged. - Check the content in the case of a recorded CD: consult the advice in the "Audio" section. - The audio system's CD player does not play DVDs. - Due to their quality level, certain writeable CDs will not be played by the audio system.
The CD player sound is poor.	The CD used is scratched or of poor quality.	Insert good quality CDs and store them in suitable conditions.
	The audio settings (bass, treble, ambiance) are unsuitable.	Set the treble or bass level to 0, without selecting an ambiance.
In "Random all" play, not all of the tracks are played.	In "Random all" play, the system can only take into account up to 999 tracks.	
With the engine off, the audio system switches off after a few minutes of use.	When the engine is switched off, the audio system operating time depends on the battery charge. The switch-off is normal: the audio system switches to economy mode and switches off to prevent discharging the vehicle's battery.	Start the vehicle's engine to increase the battery charge.
The message "the audio system is overheated" appears on the display.	In order to protect the installation if the surrounding temperature is too high, the audio system switches to an automatic thermal protection mode leading to a reduction of the volume or stopping of the playing of the CD.	Switch the audio system off for a few minutes to allow the system to cool.

A

Accessories	192
Accessory socket, 12V	72
AdBlue®	203
Additive, AdBlue.....	24, 203
Adjusting headlamps	117
Adjusting head restraints	57
Adjusting seat belt height	135
Adjusting the steering wheel	59
Advice on care and maintenance	191
Airbags	27, 138
Airbags, curtain.....	140, 141
Airbags, front.....	138, 141
Airbags, lateral.....	140, 141
Air conditioning	12
Air conditioning, automatic	63, 64, 67
Air conditioning, digital	70
Air conditioning, manual	63-65, 70
Air distribution adjustment	67
Air filter	214
Air flow	12
Air flow adjustment	67
Air intake	67
Air recirculation	67
Air vents	62
Alarm	50
Anti-lock braking system (ABS).....	130
Anti-theft	46
Assistance call	126, 221, 222
Assistance, emergency braking	130
Audible warning	126
Audio cable	244
Audio streaming (Bluetooth)	240, 243, 306
Audio system (radio)	321
Automatic illumination of headlamps.....	111, 116
Automatic operation of hazard warning lamps	126
Automatic rain sensitive windscreen wipers	119, 121

Auxiliary	240, 244
Auxiliary sockets	330

B

Backup starting	183
Battery.....	182-184, 214
Battery, charging.....	184
Battery, remote control	48, 49
Blue HDi.....	203
Bluetooth (hands-free)	282, 283, 307
Bluetooth (telephone).....	282, 283
Bonnet.....	195
Bonnet stay	195
Boot	54
Brake discs	215
Brake lamps	173, 174
Brake pads	215
Brakes	215
Braking assistance system	130

C

Capacity, fuel tank	198
CD	240
CD MP3.....	240, 301-303
Central locking	44
Changing a bulb	169, 173, 174
Changing a fuse	176
Changing a wheel	161, 162
Changing a wiper blade	122, 186
Changing the date	42
Changing the remote control battery.....	48

Changing the time.....	42
Checking levels	211-213
Checking the engine oil level.....	37
Checking tyre pressures (using the kit)	156
Checks	196, 197, 214, 215
Child lock.....	155
Children	148, 151-154
Child seats	142, 143, 147, 148, 150
Child seats, conventional.....	147
Cleaning (advice)	191
Closing the boot	54
Closing the doors	44
Colour screen.....	224, 225
Connectors, audio.....	73, 330
Coolant level	32, 212
Coolant temperature indicator	32
Courtesy lamps	123
Cruise control.....	100, 102
Cup holder.....	71

D

DAB (Digital Audio Broadcasting)	238, 239
Date (setting).....	42
Daytime running lamps.....	114
Deactivating the passenger airbag.....	138
Defrosting	65, 70
Demisting	65, 70
Dials and gauges	14, 15
Diesel additive level	213
Digital Audio Broadcasting (DAB)	238, 239
Dimensions	219
Dipped beam.....	110, 170
Dipstick.....	37, 211
Directional lighting	118

Direction indicators 115, 125, 170, 173, 174
 Door trays 71
 Dynamic stability control
 (DSC) 23, 130, 132, 133

E

EBA (Emergency braking assistance) 130
 Eco-driving 12
 Eco-driving (advice) 12
 Economical driving 12
 Economy mode 185
 Electric window controls 52
 Electronic brake force distribution (EBFD) ... 130
 Electronic engine immobiliser 46, 49
 Electronic
 gearbox system 12, 82, 85, 94, 184, 215
 Emergency boot release 54
 Emergency call 126, 221, 222
 Emergency warning lamps 78, 125, 126
 Emissions control system, SCR 25
 Engine economy mode 185
 Engine compartment 196, 197
 Engine compartment fusebox 176
 Engine, Diesel 197, 201, 202
 Engine oil level indicator 37, 211
 Engine, petrol 196, 201
 Environment 12, 48

F

Filling with fuel 198, 200, 201
 Fitting a wheel 164
 Fitting roof bars 191
 Fittings, boot 75
 Flashing indicators 115, 125, 170
 Folding/unfolding the door mirrors 60
 Frequency (radio) 235, 237
 Front foglamps 112, 118, 172
 Front seats 56
 Fuel 12, 201
 Fuel consumption 12
 Fuel filler flap 198, 200
 Fuel gauge 198
 Fuel tank 198, 200
 Fusebox, dashboard 176
 Fuses 176

G

Gearbox, automatic 12, 89, 184, 215
 Gearbox, manual 12, 81, 94, 215
 Gear lever 12
 Gear lever, automatic gearbox 89
 Gear lever, manual gearbox 81
 Gear shift indicator 93
 Glove box 72
 Grip control 133
 Guidance 259
 Guide-me-home 116

H

Hands-free kit 282, 283, 307
 Hazard warning lamps 78, 125, 126
 Head restraints, front 57
 Head restraints, rear 59
 Heated seats 57
 Heating 12, 64, 65
 Height and reach adjustment,
 steering wheel 59
 High load retaining net 76
 Hill start assist 97

I

Identification plates 220
 Ignition 79
 Indicators, direction 125, 170
 Inflating accessories (using the kit) 156
 Inflating tyres 12
 Inputs for audio system 330
 Instrument panels 14, 15
 Instrument panel screen 14, 15, 93
 Interior fittings 71, 72
 Interior mood lighting 124
 ISOFIX child seats 151-154
 ISOFIX mountings 151, 153

J

Jack 161, 162, 244
 Jack cable 244
 JACK socket 73, 244
 Jukebox (playing) 245

K

Keeping children
safe 138, 142, 143, 148, 151-154
Key 43, 44
Key in ignition warning 79
Key with remote control 46, 49

L

Labels, identification 220
Lamps, warning and indicator 16, 20, 21
LED daytime running lamps 114, 171
LEDs - light-emitting diodes 173
Level, AdBlue® additive 203
Level, brake fluid 211
Levels and checks 196, 197, 211-213
Light-emitting diodes - LEDs 173
Lighting bulbs (replacement) 169, 173, 174
Lighting control stalk 110, 115
Lighting, guide-me home 46, 115, 116
Lighting, interior 123, 124
Lighting on reminder 113
Loading 12, 191
Load reduction mode 185
Load space cover 76
Locating your vehicle 45
Locking the boot 54
Luggage retaining strap 75

M

Main beam 110, 170
Maintenance 12
Maintenance (advice) 191

Map reading lamps 123
Markings, identification 220
Mat 74
Menu 228, 230, 232, 246,
248, 250, 266, 278, 280
Menus (audio) 228, 230, 232, 246,
248, 250, 266, 278, 280
Menus (Touch screen) 224
Mini fuel level 198
Mirror, rear view 61
Mirrors, door 60
Misfuel prevention 200
Motorway function (direction indicators) 125
Mountings for ISOFIX seats 151, 153
MP3 CD 302, 303

N

Number plate lamps 175

O

Oil filter 214
Oil level 37, 211
Opening the bonnet 195
Opening the boot 54
Opening the doors 43
Opening the fuel filler flap 198
Opening the panoramic sunroof blind 55
Operation indicator lamps 16, 20

P

Paint colour code 220
Panoramic sunroof 55
Park Assist 106
Parking brake 80, 215
Parking lamps 115
Parking sensors, front 105
Parking sensors, rear 104
Particle emission filter 213, 214
Passenger compartment filter 214
PEUGEOT CONNECT APPS 277
Peugeot Connect Assistance 222
Peugeot Connect SOS 222
Player, CD MP3 302, 303
Port, USB 73, 304
Priming the fuel system 202
Protecting
children 138, 142, 143, 148, 151-154
Puncture 156

R

Radio 234-236, 240, 298
Radio station 234, 235, 237
RDS 237
Rear foglamp 112, 173, 175
Rear screen (demisting) 70
Recharging the battery 184
Reduction of electrical load 185
Regeneration of the particle
emissions filter 214
Reinitialising the remote control 48
Remote control 43, 44, 49
Removing a wheel 164
Removing the mat 74
Replacing bulbs 169, 173, 174

Replacing fuses	176
Replacing the air filter	214
Replacing the oil filter	214
Replacing the passenger compartment filter	214
Replacing wiper blades.....	122, 186
Resetting the service indicator	35
Reversing lamp	173, 175
Risk areas (update).....	255
Roof bars.....	191
Roof blind.....	55
Routine checks	214, 215
Running out of fuel (Diesel).....	202

S

Safety for children.....	155
Screen, instrument panel.....	38, 40
Screen menu.....	228, 230, 232, 246, 248, 250, 266, 278, 280
Screen menu map.....	228, 230, 232, 246, 248, 250, 266, 278, 280, 315, 333
Screenwash	119
Screenwash fluid level.....	212
Screen-wash reservoir	212
SCR (Selective Catalytic Reduction).....	203
SCR system	203
Seat adjustment	56
Seat belts	135-137, 147
Seats, rear.....	58
Selector lever, electronic gearbox system.....	82, 85, 215
Serial number, vehicle	220
Service indicator	34
Servicing	12

Setting the clock	42
Sidelamps	110, 114, 115, 171, 173
Side repeater	172
Snow chains.....	168
Spare wheel.....	161, 162
Speed limiter	98, 102
Start.....	183
Starting the vehicle.....	79, 82, 85, 89
Steering mounted control	297
Steering mounted controls, audio	227
Stopping the vehicle	79, 82, 85, 89
Stop Start....	41, 70, 94, 106, 182, 195, 198, 214
Storage.....	71, 72
Storage net.....	75
Stowing rings	75
Synchronising the remote control.....	48
Synthesiser, voice.....	265
System settings.....	274

T

Tables of fuses.....	176
Tank, AdBlue® additive	203, 208
Tank, fuel.....	198, 200
Telephone	282-285, 287
Temperature adjustment.....	67
Temperature control for heated seats	57
Temperature, coolant.....	32
Temporary tyre repair kit.....	156
Third brake lamp	175
TMC (Traffic info).....	260
Tools.....	161, 162
Touch screen.....	28, 30, 31, 40, 223, 225
Touch screen (Menus)	224

Towbar.....	189
Towing another vehicle	187
Traction control (ASR)	23, 130
Traffic information (TA)	261, 300
Traffic information (TMC).....	260, 261
Trailer	189
Trajectory control systems.....	130
Trip computer	38, 40, 41
Tyre pressures	160, 220
Tyres.....	12
Tyre under-inflation detection.....	127, 160

U

Under-inflation (detection)	127
Unlocking	43
Unlocking the boot	54
Update risk areas.....	255
Updating the date.....	42
Updating the time.....	42
UREA	203, 204
USB	240
USB player	240

V

Vehicle identification.....	220
Ventilation	62-65

W

Warning lamps	21
Warning lamp, SCR emissions control system	25
Warning triangle.....	78
Washing (advice).....	191
Wash-wipe, rear	120
Window controls	52
Wiper control stalk	119-121
Wiper, rear.....	120
Wipers	19, 119, 121







This handbook describes all of the equipment available in the whole range.

Your vehicle will be fitted with some of this equipment described in this document, depending on its trim level, version and the specification for the country in which it is sold.

The descriptions and illustrations are given without any obligation. Automobiles PEUGEOT reserves the right to modify the technical specifications, equipment and accessories without having to update this edition of the handbook.

This document is an integral part of your vehicle. It should be passed on to the new user in the event of sale or transfer. In addition, there are labels present in your vehicle to warn you of the need for certain precautions to take for your safety; don't remove them, they will be useful again for a new owner.

Automobiles PEUGEOT declares, by application of the provisions of the European regulation (Directive 2000/53) relating to End of Life Vehicles, that it achieves the objectives set by this regulation and that recycled materials are used in the manufacture of the products that it sells.

Reproduction or translation of all or part of this document is prohibited without written authorisation from Automobiles PEUGEOT.

For any work on your vehicle, use a qualified workshop that has the technical information, competence and equipment required, which a PEUGEOT dealer is able to provide.

Printed in the EU

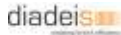

PEUGEOT

Automobiles PEUGEOT - Siège Social : 75, avenue de la Grande-Armée 75016 PARIS

Tél. 33 (0)1 40 66 55 11 - Fax 33 (0)1 40 66 54 14

Adresse postale : Automobiles PEUGEOT B.P. 01 75761 PARIS cedex 16 - Adresse Internet : <http://www.peugeot.com>

Société Anonyme au capital de 172 771 770 Euros - R.C.S. PARIS B 552 144 503. SIRET 552 144 503 00018. APE 341 Z

Anglais

03-14

