

















Contents

| | | | | |
|---|--------------|---|-----|---|
|  | Chapter I | Basic Information | 1-1 |  |
|  | Chapter II | Technical Parameters and Vehicle Identification | 2-1 |  |
|  | Chapter III | Use of Vehicle | 3-1 |  |
|  | Chapter IV | Vehicle Equipment | 4-1 |  |
|  | Chapter V | Vehicle Driving | 5-1 |  |
|  | Chapter VI | Emergency | 6-1 |  |
|  | Chapter VII | Vehicle Maintenance | 7-1 |  |
|  | Chapter VIII | Knowledge on Safe Driving | 8-1 |  |

welcome!



Thank you and congratulate for choosing JAC passenger car “ONLY FOR YOU”!

Thank you wholeheartedly for your love and passion for JAC and its products!

Before driving onto road, you are cordially requested to read this manual carefully. The purpose of this manual is to introduce the driving methods, configuration and relevant cautions of JAC passenger car “ONLY FOR YOU” so that you can get familiarized with the characteristics of this model, make full use of its excellent features and safeguard driving safety and retain its outstanding performance.

This manual embodies relevant information on vehicle service and maintenance to provide guarantee for your physical safety and reliability of your beloved vehicle. Full knowledge of your beloved vehicle will bring you robust driving funs.

Jianghuai Automobile Co., Ltd.



Special Notes

JAC shall ceaselessly make improvement to its vehicle products in terms of appearance, interior trimming and technical specifications. Photos, data and explanations in this manual shall not act as basis for ordering and acceptance of its products.

This manual serves as an introduction to this vehicle model. Therefore, certain equipment and functions may not be available in your vehicle.

JAC reserves the rights to change vehicle model and its equipment without further notice.

Chapter I Basic Information

| | |
|--|------|
| Safety and other precautions | 1-02 |
| Important information | 1-04 |
| Parts, optional parts and accessories | 1-04 |
| Environment protection and energy saving | 1-05 |
| Initial 1,000km for new vehicles | 1-06 |

Safety and other precautions

This manual is important for you in terms of physical safety and vehicle lifespan. Ignorance of such information may lead to severe consequences for driver safety and vehicle performance or loss of certain rights, including:

Correct use safety belt

All passengers in front and rear rows should use safety belt while children must be seated in the rear seat.

Safety belt should be buckled up when driving on urban road or highways.

According to statistics, safety belt can effectively lower death and severe injury rates. (For detailed explanations, please refer to Chapter VIII, "Safety Belt".)

| Notes |
|---|
| Safety belt must be used in vehicles equipped with air bag systems, which serve only as an auxiliary unit for safety belt. Air bag can only provide driver and passengers with protection under the premise that safety belts are on. In case air bag opens in a collision accident and driver and passenger in first row who do not have belt on may greatly increase opportunities for fatality, even additional damages. |

Check tires and tire pressures

| Notes |
|--|
| Excessive wearing and abrasion of tires and too low or too high tire pressures will lead to accidental explosion, causing physical injury. |

Check tire pressure at least twice a month, or before each driving, or when load is increased. Inflate tires according to specified rules. This will prolong lifespan of tires and keep your vehicle in compliance with design safety requirement. Do not forget to calibrate spare tire pressure when your tires are inflated.

Fluids and lubricants for vehicle use

Please use fluids and lubricants at specified intervals and specifications. Otherwise, damages can occur to your vehicle, even physical injury may happen. Please read Chapter VII "Maintenance" carefully.

Change oil per specified

Change qualified oil at specified intervals and mileage and this will prolong the lifespan of the engine. Use relevant oil correctly under working ambient temperature. Otherwise, severe damages may occur to the engine and such damages are not subject to warranty. If a vehicle is used most often on populated urban roads during rush hours or dusty roads, greater amount of oil will be consumed. Therefore, change oil and oil filter at every 5,000km or 3 months' interval (subject which falls due first).

If you are mostly often driving on good roads, change oil and oil filter at every 5,000km or 6 months' interval (See Chapter VII "Maintenance").

To prevent worries later, please change oil at after-sales service centers designated by JAC to ensure the oil is in compliance with the specification and usage requirements. Do not accept oil from unknown sources or stored in already opened containers.

Check coolant level

Check the coolant level every week to ensure that it is in the normal level limit to avoid urgency during driving.

Important information

This manual comes with safety tips which must be followed carefully to avoid possibilities of injuries or vehicle damages. Friendly tips and their usages are as follows:

| |
|----------------------|
| Friendly Tips |
| Friendly tips on FAQ |

| |
|--|
| Notes |
| To avoid events leading to vehicle damages or physical injuries. |

Safety Labels



Safety labels shown above mean “CAN NOT DO LIKE THIS” or “AVOID THIS”.

What should be emphasized is that this manual must be read carefully as it contains information on how to drive calmly on various road conditions and correctly use the vehicles.

Please read the contents from time to time and remember all the friendly tips as it will benefit you when such information is needed.

Parts, optional parts and accessories

Parts, optional parts and accessories

Please do contact the JAC designated after-sales service center to ensure that your vehicle is equipped with genuine parts.

| Notes |
|---|
| Do not install non-OEM recommended electrical equipment on the vehicle, such as the warning device, power source, in-vehicle cell phone, ignition device and kerosene suppressor to avoid severe damages of the vehicle, especially the electrical system, which can encounter malfunctions, even circuit break and flame. Damages due to installation of such non-OEM recommended parts are exempted from warranty. Information put on vehicles includes JAC User’s Manual: ONLY FOR YOU, JAC Maintenance Manual: ONLY FOR YOU, Simplified Operation Manual: ONLY FOR YOU and DVD User’s Manual. |

Environment protection and energy saving

Face to future technology
In consideration to environment protection, the Company adopts environmental friendly materials and recyclable materials to the extent possible in vehicle design and assembly. The production is also in compliance with environment protection requirements.

Such manner of productivity is the result of technology progress to make it easier for disintegration and material breakdown for recycle and reuse purposes. Asbestos and cadmium and other materials are no longer used while the A/C system adopts non-CFCs refrigerants. Your JAC vehicle emission system meets

the standard. In the valid use period of the catalytic system specified by the emission regulation, the emission can reach contaminant limits. As the user of JAC products, your contribution to environment protection is prominent.

Awareness in environment protection during driving

Awareness in environment protection should be kept during driving. Thank you for your efforts in lowering noises and reducing waste gases. This is not only energy saving, but also favorable for improving life quality.

Unnecessary speedy acceleration will obvious level up fuel consumption, tire noises at starting and excessively high engine idling rotation can increase noise level by as much as four folds.

Shift to higher gears as possible. A vehicle running at 2nd gear can produce noises equal to noise made by 3 vehicles at 4th gear at the speed of 50km/hr.

The first 1,000km

for new vehicles are crucial in terms of their durability and performances. Please refer to relevant information.

Keep speed balanced

Shift to higher gears as possible.

In urban traffic, 4th gear is often applied. The fuel consumption of vehicles at 3rd gear can be 30% more than those at 4th gear when running at a speed of 50-80km/hr and more noises are released to environment. The fuel consumption of a vehicle running at 4th gear can be over 20% more than that at 5th gear at a speed of 70-90km/hr.

Urban Traffic

Frequent stopping and moving, like at cross-roads with traffic light control, will

prominently increase fuel consumption and noise level. Be always cautious of the traffic ahead of you to avoid unnecessary braking. Choose the roads where traffic is smooth as possible. Be careful of brake distance and do not frequently apply brake or acceleration pedal in order to reduce noise contamination, excessive emission and fuel consumption, especially when driving in residential areas or during night time.

Friendly Tips

If you have to park and move your vehicle on urban road often, you are advised to run on the highway for 100-200km at an interval of 5,000km driving to effectively decrease carbon residuals and engine shivering.

Idle speed

Even at idle speed, engine burns oil and produces noises. The fuel consumption of a 5-minute idle time equals to traveling about 1km. Therefore, the idle time during parking should be shortened as possible.

High speed driving

Excess accelerated driving can lead to exorbitant fuel consumption and louder noises. Even if the acceleration pedal is released somewhat, fuel will be saved while vehicle speed is not reduced notably. The higher the speed the vehicle travels, the louder the tire and wind noises will be. When vehicle speed in high gear exceeds 70km/hr, the noise from the tire will be clearly evident.

Noises from a vehicle running at 150km/

hr are equivalent to noises of 4 vehicles at the speed of 100km/hr or 10 vehicles at the speed of 70km/hr.

Door

Close the door tenderly.

Tire pressure

Too low tire pressures can increase your fuel consumption, accelerate wearing of tires, add up to your cost of use and affect driving safety while too high tire pressures will reduce the adhesiveness of wheels and increase body vibration, thus affecting driving safety and comfort. Please check tires on a regular bi-weekly basis.

Loading

Unnecessary loading can add up to fuel consumption, especially during acceleration on urban road, running on urban road with the loading of 100kg will add about 0.5L/100km in terms of fuel consumption.



Repair and check-up

During the repair, production and inspection processes, JAC adopts environment friendly materials.

Do not repair commission and/or inspect the engine on your own. The reasons are as follows:

- ※ Due to unfamiliarity to equipment, operations against the current environment protection regulations may happen.
- ※ Recyclable parts are not recycled for reuse.
- ※ Contact to certain materials may do harm to the skin.
- ※ Inappropriate repair waives up rights in claims.

Please turn your vehicle in a designated

after-sales service center for maintenance purposes.

Wish you a pleasant driving!

Chapter II Technical Parameters and Vehicle Identification

| | |
|--|------|
| Main vehicle dimensions | 2-02 |
| Vehicle quality parameters | 2-03 |
| Main fluids | 2-04 |
| Main engine parameters and performances | 2-04 |
| Power performance index | 2-05 |
| Gear ratio of transmission | 2-05 |
| Front and rear wheel alignment parameters (unloaded) | 2-06 |
| Wheel, tire specifications and cold state pressure | 2-06 |
| Vehicle VIN | 2-07 |

Main vehicle dimensions

| Items | Unit | Parameter |
|-----------------------|---------------------|-----------|
| Length | mm | 4,865 |
| Width | mm | 1,805 |
| Height (Unloaded) | mm | 1,450 |
| Wheel Base | mm | 2,790 |
| Front Tread | mm | 1,565 |
| Rear Tread | mm | 1,560 |
| Boot Capacity | dm ³ (h) | 550 |
| Min. Ground Clearance | mm | 125 |
| Approaching Angle | (°) | 15 |
| Departure Angle | (°) | 16 |

Vehicle quality parameters

| Items | Unit | Parameter | |
|---------------------------|--------|-----------|------|
| | | 2.0L | 2.4L |
| Number of Passengers | Person | 5 | |
| Curb Weight | kg | 1,470 | |
| Loaded Weight | kg | 1,845 | |
| Front Axle Load (Curb) | kg | 885 | |
| Rear Axle Load (Curb) | kg | 585 | |
| Front Axle Load (Loaded) | kg | 995 | |
| Rear Axle Load (Loaded) | kg | 850 | |

Main fluids

| Description | Recommendation | Volume |
|----------------------------------|-------------------------|-------------|
| Unleaded Petrol | Octane Ratio: 93 | 70L |
| Engine Coolant | Premium Ethylene Glycol | 7L |
| MT Lubrication Oil | SAE 75W/90 API G1-4 | 2.0L |
| (-20° to 30°) Type of Engine Oil | SAE 10W/30 SG | 4L |
| (-30° to 20°) Type of Engine Oil | SAF 5W/40 SG | 4L |
| Power Steering Fluid | PSF-3 | 1.1L |
| Brake Fluid | DOT4 | about 0.64L |

Main engine parameters and performances

| Items | Unit | Parameter | |
|--------------------|--------|-----------------|-----------------|
| | | 2.0 (MT) | 2.4 (MT) |
| Gross Displacement | L | 2.0 (MT) | 2.4 (MT) |
| Rated Power/RPM | kW/rpm | 95/5,500 | 100/5,500 |
| Max. Torque/RPM | Nm/rpm | 172/3,000-4,500 | 193/2,500-3,000 |
| Diameter ×Stroke | mm | 85×88 | 86.5×100 |
| Idle Speed | r/min | 750±30 | 750±30 |

Power performance index

| Items | Unit | 2.0L (MT) | 2.4L (MT) |
|--|------|-----------|-----------|
| Start and Acceleration Gear Shifting Time (0-100) km/h | S | ≤18 | ≤16 |
| Max. Speed | km/h | 185/5,400 | 190/5,500 |

Gear ratio of transmission

| Items | | Parameter | | |
|--------------------------|-------------|-----------------|-----------|-------|
| Shifting Method | | MT (2.4L) | MT (2.0L) | |
| Max. Output Torque (N·m) | | 230 | 230 | |
| Gear Ratio | Gear | 1 st | 3.583 | 3.583 |
| | | 2 nd | 1.947 | 1.947 |
| | | 3 rd | 1.379 | 1.379 |
| | | 4 th | 1.030 | 1.030 |
| | | 5 th | 0.767 | 0.820 |
| | Reverse (R) | 3.363 | 3.363 | |
| Main Reduction Ratio | | 4.312 | 4.312 | |

Front and rear wheel alignment parameters (unloaded)

| Item | Parameter (Unloaded) | Parameter (°) |
|-------------|-------------------------|--|
| Front Wheel | Camber Angle (Unloaded) | 8'±30' (Left and right difference within 30') |
| | Castor Angle (Unloaded) | 5.6°±1.5° (Left and right difference within 30') |
| | Toe-in (Unloaded) | 11'±9' |
| Rear Wheel | Castor Angle (Unloaded) | -40'±30' |
| | Toe-in (Unloaded) | 9'±9' (Left and right difference within 30') |

Wheel, tire specifications and cold state pressure

| | | |
|--------------------------------|---------------------------|------------------------|
| Tire | 205/55 R16 91V (Aluminum) | 195/65 R15 91V (Steel) |
| Tire Cold State Pressure (kPa) | 220 | |

Vehicle VIN

I . Vin

There are three legal VIN codes on your vehicle.

1.VIN code on the instrument panel



This VIN code is at the left corner of the instrument panel at the driver side.

2. VIN code on nameplate

This VIN code is on the front side panel under the engine hood at the passenger side (See the following photo illustration).



3. Body VIN code under the engine hood

This VIN frottage is not on the nameplate, but carved on the body under the engine hood and above the nameplate.



II. Engine No.



Engine No. is printed on the cylinder block at the upper position of the engine.

III. MT identification No.



MT Identification No. is at the connection end between the transmission and clutch.

Chapter III Use of Vehicle

| | | | |
|-------------------------------------|------|---|------|
| Key | 3-02 | Mileage/ shift/ time indicator light | 3-25 |
| Door and lock | 3-06 | Indicator light and warning light | 3-27 |
| Boot lock | 3-09 | Hazard warning flashing light | 3-34 |
| Oil tank cover release button | 3-10 | Other warning devices | 3-34 |
| Engine hatch cover | 3-10 | Turning signal/ multi-function control lever | 3-36 |
| Air operated outrigger | 3-11 | Front fog lamp | 3-39 |
| Electric window | 3-11 | Rear fog lamp | 3-39 |
| Back mirror | 3-12 | Panel board brightness | 3-40 |
| Front seat | 3-15 | Illumination angle adjustment of dipped beam light and high beam light | 3-40 |
| Rear seat | 3-19 | Glove compartment | 3-40 |
| Inclinable steering wheel | 3-20 | Cigarette lighter and ash tray | 3-41 |
| Console | 3-21 | Cup support | 3-42 |
| Combined device | 3-22 | Storage box at driver's side | 3-42 |
| Tachometer | 3-24 | Storage area of central control console | 3-42 |
| Car speed gauge | 3-24 | Rear seat armrest | 3-43 |
| Fuel gauge | 3-25 | | |
| Thermometer | 3-25 | | |

Key



When you buy your new car, you will get two keys. Please keep one key properly as a standby one. The key coding is recorded on one number plate (which is attached with the key). For the sake of safety, record the numbers on the key plate and keep them in a safe place if needed when you prepare a new key.

Notes

Please well keep your key number plate, for it is the basis when you prepare a new one.

Notes

Do not leave your child and key in your car independently, for your child may start the electric window or other control devices, or even start your car, which might cause serious injuries to your child as well as to other people.

If your car is equipped with electric anti-theft alarm system, only the key with correct electronic codes could start it up. The key of the same shape but with wrong codes could neither start the engine. If you need an extra key or if you lose your key, the distributor (s) authorized by Jianghuai could prepare a new one for you if you can correctly tell your key codes.

Remote control door lock system

Sometimes you will find the effective range of emitter becomes smaller, but this is very normal to any remote control door lock system. If your emitter cannot work or works only when stand very near, please try the following procedures:

- ※ Check the distance. Maybe you stand a little far away from your car. And in rainy or snowy day, you need stand closer to the car.
- ※ Check the place. To see if there are other vehicles or objects blocking your signal, walk a little to the left or right and raise your emitter a little higher and try once more.
- ※ Check whether the cell needs to be replaced. Refer to “The Replacement of Cell” in “Remote Control Door Lock

System” of this Chapter.

- ※ If there is still problem, please visit the special maintenance center of Jianghuai automobiles for service.

Remote control door lock system operation

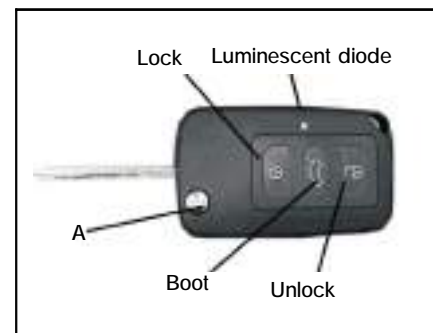

You may lock or open the door by using the remote control door lock system:

Lock: You may lock all doors if this button is pressed. If all the doors and boots are closed, the hazard warning light will flash for once, which indicates that the car is well locked and the anti-theft system is started.

Close the window remotely: If you press the lock key on the remote controller for over 300ms, the windows on the four doors will automatically lift up until closed.

Unlock: All the doors are unlocked if this button is pressed. At this moment, the hazard warning light will flash for twice indicating that the car is unlocked and the anti-theft system is cancelled.

Descend the window remotely: The windows on the four doors will automatically descend if the unlocking key on the controller is pressed down for over 300ms. If the door is not opened or the engine is not started within 30s after the emitter unlocks the door, all the doors will be locked automatically and the anti-theft system will be resumed.

Boot: The boot can be opened if this button is pressed.

When this button is pressed, the light emitting diode lamp will flash for once indicating that the boot is opened.

Bounce out the key: The key folded in the remote control will bounce out if Button A is pressed. The key could be turned back to the remote control if Button A is continuously pressed.

Friendly Tips

If the ignition key is not pulled out, the buttons on the remote door lock emitter will not work and the anti-theft system will not be started. Refer to “Anti-theft System” of this Chapter for details.

Matched key emitter

Each emitter is electronically coded to prevent other emitters opening the door lock. If your emitter is lost or stolen, you could buy a substitution emitter through the selling and service center of Jianghuai Automobile.

If you need one or more substitution emitters, you should take the current emitter when you want to buy substitution emitter from the service center. When the selling and service center is matching the substitution emitter with your car, the existing emitter must also match with it.

If the selling service center finishes the electronic coding to the new emitter, the lost emitter could not open the door

lock. For each car, two key emitters at most could be kept simultaneously.

Replacing the cell

Under normal use condition, the cell in the remote lock emitter can be used for two years.

If the light emitting diode lamp does not light up or must work when approaching near the car, it indicates that the electric quantity of cell is insufficient and new one should be replaced at once.

Type of remote key button cell: CR2032.



Steps to replace the emitter cell:

1. Dismount the cover plate of the front face of remote key and take out the emitter.

2. Carefully open the emitter cover, take out the used cell and install a new one. The positive pole of the cell must face upwards.

3. Cover the emitter cover and make sure the cover is tightly covered to prevent water.

4. Put the emitter into the remote key and cover the cover plate.

5. Test the operation of emitter.

- Press two buttons on the emitter for around 10s continuously, and the LED indicator light will rapidly flash on and then out.

- Continuously press down the lock and unlock buttons thrice respectively and hold for over 1.5s each time. If the LED indicator light distinguishes, loosen the button. At this moment, the LED indicator light will continue flashing.

Friendly Tips

When replacing the cell, be careful and not contact the circuit board.

The static electricity transferred from your body to the circuit board will damage the emitter.

Do not touch the two surfaces of the cell if you aren't wearing the gloves, for this will shorten the service life of the cell.

The used cell will be harmful to the environment, so

- ※ Comply with local recycling rules for disposed cells.
- ※ Do not throw it away together with domestic wastes.

In order to keep the emitter at good condition, please abide by the following rules:

- ※ Do not drop the emitter onto the ground.
- ※ Do not put heavy objects on the emitter.
- ※ Keep the emitter away from water or direct sunshine. If the emitter is wetted, mop it up with soft cloth.

Door and lock

Door lock

Notes

The temperature inside the car will rise rapidly and exceed that outside the car.

※ Do not leave the child or pet inside the car individually; or else serious injuries might happen, for the child may control the electric window or other control buttons and even initiate the car.

※ Do not leave the child with key inside the car, which will possibly lead to serious injuries.

Friendly Tips

When you walk away from the unkept car, you must lock all the doors and take the keys away.



To lock the door with key outside the car, you should insert the key and turn it clockwise.

To unlock the door, turn the key counter-clockwise.



To lock any door inside the car, you should toggle the door lock control button right inward.

To unlock any door inside the car, you should toggle the door lock control button left outward.



To open the door from inside of the car, pull the door handle inwards.



To open the door from outside of the car, pull up the door handle outwards.

Door central lock system



The electric door lock buttons on the door switch of driver's side can control the opening and closing of all the four doors. By pressing the electric door lock's central switch button, the four doors will be locked. Press down the central control electric door lock switch button, the four doors will be opened. If the car speed exceeds 40km/h, the door lock will be automatically locked.

Friendly Tips

Only the door at driver's side is closed can all doors be locked. If that door is opened, all the car doors cannot be locked by using the above methods.

Door ajar warning



If one of the doors is not properly closed, the door ajar warning light on the combined device will light on until the door is well closed.

Child safety lock

All rear doors of this car install the child safety lock to prevent passenger (especially the child) from pulling the door handle and opening the rear door from inside accidentally.

Friendly Tips

When the child safety lock is setting at “LOCK (locked)” position, do not pull the door handle inside the car. Otherwise, the handle may be damaged.



To start up the child safety lock:

- ※ Open the rear door you want to lock.
- ※ Find out the child safety lock lever which locates at door end near the middle position.
- ※ Slide the lever to LOCK (locked) position.

Friendly Tips

All rear doors are equipped with their respective locks. The child safety lock at the left and right rear doors must be started manually.

When the child safety lock is used and you want to open the rear door, you have to open the door from outside the car.

To cancel the child safety lock, turn the lever to “UNLOCK (unlocked)” position.

Boot lock



- ※ Press the indicator button of boot switch on the remote controlled key (see “Key” of this Chapter) to open the boot.
- ※ You can also open the boot cover by pressing the boot switch on the left switch group assembly of instrument desk (shown in the above picture).

Notes

During driving, do not press the boot switch button on the console, as the boot will be opened if this button is pressed.



- ※ To open the boot cover, please insert the key and screw it clockwise, lift the boot cover and return the key to neutral position and then pull it out. To close the cover, please press the boot cover downward and lock it.

Friendly Tips

Make sure your and other people’s hands and other bodily parts are away from the closing area of boot or tail door.

Notes

- ※ If the car is driven under the condition that the boot cover or tail door is opened, the exhausted gas will enter the passenger chamber and lead to serious casualties for the exhaust gas is toxic usually.
- ※ When the boot cover is opened, it may screen out your rear vision. When driving, if the rear vision is screened, collision accidents may be caused, which will damage your car or other properties and even lead to casualty accidents.

Oil tank cover release button



Press the oil tank cover switch on the left switch group assembly of instrument desk, and you can open the oil tank cover.

Notes

When driving, do not press the above button, for the oil tank cover will be opened if this button is pressed.

Engine hatch cover



1. Pull the engine cover release bar at left lower side of console.



2. Extend your hands to the front lower side of the engine cover and turn the engine cover release bar leftward.

Air operated outrigger



3. Lift the engine cover to the highest point (air operated outrigger support).

Electric window



The switch of electric window locates at the door handle at the driver's side. In addition, each passenger door is equipped with their individual window switch.

Press downward the switch and the window glass can be lowered.

Lift upward the switch and the window glass can be lifted.

Friendly Tips

- ※ The electric window can be used only when the ignition switch is connected.
- ※ The rear window cannot be fully lowered.

Lower the window glass rapidly

The windows on the four doors can be rapidly lowered if the switches are temporarily pressed downward to the bottom (around 50ms) and then loosened. By doing this, the window glass can be completely lowered.

When the window glass is declining, you can stop its moving by press the switch once again. You can also lift the glass by lifting the switch and hold it for a moment.

Window locked



The electric window control device of the driver's also includes a locking button. When the locking button is pressed down, the front and rear passengers cannot use their window switches. The driver can still operate all the windows at locking condition. Press the locking button once again and the normal operation of windows will be resumed.

Notes

The child is able to operate the electric window and possible to be blocked by the window during the operation, thus serious casualty accidents may be caused.

When the child is sitting at rear seat, the electric window lock must be applied.

Back mirror

Inner rearview mirror



The inner back mirror can be adjusted upward, downward, leftward and rightward. Adjust the daily and night vision of the mirror by using the inner rearview mirror adjust rod. This adjustment will reduce the glare of the headlight at the back of your car.

Notes

The unclearness of back vision when driving will lead to collision accidents, damaging your car or other properties and even cause injuries.

Exterior electric rearview mirror



The control switch of electric back mirror locates at the front door switch panel at the driver's side.

The rearview mirror can be adjusted to the required direction through the four-direction adjusting button (2) when the exterior rearview mirror control button (1) is turned to the left side. The right rearview mirror can be adjusted if the

exterior rearview mirror control button (1) is turned to the right side. If the control button is placed at middle position, the rearview mirror at both sides will not move.

Friendly Tips

The rearview mirror can be adjusted only when the ignition switch is at ON (connecting) position.

Notes

Make sure the rearview mirrors are always under correct adjusting condition and can be used when driving in order to expand the vision and clearly watch the surrounding objects and other vehicles. If you can't correctly judge the distance between your car and other objects, you might cause collision accident and thus damage your car or other properties and even lead to injuries. The improper maintenance of the rearview mirror will cause damages. Do not scrape the ice on the surface of the rearview mirror. If the ice or other objects restrain the movement of rearview mirror, it is forbidden to make imperative adjustment. Eliminate the ice with de-icing can or warm air blower.



Push the exterior rearview mirror backward to the car and you can fold the mirror and put it flatly on the side surface of the car.

Notes

Do not drive when the exterior back mirror is folded. Otherwise, your vision will be lessened and collision accidents might be caused.

Front seat

Manual seat



Pull up and fix the operating lever in the front below the seat, you can cancel the locking condition of the seat.

Slide the seat to where you want and then release the lever. Then try to move the seat with your body and check whether the seat is well locked.

Notes

When driving the car, the adjustment of the manual seat of the driver's might cause your car out of control, as the sudden movement of seat might scare you or make you be at wit's end, or make you step on certain pedal subconsciously. You can adjust the driver's seat only when the car is stopped.

Height adjustment of driver's seat



The adjustment hand wheel of the manual driver's seat locates at the exterior side of the seat.

You can adjust the inclination of the front part of seat by screwing the hand wheel in the front. And you can adjust the inclination of the rear part of seat by screwing the middle hand wheel.

Inclinable seat backrest adjustment



The manual lever, which locates at the exterior side of the seat, is equipped in your car to control the inclination of your backrest.

To adjust the seat backrest, lift the lever and adjust the backrest to where you want. Then, loosen the lever and push backward the seat backrest, making sure that the backrest is well locked.

Pull up the lever and the seat backrest will move to vertical position.

Electric seat (if equipped)



If your car is equipped with this device, there will be a multi-direction adjustment electric seat control device at the exterior side of driver's seat.

The adjusting method of electric seat is as follows:

Push the switch forward or backward and the seat can be moved fore and aft.

Press the front part of the switch upward or downward, and you can lift or

lower the front part of the seat.

Press the rear part of the switch upward or downward, and you can lift or lower the rear part of the seat.

Push the entire switch upward or downward, and you can lift or lower the entire seat.



Push the switch on the upper side forward or backward, you can adjust the inclination of the seat backrest.

When your seat reaches to where you want, please loosen the switch.

Manual waist rest (if equipped)



To adjust the waist rest of the driver's seat, please use the control lever at exterior side of the seat backrest.

Push the lever downward, and the waist rest can be adjusted to the lower position of the backrest.

Pull the lever upward, and the waist rest will return to normal position.



Do not incline the seat backrest when your car is running.

Notes

When the car is running, it is very dangerous to sit on the seat with inclined backrest. Even if you have already tied the safety belt, it won't act if your body is so much inclined; neither will be the shoulder belt as it cannot closely cling to your body. The shoulder belt lies in your front side, and when the car collides, you might clash onto the shoulder belt, injuring your neck or other body parts. The hip belt could neither act, for during collision process, this belt will slide to the upper side of your abdomen. The effect of hip belt still exists but not on your hipbone position, which will cause serious internal injuries.

In order to protect the passengers inside the car when driving, the seat backrest should be at vertical position. Then lean against the back part of the seat as much as you can and correctly wear the safety belt.

Pillow



Adjust the pillow height and make its upper side approach your crown as much as you can, so as to minimize the chances of your neck getting injured during the car collision.

Lift: pull up the pillow and you can adjust the pillow height.

Rear seat



Descend: While pressing down the lock-release button, press the pillow down. To dismount the pillow, please fully pull up the pillow, and then press the release button and lift the pillow from inside the guiding sleeve.

Before driving, the pillow should be re-assembled and readjusted to the original position.



The two exterior seats in rear row and the middle seat are all equipped with



three-point safety belt. To use the middle handle of rear seat, pull out the middle handle with cup support installed as shown in the above picture.

Inclinable steering wheel



To adjust the position of steering wheel:

1. Push downward the control lever at the lower part of steering column.
2. When reaching the required position, pull upward the control lever to lock the steering wheel.
3. Make sure that the steering wheel is completely locked.

Notes

- ※ When driving, the driver must be able to completely control the steering wheel.
- ※ When driving, do not adjust the position of the steering wheel. The adjustment of steering wheel when you are driving will make your car out of control.

Console



- | | | |
|--|---|---|
| 1. Air outlet | 7. Engine hatch cover release bar | 14. Hazard warning flashing light switch |
| 2. Combined device | 8. Storage box at driver's side | 15. Temperature control system |
| 3. Hi-fi system (refer to Chapter 4 Vehicle Equipment) | 9. Headlight height regulating switch | 16. Rear windshield defroster switch |
| 4. Gas filler cover opening switch | 10. Reserved switch (no function temporarily) | 17. Reserved switch (no function temporarily) |
| 5. Backup hatch cover opening switch | 11. Front fog lamp switch | 18. Glove compartment |
| 6. Background light brightness regulating switch | 12. Rear fog lamp switch | 19. Horn |
| | 13. Cigarette lighter and ash tray | |

Combined device



1. Tachometer 2. Car speed meter 3. Thermometer 4. Fuel oil meter 5. Mileage/shift/time indicator light

| | | | |
|-----|--|--------|--------------------------------|
| | Charging and discharging indicator light | | Brake shoe abrasion indicator |
| | Oil pressure alarm | | Safety belt indicator |
| | Fuel alarm | | Safety airbag indicator |
| EPC | Engine check | | ABS alarm |
| | Small light indicator | | Door ajar indicator |
| | Distant light indicator | | Engine anti-theft indicator |
| | Front fog lamp indicator | | Boot indicator |
| | Rear fog lamp indicator | | OBD indicator |
| | Left/right steering indicator | CRUISE | Cruise indicator (if equipped) |
| | Parking brake and braking liquid level warning/EBD | | |

Tachometer



The tachometer indicates the number of revolution of the engine per minute.

In order to improve the fuel economical efficiency, you should keep the revolution speed at low scope from 2,000r/m to 3,000 r/m when driving.

Do not operate the engine when the pointer of tachometer enters the red area.

| Notes |
|---|
| The over-revolution of engine will damage the engine. Do not let the engine rotate too fast which will move the pointer into red area. Otherwise, expensive repair charges may be incurred. |

Speed gauge



The speed gauge indicates the speed by km/h.

Fuel gauge



Indicating the amount of fuel remained in the tank.

After refilling the oil and restarting the engine, the pointer of fuel gauge moves slowly and indicates a new oil level.

During braking, accelerating or turning processes, the fuel oil inside the tank will swing, which will lead to the movement of fuel oil tank pointer.

Volume of fuel oil tank: 70L

Thermometer



Indicating the water temperature of the engine. When the pointer reaches the red area, the car must be stopped for overhaul, preventing the engine damage. It should not be restarted until the water temperature decreases. If such similar fault still exists, please promptly contact with the special service center of Jianghuai Automobile Company.

Mileage/ shift/ time indicator light



With accumulated mileage, mileage subtotal and time showing function

① is the time and mileage subtotal meter

② is the accumulated odometer

Mileage subtotal reset and clock setting shift



The reset lever can be used to shift among modes, adjust time and reset the odometer. When operating the shift display modes, one must press it in short time (>300ms and <2s).

Mileage subtotal

The mileage subtotal is displayed on the upper row of LCD, indicating the total mileage from the previous subtotal reset or the battery pressure cut-off till now. Its display scope is 0-999.9kms, with a precision of 0.1km. If the instrument power is cut off (the battery power instead of the ignition power), the mileage subtotal meter will be reset.

Reset the mileage subtotal meter

Under the display mode of mileage subtotal meter, if you press and hold the regulating lever for long period (more than 2s), the current readout in mileage subtotal meter will be reset.

Clock

Both the time and clock sign are simultaneously displayed on the upper row of LCD, with the time displayed using 24-hour system.

Clock setting

The time is displayed in the form of 24-hour.

Press down and hold the regulating lever for long period (more than 2s), the clock setting mode will be accessed. At this moment, the hour digits and the colon flash at 1Hz.

Hour setting

The hour setting mode will be accessed if the regulating lever is pressed and held for long period (more than 2s) under the clock setting mode. Under the hour setting mode, the hour will increase along with the short press of regulating lever (>300ms and <2s). If the time of regulating lever pressed is more than 2s, the hours will continuously increase by 5h once. If the regulating lever hasn't been contacted within 5s, it will enter the minute setting mode. At this moment, the minute digits and colon flash at 1Hz.

Minute setting

The regulating lever will enter minute setting mode when the lever is pressed for long period (more than 2s) under the hour setting mode.

Same as the hour setting, if there is no contact of regulating lever within 5s, the minute setting mode will terminate and the clock will not flash at this moment.

Indicator light and warning light

Charging and discharging indicator light
As one check, when the ignition switch is connected and the engine is not started, the charge system indicator light will turn on shortly, indicating it under normal condition.

After the engine is started, this indicator light should turn off. If the indicator light doesn't distinguish or lights up during driving process, it indicates the charging system may have electrical failure. You should visit the after sale service center to check the charging system. If you drive with this light on, the battery will be used up. If you have to drive in short distance with this light on, please shut off all the attached devices, such as radio and air conditioner.

Engine oil pressure alarm light

If the engine oil pressure is too low, this alarm light will keep turning on after the engine is started. If the light lights on when the car is driving, it indicates the engine oil is insufficient. This is caused by the lower of engine oil level or other faults related with the oil. Please find the special sale and service center of Jianghuai Automobile for check. The engine oil alarm light may also light up under another three situations:

- ※ As a kind of test, when the ignition switch is connected but the engine is not started, this alarm light will switch on, indicating its function is normal. After the engine is started, this alarm light will distinguish. If the ignition switch is connected but the light isn't on, it is the

fault of fuse or bulb.

- ※ If the engine idles when coming across red lamp, the alarm light may flash and then distinguish.
- ※ If you conduct emergency brake, this light will be on for short time, which is very normal.

Friendly Tips

If the engine oil is in shortage, it may damage the engine and the maintenance caused by this is not within the warranty scope. Please replace the engine oil as per the maintenance schedule in this Manual.

Notes

When the engine oil pressure is too low, do not continue driving. Otherwise, the engine will overheat and caught on fire, which will injure people. You should check the engine oil and send the car for repair as soon as possible.

Fuel alarm light

When the fuel tank level is too low, this alarm light will be on.
When the remaining oil in the tank approaches 7.5L, the fuel level too -low alarm light will turn on.
After refill fuel into the fuel tank, the alarm light will distinguish.

Engine check indicator light

After the ignition switch is connected and before the engine is started, the indicator light will light on.
This indicates the indicator light bulb is in normal condition.
The light will distinguish after the engine is started.

Notes

Do not drive the car when the fault indicating light is on.
The indicator light indicates that your car has faults that need paying attention. Driving when the fault indicator light is on will damage the exhaust control system and influence the fuel economic efficiency and the car performance.
Please find the special after service center of Jianghuai Automobile for repair and maintenance as soon as possible.

Distant light indicator light

When the distant light of headlight is connected, the distant light indicator light will be on.

Small light indicator

The small light will be used at dark but it's still bright outside. At this moment, the small light indicator light will be on.

Front fog lamp indicator

When the front fog lamp lights on, the indicator light will be on.

Rear fog lamp indicator

When the rear fog lamp lights on, the indicator light will be on.

Left and right steering indicator

The turning signal light indicator light is to confirm whether the outside turning signal light is in normal condition.

If the green arrow fails to flash when you

send out the turning signal or press down the hazard warning button, check the fuse and bulb and replace if necessary.

Parking brake and braking liquid level alarm light

After the ignition switch is connected and before the engine is started, the brake system alarm light will turn on. This indicates the indicator light is in normal condition. After the engine is started, this light will light on together with the ABS indicator light, which indicates the system is under self-check and the indicator light bulb in normal condition. The light should distinguish after around 2s.

When the parking brake is connected, the brake system alarm light will also

light on. The indicator light will be out after the parking brake is loosened. Please loosen the parking brake before driving the car.

| Notes |
|---|
| <p>Do not drive the car when the brake system alarm light is still on. It may indicate that your brake works abnormally. Driving with brake faulted may cause collision accidents and result in bodily injuries, and even damage your car or other objects.</p> |

If the brake system alarm light is still on when the parking brake is completely loosened, it indicates the braking liquid level inside the storage tank is too low.

To deal with it, you should perform the following procedures:

1. Carefully drive your car away from the pavement and stop it.
2. Check the braking liquid level.
3. Add the recommended braking liquid up to appropriate position. Refer to Chapter 7 "Maintenance" for details.

Brake shoe abrasion indicator

This light will turn on if the brake shoe is seriously worn out and unable to ensure the stability of brake.

Safety belt indicator

When the ignition switch is turned on, the alarm LED will not work if the safety belt is connected.

When the ignition switch is placed at ON position, if the driver forgets to tie the safety belt, the safety belt warning light will flash in an interval of $0.3 \pm 0.1\text{sec}$ and the door bell sound in an interval of $0.45 \pm 0.1\text{sec}$, taking $6 \pm 1\text{sec}$ as a whole cycle. Whenever the car speed rises from less than 20km to 20km, the instrument also needs to output the control signal and control the door bell to sound for one cycle ($6 \pm 1\text{sec}$); if the

safety belt is well tied within one cycle, the chirping will stop.

When the ignition switch is placed at ON position, if the driver well ties the safety belt, the safety belt alarm light will flash for one cycle ($0.3 \pm 0.1\text{sec}$) without giving off any hint sounds; when the safety belt is untied, the alarm light flashes and gives off hinting sound. It will stop when the safety belt is properly tied once again.

Connect the safety belt when the ignition switch is turned on. During driving if the belt is disconnected, the alarm LED will light on.

Safety airbag ready indicator light

There is one airbag indicator light on the console showing the symbol of airbag. The system will check whether there is fault on airbag system. Through this light, you will know whether there is electric fault in airbag system. The system will check airbag sensor, airbag module, circuit and diagnosis module. When the car is started, this light will be on for around 7s and then distinguish, which indicates that the airbag system is fully prepared.

If the airbag ready indicator light keeps on when the car is started or lights on when driving, it indicates there is abnormality in airbag system and the car needs repairing right now.

ABS alarm

Your car is equipped with anti-lock braking system (ABS), and when the ignition switch is turned on connecting position, this alarm light will keep lighting on for several seconds. This is very normal.

If this alarm light keeps on, do not drive the car. If the alarm light lights on suddenly, please stop the car and shut off the ignition switch as soon as possible, and then restart the engine and reset the system. If the alarm light still keeps on or lights on during driving, the car needs to be repaired. If the routine brake system alarm light (i.e. parking brake and braking liquid level alarm/EBD alarm light) fails to light on, the car can still be stopped, but cannot perform

anti-lock brake. If the routine brake system alarm light also lights on, not only the anti-lock brake is out of work, but also the routine brake system has problems.

Door ajar alarm light

When the ignition switch is connected, this indicator light will keep lighting on until all doors are closed and completely locked.

Engine anti-theft indicator light

There is electronic chip installed inside the ignition key of the automobile. Inside each chip installs a fixed ID (equals identification number). And only then the ID on key chip is consistent with the ID at the engine's side can the car be started. On the contrary, if inconsistent, the car will automatically cut off the circuit at once and disable the engine to be started.

※ Once the ignition switch is turned to "ON" position, the alarm light will light on for 2s.

※ When at sleep mode, the alarm light will flash according to the following frequency: light up for 50ms for every 2s.

※ If the password is verified incorrect, the alarm light will flash at the following

frequency: once every 1s.

※ If the password is verified correct, the alarm light will switch off.

※ If at working diagnosis mode, the alarm light will switch off.

The constant flashing of anti-theft starting indicator light may be caused by fault of anti-theft starting system or signal interference; you only need to turn the ignition switch to ON first and start the engine after the anti-theft starting light distinguishes several seconds later according to normal operation. Repeat the start-up procedure for several times and the anti-theft starting system will reset to normal condition. If you still cannot eliminate the fault, please check your car at special maintenance shop of Jianghuai Automobile.

Boot indicator

This indicator light will be on when the boot is opened.

EOBD

EOBD will light up the fault indicator light and record a diagnosis fault code when the exhaust of Hydrogen Compound (HC), Carbon Oxide (CO) and Nitrogen Oxide (NOx) exceeds the EOBD exhaust limit specified by the exhaust rule. If the EOBD light of your car suddenly light up when driving, please stop the car and shut off the engine at once, and then restart the engine. If the indicator light is still on, please check and repair your car to the special service shop of Jianghuai Automobile.

Cruise indicator (if equipped)

If the “CRUISE” indicator keeps on, it indicates that the system is still working. Close the cruise control and the “CRUISE” indicator light will distinguish. In case of any of the following situations, it indicates that the cruise control system has fault:

1. Indicator light fails to light on.
2. Indicator light flashes once more.
3. Indicator distinguishes after lit up.

Under such circumstance, please contact with the dealer and have your car checked.

Hazard warning flashing light

The hazard warning flashing light is used to give off warning to other people as well as to tell the police that you have met with troubles. The turning signal lights in the front and rear part of the car and the side turning light will flash.

The button for hazard warning flashing light locates at the middle position of the mid switch group assembly of instrument desk.

Wherever the ignition switch locates and even if the ignition key is not inserted, the hazard warning light will work. By pressing down this button, the front and rear turning signal lights and the side turning light will flash. The flashing lights can be turned off if this button is pressed once again.

Notes

When the hazard warning flashing light is connected, turning signal is unable to be sent out.

Other warning devices



If you take with reflective tripod, you can set it at around 100 meters backwards your car at the roadside.

Turning signal/multi-function control lever (as follows)

| Types | Switch position | Work shift and function | Description |
|---|--|--|--|
| Right handle function (windshield wiper switch) | Inching position | Handle can automatically reset at this position | Handle temporarily lifted |
| | Close | Windshield wiper off | 0 position |
| | Intermittent | Windshield wiper works intermittently | Turn the handle downward to the 1st shift |
| | Low speed | Windshield wiper works at low speed | Turn the handle downward to the 2nd shift |
| | High speed | Windshield wiper works at high speed | Turn the handle downward to the 3rd shift |
| | Intermittent shift | When at intermittent operation, control the intermittence interval | Rotate the rotary button at the end of handle |
| Left handle (light and signal indicator light switch) | Washing apparatus | Spraying water and then wipe it clean | Lift the handle towards the driver's direction until the washing solution splashes out |
| | Change lane leftward | Left turning light lights on | Temporarily turn the handle downward |
| | Change lane rightward | Right turning light lights on | Temporarily turn the handle upward |
| | Left turn | Left turning light lights on | Turn the handle downward to the locking |
| | Right turn | Right turning light lights on | Turn the handle upward to the locking position |
| | Close | Lights out | Rotate the rotary button at the end of the handle to 0 position |
| | Parking light | Parking light on | Rotate the rotary button at the end of the handle to 1st shift |
| | Headlight | Headlight and parking light on | Rotate the rotary button at the end of the handle to 2nd shift |
| Change of high beam light and dipped headlight | Realize the exchange of distant and dipped beams | Pull the handle towards the driver's direction until locking position | |
| Headlight flash | Control the main beam | Pull the handle toward the driver's direction slightly and then loosen | |

Turning signal/Multi -function control lever



Turning and lane changing signal

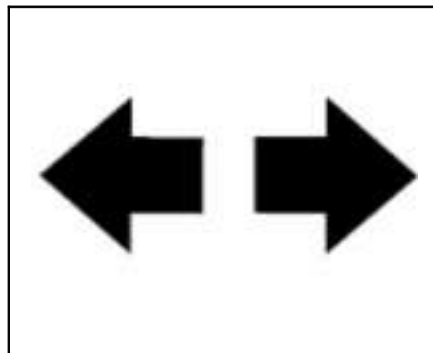

There are two upward positions (right turning) and two downward positions (left turning) on the turning signal control lever. These positions will be used to send out signals for turning and lane changing.

To send out the turning signal: push the control lever upward or downward till the end. And when the turning is terminated, the control lever will return automatically.

There is an arrow on the combined device of the console that will be flashing, which indicates the direction of turning or lane changing.

To send out the lane changing signal: You need only lift or press down the control lever until the arrow begins flashing. Hold the control lever until the lane changing is terminated. When you loosen the lever, it will return automatically. When you give off turning or lane changing signals, if the arrow flashes too quickly, the signal light may be burnt and other drivers will be unable to

observe the turning signals you sent out.

If a certain bulb is burnt, it should be replaced at once to avoid traffic accidents. If the arrow fails to flash when you send out the turning command, you should firstly check whether the bulb is burnt and then check the fuse.

Headlight/Dipped beam exchanger

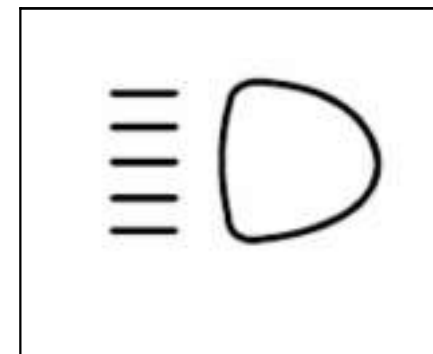

When you want to change the headlight from dipped beam to high beam, you should push the turning signal/multi -function control lever opposite you.

When high beam is connected, if the ignition switch is on, the indicator light on the combined device will also light on.

If you want to change the headlight from

high beam to dipped beam, you should push the turning signal/multi -function control lever towards you.

Front headlight flashing

This function enables you to send out overtaking signal to the front drivers by using the high beam headlight.

When using this function, pull the turning signal/multi -function control lever towards you until the high beam of headlight lights on. Then loosen the control lever and distinguish the headlight.

Front windshield wiper



Operate the front windshield wiper by using the control lever at the right side of the steering column. The ignition switch must be connected to operate the wiper. Clearance: turn the handle downward to the 1st shift and select one cycle of delayed wiping and washing. Low: turn the handle downward to the 2nd shift and you can conduct stable

low speed wiping.

High: turn the handle downward to the 3rd shift and you can conduct stable high speed wiping.

You can also control the intermittence interval by rotating the rotary button at the end of handle.

Stop: turn the control lever to 0 position, and the front windshield wiper is shut off.

When lifting the control slightly from 0 position, the front windshield wiper will act for one cycle.

Front windshield washing solution

To washing the front windshield, pull the front windshield wiper washing solution control lever toward the driver when the ignition switch is connected. The washing solution will splashed out from the front windshield spray nozzle.

When you loosen the lever, the washing apparatus will stop working, but the wiper will continue acting for another two cycles. Then you can choose to stop the wiping or recover to the washing speed previously.

Friendly Tips

In cold and freezing weather, you should not start the wiper if the front windshield is not preheated. Otherwise, the washing solution will freeze on the front windshield and block your vision.

Front fog lamp



Press the front fog lamp button on the mid switch group assembly of instrument desk, the front fog lamp will be connected and the indicator light on the button will light on. At the same time, the front fog lamp indicator light on the combined device will light on. Press the button once again and the front fog lamp will distinguish.

Friendly Tips

When using the fog lamp, the ignition switch must be placed at ACC (annex) or ON (connecting) position.

Rear fog lamp

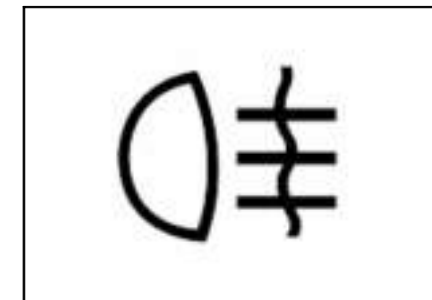

When the front fog lamp is on, press the rear fog lamp button on the mid switch group assembly of instrument desk, the front fog lamp will be connected and the rear fog lamp indicator light on the combined device will light on. The indicator light on the button will light on.

Friendly Tips

When using the rear fog lamp, the front fog light must be on.

Panel board brightness



The third switch on the left switch group assembly of instrument desk is the dimming switch which can adjust the brightness of the light on the console. Toggle the thumbwheel switch of the dimming switch upward to increase the brightness of the light, and vice versa.

Illumination angle adjustment of dipped beam light and high beam light



The fourth switch on the left switch group assembly on the instrument desk is the dimming switch of headlight which could adjust the illumination angle of the dipped beam light and high beam light. Toggle the thumbwheel switch of the dimming switch upward to upper the beam of dipped beam light and high beam light and vice versa.

Glove compartment



The glove compartment is equipped with locking core. You can lock and unlock the glove compartment by the ignition key. To open the glove compartment, just pull upward the glove compartment handle when the compartment is at unlocking position.

Cigarette lighter and ash tray



The front cigarette lighter and ash tray locate at the lower part of the central console with an integrated protective cover. Press at the bright stripe ornament part on the cover and then release, the protective cover will open automatically. To take out the front ash tray for cleaning, pull out the ash tray and pour the ash. When reassembling, just push the ash tray back.



The rear ash tray locates at the rear part of auxiliary fascia console. Pull out the rear ash tray for cleaning. When re-assembling, just first clamp it on the bottom tongue and then push it back.

| Notes |
|--|
| Do not put inflammable substances into ash tray. If you put paper or other inflammable substances into the ash tray, the un-extinct cigarette head may light them up, which might damage your car. |

Cup support



The cup support locates at the auxiliary fascia console and rear seat armrest. To use the front cup support, press the bright stripe ornament part of the cup support protective cover and then loosen, the cover will open automatically. To use the rear cup support, pull down the central handle at rear seat (refer to the next page “Rear Seat Armrest”).

Storage box at diver's side



The storage box at driver's side locates at the console at the left side of steering wheel. It is used as the interior fuse check mouth as well. To use it, just pull out the storage box or take it out.

Storage area of central control console



The central control console has two independent storage areas and the upper storage hatch is also an armrest. To open the upper storage hatch, just pull up the armrest cover plate at the upper layer. To open the lower part storage hatch, just lift the lower starting wrench and raise the hatch cover. To close the

storage hatch, press down the cover until it is tightly locked.

Rear seat armrest



There are two cup supports on the rear seat armrest. To use them, pull down the armrest from the backrest of the rear seat.

Chapter IV Vehicle Equipment

| | | | |
|---|------|---|------|
| Temperature control | 4-02 | Sunroof | 4-12 |
| Rear window and exterior view mirror defroster | 4-06 | Sunroof vanity mirror | 4-12 |
| Air outlet control | 4-07 | Airbag system | 4-13 |
| Passenger compartment air cleaner | 4-07 | Accessory power supply socket | 4-14 |
| Reverse radar system | 4-08 | Sun roof | 4-15 |
| Interior lighting | 4-10 | Front seat pre-tension type safety belt | 4-16 |
| Hi-fi system | 4-11 | Rear seat three-point type safety belt | 4-16 |
| Rear windscreen antenna | 4-12 | Anti-theft system | 4-17 |

Air conditioner

Automatic temperature control system

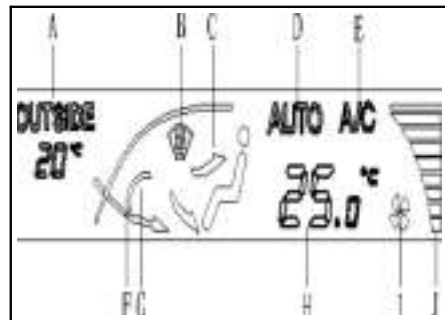

Your vehicle is equipped with automatic temperature control system. This system allows you to control the refrigeration, heating and ventilation of vehicle.

Below is the display screen of temperature control system: A. External temperature (ambient temperature)

B. Defroster indicator

C. Air allocation mode indicator

D. AUTO mode indicator

E. Compressor switch indicator

F. External circulation mode indicator

G. Internal circulation mode indicator

H. Selected temperature (internal temperature)

I. Fan working indicator

J. Fan speed indicator

Automatic operation

Set automatic operation as following:



AUTO (automatic): press AUTO button to enable automatic control over internal air temperature, air delivery mode and fan speed. Then, the AUTO mode indicator will present on the display.

OFF: press this button to shut down the system.

Set the desired temperature according

to the following procedures:

1. Press AUTO button.
2. Turn the temperature control button until the desired temperature appears on the display screen. You can set the desired temperature between 17°C and 32°C.
3. Turn the knob clockwise, you can raise the temperature by 0.5°C. Turn the knob counterclockwise, you can reduce the desired temperature by 0.5°C.

Notes

Don't cover the right sunshine sensor at right defrosting bar rack on the instrument panel. To learn about the sunshine sensor in details, refer to the following section of Sensor in this chapter.

Manual operation

(Fan) Turn the fan control button (center control button) clockwise, you can increase the fan speed; anticlockwise could reduce the fan speed. When this button is turned, AUTO mode will be cancelled. You can select the following modes by turning the control button near the second driver's seat:

(Instrument panel mode): this mode will allow the air to flow to the instrument panel air outlet.

(Double -function mode): this mode will allow about half air to flow to instrument panel air outlet and the rest air to flow to the floor air outlet.

(Floor mode): this mode will allow most air to flow to the floor air outlet. If your vehicle is equipped with rear air

outlet, a portion of airflow will be guided to it as well. Make sure there is no obstacle under the front seat so as to allow clear airflow to the compartment tail. Demisting mode can be selected by mode button. For information on demisting and defrosting, refer to the following in this chapter.

(Internal circulation mode): This mode will prevent external air and abnormal taste entering the vehicle or raise or reduce internal air temperature faster.

Press this button, you can start or shut down internal circulation mode.

Long term use of internal circulation mode will result in mist on the window. If there is mist on the window, please select defrosting mode.

A/C (air conditioner): press this button, you can override automatic control system and shut down or start the air conditioner. When the A/C button is pressed, the indicator lamp on the display will be on to indicate the air conditioning system has started.

Press this button again, you can shut down the air conditioning system; or, press OFF button again, you can shut down overall system. In the case of burning hot days, open the window to have the hot air inside the vehicle escape and then close the window. This will help to shorten required time for vehicle refrigeration. This also helps to increase system operation efficiency.

To allow quicker refrigeration in burning hot days, press AUTO button and this

system will access internal circulation mode automatically. If the said equipment is used at the same time for a long time, it will cause interior air excessively dry. To prevent the above situation, please shut down internal circulation mode after interior air cools off.

Friendly Tips

As the air conditioning system may remove moisture, when the engine is idling or the vehicle is running at low speed, the indicated temperature may be impacted by heat of road surface or engine. Therefore, the indicated temperature is accurate only when vehicle speed exceeds 40km/h.

Sensor



The sunshine sensor monitors the quantity of sunshine radiation and performs necessary adjustment on temperature, fan speed and air delivery system basing on this information to maintain the selected temperature.

Friendly Tips

Don't cover the sunshine sensor near the front windscreen at middle of the instrument panel, otherwise, the system cannot operate normally.



There is an interior temperature sensor in the lower left side plate of instrument desk, which reads the interior air temperature and helps to establish ventilation system demand under AUTO mode.

Friendly Tips

Don't cover the temperature sensor, otherwise the system cannot operate normally.

Demisting and defrosting

The fog on inside surface of window is caused by the condensation of excessive moisture on the cool window glass.

This can be relieved to the most extent if temperature control system is used correctly. Two modes can be used to demist and defrost the front windscreen. Demisting mode allows window demisting and desiccation while defrosting mode allows faster demisting or defrosting of front windscreen.

 (Demisting mode): this mode will allow most air to flow to the front windscreen and floor air outlet. Little airflow will be guided to the external air outlet of side window. Perform the following operation to quicken side window demisting.

1. Select double-function mode.
2. Select the maximum fan speed.
3. Press A/C button.
4. Select temperature.

 (Defrosting mode): this mode will allow the air to flow to the external air outlet of front windscreen and side window. Perform the following operation to quicken the front windscreen defrosting:

1. Select defrosting mode.
2. Select the maximum temperature.
3. Select the maximum fan speed.

Start your vehicle after all windows are clear.

To cancel defrosting function, turn the mode control knob or push the AUTO button. If you push the AUTO button, the system will perform automatic operation.

Rear window and exterior view mirror defroster



Your vehicle is equipped with a rear window and exterior view mirror defroster, which can operate only when the ignition switch is switched on.

The rear window and exterior view mirror defroster adopts heating grid for rear window demisting or defrosting. Before

use this function, please try to remove all the snow on the rear window.

 (Rear window and exterior view mirror demisting): press this button, you can start or shut down rear window and exterior view mirror defroster. This button is in the center switch group on the instrument desk. When the indicator lamp of the button is on, it means this function is activated.

The rear window and exterior view mirror defroster will shut down about 20 minutes after this button is pressed. You can shut down the defroster through pressing this button again or shut down the engine.

Notes

Prohibit use of any sharp tool at rear window inside. Otherwise, the heating grids may be cut off or damaged, and the repair thereof is not covered by warranty. Don't fix the temporary license plate, adhesive tape, glass decal or other similar objects to the defroster grid.

Air outlet control

Alter the airflow direction through the center control lever of each air outlet. Operate the roller wheel above the side air outlet, you can open and close the air outlet.

Friendly Tips

If front wall upper cover plate for engine compartment not approved by JAC is used, it may have adverse impact on system performance.

Make sure there is no obstacle under the front seat to allow more effective circulation of internal air.

Passenger compartment air cleaner

Your vehicle is equipped with passenger compartment air cleaner. It's located at the base of front windscreen at occupant side and can be removed by the movable service plate in the engine compartment.

The cleaner may filtrate most pollen and dust in the air inside the vehicle. Just the same as engine air cleaner, it shall be washed or replaced periodically.

Replace the passenger compartment air cleaner in the following procedures:

1. Lift the engine compartment cover.
2. Unscrew the two retaining screws and remove the service plate.
3. Disassemble the old passenger compartment air cleaner assembly to remove the air cleaner.
4. Then install the new air cleaner in the

reverse procedures and refit the service plate.

Reverse radar system

The reverse radar determines whether there is obstacle in the reverse direction of vehicle and indicates the distance from the nearest obstacle according to ultrasonic ranging principle and computer data fuzzy processing technology. When reverse gear is engaged, the reverse gear switch opens and reversing light is on. After receiving the reversing signal, the controller will control the ultrasonic sensor (four probes) to release ultrasonic signal. When the ultrasonic sensor receives ultrasonic echoed signal, it sends this echoed signal to the controller, which will determine whether there is obstacle within the sensing distance and the distance to the nearest

obstacle through analysis processing. Then the buzzer will send out rings at different frequencies according to the different distance range to indicate the obstacle distance.

The reverse radar starts working when the reverse gear is engaged. At this moment, the reverse radar will perform a

quick self-inspection on overall system to ensure all components work normally. If some system operation is abnormal or overall system operates abnormally, the buzzer will ring for warning. For the self-inspection results, refer to the following table.

| Self-inspection result | Buzzer |
|------------------------|---|
| Normal | Ring twice |
| Part system abnormal | Ring twice |
| System cannot operate | Hurry ring for a period of time, then the buzzer shuts down |

The controller sends pulse signal of different frequencies to the buzzer according to the position of detected obstacle and the buzzer ring frequency changes upon different frequencies, see the below table.

| Obstacle distance | Sound tip | Zone | Note |
|-------------------|-----------------|-----------------|--------------------------|
| 0.8m~1.2m | Once 1/2 second | Safety zone | Normal reverse |
| 0.4m~0.8m | Once 1/8 second | Slow speed zone | Deceleration and reverse |
| ≤0.4m | Long ring | Danger zone | Stop reversing |

Interior lighting

Front dome lamp



The front dome lamp and rear dome lamp switches have three positions. ON position will switch on the dome lamp. The dome lamp will keep being on until it's switched off manually. When the switch is turned to middle position, the dome lamp will be switched on upon opening of any door. When the door is

closed, the dome lamp will extinguish slowly. OFF position will shut down the dome lamp completely (even if certain door is opened).

Rear dome lamp



Door control lamp



When you open the front door or rear door, the door control lamp inside the vehicle will be on. The door control lamp is located at inside of driver and front passenger door and rear passenger door. When you close all the doors, this lamp will be off.

Indoor small light assembly



It's located at the driver and copilot feet position for feet lighting.

Hi-fi system



Refer to the DVD Operation Instruction (the configuration of Hi-fi system of different vehicle is different)

Model of DVD remote controller fastener battery: Panasonic CR2025 3V

The DVD disc package is in the left recessed box of the trunk (see the above figure).



Refer to the CD Operation Instruction (the configuration of Hi-fi system of different vehicle is different)

Rear windscreen antenna



It's located at the rear window defroster and equipped with AM-FM antenna. Ensure there is no scratch on the internal surface of rear window and the grid line on the rear windscreen is not damaged. If the internal surface of rear window is damaged, it may interfere with radio receiving signal. In addition, to ensure normal receiving signal of radio, the antenna signal amplifier in rear right C pil-

lar of rear dome window shall be connected to the terminal post of rear windscreen correctly.

Sunroof



Your vehicle is equipped with two sunroofs to protect driver and passenger against glare. You can turn the sunroof upward and downward.

Sunroof vanity mirror



Each sunroof is equipped with a vanity mirror, which contains a small light for your lighting. You can turn the mirror upward to use the vanity mirror. When you close the cover, the small light will be off automatically.

Airbag system

Your vehicle is equipped with two airbags, one is driver front airbag and the other one is the front right passenger front airbag.



There is an airbag ready indicator lamp on the combined meter of instrument panel, which displays the airbag symbol. The system will check whether airbag system has fault. For details, refer to Airbag Ready Indicator Lamp in Chapter Three.

Where is the airbag?

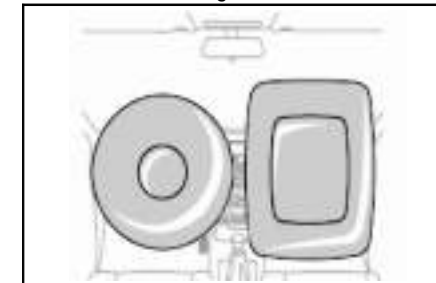

The driver airbag is in the center of steering wheel.

The front right passenger airbag is on the passenger instrument panel.

Notes

※ If the passenger faces the airbag or is near the airbag, severe injury may occur upon airbag inflation. Airbag with safety belt may provide best protection for adult or older children.

However, it's not in the same way for the infants. The safety belt system and airbag system are not specially designed for the infant protection. The protection of infant shall be provided by children restraint. Make sure to hold the children inside the vehicle correctly. For detailed methods, refer to Older Children and Infant in safe operation recommendation.

※ In case there is obstacle between the passenger and airbag, the airbag may not be inflated normally or the airbag will squeeze the obstacle into passenger body and result in severe injury. The inflation passage of airbag shall be free of obstacle. Prohibit fixing or placing any object on the steering wheel or airbag cover.

Accessory power supply socket



Your vehicle is equipped with an accessory power supply socket. You can connect the accessory electrical equipment through accessory power supply socket. The accessory power supply socket is in the trunk. To use the power supply socket, remove the protective cover first. When the socket is not used, make sure to close the protective cover. The

socket will supply power when the ignition switch is in ACC (accessory) or ON (switching on) position.

Notes

Long term connection of electrical equipment will exhaust the battery. When not used, the electrical equipment must be disconnected and never connect equipment whose rated current exceeds the maximum rated current of socket.

Some electrical accessories may not match the accessory power supply socket, which will result in vehicle or power supply adapter fuse blown out. In such cases, please contact the sales service center to learn about other information on accessory power supply socket.

Notes

Adding any electrical equipment to the vehicle may result in vehicle damage or failure of other components. Repair caused by doing so is not covered by warranty. Before adding electrical equipment, please consult the sales service center. Make sure to observe the accompanied instructions for installation of equipment during electrical equipment adding.

Damage caused by improper use of power supply socket is not covered by warranty. The accessory power supply socket is for the accessory power supply plug only. Prohibit hanging any accessory or accessory bracket on the plug.

Sun roof (if equipped)





If the vehicle is equipped with this device, the switch will at right side of driver top between the two driver small lights. The sun roof is equipped with sunroof, which can be used to adjust or prevent incoming sunlight when the sun roof is closed.

Notes

Never adjust the sunroof during driving.

The sun roof can be adjusted to open or incline.

The sun roof can be opened and closed only when the ignition key is in ON position. Please press the  or  button on the front dome lamp before opening or closing the sun roof. You can adjust the sun roof to the desired position in the above method.

To incline the sun roof, please press the UP button on the front dome lamp and the rear end of sun roof will tilt; to close the sun roof, press the button , the sun roof will close.

Notes

Don't close the sun roof in case the hand, arm or other body part is at middle position of sun roof. Never stretch your head or arm when opening the sun roof.

Friendly tips

Please don't open the sun roof in case snow or ice covers the sun roof in frigid season. When you remove the dust, please note that some dust may accumulate in the guide track.

Front seat pre-tension type safety belt



The feature of pre-tension type safety belt is that at the moment of vehicle collision and the occupant does not move forward, the belt will tension the strap first to bind the occupant to the seat tightly and then lock the strap to prevent occupant body creep and protect occupant safety effectively. Compared with

common safety belt, in addition to retracting and releasing the strap, the retractor of pre-tension type safety belt can enhance restraining force to the occupant to prevent body creep impacting the steering wheel, instrument panel and glass window within 0.1s upon rapid change of vehicle speed.

Rear seat three-point type safety belt



The rear seat is equipped with three-point type safety belt.

Notes

No matter on urban road or express way, the airbag can exert protection function only when safety belt is used.

Anti-theft system

Guard against vehicle theft is very important, in particular in some cities. Though this vehicle is provided with anti-theft function, it's well known that no anti-theft device may prevent vehicle theft absolutely.

Your vehicle is equipped with anti-theft system. The anti-theft system can be activated only when closing the door with key. The anti-theft system will not activate if you close the door at will other than using key.

Starting the anti-theft system

Start the anti-theft system in the following procedures:

1. Turn the ignition switch to LOCK position and pull the ignition key out.
2. Close the door, window, engine compartment cover and luggage boot. Be sure that the windows are closed, cause the system could be started even if the windows are not closed
3. Lock the door with key. The anti-theft system shall be started with key only.

Close the door with key:

- The LED on the emitter will blink.
- Lock all the doors.
- Anti-theft mode will activate.

The safety warning lamp will start blinking once a second to indicate the anti-theft system has activated. The safety

warning lamp is located at the defrosting grid side of left side of instrument panel and is near the front windscreen. Prevent unexpected warning start through one of the following procedures:

- ※ Open the door with inside handle.
- ※ Open the trunk with key.
- ※ Press the locking/unlocking button on the remote control door lock emitter.

Warning will be activated no matter in what other way the door lock or luggage boot is opened. If you cannot activate the anti-theft system, please lock the vehicle with key or manual door lock.

Canceling the anti-theft system

Cancel the system through one of the following procedures:

Open the lock of driver or copilot side door.

Press the locking/unlocking button on the emitter.

The LED on the emitter will blink.

Open all the doors.

The hazard warning light will blink twice.

Anti-theft mode will cancel.

If the door is not opened or the engine is not started 30s after the system is cancelled by emitter, all the doors will be locked automatically and the anti-theft mode will be activated again.

How to activate anti-theft warning

If the door or luggage boot is not opened by key or remote control door lock emitter, the horn will ring and the hazard warning light will blink up to 100s.

How to shut down anti-theft warning

If the anti-theft warning has activated, this warning can be cancelled in one of the following ways:

※ Press the locking/unlocking button on the remote control door lock emitter.

※ Open the lock of driver or passenger front door.

How to detect warning conditions

If the hazard warning light blinks once when you press the locking/unlocking button on the remote control door lock emitter, it means the anti-theft system alarm has been activated when you leave your vehicle.

Engine anti-theft device (if equipped)

This vehicle is equipped with anti-theft system, which will prevent illegal actuation of vehicle by others.

If the vehicle is equipped with engine anti-theft system, it shall have the dedicated key. There is a radio frequency transceiver with electric coding in the key head. The vehicle can be started through correct use of key only. If invalid key is used, the engine cannot start, and the engine anti-theft system will switch off the power supply of ignition system, fuel pump and fuel injector. Turn the ignition switch to LOCK position and pull the ignition key out, the engine anti-theft system will activate. After engine anti-theft system starts, the safety warning lamp near the front

windscreen on upper center part of instrument panel will blink. If the lamp stops blinking when the key is pulled out, please have this system checked in the specially designated after service center of JAC.

If the engine anti-theft system starts operation, the engine cannot start and the safety warning lamp will keep blinking.

If the key is damaged, the vehicle cannot be started.

If the engine cannot start and the safety warning lamp keeps blinking upon vehicle start, it indicates the radio frequency transceiver on the key might be damaged. Please shut down the ignition switch and try once again.

If the engine still does not start and the key appearance is intact, please try with an-

other key and check the fuse by this time. Service the vehicle if the engine cannot be started by another key. If vehicle starts, it indicates the first key is at fault. Please prepare a new key in the after service center specially designated by JAC, which can service the anti-theft system.

The vehicle can be equipped up to four keys. In the case of key loss or damage, prepare new key in after service center specially designated by JAC only.

If the safety warning lamp keeps on during vehicle running, you can restart it after shutting down the engine. However, the anti-theft system cannot operate normally by this time and it shall be serviced by the after service center specially designated by JAC. In such cases, the vehicle is not protected by the anti-theft system.

Chapter V Vehicle Driving

| | |
|--------------------------------------|------|
| New vehicle | 5-02 |
| Driving notice | 5-02 |
| Fuel | 5-03 |
| Charging fuel tank | 5-04 |
| Ignition switch | 5-05 |
| LOCK | 5-06 |
| ACC (accessory) | 5-06 |
| START | 5-06 |
| Engine start | 5-06 |
| Vehicle driving | 5-08 |
| Brake | 5-08 |
| Parking brake | 5-10 |
| Suggestion on economic driving | 5-13 |

New vehicle

This vehicle requires no special running-in. However, the long-time running performance of vehicle can be increased if you follow the following principles:

※ Don't drive your vehicle at constant speed (no matter slow or fast) in the first 1,000km.

※ Avoid emergency brake in the first 300km running distance. By this time, the new brake linings are not subjected to running-in yet.

Emergency brake with new brake lining will cause undue wear of spare part and untimely replacement. Please follow the above running-in principles each time when you use new brake lining.

Driving notice

Before entering your vehicle

1. Ensure all windows, interior and exterior mirrors, bulbs and lamps are clean and normal.

2. Check whether there is leak under the vehicle.

3. Check the level of engine oil and other oil in the engine compartment.

4. Carry out visual inspection on tyre to check whether it's damaged, whether the inflation pressure is proper and whether there is foreign body in the tread. Take corrective measures if necessary.

Notes

Ensure all exterior bulbs, lamps, signal system and warning indicator lamps are clean and normal.

These help to prevent human injury accident or vehicle damage.

Before driving

1. Make sure to get yourself familiar with your vehicle and the equipment thereof.

2. Method of safe operation.

3. Adjust the seat to comfortable position.

4. Adjust the interior and exterior mirrors.

5. Ensure all occupants have fastened the safety belt.

6. Check the working condition of warning lamp when the ignition switch is connected.

Notes

The objects on the instrument panel or rear window bedplate may screen your sight.

Please remove the objects on the instrument panel or rear window bedplate.

These objects may hit the passengers in the case of hard braking or impact and cause personal injury or vehicle damage consequently.

As the following actions will increase risk of collision greatly, please plan the actions to be done in advance and try to complete them before start or during parking.

- ※ Loosen or fasten the safety belt;
- ※ Search small change upon approaching the toll gate.

Fuel

Suggestion on fuel

Fuel quality and fuel charging have important effect on engine power output, drive ability and lifetime. Fuel with excessively low octane ratio will result in engine knock. It's suggested that you use fuel with high octane rating.

Friendly Tips

Use of fuel of poor quality or with excessively low octane ratio may damage the engine.

If leaded fuel is used in the vehicle using unleaded petrol, the emission system will be damaged and result in warranty loss.

Don't use methanol

Don't use fuel containing methanol.

Such fuel will reduce vehicle performance and damage components of fuel system.

Driving in other countries

If you drive your vehicle in other countries:

※ Please observe all registration and insurance acts.

※ Please confirm appropriate fuel is available in that country.

Notes

Use of methanol may damage the fuel system. Fault caused thereof is not covered by the warranty.

Charging fuel tank



1. Stop the engine.
2. Press the fuel tank cap switch on the switch group assembly at left side of instrument desk and open the fuel tank cap.

Notes

If you cannot open the filler cap in frigid days, you may tap the oil filler gate. And then try once again.



3. Turn the filler cap counterclockwise slowly. If fizz is heard, please wait until the sound disappears.
4. Unscrew the filler cap.
5. Fit the filler cap back after fuel charging. Turn the filler cap clockwise until click is heard.
6. Close the oil filler gate tightly.

Notes

The fuel vapor is highly flammable.

※ Make sure to keep the petrol away from spark, flame and other smoking objects.

※ Shut down the engine.

Petrol vapor catching fire may result in serious burn and damage your vehicle.

Friendly Tips

If your vehicle will be out of use for a long time, please drain the petrol in the tank off to prevent petrol volatilizing and damaging vehicle parts.

Ignition switch

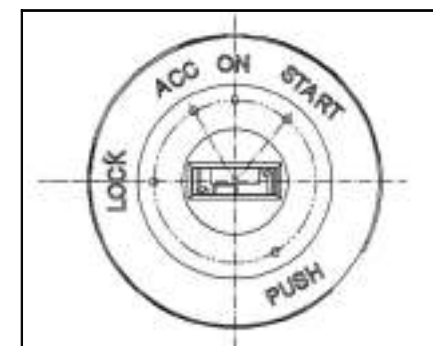

Insert the key into ignition switch, you can turn the key to four different positions.

Friendly Tips

Turning the key with tool forcedly may damage or break the key. Please use the key correctly and turn it by hand only. Ensure the key is completely inserted. If the key cannot turn after complete insertion, please turn the steering wheel left or right. If the above measures are inoperative, this vehicle shall be serviced.

LOCK: this position will lock the steering wheel, ignition switch, gear shift lever and transmission (with key being pulled out). This is the only position to insert or pull the key. When the right turning of steering wheel is locked, apply rightward force to it upon unlocking; when the left turning of steering wheel is locked, apply leftward force to it upon unlocking.

ACC (accessory): when the ignition key is in this position, it will allow use of certain electrical accessories, for instance, the radio.

ON (switching on): after start engine, release the key and turn the ignition switch to this position. When the engine is running, the ignition switch is kept in ON position, however, the switch can be

kept in this position even if the engine is not running so as to control the electrical accessory and display some warning lamps on the instrument panel.

START: in this position, the ignition switch can start the engine. After engine starts, release the key. Then the ignition switch will return to ON position to allow normal running of vehicle. Don't turn the key to START position during engine running, otherwise, the starting motor will be damaged.

Engine start

Before engine start

Ensure there is no obstacle around the vehicle.

Ensure all windows and lamps are clean.

Check tyre conditions and confirm whether inflation pressure is proper and whether there foreign body.

Adjust the seat head restraint and exterior and interior back mirrors.

Wear the safety belt and require all passengers wear the safety belt as well.

Check whether the warning lamp and indicator lamp on the instrument panel are normal when turning the key to ON position.

| Notes |
|---|
| <p>Don't run the starting motor exceeding 15min at one time. If the engine does not start please try it again after 10s. This may help to avoid starting motor damage.</p> <p>Don't have the engine racing exceed 5min. Too high temperature will result in exhaust system damage.</p> <p>Don't step the throttle pedal before and during engine start.</p> |

Manual transmission



1. Ensure the driver and passengers have fastened the safety belt.
2. Apply the parking brake.
3. Ensure the seat and back mirror are in proper positions and adjust them if necessary.
4. Ensure the gear shift lever is in neutral position and then step the clutch pedal to the end.

5. Turn the ignition switch to starting position with throttle pedal not being stepped and release the switch when the engine starts. If the engine cannot start, please try it again after 10s.

6. Keep the engine racing for 30s at least.

7. Release the parking brake.

8. Don't drive your vehicle at high speed before the engine reaches normal running temperature.

Vehicle driving

Manual transmission



To shift the gear, please depress the clutch pedal completely, turn the gear shift lever to required gear and release the clutch slowly.

To shift to reverse gear, you must stop your vehicle, depress the clutch and shift the gear shift lever from neutral gear to reverse gear (R).

Friendly Tips

- ※ Please stop your vehicle completely before shifting between drive gear and reverse gear.
 - ※ Please stop your vehicle completely and depress the clutch to the end before shifting drive gear to reverse gear.
 - ※ After depressing the clutch completely, wait for a moment and then engage the reverse gear.
 - ※ Shifting between drive gear and reverse gear during vehicle running may damage the transmission.
- Correct operation may prevent gear abrasion and prolong the lifetime of transmission.
- ※ If gear shifting is not required during driving, please don't put your feet on the clutch pedal.
- Otherwise, it will accelerate clutch abrasion.

Brake

The brake system is designed to brake the vehicle under different driving conditions.

The front and rear wheels of this vehicle adopt disk brake with double -circuit brake system.

In the event of failure of one brake circuit, the other circuit will stop the vehicle, however, the braking length will increase and stepping of brake pedal will require more force.

Notes

Stepping of brake pedal will be harder and braking length will increase if one circuit is at fault.

If brake pedal travel increases, it indicates the brake might require service. Please have the brake system checked and repaired by after service center specially designated by JAC immediately.

Friendly Tips

Don't put your feet on the brake pedal during driving.

Otherwise, it will accelerate abrasion of brake components. In addition, it will result in brake overheating, prolong braking length and reduce safety consequently.

After brake is wet

The brake components may get wet after vehicle passing through water or vehicle washing.

To restore the normal brake performance:

1. Check whether there is coming vehicle rearward.
2. Keep safe driving speed and ensure there is sufficient space behind and beside the vehicle.
3. Step the brake intermittently with care until normal performance is restored.

Brake overheating

When you drive your vehicle on the long steep slope downward, excessive braking may result in temporary brake overheating. Engage lower gear upon downslope driving and don't apply the

brake continuously.

For details, refer to Engine Braking below in this chapter.

Notes

When the vehicle passes through water or is washed, or the brake is excessively applied on long steep slope, the brake will lose braking capacity temporarily. This might be caused by brake component wetting or overheating.

In case the braking capacity loses temporarily due to overheating:

- ※ Engage lower gear upon downslope driving. Refer to Engine Braking.

Parking brake

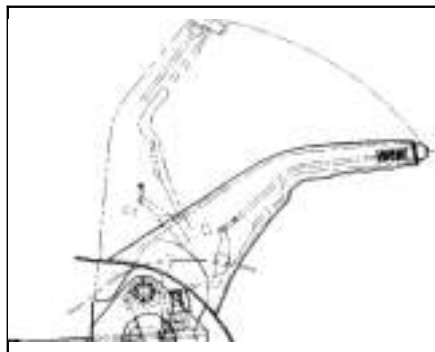

Parking brake lever is between the front seats.

To tension the parking brake, please step the brake pedal and pull the parking brake level up. If the ignition switch is connected, the brake system warning lamp will be on. See Brake System Warning Lamp in Chapter 3.

To release the parking brake system, step the brake pedal and pull the parking brake level up until the release button can be pressed. Press the release button and lower the parking brake lever to the end at the same time.

Friendly Tips

Don't drive your vehicle with parking brake not released, otherwise it will result in brake system overheating and cause undue abrasion or damage of brake system parts. Check whether the parking brake is completely released and the brake warning lamp is off before driving.

Neutral

Notes

It's very dangerous to get off the vehicle when the parking brake is applied while the gear shift lever is not engaged to parking gear, since the vehicle may move suddenly. If you leave the vehicle with engine running, the vehicle may move suddenly, which may result in injury of you or others. To prevent the vehicle moving, please observe the following procedures even if the vehicle is on flat road surface.

1. Step the brake pedal and tension the parking brake.
2. Engage the neutral gear.
3. Turn the ignition key to LOCK position.
4. Pull the key out and carry it by yourself.

Leaving vehicle with engine running

Notes

It's very dangerous if you leave the vehicle with engine running. If the parking brake is tensioned while the gear shift lever is not engaged to neutral gear completely, the vehicle may move suddenly. Furthermore, if you don't shut down the engine after leaving the vehicle, it will cause overheating of engine and even initiate fire get you or other injured. Please shut down the engine when you leave the vehicle.

In case you have to leave your vehicle with engine running, please confirm the parking brake has been tensioned and the neutral gear is engaged before leaving.

Anti-lock braking system (ABS)

Anti-lock braking system is an advanced electronic brake system which helps to prevent vehicle sliding and out-of-control. This system enables you to steer clear of obstacle upon hard braking and provides maximum braking ability on slipping road surface.

When the ignition switch is connected, the ABS warning lamp will be on for about 3s. If the ABS warning lamp is not off or it's on during driving, it indicates the ABS is at fault.

Please consult the after service center specially designated by JAC immediately. Please refer to the "ABS" warning. The ABS system will monitor each wheel speed during braking. If one wheel tends to be blocked, the com-

puter will control the brakes of the two front wheels and rear wheels respectively. When the ABS is working, the brake pedal will present slight vibration accompanied with noise generally.

Notes

ABS neither changes the time required by brake engagement nor shortens the braking length absolutely. Please keep sufficient braking length even if your vehicle is equipped with ABS.

Though the brake system is equipped ABS, please don't step the brake pedal frequently under any road conditions. Step the brake pedal to the end and hold it to enable the ABS to work.

Notes

If the brake system and ABS warning lamps are on at the same time, it indicates the brake system is at fault. Please have the system checked by the after service center specially designated by JAC immediately.

Using anti-lock function

Step the brake pedal firmly other than stab braking to allow the anti-lock system to work. You may feel slight pulsation or hear some noise, which are normal phenomenon.

Braking in the case of emergency

You can perform steering and braking at the same time with the help of anti-lock braking system. In most cases, even the best braking effect is not better than steering.

Engine braking

Generate braking effect through engine compression during downslope driving: In the case of manual transmission, please downshift in turn.

Notes

In the case of manual transmission, don't downshift two gears in one time. Otherwise, the transmission may be damaged and result in vehicle out-of-control and human injury.

Friendly Tips

Using the engine compression braking effect during downslope driving may prolong lifetime of brake.

Stopping vehicle

To stop your vehicle on the slope, please tension the parking brake or step the brake pedal. Don't try to hold your vehicle on the slope through stepping the throttle pedal.

If the vehicle shall stop for a long time, e.g., in the case of traffic jam or passing through railway crossing, please shut down the engine.

To park your vehicle, please engage the gear selecting lever, apply parking brake and pull the key out from the ignition switch.

Parking vehicle

Step the brake pedal and tension the parking brake at the same time.

For vehicle equipped with manual transmission:

1. To park your vehicle on level ground, please engage the gear shift lever to neutral gear.
2. To park your vehicle downslope, please engage the gear shift lever to reverse gear.
3. To park your vehicle in upslope direction, please engage the gear shift lever to 1st gear.

Suggestion on economic driving

Economical efficiency of fuel mainly depends on your driving style.

Driving mode, running road and driving time impact the running distance every litre of fuel.

To achieve the best fuel economical efficiency:

- ※ Increase the speed slowly
- ※ Avoid unnecessary idling.
- ※ Keep engine adjustment proper.
- ※ Don't have the engine overspeed.
- ※ Use air conditioner only when necessary.
- ※ Slow down on uneven road.
- ※ Keep the tyre inflation pressure in accordance with recommended value.

※ Keep safe distance with other vehicles to avoid collision in the case of emergency braking and reduce abrasion of braking filler block and lining.

※ Don't carry unnecessary heavy goods.

※ Don't put your feet on the brake pedal during driving.

Observe the vehicle specification described in vehicle maintenance instruction and this manual.

Chapter VI Emergency

| | |
|---|------|
| Spare tyre, jack and driver tool | 6-02 |
| Specification of jack | 6-03 |
| How to replace flat tyre | 6-03 |
| Starting the engine with jumper cable | 6-07 |
| Towing vehicle | 6-10 |
| Towing your vehicle with wheel lift | 6-11 |
| Emergency towing | 6-12 |
| Escaping from vehicle trapping | 6-13 |
| Overheating of engine | 6-15 |

Spare tyre, jack and driver tool



Spare tyre, jack and tool shall be fixed in the luggage boot.

| Notes |
|---|
| <p>Make sure to keep the jack, spare tyre and other tools and equipment in corresponding place.</p> <p>Never keep the jack, spare tyre or other equipment in passenger compartment. These objects may scatter in the vehicle and cause personal injury in the event of hard braking or collision.</p> |

For details, refer to Wheel and Tyre.

| Notes |
|--|
| <p>To avoid jack, jack handle and tool dithering during driving, please keep them under the floor cover plate.</p> |

There is triangle reflection warning plate in the driver tools. When parking your vehicle, please place the triangle warning plate at the roadside about 100m behind your vehicle.

Specification of jack

| | |
|------------------------|--|
| Maximum operating load | 650 (kg) |
| Grease category | Lithium base grease |
| Grease grade | National lubricating grease institute (NLGI) |

| Notes |
|--|
| <p>The jack of JAC is designed for your vehicle only.</p> <p>Forbid using your jack to raise other vehicle.</p> <p>Forbid exceeding the maximum permissible load of jack.</p> <p>Using the jack of this vehicle for other vehicles may cause damage of other vehicles or jack and personal injury.</p> |

How to replace flat tyre

If the tyres lose pressure, please replace them according to the following safety notices.

| Notes |
|--|
| <ol style="list-style-type: none"> 1. Switch on the danger warning flash lamp. 2. Park the vehicle in safe place without traffic stream. 3. Keep the vehicle on solid and level ground. 4. Shut down the engine and pull the key out. 5. Tension the parking brake. 6. Ask all passengers to get off the vehicle and stay in safe place. |

| |
|---|
| <ol style="list-style-type: none"> 7. Block the tyre diagonal to the tyre to be replaced with wedge block, wood block or stone block front and back. Violating these safety notices may cause vehicle sliding from the jack and result in personal injury. |
|---|

Replace flat tyre



1. Take the jack, replacing tool and spare tyre out from the luggage compartment foam tool rack.
2. Loosen the wheel nuts or bolts with wheel spanner and rotate them one turn.
3. Pry the wheel hub cap (if equipped) out with accompanied wheel spanner or flat head screwdriver.

Notes

Make sure to raise the wheel off the ground, otherwise, don't disassemble any nut or bolt.



3. Insert the jack handle and wheel spanner in the jack.
4. Rotate the jack handle clockwise and raise the lifting head slightly.
5. Determine the lifting position according to the above figure. Both front door and rear door have a notch in the lower part.
6. Place the jack vertically to the front

and rear notches which are the nearest to the tyre you are to replace.

Notes

Prohibit attempt of lifting vehicle with jack in incorrect position. The jack shall be fixed to the vehicle and ground.



7. Rotate the jack handle clockwise to raise the vehicle until the lifting head is inserted into corresponding notch firmly and the tyres are about 3cm above the ground.
8. Rotate the wheel nuts counterclockwise to remove them completely.
9. Disassemble the tyre and wheel.
10. Fit the tyre to the hub.

Notes

Prohibit applying engine oil or grease to the wheel nuts or bolts. Be sure to use correct wheel nuts. Fasten the nut or bolt with lug through the wheel lug spanner in the driver tool box. Drive your vehicle to the after service center specially designated by JAC as soon as possible and fasten the wheel nuts or bolts according to the specification. Incorrect fastening may result in gradual loosening of nuts or bolts.

11. Fit the wheel nuts or bolts back through clockwise rotation and fasten them slightly.
12. Rotate the jack handle counterclockwise and lower the vehicle to the ground.
13. Tighten the wheel nuts or bolts to

120N.m in X pattern: 1→2→3→4 (see the below figure)



Notes

Be sure to use appropriate nuts or bolts and tighten them to effective torque. Incorrect parts or unsuitable fastening of wheel nuts or bolts may result in nuts or bolts falling from the vehicle.

14. Install the wheel hub (if required).

Notes

Please have the flat tyres repaired or replaced in the after service center specially designated by JAC as soon as possible for backup.

15. Keep the jack, tool and flat tyre in corresponding places.

Notes

- ※ Prohibit keeping the jack and tools in passenger compartment. These objects may scatter in the vehicle and cause personal injury in the event of hard braking or collision.
- ※ When the jack is being used, the vehicle may be instable and move, causing vehicle damage and personal injury.
- ※ Use the accompanied jack in correct position.
- ※ When install the jack to raise the vehicle, please keep the jack perpendicular to the ground.

Notes

(Continued)

- ※ Never stay under the vehicle supported by jack.
- ※ Prohibit starting the jacked vehicle.
- ※ Before jacking the vehicle, require all passengers to get off the vehicle and keep away from this vehicle and other vehicles.
- ※ Use jack only when replacing the wheels.
- ※ Prohibit supporting the vehicle with jack on the inclined or slipping plane.
- ※ Keep the raising position nearest to the wheel to be replaced and block the wheel in the diagonal position of the wheel to be replaced.
- ※ Before jacking the vehicle, ensure the parking brake has been tensioned and the transmission is engaged to 1st gear or reverse gear. Prohibit vehicle jacking and wheel replacement where there is heavy traffic.

If vehicle jacking conditions are not sufficient or you are not sure about the safety, please have the vehicle repaired by professional maintenance staff.

Start the engine with jumper cable

Notes

If the vehicle cannot be started due to battery electricity loss, don't try to start the vehicle through pushing or towing. Otherwise, the catalytic converter and automatic transmission may be damaged, even causing personal injury.

You can transfer the battery power of another vehicle to the vehicle whose battery has discharged to start the vehicle.

Notes

The battery has the hazard of explosion. You may get burnt by battery acid while electrical short circuit may cause personal injury or vehicle damage.

- ※ Prohibit approaching the battery to naked flame or spark.
- ※ Prohibit leaning your body above the battery when you start the vehicle through jumper cable.
- ※ Prohibit contact of cable terminals.
- ※ Please wear the safety goggles when you operate near the battery.
- ※ Prohibit battery acid contacting eye, skin, fabric or paint surface.
- ※ Ensure the voltage of battery used for jumper starting is the same as that of the original battery.
- ※ Prohibit disconnecting the empty battery from the vehicle.

Violating the above notices or the following description during engine start through jumper cable will result in battery explosion, battery acid burning or short circuit. This will damage the electrical systems of the two vehicles and result in severe personal injury.

Preparation of jumper starting

1. Tension the parking brake.
2. Engage the neutral gear.
3. Shut down all electrical accessories.

Notes

Shut down the Hi-fi system before starting the vehicle through jumper cable. Otherwise, the Hi-fi system may be damaged.

Notes

Determine the proper position of jumper cable and don't wind it to the rotating member of engine compartment. Otherwise, vehicle damage and personal injury may be caused.

Connecting the jumper cable



Connect the jumper cable according to the following sequences when starting the vehicle:

1. Clip one end of the first jumper cable to the positive terminal of charged battery (There is mark of “+” on the battery jar or terminal).
2. Clip the other end of this cable to the positive terminal of the empty battery (There is mark of “+” on the terminal).

3. Clip one end of the second jumper cable to the negative terminal of charged battery (There is mark of “-” on the battery jar or terminal).

Notes

Before connecting the vehicle to be charged in the end, don't connect the battery negative (-) terminal. Connect the clip which is connected in the end to the steel bracket of engine cylinder body through bolts. The final connection point shall be as far from the battery as possible. Connecting the jumper cable to the negative terminal of empty battery may generate electric arc, cause battery explosion and result in severe personal injury or vehicle damage.

4. Ensure the cable is finally connected to the suitable earth position, for example, connecting it to the steel bracket of engine cylinder body with bolts.
5. The engine of vehicle supplying power may operate during jumper starting.

Notes

Start the engine of vehicle whose battery has been discharged at an interval of about 1min and each starting shall not exceed 15s.

After the start of vehicle whose battery has been discharged:

1. Disconnect the earth connector (1) carefully. Disconnect it from the vehicle whose battery has been discharged

first. Keep the vehicle whose battery has been discharged running.

2. Disconnect the negative wire from the vehicle supplying jumper starting power.

3. Disconnect the positive wires of the two batteries. Keep the jumper cable and spare tyre together.

4. Run the vehicle whose battery has been charged for about 20min. This will allow the charging system to charge battery again.

5. If discharge phenomenon occurs again, please consult the after service center specially designated by JAC.

Towing vehicle

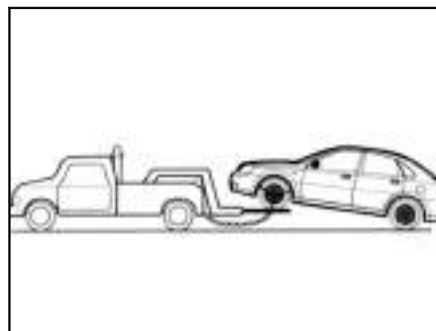

If the vehicle shall be towed, please contact the after service center specially designated by JAC or professional towing service company.

Notes

Passengers shall not seat in vehicle being towed. The towing speed shall not exceed the safe speed or indicated road speed limit.

Prohibit towing vehicle with damaged part which is not completely fixed to the vehicle.

Violating the above notices may result in personal injury.

Towing your vehicle with wheel lift

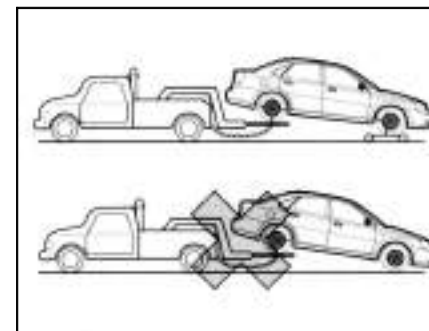

1. Switch on the danger warning flash lamp.
2. Turn the ignition key switch to ACC (accessory) position.
3. Engage the neutral gear.
4. Release the parking brake.

Notes

If the vehicle shall be towed from the tail, please use supporting wheels for the towing mechanism under the front wheels.

It's forbidden to have the front wheels touch ground when towing the vehicle from the tail. If the front wheels touch ground during towing, the transmission will be severely damaged.

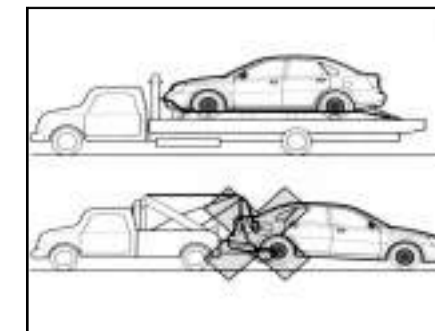

5. The front wheels must be off the ground during vehicle towing.

Notes

Prohibit towing the vehicle through pendant chain type equipment. The vehicle must be towed through slab or wheel lifting equipment.

Emergency towing

If there is no towing vehicle in the event of emergency, you can fix a rope to the emergency towing hole under the wheel to tow the stalled vehicle temporarily.

Front towing hole



The front towing hole is located under the front guard. There shall be a driver in the vehicle to control steering and braking.

Such towing can be performed on hard road only while the towing distance cannot be long and the towing speed cannot be high.

In addition, the wheels, axles, transmission system, steering system and brake must be in good working conditions.

Notes

When towed by rope, the vehicle might be damaged.

To reduce vehicle damage:

Make sure to use the towing hole if there is no other towing equipment.

Tow the vehicle from the front end only.

Keep the towing rope away from the bumper.

Ensure the two ends of towing roped are fixed to the towing hole.

Pull the towing rope to check it.

Drive the vehicle slowly and try to avoid sharp turn.

Notes

The wheel being towed may be out of control when towed by rope.

Prohibit towing if the wheels, transmission, axle shaft, steering system or brake system are damaged.

Prohibit pulling the key out from the ignition switch, otherwise, the steering system will be locked to prevent vehicle running.

Rear towing hook



Tow the other vehicle with rear towing hook. The rear towing hook can be used in emergency only (for example, tow the vehicle trapped in the ravine, snow or slough).

When using the rear towing hook, make sure to keep the rope or chain perpendicular to the towing hook. Prohibit applying force to the towing hook laterally. Prohibit sudden start so as to avoid damage.

Escaping from vehicle trapping



When the vehicle is trapped into snow, slough or other unstable surface, please escape the vehicle from such situation according to the following procedures.

1. Turn the steering wheel leftward to the end and then turn it rightward to the end. In this way, a piece of empty land can present around the front wheels.
2. Engage the reverse gear and drive gear to and fro.

3. Reduce wheel spin as much as possible.
 4. Release the throttle pedal upon gear shifting.
 5. Step the throttle pedal slightly after gear engagement.
- If the vehicle cannot escape from the difficult situation after several times of attempt, it shall be towed. Refer to above paragraph Towing Vehicle in this section.

| Notes |
|--|
| In case your vehicle is trapped into snow, slough and sand soil, you might have to drive it away. First, check whether there are obstacles or human around the vehicle. The vehicle may advance or reverse suddenly during operation, which may damage the objects. To avoid damage of transmission and other parts, please observe the following notices when escaping the vehicle from trapping: Don't step the throttle pedal upon gear shifting or before drive gear or reverse gear engagement. Prohibit too high engine speed and avoid wheel spin. |

| |
|--|
| If the vehicle cannot escape from trapping after several times of attempt, please consider of other manners, for instance, towing. |
|--|

| Notes |
|--|
| If the wheels keep fast idling, the tyres may burst and hurt you or other passengers. Furthermore, the transmission or other vehicle spare parts may overheat and result in engine compartment catching fire or other damage consequently. Try to avoid wheel spin in the case of vehicle trapping, pay attention to speed meter and prohibit wheel spin speed exceeding 55km/h. |

Overheating of engine

If the engine coolant temperature indicates overheating of engine or you doubt the engine may overheat because of other reasons:

1. Stop the vehicle.
2. Shut down the air conditioner.
3. Run the engine idling for a few minutes.
4. Ensure the cooling fan is working.

| Notes |
|---|
| If steam can be seen, please leave the vehicle and wait for engine cooling. Steam may result in severe burning. |

| Notes |
|---|
| Using air conditioner when climbing long slope or during traffic jam may result in overheating of engine. |

If the fan is not working while steam can be seen, please carry out the following procedures:

1. Stall the engine.
2. Leave the vehicle and don't open the engine hood.
3. Wait for engine cooling.
4. Lift the engine hood carefully when no steam can be seen.
5. Consult the after service center specially designated by JAC as soon as possible.

Chapter VII Vehicle Maintenance

| | | | |
|---|------|--|------|
| Maintenance | 7-02 | Fuse box in engine cabin | 7-23 |
| Safety protective measures | 7-02 | Cab fuse box | 7-26 |
| Driver inspection bill | 7-05 | Lamp | 7-29 |
| Engine cabin | 7-06 | Transmission belt | 7-33 |
| Engine oil filling | 7-07 | Tyre | 7-34 |
| Air filter/filter element | 7-09 | When to replace the old tyre | 7-37 |
| Inspecting coolant | 7-12 | Appearance curing | 7-39 |
| Power steering fluid | 7-17 | Maintenance plan | 7-46 |
| Front windscreen washing solution | 7-18 | Maintenance in general driving condition - - - | 7-48 |
| Brake fluid | 7-19 | Additional maintenance of driving in severe | |
| Storage battery | 7-21 | condition | 7-50 |

Maintenance

Special After -sale Service Center of Jianghuai Automobile Co., Ltd. Knows of your vehicle best and hopes that you are satisfied with the vehicle. We wish you can come to Special After -sale Service Center of Jianghuai Automobile Co., Ltd. When you need some maintenance service for your vehicle. There, you can buy pure Jianghuai automobile components and receive the service from the maintenance personnel trained by Jianghuai Automobile Co., Ltd.

Mounting equipment outside the vehicle

Mounting equipment outside the vehicle will affect the air flow around the body. It may cause wind noise and affect the work of front windscreen washer. So please consult Special After -sale Service Center of Jianghuai Automobile Co., Ltd. Before mounting equipment outside the vehicle.

Safety protective measures

When you are inspecting and maintaining the vehicle, you must take protective measures to reduce the danger to person injuries and damages.

The following are some note items to be followed when maintaining vehicle:

- ※ Prohibit operating before the engine cools down.
- ※ Prohibit getting under the vehicle that can only be supported by jack.
- ※ Use safety support when operating under the vehicle.
- ※ Storage battery, all the fuel and the part associated with fuel must be kept away with fuming articles, flame and spark.

※ Prohibit connecting or disconnecting the storage battery or any transistor components when ignition switch is switched on.

※ When connecting storage battery cable, pay attention to the polarities. Do not connect the anode cable to the cathode binding post or connect the cathode cable to the anode binding post.

※ Pay attention to the storage battery, ignition line and vehicle lead wire, take care not to be injured for the high current or voltage.

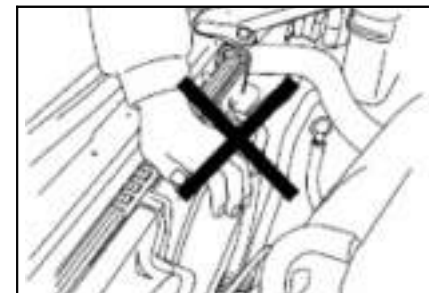

Notes

Before working or inspecting under the engine cover, turn off the ignition switch and pull out the key.

Touching the live components when the ignition switch is switched on will cause electric shock or burned.

If you have to work in the engine room, be sure to take off the loose coat which is easily winded -up and take away the jewelries. Keep the body away from fan, strap and other moving components.

※ When the engine is working in the closed space (such as garage), good ventilation should be guaranteed.

※ Keep the children or pet away from the used oil, coolant and other oil fluid.

※ Prohibit treating the empty oil barrel and fluid tank or the vessel containing used oil and oil fluid together with the life garbage.

※ If inspection is needed under the engine cover when the engine is running, take care if the vehicle moves suddenly. Turn the gear change lever at the neutral position and pull tightly the parking brake.

※ In order to avoid accidental person damage, turn off the ignition switch and pull out the key when operating under the engine cover, unless the maintenance procedure requires the engine to keep running. If the engine must be kept running when working, take off the loose coat and take away the jewelries, otherwise, they will be winded-up at the moving components and cause damage.

Inspecting the inner components of the engine cabin

| |
|--|
| Notes |
| Even if the engine is not running, the engine cooling fan inside the engine cabin may be started and cause damage to you. So, the hands, dresses and tools shall be kept away from the fan inside the engine cabin. |
| Notes |
| If the combustibles fall on the engine components of high temperature, it may cause fire. These combustibles include fuel, oil, coolant, brake fluid, front windscreen washing solution, etc, and plastic and rubber. The fire may cause damage to you and others. So, take care to avoid the combustibles flatter-ing or falling on the un-cooled engine. |

Before any inspection of the engine, extinguish the engine and stop the fan from working to avoid any damage by the cooling fan.

Besides, the voltage of the electronic ignition system is higher than that of the common system, so, touch the live components of the vehicle is very dangerous when the ignition is on.

Driver inspection bill

Inspect the inner vehicle, outer vehicle and engine room regularly to keep the vehicle safe and reliable.

Outer vehicle

※ Tyre

The expansion is mild (see “wheel and tyre”)

There is no crack on the tyre side and tyre surface.

There is no foreign matter in the tyre thread.

※ Wheel

The bolt and nut are tightened. (See section VI “How to Replace the Flat Tyre”)

※ Lamp

All the traveling lamp, headlamp, rear lamp, width showing lamp, steering signal lamp, stop lamp and fog lamp can work normally.

※ Oil fluid

Check the oil level of all the fluid tanks under the engine cover is suitable.

※ Windshield wiper of Front wind-screen

Check the state of the wiper arm and wiper blade (including windshield wiper of rear window, such as equipment)

Inner vehicle

※ Steering

Check whether the steering wheel is over loosened (idling).

※ Parking brake

Ensure the travel of the control rod of the parking brake is suitable.

※ Console

Check whether the operation of the all the console instruments, control button and warning lamp is normal.

※ Rear mirror

Ensure that all the reflecting surfaces of three rear mirrors are in good condition and clean.

Check whether all the rear mirrors can be readjusted.

※ Controlling

Check whether the clearance between the brake pedal and the clutch pedal is suitable.

Engine cabin



1. Engine oil filler cap
2. Engine oil rule
3. Engine air filter/filter element
4. Stock solution tank for engine coolant
5. Stock solution tank for power steering fluid
6. Stock solution tank for front wind-screen washing solution
7. Stock solution tank for brake fluid
8. Storage battery
9. Fuse box of engine cabin

Engine oil filling



If the oil pressure warning lamp on the combined instruments of the console is on, it shows that inspection of the engine oil level is immediately required. For details, see Section III “Oil Pressure Warning Lamp”. You should check the engine oil level regularly, for the warning lamp only functions as warning.

Check the engine oil level



You'd better check the engine oil when filling oil. The oil should be cooled in order to get accurate reading.

1. The vehicle shall be on the flat floor.
2. Shut off the engine, and wait for a minute to make the oil flow to the stock solution tray. If not, the actual berth will not be shown on the oil rule.

3. Draw out the oil rule, insert back to the place after wipe clean with paper and cloth. Draw out again and keep the tip downwards, check the berth.

When to fill engine oil

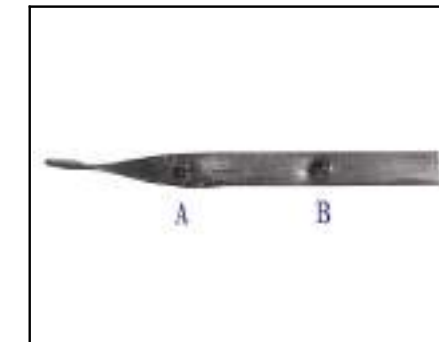

4. If the oil level is at the position of mark hole (A) at the lower part of the oil rule or lower than this position, you should fill oil. In this section, we will show which oil type shall be used.

5. Do fill proper quantity of oil to make the berth in the range of normal operation, that is, the oil rule is in the middle of two mark holes. Insert the oil rule back completely after finishing filling oil. Which kind of engine oil shall be used? It is suggested to use the following oil types:

1. -20°C ~30°C SAE 10W/30 Grade SG

2. -30°C~20°C SAE 5W/40 Grade SG Engine oil additive

Do not add any substance into the oil. The recommended oil can completely ensure the engine run well and protect the engine.

Notes

The engine oil is irritative, it will cause illness or death after swallowing it. Keep away from the children. Keep the skin from touching the oil frequently or for a long time. Wash the touched position with soap and water or washing fluid.

Notes

Over filling of oil will affect the operation of the engine. Prohibit exceeding the MAX mark on the oil rule. Over filling will cause damage the vehicle, the reasons are:

- ※ Increase the consumption of engine oil
- ※ The oil will spill from the ignition plug
- ※ A lot of carbon will assemble on the engine

Replacing the Engine Oil and Lubricating Oil Filter

The engine oil will lose lubricating capability after being polluted. Do replace the engine oil as the maintenance regulation. Replace the lubricating oil filter each time when replacing the engine oil. Under severe condition, the replacing time of oil and lubricating oil filter shall be shorter than the time stated in the standard maintenance regulation.

Notes

This job requires special skills, tool and equipment. Before trying to undertake this job, you'd better be sure that you are up to this job. It is suggested that it shall be done by Special After-sale Service Center of Jianghuai Automobile Co., Ltd. Otherwise, it will cause damage or injury to the vehicle.

The severe conditions include but not limit to the following:

- ※ Always cold start-up
- ※ Frequently stop when the traffic is not smooth
- ※ Always travel for a short distance
- ※ Always travel when the outer vehicle temperature is lower than the ice point
- ※ Idling for a long time
- ※ Always travel at low speed
- ※ Travel under dusty condition

Air filter/filter elements



According to the maintenance regulation introduced in this manual, check and replace air filter element regularly.

Notes

The normal operation of the engine requires fresh air. Prohibit driving the vehicle without mounting air filter/filter element. Driving without mounting air filter element will cause damage to the vehicle.

Clean the air filter

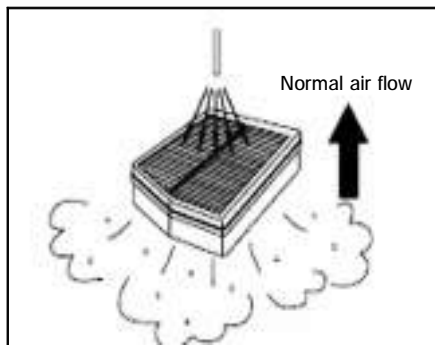

If the air filter element is dirty, clean it as the following orders:

1. Flick the air filter elements to throw away the floating dust
2. Clean the inner housing of the air filter
3. Cover the filter housing with wet cloth when cleaning the filter element

4. Clean the filter element with compressed air in the opposite direction to the normal air flow
Maintenance regulation
See “Section VIII Maintenance Plan”.

Engine coolant

The following part has introduced the cooling system of this vehicle and the method of adding coolant when the coolant level is low. If there is overheat failure on the engine, see “Overheated Engine”.

The mixture of 43/57 clean drinking water and proper coolant has the following functions:

- ※ Anti-freezing, the lowest temperature can be -45°C ;
- ※ Anti-boiling, the highest temperature can be 110°C ;
- ※ Anti-rust; (Preservative agent shall be added in it.)
- ※ Help to keep normal engine rotating speed;

- ※ Ensure the warning lamp and instrument to work normally.
Using which kind of coolant
Use 43/57 clean drinking water and the coolant mixture in compliance with the requirements of Jianghuai Automobile Co., Ltd. This kind of coolant will not cause damage to the aluminium components.

Notes

When the engine is in heat state, do not fill coolant, and fill after the engine become cold. Otherwise, it will cause great damage to the engine.

Notes

Try to use the anti-freezing solution of the same brand. Different brand anti-freezing solutions have different making recipe. If mixed to use, chemical reaction may appear in different additives, which will invalidate the additives; the effective period of most anti-freezing solutions is two years (the period of some products will be longer), make sure that they are in effective period when filling; replace regularly, generally, replace once for every two year or every ten thousand kilometers. For the taxi, they need replace more frequently. Let out all the old fluid when replacing, clean the cooling system and then replace for the new fluid; avoid using with water.

The traditional inorganic anti-freezing solution can not be used with water, because it will deposit and seriously influence the normal function of anti-freezing solution. The organic anti-freezing solution can be used with water, but not too much water. Although glycol itself is not poisonous, with the existence of anti-rust solution, the anti-freezing solution becomes poisonous. Therefore, the vehicle owner shall store the anti-freezing solution in the special container which the children can not reach. When filling anti-freezing solution, pay attention not to splash the anti-freezing solution on the vehicle paint, for it will cause damage to the paint film; and pay attention not to let the anti-freezing

solution overflow to the engine parts with high temperature, which will cause combustion. For safety, the vehicle owner shall let the engine in the cold state when adding engine coolant and anti-freezing solution. So, not only the adding quantity is accurate, but also it is safe.

If you add coolant over 4 times in a year, ask Special After-sale Service Center of Jianghuai Automobile Co., Ltd. to check the cooling system of the vehicle.

If you have used the proper coolant, it is unnecessary to add the so-called inhibitor or additive solutions to improve the performance of the cooling system, for these inhibitors are harmful to the system.

Inspecting the coolant



The engine coolant expansion pot is located in the engine cabin beside the vehicle passengers. The detailed position, see “General Drawing of Engine Cabin”.

Notes

If unscrew the coolant expansion pot cover or the radiator cover when the engine and the radiator are very hot, the steam and hot air will spray out and burn you. So, do not unscrew the coolant expansion pot cover or the radiator cover when the engine and the radiator are very hot. The vehicle shall stop on the flat ground. After the engine cools down, the coolant level shall be between the upper (F) limit and lower limit (L) of the coolant expansion pot. When the engine reaches the normal operation temperature, the fluid level will rise, and when the engine cools down, the fluid level will fall down again.

Adding coolant

If the fluid level is under the lower limit (L) mark, add proper coolant mixture to the expansion pot, but can only add when the engine cools down.

Notes

If splash the coolant on the high-temperature engine components, it may burn you. The coolant contains glycol, if the temperature of the engine components is high enough, the glycol will burn. So, do not splash the coolant on the high-temperature engine. When remounting the expansion pot cover, please confirm that it had been screwed tightly.

Pressure cover of coolant stock solution tank

Notes

If the pressure cover board is not screwed tightly, it will cause the coolant to run away and cause damage to the engine. So, do screw the pressure cover tightly and correctly.

The engine is overheated
The coolant temperature meter is on the combined instrument of the vehicle console. See “Temperature Meter” in Section III.

The steam comes out of the engine

| Notes |
|---|
| <p>If the steam comes out when the engine is overheated, it will burn you seriously, even if you are just opening the engine cabin. If you see the steam comes out of the engine, please keep away from the engine. Shut off the engine, and make every one far away from the engine till it is cooled down. Open the engine cabin when there is no steam or coolant comes out of the engine.</p> <p>If continue to run when the engine is overheated, the oil in the engine will catch fire and burn you or others. If the engine is overheated, shut off the engine, get off the vehicle and wait till the engine cools down.</p> |

| Notes |
|---|
| <p>If continue to run when there is no coolant and cause the engine to catch fire, the vehicle will seriously be damaged. The expensive repair fee thus caused is not in the guarantee range.</p> |

Cooling system

| Notes |
|---|
| <p>Even if the engine does not run, the engine cooling fan in the engine cabin may also start and cause damage to you, so, the hands, coat and tools shall be kept away from the fan inside the engine cabin.</p> |

If the coolant inside the expansion pot is boiling, do not carry out any operation until the engine cools down. The vehicle shall stop on the flat ground and ensure the air conditioning is shut off. After the engine cools down, the coolant level shall be between the upper limit and lower limit of the expansion pot. If it is not between these two marks, it is because there is leakage in the expansion pot cover, radiator hose, radiator and pump or other places.

| Notes |
|---|
| <p>The radiator hose and other engine components may be very hot, do not touch these components; otherwise, you will be scalded.</p> <p>Do not run the engine when there is coolant leakage. If you run the engine, it will cause all the coolant run away, and it will cause the engine to catch fire and you will be scalded. So, repair all the leakage points before driving the vehicle.</p> |

If there is no leakage when the engine runs, check whether the engine cooling fan runs or not. If the engine is overheated, the fan shall be running, and if the fan does not run, repair the vehicle.

| Notes |
|--|
| <p>The engine damage caused by running engine without coolant is not in the guarantee range.</p> |

How to add coolant to the expansion pot

| Notes |
|--|
| <p>It is very dangerous to only add clean water to the cooling system, the boiling point of clean water or alcohol and other fluid is lower than normal coolant mixture. And the coolant warning system of the vehicle is set according to normal coolant mixture. Using water or other improper mixture will cause the engine overheated, and the warning system will not send warning.</p> <p>The engine caught fire will scald you and others. Do use the mixture proportioned by 43/57 of clean drinking water and proper coolant.</p> |

| Notes |
|--|
| When the weather is cold, the water will cause the engine, radiator and other components to become frost cleft. So, please use the recommended coolant and proper coolant mixture. |

You can remove the coolant expansion pot cover after the cooling system, including coolant expansion pot cover and radiator hose, cools down.

Add proper mixture to the coolant expansion pot till it reaches the upper limit mark of the expansion pot. Wait for 5 minutes, and check whether the fluid level is lower than the upper limit mark. If the fluid level is lower than the upper limit mark, raise the level to the upper

limit position by adding some coolant again. Repeat this step to keep the level at the upper limit position for at least 5 minutes.

Do not cover the expansion pot cover and start the engine to let it run until you can feel the upper radiator hose become hot. Be careful not to touch the cooling fan. At this time, the coolant level in the expansion pot will fall; add more mixture to the expansion pot to make the level reach the upper limit mark position if the level is lower than the upper limit mark. Then cover the cover and make sure the cover is mounted in place.

Main fluid parameters

It is suggested to use the following coolant specification.

| Name | Brand | Volume |
|----------------|--|--------|
| Engine coolant | 43/57 proportioned anti-freezing solution at -45°C | 7L |

Power steering fluid

When to check the power steering fluid
The power steering stock solution tank is in the front of the engine cabin beside the vehicle passengers. See “General Drawing of Engine Cabin” in this section to confirm the position of the stock solution tank.

Unless you doubt that there is leakage in the system or you have heard abnormal sound, it is unnecessary to inspect the power steering fluid. The run away of the power steering fluid shows that there is failure, and it is required to check and repair the system.

How to inspect the power steering fluid?

Inspect the power steering fluid as the following steps:

1. Cut off the ignition switch and wait the engine cabin to be cool.
2. Wipe clean the tank cover and the surface of the stock solution tank.
3. Unscrew the tank cover.
4. Add power steering fluid to the proper level.

Mount the tank cover again and screw tightly completely.



The level shall be between the upper limit MAX mark and lower limit of the stock solution tank.

If the level falls to or below the lower limit MIN mark position, add power steering fluid to make the level rise to the upper limit MAX position.

Front windscreen washing solution



Before driving, make sure that the level of front windscreen washing solution is suitable and add proper solution as the regulation of this manual.

Under the condition of cold weather, prohibit adding front windscreen washing solution to more than one fourth.

The washing solution will freeze and ex-

pand at low temperature. If add too much, the washing solution will loss the expansion space and it may cause damage to the solution tank.

Notes

Adding front windscreen washing solution tank:

Do use special washing solution sold in the market.

Prohibit using tap water, because the mineral substances will block the pipe of the front windscreen washer.

If the temperature may reduce to ice point, do use the front windscreen washing solution with enough anti - freezing performance.

Prohibit adding water or radiator anti - freezing solution to the front windscreen washer solution tank.

Water will freeze the solution, and the solution freezing will cause damage to the front windscreen washer system.

The radiator anti - freezing solution may also cause damage to the front windscreen washer system and the vehicle paint.

Brake fluid

What is added to the brake master cylinder stock solution tank is DOT4 brake fluid.

There two reasons for the falling of the brake fluid level in the stock solution tank. One is that the brake fluid falls to the acceptable level position in the normal wear process of the braker friction gasket. And the level can recover to the normal position after replacing new friction gasket.

Another reason is that the brake fluid is leaking outwards from the brake system. If it is for this reason, you should repair the brake system. Because leakage means that the brake will not work normally or can not work sooner or later.

So, it is useless to add brake fluid when the level falls. Add brake fluid can not change the leakage. What's more, if you add brake fluid when the friction gasket wears out, the brake fluid will be too much after replacing the old friction gasket. Only when the repair work of the brake hydraulic system has been finished, can add or reduce the brake fluid as required.

Notes

If the brake fluid is too much, it will splash onto the engine. If the temperature of the engine is high enough to burn the brake fluid and to burn you or others, and it will cause damage to the vehicle. So, only when the repair work of the brake hydraulic system has been finished, can add brake fluid.

If the brake fluid level is low, the brake warning lamp will light on; see "Warning Lamp for Brake System" in section III.

Which kind of brake fluid to be added?



When it is required to add brake fluid, you can only use JG4 brake fluid and can only use new brake fluid in unopened container. See “Main Fluid Parameters” in section II.

Before unscrew the stock solution tank cover for brake fluid, you should clean the tank cover and the components around it. It can prevent the dirt from

going to the stock solution tank by doing this.

Notes

If the type of brake fluid which is added to the brake system is not correct, the brake can not work normally. And it will cause accident. So, do use the correct type of brake fluid.

※ Using wrong type of brake fluid will cause serious damage to the components of brake system. For example, adding only a few drops of mineral oil to the brake system will cause serious damage to the components of brake system, and you have to replace these components. Therefore, you should prevent anyone to add the wrong type of brake fluid.

※ It will cause damage to the vehicle paint if the brake fluid splashes onto the vehicle paint surface. So pay attention not to splash the brake fluid onto the vehicle. If it does, clean it immediately. See “Appearance Curing” in this section.

Storage battery



There is maintenance free storage battery installed in your vehicle. If you want to replace the storage battery, the part number on volume of all the storage battery shall be the same with that of the original storage battery. See “General Drawing of Engine Cabin” in this section to confirm the position of the storage battery.

Notes

There is lead, lead compound and other chemical compounds in the ends, binding post and the relative accessories. So wash hands after touching it.

Vehicle storage

If the vehicle will not run in at least three weeks, the cathode cable of the storage battery should be cut off, which will prevent the storage battery from leakage.

Notes

The acid liquor in the storage battery will burn you, and the generated gas is explosive. If you are not careful, you will be seriously injured. See “Jumper Start” in this section to know of the related hints for avoiding damage when working around the storage battery.

Clear up binding post of storage battery

1. Shut off the ignition switch and draw out the key.
2. Loosen and disassemble the cable clip of the storage battery from the binding post with spanner. Do cut off the cathode binding post (—) of the storage battery first.
3. Clear up the binding post with steel wire brush and clearing tool for binding post.
4. Check if there is white or light blue powder on the binding post of the storage battery. If there is, it shows the binding post has been eroded.
5. Clear up the eroded substances with water solution of sodium bicarbonate. The water solution of sodium bicarbonate will make bubbles and become

brown.

6. When it stops making bubbles, flush the solution with clean water, then wipe the storage battery with paper and cloth.

7. Connect and tighten the anode (+) binding post again and then connect the cathode (—) binding post again.

Maintenance of storage battery

When maintaining and assembling storage battery, do carry and place it gently. And avoid the electrolyte from leakage or exploding or generating safety accident. Check if there is electricity before assembling the storage battery. If the electricity indicator on the storage battery shows dark blue, it means the electricity in the storage battery is full; if shows light blue or transparent color, it means there is leakage in the storage battery, and it needs charge.

In order to prolong the lifespan of the vehicle storage battery, the following way should be obeyed.

※ Keep the proof of storage battery clean and dry.

※ Keep the binding post and post head clean tightened and smear vaseline or lubricating grease on it.

※ Immediately flush the splashed electrolyte with water solution of sodium bicarbonate.

※ If you do not use your vehicle for a long time, cut off the cathode (—) binding post of the storage battery and charge the storage battery one every 6 weeks.

Notes

The storage battery contains poisonous substances, and the used storage battery is bad for health and environment.

Prohibit treating the used battery with household garbage. Do use the local legal automobile waste disposal facility.

Fuse box of engine cabin

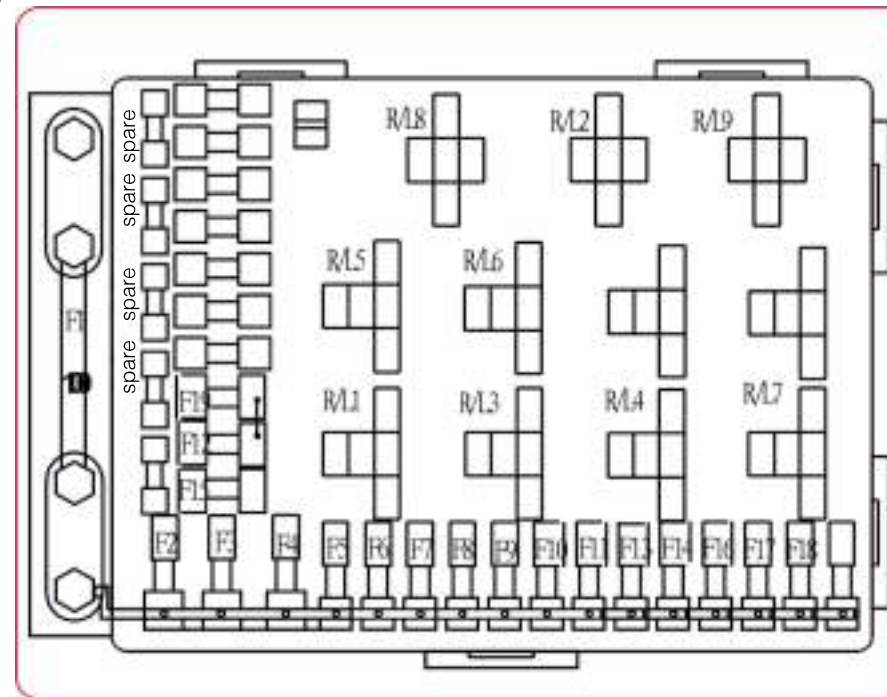

| | | |
|--------------------------------|---|---|
| F20-reserved | F35-diagnosis insurance | F49 -electric rear mirror heating insurance |
| F21-reserved | F36-reserved | F50-small lamp insurance |
| F22-reserved | F37-reserved | F51-reserved |
| F23-reserved | F38-reserved | R/L10-on relay |
| F24-anti-theft alarm insurance | F39-reserved | R/L11-reserved |
| F25-front fog lamp insurance | F40-reserved | R/L12-blower relay 1 |
| F26-ACC insurance | F41-seat heating insurance | R/L13-blower relay 2 |
| F27-instrument insurance | F42-insurance of radio with cassette player | R/L14-rear defrost relay |
| F28-BCM IG insurance | F43-AM insurance | R/L15-front fog relay |
| F29-windscreen wiper insurance | F44-insurance of start relay coil | R/L16-anti-theft relay |
| F30-IG2 insurance | F45-turn light insurance | R/L17-small light relay |
| F31-ABS insurance | F46-stop lamp insurance | R/L18-horn relay |
| F32-danger alarm insurance | F47-horn insurance | R/L19-cigarette light relay |
| F33-reversing lamp insurance | F48-airbags insurance | R/L20-light flash relay |
| F34-indoor lamp insurance | | |

Fuse

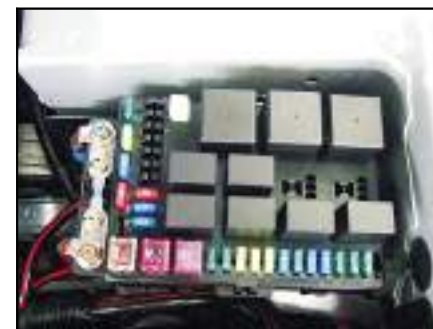

Replacing fuse:

1. Open the fuse cover.
2. Judge the damaged fuse by burnt fuse.
3. Remove the broken fuse with fuse remover.

Notes

※ Prohibit disassembling the broken fuse with electric tool. Do use the fuse remover.

Using the electric material, such as metal, will cause short circuit and break the electric system or get fire. And it may cause damage to people.

4. Confirm the reasons of causing the fuse to break and eliminate the failure.

5. Install new fuse with the rating current conforming to the regulation of this manual.

Notes

Using fuse substitute or the fuse with wrong type and rating value will cause damage to the electric system or get fire.

※ Do use the fuse with the type and rating current conforming to this manual.

Otherwise, it will cause damage to people and to vehicle or other property.

Attentive hint

There are four spare fuses (10A, 15A, 20A, and 30A) in the fuse and relay box of the engine room.

Cab fuse box

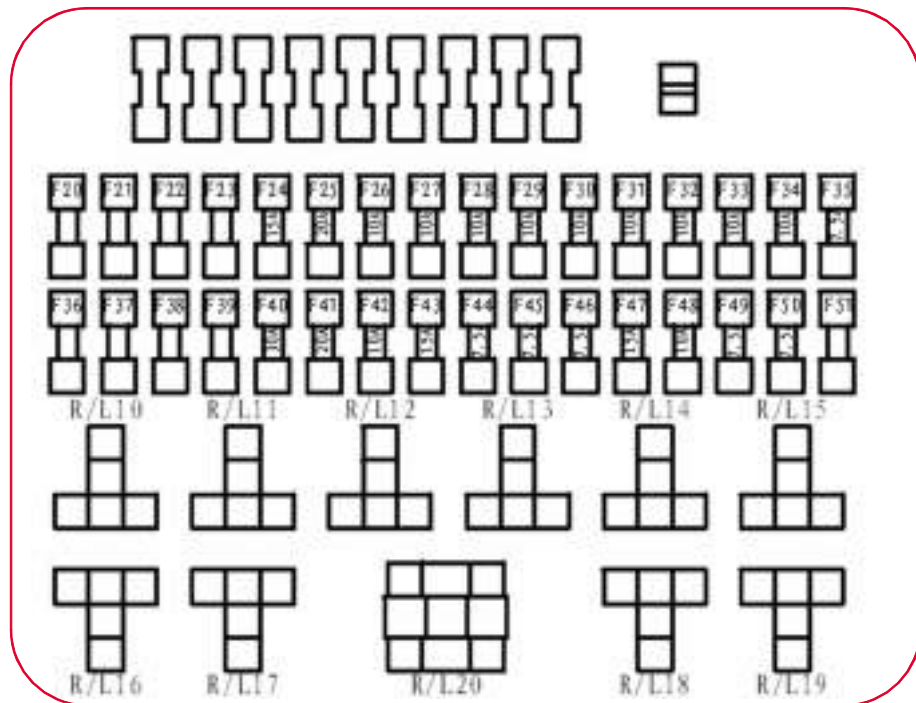

F1-main insurance
 F2-IG fuse buffer
 F3-30 fuse buffer
 F4-start fuse buffer
 F5-electric fan insurance 1
 F6- electric fan insurance 2
 F7-electric window insurance 1
 F8- electric window insurance 2
 F9 -central controlling lock insurance

F10-cigarette lighter insurance
 F11 -rear defrost /rear mirror heating insurance
 F12-EFI main relay insurance
 F13-high beam light insurance
 F14-dipped headlight insurance
 F15-fuel pump insurance
 F16-30 fuse buffer 2
 F17-30 fuse buffer 3
 F18-blower insurance

F19-EFI B+ insurance
 R/L1-oil pump relay
 R/L2-main relay of engine
 R/L3-compressor relay
 R/L4-high beam relay
 R/L5-condensing fan relay
 R/L6-radiator fan relay 2
 R/L7- high beam relay
 R/L8-fan controlling relay
 R/L9-start protective relay

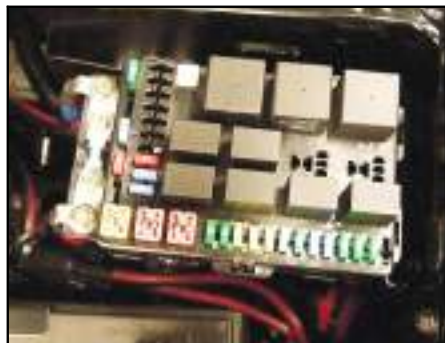

Replacing fuse:

1. Disassemble storage box at the driver's side.
2. Judge the damaged fuse by burnt fuse.
3. Remove the broken fuse with fuse remover.

Notes

Prohibit disassembling the broken fuse with electric tool. Do use the fuse remover. Using the electric material, such as metal, will cause short circuit and break the electric system or get fire. And it may cause damage to people.

4. Confirm the reasons of causing the fuse to break and eliminate the failure.
5. Install new fuse with the rating current conforming to the regulation of this manual.

Notes

Using fuse substitute or the fuse with wrong type and rating value will cause damage to the electric system or get fire. Do use the fuse with the type and rating current conforming to this manual. Otherwise, it will cause damage to people and to vehicle or other property.

Lamp

Arrangement plan of outer vehicle lamps

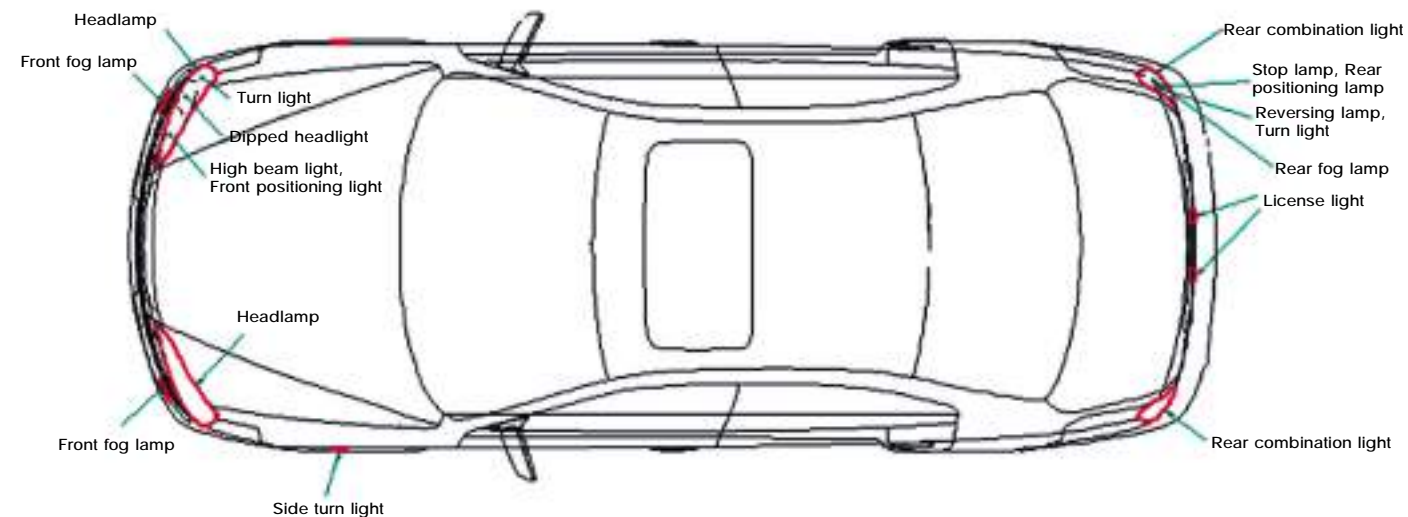

Outer illumination and signal device type

| Lamp name | Functions and structure type |
|-------------------------|--|
| Front combination light | High beam light, dipped headlight, Front positioning light, Turn light. |
| | Combined four-lamp headlamp |
| | Projecting mirror is adopted with glass lens of dipped headlight. |
| Front fog lamp | Mounted on the front bumper. |
| Side steering lamp | Mounted on the flank board |
| Rear combination light | Including rear positioning lamp, stop lamp, turn light, reversing lamp, rear fog lamp. |
| | Combine rear light |
| | The color of glass lens is mainly double colors. |
| | Brake lamp and position lamp share the same luminous surface. |
| High position stop lamp | Using LED light source |
| License lamp | Common structure |

Inner illumination device type

| Collocation name | Functions and structure type |
|---------------------------------------|--|
| Front indoor (ceiling) light | Reading lamp, with eye box and sun roof switch |
| Rear indoor (ceiling) light | Reading lamp with door control function |
| Four door lamps | Bulb and lamp shade are installed separately. |
| Rear boot lamp | Cylindrical bulb |
| Grocery room lamp | Cylindrical bulb |
| Left and right feet illumination lamp | Cylindrical bulb |

| No. | Name | Parameter requirements | | Power |
|-----|------------------------------|---|--|-------|
| 1 | Front combination light | High beam light | Tungsten halide lamp H1 | 55W |
| | | Dipped headlight | Shooting lamp: Tungsten halide lamp H7 | 55W |
| | | Position light | Filament lamp | 5W |
| | | Turn light | Filament lamp | 21W |
| 2 | Rear combination light | Turn light | Filament lamp | 21W |
| | | Stop light | LED | 3W |
| | | Reversing lamp | Filament lamp | 21W |
| | | Rear fog lamp | Filament lamp | 21W |
| | | Position lamp | LED | 3W |
| | | Reverting reflector lamp | The installing height is according to International Standards. | |
| 3 | Front fog lamp | Tungsten halide lamp | | 55W |
| 4 | Side steering lamp | Filament lamp | | 5W |
| 5 | High position stop lamp | LED | | 3W |
| 6 | License lamp | Filament lamp | | 5W |
| 7 | Front ceiling light assembly | Incandescent bulb, integrated sun roof control switch | | 5W×2 |
| 8 | Rear ceiling light assembly | Incandescent bulb, control, see inner schematic diagram | | 5W×2 |
| 9 | Indoor small lamp assembly | Filament lamp | | 5W |
| 10 | Door light | Filament lamp | | 5W |

Transmission belt

Transmission belt must be in good condition and adjusted in place, so that the generator can work normally. Replace the transmission belts which are worn, cracked and broken.

Notes

The engine may start unexpectedly if the key is not turned out. Prohibit keeping the key in the ignition switch when inspecting the transmission belt. When the engine is working, it may be caused serious accident injury if moving the components.

Inspecting the belt

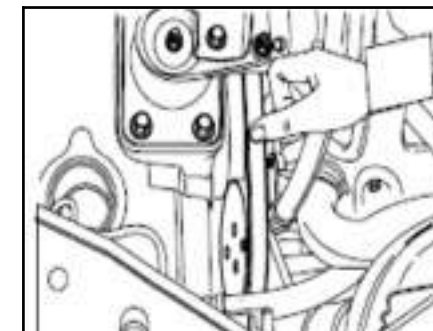

Inspecting the rate of tension of the transmission belt:

1. Slightly press the middle of the longest unsupported length of the transmission belt with thumb. The pressure of the thumb is about 10kg.
2. Press the transmission belt with thumb, which produce the deflection of about 10mm.

3. If the belt is too loose, it should be adjusted by Special After-sale Service Center of Jianghuai Automobile Co., Ltd.

Tyre

The high quality tyre equipped on your new vehicle is manufactured by a tyre manufacturer who is leading the way in this industry. If you have any question about tyre guarantee and where to maintain, please refer to the guarantee and maintenance manual made by Jianghuai Automobile Co., Ltd.

Notes

It is dangerous that the tyre is lack of guarantee and used improperly.

- ※ The overloaded tyre may cause overheating of the tyre because of the oversize friction force. Thus, the tyre leaks gas which may lead to serious accident.

- ※ The insufficient inflation of the tyre is dangerous as well as the overloaded tyre. The accident caused by them may lead to serious accident injury. Inspect all the tyres regularly to maintain the proposed pressure value. Inspect the pressure of the tyre in cold conditions.

- ※ If the inflation is excessive, the tyre may be easy to be cracked and punctured or may burst because of a sudden pumping (for example, hit the hole). Therefore, the tyre should ensure the proposed pressure value.

- ※ Old and broken tyre may cause accident. Replace the tyre in time if the tyre has been broken or its surface is abrasion.

Side wall tags of the tyre

Available tyre information is mould pressed on the side wall of the tyre.

Inflation pressure of the tyre

The tyre can only work effectively with the proper inflation pressure.

Notes

Do not think that the insufficient inflation or excessive inflation of the tyre is no difference. But it is not the case, if the tyre inflation is insufficient, it will cause:

- ※ Excessive deflection or distortion
- ※ Overheating
- ※ Overload of the tyre
- ※ Early or irregular abrasion
- ※ Bad maneuverability
- ※ The reduction of the fuel economical efficiency

If the tyre inflation is excessive, it will cause:

- ※ Abnormal abrasion
- ※ Bad maneuverability
- ※ Bad riding comfort
- ※ Unnecessary damage because of bad road

The tyre and weight information scrolling are fixed on the side of the vehicle door of the driver. The tag indicates the proper inflation pressure when the tyre is in cold condition, and the proposed inflation pressure indicated on the tags for the tyre in cold condition is the minimum tyre pressure required for supporting the maximum vehicle capacity.

When to inspect the tyre pressure

Inspect the tyre pressure at least once per month.

How to inspect the tyre pressure

Inspect the tyre pressure with pocket-sized tyre gauge of good quality. It can not be determined whether the tyre pressure is suitable only by visual inspection. The braced-tread tyre looks normal even if the inflation is insufficient. Inspect the inflation pressure of the tyre when it is in cold condition. The tyre in cold condition refers to the tyre works within 3 hours or not more than 1.6km.

Remove the valve cock from the valve pin of the tyre, press the tyre gauge on the valve and then measure the pressure number. If the inflation pressure of the tyre in cold condition conforms to the proposed pressure value of the tyre and weight information scrolling, it does not need adjust. Continue inflating until

it is up to the proposed pressure value if the pressure is too low.

If the pressure is too high, press the metal valve pin in the middle of the valve to discharge. Inspect the tyre pressure again with the tyre gauge.

Make sure that the valve cap is installed back to the valve pin. The valve cap can prevent the dust and moisture from entering.

Tyre inspection and rearrangement

Rearrange the tyre from every 8000 to 13000km.

Rearrange the tyre as soon as possible and inspect the wheel alignment if abnormal abrasion is found. Meanwhile, inspect whether the wheel or tyre is damaged.

The purpose of regular tyre rearrangement is to make the tyre abrasion to be even. The first rearrangement is the most important.

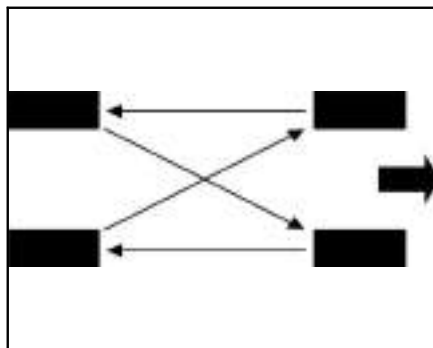

When rearranging the tyre, make sure that rearrange the tyre in proper mode shown in the figure.

Do not use compact spare tyre when rearranging.

After rearranging, adjust the inflation pressure of front and rear tyre in accordance with the tyre and weight information scrolling. Make sure that all the wheel nuts are fixed properly and tightly.

Notes

The rust or dirt on the wheel or wheel connecting parts will make the wheel nuts loosen after a long time. The wheel may come off the vehicle and lead to accident. Before replacing the wheel, any rust or dirt on the wheel or wheel connecting parts must be removed. Remove them with cloth or tissue in an emergency; after that, remove all the rust or dirt with strickle and steel wire brush if necessary.

When to replace the old tyre

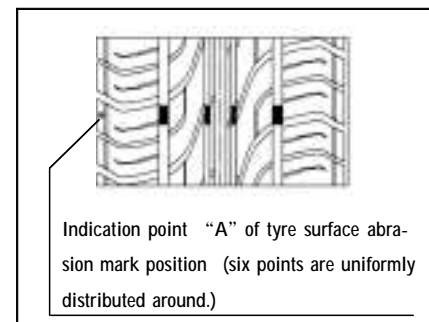

You can determine when to replace the tyre according to the abrasion indication mark on the tyre surface. When the tyre surface is worn and its thickness is 1.6mm or below, the abrasion indication mark on the tyre surface will appear.

If found any one of the following conditions, replace the tyre with a new one:

- ※ There are at least 3 abrasion indi-

cation marks on the tyre.

- ※ The tyre rubber takes on yarn or cord.
- ※ The tyre surface and tyre side cracks, and the cracks are deep enough for seeing the yarn or cord.
- ※ There are lumps, upwarping and layering on the tyre.
- ※ The tyre is punctured and broken or it has other damages. The damage range and places are difficult to repair.

Purchasing new tyres

See the tyre and weight information scrolling on the vehicle, and know about the required tyre model and size. Make sure that the size, load index, speed grade and structure type (diagonal tyre, bias belted tyre or braced-tread tyre) of the replaced tyre are the same as that of the original tyre.

Notes

Intermix using tyre may cause the vehicle out of control when driving. If you intermix using the tyre of different size or model (braced-tread tyre and bias belted tyre), you will not control the vehicle normally, and may cause accident. The vehicle will be damaged for using the tyre of different size. Therefore, the same size and model tyre must be used for all the wheels.

Wheel alignment and tyre balance

To prolong the service life of the tyre as much as possible and provide the best integral performance, the wheel alignment and tyre balance are conducted before leaving the factory. There is no need for regular adjustment of the wheel alignment and tyre balance. However, if found any abnormal abrasion of the tyre or off tracking of the vehicle, inspect the wheel alignment. If driven on the flat road and the vehicle takes on bumping, you need balance the tyre and wheel again.

Replacement of wheel

Replace the wheel which is bent, cracked, seriously rusty or corrosion. If the wheel nut is loosening frequently, replace the wheel, wheel bolt or wheel

nut. If the wheel leaks gas, replace it (expert some aluminium wheel that can be repaired).

The load capacity, diameter, width and offsetting as well as the installation method of the new wheel should be the same as that of the original wheel.

If the wheel, wheel bolt or wheel nut need to be replaced, use the original new components only. Thus, it can ensure that the wheel, wheel bolt or wheel nut are matched with your vehicle.

Notes

It is dangerous to use unsuitable wheel, wheel bolt or wheel nut, which will influence the brake and drivability of the vehicle. It will make the tyre leak gas and lead to out of control of the vehicle,

which may cause accident and hurt yourself and others. So, remember to use proper wheel, wheel bolt or wheel nut.

Notes

Using wrong wheel may cause problems in such respects as service life of bearing, brake cooling, car speed meter or odometer verifying, headlamp focusing, bumper height, ground clearance of the vehicle, clearance between the tyre and the body and bottom plate, etc.

For the details, see the “flat tyre replacement” for the treatment in an emergency.

Appearance curing

Be sure to conform to the warning and instruction of the manufacturer on the container when cleaning the vehicle with cleaning articles. Make sure that the vehicle door or window is open when cleaning the inside of the vehicle.

Do not use the following articles to clean the vehicle:

- ※ Petrol
- ※ Benzene
- ※ Naphtha
- ※ Carbon tetrachloride
- ※ Acetone
- ※ Coating thinner
- ※ Oil of turpentine
- ※ Paint thinner
- ※ Nail polish remover

Notes

The cleaning articles have harmfulness. Some are poisonous. Moreover, some cleaning articles may burn if there is fire near them or heat parts contact them. It is dangerous to absorb the smoke and dust in the close space.

These articles are all harmful. Some are more harmful than others, but all of them can damage the vehicle. Therefore, unless the manual indicates, do not use the above mentioned cleaning articles. In many circumstances, the following articles may damage the vehicle:

- ※ Alcohol
- ※ Washing soap
- ※ Bleaching powder
- ※ Reducing agent

Textile/carpet

Frequently remove dust and scum with vacuum cleaner. Wipe the polyethylene resin surface, leathering and painting surface with clean wet cloth.

You can get the authorized cleaning articles from the Special After-sale Service Center of Jianghuai Automobile Co., Ltd.

Friendly tips

The following several hints are for cleaning:

- ※ Be sure to read the instructions on the label of the detergent.
- ※ Clean the stain as soon as possible before they solidified.
- ※ Scrape excessive stain carefully.
- ※ Use clean cloth or sponge and change the clean places of the cloth or sponge for cleaning. Use soft brush to clean the serious stain.
- ※ To avoid leaving ring trace after removing stain, clean the whole area at once, otherwise, the ring trace will not be removed.

Most stain can be removed by soda water. Conform to the following instructions when cleaning:

1. Liquid stain: remove stain with clean and soft white cloth. Solid stain: remove them as soon as possible and then clear off with cleaner or soft brush.
2. Dip soda water on the clean and soft white cloth. Do not saturate too much, the soft cloth should not have dropping waters.
3. Clean the entire area. Avoid making the textile too wet.
4. Begin cleaning from the seam to the stain and avoid leaving ring trace.
5. If the cloth is dirty, change to use its other clean parts.

After removing the stain, soak up the water in cleaning place with another clean and soft white dry cloth.

Cleaning textile with detergent

1. First of all, try to clean the place on the textile that it is not easy to be seen, and make sure that the cleaning will not influence the color of the textile.
2. Liquid stain: remove stain with clean and soft white cloth. Solid stain: remove them as soon as possible and then clear off with cleaner or soft brush.
3. Spray little detergent on the clean and soft white cloth. Do not directly spray the detergent on the textile.
4. Begin cleaning from the seam to the stain and avoid leaving ring trace.
5. If the cloth is dirty, change to use its other clean parts.
6. After removing the stain, soak up the water in cleaning place with another clean and soft white dry cloth. If there is ring trace of detergent left,

continue cleaning according to the instruction about soda water in the former text of this section.

Special cleaning problem of textile

The stain caused by such things as tomato paste, coffee, eggs, fruit, fruit juice, mild, soft drinks, vomit, urine or blood can be removed according to the instruction about using soda water in the former text of this section. If there is still abnormal smell after cleaning the vomit or urine, clean the area with soda water. The preparation proportion is a soup spoon (5ml) of soda to a cup (250ml) of mild water. Dry it after cleaning. The stain caused by oil and grease can be removed by the detergent authorized by Jianghuai Automobile Co., Ltd. with clean white cloth.

1. Scrape the excessive stain carefully.
2. Clean with cold water and ensure complete drying.
3. If the stain is not removed, clean according to the instruction of the above mentioned "Cleaning textile with detergent".

Leather cleaning

Remove them with soft cloth dipped into mild water and neutral soap or leathering soap, and dry with soft cloth. Let it dry naturally and do not oven drying.

- ※ Use leather detergent if there are serious stains.
- ※ Prohibit using oil, paint, solvent based detergent or abrasive detergent, furniture oil polish or shoeshine on leather.
- ※ Clean the leather at once when it is dirty. If the stain is permeated into the inner of the leather surface, it may damage the leather.

Cleaning console

Clean the upper surface of the console with neutral soap and water only. The spray including Si and paraffin will make the front windscreen have annoying glint. In some conditions, it may seriously influence the view permeability of front windscreen.

Cleaning inner plastic parts

Clean those only with soft cloth or sponge dipped into the neutral soapy water. Commercial detergent may influence the surface brightness.

Cleaning glass surface

| Notes |
|---|
| If clean the glass surface of the vehicle with abrasive detergent, it will scuff the glass. So when cleaning the glass, only uses soft cloth and glass detergent. |

Clean glass frequently. Clean the tobacco soot and dust left on the glass surface in the vehicle with authorized detergent supplied by Special After - sale Service Center of Jianghuai Automobile Co., Ltd. or household liquid glass washer. Refer to “appearance curing” of this section.

Cleaning sealing strip of door and window

Si grease can increase the durability and sealing performance of the sealing strip of the door and window, and avoid clamping or creak. Paint Si grease on the sealing strip with clean cloth. Paint Si grease more frequently if the whether is cold and wet.

Cleaning the vehicle

The best way to maintain the vehicle finishing coat is that washes it regularly and keeps it clean.

Park the vehicle in the place without direct sunlight.

Clean the vehicle with designated neutral soap lye or mild water.

Be sure to clean the soap lye and detergent on the surface.

| Notes |
|--|
| <ul style="list-style-type: none"> ● Prohibit cleaning the vehicle with household dish washing detergent. The lacquer wax can be removed by the dish washing detergent. ● Avoid high pressure when washing the vehicle, because water can enter the vehicle and damage the inner of the vehicle. |

| |
|--|
| <ul style="list-style-type: none"> ● Prohibit washing the engine hatch, especially for the light fittings with high pressure squirt gun to. Because of high pressure of the squirt gun, the accessories on the light fittings will loosen and drop off, and such parts as ventilating hole and wire harness plug -in will be affected with damp, which will result in water entering and accumulation of the moisture, and produce serious fog. |
|--|

The vehicle of JAC is manufactured to be operated under normal environment conditions and natural factors.

Polishing and waxing

Regularly polishing can clean the residue on the surface of the vehicle. Protect the vehicle with good quality of wax after polishing.

Protect the bright metal parts outside the vehicle.

Regularly clean the bright metal decoration parts. Normally, wash with water.

| Notes |
|--|
| Prohibit cleaning or polishing the aluminium decoration parts with automobile or chroming polishing agent, steam or alkaline soap lye. These materials have abrad ability which can damage decoration parts and wheel. |

When waxing for the vehicle, do not forget to wax the bright metal parts.

Clean aluminium wheel and its decoration cover

To maintain the original appearance of the wheel and its decoration cover, keep off the dust or brake mill dust on them. Regularly clean the wheel/wheel decoration cover.

| Notes |
|---|
| Prohibit cleaning aluminium wheel or its decoration cover with abrasive detergent or bursh. |

Prevention of corrosion

The vehicle of JAC has the ability of corrosion prevention. Special materials and protective paint are used for most automobile components, which is good for the appearance, its strength and reliability.

Although the surface of some parts in engine room or at the bottom of the vehicle body will be rusty, it will not influence their reliability or function.

Damage of sheet-metal parts

Make sure that suitable anti-rot materials are used by repair factory to recover corrosion prevention performance, if the vehicle body needs repair or replace. The replacing parts of original factory can ensure its corrosion prevention performance and guarantee.

Foreign matter deposit

The following materials may damage the surface of the paint:

- ※ Lime chloride and other salt.
- ※ De-icing agent.
- ※ Pavement oil and asphalt.
- ※ Sap.
- ※ Bird manure.
- ※ Industrial dust.

Clean the harmful materials on the vehicle in time. If the residue cannot be removed by soap water, use special detergent.

Notes

Use safety detergent which is not harmful to the surface of the paint. Other detergent may permanently damage the paint.

Damage of paint surface

The pit, crack or deep scratch impacted by stone should be repaired at once, for bare metal can be eroded soon. The fee for after corrosion maintenance is expensive.

Little pit or scratch can be repaired with the patching materials provided by the Special After-sale Service Center of Jianghuai Automobile Co., Ltd. The damage with bigger area can be maintained in the vehicle body and painting workshop of the Special After-sale Service Center of Jianghuai Automobile Co., Ltd.

Body chassis maintenance

Deicing agent, thawing agent and dust preventive may be collected in the bottom of the body. If those are not removed, the parts in the bottom of the body such as fuel pipe, frame, floor board and exhaust system will be eroded or corroded because of rust, even they have corrosion prevention performance.

The above mentioned foreign matter should be removed from the bottom of the body with water at least in every spring. Clean all the parts collected with earth dirt. Loosen the dirt near the frame area with shovel before washing. The body bottom cleaning work can be conducted by body bottom cleaning device or you can have it cleaned in the Special After-sale Service Center of Jianghuai Automobile Co., Ltd.

Notes

When washing the engine room, the sediments of fuel, lubricating grease and oil may be washed into the environment. Wash the engine in the Special After-sale Service Center of Jianghuai Automobile Co., Ltd. or other places that has oil separating equipment. Dispose the old engine oil, brake fluid, gearbox oil fluid, anti-freezing solution, storage battery and tyre in the waste disposal agency regulated by the local law or dispose them by the dealer who has legal disposal obligation when replacing these materials. Prohibit mixing these materials in the household garbage or pouring into sewer.

If these materials are disposed improperly, they will permanently damage the environment.

Maintenance plan

Introduction

General introduction

This section has introduced the maintenance plans of the vehicle. These plans are necessary for assuring your vehicle can supply satisfied drivability for you.

You have the responsibility to follow the correct operation which is explained by this manual and maintain your vehicle. Otherwise, it is possible to cause refusing guarantee.

You have the responsibility to maintain and operate your vehicle correctly. You should assure to follow the periodical appointed maintenance plan and the general operating introduction as regulated in this manual.

You also have the responsibility to keep all kinds of records and receipt invoices and treat them as the evidence of the

periodical maintenance. When transferring your vehicle, you should hand over these records, invoices together with the vehicle owner manual to the next owner. Jianghuai Automobile Co., Ltd. has only authorized Special After-sale Service Center of Jianghuai Automobile Co., Ltd. as the distributive station of Jianghuai automobile pure mountings. Jianghuai Automobile Co., Ltd. has not appointed, authorized or consigned any the third party to act as an agent or distribute its pure mountings, and it will take no responsibility of the results caused by that. At the same time, the direct or indirect malfunction or breakage caused by using the non-pure mountings which is not of Jianghuai Automobile Co., Ltd., are not included in the scope of quality guarantee.

The spare parts and accessories, which are not produced by Jianghuai Automobile Co., Ltd., are not passed the check and the approval of Jianghuai Automobile Co., Ltd. Jianghuai Automobile Co., Ltd. can not check their applicability and also can not check their safety. Therefore, Jianghuai Automobile Co., Ltd. will not take any responsibility for the breakage caused by using these kinds of spare parts. Unsuitable, incompletely and insufficient maintenances will cause the operation problems of your vehicle. Those causes will lead to breakage of vehicle, accident or personal injury.

Maintenance requirements

The maintenance interval, inspection items and the recommended oil and lubricant oil, which are regulated in this manual, are the necessary condition of assuring the vehicle in good condition. Any loss caused by not following maintenance plan will not be included in the scope of guarantee.

Operation condition

Firstly, you should confirm that which is applicable for your vehicle in the following two plans. The method of confirming maintenance plan is as follows:

General definition of the driving condition

The normal driving condition is driving under condition of daily driving. You can obey the general maintenance plan.

Severe condition

If the vehicle works under any kind of the following condition, some items in the maintenance plan shall be carried out more frequently, see the data in the "Periodical technical maintenance" of the latter part of this section.

※ Frequent driving within the short distance which is less than 10km and the Long time and high speed (over

170km/h) driving.

※ Under the condition of start-and-stop, driving in idle speed or low speed is usually used.

※ Running on the road which is full of dust.

※ Running on the hills, sandlot or mountainous ground.

※ Always towing vehicle

※ Running under condition of the busy traffic in the city. The temperature out of the vehicle is always up to 30°C or more.

※ To be treated as taxi, police vehicle or transfer vehicle.

※ Always running outside, and the outdoor temperature is lower than 0°C.

Maintenance in general driving condition:

Mark instruction: ●=Inspect, adjust or clean if necessary, replace; ▲=replace; T=screw tightly to regulated torque. (Remarks: for number of mileage or month, take the one firstly reached as the standard.)

| Interval Item | Mileage (km) ×1000 month | 5 | 10 | 20 | 30 | 40 | 50 | 60 | 70 | 80 | 90 | 100 |
|--|--|---|----|----|----|----|----|----|----|----|----|-----|
| | | 3 | 6 | 12 | 18 | 24 | 30 | 36 | 42 | 48 | 54 | 60 |
| Oil, lubricating oil filter | Replace when driving for every 5,000km or 6 months. | | | | | | | | | | | |
| Filter element of air filter | Clean when driving for every 5,000km, and replace for every 15,000km | | | | | | | | | | | |
| Air conditioning warm air system | ● | | ● | | ● | | ● | | ● | | ● | |
| Coolant | ● | ● | ● | ● | ▲ | ● | ● | ● | ▲ | ● | ● | |
| Cooling system hose and clamping band | | | | | ● | | | | ● | | | |
| Ventilating hose and joint | ● | | ● | | ● | | ● | | ● | | ● | |
| Crankshaft case ventilating control system | | | | | ● | | | | ● | | | |
| Fuel filter | | ▲ | | ▲ | | ▲ | | ▲ | | ▲ | | |
| Exhaust pipe and installation seat | ● | ● | | ● | | ● | | ● | | ● | | |
| Ignition plug | | | | ▲ | | | ▲ | | | ▲ | | |
| Ignition timing | | | | | ● | | | | ● | | | |
| First-class toothed belt | ● | ● | ● | ● | ● | ● | ● | ● | ▲ | ● | ● | ● |
| Second-class toothed belt | ● | ● | ● | ● | ● | ● | ● | ● | ▲ | ● | ● | ● |

Maintenance in general driving condition (continued)

Mark instruction: ●=Inspect, adjust or clean if necessary, replace; ▲=replace; T=screw tightly to regulated torque.

| Interval Item | Number of mileage or month (take the one firstly reached as the standard) | 5 | 10 | 20 | 30 | 40 | 50 | 60 | 70 | 80 | 90 | 100 |
|------------------|---|---|----|----|----|----|----|----|----|----|----|-----|
| | | 3 | 6 | 12 | 18 | 24 | 30 | 36 | 42 | 48 | 54 | 60 |
| Chassis and body | Free travel of clutch pedal | ● | ● | ● | ● | ● | ● | ● | ● | ● | ● | ● |
| | Free travel of brake pedal and brake | ● | ● | ● | | ● | | ● | | ● | | ● |
| | Brake friction block and brake disk | ● | ● | ● | ● | ● | ● | ● | ● | ● | ● | ● |
| | Brake fluid and hose | ● | ● | ● | ● | ▲ | ● | ● | ● | ▲ | ● | ● |
| | Steering wheel and gearbox | ● | | ● | | ● | | ● | | ● | | ● |
| | Four-wheel alignment | ● | ● | ● | ● | ● | ● | ● | ● | ● | ● | ● |
| | Ball pin and dust boot | ● | ● | ● | ● | ● | ● | ● | ● | ● | ● | ● |
| | Oil of gearbox and differential | ● | | ● | | ▲ | | ● | | ▲ | | ● |
| | Front and rear suspension | ● | | ● | | ● | | ● | | ● | | ● |
| | Bolt and nut of chassis and body | T | T | T | | T | | T | | T | | T |
| | Tyre and inflation pressure | ● | ● | ● | | ● | | ● | | ● | | ● |
| | Power steering oil | ● | ● | ● | ▲ | ● | ● | ● | ● | ▲ | ● | ● |
| | Air conditioning /cold air | ● | ● | ● | | ● | | ● | | ● | | ● |



Additional maintenance of driving in severe condition:

Mark instruction: ●=Inspect, adjust or clean if necessary, replace; ▲=replace; T=items that are screwed tightly to regulated torque.

| Interval | Number of mileage or month (take the one firstly reached as the standard) | | | | | | | | | | | | |
|--------------|---|---|----|----|----|----|----|----|----|----|----|-----|---|
| | Mileage (km) ×1000 month | 5 | 10 | 20 | 30 | 40 | 50 | 60 | 70 | 80 | 90 | 100 | |
| | | 3 | 6 | 12 | 18 | 24 | 30 | 36 | 42 | 48 | 54 | 60 | |
| Engine | Transmission belt | Inspect and adjust when driving for every 10,000km, replace when necessary. | | | | | | | | | | | |
| | Oil, lubricating oil filter | Replace when driving for every 3,000km or 3 months. | | | | | | | | | | | |
| | Filter element of air filter | Clean for 3000km, and replace for 10000km. | | | | | | | | | | | |
| | Ventilating hose and joint | | ● | | ● | | ● | | ● | | ● | | |
| | Ignition plug | | | ▲ | | ▲ | | ▲ | | ▲ | | ▲ | |
| | Idle speed | ● | | ● | | ▲ | | ● | | ▲ | | ● | |
| Chassis body | Free travel of clutch pedal | Adjust for every 5,000km | | | | | | | | | | | |
| | Tyre and inflation pressure | ● | ● | ● | ● | ● | ● | ● | ● | ● | ● | ● | ● |
| | Dust filter screen | ● | ● | ▲ | ● | ▲ | ● | ▲ | ● | ▲ | ● | ▲ | |
| | Front wheel alignment | ● | ● | ▲ | ● | ▲ | ● | ▲ | ● | ▲ | ● | ▲ | ▲ |
| | Gearbox oil | ● | ● | ● | ▲ | ● | ● | ▲ | ● | ● | ▲ | ● | ● |

Mark instruction: ●=Inspect, adjust or clean if necessary, replace; ▲=replace; T=items that are screwed tightly to regulated torque.

* No matter the maintenance plan is in general condition or difficult condition, if torque value is less than the regulated value, the glue coated bolt and nut in the body and chassis must be replaced or painted with regulated screw fastening glue after removing, and then screw tightly according to the regulated torque value.

Chapter VIII Knowledge on Safe Driving

| | | | |
|--|------|---|------|
| Safety belt | 8-02 | Change the parts and components of the protection system after collisions | 8-26 |
| Why the safety belt works | 8-02 | Drive cautiously | 8-27 |
| Question and answer for the general knowledge of safety belt | 8-04 | Drive on the wet-skidding road in rainy days | 8-36 |
| How to wear the safety belt correctly | 8-05 | Hydroplaning | 8-37 |
| Driver's seat | 8-05 | Drive across the deep-water area | 8-38 |
| Hip-type/ shoulder-type safety belt | 8-06 | Drive across the running water | 8-38 |
| Protection device for the children | 8-13 | Other hints about the drive in rainy days | 8-39 |
| Airbag system | 8-18 | Drive in the urban area | 8-39 |
| Check of the protection system | 8-26 | | |

Safety belt

Everybody shall wear the safety belt. This section will introduce how to use the safety belt correctly. Some behaviors which are forbidden to carry out for safety belt will also be introduced.

Notes

Anyone sitting on the seat, of which the safety belt cannot be used normally, is forbidden.

If you meet the collision without fastening the safety belt, the injury will be more serious. You may hit on the interior things of the vehicle or you may flick from those things and the serious injury and death accident will be caused because of that. If the safety belt is fastened, you will be safe and well in the same accident. Therefore, you shall not

only fasten the safety belt for yourself at all time, but also check whether the passengers' safety belts are fastened or not. You can not anticipate whether the collision accident will happen or not. Although the collision accident has happened, you still can not anticipate the seriousness of the consequence of the accident.

In many similar collision accidents, the passenger who fastened safety belt can survive and some passengers even can escape from the scene by walk. If they didn't fasten safety belt, they may suffer very serious injury and death.

Over 30 years' use experience of the safety belt in the car has showed clearly that: In the most collision accidents, whether fasten the safety belt will indeed bring very different consequence.

Why the safety belt works

When you are riding in or on some objects, your moving speed will be same as that of the objects. Take the

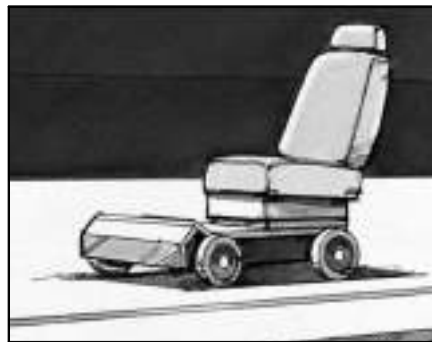

simple vehicles for example. Put the case that a vehicle is just a seat which supports by the wheels.

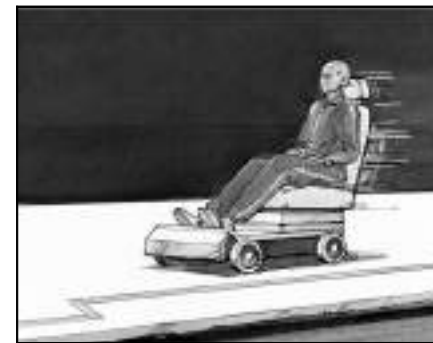

Let somebody sit on the seat.

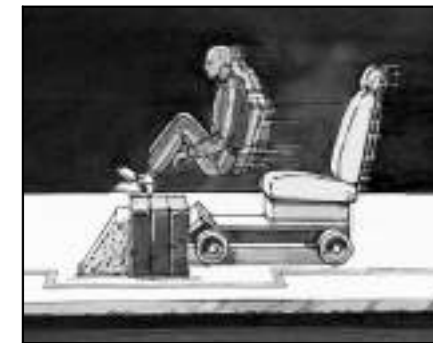

Speed up the vehicle and then stop. The person on the vehicle will not stop.



The person will keep moving forward till stopped by some objects. In the actual vehicle, the object may be the front windscreen.



May be the instrument panel



May be the safety belt

Question and answer for the general knowledge of safety belt

Question: If I fasten the safety belt, whether I will be trapped in the vehicle when collision happens?

Answer: It is possible. - whether you have fastened the safety belt or not. You can untie the safety belt (even your pose is handstand). Moreover, if you have fastened the safety belt, it is more possible for you to keep clear consciousness in the accident and you are able to untie the safety belt and get off the car safely.

If you have safety belt, you will slow down together with the vehicle. So you will have longer cushioning time before stopping. You will also have longer cushioning distance before stopping. Moreover, the impulse force will be sustained by the most firm skeleton in your body. This is the reason why the function of the safety belt is so important.

Question: If my vehicle has been mounted airbags, why the safety belt is still needed?

Answer: Nowadays, many vehicles have been mounted airbags. But the airbag is only the auxiliary protecting system; so the airbag only works in conjunction with the safety belt, rather than taking the place of the safety belt. Until now, all the airbags sold in the market are required to be used together with safety belt. Although you are riding in the car which has been mounted airbags, you still need fasten safety belt for acquiring the maximum protect. We should do like that not only in the head-on collision, but also and especially in the side or other collisions.

Question: If I am a very good driver and I never drive the vehicle far away from my home, why I still need fasten the safety belt?

Answer: You may be a very good driver, but if you meet traffic accident (although it is not caused by you), you and your passengers will be injured. An excellent driver can not make himself escape from the injury which is out of the scope of his control.

Most of the traffic accidents happen within 40 kilometers away from their homes. And the occurrences of the serious accident under the speed of 65km/h head the list.

Therefore, everyone should wear safety belt.

How to wear the safety belt correctly

The content of this part is only applicable for the passengers which have adult stature.

Please note that: About safety belt and children, some special requirements shall be known. As for the younger infant, there are additional requirements. If you want to carry children passenger, please see the part of "the elder children" and "the infant" in this section.

Firstly, you may want to know what protecting system your vehicle has.

We will begin our introduction from the driver's seat.

Driver's seat

The protecting system of driver is introduced as follows.

Hip-type/ shoulder-type safety belt

A strip of hip -type/ shoulder -type safety belt has been provided for the driver. The correct fastening method of safety belt is as follows.

1. Close and lock the car door.
2. Adjust the seat till you can straighten your body up. Fro the details see the part of "Seat".



3. Take up the lock plate, pull the safety belt over your body and not make the safety belt twist.

If you pull the shoulder belt too fast, the shoulder belt may be locked. If like that, you can let the shoulder belt retract for opening the lock of the shoulder belt, and then pull slowly the shoulder belt over the body.

4. Press the lock plate into the lock catch until the "click" sound is heard. Pull the lock plate for assuring it is locked.

Check the position of the release button on the lock catch, for making sure that the release button can be press conveniently when it is needed.



5. When pulling the shoulder belt up, pulling down the lock catch end of the hip belt, then the hip belt part can be tightened.

6. Press the snap ring, then the safety belt can be loosened. The safety belt will automatically contract back.

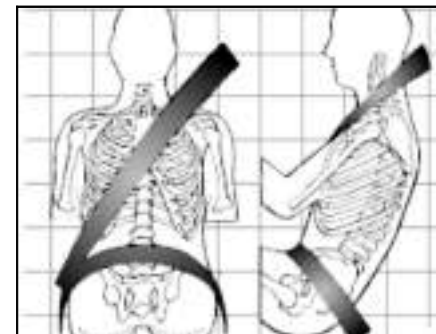

The position of the hip belt part should be downward as much as possible and stick closely to the rump; it should just contact the thigh, in such a case, the acting force will be applied onto the firm pelvis when collision accident happens. Besides, the possibility of the slide under the hip belt can also be reduced. If you slide under the hip belt, the hip belt will put force to your abdomen, which may

cause severe even fatal injury. The hip belt should cross over the shoulder belt and stride the chest. The above mentioned parts of the body can best bear the restraining force of the safety belt. If emergent brake or collision of the vehicle happens, or if you pull out the safety belt too fast from the retractor, the safety belt will automatically be locked.

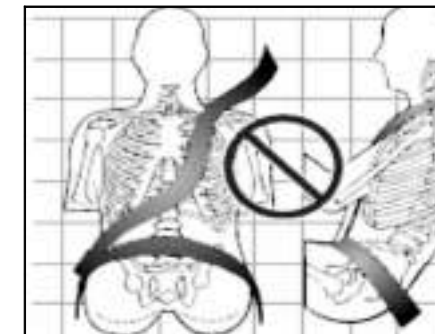

Question: Is there anything wrong?

Answer: the shoulder belt is too loose, in such a case, the protection provided by the shoulder belt is slight.

Notes

If the shoulder belt is too loose, you may be injured seriously. When collision happens, your body may rush forward excessively, in order to relieve the injury, the shoulder belt should be stick closely to the body.

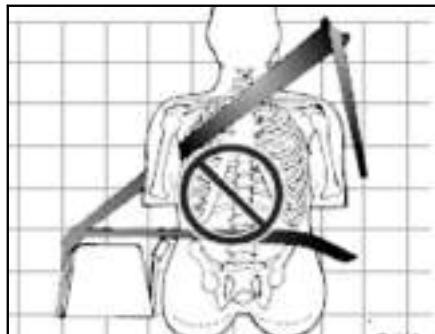

Question: Is there anything wrong?

Answer: The tightening position of the safety belt is wrong.

Notes

If tighten the safety belt to the wrong position as the figure shows, you may be injured seriously. The hip will slide above your abdomen in the collision process. The acting force of the hip still exists, but it does not act on your pelvis, which may cause severe internal injury. The safety belt must be tightened into the lock catch nearest to your body.

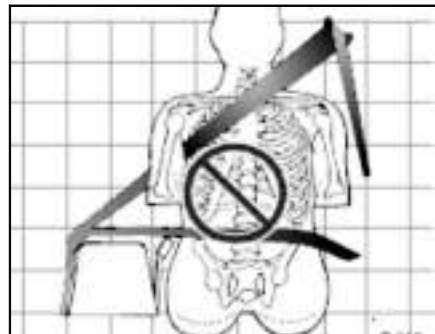

Question: Is there anything wrong?

Answer: The shoulder belt strides under the shoulder, the shoulder belt should be worn above the shoulder all the time.

Notes

If the shoulder belt is placed under the shoulder, you may be injured seriously. When the collision accident happens, your body will rush forward excessively, which will increase the possibility of the injury on the head and neck. Besides, the safety belt will put excessive acting force on the rib, while the rib is not such firm as the skeleton of the shoulder. And your viscus, such as the liver and spleen, may be injured.

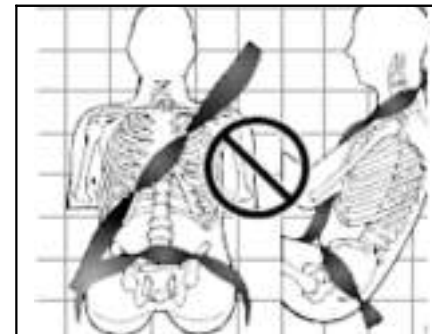

Ask: Is there anything wrong?

Answer: Twist appears when the safety belt strides the body.

Notes

The twisted safety belt may cause severe injury. When the collision accident happens, the impact force can not be spread to the whole width of the safety belt. If there is twist of safety belt, the safety belt should be placed flat and vertical, so it can work normally. Or require Special After-sale Service Center of Jianghuai Automobile Co., Ltd. to repair.

Height adjustment of the shoulder belt

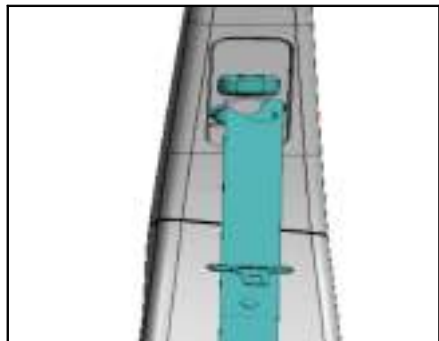

Before you drive the vehicle, move the adjuster of the shoulder belt to the proper height. Adjust the height to have the shoulder belt part be in the middle of your shoulder. The shoulder belt should be away from your face and neck but can not slide under the shoulder. Lower the shoulder belt, press down the

release button and move the height controller to the expected position.

When the height controller is moved in place, loosen the release button, and try moving down the height controller in order to check whether the height controller has been locked in place.

Safety belt use during the gravidity process



The safety belt is useful for all the people, including the gravida. Like all the passengers, if gravida does not wear the safety belt, she is more likely to be injured seriously.

During the whole gravidity process, the gravida should wear the hip-type/shoulder-type safety belt, and the hip belt

part should be worn lower as possible as it can under the salient abdomen.

The best approach to protect the embryo is to protect the mother. When the safety belt is worn correctly, the injury probability of the embryo in the collision accident will be reduced. For the gravida (the same as the other people), the key to have the safety belt function is to wear the safety belt correctly.

The position of the right front passenger In order to know how to wear the safety belt of the right front passenger correctly, please refer to "Driver Position" in this section. The operating principle of the safety belt of the right front passenger seat is the same as that of the driver safety belt.

The safety belt use of the rear seat passenger

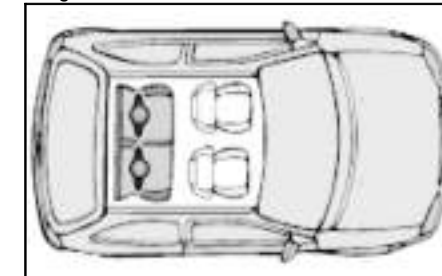

The rear seat passenger must fasten the safety belt.

The accident statistics shows, the rear seat passengers not wearing the safety belt are much easier to be injured than those wearing the safety belt.

In the traffic accidents, the rear seat passengers not wearing the safety belt may be thrown out of the vehicle. They may also collide with the passengers wearing the safety belt.

The safety belt use of the rear seat external side passenger



1. Take the hasp to have the safety belt move around your body, but the safety belt can not be twisted.
2. Insert the hasp into the snap ring until the click sound is heard.
3. Ensure that the release button is upward or outward so as to untie the safety

belt when necessary. Pull the shoulder belt upward and pull the hip belt tightly.
4. If you want to untie the safety belt, press the snap ring, and then safety belt will automatically draw back.

The safety belt use of the rear middle seat passenger



The passengers sitting in the middle seats should fasten the safety belt.
Pull the hasp along the safety belt if you want to adjust the length of the safety belt.

1. Insert the hasp of the front end into the snap ring at the right side of your body, and take the middle hasp to have the

safety belt move around your body, but the safety belt can not be twisted. Insert the hasp into the snap ring of the other end.
2. If you want to untie the safety belt, press the red button on the snap ring.

Pre-tensioner of the safety belt
Your vehicle has been equipped with the pre-tensioner of the safety belt used for the driver and the right front seat passenger. When moderate or severe head-on collision accident happens to the vehicle, the pre-tensioners of the safety belt will reduce the forward impulse of the body of the wearers.
The pre-tensioner can only work once. If the pre-tensioner is activated in the collision, then it must be replaced by a new pre-tensioner. Moreover, it is likely to replace the other parts of the safety belt. Refer to "Change the Parts and Components of the Protection System after Collisions" in this section.

Protection device for the children
Children senior in age



If the children grow up to the extent that they do not need children seat any more, they should wear the safety belt on the vehicle.

Question: how to wear the safety belt correctly?

Answer: If possible, the children senior in age should wear hip -type/shoulder -type safety belt so as to use the additional protection provided by the shoulder belt. The shoulder belt can not cross over the face and neck. Hip belt should stick closely to the rump and contact the upper part of the thigh. The hip belt can not be worn at the abdomen, otherwise, there will be severe even fatal internal injury when collision happens.

Accident statistics shows: The children are much safer when fixed on the rear seat.

When collision happens, the children who are not fixed will collide with those people wearing the safety belt or will be thrown out of the vehicle. It is necessary for the children senior in age to use the safety belt correctly.



Notes

Do not use the safety belt like this. As the figure shows, two children are wearing the same safety belt, in such a case, it can not scatter the impulse correctly. When collision happens, the two children will collide with each other and get injured seriously. Thus, the safety belt can only be used by a person at one time.

Question: If a child wears the hip -type/shoulder -type safety belt for the adults, while the safety belt is close to the face and neck for the child is too small, how to deal with it?

Answer: If the child sits in the seat close to the window, move him/her to the middle position of the vehicle. If the child sits in middle of the passenger seat, move him/her to the position close to the lock catch of the safety belt. On any occasion of the above, ensure that the shoulder belt is still striding on the shoulder of the child, so the upper half body of the child can be fixed by the safety belt when collision happens.



Notes

Do not use the safety belt like this. As the figure shows, the child is sitting in the seat with hip -type/shoulder -type safety belt, but the shoulder belt lies at the back of the child. Wearing the safety belt like this, the child will slide under the safety belt when collision happens.

The acting force of the safety belt will be put on the abdomen of the child, which may cause severe casualty.

When the child rides the vehicle, the position of the hip belt should get close to and stick to the rump as possible as it can, and just contact the thigh.

In such a case, the acting force of the safety belt will be put on the pelvis of the child when collision happens.

Infants and pre-school children

Everyone in the vehicle needs protection, including the infants and pre-school children. No matter whether the journey is long or short, no matter whether the travelers are young or elder in age or slim or big in their shape, it is necessary for everyone to use the safety protection device.

Each time when the infants and pre-school children ride the vehicle, they should be protected by adopting proper protection device for children. The pre-school children should not use the safety belt for the adults in the vehicle, except that there is no other choice.



Notes

The infants can not be embraced when riding the vehicle. The weight of the infants is very light, but the state will be changed when collision happens. When collision accident happens, the infants will be too heavy to be embraced well. For example, collisions happen when the vehicle is running at the speed of 40km/h, an infant of 5.5kilogram will suddenly put the acting force of 110kilogram on the shoulder of the embracer. Therefore, the infants should be fixed in the protection device.



Notes

If the children get close to the airbag or the distance from the airbag is too short, severe casualty may happen to the children when the airbag is charged with air. The airbag and the safety belt can provide protection for the adults or the children senior in age, but for the infants and pre-school children, the situation will be changed. The safety belt system and airbag system in the vehicle are not designed for protecting the infants. The required protection for infants and pre-school children can be provided by the protection device for the children.

Protection device for the children (not provided with the vehicle)



Please read Instruction Book of the Protection Device for the Children carefully. These protection devices can make use of the safety belt system in the vehicle so as to reduce the chance of being injured. Instruction Book of the Protection Device for the Children introduces how to use these devices correctly.

Airbag system



Your vehicle has been equipped with two airbags, one is the frontal airbag for the driver, and the other one is the frontal airbag for the right front passenger.

The following is the most important points for attention about the airbag system:

Notes

If the safety belt is not worn correctly (even though the airbag is equipped), there may be severe casualty when accident happens. Wearing the safety belt in the collision accident is beneficial to reduce the possibility of the object flick in the vehicle or the object flick from the vehicle. The airbag is designed for work by cooperating with the safety belt but not for replacing the safety belt.

The frontal airbag for the driver and the right front passenger are designed for the moderate and severe head-on collision or the almost head-on collision. These airbags are not designed for the car turnover, rear collision or head-on

collision at a low speed and many side collisions. Moreover, for some passengers who are not wearing the safety belt, when the head-on collision happens, the protection function provided by the frontal airbag is less than that provided by the former stronger airbag. All the people in the vehicle should wear the safety belt, no matter whether the airbag has been equipped.

Notes

Charging air for the frontal airbag needs great acting force, whose speed is faster than that of wink. You may get injured seriously if you are too close to (for example, when you bend down forward) the airbag being charged with the air. Before the collision accident happens and in the whole process, the safety belt can fix you on the seat so as to charge air for the airbag. Even though the airbag is equipped, you still must wear the safety belt. On the precondition of keeping the vehicle control, the driver should sit backward as possible as he can. The front door passenger can not sleep by leaning on the door or abutting on the door.

Notes

If the passenger get close to the airbag or the distance from the airbag is too short, severe casualty may happen when the airbag is charged with air. The airbag and the safety belt can provide the best protection for the adults or the children senior in age, but for the infants and pre-school children, the situation will be changed. The safety belt system and airbag system in the vehicle are not designed for protecting the infants. The required protection for infants and pre-school children can be provided by the protection device for the children. The children must be fixed in the vehicle correctly. For the detailed

method, refer to "Children Senior in Age" and "Infants and Pre-school Children" in this section.



There are two airbag ready indicator lights on the combined device of the console, the airbag signs display on the lights.

The system will check whether there is fault in the airbag system. For the detailers, see "Airbag Ready Indicator Light" in Section III.

Where is the airbag?



The driver airbag locates on the center of the steering wheel.



The right front passenger airbag locates on the passenger console.

Notes

If barrier exists between the passenger and the airbag, the airbag can not be charged with the air normally or the airbag may squeeze the barrier into the body of the passenger, which will cause severe casualty. There must be no barrier in the air-charging pathway of the airbag. Fixing or placing any object on the steering wheel or on any other airbag cover or around them is forbidden. The seat cover can not block the air-charging pathway of the side collision airbag.

When to charge air for the airbag?

The driver and right front passenger airbags are used to charge air in the moderate and severe head-on collision accident or that nearly close to the head-on collision accident. But only when the impulse force exceeds the preset value of the charge valve, these airbags can be charged with the air. Conditions needing air-charging and conditions not needing air-charging have been taken into account in the value of the charge valve. Moreover, the value can be used to predict the severe extent of the collision in time, and it is beneficial to charge air for the airbag and protect the passenger. Whether the frontal airbag will be charged with the air or whether the frontal airbag should be charged with the air does not de-

pend on the running speed of the vehicle, but depends on the collision objects, the collision direction and the speed of the vehicle deceleration. If the front part of the vehicle straightly collides into a wall, while the wall surface is not moved or distorted, the speed needs to reach 14-23km/h when charging air.

The airbag can be charged with the air in each different collision, for example:

※ If the vehicle collides with some static objects, compared with the condition of the removing objects, the collision speed in the air-charging instant is different.

※ If the object is distorted, compared with those that are not distorted, the collision speed in the air-charging instant of the airbag is also different.

※ If the vehicle collides with some long and narrow objects (such as the wire pole), compared with those broader and bigger objects (such as the wall surface), the collision speed in the air-charging instant of the airbag is also different.

※ If the vehicle collides into certain object from a certain angle, compared

with straight collision with the object, the collision speed in the air-charging instant of the airbag is also different.

The driver and right front passenger airbags should not be charged with the air when car turnover, rear collision or many side collisions happen, for air-charging in this time is not beneficial to the passenger.

During any specific collision process, anyone should not assert the airbag needs charging air just according to the damage extent of the vehicle or the repair cost of the vehicle. For the frontal airbag, air-charging depends on the collision angle in the process of the head-on collision and that nearly close to the head-on collision, and the speed of the vehicle deceleration.

Which factors cause the air-charging of the airbag?

In the sufficiently severe collision, the sense system of the airbag detects that collision happens to the vehicle. The sensor system of the frontal airbag contacts the gas generator and then releases the gas so as to charge air for the airbag. The gas generator, the airbag and the related device are the constituents of the airbag module. The frontal airbag module locates on the inner of the steering wheel and the instrument.

How does the airbag carry out the protection function?

In the moderate and severe head-on collision or that nearly close to head-on collision, the passengers also may collide with the steering wheel and the console even though they wear the safety belt. In the moderate and severe side collision, the passengers also may collide with the inner of the vehicle. The airbag carry out the supplement function for the protection of the safety belt. The airbag scatters the impulse force on the upper part of the passenger's body more equally so as to have the passenger's body stops moving gradually. But the frontal airbag does not function in many kinds of the collisions, including the car turnover, rear collision and many

side collisions, whose main reason is that the direction of the passenger's body does not align that of the frontal airbag. Side collision airbag does not function in many kinds of the collisions, including the head-on collision or that nearly close to head-on collision, car turnover, rear collisions, whose main reason is that the direction of the passenger's body does not align that of the frontal airbag. The airbag is the supplement for the safety belt in any time, and the driver and right front passenger airbags can carry out the supplement function only in the moderate and severe head-on collision or that nearly close to head-on collision.

What phenomenon will appear after charging air for the airbag?

The airbag after charged with air will release air quickly, whose speed is so fast that many people may not realize the airbag once was charged with air. Some parts and components of the airbag module will be very hot in a short time. These components include the steering wheel with the frontal airbag and the console with the right front passenger frontal airbag. Some parts and components of the airbag contacting your body may be in the warm state, but people will not feel very hot when touching them. The air vent of the airbag after releasing will spread some smog and dust. The air-charging of the airbag will not impede the driver's visual field, or

will impede the driver's visual field, or will impede the driver operating the vehicle steering, will not impede the passenger leaving the vehicle.

Notes

When charging air for the airbag, there will be dust spread in the air. For the people with asthmatic history or other respiratory system problems, the dust can cause respiratory system problems. In order to avoid it, all the people in the vehicle should get off the vehicle as soon as possible. If you are with respiratory system problems and can not get off the vehicle after the air - charging of the airbag, you can open the window or the door to breathe in the fresh air. If respiratory problems appear after the air - charging of the airbag, you should see the doctor.

In many severe accidents causing the airbag to be charged with the air, the front wind shield will break down because of the distortion of the vehicle. The air - charging of the right front passenger airbag will accelerate the fracture of the front wind shield.

※ The airbag can be charged with air only once, after charging air, some parts and components of the airbag system need replacing. If you do not replace these parts and components, the airbag system can not provide protection when collision accident happens next time. The parts and components of the airbag system which need replacing include the airbag module, and may include other parts and components. The vehicle maintenance manual introduces how

to properly replace other parts and components.

Your vehicle is equipped with the collision sensor and diagnosis module, this module will record some information after the collision.

The airbag system can be handled only by the qualified maintenance personnel. Improper maintenance and service will cause that the airbag system can not work normally. Please go to Special After-sale Service Center of Jianghuai Automobile Co., Ltd. for the maintenance and service.

Notes

If you break down the airbag cover of the driver or the right front passenger, or the airbag cover on the seat backrest of the driver or the right front passenger, the airbag can not work normally. You must change the airbag module on the steering wheel, the airbag module of the right front passenger and the console. Do not open or break down the airbag cover.

Vehicle equipped with maintenance and service airbag

The airbag will influence the maintenance and service mode of the vehicle. There are parts and components of the airbag system at several positions on your vehicle. Special After-sale Service Center of Jianghuai Automobile Co., Ltd. provides the related information of the maintenance and service for the vehicle and the airbag system.

Notes

Within 10 seconds after closing the ignition switch and disconnecting the storage battery, the airbag may be charged with the air in the wrong process of the maintenance and service. When charging air for the airbag, if you are too close to it, you may get injured seriously. You should keep away from those yellow connectors, because they may possibly belong to the airbag system. Please conform to the correct maintenance procedure and confirm that the maintenance personnel are competent for the maintenance work.

The airbag does not need regular maintenance.

Check of the protection system

Check the protection system

Irregularly check whether the cue light of the safety belt and all the safety belts, lock catch, lock plate, retractor and built-in fitment work normally. Check whether there are other loose and damaged parts and components in the safety belt system. If any parts and components that may influence the normal work of the safety belt are found, they should be repaired.

If the safety belt is old or worn-out, it can not provide protection in the collision accident. The safety belt will crack owing to the action of the impulse force. If the safety belt is old or worn-out, it must be replaced immediately.

At the same time, check whether the airbag cover is opened or cracked, and conduct the corresponding repair or replace. (The airbag system does not need regular maintenance.)

Change the parts and components of the protection system after collisions

Notes

※ Collision accidents may damage the protection system in the vehicle. After the protection system is damaged, it can not protect the user, which will cause severe casualty in the accident. In order to make sure whether the protection system after accident can work normally, please check or replace it as soon as possible.

※ After slight collision, it is unnecessary to change anything. But if the safety belt has been stretched in a comparatively severe collision accident, the parts and components need to be replaced.

※ Collision accidents may damage the protection system in the vehicle. After the protection system is damaged, it can not protect the user, which will cause severe casualty in the accident. In order to make sure whether the protection system after accident can work normally, please check or replace it as soon as possible.

※ After slight collision, it is unnecessary to change anything. But if the safety belt has been stretched in a comparatively severe collision accident, the parts and components need to be replaced.

Drive cautiously

The best advice for the drivers is: Drive cautiously.

Please begin from the important safety device in the vehicle: Fasten the safety belt.

The true meaning of the cautious drive is "ready to handle each kind of conditions at any time". On the urban street, the rural path or the highway, the cautious drive means "ready to handle accidental condition all the time".

It should be assumed that the passerby or the other drivers will have negligence and make mistakes. Predict what will they prepare to do for their mistakes?

Bumping into the rear is easiest preventive accident. However, such kind of accidents frequently happens. Keep enough distance between the vehicles,

which is the best measure for the cautious drive when driving in the city or the village, for you can not predict when the front vehicles brake or turn the direction.

Cautious drive requires the drivers to focus on their attention when driving. Any thing that distract their attention, such as, talking with the mobile phone, reading, catching things from the floor, etc. will impede the normal cautious drive and may cause collision and injury. When such kind of things happens, the drivers can require the passengers to assist or handle it after safely stopping the vehicle at the roadside. These simple skills of cautious drive can save your life.

Drunk driving

Drunk driving has become the chief reason causing the death accidents on roads, the alcohol influences the driver from the following four aspects:

- ※ Judgment
- ※ Harmony of the muscle
- ※ Eyesight
- ※ Attention

The police record displays, nearly half of all the death accidents related with the automotive are concerned with the alcohol. On most conditions, the reason causing the death accidents is the drunk drivers drive the vehicles. It is estimated that, nearly half of the adults never drink alcohol, so they never drive the vehicles after drinking alcohol.



The medical research shows, the alcohol in people's body will worsen the injury in the traffic accidents, especially cause the injury to the brain, vertebra or the heart. This means, for the people who drink alcohol, including the drivers or the passengers, the probability of death or lifetime deformity in the accidents is much higher than those who do not drink alcohol.

Notes

Drunk driving is very dangerous, even though a little alcohol will influence your response, observation, attention and judgment. Drunk driving may cause severe even fatal traffic accidents, so please do not drive the vehicle after drinking alcohol and ride the vehicle driven by the driver drinking the alcoholic. Go home by riding the taxi; or appoint a driver who does not drink alcoholic when joining the group activity. Drunk driving is forbidden, the consequence of the drunk driving is born by the driver themselves.

Vehicle control

There are three systems enable the vehicle to run to the destination. They are brake system, steering system and acceleration system. At the position where the tyre contacts the road, the three systems must implement function. Sometimes, when driving on the snow land or ice surface, the requirements for these control systems exceed the scope of the force between the tyre and the road, which means the vehicle may be out of control.

Brake

The brake operation includes the sense time and the response time. First, the sense time decides whether to step the brake pedal, while the response time means to raise the foot and step on the pedal.

The response time is about 3/4 second on average, but it is an average time. One driver's response time may be very short, while the other one's response time may last 2-3 seconds. Thus, the age, the people's state, alertness, harmony and eyesight will influence the response time. The alcohol, medicine and the depressive mood also will produce influence. Even though the response time is 3/4 second, and the speed of the vehicle is 100km/h, the vehicle will continuously run 20meters. Under the emergent circumstance, the distance is too long, thus, it is important to keep enough distance from the other vehicles. Of course, the practical brake distance is different when the road (highway or sandy soil road), the road state (damp, dry, freezing), the tyre surface, the

brake state, the vehicle weight and the brake force are different. In order to avoid stepping the brake pedal when unnecessary, some drivers drives the vehicles too fast, e.g. they step the brake suddenly after stepping the throttle suddenly instead of keeping pace with the vehicle stream, it is a wrong method. The brake can not be cooled between the continuously emergent brake, the brake abrasion will be accelerated if you frequently stepping the brake suddenly. Keeping pace with the vehicle stream and keeping a certain distance from the other vehicles will reduce unnecessary brake, which can improve the brake effect and extend the service life of the brake.

Steering on the emergent condition



Sometimes steering is more effective than the brake, e.g. if you find a truck stopping in your lane when climbing over a ramp, or another vehicle is driving in, or a child came out from the stopped vehicle and stops in front of your vehicle, you can adopt the brake to avoid these barriers on the premise that you can stop the vehicle in time. But

sometimes you can not do this because there is no enough space. Then you need to take measures to avoid the barriers.

On this emergent condition, your vehicle will show its excellent performance. First, step down the brake pedal. See " Brake" in this section.

You'd better slow the speed if it is likely to appear collision. And then cross over the barrier by turning left or right according to the existing space.

On this emergent condition, you need to focus on your attention and you must be resolute. If you grasp the position of 9 o'clock and 3 o'clock in the steering wheel according to the proposed mode, you can turn the steering wheel for 180 degrees but do not need to move a

hand. Your action must be very fast, the steering must be prompt, and the wheel must be aligned as soon as possible after the barrier is avoided.

In fact, you should drive cautiously and fasten the safety belt well because this emergent condition may appear at any time.

Alignment after the offset track

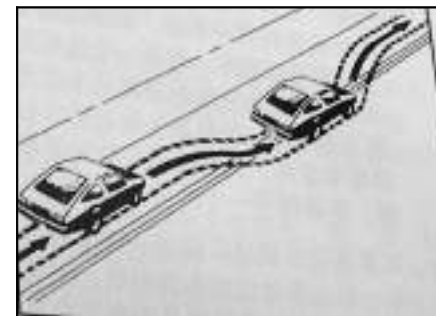

You may find the right wheel slides down to the shoulder of road from the road side.

If the shoulder height is slightly lower than the road, the wheel is easy to be aligned. Loose the accelerating pedal, and drive the vehicle cross the road verge by steering on the condition that there is no barrier. Turn the steering

wheel for 1/4 circle at most until the right front wheel contacts the road verge. And then drive the vehicle in line by turning the steering wheel.

Overtaking of the vehicle

If the drivers want to overtake other vehicles on the double-lane road, they only need to wait for the chance, and accelerate the speed and overtake the front vehicles, and then return to the right lane. There is potential danger when overtaking other vehicles on the double-lane road, for the overtaking vehicles will occupy the same lane as the head-on vehicles in several seconds. Incorrect estimation, the missed judgment, the instant depression or anger may have the overtaking driver

encounter the severest traffic accidents, which means the head-on collision.

There are a few hints about overtaking of the vehicle.

※ Linear drive. Observe the conditions of the front, the two sides and the crossroad of the road. These conditions may influence the overtaking mode. If the drivers can not make sure whether they can succeed in overtaking the other vehicles, they should wait for the better chance.

※ Pay attention to the traffic mark, road mark and the lane line. If there is steering mark or crossroad mark, the driver should delay the overtaking. The center dashed mark usually indicates that the driver can overtake the other vehicles, on the premise that there is no

barrier on the front road. Do not cross over the real line or the double real line at the two sides of your vehicle, even though there is no vehicle close to your vehicle on the road.

※ When waiting for the overtaking chance, the distance from the vehicle which intends to overtake your vehicle can not be too short. First, excessive short distance will narrow the scope of the visual field, especially when following the large vehicles. If the front vehicles decelerate their speed suddenly or stop, you will have no enough distance to brake. Please keep proper distance from the other vehicles.

※ If overtaking chance appears, you can accelerate the speed, but you still need to stay at the right lane and do not

get close to the front vehicle. Estimate the drive time so as to turn to another lane in a proper chance. When there is no barrier for overtaking, it is a good beginning which can make up for the lagging distance at the time you return to the original lane. If the situations which may have you change your overtaking plan, you just need to slow down the speed and return to the original lane to wait for the next chance.

※ If other vehicles queue to overtake a vehicle at a slow speed, you need to wait for your chance. But you should notice whether there is any other vehicle trying to overtake your vehicle when you overtake the slow vehicle, and remember to scan backward and check the blind spot.

Before implementing overtaking at the right lane, you should examine the back mirror, scan backward and start the signal of changing lane towards the left. When you have overtaken the other vehicle far enough and can see the front of the other vehicle from the back mirror in the vehicle, start the signal of changing lane towards the right and return to the right lane. Remember the back mirror at the right side out of the vehicle is the convex mirror, thus, the distance from the vehicle that you have taken over appears farer than the practical distance.

※ You should try to overtake a vehicle once on the double-lane road, and you should be cautious before continuously overtaking the next vehicle.

※ Do not overtake the slow vehicle excessively fast, even though the stop lamp is not flashed, the driver may intend to slow down or steer the direction.

※ If someone wants to overtake your vehicle, please provide convenience for the driver. You'd better turn right slightly.

Out of control

Sideslip

The vehicle may be out of control when sideslip happens. The cautious drivers may take proper measures according to the existing drive condition and avoid over speed driving according to the driving condition, which can avoid most sideslip phenomena. But the sideslip may happen at any time.

There are three sideslip mode which match with the three control systems of the vehicle. The wheel will not rotate when brake sideslip happens. The cause of steering or turning sideslip is that excessively fast speed or excessive steering at the curved lane leads to the tyre slip and the extinction of the steering force. The cause of accelerating

sideslip is that the excessive opening of the air throttle leads to the slip of the drive wheel.

The best way to handle the steering sideslip is to loose the accelerating pedal.

Please remember: Any traction force control system can only help to avoid the accelerating sideslip. If the traction force control system is opened, the best way to handle the accelerating sideslip is to loose the accelerating pedal.

If the vehicle begins to slip, loose the accelerating pedal and implement steering fast towards the required direction. If the speed of the steering is fast enough, the vehicle can recover its linear drive and be ready to handle the next sideslip.

Of course, if there is accumulated water, snow, ice, sandstone or other sundries, the traction force will be very small. For the sake of the safety, you can slow down the speed and adjust the drive mode according to these road conditions. The brake distance will be extended and the vehicle control will be more restricted when driving on the wet-skidding road, thus, it is important to slow down the speed.

When driving on the road with small traction force, the driver should avoid the sudden steering, acceleration or brake, including implement the engine brake by reducing the gear. Any sudden change may cause the tyre slip. You may realize the wet-skidding road after the vehicle slips. Learn to identify

the alarm warning sign, such as, water, ice or accumulates snow on the road may make the road smooth like a mirror. If there is any doubt, you need to slow down the speed.

Please remember: Any anti-skid braking system (ABS) can only help to avoid the brake sideslip.

Drive at night



Drive at night is more dangerous than that at daytime. One of the reasons is some drivers may be obsessed by the fatigue and the problems like alcohol, medicine and the visual field at night.

The following are some small hints about drive at night:

- ※ Drive cautiously.
- ※ Do not drive after drinking alcohol.
- ※ Adjust the back mirror in the vehicle in order to reduce the glare of the headlight on the back vehicle.
- ※ Owing to the low visibility, the driver needs to slow down the speed and keep farer distance from the other vehicles.
- ※ Drive by slowing down the speed, especially on the highway lane, the headlamp can only illuminate limited road in the front.
- ※ Take care of the animals when driving in the remote region.
- ※ If the drivers feel tired, they can rest by stopping the vehicle on the roadside.

The eyesight of anyone at night is worse than that at daytime. As we grow up, the difference is more evident. If a 50-year-old driver wants to see a target at night clearly, he will need twice lights as that required by a 20-year-old young person. The daytime activities will influence the eyesight at night. E.g. if you stay under the strong light for a long time, you'd better wear the sunglass, so it is easy to adapt your eyes to the light at night. But it is unnecessary to wear the sunglasses when driving at night, though they can reduce the glare of the headlamp, you can not see many objects clearly. You may be temporarily blind when getting close to the headlamp and it will take you 1-2 or several seconds to adapt your eyes to the black environ-

ment. When you see the strong glare, such as, the other driver does not turn the high light of the headlamp to the dim light, or the light from the headlamp of the other vehicle is not aligned, you should slow down the speed slightly and avoid seeing the headlamp of the head-on vehicle directly. Keep the windshield and the internal and external surface of all the glass clean. The smudge on the glass will worsen the glare at night. Even though there may be accumulated dust on the internal surface. The glare from the dirt glass is stronger than that from the clean glass, which may lead to repeated shrinkage to your pupil. Please remember: When the turning is conducted or the vehicle drives on the

curved lane, the irradiation distance of the headlamp is shorter than that when the vehicle drives linearly. Turning your eyes constantly can help you to identify the dim objects. Just as the headlamp needs to check the light -alignment condition periodically, your eyes also need to be checked periodically. Some drivers suffer the nyctalopia, which means that they can not see objects clearly under the dim light, even they themselves do not realize it.

Drive on the wet -skidding road in rainy days



The wet-skidding road at rainy days will cause difficulty. Because the traction force of the tyre on the wet -skidding road at rainy days is smaller than that on the dry road, the brake, acceleration or steering performance are relatively bad. Moreover, if there are fewer veins left on the tyre surface, the traction force of the tyre is much smaller. If it begins

to rain when you are driving, you'd better slow down the speed and be very careful. Your reaction is still kept at the state of driving on the dry road, though the road may become wet-skidding. The bigger the rain becomes, the lower the visibility will be. Even though the wiper blade of the front windshield is in good working state, it is still difficult to see the road sign, the traffic signal, the road mark, the lane verge and even the passerby when the heavy rain appears.

Be sure that the wiper blade of the front windshield is in good working state, and the washing solution tank of the front windshield is filled with the washing solution. If the towage phenomenon appears when washing the wiper blade or if there is missed wiper area left on the front windshield, or if the rubber strip separates from the wiper blade, the wiper blade must be replaced. Driving cross the big water hole or the car -washing device fast also may cause fault. The water may influence the brake performance. The drivers should try their best to avoid driving cross the water hole. If the water hole can not be avoided, they should try their best to cross it slowly.

Notes

The damp brake may cause accidents. When the emergent brake is needed, the poor performance of the damp brake may cause the vehicle to deflect towards one side, and the vehicle may be out of control. After driving cross the big water hole or the car -washing device, step on the brake pedal until the brake turns to normal.

Hydroplaning

The hydroplaning is very dangerous. The excessively accumulated water under the tyre will cause the tyre float on the water film. This condition will happen when the road is wet -skidding and the speed is too fast. When the hydroplaning happens to the vehicle, the contact between the tyre and the road is very few or there is absolutely no contact between them. The hydroplaning does not happen frequently. If the tyre surface is abraded to be flat or if one or several tyres are short of air pressure, the hydroplaning will happen. Excessively accumulated water on the road also may cause the hydroplaning phenomenon. If you can see the reflections of the trees, the wire

poles or other vehicles and if there is water bloom appears when the rain drops on the water surface, the hydroplaning may also happen. The hydroplaning generally happens when driving in high speed. For hydroplaning, there is no strictly and unchangeable driving rule. The best suggestion is that slow down you speed when driving in rainy days.

Drive across the deep-water area

| Notes |
|---|
| Drive across the deep -water hole or the accumulated water area, the water may enter the engine through the air inlet of the engine and then the engine may be damaged seriously. Do not drive across the deep -water area whose level is slightly lower than that of the vehicle bottom. If the deep -water hole or the accumulated water area can not be avoided, the drivers must drive their vehicles slowly. |

Drive across the running water

| Notes |
|---|
| The running water or the torrent will generate strong impulse force. When the water level is relatively low, you may try to cross the running water, but the vehicle may be rushed away. The small vehicles can be rushed away by the running water of 6 -inch. When this condition occurs, the people in the vehicle will suffer the drowning accidents. Do not neglect the warning mark set by the police, the drivers must be very cautious when you have to drive across the running water. |

Other hints about the drive in rainy days

- ※ Slow down the speed and extend the distance between the vehicles. You should be very carefully, especially when you want to overtake the other vehicle. Maintain more space in front of the road and be well prepared for the limited visual field caused by the splash of the rainwater.
- ※ The tyre in good quality with mild depth of the tyre surface veins should be used. Refer to "Tyre" in section V .

Drive in the urban area



One of the biggest problems when driving in the urban area is the vehicle slow on the urban street. You must pay close attention to the action of the other drivers and the traffic signal light. The methods to improve the safety of the drive in the urban area are as follows:

- ※ Know the best route to the destination. Just like the multinational travel,

you need to find an urban map and make a plan about the traveling route to the strange place of the urban area.

- ※ Try your best to use the transfixion highway at the verge of most big cities. In such a case, you can save the time and energy. Refer to "Drive on the highway" in this section.
- ※ Regard the green light as the warning signal light. Traffic signal light is set for the busyness of the traffic at the road junction. After the signal light turns to green, please first examine whether there are the vehicles which do not cross the crossing or the vehicles which cross the road when the red light is on, and then start to run.

Drive on the highway



Highway is the safest in all kinds of roads. But there is special driving rule on highway.

The most important advice for driving on the highway is: keep up with the vehicle stream and drive on the right. The speed must be complied with that of the most other drivers when driving. Excessively fast drive or excessively slow drive will stop the smooth vehicle stream. The left

lane on the highway should be regarded as the overtaking lane.

At the entrance of the highway, there is always guiding ring road. If you can see clearly the highway when driving along the entrance of the ring road, you should examine the vehicle stream and make sure where to enter into the vehicle stream. When the speed reaches the speed of vehicle stream, you can enter the gap of vehicle stream. Turn on the steering signal light, and examine the back mirror, if necessary, you can scan backwards. Try your best to enter the vehicle stream smoothly.

After driving into the highway, adjust the speed according to limit speed or the speed of the vehicle stream (when the speed of vehicle stream is relatively

slow). You can drive on the right lane unless you want to overtake the other vehicle.

Examine the back mirror before changing the lane. Then use the steering signal light.

Before leaving the lane, scan backwards fast to ensure there is no other vehicle in the blind area of your line of sight.

When driving on the highway, you must keep moderate distance from other vehicle.

Slow down the speed slightly when driving at night.

When leaving the highway, please drive into the correct lane ahead. If missing at the exit, prohibit parking and reversing in any case, and continuously drive to

the next exit.

The ring road of the exit may be the curved lane, and sometimes the curvature is very big. Generally, the road sign shows the value of the limit speed. Slow down the speed according to the speedometer other than your own feeling. Because after driving for a distance at high speed, the speed you feel will be lower than the actual speed.

Before running for a long distance

Be sure that you have made interrelated preparation. Try to have a good rest. If you have to start when you are in low mood (after a day's work), do not run too much distance in the first stage of your journey. The dress shall be comfortable and the shoes shall be easy to wear and take off.

Has the vehicle been prepared for the long journey? If you keep maintaining and curing the vehicle, then you can start. If the vehicle needs to be repaired, finish repairing before starting out. Of course, you can find the experienced and skilled maintaining experts in Special After-sale Service Center of Jianghuai Automobile Co., Ltd. They are ready to provide service anytime when

you need help.

Check the following components before the journey:

- ※ Front windscreen washing solution: Is the washing solution tank full? Have all the inner and outer side of the vehicle window been cleaned up?
- ※ Wipe blade: Whether it is in good condition?
- ※ Fuel, engine oil and other oil fluid: Have you checked all the fluid level?
- ※ Vehicle lamp: Whether can they work normally? Is the glass lens of vehicle lamp clean?
- ※ Tyre: Tyres are very important to the journey. Is the tyre surface vein suitable to run for a long distance? Have all the tyres been charged to the recommended pressure value?

- ※ Weather report: What's about the weather report during the journey? Is it required to delay the journey a little to avoid the storm or hurricane?
- ※ Map: Is there any latest map?

Highway hypnosis

This is just a phenomenon of sleeping when driving, and we call it highway hypnosis, comatose for the moment.

On a flat, extending road, you can only see the same black color and hear the humdrum sound of tyre and engine or the wind blowing the vehicle, and this makes you want to sleep. Remember not to let such thing happen to you. If it really happens to you, the vehicle may leave the road immediately, and collision may happen to cause damage to you.

How to deal with highway hypnosis? First of all, pay attention to this situation may happen:

The following are some interrelated hints:

- ※ Ensure the ventilation of the vehicle is good; it is cool and comfortable inside the vehicle.
- ※ Do not gaze at one place. Look forwards and two side of the vehicle. Check the back mirror and console.
- ※ If you feel tired, park at the road side, fixing area or parking area, have a snap or do some exercise or both. For safety, treat the sleep in running as an emergency.

Ramp and mountainous road



If you always drive on the rugged mountainous road or you planed to go there, the following suggestions can make your journey safer and more comfortable.

- ※ Keep good vehicle condition. Check all the fluid level and the brake, tyre, cooling system and gearbox. For these systems have great load when

running on the mountainous road.

- ※ Master the down -slope skill. The most important thing is: reducing the speed with the engine braking effect. Reduce gear when in steep slope or long slope.

| Notes |
|---|
| If you don't slow down when in falling gradient, the brake will not work normally for overheated. And this will reduce the braking effect when in falling gradient or it is hardly to brake. So it may cause accident. When in falling gradient, use engine to brake through reducing gear. |
| Notes |
| Idle sliding or extinguishing when in gradient falling is very dangerous. Because this time the reducing speed of the vehicle completely depends on the brake. The brake will not work normally for overheated. So it may cause accident. Therefore, keep the engine running when in gradient falling and the vehicle can not be in neutral position. |

※ Master the up-slope skill. Try to engage the highest gear.

※ When running on the slope or mountainous road with double lane, keep yourself in your own lane. Do not swing on the road or cross the road middle line. The speed shall be mild to keep you running in your own lane.

※ Pay special attention when crossing the slope top. There may be barrier in you lane, such as the flameout vehicle or traffic accident.

※ You may see special warning mark, such as long slope, overtaking area or non-overtaking area, rock falling area or curved way. Pay attention to these signals and take proper measure.

Driving in winter



Some notes about driving in winter as follows:

※ Keep the vehicle in good condition for getting used to the driving in winter.

※ Put some emergency things of driving in winter in the boot.



These emergency things include a screen wiper, a small brush, washing solution for front windscreen, dishcloth, some outside winter clothes, a small shovel, a flashlight, a piece of red cloth and two reflecting tripod for warning. Moreover, if the running condition is extremely bad, a small bag of sand, a piece of old carpet or two raw gunny bags should be pre-

pared for supplying hauling capacity when the vehicle suffers skidding. To make sure the things as mentioned above have been fixed in the vehicle.

Traveling on Icy and Snowy Road

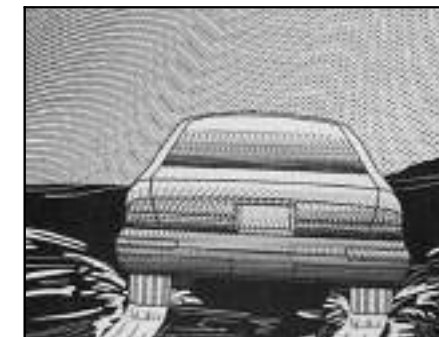

In most instances, there is enough hauling capacity between tyre and road surface. However, if there is ice and snow between tyre and road surface, the vehicle will skid. The hauling capacity or ground-grip capacity will decrease sharply; you should be very carefully at this time.

What is the worst situation? It is the wet and slippery ice surface. The very cold ice and snow is very slippery and it will bring troubles to driving. But the driving on the wet and slippery ice surface is more difficult and its hauling capacity on this kind of road surface is the least. When the temperature is close to freezing point, namely, 0°C and it begins ice raining, the wet and slippery ice surface will be formed. Before the cleaner using salt and sand to clean the ice and snow, driving on the wet and slippery ice surface is needed to avoid. No matter on the smooth ice surface, in snow, in flurry, or on the loose snow surface, driving should be very carefully.

At the time of emergency braking on the wet and slippery road, (ABS) can increase the stability of the vehicles. Compared with driving on the dry road, pre-act braking when driving on the wet and slippery road, even though the anti-skid braking system is equipped.

※ Driving on the wet and slippery road, larger vehicle space should be kept.

※ Pay attention to the wet and slippery position. Before you meet the wet and slippery position which is freezing, the road situation may always be good. Although the road looks very clean, there may be residual ice in the boscage, at the back of construction or under the bridge which are the un-sunned shelters. Sometimes, after the

surrounding roads being cleaned, curved road or overhead road are still possible to be freezing. If you have not-ed that there is ice surface ahead, please brake before running on the ice surface. But if you have driven on the ice surface, please do not brake and do not turn abruptly.

If the drivers suffer the snowstorm



If you are forced to stop their vehicles because of the heavy snow, you may be trapped into the trouble. In such a case, you'd better stay in the vehicle, except when you are very sure that you can get help from the adjacent area or you can cross by foot. The followings are some measures used for seeking help and as-suring the safety of yourself and the passengers:

- ※ Open the flash light for hazard wa-rning.
- ※ Fasten a piece of red cloth in order to give the police hint that you are trapped by the heavy snow.
- ※ Enclose the redundant clothes or blanket on the body. If the blanket or the redundant clothes can not be found, you can make use of the newspaper, coarse gunny bag, dishcloth, floor pad or anything that can be enclosed on the body or filled in the cloth to keep warm. You can also start the engine to keep warm, but you must be very careful.

Notes

Snow mantle may prevent the ejection exhaust gas from the vehicle bottom, which will let the deadly carbon monoxide enter the vehicle, and the carbon monoxide will make you loss conscious and kill you. The carbon monoxide is tasteless and colorless, so it can enter the vehicle without your awareness. Clear up the snow mantle around or at the bottom of the vehicle, especially those which will block the e-jection pipeline. Then check around the vehicle from time to time to confirm there is no more snow mantle. Open the leeward side window of the vehicle, which can help to ejecting carbon monoxide.

Run the engine when necessary, this can save fuel. When the engine is running, the running speed shall be a little higher than the idle speed. That's to say to step the accelerating pedal lightly. And this can save fuel and keep the electricity in the storage battery under warmness condi-tion. You must keep enough electricity in the storage battery so as to use head-lamp to send signal when the vehicle restart. Make the heater run for a moment. Then shut off the engine and completely close the window to keep the heat. Only when you feel it is really cold, you can restart the engine and repeat this oper-ation. But try not to do so. And try to save fuel. In order to keep warm, get off the vehicle and do proper exercises ev-ery half an hour till the rescuers come.

Jianghuai Automobile Co., Ltd. reserves the right to modify the Jianghuai "Only for You" Owner's Manual without further notice. Please forgive us.

Jianghuai Automobile Co., Ltd.